

YAGIELA • DOWD • JOHNSON • MARIOTTI • NEIDLE

PHARMACOLOGY
AND THERAPEUTICS FOR
DENTISTRY



SIXTH EDITION

MOSBY
ELSEVIER

PHARMACOLOGY
AND THERAPEUTICS^{FOR}
DENTISTRY

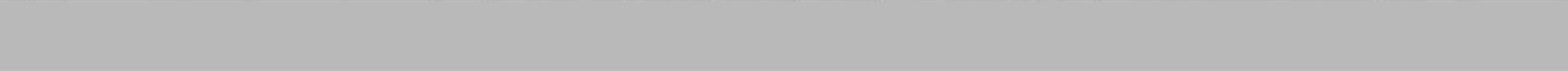
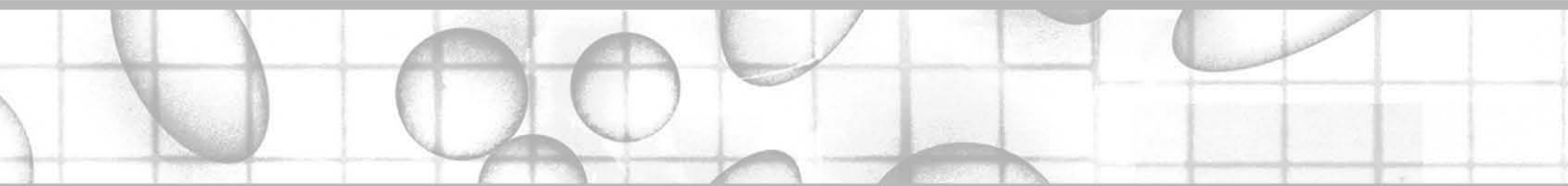

This page intentionally left blank

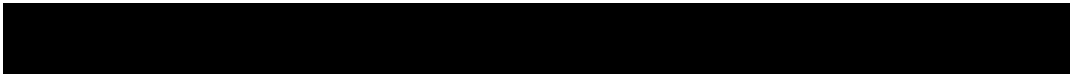

PHARMACOLOGY AND THERAPEUTICS FOR DENTISTRY

SIXTH EDITION

JOHN A. YAGIELA, DDS, PhD

Professor and Chair, Division of Diagnostic and Surgical Sciences
School of Dentistry
Professor of Anesthesiology, School of Medicine
University of California, Los Angeles
Los Angeles, California

FRANK J. DOWD, DDS, PhD

Professor, Department of Pharmacology
Professor, Department of Oral Biology
School of Dentistry
Creighton University School of Medicine
Omaha, Nebraska

BARTON S. JOHNSON, DDS, MS

Director, General Practice Residency Program
Swedish Medical Center
Private Practice
Seattle Special Care Dentistry
Seattle, Washington

ANGELO J. MARIOTTI, DDS, PhD

Professor and Chair, Department of Periodontology
College of Dentistry
Ohio State University
Columbus, Ohio

ENID A. NEIDLE, PhD

Professor Emeritus, Pharmacology, New York University
New York, New York
Former Assistant Executive Director, Scientific Affairs
American Dental Association
Chicago, Illinois

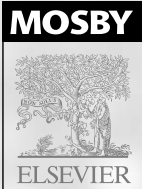

© 2011, 2004, 1998, 1989, 1985, 1980 by Mosby, Inc., an affiliate of Elsevier Inc. All rights reserved.

No part of this publication may be reproduced or transmitted in any form or by any means, electronic or mechanical, including photocopying, recording, or any information storage and retrieval system, without permission in writing from the publisher. Details on how to seek permission, further information about the Publisher's permissions policies and our arrangements with organizations such as the Copyright Clearance Center and the Copyright Licensing Agency, can be found at our website: www.elsevier.com/permissions.

This book and the individual contributions contained in it are protected under copyright by the Publisher (other than as may be noted herein).

Notices

Knowledge and best practice in this field are constantly changing. As new research and experience broaden our understanding, changes in research methods, professional practices, or medical treatment may become necessary.

Practitioners and researchers must always rely on their own experience and knowledge in evaluating and using any information, methods, compounds, or experiments described herein. In using such information or methods they should be mindful of their own safety and the safety of others, including parties for whom they have a professional responsibility.

With respect to any drug or pharmaceutical products identified, readers are advised to check the most current information provided (i) on procedures featured or (ii) by the manufacturer of each product to be administered, to verify the recommended dose or formula, the method and duration of administration, and contraindications. It is the responsibility of practitioners, relying on their own experience and knowledge of their patients, to make diagnoses, to determine dosages and the best treatment for each individual patient, and to take all appropriate safety precautions.

To the fullest extent of the law, neither the Publisher nor the authors, contributors, or editors, assume any liability for any injury and/or damage to persons or property as a matter of products liability, negligence or otherwise, or from any use or operation of any methods, products, instructions, or ideas contained in the material herein.

Library of Congress Cataloging-in-Publication Data

Pharmacology and therapeutics for dentistry / [edited by] John A. Yagiela ... [et al.]. —6th ed.

p. ; cm.

Includes bibliographical references and index.

ISBN 978-0-323-05593-2 (hardcover : alk. paper) 1. Pharmacology. 2. Therapeutics.

3. Dentistry. I. Yagiela, John A.

[DNLM: 1. Dentistry. 2. Pharmacological Phenomena. QV 50 P5355 2011]

RM300.N44 2011

615'.19—dc22

2009038445

Acquisitions Editor: John Dolan

Developmental Editor: Joslyn Dumas

Publishing Services Manager: Patricia Tannian

Project Manager: Claire Kramer

Designer: Teresa McBryan

Printed in the United States

Last digit is the print number: 9 8 7 6 5 4 3 2 1

Working together to grow
libraries in developing countries

www.elsevier.com | www.bookaid.org | www.sabre.org

ELSEVIER

BOOK AID
International

Sabre Foundation

Contributors

Peter W. Abel, PhD

Professor, Department of Pharmacology
School of Medicine
Creighton University
Omaha, Nebraska

Jeffrey D. Bennett, DMD

Professor and Chair
Department of Oral Surgery and Hospital
Dentistry
School of Dentistry
Indiana University
Indianapolis, Indianapolis

Mark Blumenthal, BA

Founder and Executive Director, American
Botanical Council
Austin, Texas

Charles S. Bockman, PhD

Assistant Professor, Department of
Pharmacology
School of Medicine
Creighton University
Omaha, Nebraska

Michael T. Brennan, DDS, MHS

Associate Chairman, Department of
Oral Medicine
Carolina Medical Center
Charlotte, North Carolina

Richard P. Cohan, DDS, MS, MBA

Associate Professor
Diagnostic and Emergency Services
School of Dentistry
University of the Pacific
San Francisco, California

George A. Cook, PhD

Professor, Department of Pharmacology
University of Tennessee, Memphis
Memphis, Tennessee

Stephen A. Cooper

Senior Vice President, Global, Clinical,
and Medical Affairs
Wyeth Consumer Healthcare
Madison, New Jersey

Linsey R. Curtis, PharmD, BCOP

Clinical Pharmacist
University of Washington
Seattle Cancer Care Alliance
Seattle, Washington

Paul J. Desjardins, DMD, PhD

Visiting Professor, Department of Oral Biology
New Jersey Dental School
University of Medicine and Dentistry of
New Jersey
Newark, New Jersey
Senior Vice President
Global, Clinical, and Medical Affairs
Wyeth Consumer Healthcare
Madison, New Jersey

Xi-Qin Ding, PhD

Assistant Professor, Department of
Cell Biology
The University of Oklahoma Health Sciences
Center
Oklahoma City, Oklahoma

Raymond A. Dionne, DDS, PhD

Scientific Director
National Institute of Nursing Research
National Institutes of Health
Bethesda, Maryland

Gail T. Galasko, PhD

Department of Biomedical Sciences
College of Medicine
Florida State University
Tallahassee, Florida

Gerald F. Gebhart, PhD

Director, Center for Pain Research
University of Pittsburgh
Pittsburgh, Pennsylvania

Joseph A. Giovannitti, Jr., DMD

Associate Professor, Department of
Anesthesiology
School of Dental Medicine
University of Pittsburgh
Pittsburgh, Pennsylvania

Denis M. Grant, PhD

Professor and Chair, Department of
Pharmacology and Toxicology
Faculty of Medicine
University of Toronto
Toronto, Ontario, Canada

Karen S. Gregson, PhD

Assistant Professor, Department of
Oral Biology
School of Dentistry
Indiana University
Indianapolis, Indiana

Daniel A. Haas, DDS, PhD, FRCD(c)

Associate Dean, Clinical Sciences
Chapman Chair in Clinical Sciences
Professor and Head of Dental
Anesthesia
Faculty of Dentistry
Department of Pharmacology
Faculty of Medicine
University of Toronto
Toronto, Ontario, Canada

Marc W. Heft, DMD, PhD

Professor and Director
Department of Oral and Maxillofacial
Surgery and Diagnostic Sciences
University of Florida
Gainesville, Florida

David W. Hein, PhD

Chair and Professor, Department of
Pharmacology and Toxicology
School of Medicine
University of Louisville
Louisville, Kentucky

Elliot V. Hersh, DMD, MS, PhD

Professor, Department of Oral Surgery
and Pharmacology
Director, Division of Pharmacology
School of Dental Medicine
University of Pennsylvania
Philadelphia, Pennsylvania

Harrell E. Hurst, MS, PhD

Professor, Department of Pharmacology and Toxicology
School of Medicine
University of Louisville
Louisville, Kentucky

William B. Jeffries, PhD

Senior Associate Dean for Medical Education
College of Medicine
University of Vermont
Burlington, Vermont

Anahid Jewett, PhD, MPH

Professor, Division of Oral Biology and Medicine
School of Dentistry
University of California, Los Angeles
Los Angeles, California

Mo K. Kang, DDS, PhD, MS

Associate Professor and Chair Section of Endodontics
School of Dentistry
University of California, Los Angeles
Los Angeles, California

Hyungsuk Kim, DDS, PhD

Pain and Neurosensory Mechanisms Branch
National Institute of Dental and Craniofacial Research
National Institutes of Health
Bethesda, Maryland

Bruno Kreiner, DMD, MD, MSc

Instructor, Department of Oral and Maxillofacial Surgery
School of Dental Medicine
Hadassah Medical Organization
The Hebrew University
Jerusalem, Israel

Karl K. Kwok, PharmD

Clinical Professor, Department of Pharmacy Practice
School of Pharmacy
University of Washington
Seattle, Washington
Clinical Pharmacist-Oncology
Department of Pharmacy Service
University of Washington Medical Center
Seattle, Washington

Rajesh V. Lalla, BDS, PhD, CCRP

Assistant Professor of Oral Medicine
Department of Oral Health and Diagnostic Sciences
University of Connecticut Health Center
Farmington, Connecticut
Attending Member of Hospital Staff
Department of Dentistry
John Dempsey Hospital
Farmington, Connecticut

Vahn A. Lewis, PharmD, MS, PhD

University of Texas Health Science Center
at Houston Dental Branch
Houston, Texas

Michael D. Martin, DMD, MPH, PhD

Associate Professor of Oral Medicine
School of Dentistry
University of Washington
Seattle, Washington

Robert L. Merrill, DDS, MS

Director, Graduate Orofacial Pain Clinic
Department of Orofacial Pain
Adjunct Professor
Section of Oral Medicine and Orofacial Pain
Department of Dentistry
University of California, Los Angeles
Los Angeles, California

John A. Molinari, PhD

Professor and Chairman, Department of Biomedical Sciences
School of Dentistry
University of Detroit Mercy
Detroit, Michigan

Paul A. Moore, DMD, MPH, PhD

Professor and Chair, Department of Anesthesiology
School of Dental Medicine
University of Pittsburgh
Adjunct Professor, Department of Epidemiology
Graduate School of Public Health
University of Pittsburgh
Pittsburgh, Pennsylvania

Michael H. Ossipov, PhD

Research Professor, Department of Pharmacology
College of Medicine
University of Arizona
Tucson, Arizona

Thomas J. Pallasch, DDS, MS

Emeritus Professor of Dentistry
University of Southern California
Los Angeles, California

No-Hee Park, DMD, PhD

Dean, School of Dentistry
University of California, Los Angeles
Los Angeles, California

Michael T. Piascik, PhD

Professor, Department of Pharmacology
University of Kentucky
College of Medicine
Lexington, Kentucky

Frank Porreca, PhD

Professor, Department of Pharmacology
University of Arizona School of Medicine
Tucson, Arizona

Morton B. Rosenberg, DMD

Professor of Oral and Maxillofacial Surgery
Head, Division of Anesthesia and Pain Control
School of Dental Medicine
Associate Professor of Anesthesia
School of Medicine
Tufts University
Boston, Massachusetts

Mark M. Schubert, DDS, MSD

Professor, Department of Oral Medicine
University of Washington
Director, Department of Oral Medicine
Seattle Cancer Care Alliance and
Fred Hutchinson Cancer Research Center
Seattle, Washington

David H. Shaw, PhD

Professor and Chairman
Department of Oral Biology
College of Dentistry
University of Nebraska Medical Center
Lincoln, Nebraska

Sarat Thikkurissy, DDS, MS

Assistant Professor, Division of Pediatric Dentistry
College of Dentistry
The Ohio State University
Columbus, Ohio

Clarence L. Trummel, DDS, PhD

Emeritus Professor, Department of Periodontology
School of Dental Medicine
University of Connecticut Health Center
Farmington, Connecticut

Yaping Tu, PhD

Associate Professor, Department of Pharmacology
School of Medicine
Creighton University
Omaha, Nebraska

Eileen L. Watson, PhD

Professor Oral Biology and Pharmacology
University of Washington
Seattle, Washington

Dennis W. Wolff, PhD

Resident Assistant Professor
Department of Pharmacology
School of Medicine
Creighton University
Omaha, Nebraska

Preface

HOW TO APPROACH PHARMACOLOGY

Although pharmacology can be considered a basic science, the ultimate purpose of pharmacology in the health science setting is to apply basic principles to clinical practice. This book, which is targeted to the dental student and dental practitioner, is designed to meet that need. Pharmacology is important to the dentist not only because of the drugs that he or she prescribes or uses in the dental office, but also because of other drugs that the patient takes. Every drug can affect the entire body. Moreover, when more than one drug is given concurrently, there is a potential for drug interactions that could have adverse consequences.

This book is designed to make specific dental applications to each drug class. Included in this information are the benefits and risks associated with those drug classes.

In the study of pharmacology it is important to learn drugs by their class on the basis of similarity of mechanism of action, not as individual stand-alone medications. Thus armed with the knowledge of the properties of a class of drugs and examples of drugs within that class, one can streamline the learning process. Organization of drug information can then be arranged around the following subcategories. (These will be useful in studying most drugs.)

1. Name of drug class and examples
2. Mechanism of action
3. Pharmacokinetics
4. Indications
5. Adverse effects
6. Contraindications
7. Miscellaneous information, including drug interactions
8. Implications for dentistry

Some devices can help in the learning of drug names. The nonproprietary (generic) names for drugs within a given class often have similarities. Being familiar with a list of suffixes of generic drug names can be helpful in identifying an individual drug. Such a list is given below.

SUFFIXES AS CUES FOR REMEMBERING DRUG CLASSES

SUFFIX	DRUG CLASS	EXAMPLE
“azole”	Azole-type antifungal drug or Antibacterial-antiparasitic drug	Fluconazole Metronidazole
“caine”	Local anesthetic	Lidocaine
“coxib”	Cyclooxygenase-2 (COX-2) inhibitor	Celecoxib

“dipine”	Dihydropyridine Ca ⁺⁺ channel blocker	Nifedipine
“ilol” or “alol”	β-Adrenergic receptor blocker that also blocks the α ₁ -adrenergic receptor	Carvedilol, labetalol
“mab”	Monoclonal antibody	Infliximab
“olol”	β-Adrenergic receptor blocker	Propranolol
“onium” or “urium”	Quaternary ammonium compound, usually used as a peripheral competitive skeletal muscle relaxer	Pancuronium, atracurium
“osin”	α ₁ -Adrenergic receptor blocker	Prazosin
“pam” or “lam”	Benzodiazepine anti-anxiety agent or sedative hypnotic	Diazepam, triazolam
“pril” or “prilat”	Angiotensin-converting enzyme (ACE) inhibitor	Captopril
“sartan”	Angiotensin II receptor blocker	Losartan
“statin”	HMG CoA reductase inhibitor anti-lipid drug	Lovastatin
“triptan”	Serotonin 5-HT _{1B/1D} agonist antimigraine drug	Sumatriptan
“vir”	Antiviral drug	Acyclovir

Application of information to clinical cases can increase retention and appreciation of pharmacology. For instance, suppose that a dental patient has been prescribed darifenacin by his or her physician to treat urinary urgency. One should know that drugs such as darifenacin are likely to cause xerostomia (dry mouth), and one should know why. Therefore it is reasonable to assume that xerostomia would be a likely complaint that a patient would have after taking such a drug. Moreover, it would also be well to consider how a dentist can help relieve symptoms of xerostomia without compromising the treatment for urinary urgency. This thought process requires knowledge of how these drugs act, including the receptors involved, and what responses are linked to these receptors.

The landscape of pharmacology is ever expanding with the constant development of new drugs, new drug classes, and new information on older drugs. Furthermore, the growth in our knowledge in areas such as pharmacogenetics and pharmacogenomics promises to lead to the practice of tailoring drug therapy to the individual.

All in all, pharmacology is an exciting and dynamic discipline. This book covers the major areas of pharmacology and provides an intellectual framework on which to use drugs in a rational manner.

ACKNOWLEDGMENTS

The competing demands of academia in the modern health science setting make the writing of textbooks such as *Pharmacology and Therapeutics for Dentistry* a challenging task. In this effort, we have been aided greatly by our contributing authors, past and present, who have given their time and expertise to ensure that the information provided herein is both accurate and current. We wish to acknowledge especially Dr. Enid Neidle, who was the lead editor for the first three editions of this book and Dr. Tom Pallasch, who died shortly after completing his revisions for this edition. We also must express gratitude to our families and colleagues for their forbearance in dealing with our distractions and preoccupations pharmacologic.

We wish to thank several individuals who made special contributions to this work. Mr. John Dolan, Acquisitions Editor; Ms. Joslyn Dumas, Developmental Editor; and Ms. Claire Kramer, Project Manager, of Elsevier played crucial roles in the completion of this edition. We wish to acknowledge Pat Dowd, Mare Akers, Jolene Winterfeld, Andrew Waters, Elizabeth Reese, Karen Bishop, Kristen Koseluk, and Leanne Tapper for their help with manuscript preparation.

John A. Yagiela
Frank J. Dowd
Barton S. Johnson
Angelo J. Mariotti
and Enid A. Neidle



Contents

PART I

Principles of Pharmacology

- 1** Pharmacodynamics: Mechanisms of Drug Action, 2

John A. Yagiela

- 2** Pharmacokinetics: The Absorption, Distribution, and Fate of Drugs, 17

John A. Yagiela

- 3** Pharmacotherapeutics: The Clinical Use of Drugs, 48

John A. Yagiela and Frank J. Dowd

- 4** Pharmacogenetics and Pharmacogenomics, 69

David W. Hein and Denis M. Grant

PART II

Pharmacology of Specific Drug Groups

- 5** Introduction to Autonomic Nervous System Drugs, 78

Peter W. Abel and Michael T. Piascik

- 6** Adrenergic Agonists, 91

Yaping Tu, Michael T. Piascik, and Peter W. Abel

- 7** Adrenergic Antagonists, 106

Michael T. Piascik and Peter W. Abel

- 8** Cholinergic Drugs, 117

Frank J. Dowd

- 9** Antimuscarinic Drugs, 129

Frank J. Dowd

- 10** Drugs Affecting Nicotinic Receptors, 136

Xi-Qin Ding

- 11** Introduction to Central Nervous System Drugs, 149

Vahn A. Lewis

- 12** Psychopharmacology: Antipsychotic and Antidepressant Drugs, 162

Vahn A. Lewis

- 13** Sedative-Hypnotics, Antianxiety Drugs, and Centrally Acting Muscle Relaxants, 188

Joseph A. Giovannitti, Jr., and Paul A. Moore

- 14** Anticonvulsants, 212

Vahn A. Lewis

- 15** Anti-Parkinson Drugs, 230

Vahn A. Lewis

- 16** Local Anesthetics, 246

John A. Yagiela

- 17** Principles of General Anesthesia, 266

John A. Yagiela and Daniel A. Haas

- 18** Agents Used in General Anesthesia and Sedation, 281

Daniel A. Haas and John A. Yagiela

- 19** Introduction to Antinociceptive Drugs, 299

Hyungsuk Kim and Raymond A. Dionne

- 20** Opioid Analgesics and Antagonists, 307

Michael H. Ossipov, Gerald F. Gebhart, and Frank Porreca

- 21** Nonopioid Analgesics, Nonsteroidal Anti-inflammatory Drugs, and Antirheumatic and Antigout Drugs, 324

Elliot V. Hersh, Paul J. Desjardins, Clarence L. Trummel, and Stephen A. Cooper

- 22** Histamine and Histamine Antagonists, 359

Clarence L. Trummel

- 23** Drugs for Treating Orofacial Pain Syndromes, 373

Robert L. Merrill

- 24** Antiarrhythmic Drugs, 393

Frank J. Dowd

- 25** Drugs Used in Heart Failure, 410

Frank J. Dowd

- 26** Antianginal Drugs, 422
Eileen L. Watson and Frank J. Dowd
- 27** Diuretic Drugs, 431
William B. Jeffries and Dennis W. Wolff
- 28** Antihypertensive Drugs, 442
Frank J. Dowd and William B. Jeffries
- 29** Lipid-Lowering Drugs, 458
George A. Cook
- 30** Antianemic and Hematopoietic Stimulating Drugs, 469
Barton S. Johnson
- 31** Procoagulant, Anticoagulant, and Thrombolytic Drugs, 487
Barton S. Johnson
- 32** Drugs Acting on the Respiratory System, 511
Karen S. Gregson, Bruno Kreiner, and Jeffrey D. Bennett
- 33** Drugs Acting on the Gastrointestinal Tract, 525
David H. Shaw
- 34** Pituitary, Thyroid, and Parathyroid Pharmacology, 538
Gail T. Galasko
- 35** Adrenal Corticosteroids, 549
Clarence L. Trummel
- 36** Insulin, Oral Hypoglycemics, and Glucagon, 558
Gail T. Galasko
- 37** Steroid Hormones of Reproduction and Sexual Development, 567
Angelo J. Mariotti
- 38** Principles of Antibiotic Therapy, 579
Thomas J. Pallasch
- 39** Antibacterial and Antibiotic Drugs, 600
Thomas J. Pallasch
- 40** Antifungal and Antiviral Agents, 640
No-Hee Park and Mo K. Kang
- 41** Immunotherapy, 660
John A. Yagiela and Anahid Jewett
- 42** Antineoplastic Drugs, 683
Karl K. Kwok, Linsey R. Curtis, and Mark M. Schubert
- 43** Aliphatic Alcohols, 711
Frank J. Dowd
- 44** Anticaries Agents, 720
Sarat Thikkurissy
- 45** Antiplaque and Antigingivitis Agents, 732
Angelo J. Mariotti
- 46** Antiseptics and Disinfectants, 744
John A. Molinari
- PART III**
-
- Special Subjects in Pharmacology and Therapeutics***
- 47** Analgesic Use for Effective Pain Control, 752
Paul J. Desjardins and Elliot V. Hersh
- 48** Management of Fear and Anxiety, 759
Daniel A. Haas
- 49** Antibiotic Prophylaxis, 771
Thomas J. Pallasch
- 50** Oral Complications of Cancer Therapy, 782
Rajesh V. Lalla, Michael T. Brennan, and Mark M. Schubert
- 51** Drugs of Abuse, 799
Charles S. Bockman and Peter W. Abel
- 52** Toxicology, 814
Harrell E. Hurst and Michael D. Martin
- 53** Geriatric Pharmacology, 834
Marc W. Heft and Angelo J. Mariotti
- 54** Drugs for Medical Emergencies, 842
Morton B. Rosenberg
- 55** Prescription Writing and Drug Regulations, 851
Vahn A. Lewis
- 56** Use of Herbs and Herbal Dietary Supplements in Dentistry, 867
Richard P. Cohan and Mark Blumenthal
- APPENDIXES**
-
- 1** Drug Interactions in Clinical Dentistry, 877
- 2** Glossary of Abbreviations, 885

Introduction

Pharmacology may be defined as the science of drugs, their preparation, their uses, and their effects. The term derives from *pharmakon*, the Greek word for drug or medicine, and *logia*, the Latin suffix traditionally used to designate a body of knowledge and its study. As an organized discipline, pharmacology is of recent origin, but the study of medicinal substances is as old as civilization itself.

HISTORY

Sir William Osler once said, "The desire to take medicine is perhaps the greatest feature which distinguishes man from animals." Although this argument has been vitiated by experiments involving self-medication in rats and other laboratory species, it nevertheless serves to illustrate the historical relationship between drugs and human beings. The use of natural products to cure disease and alter mentation dates back to the dawn of time. By the writing of the Ebers papyrus (circa 1550 BC), more than 700 prescriptions for various ailments were known. Many of the ingredients incorporated in these preparations—lizard's blood, virgin's hair, fly excreta—are humorous by modern standards, but also included were many compounds recognized today as pharmacologically active. A summary of folk remedies and other medicinals that have withstood scientific scrutiny would list such substances as opium (morphine), belladonna (atropine), squill and foxglove (*digitalis*), cinchona bark (quinine and quinidine), coca leaves (cocaine), and ma huang (ephedrine). The empirical study of plant derivatives and animal products must have been extensive to have been so fruitful.

A major hindrance to the effective use of these drugs, however, was the large number of materials usually present in apothecary formulations. For example, the most popular drug of the fifteenth century, triaca, contained more than 100 separate components. Aureolus Paracelsus (1493-1541) was the first to recognize that the indiscriminate mixing of numerous substances did little but dilute whatever effective compounds may have been present initially. The focus of Paracelsus on single agents was refined by Felice Fontana (1720-1805), who deduced from his own experiments that each crude drug contains an "active principle" that, when administered, yields a characteristic effect on the body. One of the greatest scientific achievements of the nineteenth century was the isolation and objective evaluation of such active principles.

In 1803, a young German pharmacist, Frederick Sertürner (1780-1841), extracted the alkaloid morphine from opium. This singular achievement not only marked the beginning of pharmaceutical chemistry, but also led to a revolution in experimental biology. The availability of newly purified drugs and the standardization of existing biologic preparations encouraged pioneers like Francois Magendie (1783-1855) and Claude Bernard (1813-1878) to use pharmacologic agents as probes in the study of physiologic processes. The use of curare by Bernard for the elucidation of the neuromuscular junction is but one example of the successes obtained with this

approach. Perhaps because drugs became associated with several biologic sciences and were, of course, considered under the domain of the various medical specialties, the development of pharmacology as a separate discipline was delayed.

Rudolf Buchheim (1820-1879) and Oswald Schmiedeberg (1838-1921) were the two individuals most responsible for establishing pharmacology as a science in its own right. Buchheim organized the first laboratory exclusively devoted to pharmacology and became the first professor of his discipline. A student of Buchheim's, Schmiedeberg founded the first scientific journal of pharmacology. More important, through his tutelage Schmiedeberg helped spread acceptance of pharmacology throughout the world. One protégé of Schmiedeberg was John Abel (1857-1938), generally regarded as the father of American pharmacology.

Once an obscure experimental science, pharmacology has expanded its purview to such an extent that the subject has become an important area of study for all health professionals and holds certain interests for the lay public as well. In dentistry, the impact of pharmacology was formally recognized by the American Dental Association in 1934 with publication of the first edition of *Accepted Dental Remedies*.

SCOPE OF PHARMACOLOGY

Pharmacology is one of the few medical sciences that straddles the division between the basic and the clinical. The scope of pharmacology is so extensive that several subdivisions have come to be recognized. *Pharmacodynamics* is the study of the biologic activity that a drug has on a living system. It includes a study of the mechanisms of action of the drug and the exact processes that are affected by it. The influence of chemical structure on drug action (the structure-activity relationship) is also a concern of this branch of pharmacology. *Pharmacokinetics* deals with the magnitude and time course of drug effect, and it attempts to explain these aspects of drug action through a consideration of dosage and the absorption, distribution, and fate of chemicals in living systems. *Pharmacotherapeutics* is the proper selection of an agent whose biologic effect on a living organism is most appropriate to treat a particular disease state. It requires a consideration of, among many other things, dose, duration of therapy, and side effects of drug treatment. The practice of *pharmacy* involves the preparation and dispensing of medicines. Although pharmacists today are rarely called on to actually prepare drug products, they can serve as a useful source of drug information for both the clinician and the patient. *Toxicology* is that aspect of pharmacology dealing with poisons, their actions, their detection, and the treatment of conditions produced by them. The importance of toxicology to modern life is continually underscored by new discoveries of chemical hazards in the environment. As the various disciplines of science and medicine have continued to evolve, fruitful areas of inquiry have emerged from the union of fields with overlapping interest. For example, study

of the interrelationships between drugs and heredity, aging, and the immune system has led to the respective development of *pharmacogenetics*, *geriatric pharmacology*, and *immunopharmacology*. A final subdivision of pharmacology, *pharmacognosy*, is now a somewhat vestigial science. Essential at a time when most drugs were derived from plants, it literally means “drug recognition” and deals with the characteristics of plants and how to identify those with pharmacologic activity. Most drugs today are synthesized chemically, but phytochemistry, especially the synthesis of complex chemical structures by plants, remains of interest. On the other hand, herbal medicine as a discipline has gained in importance since 1994. The use of products in this area has spurred interest in the active components of herbal medicines, their clinical efficacy, and their potential liabilities.

After a description of how the study of drugs is classified, it is appropriate to discuss what is meant by the word *drug*. To the pharmacologist, a drug is any chemical agent that has an effect on the processes associated with life. This definition is obviously broad and ill suited for many parties who define the term more restrictively to better serve their particular needs. The therapist, for example, considers as drugs those chemicals that are effective in treating disease states. To the lay public, drugs generally connote those substances that cause mental and psychological alterations. Finally, governmental agencies are concerned with the revenue derived from the taxes levied against the sale of certain substances or with public health problems associated with their use. Some of these agents, such as tobacco and alcohol, are legally sequestered; that is, by law they are considered “nondrugs.” Although pharmacologists have long recognized these agents as potent

drugs, they are exempted from the usual governmental restraints and are not subject to normal scrutiny by the U.S. Food and Drug Administration. There are other substances that have gained such special status not by historical accident, as did some of those previously mentioned, but by considerations of public health. Examples of these include chlorine and fluoride added to community water supplies and iodides mixed with table salt. Lawsuits over the question of whether these public measures constitute an illegal form of “mass medication” have been resolved by the courts, at least in part through the categorization of these chemicals as legal nondrugs when they are used in a specific manner for the public good.

Drugs to be covered in this book include almost exclusively only those substances with a known therapeutic application. Even so, the potential number of agents for consideration is large—several thousand drugs marketed in a multiplicity of dosage forms and, in some instances, in a bewildering variety of combinations. To limit confusion, emphasis is placed on single, prototypical agents that are representative of their respective drug classes. By this approach, an understanding of the properties of related agents can be more readily achieved; at the same time, differences that may exist between them can be highlighted. Finally, it is important to recognize that there are certain generalizations that apply to all drugs. These principles of drug action are the subject of the first four chapters in this book. A mastery of the concepts presented in these chapters is necessary for a thorough understanding of pharmacology, for the rational use of therapeutic agents, and for the objective evaluation of new drugs.

PHARMACOLOGY
AND THERAPEUTICS^{FOR}
DENTISTRY

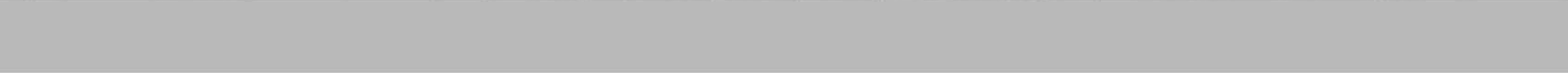
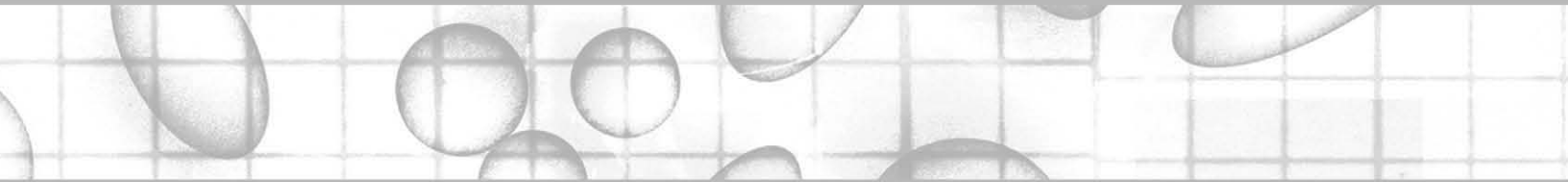

This page intentionally left blank

PART

I

Principles of Pharmacology

Pharmacodynamics: Mechanisms of Drug Action

JOHN A. YAGIELA

DRUG-RECEPTOR INTERACTIONS

The actions of most therapeutic agents are imbued with a certain degree of specificity. In conventional doses, drugs are generally selective in action; that is, they influence a narrow spectrum of biologic events. In addition, the pharmacologic profile of such agents is often markedly dependent on chemical structure; simple molecular modifications may drastically alter drug activity. These attributes of drug action suggest that the tissue components with which drugs interact to cause observable effects are uniquely individualized. Such tissue elements must have highly ordered physicochemical properties to permit particular compounds to combine with them, while prohibiting all others from doing so. They must also be intimately involved with discrete processes of life for drug interactions to exert specific physiologic influences. These "biologic partners" of drug action are given the term *receptors*.

The existence of receptors for exogenously administered drugs implies that drugs often mimic or inhibit the actions of endogenous ligands for these receptors. Drugs rarely produce novel effects; instead, they modify existing physiologic functions.

Receptor Classification

For many years after their postulation a century ago, receptors remained an enigma to pharmacologists. Little was known about them other than the probability that they were complex macromolecules possessing a ligand-binding site to interact with specific drugs and an effector site to initiate the pharmacologic response. With the development of biochemical methods for the isolation, solubilization, and characterization of proteins, however, enzymes became available as model systems for the study of drug-receptor interactions. Enzymes exhibit many of the properties that are ascribed to receptors. They are macromolecules having measurable biologic functions and possessing specific reactive sites for selected substrates. The close association between enzymes and receptors was underscored in the early 1940s when it became apparent that some enzymes are drug receptors. The list of drugs that alter known enzymatic activities is extensive and includes angiotensin-converting enzyme inhibitors, allopurinol, anticholinesterases, carbidopa, carbonic anhydrase inhibitors, disulfiram, entacapone, monoamine oxidase inhibitors, protease inhibitors, reverse transcriptase inhibitors, statin cholesterol synthesis inhibitors, sulfonamides, trimethoprim, and various antimetabolites used in cancer chemotherapy.

Besides enzymes (including coenzymes) and other easily solubilized proteins, at least two additional classes of receptors have been identified and are of clinical significance:

nucleic acids and membrane-linked proteins. Nucleic acids serve as receptors for a limited number of agents. Certain antibiotics and antineoplastic compounds interfere with replication, transcription, or translation of genetic material by binding, sometimes irreversibly, to the nucleic acids involved. Other drugs, including thyroid hormones, vitamin D analogues, sex steroids, and adrenal corticosteroids, also modify transcription, but here the affected DNA becomes activated or inhibited as a consequence of drug interaction with a separate receptor protein in the cytosol or nucleus of the cell, as described subsequently. The most common receptors of drugs are those located on or within the various membranes of the cell. Their study has been greatly aided in recent years by developments in genomics, proteomics, and informatics. Membrane transporter proteins and metabolic enzymes, described in Chapter 2 for their influence on drug disposition, are themselves targets of drug action. Of greater significance are the many integral membrane proteins that function as receptors for endogenous regulatory ligands, such as neurotransmitters, hormones, and other signaling molecules.

Receptors involved in physiologic regulation can be grouped by molecular structure and functional characteristics into several superfamilies. Most of these receptors have one or more extracellular ligand-binding domains linked by one or more lipophilic membrane-spanning segments to an effector domain often, but not always, located on the cytoplasmic side of the membrane. This arrangement is ideal for the translation of an extracellular signal into an intracellular response. Usually, the endogenous ligand "signal" is hydrophilic and incapable of passive diffusion through the cell membrane. For lipophilic regulatory ligands, such as for thyroid hormone and various steroids, a separate superfamily of intracellular receptors exists. Commonly, drug binding exposes a DNA-binding site on the receptor protein, allowing the receptor to interact with DNA and alter transcription. These major classes of receptors are illustrated in Figure 1-1 and described subsequently.

Ion channel-linked receptors

There are two general classes of ion channels: voltage gated and ligand gated. Voltage-gated ion channels are activated by alterations in membrane voltage. Voltage-gated Na⁺ channels open when the membrane is depolarized to a threshold potential and contribute to further membrane depolarization by allowing Na⁺ influx into the cell. As described in Chapter 16, local anesthetics such as lidocaine bind to voltage-gated Na⁺ channels, leading to blockade of neuronal depolarization. Specific voltage-gated ion channels also exist for K⁺, Ca⁺⁺, H⁺, and Cl⁻.

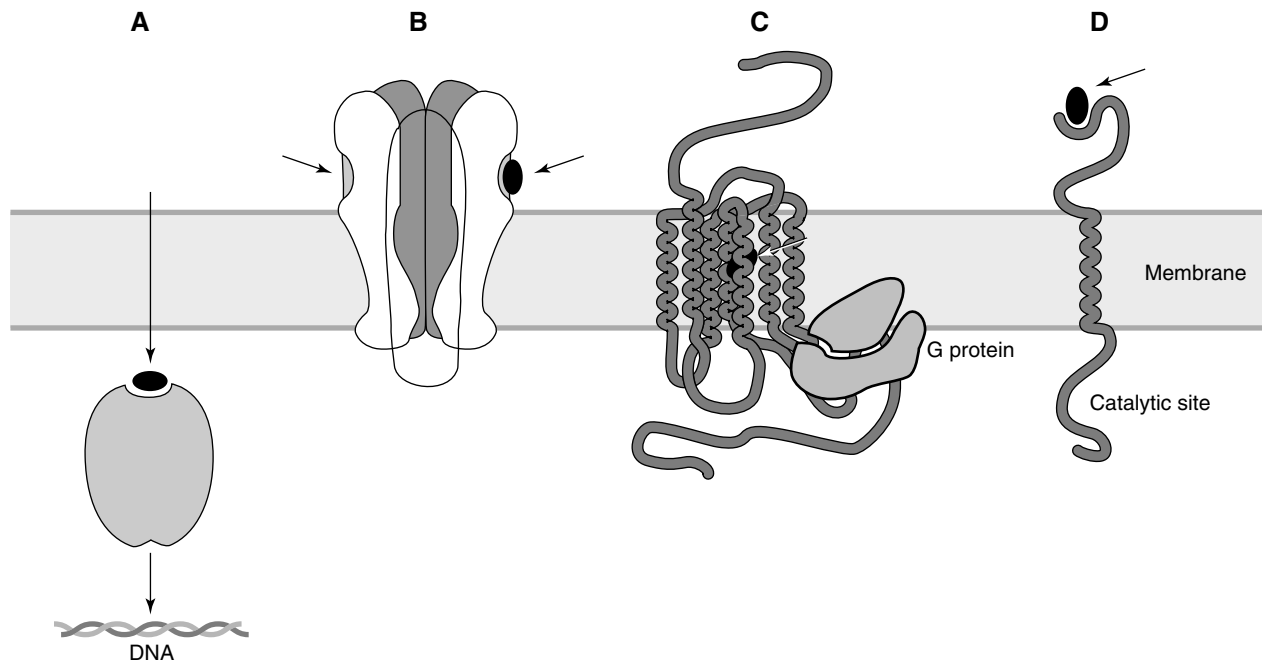

FIGURE 1-1 Examples of four major classes of receptors and signal transduction mechanisms. *Arrows* denote the receptor ligand-binding sites. **A**, Intracellular receptors. Lipophilic substances such as steroids can cross the plasma membrane and activate intracellular receptors, which, after translocation to the nucleus, alter gene transcription and, ultimately, synthesis of new protein. **B**, Ion channel-linked receptors. Drugs such as nicotine can activate ligand-gated ion channels, leading to depolarization (or hyperpolarization) of the plasma membrane. **C**, G protein-linked receptors. Many drugs can activate G protein-linked receptors, causing release of the α and $\beta\gamma$ subunits of associated G proteins. **D**, Enzyme-linked receptors. Drugs such as insulin promote dimerization of its receptor and activation of the catalytic site on the intracellular end of the receptor.

In contrast, ligand-gated ion channels are activated in response to the binding of specific ligands or drugs. Many neurotransmitters and drugs and some cytoplasmic ligands activate membrane-bound ligand-gated ion channels, including several types of glutamate receptors and one 5-hydroxytryptamine (5-HT₃) receptor promoting Na⁺, K⁺, or Ca²⁺ movements, and certain γ -aminobutyric acid and glycine receptors promoting Cl⁻ influx. Depending on the ionic charge and the direction of flow, ligand-gated ion channels can either depolarize or hyperpolarize the cell membrane.

The nicotinic receptor (Figure 1-2), the first membrane-bound drug receptor to be fully characterized,^{12,22} is an important example of a ligand-gated ion channel. An oligomeric structure, the polypeptide constituents of the nicotinic receptor are arranged concentrically to form a channel through which small ions can traverse the plasma membrane when the receptor is activated by the binding of two acetylcholine (ACh) molecules. As is the case with other ion channels, numerous subtypes of nicotinic receptors exist expressing differing affinities for specific ligands.

G protein-linked receptors

G protein-linked receptors, sometimes referred to as metabotropic receptors, constitute the largest superfamily of integral membrane proteins, and collectively serve as targets for approximately half of all nonantimicrobial prescription drugs.^{9,11} The basic structure of these receptors includes a common seven-membered transmembrane domain. Generally, metabotropic receptors greatly amplify extracellular biological signals because they activate G proteins, which activate ion channels or, more commonly, other enzymes (e.g., adenylyl

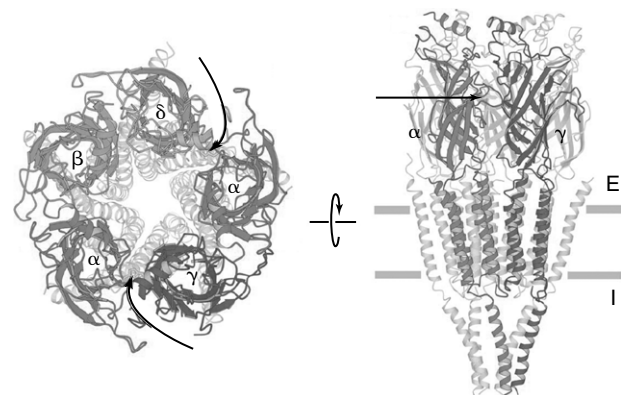

FIGURE 1-2 Ribbon structural model of the nicotinic ACh receptor from the electric organ of *Torpedo marmorata*. *Left*, View from the synaptic cleft. Five polypeptide units consisting of four different types (α , β , γ , and δ) form a rosette with a hydrophilic pore spanning the center of the oligomer. External regions, which include the ACh binding sites, are highlighted. *Arrows* indicate the α -subunit tryptophan (W149) that constitutes part of each ligand-binding site. *Right*, View parallel to the plasma membrane. Each polypeptide subunit includes four α -helical sequences that traverse the plasma membrane; the front two subunits are highlighted. *Arrow* indicates the same W149 residue. *E*, External surface (interstitial space); *I*, internal surface (cytoplasmic space). (Adapted from Unwin N: Refined structure of the nicotinic acetylcholine receptor at 4 Å resolution, *J Mol Biol* 346:967-989, 2005.)

cyclase), leading to the introduction or formation of a host of internal second messengers for each extracellular signal molecule detected. This amplification system, which also usually involves an extended duration of activation of G proteins relative to the binding of drug to the receptor, may explain why maximal pharmacologic effects are often observed when only a small proportion of receptors are activated.

G proteins are heterotrimers consisting of α , β , and γ subunits. After receptor activation, guanosine diphosphate attached to the α subunit is replaced by guanosine triphosphate, and the heterotrimer splits into the α monomer and $\beta\gamma$ dimer. Many, but not all, of the observed cellular actions are caused by the α subunit (see Figure 5-7). $G_{\alpha s}$, the specific α subunit for the G protein associated with β -adrenergic receptors, activates adenylyl cyclase, which catalyzes the synthesis of cyclic adenosine 3',5'-monophosphate (cAMP).⁹ cAMP activates protein kinase A, which catalyzes the phosphorylation of serine and threonine residues of certain intracellular proteins, leading to altered cellular function.

The G protein system is complex and still incompletely understood. One receptor subtype may activate different G proteins, several receptor subtypes may activate the same G protein, and the ultimate target proteins can exist in tissue-specific isoforms with differing susceptibilities to secondary effector systems. The different G protein pathways can also interact with one another. The complexity of G protein signal transduction provides a sophisticated regulatory system by which cellular responses can vary, depending on the combination of receptors activated and the cell-specific expression of distinct regulatory and target proteins. Several specific membrane-bound G proteins are discussed in Chapter 5.

Figure 1-3 depicts the structure of the mammalian β_2 receptor based on x-ray crystallography studies and how it is believed to be arranged within the plasma membrane.¹¹

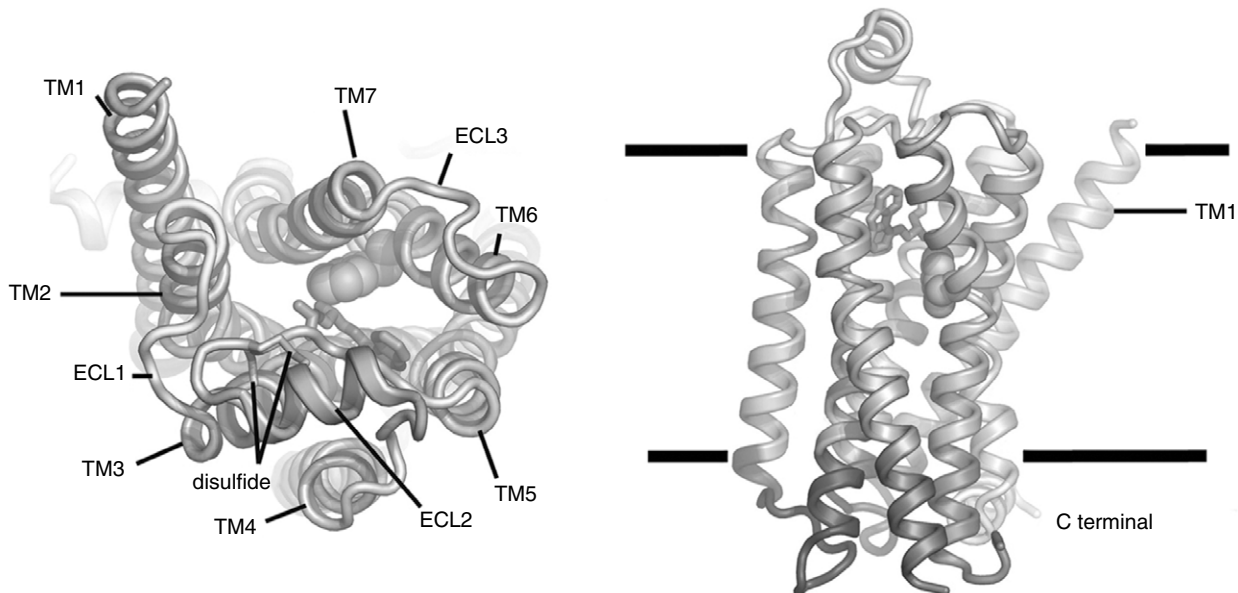

FIGURE 1-3 Ribbon structural model of the β_2 -adrenergic receptor. *Left*, View from the synaptic cleft; *right*, view parallel to the plasma membrane. For technical reasons, it was not possible to visualize the extracellular N-terminal amino acid chain attached to transmembrane helix 1 (TM1), the intracellular connector between TM5 and TM6, and a major portion of the intracellular C terminal. Binding of a drug ligand (in this case, the β -adrenergic receptor antagonist carazolol) is represented as a stick figure. The rotamer toggle switch tryptophan (W293), which allows TM6 to move in response to drug agonists, is indicated by the space-filling spheres. ECL, Extracellular loop. (Adapted from Hanson MA, Stevens RC: Discovery of new GPCR biology: one receptor structure at a time, *Structure* 17:8-14, 2009.)

Enzyme-linked receptors

Enzyme-linked receptors have only one transmembrane domain per protein subunit, with an enzymatic catalytic site on the cytoplasmic side of the receptor. Dimerization of activated receptors usually provides the conformational change required for expression of enzymatic activity. The catalytic sites are commonly protein kinases that phosphorylate tyrosine or, less commonly, serine or threonine residues on target proteins. Autophosphorylation of the receptor also occurs. Some catalytic receptors have guanylyl cyclase or tyrosine phosphatase activity. Insulin, atrial natriuretic peptide, and various growth factors (e.g., epidermal growth factor) activate catalytic receptors. A closely related group of receptors responsible for the action of numerous peptides—including various neurotrophic peptides, growth hormone, and cytokines—lacks enzymatic activity. In such cases, the catalytic site is supplied by a separate nonreceptor protein kinase that interacts with the dimerized receptor.

Many forms of cancer seem to involve mutant variants of enzyme-linked receptors in which the catalytic site or associated nonreceptor protein kinase is continuously activated.⁴ Approximately half of all oncogenes discovered to date encode for continuously activated protein kinases.

Intracellular receptors

Lipophilic substances capable of crossing the plasma membrane may activate intracellular receptors. Sex steroids, mineralocorticoids, glucocorticoids, thyroid hormones, and vitamin D derivatives all activate specific nuclear receptors that influence DNA transcription.^{8,20} The typical nuclear receptor is composed of three major subunits: the carboxyl end of the receptor forms the ligand-binding domain, the adjacent segment includes the DNA-binding region, and the amino terminus constitutes the transcription-modulating domain. When a drug (or hormone) binds to the receptor, it

folds into the active configuration and dimerizes with a partner receptor. The conformational change results in a dramatic increase in binding to specific DNA sequences. Binding of thyroid hormone to its receptor produces more than a 10-fold increase in receptor affinity for binding to DNA.²⁰ DNA binding of the activated receptor often initiates transcription, leading to increased production of specific proteins. Because this type of signal transduction requires protein synthesis, drugs that activate intracellular receptors typically have a delay of several hours before the onset of their pharmacologic effect. (For this reason, glucocorticoids cannot be used as primary drugs for the management of anaphylaxis.) In some systems, the binding of the drug-receptor complex inhibits transcription. Regardless of the specific mechanism involved, however, the intensity and duration of drug effect is temporally independent of the plasma concentration.

In addition to these intracellular receptors, other enzymes and proteins involved in cellular metabolism and gene expression are receiving increasing scrutiny as potential targets for drug therapy. Nitric oxide, which stimulates guanylyl cyclase directly to form cyclic guanosine 3',5'-monophosphate (cGMP), and sildenafil, which inhibits the breakdown of cGMP by cGMP-specific phosphodiesterase-5, are two examples of currently available agents acting intracellularly on regulatory enzymes. Finally, structural proteins such as tubulin, which are assembled to form microtubules, are targets for several drugs used in the treatment of cancer, gout, and fungal infections.

Drug-Binding Forces

Implicit in the interaction of a drug with its receptor is the chemical binding of that drug to one or more specific sites on the receptor molecule. Five basic types of binding may be involved (Figure 1-4).

Covalent bonds

Covalent bonds arise from the sharing of electrons by a pair of atoms. Although covalent bonds are required for the structural integrity of molecules, they are generally not involved in drug-receptor interactions. Most drugs reversibly associate with their receptors. As described in Chapter 2, the duration of action of these agents is related to how long an effective drug concentra-

tion remains in the vicinity of the drug receptors. This time may vary from a few minutes to many days, but usually is on the order of several hours. With bond energies of 250 to 500 kJ/mol, the stabilities of covalent linkages are so great that, when formed, drug-receptor complexes are often irreversible. In these instances, the duration of action is not influenced by the concentration of unbound drug surrounding the receptors. Instead, it may depend on the synthesis of new receptors or on the turnover of the affected cells, processes that often take days to weeks. When the receptors happen to compose or influence the genetic material of a cell, drug effects may be permanent.

Ionic bonds

Ionic bonds result from the electrostatic attraction between ions of opposite charge. Such associations are relatively weak in an aqueous environment, having bond energies of approximately 20 kJ/mol. Nevertheless, many drugs have a formal charge at physiologic pH, and it is likely that ionic bonds are commonly made with ionized groups located at receptor sites. Because the attraction between ions is inversely proportional to the square of the distance separating them, ionic influences operate over much greater distances than do other interatomic forces. It is reasonable to assume that ionic bonds initiate many drug-receptor combinations.

Cation- π interactions

Although benzene and similar aromatic compounds are hydrophobic solvents, their π electron clouds are capable of interacting with positively charged ions.⁵ Phenylalanine, tyrosine, and tryptophan—amino acids with aromatic side groups—retain this ability. These amino acids are common constituents at receptor sites for such positively charged drugs as ACh, dopamine, epinephrine, and 5-HT. Individual bond energies are similar to those of hydrogen bonds described subsequently; however, interactions between multiple aromatic amino acids and a single cationic moiety commonly strengthen the overall interaction.

Hydrogen bonds

The hydrogen bond represents a special type of interaction between polar molecules. When a hydrogen atom is cova-

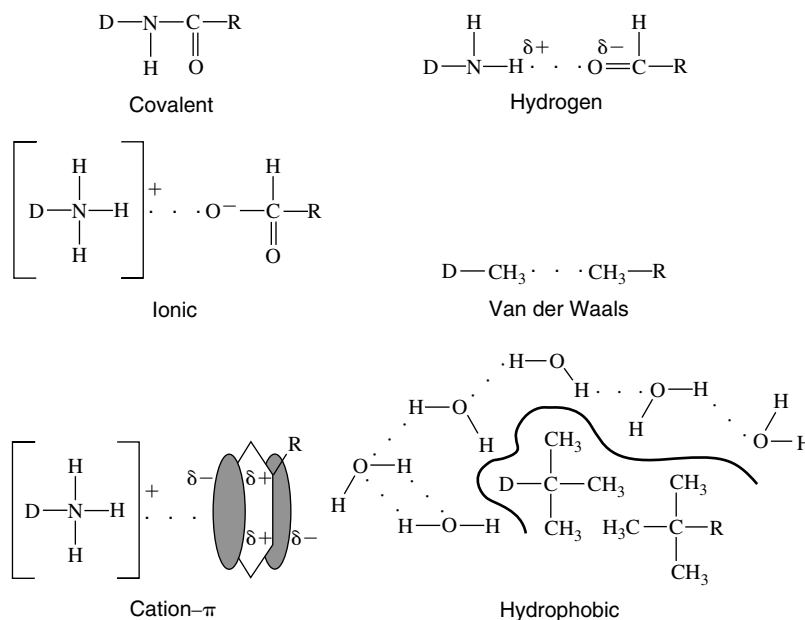

FIGURE 1-4 Major chemical bonds associated with drug-receptor interactions, where *D* is drug and *R* is receptor.

lently attached to a strongly electronegative atom such as oxygen or nitrogen, it becomes partially stripped of its electron and takes on some of the characteristics of a bare proton. Strongly electropositive and with an exceedingly small atomic radius, the hydrogen nucleus is able to associate closely with additional electronegative atoms. Hydrogen linkages are generally weaker than ionic bonds (approximately 5 kJ/mol) and are more sensitive to interatomic separation. Functional groups capable of forming hydrogen bonds are common to drugs and receptor sites, however, and if multiple unions occur, the resultant stabilizing force can far outweigh that of a single ionic bond.

Van der Waals forces

Van der Waals forces collectively describe the weak interactions that develop when two atoms are placed in close proximity. The electrostatic attractions that constitute these forces result from reciprocal perturbations in the electron clouds of the atoms involved. These “bonds” are the weakest of the five types described (approximately 0.5 kJ/mol); in addition, they decrease in strength according to the seventh power of the interatomic distance. Paradoxical as it may seem, van der Waals forces are of primary importance in conferring specificity to drug-receptor interactions. Because even electroneutral carbon atoms can participate in such associations, the number of these bonds that connect a drug to its receptor may be large, and the total binding force may be considerable. When minor steric influences prevent an exact fit between a drug and its receptor, the sensitivity of van der Waals forces to interatomic separation forestalls their development, and drug-receptor stability markedly declines.

Hydrophobic interactions

In addition to the bonding forces already described, hydrophobic interactions between the drug, its receptor, and the aqueous environment can play a major role in stabilizing drug-receptor binding. Water is an unusual liquid with respect to its ability to form hydrogen bonds with itself and with various solutes. The association of a drug with its receptor is enhanced if the drug is hydrophobic or if the surface area of a nonpolar region of the receptor is reduced by drug binding. In either case, stability occurs because of the reduced perturbation of the normal water structure.

Cooperation of binding forces

The binding of a drug to its receptor is generally not related to a particular attractive force but results from the conjoint action of ionic, cation- π , hydrogen, van der Waals, and (rarely) covalent linkages, often in synchrony with hydrophobic interactions. Each type of association contributes differently to the drug-receptor complex. When random movement causes a drug molecule to approach or collide with the receptor surface, ionic attractions, closely followed by cation- π interactions, are the first to develop. Unable to convey specificity or stability to a drug-receptor union by themselves, these forces nevertheless serve to draw in and partially orient the drug to its receptor. As the intermolecular separation diminishes, hydrophobic influences, hydrogen bonding, and subsequently van der Waals forces become prominent. In concert, these interactions provide for the specificity of drug action; without an exact fit, binding is impaired, and the drug cannot adhere well enough to influence receptor function. Covalent linkage confers a high degree of permanency to the drug-receptor complex. Fortunately, though, irreversible binding is uncommon in therapeutics. Many agents are used to produce a single, temporary effect; covalent attachment would preclude such use. In many instances, covalent bonding would make drug regimens more difficult to administer and adverse reactions more troublesome to treat.

Structure-Activity Relationships

Examination of structure-activity relationships (SARs) is a time-honored method of studying drug-receptor interactions. In SAR investigations, specific features of the structure of a drug molecule are identified and then altered systematically to determine their influence on pharmacologic activity. The chemical features that are most often involved in these considerations are the presence and type of ionic charge; the effect of neighboring groups on the degree of ionization; hydrogen-bonding capability; and steric factors such as the size of alkyl side chains, the distance between reactive groups, and the three-dimensional configuration of such groups. SAR studies of closely related agents (congeners) have led to an understanding of the chemical prerequisites for pharmacologic activity and, on a practical level, made possible the molecular modification of drugs to provide enhanced or even novel therapeutic effects, while reducing the incidence and severity of toxic reactions. In addition, SAR studies serve to illustrate how the combined action of the various binding forces described earlier are necessary for maximal drug activity, which yields certain clues concerning the physicochemical properties of the receptor sites involved that are of value to investigators seeking to unravel the exact structure of these sites.

A recent example of SARs is provided by the study of the binding of norepinephrine and related drugs to the β_2 -adrenergic receptor (Figure 1-5).² The norepinephrine molecule is composed of a catechol residue (a benzene ring with two hydroxyl groups in the meta and para positions) connected by a two-carbon intermediate chain to a nitrogen terminus that is positively charged at physiologic pH. The presence of a cationic nitrogen locus is essential for full activity; loss of the ionic charge by removing the nitrogen moiety or replacing it with a nonionic carbon group virtually eliminates drug action, as does replacement of the receptor's aspartate residue (D113) with a neutral amino acid. Hydrogen bonds involving both ring hydroxyl groups with correspond-

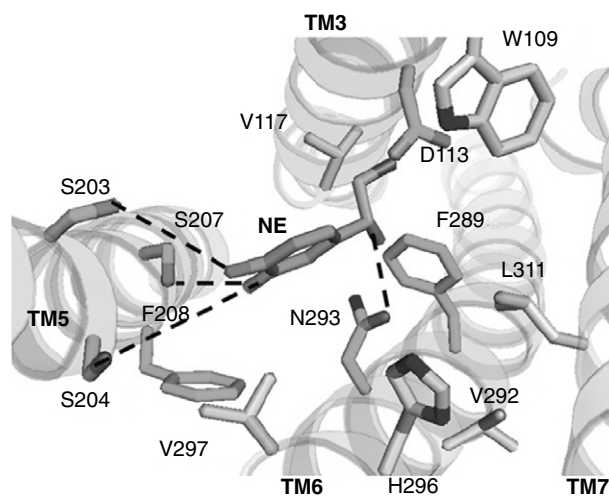

FIGURE 1-5 Ribbon model of the interaction of norepinephrine (NE) with the β_2 -adrenergic receptor. The transmembrane segments involved in agonist binding (TM3, TM5, TM6, TM7) are shown along with their serine and asparagine residues (S203, S204, S207, and N293), involved in hydrogen bonding (dashed lines), and the aspartate residue (D113) that forms an ionic bond. Other amino acids involved in agonist binding are also identified. (Adapted from Bhattacharya S, Hall SE, Li H, et al: Ligand-stabilized conformational states of human β_2 adrenergic receptor: insight into G-protein-coupled receptor activation, *Biophys J* 94:2027-2042, 2008.)

ing serine residues (S203, S204, and S207) greatly increase potency (by 25-fold, 33-fold, and 39-fold, respectively) but preclude entry of the drug into the central nervous system (CNS). Replacement of a hydroxyl with a larger group generally eliminates agonist activity at β receptors but may result in antagonistic effects. Another hydrogen bond between the β -hydroxyl group and its asparagine counterpart (N293) increases binding affinity 38 times. The distance separating the catechol and nitrogen moieties of the molecule is likewise crucial for full activity. Electrostatic interactions involving the benzene ring and aromatic amino acid residues of the receptor protein (e.g., F290) also contribute to the binding of norepinephrine.

Although norepinephrine can fully activate the β_2 receptor in vitro, it requires higher concentrations than those achieved physiologically. Epinephrine, the natural β_2 receptor ligand, has a nitrogen-bound methyl group that increases β_2 activity by 10 to 50 times. Increasing the size of the alkyl moiety on the nitrogen further increases β -adrenergic selectivity. Because alkyl moieties do not form hydrogen or ionic bonds, this finding implies that van der Waals forces or hydrophobic interactions, or both, contribute significantly to the binding of epinephrine and congeners with selective β_2 -adrenergic properties.

An important source of support for the concept of specificity in drug-receptor interactions comes from the differences so often observed in the activity of optical isomers, such as *d*-norepinephrine and *l*-norepinephrine. It is common for virtually all the activity in a racemic mixture to reside in one of the two stereoisomers. In the case of norepinephrine, the levorotatory isomer is highly active, whereas the other member of the pair is almost devoid of activity. This difference, at least with regard to the β_2 receptor, stems from the inability of the *d*-isomer to make the hydrogen bond between its β -hydroxyl group and the receptor's N293 residue. The presence of only a single atom with an opposite configuration is apparently sufficient to bring about dramatic differences in binding efficiency. Such critical sensitivity can occur only if the drug and receptor fit together with some degree of precision. The optical isomers quinine and quinidine are of interest because both have been used therapeutically but for different purposes. Quinidine (dextro) and quinine (levo) differ from each other only in the configuration of a single secondary alcohol group that serves as the connector of the two halves of the molecule. Both isomers are approximately equal in antimalarial activity, a property that depends on the drug reacting with the DNA of the plasmodial parasites responsible for the disease. The antiarrhythmic action on cardiac muscle is greater, however, for quinidine than for quinine. The enantiomers of *D*-mannose are another example of two molecules that differ only in the spatial arrangement of a single hydroxyl group, and yet vary in their biologic activity. α -*D*-Mannose is sweet when applied to chemoreceptors of the tongue, whereas β -*D*-mannose is bitter.

Consequences of Drug Binding

The combination of a drug with its receptor represents the incipient event in a series of reactions that culminate in a pharmacologic effect. Of prime importance is the second step in this chain—the receptor response to drug binding. Drugs generally are not highly reactive compounds in the chemical sense; they exert their influences indirectly by altering, through receptor attachment, the activity of an important regulator of a biologic process. The mechanism of action of a drug refers to this initial perturbation of normal function.

Ligand competition

Of the various receptor-based mechanisms of drug action, perhaps the most readily observed are those involving enzymes.

Certain drugs are analogues of natural enzyme substrates. These antimetabolites compete with the substrate for the same catalytic site on the enzyme molecule, causing a decrease in the rate of product formation. As a general rule, however, such inhibitions are likely to be of little biologic consequence unless the magnitude of inhibition at least approaches 50%. This phenomenon seems to be explained best by the concept that the number of enzyme molecules present usually exceeds what is necessary for adequate catalysis. A 20% inhibition might produce no observable response because the remaining fraction of uninhibited enzyme is still capable of providing enough product. The enzyme carbonic anhydrase represents an extreme example of this situation. To reduce by half the enzymatic hydration of carbon dioxide, 99.7% of the carbonic anhydrase activity must be abolished.¹⁷

Another consideration related to antimetabolites is the often greater affinity of the reactive site for the natural substrate. This difference may be 1000-fold and carries some significance for pharmacology. If the substrate to be interfered with is abundant, such as glucose, the dose of inhibitor needed to obtain a body fluid concentration 1000 times that of the metabolite would be formidable. Substrates that are in more limited supply, such as vitamin derivatives or chemical mediators, are more reasonable targets for therapy based on this form of inhibition.

Ligand competition may also be invoked for drugs that compete with natural ligands for binding to regulatory proteins. In this case, the drug binds to the ligand-binding site of the receptor, preventing the activating signal to be recognized.

Conformational induction

Many drugs that influence enzyme activity are not structurally related to native substrates. These drugs affect catalysis by serving as allosteric regulators; that is, by binding elsewhere on the enzyme, they induce conformational changes at the active center. These disturbances may lead to an increased affinity for the substrate, but it is more likely for the effect to be one of inhibition. Although the basis of drug-induced allosteric change in enzymes is poorly understood, hydrophobic interactions involving the surrounding hydration layer may be involved. As with other macromolecules, enzymes are covered by a surface film of water. When a drug is bound to its receptor, it upsets the microenvironment around the binding site. Alkyl groups common to many drugs are especially proficient at disturbing the hydration layer; as a result, they promote conformational changes in the drug-receptor complex that minimize their impact. The quaternary structure of proteins is greatly influenced by the state of the surrounding water molecules, and enzymes subject to allosteric regulation have quaternary structures of exceptional conformational sensitivity. The requirement described previously that a certain percentage of enzyme be affected before an observable effect is achieved also holds for allosteric regulation, but the need for the drug concentration to be greater than the substrate does not hold because the two compounds are not in direct competition for binding.

The concept of conformational induction may be of particular relevance to the regulatory receptors previously described. The allosteric concept suggests that a receptor, whether stimulated by its natural effector or by a drug substitute, becomes morphologically distorted. This disturbance causes a change in a particular enzyme activity or transport mechanism or an alteration of membrane permeability. Recent studies of the β_2 -adrenergic receptor (and other G protein receptors⁶) suggest that conformational induction is a common phenomenon.^{2,11} When a ligand such as epinephrine or norepinephrine approaches its binding site, it begins to form ionic and hydrogen bonds, as described previously (see

Figure 1-5). These developing associations cause distortions of the surrounding transmembrane helices (TMs). Rotation of the TM5 helix brings serine residues in closer association with the catechol hydroxyl groups. An ionic bond between TM3 and TM6 is broken as both helices rotate in response to the ligand's strengthening ionic bond with TM3. In particular, rotation of the TM6 helix at a specific tryptophan amino acid (see Figure 1-3) promotes this action and increases van der Waals stabilization of the active receptor configuration. As a result of TM3 rotation, additional amino acid residues move into close association with the ligand. Increased stability of the active conformation of the receptor also occurs as new hydrogen bonds and other attractions develop between the repositioned TM helices.

Drugs can directly alter processes controlled by membrane-bound receptors without resorting to mimicry of natural messengers. As is the case with enzymes, drugs can adjust receptor affinity for ligands through allosteric mechanisms at sites separate from the ligand-binding site.

Conformational selection

Most early attempts to study drug action assumed the receptor was in a quiescent state until activated by an agonist. As has been shown for ion channels and increasingly for other receptor families, however, receptors may exist individually in more than one configuration with or without the presence of a ligand. When this situation exists, drugs may work by selectively binding to a particular conformation of the receptor, stabilizing that arrangement, and altering the relative proportion of receptors existing in active versus inactive states.

Conformational selection provides a particularly credible explanation for the action of drugs that lack polar functional groups capable of strongly interacting with protein constituents to cause allosteric distortions. Inhalation anesthetics are representative in that they are uncharged and weakly interactive. It has been suggested that such anesthetics bind to preformed cavities on ligand-gated ion channels in neurons, causing little structural change themselves, but stabilizing (by occupying space) conformations that result in loss of consciousness.

Subsequent events

Although drug inhibition may simply prevent the formation of an enzyme substrate or the reading of an endogenous signal by a regulatory protein, drug activation of a receptor generally leads to a cascade of events that eventually results in an observable pharmacologic effect. Epinephrine provides a useful illustration of the consequences of drug binding.¹⁹ Incorporated into local anesthetic solutions to prolong the duration of pain relief, epinephrine mimics the action of the neurotransmitter norepinephrine. As a result of epinephrine attachment to α_1 -adrenergic receptors on vascular smooth muscle cells, the G protein known as G_q is activated, phospholipase C_β activity is stimulated, and the membrane lipid phosphatidylinositol-4,5-bisphosphate is broken down to yield the second messengers diacylglycerol and inositol-1,4,5-trisphosphate (IP_3). Diacylglycerol initiates a cascade of metabolic events that support muscle contraction. IP_3 causes the release of Ca^{++} from intracellular storage sites, which induces the activation of actomyosin and initiates vasoconstriction.

DOSE-RESPONSE RELATIONSHIPS

A fundamental aspect of drug action is the relationship between the dose administered and the effect obtained. Common experience dictates that the magnitude of a chemical's effect on a system is positively correlated with the quan-

tity or concentration of that chemical present. To increase the saltiness of a food, for example, more salt must be added. Within certain limits, the addition of salt yields a graded response, but very small increments have no effect on taste, and if the food is salty to begin with, further additions, no matter how great, will have no effect either. There is reason to expect that the dose-effect relationship of a drug is not a linear function throughout the entire dose range. Below a minimum threshold, there can be no incremental effect from a dose because there is no observable effect to begin with. Above a certain ceiling, even a large dose would exert no demonstrable influence because the maximal effect has already been reached.

Occupation Theory

Clark attempted in the 1920s to quantify drug effects through application of the law of mass action. Out of his efforts and the contributions of others emerged the occupation theory of drug action.¹⁶ The occupation theory holds that the magnitude of a pharmacologic response elicited by a drug that reversibly combines with its receptor is directly proportional to the number (or fraction) of receptors occupied by the drug. The relationship can be written as follows:

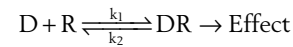

where D is the drug, R is the receptor, and k_1 and k_2 are rate constants. This reaction is analogous to the interaction of an enzyme with a single substrate yielding a single product. A derivative of the Michaelis-Menton equation can be used to quantify drug effects as follows:

$$\text{Effect} = \frac{\text{Maximal effect} \times [D]}{K_D + [D]}$$

where K_D (the dissociation constant) = k_2/k_1 .

This mathematic relationship between the dose (or concentration) of a drug and its response may be shown visually by an experiment in which an isolated muscle is exposed to increasing concentrations of a drug while the force of contraction is measured (Figure 1-6). When a drug is introduced into a tissue, it binds to its receptor in accordance with the K_D . For various reasons, very small quantities will not elicit a measurable response. Each muscle cell may require a minimal number of receptors to be occupied before it contracts, or technical difficulties in detecting small contractions may make such determinations inaccurate or impossible to obtain. The lowest concentration to elicit a measurable response is termed the *threshold concentration*. As higher concentrations are used, the number of receptors occupied increases, as does the intensity of response. An increase in the fraction of receptors occupied necessarily reduces the number available for subsequent binding so that at high concentrations each increment produces progressively smaller additions to the magnitude of contraction. At very high concentrations, the receptor population becomes saturated, and further drug administration no longer influences contraction. A maximal muscle response for the drug, termed the *ceiling effect*, is achieved.

The useful concentration range for a drug falls between the threshold and the ceiling. By expressing data as the logarithm of the concentration versus the degree of response, this important and normally hyperbolic segment of the concentration-effect relationship becomes a sigmoid curve with the linear central portion extending over a 10-fold concentration range. The advantage of plotting with the log scale instead of the arithmetic scale is that it greatly simplifies drug study. The concentration of a drug that produces a half-maximal response (EC_{50}) is often used in comparisons with similar agents. (In classic occupation theory, the EC_{50} equals

the K_D). When data from several experiments are expressed on a single graph with the log dose, this value can be accurately determined for each drug from the linear portion of the respective curve. If the concentration data were not logarithmically transformed, statistical analysis would become more complex. Figure 1-7 illustrates the difficulties encountered if two drugs differing only in receptor affinity are examined on an arithmetic scale. The curve for drug A is so compressed that the concentration yielding the EC_{50} cannot be easily ascertained; for drug B, it cannot even be represented on the same page.

Agonists

Drugs that elicit a response from a tissue are known as *agonists*. Agonists that produce ceiling effects—effects that are not exceeded by other drugs—are called *full agonists*, and drugs whose maximal effects are less than those of full agonists are referred to as *partial agonists*. The distinction between full and partial agonists is unrelated to variances in receptor affinity; the relatively low ceiling effect of a partial agonist

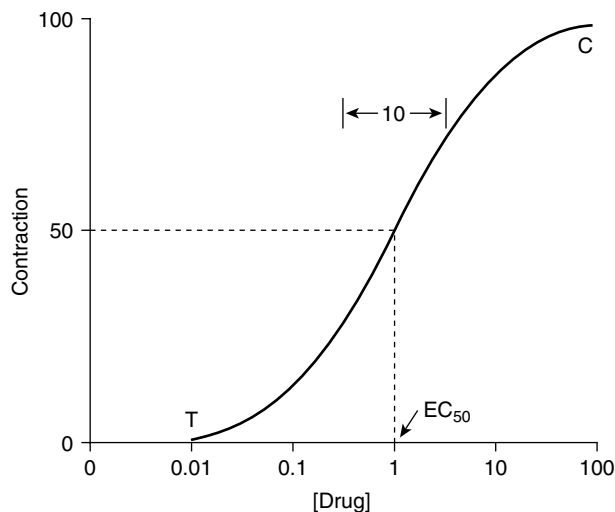
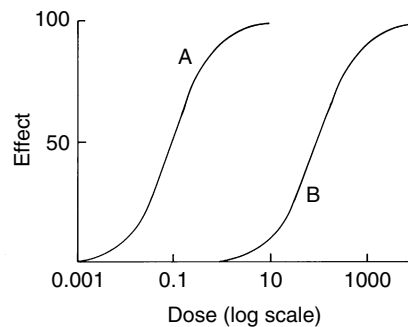

FIGURE 1-6 Theoretic dose-response curve (log scale) for a smooth muscle stimulant. The threshold and ceiling effects are represented by *T* and *C*. As shown, the linear portion of the sigmoid curve, extending from approximately 25% to 75% of the maximal effect, is encompassed by a 10-fold concentration range. A range of 10,000 times is required, however, to depict the curve in its entirety (from 1% to 99% of the maximal effect). The concentration yielding 50% of the maximal response (EC_{50}) is also shown.



cannot be elevated by increasing its dose. The difference between these two classes of agonists lies in their unequal intrinsic activities. *Intrinsic activity* is an empiric term used in classic occupation theory to describe the ability of a drug to activate a receptor after the drug-receptor complex has formed. Incorporating intrinsic activity into the concentration-effect equation yields:

$$\text{Effect} = \frac{a \times [D]}{K_D + [D]}$$

where *a* is the intrinsic activity. Drugs with a low intrinsic activity not only have a relatively low ceiling effect, but each fraction of receptors occupied elicits a response that is smaller than that produced by a similar degree of receptor binding by a full agonist. In other words, the log dose-response curve of a partial agonist has a lower maximum and a smaller slope than does that of a full agonist.

These precepts of occupation theory are shown in Figure 1-8, which presents data from a study of four agonists of muscle contraction.¹ The muscle to be investigated was removed from the animal, placed in a bath containing an oxygenated physiologic salt solution, and attached to a strain gauge to measure isometric contractions. In such experiments, conditions can be manipulated to ensure that each drug tested has equal access to the receptor in question. (This condition, which greatly simplifies the interpretation of experimental

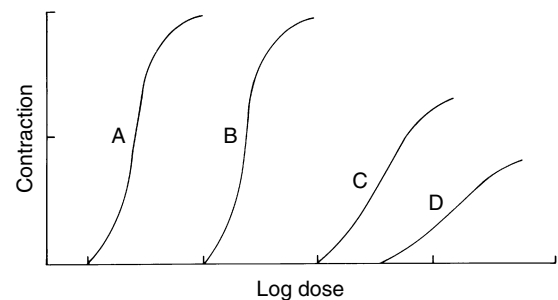

FIGURE 1-8 Effects of four catecholamines on muscle contraction in the vas deferens of the rat. Drugs *A* and *B* differ in affinity, but not in intrinsic activity. Drugs *C* and *D* differ from each other and from *A* and *B* in affinity and intrinsic activity. (Adapted from Ariëns EJ, Simonis AM, van Rossum JM: Drug-receptor interactions: interaction of one or more drugs with one receptor system. In Ariëns EJ, editor: *Molecular pharmacology: the mode of action of biologically active compounds*, New York, 1964, Academic Press.)

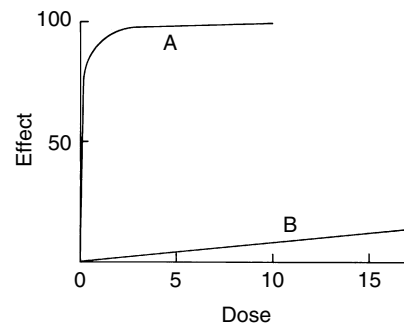

FIGURE 1-7 Dose-effect curves for two drugs differing in receptor affinity by a factor of 1000. *Left*, A log scale. Note the identical shapes of the two dose-effect relationships. *Right*, An arithmetic scale. The lack of correspondence between the two curves hinders drug comparison.

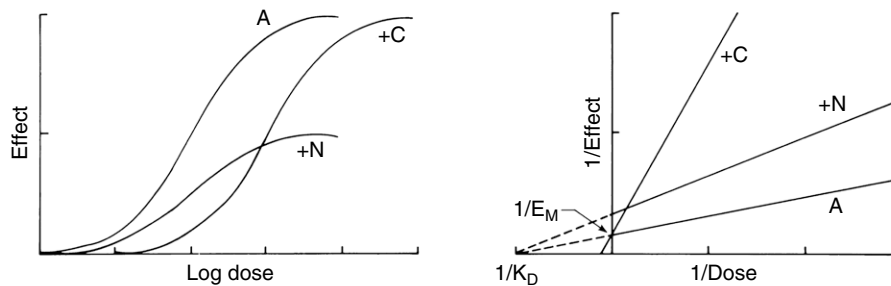

FIGURE 1-9 Modification of a pharmacologic effect by drug antagonism. *Left*, Curve A depicts the dose-effect relationship of a full agonist; curves +C and +N represent the influences of a competitive (C) and noncompetitive (N) antagonist. Note the shift to the right of the agonist dose-response curve by the competitive inhibitor and its downward displacement by the noncompetitive variety. *Right*, Double-reciprocal plot of the same curves; the competitive antagonist increases the apparent dissociation constant (K_D) without influencing the maximum effect obtainable by the agonist (E_M). The noncompetitive inhibitor selectively decreases E_M .

results, cannot be duplicated in whole-animal investigations.) The most potent drug shown is A, with drugs B, C, and D exhibiting progressively decreasing potencies. The potency of a drug is the dose required to elicit an arbitrarily determined level of response (commonly the EC_{50}). Potency is usually a matter of little importance because a drug that is very potent regarding its desirable effects is often equally potent regarding undesirable effects. In the intact animal (or patient), potency is influenced by the drug's ability to reach the receptor (determined by the rate of absorption and the patterns of distribution and elimination) in addition to the agent's intrinsic activity and receptor affinity. A very active drug will seem to have low potency if it is not well absorbed, becomes bound to nonspecific sites, or cannot reach the target organ.

Drugs A and B are full agonists (assuming no other drug with an affinity for this particular receptor can produce a greater ceiling effect), and drugs C and D are partial agonists. Drug D has the smallest intrinsic activity. The consequences of the low potency of drug B can be completely overcome by increasing its dose. According to classic receptor theory, drug B exhibits a lower potency than drug A solely because it has a weaker affinity for its receptor. Drugs C and D represent a more complex problem. These agents are less potent than drugs A and B, which suggests that they possess lesser affinities. Part of their reduced potency, however, is a consequence of their lower intrinsic activities.

Antagonists

Drugs that bind reversibly to a receptor at the same site as the agonist but have an intrinsic activity of zero (no receptor activation; $a = 0$) are competitive antagonists. By making receptors less available for agonist binding, a competitive antagonist depresses the response to a given dose or concentration of agonist. The result is a parallel shift to the right of the agonist dose-response curve. The most important aspect of this type of inhibition is that it is completely surmountable by a sufficiently high dose of agonist. As in enzymology, the presence of a competitive antagonist produces an apparent reduction in the affinity of an agonist for its receptor. Competitive antagonisms are common in pharmacology, and numerous examples are cited in succeeding chapters: histamine versus antihistamines, morphine versus naloxone, ACh versus atropine, epinephrine versus propranolol, diazepam versus flumazenil. By virtue of its small intrinsic activity, a partial agonist can also serve as a competitive antagonist of a full agonist. The aggregate receptor stimulation from the combination depends on the relative concentrations, receptor affinities, and intrinsic activities of the two agents.

Another type of antagonism commonly encountered is the noncompetitive variety. The noncompetitive blockade is insurmountable in that the ceiling effect of an agonist can never be reattained, regardless of the dose administered. A noncompetitive antagonist may decrease the effective number of receptors by irreversibly binding to the receptor site or binding with such affinity that the agonist cannot successfully compete with it for binding. The result is a downward displacement of the agonist log dose-response curve. Figure 1-9 reviews the dissimilarities between the two classic types of drug blockade as represented in occupation theory.

A third type of antagonism involves allosteric modulation of the receptor. Binding of the modulating drug at a site separate from the agonist binding site can result in changes in agonist affinity, intrinsic activity, or both. Complex dose-response relationships may occur.¹³ If the sole effect of the modulator is to decrease, but not eliminate, agonist affinity, the antagonism resembles that of classic competition because larger doses of the agonist can restore maximum activity. When all of the receptors have bound modulator molecules, however, increasing the concentration of modulator further will have no additional effect because the modulator and agonist are not in direct competition for the ligand-binding site. It is unnecessary to continue escalating the concentration of agonist to overcome the blockade. When the modulator alters, but does not eliminate, intrinsic activity of the agonist, the resulting antagonist resembles that of a noncompetitive antagonist. When all of the allosteric sites are bound by modulator, however, there can be no further depression of the agonist dose-response curve. Should the modulator completely eliminate either agonist affinity or intrinsic activity, the effect will resemble that of a noncompetitive antagonist completely except that the blockade is usually reversible in time because most modulators bind noncovalently with the receptor. Further complexities arise because the modulator may variably influence different agonists. The relative potencies of several agonists for the muscarinic M2 receptor are as follows: pilocarpine > ACh > carbachol. In the presence of the M2 receptor modulator eburnamonine, the order becomes carbachol > ACh > pilocarpine.¹³ Because modulators may also increase agonist affinity or intrinsic activity or both, potentiation of agonist action is also a possible outcome of modulator binding.

Limitations of occupation theory

The occupation theory provides a good conceptual framework to understand receptor-mediated drug effects. Basic to the foregoing discussion, however, are several assumptions about the interactions between a drug and its receptor, as follows:

1. One drug molecule reversibly combines with a single receptor.
2. This binding is independent of other drug-receptor interactions.
3. The receptors are identical and equally accessible to the drug.
4. Only a small portion of the total drug is involved in forming complexes with the receptor.
5. The biologic response is proportional to the degree of receptor occupancy and independent of time.

Research findings over the last four decades have made obvious the fact that all these assumptions are usually not valid regarding individual dose-response relationships. It has already been mentioned that equal access of receptors to drugs is unlikely *in vivo* based on uneven drug distribution. As illustrated for the nicotinic receptor in Figure 1-2, some receptors require the binding of more than one drug molecule to become active. Systematic exploration of these assumptions has led to a fuller understanding of the complexities involved in dose-response relationships and improved models of drug action.

Stimulus-Response Coupling

One representative failure of classic occupation theory is its inability to account for the inhibition of ACh by atropine. Atropine is typically classified as a competitive antagonist of ACh. It binds to the ACh receptor and causes an inhibition that can be surmounted by increasing the concentration of agonist present. Nevertheless, the association of atropine with its receptor in some tissues is practically irreversible; neither ACh nor extensive washing will remove the drug when it is bound. Atropine should therefore behave as a noncompetitive antagonist of ACh. To explain the paradox presented by atropine, pharmacologists borrowed from the phenomenon of enzyme excess described earlier in this chapter to postulate the existence of spare receptors. This amendment to the occupation theory states that for many agonists there are more receptors available than are required to yield a maximal response. Although atropine completely blocks some receptors from binding ACh, a sufficient quantity remains to produce a ceiling effect, albeit at a higher agonist concentration. As one might predict, the competitive inhibition obtained with a conventional dose of an antagonist such as atropine gradually takes on the characteristics of a noncompetitive block as larger doses of the antagonist deplete the spare receptor pool.

Another observation that cannot be reconciled with classic occupation theory is the finding that various ligands for the same receptor can behave as full agonists in one tissue but not in another expressing the same receptor. The α -adrenergic agonists norepinephrine and oxymetazoline display essentially identical potencies and ceiling effects in contracting the anococcygeus muscle in the rat. In the vas deferens, norepinephrine remains a full agonist, albeit with less potency, whereas oxymetazoline decreases in potency and ceiling effect to become a weak partial agonist.¹⁵

These two examples give only a taste of the complexities that can arise from the gulf that often separates the binding of a drug by its receptor and the resultant development of a biologic effect. Even if the assumptions basic to the occupation theory hold for the initial action of a drug, they often do not apply to an observed effect that is removed from drug binding by several intermediate events and where the magnitude of drug effect holds a complex relationship to the degree of receptor occupancy. One useful approach to resolving these findings with classic occupation theory is to consider the binding of a drug to its receptor as an initial stimulus, which is translated by the affected tissue into a response, as illustrated by the following equation¹⁴:

$$\text{Response} = f \left[\frac{\epsilon \times R_t \times [D]}{K_D + [D]} \right]$$

Here, the “effect” of classic occupation theory (see the Equation on p. 9) becomes the stimulus (in brackets), with the intrinsic activity replaced by the product of the intrinsic efficacy (ϵ) and the total number of receptors available for binding the drug (R_t). The function f couples the stimulus to the response. Intrinsic efficacy refers to the number of receptors that must be activated to yield a maximal response. A drug with high efficacy needs to stimulate only a small percentage of receptors, whereas a drug with lesser efficacy (but still considered to be a full agonist) must activate a larger proportion. In the case of a partial agonist, insufficient receptors exist even when fully occupied to yield a maximal response.

Because full agonists can differ in efficacy and in receptor affinity, potency differences between drugs such as A and B in Figure 1-8 cannot simply be ascribed to unequal affinities for the receptor. Curves similar to those in Figure 1-8 can be generated by drugs that differ from each other solely in intrinsic efficacy, and affinity constants calculated according to classic occupation theory would be grossly in error.

Figure 1-10 depicts the influence of stimulus-response coupling on three drugs that have identical dissociation constants (K_D) for the same receptor but differ significantly in intrinsic efficacy. In a highly coupled system (Tissue 1), all three drugs behave essentially as full agonists. In systems with less efficient coupling (Tissues 2 and 3), drugs B and C are revealed as partial agonists. Finally, in a system with inefficient coupling (Tissue 4), drug A remains a full agonist, drug B is a weak partial agonist, and drug C exhibits no agonistic effect at all but instead serves as a purely competitive antagonist. The selective estrogen receptor modulator tamoxifen illustrates how differences in tissue response elements can greatly alter drug activity. Tamoxifen behaves as a full estrogen receptor agonist in some tissues (e.g., mouse uterus), a partial agonist in others (e.g., rat uterus), and a competitive antagonist in still others (e.g., mouse and rat pituitary gland). Figure 1-10 helps explain these diverse responses to tamoxifen.¹⁸ Clinically, selective estrogen receptor modulators are used to block estrogen receptors in breast tumors and to stimulate estrogen receptors in managing osteoporosis.

A further complication in describing stimulus-response coupling arises from findings that the intrinsic efficacy of an agonist may not be an inherent, invariant attribute with regard to a given receptor.²³ Instead, it seems that an agonist may exhibit higher efficacy than another agonist with respect to a given receptor in one tissue yet be less effective in eliciting a pharmacologic response when stimulating the same receptor in another tissue that expresses a different response system. An explanation for this phenomenon is that the two agonists yield different versions of the active receptor that are unequally active in stimulating the response systems expressed in the two tissues.

Competitive antagonists always act in stimulus-response systems by decreasing the apparent affinity of an agonist for its receptor without altering the maximal effect that the agonist can generate. Noncompetitive antagonists, however, can present different patterns of action based on the coupling function. Figure 1-11 displays the influence of increasing concentrations of a noncompetitive antagonist in a highly coupled stimulus-response system. As previously described for atropine, low concentrations of the antagonist cause a rightward shift of the agonist's dose-response curve, whereas higher concentrations also depress the maximal effect. For noncompetitive antagonists that essentially remove receptors from the system (i.e., reduce R_t in the Equation above) by irreversibly associating with the ligand-binding site, a complete loss

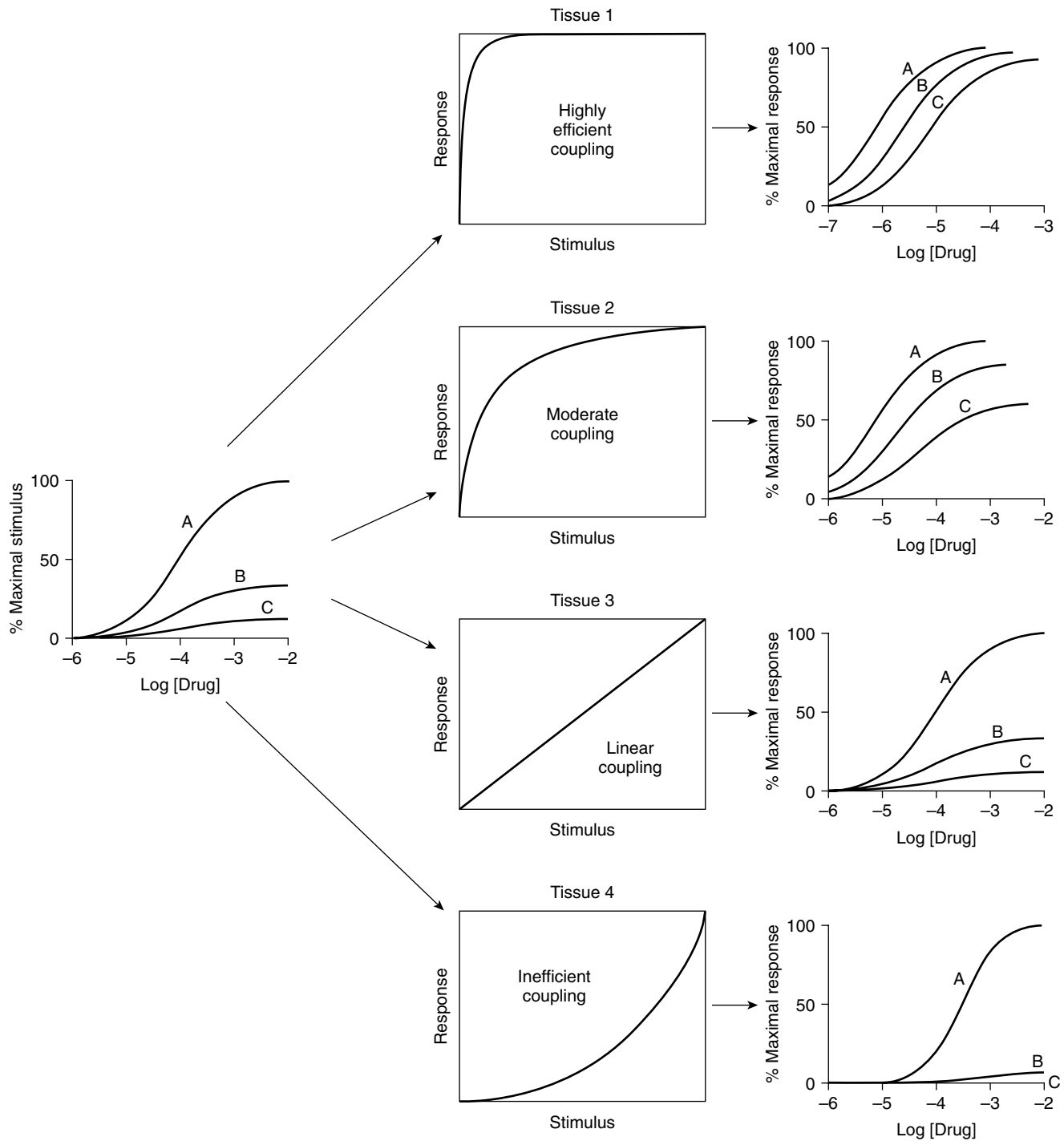

FIGURE 1-10 Stimulus-response coupling. *Left*, The dose-stimulus curves (representing the initial effect of receptor binding) for three drugs with identical receptor affinity but differing sequentially in relative efficacy by a factor of 3 ($A > B > C$). *Middle*, The tissue-dependent coupling between the initial stimulus and the evoked response in four different tissues. *Right*, The dose-response curves for the three drugs in each tissue. Note the different abscissa for *Tissue 1*, reflecting the increased potency of drugs in a highly coupled stimulus-response system. (Adapted from Ross EM, Kenakin TP: Pharmacodynamics: mechanisms of drug action and the relationship between drug concentration and effect. In Hardman JG, Limbird LE, Gilman AG, editors: *Goodman and Gilman's the pharmacological basis of therapeutics*, ed 10, New York, 2001, McGraw-Hill.)

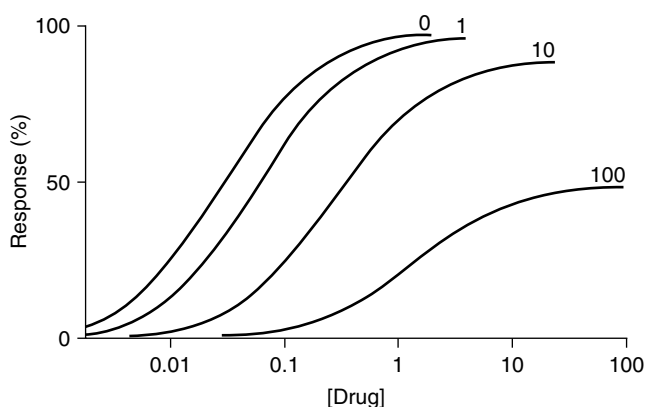

FIGURE 1-11 Noncompetitive antagonism in a highly coupled stimulus-response system. The relative concentration of the noncompetitive antagonist for each agonist dose-response curve is shown at right. Low concentrations of antagonist (1 and 10) cause a rightward shift in the agonist dose-response curve with little or no effect on the agonist-induced maximal response. Higher concentrations (100) increasingly depress the maximal agonist response, however.

of drug effect can be obtained by giving enough antagonist. For modulators that reduce intrinsic efficacy (i.e., reduce ϵ in the Equation on p. 11) to some value other than zero through an allosteric mechanism, some agonist activity may be retained in highly coupled systems despite massive doses of the agent but is completely lost in poorly coupled systems.

Receptor Diversity

In addition to the fact that pharmacologic responses are usually not linearly related to receptor occupancy, situations exist in which the receptors for a drug are not identical to one another. A repeating theme in the elucidation of the autonomic nervous system has been the division of receptor classes into an increasing array of subtypes with differing drug sensitivities. Part of the explanation for the unusual pharmacology of tamoxifen was made clear by the discovery that there were two subtypes of estrogen receptors in various tissues that responded differently to the agent.¹⁸ Individuals may even harbor differences in receptor structure based on single point mutations. An important example is the β_2 -adrenergic receptor, for which numerous single nucleotide polymorphisms have been identified that may alter drug responsiveness in diseases such as bronchial asthma.²¹ As more refined techniques are developed to study drug-receptor interactions, it is possible that subtle differences in configuration or membrane location or both will be found to negate generally the assumption that all receptors are identical and equally accessible to a drug.

Receptors with Multiple Ligand-Binding Sites

The aforementioned isolation of the nicotinic receptor for ACh provides an important exception to the assumption of the occupation theory that a single drug molecule binds to a single receptor. To activate the nicotinic receptor, two ACh molecules must be bound at the same time, although at different sites on the molecule.¹² Evidence suggests that positive cooperativity occurs (the binding of one ACh molecule improves the binding of the second). The requirement for more than one agonist to bind the receptor before a response can occur is not uncommon; other ligand-gated ion channels commonly share this characteristic, as does the insulin receptor and various receptors that must dimerize to become active (e.g., estrogen receptors).^{8,24}

Pharmacodynamic Tolerance

The preceding discussion of dose-response relationships was predicated on the often erroneous assumption that the intensity of drug effect is not influenced by the passage of time. *Pharmacodynamic tolerance* is a general term for situations in which drug effects dissipate with time despite the continued presence of the agonist at a fixed concentration. At the receptor level, various processes in addition to the primary drug effect are often invoked that subsequently limit pharmacologic responses. In the case of the β -adrenergic receptor (Figure 1-12), phosphorylation of specific amino acid constituents leads to a loss of drug action, a process termed *desensitization*.³ The effect is temporary; removal of the agonist for a certain interval re-establishes tissue responsiveness to receptor activation. A longer lasting loss of drug effect, known as *downregulation*, may also occur. In this process, membrane-bound receptors are internalized by the cell, where they may be sequestered for later use or destroyed by lysosomal enzymes. Pharmacodynamic tolerance may also occur independently of any change in the drug receptor or stimulus-response system. As an illustration of this point, consider a drug that increases blood pressure by causing vasoconstriction in selected vascular beds. In response to the hypertensive effect of the drug, various cardiovascular reflexes are evoked that tend to reduce blood pressure, including activation of the parasympathetic nervous system, which leads to bradycardia. The buildup of lactate and other metabolites in the affected tissues also limits vasoconstriction. Eventually, additional changes, such as decreased salt and water retention, may reduce drug responses further. These and other mechanisms of drug tolerance are described more fully in Chapter 3.

MULTISTATE MODEL OF DRUG ACTION

As mentioned in the discussion on conformational selection, receptors may exist constitutively in more than one conformation. According to the multistate model of drug action, these forms of receptors are in equilibrium, and drugs act by altering their relative distributions.¹⁶ Figure 1-13 illustrates a simple two-state version in which the receptor can exist in an active or inactive configuration. In this model, full and partial agonists increase the proportion of receptors that exist in the active state. The model does not distinguish between agonists whose binding tends to force a conformational change in the receptor to the active form and agonists that bind preferentially to active receptors, stabilizing their configuration and altering their number through the law of mass action. Drugs with high efficacy would produce the highest ratios of active to inactive species; partial agonist binding would produce an insufficient active form to yield a maximal response (Figure 1-14). Competitive antagonists would associate with receptors regardless of—and without influencing—their conformational state. Noncompetitive antagonists would limit the ability of agonist binding to elevate the number of receptors in the active state by reducing the total number of available receptors. Allosteric inhibitors would reflect aspects of either or both forms of antagonism.

The major attractions of the multistate model are that it gives a physical solution for differences in efficacy between congeners, and that it affords a simple mechanism for the pharmacologic response elicited by drug binding. It also provides an excellent explanation for drugs known as *inverse agonists*. An inverse agonist causes an effect opposite to that of the agonist, in contrast to a competitive antagonist, which simply blocks the agonist (or the inverse agonist) but has no inherent effect by itself. In a tonically active pathway, a drug that preferentially binds to the inactive configuration or

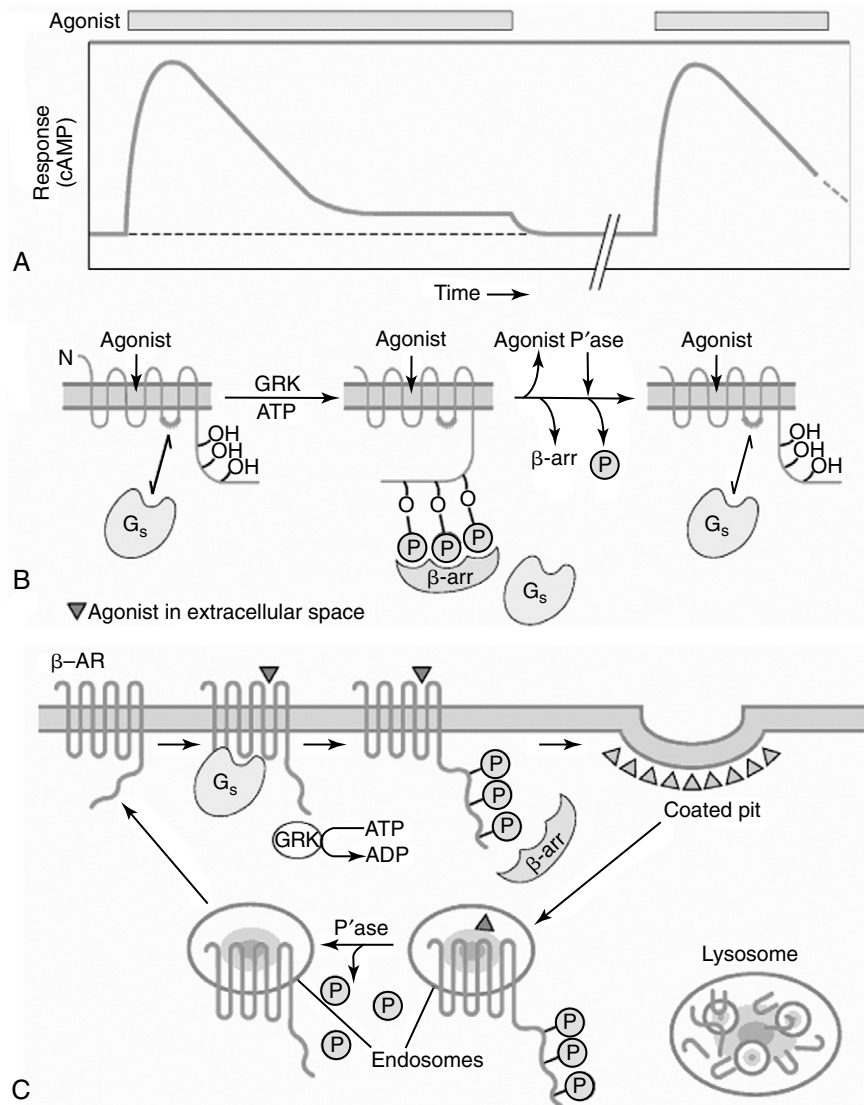

FIGURE 1-12 Rapid desensitization and longer term downregulation of the β -adrenergic receptor. **A**, Response to a β -adrenoceptor agonist (ordinate) versus time (abscissa). Temporal exposure to a constant concentration of agonist is indicated by the shaded bars. The break in the time axis indicates passage of time in the absence of agonist. Desensitization refers to the reduced cAMP production after several minutes in the continued presence of agonist; restored response is observed after a brief period (typically several more minutes in the absence of agonist). **B**, Agonist-induced phosphorylation by a G protein-coupled receptor kinase (*GRK*) of carboxyl terminal hydroxyl groups ($-OH$) of the β adrenoceptor. This phosphorylation induces binding of a protein, β -arrestin (β -arr), which prevents the receptor from interacting with G_s . Removal of agonist for a short time (e.g., several minutes) allows dissociation of β -arr, removal of phosphate (P) from the receptor by phosphatase (*P*'ase), and restoration of the receptor's normal responsiveness to agonist. **C**, Agonist-induced endocytosis and endocytotic membrane trafficking of receptors. β -Arrestin promotes receptor binding to an endocytotic structure in the plasma membrane called a coated pit. After short-term agonist exposure, receptors primarily undergo dephosphorylation by *P*'ase and recycling, promoting rapid recovery of signaling responsiveness. After longer term agonist exposure, receptors that have undergone endocytosis are degraded by lysosomes, promoting the process of receptor downregulation. (From Bourne HR, von Zastrow M: Drug receptors and pharmacodynamics. In Katzung BG: *Basic and clinical pharmacology*, ed 10, New York, 2007, McGraw-Hill Professional.)

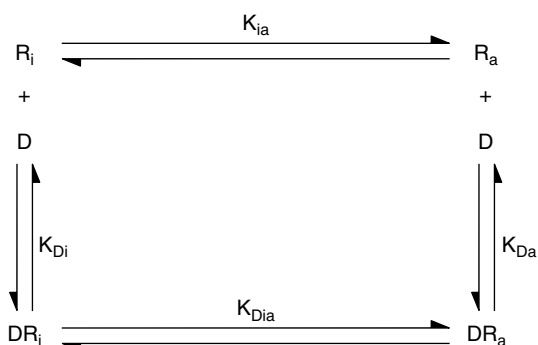

FIGURE 1-13 Two-state model of drug-receptor interaction. The receptor can exist in an active (R_a) or inactive (R_i) state, as governed by the equilibrium constant K_{ia} . Unless the receptor mediates a tonically active process, K_{ia} greatly favors the inactive form. Drugs (D) may bind to R_a , R_i , or both. Agonist binding alters the proportion of active ($R_a + DR_a$) to inactive ($R_i + DR_i$) receptors.

induces its formation would behave as an inverse agonist. Such agents (e.g., β -carboline) have been described for the benzodiazepine receptor. In contrast to sedative benzodiazepines such as diazepam, these experimental drugs cause anxiety and CNS arousal. Flumazenil, a competitive antagonist of the benzodiazepine receptor, reverses the effects of agonists and inverse agonists.¹⁰ Additional examples of inverse agonism have been shown for various G protein receptors overexpressed in cells experimentally or after neoplastic transformation. Inhibition of constitutionally active oncogenes by inverse agonists may provide a new strategy for cancer chemotherapy.

A final advantage of the multistate model is that it can accommodate desensitization and time-dependent actions of drugs such as nicotine. Nicotine exhibits a complex pharmacologic profile. Initially, this natural alkaloid acts like an agonist: it stimulates ACh receptors at autonomic ganglia and in skeletal muscle. The stimulation is temporary, however, and in minutes the action of nicotine transforms from that of excitation to one of antagonism. This metamorphosis can be adequately explained if one assumes that a third, or “desensitized,” configuration of the receptor exists to which active receptors are slowly converted and from which they even more slowly recover. Nicotine, by increasing the proportion of active receptors, causes an initial stimulation and a subsequent prolonged loss of activity as receptors are progressively trapped in the desensitized state.

RECEPTOR-INDEPENDENT DRUG ACTIONS

No description of drug action would be complete without a consideration of agents that exert pharmacologic effects through receptor-independent mechanisms. Aside from the fact that these drugs act without the benefit of receptor intermediaries, there are no common traits serving to link this miscellaneous array of compounds. It has also proved impossible to derive a quantitative description of drug responses akin to that presented for receptor-based agents. The very diversity of these drugs precludes any unifying relationship between dose and effect. Nevertheless, concentration-effect curves similar to those previously discussed are often obtained with these drugs, and general concepts such as potency and efficacy still apply. For the sake of discussion, these drugs are grouped arbitrarily into three categories: chemically reactive agents, physically active agents, and counterfeit biochemical constituents.

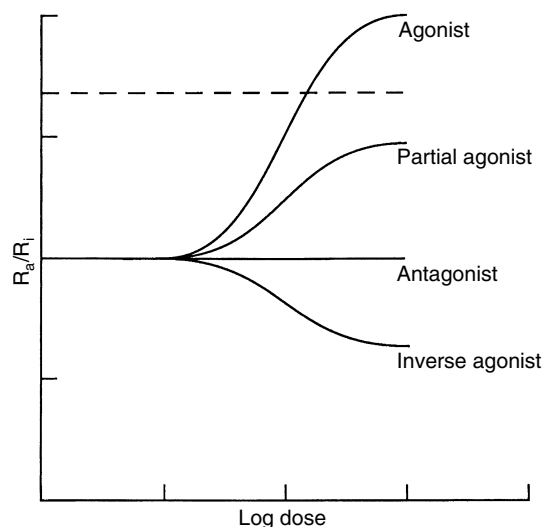

FIGURE 1-14 Dose-effect relationships according to the two-state model. In this example, a tonically active process is depicted. Full agonists can increase the ratio of active to inactive receptors (R_a/R_i) above that which causes the ceiling effect (dotted line); partial agonists also increase the ratio, but to a lesser maximal degree. Antagonists bind without disturbing the existing R_a/R_i ratio, and inverse agonists exert an opposite effect by reducing the R_a/R_i ratio and inhibiting a normally active pathway. In this example, all the drugs are assumed to have the same receptor affinity.

Chemically Reactive Agents

Chemically reactive drugs include a wide variety of compounds, some of which interact with small molecules or ions, whereas others attack proteins and other macromolecules. Gastric antacids and metallic ion chelators are two kinds of drugs that combine with inorganic substances within the body. Of particular importance to dentistry are the systemic and topical fluorides used to increase tooth resistance against dental caries. Also of interest is dimercaprol, a chelating agent capable of forming coordination complexes with mercury and other heavy metals. Drugs affecting macromolecules include most germicides and the antineoplastic alkylating agents. Sodium hypochlorite solutions provide antiseptics and facilitate canal debridement during endodontic therapy because they release hypochlorous acid, a potent chemical disrupter of biologic matter. Generally, these compounds can be readily distinguished from drugs that are receptor mediated. With the exception of certain chelating agents, they lack specificity and may individually react with various substances, organic or otherwise. Minor structural modifications also do not usually influence drug activity. Finally, the reactions of these drugs rely heavily on covalent bonding or on strong ionic attachments; they do not usually depend on hydrophobic or weak electrostatic interactions.

Physically Active Agents

Physically active agents, in contrast, are often useful therapeutically because they are chemically inert and can safely be used for their colligative properties. Magnesium sulfate is an effective cathartic because it is not absorbed from the gastrointestinal tract and exerts an osmotic effect, causing retention of large amounts of water within the intestinal lumen. The colon becomes distended and is stimulated to undergo expulsive contraction. Through a similar osmotic mechanism, mannitol helps reverse cerebral edema in a patient with traumatic brain injury. A totally unrelated physical mechanism is evoked by

hydrogen peroxide. Although highly reactive, hydrogen peroxide is useful in wound debridement because of its effervescent action. The release of gas bubbles promotes the physical removal of debris from injured tissues.

The physically active agents generally exhibit a surprising lack of structural specificity. For many agents, the major requirements for activity seem to be a certain pharmacologic inertness coupled with the ability to be administered in high concentrations (compared with most other drugs) without causing undue toxicity.

Counterfeit Biochemical Constituents

The counterfeit biochemical constituents resemble antimetabolite drugs inasmuch as they are artificial analogues of natural substrates. They have to meet the same rigid structural requirements as do their receptor-based counterparts. Counterfeit agents do not inhibit enzymes, however; they are instead incorporated into specific macromolecules by the cell. The resulting drug effects arise from an altered biologic activity of the affected macromolecules or from their increased susceptibility to destruction. The 2'-deoxycytidine analogue cytarabine is representative of this group. When incorporated into a cell's DNA, cytarabine inhibits the reparative and replicative functions of DNA polymerase. Affected cells may undergo apoptosis or terminal differentiation. Agents of this type are used therapeutically in the treatment of several neoplasias and microbial infections.

CITED REFERENCES

- Ariëns EJ, Simonis AM, van Rossum JM: Drug-receptor interactions: interaction of one or more drugs with one receptor system. In Ariëns EJ, editor: *Molecular pharmacology: mode of action of biologically active compounds*, New York, 1964, Academic Press.
- Bhattacharya S, Hall SE, Li H, et al: Ligand-stabilized conformational states of human β_2 adrenergic receptor: insight into G-protein-coupled receptor activation, *Biophys J* 94:2027-2042, 2008.
- Bourne HR, von Zastrow M: Drug receptors and pharmacodynamics. In Katzung BG, editor: *Basic and clinical pharmacology*, ed 10, New York, 2007, McGraw-Hill Professional.
- Deuel TF: Polypeptide growth factors: roles in normal and abnormal cell growth, *Annu Rev Cell Biol* 3:443-492, 1987.
- Dougherty DA: Cation- π interactions in chemistry and biology: a new view of benzene, Phe, Tyr, and Trp, *Science* 271:163-168, 1996.
- Ellis J, Warburton P, Donnelly D, et al: Conformational induction is the key process for activation of the AT1 receptor, *Biochem Pharmacol* 71:464-471, 2006.
- Franks NP: General anaesthesia: from molecular targets to neuronal pathways of sleep and arousal, *Nat Rev Neurosci* 9:370-386, 2008.
- Germain P, Staels B, Dacquet C, et al: Overview of nomenclature of nuclear receptors, *Pharmacol Rev* 58:685-704, 2006.
- Gilman AG: G proteins: transducers of receptor-generated signals, *Annu Rev Biochem* 56:615-649, 1987.
- Haefely WE: The benzodiazepine receptor and its clinically useful ligands, *Clin Neuropharmacol* 9(suppl 4):398-400, 1986.
- Hanson MA, Stevens RC: Discovery of new GPCR biology: one receptor structure at a time, *Structure* 17:8-14, 2009.
- Karlin A, Cox RN, Dipaola M, et al: Functional domains of the nicotinic acetylcholine receptor, *Ann N Y Acad Sci* 463:53-69, 1986.
- Kenakin T: Allosteric modulators: the new general of receptor antagonist, *Mol Interv* 4:222-229, 2004.
- Kenakin T: Efficacy: molecular mechanisms and operational methods of measurement. In Kenakin T, Angus JA, editors: *The pharmacology of functional, biochemical, and recombinant receptor systems. Handbook of experimental pharmacology*, vol 148, Berlin, 2000, Springer-Verlag.
- Kenakin TP: The relative contribution of affinity and efficacy to agonist activity: organ selectivity of noradrenaline and oxymetazoline with reference to the classification of drug receptors, *Br J Pharmacol* 81:131-143, 1984.
- Mackay D: A critical survey of receptor theories of drug action. In van Rossum JM, editor: *Kinetics of drug action. Handbook of experimental pharmacology*, vol 47, Berlin, 1977, Springer-Verlag.
- Maren TH: The relation between enzyme inhibition and physiological response in the carbonic anhydrase system, *J Pharmacol Exp Ther* 139:140-153, 1963.
- McDonnell DP, Wijayarathne A, Chang CY, et al: Elucidation of the molecular mechanism of action of selective estrogen receptor modulators, *Am J Cardiol* 90:35F-43F, 2002.
- Ruffolo RR Jr, Nichols AJ, Stadel JM, et al: Structure and function of α -adrenoceptors, *Pharmacol Rev* 43:475-505, 1991.
- Surks MI, Oppenheimer JH: Concentration of l-thyroxine and l-triiodothyronine specifically bound to nuclear receptors in rat liver and kidney: quantitative evidence favoring a major role of T3 in thyroid hormone action, *J Clin Invest* 60:555-562, 1977.
- Taylor DR, Kennedy MA: Genetic variation of the β_2 -adrenoceptor: its functional and clinical importance in bronchial asthma, *Am J Pharmacogenomics* 1:165-174, 2001.
- Unwin N: Refined structure of the nicotinic acetylcholine receptor at 4 Å resolution, *J Mol Biol* 346:967-989, 2005.
- Urban JD, Clarke WP, von Zastrow M, et al: Functional selectivity and classical concepts of quantitative pharmacology, *J Pharmacol Exp Ther* 320:1-13, 2007.
- Virkamäki A, Ueki K, Kahn CR: Protein-protein interaction in insulin signaling and the molecular mechanisms of insulin resistance, *J Clin Invest* 103:931-943, 1999.

GENERAL REFERENCES

- Bourne HR, von Zastrow M: Drug receptors and pharmacodynamics. In Katzung BG: *Basic and clinical pharmacology*, ed 10, New York, 2007, McGraw-Hill Professional.
- Buxton ILO: Pharmacokinetics and pharmacodynamics: the dynamics of drug absorption, distribution, action, and elimination. In Brunton LL, Lazo JS, Parker KL, editors: *Goodman and Gilman's the pharmacological basis of therapeutics*, ed 11, New York, 2006, McGraw-Hill.
- Derendorf H, Hochhaus G, editors: *Handbook of pharmacokinetic/pharmacodynamic correlation*, Boca Raton, FL, 1995, CRC Press.
- Kenakin T, Angus JA, editors: *The pharmacology of functional, biochemical, and recombinant receptor systems. Handbook of experimental pharmacology*, vol 148, Berlin, 2000, Springer-Verlag.
- Pratt WB, Taylor P, editors: *Principles of drug action: the basis of pharmacology*, ed 3, New York, 1990, Churchill Livingstone.

Pharmacokinetics: The Absorption, Distribution, and Fate of Drugs

JOHN A. YAGIELA

When the magnitude of a drug's pharmacologic effect is quantified as a function of dose, the tacit assumption is that the drug concentration vicinal to the site of action is linearly related to the amount administered. Although this assumption may strictly apply to an *in vitro* test, it ignores the temporal factors that modify drug effects *in vivo*. Drug concentrations are rarely static; they increase and decrease as dictated by the processes of absorption, distribution, metabolism, and excretion. This chapter examines these processes (Figure 2-1) and how they influence the passage of drugs through the body.

PASSAGE OF DRUGS ACROSS MEMBRANES

For a drug to be absorbed, reach its site of action, and eventually be eliminated, it must cross one or more biologic membrane barriers. These may consist of a single plasma membrane or constitute a layer of closely packed cells. Because such barriers to drugs behave similarly, the cell membrane can serve as a prototype for all. The plasma membrane is composed of a bimolecular sheet of lipids (primarily phospholipids and cholesterol) with proteins interspersed throughout and extending beyond the lipid phase of the membrane (Figure 2-2).^{8,51} The presence of protein molecules spanning the entire thickness of the membrane provides a necessary link between the extracellular environment and the cell interior, which is consistent with the concept that drug activation of a membrane-bound receptor on the external surface of a cell can be directly translated into an intracellular response. Specific transmembrane proteins also provide important pathways for the uptake and extrusion of drugs.

Passive Diffusion

The passage of drugs across biologic membranes can involve several different mechanisms. Of these, passive diffusion is the most commonly encountered. The defining characteristic of passive diffusion is that the drug moves down its electrochemical gradient when crossing the membrane.

Simple diffusion

Studies by Overton and Meyer more than a century ago showed that the cell membrane acts for the most part as a lipid barrier. As shown by Collander (Figure 2-3), the rate of transfer of nonelectrolytes across a membrane is directly proportional to the lipid/water partition coefficient. (The partition coefficient is a measure of the relative solubility of an agent in a fat solvent, such as olive oil or octanol, versus its solubility in water.) A drug with a high partition coefficient (i.e., a *lipophilic* drug) readily enters the lipid phase of the membrane and passes down its concentration gradient to the aqueous phase on

the other side. More molecules are then free to enter the membrane and continue the transfer process. With poorly lipid-soluble compounds, however, few molecules enter the membrane per unit of time, and the rate of passage is depressed.

The absence of an ionic charge is one major factor favoring lipid solubility. Drugs with a fixed charge, such as drugs containing a quaternary nitrogen atom, permeate membranes slowly if at all. The reason for the relative solubility of nonionized molecules in lipids relates to their exclusion from polar media. Simple ions and charged molecules are stabilized in water by the hydration shells that surround them, a consequence of the tendency of charged species to orient polar molecules. This process excludes nonpolar substances, and the resulting segregation causes them to coalesce in a manner analogous to the formation of oil droplets on the surface of water. The term *hydrophobic bonding*, introduced in Chapter 1, refers to the tendency for water-insoluble molecules to be drawn together; this behavior is responsible for the preferential tendency of lipid-soluble drugs to penetrate cell membranes by way of the lipid components. Ionized compounds are so stabilized by their interaction with water that movement into a lipid phase is markedly restricted. Many therapeutic agents are weak electrolytes; depending on the pH of their aqueous environment, they can exist in ionized and neutral forms. Because charged molecules penetrate membranes with considerable difficulty, the rate of movement of these drugs is governed by the partition coefficient of the neutral species and the degree of ionization. As illustrated in Figure 2-4, acidic conditions favor the transport of weak acids, and the opposite holds true for basic compounds.

The same concept of water interaction used to explain the aqueous solubility of ions also applies to many nonionic molecules. Although unsubstituted aliphatic and aromatic hydrocarbons have little or no tendency to react with water, affinity for water molecules is not restricted to structures with a formal charge. Organic residues possessing electronegative atoms such as oxygen, nitrogen, and sulfur can interact with water through the formation of hydrogen bonds to provide some degree of aqueous solubility.

Figure 2-3 shows that lipid solubility is not the only factor influencing the simple diffusion of uncharged drugs across cell membranes; molecular size is also important. Water, glycerol, and some other small molecules permeate much more readily than would be predicted from their respective partition coefficients. Figure 2-3 also shows that some large organic molecules diffuse more slowly than expected. Nonelectrolytes containing numerous hydrophobic groups are often so insoluble in water that their transit across the lipid/water interface may be retarded despite a favorable partition coefficient.²⁶ This finding suggests that some degree of water solubility is necessary for the passive diffusion of drugs across membranes.

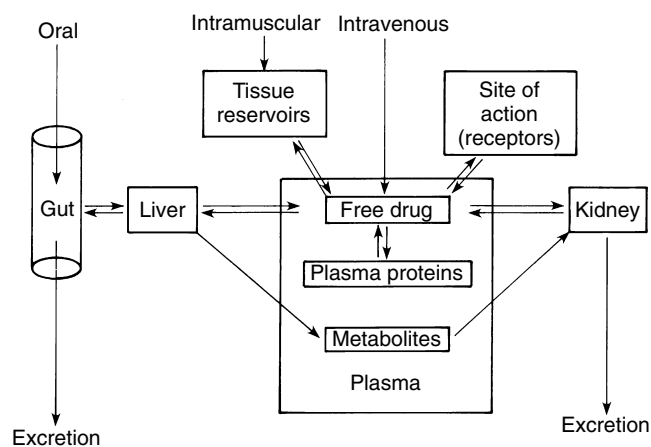

FIGURE 2-1 Outline of the major pathways of absorption, distribution, metabolism, and excretion of drugs. Compounds taken orally must pass through the liver before reaching the systemic circulation. When in the bloodstream, agents are distributed throughout the body and come in contact with their respective sites of action. Drugs are filtered by the kidney, only to be reabsorbed if lipid soluble. Metabolism of many drugs occurs primarily in the liver, after which the metabolites are excreted in bile or urine. Some agents eliminated in the bile are subject to reabsorption and may participate in an enterohepatic cycle.

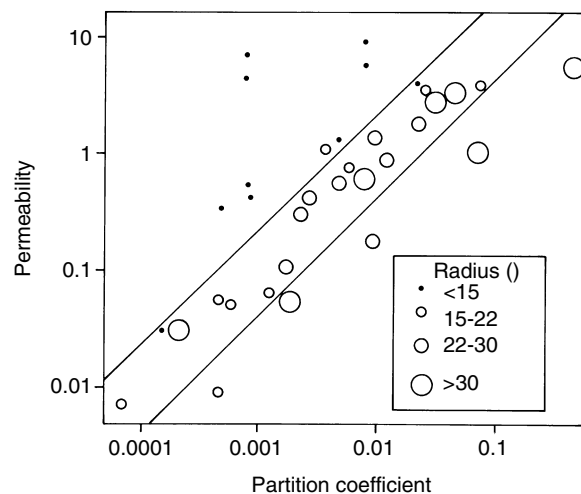

FIGURE 2-3 Relationship between membrane permeability and lipid (olive oil)/water partition coefficient in *Chara certatophylla*. Each circle represents a single nonelectrolyte with a molecular radius as indicated in the key. Small compounds permeate more readily than their partition coefficient would indicate; the reverse is true for large molecules. (Adapted from Collander R: The permeability of plant protoplasts to small molecules, *Physiol Plantarum* 2:300-311, 1949.)

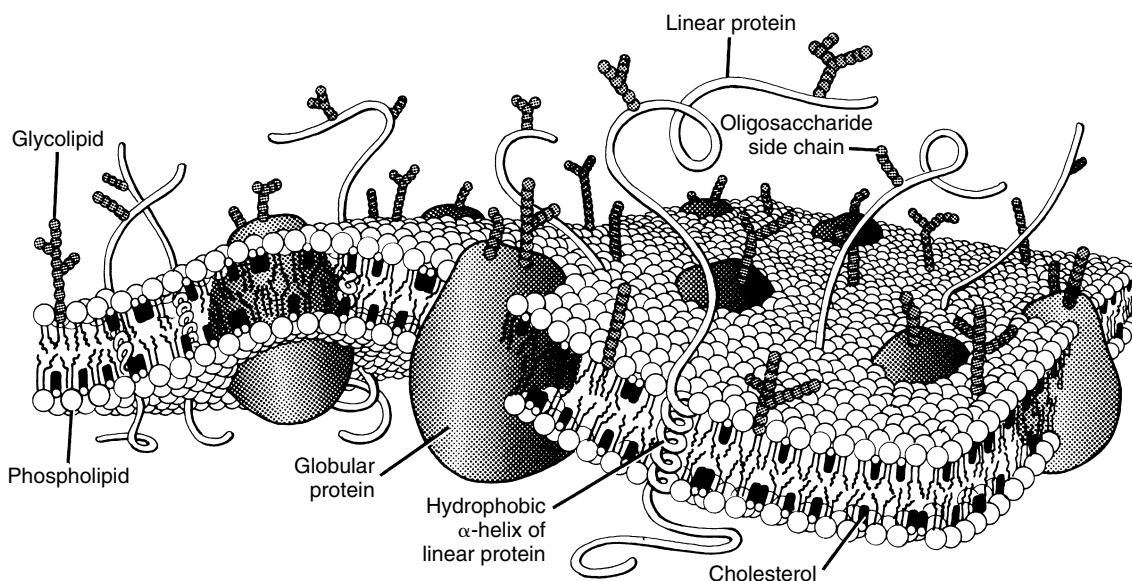

FIGURE 2-2 The plasma membrane depicting the lipid bilayer, composed of phospholipids and cholesterol, and the globular and linear proteins, which are anchored within the membrane by α -helical segments and extend beyond the 40-Å thick bilayer on the extracellular and cytoplasmic surfaces. For clarity, the ratio of lipid to protein is much larger than exists in natural membranes. Glycolipid components of the membrane and saccharide polymers attached to proteins are also shown. (Redrawn from Bretscher MS: The molecules of the cell membrane, *Sci Am* 253:100-108, 1985.)

No matter how lipid soluble an agent is, it will never cross a membrane if it cannot first dissolve in the extracellular fluid and be carried to the structure. Benzocaine, an active local anesthetic when applied directly to nerves, is ineffective after injection because its water insolubility precludes significant diffusion away from the administration site and toward its locus of action within the neuronal membrane. When inside the membrane, a drug with an extremely high partition coefficient may be so soluble in the lipid phase that it has little

tendency, despite moderate solubility in water, to diffuse out of the membrane down its concentration gradient.³⁸ A review of human clinical data involving more than 2400 compounds suggests that simple diffusion will be poor if a drug has two or more of the following characteristics: (1) more than five H-bonding donor groups, (2) more than five H-bonding acceptor groups, (3) more than 10 N and O atoms, (4) a molecular weight greater than 500 Da, and (5) a partition coefficient greater than 10,000:1.²⁸

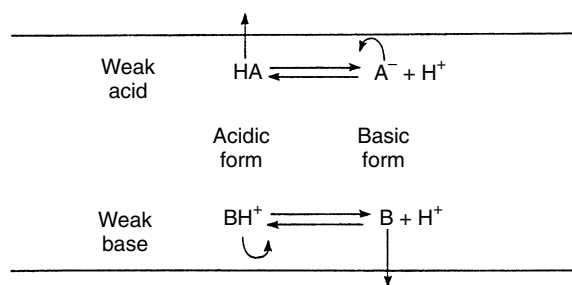

FIGURE 2-4 Membrane penetration by weak electrolytes. The nonionic species of drugs (HA , B) permeate membranes much more efficiently than do the charged forms (A^- , BH^+). Acidic conditions shift the dissociation curves to the left, favoring the diffusion of weak acids. An increase in pH favors the loss of hydrogen (H^+) and the diffusion of weak bases.

Simple diffusion across capillary walls warrants special comment. In addition to the transcellular pathway of drug diffusion just described for lipid-soluble agents, an aqueous paracellular pathway formed by 10-nm to 15-nm clefts between the endothelial cells of most capillaries permits the aqueous diffusion of water-soluble drugs between the plasma and extracellular space. Hydrophilic molecules up to small proteins in size can use this route; fixed negative charges along the diffusion pathway tend to promote the movement of positively charged macromolecules while restricting movement of those with net negative charges.

Adding to the paracellular movement of drugs across capillaries is the bulk flow of water that moves in relation to the net balance of hydrostatic and osmotic forces between the vascular and interstitial compartments. This net transfer of fluid, termed *convection*, carries with it dissolved drugs and other solutes. Convective movement of most drugs is quantitatively inconsequential; however, it may play a major role in the movement of proteins and other macromolecules that avoid filtration by the endothelium, especially in inflamed tissues. The small amounts of albumin and other plasma proteins that reach the extracellular space (4% per hour for albumin) are largely returned to the circulation by lymphatic convection.

Facilitated diffusion

Water, small electrolytes, and hydrophilic molecules of biological importance generally move across plasma membranes much more readily than would be predicted by simple diffusion. In these instances, transmembrane proteins that circumvent the lipid bilayer facilitate diffusion. The simplest mechanism involves a transmembrane pore, such as aquaporin 1. Discovered in 1991, aquaporin 1 is a 28-kDa polypeptide that forms a 3-Å channel through which water can enter or leave cells. More than 10 aquaporins have been discovered in mammalian tissues and are especially prominent in cells and organs involved with the transcellular movement of water: kidneys, capillaries, secretory glands, red blood cells, choroid plexus, brain glia, eyes, and lungs.^{1,24} Some aquaporins are selective for water only, increasing its membrane permeability by a factor of 10 to 100; others permit the passage of glycerol and several other molecules in addition to water.

The movement of specific ions (e.g., Na^+ , K^+ , and Ca^{++}) across the cell membrane is facilitated by the presence of transmembrane channels, such as the nicotinic receptor described in Figure 1-2 and the Na^+ channel illustrated in Figure 16-4. The opening of these gated channels (in contrast to porins, which are always open) is regulated by the electric potential across the membrane or by the presence of specific ligands, such as neurotransmitters. When a channel is open, passive diffusion of an ion capable of traversing it depends on

the electric potential across the membrane and the ion's own chemical gradient. Boosting the electrochemical gradient by manipulating the voltage across the cell membrane is an effective method of increasing ionic flow. Even in the absence of specific ion channels, the transport of fixed ions and weak electrolytes across tissue barriers can be facilitated by the appropriate use of electric current (as in iontophoresis, discussed subsequently).

Numerous lipid-insoluble substances are shuttled across plasma membranes by forming complexes with specific membrane constituents called *carriers* or *transporters*. Carriers are similar to receptors in many ways; they are proteins, often quite selective in the agents with which they combine, and subject to competitive inhibition. Because the number of transporter molecules is finite, carrier-mediated diffusion can be saturated at high drug concentrations. The GLUT family of glucose transporters is representative of carrier proteins that facilitate the movement of hydrophilic solutes across cell membranes. The initial step in the facilitated diffusion of glucose is its binding to the exposed active site of the transporter protein. This binding sequentially causes an external barrier or gate to close and interior gate to open, after which the glucose is released into the cell. The loss of glucose causes the internal gate to close and the external gate to open, exposing the active site and completing the cycle.

Active Transport

Active transport is the term given to the carrier-mediated transfer of a drug against its electrochemical gradient. In addition to exhibiting selectivity and saturability, active transport requires the expenditure of energy and may be blocked by inhibitors of cellular metabolism. Active transport permits the efficient absorption of substances vital for cellular function (and certain drugs that resemble them structurally) and the selective elimination of waste products and foreign chemicals, including many drugs. Approximately 2000 genes—7% of the total human genome—code for transporters and associated proteins. Two superfamilies of transporters are of special significance to pharmacokinetics: ATP-binding cassette (ABC) transporters, and solute carrier (SLC) transporters.

Approximately 49 ABC transporters hydrolyze adenosine triphosphate (ATP) to provide the energy directly needed for molecular transport and are referred to as *primary active transporters*. P-glycoprotein (P for altered permeability), also known as *multidrug resistance protein-1 (MDR-1)* and given the designation *ABCB1* by the Human Gene Nomenclature Committee, is the most extensively researched representative. Originally identified in 1976 for its ability to expel numerous antineoplastic drugs from mutated cells that overexpress it, P-glycoprotein is a 170-kDa glycoprotein composed of two subunits in a head-to-tail arrangement (Figure 2-5).^{44,48} Each subunit contains a transmembrane domain of six α -helices that span the plasma membrane and help form the pump itself, and a nucleotide-binding domain (also known as the ABC cassette) that hydrolyzes ATP to power the transport. Many ABC transporters are referred to as half transporters because they consist of only a single subunit and must dimerize to create the active pump. P-glycoprotein preferentially promotes the cellular extrusion of large (300 Da to 2000 Da) hydrophobic substances and neutral or positively charged amphiphilic molecules. Transported drugs include numerous anticancer agents (e.g., doxorubicin, vinblastine, and paclitaxel), antiviral compounds (e.g., ritonavir), Ca^{++} -channel blockers (e.g., diltiazem), digoxin, antibiotic and antifungal drugs (e.g., erythromycin and ketoconazole), hormones (e.g., testosterone), and immunosuppressants (e.g., cyclosporine).

Drug binding occurs within the plasma membrane near the cytoplasmic surface, limiting transport to drugs with good lipid solubility or sufficient length to reach the active site.

FIGURE 2-5 Structure of P-glycoprotein. Two transmembrane domains (*TMDs*) provide the transport mechanism and are powered by the nucleotide-binding domains (*NBDs*) that hydrolyze ATP. **A**, Three-dimensional model. *Top*, Lateral view. The transmembrane helices are darkened; four α -helical structures that do not traverse the membrane are lightly shaded, including one (*) that is partially intracellular in location. *Dashed lines* delimit the lipid bilayer. *Bottom*, View from the extracellular space illustrating the pseudosymmetric arrangement of the transmembrane helices. **B**, Two-dimensional topology. (A, Adapted from Rosenberg MF, Callaghan R, Modok S, et al: Three-dimensional structure of P-glycoprotein, *J Biol Chem* 280:2857-2862, 2005; B, adapted from Sarkadi B, Homolya L, Szakács G, et al: Human multidrug resistance ABCB and ABCG transporters: participation in a chemoinnity defense system, *Physiol Rev* 86:1179-1236, 2006.)

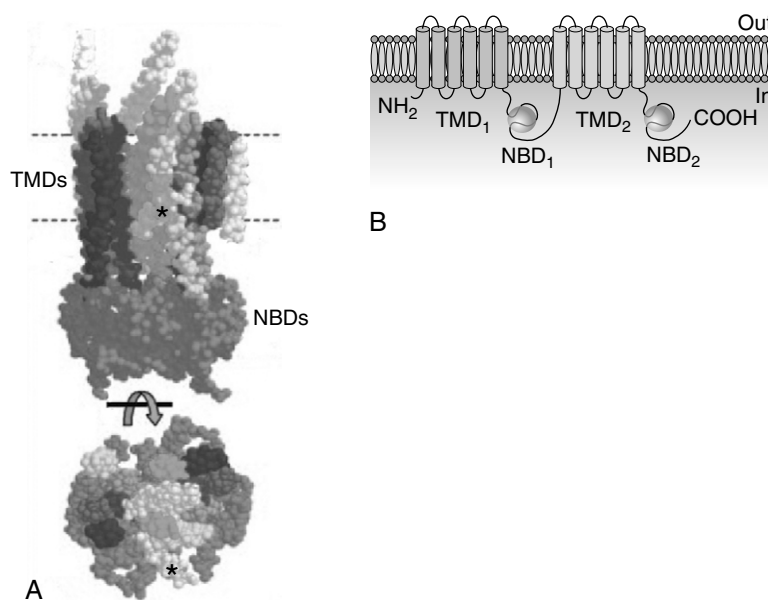

P-glycoprotein is expressed in various cells, but the highest concentrations are located in intestinal epithelial cells; renal proximal tubular cells; canalicular membranes of hepatocytes; the capillary endothelium of the brain, choroid plexus, testes, and placenta; placental trophoblasts; adrenocortical cells; and stem cells.³⁰ Other ABC transporters important in pharmacokinetics include the multidrug resistance-associated protein (MRP) family. Collectively, the MRP transporters are also widespread and involved in the vectorial (one-way) movement of drugs and other xenobiotics. In contrast to P-glycoprotein, the MRP transporters pump amphiphilic molecules with at least one negative charge. These substrates include bile salts, nucleotide analogues, and conjugates of glutathione, glucuronic acid, and sulfate.

The known SLC transporters encompass 48 families encoded in 400 genes. Because the SLC transporters do not directly use ATP as an energy source for transport, they are more accurately referred to as *secondary active transporters*. The Na⁺ pump (or Na⁺/K⁺-ATPase), which uses about one fourth of the body's ATP production, is the principal driving force for secondary active transport. By maintaining a large electrochemical gradient for Na⁺ across the plasma membrane, movements of molecules that are energetically coupled to Na⁺ (or another ion with a strong electrochemical potential difference across the membrane) can occur against their own concentration gradients. Secondary active transporters that move the coupled substances in the same direction as the linked ion are termed *cotransporters* or *symporters*. In contrast, antiporters or exchangers move the coupled substances in the opposite direction. Many SLC transporters (including the GLUT family described previously) allow the transmembrane movement of specific chemicals down their own electrochemical gradients and support facilitated diffusion. In contrast to the ABC transporters, SLC transporters can facilitate the bidirectional movement of substrates based on their existing concentrations across the cell membrane.

Organic anion transporters (OATs) and organic anion-transporting polypeptides (OATPs) are important families of SLC transporters involved in pharmacokinetics.³⁵ As a group, they promote the cellular uptake of acidic drugs into the liver, kidney, intestine, lung, and brain, and their excretion via the bile and urine. An analogous family of organic cation transporters (OCTs) provides similar handling of positively charged drugs.

Endocytosis and Exocytosis

The processes of endocytosis and exocytosis are together the most complex methods of drug transfer across a biologic membrane. The term *endocytosis* refers to a series of events in which a substance is engulfed and internalized by the cell. (Phagocytosis, or “cell eating,” is a variant of endocytosis associated more with the removal of particulate matter by macrophages than with drug transport.)

Endocytosis usually begins with the binding of a compound, usually a macromolecule, to be absorbed by its receptor on the membrane surface. Two good examples are the attachment of low-density lipoprotein (LDL) and insulin to their respective receptors. With time, the bound agent-receptor complex is concentrated in an indentation of the membrane called a coated pit. (This migration also occurs spontaneously with the LDL receptor.) Clathrin, a cytoplasmic protein that attaches to the internal surface of the plasma membrane, serves to capture the receptors within the pit while excluding other surface proteins.⁴⁹ Internal rearrangement of its structure deepens the pit, forming a coated bud. A second protein, termed *dynamain*, is believed to congregate around the collar of the invaginated bud and initiate separation from the membrane. When released, the vesicle loses its clathrin coat and fuses with an organelle called the endosome. Some of the captured contents, such as LDL receptors, are recycled back to the plasma membrane by transport vesicles; the remainder undergo lysosomal processing and release into the cytoplasm.

An alternative method of endocytosis involves indentations on the plasma membrane termed *caveolae*. Caveolae contain large amounts of cholesterol covalently linked to caveolin-1, the primary structural protein of these structures. The internalization process also involves vesicle formation, but clathrin and endosomes do not participate in the internalization process.

The complementary process of exocytosis occurs when vesicles, such as those produced by the Golgi apparatus, fuse with the plasma membrane and discharge their contents outside the cell. Exocytosis is the primary method by which cellular products such as regulatory hormones are secreted by the cell. The term *transcytosis* is descriptive of a coupled form of endocytosis and exocytosis leading to the transfer of drug from one epithelial surface of a cell to another. In this scenario, the endosomal vesicle described previously avoids lyso-

somal capture, is transported across the cell, and fuses with the plasma membrane to release its contents extracellularly.

Cells generally are capable of endocytosis; however, exocytosis and transcytosis are most intensive in tissues adapted for the absorption, distribution, and export of important foodstuffs, regulatory hormones, and secretory products. Endocytosis/transcytosis is probably responsible for the absorption of antigenic proteins and certain toxins from the small intestine and for the transfer of large molecules between tissue compartments. It plays a minor role in the transport of most drugs.

ABSORPTION

Absorption refers to the transfer of a drug from its site of administration into the bloodstream. The particular route of administration selected greatly influences the rate and perhaps the extent of drug absorption.

Oral Ingestion

Oral ingestion was the first and is still the most commonly used method for the administration of therapeutic agents. The major advantages of the oral route lie in three areas: convenience, economics, and safety. Patient acceptance of oral medication is good because the technique itself is painless, and trained personnel are not required for its accomplishment. The convenience and low cost with respect to other modes of therapy are especially prominent for drugs that must be given several times daily on a long-term basis. The oral route is relatively safe because drug absorption is comparatively slow. Sudden high blood concentrations are not nearly as likely to be achieved by the ingestion of drugs as they are by parenteral injection. Allergic reactions are also less likely to occur, especially serious reactions. The oral route does have some drawbacks, however. Because self-administration is the rule, patient compliance is required for optimal therapy. Drug absorption is likely to be delayed (on a clinical average of 30 to 60 minutes) and may be incomplete. Metabolic inactivation or complex formation may also occur before the drug has a chance to reach the systemic circulation. These limitations to the oral route translate into an increased variability in patient response. Finally, the spectrum of adverse reactions caused by oral medication can extend from one end of the gastrointestinal tract to the other.

Drugs taken orally may be absorbed along the entire alimentary canal, but the relative degree of contact with the mucosa determines the amount of uptake in each segment. Variables affecting absorption include the duration of exposure, the concentration of the drug, and the surface area available for absorption. Under normal circumstances, the oral and esophageal mucosa are exposed too briefly to a drug

during the process of swallowing for any absorption to occur. The colon normally plays no role in the uptake of orally administered compounds because, with the exception of some sustained-release preparations, little absorbable drug usually reaches it. By exclusion, the bulk of drug absorption must occur in the stomach and small intestine.

Influence of pH

As previously discussed, absorption is favored when the drug ingested is lipid soluble. For weak electrolytes, the pH of the surrounding medium affects the degree of ionization and drug absorption. Because the H^+ concentrations of the stomach and small intestine diverge widely, the two structures seem to be qualitatively dissimilar in their respective patterns of drug absorption. Figure 2-6 illustrates this difference and its effect on the previously commonly used analgesic combination of aspirin plus codeine. Aspirin is an organic acid with a pK_a (negative log of the dissociation constant) of 3.49. In gastric juice (pH 1 to 3), aspirin remains largely nonionized, and its passage across the stomach mucosa and into the bloodstream is favored. The plasma has a pH of 7.4, however. On entering this environment, the aspirin becomes ionized to such an extent that return of the drug to the gastrointestinal tract is prevented by the low lipid solubility of the anionic species. When equilibrium is established, the concentration of nonionized aspirin molecules on both sides of the membrane is the same, but the total amount of drug (ionized plus neutral forms) is much greater on the plasma side. The relative concentration of drug in each compartment can be calculated with the Henderson-Hasselbalch equation, as follows:

$$\text{Log} \frac{\text{base}(A^-)}{\text{acid}(HA)} = \text{pH} - \text{p}K_a$$

This unequal distribution of drug molecules based on the pH gradient across the gastric membrane is an example of ion trapping. The biologic process that sustains this partitioning is the energy-consuming secretion of H^+ by the gastric parietal cells. Because few organic acids have a pK_a low enough to permit significant ionization at stomach pH, almost all acidic drugs should theoretically be effectively absorbed across the gastric mucosa.

For bases such as codeine (pK_a 7.9), the opposite applies. Codeine is almost completely ionized in the acidic environment of the stomach; absorption is negligible. At equilibrium, virtually all the drug remains within the stomach. Only very weak bases are nonionized at gastric pH and available for absorption. The ion trapping of basic compounds within the gastric lumen is sometimes useful in forensic medicine. Many drugs subject to abuse are organic bases (e.g., heroin, cocaine, and amphetamine). Even when injected

	Stomach pH 1.4		Plasma pH 7.4		
Aspirin pK_a 3.4	$A^- \rightleftharpoons HA$		$HA \rightleftharpoons A^-$		
	0.01	1.0	1.0	10,000	
Total drug	1.01		10,001		$\frac{\text{Plasma}}{\text{Gastric}} \text{ Ratio} = \frac{10^4}{1}$
Codeine pK_a 7.9	$BH^+ \rightleftharpoons B$		$B \rightleftharpoons BH^+$		
	3.16×10^6	1.0	1.0	3.16	
Total drug	3.16×10^6		4.16		$\frac{\text{Plasma}}{\text{Gastric}} \text{ Ratio} = \frac{1}{10^6}$

FIGURE 2-6 Gastric absorption of aspirin, a weak acid, and codeine, a weak base. The absorption of aspirin is promoted by ion trapping within the plasma; the low pH of stomach fluid favors gastric retention of codeine. (The 3.49 pK_a of aspirin is truncated to 3.4 for purposes of illustration.)

intravenously, they tend to accumulate in the stomach by crossing the gastric mucosa in the reverse direction. Questions of intravenous overdosage can often be answered from the analysis of stomach contents.

When the gastric fluid passes into the small intestine, it is quickly neutralized by pancreatic, biliary, and intestinal secretions. The pH of the proximal one fourth of the intestine varies from 3 to 6, but it reaches neutrality in more distal segments. Under these more alkaline conditions, aspirin converts to the anionic form, whereas a significant fraction of the codeine molecules give up their positive charge. Although basic drugs are favored for absorption over acids in the small intestine, ion trapping is not as extensive because the pH differential across the intestinal mucosa is small. Differences in intestinal absorption based on pH are more concerned with the rate of uptake than with its extent. As one might expect, neutralization of gastric contents by the administration of antacids or ingestion of food temporarily removes the qualitative disparity in electrolyte absorption normally observed between the stomach and the small intestine.

Mucosal surface area

A second major difference between absorption in the stomach and absorption in the small intestine relates to the intraluminal surface areas involved in drug uptake. Aside from certain mucosal irregularities (rugae), the stomach lining approximates that of a smooth pouch with a thick mucous layer. The mucosa of the small intestine is uniquely adapted for absorption, however. Contributions by the folds of Kerckring, villi, and microvilli combine to increase the effective surface area 600-fold. Assuming a small intestine 280 cm in length and 4 cm in diameter, approximately 200 m² are available for drug absorption. The surface/volume ratio in the small intestine is so great that drugs ionized even to the extent of 99% may still be effectively absorbed. Many studies have shown that acidic drugs with a pK_a greater than 3.0 and basic compounds with a pK_a less than 8.0 readily pass from the intestinal fluid into the plasma.¹⁹ Although pH considerations favor the gastric absorption of aspirin, as much as 90% of the drug when given in tablet form is actually absorbed from the small intestine *in vivo*. Experimentally, nonelectrolytes such as ethanol are also absorbed from the intestine many times faster than from the stomach.

Gastric emptying

Because almost any substance that can penetrate the gastrointestinal epithelium is best absorbed in the small intestine, the rate of gastric emptying can significantly affect drug absorption, particularly for organic bases that are not absorbed at all from the stomach. Gastric emptying is accomplished by contraction of the antrum of the stomach. A cyclical pattern of activity occurs in fasting patients where periods of quiescence (about 1 hour each) are followed by contractions that increase in intensity over a 40-minute period before terminating in a short burst of intense contractions that migrate from the stomach to the distal ileum. Ingesting a tablet or small volume of liquid may result in gastric retention of the drug for 1 hour or longer. After eating a meal, sustained antral and pyloric contractions help break up the ingested food and permit the extrusion of liquid into the duodenum while retaining particles more than 1 mm in diameter within the stomach. A mixed meal of solids and liquids usually begins to enter the duodenum in about 30 minutes and requires about 4 hours to leave the stomach completely. A glass of water ingested on an empty stomach is moved into the small intestine in exponential fashion, with half of the water expelled from the stomach in 15 minutes, and essentially all of the liquid removed by 1 hour.

A major variable in delaying gastric emptying is the presence of fat. Unless drug-induced irritation of the gastric mucosa must be avoided, most oral medications should be

taken in the absence of food but with a full glass of water. This procedure speeds drug entry into the small intestine and provides maximum access to the gastrointestinal mucosa. Occasionally, the presence of a fatty meal promotes the absorption of a drug that has a high lipid but low water solubility. The antifungal agent griseofulvin, the protease inhibitor saquinavir, and the fat-soluble vitamins are examples of substances that are better absorbed in the presence of lipids. In these instances, the delay in gastric emptying produced by the high fat content of the chyme is compensated for by a more complete absorption.

Additional situations in which food enhances drug uptake have been reviewed.³³ Nevertheless, because gastric emptying is often a limiting factor in the rate of drug absorption, many unrelated drugs exhibit latency periods (the lag phase between oral ingestion and onset of drug effect) of a similar magnitude.

Influence of dosage form

Although the times required for gastric emptying and for diffusion across the mucosal barrier undoubtedly contribute to the delayed onset of action of drugs taken orally, situations exist in which these events are not rate limiting. Most drugs intended for oral use are marketed in the form of capsules or solid tablets. In contrast to solutions, these preparations must first dissolve in the gastrointestinal fluid before absorption can occur. If dissolution is very slow, it can become the controlling factor in drug absorption.

The first step in the dissolution process is the disintegration of the tablet (or the capsule and its granules) to yield the primary drug particles. Various excipients are usually included in solid drug preparations to promote disintegration and particle dispersion. If disintegration is impaired, drug absorption is depressed accordingly. The dissolution of drug particles occurs by a diffusion-limited mechanism. The diffusion layer of solvent surrounding each particle becomes saturated very quickly with drug molecules escaping from the solid. Because saturation of the diffusion layer occurs far more rapidly than does diffusion from it into the bulk solution, the entire process proceeds no faster than the rate of drug diffusion. Several methods can be used, however, to accelerate the dissolution rate. Because the total surface area of the particles determines the area available for diffusion, reducing the mean particle size through the process of micronization promotes solubilization. A decrease in particle size of 85% with a compensating increase in particle number doubles the rate of dissolution.²⁷ Another useful approach is to manufacture drugs in the form of water-soluble salts. The concentration of drug in the dissolution layer is enhanced (often by many times), and the rate of diffusion is increased.

The dissolution process may be considered rate limiting whenever a drug solution produces a systemic effect faster than a solid formulation of the same agent does. Sometimes discrepancies in absorption between dosage forms are of such magnitude that clinical differences are noted. With aspirin, the concentration of drug in the plasma 30 minutes after administration can be twice as high for a solution as for a solid tablet.²⁷ Although it is unclear whether this difference results solely from drug dissolution or from other factors, such as the more rapid gastric emptying typical of liquids, dissolution is probably at least partially responsible.

The influence of dosage form on drug absorption is often taken advantage of by drug manufacturers. Some drugs (e.g., erythromycin) are unstable at a low pH, and others (e.g., ammonium chloride) are irritating to the gastric mucosa. To avoid release of these drugs within the stomach, they are often prepared in the form of enteric-coated tablets. An enteric coat consists of a film of shellac or some polymeric substitute. The covering is insoluble under acidic conditions, but does break down to permit tablet disintegration in the more alkaline

environment of the small intestine. Although these preparations are often beneficial, their usefulness nevertheless is negatively affected by an increased variability in patient response. Because drug absorption cannot begin until the tablet passes into the duodenum, the time required for gastric transit becomes an important variable. The passage of a single insoluble tablet from the stomach into the intestine is a random event that can take several minutes to more than 6 hours.¹⁵

Sustained-release preparations represent another method of capitalizing on the influence of formulation on drug absorption. These products are usually designed to release a steady amount of drug within the gastrointestinal tract for 12 to 24 hours. Some preparations also provide an initial loading dose that is readily available for absorption. Sustained release may be accomplished by using a porous matrix, with the drug located in the interior spaces and on the external surface. An alternative is to make spheres of drug that dissolve at different rates because of various coatings. An intriguing form of sustained-release tablet is the “elementary osmotic pump,” in which the drug is enclosed in a semipermeable membrane that lets water in, but restricts drug egress. Constant release through a small hole in the membrane is achieved by the osmotic pressure that builds up within the tablet as the drug is slowly dissolved. Advantages claimed for these drug products include greater patient compliance and smaller fluctuations in blood concentration between dosages. Studies with some preparations have documented a greater variability in performance, however, than is normally encountered with conventional dosage forms. Because sustained-release products contain several conventional doses of medication, a danger exists that a too-rapid release of drug from these preparations might cause unexpected toxic concentrations. Conversely, inordinately slow or incomplete release could lead to inadequate drug therapy. Uncertainty over the effects of these formulations is recognized by the U.S. Food and Drug Administration (FDA), which regards them as new drugs and requires that efficacy and safety be shown before they can be marketed.

The sensitivity of gastrointestinal absorption to variations in drug formulation is best exemplified by the concern over bioavailability. In many instances, chemically identical drugs have proved in the past to be biologically nonequivalent. In one study of tetracycline hydrochloride, nine preparations of different manufacture were compared with an aqueous solution of the same drug.²⁹ Although seven brands produced blood concentrations ranging from 70% to 100% of the reference solution, two products exhibited relative bioavailabilities of only 20% to 30%. Differences in bioavailability are most likely to be clinically important with drugs that are poorly

absorbed, have low margins of safety, and are inactivated by capacity-limited processes. Since 1977, federal law has required that bioequivalence testing be performed on all new drugs, and the FDA has mandated such testing of existing products for which a problem of nonequivalence is known to exist. Bioavailability considerations related to drug selection are considered further in Chapter 55.

Active transport

Most drugs intended for oral use are absorbed by passive diffusion. Active transport systems do exist, however, for specific dietary constituents that sometimes increase the absorption of certain drugs. The absorption of levodopa and baclofen from the intestine is enhanced because they are amino acid analogues and actively transported into intestinal cells by the large neutral amino acid transporter (LNAT, an SLC transporter). Valacyclovir is likewise much better absorbed than is its congener acyclovir because it is a substrate for PepT-1, another SLC transporter.

Active transport mechanisms can also inhibit drug absorption.³⁰ P-glycoprotein is highly expressed along the luminal surface of intestinal epithelial cells, where it exports xenobiotics that would otherwise be absorbed. This function is in concert with the “chemoimmunity defensive” role P-glycoprotein plays in protecting cells from exposure to potentially toxic compounds.⁴⁸ Although P-glycoprotein may delay the absorption of many drugs and prevent altogether the uptake of pharmaceuticals of low absorptive potential, it is probably of minor significance regarding the extent of absorption of most drugs intended for oral use, whose concentrations in the chyme are sufficient to overwhelm the capacity of P-glycoprotein to export them.⁴⁷ Figure 2-7 depicts the active transport of drugs into and out of intestinal cells and at other important sites.

Drug inactivation

A shortcoming of oral ingestion is the inactivation of drugs before they reach the systemic circulation. The destruction of some agents (e.g., epinephrine and insulin) is sufficiently great to preclude their administration by this route. With other drugs (e.g., penicillin G), losses may be smaller, but still large enough to make oral administration inefficient. Gastric acid is one of the principal causes of drug breakdown within the gastrointestinal tract, but degradation also results from enzymatic activity. Vasopressin, insulin, calcitonin, and other polypeptides are subject to hydrolysis by pancreatic and intestinal peptidases. Intestinal cells also contain intracellular

Rights were not granted to include this figure in electronic media.
Please refer to the printed publication.

FIGURE 2-7 Transepithelial or transendothelial transport of drugs across the liver (absorption), brain capillaries (distribution), and liver and kidneys (elimination). ABC, ATP-binding cassette transporter; SLC, solute carrier transporter. (Adapted from Giacomini KM, Sugiyama Y: Membrane transporters and drug response. In Brunton LL, Lazo JS, Parker KL, editors: *Goodman & Gilman's the pharmacological basis of therapeutics*, ed 11, New York, 2006, McGraw-Hill.)

enzymes for metabolizing drugs. Of particular importance are the presence of monoamine oxidase for the inactivation of biogenic amines and the presence of CYP3A4/5 enzymes (described later) for the oxidation of numerous compounds. Enteric bacterial enzymes may also destroy certain ingested agents, such as chlorpromazine. Finally, intestinal contents can alter the effectiveness of many orally administered drugs. Binding to constituents of chyme, chelation with divalent cations, or formation of insoluble salts may decrease the amount of drug available for absorption.

A special fate exists for substances that are successfully absorbed from the gastrointestinal tract. The venous drainage of the stomach, small intestine, and colon is routed by the hepatic portal system to the liver. A first pass of high drug concentration through this enzyme-laden organ can significantly reduce the quantity of agent reaching the systemic circulation. Lidocaine is metabolized so rapidly in the liver that virtually all of an oral dose is destroyed during its first pass. Although less pronounced, disparities in opioid analgesic and antibiotic efficacies observed between the oral route and other modes of administration are of clinical importance to the practice of dentistry.

Other enteral routes

The oral and rectal mucosae are occasionally used as sites of drug absorption. Sublingual administration, in which a tablet or troche is allowed to dissolve completely in the oral cavity, takes advantage of the permeability of the oral epithelium and is the preferred route for a few potent lipophilic drugs, such as nitroglycerin and oxytocin. The oral and intestinal mucosal layers do not differ qualitatively as absorbing surfaces, and comparable absorption has been shown for many agents.⁶ One reason for selecting the sublingual route is to avoid drug destruction. Because gastric acid and intestinal and hepatic enzymes are bypassed, sublingual absorption can be more efficient overall for certain drugs than is intestinal uptake. The onset of drug effect may also be quicker than with oral ingestion.

Rectal administration may be used when other enteral routes are precluded, as in an unconscious or nauseated patient. Although a significant fraction of absorbed drug enters the circulation without having to pass through the liver, uptake is often unpredictable. Several drugs irritating to the gastric mucosa (e.g., xanthines) may be given rectally; for others, rectal sensitivity prohibits administration by this route.

Inhalation

The alveolar membrane is an important route of entry for some drugs and many noxious substances. Although the alveolar lining is highly permeable, it is accessible only to agents that are in a gaseous state or are inhaled in sufficiently fine powders or droplets to reach the deepest endings of the respiratory tree. Gaseous agents include the therapeutic gases, carbon monoxide, the inhalation anesthetics, and numerous volatile organic solvents. The second category of alveolar membrane penetrants is collectively known as *aerosols*. This term refers to liquid or solid particles small enough (usually $\leq 10 \mu\text{m}$ in diameter) to remain suspended in air for prolonged periods. Particles of this sort include bacteria, viruses, smoke, pollens, sprays, and dusts. Any such finely divided material, when inhaled, reaches some portion of the respiratory tree and is affected by the processes of sedimentation and inertial precipitation. Most aerosols contain a mixture of particle sizes. Relatively large particles ($\geq 5 \mu\text{m}$) impact on the terminal bronchioles and larger branches of the respiratory tree and are removed from the lungs by a cilia-driven blanket of mucus flowing continuously toward the pharynx. Smaller particles, which do reach the alveolar sacs, can be absorbed through the lining cells into the bloodstream, taken up by the process of

phagocytosis, or carried by an aqueous film covering the alveolar cells to the terminal bronchioles where they join the mucous blanket. Although two of these three possible fates involve particle uptake, the mechanism for removing solids is remarkably efficient. Only a minute portion of the inhaled dusts of a lifetime fails to be removed by ciliary transport.

Therapeutic use of aerosols is not widespread, but some emergency medications are prepared in this form. Because the onset of effect is extremely rapid after inhalation of an aerosol drug, this route can provide a means of quick self-medication for individuals in danger of acute allergic reactions to venoms or drugs. Epinephrine is one such emergency agent that is marketed as an aerosol. Many respiratory drugs are also prepared in aerosol form because they are highly effective by this route while minimizing systemic exposure. The rapidity and efficiency of alveolar membrane absorption can occasionally pose problems for therapy, however, as illustrated by the use of pressurized aerosols containing isoproterenol. Although 97% of an isoproterenol spray is swallowed under normal conditions and inactivated by various enzymes, overmedication can produce toxic effects. Data gathered over a 7-year period in the United Kingdom suggested that the undisciplined use of these preparations increased mortality in asthmatic patients. Restriction of over-the-counter sales and warnings to physicians were accompanied by a decline in mortality.²¹ Findings such as these reflect the hazards of aerosols when abused and provide a caveat for uncontrolled self-medication with any potentially dangerous drug. Concern over aerosols is also related to questions of toxicology, such as the absorption of heavy metal dusts by industrial workers.

Parenteral Injection

Drugs are frequently given by parenteral injection when oral ingestion is precluded by the patient's condition, when a rapid onset of effect is necessary, or when blood concentrations greater than those obtainable with the enteral route are required. The method of injection selected varies with the particular drug and therapeutic need of the patient.

Intravenous route

The administration of drugs by infusion or injection directly into the bloodstream is particularly useful when immediate effects or exact blood concentrations are desired. Because absorption is bypassed, intravenous injection circumvents the delays and variations in drug response characteristically associated with other modes of administration. Rapid dilution in the bloodstream and the relative insensitivity of the venous endothelium to drugs often permit the successful administration of compounds or solutions too irritating for other routes (e.g., alkylating anticancer drugs and hypertonic fluids). Also, through the technique of titration, the intravenous route provides an avenue for the controlled administration of drugs that have a very narrow margin of safety between therapeutic and toxic concentrations. The infusion of lidocaine to prevent ventricular arrhythmias and the incremental injection of anti-anxiety drugs during intravenous sedation are two examples in which titration is used to achieve a desired effect while avoiding adverse reactions. Although many intravenous agents do not require titration and may be given in standardized doses, they should still be injected slowly. If administered too quickly, a dose may move initially through the heart, lungs, and major arteries as a bolus of high drug concentration. Nonspecific but potentially disastrous cardiopulmonary side effects may result, even from the rapid injection of simple salt solutions. Most drugs should be administered over a period of 1 minute, which approximates the circulation time of blood through the body. This procedure avoids high, transient concentrations and permits discontinuance if any untoward effect is observed during the course of injection.

A major disadvantage of the intravenous route is that, once the drug is injected, very little can be done to remove it from the bloodstream. When an adverse response is noted with another route, further absorption usually can be delayed or perhaps even prevented. Toxic reactions to drugs given intravenously are often instantaneous and severe. Life-threatening anaphylactic events are also more likely because of the possibility of a massive antigen-antibody reaction. Other complications of intravenous injection include vasculitis and embolism (from drug irritation, particulate matter in the injected solution, or needle trauma), fever (from injection of pyrogens such as bacterial lipopolysaccharides), infection, and hematoma formation. Finally, the accidental intra-arterial injection of drugs (e.g., promethazine) intended for intravenous use has led to arteriospasm, gangrene, and loss of limbs.

Intramuscular route

The intramuscular route is often selected for drugs that cannot be given orally because of slow or erratic absorption, high percentage of drug inactivation, or lack of patient cooperation. The rate of absorption from an intramuscular site is governed by the same factors influencing gastrointestinal uptake, such as lipid/water partition coefficient, degree of ionization, and molecular size. Many drugs are absorbed at approximately the same rate, however, regardless of these factors. The only barrier separating a drug deposited intramuscularly from the bloodstream is the capillary endothelium, a multicellular membrane with large intercellular gaps. Many lipid-insoluble substances can enter the vascular compartment through these gaps, and even proteins are capable of being absorbed. In these circumstances, blood flow through the tissue is often the primary determinant of the rate of drug absorption. Muscles with high blood flows (e.g., deltoid) provide faster absorption rates than muscles with lesser flows (e.g., gluteus maximus). Generally, 5 to 30 minutes is required for the onset of drug effect, but this latency period can be controlled to some extent. Exercise markedly speeds absorption by stimulating local circulation. Conversely, uptake may be minimized by the application of ice packs or (in an emergency) tourniquets.

With the exception of a few drugs that are relatively insoluble at tissue pH (e.g., diazepam, phenytoin), absorption from an intramuscular injection is usually rapid and complete. Formulations have been developed, though, to provide for prolonged and steady drug release. These depot preparations consist of drugs manufactured as insoluble salts or dispensed in oil vehicles, or both, such as procaine penicillin suspended in peanut oil. Relatively large volumes of solution may be given by this route, but soreness at the injection site is frequent, and some drugs (e.g., doxycycline) are too irritating to be administered in this manner.

Subcutaneous route

Injection of drugs into the subcutaneous connective tissue is a widely used method of administration for agents that can be given in small volumes (≤ 2 mL) and are not locally damaging. Subcutaneous absorption is similar to that of resting muscle, and onset times are often comparable. As with the intramuscular route, absorption can be delayed by diminishing blood flow, either through the application of pressure or by surface cooling. Pharmacologic interruption of circulation with vasoconstrictors is also a common strategy, especially in local anesthesia. Because of the ease of subcutaneous implantation, compressed pellets of drugs, sometimes mixed with insoluble matrix material, can be inserted to provide nearly constant drug release for weeks or months. Testosterone and several progestational contraceptive agents (e.g., levonorgestrel) have been successfully administered by this approach. Slow absorption also can be achieved through the use of depot forms as described for intramuscular injections.

When subcutaneous administration is chosen for a systemic effect, the hastening of drug absorption is sometimes advantageous. Toward this end, warming the tissue promotes drug uptake by improving local circulation. Massage of the injection site, in addition to stimulating blood flow, helps spread the drug and provides an increased surface area for absorption. This latter effect can also be accomplished through the coadministration of hyaluronidase, an enzyme that breaks down the mucopolysaccharide matrix of connective tissue. The lateral spread of aqueous solutions is so enhanced that hyaluronidase is sometimes used to permit the injection of large fluid volumes in situations in which continuous intravenous infusion is difficult or impossible.

Other parenteral injection routes

Intra-arterial injections are occasionally performed when a localized effect on a particular organ or area of the body is desired. Injections of radiopaque dyes for diagnostic purposes and antineoplastic agents to control localized tumors are the most commonly encountered examples. Intrathecal administration is used when the direct access of drug to the central nervous system (CNS) is necessary. Indications for injection into the subarachnoid space include the production of spinal anesthesia with local anesthetics and the resolution of acute CNS infections with antibiotics. The intraperitoneal infusion of fluids is a useful substitute for hemodialysis in the treatment of drug poisoning. Although intraperitoneal injection is commonly used in animal experimentation, the risk of infection usually precludes such use in humans. Lastly, intraosseous (anterior tibial) injection of emergency drugs can be used when intravenous access cannot be obtained quickly.

All these specialized injection techniques are potentially dangerous to the patient. They should be performed only when expressly indicated and then only by qualified personnel.

Topical Application

Drugs are often applied to epithelial surfaces for local effects and less frequently for systemic absorption. Penetration of drugs across the epithelium is strongly influenced by the degree of keratinization.

Skin

The epidermis is a highly modified tissue that isolates the body from the external environment. The outer layer of skin (stratum corneum) is densely packed with the protein keratin. This layer is impervious to water and water-soluble drugs, and its relative thickness and paucity of lipids in contrast to other biologic membranes retards even the diffusion of strongly lipophilic agents. The impermeable nature of skin to water-soluble drugs often requires that agents (e.g., antibiotics, fungicides) intended for dermatologic conditions be administered by a systemic route despite the accessibility of the skin. For lipid-soluble drugs, however, the percutaneous route is often successful for local problems. Disruption of the keratinized layer markedly enhances drug absorption, especially of hydrophilic compounds. The underlying connective tissue (dermis) is quite permeable to many solutes, although it differs from most tissues in having an abundant supply of arteriovenous shunts, which may cause systemic absorption to be particularly sensitive to changes in temperature.

The general resistance of the intact skin to drugs does not invalidate the need for caution when dealing with potentially toxic chemicals. Sufficient documentation of epidermal absorption of foreign substances has established that certain compounds may readily penetrate the skin to cause systemic effects. These drugs include organic solvents, organophosphate and nicotine-based insecticides, and some nerve gases. Severe poisoning has also resulted from the excessive application of sunburn creams containing local anesthetics. Even

lipid-insoluble substances such as inorganic mercury can diffuse across skin if exposure is prolonged.

The benefits of improving and sufficiently controlling percutaneous absorption to make it a reliable route of drug administration have prompted several strategies. A “transdermal therapeutic system” has been developed to provide continuous systemic uptake of nitroglycerin, scopolamine, fentanyl, and nicotine for prophylaxis of angina pectoris, prophylaxis of motion sickness, management of chronic pain, and assistance with smoking cessation. The system is a complex patch that consists of an outer impermeable backing, a reservoir containing the drug in a suspended form, a semipermeable membrane, and an inner adhesive seal.

In the early 1960s, it was discovered that the industrial solvent dimethyl sulfoxide promotes the percutaneous absorption of water-soluble drugs. The potential of simplified therapy for arthritic and other patients that this drug carrier offered generated much enthusiasm. Subsequent reports of adverse reactions in animals caused interest to wane, however, until the late 1970s, when it was promoted as an effective agent for the symptomatic relief of a wide variety of musculoskeletal and collagen disorders. Although widely available as an herbal remedy, dimethyl sulfoxide is currently approved by the FDA only for the treatment of interstitial cystitis.

Another approach to improving drug penetration through the epidermis is the use of occlusive dressings. These dressings retain moisture and break down the horny layer through the process of maceration. A final technique, iontophoresis, is discussed subsequently.

Mucous membranes

The topical application of drugs to mucous membranes offers several potential advantages for local therapy. The tissues can often be visualized by the clinician, permitting accurate drug placement. The use of this route generally minimizes systemic effects while providing an optimal concentration of drug in the area being treated. In contrast to the case with skin, drugs have little trouble permeating mucous membranes to affect localized conditions. Systemic absorption of lipophilic drugs from mucous membranes readily occurs. Before this fact was widely appreciated, the topical application of tetracaine to the pharyngeal and tracheal mucosae was a leading cause of local anesthetic overdose. In dentistry, the use of corticosteroids to ameliorate inflammatory conditions has also led to systemic responses, such as the suppression of adrenocortical function by triamcinolone. Although these effects are generally mild and transient, they can create problems for patients with hypertension, diabetes mellitus, or peptic ulcer. Local therapies can also affect systemic health by serving as antigenic stimulants and, in the case of antibiotics, by disturbing the normal microbial ecology and promoting the emergence of resistant microorganisms.

Drugs are sometimes applied mucosally for their systemic effects. In addition to the previously discussed sublingual and rectal routes of administration, the nasal mucosa offers a suitable avenue for the uptake of certain agents. Desmopressin, used in the treatment of diabetes insipidus, and butorphanol, a potent analgesic, are examples of drugs that can be given intranasally.

Iontophoresis

Iontophoresis is the electric transport of positively or negatively charged drugs across surface tissues. The technique involves passing a direct electric current of appropriate polarity through the drug solution and patient. Permeation of mucous membranes, skin, and hard tissues is possible with this approach, yet the total dose delivered is small, and systemic toxicity is unlikely. In dental therapeutics, iontophoretic application of drugs has been used in several situations. Loose deciduous teeth have been extracted successfully after

the iontophoretic administration of lidocaine with epinephrine for soft tissue anesthesia.¹³ For the treatment of herpes orolabialis, galvanic current increases the tissue concentration of idoxuridine up to three times that obtainable with topical application alone. Probably the most common use of iontophoresis in dentistry is the promotion of F^- uptake into exposed hypersensitive dentin. A 1% solution of sodium fluoride administered in this manner produced better results than did a 33% paste.³⁶

DISTRIBUTION

Distribution refers to the movement of drugs throughout the body. The rate, sequence, and extent of distribution depend on many factors: the physicochemical properties of the drug, cardiac output and regional blood flow, anatomic characteristics of membranes, transmembrane electric and pH gradients, binding to plasma proteins and tissue reservoirs, and carrier-mediated transport. For all but the very few drugs that act intravascularly, the capillary membrane constitutes the first tissue barrier to be crossed in the journey of a drug from the bloodstream to its site of action.

Capillary Penetration

After a drug gains access to the systemic circulation, it becomes diluted by the plasma volume of the entire vascular compartment. For a compound administered intravenously, this process requires only several minutes for completion; for drugs given by other routes, intravascular distribution occurs concurrently with absorption. The transfer of drugs out of the bloodstream is governed by the same factors that control its entrance. Lipophilic drugs diffuse across the capillary membrane extremely rapidly. The transfer is so expeditious that equilibrium with interstitial fluid is practically instantaneous. Under these conditions, the rate of drug uptake is determined by the blood flow through the tissue under consideration. Well-perfused organs are saturated with drug long before many other tissues have had a chance to reach even a fraction of the equilibrium concentration. Water-soluble drugs diffuse through gaps located between adjacent endothelial cells. With these agents, transcapillary movement is slower than for drugs that have high lipid/water partition coefficients and is inversely proportional to molecular weight. As molecular size increases beyond 20 kDa to 30 kDa, aqueous paracellular diffusion ceases to be quantitatively important. Current evidence suggests that caveolae-based transcellular movement takes over as the primary transport method for large drugs. Convection may also be important in vascular beds with large gaps between endothelial cells, and assumes special prominence when inflammatory signals cause paracellular pathways to widen.³⁴

Entry of Drugs into Cells

As previously discussed, the cell membrane acts as a semipermeable barrier, admitting some drugs into the cell, while excluding others. Nonpolar, lipid-soluble compounds distribute evenly across plasma membranes, but distribution of weak electrolytes at equilibrium is more complex. The intracellular pH is approximately 7.0, differing slightly from the 7.4 pH of extracellular fluid. Acids with a pK_a less than 8.0 tend to remain outside the cell, whereas basic drugs with a pK_a greater than 6.0 tend to accumulate within. Because the concentration differential across the cell membrane based on a pH gradient of 0.4 can equal 2.5:1, the acid-base status of a patient can significantly affect the dose response of weak electrolytes acting intracellularly. (The influence of pH on the distribution of local anesthetics across nerve membranes is described in Chapter 16.) Ions, unless very small in size (molecular weights of ≤ 60 Da) or transported by membrane-bound carriers, penetrate cell membranes with difficulty if at

all. Charged drugs that do gain access to the cell by passive diffusion are distributed at equilibrium according to their electrochemical gradient across the membrane.

Restricted Distribution

In some tissues or organs, anatomic relationships and membrane transporters sequester interstitial or transcellular fluids from the general extracellular space and restrict intracellular access to drugs. The most important examples for therapeutics include the CNS and the fetal circulation.

Central nervous system

Entry of drugs into the CNS is unusually dependent on lipid solubility. Most drugs with high lipid/water partition coefficients are taken up very quickly, as exemplified by the immediate onset of general anesthesia after the intravenous injection of thiopental. The rapid distribution of lipophilic drugs into the brain and spinal cord arises from the fact that the CNS receives approximately 15% of the cardiac output yet composes only 2% of total body weight. Despite this favorable blood supply, drugs that are sparingly lipid soluble are largely excluded from the extracellular space of the brain. In contrast to the capillaries of most tissues, the endothelial cells of the CNS are joined together by tight junctions that limit the entry of water-soluble drugs to those agents with an effective molecular radius of 8 Å or less. Relatively large molecules (e.g., inulin, with a molecular weight of 5000 Da) that normally pass without difficulty into the interstitial space are completely barred, and most other drugs dependent on paracellular pathways for penetration and weighing more than 100 Da to 200 Da are slowed considerably. A relative absence of endocytosis/transcytosis is also notable in CNS capillaries.

A second impediment to the transfer of ions and other water-soluble substances is the cellular sheath that surrounds the capillaries of the brain. This investing layer is composed of processes extending from connective tissue astrocytes. Although the area of capillary surface coverage is incomplete, it nevertheless is sufficient to retard the diffusion of all but highly lipid-soluble compounds.

A third factor limiting access of drugs to the CNS is an extensive collection of membrane transporters that efficiently export drugs gaining entry into the endothelial cells (see Figure 2-7). Exporters such as P-glycoprotein constitute the only effective means of excluding toxic hydrophobic substances from the brain. Together, the modified capillary endothelium, astrocytic sheath, and export carrier system constitute the blood-brain barrier.

Drugs may also gain access to the CNS by way of the choroid plexuses. Each choroid plexus is composed of a network of small blood vessels and capillaries projecting into a ventricular space and covered by a layer of epithelial cells specifically adapted for the secretion of cerebrospinal fluid. Diffusion of drugs across the choroid plexus epithelium and into the cerebrospinal fluid is largely restricted to highly lipid-soluble drugs, indicating the functionally analogous existence of a barrier between blood and cerebrospinal fluid. The choroid plexus and cerebrospinal fluid are actually more closely involved with the removal of drugs from the CNS than with their entry. Secreted into the third, fourth, and lateral ventricles, the cerebrospinal fluid moves by bulk flow through the ventriculocisternal system to bathe the surfaces of the brain and spinal cord before exiting through the arachnoid villi. Drugs present in the extracellular fluid of the CNS are free to diffuse into the cerebrospinal fluid. Because the total quantity of cerebrospinal fluid (150 mL) approximates the volume of the interstitial space, and because it has a moderately fast turnover rate (10% per hour), the removal of drugs by bulk flow through the arachnoid villi can prevent an agent in the brain from ever reaching equilibrium with the blood. The presence of several active transporters in the lining cells of the

choroid plexus also promotes the removal of many drugs from the cerebrospinal fluid back into the systemic circulation.

The selective distribution of compounds into the CNS has several important therapeutic ramifications. Some alkaloids intended for peripheral nervous system effects may cause central disturbances on entry into the brain. Conversion of such drugs (e.g., scopolamine) to positively charged quaternary ammonium derivatives (e.g., methscopolamine) prevents CNS influences yet allows essential peripheral nervous system activity. Conversely, drugs used for their central effects may benefit by molecular modifications that enhance their entry into the brain. Lower total doses can be given and peripheral effects minimized.

Sometimes the blood-brain barrier is a hindrance to therapy. Penicillin G, a water-soluble organic acid with a pK_a of 2.6, diffuses slowly into the CNS and is subject to active removal by the choroid plexus. For patients with bacterial encephalitis, this lack of drug penetration can complicate treatment. (Fortunately, capillary permeability in the brain often increases during meningeal inflammation.) A clever approach to circumventing the blood-brain barrier is embodied in the treatment of parkinsonism. This condition is associated with a deficiency of dopamine within selected portions of the brain. Replacement therapy with dopamine is ineffective, however, because the drug is excluded by the blood-brain barrier. To avoid this problem, levodopa, the amino acid precursor of dopamine, is used instead. Levodopa readily enters the brain, where it is subsequently decarboxylated to the active drug.

A more drastic and potentially dangerous method of breaking through the blood-brain barrier is to disrupt it temporarily by infusing hypertonic solution into the carotid artery. An osmotically induced shrinkage of cerebrovascular endothelial cells causes the tight junctions to pull apart and permits the uptake of water-soluble drugs.⁴² Other strategies include attaching the drug to a carrier substance, or vector, that is transported into the brain. Such vectors may consist of naturally transported molecules or involve monoclonal antibodies targeted for these molecules.⁵⁰ Some peptide vectors have been identified that promote transcytosis. Coupling of drugs such as penicillin and doxorubicin greatly improves their uptake across the blood-brain barrier. A final approach to improving CNS uptake of medications is to inhibit competitively active export. Inhibition of P-glycoprotein transport has been shown to increase CNS concentrations of the anti-cancer drug paclitaxel by up to 10-fold.²³

Placental transfer

Obstetric delivery of conscious infants from anesthetized mothers was previously misconstrued as evidence for a unique placental barrier excluding even lipid-soluble drugs from the fetus. It is now understood that such observations largely result from the finite rate of drug transfer from the maternal circulation to fetal tissues. Fetal blood vessels projecting into sinuses filled with maternal blood are covered by a single syncytium of cells called *trophoblasts*. The movement of drugs across the placenta is limited by the trophoblastic membrane, which is qualitatively similar to plasma membranes elsewhere. Although trophoblasts are known to secrete amino acids and other vital nutrients actively into the fetal circulation, the entry of most drugs depends on passive diffusion across the lipid barrier. For highly lipophilic drugs such as thiopental, distribution is retarded only by the rate of maternal blood flow through the placenta and by peculiarities in the fetal circulation that limit tissue perfusion. Even so, it has been calculated that 40 minutes are required for fetal tissues to attain 90% equilibration with a constant maternal arterial concentration.⁴¹ Limited by a sluggish transmembrane diffusion, the transfer of water-soluble compounds is so inefficient that virtually no drug from a single administration may gain access to

FIGURE 2-8 Body water compartments. The membrane barriers that separate plasma from interstitial fluid and interstitial fluid from intracellular water are indicated by *dashed lines*. The upper set of figures are the respective volumes for a 70-kg man; the lower set are percentages of total body weight. Of the drugs shown, *A* is restricted to the plasma, *B* is distributed within the extracellular compartment (plasma + interstitial fluid), and *C* is disseminated throughout the total body water.

		Compartments		
		P	Interstitial	Intracellular
Volume		3 L	9 L	29 L
A	→			
B	→			
C	→			
% Body weight		4	13	41

the fetus. As in the CNS, P-glycoprotein located in the trophoblastic plasma membrane facing the maternal blood tends to prevent potentially dangerous substances from entering the fetal circulation. Nevertheless, even sparingly lipid-soluble agents eventually accumulate in the fetus if administered to the mother in multiple doses.

Concern over the placental transfer of drugs arises from the possibility of inducing toxic manifestations in the newborn and developmental defects in the embryo and fetus. These topics are discussed further in Chapter 3.

Volume of Distribution

Drugs are not distributed equally throughout the body. Although lipophilic substances tend to penetrate all tissue compartments (provided that they have a modicum of water solubility and are not actively ejected), hydrophilic compounds are often disseminated more restrictively. The volume of distribution (V_d) is a useful indicator of how drugs are dispersed among the various body compartments. In its simplest form, the V_d is calculated from the equation $V_d = Q/C$, where Q is the quantity of drug administered, and C is the plasma concentration of the drug at equilibrium. The V_d is the amount of water by which a particular dose would have to be diluted to produce a given plasma concentration, assuming that no drug has been lost through incomplete absorption or by metabolism or excretion.

Evans blue dye is typical of the few drugs that are distributed only within the vascular space. Several minutes after an intravenous injection, Evans blue becomes thoroughly mixed within the blood, and a V_d of 3 L is obtained. This value represents the total plasma volume of a 70-kg man of average build. Most compounds pass readily from the vascular tree into the interstitial compartment, however. At equilibrium, these drugs are distributed in an extracellular volume of 12 L, which includes the vascular and interstitial fluids. Ionic drugs (e.g., aminoglycosides) are generally contained in this V_d . Molecules that can freely penetrate all membranes are diluted by the water of the entire body, approximately 41 L. Figure 2-8 depicts the major body fluid volumes, and Table 2-1 provides a list of agents with representative V_d values.

It is apparent from Table 2-1 that the V_d of many compounds does not correspond to any definable anatomic fluid compartment. Accepting that the measurements were made correctly, and that problems in drug absorption and elimination were successfully avoided, several explanations remain for these results. The V_d equation provides only an apparent distribution, partly because it assumes that drugs are evenly dispersed. To illustrate this point, Na^+ is present in all body fluids (with an actual V_d of 41 L), but the appar-

TABLE 2-1

Volumes of Distribution of Various Agents

AGENT	V_d (L)	CORRESPONDING FLUID COMPARTMENT
Evans blue	3	Plasma water
Iodine 131–albumin	3	
Inulin	11	Extracellular water
Mannitol	12	
Amoxicillin	15	
Na^+	18	
Enalapril	40	Total body water
Urea	41	
Lidocaine	77	
Tetracycline	100	
Atropine	120	
Meperidine	300	
Chlorpromazine	1500	
Propofol	4000	
Chloroquine	13,000	

ent (calculated) V_d for Na^+ is only 18 L. This discrepancy arises because Na^+ is actively but incompletely extruded from intracellular water. Dissimilarities between true and calculated V_d values based on unequal compartment concentrations arise whenever ions are distributed across electrically polarized membranes, weak electrolytes are present in fluids of different pH, or drugs are actively transported into or out of a water space.

The enormous V_d values recorded for drugs such as propofol and chloroquine generally result from tissue binding. The sequestration of compounds within cells or certain tissues necessarily reduces the concentration of drug in the plasma, leading to an abnormally high calculation of V_d . (No drug can have a true $V_d > 41$ L in the typical adult.) Plasma protein binding can also affect V_d determinations. Because the total drug in plasma is usually measured, binding artificially inflates the drug concentration and depresses V_d . If free drug is measured, significant binding by plasma proteins has the same effect as binding at extravascular sites.

Drug Binding and Storage

The sojourn of drugs in the body is considerably influenced by binding to proteins and other tissue components. Reducing the concentration of free solute causes a decrease in the rate of passage across membrane barriers and may alter drug dis-

TABLE 2-2

Distribution of Drugs into Saliva

DRUG	L*	PROTEIN BINDING (%)	pK _a	SALIVA/PLASMA RATIO [†]	
				RESTING	STIMULATION
Quinidine	3000	89	8.8 (b)	3.1	1.3
Sulfamerazine	0.4	88	7.1 (a)	0.69	0.55
Diazepam	820	99	3.3 (b)	1.0	1.0
Ethanol	0.5	0	—	1.0	1.0

Adapted from Feller K, le Petit G: On the distribution of drugs in saliva and blood plasma, *Int J Clin Pharmacol Biopharm* 15:468-469, 1977.

*Lipid/water partition coefficient (*n*-octanol as the lipid).

[†]Refers to the unbound drug.

a, Acid; b, base.

tribution at equilibrium, as reflected in V_d determinations. Drug sequestration can also affect the processes of absorption, metabolism, and elimination.

Plasma protein binding

Numerous drugs become associated with plasma proteins, especially albumin. The predominant protein in plasma, albumin contains roughly 200 ionized functional groups per molecule and has the capacity to bind many different substances concurrently. A second plasma protein, α_1 -acid glycoprotein (also known as orosomucoid), is a major "acceptor" of basic, or cationic, agents. Transcortin (which is specific for corticosteroids and a few other agents), other globulins, and various lipoproteins play more limited roles in drug binding.

The reversible attachment of drugs to plasma proteins is reminiscent of drug-receptor combinations in that the reaction obeys the law of mass action, as follows:



This binding is capacity limited because the number of binding sites is finite. At concentrations less than the binding dissociation constant, the fraction bound is a fixed value; at concentrations greater than the dissociation constant, the fraction of drug bound varies inversely with the drug concentration. Clinically, the percentage of bound drug usually does not change over the dosage ranges used clinically, and assigning most drugs a fixed value is permissible (e.g., 99% for diazepam; Table 2-2). Drugs differ tremendously in their affinity for plasma proteins; the percentage of binding of individual agents ranges from 0% to 100%.

The binding of agents within the vascular compartment reduces the concentration gradient of free drug across the capillary membrane and slows egress from the plasma into the extravascular space. As free molecules leave the circulation, a portion of the bound drug dissociates according to the law of mass action and becomes available for further transport. The rate but not the extent of distribution is generally altered by plasma protein binding. There are exceptions. The attachment of Evans blue is so tight that the compound is retained virtually in toto within the bloodstream. For a drug that is 95% bound in plasma, a little more than half of the total dose would remain intravascular, assuming that the agent is not sequestered elsewhere. Drugs that are extensively but reversibly bound to plasma proteins generally bind to tissue elements as well, however, decreasing the fraction of drug in the plasma to less than one third the total even in the most extreme cases. Contributing to extravascular binding is the fact that approximately 60% of the body's total albumin is extravascular, with about 4% of the total albumin content exchanging between the two compartments every hour.

The reversibility of binding causes the plasma proteins to act as a drug reservoir. Agents must occasionally be administered in large loading doses to saturate binding sites as a prelude to achieving therapeutic concentrations at the site of action. When accommodated, reservoirs of bound drug can provide certain benefits. Fluctuations in drug concentration resulting from intermittent dosage schedules may be kept to a minimum. As the dose is absorbed, a portion becomes bound, only to be released later as metabolism and excretion reduce free drug titers. Also, drug binding often prolongs the duration of action, which may permit administrations to be spaced more conveniently than would otherwise be possible.

Glomerular filtration and passive hepatic uptake involve only free drug; significant binding may depress the metabolism and excretion of drugs. When compounds are actively or otherwise rapidly taken up by organs of elimination, however, the instantaneous reversibility of binding can lead to a faster-than-normal elimination rate. Penicillin G is secreted into the urine so efficiently that blood flowing through the kidney is almost completely cleared of the antibiotic in a single pass. Because albumin binding presents the kidney with more total drug per unit time, secretion is quicker than would be the case if the drug were more evenly distributed throughout the body.

Two potential clinical concerns related to plasma protein binding involve patient variability in binding efficacy and the possibility for drug interaction. Differences in drug binding affect the concentration of free drug within the bloodstream and may lead to insufficient therapy on the one hand and overdosage on the other. The unusual susceptibility to diazepam exhibited by patients with hypoalbuminemia should be considered when the drug is used for intravenous sedation.¹⁶ Inasmuch as the attachment of drugs to plasma proteins is generally less selective than are drug-receptor associations, competition between drugs for binding sites is relatively common. Such interactions may reach clinical significance, however, only when the drugs are highly bound, are administered in large doses, and have a narrow margin of safety or a small V_d .

Tissue binding

As previously mentioned, drugs capable of associating with plasma proteins are also likely to bind to tissue constituents. Such binding does not impede the movement of drugs out of the bloodstream, but it does slow the rate of elimination. By virtue of its aggregate size, muscle tissue is a significant reservoir for many drugs. Fat is also quantitatively important, especially for highly lipid-soluble compounds. Although uptake into fat is limited by a parsimonious blood supply, adipose tissue constitutes 10% to more than 50% of total body weight, and most of an administered dose of a lipophilic drug may

accumulate in fat over the course of several hours. Certain tissues display unusual affinities for particular drugs. The anti-malarial agents chloroquine and quinacrine are heavily concentrated in the liver. Guanethidine and other quaternary ammonium compounds adhere to negatively charged residues in mucous secretions of the gastrointestinal tract.

The attachment of drugs to drug receptors warrants special comment. Important in the pharmacologic sense, the contribution of drug-receptor interactions to the total amount of binding is usually quite small. When distribution throughout the body and the various types of sequestration are considered, the percentage of drug administered that actually reaches its receptor to evoke a response is quantitatively negligible.

Storage

The association between drugs and tissue elements is sometimes so stable that discussing such binding in terms of storage is appropriate. When drugs are stored, they are not readily available for release and generally do not prolong the duration of action. Some of the most common examples of storage involve mineralized tissues and fat. Bone-seeking ions such as F^- and lead, and Ca^{++} chelators such as the tetracyclines, may be deposited with bone salts during mineralization or become associated with existing hydroxyapatite crystals. Essentially in an insoluble state, these substances are difficult or impossible to remove completely. Bone and tooth mineralization may benefit from appropriate concentrations of F^- , but most drug-induced alterations are detrimental. In the case of radioactive metals (e.g., strontium 90), storage in bone can lead to the development of leukemia, osteogenic sarcoma, and other forms of neoplasia. Zoledronic acid is exceptional in that storage in bone does lead to an extended duration of action. Given once a year for the treatment of postmenopausal osteoporosis, zoledronic acid is taken up by new bone formed during remodeling and is sequestered. Later, as osteoclasts restart bone turnover in the same area, zoledronic acid is released to inhibit further activity.

Several general anesthetics (e.g., sevoflurane) and some lipophilic insecticides (e.g., chlorophenothane, otherwise known as DDT) are commonly sequestered in fat. Although not usually dangerous when stored, the slow release of these substances has been linked to various health problems.^{31,41} Plasma proteins are generally not associated with drug storage, yet the now-obsolete radiocontrast medium 3-hydroxy-2,4,6-triiodo- α -ethylhydrocinnamic acid exhibited a binding half-life ($t_{1/2}$; in this case, the time required for half of the bound drug to dissociate from albumin) of approximately 2.5 years.

Redistribution

Strongly lipophilic drugs, especially when administered intravenously in bolus form, characteristically go through several phases of distribution: an initial transfer into vessel-rich organs (brain, heart, kidneys, liver, and lungs) followed by progressive redistribution to less highly vascularized tissues (muscle, skin, and eventually fat). When the target organ of a drug happens to have a high blood flow per unit mass, redistribution can result in the abrupt termination of drug effect. Thiopental has been extensively studied in this regard (Figure 2-9).³² The onset of anesthesia with thiopental is almost instantaneous; however, consciousness is lost only temporarily, and the patient normally awakens in approximately 15 minutes. The quick onset and brief duration of thiopental reflect the rapidity by which the agent equilibrates between the blood and the CNS. Soon after a peak brain titer is reached (in 30 to 90 seconds), the concentration begins to decrease as thiopental continues to be absorbed by the relatively large mass of muscle. Consciousness returns at about the same time muscle reaches equilibrium with the blood. Thereafter, the brain and muscle concentrations parallel the

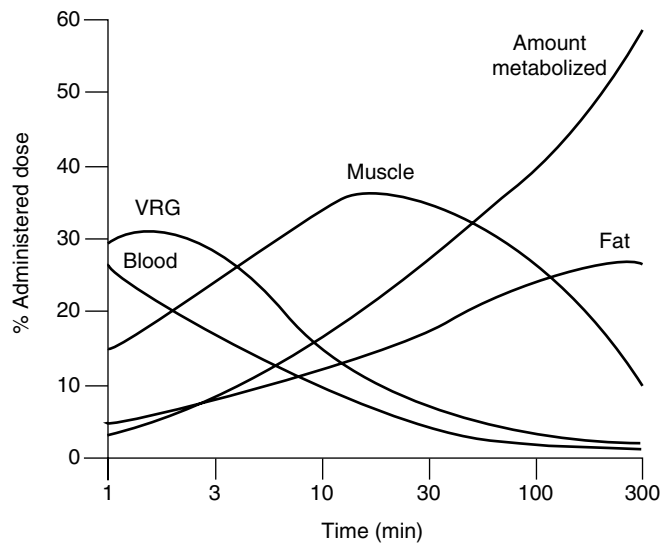

FIGURE 2-9 Redistribution of thiopental. VRG, Vessel-rich group tissues, including the brain, heart, lungs, kidneys, and liver. (Redrawn from Saidman LJ: Uptake, distribution and elimination of barbiturates. In Eger E II, editor: *Anesthetic uptake and action*, Baltimore, 1974, Williams & Wilkins.)

plasma decay curve as the drug slowly passes into adipose tissue. With a metabolic $t_{1/2}$ of approximately 10 hours, thiopental would be a relatively long-acting drug if not for redistribution. When repetitive injections saturate the fat reservoir, thiopental assumes the characteristics of a long-duration anesthetic.

Saliva

The transfer of drugs into saliva can be thought of as a form of redistribution because the drugs regain access to the systemic circulation after the saliva is swallowed. Although not involved in drug elimination, the entry of agents into the saliva is of pharmacologic interest in two other respects. First, drugs gaining access to the oral environment from the systemic circulation can affect microorganisms or tissue surfaces within the mouth. Although these influences are usually undesirable, a drug developed for a local effect, such as caries prevention, could conceivably be administered systemically to achieve a sustained therapeutic concentration in the saliva, while obviating the necessity of intraoral application. The second pharmacologic interest in saliva stems from the fact that salivary drug determinations can provide a noninvasive measure of the free plasma concentration of drugs. Because the free drug concentration in plasma is normally the primary determinant of patient response, the benefit of salivary drug quantitation to therapeutics is potentially great. Clinical studies have documented a complex relationship between plasma and salivary drug titers that must be fully understood before salivary monitoring can be successfully used.^{4,46}

Drugs may enter the oral fluids from several sources: (1) passive diffusion across the alveolar and ductal cells of salivary glands, (2) active transport into saliva, (3) passive diffusion across the oral epithelium, and (4) bulk flow of fluid from the gingival crevice. Of these avenues, the first is the most important, and the fourth is the least important (except for drugs that cannot gain entry by either of the other routes). As shown in Table 2-2, the salivary concentration of a drug is influenced by many factors.¹¹ Agents that are relatively lipid soluble (e.g., diazepam) or very small in size (e.g., ethanol) normally encounter little difficulty in equilibrating with saliva. Because only the unbound portion of a drug is involved in distribution across membranes, and the salivary compartment is quite

small with respect to the total intravascular space, protein binding does not affect the saliva/plasma ratio of the free drug (e.g., diazepam and acetaminophen). Regarding weak electrolytes, the disparity in pH between the plasma and the more acidic saliva results in the concentration of bases with a pK_a greater than 5.5 in saliva (e.g., quinidine) and an opposite effect on acids with a pK_a less than 8.5 (e.g., sulfamerazine). Finally, the rate of salivary flow can alter intraoral concentrations in at least two ways. Increased salivary production may outpace the diffusion rate of drugs with moderate to low lipid solubility (e.g., acetaminophen), reducing the saliva/plasma ratio. Additionally, the pH of stimulated saliva tends to approach 7.4, eliminating the unequal distribution of drugs based on pH (e.g., quinidine). With some weak acids, these two influences on drug concentration may tend to cancel each other out (e.g., sulfamerazine).

Active transport is a wild card with respect to predicting drug entry into saliva based on physicochemical characteristics. Digoxin is actively secreted into saliva by P-glycoprotein, effectively doubling the expected saliva/plasma ratio of 1/1 for a neutral drug with good lipid solubility. Coadministration of P-glycoprotein inhibitors significantly reduces the saliva/plasma ratio, as do polymorphisms that alter P-glycoprotein activity.⁵

METABOLISM

Metabolism is a major pathway for the termination of pharmacologic effects of drugs, and is often a prerequisite for the excretion of lipid-soluble chemicals. From an evolutionary standpoint, mechanisms for the biotransformation of lipophilic substances to compounds with reduced lipid/water partition coefficients seem necessary for terrestrial vertebrate life. The constraint imposed on land animals to eliminate waste products in limited volumes of water precludes the excretion of drugs with high lipid solubility. In humans, the kidney represents the major pathway for drug excretion. All drugs that exist free in the plasma are present in the glomerular filtrate. Polar compounds tend to remain within the renal tubule during the resorptive phase of urine formation, whereas lipophilic chemicals diffuse back into the systemic circulation. Because the urinary concentration of a lipid-soluble nonelectrolyte should theoretically equal the free plasma titer, the rate of renal excretion (given a normal urinary output of 1 L/day to 1.5 L/day) is small for a drug having a reasonably large V_d . Creatures in an aquatic habitat have little difficulty in eliminating lipophilic chemicals, however. Substances with a high lipid/water partition coefficient readily diffuse across the gill membrane and are lost to the surrounding water. The highly developed enzyme systems for metabolizing drugs in terrestrial species are often absent in marine and freshwater organisms.

Historically, the term *detoxification* was used in reference to drug metabolism. Although many compounds are rendered pharmacologically inert by metabolic attack, this is not always the case. Numerous drugs yield metabolites with full or partial activity, and some provide derivatives with novel or highly toxic drug effects. An increasing number of agents require chemical activation to be of therapeutic benefit (e.g., cyclophosphamide, mercaptopurine, methyl dopa, and sulindac). The best generalization that can be drawn concerning drug metabolism is that agents are eventually converted to polar, relatively lipid-insoluble compounds that are susceptible to renal or biliary excretion or both.

Drug metabolism can be categorized according to the types of reactions involved and where they occur. Nonsynthetic reactions include the various transformations of molecular structure: oxidation, reduction, and hydrolysis. These events are also called phase I reactions because they often

represent the initial stage of biotransformation. A common outcome of phase I reactions is the addition or uncovering of one or more functional groups: $-\text{COOH}$, $-\text{NH}_2$, $-\text{O}$, $-\text{OH}$, or $-\text{SH}$. Synthetic, or phase II, reactions consist of the conjugation of drugs or their metabolites with functional groups provided by endogenous cofactors. Drugs may be metabolized by virtually any organ of the body, but quantitatively the most important enzyme systems for the biotransformation of exogenous substances are located in the liver.

Hepatic Microsomal Metabolism

Each hepatocyte contains an extensive network of smooth endoplasmic reticulum that catalyzes the metabolism of various endogenous chemicals (e.g., bilirubin, thyroxine, and steroids). Studies of fragmented reticular elements isolated along with other membrane structures in the form of microsomes have shown that numerous drugs are also chemically altered by enzymes located within this subcellular organelle. The greatest number of reactions involve oxidation; however, reduction, hydrolysis, and conjugation with glucuronic acid also occur.

Oxidation

The oxidation of drugs results in compounds that tend to be more polar, relatively more hydrophilic, and less likely to penetrate cells and bind to tissue elements. Microsomal oxidations are catalyzed by a set of mixed-function oxidases, so named because one atom of an oxygen dimer is incorporated into the drug, while the other is converted to water through the addition of two hydrogen atoms. Of particular significance to microsomal oxidation is the component that actually binds the drug during metabolism, cytochrome P450 (CYP). This hemoprotein—actually a group of closely related isoenzymes—was designated P450 because of its absorption peak at 450 Å when combined in the reduced state with carbon monoxide. Approximately 18 distinct CYP families, encoded in 57 genes, have been identified in humans³⁷; the major enzymes involved in drug metabolism are shown in Figure 2-10.¹⁰

In aggregate, the CYP superfamily constitutes up to 20% of the total protein content of liver microsomes. It acts as the terminal acceptor of electrons in a transport chain that also includes the reduced coenzyme nicotinamide adenine dinucleotide phosphate (NADPH) and the flavoprotein NADPH-cytochrome P450 oxidoreductase (Figure 2-11). A unique ability of the CYP enzymes is their collective capacity to react with a diverse array of chemicals. The only identified requirement for microsomal oxidation is that the drug sufficiently penetrate the cell membranes to reach the hemoprotein. Table 2-3 lists the major CYP enzymes in humans along with some drugs that are metabolized by them, and drugs that can inhibit or induce their activities.

The general pathway for oxidation of drugs by the hepatic microsomal enzyme system is depicted in Figure 2-12. The drug initially attaches to an oxidized (Fe^{+++}) CYP enzyme. This complex accepts an electron from the flavoprotein-catalyzed oxidation of NADPH. A ternary structure is produced next by the inclusion of molecular oxygen; the addition of a second electron and subsequently two protons causes the complex to break down, yielding the CYP enzyme, a water molecule, and the oxidized drug.

Some microsomal oxidations are carried out by a second superfamily of enzymes: the flavine monooxygenases (FMOs). The substrates for these enzymes contain nucleophilic atoms (nitrogen, sulfur, phosphorus, and selenium); they include such common drugs as nicotine and cimetidine. The products of oxidation are similar to those produced by the CYP enzymes except that reactive intermediates are rarely produced by FMOs. Because many drugs may be substrates for both enzyme superfamilies, the exact contribution made by each catalytic pathway is generally unknown for these agents.

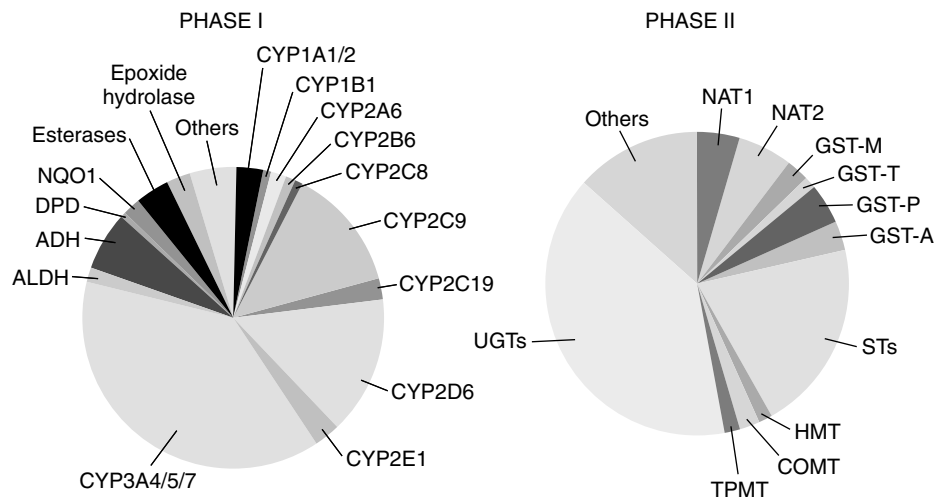

FIGURE 2-10 Major enzymes involved in drug metabolism. The percentage of phase I and phase II metabolism of drugs contributed by each enzyme is represented by the relative size of each section of the corresponding chart. *ADH*, Alcohol dehydrogenase; *ALDH*, aldehyde dehydrogenase; *CYP*, cytochrome P450; *DPD*, dihydropyrimidine dehydrogenase; *NQO1*, NAD(P)H:quinone oxidoreductase (or DT diaphorase); *COMT*, catechol-O-methyl transferase; *GST*, glutathione-S-transferase; *HMT*, histamine methyltransferase; *NAT*, N-acetyltransferase; *STs*, sulfotransferases; *TPMT*, thiopurine methyltransferase; *UGTs*, uridine diphosphate glucuronosyltransferases. (Adapted from Evans WE, Relling MV: Pharmacogenomics: translating functional genomics into rational therapeutics, *Science* 286:487-491, 1999.)

Rights were not granted to include this figure in electronic media.
Please refer to the printed publication.

FIGURE 2-11 Location of cytochrome P450 (*CYP*) in the endoplasmic reticulum (*ER*). The figure shows increasingly microscopic levels of detail, sequentially expanding the areas within each black box. *CYPs* are mostly embedded in the cytoplasmic surface of the *ER* membrane. A second enzyme, NADPH-cytochrome P450 oxidoreductase, transfers electrons to *CYP*, where it can, in the presence of molecular oxygen, oxidize xenobiotic substrates, many of which are hydrophobic and dissolved in the *ER*. A single oxidoreductase species transfers electrons to all *CYP* isoforms in the *ER*. Each *CYP* contains an iron-protoporphyrin ring that binds and activates the oxygen. Substitutions on the ring are methyl (*M*), propionyl (*P*), and vinyl (*V*) groups. (From Gonzalez FJ, Tukey RH: Drug metabolism. In Brunton LL, Lazo JS, Parker KL, editors: *Goodman & Gilman's the pharmacological basis of therapeutics*, ed 11, New York, 2006, McGraw-Hill.)

TABLE 2-3

Major Cytochrome P450 Enzymes and Representative Substrates, Inhibitors, and Inducers

CYP	SUBSTRATES	INHIBITORS	INDUCERS
1A1/2	Acetaminophen, amitriptyline, caffeine, clozapine, estradiol, haloperidol, imipramine, mexiletine, naproxen, ondansetron, propranolol, ropivacaine, tamoxifen, theophylline, <i>R</i> -warfarin, zileuton	Amiodarone, cimetidine, ciprofloxacin, clarithromycin, erythromycin, grapefruit juice, insulin, ticlopidine	Benzo[<i>a</i>]pyrene, broccoli, char-grilled meat, modafinil, nafcillin, omeprazole, rifampin
2A6	Acetaminophen, halothane, nicotine, nitrosamines, valproic acid	Azole antifungals, pilocarpine, tranlycypromine	Barbiturates, dexamethasone, rifampin
2B6	Bupropion, cyclophosphamide, ifosfamide, methadone	Amlodipine, methimazole, thiopepa, tretinoin	Barbiturates, dihydropyridines, ifosfamide, lovastatin, rifampin
2C8/9	Amitriptyline, celecoxib, fluoxetine, fluvastatin, losartan, nonsteroidal anti-inflammatory drugs, oral hypoglycemics, phenobarbital, phenytoin, sulfaphenazole, <i>S</i> -warfarin, tamoxifen	Amiodarone, azole antifungals, fluvastatin, lovastatin, metronidazole, paroxetine, ritonavir, sertraline, trimethoprim, zafirlukast	Barbiturates, dihydropyridines, ifosfamide, rifampin
2C18/19	Amitriptyline, citalopram, diazepam, indomethacin, naproxen, phenobarbital, phenytoin, primidone, progesterone, propranolol, proton pump inhibitors	Chloramphenicol, cimetidine, fluoxetine, fluvoxamine, ketoconazole, modafinil, omeprazole, paroxetine, ticlopidine, topiramate	Aspirin, barbiturates, carbamazepine, norethindrone, rifampin
2D6	Amphetamine, β -adrenergic blockers, chlorpheniramine, clomipramine, clozapine, codeine, dextromethorphan, encainide, flecainide, fluoxetine, haloperidol, hydrocodone, metoclopramide, mexiletine, ondansetron, oxycodone, paroxetine, propoxyphene, risperidone, selegiline, thioridazine, tramadol, tricyclic antidepressants, venlafaxine	Amiodarone, antipsychotics, celecoxib, cimetidine, cocaine, fluoxetine, methadone, metoclopramide, paroxetine, quinidine, ritonavir, sertraline, terbinafine, ticlopidine, venlafaxine	Dexamethasone, rifampin
2E1	Acetaminophen, ethanol, sildenafil, theophylline, volatile inhalation anesthetics	Disulfiram, propofol, tricyclic antidepressants	Colchicine, ethanol, isoniazid, tretinoin
3A4/5/7	Acetaminophen, alfentanil, alprazolam, amiodarone, atorvastatin, buspirone, chlorpheniramine, cocaine, cortisol, cyclosporine, dapsone, diazepam, dihydroergotamine, dihydropyridines, diltiazem, dronabinol, ethinyl estradiol, fentanyl, indinavir, lidocaine, lovastatin, macrolides, methadone, miconazole, midazolam, mifepristone, modafinil, ondansetron, paclitaxel, progesterone, quinidine, ritonavir, saquinavir, sildenafil, spironolactone, sufentanil, sulfamethoxazole, tacrolimus, tamoxifen, testosterone, trazodone, triazolam, verapamil, zaleplon, zolpidem	Amiodarone, atazanavir, chloramphenicol, cimetidine, ciprofloxacin, clarithromycin, dihydroergotamine, diltiazem, doxycycline, erythromycin, felodipine, fluoxetine, fluvoxamine, glucocorticoids, grapefruit juice, HIV antivirals, itraconazole, ketoconazole, nefazodone, sildenafil, verapamil	Barbiturates, carbamazepine, glucocorticoids, ifosfamide, modafinil, nevirapine, phenytoin, rifampin, St. John's wort, troleandomycin

HIV, Human immunodeficiency virus.

The oxidation of a drug may lead to several different derivatives. Oxygen may be incorporated in the form of an alcohol, aldehyde, epoxide, ketone, or carboxylic acid in such structures as aliphatic residues, aromatic rings, amino groups, and sulfur moieties. Oxygen may also replace a sulfur atom (desulfuration) or an amino group (deamination), or it may not appear in the metabolite at all but become attached to a hydrocarbon unit released during the dealkylation of nitrogen, oxygen, or sulfur. The various types of microsomal oxidations are reviewed along with other phase I reactions in Table 2-4.

Reduction

The microsomal reduction of drugs is limited to molecules with nitro or carbonyl groups or azo linkages. Similar reactions may also be mediated by nonmicrosomal enzymes of the body, but most reductions of this variety seem to result primarily from the action of enteric bacteria. When reduction

occurs at one site in a molecule, oxidation usually takes place elsewhere, and the final product is more polar despite the initial addition of hydrogen atoms.

Hydrolysis

The hydrolysis of ester or amide compounds resulting in the production of two smaller entities, each with a polar end, occasionally depends on microsomal enzymes. The hydrolysis of the ester meperidine and the cleavage of amide local anesthetics and their oxidized metabolites are two important examples of microsomal hydrolysis. Epoxide hydrolase, responsible for the biotransformation of highly reactive and toxic intermediates formed during microsomal oxidation reactions, yields inactive dihydrodiol products.

Dehalogenation

Various compounds, such as chlorophenothane and some volatile general anesthetics (e.g., halothane and sevoflurane), are

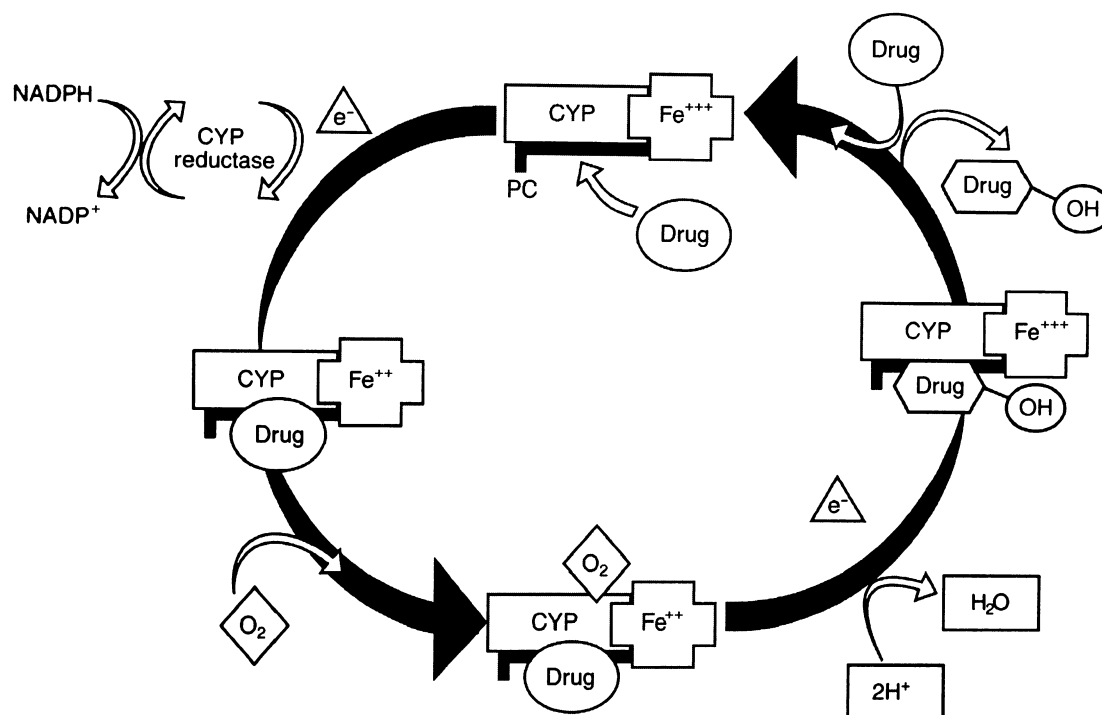

FIGURE 2-12 Microsomal oxidation. Free drug enters the cycle (*upper right*) and is complexed in the presence of phosphatidylcholine (PC) to CYP with its heme in the oxidized (Fe^{+++}) state. The Fe^{+++} is reduced (Fe^{++}) by an electron (e^-) generated in the oxidation of NADPH to $NADP^+$ by the enzyme NADPH–cytochrome P450 oxidoreductase (CYP reductase, *upper left*). The reduced complex absorbs molecular oxygen (O_2 , *lower middle*). Addition of a second e^- and two protons ($2H^+$, *lower right*) results in the generation of one molecule of water (H_2O), oxidation of the drug (hydroxylation in this case), and oxidation of Fe^{++} to Fe^{+++} . The cycle is complete with release of the oxidized drug. (Adapted from Markey SP: Pathways of drug metabolism. In Atkinson AJ Jr, Abernethy DR, Daniels CE et al, editors: *Principles of clinical pharmacology*, ed 2, Amsterdam, 2007, Elsevier.)

dehalogenated by microsomal enzymes. The reactions are complex, may involve both oxidative and reductive steps, and may result in the formation of potentially toxic metabolites.³¹

Glucuronide conjugation

The combination of compounds with glucuronic acid is the only phase II reaction catalyzed by microsomal enzymes (in this case, by a group of glucuronosyltransferases). Originally derived from glucose, glucuronic acid is transferred from its donor, uridine diphosphate, to an appropriate reactive center on the drug molecule (Table 2-5). The glucuronide conjugate produced is excreted, often with the help of active secretion, into the bile or urine (see Figure 2-7). In contrast to many phase I reactions, conjugation with glucuronic acid almost invariably results in a total loss of pharmacologic activity. An important exception to this rule is morphine-6-glucuronide, which is 100 times more potent than morphine as an analgesic when injected into the CNS.⁴⁰ Some glucuronides excreted in the bile are subject to hydrolysis by bacterial and intestinal β -glucuronidase enzymes. If it has sufficient lipid solubility, the released drug may be absorbed again. Glucuronidation is a quantitatively significant metabolic pathway for many drugs and their metabolites; for agents such as morphine, it represents the primary mode of metabolism.

Nonmicrosomal Metabolism

The pattern of drug metabolism mediated by nonmicrosomal enzymes is considerably different from that of the microsomal system. Although important, the liver is not always predominant in nonmicrosomal biotransformations. The various major types of nonsynthetic reactions already described take place,

but their relative frequencies of occurrence are dissimilar. Generally, drugs must resemble natural substrates to be metabolized by most nonmicrosomal enzymes; the spectacular lack of specificity displayed in microsomal oxidation has no counterpart here. Although cytosolic enzymes are most commonly involved, enzymes associated with the nucleus, mitochondria, and plasma membrane also play limited roles. Plasma esterase is an important example of an extracellular enzyme involved in drug metabolism.

Oxidation

Nonmicrosomal enzymes are responsible for the oxidation of numerous compounds. Selected alcohols and aldehydes are oxidized by dehydrogenases present in the cytosol of the liver. Other oxidation reactions include the oxidative deamination of drugs such as tyramine and phenylephrine by mitochondrial enzymes found in the liver, kidneys, and other organs, and the hydroxylation of the purine derivatives theophylline and allopurinol by xanthine oxidase.

Reduction

Nonmicrosomal enzymes promote the hydrogenation of double bonds and, through a reversal of the normal dehydrogenase pathway, the removal of oxygen atoms. The reduction of chloral hydrate to trichloroethanol by alcohol dehydrogenase is an often cited example of this latter type of reaction.

Hydrolysis

Most hydrolytic reactions of foreign substances depend on nonmicrosomal esterase and amidase enzymes. Nonspecific esterases are found throughout the body, but the two most

TABLE 2-4

Phase I Reactions—Metabolic Transformations

REACTION	EXAMPLE
Microsomal Enzyme System	
Oxidation	
$RCH_2R' \rightarrow R\overset{\text{OH}}{\text{C}}HR'$ <p>Aliphatic hydroxylation</p> <p>Aromatic hydroxylation</p> $RNHR' \rightarrow RNR'\overset{\text{OH}}{\text{N}}$ <p>N-hydroxylation</p>	<p>Acetanilid $\xrightarrow{[O]}$ Acetaminophen</p>
$RCH=CHR' \rightarrow R\overset{\text{O}}{\text{C}}\text{H}-\text{CHR}'$ <p>Epoxidation</p>	<p>Naphthalene</p>
$RNHR' \rightarrow RNH_2 + R' = O$ <p>N-dealkylation</p> $ROR' \rightarrow ROH + R' = O$ <p>O-dealkylation</p> $RSCH_3 \rightarrow RSH + CH_2O$ <p>S-demethylation</p>	<p>Phenacetin $\xrightarrow{[O]}$ Acetaminophen + CH_3CHO</p>
$(R)_3N \rightarrow (R)_3N = O$ <p>N-oxidation</p> $RSR' \rightarrow R\overset{\text{O}}{\text{S}}R'$ <p>Sulfoxidation</p>	<p>Chlorpromazine</p>
$R_2CHNH_2 \rightarrow R_2CO + NH_3$ <p>Deamination</p> $RSH \rightarrow ROH$ <p>Desulfuration</p>	<p>Amphetamine $\xrightarrow{[O]}$ $\text{Benzene ring}-CH_2-C(=O)-CH_3 + NH_3$</p>
<p>Reduction</p> $R\overset{\text{O}}{\text{C}}R' \rightarrow R\overset{\text{OH}}{\text{C}}R'$ <p>Carbonyl reduction</p> $RNO_2 \rightarrow RNH_2$ <p>Nitro reduction</p> $RN=NR' \rightarrow RNH_2 + R'NH_2$ <p>Azo reduction</p>	<p>Chloramphenicol</p>
<p>Hydrolysis</p> $RCOOR' \rightarrow RCOOH + R'OH$ <p>Ester hydrolysis</p> $RNHCOR' \rightarrow RNH_2 + R'COOH$ <p>Amide hydrolysis</p> $R\overset{\text{O}}{\text{C}}\text{H}-\text{CHR}' \rightarrow R\overset{\text{OH}}{\text{C}}\text{H}-\overset{\text{OH}}{\text{C}}\text{H}R'$ <p>Epoxide hydrolase</p>	<p>Meperidine $\xrightarrow{[H_2O]}$ $\text{Piperidine ring}-COOH + CH_3CH_2OH$</p>
<p>Dehalogenation</p> <p>Various reactions</p>	<p>Halothane $\xrightarrow{[O]}$ CF_3COOH</p>

Continued

TABLE 2-4

Phase I Reactions—Metabolic Transformations—cont'd

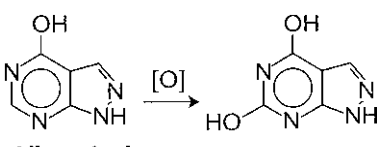
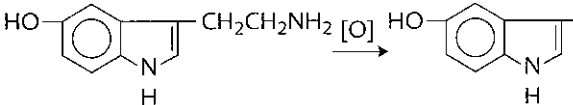
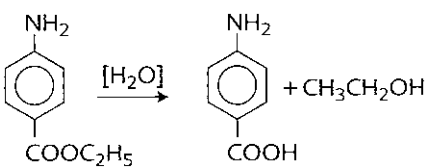
REACTION	EXAMPLE
Nonmicrosomal Enzymes	
Oxidation	
$RCH_2OH \rightarrow RCHO$	
Alcohol dehydrogenation	
$RCHO \rightarrow RCOOH$	
Aldehyde oxidation	$CH_3CH_2OH \xrightarrow{[O]} CH_3CHO$ <p style="text-align: center;">Ethanol</p>
$RCH_2R' \rightarrow RCHR'$	
Aliphatic hydroxylation	 <p style="text-align: center;">Allopurinol</p>
$R-\text{C}_6\text{H}_4 \rightarrow R-\text{C}_6\text{H}_3(\text{OH})$	
Aromatic hydroxylation	 <p style="text-align: center;">5-Hydroxytryptamine</p>
$RCH_2NH_2 \rightarrow RCHO + NH_3$	
Deamination	
Reduction	
$ROH \rightarrow RH$	
Alcohol reduction	$Cl_3C-\underset{\text{OH}}{\text{CHOH}} \xrightarrow{[H]} Cl_3C-\text{CH}_2\text{OH} + \text{H}_2\text{O}$ <p style="text-align: center;">Chloral hydrate Trichloroethanol</p>
Various reactions	$(C_2H_5)_2NC(=S)-S-S-C(=S)N(C_2H_5)_2 \xrightarrow{[H]} 2(C_2H_5)_2NC(=S)SH$ <p style="text-align: center;">Disulfiram</p>
Hydrolysis	
$RCOOR' \rightarrow RCOOH + R'OH$	
Ester hydrolysis	
$RNHCOR' \rightarrow RNH_2 + R'COOH$	
Amide hydrolysis	 <p style="text-align: center;">Benzocaine</p>

important sites, by virtue of their hydrolytic capacity and availability to drugs, are the liver and plasma. Ester local anesthetics such as procaine and benzocaine are hydrolyzed by these enzymes. Except for blood and other tissue peptidases responsible for the breakdown of pharmacologically active polypeptides, most amidase activities reside in the liver.

Conjugation reactions

A number of synthetic reactions are catalyzed by nonmicrosomal transferase enzymes. As with the microsomal synthesis of glucuronides, the body usually supplies an acidic moiety (e.g., sulfate, acetate, cysteine, glycine, glutamine, or riboside phosphate) attached to a particular cofactor or carrier molecule. The addition of methyl groups to phenols, mercaptans, and amines may lead to less polar compounds, but even here subsequent oxidation or conjugation reactions decrease lipid solubility. With amines, methylation may increase polarity, as in the formation of a quaternary ammonium cation. The quantitative contributions of the various phase II reactions are illustrated in Figure 2-10.

Conjugation with glutathione is unusual because it is directed against highly reactive metabolites, such as epoxides and quinones, and may occur with or without enzymatic

support. Although a quantitatively minor pathway, glutathione conjugation is often of major importance in preventing metabolism-induced drug toxicity.

Phase II reactions can be expected whenever a drug carries one or more of the reactive centers listed in Table 2-5. Such conjugations generally result in the termination of drug effect, restriction in the apparent V_d , and acceleration of drug excretion through active secretory processes.

Nonhepatic Metabolism

Although focusing on the liver when considering biotransformation is appropriate generally, other organs contain drug-metabolizing enzymes (including members of the CYP family) and contribute to the microsomal and nonmicrosomal metabolism of drugs. This ability is occasionally taken advantage of by preparing prodrugs that become metabolically activated in target tissues. The aforementioned use of levodopa to circumvent the blood-brain barrier is an example of this approach; administration of acyclovir, an antiviral prodrug that is converted to the active nucleotide form in diseased cells (see Chapter 40), is another. By virtue of location and blood supply, certain organs play special roles in drug metabolism. As previously discussed in the context of bioavailability,

TABLE 2-5

Phase II Reactions—Conjugations

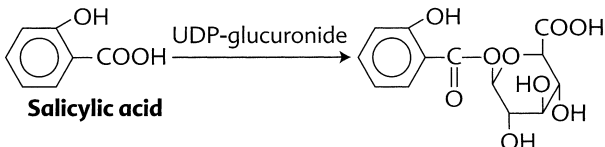
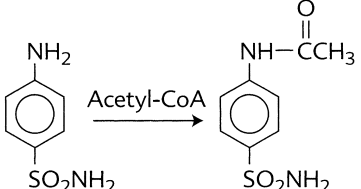
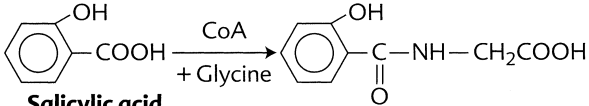
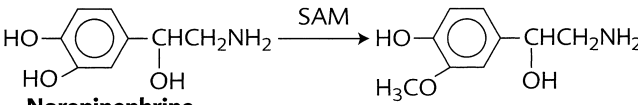
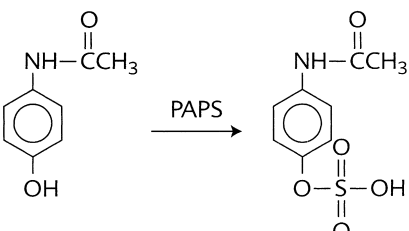
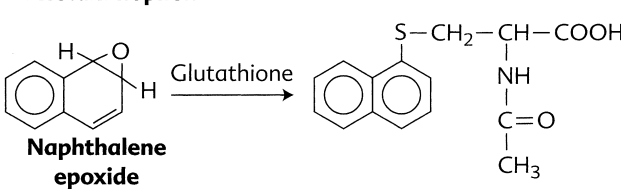
CONJUGATION REACTION (COFACTOR)	SUBSTRATES	EXAMPLE
Glucuronide synthesis (uridine diphosphate)	Amines Carboxylic acids Alcohols Phenols Mercaptans	 <p>Salicylic acid</p>
Acetylation (coenzyme A)	Amines Hydrazines	 <p>Sulfanilamide</p>
Glycine conjugation (coenzyme A)	Carboxylic acids	 <p>Salicylic acid</p>
Methylation (S-adenosyl-methionine)	Amines Phenols Mercaptans	 <p>Norepinephrine</p>
Sulfate addition (3'-phosphoadenosine-5'-phosphosulfate)	Aromatic amines Alcohols Phenols	 <p>Acetaminophen</p>
Other reactions (various)	Purines Pyrimidines Epoxides and other reactive metabolites	 <p>Naphthalene epoxide</p>

the intestine, working alone or in concert with the liver, can metabolize some drugs so completely that the oral route cannot be used for their administration. CYP3A4 is the principal enzyme involved. The kidney is well suited for drug metabolism because it has a well-developed microsomal enzyme system and receives a bountiful blood supply. Glucuronidation is an especially prominent activity.

In recent years, the role of the lung in drug disposition has been an active area of investigation. By means of the pulmonary circulation, virtually all the blood is exposed to lung tissue with each circulation. Studies have shown that the lung is a primary site for metabolism of endogenous blood-borne compounds such as bradykinin, angiotensin I, prostaglandins, and biogenic amines.⁴⁵ Its role in the biotransformation of purely exogenous compounds was discounted previously because the liver has such a high content of drug-metabolizing enzymes. This reasoning failed to account for the important influence of blood flow or drug delivery on the metabolism of some drugs. Although the

activity of arylhydrocarbon hydroxylase in the liver is more than 1000 times that of the lung, the pulmonary metabolism of benzo[*a*]pyrene by this enzyme in vivo may approach or even exceed the hepatic rate.⁴⁵

Factors Affecting Drug Metabolism

The rate of drug biotransformation depends on numerous variables, including access to the site of metabolism, the concentration and phenotype of the enzyme present, and the effect of certain agents on enzymatic activity. Because most drugs are metabolized in the liver, attention is centered on factors influencing hepatic drug biotransformation.

Entry into the liver

As stated previously, plasma protein binding can significantly reduce the rate of uptake and metabolism of drugs by the liver. Inverse correlations between the rate of biotransformation and the degree of protein binding have been reported for sulfonamides, warfarin, and phenytoin, among others.¹⁵ A

similar relationship exists for drugs bound to extravascular reservoirs. For some compounds, however, plasma protein binding does not hinder metabolism and may even enhance it. Lidocaine and propranolol are so effectively absorbed by hepatic tissues that, even with significant binding, the clearance of these drugs from the body is primarily limited by hepatic blood flow. Because protein binding retains extra drug within the vascular compartment, more is presented to the liver per unit of time for metabolism.

Certain disease states and drug interactions can affect the accessibility of liver enzymes to pharmacologic agents. Uremia, by reducing the binding capacity of albumin, promotes the biotransformation of some highly bound drugs. Because inflammation and stress increase the plasma concentration of α_1 -acid glycoprotein, the opposite effect may occur with some basic drugs.⁵⁵ Hepatic damage can affect drug delivery to the liver in several ways. It may lead to reduced plasma protein concentrations and altered drug binding. Decreased metabolism of bilirubin and other substrates may also alter distribution of a drug and its availability for hepatic uptake. Finally, cirrhosis, cardiac insufficiency, and other conditions that reduce hepatic blood flow may significantly retard the metabolism of lidocaine and similar agents whose biotransformation is normally limited by the rate of drug delivery to the liver.

As illustrated in Figure 2-7, hepatic transporters can significantly influence the uptake of drugs by the liver. SLC transporters, including several OATs, OATPs, and OCTs, facilitate the uptake of a wide variety of xenobiotics from the hepatocyte's sinusoidal surface into the cytoplasm. Although a handful of ABC transporters, including P-glycoprotein and several MRPs, actively export numerous compounds out of hepatocytes, most of this activity is aimed at exporting drugs and their metabolites through the canalicular membrane and into the bile. (It is unclear what role ABC transporters play in pumping drugs or their metabolites directly back into the blood.) Pravastatin and related statin cholesterol-lowering drugs provide excellent examples of the critical importance of active transport to hepatic uptake. Pravastatin is a hydrophilic drug that nevertheless is taken up efficiently into the liver by OATP transporters.³⁵ This sequestration of pravastatin reduces the drug's systemic bioavailability to 17%, while focusing the drug's effect within the liver. This action is beneficial in two respects: (1) it augments the ability of pravastatin to depress hepatic synthesis of cholesterol; (2) it minimizes the toxic effects of pravastatin on skeletal muscle and other tissues.

Enzyme inhibition

Drug-metabolizing enzymes are subject to competitive and noncompetitive antagonism. Because so many drugs are acted on by the CYP system, competitive inhibition of microsomal oxidation is easily shown in the laboratory. Drug interactions of this type are usually not clinically important. In many instances, the rate of biotransformation is limited not by the CYP electron transport chain but by the movement of drugs into the smooth endoplasmic reticulum. Some compounds exhibit saturation kinetics, however, and are restricted in metabolism by the rate of binding to specific CYP enzymes. Competition involving these agents (e.g., phenytoin and dicumarol competing for CYP2C9) is of practical significance.

Various metabolic poisons—carbon monoxide, cyanide, heavy metals—noncompetitively inhibit microsomal biotransformation. These actions are of experimental interest only, however, because effects on respiration and other vital processes take precedence *in vivo*. A much more specific inhibition of microsomal oxidation is achieved with proadifen, which avidly binds to the heme iron of CYP. This compound blocks the metabolism of numerous agents dependent on CYP enzymes; it can also inhibit glucuronidation. The effect on most

drugs is a prolongation of action, but compounds requiring microsomal activation may have a loss of potency. The plethora of substances affected by proadifen prohibits its use in humans; however, similar compounds have applications as potentiators of insecticides that are inactivated by microsomal biotransformation. Clinically useful drugs that inhibit the metabolism of numerous other agents by inactivating various CYP enzymes include the macrolide antibiotics (other than azithromycin), chloramphenicol, certain imidazole derivatives (cimetidine and theazole antifungals), and amiodarone (see Table 2-3). These drugs—or their metabolites—react covalently or otherwise strongly with specific sites on the CYP molecule. Gingko biloba and grapefruit juice are herbal and dietary constituents that powerfully inhibit certain classes of CYP enzymes.

Several drugs are used specifically as inhibitors of selected nonmicrosomal enzymes. When the enzyme affected happens to be responsible for the inactivation of other therapeutic agents, drug interactions are likely to develop. Examples of such enzymes are monoamine oxidase, pseudocholinesterase, and xanthine oxidase. The inhibition of aldehyde dehydrogenase by disulfiram is exceptional because that drug's primary indication is to interrupt the metabolism of another foreign compound, ethanol (see Chapter 43).

Enzyme induction

Microsomal CYP drug-metabolizing enzymes are inducible; under an appropriate chemical stimulus, catalytic activity increases. Many chemicals, including therapeutic agents, "social" drugs, and environmental toxins, are capable of stimulating their own biotransformation and the biotransformation of closely related compounds. In addition, some chemicals can augment the breakdown of a host of diverse substances. Phenobarbital illustrates this latter type of induction. On reaching the interior of the hepatocyte, phenobarbital activates a nuclear transcription factor termed the *constitutive androstane receptor*, which then migrates into the nucleus to activate genes with the appropriate response elements.¹⁴ Several hours thereafter, an elevation in hepatic protein synthesis becomes apparent. Reductions in the metabolic half-lives of affected drugs are paralleled by increases in microsomal weight and in the concentrations of NADPH-cytochrome P450 oxidoreductase and several CYP enzymes (most importantly, CYP2B6, CYP2C8/9, CYP2C18/19, and CYP3A4/5). The liver eventually hypertrophies, and hepatic blood flow and bile secretion are likewise enhanced. Rifampin, another broad-spectrum inducer, binds to a closely related transcription factor termed the *pregnane X receptor* to initiate a similar response.

By way of contrast, benzo[a]pyrene exemplifies agents with a more restrictive form of induction. Although benzo[a]pyrene requires new enzyme formation for its stimulation of metabolism (inhibitors of protein synthesis block its action), structural changes in the smooth endoplasmic reticulum are not prominent and may be undetectable. Enzyme induction in this case principally involves the CYP1 gene family (CYP1A1/2 and CYP1B1). The transcription factor for benzo[a]pyrene and many other aromatic hydrocarbons and heterocyclics is the aryl hydrocarbon receptor.

Regardless of the pattern of induction, the rate of metabolism of affected compounds may be enhanced experimentally by seven times the baseline. Stimulation is usually less pronounced clinically; nevertheless, enzyme induction has many important therapeutic ramifications. It is a major cause of drug interactions. A classic example of this form of drug interaction is the stimulation by phenobarbital of the metabolism of the anticoagulant dicumarol, which causes standard doses of the anticoagulant to be ineffective.⁹ Induction of microsomal enzymes leading to a loss of pharmacologic responsiveness is referred to as *pharmacokinetic tolerance*. Finally, enzyme induction may affect the function of endogenous chemicals metabolized microsomally. Acceleration of vitamin D oxida-

tion to yield inactive products is the leading cause of rickets and osteomalacia in epileptic patients receiving medications such as phenytoin and phenobarbital.¹⁸

It would seem an obvious outcome that enzyme induction should decrease drug toxicity in concert with any reduction in drug potency. This is not always the case, however. Of strong concern in the field of toxicology is the potential danger posed by highly reactive intermediary substances produced during microsomal oxidation of drugs such as acetaminophen, halothane, and benzo[*a*]pyrene.³⁹ These substances are normally synthesized in such limited quantities that succeeding reactions, including hydrolysis and glutathione conjugation, inactivate them before cellular injury can ensue. Selective microsomal enzyme induction may sufficiently increase their synthesis that subsequent protective reactions become overwhelmed. In agreement with this thesis is a report in which cigarette smokers who exhibited high inducibility of arylhydrocarbon hydroxylase activity, which converts benzo[*a*]pyrene and related polycyclic hydrocarbons into epoxide intermediates, were estimated to have a 36-fold increased risk of developing bronchogenic carcinoma than individuals having low inducibility.²²

Transporter inhibition and induction

Interactions that result in decreased or increased active transport of drugs to and from their sites of metabolism show many similarities to those described earlier for drug-metabolizing enzymes. P-glycoprotein is the most conspicuous example. Biologically, P-glycoprotein and CYP3A4 seem to act in a coordinated fashion to protect cells from toxic compounds. Both proteins share considerable overlap in substrate specificity. Most of the inhibitors for CYP3A4 listed in Table 2-3 also block P-glycoprotein transport, and drugs that activate the pregnane X receptor (e.g., rifampin) induce the formation of both proteins. Although P-glycoprotein exports drugs in the intestine back into the luminal space, it exposes the drugs to CYP3A4 metabolism during the process. In the liver, the principal action of P-glycoprotein is to convey drugs and their metabolites into the bile. This action ensures that the compounds either are excreted via the feces or are subjected again to intestinal and hepatic biotransformation.

The SLC transporters responsible for the active and facilitated uptake of drugs by the liver are subject to inhibition by various agents. With regard to the previously mentioned pravastatin, the antidiabetic drug repaglinide can completely block pravastatin uptake by OATPB1 *in vitro*.³ Potential consequences of this inhibition include loss of therapeutic effect within the liver and increased systemic toxicity elsewhere. A case report of acute myopathy in a woman taking pravastatin and colchicine underscores the potential for this interaction.² In contrast to P-glycoprotein, little is known about induction of SLC transporters other than complex patterns of induction and inhibition have been reported for drugs that activate transcription factors such as the pregnane X receptor.

Genetic factors

Individuals vary in their ability to metabolize drugs. Although differences can result from the environmental induction of microsomal enzymes (as seen in chemical factory workers and cigarette smokers), studies comparing identical and fraternal twins have conclusively established the preeminent influence of heredity on the rate of biotransformation.⁵⁴ For some drugs, the range in metabolic $t_{1/2}$ may exceed an order of magnitude, but usually this figure is restricted to a value of two or three. The ability to metabolize a particular type of compound at an abnormal rate does not usually signify anything concerning the biotransformation of unrelated substances. Normal individuals exhibiting the lowest microsomal metabolism rates are the most likely to undergo profound enzyme induction after phenobarbital treatment, however.⁵⁴

Genetic influences on metabolism are most easily characterized when single genes are involved. A good example of this principle is provided by the plasma enzyme pseudocholinesterase. Approximately one individual in 3000 is homozygous for an atypical gene whose enzyme product metabolizes esters very slowly. A conventional dose of the muscle relaxant succinylcholine produces prolonged apnea in these patients. Individuals with a combination of typical and atypical genes (heterozygotes) still have enough normal enzyme to hydrolyze the drug fast enough to avoid unusual clinical manifestations. Since the discovery of the atypical gene for pseudocholinesterase, other novel genotypes have been described, including one that is "silent" (its product has no enzymatic activity whatsoever) and one that yields an enzyme so effective in catalysis that patients with it exhibit a remarkable innate resistance to the paralyzing effect of succinylcholine. The pharmacogenetics of drug metabolism are explored more fully in Chapter 4.

Information is accumulating that genetic differences in transporter expression may alter drug metabolism. In the case of pravastatin, several studies have documented polymorphisms that result in markedly increased pravastatin concentrations in a small percentage of patients exposed to the drug.²⁵

Age

Neonates, especially premature infants, often lack certain functional drug-metabolizing systems. The relative inability to conjugate bilirubin with glucuronic acid and the resultant development of hyperbilirubinemia is a commonly observed example of this deficiency in biotransformation. The failure to account for marked quantitative differences in neonatal metabolism is highlighted by the "gray syndrome" and infant death associated with chloramphenicol. In contrast to newborns, children are often more adept at metabolizing drugs on a weight basis than are young adults.⁵² Thereafter, biotransformation capacity seems to diminish with age; elderly individuals may often exhibit retarded rates of drug metabolism.

Pathology

Significant destruction of the hepatic parenchyma with loss of drug-metabolizing enzymes can directly depress the biotransformation of many agents. The clinical effect may be quite small, however, because of the liver's reserve metabolic capacity and enzyme induction in the unaffected tissue. (See Chapter 3 for further discussion of hepatic dysfunction and patient response.)

A more subtle effect of pathology is exemplified by the influence of infection on hepatic metabolism.⁴³ Viral illnesses have been linked to depression of CYP activity and inhibition of the microsomal oxidation of theophylline and a few other drugs. Interferons produced in response to these diseases or to vaccines prepared from disrupted virions may cause the inhibition. Several nonviral infections, such as malaria, leprosy, and various forms of pneumonia, have also been associated with impaired drug biotransformation.

Finally, endocrine derangements may alter drug metabolism. Hypothyroidism may slow biotransformation of certain drugs; hyperthyroidism tends to have the opposite effect. In animals, derangements of the pituitary gland, adrenal cortex, and gonads have been shown to affect drug metabolism; whether similar effects occur in humans is unknown.

EXCRETION

Foreign substances, including therapeutic medications, are prevented from building up in the body by the combined action of metabolism and excretion. Drugs and their metabolites may be eliminated by numerous routes, including urine,

bile, sweat, saliva and other gastrointestinal secretions, pulmonary exhalation, tears, and breast milk. Quantitative considerations make the kidney the major organ of drug excretion.

Renal Excretion

Three processes—glomerular filtration, tubular reabsorption, and active transport—control the urinary elimination of drugs. Although all drugs are subject to filtration, the percentage filtered varies inversely according to the degree of plasma protein binding and to the V_d . When filtered, agents tend to be resorbed in relation to their lipid/water partition coefficients. These considerations favor the renal excretion of highly polar compounds, but the exact rate of elimination also depends on whether active transport into (or, rarely, out of) the tubular fluid occurs.

Glomerular filtration

Each day, the kidneys filter approximately 180 L of plasma. Arterial blood entering Bowman's capsule is routed through a tuft of capillaries collectively described as the glomerulus. These capillaries are uniquely modified for filtration, having large numbers of pores with an effective diameter to 80 Å penetrating through the endothelium. Because these pores are sufficiently large to allow passage of all but the cellular elements of blood, the actual filtration barrier is provided by the thick basement membrane. Large amounts of negatively charged glycosaminoglycans help to repel albumin and other plasma proteins from entering the nephron. Approximately one fifth of the plasma entering the glomerular apparatus is actually filtered; the remainder exits by way of efferent arterioles to supply other portions of the nephron. Generally, molecules smaller than albumin (molecular weight 69 kDa) appear in the tubular fluid. Because plasma proteins are almost completely retained within the bloodstream, bound drugs are not subject to filtration.

Tubular reabsorption

Only about 1.5 L of urine is excreted every 24 hours (<1% of the daily filtered load); the kidney must have an efficient reabsorption system. Were this not the case, a person would lose valuable fluid and nutrients and quickly die. Approximately 80% of the glomerular filtrate is reclaimed by the proximal convoluted tubule. A high-capacity pump actively transports Na^+ back into the bloodstream, with anions (principally Cl^-) and water following passively. This process continues throughout the nephron and is aided by specific transport systems, such as in the ascending loop of Henle, where cotransport of Na^+ , K^+ , and Cl^- occurs. In addition, the reabsorption of Na^+ is aided by its exchange with H^+ and, in the distal convoluted tubule, K^+ . The resultant concentration of the tubular fluid creates a chemical gradient for the diffusion of drugs back into the systemic circulation. Agents with a favorable lipid/water partition coefficient readily traverse the tubular epithelium and escape from the urine.

A major factor influencing the reabsorption of weak electrolytes from renal tubular fluid is the pH. Depending on the rate of H^+ secretion, the urinary pH may vary from 4.5 to 8.0. Weak acids such as aspirin and phenobarbital are reabsorbed more effectively under acidic conditions; the reverse is true for weak bases such as amphetamine and ephedrine. Occasionally, the influence of pH on drug excretion is used to clinical advantage. A common strategy in the face of aspirin toxicity is to promote salicylate elimination through alkalization of the urine by the systemic administration of sodium bicarbonate. For the sulfonamides (also weak acids), alkalization of the urine may reduce the plasma $t_{1/2}$ by 50% and prevent the development of crystalluria by increasing aqueous solubility.¹⁵ Attempts to enhance renal excretion are of little value for agents whose inactivation depends largely on biotransformation.

Active secretion

Numerous organic anions and cations are actively secreted by cells of the proximal convoluted tubule (see Figure 2-7). The anionic transport system, responsible for the secretion of amphiphilic anions and conjugated metabolites (e.g., glucuronides, sulfates), relies primarily on two basolateral transporters—OAT1 and OAT3—to take up anions (and some neutral and even cationic drugs). These antiporters exchange intracellular α -ketoglutarate for the interstitial anions. Transfer of the now intracellular organic anions into the urine principally involves the Na^+ /phosphate transporter-1 (NPT-1) and two ABC transporters (MRP2 and MRP4). Because each transport carrier is nonselective, competition for binding sites is sometimes observed. Probenecid, an acidic anion, has been used to block the active secretion of another acid, penicillin G. The inhibition of penicillin secretion by NPT-1 was beneficial at a time when the drug was in short supply and is still used when it is necessary to maintain a high concentration of the antibiotic for prolonged periods.

Vectorial transport of organic cations also involves SLC transporters (OCT1, OCT2, OCT3) on the basolateral side of the tubular epithelium and a mix of transporters on the luminal side. Because of a favorable electrochemical gradient for cations, energy is not required for facilitated transport of extracellular cations. When inside, the compounds are pumped into the urine by one or more transporters, including P-glycoprotein, OCT3, OCTN1, and OCTN3.

Specific transport systems of the kidney, found principally in the distal convoluted tubule, also exist to reabsorb specific agents actively. The most important active reuptake of organic ions by this mechanism involves uric acid. Because probenecid can compete with urate ions as readily as it can with penicillin, probenecid has an application in gout as a promoter of uric acid excretion.

Active secretion of substances into the urine is not adversely affected by plasma protein binding. The transport is often so effective that drug dissociation occurs instantly, making available more drug for secretion, until all the drug has been cleared from the local blood supply. Binding to extravascular tissues does reduce the rate of renal elimination, however, regardless of the mechanisms involved.

Clearance

The amount of drug removed by the kidney per unit of time is often evaluated as a function of the plasma water "cleared" of drug. Mathematically, the volume of plasma cleared per minute (CL) can be written as $\text{CL} = U \times V/P$, where U is the urinary concentration of drug, V is the volume of urine produced per minute, and P is the plasma concentration. The clearance and V_d are related by the simple formula $\text{CL} = k_e \times V_d$, where k_e is the elimination rate constant. Agents that are filtered but not resorbed or secreted, such as inulin, yield a clearance of 130 mL/min (assuming no plasma protein binding), and serve as a measure of the glomerular filtration rate. With a V_d of 12 L, this clearance rate translates into a plasma $t_{1/2}$ for inulin of 64 minutes. Compounds actively secreted into the urine and not reabsorbed, such as penicillin G and *p*-aminohippurate, may approach a clearance of 650 mL/min, which is the rate of total plasma flow through the kidneys. Assuming a V_d of 12 L, such a drug would have a plasma $t_{1/2}$ of approximately 13 minutes. By way of contrast, drugs that are highly bound and subject to passive reabsorption may exhibit clearance rates approaching 0.

Biliary Excretion

Numerous cationic, anionic, and steroid-like molecules are selectively removed from the blood for excretion into the bile and eventually the feces. Generally, these substances have molecular weights exceeding 500 Da. The transport

process is an active one in which the dissolved substance is transferred from the plasma to the hepatocytes and then to the bile, as described previously for drugs that are metabolized. The bile is also a route of excretion for metabolized drugs, especially drugs that have undergone phase II reactions such as glucuronidation.

Biliary excretion is responsible for all but a small portion of the fecal elimination of drugs. The remainder results from direct transmucosal passage into the gastrointestinal tract from the bloodstream or represents compounds dissolved in one or more gastrointestinal tract secretions. The feces may also contain a variable amount of unabsorbed drug. Reabsorption of molecules excreted through the bile can occur, such as with the laxative phenolphthalein. Such enterohepatic recycling can prolong the duration of action and may continue *ad infinitum* until the system is interrupted (e.g., by metabolism, curtailment of bile flow, or ingestion of a drug chelator).

Other Routes of Excretion

Pulmonary excretion is a primary route for the elimination of gases and some volatile compounds. Except for the inhalation anesthetics, however, excretion of chemicals into the respiratory tree may be of more aesthetic concern than pharmacokinetic interest. Halitosis produced by odoriferous agents (e.g., paraldehyde) may impair clinical suitability.

Elimination of drugs by breast milk is important, not because of any quantitative significance, but because it represents a potential danger to the nursing infant. Drugs of particular concern include lithium, various anticancer agents, and isoniazid.⁷ The primary variable influencing the passage of drugs into milk is lipid solubility.

Other minor routes of excretion include sweat; tears; saliva; and gastric, pancreatic, and intestinal secretions. In all cases, excretion is limited by the lipid/water partition coefficient. For saliva and related gastrointestinal fluids, drugs are deposited into the gastrointestinal tract after secretion and are available for reabsorption into the systemic circulation.

TIME COURSE OF DRUG ACTION

The close correspondence between the plasma concentration of an agent and its magnitude of effect has already been emphasized. Because drug administration usually encompasses the linear midrange of the log dose-response curve, the relationship between plasma titer and patient reaction is often straightforward. A temporal description of drug concentration on the basis of pharmacokinetic principles is useful in illustrating how absorption, distribution, metabolism, and excretion influence drug effects in concert and provides guidance for adjusting dosage schedules to achieve therapeutic results with a minimum of drug toxicity.

Kinetics of Absorption and Elimination

Most biologic events involving the fate of drugs can be described in simple kinetic terms: zero order, first order, or capacity limited (a combination of the two).

Zero-order kinetics

Zero-order kinetics define processes that occur at a constant rate per unit of time. Mathematically, this can be written as $dC/dt = k_0$, where dC/dt is the rate of change in concentration, and k_0 is a constant in units of amount per time. A good example of zero-order input of drugs is the continuous intravenous infusion in which the quantity of compound entering the bloodstream each minute is held constant (e.g., 5 mg/min). Another example of zero-order absorption is provided by the intramuscular or subcutaneous injection of a depot form of drug. Poor aqueous solubility of the preparation

permits a constant rate of drug release for hours to days. With oral administration, essentially zero-order absorption is realized whenever the rate-limiting factor is the dissolution of the primary drug particles. Finally, topical therapy often results in zero-order uptake. As long as the agent is in great excess, a relatively fixed quantity of drug permeates the skin per unit of time.

First-order kinetics

First-order kinetics relate to events that occur at a constant fractional rate per unit of time (e.g., 5%/min). Here $dC/dt = k_1C$, with k_1 representing the fractional rate constant in units of time^{-1} and C representing the drug concentration. The absorption, distribution, and elimination of compounds commonly exhibit this type of kinetics because they generally rely on processes that are first-order in character: passive diffusion, blood flow, or drug transport or metabolism operating well below saturation. Because the fraction of drug affected per unit of time is independent of concentration, referring to the reaction rate by its $t_{1/2}$, the period required for the process to reach 50% of completion, is often useful. The $t_{1/2}$ is related to the fractional rate constant by the formula $t_{1/2} = 0.693/k_1$. The greater the rate constant, the shorter the $t_{1/2}$ and the faster the reaction. It is easily shown that first-order processes are essentially complete (94%) after four half-lives. Figure 2-13 provides an example of the first-order elimination of a drug with a $t_{1/2}$ of 2 hours, and Table 2-6 lists the elimination half-lives of some commonly used categories of drugs in dentistry.

Capacity-limited reactions

Capacity-limited reactions involve enzymes responsible for the metabolism of drugs and transporters concerned with moving drugs across membranes. This kind of process initially displays zero-order kinetics when the endogenous factor (enzyme or transporter) is saturated with drug; it gradually takes on the features of a first-order reaction as the drug concentration decreases. As already stated, doses used clinically are usually less than the doses required for saturation. Some exceptions exist, however, in which saturation kinetics are evident. Alcohol, even in moderately intoxicating doses, is metabolized at a constant rate of approximately 8 g/hr. Only when the concentration decreases to far less than that producing any observable effect does alcohol dehydrogenation assume a first-order rate.

Another important instance of capacity-limited biotransformation involves aspirin. Aspirin is quickly deacetylated to salicylate, the anion responsible for much of the drug's pharmacologic activity. The salicylate is eliminated through several metabolic pathways and by renal excretion, yielding an overall elimination $t_{1/2}$ of approximately 3 hours. Some of the inactivation routes are easily saturated, however, so that when an overdose is ingested the toxicity problem is compounded by a relative loss in elimination efficiency. Elimination half-lives can be calculated for drugs displaying capacity-limited kinetics, but the values obtained vary continuously according to the drug concentration (see Table 2-6). Salicylate has a plasma $t_{1/2}$ of 20 hours when a very high concentration is present in the bloodstream. As the salicylate titer decreases into the therapeutic range, the elimination $t_{1/2}$ decreases to a constant of 3 hours.

Single-Compartment Model

In its entirety, the body's disposition of an administered drug involves such a complex temporal interplay of biochemical and physiologic processes, each with its own unique set of kinetic parameters, that a full quantitative description of the time course of drug action may be impossible to achieve. For practical purposes, however, the sojourn of many agents can be described by a simple model system (Figure 2-14) in which

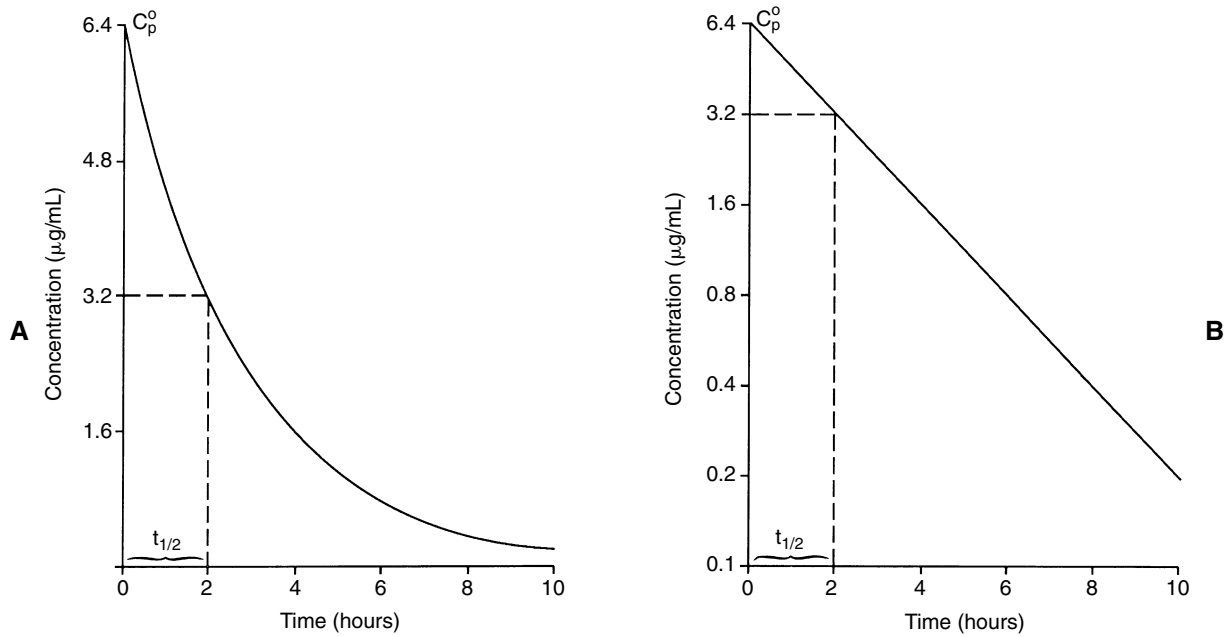

FIGURE 2-13 First-order elimination of a drug given as an intravenous bolus. In this example of a plasma concentration-time curve, it is assumed that the body behaves as a single compartment and that the distribution of the drug is essentially instantaneous. **A**, The plasma concentration is plotted on an arithmetic scale. **B**, A logarithmic scale is used to yield a straight line. The elimination half-life ($t_{1/2}$) is determined by the time interval required (2 hours in this case) for the plasma concentration to decrease by 50%. C_p^0 indicates the interpolated concentration of drug immediately after drug injection.

TABLE 2-6

Approximate Half-Lives of Common Drugs

DRUG	ELIMINATION HALF-LIFE (hr)
Antibiotics	
Amoxicillin	1.7
Clindamycin	3
Erythromycin	1.5
Penicillin G	0.5
Tetracycline	10
Analgesics	
Acetaminophen	3
Aspirin (as salicylate)	3-20*
Codeine	3 [†]
Meperidine	3
Morphine	2 [†]
Local Anesthetics	
Articaine	0.4
Bupivacaine	2.4
Lidocaine	1.8 [†]
Procaine	0.01
Sedative Agents	
Alcohol	1.4-20*
Diazepam	45 [†]
Pentobarbital	30
Triazolam	3

*Capacity-limited metabolism.
[†]Converted to active metabolite.

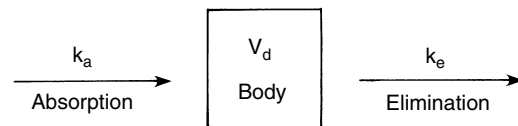

FIGURE 2-14 Single-compartment model of drug kinetics. Absorption into and elimination from the body are each assigned a single first-order rate constant. Distribution, assumed to be rapid regarding absorption and elimination, is not considered.

the body is depicted as a single compartment whose size corresponds to the V_d and whose elimination is based on first-order kinetics. In this model, which assumes rapid distribution with respect to absorption and elimination, the relationships among elimination $t_{1/2}$, total body clearance (CL, or the volume of blood “cleared” of the drug per unit of time by the combined processes of metabolism and excretion), and V_d are straightforward, as follows:

$$t_{1/2} = 0.693 \times V_d / CL$$

The unknowns of this equation are best determined by injecting the drug intravenously (eliminating the absorption variable) and measuring the plasma concentration at regular intervals sufficient to construct a plasma concentration-time curve, as shown in Figure 2-13. Given an initial dose of 500 mg (Q) and an initial plasma concentration of 6.4 µg/mL (C_p^0), determined by extrapolating the plasma concentration curve back to the moment of injection, V_d equals Q/C_p^0 , or approximately 78 L. With a $t_{1/2}$ of 2 hours, clearance approximates 27 L/hr or 450 mL/min.

The elimination $t_{1/2}$ is a dependent variable based on two independent attributes: the V_d and drug clearance. If a drug exhibits an increased $t_{1/2}$ in a patient, this could mean that tissue binding of the drug is greater than normal just as easily as it could indicate a reduction in the rate of metabolism or excretion of the agent. Similarly, a significant reduction in V_d , which can occur in some diseases, could have the curious result of reducing the $t_{1/2}$ of a drug even in the face of impaired clearance.

Plasma concentration—single doses

Therapeutic agents are often administered in dental practice as single doses. Whether the drug is lidocaine injected for regional anesthesia, atropine to control salivation, or midazolam to provide preoperative sedation, the plasma concentration increases to a peak during the absorptive phase and subsequently decreases, eventually to zero, as the drug is eliminated from the bloodstream. By using the single-compartment model, it is possible to construct theoretic plasma concentration curves and observe how modifications of dosage, absorption, or elimination can alter drug concentrations and, presumably, drug effects. As shown in Figure 2-15, the plasma concentration is at all times directly proportional to the dose. This relationship does not exist for agents that are capacity limited in absorption, binding, metabolism, or excretion.

As long as absorption is several times faster than elimination, changes in the rate of drug uptake have little effect other than to alter the peak concentration. The duration of action is hardly influenced at all. A different pattern emerges, however, in instances in which the rate of absorption approximates that of elimination (not shown in Figure 2-15), either because a timed-release formulation is used to slow absorption or because the drug is quickly metabolized or excreted. As exemplified by penicillin G ($t_{1/2}$ of 30 minutes), the slow absorption achieved by oral ingestion relative to its swift excretion results in a peak concentration that is much reduced and considerably delayed compared with intravenous injection. On the positive side, oral administration can result in a duration of effect that is significantly prolonged.

Variations in the elimination rate markedly affect the postabsorptive phase of drug action. As shown in Figure 2-15, a threefold decrease in elimination can be more effective than a similar increase in the dose in extending the duration of effect. Because the peak titer is generally not nearly as sensitive to changes in elimination as it is to alterations in dosage, retarding elimination may be the better approach to lengthening the duration of effect of compounds with a low or moderate margin of safety. For penicillin G, retarding elimination can be accomplished by inhibiting urinary excretion through

the coadministration of probenecid. Penicillin G is exceptional, however, in that the antibiotic has such a low toxicity that its rapid elimination can be offset safely by simply multiplying the dose several times.

Plasma concentration—repeated doses

Whenever a drug is administered more than once every four elimination half-lives, accumulation of the compound occurs within the body. Figure 2-16 shows the result of continued use of a drug given either by intravenous infusion (a zero-order process) or by repetitive administration (first-order absorption of each dose, but zero-order in aggregate). Regardless of the administration format, a plateau concentration is reached in approximately four elimination half-lives. The periodic fluctuations obtained with intermittent administration are a function of the absorption rate and the dosage interval. Approaching 50% of the peak concentration when absorption is very rapid and the dosage period equals the elimination $t_{1/2}$, such variations can be minimized by increasing the frequency of administration or retarding the rate of absorption.

The average steady-state concentration relative to the peak value obtainable after an initial dose can be determined by multiplying the number of doses administered per elimination $t_{1/2}$ by 1.44. The steady-state concentration of a drug given once every $t_{1/2}$ equals 144% of the initial peak concentration. For diazepam ingested three times per day, the average equilibrium concentration approximates (assuming a $t_{1/2}$ of 2 days) 1.44×6 , or 8.6 times the peak concentration after a single dose. At least 8 days (four half-lives) are required to reach this final drug titer.

The gradual approach to steady-state concentrations associated with slowly eliminated drugs can either benefit or hinder therapy. On the positive side, a long $t_{1/2}$ permits the clinician to administer the drug at convenient intervals, perhaps once a day, without having to be concerned with wide swings in plasma concentration. If patient monitoring reveals an unusual buildup of drug because of impaired metabolism or excretion or some other cause, time is available to adjust the dose before toxic effects ensue. On the debit side, the attainment of a therapeutic effect is delayed by the time required for drug accumulation to proceed. If an immediate pharmacologic effect is needed, a loading dose of the drug must be administered. A loading dose is a large, initial quantity of drug substituted for the normal amount to produce quickly a concentration approximating the steady state. For an agent given once each $t_{1/2}$, the loading dose equals twice the maintenance dose; for drugs given more frequently, the loading dose is larger. Dividing a loading dose into several

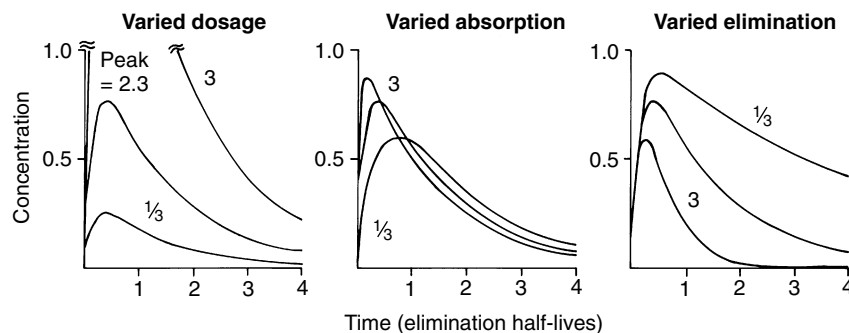

FIGURE 2-15 Time course of plasma concentration after single doses of drug. The various curves illustrate the influence of threefold increases (3) or decreases ($1/3$) of dosage, absorption, and elimination on drug titers. The standard curve reproduced in all three graphs represents an agent whose first-order absorption rate is 10 times faster than elimination. A concentration of 1.0 is the value that would result if the drug were absorbed instantaneously, as with an intravenous injection.

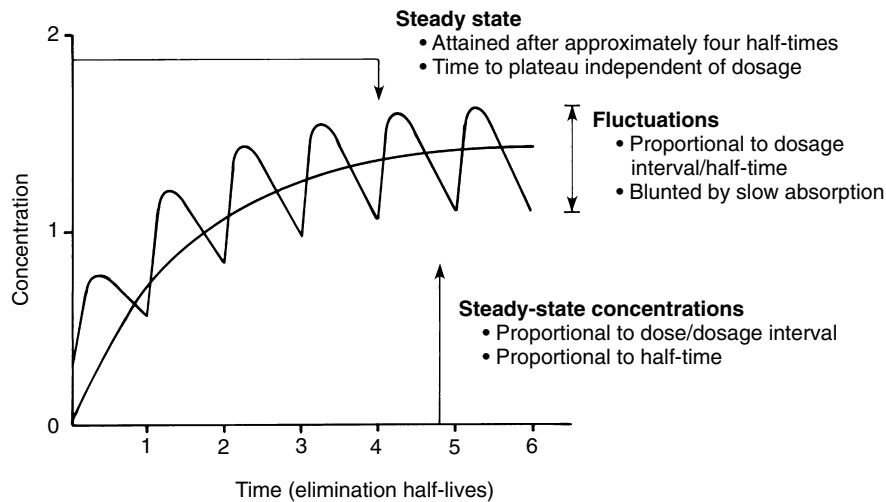

FIGURE 2-16 Time course of plasma concentration involving drug accumulation. The *serrated line* reflects the pattern of accumulation observed during the repeated administration of a drug at intervals equal to its elimination half-life, when drug absorption is 10 times as rapid as elimination. As the relative rate of absorption increases, the concentration maximums approach twice the minimums during the steady state. The *smooth line* depicts drug accumulation during the administration of an equivalent dosage by continuous intravenous infusion. (Adapted from Benet LZ, Kroetz DL, Sheiner LB: *Pharmacokinetics: the dynamics of drug absorption, distribution, and elimination*. In Hardman JG, Limbird LE, Gilman AG, editors: *Goodman & Gilman's the pharmacological basis of therapeutics*, ed 9, New York, 1996, McGraw-Hill.)

smaller fractions is often wise. The sacrifice of some speed in attaining a therapeutic concentration is usually more than compensated for by the ability to evaluate patient responses during the early phase of therapy. The fact that elimination rates, which help regulate steady-state concentrations, can vary greatly among individuals should dictate caution whenever cumulative drug effects are sought.

Multiple-Compartment Models

For many drugs, the simple single-compartment model does not adequately describe the early time course of plasma concentration. Large discrepancies are particularly likely to be observed when a relatively lipophilic drug is given intravenously, as in the use of CNS depressants for conscious sedation. In that situation, the assumption that the body acts as a single compartment does not hold, and one or more additional drug reservoirs must be postulated.

Figure 2-17 depicts a two-compartment model in which the drug is administered into a small central compartment. The agent may leave the central compartment either by distribution to a larger peripheral compartment or by processes of elimination. With time, a quasi-steady state is established between the central and peripheral reservoirs in which net redistribution back into the central compartment occurs as the drug is metabolized or excreted. In the example provided, which is analogous to the scenario in Figure 2-13, the initial high concentration (C_p^0) after a 500 mg dose reflects the smaller V_d of the central compartment ($V_c = 9.8$ L). The central compartment consists of organs (including the brain, heart, lungs, and kidneys) that receive a large blood supply. A terminal $t_{1/2}$ is determined from the log-linear portion of the curve, but in this case the term reflects distribution and elimination functions. Other parameters, such as the total V_d , are likewise more complex in derivation and interpretation than their counterparts in the single-compartment model.¹⁵ This complexity is compounded as the number of compartments in the model is increased. Nevertheless, multicompartment

models are useful in understanding how the duration of a drug's effect after a single injection may be largely independent of the clearance rate or elimination $t_{1/2}$. In Figure 2-17, if the threshold concentration for a sedative effect of the drug was 10 $\mu\text{g/mL}$, a patient would recover from the sedation within 30 minutes, even if metabolism and excretion were completely blocked, simply by distribution into less well-perfused tissues.

Context-Sensitive Half-Lives

The numerous variables of the multicompartment model make it impossible to predict intuitively the influence of individual pharmacokinetic parameters such as half-lives, V_d values, and clearance rates on the plasma-concentration profile of a highly lipid-soluble drug given repeatedly or continuously for a period of time. This situation poses a problem when intravenous agents are administered by continuous infusion for anesthesia or sedation. A partial solution involves the use of computer modeling to estimate context-sensitive half-lives.²⁰ The context-sensitive $t_{1/2}$ is the time required for the plasma concentration of a drug to decrease by 50% when consideration is given to how long the drug has been infused. As illustrated in Figure 2-18, fentanyl shows a significant increase in this parameter as the duration of infusion exceeds 2 hours. This phenomenon is the result of saturation of redistribution sites. Conversely, propofol, with its enormous capacity for redistribution, experiences only a slow increase over time. Such information is useful clinically in selecting the appropriate agent for use and in estimating the changing duration of drug effect. Similar context-sensitive curves can be generated for recovery to different percentages (e.g., 25%) of the plasma concentration, depending on what value best predicts recovery of function. Further advances in computer modeling will undoubtedly help address other limitations of the multicompartment model, such as the oscillations in arterial plasma concentrations that occur with bolus injection of drug and errors associated with the fact that some drugs are metabolized in more than a single compartment.¹²

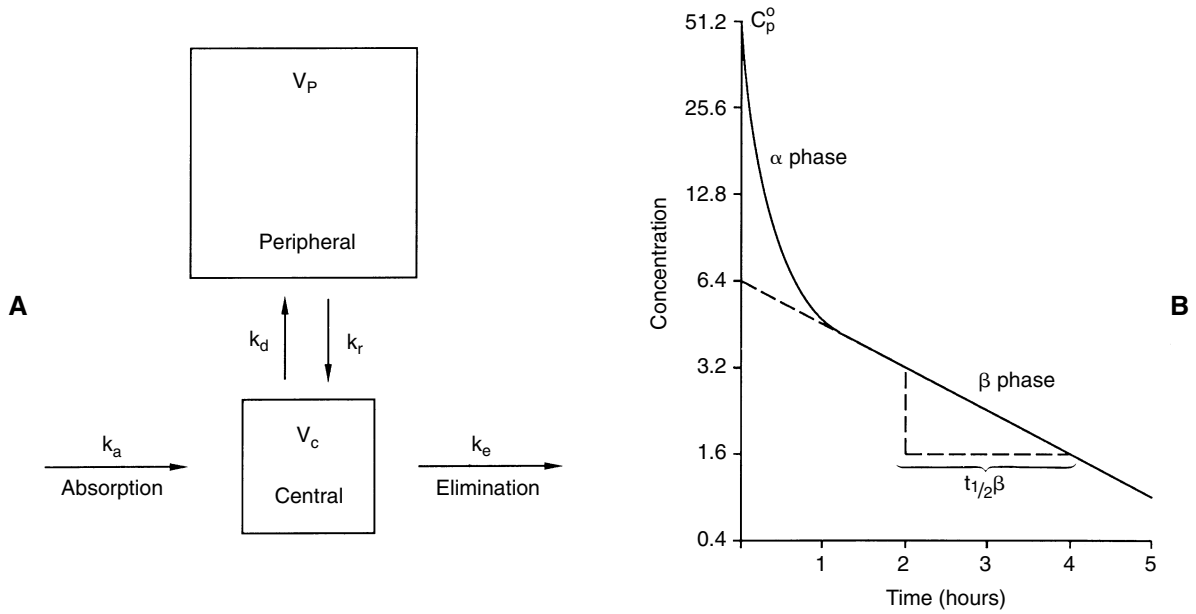

FIGURE 2-17 Two-compartment model of drug kinetics. **A**, In this model, drugs are absorbed into and eliminated from a central compartment that is linked by distribution processes (having rate constants of k_d and k_r) to a second, peripheral compartment. The central compartment includes the blood, from which drug determinations are taken. **B**, The plasma concentration-time curve consists of two phases: an early distribution or α phase, during which the concentration decreases largely as a result of distribution out of the central compartment, and a late elimination or β phase, during which metabolism and excretion predominate. The terminal half-life ($t_{1/2\beta}$) is calculated from the log-linear portion of the elimination curve.

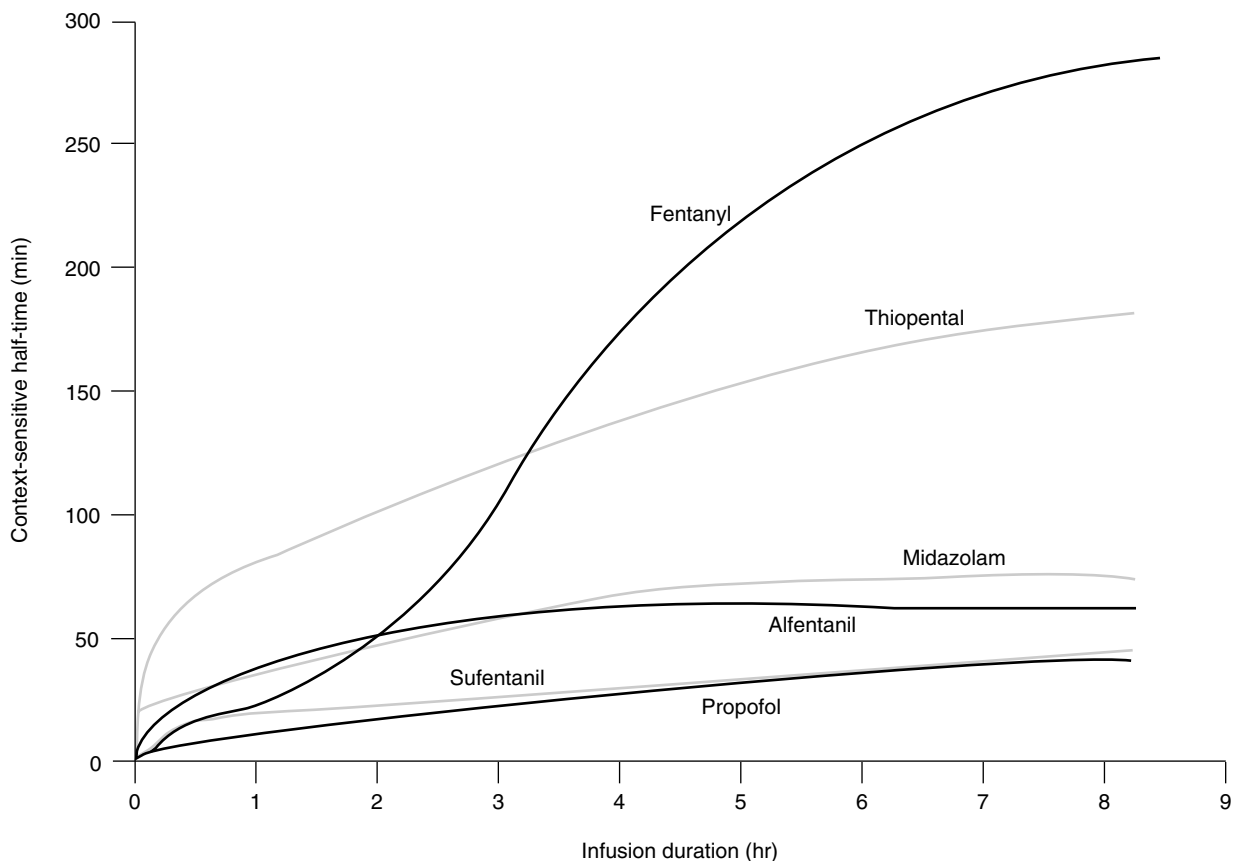

FIGURE 2-18 Context-sensitive half-times. (Redrawn from Hughes MA, Glass PSA, Jacobs JR: Context-sensitive half-time in multicompartment pharmacokinetic models for intravenous anesthetic drugs, *Anesthesiology* 76:334-341, 1992.)

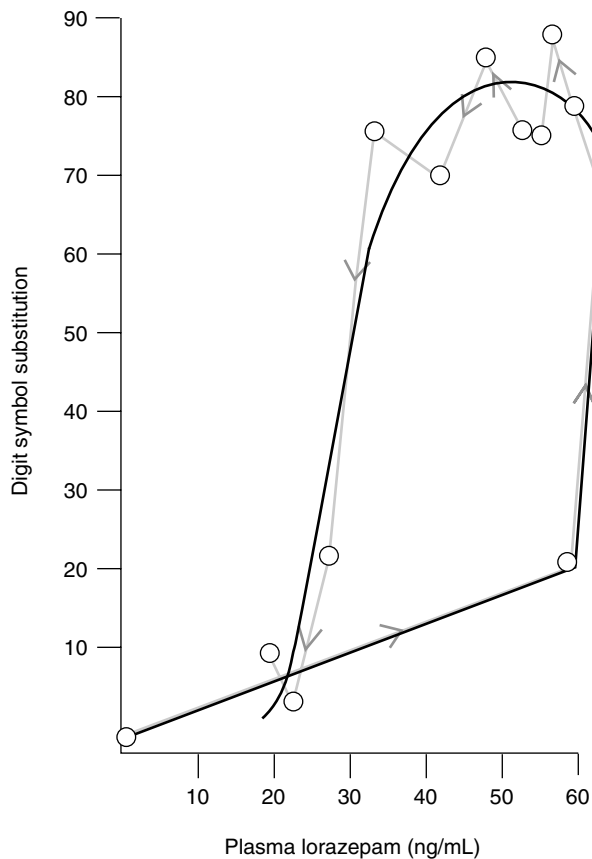

FIGURE 2-19 Temporal distortion between the plasma concentration of lorazepam and cognition as measured by the digit symbol substitution test. The counterclockwise hysteresis loop indicates a delay in the distribution of lorazepam to its site of action within the brain. (Adapted from Gupta SK, Ellinwood EH, Nikaido AM, et al: Simultaneous modeling of the pharmacokinetic and pharmacodynamic properties of benzodiazepines. 1. Lorazepam, *J Pharmacokinet Biopharm* 18:89-102, 1990.)

PHARMACOKINETIC-PHARMACODYNAMIC MODELING

Two basic assumptions underlying pharmacokinetic studies are that the plasma concentration of a drug is predictive of the concentration around the site of drug action and the magnitude of drug effect depends on this concentration. Although these assumptions generally hold, important exceptions to them do exist. As previously stated, drugs that bind covalently to their receptors produce effects that far outlast the drugs' passage in the bloodstream. Drugs that rely on transcription and protein synthesis are delayed in effect because of the time required for these processes to occur. Additional discrepancies between plasma concentration and drug effect arise because of delays in reaching the site of action and temporal changes that occur in receptor responsiveness. Pharmacokinetic-pharmacodynamic modeling seeks to account for these discrepancies.

Lorazepam provides a good example of a drug whose effects are temporally delayed (Figure 2-19). Lorazepam, a benzodiazepine used for relief of anxiety, must gain access to the CNS to stimulate its receptor and produce its characteristic CNS effects. The drug's modest lipid solubility ensures, however, that the peak plasma concentration after oral administration occurs before the drug has had any significant effect in the brain.¹⁷

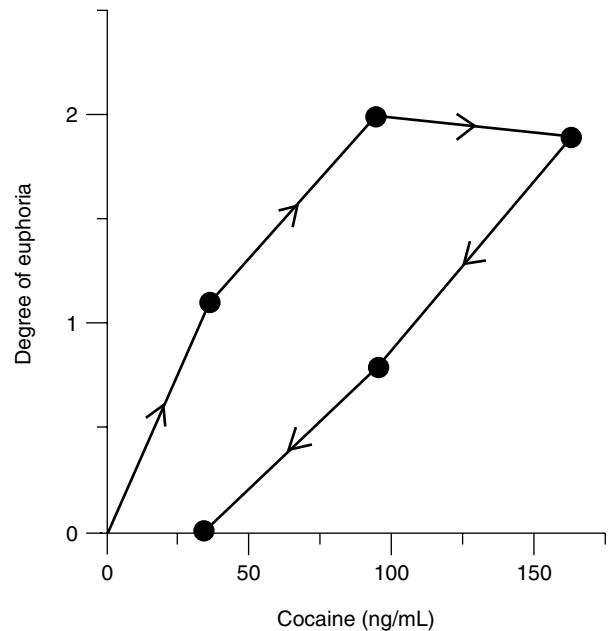

FIGURE 2-20 Acute tolerance to a single dose of intranasal cocaine. The clockwise hysteresis loop indicates a loss of subjective drug effect as a function of the plasma concentration over time. (Data from Van Dyke C, Jatlow P, Ungerer J, et al: Oral cocaine: plasma concentrations and central effects, *Science* 200:211-213, 1978.)

Cocaine produces the opposite relationship in that maximal drug effects after oral administration precede the peak plasma concentration (Figure 2-20).⁵³ In this case, receptors that mediate the pharmacologic effect of cocaine undergo desensitization. Desensitization often involves a change in receptor sensitivity, either by phosphorylation of a regulatory subunit of the receptor or uncoupling of the receptor from its intracellular response system. Longer lasting losses of drug responsiveness may include downregulation of receptors, in which the number of receptors decreases on continuous exposure to the drug. See Figure 1-12 for an example of desensitization and downregulation.

CITED REFERENCES

1. Agre P, King LS, Yasui M, et al: Aquaporin water channels—from atomic structure to clinical medicine. *J Physiol* 542.1:3-16, 2002.
2. Alayli G, Cengiz K, Cantürk F, et al: Acute myopathy in a patient with concomitant use of pravastatin and colchicine. *Ann Pharmacother* 39:1358-1361, 2005.
3. Bachmakov I, Glaeser H, Fromm MF, et al: Interaction of oral antidiabetic drugs with hepatic uptake transporters. *Diabetes* 57:1463-1469, 2008.
4. Barchowsky A, Stargel WW, Shand DG, et al: Saliva concentrations of lidocaine and its metabolites in man. *Ther Drug Monit* 4:335-339, 1982.
5. Bartnicka L, Kurzawski M, Drozdziak A, et al: Effect of ABCB1 (MDR1) 3435C>T and 2677G>A, T polymorphisms and P-glycoprotein inhibitors on salivary digoxin secretion in congestive heart failure patients. *Pharmacol Rep* 59:323-329, 2007.
6. Beckett AH, Hossie RD: Buccal absorption of drugs. In Brodie BB, Gillette JR, editors: *Handbook of experimental pharmacology*, Berlin, 1971, Springer-Verlag.
7. Berlin CM, Jr: Pharmacologic considerations of drug use in the lactating mother. *Obstet Gynecol* 58(suppl):17S-23S, 1981.
8. Bretscher MS: The molecules of the cell membrane. *Sci Am* 253:100-108, 1985.

9. Cucinell SA, Conney AH, Sansur M, et al: Drug interactions in man. I. Lowering effect of phenobarbital on plasma levels of bishydroxycoumarin (Dicumarol) and diphenylhydantoin (Dilantin). *Clin Pharmacol Ther* 6:420-429, 1965.
10. Evans WE, Relling MV: Pharmacogenomics: translating functional genomics into rational therapeutics. *Science* 286:487-491, 1999.
11. Feller K, le Petit G: On the distribution of drugs in saliva and blood plasma. *Int J Clin Pharmacol Biopharm* 15:468-469, 1977.
12. Fisher DM: (Almost) everything you learned about pharmacokinetics was (somewhat) wrong! *Anesth Analg* 83:901-903, 1996.
13. Gangarosa LP, Sr: Iontophoresis for surface local anesthesia. *J Am Dent Assoc* 88:125-128, 1974.
14. Germain P, Staels B, Dacquet C, et al: Overview of nomenclature of nuclear receptors. *Pharmacol Rev* 58:685-704, 2006.
15. Gibaldi M: *Biopharmaceutics and clinical pharmacokinetics*, ed 3, Philadelphia, 1984, Lea & Febiger.
16. Greenblatt DJ, Koch-Weser J: Clinical toxicity of chlorthalidopoxide and diazepam in relation to serum albumin concentration: a report from the Boston Collaborative Drug Surveillance Program. *Eur J Clin Pharmacol* 7:259-262, 1974.
17. Gupta SK, Ellinwood EH, Nikaido AM, et al: Simultaneous modeling of the pharmacokinetic and pharmacodynamic properties of benzodiazepines. 1. Lorazepam. *J Pharmacokinetic Biopharm* 18:89-102, 1990.
18. Hahn TJ, Hendin BA, Scharp CR, et al: Serum 25-hydroxycalciferol levels and bone mass in children on chronic anticonvulsant therapy. *N Engl J Med* 292:550-553, 1975.
19. Hogben CAM, Tocco DJ, Brodie BB, et al: On the mechanism of intestinal absorption of drugs. *J Pharmacol Exp Ther* 125:275-282, 1959.
20. Hughes MA, Glass PSA, Jacobs JR: Context-sensitive half-time in multicompartment pharmacokinetic models for intravenous anesthetic drugs. *Anesthesiology* 76:334-341, 1992.
21. Inman WHW, Adelstein AM: Rise and fall of asthma mortality in England and Wales in relation to use of pressurized aerosols. *Lancet* 2:279-285, 1969.
22. Kellermann G, Shaw CR, Luyten-Kellerman M: Aryl hydrocarbon hydroxylase inducibility and bronchogenic carcinoma. *N Engl J Med* 289:934-937, 1973.
23. Kemper EM, van Zandbergen AE, Cleypool C, et al: Increased penetration of paclitaxel into the brain by inhibition of P-glycoprotein. *Clin Cancer Res* 9:2849-2855, 2003.
24. King LS, Yasui M: Aquaporins and disease: lessons from mice to humans. *Trends Endocrinol Metab* 13:355-360, 2002.
25. Kivistö KT, Niemi M: Influence of drug transporter polymorphisms on pravastatin pharmacokinetics in humans. *Pharm Res* 24:239-247, 2007.
26. Levine RR: *Pharmacology: drug actions and reactions*, ed 4, Boston, 1990, Little, Brown.
27. Levy G: Kinetics and implications of dissolution rate: limited gastrointestinal absorption of drugs. In Ariens EJ, editor: *Physicochemical aspects of drug action*, Oxford, 1968, Pergamon Press.
28. Lipinski CA, Lombardo F, Dominy BW, et al: Experimental and computational approaches to estimate solubility and permeability in drug discovery and development settings. *Adv Drug Deliv Rev* 46:3-26, 2001.
29. Lovering EG, McGilveray IJ, McMillan I, et al: The bioavailability and dissolution behavior of nine brands of tetracycline tablets. *Can J Pharm Sci* 10:36-39, 1975.
30. Marchetti S, Mazzanti R, Beijnen JH, et al: Concise review: clinical relevance of drug-drug and herb-drug interactions mediated by the ABC transporter ABCB1 (MDR1, P-glycoprotein). *Oncologist* 12:927-941, 2007.
31. Marier JR: Halogenated hydrocarbon environmental pollution: the special case of halogenated anesthetics. *Environ Res* 28:212-239, 1982.
32. Mark LC: Thiobarbiturates. In Papper EM, Kitz RJ, editors: *Uptake and distribution of anesthetic agents*, New York, 1963, McGraw-Hill.
33. Melander A: Influence of food on the bioavailability of drugs. In Gibaldi M, Prescott L, editors: *Handbook of clinical pharmacokinetics*, New York, 1983, ADIS Health Science Press.
34. Minshall RD, Malik AB: Transport across the endothelium: regulation of endothelial permeability. *Handb Exp Pharmacol* 176(Pt 1):107-144, 2006.
35. Mizuno N, Niwa T, Yotsumoto Y, et al: Impact of drug transporter studies on drug discovery and development. *Pharmacol Rev* 55:425-461, 2003.
36. Murthy KS, Talim ST, Singh I: A comparative evaluation of topical application and iontophoresis of sodium fluoride for desensitization of hypersensitive dentin. *Oral Surg Oral Med Oral Pathol* 36:448-458, 1973.
37. Nebert DW, Russell DW: Clinical importance of the cytochromes P450. *Lancet* 360:1155-1162, 2002.
38. Ohki S, Gravis C, Pant H: Permeability of axon membranes to local anesthetics. *Biochim Biophys Acta* 643:495-507, 1981.
39. Okey AB, Roberts EA, Harper PA, et al: Induction of drug-metabolizing enzymes: mechanisms and consequences. *Clin Biochem* 19:132-141, 1986.
40. Portenoy RK, Khan E, Layman M, et al: Chronic morphine therapy for cancer pain: plasma and cerebrospinal fluid morphine and morphine-6-glucuronide concentrations. *Neurology* 41:1457-1461, 1991.
41. Pratt WB: The entry, distribution, and elimination of drugs. In Pratt WB, Taylor P, editors: *Principles of drug action: the basis of pharmacology*, ed 3, New York, 1990, Churchill Livingstone.
42. Rapoport SI, Robinson PJ: Tight-junctional modification as the basis of osmotic opening of the blood-brain barrier. *Ann N Y Acad Sci* 481:250-267, 1986.
43. Renton KW: Factors affecting drug biotransformation. *Clin Biochem* 19:72-75, 1986.
44. Rosenberg MF, Callaghan R, Modok S, et al: Three-dimensional structure of P-glycoprotein. *J Biol Chem* 280:2857-2862, 2005.
45. Roth RA: Biochemistry, physiology and drug metabolism—implications regarding the role of the lungs in drug disposition. *Clin Physiol Biochem* 3:66-79, 1985.
46. Rylance GW, Moreland TA: Saliva carbamazepine and phenytoin level monitoring. *Arch Dis Child* 56:637-640, 1981.
47. Sakaeda T: MDR1 genotype-related pharmacokinetics: fact or fiction? *Drug Metab Pharmacokinetic* 20:391-414, 2005.
48. Sarkadi B, Homolya L, Szakács G, et al: Human multidrug resistance ABCB and ABCG transporters: participation in a chemoinnate defense system. *Physiol Rev* 86:1179-1236, 2006.
49. Schekman R, Orci L: Coat proteins and vesicle budding. *Science* 271:1526-1533, 1996.
50. Scherrmann J-M: Drug delivery to brain via the blood-brain barrier. *Vasc Pharmacol* 38:349-354, 2002.
51. Singer SJ, Nicholson GL: The fluid mosaic model of the structure of cell membranes. *Science* 175:720-731, 1972.
52. Tanaka E: In vivo age-related changes in hepatic drug-oxidizing capacity in humans. *J Clin Pharm Ther* 23:247-255, 1998.
53. Van Dyke C, Jatlow P, Ungerer J, et al: Oral cocaine: plasma concentrations and central effects. *Science* 200:211-213, 1978.
54. Vesell ES: Advances in pharmacogenetics. *Prog Med Genet* 9:291-367, 1973.
55. Wood M: Plasma drug binding: implications for anesthesiologists. *Anesth Analg* 65:786-804, 1986.

GENERAL REFERENCES

- Atkinson AJ Jr, Abernethy DR, Daniels CE, et al, editors: *Principles of clinical pharmacology*, ed 2, Amsterdam, 2007, Elsevier.
- Brunton LL, Lazo JS, Parker KL, editors: *Goodman & Gilman's the pharmacological basis of therapeutics*, ed 11, New York, 2006, McGraw-Hill.
- Derendorf H, Hochhaus G, editors: *Handbook of pharmacokinetic/pharmacodynamic correlation*, Boca Raton, FL, 1995, CRC Press.
- Gibaldi M: *Biopharmaceutics and clinical pharmacokinetics*, ed 4, Philadelphia, 1991, Lea & Febiger.
- Katzung BG: *Basic and clinical pharmacology*, ed 10, New York, 2007, McGraw-Hill Professional.
- Pratt WB, Taylor P, editors: *Principles of drug action: the basis of pharmacology*, ed 3, New York, 1990, Churchill Livingstone.
- Walsh CT, Schwartz-Bloom RD: *Levine's pharmacology: drug actions and reactions*, ed 7, New York, 2005, Taylor & Francis.

Pharmacotherapeutics: The Clinical Use of Drugs

JOHN A. YAGIELA AND FRANK J. DOWD

The primary goal of drug treatment is to achieve a desired pharmacologic effect without causing adverse reactions. Because no therapeutic regimen is without risk, the clinician must weigh the benefits expected from a drug against the dangers inherent in its use. If drugs are to be properly selected and administered, numerous factors should be considered that complicate the attainment of therapeutic responses and the avoidance of unwanted effects.

As stated in Chapter 1, drugs are often selective in the effects they produce because they activate or inhibit specific drug receptors. Even the most selective agents generally evoke a spectrum of reactions, however, rather than a single pharmacologic outcome. Atropine in therapeutic concentrations specifically prevents the stimulation of muscarinic receptors by acetylcholine. Because these receptors are vital to the normal function of the entire parasympathetic nervous system, their blockade can result in a wide range of autonomic responses. Although specific in action, atropine is nonselective in effect. In addition, specificity of receptor binding is usually a matter of dose; in concentrations greater than therapeutic, atropine blocks the nonmuscarinic effects of acetylcholine and may inhibit the actions of other chemicals, such as histamine and 5-hydroxytryptamine. Finally, nonspecific effects unrelated to receptor blockade may be observed. Large concentrations of atropine have local anesthetic activity and directly affect the central nervous system (CNS) and peripheral vasculature.

In addition to the fact that single agents can produce multiple effects, pharmacotherapeutics is complicated by variations in patient responsiveness. A therapeutic dose of drug for one person may be ineffective for a second person and toxic to a third person. Even highly inbred laboratory species display measurable biologic variations in drug sensitivity. Figure 3-1 is a quantal dose-effect graph illustrating the percentage of subjects responding to an agent as a logarithmic function of the dose. The graph is constructed by counting the number of animals or patients exhibiting a specified effect at various doses. With low amounts of drug, very few individuals react; as the dose is increased, however, more are affected until a dose is reached at which the response is universal. Although similar in appearance, this *quantal* dose-effect relationship must not be confused with the *graded* dose-response curve described in Chapter 1 (see Figure 1-6). The quantal dose-response curve is sigmoidal because of the log-normal distribution of drug sensitivities found in most populations (see Figure 3-1). The median effective dose (ED_{50}) is the amount of drug required to produce a particular effect in 50% of treated individuals. Although potency is represented in quantal and graded relationships by the position of the curve on the abscissa, intrinsic activity or efficacy

is apparent only in graded responses. Biologic variation, which is inversely correlated with the slope of the quantal dose-effect curve, cannot be estimated from a single graded dose-response graph.⁵³

Patients who are unusually sensitive to a drug are said to be *hyperreactive*. Terms more or less synonymous with hyperreactivity include *hypersusceptibility* and *drug intolerance*. The term *hypersensitivity* is also used occasionally, but this usage can be misleading because hypersensitivity commonly indicates drug allergy. Individuals unexpectedly resistant to conventional doses of drug are referred to as being *hyporeactive*. Tolerance, tachyphylaxis, and several additional types of hyporeactivity are discussed later. Many variables influence the responsiveness of individuals to drugs. Some of these are readily apparent and under the control of the clinician; others are often hidden from view and not amenable to modification. Because it is impossible to predict how a given patient will respond to a particular agent, appropriate monitoring of drug effects is usually necessary to achieve optimal therapy.

FACTORS INFLUENCING DRUG EFFECTS

Differences between patients in reaction to a therapeutic agent may arise from disparities in drug concentration obtained with a standardized dose (*pharmacokinetic differences*), from variations in individual responsiveness to a given drug concentration (*pharmacodynamic differences*), or from secondary factors such as the failure of patients to take their medication as prescribed (*noncompliance*). Figure 3-2 shows the lack of correlation that can develop clinically between the prescribed dose of a drug—in this case the anticonvulsant phenytoin—and the resultant plasma concentration and pharmacologic response. Even with the daily dose corrected for body weight, this study revealed that the steady-state concentration of phenytoin differed 20-fold or more.²⁷ A small percentage of patients experienced nystagmus, an early indication of drug toxicity, at plasma concentrations barely sufficient to control convulsions in other patients. It is apparent that, given a therapeutic concentration range of 10 $\mu\text{g}/\text{mL}$ to 20 $\mu\text{g}/\text{mL}$ (the plasma concentration of phenytoin supposed to provide seizure protection with minimal adverse effects), most patients were prescribed or took on their own either insufficient medication or an overdose. Although pharmacokinetic dissimilarities account for many differences in patient responsiveness, the fact that phenytoin has a “therapeutic range,” rather than a single effective concentration, indicates that there also exists some variation in pharmacodynamic sensitivity to the anticonvulsant.

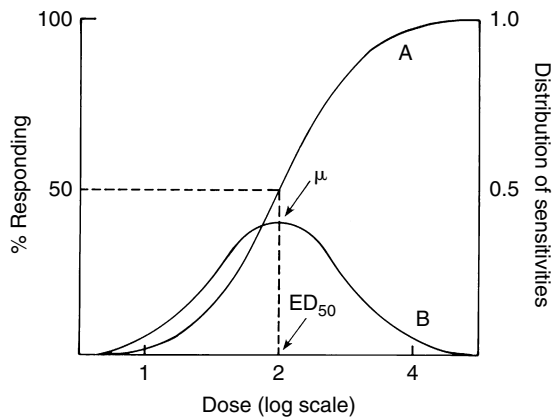

FIGURE 3-1 Quantal dose-response curves (log scale). Curve *A* represents the cumulative distribution, and curve *B* represents the frequency distribution of patient responses in a normal population. As shown, the mean (μ) and median (50% responding) sensitivities fall on the same dose (median effective dose, ED_{50}). (Adapted from Goldstein A, Aronow L, Kalman SM: *Principles of drug action: the basis of pharmacology*, ed 2, New York, 1974, John Wiley & Sons.)

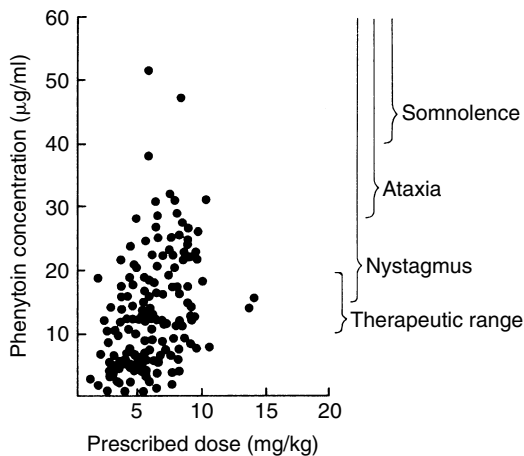

FIGURE 3-2 Plasma phenytoin concentration as a function of the prescribed dose. Each black circle represents a single patient ($n = 294$). Closed bracket indicates the accepted therapeutic concentration range for phenytoin in plasma; open-ended brackets denote concentrations at which the various toxic manifestations listed may occur. (Data from Lund L: Effects of phenytoin in patients with epilepsy in relation to its concentration in plasma. In Davies DS, Prichard BNC, editors: *Biological effects of drugs in relation to their plasma concentrations*, Baltimore, 1973, University Park Press; and Kutt H, Winters W, Kokenge R, et al: Diphenylhydantoin metabolism, blood levels, and toxicity, *Arch Neurol* 11:642-648, 1964.)

Patient Factors

Many factors that can influence drug effects clinically are highly variable in individual patients. Although attributes such as size, age, and genetic makeup are not amenable to modification, they must be taken into account whenever drug therapy is planned.

Body weight and composition

Adults may differ three times or more in weight. Because the volume of distribution of a drug is a function of body mass,

extremes in patient size may result in significant differences in plasma concentration when drugs are administered in the form of a “standard adult dose.” Body composition is also an important variable. Two equally heavy patients, one obese and the other muscular, may react quite differently to certain agents. Because adipose tissue contributes very little to body water, the obese person will be more susceptible to a drug distributed essentially within one or more body fluid compartments. The same person may show unusual resistance to a highly lipophilic agent such as thiopental, especially when it is given in repeated doses.

Age

Pediatric patients generally cannot be given adult dosages of drugs. The primary reason is their smaller body size, and various formulas (discussed in Chapter 55) have been devised to calculate pediatric fractions of the adult dose. For the following reasons, however, children must not be thought of as merely miniature adults. First, even with the size differential taken into account, neonates display an unusual hyperreactivity to drugs. Immature hepatic and renal systems during the first weeks of life tend to promote drug accumulation, and the relative inefficiency of drug binding by albumin (sometimes because of competition for binding sites by bilirubin) may also lead to abnormal concentrations of drug in the vicinity of receptors. In addition, distribution of compounds into the CNS may be enhanced by an incomplete maturation of the blood-brain barrier. Second, in contrast to neonates, children and infants older than 6 months often require large milligram-per-kilogram body weight doses of drugs during therapy. This relative hyporeactivity is mostly attributable to an enhancement in the rate of elimination.¹⁴ Dosage adjustment on the basis of surface area (see Figure 55-6) rather than body weight is empirically a useful strategy in correcting for age-related differences in elimination.

Pharmacodynamic differences also exist in pediatric patients. Incomplete maturation renders children especially vulnerable to the toxic effects of certain agents. Benzocaine is especially likely to cause methemoglobinemia in infants younger than 6 months, tetracyclines pose the risk of tooth discoloration until age 8 years, and sex steroids and other hormones administered before puberty may impair normal growth and development. In part because of the young child's high metabolic rate, atropine intoxication may readily cause hyperthermia, and salicylate overdosage may quickly lead to acid-base and electrolyte disturbances. The association of Reye's syndrome with aspirin and excitement reactions with antihistamines give added proof that children respond differently than adults to certain drugs.

There is no method of pediatric dosage calculation suitable for all drugs and therapeutic situations. In older children, adjustments based on age, weight, or (preferably) surface area may be satisfactory, but no general guide is possible for very young children. Dosages for neonates, infants, and young children should be based on clinical trials; studies of this nature were rarely performed before 1998, when the U.S. Food and Drug Administration (FDA) first mandated that information pertaining to safety and effectiveness of new drugs include data for demographic subgroups, such as children, who would benefit from their use. Pediatric dosage schedules for older drugs are often unavailable.

Geriatric patients are frequently hyperreactive to drugs. Although increased sensitivity may result from organic pathologic conditions or from drug interactions (both more likely to occur in elderly patients), age-related functional changes in drug disposition and cellular responsiveness are also involved. Because patients older than 65 years are much more likely to experience adverse drug reactions than young adults, at least in part because elderly patients consume many more medi-

cines, careful selection of drug and dosage schedules is necessary, especially with drugs of low safety. Geriatric pharmacology is becoming increasingly important to the dentist as the general population ages and a higher proportion of elderly individuals retain their teeth (thanks to improved oral hygiene and professional care); this subject is covered in its entirety in Chapter 53.

Sex, pregnancy, and lactation

The sex of a patient is sometimes important with respect to drug effects. As with children, information is lacking for many drugs because of the historic exclusion of female subjects from most drug studies. Dosage adjustments may be necessary for some drugs simply because women tend to be smaller than men and to have a higher percentage of body fat. Hepatic disposition of drugs seems not to be influenced by sex when variables such as age, size, body composition, and drug use are taken into account. Side effects such as hirsutism are less tolerable in women, and gynecomastia is more disconcerting in men.

Women seem to be more susceptible to drug-induced blood dyscrasias, and women taking systemic contraceptives may be more prone to some drug interactions. Drug-induced torsades de pointes is a potentially life-threatening arrhythmia with a significant sex bias. Women may be more likely to develop torsades because the QT interval of the electrocardiogram (see Chapter 24) is longer in women after puberty. The antiarrhythmic sotalol, one of the approximately 50 drugs that prolong the QT interval, is associated with a three times higher incidence of torsades in women.⁷ Because the preapproval clinical trials of sotalol enrolled only men, the relatively common side effect of QT prolongation was not recognized before the drug was released for general use.

Pregnancy is a major concern in pharmacotherapeutics. Alterations in liver function are common, and the hepatic toxicity of tetracycline and certain other compounds is markedly accentuated by pregnancy. The metabolism of numerous drugs is increased because of the ability of the high estrogen and progesterone concentrations to stimulate the pregnane X receptor (see Chapter 2) and cause enzyme induction. Renal excretion is likewise increased because of the elevated cardiac output and glomerular filtration. When present, pregnancy toxemia may increase drug effects by reducing the binding capacity of albumin, which is already reduced in a healthy pregnancy.

Of primary importance are the actions of drugs on the fetus. Spontaneous abortion, teratogenesis, mental retardation, drug dependence, and cancer have resulted from drug administration during pregnancy. Because few, if any, agents have been proved to be totally safe for the fetus, it is best to avoid all medications when possible. Drug administration should also be conservative in women of childbearing age because pregnancy is often undiagnosed during the first trimester, the most critical period of fetal development. Many drugs (e.g., methadone) are excreted in the milk. Because some of these agents may cause unwanted effects in the nursing infant, it is advisable to review carefully drug exposure during lactation as well. Nursing is contraindicated in women taking anticancer drugs, immunosuppressants, radioactive chemicals, ergot alkaloids, drugs of abuse, lithium salts, gold, iodine, and various antibiotics. Toxicologic concerns related to pregnancy are discussed in more detail later in this chapter.

Environmental factors

Factors such as ambient temperature, sunlight, and altitude are capable of influencing responses to certain drugs. Children given atropine on a warm day are especially susceptible to drug-induced hyperthermia, toxic skin reactions to sulfon-

amides increase with exposure to sunlight, and nitrous oxide loses efficacy in mountainous regions. Probably the most important environmental factor influencing drug effects is diet. The timing of meals and the types of food eaten can markedly affect drug absorption. The gastrointestinal absorption of most tetracyclines is impaired when taken with milk or other dairy products.

Numerous chemicals that are ingested, inhaled, or absorbed through the skin can influence the body's disposition of, or response to, various drugs. Patients receiving monoamine oxidase inhibitors risk severe hypertension and death if they eat foods containing tyramine (e.g., certain cheeses, beers, and wines). The therapeutic effects of levodopa in parkinsonism may be prevented by pyridoxine (vitamin B₆), present in foods and multivitamin supplements. Grapefruit juice contains substances that inhibit the CYP3A enzymes responsible for metabolizing a host of drugs (see Chapter 2). Finally, the use of insulin must be carefully matched to the patient's dietary intake to avoid complications associated with hypoglycemia and hyperglycemia.

The indigenous microflora represents a special kind of environmental variable. Several drugs given orally are metabolized by bacterial enzymes to such an extent that absorption may be significantly impaired. The dose of coumarin anticoagulants is partially governed by the amount of vitamin K produced by enteric bacteria. During antibiotic therapy, the type and number of microorganisms surviving play a large role in determining whether superinfection develops in patients.

Physiologic variables

Numerous physiologic factors can modify clinical responses to drugs. Fluctuations in gastric, plasma, and urinary pH may alter the pharmacokinetics of weak electrolytes. Salt and water balance, exercise, sleep, body temperature, blood pressure, and many other factors also influence patient reactions. The effects of blocking agents are particularly sensitive to variations in physiologic or biochemical events. Isoproterenol, an adrenergic agonist, increases heart rate regardless of autonomic nervous system tone, but atropine, an acetylcholine antagonist, increases heart rate only in the face of tonic vagal activity.

Many physiologic functions reveal a daily periodicity of intensity. These circadian rhythms often result in daily fluctuations of drug responsiveness. In dentistry, the duration of local anesthesia after nerve blockade varies by a factor of two during the course of a day, with the greatest effect occurring in the afternoon in patients with normal sleep patterns.⁴⁰

Pathologic factors

Diseases may influence pharmacotherapeutics by modifying drug disposition or tissue responsiveness. Pathologic states most commonly associated with altered patient reactivity involve the organs of absorption, distribution, metabolism, and excretion. Achlorhydria, diarrhea, malabsorption syndromes, and other disturbances of the gastrointestinal tract may depress the absorption of ingested agents.

The distribution of drugs is sensitive to pathologic changes in the blood and circulatory system and to perturbations in anatomic and functional barriers to diffusion. Disturbances in the concentration of plasma proteins (e.g., hypoalbuminemia) or in their function (as in uremia) may lead to drug toxicity or to a loss of therapeutic benefit. Congestive heart failure and arteriosclerosis may so diminish tissue perfusion that drug elimination is significantly retarded. Meningeal inflammation permits entry into the CNS of many drugs (e.g., penicillins) normally excluded by the blood-brain barrier.

Hepatic dysfunction, whether caused by specific hepatic disease, infection, or other conditions, can markedly retard the metabolism and biliary excretion of drugs. Reduced trans-

port capabilities can inhibit the uptake of drugs into the liver and export of metabolites from it.⁵² Standard liver function tests are of little prognostic value regarding drug biotransformation. Some patients with demonstrable cirrhosis or hepatitis may show little metabolic deficit, whereas others may exhibit marked hyperreactivity to standard doses of drugs. Within the same individual, the metabolism of some drugs may be impaired but not others. Because the liver is responsible for the synthesis of plasma proteins such as albumin and pseudo-cholinesterase, and for the breakdown of compounds such as bilirubin that compete for drug binding sites in plasma and various tissues, hepatitis may significantly alter (up or down) a drug's volume of distribution and elimination half-life independently of its specific effects on hepatic drug metabolism. For drugs with high hepatic clearance, metabolism is decreased by cirrhosis-induced reductions in total liver blood flow. The uncertainties of drug metabolism introduced by hepatic disease require that substances inactivated in the liver be used cautiously in affected patients and that drug effects be monitored carefully to avoid serious adverse reactions.

Renal disease is a common modifier of drug effects. The plasma half-lives of agents eliminated in the urine are often greatly prolonged by renal failure. Even for compounds completely inactivated in the liver, inadequate excretion of metabolites may increase the incidence of untoward reactions. A good measure of renal status is provided by the endogenous

creatinine clearance. A 50% decrease in creatinine clearance should theoretically indicate a twofold increase in the elimination half-life of a drug that is removed from the blood solely by glomerular filtration. For a drug partially eliminated in the urine, the increase in plasma half-life should be correspondingly less. The customary approach to avoiding excessive drug accumulation in patients with renal disease is to lengthen the dosage interval in accordance with the degree of impaired elimination. Table 3-1 lists for several drugs (including some commonly used in dentistry) the approximate dosage intervals indicated for patients with moderate or severe renal failure.⁴⁴ Although it is possible for active secretory and resorptive processes to be relatively less or more affected by renal disease than is glomerular filtration, the renal elimination of most drugs simply parallels the creatinine clearance.

An insidious form of interaction between pathologic factors and drug effects occurs with agents potentially toxic to their primary organs of elimination. Acetaminophen accumulation permitted by liver disease may result in hepatic necrosis and further impairment of drug metabolism.¹⁰ A similar vicious cycle involving the kidney has been observed with various drugs.

Exaggeration of the systemic effects of epinephrine and reduction in the analgesic potency of morphine in uncontrolled hyperthyroidism are two examples of drug effects modified by disease states through nonpharmacokinetic means.

TABLE 3-1

Dosage Adjustments in Renal Failure

DRUG	ROUTE OF ELIMINATION	DOSE INTERVAL IN HOURS (AND PERCENTAGE OF NORMAL DOSE) ACCORDING TO DEGREE OF RENAL FAILURE*		
		NORMAL FUNCTION	MODERATE IMPAIRMENT	SEVERE IMPAIRMENT
Antibiotics				
Cefoxitin	Mainly renal	6	8-12	24
Erythromycin	Hepatic	6	6	12
Penicillin G	Mainly renal	4-6	4-6 (50%)	8 (33%-50%)
Tetracycline [†]	Renal/hepatic	12	12-24	Avoid use
Analgesics				
Acetaminophen [†]	Hepatic	4	6	6
Aspirin [†]	Hepatic/renal	4	4-6	Avoid use
Codeine [‡]	Mainly hepatic	4-6	4-6 (75%-100%)	4-6 (25%-50%)
Meperidine [‡]	Hepatic	3-4	3-4 (50%-100%)	Avoid use
Cardiovascular Agents				
Diltiazem	Hepatic	8	8	8
Furosemide	Renal/hepatic	12	12	12
Lisinopril	Fecal/renal	24	24 (50%-75%)	24 (25%-50%)
Propranolol	Hepatic	8	8	8 (75%-100%)
CNS Depressants				
Alprazolam	Hepatic	8	8	8
Lorazepam	Hepatic	12	12	12
Pentobarbital	Hepatic/renal	8	8	8
Phenobarbital	Hepatic/renal	8	8	8 (75%-100%)
Others				
Diphenhydramine	Hepatic	6-8	6-8	6-8
Insulin	Hepatic/renal	Variable	Variable (75%)	Variable (50%)
Prednisone	Hepatic	12	12	12
Ranitidine	Renal/hepatic	8	12	24

Data from St. Peter WL, Halstenson CE: Pharmacologic approach in patients with renal failure. In Chernow B, editor: *The pharmacologic approach to the critically ill patient*, ed 3, Baltimore, 1994, Williams & Wilkins.

*The degree of renal failure as defined by creatinine clearance: normal function to minimal impairment, >50 mL/min; moderate impairment, 10-50 mL/min; severe impairment, <10 mL/min.

[†]Drugs that may accentuate renal damage.

[‡]Accumulation of active metabolite limits dosing.

CNS, Central nervous system.

Although pathologic factors may influence drug-receptor interactions directly, as in myasthenia gravis (in which receptor reactivity to acetylcholine is reduced), most alterations of patient response occur indirectly through the augmentation of overt disease or the unmasking of latent physiologic deficits. Agents that promote hyperuricemia may cause an acute exacerbation of gout, and propranolol may induce heart failure in patients with a severely compromised myocardium.

Genetic influences

Genetic variables contribute greatly to the differences in drug responsiveness illustrated in Figure 3-1. Although the importance of heredity is underscored by the evolution of pharmacogenetics into a recognized field of study, the elucidation of multigenetic factors that lead to log-normal distributions in drug reactivity has proved difficult (see Chapter 4). Previously, the only variations in drug effects that had been unequivocally linked to genetic differences were variations that exhibit simple inheritance patterns and yield bimodal or otherwise discontinuous distribution curves and variations that can be associated with certain groups of people on the basis of blood type, race, or ethnic background. Now, studies of gene expression and polymorphisms are helping to uncover an increasingly broad array of genetically determined differences in drug responsiveness. Genetic factors are responsible for idiosyncratic reactions and determine, in part, the relative likelihood of a patient having other adverse responses to an administered agent. Genetic influences can alter drug effects quantitatively; they may also result in the appearance of novel pharmacologic outcomes. Genetic influences affecting drug metabolism and drug receptors are discussed in Chapter 4.

Drug Factors

In addition to individual variations in patient reactivity, certain drug factors, namely the formulation and dosage regimen of an agent and the development of tolerance, can markedly influence the success of drug therapy.

Variables in drug administration

Of all factors influencing pharmacologic responses clinically, only those involved with drug selection and administration are totally under the control of the clinician. Some of these variables—dose, drug formulation, route of administration, and drug accumulation—are discussed in detail in previous chapters. Two additional factors are the time of administration and the duration of therapy. Many disturbing side effects are minimized if an agent can be given shortly before sleep, including the autonomic effects of the belladonna alkaloids, the vestibular component of nausea associated with opioid analgesics, and the sedative properties of the antihistamines. Conversely, agents producing mild CNS stimulation are better tolerated in the daytime. The scheduling of doses with or between meals to limit gastrointestinal upset or to enhance absorption is discussed in Chapter 2.

The duration of therapy has several important ramifications. Treatment must be sufficiently long to be effective. This is particularly true with antimicrobial agents, in which an inadequate duration of coverage can lead to reinfection. Because adverse drug reactions are more likely to occur during extended courses of therapy, treatment should never be unduly prolonged. It is generally inappropriate to continue a patient on medication after the condition requiring therapy has subsided. The duration of administration should be monitored especially carefully when drugs capable of producing physical or psychological dependence are being used.

Drug tolerance and sensitization

In pharmacology, *tolerance* to a drug refers to a state of decreased responsiveness that develops on repeated or con-

tinuous exposure to the agent or one of its congeners. Two major categories of tolerance are recognized: pharmacokinetic or drug-disposition tolerance, in which the effective concentration of the drug is diminished, and pharmacodynamic or cellular tolerance, in which the reaction to a given concentration of the drug is reduced.

Most documented cases of drug-disposition tolerance involve agents that stimulate their own metabolism through the induction of microsomal enzymes. It has also become apparent that induction of active transporters can reduce plasma concentrations by increasing hepatic uptake (and metabolism) and biliary excretion of drugs and possibly by decreasing gastrointestinal absorption and enhancing renal secretion. Immune tolerance may also occur in which circulating antibodies produced in response to an antigenic substance (e.g., bovine insulin) combine with the agent, decreasing its effective concentration at the receptor site. When pharmacokinetic tolerance is encountered, clinical effectiveness can usually be restored through simple adjustment of the dose or administration interval.

Cellular tolerance is commonly observed with drugs that alter mood, perception, or thought; opioid analgesics, barbiturates, benzodiazepines, alcohol, amphetamines, caffeine, and cocaine are examples. Tolerance is usually acquired gradually, depending on the drug, its dose, and how often it is administered. In general, cellular tolerance does not develop equally to all effects of a drug. Sometimes this is beneficial, as when undesirable side effects of an agent are lost, but therapeutic activity is retained. Differences in tolerance can also promote adverse reactions. Alcoholics become tolerant to the effects they desire from ethanol yet remain normally susceptible to the lethal effect. Continual use of ethanol leads to a potentially dangerous reduction in the drug's margin of safety because the user is forced to approach toxic concentrations to achieve the desired level of inebriety. (The ability of alcoholics to walk a straight line while inebriated also involves a "learned tolerance," in which they develop coping skills to mask their inebriation.) A similar phenomenon occurs with other CNS depressants. Clinical management of pharmacodynamic tolerance can often be accomplished by increasing the dose; however, this approach is occasionally ineffective in restoring drug activity and may result in serious toxicity or drug dependence. Normal sensitivity in a tolerant person can be restored eventually through abstinence from the drug.

Although the bases for most types of cellular tolerance are not well understood, it seems that adaptive changes to oppose drugs administered long-term that act on specific receptor systems are a common phenomenon. Receptor responsiveness is not static; in the case of agonist drugs, receptors may become diminished in activity and number through the respective processes of desensitization and downregulation, as described in Chapter 1. Response elements downstream from the primary receptor may be similarly affected. Other adaptive changes may include alterations in endogenous mediator synthesis, storage, release, and reuptake.

Specific mechanisms of tolerance have been established for certain drugs that evoke a rapidly developing form of tolerance termed *tachyphylaxis*. The sympathomimetic agent tyramine provides a classic example of tachyphylaxis. Administered intravenously to an animal whose vagal innervation of the heart has been interrupted, tyramine indirectly increases heart rate and blood pressure by causing the release of norepinephrine from adrenergic nerves. A subsequent dose given after the effects of the first dose have disappeared generates a smaller response, and, after a series of repetitions, the drug may lose essentially all activity. Acute tolerance to tyramine is produced by rapid depletion of the functional norepinephrine stores of the adrenergic nerve terminals. Two additional examples of

tachyphylaxis are associated with histamine. Because endogenous stores of histamine can be quickly depleted but take a long time to be replenished, drugs that cause histamine release (e.g., morphine and tubocurarine) generate tolerance in much the same manner as does tyramine. Tachyphylaxis may also occur to histamine itself. Repetition of increasing doses of intravenous histamine can produce in several hours a hyporeactivity of 100-fold less than normal. Other drugs capable of evoking acute tolerance include the benzodiazepines, nitrites, cholinergics, and anticholinergics.

A final form of tolerance involves drug-induced changes in cellular distribution. A classic example is the development of tolerance to anticancer chemotherapy by cells that overexpress the drug exporter P-glycoprotein, otherwise known as *multidrug resistant protein-1*. Similarly, the induction of P-glycoprotein by toxins may increase the ability of the blood-brain barrier to prevent their entry into brain cells.³⁰ This form of “distributional tolerance” exhibits aspects of pharmacokinetic and pharmacodynamic tolerance—pharmacokinetic in the sense that the distribution of the drug is altered and pharmacodynamic in that increasing the dose may be an unsuitable strategy to restoring drug effect (because of toxicity to cells not protected by P-glycoprotein).

Pharmacodynamic sensitization, in which the individual becomes increasingly responsive to drugs administered on a regular basis, has been documented for several CNS stimulants. Cocaine given in single daily doses to rats causes increased motor activity after 1 week of treatment. This effect, associated with increased release of dopamine in the brain, is a conditioned response because placebo substitution for cocaine after 1 week elicits a similar response.¹⁹

Factors Associated with the Therapeutic Regimen

Some factors influencing drug effects are related to the therapeutic context in which the agent is administered or prescribed. Attitudes toward the drug regimen or practitioner may determine whether an agent proves effective in a patient (or even if the drug is taken). Concurrent use of other medicines may alter drug effects directly through pharmacologic mechanisms or indirectly by promoting errors in drug administration.

Placebo effects

A placebo effect is any effect attributable to a medication or procedure that is not related to its pharmacodynamic or specific properties.⁵⁵ The term *placebo* is derived from the Latin verb *placere*, meaning “to please.” In pharmacotherapeutics, a placebo may be either “pure,” in which the preparation is pharmacologically inert (e.g., a lactose tablet), or “impure,” in which the drug has pharmacologic activity, but is given for a condition or in a manner such that no benefit can be obtained from its specific properties. Two commonly held misconceptions are that placebos provide nothing more than a means of placating patients and that they may help in psychosomatic illness but are worthless when symptoms are organically based. Numerous studies have revealed, however, that placebo medication is effective in treating the subjective responses to various “real” medical conditions (e.g., the pain of cancer, angina pectoris, headache, and surgical wounds). The distinction between psychogenic and organic illness has become blurred by the realization that psychological disturbances often produce physiologic or pathologic manifestations and that organic diseases, or at least their signs and symptoms, can be influenced by the CNS through regulation of hormonal secretion and peripheral nervous system activity. Placebo effects are not merely subjective in nature; the administration of pharmacologically inert substances has led to measurable changes in gastric acid secretion, in heart rate and blood pressure, in the number of circulating leukocytes, and in

the plasma concentrations of various compounds, including adrenal steroids, catecholamines, electrolytes, and glucose. Even so-called subjective responses to placebos may have a biochemical basis. It has been argued that placebo analgesia can be blocked by naloxone, a specific opioid antagonist,²⁴ and that the placebo effect may involve the dopaminergic reward system.¹² Nevertheless, “physical parameters” (e.g., blood pressure and bronchial muscle tone) are much more likely to be affected than are “biochemical parameters” (e.g., blood cholesterol or glucose concentrations).⁴²

Placebo responses to drugs arise from expectations by the patient concerning their effects and from a wish to obtain benefit or relief. Expectations develop at the conscious and subconscious levels and are influenced by many factors. The patient must be aware that treatment is being rendered. The symbolic association of receiving medication in a therapeutic environment generates placebo reactions. The patient must also be anxious about the problem and desirous of being cured. Placebo effects are unlikely if there is patient indifference to the condition or to the therapeutic regimen. Past experience is another important variable. Previous drug exposure informs a patient of what to expect from a drug; repeated administrations evoking prompt, noticeable effects may produce conditioned reflexes. Because suggestion is involved, placebo effects are subject to modification by the practitioner’s attitudes (toward the patient, toward the patient’s illness, and toward the drug or placebo) and how these feelings are communicated. In one study, a 45% reduction in placebo response occurred solely as a result of the administrators’ negative bias toward the placebo medication.³

Several important similarities and differences between placebo and specific effects of drugs must be remembered if clinicians are to avoid being deceived by the preparations they use. Therapeutic responses to placebos and to active agents may resemble each other in magnitude and duration. The pain relief and cough suppression afforded by a placebo may parallel that of codeine. Toxicities can also overlap. Pure placebos are associated with many common side effects—nausea, drowsiness, sweating, xerostomia—and may occasionally be associated with life-threatening emergencies such as bronchial asthma, acute hypotension, and cardiac arrhythmia. In contrast to active agents, placebos have a relative lack of predictability. Although some drugs can be relied on to produce a given effect in essentially all patients, only approximately one third of patients receiving placebos usually react. Attempts to identify placebo responders on the basis of psychological profile or other characteristics have been unfruitful; it seems that anyone may respond to placebos in the appropriate situation. Finally, there are many classes of drugs, such as the general anesthetics and the antibiotics, whose effects placebos cannot duplicate.

More recently, the placebo effect has been more carefully scrutinized. Because most studies using placebo controls have not adequately distinguished between the effects they produce and the natural course of a symptom, disease, or healing process, the placebo effect may have been overemphasized.¹⁸ The administration of a placebo involves the placebo intervention (e.g., the giving of a lactose tablet) and the remainder of the patient-doctor interaction.¹⁷ Determining the relative contributions of each experience may be especially difficult.

Placebos are valid and often necessary inclusions in clinical trials, especially in studies such as analgesic drug trials, in which the placebo effect is well documented.¹⁵ Studies involving other subjective outcomes also represent a strong argument for placebo use.³⁰ Placebo effects advantageous to therapy—in addition to beneficial pharmacologic effects—should also be sought whenever a drug is administered clinically.³³ Sometimes the effective communication of confidence and other positive attitudes by the practitioner can make the

difference between therapeutic success and failure. The clinical application of placebo drugs should be restricted, however, to conditions for which no other agent is superior. Even then, the evolution of informed consent into a basic patient right has, at best, complicated the clinical administration of placebo medication.³³ Despite the apparently widespread continuing use of placebos (mostly impure varieties) in medicine,⁴⁹ there seems to be no justification for the therapeutic use of placebo medication in routine dental practice.

Medication errors and patient noncompliance

Medication errors commonly result in suboptimal therapy and occasionally life-threatening responses. Poor pharmacotherapeutic decisions by the clinician may stem from a lack of knowledge about the patient, disease, or drug. In addition, drugs are often not used in the manner intended by the prescriber. Occasionally, the clinician may miswrite the prescription, or the pharmacist may supply the wrong drug or incorrectly transcribe the instructions to the patient. In the hospital setting, the nursing or house staff may administer the drug incorrectly, neglect to administer it, or administer it to the wrong patient. Most medication errors arise, however, from the failure of patients to take their preparations as directed. Drug defaulting is a major problem in therapeutics; most studies document a noncompliance rate of 25% to 60%.⁴⁶

The reasons for noncompliance are varied. They include a lack of understanding of the drug, the purpose for which it was prescribed, or how it is to be administered; economic factors; negative feelings toward the drug or prescriber; development of adverse reactions; forgetfulness or carelessness; and resolution of the problem before the drug regimen is complete or, conversely, failure to notice any therapeutic benefit. Although infrequent omissions and minor mistakes in dosage or time of administration are often innocuous, complete failure to take the prescribed drug, premature discontinuance, or ingestion of excessive amounts can be disastrous. The possibility of noncompliance should be considered whenever a drug is seemingly without activity. Patients are notoriously inaccurate in reporting their own compliance, and physicians are not much better in estimating its occurrence. When effective therapy is essential, direct assay of the patient's blood, urine, saliva, or feces for the drug or its metabolites may be necessary to detect noncompliance.

As with the placebo responder, attempts have been made to characterize the potential drug defaulter on the basis of such factors as age, sex, education, race, and socioeconomic status. Although some correlations have been drawn (e.g., elderly patients are more apt to forget their medicine or to confuse one type of pill with another), many investigations have been either inconclusive or contradictory. The most important variables relate, not to the patient, but to the illness, the drug administered, the overall therapeutic regimen, and the doctor-patient relationship. Administration schedules are followed more faithfully by patients with life-threatening diseases than by patients with minor ailments. Even with serious illnesses such as essential hypertension, chronic infection, or hyperlipidemia, compliance is generally poor (approximately 50%) when the benefits of therapy are not superficially apparent.³⁵ Drugs that produce unwanted side effects are especially likely to be discontinued. Deviations in self-administration tend to increase progressively with drugs that are taken long-term. Also, the more complex the therapeutic regimen in terms of doses and drugs, the higher the incidence of drug defaulting. The quality of the doctor-patient relationship is important in several respects. Patients who trust and respect their dentist or physician are more likely to take their prescribed medications. Effective communication further promotes compliance and reduces the possibility of a patient

unilaterally terminating the drug if adverse effects occur. Measures that the clinician may use to enhance patient compliance are discussed in Chapter 55.

Drug interactions

The effect of a drug may be increased, decreased, or otherwise altered by the concurrent administration of another compound. Because agents routinely used in dental practice have been implicated in drug interactions, the topic is of considerable interest to the clinician and is addressed separately in Appendix 1.

ADVERSE DRUG REACTIONS

According to the Institute of Medicine, at least 1.5 million preventable adverse drug events occur annually in the United States.² It has also been estimated that 5% to 17% of all patients hospitalized in the United States each year are admitted because of adverse reactions to drugs.^{5,28} Estimates of the annual cost of managing these reactions range from \$3 billion to \$7 billion.²⁸ In addition, a survey of hospitalized patients between 1966-1996 revealed that 7% of hospitalized patients had a serious adverse drug reaction resulting in death, permanent disability, or prolonged care.²²

The introduction of new, highly efficacious compounds into pharmacotherapy during the past few decades has led to a disturbing increase in the incidence of adverse reactions; drug toxicity is now considered a major cause of iatrogenic disease. Reductions in mortality rate associated with certain drugs (e.g., aspirin) show, however, that toxic responses to therapeutic agents can be minimized through concerted efforts by health professionals, the pharmaceutical industry, government, and lay public.

Classification of Adverse Drug Reactions

Drug toxicity may come in many forms: acute versus chronic, mild versus severe, predictable versus unpredictable, and local versus systemic. Therapeutic agents also differ widely in their tendency to elicit adverse reactions. Acetaminophen used to relieve headache rarely causes undesired responses, but many agents used in cancer chemotherapy invariably produce some degree of toxicity. Agents that are safe for some individuals may be life-threatening to others. Penicillin V, which normally has an exceptionally high margin of safety, can in small doses initiate fatal anaphylaxis in allergic patients. Adverse drug reactions can be classified according to their onset (acute, subacute, or delayed), degree (mild, moderate, or severe), or predictability (type A, predictable and dose related; type B, unpredictable and not necessarily dose related, such as idiosyncratic and immunologic reactions). Although no classification of adverse drug reactions is universally accepted, a taxonomy based on mechanism of toxicity is the most useful in promoting the recognition, management, and prevention of untoward responses to drugs.

Extension effects

Many drugs are used clinically in dosages that provide an intensity of effect that is submaximal. The reason for this conservatism is simple: increasing drug effects beyond a certain point may be dangerous. The anticoagulant warfarin is a typical example of a drug whose therapeutic action must be held in check to avoid serious toxicity. For the treatment of peripheral vascular thrombosis, warfarin is administered in doses that sufficiently increase the prothrombin time to yield an international normalized ratio (see Chapter 31) of 2 to 3. Warfarin could be given in larger amounts to inhibit clotting further, but the risk of spontaneous bleeding would be unacceptably high. Even with conventional therapy, hemorrhage—

TABLE 3-2

Examples of Drug Toxicity as an Extension of the Therapeutic Effect

DRUG	MEDICAL INDICATION	THERAPEUTIC EFFECT	TOXIC EXTENSION OF THERAPEUTIC EFFECT
Furosemide	Edema	Diuresis	Hypovolemia
Heparin	Thromboembolic disorders	Inhibition of coagulation	Spontaneous bleeding
Insulin	Diabetes mellitus	Reduction of blood glucose concentration	Hypoglycemia
Modafinil	Narcolepsy	Wakefulness	Insomnia
Vecuronium	Abdominal surgery	Skeletal muscle relaxation	Prolonged respiratory paralysis
Zolpidem	Insomnia	Hypnosis	Unconsciousness

the toxic extension of warfarin's anticoagulant effect—occurs in 2% to 4% of the patients treated. Inadvertent overmedication is one cause of warfarin toxicity; however, many additional factors influencing drug effects may also be involved, such as diet; heredity; gastrointestinal ulceration; genetic differences in drug metabolism; renal, hepatic, or cardiac insufficiency; drug interactions; and variable patient compliance. "Normal dose" has little meaning regarding warfarin because a therapeutic dose to one patient may represent an overdose to another.

Adverse responses arising from an extension of the therapeutic effect are dose related and predictable. Theoretically, they are the only toxic reactions that can always be avoided without loss of therapeutic benefit by properly adjusting the dosage regimen. Table 3-2 provides additional examples of drugs that display this form of toxicity.

Side effects

Predictable, dose-dependent reactions unrelated to the goal of therapy are referred to as *side effects*. As illustrated in Table 3-3, drugs can produce a huge array of deleterious side effects. Although many such reactions are associated with only a single agent or class of drugs, others seem to be almost universal in occurrence. It is questionable, however, whether frequently noted side effects, such as nausea and drowsiness, are always drug related; similar symptoms are also commonly observed in patients after placebo administration and are reported by individuals receiving no medication whatsoever.

Side effects may be produced by the same drug-receptor interaction responsible for the therapeutic effect, differing only in the tissue or organ affected. In these instances, the categorization of drug responses as toxic or therapeutic may depend on the purpose of treatment. Xerostomia induced by atropine is a side effect during the management of gastrointestinal hypermotility, but is a desired effect when the drug is used to control excessive salivation. Side effects unrelated pharmacodynamically to the therapeutic action are also quite common, and they too may occasionally be useful. Table 3-4 lists some drugs whose side effects were found sufficiently noteworthy to provide new and unanticipated indications for therapeutic use.

Many side effects, particularly the more dangerous forms, develop only with drug overdose. Careful alteration of the administration regimen usually resolves these problems while maintaining effective treatment. Many other side effects occur at therapeutic or even subtherapeutic concentrations, and cannot be avoided by dosage adjustment without loss of drug benefit. Such reactions can be tolerated, however, if they are mild, brief in duration, reversible, and compatible with therapy. Occasionally, even disturbing side effects are accepted if the need for medication is great. Drugs used in the treatment of various cancers produce severe toxic effects that must be tolerated because no therapeutic alternative is available.

When two drugs share a common desired effect but cause different side effects, it is sometimes possible to limit toxic responses by using reduced doses of the agents in combination. Another pharmacologic approach to avoiding side effects is to add a secondary agent that is capable of blocking or otherwise compensating for the unwanted activity of the principal drug. These strategies presuppose that no additional toxicity will be generated by the combination over that produced by a single effective drug. The association of renal papillary necrosis with long-term abuse of analgesic mixtures that formerly contained aspirin, phenacetin, and caffeine is highly instructive regarding the noncritical acceptance of this assumption.⁴³ The most fruitful pharmacologic approach to eliminating undesired side effects is through the development of more selective drugs. Studies of structure-activity relationships have proved invaluable in removing side effects unrelated to therapeutic actions and in reducing side effects that are related.

Idiosyncratic reactions

An *idiosyncratic reaction* may be defined as a genetically determined abnormal response to a drug. Although dose dependent, such reactions are unpredictable in most instances because very few patients given an agent respond idiosyncratically and because the genetic trait responsible for an atypical reaction may be completely "silent" in the absence of drug challenge. When confronted with an unexpected response to a drug, it is a common, although erroneous, practice to describe the event as an idiosyncrasy. This habit may explain why the idiosyncratic reaction is jocularly defined as a reaction the "idiots can't explain." Most responses lying outside the normal range of drug reactivity are not truly idiosyncratic in nature but represent allergic manifestations or reflect extension or side effects in patients intolerant to the drug by virtue of factors such as age, weight, or existing disease. In dentistry, most "idiosyncratic" reactions to local anesthetics are the result of accidental intravascular injections or anxiety reactions to the process of injection.

An idiosyncratic reaction is often manifested as abnormal drug sensitivity in which the agent produces its characteristic effect at an unconventional dose. Drug effects may be unusually strong or weak in intensity or brief or prolonged in duration. In most such instances (e.g., involving succinylcholine, isoniazid, vitamin D, or phenytoin), altered drug metabolism is responsible for the abnormal responses; however, additional mechanisms have been identified, such as abnormal distribution (iron, thyroxine) and unusual receptor affinity (warfarin). In addition to perturbing characteristic drug responses, genetic singularities can produce novel drug effects that, regardless of dose, may never occur in normal individuals. One example of a novel drug effect is hemolytic anemia caused by the anti-malarial drug primaquine. Red blood cells of sensitive individuals are deficient in glucose-6-phosphate dehydrogenase,

TABLE 3-3

Side Effects of Drugs

DRUG	EFFECT
	Oral Cavity
Diphenhydramine	Xerostomia
Griseofulvin	Black hairy tongue
Phenytoin	Gingival hyperplasia
Tetracycline	Pigmentation, hypoplasia of the teeth
	Skin and Hair
Amoxicillin	Dermatitis
Cyclophosphamide	Alopecia
Methandrostenolone	Acne
Minoxidil	Hypertrichosis
	Bone and Joints
Ciprofloxacin	Arthralgia
Hydralazine	Arthralgia
Phenobarbital	Osteomalacia
Prednisolone	Osteoporosis
	Sensory Apparatus
Baclofen	Blurred vision
Digoxin	Yellow vision
Gentamicin	Ototoxicity
Thioridazine	Pigmentary retinopathy
	Blood
Cytarabine	Pancytopenia
Prilocaine	Methemoglobinemia
Valproic acid	Thrombocytopenia
Zidovudine	Granulocytopenia
	Metabolic Effects
Aspirin	Metabolic acidosis
Furosemide	Hyperglycemia
Nadolol	Hypoglycemia
Rifampin	Jaundice
	Neuromuscular System
Atorvastatin	Myalgia
Chlorpromazine	Tardive dyskinesia
Dantrolene	Weakness
Lidocaine	Convulsions
Theophylline	Tremors
	Central Nervous System
Clonidine	Drowsiness and lethargy
Dexamethasone	Mental depression
Diazepam	Confusion
Levodopa	Mania
	Cardiovascular System
Bupivacaine	Bradycardia
Phenelzine	Hypertensive crisis
Propofol	Hypotension
Propranolol	Cardiac failure
	Respiratory System
Isoflurane	Cough
Ketamine	Larygospasm
Meperidine	Respiratory depression
Propranolol	Bronchospasm
	Gastrointestinal Tract
Aspirin	Melena
Erythromycin	Diarrhea
Lithium	Nausea and vomiting
Morphine	Constipation
	Genitourinary System
Ergonovine	Abortion
Guanethidine	Impotence
Sulfadiazine	Crystalluria
Testosterone	Priapism

TABLE 3-4

Useful Side Effects of Drugs

DRUG	ORIGINAL USE	SUBSEQUENT USE
Amantadine	Antiviral	Parkinsonism
Amphetamine	CNS stimulant	Attention-deficit/hyperactivity disorder
Chlorothiazide	Diuretic	Antihypertensive
Diphenhydramine	Antihistaminic	Sedative
Lidocaine	Local anesthetic	Antiarrhythmic
Methadone	Analgesic	Heroin substitute
Metronidazole	Antiparasitic	Antibacterial
Phenytoin	Anticonvulsant	Antiarrhythmic
Probenecid	Inhibition of penicillin excretion	Uricosuric
Quinidine	Antimalarial	Antiarrhythmic

CNS, Central nervous system.

an enzyme involved in the intermediary metabolism of glucose.³⁸ Lacking the ability to produce normal amounts of reducing equivalents, these erythrocytes are susceptible to oxidative destruction by primaquine and several dozen other compounds. The genetic basis of primaquine hemolysis is clear: the reaction occurs almost exclusively in men of certain racial and ethnic groups (e.g., African Americans, Sardinians, Sephardic Jews, Iranians, and Filipinos).

Various idiosyncrasies are known to be associated with drugs. Some examples are listed in Table 3-5. If an adverse response is suspected to have a genetic basis, it becomes important to determine whether the patient has a personal or familial history of atypical reactivity to the drug. Because idiosyncratic reactions are quite reproducible within any individual, a single episode of serious toxicity should preclude future use of the inciting compound. Examination of the patient's family is helpful in establishing the hereditary nature of the reaction and identifying other individuals at risk.

Drug allergy

Adverse responses of immunologic origin account for approximately 10% of all untoward reactions to drugs. Allergy can be distinguished from other forms of drug toxicity in several respects. First, prior exposure to the drug or a closely related compound is necessary to elicit the reaction. Second, the severity of response is seemingly dose independent. Third, the nature of the unfavorable effect is a function not of the offending drug but of the immune mechanism involved. Finally, the reaction is unpredictable; it usually occurs in a small portion of the population, sometimes in patients who had been previously treated on numerous occasions without mishap.

Drugs differ enormously in antigenic potential. Certain compounds (e.g., caffeine and epinephrine) never cause drug allergy; others (e.g., phenylethylhydantoin) have proved too allergenic for human use. With drugs commonly implicated clinically in allergic reactions (e.g., penicillins, sulfonamides, quinidine), the incidence of such responses is approximately 5%. Occasionally, another substance in a preparation besides the active drug (e.g., a preservative or coloring agent) causes the allergy.

Aside from agents of high molecular weight (insulin, dextran, polypeptides), drugs are usually not antigenic in the free state but must be covalently linked to endogenous carrier molecules such as albumin to generate immunologic responses. Because these therapeutic agents are often chemically inert, they generally require activation by metabolism

TABLE 3-5

Idiosyncratic Reactions to Drugs

GENETIC ABNORMALITY	DRUGS AFFECTED	IDIOSYNCRATIC RESPONSE
NADH-methemoglobin reductase deficiency	Benzocaine, prilocaine	Methemoglobinemia
Glucose-6-phosphate dehydrogenase deficiency	Aspirin, primaquine, sulfonamides	Hemolytic anemia
Abnormal heme synthesis	Barbiturates, sulfonamides	Porphyria
Low plasma cholinesterase activity	Procaine and other ester local anesthetics	Local anesthetic toxicity
Altered muscle calcium homeostasis	Volatile inhalation anesthetics, succinylcholine	Malignant hyperthermia
Prolonged QT interval	Cisapride, some antipsychotics and antiarrhythmics	Torsades de pointes

NADH, Reduced nicotinamide adenine dinucleotide.

or by sunlight (photoallergy) before serving as haptens in the formation of antigen. Penicillins, which are responsible for most fulminating reactions, are exceptional in that they spontaneously convert to highly reactive derivatives in addition to undergoing *in vivo* metabolism to a small degree.

Four types of drug allergy have been differentiated on the basis of the immune reactions that cause them and the loci of their actions.³⁶ Type I reactions, otherwise known as reaginic or anaphylactic responses, include the immediate forms of drug allergy, in which disturbances appear within minutes or hours of taking the drug. The underlying immune reactions are initiated by the attachment of antigen to IgE antibodies bound to the surface of mast cells and basophils. Subsequent cellular degranulation and release of histamine, leukotrienes, cytokines, and other mediators are responsible for the undesired effects. Major signs and symptoms of type I allergy involve the gastrointestinal tract (cramps and diarrhea), skin and mucous membranes (erythema, urticaria, angioneurotic edema), lungs (bronchoconstriction), and blood vessels (vasodilation, increased permeability). In its most severe form, anaphylaxis can cause death by airway obstruction or by cardiovascular collapse within a few minutes after drug exposure. Parenteral injection of the drug is more likely than oral or topical use to produce life-threatening reactions. Nevertheless, patients have died from topical application of less than 1 µg of penicillin. It is believed that patients with allergic diathesis (noted by a history of hay fever or bronchial asthma) are more prone to develop serious type I reactions. The immediate anaphylactic response is the only type of drug allergy that the dentist may be forced to treat without the benefit of medical backup. Epinephrine is the drug of choice to reverse the manifestations of a severe response; antihistamines and adrenal corticosteroids are useful as adjunctive medications (see Chapter 54).

Type II, or cytotoxic, reactions are caused by circulating antibodies (IgG and IgM). When a plasma membrane constituent serves as the hapten carrier, or when a complete antigen is adsorbed on the membrane surface, the binding of immunoglobulin is followed by complement fixation and lysis of the cell. Many forms of drug-induced hemolytic anemia, leukopenia, and thrombocytopenia are the result of this form of immunologic destruction. Type II responses are usually delayed and manifest from several hours to days after drug administration.

Type III, or immune-complex, reactions occur when soluble antigen-antibody complexes form in intravascular or interstitial spaces. Eventual deposition of the complexes on the walls of small blood vessels is followed by activation of complement and migration of neutrophils into the area. These cells degranulate in attempts to remove the complexes, releasing lysosomal enzymes that cause local tissue damage and promote thrombosis of affected vessels. Type III reactions can

induce many unpleasant sequelae, some of which can be quite serious (e.g., neuropathy, glomerulonephritis, serum sickness). Reactions indistinguishable from disease states such as lupus erythematosus and erythema multiforme are also observed. Finally, soluble antigen-antibody complexes can attach to cell membranes and cause cytotoxicity indistinguishable from type II reactions.

Type IV reactions are synonymous with cell-mediated immunity. Sensitized T lymphocytes exposed to the drug hapten or its conjugate release lymphokines that attract additional cells (lymphocytes, macrophage, cytotoxic T cells) to the antigenic site. Lysozymes and other substances (including toxic lymphokines) elaborated by the recruited cells produce local tissue necrosis. Type IV reactions are usually delayed because of the time required for effector cells to concentrate in the area involved. For dentists, an important cellular immune reaction was the contact dermatitis acquired from repeated exposure of the hands to ester local anesthetics such as procaine. Before the availability of amide anesthetic drugs, allergy to procaine markedly complicated clinical practice. Allergy to ester-based local anesthetics presents a problem for some patients today because of various substances that may cross-react to elicit an eczematoid rash; two examples are methylparaben, a pharmaceutical preservative in widespread use, and *p*-phenylenediamine, a component of hair dyes.¹

Although drug allergies cannot always be prevented, their frequency of occurrence can be minimized by observing the following precautions:

1. *Take an adequate medical history.* If a patient has a presumptive history of drug allergy, it is important to discover the identity of the inciting preparation and to determine whether the reaction is consistent with an immunologic cause.
2. *Avoid the offending drug and likely cross-reactors.* A patient truly allergic to a drug should not receive the agent or congener again unless need for the particular medication is great.
3. *Avoid inappropriate drug administration.* In one study, a review of 30 fatalities to penicillin revealed that the antibiotic was not even indicated in more than 50% of the cases examined.⁴¹
4. *Promote oral use and limit topical exposure.* With the penicillins, the oral and topical routes are the least (oral) and most (topical) allergenic avenues of drug administration.
5. *Request allergy testing when appropriate.* Although such methods are generally unreliable and can be dangerous, skin tests for penicillin allergy have proved predictive.⁴⁸ Success has also been claimed regarding local anesthetics.¹ Allergy testing may be necessary when suitable alternatives to the drug in question are unavailable.

Adherence to these recommendations will reduce the incidence of allergic reactions to drugs. For example, the more prudent use of penicillin in recent years may have led to a

decline in the drug's mortality rate, previously estimated in the United States to be 500 individuals per year.³⁴

Pseudoallergic and secondary reactions

Pseudoallergic reactions are adverse drug responses caused by mediators of allergy that are released through antibody-independent processes. In the case of macromolecules, the alternate pathway of complement fixation may lead to various cytotoxic and immune-complex reactions. Much more common are anaphylactoid reactions that mimic one or more aspects of anaphylaxis. Some opioid analgesics, neuromuscular blocking drugs, and intravenous anesthetic agents can cause the release of histamine from mast cells. Aspirin, ibuprofen, and related inhibitors of prostaglandin synthesis can result in the overproduction of bronchospastic leukotrienes. As with true allergies, these reactions are unpredictable; however, they seem to be dose dependent, do not require prior sensitization, and may occur on initial exposure to the drug.

Secondary reactions are indirect (and often unpredictable) consequences of a drug's primary pharmacologic action. Antibiotics provide the best examples. One possible outcome of antibiotic administration is the development of superinfection, a secondary microbial disease made possible by the antibiotic-induced suppression of the normal microflora (see Chapters 38 and 39). Alternatively, the rapid lysis of susceptible bacteria may result in the Jarisch-Herxheimer phenomenon, a serum sickness-like syndrome caused by the release of microbial antigens, endotoxins, or both.

Carcinogenesis

One aspect of drug toxicity that has had a strong impact on public awareness is carcinogenesis. Although most attention has been focused on environmental pollutants, including chemicals that pose an occupational hazard, the association of leukemia with various anticancer agents and uterine neoplasia with diethylstilbestrol underscores the tumorigenic potential of certain therapeutic drugs. The most pervasive cancer-producing substances in our society are derived from a "social" drug—the cigarette.

Virtually any agent capable of altering the structure of DNA is a potential carcinogen. Agents known to be carcinogenic include radioactive substances, alkylating agents, nitrosamines, and various aromatic amines and polycyclic aromatic hydrocarbons. With the exception of radioactive materials, most drugs capable of initiating neoplastic change must become chemically activated. This process occurs spontaneously with some alkylating substances, but it usually depends on metabolic biotransformation. Cytochrome P450 enzymes are commonly involved, yielding highly reactive electrophilic intermediates. These activated molecules can interact with DNA at specific sites. Alkylating drugs can form covalent linkages with the 7-nitrogen atom of guanine. If replication occurs before the damage can be repaired, a transversion may occur in which the alkylated guanine-cytosine pair is replaced by a thymine-adenine. Such transversions are not randomly distributed throughout the genome, but are clustered at specific loci.¹³ Neoplastic transformation occurs when mutations develop in genes regulating cellular growth.

Compelling evidence has accumulated since 1980 implicating two groups of genes in chemical carcinogenesis: oncogenes and tumor suppressor genes.⁴⁵ Oncogenes are derived from normal genes, or proto-oncogenes, whose function is to promote growth and development. Several mechanisms for neoplastic transformation of proto-oncogenes have been discovered, including point mutation, which would seem to be the most likely candidate for chemical carcinogenesis. The *ras* group of proto-oncogenes is frequently transformed in human cancer. Each *ras* gene codes for a protein that helps convey stimulatory signals from membrane-bound tyrosine kinase receptors to the nucleus. Ras proteins are activated by binding

guanosine triphosphate (GTP) and inactivated by autohydrolysis of the bound GTP to guanosine diphosphate. The *ras* oncogene products differ from the natural protein by a single amino acid substitution at one of several key points that are apparently involved in nucleotide binding and protein regulation.³⁷ The net result is a protein that loses its ability to split GTP and remains activated at all times. Other oncogenes have been identified that code for various tyrosine kinases, serine/threonine-specific protein kinases, and gene regulatory proteins.

Tumor suppressor genes code for proteins that normally inhibit cell growth. An important example involved in most human cancers is the *p53* gene. Its protein derivative, p53, is a nuclear regulatory protein that activates transcription of a gene whose protein product prevents the cell from replicating. When the *p53* gene is rendered inactive or mutated, this important inhibitory pathway is lost, and the affected cell may begin to multiply.⁵⁰ Spontaneous errors in replication may also accumulate because rapid cellular division leaves insufficient time for DNA repair.

Cancer is normally a multistage phenomenon involving multiple genetic mutations.¹¹ In the case of oral squamous cell carcinoma, a series of deletions involving multiple tumor suppressor genes and overexpression of the proto-oncogenes cyclin D1 and epidermal growth factor receptor are common steps leading to carcinogenesis.⁸ Collectively, these changes are responsible for the initiation of neoplastic transformation and the subsequent promotion of cellular growth.

Certain compounds cause tumors only after prior treatment with another agent. The first chemical seems to initiate the neoplastic transformation, and the second promotes tumor growth. The latter are called *promoters* or *nongenotoxic carcinogens*. It is hypothesized in these instances that the promoter removes the control of growth that distinguishes normal from cancerous cells. Examples of promoters in experimental models include phorbol esters, saccharin, chlorophenothane, and phenobarbital. Regardless of initiating or promoting factors, immunosuppressive drugs may foster cancer development generally by interfering with immunologic surveillance mechanisms responsible for the elimination of transformed neoplastic cells.

Carcinogens are often detected by screening for mutagenicity by the Ames test. Major difficulties are encountered, however, in assessing the carcinogenicity of agents intended for human use. First, the latency period between the initiation and clinical appearance of neoplasia may span years to decades. Second, although the incidence of tumor induction is dose dependent, it is not established whether a dose or duration of exposure below which tumors will not be produced can be found for any drug. Third, because an administered agent usually requires metabolism for activation, interspecies differences in biotransformation severely limit the use of animal testing in such instances. Without a foolproof method of screening drugs, continued appraisal of cancer rates regarding drug intake is a necessary, if not ideal, approach to identifying carcinogenic compounds. In view of the prolonged latency of cancer development and the flood of agents introduced into pharmacology in recent decades, it would be surprising not to witness the discovery of new carcinogens among therapeutic agents now in use.

Special Problems

Hazards of medication pertaining to abuse, poisoning, and effects on the unborn child warrant special comment because the individuals affected are generally not exposed to the agent for therapeutic purposes. In these situations, the prevention and management of adverse reactions can be complicated by matters such as the intent of the person taking the drug, an inability to identify the offending agent, and the unique susceptibility of the embryo to drug toxicity.

Drug abuse

Typified by persistent and excessive self-administration, drug abuse refers to the inappropriate and deviant use of any drug. Drug abuse presents a special problem in toxicology because, in addition to the hazards of taking pharmacologically active agents without proper medical supervision (e.g., drug toxicity, infection from inadequate antisepsis), adverse consequences may arise from the acts involved in procuring and using such compounds. Compulsive behavior is especially strong with drugs that act on the CNS, and, with the exception of substances to which little stigma is attached—caffeinated beverages and tobacco products—the attendant social, economic, and legal costs of the abuse of these agents can be enormous. Even in the case of tobacco products, restrictions are increasingly being placed on their use that can have legal ramifications if violated. Abstinence from drugs producing physical dependence results in the appearance of withdrawal symptoms characteristic of the substance involved and the intensity of previous use. A thorough discussion of drug abuse involving centrally acting agents is presented in Chapter 51.

Drug poisoning

As revealed by data from the American Association of Poison Control Centers, more than 2.4 million poisonings were reported in 2007.⁶ Of the more than 1000 poisoning deaths in the same report, over half were believed to be the result of suicide. Drug poisoning accounts for a significant percentage of reported episodes and is a major concern for health professionals and laypersons alike. Drugs most commonly implicated in fatal poisonings are analgesics, antidepressants, alcohol, CNS stimulants, and cardiovascular agents.

Children younger than 5 years account for most poisonings and for approximately 2% of deaths from poisoning. Despite these statistics, fatal poisonings of small children have decreased by more than 70% since the early 1960s. Aspirin, historically the leading cause of drug toxicity in small children, provides a noteworthy example of how unintentional poisoning can be controlled. Recognizing the special hazard of flavored baby aspirin, the pharmaceutical industry voluntarily limited the number of aspirin tablets per bottle to a (normally) sublethal total of 36. Safety packaging, which became mandatory after the passage of the Poison-Prevention Packaging Act of 1970, reduced the incidence of fatal ingestion further. Finally, increased public awareness concerning the danger of aspirin overdose, engendered in part by the proliferation of poison control centers throughout the United States, led to safer storage of aspirin in the home. Further decrements in the aspirin mortality rate have occurred, aided partly by the increased reliance on liquid acetaminophen and ibuprofen preparations for analgesia and antipyresis. As one might predict, however, acetaminophen and ibuprofen poisonings, previously quite rare, are now more common. The principles of toxicology and the prevention and management of drug poisoning are discussed in Chapter 52.

Drugs and pregnancy

The hazard to the unborn child of administering drugs during pregnancy has received considerable attention in the lay and professional literature. Over the years, certain compounds have been implicated in the development of congenital abnormalities. These teratogens disturb organogenesis in the developing embryo so that defects in one or more structures are produced. If the defects are incompatible with life, fetal death and either resorption or spontaneous abortion ensues; if they are less severe, the result is a malformed child.

Very little is known about the teratogenic potential of most drugs in humans, but the thalidomide disaster of 1960-1962 proved that an ordinary drug, extremely safe in adults, could induce extensive malformation prenatally. Thalidomide is a sedative-hypnotic that was released for clinical use in

Europe and elsewhere in the late 1950s. The drug quickly gained wide acceptance and was commonly used by women to relieve the nausea of “morning sickness.” Shortly after its introduction, an epidemic occurred of infants born with phocomelia, or “seal limb” malformation of the arms and legs. Retrospective studies determined that phocomelia was caused by thalidomide when the agent was taken 24 to 29 days after conception.²³ Other defects were also produced by thalidomide (e.g., absence of external ears, cranial nerve dysfunction, anorectal stenosis), depending on the time of administration. Removed from the worldwide market for many years, thalidomide has made a comeback in therapy. It is currently approved for treating certain forms of leprosy; it is also used clinically to manage various sequelae of human immunodeficiency virus (HIV) infection, to treat multiple myeloma and aphthous ulcers, and as an immune modulator in disorders such as Crohn’s disease. Strict prescribing controls are in place to prevent its use in pregnant women.

Laboratory experiments in animals and investigations of accidental teratogenesis in humans have found that drug-induced malformation is governed by the sequential pattern of embryonic and fetal development. From fertilization to approximately 20 days, an embryo either survives or succumbs to a chemical insult. No malformations occur, however, because the cells remain undifferentiated during this period. Beginning at day 21 (when the somites appear) and continuing until the end of the first trimester (when differentiation and organogenesis are well established), teratogenic malformations are possible. The defects produced vary with the toxic action of the agent and with the time of administration. Certain malformations, such as cleft palate, may be produced by various substances; some teratogens, such as antifolate drugs, can evoke a wide spectrum of structural defects.⁵¹ Selective toxicity of drugs to the fetus does not end after 3 months’ gestation. Although gross malformation may not occur, normal development may be retarded or otherwise affected throughout pregnancy. Immaturities in physiology and biochemistry may promote adverse reactions in the fetus at doses safe to the mother. The administration of drugs at the time of delivery is commonly associated with exaggerated effects in the neonate.

Table 3-6 lists several agents known to elicit toxic effects during pregnancy and indicates when their administration is most dangerous to the embryo or fetus. In an attempt to classify drugs on the basis of their toxic potential during pregnancy, the FDA instituted a pregnancy category rating, which is summarized in Table 3-7. Many older drugs have not yet been rated; of the drugs that have been classified, most fall into categories indicating a lack of definitive information regarding safety in humans.

Despite uncertainties concerning most drugs and the unborn child, pharmacologic agents have been used extensively by pregnant women. The major drug categories include iron supplements, analgesics, vitamins, sedative-hypnotics, diuretics, antiemetics, antimicrobials, cold remedies, hormones, “tranquilizers,” bronchodilators, and appetite suppressants. Drugs vary widely in their relative risk during pregnancy.⁴ Although women and health care professionals are now more aware of the risks posed by drugs, the admonition to restrict usage of therapeutic agents, especially during the first trimester, bears reiteration. For dentistry, there are no clear data regarding the use of local anesthetics in the first trimester. In light of the possibility that local anesthetics may pose a small risk to the unborn child, prudence dictates that only urgent or emergent treatment be rendered during this critical period of fetal development. Benzodiazepine sedatives, which are known to be human teratogens, must be avoided throughout the pregnancy. Regular dental care need not be postponed, however, during the second trimester as long as reasonable attention and care are given to avoiding undue physical and emotional stress in the patient and drugs that pose a known risk to the fetus.³¹

TABLE 3-6

Toxic Effects of Drugs During Pregnancy

DRUG	TOXIC EFFECT TO FETUS	MOST SUSCEPTIBLE PERIOD*			
		FIRST TRIMESTER	SECOND TRIMESTER	THIRD TRIMESTER	TERM
Anticancer drugs	Cleft palate, extremity defects, severe stunting, death	✓			
Chloramphenicol	Gray syndrome, death				✓
Cortisone	Cleft palate	✓			
Coumarin anticoagulants	Hemorrhage, death				
Diazepam	Cleft palate, respiratory depression	✓			✓
Local anesthetics	Bradycardia, respiratory depression				✓
Lysergic acid diethylamide	Chromosomal damage, stunted growth	✓			
Opioid analgesics	Respiratory depression, neonatal death				✓
Potassium iodide	Goiter, mental retardation				
Quinine	Deafness, thrombocytopenia			✓	✓
Sex steroids	Masculinization, vaginal carcinoma (delayed)				
Streptomycin	Eighth cranial nerve damage, micromelia, multiple skeletal abnormalities				
Tetracyclines	Inhibition of bone growth, tooth discoloration, micromelia, syndactyly				
Thalidomide	Phocomelia, multiple defects	✓			
Thiazide diuretics	Thrombocytopenia, neonatal death			✓	✓

Adapted from Underwood T, Iturrian EB, Cadwallader DE: Some aspects of chemical teratogenesis, *Am J Hosp Pharm* 27:115-122, 1970.

*Coumarins and other drugs with no indication mark are approximately evenly toxic throughout pregnancy.

TABLE 3-7

U.S. Food and Drug Administration Pregnancy Risk Categories

CATEGORY	DEFINITION	EXAMPLE DRUGS
A	Adequate and well-controlled studies have failed to show a risk to the fetus in the first trimester of pregnancy (and there is no evidence of risk in later trimesters)	Levothyroxine, magnesium sulfate (injectable), sodium fluoride*
B	Either (1) adequate and well-controlled studies have failed to show a risk to the fetus in the first trimester of pregnancy, and there is no evidence of risk in later trimesters, but animal reproduction studies have shown an adverse effect on the fetus; or (2) human studies are lacking, but animal studies have failed to show a risk to the fetus	Acetaminophen,* amoxicillin and clavulanate, cefaclor, erythromycin, lidocaine, naproxen, penicillin V*
C	No adequate and well-controlled studies have been performed in pregnant women, but animal reproduction studies are lacking or have shown an adverse effect on the fetus. Potential benefit may warrant use of the drug in pregnant women despite potential risk	Atropine, bupivacaine, butorphanol, codeine, diflunisal, epinephrine, hydrocortisone (topical), mepivacaine, morphine, thiopental
D	Positive evidence exists of human fetal risk based on adverse reaction data from investigational or marketing experience or studies in humans. Potential benefit may warrant use of the drug in pregnant women despite potential risk	Aspirin,* hydrocortisone (systemic),* lorazepam, midazolam, pentobarbital, valproic acid
X	Studies in animals or humans have shown fetal abnormalities, or there is positive evidence of human fetal risk based on adverse reaction data from investigational or marketing experience, or both, and the potential risk of the drug in pregnant women clearly outweighs the potential benefit	Ergotamine, estradiol, isotretinoin, temazepam, triazolam, warfarin

Adapted from *USP dispensing information—drug information for the health care provider*, ed 26, Rockville, MD, 2006, The United States Pharmacopeial Convention, Inc.

*Estimated ranking based on current information and FDA category definitions.

DEVELOPMENT OF NEW DRUGS

Advances in pharmacotherapy ultimately depend on the discovery, evaluation, and marketing of new drugs. The past several decades have witnessed an unprecedented proliferation of medicinal agents, and major revisions in how drugs intended for human use are evaluated have contributed to the manufacture of safer and more effective compounds. As a prescriber of drugs, however, the practitioner should be aware of the attendant problems and costs of developing therapeutic agents and of the unavoidable limitations in assessing drug safety before widespread use. Only with this knowledge can the clinician arrive at a balanced attitude toward new drugs and claims made for them.

Sources of New Drugs

For several centuries, considerable effort in pharmacology was devoted to the purification of active constituents from natural plant and animal products previously used for medicinal purposes. With the exception of various herbal medicines, these traditional sources of drugs are, for the most part, depleted.

Many new therapeutic agents are discovered by empiric screening. In screening tests, thousands of compounds from natural materials or synthetic chemistry are examined for a particular pharmacologic activity. Microplate, microarray, and other types of high-throughput technology have made screening an important method of finding new drugs capable of producing a defined drug effect. With the exception of penicillin, all the antibiotic groups have been isolated by the screening of soils and other materials for antimicrobial activity. In recent years, advances in synthetic chemistry and molecular biology have led to a proliferation of screening tests in which cells engineered to express receptors of interest and easily measured biologic responses to receptor activation are exposed to large collections of chemicals and examined for activity.

One productive technique of finding new drugs is to alter the molecular structure of an existing agent. Structure-activity relationship studies are intimately involved in this approach. When derivatives are produced, they are frequently little more than “me too” drugs—agents that, although similar in activity to the parent compound, offer no therapeutic advantage but are marketed anyway for economic reasons. Less often, a drug is synthesized that differs substantially from its predecessor in pharmacokinetic properties. Penicillin V, which is nearly identical in antimicrobial activity to its precursor, penicillin G, is nevertheless preferred for oral use because its absorption is two to five times better. Pharmacokinetic differences are especially prominent among the benzodiazepine congeners, with elimination half-lives ranging from several hours to several days. The least common but usually most desirable outcome of molecular modification is the synthesis of a derivative that differs qualitatively from the parent drug in pharmacodynamic effect. Such discoveries are generally the result of attempts to enhance one aspect of an agent's spectrum of activity over all others. The observations that sulfonamides used in chemotherapy of bacterial infections could decrease blood glucose concentrations and promote urine flow under appropriate conditions eventually led to the manufacture of several new classes of drugs: carbonic anhydrase inhibitors, thiazide diuretics, and sulfonylurea hypoglycemic agents.

Increasingly, discoveries of new drugs are evolving from advances in understanding of basic physiology, biochemistry, and the human genome. Nowhere is this “rational drug discovery” approach more apparent than in the synthesis of antimetabolites for antiviral and cancer chemotherapy and the development of drugs to modify immune reactions. The extraction of some natural effectors (e.g., insulin, calcitonin,

and adrenocorticotropin) and the synthesis of others (e.g., adrenal and sex steroids, epinephrine, vitamin D derivatives, and prostaglandins) have provided a host of therapeutic agents. Recombinant DNA technology, by which bacteria or even transformed mammalian cells can be altered genetically to synthesize foreign proteins, is fulfilling its promise for the large-scale production of human-derived agents (e.g., interferons, insulin, calcitonin, growth hormone, hematopoietic growth factors, and monoclonal antibodies) that were previously obtainable only in small amounts. This source of drugs is likely to continue to grow, and it is expected that hitherto unknown agents will become available for pharmacotherapy as studies of the human genome progress.

A burgeoning source of new pharmaceutical products comes from the development of novel delivery systems for existing drugs. The use of prodrugs to provide for improved gastrointestinal absorption (e.g., enalapril), regional distribution (e.g., levodopa, when given with carbidopa), or greater safety (e.g., acyclovir) is a well-established strategy. More complex approaches, such as various lipid formulations of drugs, may provide a safer parenteral delivery of drugs such as amphotericin B, a highly toxic antifungal agent. Conjugated monoclonal antibodies, whose production is outlined in Chapter 41, are now being used in cancer patients as vehicles for cytotoxic substances (e.g., diphtheria toxin) and various anticancer drugs and radioactive isotopes.²¹ The antibody attaches to tumor-associated surface antigens and positions the active ligand so that it can provide the tumoricidal effect. Similar drug-carrying monoclonal antibodies directed against discrete cellular elements of the immune system have found use in preventing transplant rejection and in the treatment of autoimmune diseases.³⁹ Attaching drugs, often covalently, to polymeric carriers is proving effective in localizing and prolonging drug effects, either because the controlled release of free drug from the immobilized matrix permits only local effects, or because the drug is active in the bound state. In either case, the distribution of drug action is determined by the properties of the carrier. There are many potential applications for such systems; in dentistry, the controlled release of antibiotics is useful in treating certain forms of periodontitis.²⁰

The last major source of new drugs is serendipity. Probably the greatest single breakthrough in pharmacotherapeutics in the twentieth century was the isolation of penicillin, made possible by the chance but astute observation of Fleming that bacteria in a culture dish were lysed by a mold contaminant of the genus *Penicillium*. Other classes of agents that originated by accident include the antiarrhythmic drugs (quinine) and the oral anticoagulants (dicumarol). Table 3-4 lists several drugs for which new therapeutic applications were fortuitously discovered after marketing.

Evaluation of New Drugs

Before a drug can be released for general use, it must pass a rigorous evaluation program established by the FDA (Figure 3-3). This program, although subject to some modification depending on the drug's intended use, invariably includes a series of animal and human investigations to ensure the product's safety and efficacy. (See Chapter 55 for a review of drug regulations pertaining to the FDA and the development of new drugs.)

Preclinical testing

The first step in evaluating a newly discovered compound is to ascertain its pharmacologic activity in animals. Initially, a few rats may be given several different doses of the chemical and observed for any disturbances that may occur in physiology or behavior. If the drug is being developed for a given purpose (e.g., to reduce blood pressure), it would be tested for that particular effect as well. Agents that seem to have a

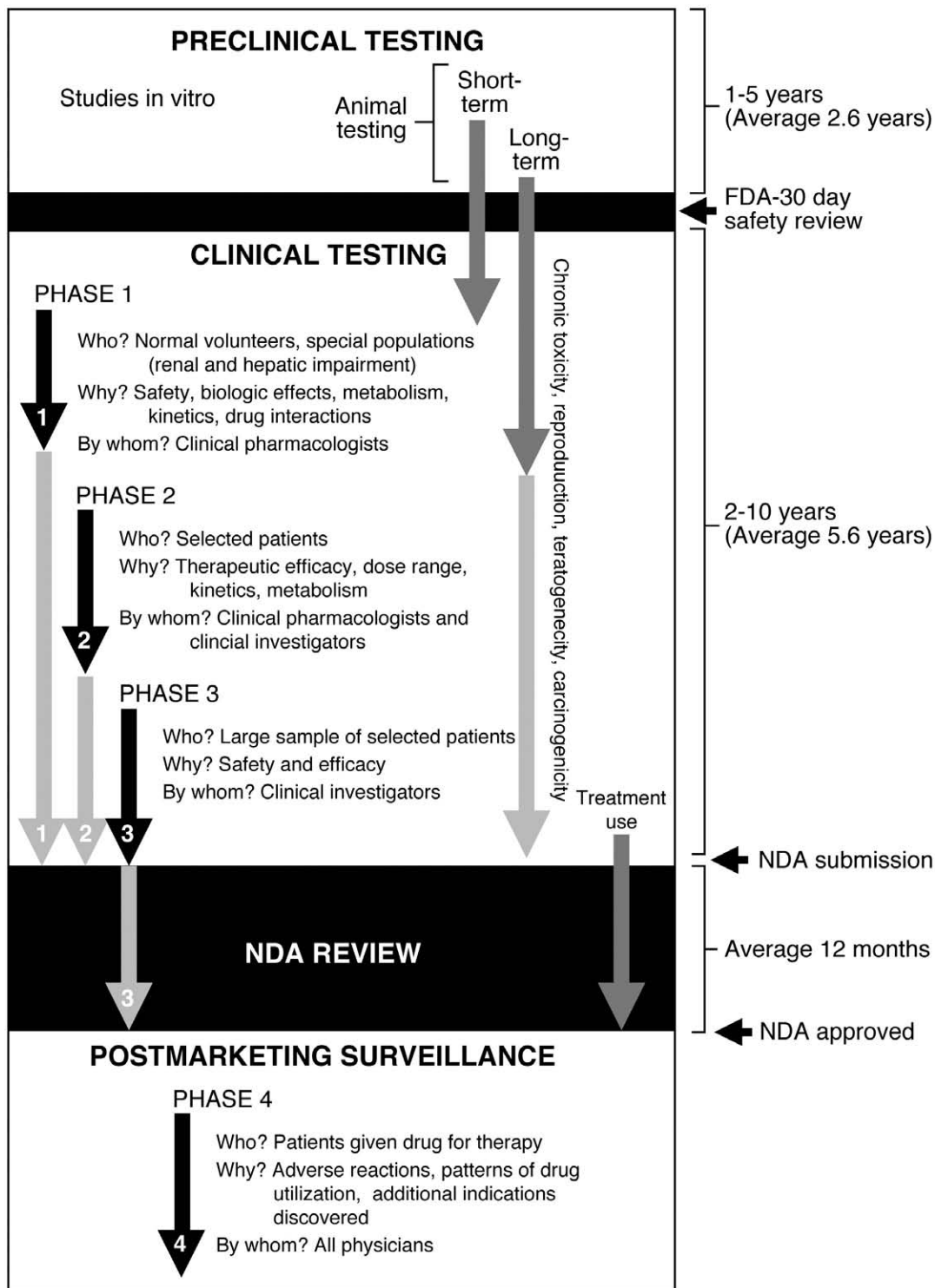

FIGURE 3-3 Overview of drug development. (Adapted from Oats JA: The science of drug therapy. In Brunton LL, Lazo JS, Parker KL, editors: *Goodman and Gilman's the pharmacological basis of therapeutics*, ed 11, New York, 2006, McGraw-Hill.)

useful action are enrolled in more extensive examinations. Graded dose-response curves are constructed to determine the potency and intrinsic activity of the compound (see Chapter 1). When a specific therapeutic effect is identified, quantal dose-effect relationships are drawn to estimate the compound's relative safety. As shown in Figure 3-4, quantal dose-effect curves can be prepared for desired and toxic responses.

When working with laboratory animals, one of the most convenient toxic effects to monitor is lethality. Death is universal, all drugs are capable of producing it, and it represents a definite end point that can be quickly and unequivocally recognized. The dose causing death in 50% of the test animals in a given period is designated as the median lethal dose (LD_{50}). The ratio of this dose to the median effective dose (LD_{50}/ED_{50}) defines the therapeutic index, a crude but

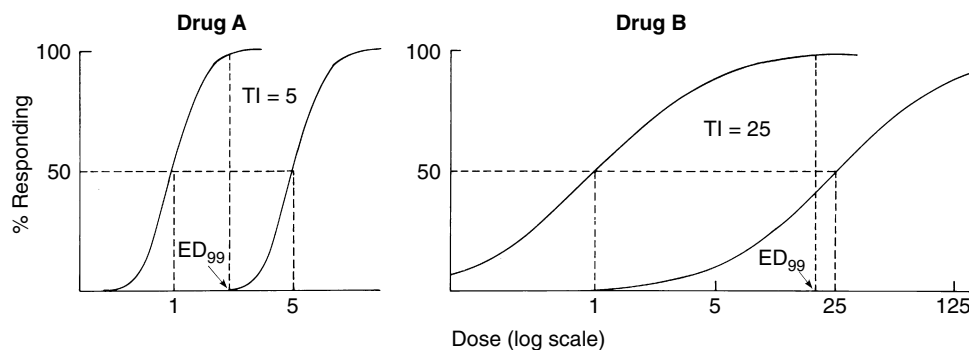

FIGURE 3-4 Quantal dose-response relationships (log scale) of two drugs, A and B. For each drug, the curve on the left reflects therapeutic responses, and the curve on the right represents toxic reactions. ED₉₉, Dose effective in 99% of the population; TI, therapeutic index.

TABLE 3-8

Comparison of Potency, Irritancy, and Lethality of Local Anesthetics

DRUG	ANESTHESIA* TAC (mmol/L)	LOCAL IRRITANCY [†]		LETHALITY [‡]	
		TIC (mmol/L)	RELATIVE SAFETY	LD ₅₀ (μmol/L)	RELATIVE SAFETY
Procaine	8.8	176	1	220	1
Tetracaine	0.69	12	0.9	27	1.6
Propoxycaine	0.81	75	4.6	22	1.1
Lidocaine	2.69	62	1.2	85	1.3
Cocaine	1.16	79	3.4	62	2.1

Data from Luduena FP, Hoppe JO: 2-Alkoxy benzoate and thiolbenzoate derivatives as local anesthetics, *J Pharmacol Exp Ther* 117:89-96, 1956.

*Intracutaneous wheal test in guinea pigs.

[†]Trypan blue test in rabbits.

[‡]Intravenous injection in mice.

LD₅₀, Median lethal dose; TAC, threshold anesthetic concentration; TIC, threshold irritant concentration.

useful measure of drug safety. Other things being equal, a drug with a large therapeutic index is safer than an agent with a smaller value. When many congeners are being tested concurrently, those with the most favorable therapeutic indexes are given preference in further investigations and are considered the most promising candidates for clinical application. The LD₅₀/ED₅₀ ratio is not fully predictive of relative safety. Drugs produce many toxic effects besides death that can prevent their use in humans. An agent that has a large therapeutic index regarding one adverse reaction may fare poorly in regard to another type of toxicity.

Table 3-8 compares a group of local anesthetics in their propensity to elicit two separate toxic effects—death and local tissue irritation—as a function of the anesthetic concentration.²⁶ Each test was performed in a different species: lethality in mice, irritability in rabbits, and anesthesia in guinea pigs. With procaine used as a standard, propoxycaine was 4.6 times safer regarding tissue irritation, but essentially equivalent in relation to lethality. From these data, cocaine would seem to be the safest local anesthetic for human administration; however, cocaine has some additional liabilities—CNS stimulation and abuse potential—not shared by the other agents that severely restrict its medical usefulness.

A second limitation of the therapeutic index is that biologic variability is not taken into account. In Figure 3-4, drug B has a larger therapeutic index than drug A, but is nevertheless clinically inferior. The goal of pharmacotherapy is to achieve a desired effect in virtually all patients without producing toxicity in any. Because the slopes of the quantal

dose-effect curves of drug A are steep (indicating little variation in responsiveness to the drug), a dose effective in 99% of the population (ED₉₉) can be administered with little risk to the recipients. Although drug B exhibits a therapeutic index five times greater than drug A, the biologic variability to it is so great that an ED₉₉ would produce toxicity in a significant fraction of the population. Estimates of relative safety that take biologic variation into account include the *certain safety factor*, which is the LD₀₁/ED₉₉ ratio (with LD₀₁ being the lethal dose in 1% of the population), and the *standard safety margin*, which is the percent increase over the ED₉₉ needed to reach the LD₀₁, calculated as follows:

$$\frac{LD_{01} - ED_{99}}{ED_{99}} \times 100$$

The disadvantage of these measures compared with the therapeutic index is the larger number of animals required for their determination.

To evaluate drug safety in animals thoroughly, acute, sub-acute, and chronic toxicity testing must be carried out in several different species and by several different routes of administration. Special studies are performed to detect carcinogenic and teratogenic activity, and adjuvants (e.g., Freund's) are used to test new products for their propensity to cause contact dermatitis. In addition to toxicity evaluations, pharmacokinetic investigations are done to determine the rate and extent of drug absorption, pattern of distribution, plasma half-life, and routes of elimination. Correlation of pharmaco-

logic effect with plasma titer has some predictive value for the therapeutic concentration in humans, and can indicate if the parent drug or a metabolite is the active moiety. Some more protracted and costly investigations may be run concurrently with human studies to save time and expense (if the drug proves unsuitable during initial clinical trials).

Regardless of the number, size, or sophistication of animal tests used, studies in humans are necessary to establish the clinical worth of any drug. Primarily because of unpredictable differences in biotransformation, pharmacokinetic studies in animals cannot be relied on to determine the correct dose or the duration of action of a drug in humans. Of even greater importance is the inability of preclinical studies to detect many forms of drug toxicity that occur in humans. Most revealing in this regard was a retrospective compilation of adverse reactions to six unrelated drugs, each used in humans, rats, and dogs.²⁵ Considering only toxic signs that are observable in animals and humans, 43% of the various kinds of human toxicity caused by the drugs were not found in either of the test species. When subjective responses (e.g., depression and giddiness) and other effects not detectable in animals (e.g., urticaria, nausea, headache) are taken into account, it becomes apparent that at least half of the untoward responses frequently caused by drugs cannot be ascertained preclinically. The need for human experimentation in drug development is unassailable.

Clinical trials

If an agent seems sufficiently promising on the basis of its preclinical evaluation to warrant testing in humans, the drug sponsor (generally a large pharmaceutical company) must first submit an application to the FDA in the form of a *Notice of Claimed Investigational Exemption for a New Drug* (IND application) detailing, among other things, (1) the identity of the drug and how it is prepared; (2) all results of preclinical investigations to date; (3) the intended use of the agent, dosage form, and route of administration; and (4) the procedures to be followed in assessing the drug's safety and effectiveness in humans. On FDA approval of the IND application, the first phase of clinical evaluation can begin.

Phase I trials represent an intensive study of the drug in a few, usually healthy, volunteers. The safe or tolerable human dose is arrived at by cautiously administering increasing increments of the drug to subjects until the desired response is obtained or a toxic side effect intervenes. Pharmacokinetic data from single and repeated administrations are collected to determine the bioavailability of the compound, its time course of action, and how it is eliminated from the body. Careful attention is given to any adverse effects that may occur. As with subsequent clinical studies, informed consent must be obtained from all subjects involved in phase I trials. Regulations by the FDA involving human experimentation conform to the principles incorporated in the Nuremberg Code and Declaration of Helsinki of the World Medical Association.¹⁶

The second phase of clinical evaluation involves administration of the drug to a few targeted patients. Phase II trials are the first real attempt to establish therapeutic efficacy, and many drugs are withdrawn from further investigation at this point. The exact studies made during phase II are determined in large measure by the drug. The major goals of investigation are constant, however: to establish efficacy and safety in patients and to arrive at the therapeutic dose. These first two phases are conducted exclusively by professionals trained and experienced in clinical pharmacology.

The decision to proceed to phase III trials commits the drug sponsor to a large-scale, controlled study of the drug. In phase III, the agent must be proved to be relatively safe and effective in a clinical setting. Such proof may require the combined efforts of more than 100 practitioners administering

the drug to several thousand patients. It is most important that these trials be designed and organized to provide a scientifically sound appraisal of the drug's therapeutic value. There must be a clearly defined end point of treatment so that drug effectiveness can be accurately determined. Proper controls (i.e., placebos when appropriate, active drugs when available) must be run concurrently to provide the necessary comparisons of drugs, and sufficient numbers of subjects must be used in the study to make such comparisons meaningful. The assignment of subjects to control and test categories must be unbiased. This unbiased assignment generally requires either a randomly assigned allotment of patients, in which each volunteer has an equal chance of being in any treatment group, or a crossover design, in which every subject receives each treatment in a balanced order. Bias in reporting drug effects also must be avoided; this can often be accomplished only by performing the trial under "blind" conditions. In a single-blind study, patients are not informed of which drug they receive; in a double-blind investigation, the identity of the medication is concealed from all individuals directly engaged in the study. Finally, appropriate statistical methods must be used to verify any conclusions reached about the drug.

Drug approval and continued surveillance

At the conclusion of phase III, a considerable body of information will have been gathered about the drug. These data are submitted to the FDA in the form of a *New Drug Application* (NDA). If accepted as "complete," the drug is approved for marketing as a prescription drug or as an over-the-counter item, depending on the need for professional supervision to ensure user safety. More often than not, the NDA is labeled "incomplete," however, and the sponsor is advised of additional evaluations that must be performed for it to be accepted. Even with approval of the agent, the sponsor must continue to submit reports to the FDA at regular intervals describing the quantity of drug distributed and detailing any unusual responses to the preparation, such as allergic reactions, idiosyncratic responses, or unanticipated drug interactions. This review constitutes phase IV of the clinical investigation.

Continued surveillance of the drug after general release is often the only method available for identifying uncommon or delayed toxic effects. Chloramphenicol was extensively used for 2 years before it was discovered to be capable of inducing severe blood dyscrasias (in approximately 0.002% of treated patients),²⁹ and it was in use for 17 years before it was recognized to be capable of causing visual impairment.⁹ It seems an ever-repeating cycle that a new drug is initially hailed as being essentially nontoxic, only to have enthusiasm dampened several years later by the realization that adverse effects are an integral part of the agent's pharmacologic profile.

Impact of FDA regulations on the development of new drugs

Regulations by the FDA governing the development and marketing of therapeutic agents exist largely as a result of public concern over the toxic liabilities of drugs. Had similar regulations been in force in Europe before 1959, the thalidomide disaster affecting approximately 10,000 children probably could have been averted. There are, however, several disadvantages to the present evaluation system used in the United States. It may take an average of 15 years for a new chemical entity (an agent unrelated to other drugs) to negotiate successfully the obstacle course of preclinical and clinical testing. The development expenses, including those associated with unfruitful compounds, may exceed \$1 billion.

The delay in introducing new drugs into pharmacotherapeutics after 1962 opened up a "drug lag" between the United States and other countries.⁵⁴ In response to this problem (and more specifically in response to pressure from acquired immu-

odeficiency syndrome advocates), the FDA established new regulations that allowed patients to receive investigational drugs targeted against serious or life-threatening disease outside clinical trials when no satisfactory alternative therapy was available. In the most extreme example, several promising drugs against HIV were made available to patients immediately after completion of phase I trials. Other strategies were instituted within the FDA to speed the review process. The FDA Modernization Act of 1997 incorporated these and other additional changes to streamline drug development.

The uncertainty and expense of bringing new drugs to market in recent years have had a striking influence on the pharmaceutical industry. Only the largest drug manufacturers have the resources to meet FDA guidelines for new drugs. Because pharmaceutical companies are profit-oriented enterprises, the enormous cost of developing a drug is incurred only if a reasonable return on the investment can be anticipated. Without some additional incentive, the development of drugs for rare diseases has been priced out of consideration. It is also to be expected that agents under patent protection will be highly priced and heavily promoted.

Two laws pertaining to drug development have been enacted in an effort to stimulate therapies for “orphan” diseases and to reduce the cost of pharmaceuticals. The Orphan Drug Act of 1983 provided tax incentives and other considerations to companies for the development of drugs for rare disorders (affecting <200,000 people in the United States) and for more common diseases in which there is no reasonable expectation for recovery of development costs. Future advances in genetics and genomics are likely to increase the need for orphan drugs, which are likely to be “tailor-made” to fit the genetic traits of individual patients. The Drug Price Competition and Patent Term Restoration Act of 1984 extended the period of patent protection for drugs whose introduction is delayed by the FDA approval process, and it abbreviated the requirements for NDA approval of generic versions of drugs approved after 1962 that are pharmaceutically identical and have equivalent bioavailability.

Drug Nomenclature

During the course of development and marketing, a drug acquires various names or designations (Figure 3-5). The first identification of a drug is the formal chemical name. Although descriptive of the molecular structure of the compound, the chemical name is usually too unwieldy for practical purposes. A newly synthesized drug is often given a simple code name by the parent pharmaceutical firm to denote the agent during

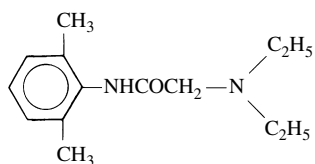

Chemical name (IUPAC):	2-(diethylamino) N-(2,6-dimethylphenyl) acetamide)
Code name (Astra):	LL 30
Nonproprietary name (USANC):	Lidocaine
Official name (USP):	Lidocaine
Nonproprietary name (BAN):	Lignocaine
Trade names (selected):	Xylocaine, Dilocaine, Lignospan, Nervocaine, Octocaine

FIGURE 3-5 Full nomenclature of a local anesthetic. BAN, British Adopted Name; IUPAC, International Union of Pure and Applied Chemistry; USANC, United States Adopted Name Council; USP, United States Pharmacopeia.

the various stages of drug evaluation. If the drug manufacturer intends to request approval by the FDA for distributing the agent, a nonproprietary name, or United States Adopted Name, is assigned to the drug by the United States Adopted Name Council (USANC), an organization jointly sponsored by the United States Pharmacopeial Convention, the American Medical Association, and the American Pharmacists Association. The nonproprietary name is commonly referred to as the “generic” name, but by definition, the generic designation should be reserved to indicate a family of compounds (e.g., penicillins), rather than a single entity (e.g., ampicillin). If the drug is eventually admitted to the *United States Pharmacopeia (USP)*, its nonproprietary name becomes the official name. The USANC works in cooperation with the World Health Organization to standardize nonproprietary names; drugs introduced before harmonization efforts began may have different nonproprietary names.

Much confusion over drug nomenclature arises because a single drug may be marketed under many different trade names. A trade, or proprietary, name is given to a drug by the manufacturer when the agent is approved for general release. In contrast to the nonproprietary name, which is publicly owned, a trade name receives copyright protection and is the sole property of the drug company. Occasionally, a manufacturer may distribute the agent under several different trade names to promote separate uses of the drug. In addition, the manufacturer may arrange with other pharmaceutical firms to sell the drug, each using its own trade name. A profusion of trade names may develop when the drug patent expires, and all companies are permitted by law to produce the agent. Assignment of trade names to drug combination products contributes yet another voice to the babel of drug names.

Confusion has arisen when the manufacturer of a popular drug uses an extension of the drug’s trade name to market additional, sometimes unrelated, products. Chlor-Trimeton is a well-known brand name for the antihistamine chlorpheniramine.³² The marketing of the adrenergic vasoconstrictor pseudoephedrine in the 1990s as Chlor-Trimeton Non-Drowsy raised the potential for ineffective therapy in allergic patients and hypertension and angina pectoris in patients with cardiovascular disease. Today, chlorpheniramine is marketed by the manufacturer with the label Chlor-Trimeton Allergy; the combination of chlorpheniramine and pseudoephedrine is not sold with the Chlor-Trimeton name.

Throughout this book, nonproprietary names are emphasized in discussions of the various drugs. This practice reduces confusion and equips the reader to use other sources of drug information to the best advantage. The benefits and debits of using nonproprietary designations in prescription writing are discussed in Chapter 55.

SOURCES OF DRUG INFORMATION

The continued development of new drugs and the acquisition of new information about existing agents make pharmacology a discipline requiring continual study. Various resources are available to aid the clinician in keeping abreast of advances in pharmacotherapeutics.

Official Compendia

The *USP* and the *National Formulary (NF)* were designated as official compendia of drugs in the United States by the Pure Food and Drug Act of 1906. First published in 1820, the *USP* is revised every 5 years, with interim supplementation as needed, by the United States Pharmacopeial Convention, Inc. Members of the Council on Scientific Affairs of the American Dental Association serve in an advisory capacity during the revision process. Before 1975, only single-entity drugs (prepa-

rations with a single active ingredient) of proven therapeutic value were considered for inclusion in the *USP*. The *NF*, first released in 1888, was a publication of the American Pharmaceutical Association. In addition to single-entity agents of therapeutic value, the *NF* admitted combination products when their use provided a therapeutic advantage to the patient. After publication of the fourteenth edition in 1975, the *NF* was consolidated with the *USP* under the management of the *USP* organization. With this consolidation, the *USP* was expanded to include “all drugs having proven efficiency as therapeutic agents,” including selected combination products, whereas the *NF* was restricted to describing pharmaceutical ingredients used in the formulation of marketed products.⁴⁷ The *USP-NF* is not a good source of information about the clinical use of drugs. It provides an invaluable service to the practitioner, however, by defining criteria for the manufacture of pharmaceutical preparations. It ensures that when a prescription is written for an official drug, the medication supplied to the patient meets certain standards of strength, purity, and chemical and physical properties.

The *American Hospital Formulary Service Drug Information (AFHS DI)* is currently the only compendium recognized by the federal government for determination of medically accepted but not FDA-approved indications of drugs. Published by the American Society of Health-System Pharmacists, a nonprofit organization, the *AFHS DI* is independent of the FDA and the pharmaceutical industry and relies on peer review by more than 500 physicians, pharmacologists, and other health care professionals to ensure information is accurate and evidence based. The *AFHS DI* contains information on more than 100,000 drug products and includes extensive off-label use information. Updates are available online.

Many other nations have their own official compendia. In addition, the *International Pharmacopoeia* is issued by the World Health Organization. Although not official in the sense of the *USP*, the *International Pharmacopoeia* is instrumental in promoting the standardization and unification of the various national compendia.

Unofficial Compendia

The *Physicians' Desk Reference (PDR)* is perhaps the most widely distributed source of prescribing information available to health professionals. The *PDR* is published annually (with interim revisions as necessary) by Thompson Healthcare in cooperation with more than 200 pharmaceutical manufacturing and distributing concerns. More than 2400 drugs are listed by proprietary name in an alphabetical arrangement according to drug distributor. (The cost of including a drug deters many companies from listing all their products.) Although the *PDR* is well indexed, its organization makes the comparison of similar agents difficult. The product information, which is largely derived from phase III trials and must legally conform to FDA regulations, contains concise summaries of the uses, dosage forms and schedules, contraindications, and adverse effects of the drugs listed. Nevertheless, the lack of critical appraisals of, or relative comparisons between, the various preparations included in the *PDR* limits its use as a reliable guide for the rational selection of drugs in therapy. The *PDR for Nonprescription Drugs, Dietary Supplements, and Herbs*, and the *PDR Guide to Drug Interactions, Side Effects, and Indications* are specialized sources of information offered by Thompson Healthcare. These books are also available on compact disc (CD) format, and an electronic site called PDR.net provides World Wide Web access to these resources for health care personnel (including dentists) free of charge.

A suitable alternative to the *PDR* is *Facts and Comparisons*. Published independently of the pharmaceutical industry, *Facts and Comparisons* contains monographs in a format designed to facilitate comparisons between drugs. *Facts and*

Comparisons is available in a hardcover edition, a loose-leaf version, on CD-ROM, and online. The publisher of *Facts and Comparisons* has also combined efforts with Unbound Medicine and Skyscape to produce a product called *A2z Drugs* for handheld devices.

Mosby's Drug Reference for Health Professions is a concise compilation of monographs for more than 950 “generic” drugs (including 4500 proprietary name products). Because drug entries in *Mosby's Drug Reference* are not paid for by pharmaceutical companies, the book contains information specifically for health care providers and not necessarily to be in compliance with FDA-approved drug information.

In 1975, the *USP* organization decided to assist and benefit health care practitioners directly in the use of drugs. Publication of the *USP Dispensing Information (USP DI)* was a major outcome of that decision. The *USP DI* comprised three separate volumes. Volume I, *Drug Information for the Health Care Professional*, contained useful clinical information for numerous drugs. Volume II, *Advice for the Patient, Drug Information in Lay Language*, included information for the patient regarding the proper use of specific medications, precautions to consider, and adverse effects that may occur. Drug monographs from this volume could be reproduced and distributed without authorization to patients receiving the medications. Volume III, *Approved Drug Products and Legal Requirements*, contained information on the therapeutic equivalence of drugs and various regulatory issues. For a decade, the *USP DI* was published by Thompson Micromedex, but in 2007, publication of *USP DI* ceased in favor of its “successor” *Drug-Points*, a prescription online source of drug information.

Books on Pharmacology and Therapeutics

Textbooks of general pharmacology usually present basic principles of drug action and pharmacologic profiles of the various classes of therapeutic agents. Descriptions of relationships between pathophysiologic characteristics and drug effects contained in textbooks significantly contribute to the understanding of pharmacotherapeutics. Although textbooks can provide the best overview of pharmacology, for clarity of presentation and because of limitations of space, detailed coverage of individual agents in each drug category is generally restricted to a few prototypical compounds. Epinephrine may be discussed in depth, whereas other sympathomimetic amines commonly used by practitioners (e.g., levonordefrin as a vasoconstrictor in local anesthetic solutions) or patients (e.g., pseudoephedrine as a vasoconstrictor in cold remedies) may not be discussed as extensively. Textbooks are also limited in that they cannot include information on the most recent advances in pharmacotherapeutics, such as the introduction of new drugs.

The *Handbook of Nonprescription Drugs*, published by the American Pharmacists Association, is one of the few sources of information concerning over-the-counter drugs. The handbook presents critical evaluations of the various preparations available to the public. Of special interest to dentists are the chapters on headache and muscle and joint pain, herbal remedies, and oral pain and discomfort.

Periodicals

Numerous journals and reviews are devoted to pharmacology and therapeutics. The *Journal of Pharmacology and Experimental Therapeutics* and *Molecular Pharmacology* offer in-depth treatment of all areas of pharmacology. These journals are primarily concerned with the experimental aspects of pharmacodynamics. *Clinical Pharmacology and Therapeutics* has articles dealing with drug effects in humans. Journals that review pharmacologic information of direct clinical relevance include *Drugs* and the *Annual Review of Pharmacology and Toxicology*. Although not restricted in scope to drugs, the *New*

England Journal of Medicine is noteworthy for its excellent coverage of pharmacotherapeutics. Specialty journals of significance to dentistry include *Anesthesiology*, *Anesthesia and Analgesia*, and *Pain*.

The *Medical Letter on Drugs and Therapeutics* provides a unique service to practitioners in the United States. Published biweekly, the *Medical Letter* offers current, concise, and critical reviews of new drugs and pharmaceutical preparations. Expert opinion is also provided regarding the therapeutic and toxic effects of established drugs. In this respect, the periodic updates on drug interactions and on clinical selection of antimicrobial agents are especially helpful.

Dental Sources of Information

The *American Dental Association Guide to Dental Therapeutics* is published by the American Dental Association in association with Thompson Healthcare. This resource has information on drugs listed in tabular form, with more extensive coverage of drugs pertaining predominantly to dentistry. It uses the Thompson PDR database for much of its information. In addition, chapter authors provide specific details pertinent to clinical dental practice.

Mosby's Dental Drug Reference and *Drug Information Handbook for Dentistry* are reference handbooks useful for the quick identification of drugs and their dental implications. Both sources are published annually; the latter is now available online and for downloading to computers and handheld electronic devices.

Although there is currently no dental periodical solely concerned with pharmacology, numerous journals feature articles dealing with drugs in dental practice. *Anesthesia Progress* is the official journal of the American Dental Society of Anesthesiology. It publishes articles on drugs useful in pain and anxiety control, and prints abstracts from other periodicals of related articles of interest. The *Journal of the American Dental Association* is also a good source of information about dental pharmacotherapeutics. In addition to publishing original contributions and review articles, the *Journal of the American Dental Association* provides evaluations from the Council on Scientific Affairs on issues pertaining to drugs and dentistry. The *Journal of Dental Research*, which features *Critical Reviews in Oral Biology and Medicine*, occasionally publishes articles and reviews relating to drug therapy in dentistry. Specialty journals, such as the *Journal of Oral and Maxillofacial Surgery* and the *Journal of Periodontology*, also publish articles on dental pharmacotherapeutics.

Electronic Media

Computerization of sources of drug information is rapidly progressing. Most of the sources of information described previously, or the databases from which they are derived, are now available on CD. These formats permit the use of Boolean descriptors and hypertext links to facilitate searches within a single source or among several sources at the same time. Digital book systems, incorporating one or more sources of information in a palm-sized reader, facilitate immediate access to drug information in all clinical settings. ePocrates Rx (www.epocrates.com) is a free resource on drugs that includes concise information ranging from pharmacodynamics to cost of drugs. It is available online and for download to Palm, Windows Mobile, iPhone, and BlackBerry devices.

The Internet is increasingly becoming a vital source of drug information. Numerous sites on the World Wide Web provide information regarding specific issues pertaining to dental therapeutics. Some of these are free; others charge a monthly or connect fee. Many of the book titles listed previously are also available online. Some other sources are as follows. PubMed (www.ncbi.nlm.nih.gov/PubMed) is the National Library of Medicine's interface to MEDLINE and

other information sources. It provides access, for a fee, to numerous scientific journals. Free access to numerous journal articles may be obtained through PubMed Central (www.pubmedcentral.gov). Micromedex (www.micromedex.com) is a reference that provides useful drug information for health care professionals. Lexi-Comp ONLINE (www.lexi.com) has a useful drug identification and vocal pronunciation guide for drugs and information on pharmacokinetics, adverse effects, and drug interactions. eMedicine (www.emedicine.medscape.com) is an extensive online resource that presents a discussion of disorders and treatment options.

RxList (www.rxlist.com) is a handy and valuable online resource concentrating on the clinical aspects of drugs. xPharm (www.xpharm.com) is a comprehensive online resource in pharmacology. xPharm is extensively linked internally and externally, offering significant search capabilities. Principles of pharmacology and drug and receptor characteristics are covered in depth. This resource also has extensive discussions of disorders for which the drugs are used. It is available for institutional subscriptions.

CITED REFERENCES

1. Arora S, Aldrete JA: Investigation of possible allergy to local anesthetic drugs: correlation of intradermal with intramuscular injections. *Anesth Rev* 3:13-16, 1976.
2. Aspden P, Wolcott JA, Bootman JL, et al, editors: and the Committee on Identifying and Preventing Medication Errors: *Preventing medication errors: quality chasm series*, Washington, DC, 2007, National Academies Press.
3. Beck FM: Placebos in dentistry: their profound potential effects. *J Am Dent Assoc* 95:1122-1126, 1977.
4. Black RA, Hill DA: Over-the-counter medications in pregnancy. *Am Fam Physician* 67:2517-2524, 2003.
5. Bretherton A, Day L, Lewis G: Polypharmacy and older people. *Nurs Times* 99:54-55, 2003.
6. Bronstein AC, Spyker DA, Cantilena LR, et al: 2007 Annual report of the American Association of Poison Control Centers' National Poison Data System (NPDS): 25th annual report. *Clin Toxicol* 46:927-1057, 2008.
7. Chen M, Bertino JS, Jr, Berg MJ, et al: Pharmacological differences between men and women. In Atkinson AJ, Jr, Abernethy DR, Daniels CE, et al, editors: *Principles of clinical pharmacology*, ed 2, Amsterdam, 2007, Elsevier.
8. Choi S, Myers JN: Molecular pathogenesis of oral squamous cell carcinoma: implications for therapy. *J Dent Res* 87:14-32, 2008.
9. Cocke JG, Jr, Brown RE, Geppert LJ: Optic neuritis with prolonged use of chloramphenicol: case report and relationship to fundus changes in cystic fibrosis. *J Pediatr* 68: 27-31, 1996.
10. Cullen JM: Mechanistic classification of liver injury. *Toxicol Pathol* 33:6-8, 2005.
11. de la Chapelle A: Genetic predisposition to colorectal cancer. *Nat Rev Cancer* 4:769-780, 2004.
12. de la Fuente-Fernández R, Schulzer M, Stoessl AJ: The placebo effect in neurological disorders. *Lancet Neurol* 1:85-91, 2002.
13. de Vos AM, Tong L, Milburn MV, et al: Three-dimensional structure of an oncogene protein: catalytic domain of human c-H-ras p21. *Science* 239:888-893, 1988.
14. Done AK, Cohen SN, Strebel L: Pediatric clinical pharmacology and the "therapeutic orphan." *Annu Rev Pharmacol Toxicol* 17:561-573, 1977.
15. Dworkin RH, Katz J, Gitlin MJ: Placebo response in clinical trials of depression and its implications for research on chronic neuropathic pain. *Neurology* 65(Suppl 4):S7-S19, 2005.
16. Grilley B: Investigational drugs. In Malone PM, Mosdell KW, Kier KL, et al, editors: *Drug information: a guide for pharmacists*, ed 2, New York, 2001, McGraw-Hill.
17. Hrobjartsson A: What are the main methodological problems in the estimation of placebo effects? *J Clin Epidemiol* 55:430-435, 2002.
18. Hrobjartsson A, Gotzsche PC: Is the placebo powerless? An analysis of clinical trials comparing placebo with no treatment. *N Engl J Med* 344:1594-1602, 2001.

19. Kalivas PW, Duffy P: Effect of acute and daily cocaine treatment on extracellular dopamine in the nucleus accumbens. *Synapse* 5:48-58, 1990.
20. Killoy WJ, Polson AM: Controlled local delivery of antimicrobials in the treatment of periodontitis. *Dent Clin North Am* 42:263-283, 1998.
21. Kreitman RJ: Recombinant toxins for the treatment of cancer. *Curr Opin Mol Ther* 5:44-51, 2003.
22. Lazarou J, Pomeranz BH, Corey PN: Incidence of adverse drug reactions in hospitalized patients: a meta-analysis of prospective studies. *JAMA* 279:1200-1205, 1998.
23. Lenz W: Epidemiology of congenital malformations. *Ann N Y Acad Sci* 123:228-236, 1965.
24. Levine JD, Gordon NC, Fields HL: The mechanism of placebo analgesia. *Lancet* 2:654-657, 1978.
25. Litchfield JT, Jr: Evaluation of the safety of new drugs by means of tests in animals. *Clin Pharmacol Ther* 3:665-672, 1962.
26. Luduena FP, Hoppe JO: 2-Alkoxy benzoate and thiolbenzoate derivatives as local anesthetics. *J Pharmacol Exp Ther* 117:89-96, 1956.
27. Lund L: Effects of phenytoin in patients with epilepsy in relation to its concentration in plasma. In Davies DS, Prichard BNC, editors: *Biological effects of drugs in relation to their plasma concentrations*, Baltimore, 1973, University Park Press.
28. Malone PM: Pharmacy and therapeutics committee. In Malone PM, Mosdell KW, Kier KL, et al, editors: *Drug information: a guide for pharmacists*, ed 2, New York, 2001, McGraw-Hill.
29. McCurdy PR: Chloramphenicol bone marrow toxicity. *JAMA* 176:588-593, 1961.
30. Meissner K, Distel H, Mitzdorf U: Evidence for placebo effects on physical but not on biochemical outcome parameters: a review of clinical trials. *BMC Med* 5(3), 2007. Available at: <http://www.biomedcentral.com/1741-7015/5/3>. Accessed January 10, 2010.
31. Michalowicz BS, DiAngelis AJ, Novak MJ, et al: Examining the safety of dental treatment in pregnant women. *J Am Dent Assoc* 139:685-695, 2008.
32. OTC names: an invitation to err? *USP Quality Review*, no. 54, Rockville, MD, 1996, United States Pharmacopeial Convention.
33. Papakostas YG, Daras MD: Placebos, placebo effect, and the response to the healing situation: the evolution of a concept. *Epilepsia* 42:1614-1625, 2001.
34. Parker CW: Drug allergy, part 3. *N Engl J Med* 292:511-514, 1975.
35. Peterson AM, McGhan WF: Pharmacoeconomic impact of non-compliance with statins. *Pharmacoeconomics* 23:13-25, 2005.
36. Pichler WJ: Immune mechanism of drug hypersensitivity. *Immunol Allergy Clin North Am* 24:373-397, 2004.
37. Pincus MR: Development of new anti-cancer peptides from conformational energy analysis of the oncogenic ras-p21 protein and its complexes with target proteins. *Front Biosci* 9:3486-3509, 2004.
38. Prchal JT, Gregg XT: Red cell enzymes. *Hematology Am Soc Hematol Educ Program* 19-23, 2005.
39. Prete M, Perosa F, Favoino E, et al: Biological therapy with monoclonal antibodies: a novel treatment approach to autoimmune disease. *Clin Exp Med* 5:141-160, 2005.
40. Reinberg A, Reinberg MA: Circadian changes of duration of action of local anaesthetic agents. *Naunyn Schmiedebergs Arch Pharmacol* 297:149-152, 1997.
41. Rosenthal A: Follow-up study of fatal penicillin reactions. *JAMA* 167:1118-1121, 1958.
42. Sarkadi B, Homolya L, Szakács G, et al: Human multidrug resistance ABCB and ABCG transporters: participation in a chemoinnate defense system. *Physiol Rev* 86:1179-1236, 2006.
43. Shelley JH: Phenacetin, through the looking glass. *Clin Pharmacol Ther* 8:427-471, 1967.
44. St. Peter WL, Halstenson CE: Pharmacologic approach in patients with renal failure. In Chernow B, editor: *The pharmacologic approach to the critically ill patient*, ed 3, Baltimore, 1994, Williams & Wilkins.
45. Stanley LA: Molecular aspects of chemical carcinogenesis: the roles of oncogenes and tumour suppressor genes. *Toxicology* 96:173-194, 1996.
46. Stewart RB, Cluff LE: A review of medication errors and compliance in ambulant patients. *Clin Pharmacol Ther* 13:463-468, 1972.
47. *The United States Pharmacopeia*, rev 32, and *The National Formulary*, ed 27, Rockville, MD, 2008, The United States Pharmacopeial Convention.
48. Thethi AK, Van Dellen RG: Dilemmas and controversies in penicillin allergy. *Immunol Allergy Clin North Am* 24:445-461, 2004.
49. Tilburt JC, Emanuel EJ, Kaptchuk TJ, et al: Prescribing "placebo treatments": results of national survey of US internists and rheumatologists. *BMJ* 337:a1938, 2008. Available at: http://www.bmj.com/cgi/content/full/337/oct23_2/a1938?view-long&pmid18948346. Accessed January 10, 2010.
50. Tommasino M, Accardi R, Caldeira S, et al: The role of TP53 in cervical carcinogenesis. *Hum Mutat* 21:307-312, 2003.
51. Underwood T, Iturrian WB, Cadwallader DE: Some aspects of chemical teratogenesis. *Am J Hosp Pharm* 27:115-122, 1970.
52. van Montfoort JE, Hagenbuch B, Groothuis GM, et al: Drug uptake systems in liver and kidney. *Curr Drug Metab* 4:185-211, 2003.
53. Walsh CT, Schwartz-Bloom RD: *Levine's pharmacology: drug action and reactions*, ed 7, Boca Raton, FL, 2005, Taylor & Francis.
54. Wardell WM: Therapeutic implications of the drug lag. *Clin Pharmacol Ther* 15:73-96, 1974.
55. Wolf S: The pharmacology of placebos. *Pharmacol Rev* 11:689-704, 1959.

GENERAL REFERENCES

- Atkinson AJ Jr, Abernethy DR, Daniels CE, et al, editors: *Principles of clinical pharmacology*, ed 2, Amsterdam, 2007, Elsevier.
- Brunton LL, Lazo JS, Parker KL, editors: *Goodman and Gilman's the pharmacological basis of therapeutics*, ed 11, New York, 2006, McGraw-Hill.
- Hansten PD, Horn JR: *Hansten and Horn's drug interactions analysis and management*, St. Louis, MD, 2006, Facts & Comparisons.
- Malone PM, Kier KL, Stanovich JE: *Drug information: a guide for pharmacists*, ed 3, New York, 2006, McGraw-Hill.
- Nielsen JR: *Handbook of federal drug law*, ed 2, Philadelphia, 1992, Lea & Febiger.

Pharmacogenetics and Pharmacogenomics

DAVID W. HEIN AND DENIS M. GRANT

Individual patient differences in drug responsiveness are well recognized by health care professionals. Understanding the basis for these differences is of major clinical and economic importance because of the high frequency of therapeutic failure and adverse reactions to drugs. Patients may receive inadequate or suboptimal benefit, suffer adverse effects from drug treatment, or both. This chapter highlights pharmacogenetic and pharmacogenomic principles and provides illustrative examples where these principles can be applied to optimize therapeutic benefit and minimize adverse effects.

Pharmacogenetics is the branch of pharmacology that seeks to understand the genetic basis for differences in drug responsiveness among humans. The ability to select the safest and most effective drug and dose for a patient based on the patient's pharmacogenetic profile should simplify the process of adjusting the therapeutic regimen to achieve the desired clinical response. Pharmacogenetics is defined by the U.S. Food and Drug Administration (FDA) as the investigation of the role of variations in DNA sequence on drug response. The term *pharmacogenomics*—sometimes used interchangeably with *pharmacogenetics*—is defined by the FDA as the investigation of variations in DNA and RNA characteristics as related to drug response. Pharmacogenomics may also refer to the application of genomic information toward the discovery and development of drugs with new and more specific targets.

FDA labeling regulations now stipulate “if evidence is available to support the safety and effectiveness of the drug only in selected subgroups of the larger population with a disease, the labeling shall describe the evidence and identify specific tests needed for selection and monitoring of patients who need the drug.” So far, the FDA has recommended changes in the labeling for 6-mercaptopurine, irinotecan, and tamoxifen to include pharmacogenetic information on treatment outcome. It has also been estimated more recently that 25% of all outpatients receive at least one prescribed medication that contains pharmacogenetic information in the drug label.¹⁸ This information is not generally helpful at present because testing for most pharmacogenetic variants is not yet routine in clinical practice and most general practitioners would be incapable of using such information even if it were currently freely available. The broader field of “personalized medicine” also includes more rational targeting of drugs, such as restricting the use of trastuzumab to treat tumors based on their tumor phenotype (i.e., only those tumors that over-express human epidermal growth factor receptor 2, the ligand for trastuzumab). This approach to therapy is sometimes included under the umbrella of pharmacogenetic testing.

Pharmacogenetics and pharmacogenomics are areas of intense interest and development within the biotechnology and pharmaceutical industries.⁴⁹ Many pharmaceutical com-

panies are beginning to genotype patients in premarket clinical trials to exclude individuals who are predicted to experience adverse effects or therapeutic failure. This concept is illustrated in Figure 4-1. A consortium that includes major pharmaceutical companies is assembling a high-density map of the single nucleotide polymorphisms (SNPs) that exist throughout the human genome to facilitate the construction of pharmacogenetic profiles that predict drug responsiveness. SNPs occur, on average, about once every 1000 bases in the 3 billion-base human genome. A website (<http://www.ncbi.nlm.nih.gov/SNP>) sponsored by the National Center for Biotechnology Information maintains an updated listing of these SNPs.

This chapter presents basic principles and mechanisms that account for pharmacogenetic differences in drug therapy and toxicity. The pharmacogenetic examples included are of historical or clinical interest (or both); they are not intended to be exhaustive because, with the sequencing of the human genome, tabular listings of pharmacogenetic traits of clinical interest fall rapidly out of date. For more comprehensive and contemporary information, readers are directed to monographs,^{30,59} chapters,^{22,23} and general reviews^{11,13,15,25,45,61} on pharmacogenetics and pharmacogenomics, and to the regularly updated Pharmacogenomics Knowledge Base (<http://www.pharmgkb.org>), which forms part of the National Institutes of Health–funded Pharmacogenetics Research Network.²¹

The genome determines the structure, configuration, tissue distribution, subcellular compartmentalization, and concentration of endogenous proteins. In most cases, for a drug to produce a therapeutic or toxic response, it must interact with one or more proteins, which are subject to genetic variation in humans. Genetic differences in plasma proteins may affect the affinity and the extent of drug binding. Genetic differences in the enzymes that metabolize a drug may confer differences in the concentrations of the parent compound, its active metabolites, and toxic derivatives. Genetic differences in cell membrane proteins or drug transporter proteins may influence drug absorption, distribution, and excretion. Finally, patients may have cell surface or intracellular drug receptors mediating therapeutic or adverse effects that are genetically more or less abundant or sensitive than is the norm.

The influence of genetic differences on drug response and toxicity has been highlighted in the popular press:

Every year, more than 100,000 people die in the U.S. because they carry “misspelled” genes that make medications either ineffective or deadly. Now doctors can test for the genes before prescribing... Imagine, a lawyer asking: “Doctor, did you know this drug would kill your patient? Did you know there is a test that would have predicted that? And why did you not give your patient the test?”⁴⁴

FIGURE 4-1 Diagram illustrating the strategy of selecting patients for drug therapy based on response to the drug. *Shaded figures*, responders who lack a genetic predisposition for toxicity; *white figures*, inadequate responders; *black figures*, patients predisposed to toxicity because of a genetic trait.

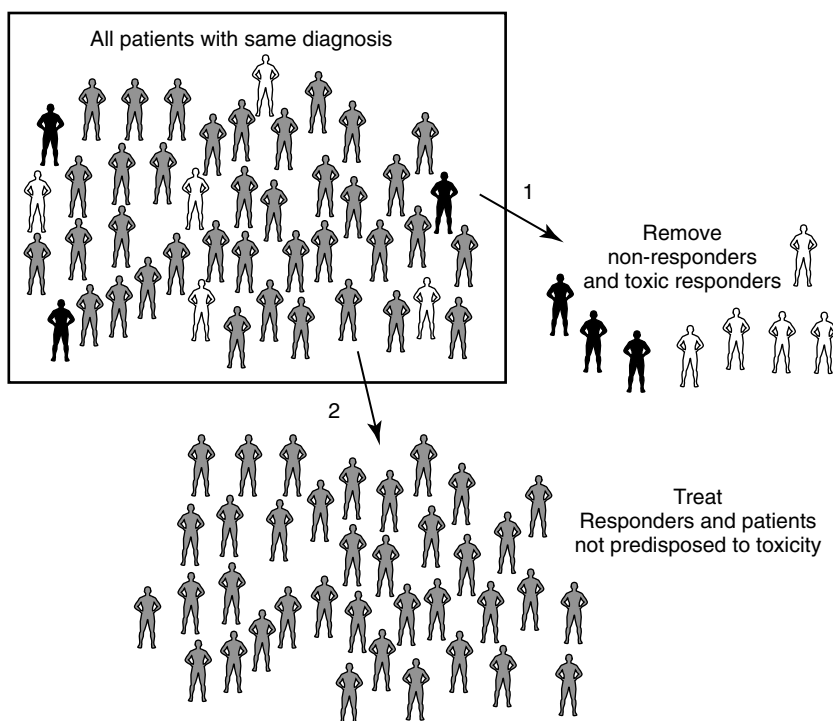

Such statements widely read by the lay public (and their lawyers) underscore the need for dental professionals to understand the role of pharmacogenetic factors in drug responsiveness. Patient malpractice claims have already alleged negligence in the use of pharmacogenetic information.⁵⁰

PHARMACOKINETICS AND PHARMACODYNAMICS

Proteins affect drug concentration (*pharmacokinetics*) and response (*pharmacodynamics*). Historically, genetic variation most often has been identified in pharmacokinetics, particularly in drug metabolizing enzymes.⁶ Genetic variation in the pharmacokinetic profile often necessitates a change in the dosage regimen of a drug, but not in its selection. Pharmacogenetic differences in drug target responsiveness²⁸ are less well understood, but potentially will also have a significant impact on patient outcomes in the future. In these instances, certain drugs would be contraindicated for patients with particular genotypes. Just as drug prescribers are currently responsible for avoiding adverse "drug-drug" interactions, as described in Appendix 1, they increasingly will be held accountable for avoiding untoward "gene-drug" interactions in clinical practice. Genetic differences in pharmacokinetics and pharmacodynamics are anticipated for many, if not most, drugs, yielding important consequences for drug responsiveness, especially for agents with a narrow therapeutic index. Figure 4-2 illustrates the separate and combined influences of genetic polymorphisms in pharmacokinetics and pharmacodynamics.¹⁴

There are many gene-drug interactions with importance to dentistry. Codeine, one of the mostly commonly prescribed opioid analgesics for pain relief, is a prodrug and depends on its activation to morphine by CYP2D6, a drug-metabolizing enzyme that is known to exhibit a common genetic polymorphism in humans.⁴⁸ As a result, codeine is an ineffective analgesic in a significant genetic subset (10%, depending on

ethnic group) of the population. Genetic polymorphisms in opioid receptors or in second messenger systems mediating opioid receptor actions have also been observed. If a patient inherits a deficiency in CYP2D6 or the μ -opioid response system, it is unlikely that standard doses of codeine will be of therapeutic benefit. Increasing the dose of codeine to compensate for the genetic deficiency will most likely result not in analgesia but rather in an adverse reaction mediated by overstimulation of an alternative receptor that is responsive to codeine.

PHENOTYPE AND GENOTYPE

An individual's *genotype* is a genetic trait defined by the DNA sequences (i.e., alleles) inherited from the mother and the father. An individual can inherit two copies of the same allele (homozygous genotype) or a different allele from each of the parents (heterozygous genotype). The *phenotype* is a biologic or measurable expression of the genetic trait that depends on the level of penetrance of the gene, the accuracy and selectivity of the method used to measure it, and the influence of environmental factors in the expression of the trait. Historically, one of the most easily measured phenotypes was plasma drug concentration, which is probably why most of the initially identified pharmacogenetic traits were pharmacokinetic phenotypes. Determination of drug concentration is invasive, however, requiring administration of a drug or surrogate chemical and collection of blood samples over time. The drug concentration also depends to varying degrees on patient age, general health, nutritional status, and other factors such as exposure to enzyme inducers and inhibitors. Determination of a patient's genotype is much less invasive because it does not require administration of a test drug or collection of blood samples over time. Instead, the genotype is determined from a small sample of DNA obtained easily from a buccal swab, hair follicle, or other ready source, and is not affected by age, general health, nutritional status,

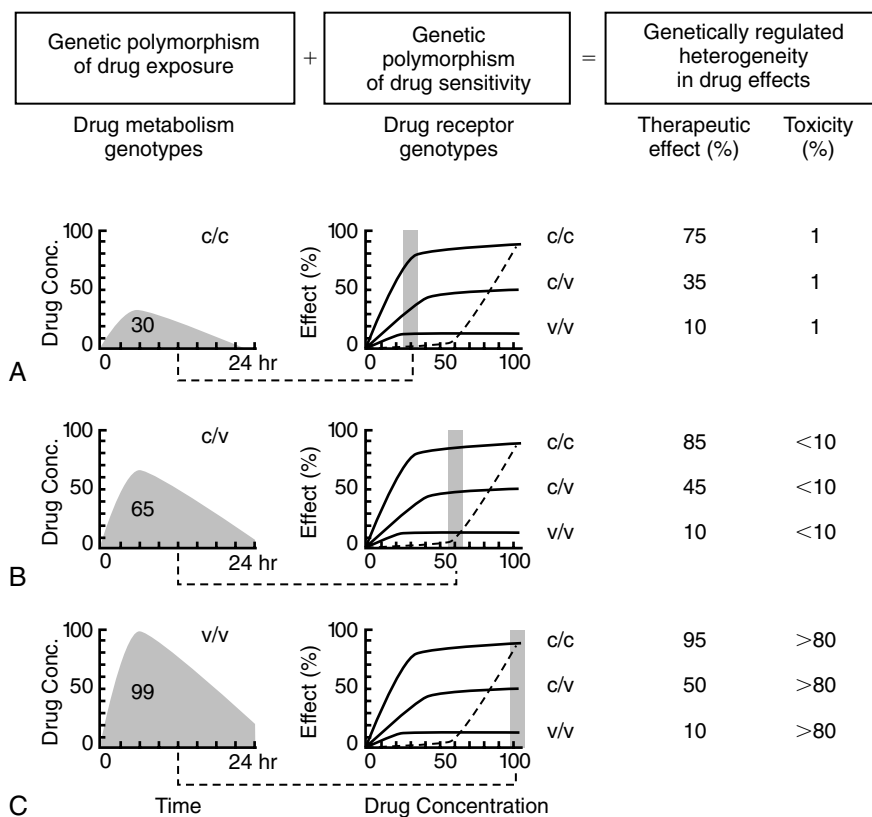

FIGURE 4-2 The potential consequences of administering the same dose of drug to individuals with genetic polymorphisms in both pharmacokinetics (drug-metabolizing enzymes) and pharmacodynamics (drug receptors). Active drug concentrations in the systemic circulation are determined by the individuals' drug metabolism genotype, with (A) homozygous common (*c/c*) genotype converting 70% of a dose to the inactive metabolite, leaving 30% to exert an effect on the target receptor. B, For the patient with heterozygous (*c/v*) drug metabolism genotype, 35% is inactivated, whereas (C) the patient with homozygous mutant (*v/v*) drug metabolism inactivates only 1% of the drug dose, yielding the three drug concentration time curves. The drug response is further influenced by drug receptor genotypes. Patients with a *c/c* receptor genotype exhibit a greater therapeutic effect (*solid lines*) at any given drug concentration in comparison to those with a *c/v* receptor genotype, whereas those with *v/v* receptor genotypes are relatively refractory to drug effects at any plasma drug concentration. The combination of genetic polymorphisms in drug metabolism and receptor yields nine different theoretical patterns of drug effect. The therapeutic ratio (efficacy versus toxicity) ranges from very favorable in a patient with *c/c* genotypes for drug metabolism and drug receptor to very unfavorable in the patient with *v/v* genotypes. (It is assumed here that the toxic dose-response curve, shown in *dotted lines*, is not influenced by these polymorphisms.) (Redrawn from Evans WE, Relling MV: Pharmacogenomics: translating functional genomics into rational therapeutics, *Science* 286:487-491, 1999.)

or other factors. For these same reasons, the prediction of drug response from a genetic test may not always be accurate or reproducible because of the influence of such nongenetic factors on drug response.

Many methods to determine the genotype have been developed in the past two decades, including restriction fragment length polymorphism analysis, allele-specific amplification, and DNA sequencing. Most methods rely on DNA amplification techniques based on the polymerase chain reaction that yield millions of copies of the specific target gene. New high-throughput methods promise to make the simultaneous determination of multiple genotypes readily available to health care professionals.⁵² Understanding the important and complex relationships between genotypes and phenotypes has fostered much research in functional genomics and proteomics.

MONOGENIC VERSUS POLYGENIC PHENOTYPES

A discussion of genetic polymorphisms in enzymes and receptors would be incomplete without consideration of the differences inherent between monogenic and polygenic phenotypes. *Monogenic* phenotypes derive from genetic variations in a single gene. Monogenic variation often separates populations into discontinuous (bimodal or trimodal) distributions of the phenotype. If the least commonly occurring phenotype arising from the monogenic variation has a frequency of greater than 1% in a population, it is termed a *polymorphism*. Different drugs or dosing regimens may be appropriate for specific phenotypes. *Polygenic* traits, in contrast, are phenotypes that derive from some combination of variations in multiple genes. In this case, clearly distinct or discontinuous phenotypes are not observed in a studied population. Instead, there is a uni-

modal, continuous, normal (Gaussian) distribution of the phenotype. A unimodal distribution of drug response is observed for most drugs metabolized by multiple enzymes, transported by multiple proteins, or acting through multiple receptors or second messenger systems. This unimodal distribution does not mean an absence of genetic variation in one or all of these proteins, but rather that multiple genes contribute to the overall drug response phenotype. Because each of the genes is potentially subject to genetic variation, the utility of genetic information in predicting therapeutic and toxic responses is considerably more complicated. Until recently, polygenic phenotypes were too complex to consider in optimizing drug therapy.

ETHNIC DIFFERENCES IN PHARMACOGENETICS

The frequency of specific alleles, genotypes, and phenotypes for drug metabolizing enzymes varies widely with ethnic origin.²⁹ A similar variance is expected for drug receptors. Clinical trials are best conducted either with ethnically diverse study populations to capture differences among ethnic groups with ethnically defined subgroups to define effects in these groups precisely. Some genotyping methods were designed originally to identify only alleles prevalent in whites. With the documented ethnic heterogeneity within the human population, however, genotyping tests need to identify all relevant alleles of a particular gene regardless of ethnic frequency.

PHARMACOGENETICS OF DRUG METABOLISM

As indicated earlier, most of the pharmacogenetic traits identified to date occur in genes encoding drug metabolizing enzymes. It is anticipated that genetic polymorphisms may be identified in all drug metabolizing enzymes. Many of these genetic polymorphisms are already known to be important in therapeutics,⁶³ and examples of historical and clinical interest are highlighted next.

Acetylation Polymorphisms

N-acetylation is an important phase II conjugation reaction for many drugs that possess an aromatic amine (e.g., procainamide, dapsone, many sulfonamides) or hydrazine (e.g., isoniazid, hydralazine) moiety. The acetylation polymorphism was originally discovered by studying the development of peripheral neuropathy in patients administered isoniazid.⁵⁹ N-acetylation of aromatic amine-containing and hydrazine-containing drugs may be catalyzed by either or both of two different N-acetyltransferase isozymes, NAT1 and NAT2.²⁴ Genetic polymorphisms have been identified in both enzymes, but genetic polymorphisms in NAT2 are more common and important for the metabolism of many drugs in common use.^{59,60} Human populations can be distinguished as rapid and slow acetylator phenotypes by measuring the production of N-acetylated metabolites after administration of drugs such as isoniazid, dapsone, or caffeine. Eleven identified SNPs in the NAT2 gene affect protein expression or stability or both.¹⁷ Acetylator genotypes derived from more than 25 different NAT2 alleles have been identified in humans. A listing of these alleles is regularly updated at <http://N-acetyltransferasenomenclature.louisville.edu>.

As is the case for most drug metabolizing enzyme polymorphisms, the frequencies of these SNPs, genotypes, and acetylator phenotypes vary markedly with ethnic origin. The frequency of slow acetylator phenotypes is about 10% in Asian populations, about 50% in many white and African populations, and greater than 85% in Egyptians. Slow acetylator phenotypes exhibit higher plasma concentrations of

parent drug and higher incidences of complications such as peripheral neuropathy from isoniazid and systemic lupus erythematosus from procainamide or hydralazine. In contrast, rapid acetylator phenotypes exhibit greater myelosuppression after treatment with amonafide.²⁷ Genetic polymorphisms in NAT2 are associated with altered cancer predisposition after environmental and occupational exposure to aromatic and heterocyclic amine carcinogens.²⁴

Oxidation Polymorphisms

The cytochrome P450 (CYP) system, as described in Chapter 2, is a family of microsomal enzymes with selective but frequently overlapping substrate specificities. CYP-mediated oxidation is the predominant pathway for phase I metabolism (activation and deactivation) and is responsible for the metabolism of a very large diversity of therapeutic drugs and environmental carcinogens. Genetic polymorphisms in many of the CYP enzymes have been identified in humans.⁷ A continuously updated listing of these polymorphisms and alleles is available at <http://www.imm.ki.se/cypalleles>. Variant alleles possess gene deletions, gene conversions with related pseudogenes, or SNPs yielding frameshift, missense, nonsense, or alternative splice sites. The phenotypic consequences of variant alleles and genotypes include absent, diminished, qualitatively altered, and enhanced CYP enzymatic activities. Three drug oxidation polymorphisms that have received the most clinical attention involve CYP2D6, CYP2C9, and CYP2C19. The different CYPs are products of separate genes. Genetic deficiency in one CYP does not infer genetic deficiencies in the others.

The oxidation polymorphism in CYP2D6 was originally discovered by the toxic responses observed in some patients after administration of debrisoquine and sparteine.⁵⁹ Humans with this genetic defect differ in their capacity to oxidize not only debrisoquine and sparteine but up to 25% of all drugs.²⁶ Poor metabolizer CYP2D6 phenotypes result from defective splicing causing inactive enzyme, gene deletion resulting in absence of protein, and missense SNPs yielding enzyme with reduced stability or reduced substrate affinity. An ultrarapid phenotype resulting from gene duplication has also been identified. Poor metabolizer phenotypes experience higher concentrations of parent drug after administration and consequently experience greater adverse effects. When CYP2D6 is required for prodrug activation to a more efficacious metabolite (e.g., codeine to morphine), poor metabolizers often experience therapeutic failure.⁵⁴ The opposite effects can occur in the ultrarapid metabolizer phenotype. Severe abdominal pain attributable to morphine has been observed in an ultrarapid metabolizer treated with codeine.⁵

Similarly, tamoxifen is biotransformed to the potent antiestrogen endoxifen by CYP2D6.⁵⁵ Genetic variation and inhibitors of CYP2D6 markedly reduce endoxifen plasma concentrations in tamoxifen-treated breast cancer patients. Patients with decreased metabolism have significantly shorter times to cancer recurrence and worse relapse-free survival rates relative to patients with extensive metabolism.⁵¹ The poor metabolizer phenotype is an independent predictor of breast cancer outcome in postmenopausal women receiving tamoxifen for early breast cancer. Because genetically determined impaired tamoxifen metabolism results in worse treatment outcomes, genotyping for CYP2D6 alleles can identify patients who would obtain little benefit from adjuvant tamoxifen therapy.

CYP2C9 catalyzes the oxidation of the vitamin K antagonist warfarin and many other drugs, including phenytoin, tolbutamide, and losartan.⁴⁶ More than 2 million patients in the United States receive warfarin treatment to prevent blood clots, heart attack, and stroke. Warfarin is a difficult

drug to use because the optimal dose varies widely and depends on many factors, including genetic polymorphisms in CYP2C9, CYP4F2 (which oxidizes vitamin K), and vitamin K epoxide reductase (VKORC1, the target of warfarin inhibition); patient age; diet; and concurrent drug therapy. Allelic variants of CYP2C9 encode enzymes with reduced or altered affinities. Individuals homozygous for certain variant CYP2C9 alleles may exhibit a 90% reduction in S-warfarin clearance, resulting in bleeding complications during warfarin therapy. The FDA has recommended labeling changes to advise patients and health care providers regarding the effects of CYP2C9 genetic polymorphism on initial dose and response to warfarin therapy, although the routine clinical use of CYP2C9 or VKORC1 genetic testing has not yet been recommended.¹⁶

CYP2C19 catalyzes the oxidation of drugs including mephenytoin and omeprazole.¹⁰ Individuals with genetic deficiencies may experience increased sedation and ataxia with the anticonvulsant mephenytoin and enhanced therapeutic efficacy with omeprazole used for the treatment of peptic ulcer.¹⁹

Plasma Cholinesterase Polymorphisms

Plasma cholinesterase catalyzes the hydrolysis of choline esters. Succinylcholine is an important neuromuscular blocking agent frequently used to produce muscular relaxation for endotracheal intubation and brief operative procedures. As described in Chapter 2, individuals with genetic deficiency in plasma cholinesterase experience prolonged apnea when treated with succinylcholine, which is potentially fatal unless appropriate respiratory support is provided. The primary atypical form of plasma cholinesterase possesses a SNP that changes an amino acid (aspartic acid to glycine) in the anionic site of the esterase, reducing its affinity for succinylcholine.³²

Thiopurine S-Methyltransferase Polymorphism

Thiopurine S-methyltransferase (TPMT) catalyzes the deactivating S-methylation of the anticancer and anti-inflammatory drugs 6-mercaptopurine, 6-thioguanine, and azathioprine. The gene encoding this enzyme exhibits genetic variation in human populations such that the frequency of the homozygous deficient phenotype is approximately 0.3% and that of heterozygotes is about 10% in whites and African Americans. More than 10 variant alleles have been identified that encode enzymes with reduced stability or catalytic activity or both.^{11,12} Treatment of acute lymphoblastic leukemia often requires long-term treatment with 6-mercaptopurine. Individuals with the homozygous deficient phenotype frequently develop severe hematopoietic toxicity when treated with standard doses of 6-mercaptopurine, requiring substantial reductions in dose. Individuals with heterozygous genotypes experience milder degrees of toxicity.³¹ Long-term outcome studies suggest that relapse-free survival is longer in patients whose chemotherapy dosing schedules were set according to prior testing for TPMT function.³⁶ 6-Mercaptopurine package inserts now provide detailed information and advice regarding pharmacogenetic TPMT deficiencies.

Dihydropyrimidine Dehydrogenase Polymorphism

5-Fluorouracil is used extensively in the chemotherapy of solid tumors. Dihydropyrimidine dehydrogenase catalyzes the rate-limiting step in the deactivation of 5-fluorouracil. Patients with genetic deficiency of this enzyme have a 90% lower clearance of 5-fluorouracil and may experience severe toxicity from modest doses.⁴⁰ The toxicity depends on the route of administration, but involves rapidly dividing tissues such as bone marrow and the mucosal lining of the gastrointestinal tract. Life-threatening neurotoxicity also has been observed.

Uridine Diphosphate Glucuronosyltransferase Polymorphism

Uridine diphosphate glucuronosyltransferase (UGT) catalyzes the glucuronidation of bilirubin and various drugs and xenobiotics. The UGT1A family of enzymes is represented in the genome by a series of four invariant exons. The transcribed product is then spliced to the product of any one of nine exons representing different substrate-binding domains. The family members are designated UGT1A1, UGT1A2, and so forth. UGT1A1 is the enzyme primarily responsible for bilirubin glucuronidation. UGT enzyme levels are regulated primarily through transcriptional control, and genetic variation in promoter structure influences transcription rate.⁵⁸ A series of TA repeats (thymine, adenine) in the proximal promoter vary in number from five to eight in different populations. The lower the number of repeats, the more efficient is the transcriptional activity of the gene. The UGT1A1*28 allele has seven TA repeats and is associated with Gilbert's syndrome.⁵⁷ The frequency of the homozygous UGT1A1*28 genotype varies with ethnic origin but is about 10% in white and African populations and 5% in Asian populations.

Irinotecan is a topoisomerase I inhibitor that is effective against several cancers, particularly colon cancer. It is a prodrug that is converted to an active metabolite, SN-38. This active metabolite is inactivated by glucuronidation catalyzed by UGT1A1. Individuals with genetic polymorphism in UGT1A1 have been shown to experience increased toxicity (myelosuppression and diarrhea) with the use of irinotecan alone and in combination with other anticancer drugs. The FDA-required package insert for irinotecan states: "individuals who are homozygous for the UGT1A1*28 allele are at increased risk for neutropenia after initiation of CAMPTOSAR [irinotecan] treatment." The FDA has also approved a pharmacogenetic test to identify these individuals, although the clinical utility of the test is debated.⁸

Drug Transporter Polymorphisms

Numerous families of specific small-molecule transport proteins are now known to mediate the movement of endogenous and exogenous substances across cellular membranes, influencing their tissue distribution and concentration (as described in Chapter 2). Genetic variants of many of these proteins have been identified, with consequences for drug pharmacokinetics and response.³⁹ Genetic variants of the multidrug resistance transporter P-glycoprotein, the product of the *MDR1* gene, have been associated with altered transport, efficacy, and toxicity of digoxin, tacrolimus, and irinotecan,³⁷ whereas variants in the organic anion transporter families OATP and OAT may alter the cellular uptake of a broad array of charged substances.³⁸

PHARMACOGENETIC POLYMORPHISMS IN DRUG TARGETS

Because therapeutic response is often more difficult to quantify than plasma drug concentration, genetic polymorphisms in drug targets have been less extensively characterized. There is little doubt, however, that genetic polymorphisms exist in most, if not all, proteins, including drug receptors. Several genetic polymorphisms reported in recent years are provided here as examples. Many more clinically relevant genetic polymorphisms in drug receptors are expected to be discovered in the near future.

Malignant Hyperthermia

Malignant hyperthermia (MH) is perhaps the first pharmacogenetic trait identified resulting from genetic polymorphism in a drug target (receptor).⁵⁶ As described in Chapter 18, MH

is triggered in susceptible individuals by the administration of inhalation anesthetics such as halothane and the depolarizing muscle relaxant succinylcholine.³⁵ The syndrome manifests with tachycardia, hypercarbia, hypoxia, muscular rigidity, arrhythmias, and, eventually, high fever. The molecular basis of the phenotype, at least in some individuals, is a variant of the ryanodine receptor 1, an intracellular Ca⁺⁺-release channel that bridges the gap between the sarcoplasmic reticulum and the t-tubular system in skeletal muscle. Administration of a volatile anesthetic to predisposed individuals disturbs Ca⁺⁺ regulation and enhances Ca⁺⁺ release in the sarcoplasmic reticulum, which in turn stimulates muscle contraction, ATP hydrolysis, carbon dioxide production, and lactate buildup. These responses result in the symptomatic heat generation that gives MH its name. If appropriate therapy is not initiated immediately, the patient may die within minutes from ventricular fibrillation, within hours from pulmonary edema or coagulopathy, or within days from neurologic damage or renal failure. An acute attack of MH is treated by administration of the muscle relaxant dantrolene.

β-Adrenergic Receptor Polymorphisms

β-Adrenergic receptors mediate crucial sympathetic responses in the cardiovascular, pulmonary, metabolic, and central nervous systems. β₂-Adrenergic agonists such as albuterol are potent bronchodilators widely used in the treatment of asthma. Other β-adrenergic agonists are administered to increase cardiac output in the emergency management of cardiogenic shock and decompensated congestive heart failure. Antagonists of β-adrenergic receptors are used to treat several disorders, including hypertension and chronic heart failure.

Genetic polymorphisms in β₁ and β₂ receptors have been identified in human populations.³³ β₂-Adrenergic receptor genotype variation has been shown to affect therapeutic response to β₂-selective agonists such as albuterol.³⁴ Polymorphisms in β receptors potentially influence drug treatment of cardiovascular diseases in two ways. The primary effect is alteration of agonist or antagonist efficacy because of a variant β₁ or β₂ receptor. The influence on drug efficacy also may be secondary, however, to an effect of the polymorphism on cardiovascular function. One β₂ receptor variant is associated with lower systemic vascular resistance and a greater vasodilatory response. Individuals with this β₂ receptor variant might be more sensitive to a vasodilator (e.g., captopril) acting via another mechanism, secondary to the altered systemic vascular tone.

Dopamine and Other Receptor Polymorphisms

Genetic polymorphisms in dopamine receptors have been associated with drug abuse liability and the reinforcing effects of alcohol, cocaine, and nicotine. Genetically variant dopamine receptors are also associated with an increased incidence of tardive dyskinesias after long-term treatment of schizophrenia with dopamine receptor antagonists.²³ Schizophrenia is itself a complex set of diseases that is not adequately managed in many patients. Typical and atypical antipsychotic drugs have been found to be effective in some but not all patients with schizophrenia. Genetic polymorphisms in antipsychotic medication receptor targets (dopaminergic, adrenergic, serotonergic, or histaminergic receptor subtypes) have been associated with different clinical responses.² Combinations of drug target polymorphisms and drug metabolism variants may eventually form the basis for targeting genetic subgroups of patients with schizophrenia for effective treatment with specific antipsychotic drugs.^{3,9}

Miscellaneous Drug Targets

Many additional genetic polymorphisms in drug targets have been reported, and many more are expected. A genetic poly-

morphism in the cholesterol transport protein apolipoprotein E is associated with a loss of efficacy of acetylcholinesterase inhibitors such as tacrine in the treatment of Alzheimer's disease.⁴³ Genetic polymorphisms in cholesteryl ester transfer proteins have been found to alter the benefits of HMG-CoA reductase inhibitors such as pravastatin in the treatment of coronary atherosclerosis.⁴⁴

IMPLICATIONS FOR DENTISTRY

The sequencing of the human genome—coupled with advances in DNA array technology, high-throughput genotyping, and bioinformatics—will soon enable rapid elucidation of complex genetic factors necessary for better optimization of drug therapy. Pharmacogenomics is expected to result increasingly in the development of drugs that are targeted to specific, genetically identifiable subgroups of patients.⁴⁹ Some drugs previously abandoned for clinical use because they proved toxic in some patients will likely return to clinical use, albeit with restrictions for specific genetic subgroups. Health care providers, including dentists, will be accountable for prescribing drugs appropriately to genetic subgroups. Automated genotyping systems and easily accessible genetic data will provide crucial information necessary for optimal drug therapy in the individual patient.

The determination and accessibility of human pharmacogenetic information carry potential ethical and legal concerns.^{42,53} One proposed solution is to use “abbreviated pharmacogenetic chips” that assess anonymous genetic information specific to each drug, rather than a “comprehensive genetic profile” determined for each patient.⁶² Alternatively, patient-specific pharmacogenetic information may be part of the patient's “electronic record” accessible at secure websites.¹ Although significant challenges exist to the development of means by which pharmacogenetic information is accessed and fully used,^{20,41,47} genetically enabled “personalized medicine” is likely to become more and more the standard of patient care.⁶⁴ The “one size fits all” mode of drug therapy that fails to consider pharmacogenetic information will increasingly be considered substandard clinical care.

CITED REFERENCES

1. Abrahams E, Ginsburg GS, Silver M: The Personalized Medicine Coalition: goals and strategies. *Am J Pharmacogenomics* 5:345-355, 2005.
2. Arranz MJ, de Leon J: Pharmacogenetics and pharmacogenomics of schizophrenia: a review of last decade of research. *Mol Psychiatry* 12:707-747, 2007.
3. Arranz MJ, Munro J, Birkett J, et al: Pharmacogenetic prediction of clozapine response. *Lancet* 355:1615-1616, 2000.
4. Begley S: Screening for genes: matching medications to your genetic heritage. *Newsweek* Feb. 8, 1999. Available at: <http://www.newsweek.com/id/87207>. Accessed January 10, 2010.
5. Dalen P, Frengell C, Dahl ML, et al: Quick onset of severe abdominal pain after codeine in an ultrarapid metabolizer of debrisoquine. *Ther Drug Monit* 19:543-544, 1997.
6. Daly AK: Pharmacogenetics of the major polymorphic metabolizing enzymes. *Fundam Clin Pharmacol* 17:27-41, 2003.
7. Daly AK: Pharmacogenetics of the cytochromes P450. *Curr Top Med Chem* 4:1733-1744, 2004.
8. Deeken JF, Slack R, Marshall JL: Irinotecan and uridine diphosphate glucuronosyltransferase 1A1 pharmacogenetics: to test or not to test, that is the question. *Cancer* 113:1502-1510, 2008.
9. de Leon J, Arranz MJ, Ruano G: Pharmacogenetic testing in psychiatry: a review of features and clinical realities. *Clin Lab Med* 28:599-617, 2008.
10. Desta Z, Zhao X, Shin JG, et al: Clinical significance of the cytochrome P450 2C19 genetic polymorphism. *Clin Pharmacokinetics* 41:913-958, 2002.

11. Eichelbaum M, Ingelman-Sundberg M, Evans WE: Pharmacogenomics and individualized drug therapy. *Annu Rev Med* 57:119-137, 2006.
12. Evans WE: Pharmacogenetics of thiopurine S-methyltransferase and thiopurine therapy. *Ther Drug Monit* 26:186-191, 2004.
13. Evans WE, McLeod HL: Pharmacogenomics—drug disposition, drug targets, and side effects. *N Engl J Med* 348:538-549, 2003.
14. Evans WE, Relling MV: Pharmacogenomics: translating functional genomics into rational therapeutics. *Science* 286:487-491, 1999.
15. Evans WE, Relling MV: Moving towards individualized medicine with pharmacogenomics. *Nature* 429:464-468, 2004.
16. Flockhart DA, O’Kane D, Williams MS, et al: Pharmacogenetic testing of CYP2C9 and VKORC1 alleles for warfarin. *Genet Med* 10:139-150, 2008.
17. Fretland AJ, Leff MA, Doll MA, et al: Functional characterization of human N-acetyltransferase 2 (NAT2) single nucleotide polymorphisms. *Pharmacogenetics* 11:207-215, 2001.
18. Frueh FW, Amur S, Mummaneni P, et al: Pharmacogenomic biomarker information in drug labels approved by the United States food and drug administration: prevalence of related drug use. *Pharmacotherapy* 28:992-998, 2008.
19. Furuta T, Ohashi K, Kamata T, et al: Effect of genetic differences in omeprazole metabolism on cure rates for *Helicobacter pylori* infection and peptic ulcer. *Ann Intern Med* 129:1027-1030, 1998.
20. Gardiner SJ, Begg EJ: Pharmacogenetics, drug-metabolizing enzymes, and clinical practice. *Pharmacol Rev* 58:521-590, 2006.
21. Giacomini KM, Brett CM, Altman RB, et al: The pharmacogenetics research network: from SNP discovery to clinical drug response. *Clin Pharmacol Ther* 81:328-345, 2007.
22. Grant DM: Pharmacogenetic and biologic markers of unintended drug effects. In Hartzema AG, Tilson HH, Chan KA, editors: *Pharmacoepidemiology and therapeutic risk management*, Cincinnati, 2008, Harvey Whitney Books.
23. Grant DM, Kalow W: Pharmacogenetics and pharmacogenomics. In Kalant H, Grant DM, Mitchell J, editors. *Principles of medical pharmacology*, ed 7, Toronto, 2007, Saunders Elsevier Canada.
24. Hein DW, Doll MA, Fretland AJ, et al: Molecular genetics and epidemiology of the NAT1 and NAT2 acetylation polymorphisms. *Cancer Epidemiol Biomarkers Prev* 9:29-42, 2000.
25. Ingelman-Sundberg M: Pharmacogenetics: an opportunity for a safer and more efficient pharmacotherapy. *J Intern Med* 250:186-200, 2001.
26. Ingelman-Sundberg M, Oscarson M, McLellan RA: Polymorphic human cytochrome P450 enzymes: an opportunity for individualized drug treatment. *Trends Pharmacol Sci* 20:342-349, 1999.
27. Innocenti F, Iyer L, Ratain MJ: Pharmacogenetics of anticancer agents: lessons from amonafide and irinotecan. *Drug Metab Dispos* 29:596-600, 2001.
28. Johnson JA, Lima JJ: Drug receptor/effector polymorphisms and pharmacogenetics: current status and challenges. *Pharmacogenetics* 13:525-534, 2003.
29. Kalow W: Interethnic differences in drug response. In Kalow W, Meyer UA, Tyndale RF, editors: *Pharmacogenomics*, ed 2, Boca Raton, 2005, Taylor & Francis.
30. Kalow W, Meyer UA, Tyndale RF: Pharmacogenomics. In Swarbrick J, editor: *Drugs and the pharmaceutical sciences*, ed 2, vol 156, Boca Raton, 2005, Taylor & Francis.
31. Krynetski EY, Evans WE: Genetic polymorphism of thiopurine S-methyltransferase: molecular mechanisms and clinical importance. *Pharmacology* 61:136-146, 2000.
32. La Du BN, Bartels CF, Nogueira CP, et al: Phenotypic and molecular biological analysis of human butyrylcholinesterase variants. *Clin Biochem* 23:423-431, 1990.
33. Liggett SB: Pharmacogenetics of beta-1- and beta-2-adrenergic receptors. *Pharmacology* 61:167-173, 2000.
34. Lima JJ, Thomason DB, Mohamed MH, et al: Impact of genetic polymorphisms of the β_2 -adrenergic receptor on albuterol bronchodilator pharmacodynamics. *Clin Pharmacol Ther* 65:519-525, 1999.
35. MacLennan DH, Phillips MS: Malignant hyperthermia. *Science* 256:789-794, 1992.
36. McLeod HL, Krynetski EY, Relling MV, et al: Genetic polymorphism of thiopurine methyltransferase and its clinical relevance for childhood acute lymphoblastic leukemia. *Leukemia* 14:567-572, 2000.
37. Marzolini C, Paus E, Buclin T, et al: Polymorphisms in human MDR1 (P-glycoprotein): recent advances and clinical relevance. *Clin Pharmacol Ther* 75:13-33, 2004.
38. Marzolini C, Tirona RG, Kim RB: Pharmacogenomics of the OATP and OAT families. *Pharmacogenomics* 5:273-282, 2004.
39. Marzolini C, Tirona RG, Kim RB: Pharmacogenetics of drug transporters. In Kalow W, Meyer UA, Tyndale RF, editors: *Pharmacogenomics*, ed 2, Boca Raton, 2005, Taylor & Francis.
40. Mattison LK, Soong R, Diasio RB: Implications of dihydropyrimidine dehydrogenase on 5-fluorouracil pharmacogenetics and pharmacogenomics. *Pharmacogenomics* 3:485-492, 2002.
41. Nebert DW, Zhang G, Vesell ES: From human genetics and genomics to pharmacogenetics and pharmacogenomics: past lessons, future directions. *Drug Metab Rev* 40:187-224, 2008.
42. Palmer LI, Martin RC, Hein DW: Chemopreventive drug treatment in subjects with genetic predisposition to cancer: prescriber liability and healthcare disparities. *Pharmacogenomics* 5:319-329, 2004.
43. Poirier J, Sevigny P: Apolipoprotein E4, cholinergic integrity and the pharmacogenetics of Alzheimer’s disease. *J Neural Transm Suppl* 53:199-207, 1998.
44. Regieli JJ, Jukema JW, Grobbee DE, et al: CETP genotype predicts increased mortality in statin-treated men with proven cardiovascular disease: an adverse pharmacogenetic interaction. *Eur Heart J* 29:2792-2799, 2008.
45. Relling MV, Giacomini KM: Pharmacogenetics. In Brunton LL, Lazo JS, Parker KL, editors: *Goodman and Gilman’s the pharmacological basis of therapeutics*, ed 11, New York, 2006, McGraw-Hill.
46. Rettie AE, Jones JP: Clinical and toxicological relevance of CYP2C9: drug-drug interactions and pharmacogenetics. *Annu Rev Pharmacol Toxicol* 45:477-494, 2005.
47. Roden DM, Altman RB, Benowitz NL, et al: Pharmacogenomics: challenges and opportunities. *Ann Intern Med* 145:749-757, 2006.
48. Rollason V, Samer C, Piguat V, et al: Pharmacogenetics of analgesics: toward the individualization of prescription. *Pharmacogenomics* 9:905-933, 2008.
49. Roses AD: Pharmacogenetics in drug discovery and development: a translational perspective. *Nat Rev Drug Discov* 7:807-817, 2008.
50. Rothstein MA, Epps PG: Ethical and legal implications of pharmacogenomics. *Nat Rev Genet* 2:228-231, 2001.
51. Schroth W, Antoniadou L, Fritz P, et al: Breast cancer treatment outcome with adjuvant tamoxifen relative to patient CYP2D6 and CYP2C19 genotypes. *J Clin Oncol* 25:5187-5193, 2007.
52. Shi MM: Technologies for individual genotyping: detection of genetic polymorphisms in drug targets and disease genes. *Am J Pharmacogenomics* 2:197-205, 2002.
53. Sillon G, Joly Y, Feldman S, et al: An ethical and legal overview of pharmacogenomics: perspectives and issues. *Med Law* 27:843-857, 2008.
54. Stamer UM, Stuber F: The pharmacogenetics of analgesia. *Expert Opin Pharmacother* 8:2235-2245, 2007.
55. Stearns V, Rae JM: Pharmacogenetics and breast cancer endocrine therapy: CYP2D6 as a predictive factor for tamoxifen metabolism and drug response? *Expert Rev Mol Med* 10:e34, 2008.
56. Stowell KM: Malignant hyperthermia: a pharmacogenetic disorder. *Pharmacogenomics* 9:1657-1672, 2008.
57. Strassburg CP: Pharmacogenetics of Gilbert’s syndrome. *Pharmacogenomics* 9:703-715, 2008.
58. Strassburg CP, Kalthoff S, Ehmer U: Variability and function of family 1 uridine-5’-diphosphate glucuronosyltransferases (UGT1A), *Crit Rev Clin Lab Sci* 45:485-530, 2008.
59. Weber WW: *Pharmacogenetics*, New York, 1997, Oxford University Press.
60. Weber WW, Hein DW: N-acetylation pharmacogenetics. *Pharmacol Rev* 37:25-79, 1985.
61. Weinshtilboum R: Inheritance and drug response. *N Engl J Med* 348:529-537, 2003.
62. Wilkins MR, Roses AD, Clifford CP: Pharmacogenetics and the treatment of cardiovascular disease. *Heart* 84:353-354, 2000.
63. Zanger UM, Turpeinen M, Klein K, et al: Functional pharmacogenetics/genomics of human cytochromes P450 involved in drug biotransformation. *Anal Bioanal Chem* 392:1093-1108, 2008.

64. Zhou SF, Di YM, Chan E, et al: Clinical pharmacogenetics and potential application in personalized medicine. *Curr Drug Metab* 9:738-784, 2008.

GENERAL REFERENCES

- Eichelbaum M, Ingelman-Sundberg M, Evans WE: Pharmacogenomics and individualized drug therapy, *Annu Rev Med* 57:119-137, 2006.
- Grant DM: Pharmacogenetic and biologic markers of unintended drug effects. In Hartzema AG, Tilson HH, Chan KA, editors: *Pharmacoepidemiology and therapeutic risk management*, Cincinnati, 2008, Harvey Whitney Books.
- Grant DM, Kalow W: Pharmacogenetics and pharmacogenomics. In Kalant H, Grant DM, Mitchell J, editors. *Principles of medical pharmacology*, ed 7, Toronto, 2007, Saunders Elsevier Canada.
- Ingelman-Sundberg M: Pharmacogenetics: an opportunity for a safer and more efficient pharmacotherapy, *J Intern Med* 250:186-200, 2001.
- Rothstein MA, editor: *Pharmacogenomics: social, ethical, and clinical dimensions*, Hoboken, 2003, John Wiley & Sons.

PART

II

*Pharmacology of
Specific Drug Groups*

Introduction to Autonomic Nervous System Drugs

PETER W. ABEL AND MICHAEL T. PIASCIK

The autonomic nervous system (ANS) and the endocrine system are the major regulatory systems for controlling homeostatic functions. These two systems collectively regulate and coordinate the cardiovascular, respiratory, gastrointestinal, renal, reproductive, metabolic, and immunologic systems. Drugs that alter the activity of either the ANS or the endocrine system often exhibit multiple actions and side effects. This chapter introduces the pharmacology of the ANS; the endocrine system and drugs are reviewed in Chapters 34 through 37. An understanding of the pharmacology of agents affecting the ANS rests on two basic foundations: a knowledge of the structural and functional organization of the ANS, and an understanding of where certain neurotransmitters are located and how these neurotransmitters affect cellular function.

AUTONOMIC NERVOUS SYSTEM

The ANS, also referred to as the visceral, vegetative, or involuntary nervous system, regulates the function of smooth muscle, the heart, and certain secretory glands. These structures possess intrinsic mechanisms that allow them to function in the absence of neuronal input, but the ANS contributes a regulatory and coordinating function. Most of our knowledge of the ANS is restricted to efferent functions; much less is known about the afferent limb. Sensory afferent fibers carry impulses that are received and organized centrally, often at an unconscious level. A person is unaware of impulses generated at the baroreceptors, although these impulses may trigger a generalized body response, such as a reflex decrease in blood pressure, which the person may sense. It has been estimated that approximately 80% of the vagus nerve consists of primary afferent fibers and that the effects of certain drugs (e.g., opioids) may be mediated in part by altering autonomic sensory inputs.^{16,30} Nevertheless, most currently available ANS drugs influence efferent activity.

Anatomy

The structural organization of the efferent arm of the ANS differs from that of the somatic nervous system. Somatic efferent fibers originate from cell bodies located in the central nervous system (CNS) and innervate skeletal (striated) muscle without intervening synapses (Figure 5-1). In contrast, the ANS consists of a two-neuron system in which preganglionic nerves emanating from cell bodies in the cerebrospinal axis synapse with postganglionic nerves originating in autonomic ganglia outside the CNS. The ANS is divided into two parts on the basis of the anatomic characteristics of each division. The sympathetic division includes nerve pathways that originate in the thoracolumbar regions of the spinal cord, whereas

the parasympathetic division includes nerve pathways from the craniosacral regions of the cerebrospinal axis.

Sympathetic nervous system

The organizational anatomy of the two divisions of the ANS is shown in greater detail in Figure 5-2. The sympathetic division originates from neurons with cell bodies located in the intermediolateral columns of the spinal cord, extending from the first thoracic to the third lumbar segments. The myelinated preganglionic fibers emerge with the ventral roots of the spinal nerves and synapse with second neurons in one of three possible types of ganglia: paravertebral (vertebral or lateral), prevertebral, or terminal. The paravertebral ganglia are composed of 22 pairs of ganglia lying on either side of the spinal cord and connected to each other by communicating nerve fibers. The superior cervical ganglia (the topmost pair) innervate structures in the head and neck, including the submandibular glands, whereas the superior, middle, and inferior cervical ganglia all innervate the heart. The prevertebral ganglia are located in the abdomen and pelvis and include the celiac, superior mesenteric, and inferior mesenteric, which innervate the stomach, the small intestine, and the colon. The few terminal ganglia lie near the organs they innervate, principally the urinary bladder and rectum.

A striking anatomic aspect of the sympathetic nervous system—and one that has great functional significance—is that a single preganglionic nerve may contact 20 or more postganglionic nerves. Impulses arising in one preganglionic neuron of the sympathetic nervous system may ultimately affect many postganglionic neurons, which explains the diffuse and widespread character of sympathetic nervous system responses. Stimulation of the sympathetic nervous system also activates nerves that innervate the adrenal medulla and cause it to release a mixture of the catecholamines epinephrine and norepinephrine. This release provides an additional basis for the widespread effects of the sympathetic nervous system.

Parasympathetic nervous system

The parasympathetic nervous system, or craniosacral division, has its origin in neurons with cell bodies located in the brainstem nuclei of four cranial nerves—the oculomotor (cranial nerve III), the facial (cranial nerve VII), the glossopharyngeal (cranial nerve IX), and the vagus (cranial nerve X)—and in the second, third, and fourth segments of the sacral spinal cord. The preganglionic nerves arising from the brainstem form part of the cranial nerves and travel with them to synapse with postganglionic neurons located in ganglia near or actually within the structures innervated. The midbrain outflow from the nucleus of the oculomotor nerve synapses in the ciliary

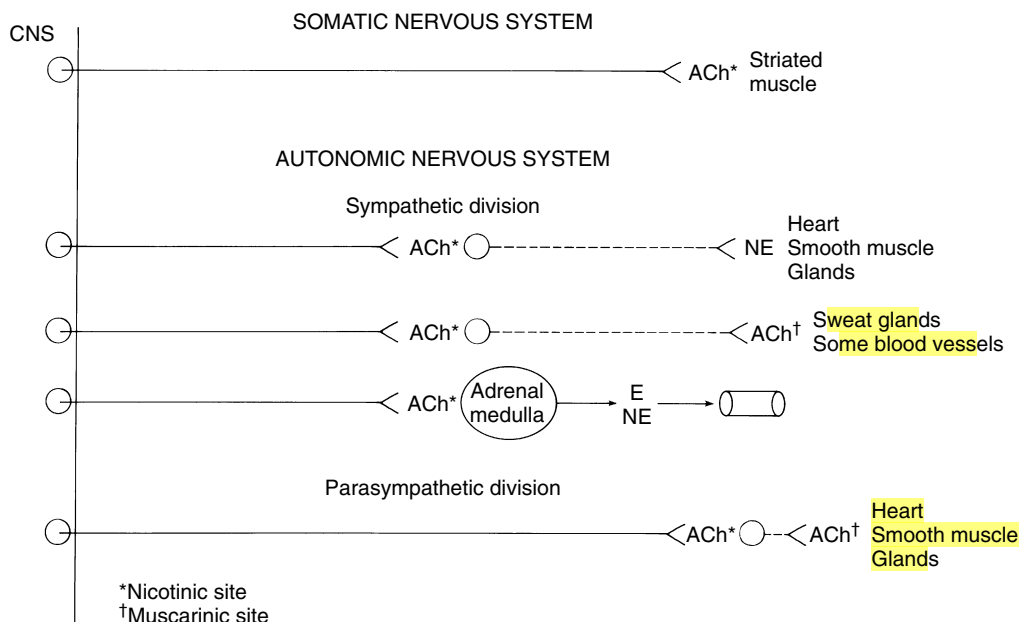

FIGURE 5-1 Functional organization of the somatic nervous system and the autonomic nervous system, with the structures innervated by the different nerves and the chemical mediators responsible for transmission at the various sites. *Solid lines* indicate somatic motor or preganglionic autonomic nerves; *dashed lines* indicate postganglionic autonomic nerves. *ACh*, Acetylcholine; *E*, epinephrine; *NE*, norepinephrine.

ganglion located in the orbit. The ganglion gives rise to nerves that supply the ciliary muscle and the sphincter muscle of the eye. Neurons of the facial nerve that synapse in the sublingual and submandibular ganglia form the chorda tympani and provide innervation to the sublingual and submandibular glands. Other neurons of the facial nerve synapse in the sphenopalatine ganglion; postganglionic nerves terminate in the lacrimal gland and in mucus-secreting glands of the nose, palate, and pharynx. Nerves originating in the glossopharyngeal nuclei synapse in the otic ganglion; its postganglionic neurons innervate the parotid gland. A major component of the cranial outflow is the vagus nerve, which originates from vagal nuclei in the medulla oblongata. Preganglionic nerves pass to ganglia located within the heart and the viscera of the thorax and abdomen. Postganglionic nerves, very short in length, arise from these ganglia to terminate in the aforementioned structures. Neurons originating from sacral segments form the pelvic nerves, which synapse in terminal ganglia lying near or within the uterus, bladder, rectum, and sex organs.

In contrast to the arrangement in the sympathetic nervous system, there is little overlap or divergence in the parasympathetic nervous system. With few exceptions (e.g., in Auerbach's plexus in the gastrointestinal tract, where 1 preganglionic nerve exists for every 8000 postganglionic nerves), there is a one-to-one relationship between preganglionic and postganglionic nerves, which makes possible discrete and limited responses in the parasympathetic nervous system. The parasympathetic nervous system is characterized by long preganglionic and very short postganglionic nerves and, with only a few exceptions, an absence of well-defined, anatomically distinct ganglia.

Functional Characteristics

Most organs are dually innervated by the sympathetic and parasympathetic nervous systems, such as most salivary glands and the heart, lungs (bronchial muscle), and abdominal and pelvic viscera, whereas other organs receive innervation from

only one division. The sweat glands, adrenal medulla, piloerector muscles, and most blood vessels receive innervation from only the sympathetic nervous system. The parenchyma of the parotid, lacrimal, and nasopharyngeal glands are supplied only with parasympathetic nerves. Table 5-1 lists the organs to which nerve fibers of the parasympathetic and sympathetic nervous systems are distributed, the effects of stimulation of these nerves, and the autonomic receptors that are activated by neurotransmitters released from autonomic nerves.

To understand or predict the effects of autonomic drugs on a specific organ, it is necessary to know how each division of the ANS affects that organ, whether the organ is singly or dually innervated, and if dually, which of the two systems is dominant in the organ. In most circumstances, one or the other of the two divisions of the ANS will provide the dominant influence, but often neither division is totally dominant in many of the dually innervated organs. The fact that both divisions of the ANS modulate the intrinsic activity of the various tissues cannot be overemphasized.

The anatomic and functional characteristics of the two divisions of the ANS show that there are striking differences between the sympathetic and parasympathetic nervous systems. Cannon¹¹ was the first to recognize that the sympathetic nervous system is capable of producing the kind of widespread and massive response that would enable an organism confronted with a stressor (e.g., pain, asphyxia, or strong emotions) to mount an appropriate response ("fright, fight, or flight"). Controlled clinical trials in dental patients indicate that oral surgical procedures constitute physiologically significant stressors for stimulating the sympathetic nervous system, with noticeable increases in circulating norepinephrine concentrations observed in patients during surgery and with the development of postsurgical pain (Figure 5-3). The stress of oral surgery is mediated by the CNS because drugs that reduce anxiety (e.g., diazepam) also reduce the sympathetic response to surgical stress and postoperative pain.^{15,19} The parasympathetic division is primarily concerned with the pro-

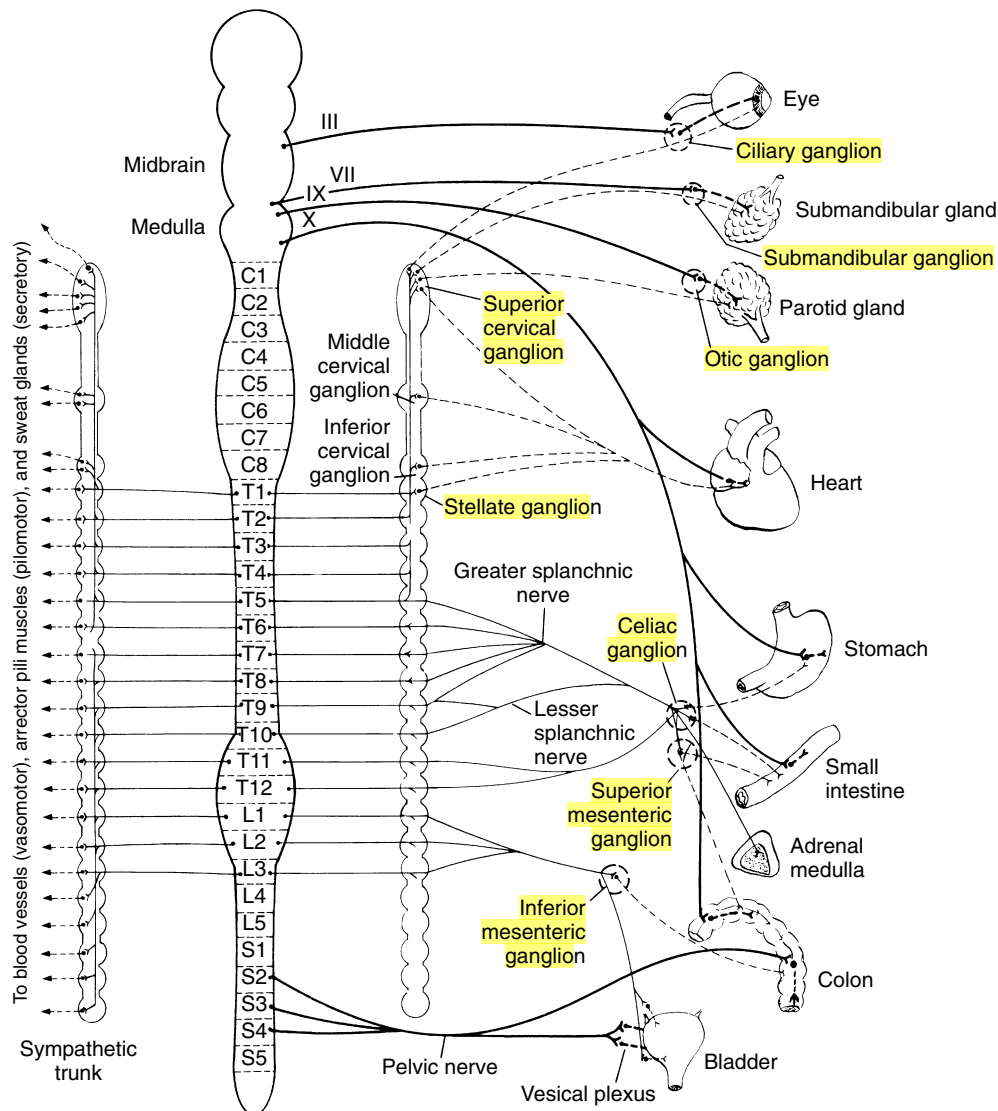

FIGURE 5-2 General arrangement of the autonomic nervous system showing one side of the bilateral outflow. On either side of the spinal cord (C1 to S5) are pictured the two chains of the paravertebral sympathetic ganglia. Preganglionic nerves of the sympathetic nervous system are indicated by *light solid lines*; postganglionic nerves of the sympathetic nervous system are indicated by *light dashed lines*. Preganglionic nerves of the parasympathetic nervous system, originating from the brain and sacral spinal cord, are shown by *bold solid lines*; postganglionic nerves of the parasympathetic nervous system are shown by *bold dashed lines*. (Adapted from Copenhaver WM, editor: *Bailey's textbook of histology*, ed 15, Baltimore, 1964, Williams & Wilkins.)

tection, conservation, and restoration of bodily resources. These differences in function are subserved by some of the anatomic characteristics that have already been mentioned, including the involvement of the adrenal medulla and the high ratio of postganglionic to preganglionic nerves in the sympathetic, but not the parasympathetic, nervous system.

NEUROTRANSMITTERS

The concept that chemical mediators were responsible for transmission of information in the ANS emerged at the end of the nineteenth and the beginning of the twentieth century. Acetylcholine was identified as the primary neurotransmitter released from preganglionic nerves and from postganglionic

nerves in the parasympathetic nervous system. Norepinephrine was found to be the neurotransmitter released from most postganglionic sympathetic nerves, whereas norepinephrine and epinephrine are released after sympathetic stimulation of the adrenal medulla. More recently, dopamine has also been found to be an important neurotransmitter at some sites in the ANS. Although acetylcholine, norepinephrine, epinephrine, and possibly dopamine have come to be recognized as the principal mediators of ANS activity, evidence exists that other molecules may also serve as chemical transmitters for specific neuronal circuits. Among these are histamine; 5-hydroxytryptamine (5-HT, serotonin); γ -aminobutyric acid (GABA); prostanoids; aspartate; adenosine triphosphate (ATP); glutamate; glycine; and various peptides, including neuropeptide Y, cholecystokinin, enkephalins, substance P,

TABLE 5-1

Responses of Various Effectors to Stimulation by Autonomic Nerves

EFFECTOR	SYMPATHETIC		
	RESPONSE	RECEPTOR	PARASYMPATHETIC RESPONSE*
Eye			
Radial muscle of the iris	Contraction (mydriasis)	α_1	—
Sphincter muscle of the iris	—		Contraction (miosis)
Ciliary muscle	Slight relaxation (far vision)	β_2	Contraction (near vision)
Heart [†]			
Sinoatrial node	Increase in rate	β_1, β_2	Decrease in rate
Atria	Increased contractility and conduction velocity	β_1, β_2	Decreased contractility, usually increased conduction velocity
Atrioventricular node	Increase in automaticity and conduction velocity	β_1, β_2	Decrease in conduction velocity
Ventricles	Increased contractility, conduction velocity, and automaticity	β_1, β_2	—
Blood vessels [‡]			
Coronary	Functional significance is doubtful	$\alpha_1, \alpha_2, \beta_2$	Same as sympathetic
Skin and mucosa	Constriction	α_1, α_2	Dilation, but of questionable significance
Skeletal muscle	Constriction; dilation	α, β_2^{\S}	—
Abdominal viscera	Constriction; dilation	α_1, β_2	—
Salivary glands	Constriction	α_1, α_2	Dilation
Erectile tissue	Constriction	α	Dilation
Lungs			
Bronchial smooth muscle	Relaxation	β_2	Contraction
Bronchial glands	Decreased secretion; increased secretion	α_1, β_2	Increased secretion
Gastrointestinal tract			
Smooth muscle	Decreased motility and tone	$\alpha_1, \alpha_2, \beta_1, \beta_2$	Increased motility and tone
Sphincters	Contraction	α_1	Relaxation
Secretion	Inhibition	α_2	Stimulation
Salivary glands	Protein-rich secretion [¶]	$\alpha_1, \beta_1, \beta_2$	Profuse, watery secretion
Spleen capsule	Contraction; mild relaxation	α_1, β_2	—
Urinary bladder			
Detrusor	Relaxation	β_2	Contraction
Trigone and sphincter	Contraction	α_1	Relaxation
Ureter			
Motility and tone	Increased	α_1	Increased (?)
Uterus	Variable, depending on species, endocrine status	α_1, β_2	Variable
Skin			
Pilomotor muscles	Contraction	α_1	—
Sweat glands	Secretion ^{¶¶}		—
Liver	Glycogenolysis, gluconeogenesis	α_1, β_2	Glycogen synthesis
Adipose tissue	Lipolysis	$\alpha_2, \beta_1, \beta_3$	—

*All parasympathetic responses are mediated by activation of muscarinic receptors.

[†]Norepinephrine released from sympathetic nerves to the heart activates only β_1 receptors; epinephrine released from the adrenal medulla stimulates β_1 and β_2 receptors. The predominant adrenergic receptor in the heart is β_1 .

[‡]In most smooth muscles, including blood vessels, α_1 receptors contract (constrict), whereas β_2 receptors relax (dilate). Prejunctional α_2 receptors on sympathetic nerve terminals inhibit norepinephrine release, which relaxes blood vessels and causes vasodilation; postjunctional α_2 receptors cause vasoconstriction.

[§]Blood vessels in skeletal muscle are innervated by some sympathetic nerves that release acetylcholine, which acts on muscarinic receptors to cause vasodilation.

[¶]The human parotid glands do not receive sympathetic innervation.

^{¶¶}The sweat glands receive sympathetic innervation, but with few exceptions (e.g., the sweat glands of the palms of the hands, which are activated by α_1 receptor stimulation), the transmitter is acetylcholine, and the receptors activated are muscarinic.

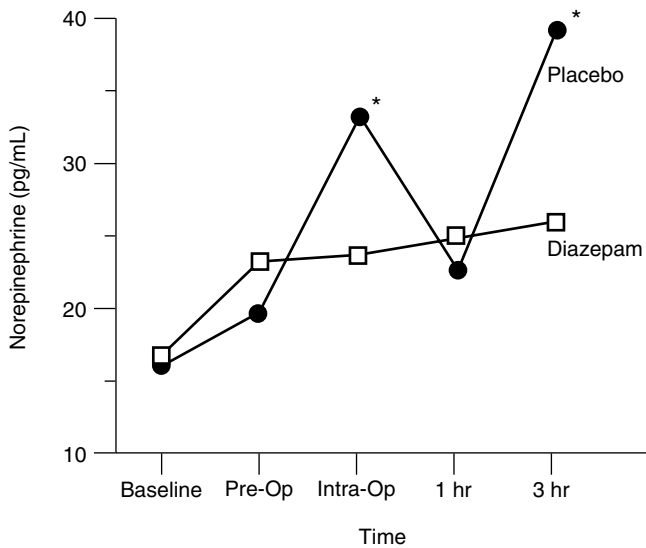

FIGURE 5-3 Response of the sympathetic nervous system to the stress of oral surgery, as indicated by the circulating concentration of norepinephrine. Plasma norepinephrine was measured 1 week before surgery (baseline) and on the day of surgery at the indicated time points. Patients were randomly injected intravenously with either placebo or diazepam (0.3 mg/kg), followed by intraral injections of 2% lidocaine with 1:100,000 epinephrine before surgical removal of impacted third molars. Placebo-treated patients showed significant increases (*asterisks*) in norepinephrine at the intraoperative and 3-hour postoperative periods, whereas diazepam-treated patients did not. (Adapted from Hargreaves KM, Dionne RA, Mueller GP, et al: Naloxone, fentanyl, and diazepam modify plasma β -endorphin levels during surgery, *Clin Pharmacol Ther* 40:165-171, 1986.)

calcitonin gene-related peptide, and vasoactive intestinal peptide.

Location of Adrenergic and Cholinergic Junctions

Figure 5-1 shows the sites at which the neurotransmitters acetylcholine and norepinephrine and the hormone epinephrine act as chemical mediators. With the exception of effectors (smooth muscle, the heart, and secretory glands) that are innervated by postganglionic sympathetic nerves where the neurotransmitter is norepinephrine, all other sites are innervated by cholinergic nerves, including the ganglia of the ANS, the adrenal medulla, a few effectors of the sympathetic nervous system, and all the effectors of the parasympathetic nervous system. At cholinergic junctions, cholinergic nerves release acetylcholine, which acts on cholinergic receptors to produce an effect. These ubiquitous cholinergic receptors are composed of two structurally unrelated types, called *muscarinic* and *nicotinic*, which are located at specific sites in the ANS. Muscarinic receptors are located on effectors innervated by cholinergic nerves; this includes effectors at postganglionic parasympathetic junctions and a few postganglionic sympathetic junctions (most sweat glands and some blood vessels). Nicotinic receptors are found at different anatomic sites, including postganglionic nerve cell bodies at all autonomic ganglia, the adrenal medulla, and skeletal muscle. There are also different types of structurally related adrenergic receptors (α_1 , α_2 , β_1 , β_2 , β_3)^{10,37} that are found at postganglionic sympathetic junctions where norepinephrine is released from postganglionic sympathetic nerves. These adrenergic receptors do not have a precise anatomic distribution, however; some effector organs have only a single adrenergic receptor, whereas other organs have two or more adrenergic receptor types. The

fact that there are significant differences in autonomic receptor types is supported by the discovery of agonists that stimulate one receptor type but not others and of antagonists that block one receptor but not others. Research has revealed the existence of additional subtypes for adrenergic and cholinergic receptors, and it is anticipated that drugs highly selective for these additional receptor subtypes will be developed for future clinical use.

Mechanism of Neurotransmitter Release

The current understanding of exocytotic neurotransmitter release has arisen from the work of many different investigators. Although several mechanisms for neurotransmitter release may exist, as summarized in reviews on the subject,^{26,36} one main model has been developed for the secretion of classic neurotransmitters, such as acetylcholine (Figure 5-4) and norepinephrine (Figure 5-5). It has been proposed that when an action potential reaches the axon terminal it depolarizes the membrane, leading to the opening of voltage-gated Ca^{++} channels.³¹ This activation of Ca^{++} channels causes high, but transient, increases in intracellular Ca^{++} concentrations near the neurotransmitter storage vesicles. Intracellular Ca^{++} activates calmodulin, a small Ca^{++} -binding protein found in nearly all cells.¹⁴ Calmodulin activates an enzyme called Ca^{++} /calmodulin-dependent protein kinase. This enzyme, found in extremely high concentrations in neurons (approximately 1% of total protein), catalyzes the phosphorylation of several proteins associated with the storage vesicle, including synapsin I. Synapsin I binds to actin present on the cytoskeleton and is thought to interact with other proteins (e.g., synaptobrevin, synaptophysin, and synaptoporin) to initiate docking and fusion of the storage vesicle with the cell membrane, followed by exocytotic neurotransmitter release. The neurotransmitter crosses the synaptic or junctional cleft and binds to its receptor on the nerve or effector cell membrane, which could be located on a ganglionic neuron, a skeletal muscle fiber, an autonomic effector, or a cell in the CNS.

ADRENERGIC NEUROTRANSMISSION

Catecholamine Synthesis

The catecholamines norepinephrine and epinephrine are the primary neurotransmitters and hormones released after stimulation of the sympathetic nervous system. The synthesis and storage of the catecholamines can be modified by a number of clinically useful drugs. The synthetic process, shown in Figure 5-6, involves numerous enzymes that are synthesized in the nerve cell body and carried by axoplasmic transport to the nerve endings. The enzyme tyrosine hydroxylase, which catalyzes the conversion of tyrosine to dihydroxyphenylalanine, is the rate-limiting enzyme in this process; any drug that inhibits the function of tyrosine hydroxylase reduces the rate at which norepinephrine is produced in the nerve terminal. The concentration of norepinephrine in the cytoplasm is one of the factors that regulates its own formation, principally by feedback inhibition on tyrosine hydroxylase activity.²⁷ The enzyme phenylethanolamine-N-methyltransferase, which catalyzes the conversion of norepinephrine to epinephrine, occurs almost exclusively in the chromaffin cells of the adrenal medulla and is missing in peripheral nerve terminals.³ Norepinephrine is the final product in most adrenergic nerves, whereas mainly epinephrine (80%), with some norepinephrine (20%), is produced in adrenal chromaffin cells in human beings.

Catecholamine Release

Evidence suggests that 90% to 95% of intracellular norepinephrine is stored in small granulated vesicles, where it is protected from intracellular enzymatic destruction until it is

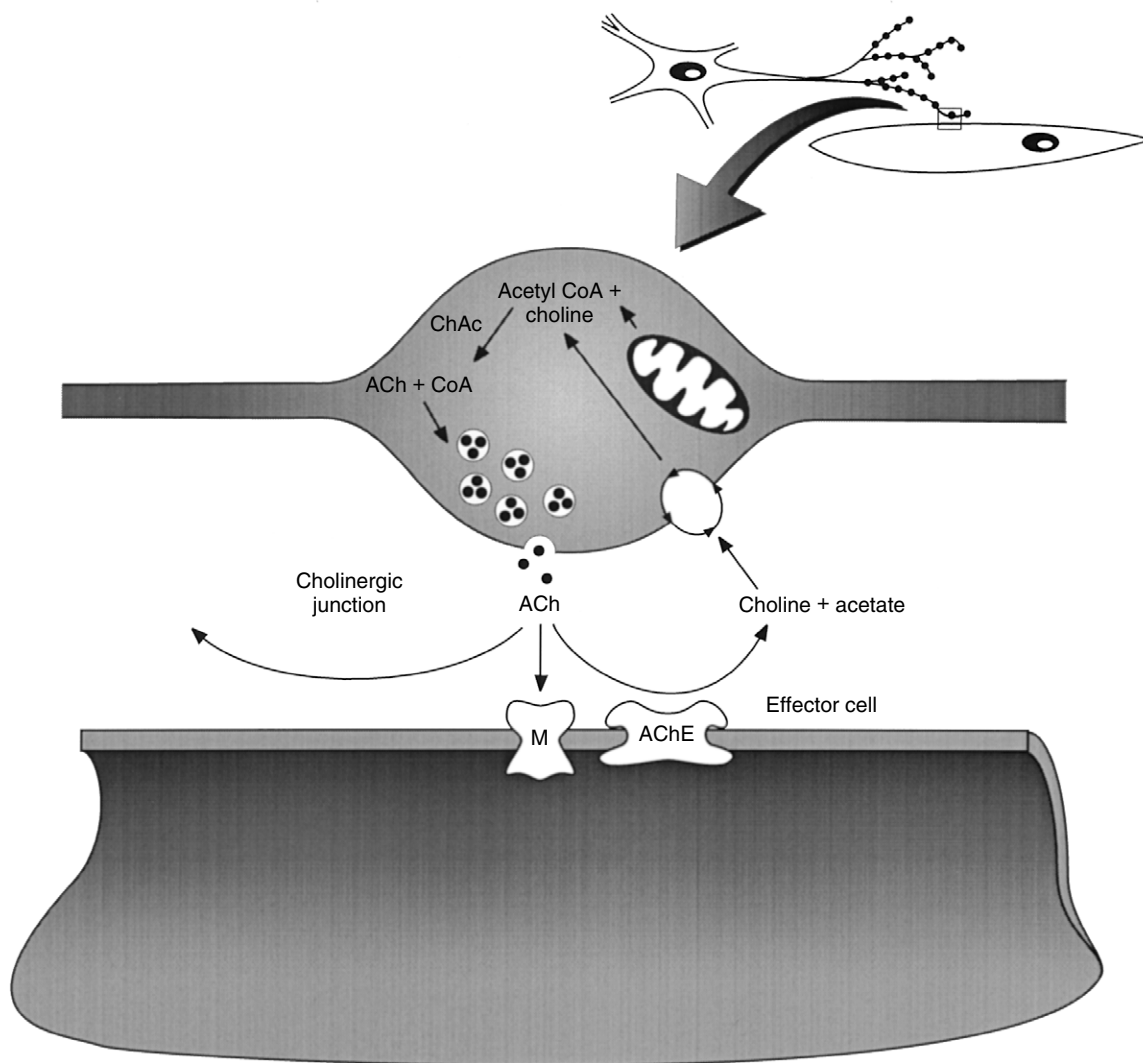

FIGURE 5-4 Cholinergic nerve terminal and its effector, in which are shown the intraneuronal synthesis of acetylcholine (*ACh*), the vesicles containing *ACh*, the release of *ACh* into the junctional cleft, its removal by the action of acetylcholinesterase (*AChE*) and diffusion, and the subsequent reuptake of choline back into the nerve terminal. *CoA*, Coenzyme A; *ChAc*, choline acetyltransferase; *M*, muscarinic receptor. (Adapted from Hubbard JI: Mechanism of transmitter release from nerve terminals, *Ann N Y Acad Sci* 183:131-146, 1971.)

released by depolarization; the other 5% to 10% is found in the cytoplasm. Most norepinephrine is stored in vesicles complexed with the protein chromogranin, the enzyme dopamine β -hydroxylase, and ATP. There are two different norepinephrine pools inside the neuron: a mobile and a reserve pool. Membrane depolarization causes release of transmitter from the mobile pool. Newly synthesized norepinephrine would seem to constitute the mobile pool because it is preferentially released during depolarization.⁴⁰ The function of the small cytoplasmic pool and its relationship to vesicular norepinephrine are not well understood. A diagrammatic representation of the adrenergic nerve terminal is shown in Figure 5-5.

Autonomic neuroeffector junctions are less structurally organized than the classic neuromuscular junction. The autonomic axon resembles a string of beads as it passes among smooth muscle fibers in blood vessels, intestines, and other sites (see the top right of Figure 5-5). The beaded varicosities release neurotransmitter near directly innervated effector cells. As the nerve impulse passes down the axon, and depolariza-

tion successively involves each varicosity, extracellular Ca^{++} enters into the nerve terminals, and norepinephrine is released into the junctional cleft by the process of exocytosis, as previously described. The cleft distances in the sympathetic and parasympathetic nervous systems are quite variable, ranging from 15 nm to many hundred nanometers, depending on the specific neuroeffector junction.⁶ After crossing the junctional cleft by passive diffusion, the transmitter binds to receptor sites on the effector organ and elicits an appropriate response.

Adrenergic Receptors

In 1948, Ahlquist¹ proposed the existence of two kinds of adrenergic receptors. He called these alpha (α) and beta (β). Two types of the β -adrenergic receptor, called β_1 and β_2 , were identified, followed by two different α -adrenergic receptors: α_1 , the predominant postjunctional membrane receptor, and α_2 , located prejunctionally³³ and postjunctionally.⁵ The presence or absence of these different adrenergic receptors, identified in part by experiments using synthetic drugs (ago-

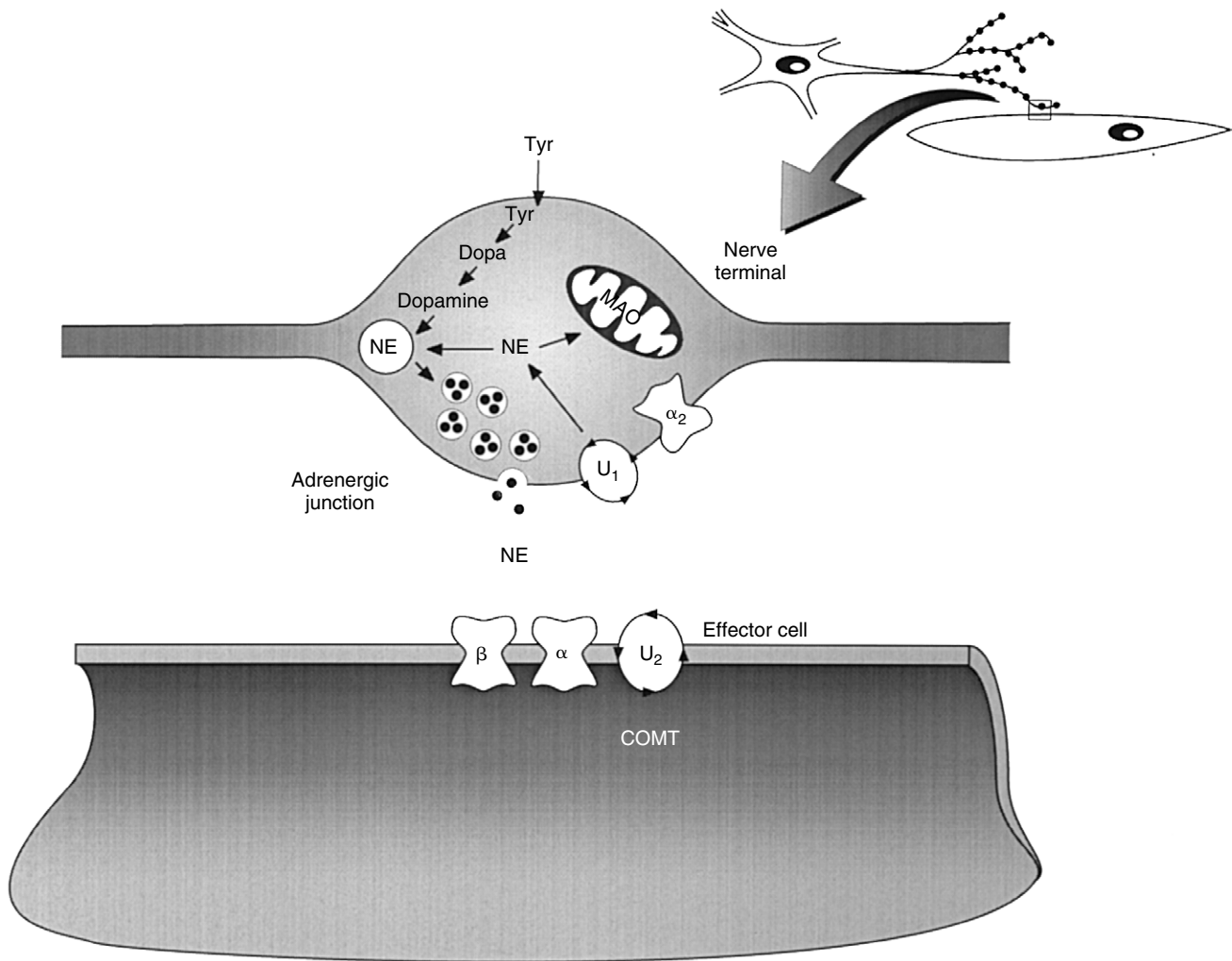

FIGURE 5-5 Adrenergic nerve terminal and its effector cell. Shown are the precursors of norepinephrine (NE), the sites of synthesis and storage of dopamine and NE, and the location of prejunctional and postjunctional adrenergic receptors (α_2 , α , β). It also shows the enzymatic (catechol-O-methyltransferase [COMT], monoamine oxidase [MAO]) and uptake-1 (U_1) and uptake-2 (U_2) mechanisms by which the action of NE is terminated. *Dopa*, Dihydroxyphenylalanine; *Tyr*, tyrosine.

nists and antagonists) highly selective for individual adrenergic receptor types, provides an explanation for the seemingly contradictory (or opposing) actions of the adrenergic transmitters (e.g., vasodilation in some vascular beds and vasoconstriction in others; see Table 5-1).

More recent molecular cloning and pharmacologic studies have shown the existence of multiple subtypes of adrenergic receptors. The α_1 -adrenergic receptor family consists of three subtypes, classified as α_{1A} , α_{1B} , and α_{1D} .^{28,42} Similar studies have shown the existence of multiple subtypes of the α_2 receptor (α_{2A} , α_{2B} , α_{2C}) and the β -adrenergic receptor (β_1 , β_2 , β_3).¹⁰ Using molecular biologic techniques, it is now possible to define a protein structure for these receptors.³⁷ The human β_2 receptor is a protein of 413 amino acids, with seven transmembrane spanning domains (see Figure 1-3). This heptahelical structure is a general characteristic of many cell surface neurotransmitter receptors. Because many of these receptors seem to have substantial differences in tissue distribution and function, considerable research is being directed toward the

development of drugs with selectivity at individual receptor subtypes.^{4,28} These drugs may possess greater specificity of action compared with currently used adrenergic agonists or antagonists.

As can be seen in Table 5-1, some organs express only one type of adrenergic receptor, whereas others have several types. α_1 -Adrenergic receptors mediate smooth muscle contraction and glandular secretion and are often excitatory. The function of α_2 receptors at postjunctional sites includes regulation of several metabolic functions (e.g., glycogenolysis, lipolysis, and water absorption)⁴ and vascular smooth muscle contraction. Norepinephrine acts on prejunctional α_2 receptors to inhibit transmitter release. This negative feedback control is supported by the observation that antagonists for these receptors (e.g., phentolamine) cause an increase in the release of transmitter in response to nerve stimulation.³³ Centrally, α_2 receptors are known to be involved in the regulation of blood pressure. Although several important exceptions exist, β_1 receptors are often associated with excitatory cellular

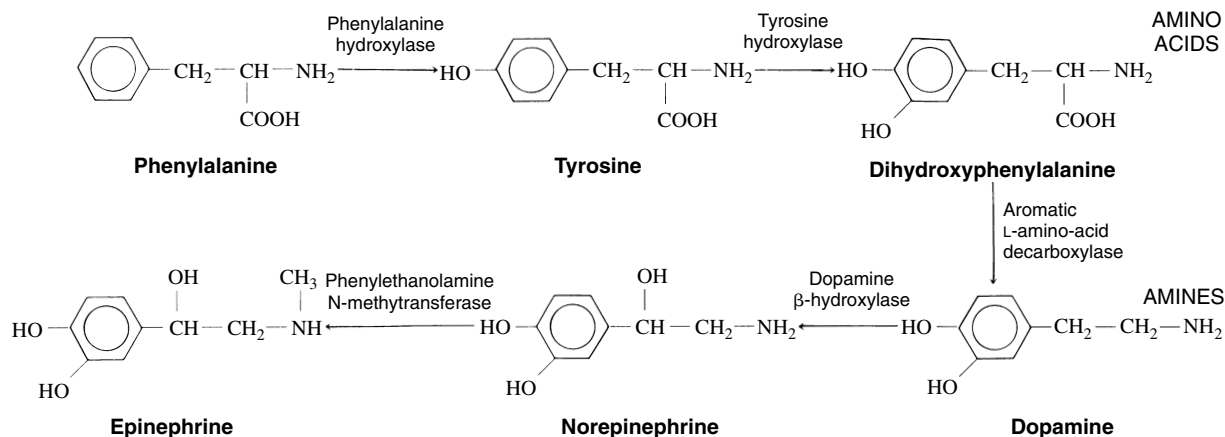

FIGURE 5-6 Biosynthesis of adrenergic transmitters. The amino acids in the top row can penetrate the blood-brain barrier, whereas the amines in the bottom row cannot. Conversion of dopamine into norepinephrine occurs in the storage vesicles of adrenergic nerves and the adrenal medulla, whereas conversion of norepinephrine to epinephrine occurs only in storage vesicles in the adrenal medulla and in some neurons of the central nervous system. The enzyme tyrosine hydroxylase is the rate-limiting regulatory enzyme in the synthesis of catecholamines and is a target for the enzyme inhibitor metyrosine.

responses, and β_2 receptors are associated with relaxation. β_3 Receptors primarily stimulate lipolysis in fat cells.

Catecholamine Fate

The fate of the released catecholamines and systems responsible for termination of their action are quite different from mechanisms of neurotransmitter termination at cholinergic junctions. At adrenergic junctions, enzymatic destruction of the transmitter normally plays a minor role. Uptake of the transmitter accounts for the greatest proportion of transmitter loss, with enzymatic breakdown and diffusion away from the junction responsible for only a small percentage of the total. As depicted in Figure 5-5, uptake can be neuronal (uptake-1) or extraneuronal (uptake-2).²¹ Uptake-1, also called the *norepinephrine transporter*, requires energy and extracellular Na^+ and exhibits stereospecificity. Amphetamines, tyramine, and levonordefrin (α -methylnorepinephrine) are examples of drugs that are taken up by this transporter system. Inhibitors of neuronal uptake include cocaine and imipramine. Uptake-2, synonymous with the *extraneuronal transporter* or *organic cation transporter 3*, has a greater capacity but lower affinity than uptake-1. At high concentrations of norepinephrine, uptake-2 results in the rapid removal of the transmitter. Uptake-2 is sometimes described as the cocaine-insensitive uptake.

Within the nerve terminal, uptake of norepinephrine into the storage vesicles also takes place. It is an active process, requiring ATP and Mg^{++} ; by this mechanism, norepinephrine and structurally related compounds (e.g., some vasoconstrictors added to local anesthetic solutions) ultimately enter the storage vesicles. The drug best known for its ability to inhibit this transfer of norepinephrine and related compounds from the neuronal cytoplasm into storage vesicles is reserpine.

In the cytoplasmic pool, the neurotransmitter is susceptible to the enzymatic action of a mitochondrial enzyme, monoamine oxidase (MAO), which is capable of deaminating the molecule. MAO is widely distributed throughout the body, especially in the liver, kidney, and brain, and is associated with the mitochondria of the adrenergic nerve terminals. It is the principal intraneuronal enzyme concerned with the breakdown of norepinephrine. Certain drugs are capable of inhibiting MAO, leading to an accumulation of the transmitter in the nerve terminal, an effect that has physiologic and therapeutic implications. A second enzyme

concerned with the breakdown of norepinephrine is catechol-O-methyltransferase (COMT). It is widely distributed in many tissues and is the principal extraneuronal enzyme involved with the metabolic inactivation of norepinephrine.

CHOLINERGIC TRANSMISSION

Synthesis, Release, and Fate of Acetylcholine

The general concept of transmitter synthesis, storage, and removal also applies to acetylcholine at cholinergic junctions of the ANS. As shown in Figure 5-4, the conversion of choline to acetylcholine in the nerve terminal is accomplished by the enzyme choline acetyltransferase. The mitochondrial cofactor acetyl coenzyme A serves as the acetyl group donor for the reaction. The newly synthesized acetylcholine is stored in vesicles.²⁰ The vesicles are transported toward the presynaptic membrane and make contact with specialized docking proteins, and the contents of the vesicles are released by exocytosis,²⁰ as described previously. Acetylcholine crosses the junctional cleft and attaches reversibly to the postjunctional receptor, which exists in close proximity to a highly specific enzyme, acetylcholinesterase (AChE). Acetylcholine becomes bound to the enzyme at two primary sites (see Figure 8-6) and is hydrolyzed to choline and acetate at such a rapid rate that the nerve can respond to another stimulus milliseconds later. The choline produced by the action of AChE is returned to the nerve terminal by a carrier mechanism and is used again in the synthesis of acetylcholine.

Even in the total absence of AChE activity, the action of acetylcholine can be terminated quickly by pseudocholinesterase, a nonspecific plasma enzyme also known as butyrylcholinesterase, which is found in many tissues, including blood. Clinically, a subpopulation of patients lacks plasma pseudocholinesterase activity and can have prolonged paralysis with muscle-relaxing agents such as succinylcholine, which is metabolized primarily by this enzyme (see Chapter 10). Acetylcholine is also removed from the junctional cleft by the simple process of diffusion.

Cholinergic Receptors

As with the adrenergic receptors, receptors for acetylcholine can be separated into two major categories: nicotinic and muscarinic. The anatomic distribution and functional signifi-

cance of these receptors have been described (see Table 5-1 and Figures 5-1 and 5-2). Nicotinic receptors outside the CNS are located on postganglionic nerves in autonomic ganglia, on chromaffin cells in the adrenal medulla, and on skeletal muscle in neuromuscular junctions. Nicotinic receptors on postganglionic neurons and in the adrenal medulla are classified as N_N (nerve) receptors; N_M (muscle) receptors are found on skeletal muscle in neuromuscular junctions. In contrast to adrenergic receptors and muscarinic receptors, nicotinic receptors are ion channel receptors composed of an allosteric protein containing four different subunit types— α , β , δ , and γ —gathered together in a transmembrane pentamer.²⁴ Each of the subunits has an intracellular and extracellular exposure, and together they surround a central channel. Recognition sites for acetylcholine and other agonists, cholinergic antagonists, and certain snake venom toxins are located primarily on the α subunits.

Muscarinic receptors of the ANS are located primarily on effector cells—smooth muscle, the heart, and secretory glands—that are innervated by postganglionic parasympathetic nerves. Molecular cloning studies have deduced the amino acid sequence of five subtypes of muscarinic receptors classified as M_1 to M_5 .¹² As with adrenergic receptors, muscarinic receptors all have seven transmembrane-spanning domains and display the same general structure as the β_2 -adrenergic receptor shown in Figure 1-3.

SIGNAL TRANSDUCTION AND SECOND MESSENGERS

The binding of an autonomic neurotransmitter to its receptor on the plasma membrane surface of a target cell initiates a signaling cascade that alters the physiologic activity of the cell. The exact response elicited depends not on the neurotransmitter per se, but on the type of receptor activated. There are two general classes of membrane-bound receptors that interact with autonomic drugs: ion channel-linked and G protein-linked receptors.

Ion Channel-Linked Receptors

Ion channel-linked receptors, otherwise known as ionotropic receptors, are ligand-gated ion channels that undergo binding-dependent conformational changes leading to an opening of the ion channel (see Chapter 1). The nicotinic receptor was first isolated and purified from the electric organ of the eel, *Electrophorus torpedo*, and by 1984 it had become the first receptor for which complete structural data had been obtained.¹³ The nicotinic receptor is a ligand-gated ion channel that, when activated, leads to rapid membrane depolarization as a result of the net inward passage of positively charged ions through the channel. Ligand-gated ion channels may increase permeability of the membrane to all ions or selectively increase permeability only to certain ions. In the case of a ligand-gated Na^+ or Ca^{++} channel, opening produces an excitatory postsynaptic potential, and in the case of a ligand-gated K^+ or Cl^- channel, an inhibitory postsynaptic potential. An excitatory postsynaptic potential activates a neuron, whereas an inhibitory postsynaptic potential inhibits neuronal activity.

G protein-linked receptors

Adrenergic and muscarinic receptors belong to a large family of receptors characterized by their functional dependence on G proteins (shorthand for guanine nucleotide-binding proteins) to initiate cellular signaling. G proteins are heterotrimers, so named because they consist of three different proteins: the α subunit, which activates target proteins (enzymes, ion channels) and hydrolyzes guanosine triphosphate (GTP) to guanosine diphosphate (GDP), and the β and γ subunits, which attach the G protein to the cell membrane and have

signaling properties distinctly different from the α subunit.^{7,38} G proteins are signal transducers in that they convert the external signal of neurotransmitter binding into an alteration of cellular function. Molecular cloning studies suggest that there are many different types of G protein heterotrimers consisting of different varieties of α , β , and γ subunits.

As an immediate result of G protein actions, intracellular signaling molecules are generated that serve as “second messengers” for the neurotransmitters, which are the primary messengers. Figure 5-7 depicts two major second messenger pathways: the cyclic 3',5'-adenosine monophosphate (cAMP) and the Ca^{++} /inositol phospholipid pathway. These two pathways mediate many of the actions of the G protein-coupled adrenergic and muscarinic receptors.^{7,22,41}

G_s protein-dependent events

In the example illustrated in Figure 5-7, activation of the β_1 -adrenergic receptor by norepinephrine leads to the receptor's association with a membrane-bound G protein heterotrimer called G_s (“s” implies a stimulatory effect). This binding activates $G_{\alpha s}$, causing the $G_{\alpha s}$ subunit to exchange its bound GDP for GTP and to dissociate from the adrenergic receptor and from the $\beta\gamma$ subunit pair. The free $G_{\alpha s}$ complexed with GTP is capable of binding to and activating effector enzymes such as adenylyl cyclase, leading to the production of cAMP. cAMP activates protein kinase A, which phosphorylates numerous target proteins. This phosphorylation step alters the ongoing activity of the cell because many of these target proteins are either enzymes or ion channels. Protein kinase A can activate the enzyme glycogen phosphorylase, leading to increased glycogen breakdown and release of glucose. Some other responses linked to increased cAMP synthesis include relaxation of vascular smooth muscle, increased contractile force of the myocardium, and secretion of amylase and other proteins by salivary glands.^{9,32,34} In addition to β receptors, many other receptors activate the cAMP pathway, including dopamine D_1 and D_5 receptors, 5-HT₄ receptors, histamine H_2 receptors, adenosine A_2 receptors, and certain peptide and prostanoid receptors.^{38,39} These receptors are discussed in other chapters.

Hydrolysis of the bound GTP by $G_{\alpha s}$ leads to inactivation of the subunit. $G_{\alpha s}$, complexed with GDP, now reassociates with the β and γ subunits. The heterotrimer can be reactivated by an appropriate stimulus. Cholera toxin blocks the ability of $G_{\alpha s}$ to hydrolyze GTP. $G_{\alpha s}$ is permanently activated, contributing to the signs and symptoms of cholera. When formed, cAMP is subject to breakdown by a second enzyme, cAMP phosphodiesterase. Inhibition of this enzyme blocks the breakdown of cAMP and accentuates the adrenergic response. Caffeine and related methylxanthines are effective inhibitors of phosphodiesterase, at least in vitro.² A particular form of cAMP phosphodiesterase is the site of action for inamrinone and milrinone, agents used to treat congestive heart failure (see Chapter 25).

The G protein system serves to amplify greatly the biologic response to a drug or neurotransmitter. Because of the large degree of signal amplification, stimulation of only a small proportion of the total receptors may be required to elicit a maximal biologic response. It has been estimated that binding of only 1% of the insulin receptors can produce maximal rates of glycogenolysis in liver cells. Amplification of the biologic response by second messenger systems may contribute to the phenomenon of “spare receptors” described in Chapter 1, in which maximal responses are observed after activation of only a fraction of the available receptors.

G_i protein-dependent events

Different biologic responses can occur when receptors activate different G_{α} protein subunits. Stimulation of α_2 -adrenergic receptors (see Figure 5-7) leads to the release of

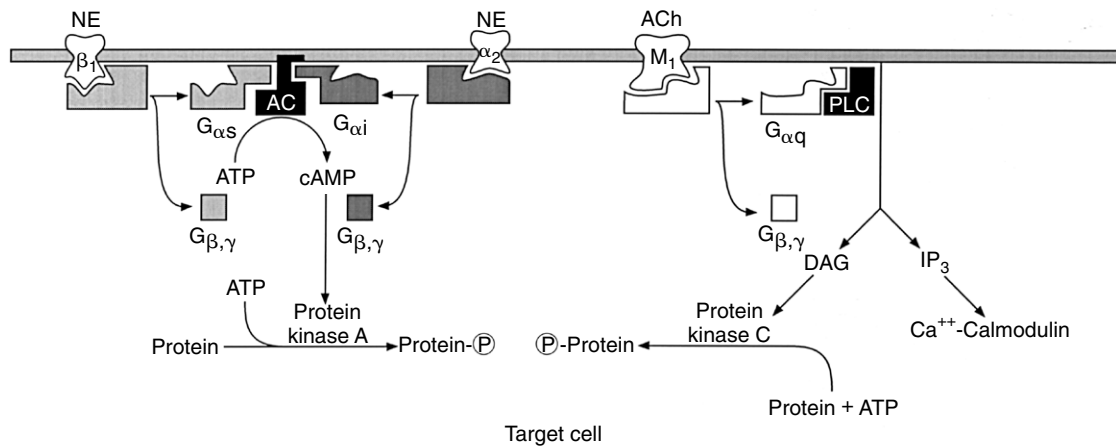

FIGURE 5-7 Sites of action of primary messengers, such as norepinephrine (*NE*) and acetylcholine (*ACh*), and their role in regulating the formation of second messengers in target cells. The binding of the agonist to its receptor (in this example, β_1 -adrenergic or α_2 -adrenergic, or M_1 -muscarinic) leads to release of the α subunit of the associated G protein ($G_{\alpha s}$, $G_{\alpha i}$, or $G_{\alpha q}$). $G_{\alpha s}$ activates adenylyl cyclase (*AC*), leading to the production of cAMP. Elevated cAMP activates protein kinase A, which catalyzes the phosphorylation of numerous target proteins. $G_{\alpha i}$ inhibits AC, leading to a reduction in cAMP. Receptor activation of $G_{\alpha q}$ leads to stimulation of the enzyme phospholipase C (*PLC*). PLC catalyzes the hydrolysis of phosphatidylinositol 4,5-bisphosphate in the cell membrane, yielding diacylglycerol (*DAG*) and inositol 1,4,5-trisphosphate (*IP*₃). DAG activates protein kinase C, which catalyzes the phosphorylation of numerous target proteins. *IP*₃ increases intracellular Ca^{++} release from intracellular storage sites, resulting in activation of calmodulin and other Ca^{++} -dependent events.

$G_{\alpha i}$ ("i" for inhibitory). $G_{\alpha i}$ inhibits adenylyl cyclase and causes decreased cAMP concentrations.²³ Other receptors that act by reducing cAMP include adenosine A_1 receptors; dopamine D_2 receptors; 5-HT₁ receptors; GABA_B receptors; M_2 -muscarinic and M_4 -muscarinic receptors; and several glutamate, opioid, and other peptide receptors.³⁹ In addition, certain toxins, such as pertussis toxin, inactivate $G_{\alpha i}$ so that it cannot inhibit adenylyl cyclase, which promotes an increase in cAMP and contributes to many of the signs and symptoms of whooping cough.

G_q protein–dependent events

$G_{\alpha q}$, a third G_{α} subunit important in ANS responses, activates the Ca^{++} /inositol phospholipid pathway. In the example in Figure 5-7, acetylcholine stimulation of the M_1 -muscarinic receptor leads to release of $G_{\alpha q}$ from its associated β and γ subunits. $G_{\alpha q}$ activates the enzyme phospholipase C, which hydrolyzes phosphatidylinositol 4,5-bisphosphate (*PIP*₂), a minor phospholipid found on the cytoplasmic surface of the cell membrane. The hydrolysis of *PIP*₂ yields two biologically active products, diacylglycerol (*DAG*) and inositol 1,4,5-trisphosphate (*IP*₃). *DAG* stimulates the enzyme protein kinase C, which phosphorylates target proteins generally consisting of other enzymes or ion channels. In addition, *DAG* itself can be hydrolyzed to yield prostanoids, resulting in activation of additional cellular responses. *IP*₃ releases Ca^{++} from intracellular binding sites, leading to increased activation of protein kinase C and to other biologic responses, including activation of calmodulin-mediated events.

α_1 Receptors activate the second messenger system linked to $G_{\alpha q}$ — Ca^{++} , *DAG*, and *IP*₃. Additional receptors that activate this second messenger system include histamine H_1 receptors; M_1 -muscarinic and M_3 -muscarinic receptors; leukotriene receptors; several 5-HT₂ receptors; and certain recep-

tors for glutamate and various peptides, including angiotensin, bradykinin, cholecystokinin, and substance P.^{38,39}

Additional second messenger systems

Other second messenger systems exist besides those mentioned, and the roles of cyclic 3',5'-guanosine monophosphate, Ca^{++} , calmodulin, nitric oxide, prostanoids, peptides, and other mediators of cellular function are currently under extensive investigation.

DOPAMINERGIC TRANSMISSION

Dopamine receptors exist outside the CNS, in the kidney (where their activation leads to vasodilation), the mesenteric vascular bed, the coronary blood vessels, and other vascular and nonvascular smooth muscle. The discovery of dopamine receptors in the periphery has led to the application of dopamine to many clinical situations, such as the treatment of cardiogenic shock and renal failure, where it has the capacity to increase cardiac contractility (by stimulating β_1 -adrenergic receptors) and renal blood flow without causing marked systemic vasodepressor effects.¹⁷ The existence of dopaminergic nerves in the peripheral nervous system is less settled; one location where dopamine may be a neurotransmitter is the gastrointestinal tract. The possible role of dopamine in sympathetic ganglionic transmission is outlined in Chapter 10. Most of the evidence to date indicates that dopamine is synthesized, stored, released, and taken up in a manner identical to that of norepinephrine.¹⁷ Molecular cloning studies indicate that there are five subtypes of dopamine receptors (D_1 to D_5), all of which resemble adrenergic receptors in overall structure and use G protein–mediated second messenger systems.³⁸

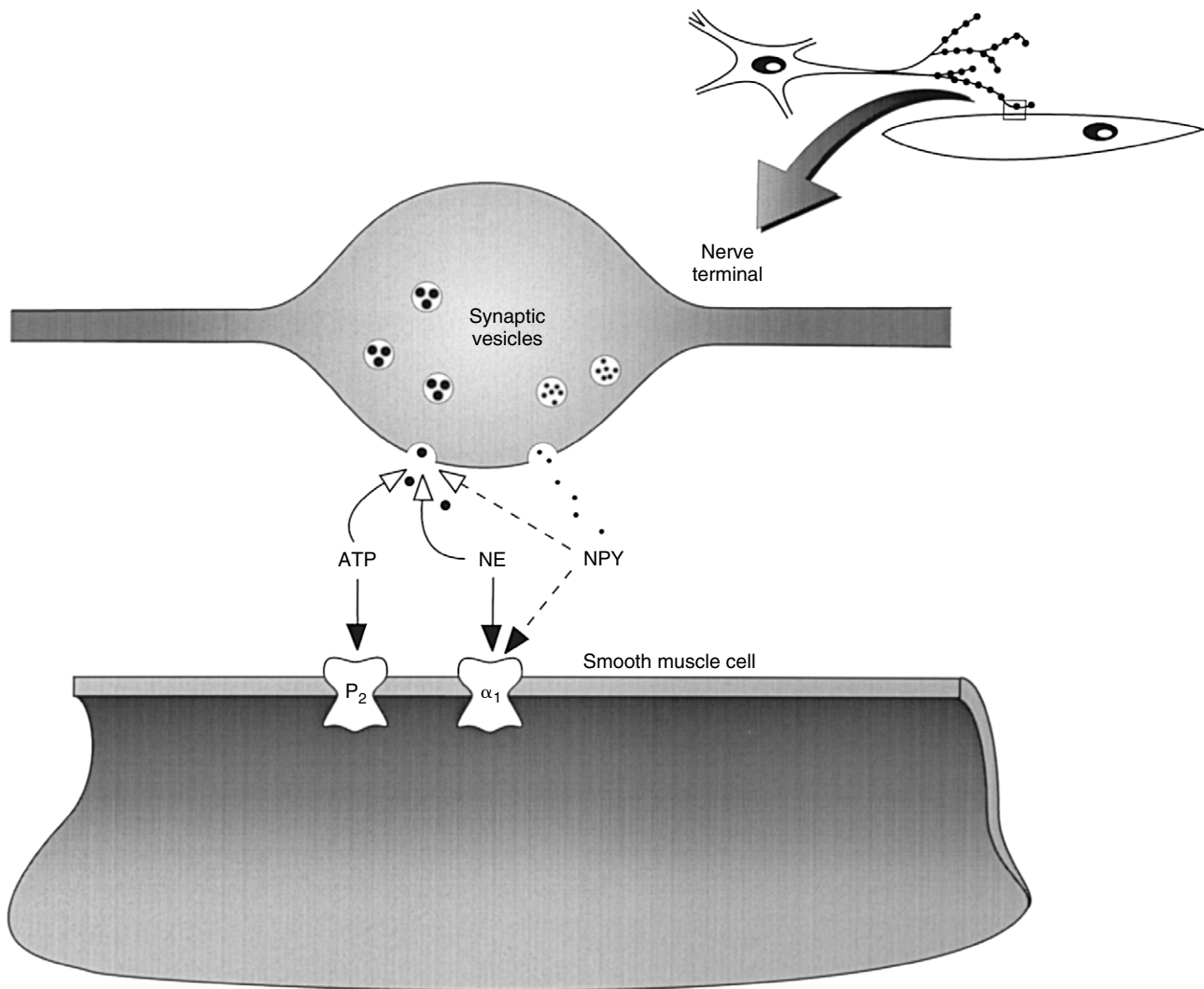

FIGURE 5-8 Co-release of neurotransmitters and neuromodulators. Norepinephrine (*NE*) and ATP, stored in the same storage vesicles, are released together from the sympathetic nerve varicosity to stimulate (*solid arrows*) their respective α_1 and P_2 receptors on smooth muscle. Neuropeptide Y (*NPY*), stored in separate vesicles, is also released during sympathetic nerve stimulation. Here, *NPY* serves as a neuromodulator (*dashed arrows*), increasing the activity of *NE*. All three agents inhibit further release (*open arrowheads*) through effects on prejunctional receptors (not shown).

PURINERGIC TRANSMISSION

Evidence has accumulated that there are noncholinergic, nonadrenergic nerves, designated as purinergic, that are found in the gastrointestinal tract of all vertebrates and in certain areas of the CNS; the vasculature; and the lungs, trachea, and bladder.⁸ ATP is stored in vesicles in purinergic nerve endings and, when released, directly activates purinergic receptors of the P_2 type, or it is broken down to adenosine, which activates P_1 or adenosine receptors. There are four types of adenosine receptors (A_1 , A_{2A} , A_{2B} , A_3), which are linked to either $G_{\alpha s}$ or $G_{\alpha i}$, and two major groups of P_2 receptors ($P2X_{1-7}$ and $P2Y_{1,2,4,6,11-14}$), which are either ligand-gated ion channels ($P2X$) or G protein-linked receptors ($P2Y$).^{8,29} The demonstration that adenosine and its nucleotides inhibit norepinephrine release from adrenergic nerves has led to the hypothesis that purines may act as neuromodulators, regulating the release of norepinephrine through a feedback mechanism.³⁵

ATP can also act as a neurotransmitter or as a cotransmitter with norepinephrine and acetylcholine (Figure 5-8).

PEPTIDE TRANSMISSION AND CO-RELEASE OF NEUROTRANSMITTERS

Certain neurons release more than one neurotransmitter, such as norepinephrine with ATP. Often, co-release is automatic because both substances are found in the same storage vesicle. Simultaneous release of transmitters may also occur when they are stored separately. In recent years, it has become increasingly clear that various peptides in particular are co-released with classic ANS transmitters through both of these mechanisms.

When co-release occurs, it is thought that the two substances may have slightly different functions, with one substance functioning as a neurotransmitter and the other

TABLE 5-2

Mechanism of Action of Representative Drugs Affecting the Autonomic Nervous System

MECHANISM OF ACTION	SITE OF ACTION	
	CHOLINERGIC JUNCTIONS	ADRENERGIC JUNCTIONS
Interfere with synthesis of transmitter	Hemicholinium	Metyrosine
Causes formation of “false” transmitter	—	Methyldopa
Prevent release of transmitter	Botulinum toxin	Guanethidine
Prevent reuptake of transmitter	—	Imipramine, cocaine
Prevent incorporation of transmitter in storage vesicles	Vesamicol	Reserpine
Cause release of transmitter	Carbachol	Tyramine, amphetamine
Activate postjunctional receptor	Muscarinic: choline esters, cholinomimetic alkaloids; nicotinic: nicotine	α_1 Receptor: phenylephrine; α_2 receptor: clonidine; β_1 and β_2 receptors: isoproterenol; β_2 receptor: albuterol
Block access of transmitter to receptor	Muscarinic: atropine; nicotinic: tubocurarine, trimethaphan	α_1 and α_2 Receptors: phentolamine; α_1 receptor: prazosin; α_2 receptor: yohimbine; β_1 and β_2 receptors: propranolol; β_1 receptor: metoprolol
Inhibit enzymatic breakdown of transmitter	Acetylcholinesterase inhibitors (physostigmine, isoflurophate)	MAO inhibitors (tranylcypromine, selegiline); COMT inhibitors (entacapone, tolcapone)

COMT, Catechol-O-methyltransferase; MAO, monoamine oxidase.

functioning as a neuromodulator, or that they act cooperatively as transmitters to elicit some physiologic response. Cholinergic neurons in the cat submandibular gland contain and release vasoactive intestinal peptide, a transmitter that potentiates the salivary secretion induced by acetylcholine, possibly by enhancing the binding of acetylcholine to its receptor.²⁵ Similarly, neuropeptide Y enhances vasoconstriction by a direct action on the vasculature and by potentiating the effects of norepinephrine (see Figure 5-8).¹⁸ The recognition of the existence of multiple peptide neurotransmitters affecting the ANS offers additional new targets for drug development.

CENTRAL CONTROL OF AUTONOMIC FUNCTION

Virtually all levels of the CNS contribute significantly to the regulation of the ANS; this includes the spinal cord and brainstem, where reflexes regulating blood pressure are integrated, and the higher centers in the hypothalamus, limbic system, and cerebral cortex, which integrate highly complex autonomic responses involved in behavior, reproduction, and emotional states. The finding that benzodiazepines reduce sympathetic responses to oral surgery (see Figure 5-3) emphasizes the role of the CNS in initiating and coordinating sympathetic responses to stress. The locations of centers in the CNS that directly regulate functions such as blood pressure, respiration, micturition, and sweating are known. The ANS modulates the activity of these centers by the hypothalamus, which plays a crucial role in the integration of responses to changes in temperature, emotional states, and patterns of sexual and reproductive activity, all of which involve integration of the endocrine, autonomic, and somatic nervous systems. The limbic system has been shown through stimulation experiments to cause changes in blood pressure, sexual activity, rage-like responses, and a host of other reactions characteristic of ANS stimulation. It is believed that the limbic system plays an important role in patterns of sexual activity and states of rage and fear, and that its effects may be superimposed on the effects exerted by the hypothalamus. The cerebellum and the cerebral cortex also make contributions to patterns of autonomic activity, but their importance is less than that of the hypothalamus (see Chapter 11).

SPECIFIC SITES AND MECHANISMS OF ACTION OF AUTONOMIC DRUGS

The foregoing discussion in this chapter has shown that neurotransmission in the ANS—and normal function of the two divisions of the ANS—depends on many integrated steps, including synthesis of transmitter, release of transmitter, combination of the transmitter with the receptor, and destruction by highly specific enzymes or reuptake and reuse of the transmitter in the nerve terminal. The explosion of knowledge about the function of the ANS at the neuronal and molecular levels has been accompanied by the discovery and development of drugs that interfere with one or several steps in the complex processes described in the earlier sections on cholinergic and adrenergic transmission.

Some of these drugs and their specific mechanisms and sites of action are listed in Table 5-2. Their pharmacology is described in the appropriate chapters of this book. With a working knowledge of the ANS and the role it plays in the normal function of various organs, it is possible to predict what effects a drug with a known mechanism of action would have. If a drug (e.g., reserpine) prevents norepinephrine from being transferred from the cytoplasm of the neuron into storage vesicles, it is reasonable to expect that the norepinephrine that has been taken up from the neuroeffector junction will remain in the cytoplasm. Here it will be subject to destruction by MAO, and in time (a relatively short time) the stores of norepinephrine will be reduced, leaving adrenergic nerve terminals throughout the body depleted of norepinephrine. It is now possible to predict that the depletion of norepinephrine throughout the sympathetic nervous system will place the animal under the unopposed control of the parasympathetic nervous system. The pupils are constricted, postural hypotension occurs, and gastrointestinal motility and secretion are increased. Knowledge of autonomic drug mechanism of action is important to understand the actions of and therapeutic uses of the various types of autonomic drugs.

CITED REFERENCES

- Ahlquist RP: A study of adrenergic receptors. *Am J Physiol* 153:586-600, 1948.

2. Andersson R: Cyclic AMP as a mediator of the relaxing action of papaverine, nitroglycerine, diazoxide, and hydralazine in intestinal and vascular smooth muscle. *Acta Pharmacol Toxicol* 32:321-336, 1973.
3. Axelrod J: Purification and properties of phenylethanolamine-N-methyl-transferase. *J Biol Chem* 237:1657-1660, 1962.
4. Berlan M, Montastruc JL, Lafontan M: Pharmacological prospects for α_2 -adrenoceptor antagonist therapy. *Trends Pharmacol Sci* 13:277-282, 1992.
5. Berthelsen S, Pettinger WA: A functional basis for classification of α -adrenergic receptors. *Life Sci* 21:595-606, 1977.
6. Bevan JA: Some functional consequences of variation in adrenergic synaptic cleft width and on nerve density and distribution. *Fed Proc* 36:2439-2443, 1978.
7. Birnbaumer L: G proteins in signal transduction. *Annu Rev Pharmacol Toxicol* 30:675-705, 1990.
8. Burnstock G: Physiology and pathophysiology of purinergic neurotransmission. *Physiol Rev* 87:659-797, 2007.
9. Butcher FR: The role of calcium and cyclic nucleotides in α -amylase release from slices of rat parotid: studies with the divalent cation ionophore A-23187. *Metabolism* 24:409-418, 1975.
10. Bylund DB, Eikenberg DC, Hieble JP, et al: International Union of Pharmacology nomenclature of adrenoceptors. *Pharmacol Rev* 46:121-136, 1994.
11. Cannon WB: *Bodily changes in pain, hunger, fear, and rage*, ed 2, New York, 1929, Appleton-Century.
12. Caulfield MP, Birdsall JM: International union of pharmacology. XVII. Classification of muscarinic acetylcholine receptors. *Pharmacol Rev* 50:279-290, 1998.
13. Changeux J-P, Devillers-Thiery A, Cemoilli P: Acetylcholine receptor: an allosteric protein. *Science* 225:1335-1345, 1984.
14. DeLorenzo RJ, Freedman SD, Yohe WB, et al: Stimulation of Ca^{2+} -dependent neurotransmitter release and presynaptic nerve terminal protein phosphorylation by calmodulin and a calmodulin-like protein isolated from synaptic vesicles. *Proc Natl Acad Sci U S A* 76:1838-1842, 1979.
15. Dionne RA, Goldstein DS, Wirdzek PJ: Effects of diazepam premedication and epinephrine-containing local anesthetic on cardiovascular and plasma catecholamine responses to oral surgery. *Anesth Analg* 63:640-646, 1984.
16. Fitzgerald M: The course and termination of primary afferent fibres. In Wall P, Melzack R, editors: *Textbook of pain*, New York, 1984, Churchill Livingstone.
17. Goldberg LI, Hsieh Y-Y, Resnekov L: Newer catecholamines for treatment of heart failure and shock: an update on dopamine and a first look at dobutamine. *Prog Cardiovasc Dis* 19:327-340, 1977.
18. Han C, Abel PW: Neuropeptide Y potentiates contraction and inhibits relaxation of rabbit coronary arteries. *J Cardiovasc Pharmacol* 9:675-681, 1987.
19. Hargreaves KM, Dionne RA, Mueller GP, et al: Naloxone, fentanyl, and diazepam modify plasma β -endorphin levels during surgery. *Clin Pharmacol Ther* 40:165-171, 1986.
20. Hubbard JI, Kwanbumpen S: Evidence for the vesicle hypothesis. *J Physiol (London)* 194:407-420, 1968.
21. Iversen LL: Catecholamine uptake processes. *Br Med Bull* 29:130-135, 1973.
22. Kobilka B: Adrenergic receptors as models for G protein-coupled receptors. *Annu Rev Neurosci* 15:87-114, 1992.
23. Limbird LE: α_2 -Adrenergic systems: models for exploring hormonal inhibition of adenylate cyclase. *Trends Pharmacol Sci* 4:135-138, 1983.
24. Lukas RJ, Changeux J-P, le Novère N, et al: International Union of Pharmacology. XX. Current status of the nomenclature for nicotinic acetylcholine receptors and their subunits. *Pharmacol Rev* 51:379-401, 1999.
25. Lundberg JM, Hedlund B, Bartfai T: Vasoactive intestinal polypeptide enhances muscarinic ligand binding in cat submandibular salivary gland. *Nature* 295:147-149, 1982.
26. Matteoli M, DeCamilli P: Molecular mechanisms in neurotransmitter release. *Curr Opin Neurobiol* 1:91-97, 1991.
27. Mueller RA, Thoenen H, Axelrod J: Increase in tyrosine hydroxylase activity after reserpine administration. *J Pharmacol Exp Ther* 169:74-79, 1969.
28. Piascik MT, Perez DM: α_1 -Adrenergic receptors: new insights and directions. *J Pharmacol Exp Ther* 298:403-410, 2001.
29. Ralevic V, Burnstock G: Receptors for purines and pyrimidines. *Pharmacol Rev* 50:413-492, 1998.
30. Randich A, Maixner W: [D-Ala²]-methionine enkephalinamide reflexively induces antinociception by activating vagal afferents. *Pharmacol Biochem Behav* 21:441-448, 1984.
31. Robitaille R, Adler EM, Charlton MP: Strategic location of calcium channels at transmitter release sites of frog neuromuscular synapses. *Neuron* 5:773-779, 1990.
32. Schramm M, Selinger Z: The functions of cyclic AMP and calcium as alternative second messengers in parotid gland and pancreas. *J Cyclic Nucleotide Res* 1:181-192, 1975.
33. Starke K: Regulation of noradrenaline release by presynaptic receptor systems. *Rev Physiol Biochem Pharmacol* 77:1-24, 1977.
34. Sutherland EW, Robison GA, Butcher RW: Some aspects of the biological role of adenosine 3',5'-monophosphate (cyclic AMP). *Circulation* 37:279-306, 1968.
35. Todorov LD, Bjur RA, Westfall DP: Inhibitory and facilitatory effects of purines on transmitter release from sympathetic nerves. *J Pharmacol Exp Ther* 268:985-989, 1994.
36. Trimble WS, Linial M, Scheller RH: Cellular and molecular biology of the presynaptic nerve terminal. *Annu Rev Neurosci* 14:93-122, 1991.
37. Venter JC, Fraser CM: The structure of α - and β -adrenergic receptors. *Trends Pharmacol Sci* 4:256-258, 1983.
38. Watson S, Arkininstall S: *The G-protein linked receptor factsbook*, London, 1994, Academic Press.
39. Watson S, Girdlestone D: 1994 receptor and ion channel nomenclature supplement. *Trends Pharmacol Sci* 15(Suppl):1-51, 1994.
40. Weiner N, Clotier G, Bjur R, et al: Modification of norepinephrine synthesis in intact tissue by drugs and during short-term adrenergic nerve stimulation. *Pharmacol Rev* 24:203-221, 1972.
41. Yuen PS, Garbers DL: Guanylyl cyclase-linked receptors. *Annu Rev Neurosci* 15:193-225, 1992.
42. Zhong H, Minneman KP: α_1 -Adrenoceptor subtypes. *Eur J Pharmacol* 375:261-276, 1999.

GENERAL REFERENCES

- Alberts B, Johnson A, Lewis J, et al: *Molecular biology of the cell*, ed 4, New York, 2002, Garland Publishing.
- Cooper JR, Bloom FE, Roth RH: *The biochemical basis of neuropharmacology*, ed 8, New York, 2003, Oxford University Press.
- Kalsner S, editor: *Trends in autonomic pharmacology*, vol 2, Baltimore, 1982, Urban & Schwarzenberg.
- Kandel ER, Schwartz JH, Jessell TM: *Principles of neural science*, ed 4, New York, 2000, McGraw-Hill.
- Nestler EJ, Hyman SE, Malenka RC: *Molecular neuropharmacology: a foundation for clinical neuroscience*, New York, 2001, McGraw-Hill.
- Westfall TC, Westfall DP: Neurotransmission: the autonomic and somatic motor nervous systems. In Brunton LL, Lazo JS, Parker KL, editors: *Goodman and Gilman's the pharmacological basis of therapeutics*, ed 11, New York, 2006, McGraw-Hill.

Adrenergic Agonists

YAPING TU, MICHAEL T. PIASCIK, AND PETER W. ABEL

The endogenous catecholamines norepinephrine, epinephrine, and dopamine compose an important class of neurotransmitters and hormones. By activating adrenergic receptors, these biochemicals mediate numerous functions in the periphery and in the central nervous system (CNS). These and other adrenergic agonists represent an important group of drugs with a broad spectrum of actions. Adrenergic agents are also referred to as *sympathomimetic drugs* because they mimic the effects caused by stimulation of the sympathetic nervous system. There are several therapeutic uses for these compounds: as vasoconstrictors in local anesthetic solutions and for hemostasis; as decongestants in ophthalmic and nasal preparations; as vasopressor agents to maintain blood pressure in some types of shock; and as bronchodilators for asthmatic attacks and for allergic reactions, including anaphylaxis. Centrally acting adrenergic agonists are used to treat essential hypertension, narcolepsy, and attention-deficit/hyperactivity disorder.

HISTORY

The first recorded study of an adrenergic agent resulted in the isolation in 1887 of ephedrine from the herb *ma huang*, which had been grown and used in China for centuries. At the same time, investigators were making extracts of all the organs of the body in an attempt to discover new hormones. Studies by Oliver and Schafer in the early 1890s showed a potent vasopressor substance in extracts of the adrenal gland. The active agent, epinephrine, was soon isolated by Abel, prepared commercially, and marketed in the United States under the trade name of Adrenalin(e). By 1905, it had been synthesized and was being incorporated with local anesthetics. In that year, an account was published of the results of mixing procaine with epinephrine to obtain dental anesthesia.³ 1887 also witnessed the synthesis of amphetamine, which was first marketed in the 1930s and became widely abused by the mid 1950s. The addictive nature of amphetamine was soon realized and led to its designation in 1970 as a drug of high abuse potential. Concerns in more recent years regarding the potential adverse cardiovascular effects of various sympathomimetic drugs have prompted the U.S. Food and Drug Administration to regulate increasingly their use as appetite suppressants, nasal decongestants, and cold remedies. In 2004, *ma huang* was banned for sale as a dietary supplement.

CLASSIFICATION OF ADRENERGIC DRUGS AND RECEPTORS

Since the identification of norepinephrine as the neurotransmitter at adrenergic neuroeffector junctions, and of epineph-

rine and norepinephrine as the two adrenergic agents released by the adrenal medulla, numerous agonists with adrenergic activity have been developed. Direct-acting adrenergic agonists are agonists that directly bind to adrenergic receptors and activate the receptors to produce their effects. Indirect-acting agonists act by increasing the amount of norepinephrine available to stimulate adrenergic receptors. Although indirect-acting agonists may act through many different mechanisms, their most common action is to cause the release of the neurotransmitter norepinephrine from sympathetic nerve terminals. Mixed-acting adrenergic agonists have direct and indirect mechanisms of action. One common feature of all these drugs is that their effects are mediated through activation of adrenergic receptors.

Adrenergic receptors have been classified into three major types: α_1 -adrenergic, α_2 -adrenergic, and β -adrenergic receptors. In recent years, numerous receptor subtypes (α_{1A} , α_{1B} , α_{1D} ; α_{2A} , α_{2B} , α_{2C} ; β_1 , β_2 , β_3) have been discovered by molecular cloning and pharmacologic techniques.^{4,20,36,43} Several dopamine receptors have also been identified (D_1 , D_2 , D_3 , D_4 , D_5).^{15,45} These receptor subtypes are distinguished by differences in their amino acid sequences, as determined from gene-cloning experiments,^{4,45} and by their affinity for subtype-selective drugs. Many adrenergic agonists activate more than one of the major adrenergic receptor types. In contrast, some agonists selectively activate α receptors, others activate β receptors, and some are selective for an individual adrenergic receptor subtype (e.g., β_1 or β_2). Similarly, as discussed in Chapter 7, there are antagonists for the various adrenergic receptors, some of which are receptor type or subtype selective, and some of which are nonselective. The development of receptor-selective agonists and antagonists remains an active area of research.^{33,37,40,43}

Although most adrenergic agonists have prominent peripheral actions that form the basis for their therapeutic applications, some of these drugs have important actions in the CNS. Adrenergic drugs such as amphetamine and ephedrine are capable of causing stimulation of adrenergic receptors in the CNS. Several drugs have been developed, including the antihypertensive agent clonidine, that have their principal action on CNS α_2 receptors, whose stimulation results in a decrease in sympathetic outflow from the brain.

CHEMISTRY AND STRUCTURE-ACTIVITY RELATIONSHIPS

The chemical structures of the three endogenous adrenergic amines—dopamine, norepinephrine, and epinephrine—are illustrated in Figure 6-1. These compounds are synthesized sequentially in adrenergic nerve terminals and adrenal chromaffin cells (see Chapter 5). These three agents, all derived

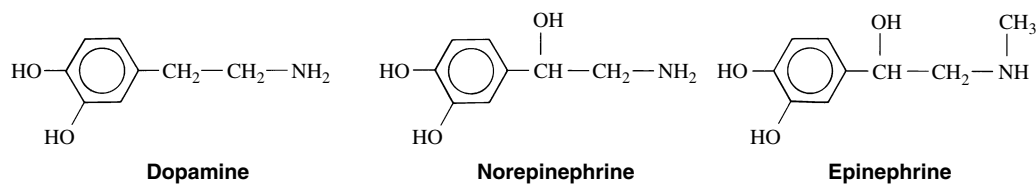

FIGURE 6-1 Chemical structures of three naturally occurring adrenergic agonists.

TABLE 6-1

Structure-Activity Relationships of Selected Adrenergic Agonists

AGONIST	RECEPTOR PREFERENCE	STRUCTURE (PHENYLETHYLAMINE NUCLEUS)
Direct Action		
Dopamine	D*, α_1 , β_1	3—OH, 4—OH
Dobutamine	β_1^\dagger	3—OH, 4—OH
Norepinephrine	α , β_1	3—OH, 4—OH
Levonordefrin	α_2 , β_1	3—OH, 4—OH
Epinephrine	α , β	3—OH, 4—OH
Isoproterenol	β	3—OH, 4—OH
Metaproterenol	β_2	3—OH, 5—OH
Terbutaline	β_2	3—OH, 5—OH
Albuterol	β_2	3—CH ₂ OH, 4—OH
Ritodrine	β_2	— 4—OH
Isoetharine	β_2	3—OH, 4—OH
Mainly Direct Action		
Methoxamine	α_1	2—OCH ₃ , 5—OCH ₃
Phenylephrine	α_1	3—OH —
Mixed Action		
Ephedrine	α , α (CNS), β	— —
Metaraminol	α , β	3—OH —
Mainly Indirect Action		
Tyramine	α , β	4—OH —
Hydroxyamphetamine	α , β	4—OH —
Amphetamine	α , α (CNS), β	— —
Methamphetamine	α , α (CNS), β	— —

*Dopaminergic.

[†]Different stereoisomers have opposing actions on β_1 receptors and β_2 receptors; thus β_1 selectivity is more apparent than real. CNS, Central nervous system.

from tyrosine, are also referred to as *catecholamines* because they are catechol derivatives of phenylethylamine.

Table 6-1 lists some adrenergic agonists currently in use and illustrates certain major alterations in biologic activity that occur with structural modifications. The following conclusions about the relationship between structure and activity can be drawn:

1. Direct-acting agonists (agonists that bind to adrenergic receptors) generally require a hydroxyl group at positions 3 and 4 of the aromatic ring plus a hydroxyl group on the β -carbon atom of the side chain for maximal stimulation

of α and β receptors. The two hydroxyl groups on the ring are believed to form hydrogen bonds with serine residues in the fifth membrane-spanning region of the receptor.⁴⁶

2. Indirect-acting agonists (agonists that cause release of norepinephrine) have no β -hydroxyl group and either no or one hydroxyl group on the ring. Agents devoid of hydroxyl substitutions can penetrate the blood-brain barrier better and exert prominent CNS effects.
3. Mixed-acting agonists (agonists having both actions already described) generally have a β -hydroxyl group and a single ring hydroxyl group.

4. Dopamine, which lacks the β -carbon hydroxyl moiety present in other endogenous catecholamines, stimulates dopamine receptors in addition to α_1 and β_1 receptors. Low concentrations of systemically administered dopamine selectively stimulate D_1 receptors.
5. Slight modifications in chemical structure can confer significant differences in pharmacodynamics. Therapeutic agents can be designed to provide specific responses by selective action on receptor subtypes.³³ Other structural modifications yield differences in pharmacokinetics. Methyl substitution on the α carbon yields orally active compounds able to resist enzymatic destruction by monoamine oxidase (MAO) in the stomach and small intestine.
6. As the alkyl substitution on the nitrogen is increased in molecular weight, a shift in drug affinity toward the β_2 -adrenergic receptor is observed. The affinity of norepinephrine, with no alkyl substitution, is much greater for α -adrenergic receptors than for β_2 -adrenergic receptors; the affinity of epinephrine, with a methyl group, is similar for α -adrenergic and β_2 -adrenergic receptors; and the affinity of isoproterenol, with an isopropyl group, is much greater for β_2 receptors than for α receptors. All three drugs have significant β_1 -adrenergic receptor effects. Changes in the position of ring hydroxyl groups (to the 3 and 5 positions, or a single hydroxyl group in the 4 position) lead to compounds (e.g., terbutaline and ritodrine) with selective affinity for the β_2 -adrenergic receptor.
7. Besides structural modifications, many of the compounds listed exist as optical isomers. Substitutions on either the α -carbon or β -carbon atom of the phenylethylamine nucleus produce stereoisomeric pairs. Levorotatory substitution on the β carbon enhances adrenergic receptor effects. Dextrorotatory substitution on the α carbon increases CNS stimulant activity (e.g., *d*-amphetamine).

The catecholamine nucleus is extremely sensitive to oxidation. This chemical reaction results in the formation of a quinone, adrenochrome, which accounts for inactivation and color changes that may occur in solutions of catecholamines, such as in dental anesthetic cartridges. A sulfite salt (e.g., sodium metabisulfite) is incorporated in such solutions as an antioxidant to prevent catecholamine degradation.

PHARMACOLOGIC EFFECTS

The pharmacology of the adrenergic agonists is complicated by the diversity of the drugs in this group. They differ in mode

of action (direct, indirect, or mixed), receptor selectivity, and relative predominance of peripheral and CNS effects. Predicting the pharmacologic activity of any adrenergic agonist is possible by knowing whether it is direct acting or indirect acting, and what receptors it affects. The density of the receptor population in a particular organ or organ system also influences the effectiveness of adrenergic agonists. A smooth muscle with a high density of α -adrenergic receptors would be strongly contracted by a drug that is efficacious in activating α -adrenergic receptors, but another smooth muscle, expressing few or no α receptors, would be minimally or not at all affected by the same agonist. Table 6-2 summarizes the relative receptor preferences of several adrenergic drugs.

Of the many adrenergic agonists that have been isolated or synthesized and are used clinically, only a few are considered in detail here. The following discussion begins with agents that are endogenous transmitters or hormones, capable of interacting with α and β receptors, and then focuses successively on other direct-acting agonists that are more selective in receptor preference. This discussion concludes with indirect-acting and mixed-acting drugs that cause the release of norepinephrine as their primary mode of action. Where appropriate, additional drugs are mentioned in the sections on therapeutic applications and adverse effects.

Endogenous Catecholamines: Norepinephrine and Epinephrine

Vascular effects

The net effect of systemic administration of norepinephrine or epinephrine on the cardiovascular system depends on various factors, including the route and rate of administration, the dose given, and the presence or absence of interacting drugs. When injected locally, norepinephrine and epinephrine cause contraction of vascular smooth muscle and vasoconstriction in the surrounding tissues by stimulating α -adrenergic receptors. Systemic effects on the vasculature occurring after absorption of these catecholamines into the circulation depend on the plasma concentrations achieved and on the drugs' actions at α -adrenergic and β -adrenergic receptors. With plasma concentrations attained by an intravenous infusion of 0.2 $\mu\text{g}/\text{kg}/\text{min}$ or more, the response to norepinephrine reflects stimulation of α receptors causing increased systolic and diastolic blood pressures, with a reflex bradycardia caused by activation of the baroreceptor reflex. The bradycardia occurs despite the direct stimulation of cardiac β_1 receptors by norepinephrine, which tends to increase heart rate.

Although the same infusion of epinephrine stimulates α -adrenergic and β_2 -adrenergic receptors in the vasculature,

TABLE 6-2

Receptor Selectivity of Adrenergic Receptor Agonists

Epinephrine (1)	Epinephrine	Epinephrine	Epinephrine
Levonordefrin (3)	Levonordefrin	Levonordefrin	
Norepinephrine (10)	Norepinephrine	Norepinephrine	
α_1-AR	α_2-AR	β_1-AR	Isoproterenol (0.05)
Phenylephrine (20)	Oxymetazoline	Dobutamine	Albuterol
Methoxamine	Tetrahydrozoline		Terbutaline
	Brimonidine		Bitolterol
	Clonidine		Salmeterol
	Guanabenz		Ritodrine

Note: Drugs listed in the same column as an adrenergic receptor (AR) activate that receptor. At low doses, the drugs below the receptors selectively activate a single receptor type. As the dose of these selective drugs is increased, they can also activate some of the other receptor types. Numbers in parentheses indicate the potency ratio of α to β_2 receptor-mediated effects, with epinephrine having equal potency at α -adrenergic and β_2 -adrenergic receptors. Potency ratios are approximate only, and vary with the tissue and species studied.

FIGURE 6-2 Schematic representation of the effects of three catecholamines on heart rate and arterial blood pressure in the dog. The drugs were administered intravenously by bolus injection at a dose of 1 $\mu\text{g}/\text{kg}$. Note the biphasic effect of epinephrine. Initially, the drug resembles norepinephrine by causing an increase in blood pressure and reduction in heart rate. As the concentration of epinephrine falls into the physiologic range, however, β -adrenergic receptor activation predominates. Diastolic pressure decreases, and direct cardiac effects are unmasked. The decreased heart rates seen with norepinephrine and at the beginning of the epinephrine response are produced indirectly by the baroreceptor reflex. The drug effects shown here last for approximately 5 minutes.

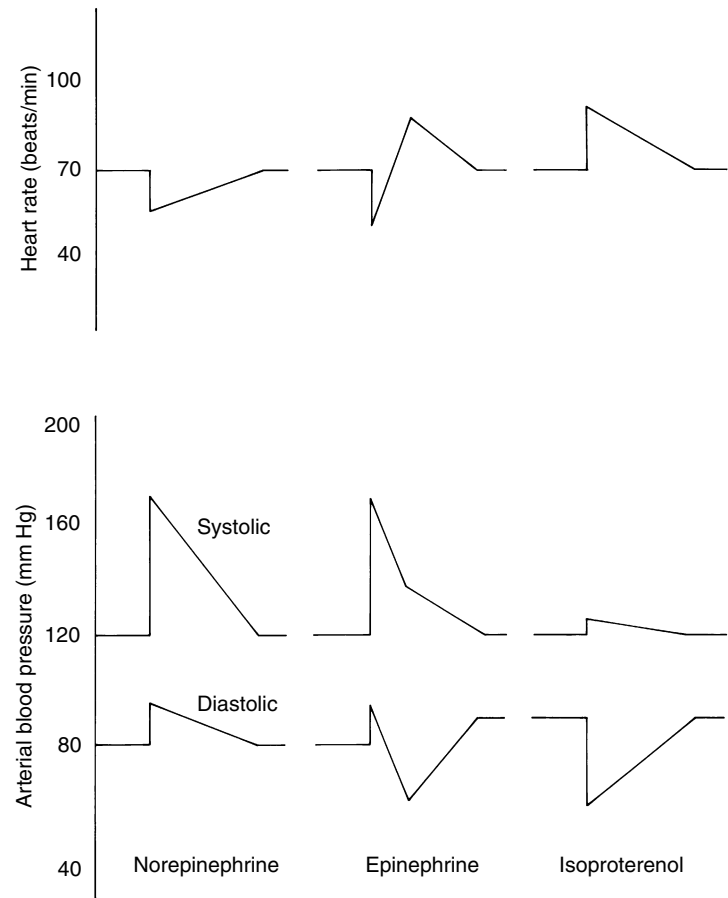

the more robust α receptor-mediated vasoconstrictor response masks the vasodilatory effect of β_2 receptor stimulation, and the net result is usually vasoconstriction, similar to that of norepinephrine. However, at low plasma concentrations, as achieved by an intravenous administration of 0.1 $\mu\text{g}/\text{kg}/\text{min}$ or less, the effect of epinephrine on α -adrenergic receptors is less, allowing the β_2 receptor vasodilator response to become manifest. Under these conditions, mean arterial blood pressure may decrease, and the direct stimulant effect of epinephrine on the myocardium (tachycardia) is observed. This effect is not shared by norepinephrine because it does not stimulate β_2 receptors.

Figure 6-2 shows the typical cardiovascular responses to the intravenous bolus injection of these catecholamines. The qualitatively different effects of high versus low doses of epinephrine on blood pressure and heart rate described earlier are apparent as the initially high concentration of drug declines over the course of several minutes into the low dose range.

Cardiac effects

Norepinephrine and epinephrine stimulate β_1 -adrenergic receptors located in cardiac muscle, pacemaker, and conducting tissues of the heart; β_2 receptors, also located in these tissues but in smaller numbers, contribute to the cardiac effects of epinephrine. Not only is the strength of contraction increased by β receptor stimulation (positive inotropic effect), but also the rate of force development and subsequent relaxation is accentuated, resulting in a shorter systolic interval. The spread of the excitatory action potential through the conductile tissues is also increased (positive dromotropic action). Pacemaker cells increase their firing

rate (positive chronotropic effect), and automaticity is enhanced in normally quiescent muscle (latent pacemaker cells are activated).

All the effects described are effectively antagonized by β receptor blockade. Stimulation of α_1 -adrenergic receptors has been shown to enhance myocardial contraction and to prolong the refractory period, however, and has been implicated in certain ventricular arrhythmias occurring during general anesthesia.⁴¹

Stimulation of β -adrenergic receptors increases the work of the heart, which elevates cardiac oxygen consumption. Overall, cardiac efficiency (cardiac work done relative to oxygen consumption) is diminished. The delivery of oxygen to the heart by the coronary arteries is variably affected by the relative amounts of α and β receptor activation produced by each adrenergic agonist (see Table 6-2) and by metabolic regulators of local blood flow.

Effects on nonvascular smooth muscle

The effect of adrenergic agonists on smooth muscle in the organs of the thoracic and abdominal cavities is usually relaxation. The gastrointestinal tract shows decreased motility from activation of β_2 -adrenergic receptors on smooth muscle, causing relaxation, and α_2 -adrenergic receptors located on excitatory parasympathetic nerves that inhibit acetylcholine release. The sphincters are constricted through α_1 receptor stimulation. A similar situation exists for the urinary bladder. The sphincter and trigone muscles contract as a result of α_1 receptor stimulation, whereas the detrusor muscle is relaxed by β_2 receptor stimulation, causing urinary retention. The response of the uterus varies with the species, the stage of the

estrous cycle, and pregnancy. Generally, α_1 -adrenergic receptor activation leads to contraction, whereas β_2 receptor activation leads to relaxation. In either case, these effects require doses of epinephrine or norepinephrine that result in significant cardiovascular stimulation and are too evanescent to be useful therapeutically.

Bronchodilation is another example of smooth muscle relaxation that is of major therapeutic importance. The β_2 -adrenergic receptors of the bronchioles are stimulated by epinephrine. Although epinephrine is a drug of choice to counteract bronchospasm associated with hypotension, as in anaphylactic shock, β_2 receptor-selective drugs such as albuterol produce bronchodilation with less concomitant β_1 receptor stimulation of the heart and are preferred in asthmatic patients.

Epinephrine and norepinephrine stimulate α_1 receptors to cause the splenic capsule to contract, although in humans this does not seem to play an important role in increasing the hematocrit. The pilomotor muscles of the skin contract to cause piloerection, and the radial muscle of the iris contracts to cause mydriasis in response to norepinephrine and epinephrine activation of α_1 receptors.

Effects on salivary glands

Epinephrine and norepinephrine affect secretion by salivary glands through activation of adrenergic receptors on secretory cells and by stimulation of vascular adrenergic receptors that alter blood flow to the glands. Secretory cells of the major salivary glands contain α_1 -adrenergic, β_1 -adrenergic, and some β_2 -adrenergic receptors. The principal adrenergic receptor linked to protein secretion is the β_1 receptor, although α_1 receptors also play a secretory role, and some evidence supports a role for β_2 receptors, at least in some species. The primary effect of α_1 receptor stimulation on secretory cells resembles qualitatively that of muscarinic receptor stimulation because water and electrolyte secretion is stimulated. Salivary glands also contain myoepithelial cells, in which α_1 receptor stimulation causes contraction around secretory acinar units, contributing to secretion. Stimulation of β receptors causes a more protein-rich (e.g., amylase) secretion. Overall, the predominant characteristic of epinephrine and norepinephrine stimulation of the salivary glands is a modest secretion with a high concentration of protein.

Metabolic responses

Metabolic responses to β_2 -adrenergic and β_1 -adrenergic receptor stimulation lead to a transitory increase in circulating blood glucose as a result of liver glycogenolysis and increased glucagon secretion.¹ An α_2 receptor-mediated inhibition of insulin secretion contributes to the hyperglycemia caused by epinephrine. Stimulation of β_1 and β_3 receptors is involved in the hydrolysis of triglycerides, causing an increase in triglyceride lipase activity and subsequently in the concentration of circulating free fatty acids. The specific receptors that mediate metabolic effects vary among species.

Central nervous system effects

Although the catecholamines are extensively involved in neurotransmission in the CNS, peripherally administered catecholamines gain little access to the CNS because hydroxyl groups on the aromatic ring deter passage across the blood-brain barrier. Intravenous injection of epinephrine produces a variety of apparently central effects, however, including feelings of anxiety, jitteriness, and apprehension. Most, if not all, of these effects are thought to be indirect, resulting from sensory input to the brain from the periphery. Centrally mediated reflex respiratory apnea is induced by drugs that cause an increase in blood pressure.

Dopamine

Although dopamine is primarily a CNS neurotransmitter, it also has effects in the periphery, where dopamine receptors have been identified in various tissues. Molecular cloning studies have revealed at least five subtypes of the dopamine receptor (D_1 to D_5). Although the D_1 receptor subtype is thought to cause peripheral vasodilation, other dopamine receptor subtypes may also contribute to the various peripheral effects of dopamine. Peripheral dopamine-containing neurons have been found in autonomic ganglia in the form of small, intensely fluorescent cells and in kidney glomeruli. Evidence suggests that dopamine neurons help regulate sympathetic nervous system transmission, promote gastrointestinal relaxation, and cause vasodilation in some vascular beds.

Cardiovascular effects

Dopamine interacts with various receptor types to influence vascular function, and is used therapeutically for maintaining renal function in cases of shock associated with compromised cardiac output. Although "low-dose" dopamine has now been used in this manner for more than 30 years, there is currently a growing body of evidence suggesting that this use for dopamine should be abandoned. Early data using indirect clearance measurements of blood flow suggested that dopamine stimulates vascular D_1 receptors to dilate selectively the renal, celiac, hepatic, and mesenteric vasculatures, and that increases in glomerular filtration rate and Na^+ excretion occur in conjunction with increased renal blood flow.¹⁶ With moderate doses, dopamine was thought to act at myocardial β_1 -adrenergic receptors to increase contractile force. Critics of low-dose dopamine have suggested that this increase in cardiac index, rather than dilation of the renal vasculature, is the primary reason for any observed increases in renal blood flow with low-dose dopamine,⁴⁴ and that the potential for harm outweighs the benefits.³⁰ At higher doses, dopamine also stimulates α_1 -adrenergic receptors, which produces vasoconstriction. As with all catecholamines, excessive doses of dopamine can cause tachycardia and generate arrhythmias. In addition to stimulating α_1 and β_1 receptors directly, dopamine in moderate to high doses causes the release of norepinephrine from sympathetic nerve terminals.

Fenoldopam, a pharmacologic congener of dopamine, selectively activates D_1 receptors at therapeutic doses. It decreases mean blood pressure, increases renal blood flow, and causes diuresis and natriuresis. It is used intravenously for acute treatment of severe hypertension (see Chapter 28).

Other effects

Dopamine is involved with the sensory division of the autonomic nervous system. The high concentration of dopamine in the glomus cells of the carotid body and the effects of hypoxia on these cells suggest that dopamine is an inhibitory transmitter that modulates the frequency of discharge of the sensory fibers from that structure.¹⁹ It is theorized that, by this mechanism, dopamine may affect cardiovascular and respiratory responses.

Dopamine itself does not penetrate the blood-brain barrier. Levodopa, which is converted into dopamine, does enter the CNS, however, and is used to treat Parkinson's disease (see Chapter 15). Approximately 95% of an oral dose of levodopa is normally decarboxylated in the periphery to dopamine,³ leading to significant peripheral side effects attributable to dopamine. Dopamine can also produce nausea and vomiting as a result of excitation of the medullary chemoreceptor trigger zone, which lies outside the blood-brain barrier.

Another physiologic role for dopamine is modulation of the release of several anterior pituitary hormones. Dopamine acts as a prolactin release-inhibiting hormone by binding to D_2 receptors on the lactotrope cells of the anterior pituitary.

Although dopamine itself is limited therapeutically by its inability to penetrate the blood-brain barrier, bromocriptine and other dopamine receptor agonists that are sufficiently lipid soluble to enter the CNS have been used successfully in the treatment of female infertility and other health problems resulting from hyperprolactinemia. Bromocriptine has also proved effective in controlling excessive secretion of growth hormone associated with pituitary adenomas. This last therapeutic application is surprising because dopamine is a stimulant of growth hormone release in the normal pituitary.

α -Adrenergic Receptor Agonists

The group of drugs classified as α -adrenergic receptor agonists is growing increasingly diverse. These drugs stimulate α -adrenergic receptors, but have low affinity for β -adrenergic receptors. Phenylephrine and methoxamine differ from epinephrine and norepinephrine by being selective agonists at α_1 -adrenergic receptors. Their primary pharmacologic effect is to cause contraction of vascular smooth muscle, resulting in an increase in systolic and diastolic blood pressures and reflex bradycardia. They are often administered either intranasally or systemically for temporary relief from nasal congestion. Because these drugs increase blood pressure, safety is always a concern. The α -adrenergic receptor agonist phenylpropranolamine was widely used in over-the-counter cold remedies until research studies showed that it increased the risk of hemorrhagic stroke in women,²⁵ which led the U.S. Food and Drug Administration (FDA) to mandate its removal from these medications. Other agonists with actions similar to phenylephrine and methoxamine include metaraminol, although it is a mixed-acting agonist (discussed later) because it releases catecholamines in addition to directly stimulating α_1 -adrenergic receptors. Midodrine is a newer synthetic drug that selectively activates α_1 -adrenergic receptors. It also causes vasoconstriction, and is used to treat postural hypotension caused by impaired autonomic nervous system function.

The α_2 -adrenergic receptor agonists clonidine, guanabenz, guanfacine, and methyldopa (Figure 6-3) effectively enter into the CNS and stimulate α_2 -adrenergic receptors in the brain. They are, in varying degrees, selective agonists at α_2 receptors. Methyldopa, an α -methyl derivative of dopa (dihydroxyphenylalanine, an important intermediate in the synthesis of norepinephrine), enters into the nerve terminal and is converted into the α_2 receptor-selective agonist α -methylnorepinephrine by the same synthetic process that converts dopa into norepinephrine. Although α -methylnorepinephrine is present in neuronal storage vesicles in peripheral sympathetic nerves, this metabolite of methyldopa is nearly equipotent to norepinephrine as a vasoconstrictor in humans. This agent has been

developed as the drug levonordefrin, which is used as a vasoconstrictor in local anesthetic solutions. Clonidine was first used as a nasal decongestant, but it was soon found to decrease blood pressure. An imidazoline derivative, clonidine is a selective α_2 -adrenergic receptor agonist with relatively weak peripheral effects. Guanabenz and guanfacine are guanidine derivatives that, similar to clonidine, also selectively activate α_2 -adrenergic receptors.

These centrally acting agonists are thought to exert their antihypertensive effect by acting on α_2 receptors in the nucleus tractus solitarius of the brainstem, leading to a decrease in sympathetic outflow. This proposed mechanism of action is supported by experiments involving the stereotaxic administration of α_2 receptor agonists into the nucleus tractus solitarius followed by inhibition of drug effects by α receptor antagonists injected into the cerebrospinal fluid. Blocking the conversion of methyldopa to α -methylnorepinephrine prevents the antihypertensive action of this drug.

The administration of these centrally acting drugs in humans results in moderate decreases in mean arterial blood pressure. This effect usually occurs without increases in heart rate because a decrease in CNS sympathetic outflow tends to reduce venous return, heart rate, and cardiac output. Guanfacine decreases peripheral vascular resistance without affecting cardiac output.¹⁸ Intravenous administration of these drugs may increase blood pressure acutely as a result of stimulation of peripheral vasoconstrictor α_2 receptors. This effect is not usually seen with oral administration.

Serendipity has played a role in the use of clonidine to treat the withdrawal symptoms of opioid addiction.²⁹ Clonidine, when given to addicts undergoing withdrawal, blocks the nausea, vomiting, sweating, diarrhea, and other symptoms of excessive autonomic discharge (see Chapter 51). Evidence indicates that either systemic or intracerebral injection of opioids inhibits neuronal activity in the locus ceruleus of the dorsolateral pons. When the opioids are withdrawn, certain neurons are thought to be disinhibited and to release excessive norepinephrine, which gives rise to the symptoms of withdrawal. Clonidine, by stimulating presynaptic α_2 receptors on these same neurons, causes inhibition of neurotransmitter release. The current clinical practice is to follow abrupt withdrawal of the opioid with oral administration of clonidine for 2 weeks or until opioid detoxification is complete. Similarly, patients with alcohol abuse problems, certain neurologic diseases, or some forms of psychotic illness show some improvement in their condition with clonidine. Other studies have found that clonidine has analgesic and sedative effects when given alone or in combination with opioids, and clonidine has been used as an adjunct in general anesthesia and for treating

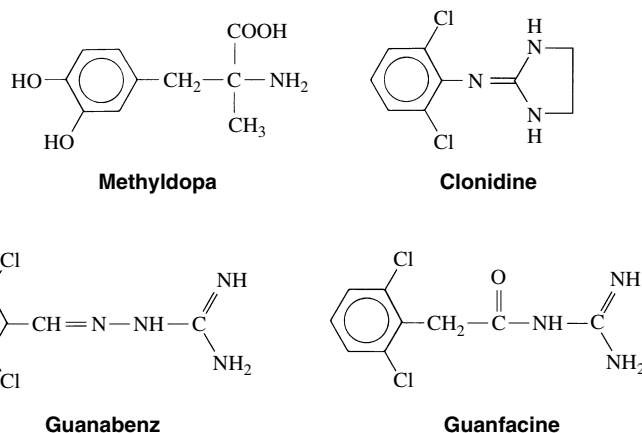

FIGURE 6-3 Structural formulas of some centrally acting α_2 -adrenergic receptor agonists.

some patients with chronic pain. Dexmedetomidine is the first α_2 agonist specifically developed as a sedative for patients receiving intensive care (see Chapter 18).

Oxymetazoline is also an imidazoline derivative selective for α_{2A} receptors, causing contraction of smooth muscle in certain blood vessels. It is used as a nasal decongestant. Other imidazoline agonists available for the same therapeutic indication include tetrahydrozoline, xylometazoline, and naphazoline. Brimonidine and apraclonidine are newer α_2 receptor agonists that are used to decrease intraocular pressure in patients with glaucoma.

β -Adrenergic Receptor Agonists: Isoproterenol

Isoproterenol, a synthetic catecholamine, is a potent nonselective β -receptor agonist. It does not appreciably distinguish among the β_1 , β_2 , and β_3 receptor subtypes, but has very low affinity for α -adrenergic receptors, and has no significant effect resulting from α receptor stimulation.

Cardiac and vascular effects

The actions of isoproterenol on the cardiovascular system are based solely on the stimulation of β -adrenergic receptors (see Figure 6-2). It causes a marked decrease in diastolic blood pressure from β_2 receptor-mediated vasodilation, primarily caused by relaxation of blood vessels in skeletal muscle, with some additional vasodilation in the renal and mesenteric vascular beds. There is also an increase in systolic blood pressure largely resulting from the increase in cardiac output caused by β_1 receptor stimulation of contractility. Because of the effects on systolic (slight increase) and diastolic (decrease) pressures, the mean arterial blood pressure is usually decreased. Heart rate is increased by the stimulation of β_1 receptors in pacemaker cells. The drug's ability to increase excitability and conduction velocity in the heart may induce palpitation and arrhythmias. The powerful inotropic and chronotropic actions may increase myocardial oxygen demand sufficiently to cause ischemia.

Effects on bronchial smooth muscle

As an agonist of β_2 -adrenergic receptors, isoproterenol relaxes bronchial smooth muscle in the lungs to relieve or prevent bronchoconstriction. Disadvantages of the use of isoproterenol for relief of bronchospastic disorders that limit its clinical use are its nonselectivity for β -adrenergic receptor subtypes (which can result in β_1 receptor-induced tachycardia, palpitation, and arrhythmias) and the development of tolerance and refractoriness with frequent use.³⁹ The introduction of selective β_2 receptor agonists has provided an important alternative class of drugs for bronchodilation. Although the β_2 receptor-selective drugs have weaker cardiac effects than isoproterenol, they still have the potential to cause cardiac acceleration and tachyarrhythmias.

Metabolic and other effects

Although the β receptor agonist activity of isoproterenol stimulates glycogenolysis and gluconeogenesis in the liver, it is not as effective as epinephrine in elevating plasma glucose. Isoproterenol stimulates the secretion of saliva that is rich in amylase and other proteins. The drug is also capable of causing CNS excitation at doses higher than are conventionally used clinically.

Dobutamine

A synthetic analogue of dopamine, dobutamine acts as an adrenergic receptor agonist with little or no effect on dopamine receptors.³⁴ The two stereoisomers of the racemic drug preparation have different effects on the various adrenergic receptor types, which together account for β_1 and α_1 receptor stimulation and α_1 receptor inhibition. The primary action of

dobutamine is to increase myocardial contractility and cardiac output without significantly increasing the heart rate. The inotropic effect results primarily from direct β_1 receptor stimulation in the heart, with lesser contributions from β_2 receptor activation. Peripheral vascular resistance is usually changed very little. Because blood pressure effects of this drug are a function of the combination of α_1 and β_2 receptor activation and α_1 receptor blockade, however, some patients may show a greater pressor effect, whereas others may experience a moderate reduction in ventricular filling pressure and peripheral vascular resistance. Dobutamine is used for short-term treatment of acute myocardial insufficiency resulting from congestive heart failure, myocardial infarction, or cardiac surgery.³¹

Selective β_2 -Adrenergic Receptor Agonists

Although isoproterenol and epinephrine are capable of relaxing bronchial smooth muscle, both drugs (especially isoproterenol) can also cause dangerous tachycardia and arrhythmias. These side effects limit the therapeutic use of these drugs and stimulated a search for selective agonists capable of stimulating β_2 -adrenergic receptors in bronchial and uterine smooth muscle, while having less effect on the β_1 receptors of the heart. Even with the selective β_2 receptor agonists, effects on the heart are substantial, however, especially at higher doses. Metaproterenol, terbutaline, albuterol, levalbuterol, pirbuterol, and salmeterol are relatively selective β_2 receptor agonists that are effective in decreasing airway resistance without causing as much cardiac acceleration as isoproterenol. These drugs are usually inhaled; however, oral administration of metaproterenol, albuterol, and terbutaline may be useful under certain limited conditions. Systemic adverse effects are usually greater by the oral route. Ritodrine, another selective β_2 -receptor agonist, was used as a uterine relaxant in the short-term management of preterm labor for several years, but was withdrawn from the market in 2001. The drug was initially given intravenously, followed in some cases by oral dosing. The use of β_2 agonists in the therapy of bronchospastic disorders is discussed in Chapter 32.

Mixed-Acting and Indirect-Acting Adrenergic Agonists

Numerous adrenergic agonist drugs produce some or all of their effects by causing the release of norepinephrine from adrenergic nerve terminals. They do so by being transported into the adrenergic nerve ending or adrenal chromaffin cells, where they are transported into the storage vesicles. These drugs displace catecholamines from their vesicular storage sites into a cytoplasmic pool in the nerve endings or chromaffin cells, from which norepinephrine or epinephrine is released. This cytoplasmic pool is distinct from that of the storage vesicles from which release occurs during nerve stimulation. These drugs have a pharmacologic profile similar to that of norepinephrine. Differences that do exist are associated with the relative ability of the various drugs to stimulate α or β receptors directly and with the ease by which these agents gain access to the CNS. In contrast to norepinephrine, these drugs are generally not subject to rapid inactivation and are usually effective by the oral route.

Ephedrine is an example of an orally active, mixed-acting drug. In addition to releasing norepinephrine, ephedrine is a direct α and β receptor agonist. It can cause bronchodilation, vasoconstriction, increased heart rate, and modest CNS stimulation. Amphetamine, a more lipophilic drug, is primarily a purely indirect-acting drug that easily enters the brain and stimulates the release of catecholamines in the CNS. Amphetamine is a potent CNS stimulant that causes numerous effects, including increased alertness, relief of fatigue, enhanced athletic performance, and euphoria. Although a person taking amphetamine may work more rapidly, there is a dispropor-

tionate increase in mistakes. The need for sleep can be delayed with amphetamine but not diminished. Drugs related to amphetamine include dextroamphetamine and methamphetamine. Compared with amphetamine, both tend to have more effects on the CNS relative to the periphery. The addition of a single hydroxyl group (4-OH) to yield hydroxyamphetamine produces a drug with less CNS activity.

Acute tolerance (tachyphylaxis) is a common outcome of repeated administration of indirect-acting adrenergic drugs. Multiple doses of either mixed-acting or indirect-acting adrenergic agonists may lead to a depletion of the neurotransmitter, resulting in a reduction or loss of activity in response to nerve stimulation. These drugs are also susceptible as a class to several drug interactions. Compounds such as the tricyclic antidepressants and some adrenergic neuron-blocking drugs interfere competitively with the uptake of indirect-acting agonists into adrenergic nerve terminals and block their subsequent release of norepinephrine. MAO inhibitors promote the accumulation of intraneuronal catecholamines, which are released by these agonists. The combination of an MAO inhibitor and an indirect-acting or mixed-acting sympathomimetic drug typically results in excessive release of catecholamines with serious consequences. Some indirect-acting compounds, such as tyramine, occur naturally in several foods and beverages, and pose a great risk to patients taking MAO inhibitors.

ABSORPTION, FATE, AND EXCRETION

As noted in the section on chemistry and structure-activity relationships, the route for administering adrenergic agonists is determined by the chemical structure. All catecholamines and certain other drugs, unless specifically modified at the α carbon of the side chain, are subject to enzymatic destruction in the gastrointestinal tract. Catecholamines are usually administered systemically by parenteral injection or intravenous infusion. Topical instillation and inhalation are the preferred routes of administration for ocular and respiratory applications, respectively.

The inactivation and metabolic disposal of catecholamines can involve many processes, as illustrated by the fate of endogenously released norepinephrine (Figure 6-4). After

neuronal release, a large portion (80% in some cases) of the adrenergic neurotransmitter is returned to the nerve terminal by an active neuronal uptake process. What remains in the junctional cleft is subjected to O-methylation by catechol-O-methyltransferase (COMT) after uptake by postjunctional effector cells. Norepinephrine that diffuses out of the junction may be taken up by other cells and metabolized by COMT. When the transmitter is O-methylated to normetanephrine, it can no longer be transported into the adrenergic nerve terminal but is instead carried by the blood to the liver, where it is largely deaminated by hepatic MAO.¹² Some portion of the released neurotransmitter also diffuses away from the junctional cleft to enter the circulation intact.

Of the norepinephrine that is actively transported back into the neuron, a large part is actively returned to the storage vesicles from which it can be released again on neuronal stimulation. A smaller portion is deaminated by MAO located in the outer membrane of the mitochondria to form 3,4-dihydroxyphenylglycolaldehyde. Most of the aldehyde is converted to a glycol, the remainder to an acid. Both metabolites enter the circulation and are eventually O-methylated by COMT. The major metabolic products of norepinephrine resulting from the combined action of MAO and COMT (and several supportive reductases and dehydrogenases) are 3-methoxy-4-hydroxymandelic acid, also referred to as vanillylmandelic acid, and 3-methoxy-4-hydroxyphenylglycol.¹⁰ About 90% of the total endogenous norepinephrine load excreted in the urine is in the form of vanillylmandelic acid and 3-methoxy-4-hydroxyphenylglycol, with the remainder consisting of other O-methylated compounds and lesser quantities of other derivatives and unmetabolized norepinephrine.²⁸ Several of these products are conjugated to the sulfate or glucuronide before being excreted by the kidney.

Exogenously administered catecholamines and endogenous dopamine and epinephrine are transported and metabolized in much the same manner as norepinephrine. Nevertheless, there are some differences. The metabolic inactivation of epinephrine and most injected catecholamines (including norepinephrine) largely depends on COMT because COMT is widely distributed throughout the body and the administration of exogenous catecholamines allows them to be distributed far beyond the adrenergic neuroeffector junctions. The relative shift toward COMT for the initial

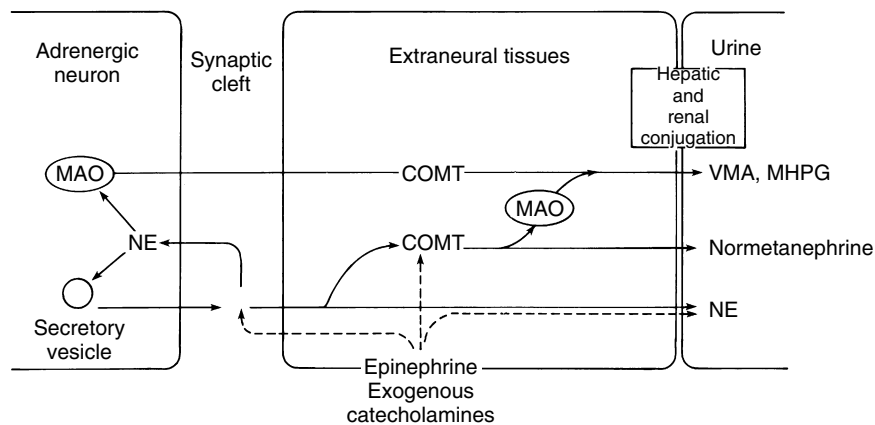

FIGURE 6-4 Biotransformation and excretion of catecholamines. After release, up to 80% of norepinephrine (NE) is taken up by a reuptake process into the nerve terminal, where most is recycled into storage vesicles, and some is metabolized by mitochondrial monoamine oxidase (MAO). Extraneuronal tissues metabolize endogenously released catecholamines through catechol-O-methyl transferase (COMT) and MAO. Excreted substances include the metabolites 3-methoxy-4-hydroxymandelic acid (VMA) and 3-methoxy-4-hydroxyphenylglycol (MHPG), and normetanephrine, small amounts of unmetabolized catecholamines, and related sulfate and glucuronide conjugates. Injected vasoconstrictors and some other adrenergic agonists are also biotransformed and excreted by some of these same pathways.

enzymatic attack ensures the recovery of high concentrations of O-methylated derivatives in the urine. In patients with a pheochromocytoma, the relatively large percentage of catecholamines produced by the adrenal medulla is converted in the adrenal gland to metanephrine and normetanephrine. These two metabolites are released into the plasma, and measuring them in the plasma is a sensitive test for pheochromocytoma.¹⁰ As with norepinephrine and epinephrine, dopamine is a substrate for MAO and COMT. The metabolite formed by the combined action of these enzymes is homovanillic acid. In contrast to the other endogenous catecholamines, dopamine, when given by intravenous infusion, is significantly potentiated by MAO inhibitors.

A small percentage of epinephrine injected as a vasoconstrictor during local anesthesia ultimately resides in the patient's adrenergic nerve terminals and is released during sympathetic nerve stimulation.¹⁴ Similarly, a small amount of administered dopamine may be converted to norepinephrine by β hydroxylation in the adrenergic nerve terminal.

Noncatecholamines are not subject to metabolism by COMT and typically have durations of action significantly longer than the catecholamines. The centrally acting α_2 receptor agonists used to treat hypertension are given orally and are eliminated largely as unchanged drug (e.g., clonidine), are extensively metabolized (e.g., guanabenz), or are partly metabolized and partly excreted as the parent compound (e.g., guanfacine, methyl dopa). Several of the selective β_2 receptor agonists are excreted in the urine as conjugates of sulfate or glucuronic acid.

The indirect-acting adrenergic agonists, which act by displacing the neurotransmitter norepinephrine from the cytoplasmic pool, must first enter the neuron to evoke this release. While in the cytoplasm, these compounds may be subjected to deamination by MAO and other enzymes. A small amount of tyramine in the neuron is oxidized at the β carbon to form octopamine. Octopamine, which has only weak adrenergic activity, can be transported into the storage vesicles, where it may act as a false transmitter.²⁷ Other avenues for the metabolism of these noncatecholamines include *p*-hydroxylation, N-demethylation, deamination, conjugation in the liver and kidney, or a combination of all these. Amphetamine and ephedrine, which are resistant to the actions of MAO (also found in abundance in the gastrointestinal tract), can be administered orally.

GENERAL THERAPEUTIC USES

Clinical applications of the adrenergic agonists can be divided into eight major categories: local vasoconstriction, vasoconstriction in the treatment of hypotension and shock, bronchodilation, relaxation of uterine smooth muscle, ophthalmic uses, relief of allergic states (including anaphylaxis), CNS stimulation, and control of hypertension. The choice of a specific drug for each of these uses depends on the relative contribution of α -adrenergic or β -adrenergic receptors or dopamine receptors to the response in these tissues, and the drug's receptor subtype selectivity. Other factors that determine the choice of a drug include the therapeutic effect versus adverse effects profile and pharmacokinetic factors, such as the rate and routes of absorption, duration of action, and metabolic fate. Most commercially available adrenergic agonists are marketed as water-soluble salts. The following section examines all of these therapeutic uses, indicating in each case one or more preferred drugs.

Local Vasoconstriction

Various drops, sprays, aerosols, and oral dosage forms of several adrenergic agonists have proved useful in providing

temporary symptomatic relief of nasal congestion associated with a variety of causes. These compounds are agonists at α receptors (α_1 or α_2 or both) and have minimal CNS stimulant effects. Common examples include phenylephrine, pseudoephedrine, and oxymetazoline.

An adverse effect associated with the local administration of nasal decongestants is rebound congestion, a chronic swelling of the nasal mucous membranes after the effect of the drugs wears off. This response is more likely with the longer acting α_2 receptor-selective nasal decongestants that have the imidazoline structure. Overdose, with systemic effects, is frequently manifested by signs of excessive adrenergic stimulation. Imidazoline derivatives, such as tetrahydrozoline and oxymetazoline, can paradoxically produce drowsiness, comatose sleep with hypotension, and bradycardia. These effects are thought to be caused by the entry of the drugs into the CNS, where they stimulate central α_2 -adrenergic receptors. Children and infants are especially prone to these adverse effects.

Decongestants have also been used to constrict dilated conjunctival vessels and to relieve itching in hyperemic (bloodshot) eyes. Such agents include naphazoline and tetrahydrozoline. Sometimes these drugs are mixed with other agents used to treat disorders of the conjunctiva or corneal epithelium.

Adrenergic agonists are often used to produce hemostasis for surgery and to enhance local anesthesia. Whether applied topically or administered by injection with or without a local anesthetic, adrenergic agonists can significantly improve visibility in the operative field in certain situations. Because vasoconstriction is temporary, the use of these drugs is no substitute for the adequate surgical control of bleeding. Adrenergic agonists must often be used with special caution during general anesthesia because certain inhalation anesthetics (e.g., halothane) predispose the heart to the arrhythmogenic action of the adrenergic agonists.^{13,23} Finally, the injection of vasoconstrictors into appendages supplied by end arteries is commonly listed as an absolute contraindication. Failure to heed this admonition has been reported to cause tissue necrosis and gangrene of the fingers, toes, ears, and penis. A more recent study found that epinephrine with lidocaine produced no adverse sequelae when administered for local anesthesia of the digits.⁵⁰ Employment of vasoconstrictors for surgical hemostasis and as adjuvants for local anesthetics is discussed later in the section on dental uses.

Treatment of Hypotension and Shock

Shock is a condition caused by inadequate tissue perfusion. It is usually associated with a decrease in arterial blood pressure and, if not treated, may quickly lead to multiorgan system failure. Shock has many causes, including hemorrhage; fluid losses from diarrhea or third-degree burns; internal fluid derangements from sepsis or anaphylaxis; disruption of autonomic tone as a result of drugs or spinal damage; and inadequate cardiac output because of myocardial infarction, arrhythmia, mechanical defects, or outflow obstruction. In most cases of hypotension, baroreceptor reflex-mediated sympathetic stimulation occurs, causing tachycardia, peripheral vasoconstriction, dyspnea, excessive sweating, and mental disturbances.

Treatment of shock includes specific therapies aimed at reversing the underlying problem and nonspecific measures to sustain an effective circulation. If hypotension is the result of blood or fluid loss (hypovolemic shock), the intravascular volume should be restored with blood or other intravenous fluids or both. Additional specific treatments include antibiotics for sepsis, surgery to correct reparable myocardial defects, and antidotes to reverse the effects of drug overdose. Lastly, adrenergic agonists may prove useful in restoring blood pres-

sure and in correcting the distribution of blood flow, especially to the vital organs, whenever shock develops under normovolemic conditions.

The pharmacologic management of shock has three general goals: (1) constriction of capacitance vessels to reduce venous pooling, (2) dilation of resistance vessels to increase perfusion of vital organs, and (3) improvement of myocardial contractility to increase cardiac output. Adrenergic agonists are used to treat various conditions associated with hypotension. α -Adrenergic receptor agonists (e.g., phenylephrine), which increase blood pressure by causing vasoconstriction, are most useful during episodes of inadequate sympathetic nervous system function that may result from spinal anesthesia or hypotensive drug overdose. Such drugs are less beneficial in other shock states associated with hypotension, however, because they may impair blood flow to the kidneys and mesenteric organs.

In cardiogenic shock, which is most often caused by acute myocardial infarction, the β_1 -adrenergic receptor agonists should be useful, but the improvement in tissue perfusion and coronary blood flow is often accompanied by increased myocardial oxygen demand. A drug such as isoproterenol, which typically causes tachycardia, may worsen the myocardial ischemia and predispose an already damaged heart to arrhythmias. Dopamine has often been used for initial therapy of cardiogenic shock because it causes less generalized vasodilation than typical β receptor agonists, increases contractile force in the heart without increasing heart rate, and, through stimulation of dopamine receptors, may improve renal and mesenteric perfusion.^{16,38} Newer studies have cast doubt, however, on the benefits of dopamine.^{30,44} Dobutamine, similar to dopamine, can increase the force of myocardial contraction without producing changes in heart rate and is also used in patients with heart failure.

Bronchodilation

Acute and chronic obstructive pulmonary diseases are marked by increased inspiratory and expiratory resistance, and the adrenergic agonists have historically played an important role in the relief of these conditions. Epinephrine or isoproterenol, given by spray or aerosol, promptly relieves constricted bronchial passageways. The β_1 receptor stimulation by these drugs is associated with cardiac palpitation and arrhythmias, however, which severely limit their usefulness. Epinephrine also causes an undesired drying effect because of decreased secretions.

Currently, the adrenergic agents most useful in the treatment of bronchospastic disease are agonists with selectivity for β_2 -adrenergic receptors because they produce marked bronchodilation with less effect on the heart than nonselective β receptor agonists. The selective β_2 receptor agonists used for bronchodilation include metaproterenol, terbutaline, albuterol, levalbuterol, pirbuterol, salmeterol, and formoterol. Salmeterol and formoterol have durations of action of about 24 hours.⁴² This extended duration can be of significant benefit in treating patients with asthma.³⁹ The shorter acting drugs are used to reverse acute bronchoconstriction, whereas salmeterol and formoterol are used prophylactically to prevent bronchoconstriction. See Chapter 32 for a more complete discussion of the use of these agents in bronchial asthma.

Uterine Relaxation

Selective β_2 -adrenergic receptor agonists have been administered to arrest premature labor by relaxing uterine smooth muscle. Drugs that control premature labor are often termed *tocolytics*. β_2 agonists are effective at relaxing the uterus for only a few days. Simultaneous stimulation of β receptors in the heart can cause palpitation and arrhythmias, which limits the usefulness of these drugs. The β_2 agonist ritodrine was

used almost exclusively to cause uterine relaxation, but was withdrawn from the market in 2001 because of safety concerns. Terbutaline is currently the only β_2 -adrenergic receptor agonist available in a form that could be injected as tocolytic therapy, but it is not FDA-approved for this purpose, and this use is discouraged by its manufacturer.

Ophthalmic Uses

The two major ocular indications for adrenergic agonists are for the production of mild mydriasis and the reduction of intraocular pressure. The former is mediated by stimulation of α_1 -adrenergic receptors in the radial muscle of the eye. Although muscarinic receptor antagonists such as atropine produce a much stronger pupillary dilation, adrenergic agonists are useful because they cause mydriasis without paralyzing the ciliary muscle (cycloplegia). Even greater mydriasis can be obtained if a combination of a muscarinic receptor-blocking drug and an adrenergic agonist drug is used. Phenylephrine and hydroxyamphetamine are the principal adrenergic agonists used to produce mydriasis.

The mechanisms for the reduction in intraocular pressure by adrenergic agonist drugs are not well elucidated, but several of these drugs seem to reduce the production and enhance the outflow of aqueous humor and are useful in treating wide-angle glaucoma. These drugs include the nonselective adrenergic agents epinephrine and dipivefrin (a prodrug of epinephrine), and the α_2 -adrenergic receptor-selective agonists apraclonidine and brimonidine. The treatment of glaucoma is discussed in Chapter 8.

Treatment of Allergic States

Adrenergic agonists, especially epinephrine, are especially useful in reversing the effects of histamine and other mediators associated with allergic reactions. In contrast to the antihistamines, adrenergic agonists are physiologic antagonists, producing responses opposite to the acute effects produced by histamine and associated autacoids. For acute allergic reactions such as urticaria, subcutaneous injection of 0.1 mL to 0.5 mL of 1:1000 epinephrine should be adequate. Fulminating disturbances such as anaphylactic shock require a faster absorption of epinephrine than provided by subcutaneous injection, especially if circulation is impaired. Intramuscular (intralingual) injection of 0.3 mL to 0.5 mL of 1:1000 epinephrine or, if the patient has previously been prepared for intravenous injections, slow intravenous administration of 1:10,000 epinephrine (0.1 mg in 5 minutes) is recommended. With this latter route of administration, there is a considerable risk of precipitating serious cardiac arrhythmias and ventricular fibrillation. Because of the rapid metabolism of epinephrine, reinjection at intervals of 5 to 15 minutes may be required. Subcutaneous administration generally provides the longest duration of action, and intravenous injection provides the shortest.

Central Nervous System Stimulation

For many years, selected adrenergic agonists have been used clinically because of their ability to produce stimulation of certain functions of the CNS that result in increased alertness and attention span and decreased sense of fatigue. Another potentially therapeutic effect of these agents is stimulation of the lateral hypothalamus and satiation of the food drive. The principal sympathomimetic drugs that cross the blood-brain barrier are ephedrine, amphetamines, and methylphenidate. Because of the history of abuse of amphetamine-like drugs, their procurement and use are strictly controlled by various state and federal statutes.

A major accepted use of amphetamine and related drugs is for the management of children with attention-deficit/hyperactivity disorder. The use of CNS stimulants, along with

psychotherapy and family counseling, has provided remarkable relief from the restlessness, brief attention span, and impulsiveness that mark this disorder. Methylphenidate has been used most often for the pharmacologic treatment of attention-deficit/hyperactivity disorder. It has a relatively brief duration of action (3 to 5 hours), requiring a second dose that often must be administered by teachers or daycare providers. Alternative agents that have gained wider use in recent years include extended duration formulations of methylphenidate or the combination of amphetamine and dextroamphetamine.¹⁷ Another clinical use of adrenergic CNS stimulants is for the treatment of narcolepsy, a disorder characterized by uncontrollable attacks of sleep in the daytime. Modafinil, a nonadrenergic CNS stimulant, is an alternative therapy with a different adverse effects profile (e.g., higher incidence of headache, less cardiovascular stimulation).

A clinical application that has drawn considerable attention is the pharmacologic suppression of hunger in short-term adjuvant therapy in weight loss programs. Among the drugs that produce anorexia are the amphetamines, diethylpropion, phentermine, and ephedrine. Some states restrict the use of amphetamines for weight loss because these drugs have a relatively high potential for abuse. Ephedrine is not approved for weight loss but was a common component of oral herbal products (ephedra, *ma huang*) and dietary supplements promoted to increase energy and decrease weight. In its first formal action against an herbal remedy, the FDA banned the use of ephedra alkaloids, including ephedrine, in these products.

A limitation to the therapeutic use of these classic sympathomimetic anorexic drugs is that they produce undesired effects, including CNS stimulation, insomnia, anxiety, nervousness, gastrointestinal disturbances, cardiovascular stimulation, and development of psychological dependence. These drugs are also generally without long-term benefit if not accompanied by stringent caloric restrictions. They are often taken to make a rigid diet seem more acceptable. They are contraindicated in patients taking MAO inhibitors and patients with hypertension, cardiac arrhythmias, thyrotoxicosis, or other severe cardiovascular disease.

Treatment of Hypertension

As mentioned earlier and discussed in Chapter 28, four centrally acting α_2 -adrenergic receptor selective agonists are used for the treatment of hypertension: clonidine, guanabenz, guanfacine, and methyl dopa. They act on central α_2 receptors that are involved in the autonomic regulation of the cardiovascular system. Activation of inhibitory neurons in the brain causes peripheral vasodilation by inhibiting sympathetic outflow from the CNS and decreasing cardiac output through enhanced vagal tone and decreased sympathetic tone. Gener-

ally, these drugs do not reduce sympathetic tone as much as do peripherally acting inhibitors of the sympathetic nervous system or its receptors (see Chapter 7).

THERAPEUTIC USES IN DENTISTRY

Vasoconstrictors are widely used in conjunction with local anesthetic solutions. The vasoconstrictor most commonly used in dentistry is epinephrine, with levonordefrin (the *l* isomer of nordefrin) being used less frequently, usually with mepivacaine.

Table 6-3 lists the concentrations and amounts of adrenergic vasoconstrictors contained in commercially available dental local anesthetic cartridges. The concentration listed for levonordefrin is considered approximately equivalent in clinical effectiveness to 1:100,000 epinephrine, as judged by prolongation of dental anesthesia. The maximum recommended strength of the vasoconstrictor is 1:100,000 epinephrine equivalency for routine nerve block anesthesia. When local tissue hemostasis is required for surgical procedures, such as periodontal surgery, the dentist may additionally choose to infiltrate the area with local anesthetic solution containing 1:50,000 epinephrine, but repeated injections of 2% lidocaine with 1:50,000 epinephrine may cause tissue necrosis and microscarring.²

Vasoconstrictors serve several useful purposes when used with local anesthetic solutions. First, they prolong the duration of local anesthesia severalfold and may improve the frequency of successful nerve block.²⁴ Table 6-4 illustrates the effect of vasoconstrictors on duration of local anesthesia. Second systemic toxicity of the local anesthetic may be minimized by reducing the peak blood concentration of the anesthetic agent.⁷ Third, when anesthetic solutions are

TABLE 6-3

Concentrations and Amounts of Adrenergic Vasoconstrictors in Dental Local Anesthetic Cartridges

VASOCONSTRICTOR	DILUTION	AMOUNT PER DENTAL CARTRIDGE (µg/1.8 mL)
Epinephrine hydrochloride	1:200,000	9
Epinephrine hydrochloride	1:100,000	18
Epinephrine hydrochloride	1:50,000	36
Levonordefrin hydrochloride	1:20,000	90

TABLE 6-4

Effect of Epinephrine on the Duration of Local Anesthesia

LOCAL ANESTHETIC	VASOCONSTRICTOR	DURATION	
		MEAN (min)	MAXIMUM (min)
Lidocaine 2%	None	44	100
Lidocaine 2%	Epinephrine 1:1,000,000	57	130
Lidocaine 2%	Epinephrine 1:750,000	67	145
Lidocaine 2%	Epinephrine 1:250,000	90	175
Lidocaine 2%	Epinephrine 1:50,000	88	210

Adapted from Keesling GG, Hinds EC: Optimal concentrations of epinephrine in lidocaine solutions, *J Am Dent Assoc* 66:337-340, 1963. Note: Data were obtained by oral surgeons from patients undergoing exodontia. The mean and maximum duration of anesthesia was judged by luxation of the tooth and by the use of probes for soft tissue effects. All injections were inferior alveolar nerve blocks; 24 patients were included in each group.

given by infiltration, vasoconstrictors tend to reduce blood loss associated with surgical procedures (see Chapter 16).

Local anesthesia with vasoconstrictors has been implicated with ischemic conditions of the pulp and alveolar bone, the latter being associated with an increased incidence of osteitis after extractions.⁵ Local tissue damage at the site of injection is related to or accentuated by the presence of vasoconstrictor adrenergic agonists.

An important issue related to potential toxicity is the systemic effects of vasoconstrictors after intraoral injection. A related question often faced by the dentist is whether to administer a vasoconstrictor-containing local anesthetic solution to a patient with cardiovascular disease. A traditional opinion held that vasoconstrictors contained in dental anesthetic cartridges produced little, if any, clinically significant systemic effects. Some older reports recommend that cardiac patients be given local anesthetics with vasoconstrictors if needed for adequate anesthesia because the benefits of satisfactory pain control were greater than the risks of small amounts of vasoconstrictor.³⁵ The validity of this statement depends on the level of stress on the patient and the amount, rate, and manner in which the epinephrine-containing solution is injected.

In the last three decades, numerous well-controlled studies have shown that even the small amounts of vasoconstrictor used in dentistry significantly increase resting plasma catecholamine concentrations and alter some measures of cardiac function (e.g., increase stroke volume).^{21,26,32,47} As illustrated in Figure 6-5, intraoral injection of lidocaine with 1:100,000 epinephrine for removal of impacted third molars resulted in significantly increased circulating epinephrine compared with injection of a local anesthetic without vasoconstrictor.⁴⁸ Although large therapeutic dosages were used

in this study, injection of even a single cartridge of local anesthetic with 1:100,000 epinephrine can result in a temporary doubling of the plasma epinephrine concentration.⁵¹ It is often assumed that the amount of epinephrine released from the adrenal medulla during acute stress greatly exceeds that contained in local anesthetic cartridges. With clinically achievable doses, as shown in Figure 6-5, the stress-induced increase in epinephrine concentration in the “no epinephrine” group was only a small fraction (approximately 14%) of that obtained after intraoral injection of eight cartridges of lidocaine with 1:100,000 epinephrine.

With these developments in mind, a joint report of the American Heart Association and American Dental Association concluded that “vasoconstrictor agents should be used in local anesthesia solutions during dental practice only when it is clear that the procedure will be shortened or the analgesia rendered more profound,” that “extreme care should be taken to avoid intravascular injection,” and that “the minimum possible amount of vasoconstrictor should be used.”²² More recent reports support this recommendation (see General References). An alternative is available; effective local anesthetic preparations without vasoconstrictor agents (e.g., 3% mepivacaine) have been shown to provide clinically effective local anesthesia, especially for nerve block procedures (see Chapter 16).

It is often necessary to produce gingival retraction for operative procedures on teeth and for making impressions. Besides astringents such as zinc and aluminum salts, cotton cord impregnated with racemic (*d* and *l* isomers) epinephrine, containing as much as 1.2 mg of drug per inch of cord, is commercially available. Racemic epinephrine has approximately half the potency of *l*-epinephrine because *d*-epinephrine has approximately $\frac{1}{15}$ the activity of *l*-epinephrine.

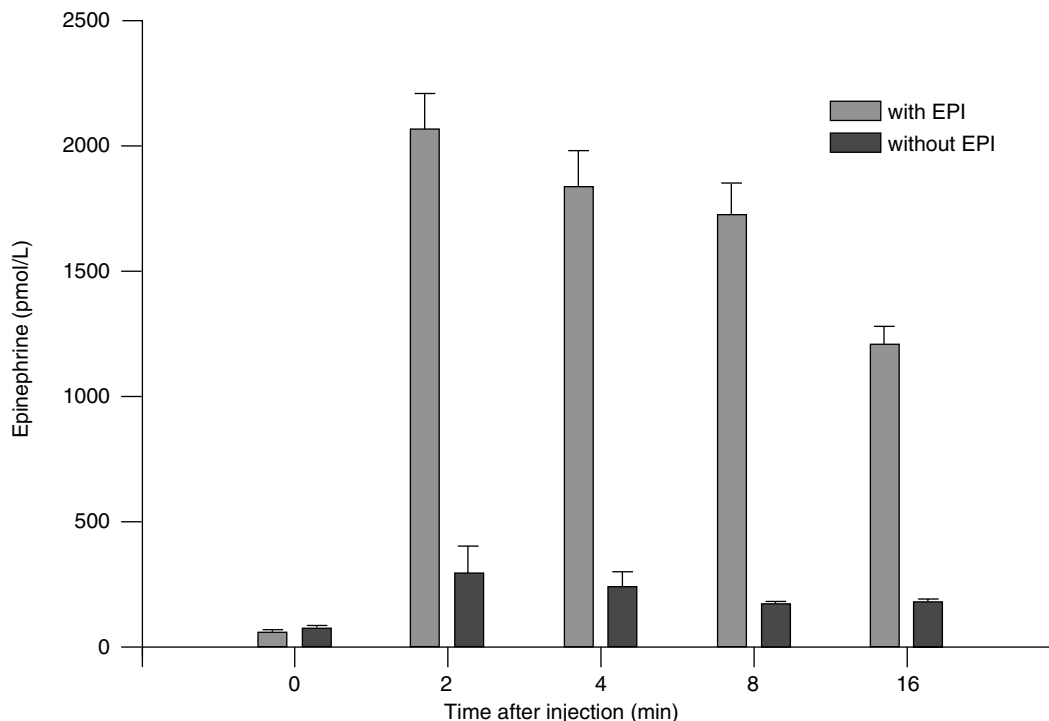

FIGURE 6-5 Effect of intraoral local anesthetic injections on plasma epinephrine. Unsedated oral surgery patients ($n = 26$) were injected with either 14.4 mL of 2% lidocaine with 1:100,000 epinephrine (*with EPI*, 144 μ g epinephrine total dose) or 3% mepivacaine without vasoconstrictor (*without EPI*) under randomized, double-blind conditions. Brackets indicate the standard error. (Adapted from Troullos ES, Hargreaves KM, Goldstein DS, et al: Epinephrine suppresses stress-induced increases in plasma immunoreactive β -endorphin in humans, *J Clin Endocrinol Metab* 69:546-551, 1989.)

Whether these large amounts of epinephrine present a hazard to a normal patient and to patients with cardiovascular disease depends on several factors. Experimental and clinical studies indicate a relatively high absorption of the vasoconstrictor if the epithelium is abraded or the vasculature is exposed, which is common in extensive restorative procedures. Systemic absorption is marked by signs of anxiety, elevated blood pressure, increased heart rate, and occasional arrhythmias. These effects can be extremely serious in a patient with cardiovascular disease or in a patient who is taking medication that reduces the uptake or otherwise enhances the activity of adrenergic agents. Because of this concern, epinephrine-impregnated retraction cord is used much less often than other types of retraction cord.

Various products are available to control capillary bleeding occurring with surgical procedures on gingival tissues. Topical epinephrine hydrochloride (1:1000) and phenylephrine (1:100) are most common. More concentrated solutions have occasionally been recommended, but their use can heighten the risk of cardiovascular problems without producing any significant increased effectiveness in reducing hemorrhage.

ADVERSE EFFECTS

Almost all adverse effects of the adrenergic agonists are dose related. Toxic reactions can result from the administration of too large a dose, accidental intravascular injection, impaired uptake of the drug, a heightened sensitivity or number of adrenergic receptors, or therapeutic doses given to a patient with preexisting cardiovascular disease. Relatively small amounts of epinephrine can cause potentially grave effects in a highly susceptible patient. Generally, serious complications may be expected with doses of epinephrine greater than 0.5 mg, and fatalities are likely to occur with doses of 4 mg or more, although one patient is reported to have survived an injection of 30 mg.⁴⁹ Correct dosage calculations, careful reading of labels, and a complete medical history can help reduce accidents. Reviews of the literature indicate that reported adverse reactions attributable to vasoconstrictors used with local anesthetics in dentistry are rare.^{6,49}

Most serious of the toxic effects of epinephrine are cardiac disturbances, with increased stimulation of the heart leading to myocardial ischemia, possibly heart attack, and arrhythmias, including ventricular fibrillation. Patients with a history of uncontrolled hyperthyroidism, hypertension, or angina pectoris are particularly susceptible. If epinephrine is administered to a patient who is taking a nonselective β -adrenergic receptor blocking drug such as propranolol (see Chapter 7), unopposed α -receptor stimulation may cause excessive vasoconstriction. The increase in blood pressure from rapid parenteral administration can be severe enough to result in hypertensive crisis, which can cause cardiac disturbances or a cerebrovascular accident.¹¹ Drugs with primarily α -adrenergic receptor stimulation can cause excessive vasoconstriction in overdose. Local tissue necrosis may result from any vasoconstrictor injected into a region where ischemia is likely, such as the digits of the hands or feet.

CNS reactions to classic sympathomimetic drugs include nervousness, excitability, insomnia, dizziness, and tremors. Long-term use of amphetamines can lead to psychotic symptoms. The most common side effects of centrally acting α_2 -agonist antihypertensive agents are dizziness, drowsiness, and xerostomia. The xerostomia seems to be most severe with clonidine and guanabenz. Constipation, sexual dysfunction, CNS disturbances, bradycardia, and excessive hypotension have also been reported. A particularly troubling adverse effect is rebound hypertension of serious proportions if these drugs are withdrawn abruptly.

Unique to methyl dopa is the occurrence of drug-induced hepatitis, with a fever that may reach alarming levels (105° F). Withdrawal of the drug usually allows liver function to return to normal. This reaction has been shown to be related to the transformation of methyl dopa to reactive compounds that combine covalently with cellular macromolecules.⁹ Other adverse effects of methyl dopa include parkinsonian signs, hyperprolactinemia, and hemolytic anemia.

ADRENERGIC AGONISTS

<i>Nonproprietary (generic) name</i>	<i>Proprietary (trade) name</i>
Ophthalmic products	
<i>Mydriatics</i>	
Hydroxyamphetamine	Paredrine
Phenylephrine	Neo-Synephrine
<i>Decongestants</i>	
Naphazoline	Allerest, Naphcon
Oxymetazoline	Visine L.R.
Phenylephrine	Neo-Synephrine
Tetrahydrozoline	Visine
Antiglaucoma agents (see Chapter 8)	
Respiratory tract products	
<i>Nasal decongestants</i>	
Ephedrine	Pretz-D
Epinephrine	Adrenalin
Naphazoline	Privine
Oxymetazoline	Afrin, Nostrilla
Phenylephrine	Neo-Synephrine, Sudafed PE
Propylhexedrine	Benzedrex
Pseudoephedrine	Sudafed
Tetrahydrozoline	Tyzine
Xylometazoline	Otrivin
<i>Cold remedies</i>	
These preparations consist of antihistamines, analgesics, cough suppressants, other drugs, and one of the following adrenergic agonists:	
Phenylephrine	In Dimetapp Cold & Cough, in Dristan Multi-Symptom Nasal Decongestant
Pseudoephedrine	In Claritin-D, in Sudafed Multi-Symptom Cold & Cough
<i>Bronchodilators</i>	
Albuterol	Proventil, Ventolin, in Combivent
Bitolterol	Tornalate
Ephedrine	Primatene Tablets
Epinephrine	Adrenalin, Primatene Mist
Ethylnorepinephrine	Bronkephrine
Formoterol	Foradil
Isoetharine	Bronkosol
Isooproterenol	Isuprel, Medihaler-Iso

Continued

ADRENERGIC AGONISTS—cont'd

Nonproprietary (generic) name	Proprietary (trade) name
Levalbuterol	Xopenex
Metaproterenol	Alupent
Pirbuterol	Maxair
Salmeterol	Serevent
Terbutaline	Brethine, Bricanyl
Cardiovascular system products	
<i>Vasoconstrictors and cardiac stimulants</i>	
Dobutamine	Dobutrex
Dopamine	Intropin
Ephedrine	—
Epinephrine	Adrenalin
Isoproterenol	Isuprel
Levonordefrin	Neo-Cobefrin
Mephentermine*	Wyamine
Metaraminol*	Aramine
Methoxamine*	Vasoxyl
Midodrine	Orvaten, ProAmatine
Norepinephrine	Levophed
Phenylephrine	Neo-Synephrine
<i>Antihypertensive agents</i>	
Clonidine	Catapres
Fenoldopam	Corlopam
Guanabenz	Wytensin
Guanfacine	Tenex
Methyl dopa	Aldomet
Methyldopate	—
CNS stimulants and anorexiant	
Amphetamine	in Adderall
Benzphetamine	Didrex
Dexmethylphenidate	Focalin
Dextroamphetamine	Dexedrine, in Adderall
Diethylpropion	Tenuate
Methamphetamine	Desoxyn
Methylphenidate	Methylin, Ritalin
Modafinil	Provigil
Pemoline	Cylert
Phendimetrazine	Bontril, Plegine
Phentermine	Adipex-P, Fastin
Sibutramine	Meridia
Miscellaneous products	
<i>Hemorrhoid treatments</i>	
<i>Phenylephrine sedative</i>	In Hemorid, in Preparation H
Dexmedetomidine	Precedex

*Not currently available in the United States.

CITED REFERENCES

- Arnold A, McAuliff JP, Colella DF, et al: The β_2 -receptor mediated glycogenolytic responses to catecholamines in the dog. *Arch Int Pharmacodyn Ther* 176:451-457, 1968.
- Benoit PW: Microscarring in skeletal muscle after repeated exposures to lidocaine with epinephrine. *J Oral Surg* 36:530-533, 1978.
- Braun H: Über einige neue örtliche Anästhetica (Stovain, Alypin, Novocain). *Deutsche Med Wochens* 31:1667-1671, 1905.
- Bylund DB, Eikenberg DC, Hieble JP, et al: International Union of Pharmacology nomenclature of adrenoceptors. *Pharmacol Rev* 46:121-136, 1994.
- Calhoun NR: Dry socket and other postoperative complications. *Dent Clin North Am* 15:337-348, 1971.
- Campbell RL: Cardiovascular effects of epinephrine overdose: case report. *Anesth Prog* 24:190-193, 1977.
- Cannell H, Walters H, Beckett AH, et al: Circulating levels of lignocaine after perioral injections. *Br Dent J* 138:87-93, 1975.
- Drugs used in extrapyramidal movement disorders. In: *Drug evaluations annual 1995*, Chicago, 1995, American Medical Association.
- Dybing E, Nelson SD, Mitchell JR, et al: Oxidation of α -methyl dopa and other catechols by cytochrome P-450-generated superoxide anion: possible mechanism of methyl dopa hepatitis. *Mol Pharmacol* 12:911-920, 1976.
- Eisenhofer G, Kopin IJ, Goldstein DS: Catecholamine metabolism: a contemporary view with implications for physiology and medicine. *Pharmacol Rev* 56:331-349, 2004.
- Foster CA, Aston SJ: Propranolol-epinephrine interaction: a potential disaster. *Plast Reconstr Surg* 72:74-78, 1983.
- Fuller RW, Roush BW: Substrate-selective and tissue-selective inhibition of monoamine oxidase. *Arch Int Pharmacodyn Ther* 198:270-276, 1972.
- Funakoshi Y, Iwai S, Kaneda H, et al: Hemodynamic effects of locally applied epinephrine used with various general anesthetic techniques. *J Oral Surg* 35:713-718, 1977.
- Gerke DC, Ahrns B, Frewin DB, et al: The effect of local anaesthetics on the neural uptake of catecholamines in isolated arteries—a histochemical study. *Aust J Exp Biol Med Sci* 54:601-604, 1976.
- Gingrich JA, Caron MG: Recent advances in the molecular biology of dopamine receptors. *Annu Rev Neurosci* 16:299-321, 1993.
- Goldberg LI, Kohli JD: Peripheral dopamine receptors: classification based on potency series and specific antagonism. *Trends Pharmacol Sci* 4:64-66, 1983.
- Greenhill LL: Pharmacologic treatment of attention deficit hyperactivity disorder. *Psychiatr Clin North Am* 15:1-27, 1992.
- Guanfacine for hypertension. *Med Lett Drugs Ther* 29:49-50, 1987.
- Hanbauer I: Regulation of tyrosine hydroxylase in carotid body. *Adv Biochem Psychopharmacol* 16:275-280, 1977.
- Hieble JP, Bylund DB, Clarke DE, et al: International Union of Pharmacology. X. Recommendation for nomenclature of α_1 -adrenoceptors: consensus update. *Pharmacol Rev* 47:267-270, 1995.
- Jastak JT, Yagiela JA: Vasoconstrictors and local anesthesia: a review and rationale for use. *J Am Dent Assoc* 107:623-630, 1983.
- Kaplan EL, editor: *Cardiovascular disease in dental practice*, Dallas, 1986, American Heart Association.
- Katz RL, Epstein RA: The interaction of anesthetic agents and adrenergic drugs to produce cardiac arrhythmias. *Anesthesiology* 29:763-784, 1968.
- Keesling GR, Hinds EC: Optimal concentration of epinephrine in lidocaine solutions. *J Am Dent Assoc* 66:337-340, 1963.
- Kernan WN, Viscoli CM, Brass LM, et al: Phenylpropanolamine and the risk of hemorrhagic stroke. *N Engl J Med* 343:1826-1832, 2000.
- Knoll-Kohler E, Frie A, Becker J, et al: Changes in plasma epinephrine concentration after dental infiltration anesthesia with different doses of epinephrine. *J Dent Res* 68:1098-1101, 1989.
- Kopin IJ: Monoamine oxidase and catecholamine metabolism. *J Neural Transm Suppl* 41:57-67, 1994.
- Kopin IJ: Catecholamine metabolism: basic aspects and clinical significance. *Pharmacol Rev* 37:333-364, 1985.
- Lal H, Fielding S: Clonidine in the treatment of narcotic addiction. *Trends Pharmacol Sci* 4:70-71, 1983.
- Lauschke A, Teichgräber UKM, Frei U, et al: "Low-dose" dopamine worsens renal perfusion in patients with acute renal failure. *Kidney Int* 69:1669-1674, 2006.
- Leier CV: Current status of non-digitalis positive inotropic drugs. *Am J Cardiol* 69:120G-129G, 1992.
- Lipp M, Dick W, Daublander M, et al: Exogenous and endogenous plasma levels of epinephrine during dental treatment under local anesthesia. *Reg Anesth* 18:6-12, 1993.
- Lomasney JW, Cotecchia S, Lefkowitz RT, et al: Molecular biology of α -adrenergic receptors: implications for further clas-

- sification and structure-function relationships. *Biochem Biophys Acta* 1095:127-139, 1991.
34. Malta E, McPherson GA, Raper C: Selective β_1 -adrenoceptor agonists—fact or fiction? *Trends Pharmacol Sci* 6:400-403, 1985.
 35. Management of dental problems in patients with cardiovascular disease. Council on Dental Therapeutics, American Dental Association and American Heart Association joint report. *J Am Dent Assoc* 68:333-342, 1964.
 36. Michel MC, Kenny B, Schwinn DA: Classification of α_1 -adrenoceptor subtypes. *Naunyn Schmiedebergs Arch Pharmacol* 352:1-10, 1995.
 37. Minneman KP, Theroux TL, Hollinger S, et al: Selectivity of agonists for cloned α_1 -adrenergic receptor subtypes. *Mol Pharmacol* 46:929-936, 1994.
 38. Murphy MB, Elliott WJ: Dopamine and dopamine receptor agonists in cardiovascular therapy. *Crit Care Med* 18:S14-S18, 1990.
 39. Nelson HS: β -Adrenergic bronchodilators, *N Engl J Med* 333:499-507, 1995.
 40. Piascik MT, Perez DM: α_1 -Adrenergic receptors: new insights and directions. *J Pharmacol Exp Ther* 298:403-410, 2001.
 41. Priori SG, Napolitano C, Schwartz PJ: Cardiac receptor activation and arrhythmogenesis. *Eur Heart J* 14(Suppl E):20-26, 1993.
 42. Rabe KF, Jorres R, Nowark D, et al: Comparison of the effects of salmeterol and formoterol on airway tone and responsiveness over 24 hours in bronchial asthma. *Am Rev Respir Dis* 147:1436-1441, 1993.
 43. Ruffolo RR Jr, Nichols AJ, Stadel JM, et al: Pharmacologic and therapeutic applications of α_2 -adrenoceptor subtypes. *Annu Rev Pharmacol Toxicol* 33:243-279, 1993.
 44. Schenarts PJ, Sagraves SG, Bard MR, et al: Low-dose dopamine: a physiologically based review. *Curr Surg* 63:219-225, 2006.
 45. Sibley DR, Monsma FJ Jr: Molecular biology of dopamine receptors. *Trends Pharmacol Sci* 13:61-69, 1992.
 46. Strader CD, Candetore MR, Hill WS, et al: Identification of two serine residues involved in agonist activation of the β -adrenergic receptor. *J Biol Chem* 264:13572-13578, 1989.
 47. Troullos ES, Goldstein DS, Hargreaves KM, et al: Plasma epinephrine levels and cardiovascular response to high administered doses of epinephrine contained in local anesthesia. *Anesth Prog* 34:10-13, 1987.
 48. Troullos ES, Hargreaves KM, Goldstein DS, et al: Epinephrine suppresses stress-induced increases in plasma immunoreactive β -endorphin in humans. *J Clin Endocrinol Metab* 69:546-551, 1989.
 49. Verrill PJ: Adverse reactions to local anaesthetics and vasoconstrictor drugs. *Practitioner* 214:380-387, 1975.
 50. Wilhelmi BJ, Blackwell SJ, Miller JH, et al: Do not use epinephrine in digital blocks: myth or truth? *Plast Reconstr Surg* 107:393-397, 2001.
 51. Yagiela JA: Local anesthetics. *Anesth Prog* 38:128-141, 1991.

GENERAL REFERENCES

- Bader JD, Bonito AJ, Shugars DA: Cardiovascular effects of epinephrine in hypertensive dental patients. *Summary, Evidence Report/Technology Assessment: Number 48*, AHRQ Publication No. 02-E006, Rockville, MD, 2002, Agency for Healthcare Research and Quality. Available at: <http://www.ncbi.nlm.nih.gov/books/bv.fcgi?rid=hstat1.chapter.71824>. Accessed January 10, 2009.
- Cooper JR, Bloom FE, Roth RH: *The biochemical basis of neuropharmacology*, ed 8, New York, 2003, Oxford University Press.
- Jowett NI, Cabot LB: Patients with cardiac disease: considerations for the dental practitioner, *Br Dent J* 189:297-302, 2000.
- Nestler EJ, Hyman SE, Malenka RC: *Molecular neuropharmacology: a foundation for clinical neuroscience*, New York, 2001, McGraw-Hill.
- Ruffolo RR Jr, Hieble JP: Alpha-adrenoceptors, *Pharmacol Ther* 61:1-64, 1994.
- Wong J: Adjuncts to local anesthesia: separating fact from fiction, *J Can Dent Assoc* 67:391-397, 2001.

Adrenergic Antagonists

MICHAEL T. PIASCIK AND PETER W. ABEL

Understanding of the mechanisms of transmission in the sympathetic nervous system has increased significantly as a result of a better understanding of the actions of drugs; an increased appreciation of receptors and the second messenger pathways used by them; and extensive investigation of important diseases such as congestive heart failure, coronary artery disease, and hypertension. The consequence of this work has been the development of numerous new pharmacologic agents possessing increasingly selective mechanisms of action. Chapter 5 discusses the theoretic mechanisms by which drugs produce effects on the autonomic nervous system (see Table 5-2). The drugs discussed in this chapter all interfere with sympathetic nervous system transmission. Despite having diverse mechanisms of action, these drugs are collectively referred to as *adrenergic antagonists* or *sympatholytics*. Most, but not all, adrenergic antagonists are competitive antagonists of either α -adrenergic or β -adrenergic receptors (adrenoceptors). As a result, these agents block the actions of the endogenous neurotransmitters epinephrine and norepinephrine and exogenously administered adrenergic agonists and are also called *adrenergic receptor blockers*.

A group of agents with sympatholytic activity includes drugs that are agonists at α_2 -adrenergic receptors in key brain nuclei controlling cardiovascular function (see Chapter 6). These drugs reduce blood pressure largely by decreasing the outflow of sympathetic nervous system transmission to cardiovascular effectors. Several agents that are mainly of historical interest are known collectively as *adrenergic neuron-blocking drugs*. They act on nerve terminals to produce their sympatholytic effects and are discussed in Chapter 28.

HISTORY

Evidence that drugs could be used to antagonize the actions of other pharmacologic agents was obtained shortly after the isolation and synthesis of epinephrine. In 1906, Dale noticed that certain alkaloids isolated from ergot, produced by a fungus disease of rye grain, blocked the ability of epinephrine to increase systemic arterial blood pressure. After an injection of ergotamine (a mixture of ergot alkaloids), a hypotensive effect was observed in response to epinephrine treatment; it was aptly named by Dale the "epinephrine reversal" response.⁹ These early studies also provided the first example of selective antagonism by showing that ergot derivatives were capable of blocking some, but not all, of the actions of epinephrine. This idea of selective antagonism remains an important aspect of drug development and use.

The pioneering work of Ahlquist¹ in delineating the α -adrenergic and β -adrenergic receptors provided the framework necessary to classify more systematically antagonists of sympathetic nervous system function. Nickerson and Goodman²¹ reported in 1947 the development of dibenamine, an agent capable of irreversibly blocking the α -adrenergic receptor, which inhibited certain responses to exogenous epinephrine and to adrenergic nerve stimulation. Selective blockade of α -adrenergic receptors by ergotamine also explained the epinephrine reversal described by Dale.⁹ Phentolamine and related imidazolines were early examples of nonselective, competitive antagonists at α -adrenergic receptors. Selective antagonists of the α_1 -adrenergic and α_2 -adrenergic receptors have now been developed. Dichloroisoproterenol was the first β -adrenergic receptor blocker developed. The first clinically useful β blocker introduced was propranolol, which blocks β_1 -adrenergic and β_2 -adrenergic receptors. Selective β_1 antagonists were then discovered. We now know that there are at least nine adrenergic receptors (α_{1A} , α_{1B} , α_{1D} , α_{2A} , α_{2B} , α_{2C} , β_1 , β_2 , and β_3). Increasingly selective antagonists against each of these receptors are being developed with the goal of obtaining drugs capable of specifically interfering with the receptor involved in a pathophysiologic condition without blockade of other receptors that could lead to unwanted side effects.

In addition to effects on adrenergic receptors, it was found that sympathetic nervous system transmission could also be altered by actions directly on the nerve terminal. The drug bretylium interferes with the release of norepinephrine in response to nerve stimulation.⁴ Other drugs were also developed that interfere with neuronal function at the level of the nerve terminal. Reserpine depletes the norepinephrine stored in these nerve terminals.⁵ Metyrosine (α -methyl-L-tyrosine) competitively inhibits tyrosine hydroxylase, the rate limiting enzyme in the synthesis of norepinephrine.¹¹ These sympatholytics are not as therapeutically beneficial as the selective receptor antagonists, however, because their administration is associated with many unpleasant side effects. In the 21st century, the use of these agents has been curtailed, and they have been largely relegated to historical footnotes. Brief descriptions of these drugs are given in Chapters 5, 12, and 28.

SELECTIVE α_1 -ADRENERGIC RECEPTOR ANTAGONISTS

As discussed in Chapter 5, α_1 -adrenergic receptors are located predominantly on the postjunctional membranes of glands

and smooth muscle. The α_1 -adrenergic receptors associated with smooth muscle of arteries and veins play an important role in promoting vasoconstriction and in regulating systemic arterial blood pressure and blood flow. The α_1 -adrenergic receptors are also important in regulating the tone of nonvascular smooth muscle, such as in the neck of the urinary bladder and capsule of the prostate. More recent evidence has suggested that the α_1 -adrenergic receptor plays a role in the regulation of hypertrophic growth, the generation of reactive oxygen species, and apoptotic cell death. Antagonism of these cellular events may also be the reason that α_1 -adrenergic receptor blockers are effective in the treatment of benign prostatic hyperplasia. The α_2 -adrenergic receptors are found on the prejunctional neuronal membrane, where they play an autoregulatory role in inhibiting norepinephrine release. They are also located postjunctionally on the membranes of pancreatic islet cells, smooth muscle, and blood platelets.¹⁷

Prazosin and Analogues

The first antagonists that targeted the α_1 -adrenergic receptor were nonselective (see later) and also blocked the α_2 -adrenergic receptor. These drugs were unsuitable as antihypertensive agents, presumably because of the α_2 -adrenergic receptor blockade. The disadvantages associated with the nonselective blockade of α receptors inspired a search for agents with receptor selectivity.

The first therapeutically useful α_1 -adrenergic receptor antagonist developed was prazosin (Figure 7-1).³ Terazosin and doxazosin are structural analogues that were subsequently introduced. Although these agents differ in pharmacokinetic properties, their mechanism of action is the same. The α_1 -adrenergic receptor antagonists prevent the action of sympathetic neurotransmitters and exogenously administered agonists at α_1 -adrenergic receptors on effector organs. Prazosin and related compounds have essentially equal affinity for all three subtypes (α_{1A} , α_{1B} , and α_{1D}) of the α_1 -adrenergic receptor.

As a result of blocking smooth muscle α_1 -adrenergic receptors, prazosin dilates arterioles and veins. Each of these

actions contributes to the hypotension seen with this drug. Blockade of arterial smooth muscle produces hypotension by reducing peripheral resistance. The venodilation resulting from blocked venous α_1 -adrenergic receptors decreases cardiac preload. Compared with the nonselective α receptor antagonists, prazosin causes less tachycardia, a smaller increase in cardiac output, and less renin release.³

Absorption, fate, and excretion

Prazosin is variably absorbed, with 40% to 70% of an oral dose becoming systemically bioavailable. A large percentage of circulating drug in the plasma is bound to α_1 -acid glycoprotein. The plasma half-life is approximately 2 to 3 hours, requiring dosing two to three times per day. Most of the drug is demethylated and conjugated in the liver. Some prazosin metabolites are pharmacologically active and contribute to its therapeutic effect. Metabolites are excreted in the bile.

Terazosin is almost completely absorbed after oral administration and thus has a higher bioavailability than prazosin. It is also highly bound to plasma proteins. With a half-life of approximately 12 hours, the drug can be administered once a day. It is extensively metabolized in the liver, with both active and inactive metabolites formed. Approximately 60% of the drug is eliminated in the bile and 40% in the urine.

The systemic bioavailability of doxazosin is 60% to 70% after oral administration. Similar to the other members of this class of compounds, doxazosin circulates highly bound to plasma proteins, is extensively metabolized, and is excreted in the bile and urine. Its half-life is 10 to 20 hours, giving it an extended duration of action.

Therapeutic uses

Prazosin, terazosin, and doxazosin can be used in monotherapy for the treatment of hypertension (see Chapter 28). Terazosin and doxazosin, which are given once a day, may have advantages over prazosin, which requires more frequent administration. Otherwise, the clinical effects of terazosin and doxazosin are similar to the effects of prazosin. Although prazosin and analogues can alleviate the signs and symptoms of congestive heart failure (because of a reduction in preload and afterload), they have not been shown to increase survival in patients with congestive heart failure.^{20,23} The doxazosin arm of a more recent clinical trial, the ALLHAT study, was discontinued because of increased cardiovascular risks compared with alternative treatments.²⁰ This finding has resulted in a significant reduction in the use of prazosin analogues in the therapy of hypertension. These drugs do not have adverse effects on lipids or cholesterol and may be particularly useful in treating patients with hyperlipidemia.^{7,18} Prazosin and its analogues are also effective in treating benign prostatic hyperplasia caused by the blocking of the α_1 -adrenergic receptors associated with smooth muscle of the bladder neck and prostate. This action reduces pressure on the urethra and improves urine flow. Because of their longer plasma half-lives, terazosin and doxazosin may be preferred over prazosin for this indication.^{7,18}

Adverse effects

Orthostatic or postural hypotension is a potential concern with prazosin analogues. The effect is most likely to occur with initial administration and is known as “first-dose” syncope. Hypotension ensues when the systemic arterial blood pressure decreases by more than 20 mm Hg on standing. In this situation, cerebral perfusion decreases, and an individual may become lightheaded, dizzy, or faint. In changing from the supine to the standing position, gravity tends to cause blood to pool in the lower extremities. Several reflexes, including sympathetically mediated vasoconstriction, minimize this pooling, however, and maintain cerebral perfusion. If these reflex actions do not occur, orthostatic hypotension can result.

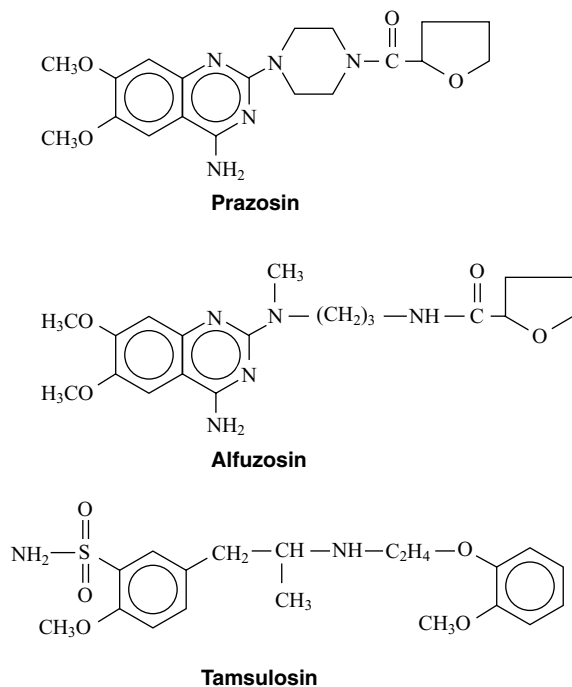

FIGURE 7-1 Structural formulas of three α_1 -adrenergic receptor-blocking agents.

By blocking the α_1 receptors associated with venous smooth muscle, prazosin-like drugs inhibit the sympathetically mediated vasoconstriction associated with postural changes.

Therapy with prazosin and its analogues should be instituted initially with small doses, followed by a gradual dosage increase over time. These drugs may cause fluid retention and edema; it may be necessary to give a diuretic simultaneously. A more recently described adverse effect of the prazosin-type drugs is inoperable floppy iris syndrome (IFIS). IFIS occurs during phacoemulsification cataract surgery. In this procedure, ultrasound is used to break up the cataract so that it can be removed by aspiration. This delicate procedure requires that the pupil be dilated by administration of an α -adrenergic receptor agonist. This pupillary dilation is blocked by prazosin. In addition, the flaccid iris is difficult to manipulate and obstructs the surgical field. Surgery is rendered more difficult, and the risk of complications is increased. Prazosin and its analogues should be withheld before cataract procedures. Other adverse effects include dry mouth, dizziness, headache, nasal stuffiness, and fatigue.

Alfuzosin

Alfuzosin (see Figure 7-1) is an analogue of prazosin that selectively blocks the α_1 -adrenergic receptors associated with the prostate gland.¹⁹ Alfuzosin binds to α_1 -adrenergic receptors with equal affinity. The reason for its prostate selectivity is not well understood. It seems to be related to the ability of alfuzosin to accumulate selectively in prostate tissue. Because of this prostate affinity, therapeutic doses of alfuzosin have little effect on systemic arterial blood pressure and are much less likely to cause syncope. IFIS remains a concern, however, with the use of alfuzosin. The drug is well absorbed and is available in a once-daily dosage form.

Tamsulosin

Tamsulosin (see Figure 7-1) is the first clinically available antagonist that blocks specific subtypes of the α_1 -adrenergic receptor: the α_{1A} and α_{1D} subtypes. The α_{1A} -adrenergic receptor has been shown to mediate the contraction of human prostatic smooth muscle.²⁶ Because tamsulosin has a high affinity for the α_{1A} -adrenergic receptor, it is effectively used to treat benign prostatic hyperplasia. The selectivity of this compound for the prostate is reflected in the fact that there is little decrease in blood pressure after therapeutic doses of the drug. Tamsulosin is well absorbed after oral administration and circulates tightly bound to plasma proteins. It is extensively metabolized in the liver and excreted as inactive conjugation products in the urine. Tamsulosin is less likely to cause orthostatic hypotension and syncope than other α_1 -selective antagonists.^{7,18} Similar to the other α_1 -adrenergic receptor antagonists, tamsulosin use has been associated with an increased incidence of IFIS. Other adverse effects include nasal stuffiness and skin rash.

NONSELECTIVE α -ADRENERGIC RECEPTOR ANTAGONISTS

The nonselective α -adrenergic receptor-blocking drugs prevent the action of adrenergic transmitters and sympathomimetic agonists at all α -adrenergic receptors. Although many drugs exhibit some α blocking activity, only the imidazolines and haloalkylamines are classified and used clinically as nonselective α -adrenoceptor antagonists.

Imidazolines

Analogues of the imidazoline adrenergic amines were among the first synthetic adrenergic blocking agents to be identified. Phentolamine (Figure 7-2) is the only compound from this

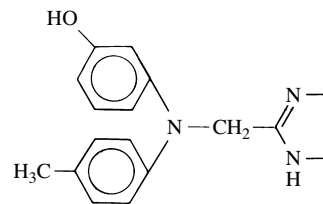

FIGURE 7-2 Structural formula of phentolamine.

class that is still clinically available. It is a competitive antagonist at α_1 -adrenergic and α_2 -adrenergic receptors. It also evokes histamine release, acts as a cholinomimetic, and blocks 5-hydroxytryptamine (serotonin, 5-HT) receptors. Therapeutically, doses sufficient to achieve adrenergic blockade can produce side effects attributable to these other actions. Nevertheless, adverse responses linked to significant decreases in peripheral vascular resistance—such as hypotension—are the major problems associated with phentolamine use. Reflex tachycardia is a special concern with phentolamine. By blocking prejunctional α_2 receptors, the drug interferes with the negative feedback mechanism (autoregulation) that normally limits the amount of norepinephrine released in response to an acute decrease in blood pressure. This lack of autoregulation leads to excessive transmitter release by sympathetic nerves supplying the heart, which may produce increases in heart rate sufficient to cause myocardial ischemia and cardiac arrest.^{27,29}

In recent years, phentolamine has had very limited therapeutic applications. It has been infused intravenously to control acute episodes of hypertension during anesthesia and in the preoperative and intraoperative management of patients with pheochromocytoma. It has also been used in clonidine withdrawal and in the treatment of hypertensive crises resulting from the interaction of monoamine oxidase (MAO) inhibitors and sympathomimetic amines. Subcutaneous injections of phentolamine are indicated in cases of extravasation of infusions of catecholamines, especially norepinephrine.

Most recently, phentolamine mesylate has been approved for the reversal of soft tissue numbness after administration of local anesthetics with vasoconstrictors for nonsurgical dental procedures. The drug is formulated in dental cartridges (0.4 mg/1.7-mL cartridge) and is injected in the same manner as the local anesthetic when pain relief is no longer needed. The median duration of post-treatment anesthesia in the upper and lower lips of adults¹⁶ and children³¹ is reduced by 85 minutes when phentolamine mesylate is injected at the end of restorative and dental hygiene procedures lasting about 45 minutes. Return of normal function (e.g., speaking, smiling, drinking) occurs in concert with return of normal sensation. It is unlikely that the phentolamine is acting by reversing the vasoconstrictor effect of injected epinephrine or levonordefrin, which should have already disappeared from the local tissues. Instead, the phentolamine probably increases local blood flow by blocking sympathetic tone, which hastens the removal of the local anesthetic from local neurons. Doses of phentolamine used for this purpose (0.2 mg to 0.8 mg) are approximately 10 times less than doses injected intravenously for treatment of hypertensive emergencies, and adverse effects have been similar to those reported after sham injection.

β -Haloalkylamines

Phenoxybenzamine is the only currently used member of the β -haloalkylamines. It is classified as an antagonist at α_1 -

adrenergic and α_2 -adrenergic receptors. Phenoxybenzamine initially binds reversibly to the receptors, but then it undergoes a chemical reaction that allows the drug to become covalently linked. The initial binding is governed by the same chemical binding forces described in Chapter 1. During development of the blockade, the presence of an agonist, or even a competitive α -blocking drug, decreases the blocking activity of phenoxybenzamine by competing for the α -adrenergic receptors. When the block has developed completely, usually in approximately 1 hour, no drug can successfully compete for the receptor because phenoxybenzamine will have formed a stable covalent bond with the receptor. This stage of the block is referred to as irreversible or nonequilibrium and has a half-life of about 24 hours, with effects persisting for several days. Similar to phentolamine, phenoxybenzamine is nonselective and blocks the prejunctional α_2 receptors responsible for regulating the release of norepinephrine. Its adverse effects are largely predicated on its long-lasting, insurmountable blockade of α receptors. In high doses, phenoxybenzamine also inhibits responses to histamine, acetylcholine, and 5-HT, however, and blocks transporter systems responsible for the tissue uptake of norepinephrine.

It was originally hoped that phenoxybenzamine would prove to be a useful antihypertensive. Many nonspecific effects and troublesome side effects have significantly restricted its therapeutic application. Phenoxybenzamine is used in the long-term therapy of pheochromocytoma in preparation for surgery or in patients who are judged to be unsuited for surgery. It rarely has been used to relax the bladder sphincter of patients with motor paralysis of the bladder or obstruction caused by prostatic hyperplasia.

Most of the adverse effects of phenoxybenzamine are shared by other α receptor antagonists; however, they are often more intense and prolonged with phenoxybenzamine because of the irreversible nature of its receptor block. The reduction of blood pressure caused by blockade of postjunctional α_1 and α_2 receptors, coupled with the inhibition of regulatory prejunctional α_2 receptors and possibly norepinephrine reuptake, results in prominent compensatory reflex activity, especially increased cardiac excitability, contractility, rate, and output. Orthostatic hypotension commonly results from the loss of control over the capacitance veins; exaggerated sensitivity to hypovolemia and the hypotensive influences of other drugs is also a common outcome. Symptoms of tachycardia, dizziness, headache, and syncope all are typical. Abdominal distress and diarrhea caused by uncompensated parasympathetic activity are added problems, as are the minor irritants of nasal stuffiness and miosis. In addition, inhibition of ejaculation has made compliance among men extremely poor. The symptoms of therapy with phenoxybenzamine can seem worse than the symptoms of the disease this drug is used to treat.

β -ADRENERGIC RECEPTOR ANTAGONISTS

The β -adrenergic receptor antagonists, also called β -adrenergic receptor blockers, are an important and versatile class of drugs widely used in cardiovascular therapeutics. The β blockers are also used to treat numerous noncardiovascular disease states. Several β blockers are among the most widely prescribed medicines in the United States.

The β -adrenergic receptors are categorized into three subtypes: β_1 , β_2 , and β_3 . Propranolol was the first β blocking drug to be approved in the United States and is considered the prototype for this class of compounds. This drug is a competitive antagonist at β_1 -adrenergic and β_2 -adrenergic receptors and is referred to as a nonselective β blocker. The beneficial effects of propranolol and other nonselective β blockers are

mostly attributable to blockade of the β_1 -adrenergic receptor. As discussed subsequently, blockade of the β_2 -adrenergic receptor is associated with undesirable effects on the airways, vascular smooth muscle, and endocrine function. Metoprolol, the first selective β_1 receptor antagonist, and its successors (e.g., atenolol, acebutolol, and esmolol) have attracted considerable attention because of their relative freedom from the unwanted effects of β_2 -adrenergic receptor blockade. This β_1 selectivity is relative with existing agents, and these drugs lose much of their selectivity at higher doses. Presently, nonselective and selective β_1 blockers are used clinically. Certain β blockers have weak partial agonistic properties; this is referred to as intrinsic sympathomimetic activity (ISA). The value of such drugs is discussed subsequently. The pharmacodynamic and pharmacokinetic properties of propranolol and other selected β blockers are summarized in Table 7-1.

The physiologic role of the β_3 receptor is not as well defined as the roles of the β_1 -adrenergic and β_2 -adrenergic receptors (which are reviewed in Chapter 5).^{15,30} Selective agonists and antagonists of the β_3 -adrenergic receptor have been developed. Activation of the β_3 receptor results in a negative inotropic but positive chronotropic effect. Similar to the β_2 -adrenergic receptor, activation of the β_3 receptor causes vasodilation.²⁵ β_3 Receptor stimulation is also being investigated for the treatment of overactive bladder.³⁴ Activation of the β_3 -adrenergic receptor has been shown to stimulate lipolysis, and many β_3 receptor-selective agonists have been developed that are effective in rodent models of obesity. So far, none of the selective β_3 receptor agonists has been shown to be effective in stimulating weight loss in humans.^{15,30} There is no current role for antagonists of the β_3 receptor.

Chemistry

As exemplified by the first β blocker, dichloroisoproterenol, halogen substitution of the catechol hydroxyl groups of the β agonist isoproterenol results in a partial agonistic activity at the β receptor. As illustrated in Figure 7-3, the currently available β blocking drugs all possess an ethylamino moiety similar to that seen in β -adrenergic receptor agonists attached through a methoxy linkage to a variant ring structure. β_1 Selectivity is conferred by a benzene ring with a large substitution in the para position.

Pharmacologic Effects

The pharmacologic effects of the β blockers occur as a result of preventing binding and subsequent receptor activation by epinephrine, norepinephrine, and exogenously administered adrenergic agonists in tissues regulated by β -adrenergic receptors.

Drugs that do not have ISA decrease resting heart rate, plasma renin activity, and cardiac output. Because of their partial agonist activity, drugs with ISA, such as pindolol, do not depress resting cardiac function or plasma renin activity to the degree seen with other β blockers. Agonist-driven increases in these parameters are small, however, because of the low intrinsic activity of pindolol. In situations of high sympathetic nervous system activity, β blockers with ISA antagonize the ability of endogenously released epinephrine and norepinephrine (agonists with high intrinsic activity) to increase heart rate, contractility, and renin secretion. Under these conditions, epinephrine and norepinephrine must compete for binding with drugs that have much less intrinsic activity.

Several β blockers can exert a local anesthetic effect in the heart. This activity derives from the blockade of Na^+ channels and results in disruption of electric impulse propagation in the heart. The local anesthetic effect is also referred to as *membrane-stabilizing activity* (see Table 7-1). Membrane-stabilizing activity is especially strong with propranolol.

TABLE 7-1
Comparison of β -Adrenergic Receptor Blocking Drugs

DRUG	POTENCY OF BLOCKADE (PROPRANOLOL = 1)	MEMBRANE-STABILIZING ACTIVITY	INTRINSIC SYMPATHOMIMETIC ACTIVITY	ORAL BIOAVAILABILITY	HALF-LIFE (hr)	ROUTE OF ELIMINATION	LIPOPHILICITY	DOSING FREQUENCY (times/day)	THERAPEUTIC INDICATIONS
Nonselective ($\beta_1 + \beta_2$)									
Nadolol	1.0	0	0	30	10-24	Renal	Low	1	Angina pectoris; hypertension
Pindolol	6.0	+	++	80	3-4	Hepatic/renal	Moderate	1-2	Hypertension
Propranolol	1.0	++	0	30	3-5	Hepatic	High	2-3	Angina pectoris; arrhythmias; hypertension; hypertrophic subaortic stenosis; migraine prophylaxis; myocardial infarction; pheochromocytoma
Timolol	6.0	0	0	50	3-5	Hepatic/renal	Moderate	1-2	Hypertension; migraine prophylaxis; myocardial infarction; glaucoma
Selective (β_1)									
Acebutolol	0.3	+	+	40	3-4	Hepatic/renal/nonrenal	Moderate	2-3	Hypertension; ventricular arrhythmias
Atenolol	1.0	0	0	50	6-9	Renal	Low	1-1	Angina pectoris; hypertension; myocardial infarction
Esmolol*	0.02	0	0	—	0.15	Red blood cell esterase	—	—	Supraventricular tachycardias; noncompensatory tachycardias
Metoprolol	1.0	—	0	40	3-7	Hepatic/renal	Moderate	2-3	Angina pectoris; hypertension; myocardial infarction

*Has a very brief duration of action and is given intravenously only.

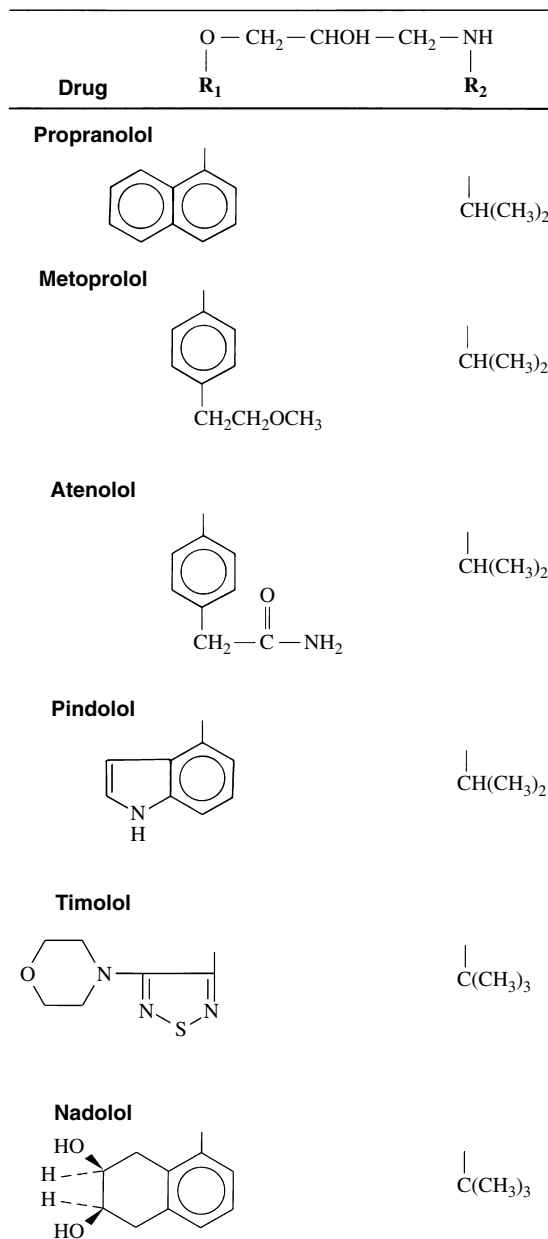

FIGURE 7-3 Structural formulas of some β adrenoceptor-blocking agents. All the drugs share a similar side chain, differing only in the terminal hydrocarbon group (R_2). Considerable variation exists in the ring structures (R_1).

Blockade of Na^+ channels is a property of many antiarrhythmic agents (see Chapter 24). In the case of β blockers, the blockade of Na^+ channels requires higher blood concentrations than the concentrations necessary for receptor blockade.⁸ Toxic (but not therapeutic) doses of propranolol can exert effects similar to certain antiarrhythmic drugs, such as quinidine.¹⁰ These effects include a decrease in the slope of the upstroke of the action potential (phase 0) and an increase in the refractory period in ischemic ventricular tissue.

Effects on the cardiovascular system

The β blockers decrease the rate and force of myocardial contraction. The major sites of action for the negative chronotropic effects of the β blockers are the β_1 -adrenergic receptors associated with the sinoatrial (SA) node, the atrioventricular

(AV) node, and the His-Purkinje system. There is a decrease in SA nodal firing rate, slowed conduction, and reduced automaticity. These actions contribute to the antiarrhythmic efficacy of the β blockers. The decrease in contractile force occurs largely as a result of β_1 -adrenergic receptor blockade associated with ventricular (the major site of action) and atrial muscle. Collectively, these changes result in a decrease in cardiac output. The negative inotropic and chronotropic actions lessen the oxygen consumption of the heart and contribute to the usefulness of the β blockers in treating ischemic heart disease. The effects of the β blockers are most pronounced under conditions of heightened sympathetic activity, when there are significant amounts of circulating and neuroally released catecholamines.

In normotensive patients, β blockers do not normally reduce blood pressure; however, they are highly effective in reducing blood pressure in hypertensive patients. These agents reduce blood pressure equally in the supine and standing positions, with no orthostatic hypotension. This attribute was discovered serendipitously while β blockers were being used to treat angina pectoris. Since that time, propranolol and other β blockers, alone or in combination with other drugs, are among the drugs of first choice in the treatment of hypertension. Although the mechanisms by which the β blockers reduce blood pressure are not completely understood, certain facts are known. The reduction in blood pressure is associated only with the *l* isomer, which has a much higher affinity for β -adrenergic receptors than the *d* isomer. When propranolol is first administered to a patient, cardiac output decreases, and peripheral resistance increases. The latter effect may result from β_2 receptor blockade in the vasculature or from a baroreceptor-mediated increase in sympathetic tone. With continued therapy, peripheral resistance also decreases. By blocking renal β_1 -adrenergic receptors involved in renin secretion, β blockers cause a reduction of plasma renin concentrations. The reduction in plasma renin activity eventually leads to a reduction in angiotensin II concentrations and aldosterone secretion. Other mechanisms that seem to contribute to the reduction in blood pressure include decreases in heart rate, cardiac output, and central nervous system (CNS) sympathetic outflow¹⁴ and an alteration in baroreceptor responsiveness.

Effects on smooth muscle

By blocking the β_2 -adrenergic receptors associated with airway smooth muscle, propranolol and other nonselective β blockers prevent sympathetic stimulation of bronchiolar smooth muscle, while leaving parasympathetic activity and other bronchoconstrictive influences unchecked. This imbalance can lead to a marked increase in airway resistance in patients with bronchospastic disorders such as asthma, chronic bronchitis, and emphysema. Propranolol and other nonselective β blockers are contraindicated in patients with bronchospastic disease. This limitation was a major impetus for development of selective β_1 receptor-blocking drugs. In a similar fashion, nonselective β blockers can also exacerbate peripheral vascular disease by blocking vasodilatory β_2 -adrenergic receptors on vascular smooth muscle.

Gastrointestinal tract effects

Similar to other adrenergic antagonists, propranolol tends to produce a relative preponderance of parasympathetic activity in the gastrointestinal tract. The net effect is related to the amount of sympathetic activity that is blocked, but it is usually of little importance.

Metabolic effects

Propranolol and other nonselective β blockers antagonize the β_2 -adrenergic receptors responsible for initiating glycogenolysis in the liver and in skeletal muscle. Hypoglycemia may

result from this action, but it is rare in the nondiabetic individual. The release of fatty acids from adipocytes by epinephrine is mediated by β_1 -adrenergic or β_3 -adrenergic receptors. All clinically useful β -adrenergic antagonists blunt this release. Nevertheless, these drugs also increase triglyceride concentrations and decrease blood concentrations of high-density lipoproteins. This response does not preclude the use of β blockers in patients with elevated serum lipids, including cholesterol.

Ocular effects

While the antihypertensive effects of the β blockers were being studied, investigators noticed that intraocular pressure in patients with open-angle glaucoma was reduced.³⁵ The production of aqueous humor is decreased by β blockers. Several β receptor blockers are commonly used topically (eye drops) in treating glaucoma and ocular hypertension. The pharmacotherapy of glaucoma is discussed in Chapter 8.

Central nervous system effects

The versatility of the β blockers is reflected in the fact that they can be used to treat a variety of disorders that have CNS involvement, including migraine headache, tremor associated with anxiety (stage fright), and benign essential tremor. Reduction of tremors is also mediated by blocking β_2 -adrenergic receptors in skeletal muscle.

As described subsequently, the β blocking drugs can cause various side effects related to their CNS activity. Theoretically, the most hydrophilic β blockers (e.g., nadolol and atenolol) should have the least access to the CNS and be associated with the lowest occurrence of such CNS effects; studies of atenolol tend to confirm this relationship.³²

Absorption, Fate, and Excretion

Most clinically approved β blockers are available in oral dosage forms. Esmolol, a selective β_1 receptor antagonist with a very brief duration of action, is limited to intravenous use for the treatment of acute hypertension and to control ventricular rate in patients with supraventricular tachyarrhythmias. Levobunolol and metipranolol are available only in solutions suitable for ophthalmic use. Key features of the pharmacokinetic properties of selected β blockers are summarized in Table 7-1.

In its first pass through the liver, approximately 50% of propranolol is metabolized. The first-pass extraction can vary widely among patients, necessitating individualized dosing regimens. Peak plasma concentrations of propranolol occur approximately 90 minutes after oral administration, with 90% of the drug bound to plasma proteins. The half-life after oral administration is 3 to 5 hours; intravenous administration results in a half-life of 1.5 to 2 hours.²² Nadolol is unique among currently available drugs because it has an elimination half-life of up to 24 hours. The bioavailability of propranolol and metoprolol may be significantly improved if the drugs are taken after a high-protein meal, presumably because the protein reduces first-pass metabolism of the drugs. To minimize variation in drug effects, the dosing schedule should be consistent regarding meals.

Metabolism of propranolol occurs almost exclusively in the liver, with oxidative reactions involving the benzene ring and the side chain. One metabolite, 4-hydroxypropranolol, is as active as the parent compound.⁶ Less than 5% of the administered drug is excreted intact in the urine. As noted in Table 7-1, most of the other β -blocking drugs are excreted more extensively by the kidney than is propranolol.

Therapeutic Uses

A brief discussion of the important therapeutic uses of the β blockers follows. Individual indications are also discussed in Chapters 24, 25, 26, and 28.

Hypertension

As described in Chapter 28, β blockers are used as first-line agents in the treatment of hypertension. Numerous studies have shown these agents to be safe and effective at decreasing the morbidity and mortality associated with elevated blood pressure. The β blockers can be used as monotherapy to control hypertension or used in combination with other drugs, such as diuretics, to produce a more vigorous antihypertensive response. Many of the side effects associated with the use of other antihypertensives, such as Na^+ and water retention or the development of tolerance, do not occur with β blockers. The effects of β blockers on blood triglycerides and glucose metabolism described previously do not preclude their use in patients with hyperlipidemia or diabetes. The only systemic β blockers not approved for use in hypertension are esmolol and sotalol.

Ischemic heart disease

The β blockers are widely used to prevent angina pectoris associated with atherosclerotic coronary artery disease. In this condition, there is an imbalance between the oxygen demand of the myocardium and the ability of the partially occluded coronary arteries to deliver oxygen-rich blood to the myocardial muscle. This imbalance leads to cardiac ischemia and development of the characteristic chest pain of angina pectoris. Two of the major determinants of myocardial work and oxygen consumption—the force and rate of contraction—are decreased by β blockade. Although β blocker-mediated reductions in oxygen consumption are efficacious in reducing the incidence and severity of exertional (classic) anginal attacks, they are not helpful in managing vasospastic (variant) angina.

Post-myocardial infarction

The favorable action on cardiac work and on myocardial oxygen consumption is the reason β blockers are used after myocardial infarction. These drugs can limit the likelihood and reduce the severity of reinfarction. The antiarrhythmic activity of the β blockers may also contribute to reducing mortality rates after myocardial infarction.

Congestive heart failure

In patients with left ventricular dysfunction, various sympathetically mediated reflexes are activated that ultimately contribute to the signs and symptoms of congestive heart failure. These sympathetic reflex responses include increases in circulating catecholamines, angiotensin II formation, and peripheral vascular resistance; activation of hypertrophic growth responses; and activation of myocardial β -adrenergic receptors. These activities impair cardiac performance further, which sets in motion a vicious cycle of increasingly compromised ventricular performance (see Chapter 25). Numerous more recent clinical studies have shown that β blockers decrease the morbidity and mortality rates of congestive heart failure.^{13,23} These drugs act at several levels to interrupt the sympathetic nervous system contribution to heart failure.

The β_1 -adrenergic receptor-mediated increase in renin secretion is blocked, decreasing circulating concentrations of angiotensin II. Angiotensin II not only has the ability to increase peripheral vascular resistance and promote Na^+ and water retention, but it is also a positive signal for the generation of reactive oxygen species and hypertrophic growth responses. The β_1 -adrenergic receptor is also a potent stimulant to the generation of reactive oxygen derivatives and hypertrophic growth. In heart failure, chronic activation of the sympathetic nervous system leads to the desensitization and downregulation of the myocardial β_1 -adrenergic receptor. The downregulation of this signaling pathway, a pathway vital to producing increases in contractile force, also contributes to contractile dysfunction and the development of heart failure.

Blocking β_1 -adrenergic receptors prevents chronic receptor stimulation and the associated downregulation of the β_1 -adrenergic receptor signaling pathway. β Blockers may promote the upregulation of β_1 -adrenergic receptor signaling in heart failure. Blockade of the β_1 -adrenergic receptor inhibits the generation of reactive oxygen species and hypertrophic growth produced by this receptor system. Bisoprolol, carvedilol, and metoprolol have been shown to decrease mortality and morbidity associated with congestive heart failure.¹³ It has also been suggested that carvedilol has antioxidant effects independent of β_1 -adrenergic receptor blockade.

Treatment of arrhythmias

The β blockers can be used to treat various supraventricular tachyarrhythmias, including atrial flutter and atrial fibrillation. In treating sinus tachycardia, the β_1 -adrenergic receptors in the SA node, whose inhibition slows heart rate, are the major focus of action. In atrial flutter and fibrillation, the β_1 -adrenergic receptors in the AV node are the site of action. The slowing of conduction and increased refractory period at the AV node protect the ventricle in these conditions from the excessive stimulation caused by the abnormal atrial depolarizations. Sotalol has antiarrhythmic properties not shared by other β blockers and can be used to treat life-threatening ventricular arrhythmias. Acebutolol can be used to treat premature ventricular contractions. Esmolol has a short plasma half-life, which makes it useful in the acute management of supraventricular tachyarrhythmias.

Other uses

The β blockers can be used to treat pheochromocytoma (administered with an α -adrenergic receptor-blocking drug), thyrotoxicosis, migraine headache (prophylaxis only), glaucoma, hypertrophic subaortic stenosis, stage fright, and tremors and to prevent bleeding episodes associated with esophageal varices. Among the β blockers, propranolol has the largest number of approved uses. Timolol, metoprolol, nadolol, and

atenolol can be used to treat migraine headaches. Levobunolol and metipranolol are used exclusively as ophthalmics.

Adverse Effects

Many of the adverse effects of the β blockers (Table 7-2) are logical extensions of their pharmacologic effects, which are caused by blockade of β -adrenergic receptors. These effects are most prominently seen on the heart, smooth muscle, brain, and organs that mediate metabolic responses.²⁸

Effects on the heart

As an extension of their actions on SA and AV nodal function, β blockers can induce bradycardia and AV block. The abrupt withdrawal of propranolol has been linked to attacks of angina pectoris, myocardial infarction, and sudden death, especially in patients with angina. The chronic blockade of the β -adrenergic receptor may induce β receptor supersensitivity, which contributes to a rebound exacerbation of these clinical problems.² Withdrawal from β blocking drugs should be done slowly, over 1 to 2 weeks. In patients with moderate-severe congestive heart failure, β blockers can precipitate bradyarrhythmias, AV nodal conduction abnormalities, severe ventricular dysfunction, and cardiac failure. The risk is higher in patients with preexisting cardiac disease and in patients who take β blockers with cardiac glycosides or other drugs that also slow pacemaker activity and impair AV nodal conduction velocity. A reduction in myocardial contractility is especially great when β blockers are combined with Ca^{++} channel blockers such as verapamil.

Effects on smooth muscle

Because of the blockade of β_2 receptors in blood vessels, non-selective β blockers tend to reduce adrenergic vasodilator responses of the vasculature to epinephrine. This effect is of little consequence in most patients, even though cold hands and feet may result. In patients with peripheral vascular disease, such as Raynaud's disease, worsening of the condition

TABLE 7-2

Major Adverse Effects of Drugs That Suppress the Activity of the Sympathetic System by Actions at Adrenergic Receptors

ADVERSE EFFECTS	RECEPTOR-BLOCKING DRUGS			SELECTIVE α_2 -ADRENERGIC RECEPTOR AGONIST ACTING ON THE CNS (CLONIDINE)
	NONSELECTIVE α RECEPTOR-BLOCKING DRUGS	SELECTIVE α_1 RECEPTOR-BLOCKING DRUGS	β RECEPTOR-BLOCKING DRUGS	
CNS Effects				
Depression		+	+	+
Drowsiness			++	+++
Dreams/insomnia			++	
Cardiovascular Effects				
Orthostatic hypotension	+++	++ (first dose)		+
Heart rate	↑	↑*	↓	↓
General Autonomic Effects				
Diarrhea	++	+		Constipation
Nasal stuffiness	++	+		
Xerostomia		+		+++
Asthma			++	
Fluid retention				++
Special Reactions			Heart failure, angina withdrawal reaction	Withdrawal reaction

+, Rare; ++, occasional; +++, common; ↑, increase; ↓, decrease.
 CNS, Central nervous system.

*Heart rate increase is less than with nonselective α receptor-blocking drugs.

is likely, and β blockers, especially nonselective ones, are contraindicated in such patients.

Bronchospasm resulting from blockade of β_2 receptors is apt to occur in patients with chronic obstructive airway diseases such as asthma, chronic bronchitis, and emphysema. Drugs selective for β_1 receptors have less effect than nonselective blockers on bronchial smooth muscle. Nevertheless, the risk of bronchoconstriction with these drugs is still present because of their limited selectivity for the β_1 receptor.

Metabolic effects

In a diabetic patient taking hypoglycemic drugs, the effects of compensatory sympathetic stimulation and epinephrine release resulting from reduced blood glucose concentrations may be blocked in patients receiving β blockers. A common warning sign of hypoglycemia to a diabetic patient is an increase in heart rate. Because this action is largely mediated by the β_1 -adrenergic receptor, this early sign of hypoglycemia is blunted by all clinically used β blockers.

Central nervous system effects

Patients receiving β blockers may experience CNS depression, weakness, fatigue, sleep disturbances including insomnia and nightmares, hallucinations, dizziness, and depression of mood.

DRUGS WITH COMBINED α -ADRENERGIC AND β -ADRENERGIC RECEPTOR ANTAGONIST ACTIVITY

Labetalol

Labetalol combines nonselective β blocking properties with α_1 -adrenergic antagonism. It is five to seven times more potent at blocking β -adrenergic receptors compared to α_1 receptors. These properties are the result of the different receptor-blocking characteristics of the four isomers that make up the drug formulation. Because of actions at β -adrenergic and α_1 -adrenergic receptors, labetalol decreases peripheral resistance and blood pressure. The drug has some direct vasodilatory properties because at least one isomer is a partial agonist at β_2 receptors, and at least one isomer may exert vasodilator properties not mediated by inhibition of adrenergic receptors. Administration of labetalol occasionally causes orthostatic hypotension; however, the use of labetalol is usually not associated with decreased cardiac output, severe bradycardia, or congestive heart failure.

Labetalol can be used orally in the long-term treatment of hypertension or administered intravenously for management of hypertensive emergencies (see Chapter 28). It exhibits near-complete oral absorption. Extensive first-pass metabolism significantly decreases the amount of drug that reaches the systemic circulation, however. The adverse effects seen with labetalol are predictable considering the drug is a nonspecific β blocker and an α_1 receptor blocker. Untoward reactions associated with β receptor blockade include bradycardia and AV block, complications in asthmatic and diabetic patients, airway dysfunction, sedation, fatigue, and other CNS manifestations.

Carvedilol

Carvedilol, a racemic mixture of two isomers, is the second drug to be marketed with α_1 and β blocking activities. In contrast to labetalol, carvedilol is without ISA. Carvedilol is also much more selective for β -adrenergic receptors than labetalol. Carvedilol was initially approved for use as an antihypertensive (because of its ability to block α_1 and β receptors), but more recent clinical studies have shown that it is particularly useful in decreasing morbidity and mortality asso-

ciated with congestive heart failure.¹³ The pharmacologic actions that make carvedilol useful in treating heart failure are probably the result of blockade of both α_1 -adrenergic and β -adrenergic receptors. The beneficial effects of β receptor blockade in heart failure have been previously discussed. The vasodilatory actions of carvedilol that occur as a result of α_1 receptor blockade decrease peripheral resistance and, as a result, the workload of the heart. There is also evidence that carvedilol exerts antioxidant activity and acts as a free radical scavenger, which could provide benefit in patients with heart failure.¹² Similar to labetalol, carvedilol is metabolized in the liver and undergoes extensive first-pass metabolism. The adverse effects of carvedilol are similar to the adverse effects observed with labetalol.

DRUGS THAT REDUCE SYMPATHETIC OUTFLOW

Centrally Acting Adrenergic Agonists

Several drugs, including methyl dopa, clonidine, guanabenz, and guanfacine, inhibit sympathetic outflow through actions within the CNS. These drugs are actually α_2 -adrenergic agonists and are discussed in Chapter 6. They interfere with sympathetic nervous system activity by stimulating regulatory α_2 receptors in the CNS. These drugs have largely been supplanted as antihypertensives by safer, more effective therapeutic entities. Clonidine does have clinical uses not associated with cardiovascular therapeutics. Some of the major adverse effects of these drugs are summarized in Table 7-2. The use of drugs that reduce sympathetic outflow from the CNS in the treatment of hypertension is discussed in Chapter 28.

Monoamine Oxidase Inhibitors

MAO inhibitors are capable of inhibiting the intracellular enzyme responsible for inactivation of norepinephrine. By poorly understood mechanisms, MAO inhibitors reduce systemic arterial blood pressure. One such drug, pargyline, was specifically marketed for the treatment of essential hypertension. Currently, MAO inhibitors are occasionally used to treat depression (see Chapter 12). The risks of MAO inhibitor therapy in the treatment of hypertension outweigh its benefits, and its use as an antihypertensive drug is rare.

The most frequent adverse effects are those associated with other adrenergic neuron blocking drugs and with ganglionic blocking drugs, including orthostatic hypotension, dizziness, weakness, xerostomia, and syncope. Tremors and hallucinations have also been reported. Difficulties in micturition and ejaculation are also experienced. Most serious is the hypertensive crisis that can occur after eating or drinking foodstuffs containing substantial amounts of tyramine. Aged cheese, liver, beer, and wines are among the most common of these tyramine-containing foods. Hypertension is the result of three factors: (1) the metabolism of tyramine by MAO that would normally occur in the gastrointestinal tract is blocked by the MAO inhibitors; (2) tyramine is an indirect-acting amine, and causes release of neurotransmitter from the cytoplasmic pool of adrenergic nerve endings; and (3) large amounts of the transmitter accumulate in the cytoplasmic pool of adrenergic nerve endings as a result of the inhibition of MAO. In addition to the typical symptoms of acute hypertension (throbbing headache, flushing, and hyperpyrexia), cerebrovascular accidents and occasionally deaths have occurred.²⁴ The use of drugs that release catecholamines should be scrupulously avoided with MAO inhibitors. Amphetamines and drugs with mixed sympathomimetic actions such as ephedrine and mephentermine are absolutely contraindicated. The use of the analgesic meperidine is contraindicated in patients

taking MAO inhibitors because a syndrome of CNS excitation, hyperthermia, and convulsions may commonly result. Opioid analgesics unrelated to meperidine (e.g., morphine) should be used cautiously because MAO inhibitors tend to increase the CNS depression from many opioid analgesics and sedatives.

IMPLICATIONS FOR DENTISTRY

Many of the drugs discussed in this chapter are widely used to treat hypertension, ischemic heart disease, congestive heart failure, and cardiac rhythm disturbances. In their daily practices, dental practitioners are likely to encounter patients taking one or more of these drugs. Dentists must pay heed to the potential risks associated with these pathologic conditions and the therapeutic agents used to manage them.

Physical Implications

A consideration for patients being treated with certain sympatholytics is the patient's position during and after dental procedures. Suddenly standing upright after being in a supine position in the dental chair is apt to cause syncope. This problem is particularly likely for the antihypertensive drugs more prone to cause orthostatic hypotension (e.g., α_1 -adrenergic receptor blocking drugs and drugs with combined α blocking and β receptor-blocking activity). Accidents ranging from chipped teeth and restorations to fractured mandibles and worse have resulted from falls. Contemporary practice standards require the measurement of blood pressure in dental patients. Blood pressure monitoring is particularly important in hypertensive patients.

Drug Interactions

Because nonselective β blockers inhibit β_2 -adrenergic receptor-mediated vasodilation, there is a risk of a hypertensive episode after administration of local anesthetic agents that contain vasoconstrictors.³³ In this situation, the vasoconstrictor actions of epinephrine at α adrenergic receptors are not opposed by the vasodilator actions of β_2 -adrenergic receptors, resulting in an exaggerated increase in blood pressure that could be deleterious in patients with hypertension or ischemic heart disease.

Clonidine is well known to cause xerostomia. The use of clonidine-like drugs may result in clinical symptoms related to dry mouth, such as difficulty in swallowing and speech. Long-term use of xerostomia-causing drugs is associated with a higher incidence of oral candidiasis and dental caries. The use of β -adrenergic receptor blockers is likely to alter the composition of salivary proteins. The effects of these changes have not been fully explored; however, there is a concern that they could adversely influence oral health. The effect of drugs that alter the function of adrenergic nerve endings on salivary proteins is also not well explored.

Patients taking MAO inhibitors must not be given drugs that have indirect sympathomimetic activity or are inactivated by MAO. Epinephrine, used in local anesthetic solutions, is not contraindicated because it is a direct agonist and largely inactivated by catechol-O-methyltransferase. Levonordefrin may be used for similar reasons. Nonetheless, in patients taking MAO inhibitors, the avoidance of hemostatic preparations containing high concentrations of epinephrine is recommended.

Opioids and other CNS depressants should be used cautiously, and usually at lower doses in patients who are taking MAO inhibitors. Meperidine is absolutely contraindicated. The dentist should reinforce the physician's instructions to the patient about dietary restrictions and contraindications of several drugs for patients taking MAO inhibitors.

ADRENERGIC ANTAGONISTS

<i>Nonproprietary (generic) name</i>	<i>Proprietary (trade) name</i>
α-Adrenergic receptor blockers (selectivity)	
Alfuzosin (α_1)	Uroxatral
Doxazosin (α_1)	Cardura
Phenoxybenzamine (α_1, α_2)	Dibenzyline
Phentolamine (α_1, α_2)	Regitine, OraVerse
Prazosin (α_1)	Minipress
Tamsulosin (α_{1A})	Flomax
Terazosin (α_1)	Hytrin
β-Adrenergic receptor blockers (selectivity)	
Acebutolol (β_1)	Sectral
Atenolol (β_1)	Tenormin
Betaxolol (β_1)	Betoptic, Kerlone
Bisoprolol (β_1)	Zebeta
Carteolol (β_1, β_2)	Cartrol
Esmolol (β_1)	Brevibloc
Levobunolol (β_1, β_2)	AKBeta, Betagan
Metipranolol (β_1, β_2)	OptiPranolol
Metoprolol (β_1)	Lopressor, Toprol XL
Nadolol (β_1, β_2)	Corgard
Nebivolol (β_1)	Bystolic
Penbutolol (β_1, β_2)	Levitol
Pindolol (β_1, β_2)	Visken
Propranolol (β_1, β_2)	Inderal
Sotalol (β_1, β_2)	Betapace
Timolol (β_1, β_2)	Blocadren
Combined α- and β-adrenergic receptor blockers	
Carvedilol ($\beta_1, \beta_2, \alpha_1$)	Coreg
Labetalol ($\beta_1, \beta_2, \alpha_1$)	Trandate, Normodyne

CITED REFERENCES

- Ahlquist RP: A study of adrenotropic receptors. *Am J Physiol* 153:586-600, 1948.
- Alderman EL, Coltart DJ, Wettach GE, et al: Coronary artery syndromes after sudden propranolol withdrawal. *Ann Intern Med* 81:625-627, 1974.
- Brogden RN, Heel RC, Speight TM, et al: Prazosin: a review of its pharmacological properties and therapeutic efficacy in hypertension. *Drugs* 14:163-197, 1977.
- Cass R, Spriggs TLB: Tissue amine levels and sympathetic blockade after guanethidine and bretylium. *Br J Pharmacol* 17:442-450, 1961.
- Chidsey CA, Braunwald E, Morrow AG, et al: Myocardial norepinephrine concentration in man: effects of reserpine and of congestive heart failure. *N Engl J Med* 269:653-658, 1963.
- Cleaveland CR, Shand DG: Effect of route of administration on the relationship between adrenergic blockade and plasma propranolol level. *Clin Pharmacol Ther* 13:181-185, 1972.
- Clifford GM, Farmer RD: Medical therapy for benign prostatic hyperplasia: a review of the literature. *Eur Urol* 38:2-19, 2000.
- Coltart DJ, Gibson DG, Shand DG: Plasma propranolol levels associated with suppression of ventricular ectopic beats. *BMJ* 1:490-491, 1971.
- Dale HH: On some physiological actions of ergot. *J Physiol (London)* 34:163-206, 1906.
- Davis LD, Temte JV: Effects of propranolol on the transmembrane potentials of ventricular muscle and Purkinje fibers of the dog. *Circ Res* 22:661-677, 1968.
- Engelman K, Horwitz D, Jequier E, et al: Biochemical and pharmacologic effects of α -methyltyrosine in man. *J Clin Invest* 47:577-594, 1968.

12. Feuerstein G, Yue TL, Ma X, et al: Novel mechanisms in the treatment of heart failure: inhibition of oxygen radicals and apoptosis by carvedilol. *Prog Cardiovasc Dis* 41:17-24, 1998.
13. Frantz RP: Beta blockade in patients with congestive heart failure. *Postgrad Med* 108:103-106, 109-110, 116-118, 2000.
14. Garvey HL, Ram N: Comparative antihypertensive effects and tissue distribution of beta adrenergic blocking drugs. *J Pharmacol Exp Ther* 194:220-233, 1975.
15. Gauthier C, Langin D, Balligand J-L: β_3 -Adrenoceptors in the cardiovascular system. *Trends Pharmacol Sci* 21:426-431, 2000.
16. Hersh EV, Moore PA, Papas AS, et al: Reversal of soft-tissue local anesthesia with phentolamine mesylate in adolescents and adults. *J Am Dent Assoc* 139:1080-1093, 2008.
17. Hoffman BB, Lefkowitz RJ: Alpha-adrenergic receptor subtypes. *N Engl J Med* 302:1390-1396, 1980.
18. Kirby RS: Clinical pharmacology of α_1 -adrenoceptor antagonists. *Eur Urol* 36(suppl 1):48-53, 1999.
19. McKeage K, Plosker GL: Alfuzosin: a review of the therapeutic use of the prolonged-release formulation given once daily in the management of benign prostatic hyperplasia. *Drugs* 62:633-653, 2002.
20. Messerli FH, Grossman E: Doxazosin arm of the ALLHAT study discontinued: how equal are antihypertensive drugs? Antihypertensive and lipid lowering treatment to prevent heart attack trial. *Curr Hypertens Rep* 2:241-242, 2000.
21. Nickerson M, Goodman LS: Pharmacological properties of a new adrenergic blocking agent: N, N-dibenzyl-chloroethylamine (Dibenamine). *J Pharmacol Exp Ther* 89:167-185, 1947.
22. Nies AS, Shand DG: Clinical pharmacology of propranolol. *Circulation* 52:6-15, 1975.
23. Packer M: Therapeutic options in the management of chronic heart failure: is there a drug of first choice? *Circulation* 79:198-204, 1989.
24. Pettinger WA, Oates JA: Supersensitivity to tyramine during monoamine oxidase inhibition in man: mechanism at the level of the adrenergic neuron. *Clin Pharmacol Ther* 9:341-344, 1968.
25. Rozec B, Gauthier C: β_3 -Adrenoceptors in the cardiovascular system: putative roles in human pathologies. *Pharmacol Ther* 111:652-673, 2006.
26. Schwinn DA, Price RR: Molecular pharmacology of human α_1 -adrenergic receptors: unique features of the α_{1A} -subtype. *Eur Urol* 36(suppl 1):7-10, 1999.
27. Starke K: Presynaptic α -autoreceptors. *Rev Physiol Biochem Pharmacol* 107:73-146, 1987.
28. Stephen SA: Unwanted effects of propranolol. *Am J Cardiol* 18:463-472, 1966.
29. Stokes GS, Oates HF: Prazosin: new alpha-adrenergic blocking agent in the treatment of hypertension. *Cardiovasc Med* 3:41-57, 1978.
30. Strosberg AD: Structure and function of the β_3 -adrenergic receptor. *Annu Rev Pharmacol Toxicol* 37:421-450, 1997.
31. Tavares M, Goodson JM, Studen-Pavlovich D, et al: Reversal of soft-tissue local anesthesia with phentolamine mesylate in pediatric patients. *J Am Dent Assoc* 139:1095-1104, 2008.
32. Westerlund A: Central nervous system side-effects with hydrophilic and lipophilic β -blockers. *Eur J Clin Pharmacol* 28(suppl): 73-76, 1985.
33. Yagiela JA: Adverse drug interactions in dental practice: interactions associated with vasoconstrictors. Part V of a series. *J Am Dent Assoc* 130:701-709, 1999.
34. Yoshimura N, Kaiho Y, Miyazato M, et al: Therapeutic receptor targets for lower urinary tract dysfunction. *Naunyn Schmiedebergs Arch Pharmacol* 377:437-448, 2008.
35. Zimmerman TJ, Kaufman HE: Timolol: a β -adrenergic blocking agent for the treatment of glaucoma. *Arch Ophthalmol* 95:601-604, 1977.

GENERAL REFERENCES

- Bavitz JB: Dental management of patients with hypertension, *Dent Clin North Am* 50:547-562, 2006.
- Carter LM, McHenry IDS, Godlington FL, et al: Prescribed medication taken by patients attending general dental practice: changes over 20 years, *Br Dent J* 203:E8, 2007.
- Herman WW, Konzelman JL Jr, Prisant LM: New national guidelines on hypertension: a summary for dentistry, *J Am Dent Assoc* 135:576-584, 2004.
- Little JW, Falace DA, Miller CS, et al: *Dental management of the medically compromised patient*, ed 7, St. Louis, 2008, Mosby/Elsevier.
- Lowe FC: Role of the newer alpha,-adrenergic-receptor antagonists in the treatment of benign prostatic hyperplasia-related lower urinary tract symptoms, *Clin Ther* 26:1701-1713, 2004.
- Moore PA, Gage TW, Hersh EV, et al: Adverse drug interactions in dental practice: professional and educational implications, *J Am Dent Assoc* 130:47-54, 1999.
- Reiter MJ: Cardiovascular drug class specificity: β -blockers, *Prog Cardiovasc Dis* 47:11-33, 2004.
- Srinivasan S, Radomski S, Chung J, et al: Intraoperative floppy-iris syndrome during cataract surgery in men using alpha-blockers for benign prostatic hypertrophy, *J Cataract Refract Surg* 33:1826-1827, 2007.

Cholinergic Drugs

FRANK J. DOWD

Cholinergic drugs are agents that mimic the actions of the endogenous neurotransmitter acetylcholine (ACh). As described in Chapter 5, ACh is the primary neurotransmitter released from the nerve terminals of the preganglionic fibers of the parasympathetic and sympathetic nervous systems, the postganglionic fibers of the parasympathetic nervous system (which include most of the postganglionic cholinergic neurons), and some postganglionic fibers of the sympathetic nervous system (mostly fibers to the sweat glands). ACh is also the primary neurotransmitter released from somatic efferents innervating skeletal muscle and from certain central nervous system (CNS) neurons.

Most cholinergic, or cholinomimetic, agonists produce parasympathetic responses by stimulating muscarinic receptors located on tissues innervated by the postganglionic fibers of the parasympathetic nervous system. These drugs are often referred to as *muscarinic* or *parasympathomimetic agonists*. Some cholinergic agonists produce a nonselective stimulation of the parasympathetic and sympathetic branches of the autonomic nervous system by activating ganglionic nicotinic receptors located on the cell bodies of postganglionic fibers. In addition, some cholinergic agonists excite skeletal muscle by activating a separate group of nicotinic receptors located on the motor end plate of the neuromuscular junction. The synapses in the CNS that contain nicotinic and muscarinic receptors can be stimulated by cholinomimetic agonists capable of penetrating the blood-brain barrier.

Drugs that inhibit the hydrolysis of ACh by the enzyme acetylcholinesterase (AChE) produce their cholinomimetic effects indirectly. These anticholinesterases prolong the effective life of ACh released at neuroeffector junctions. As a group, the anticholinesterases are less selective in effect than many direct-acting cholinomimetics, and they are largely without activity in denervated tissues. Nevertheless, their dependence on ACh release confers the potential advantage of retaining neural control over their effects.

CHOLINOMIMETIC AGONISTS

The cholinomimetic agonists directly stimulate cholinergic receptors—muscarinic or nicotinic or both—to cause a pharmacologic response in an effector. These cholinergic drugs are classified into two groups on the basis of their origin and chemical composition: choline esters, which include ACh and its synthetic congeners, and the naturally occurring alkaloids and their congeners, including muscarine, pilocarpine, cevimeline, and nicotine. With few exceptions (e.g., nicotine), all these agents exert prominent parasympathomimetic effects.

Chemistry and Classification

Choline esters

The history of the discovery of ACh and its identification is described in Chapter 5. In 1909, Hunt synthesized the acetyl ester of choline, and earlier Hunt and Taveau¹⁶ reported on the pharmacology of many synthetic congeners of ACh. Interest in the choline esters arose partly out of the hope that some of these compounds would have a longer duration of action than ACh and, at the same time, a greater degree of selectivity. This goal has not been realized completely, and ACh and related drugs generally either are not used therapeutically or are used only in selected instances. The structures of ACh and the three principal synthetic esters of choline—methacholine, carbachol, and bethanechol—are shown in Figure 8-1. Succinylcholine, a diacetylcholine derivative with selective nicotinic receptor effects in skeletal muscle, is discussed in Chapter 10.

Natural alkaloids and congeners

Several alkaloids obtained from various plants possess direct cholinomimetic activity. Muscarine, the prototype muscarinic agonist, is present during certain times of the year in the mushroom *Amanita muscaria* and is especially prominent in several *Inocybe* and *Clitocybe* species. Although a quaternary ammonium compound (Figure 8-2), muscarine has a rapid onset of action after oral ingestion and produces physiologic responses characteristic of profound parasympathetic nervous system stimulation. In severe poisoning, cardiovascular collapse may occur. Pilocarpine is found in the leaves of the South American shrub *Pilocarpus jaborandi*. It is also a selective muscarinic receptor agonist. Pilocarpine remains in the therapeutic armamentarium for a few specific indications and has a specific dental indication. Cevimeline, a synthetic agent, is similar in pharmacology to pilocarpine. Arecoline is the primary alkaloid of betel nuts. It is a euphoric and stimulates muscarinic and ganglionic nicotinic receptors. Nicotine, an alkaloid found in tobacco leaves (*Nicotiana tabacum*), is important historically as the prototype nicotinic receptor agonist. In the form of cigarettes, nicotine is the most commonly used cholinergic agonist, and it is responsible for the physical dependence associated with smoking. This drug and other drugs selective for nicotinic receptors are discussed in Chapter 10.

Mechanism of Action

Direct-acting cholinomimetic drugs produce their effects by binding to and stimulating muscarinic and nicotinic receptors. As noted previously, these receptors are located in junctional regions of the peripheral nervous system and the CNS. ACh is capable of stimulating muscarinic and nicotinic receptors

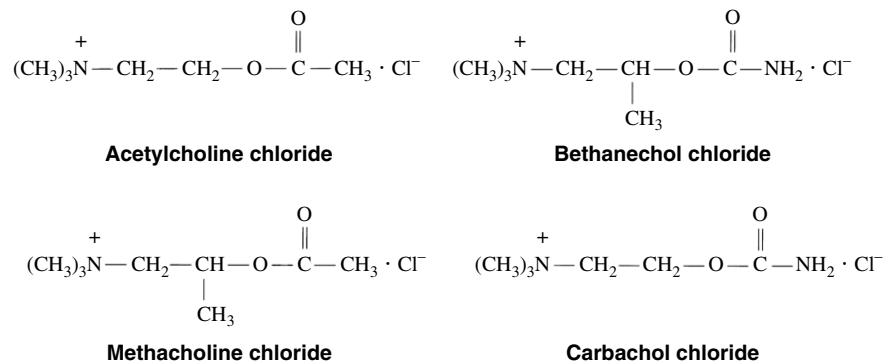

FIGURE 8-1 Structural formulas of acetylcholine and three congeners.

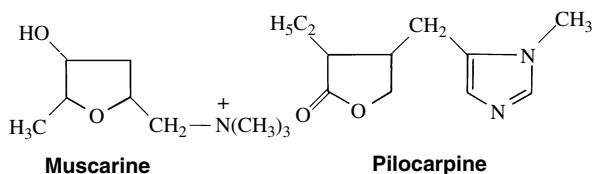

FIGURE 8-2 Structural formulas of muscarine and pilocarpine.

when administered systemically; although muscarinic responses are produced by low doses of ACh, effects on ganglionic and somatomotor transmission require increasingly higher doses. The choline ester bethanechol and the plant alkaloid muscarine produce a relatively selective activation of muscarinic receptors located on autonomic effector tissues (especially in smooth muscle and glandular tissues) and on the cell bodies of unique populations of CNS neurons. Although these muscarinic agonists produce qualitatively similar responses in different organ systems, they vary in their relative potencies in evoking these reactions.

Parasympathomimetic responses to cholinergic drugs are mediated by the stimulation of several populations of muscarinic receptors. A total of five muscarinic receptor proteins (m_1 through m_5 , corresponding to the pharmacologically identified receptors M_1 through M_5) have been produced from cloned muscarinic receptor genes, and it has been established that multiple receptor subtypes can coexist in the same organ or tissue. The exact distribution of these receptors and their functional properties are currently areas of active investigation, but a few general concepts have emerged. In the periphery, the M_1 receptor seems to be localized in ganglia, some exocrine gland cells, and the enterochromaffin cells of the stomach (see Chapter 33). The M_2 receptor is the primary subtype found in the heart and is present, along with the M_4 receptor, in the lung. The M_3 receptor is widely distributed and is most prominent in glandular tissue. Although a peripheral distribution of the M_5 receptor has not been identified, it is expressed, as are the other subtypes, in discrete regions of the CNS.

Muscarinic receptors belong to a large family of plasma membrane receptors whose basic structure consists of seven helical segments spanning the membrane and joined by alternating intracellular and extracellular peptide bridges (see Chapter 1). Although the hydrophobic helical segments, which form the ligand-binding site, show considerable structural homology among the muscarinic receptor subtypes, the third intracellular loop, joining helices V and VI, is highly divergent. Biochemical studies suggest that this loop is of primary importance in the coupling between receptor binding and intracellular action.

Stimulation of muscarinic receptors initiates a cascade of intracellular events that ultimately leads to the observed pharmacologic effects. Evidence to date suggests that all muscarinic receptor subtypes regulate the activity of G proteins (see Chapter 5). The G proteins modulate intracellular processes by influencing “second messenger” systems. Agonist-induced activation of M_1 , M_3 , or M_5 receptors stimulates the enzyme phospholipase C, which produces Ca^{++} -dependent phosphorylation of specific cellular regulatory proteins. The stimulation of M_2 or M_4 receptors inhibits the activity of adenylyl cyclase, decreasing the intracellular concentration of cyclic adenosine 3',5'-monophosphate. In the heart, this outcome of M_2 receptor activation results in increased K^+ efflux and reduced Ca^{++} influx, leading to characteristic muscarinic receptor-induced changes in cardiac function (see later). The activation of M_2 receptors on the intact vascular endothelium produces a profound vasodilation by stimulating the production and release of nitric oxide, an important endothelium-derived relaxing factor (Figure 8-3).^{13,17} Nitric oxide stimulates guanylyl cyclase located in vascular smooth muscle, which catalyzes the formation of cyclic guanosine 3',5'-monophosphate. This cyclic nucleotide reduces intracellular Ca^{++} concentrations, leading to vascular smooth muscle relaxation and vasodilation. The effect of agonists on the muscarinic receptors of endothelial cells accounts for the vasodilation when these drugs are administered systemically, especially intravenously. This vasodilation occurs despite the lack of nerve innervation to these receptors on endothelial cells.

The systemic administration of high doses of ACh activates nicotinic receptors located on the cell bodies of postganglionic nerve fibers of the autonomic nervous system (N_N receptors) and nicotinic receptors located in the neuromuscular junction (N_M receptors). As described in Chapter 5, nicotinic receptors are composed of five glycoprotein subunits forming a rosette around a central channel spanning the plasma membrane. The α subunits (see also Figure 1-2) contain the ACh-binding sites. When stimulated by ACh, nicotine, or another nicotinic receptor agonist, a conformational change in the protein occurs, allowing Na^+ and, to a lesser extent, Ca^{++} ions to move down their respective concentration gradients. The net ionic movement depolarizes the postganglionic cell body or muscle end plate. Prolonged stimulation of nicotinic receptors with ACh or nicotine results in a phenomenon referred to as “depolarization blockade,” in which responses to further stimulation are attenuated and then lost (see Chapter 10).

Pharmacologic Effects

The pharmacologic effects produced by direct-acting cholinergic drugs vary according to the receptors they stimulate, their distribution throughout the body, and their mode of

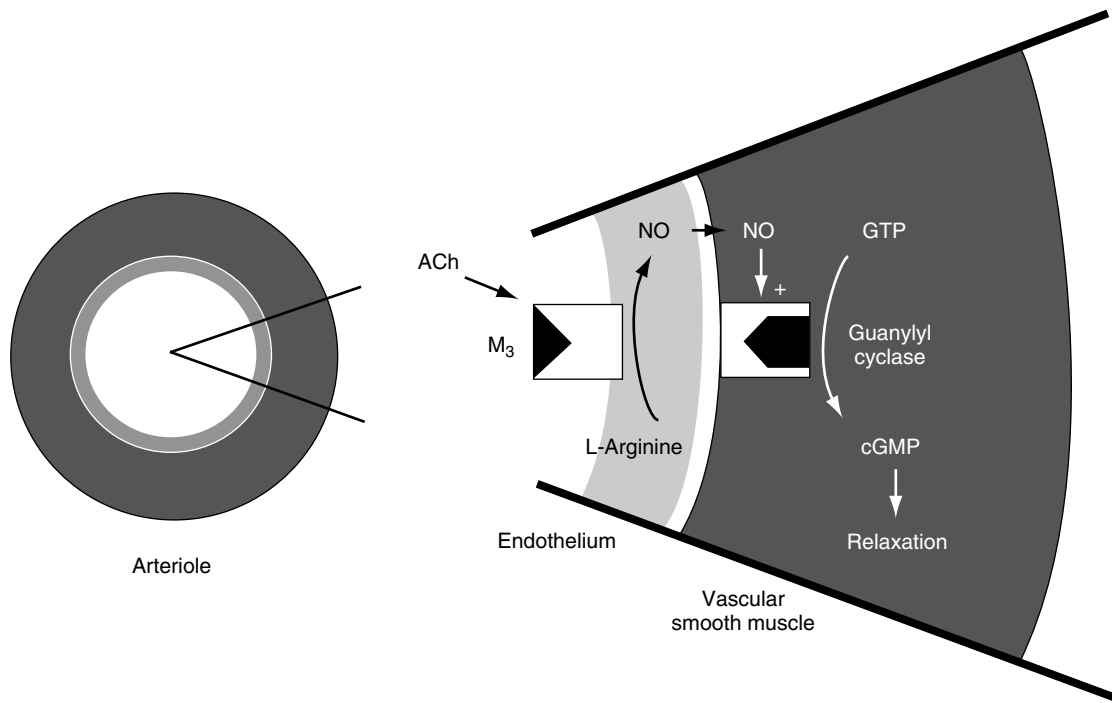

FIGURE 8-3 Mechanism of vascular relaxation by muscarinic receptor agonists. The muscarinic agent acetylcholine (*ACh*) binds to its receptor (M_3) on the intact vascular endothelium. Newly synthesized nitric oxide (*NO*) diffuses into the vascular smooth muscle, where it stimulates the formation of cyclic guanosine 3',5'-monophosphate (*cGMP*) from guanosine triphosphate (*GTP*).

inactivation. The duration of action of ACh and its congeners is determined by their susceptibility to hydrolysis by AChE and pseudocholinesterase. Methacholine, with some susceptibility only to AChE, has a longer duration of action than ACh. Bethanechol, carbachol, cevimeline, and the natural alkaloids are not affected by the cholinesterases at all and also have longer durations of action than ACh.

Currently available agents exhibit significantly different affinities for muscarinic and nicotinic sites, so that carbachol has more pronounced nicotinic effects than ACh, and bethanechol, muscarine, pilocarpine, and cevimeline have very few nicotinic properties. Differences in effect are also noted regarding various target tissues. Bethanechol and carbachol are very effective stimulants of the gastrointestinal and urinary tracts, whereas ACh and methacholine exert more prominent cardiovascular effects. Some of the limitations of injected ACh arise because the drug is so quickly metabolized that it gains little access to tissues that are not well perfused.

Peripheral muscarinic effects

Cholinergic agonists that stimulate muscarinic receptors produce end-organ responses that mimic parasympathetic nervous system stimulation. Table 5-1 outlines several of the physiologic responses produced by direct electric stimulation of parasympathetic nerves. The following discussion of the specific muscarinic effects of the cholinergic drugs is limited to actions that have some therapeutic application or toxicologic importance; not all of the cholinergic drugs possess all these actions.

Eye. Muscarinic receptor agonists activate the sphincter muscle of the iris and produce constriction of the pupil (miosis). At the same time, there is contraction of the ciliary muscle, so the eye is focused for near vision. Intraocular pressure is decreased, particularly if the tension was elevated initially. There may also be a transient hyperemia of the conjunctiva.

Heart. Direct cardiac effects are similar to the effects associated with vagal stimulation. The heart rate is decreased by drug-induced slowing of the spontaneous depolarization of the sinoatrial node (negative chronotropic effect). There is also a decrease in the force of contraction (negative inotropic effect) of atrial and, to a much lesser extent, ventricular muscle. Although the effective refractory period is shortened in atrial muscle, the refractory period in the atrioventricular node and conducting system of the heart is increased, and conduction is slowed.

These direct effects on the heart are subject to autonomic modification. A baroreceptor-mediated increase in sympathetic nervous system activity may occur if the muscarinic drug produces a significant decrease in blood pressure. In a patient receiving the muscarinic blocking drug atropine, a dose of a cholinergic drug great enough to activate nicotinic receptors in autonomic ganglia and the adrenal gland will promote the release of catecholamines and result in cardiac stimulation.

Vascular smooth muscle. Muscarinic receptor agonists produce a generalized vasodilation that causes a decrease in blood pressure. All vascular beds are affected, which is consistent with pharmacologic evidence that all parts of the vasculature, including pupal blood vessels, are supplied with muscarinic receptors. The physiologic significance of these receptors is still in doubt, however, partly because much of the vasculature receives no parasympathetic innervation. In the absence of an administered drug, it is likely that vasodilation in local tissues occurs most often in response to autoregulatory factors, such as high carbon dioxide concentrations, low oxygen concentrations, and an acidic pH, and not to stimulation of cholinergic nerves. ACh produced and released locally may facilitate vasodilation in response to local blood flow increases. As noted previously, muscarinic receptor agonists produce their vasodilatory effects by inducing the

vascular endothelium to release nitric oxide into the surrounding vascular smooth muscle, where it produces muscle relaxation.^{13,17}

Bronchial smooth muscle. The smooth muscle of the bronchioles is constricted by muscarinic receptor agonists.

Gastrointestinal smooth muscle. Motility, peristaltic contractions, amplitude of contraction, and tone all are increased by muscarinic receptor agonists. Conversely, sphincter muscles are relaxed.

Secretory glands. All glands that are innervated by cholinergic fibers are potentially stimulated by cholinergic drugs, including the salivary, lacrimal, bronchial, sweat, gastric, intestinal, and pancreatic glands. The secretion by sweat glands is controlled by sympathetic nerves, which in this case have cholinergic postganglionic fibers.

Urinary tract. Muscarinic receptor agonists stimulate contraction of the detrusor muscle, which results in decreased bladder capacity and opening of the urethral orifice in the fundus of the bladder. (Micturition is permitted by voluntary relaxation of the urethral sphincter.) Peristaltic activity in ureteral smooth muscle may also be stimulated.

Peripheral nicotinic effects

Several cholinomimetic drugs can stimulate nicotinic receptors. Nicotinic receptor agonists have varying effects at different nicotinic sites; these effects are related to the structure of the molecule,³ the dosage of the drug, and the location and type of nicotinic receptor activated. As noted earlier, there are at least two major kinds of peripheral nicotinic receptors: those on ganglia (N_N) and those in skeletal muscle (N_M). Although exogenous ACh at low doses stimulates muscarinic receptors selectively, in substantially higher doses it stimulates N_N receptors and, by close intra-arterial injection of high doses, N_M receptors. Carbachol has substantial nicotinic properties at therapeutic doses. Its affinity for nicotinic receptors is higher than that for muscarinic receptors. There is evidence that carbachol not only occupies the postsynaptic cholinergic receptor but also causes the release of ACh from nerve terminals in certain locations by activating presynaptic nicotinic receptors. Muscarinic effects are obtained indirectly through increased ACh release at parasympathetic ganglia and muscarinic neuroeffector sites. Although pilocarpine is essentially muscarinic in action, it has been reported to produce ganglionic stimulation in high doses.

Stimulation of autonomic ganglia leads to a mixture of parasympathetic and sympathetic effects. Because these effects often oppose each other, the resultant outcome is often difficult to predict. In the case of ACh and carbachol, which also exert prominent muscarinic activity, parasympathetic effects predominate; this is likely due to the fact that these drugs have a more difficult time gaining access to nicotinic receptors. The pharmacology of nicotine, which is devoid of direct muscarinic properties, is reviewed in Chapter 10. None of these agents produces clinically useful skeletal muscle stimulation.

Central nervous system effects

As previously mentioned, there are muscarinic and nicotinic receptors in the CNS. ACh, the choline esters, and the cholinomimetic alkaloids all are known to evoke CNS actions when applied directly to brain tissue. Central cholinergic systems have been implicated in central regulation of most physiologic systems (i.e., cardiovascular, respiratory, gastrointestinal, and somatomotor systems) and influence cognition and emotion. The observation that cholinergic agonists affect so many functions indicates that cholinergic receptors play an

important role in central neurotransmission. In the intact individual, many cholinergic agents are excluded from the CNS, however, because of their quaternary ammonium constituents. The fact that these drugs may still produce behavioral arousal responses is probably the result of their peripheral influences, which lead to changes in sensory inputs conducted to the brain by visceral afferent fibers.

Absorption, Fate, and Excretion

All the previously discussed cholinergic receptor agonists are absorbed after administration by oral and parenteral routes, although absorption of the quaternary ammonium compounds from the gastrointestinal tract is likely to be unpredictable. Parenteral administration of the choline esters must be done with extreme caution because of the profound effects they may have on cholinergic effectors. ACh is rapidly destroyed by AChE and pseudocholinesterase and exerts an effect measured in seconds if given by bolus intravenous injection. Methacholine, more slowly metabolized than ACh by AChE and immune to pseudocholinesterase, is longer in duration of action. For all practical purposes, carbachol and bethanechol are not affected by the cholinesterases, so they have a much longer duration of action and the potential for producing widespread and prolonged cholinergic effects.

Pilocarpine is well absorbed after oral, subcutaneous, or topical administration. It also gains ready access to the CNS, and it is well distributed through the tissues and organs of the body. A large fraction is excreted unchanged by the kidneys, with an elimination half-life of 0.75 to 1.5 hours. Cevimeline is also well absorbed after oral administration, with peak blood concentrations occurring in 1.5 to 2 hours. Most of the drug is metabolized to sulfoxides and glucuronic acid conjugates, with an elimination half-life of about 5 hours.

Adverse Effects

Generally, adverse reactions to the cholinomimetic drugs are predictable consequences of the stimulation of cholinergic receptors. Patients with increased risk of adverse responses include patients with asthma, cardiovascular disease, and peptic ulcer. Untoward reactions may include a response profile that many autonomic pharmacologists refer to as the *SLUD* response (salivation, lacrimation, urination, and defecation). In addition to the *SLUD* response, muscarinic receptor agonists can produce bronchospasm, hypotension, and arrhythmias. Hypertensive responses to pilocarpine and cevimeline may occur with parenteral injection of large doses; this seemingly atypical effect is the result of sympathetic ganglionic stimulation caused by activation of excitatory muscarinic receptors on postganglionic neurons. Intravenous and intramuscular injection is generally avoided because of the increased possibility for producing cardiopulmonary reactions; toxic reactions generally are reduced by the restricted and often topical use of these agents.

The mushrooms *Amanita pantherina* and *Amanita muscaria* contain muscarine but in amounts that are probably too small to account for the symptoms of poisoning that result from their ingestion. The mushroom *Inocybe lateraria*, with a much higher muscarine content, produces signs and symptoms of intoxication that resemble those produced by muscarine, including profuse salivation and sweating; miosis; bradycardia; severe abdominal pain with vomiting, cramps, and diarrhea; and respiratory difficulties arising from the constriction of bronchial muscle and increased secretion in the respiratory tract. The onset of poisoning is rapid, and treatment consists of the administration of atropine in large quantities, gastric lavage, and appropriate supportive measures. Recovery usually occurs in 1 or 2 days. In many cases of mushroom poisoning, there are delayed symptoms, including violent emesis and diarrhea and damage to parenchymatous

organs (principally the liver), which are not amenable to atropine treatment and are produced by a group of cyclopeptide toxins from the mushroom that inhibit the synthesis of messenger ribonucleic acid.²

ANTICHOLINESTERASES

Anticholinesterases are drugs that stimulate cholinergic transmission indirectly by inhibiting the enzyme AChE, which hydrolyzes and inactivates ACh in the synaptic clefts of the autonomic nervous system, the CNS, and the neuromuscular junction of the somatic nervous system. Agents in this class derive their pharmacologic effects from their ability to prolong the life of ACh at receptor sites. These cholinesterase inhibitors are sometimes referred to as indirect-acting cholinergic drugs.

Anticholinesterases can be subclassified as either reversible or irreversible cholinesterase inhibitors. Reversible inhibitors (e.g., edrophonium, neostigmine, and physostigmine) temporarily inactivate the enzyme by forming noncovalent associations with the enzyme or covalent bonds that are readily hydrolyzed. Irreversible cholinesterase inhibitors (organophosphates) inactivate the enzyme by forming a permanent covalent bond with the enzyme.

Physostigmine, or eserine, the earliest known anticholinesterase, has a colorful history. An alkaloid, it is derived from a bean, or nut, known as the Calabar, ordeal, or Esere bean, and it was used in witchcraft trials by certain native tribes in West Africa. The bean was brought to England by a British medical officer stationed in Calabar in the mid-1800s, and its pharmacologic properties were investigated in numerous laboratories, including those of Fraser, who studied its toxicity in the 1860s and noted that its actions were antagonized by atropine. In 1877, physostigmine was used for the treatment of glaucoma, which remains one of its principal uses today. In 1914, noting the extreme brevity of the action of ACh, Dale⁸ suggested that an enzyme capable of destroying ACh must exist in the body, and in 1930 it was found that physostigmine could prevent the rapid destruction of ACh.¹⁰

By the 1930s, the chemical structure of physostigmine had been elucidated, a series of synthetic analogues had been synthesized, and several researchers had reported independently that the derivative neostigmine was effective in the treatment of myasthenia gravis (MG).^{23,27} Until the basic mechanism of neurohumoral transmission was elucidated, however, it was not understood that these drugs acted therapeutically as anticholinesterases.

The first organophosphate anticholinesterase was synthesized in 1854, before physostigmine was known, by de Clermont, who made and tasted tetraethyl pyrophosphate (and survived to record the fact). Modern interest in these compounds did not begin until 1932, when Lange and von Krueger¹⁸ synthesized some compounds with a phosphorofluoride linkage and gave a remarkable description of the pharmacologic properties of this group of chemicals. Lange believed that these compounds would prove useful as insecticides, and he offered them to the I.G. Farben Company in Germany. It was some years before this company took an active interest, but they soon realized the potential of these compounds as chemical warfare agents. The manufacture of nerve gas began in Germany in 1940. Related investigations were being carried out in England at the same time, and in the United States diisopropyl fluorophosphate was being studied during World War II. (This agent has been given the official name of isofluorophate.) Two compounds developed by the Germans, tabun and sarin, are among the most toxic nerve gases known. Of the thousands of organophosphates that have been tested, several dozen are widely available as insecticides, and many others have military implications as lethal nerve gases.

Chemistry and Classification

Reversible anticholinesterases include the truly reversible non-ester quaternary ammonium compounds and the esters of carbamic acid, which react covalently with the enzyme surface. The carbamoylated enzyme is regenerated by hydrolysis in about 30 minutes; the continued presence of the anticholinesterase yields a duration of action of several hours. The reversible anticholinesterases may be classified as simple quaternary ammonium compounds (edrophonium) or carbamate ester derivatives, including tertiary amines (physostigmine), quaternary amines (neostigmine), and bisquaternary amines (ambenonium). Three representative reversible anticholinesterases are shown in Figure 8-4.

Irreversible anticholinesterases are organophosphates that result in a phosphorylated enzyme not significantly regenerated by hydrolysis. They have limited therapeutic value, but are of great toxicologic significance. Four examples include (1) isofluorophate, the best known and studied compound of this class; (2) malathion, a widely used insecticide; (3) echothiophate, one of the first compounds in this class to have a therapeutic application; and (4) tabun, one of the most potent and toxic nerve gases. Structures of several irreversible anticholinesterases are shown in Figure 8-5. The anticholinesterases are classified according to their uses in Table 8-1.

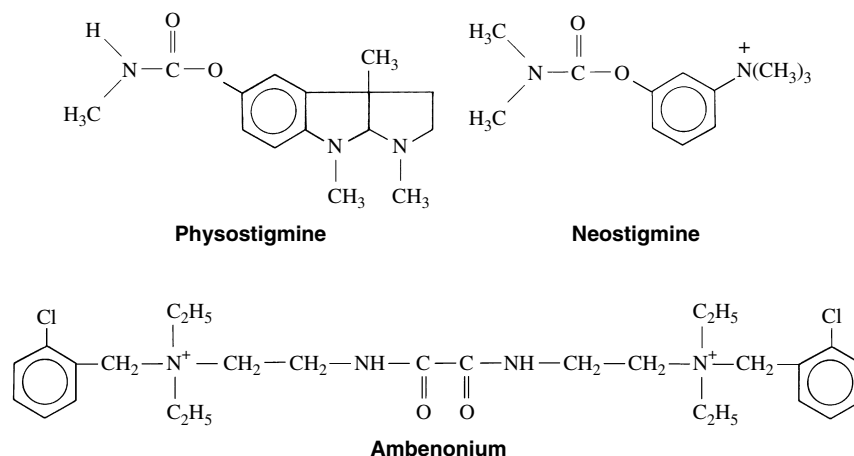

FIGURE 8-4 Representative reversible anticholinesterases.

TABLE 8-1

Uses of Anticholinesterases

USE	DRUGS
Treatment of glaucoma	Demecarium, echothiophate, physostigmine
Treatment of myasthenia gravis	Ambenonium, edrophonium,* neostigmine, pyridostigmine
Treatment of Alzheimer's disease	Donepezil, galantamine, rivastigmine, tacrine
Reversal of nondepolarizing muscle relaxants	Edrophonium, neostigmine, pyridostigmine
Nerve gas	Sarin, soman, tabun
Insecticides (organophosphates)	Malathion, paraoxon, parathion
Insecticides (carbamates)	Aldicarb, carbaryl, propoxur

*Diagnostic purposes only.

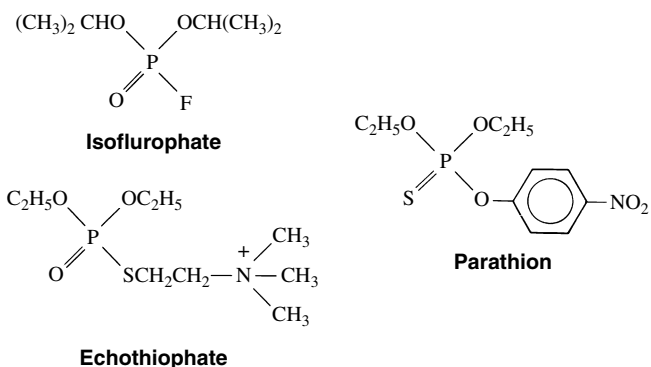

FIGURE 8-5 Representative irreversible anticholinesterases.

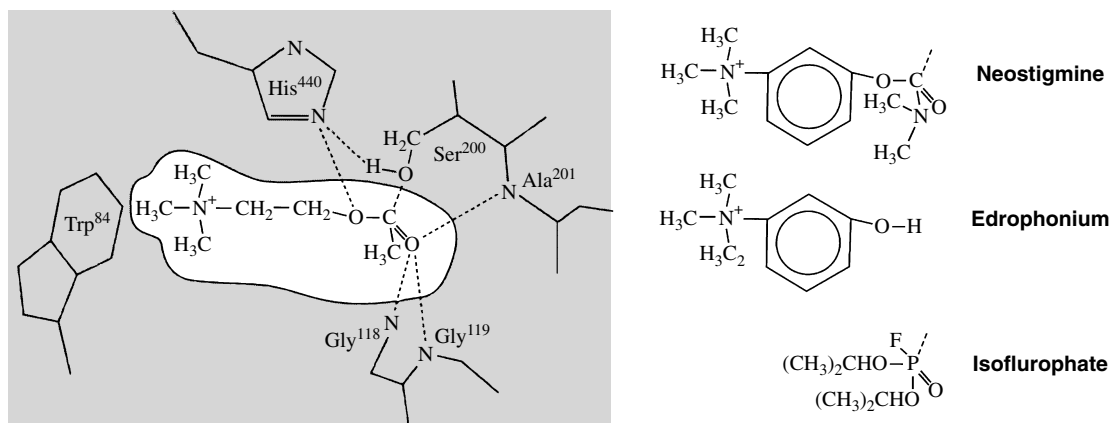

FIGURE 8-6 Interaction between acetylcholine and three anticholinesterases with acetylcholinesterase. The positive charge of the quaternary ammonium group of acetylcholine is attracted to the choline-binding site of acetylcholinesterase by the π electrons of surrounding aromatic amino acids, including the tryptophan (Trp^{84}) shown in the illustration. Hydrophobic interactions strengthen the binding of the choline moiety. A covalent attachment occurs with the serine (Ser^{200}) residue at the esteratic site. As a result, choline is split off, and the enzyme is briefly acetylated before spontaneous hydrolysis frees the enzyme. Nitrogen from nearby amino acids participates in this process by forming hydrogen bonds with the acetate group. Neostigmine mimics acetylcholine in its binding to acetylcholinesterase; however, the carbamoyl group is not as easily removed from the esteratic site. Edrophonium not only binds primarily to the choline-binding site but also participates in a hydrogen bond with the histidine (His^{440}) nitrogen of the esteratic site. The organophosphate isoflurophate reacts only at the esteratic site, where it creates a stable covalent bond. (Reprinted with permission from AAAS. Adapted from Sussman JL, Harel M, Frolov F, et al: Atomic structure of acetylcholinesterase from *Torpedo californica*: a prototypic acetylcholine-binding protein, *Science* 253:872-879, 1991.)

Mechanism of Action

In Chapter 5, it is pointed out that AChE hydrolyzes ACh with great rapidity, that the enzyme is localized in the region of the receptor, and that it acts most efficiently when ACh is present in low concentrations. There is also a nonspecific plasma cholinesterase, or pseudocholinesterase (butyrylcholinesterase), which has a greater affinity for butyric esters than for acetyl esters and is more effective when the concentration of ACh and other esters is high.

AChE is composed of protein units that have an individual molecular weight of 70,000 Da. The enzyme exists in synaptic plasma membranes in the form of simple oligomers (single units, dimers, and tetramers). A much larger configuration, present in the outer basal lamina of the synapse (and especially evident in the neuromuscular junction), has tetramers of the catalytic unit attached to a specific collagen (collagen Q) through disulfide linkages to yield a filament 50 nm in length and weighing 106 Da.²² Clusters of these structures form complex associations with various proteins on the cell surface.

The ACh molecule reacts with the enzyme AChE at two primary sites; these sites are shown, with ACh and several anticholinesterases, in Figure 8-6. AChE is depicted as having a choline-binding site, to which the quaternary ammonium portion of the ACh molecule is attracted, and an esteratic site, with an affinity for the ester portion of the molecule.²⁶ It is at the esteratic site that the ACh molecule is split, leaving the acetylated enzyme, which is rapidly regenerated by combination with water. The organophosphate anticholinesterases have an affinity chiefly for the esteratic site of the AChE molecule. They produce a very stable covalent attachment; there is virtually no hydrolysis with many of these compounds, and cholinesterase activity remains depressed until new enzyme is synthesized. Because enzyme turnover may take several weeks, the organophosphates are referred to as irreversible in action.

The anticholinesterase agents enjoying the greatest therapeutic use are drugs, such as neostigmine and physostigmine, that interact strongly with both binding sites of the receptor. As with the organophosphates, attachment of such drugs to the serine residue at the esteratic site is achieved by a covalent linkage. This bond is subject to hydrolysis, however, and these drugs are categorized as reversible cholinesterase inhibitors.

The simplest quaternary anticholinesterase, edrophonium (see Figure 8-6), binds AChE in a noncovalent manner. Its inhibition is rapidly reversible, making it useful for situations requiring a short duration of action, such as for diagnostic purposes. The terms *reversible* and *irreversible* denote differences in duration of effect, not in site of attachment.

The anticholinesterases, whether reversible or irreversible, owe their pharmacologic effects chiefly to the fact that they prolong the life of ACh at sites where it is a mediator. Their actions are often identical to the actions of ACh, although much more prolonged and, in most cases, completely dependent on the presence of endogenous ACh in the area of the effector. For this reason, most of the anticholinesterases are ineffective in denervated organs. Exceptions to this generalization are the quaternary ammonium compounds such as neostigmine and pyridostigmine and the bisquaternary amine ambenonium that stimulate nicotinic (N_M) receptors directly. Neostigmine is capable of direct stimulation of the neuromuscular junction and is effective on denervated skeletal muscle. Its pharmacology is the result of a combination of anticholinesterase and cholinomimetic properties.

Pharmacologic Effects

The cholinesterase inhibitors produce muscarinic effects similar to those elicited by the direct-acting cholinergic agonists (described earlier and outlined in Chapter 5). These effects are mediated by increasing the concentration of ACh at the autonomic neuroeffector junction and skeletal muscle neuromuscular junction. The activity of the anticholinesterases is greatest for the organs that receive more or less continuous cholinergic nerve stimulation. As a result, their effects are seen first in the smooth muscles of various ocular structures, the gastrointestinal tract, and the urinary bladder.

An important disparity in action between anticholinesterases and direct-acting muscarinic drugs is that the former do not cause significant muscarinic receptor-mediated vasodilation because many blood vessels receive no parasympathetic innervation, and no ACh is available to be protected against hydrolysis. Instead, vascular effects of high doses of anticholinesterases are largely mediated through their effects on autonomic ganglia and on medullary vasomotor centers. (The latter case occurs primarily with physostigmine, which is not permanently charged and can penetrate the blood-brain barrier.) Cholinesterase inhibitors stimulate, and in high doses subsequently block, N_N and N_M receptors indirectly by increasing the synaptic concentrations of ACh at ganglionic and neuromuscular sites. Hypotensive responses can arise from blockade of sympathetic ganglia. Quaternary cholinesterase inhibitors such as neostigmine are also able to stimulate directly N_M receptors and, to a lesser extent, N_N receptors.

As is the case with cholinomimetic alkaloids, the anticholinesterases are also known to evoke CNS actions. The CNS effects that are seen in anticholinesterase poisoning—confusion, ataxia, respiratory abnormalities, convulsions, coma, and death from respiratory paralysis—provide powerful evidence that cholinergic receptors play an important role in central neurotransmission. As pointed out in Chapter 5, there are muscarinic and nicotinic receptors in the CNS. As already mentioned, quaternary ammonium compounds penetrate biologic membranes poorly, so anticholinesterases that contain a quaternary ammonium group (e.g., neostigmine or edrophonium) are poorly absorbed after oral administration and do

not readily pass through the blood-brain barrier. Predictably, they are quite effective at skeletal neuromuscular junctions but have no CNS effects.

Absorption, Fate, and Excretion

Physostigmine is readily absorbed after oral, subcutaneous, and topical administration, and it is destroyed principally through hydrolysis at the ester linkage by plasma esterases, including pseudocholinesterase. The other reversible cholinesterases listed in this chapter, such as neostigmine and pyridostigmine, are quaternary ammonium compounds, which means that they pass through biologic membranes with difficulty. Some of these compounds are broken down by esterases or hepatic microsomal enzymes. These compounds and their metabolites appear in the urine.

The organophosphate anticholinesterases, with the exception of echothiophate, are highly lipid soluble, and they are rapidly absorbed from the gastrointestinal tract, the skin and mucous membranes, and the lungs. These characteristics explain their potential toxicity when used as aerosols, dusts, vapors, or liquids. Most organophosphates are metabolized by A-esterases (paraoxonases) in the plasma and liver and by microsomal oxidation; for a few drugs, enzymatic transformation results in a more toxic product than the original compound. In the case of isofluorophate, approximately 80% of the drug is metabolized and excreted in the urine and feces during the first 24 hours, and approximately 20% remains protein bound in the tissues for a prolonged period.

Adverse Effects

In humans, intoxication from anticholinesterases has resulted from overdose with drugs used in the treatment of MG and from exposure to toxic amounts of carbamate insecticides or organophosphate in insecticides or chemical warfare agents. Organophosphate insecticides have gained wide use in many countries, and thousands of cases of poisoning are attributable to these compounds, especially parathion. Most of the organophosphates are volatile liquids at ordinary temperatures and are highly lipid soluble. They are readily absorbed through the skin, the respiratory tract, the gastrointestinal tract, and the eyes. The symptoms of anticholinesterase poisoning reflect the role of ACh as a neuromediator at muscarinic and nicotinic receptors located peripherally and in the CNS. In high doses, the reversible anticholinesterases can produce the same symptoms as the irreversible anticholinesterases; the chief difference between these two groups lies in the ready access to the circulation and the longer duration of action of the irreversible anticholinesterases.

The first signs and symptoms to appear, especially after local exposure through aerosols, vapor, or dust, are an intense miosis, an inability to accommodate for far vision, severe rhinorrhea, and a frontal headache attributable to ciliary muscle spasm. The respiratory tract is also affected soon after exposure. In addition to the watery nasal discharge, there is nasal hyperemia, a sensation of tightness in the chest, probably because of bronchoconstriction, and increased bronchial secretion. Audible wheezing may follow, related to the bronchoconstriction and the hypersecretion. Laryngospasm may occur because of the secretory activity, which triggers a reflex spasm of laryngeal muscle. Ventilation can be severely and very rapidly compromised. Other manifestations of muscarinic stimulation include gastrointestinal effects such as salivation, anorexia, nausea, vomiting, severe cramps, diarrhea, and involuntary defecation. Sweating, lacrimation, bradycardia, urinary frequency, and involuntary micturition also occur.

With the onset of muscarinic effects, various nicotinic effects also become apparent. The affected individual shows easy fatigability and generalized weakness, especially on exertion. Involuntary muscle twitching, fasciculations, and muscle

BOX 8-1

Manifestations of Overdosage With Anticholinesterases

MUSCARINIC EFFECTS (PERIPHERAL)	NICOTINIC EFFECTS* (PERIPHERAL)	CNS EFFECTS
Miosis, frontal headache (brow ache), conjunctival hyperemia, blurred vision	Muscular weakness, twitching, fasciculations	Restlessness, giddiness, tension, anxiety, nausea
Rhinorrhea, nasal hyperemia	Tachycardia	Tremors, electroencephalographic changes
Lacrimation, salivation, sweating	Elevation or depression of blood pressure	Confusion, ataxia, convulsions
Increased bronchial secretions, tightness of chest, bronchoconstriction, wheezing	Death from respiratory failure	Depression of respiratory and circulatory centers, cyanosis, coma, respiratory and circulatory collapse
Anorexia, nausea, vomiting, cramps, diarrhea, involuntary defecation		Death from respiratory failure
Urinary urgency, involuntary micturition		
Bradycardia, hypotension		

*Nicotinic effects include stimulation and inhibition of synaptic or junctional transmission.
CNS, Central nervous system.

cramps follow; then generalized muscle weakness, including the muscles of respiration, increases in severity. Respiratory movements become more shallow and rapid, and respiratory failure may occur in minutes unless artificial respiration is instituted. Respiration is also greatly hampered by the constriction of the airway and the intense secretory activity in the respiratory tract. Sympathetic ganglia may be stimulated and later blocked in moderate to severe intoxication, but this usually does not pose a life-threatening problem. Finally, outstanding CNS manifestations start with tension, restlessness, and jitteriness, and progress to confusion and ataxia, coma, disappearance of reflexes, Cheyne-Stokes respirations, and finally generalized convulsions. The cause of death is respiratory failure resulting from paralysis of the muscles of respiration, central depression of respiration, and airway obstruction. Box 8-1 summarizes the signs of poisoning with the anticholinesterases according to muscarinic, nicotinic, and CNS effects.⁶

The treatment of acute intoxication with an organophosphate should include the following actions:

1. Remove the victim from the source of contamination, or remove the organophosphate-containing contaminant.
2. Administer atropine in very large doses. Atropine does not relieve the neuromuscular blockade produced by these agents, but it does alleviate the effects of excessive muscarinic receptor stimulation, including many of the CNS manifestations of poisoning. Repeated, often very large, doses may be required.
3. Maintain the airway and administer artificial respiration.
4. Inject a benzodiazepine, such as diazepam, if atropine fails to relieve the convulsions.
5. Administer pralidoxime. This drug is one of several oximes that were synthesized in the 1950s as cholinesterase reactivators.

When the mechanism of organophosphate poisoning was fully understood, it became possible to conceptualize a molecule that could reverse the inhibition of AChE. It was reasoned that by attaching a nucleophilic group to a cationic quaternary nitrogen group at a proper atomic distance, the phosphorus group of the alkyl phosphate would be attacked and would be removed from AChE in a displacement reaction. It was reasoned further that the cationic group of this ideal molecule would be attracted to the choline-binding site, and the nucleophilic atom would be directed toward the phosphorus atom. Numerous compounds were synthesized, and one of the most potent was pralidoxime, the structure of which is shown in Figure 8-7. Intravenous administration of the oximes

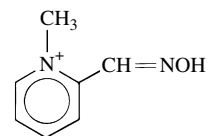

FIGURE 8-7 Structural formula of pralidoxime.

produces a remarkably rapid reactivation of the AChE at neuromuscular junctions in which transmission has failed as a result of poisoning with irreversible anticholinesterases. The reactivation occurs within minutes, but the effect of the oximes is much less dramatic at muscarinic sites and, with few exceptions, negligible in the CNS because many of the reactivators are quaternary compounds and cannot pass the blood-brain barrier. Also, the oximes are most effective when given immediately after exposure to the organophosphate because a process of "aging" of the phosphorylated AChE complex makes the enzyme resistant to reactivation. Therapeutic use of pralidoxime and its congeners is reserved for cases of intoxication with the irreversible anticholinesterases.

In some instances of organophosphate poisoning, the acute cholinergic phase may be followed by delayed peripheral neuropathy. Two types have been described. One appears 2 to 5 weeks after exposure to the organophosphate and involves phosphorylation and inhibition of an enzyme called neurotoxic esterase. The second neuropathy, called an *intermediate syndrome*, has been reported in approximately 10% of patients recently treated for organophosphate poisoning and appears 24 to 96 hours after exposure.²⁵ This condition, which is unresponsive to atropine and pralidoxime, involves the proximal limb muscles, the neck flexors, certain cranial nerves, and the muscles of respiration. These patients require respiratory support, and several have died of respiratory failure. It is theorized that the intermediate syndrome may be caused by contamination of the organophosphate or an interaction of the organophosphate with some other pesticides.

GENERAL THERAPEUTIC USES

ACh itself has had very little therapeutic application because of the extreme brevity of its action. The synthesis of congeners has solved the duration problem and resulted in drugs with

more selective actions. Although these compounds have limited use in contemporary therapeutics, the choline esters and the alkaloid pilocarpine are still used for some important purposes, as are the reversible anticholinesterases. The irreversible anticholinesterases are principally used as laboratory tools, as insecticides, and therapeutically for ophthalmologic conditions.

Glaucoma

Glaucoma is the name given to a group of diseases characterized by an elevation of intraocular pressure, a progressive atrophy of the optic disk, and a gradual loss in the field of vision. The aqueous humor is produced in the ciliary epithelium, passes into the posterior chamber, and then through the pupil into the anterior chamber. It leaves the eye by two pathways in the anterior chamber angle. In the first, the aqueous humor passes through the trabecular meshwork across the inner wall of Schlemm's canal and then into the venous circulation. In the second route, called the *uveoscleral pathway*, aqueous humor flows across the iris and anterior face of the ciliary muscle and ultimately exits through the sclera. Most forms of glaucoma result from an interference with the drainage from the trabecular meshwork or from closure of the angle by the iris.

Glaucoma is classified as primary, secondary, or congenital, based on characteristics and etiology. Of the primary types, open-angle (wide-angle, chronic simple) glaucoma and narrow-angle (angle-closure, acute congestive) glaucoma are the most common. In open-angle glaucoma, outflow resistance is elevated because there is a disturbance in the trabecular meshwork, or there is high episcleral venous pressure. The disease is slowly progressive, chronic, and often insidious because irrevocable damage can be done to the visual apparatus before symptoms develop. Narrow-angle glaucoma is usually, as its other name, acute congestive glaucoma, suggests, a medical emergency, triggered by an acute elevation of intraocular pressure, usually because iris-lens contact has obstructed the outflow of aqueous humor from the posterior to the anterior chamber. The secondary glaucoma types are associated with various systemic or ocular diseases, trauma, or drugs.

Therapy for glaucoma is directed at stimulating the musculature of the iris and ciliary body, increasing the facility of outflow of aqueous humor, reducing its formation, or extracting liquid from the eye. Although historically the cholinergic agents (in this application called *miotics*) have been the initial and principal drugs used in the treatment of chronic open-angle glaucoma, many other drugs (Table 8-2) are currently used, either alone or in conjunction with the cholinergic miotics. For first-line therapy, β -adrenergic receptor blockers and prostaglandin preparations are now more commonly used.²¹

Pilocarpine and other drugs that stimulate muscarinic receptors reduce intraocular pressure by decreasing resistance to aqueous humor outflow. Pilocarpine is available for topical administration in various solutions, and in a long-acting gel formulation. Carbachol, a slightly longer acting drug, is now used only occasionally.

The long-acting miotics—the anticholinesterases demecarium and echothiophate—are used for patients with chronic open-angle glaucoma who are refractory to the short-acting miotics and the other conventionally used drugs. These agents are quite potent and are administered in the lowest possible concentrations. Long-term administration (≥ 6 months) of echothiophate has been associated with the development of cataracts. Adverse effects limit their usefulness in the long-term therapy of glaucoma.

Xerostomia

Xerostomia can occur at any age, but it is most often seen in elderly individuals. Age-related decreases in salivary gland

TABLE 8-2

Drugs Used in the Treatment of Glaucoma

CLASS	DRUGS
Cholinergic Receptor Agonists	Carbachol, pilocarpine
Anticholinesterases	
Short-acting	Physostigmine
Long-acting	Demecarium, echothiophate
Adrenergic Receptor Agonists	
α And β agonist	Epinephrine
Prodrug	Dipivefrin
α_2 Agonist	Apraclonidine, brimonidine
β-Adrenergic receptor antagonists	
Nonselective	Carteolol, levobunolol, metipranolol, timolol
β_1 Selective	Betaxolol
Other Drugs	
Prostaglandin F _{2α} analogues	Acetazolamide, bimatoprost, latanoprost, travoprost, unoprostone
Carbonic anhydrase inhibitors	Brinzolamide, dorzolamide
Osmotic agents	Glycerin, isosorbide, mannitol
Combination products	Dorzolamide and timolol; pilocarpine and epinephrine

production, however, are not the reason many older people have dry mouth. Dry mouth may result from several causes, including radiation to the salivary glands, therapy with anti-neoplastic agents, disease (e.g., Sjögren's syndrome), and treatment with various drugs more common in older patients.¹ Saliva serves several functions in protecting the oral cavity.^{11,19} Adequate saliva volume is required for cleaning the teeth and cleansing the oral cavity. Buffers in saliva reduce the effect of acids. Proteins, including mucins, aid in mineralization of dental enamel; reduce wear on the teeth by providing lubrication; have antibacterial, antiviral, and antifungal properties; and provide growth factors for tissue repair.^{9,19} Reduced salivary flow rate, which is a major (but not the only) cause of the perception of dry mouth, is a risk factor for oral disease. Xerostomia can be very uncomfortable and is known to be associated with increased caries; oral pain; increased oral infection; and difficulty speaking, chewing, and swallowing.^{19,20} Pilocarpine and cevimeline have been approved for the treatment of xerostomia in subjects with functional salivary gland tissue.¹²

A 5-mg to 10-mg dose of pilocarpine elicits significant increases in parotid, submandibular, and sublingual secretion, with maximal flow rates being achieved in 30 minutes and a return to basal rates in approximately 3 hours. The drug is usually given three times daily. The saliva-stimulating effect depends on residual salivary gland function. Generally, at these doses, there is no significant effect on blood pressure, heart rate, or cardiac function. Sweating is a common side effect; chills, nausea, and dizziness have also been reported. Cevimeline is a selective M₁ and M₃ muscarinic receptor agonist also used for the treatment of xerostomia. Because of its receptor preference, this drug is reported to have fewer adverse effects than pilocarpine; however, clinical studies have not been done to confirm this claim. Cevimeline is administered at a dose of 30 mg three times daily. The dentist must carefully determine whether muscarinic receptor agonists should be used to treat dry mouth. Therapy for xerostomia must not compromise other therapy the patient may be

receiving. Risk factors for muscarinic receptor agonists need to be considered.

Oral fluids, including saliva substitutes, may be added for the relief of dry mouth. Oral fluids should be substituted for pilocarpine and cevimeline in patients in whom the drugs are not well tolerated, in patients at risk for adverse effects, such as patients with uncontrolled asthma, in patients for whom pilocarpine or cevimeline would compromise existing therapy, or in patients in whom there is a complete loss of salivary function. Other contraindications are addressed in the section on therapeutic uses in dentistry.

Reversal of Neuromuscular Block

The use of reversible anticholinesterases to terminate the neuromuscular block of curare-like drugs in general anesthesia is discussed in Chapter 10.

Myasthenia Gravis

MG is a disease characterized by weakness and easy fatigability of the skeletal muscles, particularly ocular and oropharyngeal muscles, and by marked variations in severity of symptoms in the course of a single day. The prevalence of the disease is about 14 to 15 per 100,000 population. Approximately 10% of patients die of MG. There is also a neonatal form of MG that tends to be transient. Although the disease was described more than 300 years ago, the underlying mechanisms and suitable treatment were unclear until two investigators, Remen in 1932²³ and Walker in 1934,²⁷ unknown to each other, administered neostigmine to patients with MG and reported relief of symptoms.

The typical patient with MG initially has ocular complaints—double vision or ptosis or both—and difficulty in chewing and swallowing. Later, dyspnea and other respiratory problems may arise. Approximately 10% of patients with MG have a tumor of the thymus, and approximately 75% have hyperplasia of lymphoid tissue of the thymus. At least 30% of patients with an enlarged thymus have a remission of myasthenic symptoms after thymectomy.

Since the work of Remen²³ and Walker,²⁷ it has been accepted that the defect in MG is probably at the neuromuscular junction. Investigators showed that although synaptic vesicle diameter is unaltered, the mean nerve terminal area and the postsynaptic membrane are abnormally simple, with clefts that are sparse, shallow, wide, or absent. The favorable response of some patients to thymectomy and certain features of the muscle response in MG have led to the recognition that this disease is an autoimmune disorder. Experimental autoimmune MG is characterized by simplified postsynaptic membrane structures, high concentrations of anti-ACh receptor antibodies in the serum, binding of antibodies to most ACh receptor in the muscle, and reduction of the ACh receptor content to approximately 30% of normal.

MG is currently viewed as an autoimmune disorder in which there is continuous production of antibody to the ACh receptor at the neuromuscular junction. The primary defect in MG is loss of ACh receptor through accelerated destruction of receptors and without a concomitant increase in rate of synthesis, and by complement-mediated focal lysis of the postsynaptic membrane. Other forms of MG may involve other proteins at the neuromuscular junction.

Treatment for MG is now fairly standardized. Diagnosis is made on the basis of a physical and neurologic examination; an elevated titer of ACh receptor IgG antibodies; an improvement in muscle strength after intravenous or intramuscular injection of edrophonium, a short-acting anticholinesterase; and single fiber electromyography. After a positive diagnosis, six methods of treatment are available.²⁴ In the first method, one of three reversible anticholinesterases (neostigmine, pyridostigmine, or ambenonium) is used to enhance neuromus-

cular transmission. Second, thymectomy is especially indicated in patients with thymomas. Third, adrenal corticosteroid therapy is presently considered the initial standard therapy for mild-moderate MG. Fourth, other immunosuppressant drugs, such as cyclosporine and azathioprine, are used. Fifth, plasmapheresis to remove offending antibodies is an effective modality used in acute situations. Sixth, high-dose intravenous immunoglobulins also are used in acute situations. (The mechanism of intravenous immunoglobulins has not been well defined.)

Treatment with immunosuppressive drugs is associated with undesirable side effects (see Chapter 41). With azathioprine, toxic effects on the gastrointestinal and hematologic systems are most common, with prominent nausea, vomiting, and abdominal discomfort in the first months. Cyclosporine use is associated with nephrotoxicity, diarrhea, gingival pain, nausea, and headaches. Treatment with corticosteroids is associated with many adverse effects (see Chapter 35). Osteoporosis is a significant risk, and patients routinely are placed on bisphosphonates or other medications to protect bone structure.

Therapy with an anticholinesterase is likely to be complicated by side effects resulting from the accumulation of ACh at cholinergic receptor sites. Some of these effects are characteristically muscarinic—abdominal cramps, diarrhea, sweating, salivation, and lacrimation—and can be well controlled by the administration of atropine and related drugs. Other side effects, such as muscle fasciculations and CNS symptoms, are not controllable by the muscarinic blocking drugs and may be warning signs of an impending cholinergic crisis, which results from overdosage with the anticholinesterases. Cholinergic crisis is characterized by muscle weakness, particularly of the respiratory muscles, resulting from persistent depolarization of the neuromuscular junction. Cholinergic crisis closely resembles myasthenic crisis, the latter of which may occur because of inadequate medication, and it is urgently necessary in such patients to determine quickly which of the two conditions exists. This determination is made by giving, with great caution and with resuscitation equipment immediately available, a very low dose of edrophonium. If the symptoms are relieved, the problem is myasthenic weakness; if muscle strength decreases, cholinergic crisis is established.

Antidote for Atropine Poisoning

All the cholinergic drugs with muscarinic properties should theoretically be useful in antagonizing the effects of atropine, but the most effective drugs for this purpose are the anticholinesterases, and the drug of choice is physostigmine. When the diagnosis of atropine poisoning is confirmed, physostigmine is administered intravenously, and it rapidly relieves the delirium and coma. Neostigmine and other quaternary ammonium compounds are of limited use because they are incapable of counteracting the CNS effects of atropine.

Numerous psychotropic agents (e.g., tricyclic antidepressants, phenothiazines, and antihistamines) share to varying degrees the antimuscarinic effects of atropine. Particularly when used in combination (for intravenous sedation or for other reasons), these agents may induce a central anticholinergic syndrome consisting of confusion, delirium, hallucination, and psychotic behavior. Intravenous physostigmine in doses of 0.5 mg to 2 mg is effective in reversing this syndrome. Because the duration of action of parenteral physostigmine is 1 to 2 hours, repeated administrations may be necessary to avoid recurrence of the syndrome.

Paralytic Ileus and Bladder Atony

After abdominal and pelvic surgery, there is often a failure of normal peristalsis that leads to postoperative abdominal distention and discomfort. Neostigmine has been used in the

treatment of this condition, as has bethanechol, which is preferred to other choline esters because of its reduced cardiac effect. Bladder atony also follows surgery and sometimes parturition. It leads to urinary retention and is treated with bethanechol or neostigmine.

Senile Dementias of the Alzheimer Type

Alzheimer's disease and related senile dementias are progressive and debilitating neuropsychiatric diseases. Alzheimer's disease is manifested by memory loss, language deficits, and other symptoms, and usually terminates in death from some debilitating condition in approximately a decade. Although the cause of Alzheimer's disease remains an active area of investigation, the dementia apparently is a form of amyloid encephalopathy resulting from the deposition of the protein β -amyloid in selective regions of the CNS.¹⁵ The deposition of this protein causes the formation of neurofibrillary tangles, oxidation, inflammation, neuronal cell death from multiple factors, and loss of several different neurotransmitters important in cognition and memory.⁷ One central neurochemical affected by Alzheimer's disease, especially early in the course of the illness, is ACh.

Deficits in ACh and in choline acetyltransferase, the enzyme responsible for the formation of ACh from choline and acetyl coenzyme A, have been identified in the brains of patients with Alzheimer's disease. The identification of these deficiencies suggested a treatment strategy for Alzheimer's disease analogous to that used in the pharmacologic therapy of Parkinson's disease—replacement of the missing (in this case cholinergic) agonist.¹⁴ Early experiments with physostigmine showed some transient, although variable, improvement. The AChE inhibitors that are used to treat Alzheimer's disease easily penetrate the blood-brain barrier. Tacrine, a longer acting reversible anticholinesterase, is approved for palliative treatment of mild-moderate forms of Alzheimer's disease; however, tacrine is also capable of producing significant, although reversible, hepatotoxicity at therapeutic doses and is now rarely used. Donepezil, rivastigmine, and galantamine are newer AChE inhibitors used to treat Alzheimer's disease. The AChE inhibitors have shown modest but significant improvement in patients with Alzheimer's disease.^{4,5} Their benefit seems to be in temporarily slowing memory loss and loss of function.

Other strategies, aimed mostly at reducing the adverse responses to β -amyloid, are being actively investigated. AChE inhibitors for Alzheimer's disease are often administered with vitamin E, an antioxidant, and memantine, an N-methyl-D-aspartate receptor antagonist.⁷

Other Uses

Methacholine inhalation is sometimes used as a challenge test for the diagnosis of bronchial asthma, and edrophonium has been given intravenously to abort attacks of paroxysmal atrial tachycardia. Both uses have undesirable adverse potentials (bronchoconstriction with methacholine and bradycardia with edrophonium), however, and are indicated only when more established diagnostic or therapeutic approaches have been exhausted.

In addition to the use of organophosphates for insecticides, many carbamate reversible AChE inhibitors are also available as insecticides.

THERAPEUTIC USES IN DENTISTRY

All the cholinomimetic drugs that have an affinity for muscarinic sites are capable of stimulating salivation. Xerostomia is a common problem encountered by dentists in patients with Sjögren's syndrome,¹ patients who have had head and neck

radiation, and patients undergoing treatment involving drugs that produce dry mouth. Muscarinic receptor agonists may be useful in stimulating salivary flow when there is functional salivary gland tissue present and when there is no contraindication for their use. Muscarinic receptor agonists should not be administered if they will compromise other therapy that the patient is undergoing. Antimuscarinic therapy for overactive bladder (see Chapter 9) would tend to be compromised by the administration of a muscarinic receptor agonist. (Antimuscarinic drug therapy would likewise reduce the clinical efficacy of pilocarpine or cevimeline.) Muscarinic receptor agonists are contraindicated in urinary tract obstruction, hyperactive airway disease, chronic obstructive pulmonary disease, acute heart failure, gastrointestinal spasms, hyperthyroidism, and acute iritis. Pilocarpine is usually taken at doses of 5 mg or 10 mg three times a day, 30 minutes before each meal. Cevimeline is given at a dose of 30 mg three times daily. As mentioned previously, physostigmine may be valuable in treating certain adverse reactions to antimuscarinic drugs used for intravenous sedation.

CHOLINERGIC DRUGS

<i>Nonproprietary (generic) name</i>	<i>Proprietary (trade) name</i>
Cholinomimetics	
Acetylcholine	Miochol-E
Bethanechol	Urecholine
Carbachol	Miostat, Isopto Carbachol
Cevimeline	Evoxac
Methacholine	Provocholine
Pilocarpine hydrochloride	Pilocar, Pilocel, Salagen
Pilocarpine nitrate*	P.V. Carpine Liquifilm
Pilocarpine ocular therapeutic system	Ocusert Pilo-20, Ocusert Pilo-40
Pilocarpine and epinephrine	E-Pilo-1, P ₂ E ₁
Pilocarpine and physostigmine	Isopto P-ES
Anticholinesterases	
Ambenonium	Mytelase
Demecarium	Humorsol
Donepezil	Aricept
Echothiophate	Phospholine
Edrophonium	Tensilon, Reversol
Galantamine	Razadvne, Reminyl
Isoflurophate*	Floropryl
Neostigmine	Prostigmine
Physostigmine	Eserine Sulfate, Isopto Eserine
Physostigmine salicylate	Antilirium
Pyridostigmine	Mestinon
Rivastigmine	Exelon
Tacrine	Cognex
Cholinesterase reactivator	
Pralidoxime	Protopam

*Not currently available in the United States.

CITED REFERENCES

1. Al-Hashimi I: Xerostomia secondary to Sjögren's syndrome in the elderly: recognition and management. *Drugs Aging* 22:887-899, 2005.

2. Ammirati JF, Traquair JA, Horgen PA: *Poisonous mushrooms of the northern United States and Canada*, Minneapolis, 1986, University of Minnesota Press.
3. Beers WH, Reich E: Structure and activity of acetylcholine. *Nature* 228:917-922, 1970.
4. Birks J: Cholinesterase inhibitors for Alzheimer's disease. *Cochrane Database Syst Rev* Issue 1:CD005593, 2006.
5. Burns A, O'Brien J: Clinical practice with anti-dementia drugs: a consensus statement from British Association for Psychopharmacology. *J Psychopharmacol* 20:732-755, 2006.
6. Cannard K: The acute treatment of nerve agent exposure. *J Neurol Sci* 249:86-94, 2006.
7. Cummings JL: Alzheimer's disease. *N Engl J Med* 351:56-67, 2004.
8. Dale HH: The action of certain esters and ethers of choline, and their relation to muscarine. *J Pharmacol Exp Ther* 6:147-190, 1914.
9. Dowd FJ: Saliva and dental caries. *Dent Clin North Am* 43:579-597, 1999.
10. Engelhardt E, Loewi O: Fermentative Azetylcholinspaltung im Blut und ihre Hemmung durch Physostigmine. *Naunyn Schmiedebergs Arch Pharmacol* 150:1-13, 1930.
11. Featherstone JD: Science and practice of caries prevention. *J Am Dent Assoc* 131:887-899, 2000.
12. Fox PC: Salivary enhancement therapies. *Caries Res* 38:241-246, 2004.
13. Furchgott RF: Endothelium-derived relaxing factor: discovery, early studies, and identification as nitric oxide. *Biosci Rep* 19:235-251, 1999.
14. Giacobini E: Cholinesterase inhibitors: from the Calabar bean to Alzheimer's therapy. In Giacobini E, editor: *Cholinesterases and cholinesterase inhibitors*, London, 2000, Martin Dunitz.
15. Harkany T, Penke B, Luiten PG: β -Amyloid excitotoxicity in rat magnocellular nucleus basalis: effect of cortical deafferentation of cerebral blood flow regulation and implications for Alzheimer's disease. *Ann N Y Acad Sci* 903:374-386, 2000.
16. Hunt R, Taveau RM: On the physiological action of certain choline derivatives and new methods for detecting choline. *BMJ* 2:1788-1791, 1906.
17. Ignarro LJ, Cirino G, Casini A, et al: Nitric oxide as a signaling molecule in the vascular system: an overview. *J Cardiovasc Pharmacol* 34:879-886, 1999.
18. Lange W, von Krueger G: Über Ester der Monofluorphosphorsäure. *Bericht Deutschen Keramischen Gesellschaft* 65:598-1601, 1932.
19. Mandel ID: The role of saliva in maintaining oral homeostasis. *J Am Dent Assoc* 119:298-304, 1989.
20. Mandel ID, Wotman S: The salivary secretions in health and disease. *Oral Sci Rev* 8:25-47, 1976.
21. Marquis RE, Whitson JT: Management of glaucoma: focus on pharmacological therapy. *Drugs Aging* 22:1-21, 2005.
22. Massoulié J, Bon S: The molecular forms of cholinesterase and acetylcholinesterase in vertebrates. *Annu Rev Neurosci* 5:57-106, 1982.
23. Remen L: Zur Pathogenese und Therapie der Myasthenia gravis pseudoparalytic. *Deutsche Z Nervenheilkunde* 128:66-78, 1932.
24. Schwendimann RN, Burton E, Minagar A: Management of myasthenia gravis. *Am J Ther* 12:262-268, 2005.
25. Senanayake N, Karaliedde L: Neurotoxic effects of organophosphorus insecticides: an intermediate syndrome. *N Engl J Med* 316:761-763, 1987.
26. Sussman JL, Harel M, Frolov F, et al: Atomic structure of acetylcholinesterase from *Torpedo californica*: a prototypic acetylcholine-binding protein. *Science* 253:872-879, 1991.
27. Walker MB: Case showing the effect of prostigmine on myasthenia gravis. *Proc R Soc Lond [Biol]* 28:759-761, 1935.

GENERAL REFERENCES

- Allingham RR, Shields MB: *Shields' textbook of glaucoma*, ed 5, Philadelphia, 2005, Lippincott Williams & Wilkins.
- Birdsall NJM, Brown DA, Buckley NJ, et al: Acetylcholine receptors (muscarinic). In *The IUPHAR receptor database online*, 2005, IUPHAR Media. Available at: <http://www.iuphar-db.org/GPCR/ReceptorListForward>. Accessed September 28, 2009.
- Massoulié J: Molecular forms and anchoring of acetylcholinesterase. In Giacobini E, editor: *Cholinesterase and cholinesterase inhibitors*, London, 2000, Martin Dunitz.
- Silman I: *Cholinergic mechanisms: function and dysfunction*, New York, 2004, Taylor & Francis. Foot note for box

Antimuscarinic Drugs

FRANK J. DOWD

Various drugs can interfere with the transmission of nerve impulses at cholinergic junctions. As shown in Table 5-2, some drugs prevent the uptake of choline by the nerve terminal or the release of acetylcholine (ACh) from the terminal; other drugs block at ganglia or, by a competitive or depolarizing form of blockade, at neuromuscular junctions. The drugs presented in this chapter block responses in muscarinic receptors and are essentially without effect except at inordinately high doses at nicotinic receptors. These drugs are known as *antimuscarinic* or *muscarinic receptor-blocking drugs*; the term *anticholinergic*, although often used for this class of drugs, is inaccurate because these drugs, for the most part, are selective for muscarinic receptors but not nicotinic receptors. They are also termed *atropine-like* because of their derivation from or relation to the oldest and best-known member of the group. Because peripheral muscarinic receptors are the primary targets of ACh released by postganglionic cholinergic neurons, the effects achieved by the antimuscarinic drugs are chiefly on smooth muscle, cardiac muscle, and glands that are innervated by these neurons.

The natural alkaloids are derived from numerous plants, including *Atropa belladonna* (deadly nightshade); *Datura stramonium*, also known as jimsonweed or Jamestown weed; *Hyoscyamus niger* (henbane); and mandragora, among others. *Datura* was used in India in ancient times—its name comes from the Sanskrit. These drugs are mentioned in the Ebers papyrus (circa 1550 BC), in the Greek herbal of Dioscorides, and by Galen. In Western civilization, the drugs were used by professional poisoners in the Middle Ages for slow poisoning because of the obscure symptoms and the slow course of illness. The Swedish botanist Linné named the shrub *Atropa belladonna* after Atropos, one of the three Fates, who cuts the thread of life. The term *belladonna* comes from the Italian and means “beautiful woman”; this term was used because instillation of one of these drugs into the eyes was said to make women more attractive. Atropine, scopolamine, and related natural chemicals are also referred to as *belladonna alkaloids*.

CHEMISTRY AND CLASSIFICATION

Antimuscarinic drugs fall into four categories, as follows:

1. Naturally occurring belladonna alkaloids—atropine and scopolamine—which are organic esters. Atropine and scopolamine are composed of an aromatic acid (tropic acid) and a complex organic base (tropine or scopine). Atropine is a racemic mixture of *d*-hyoscyamine and *l*-hyoscyamine; the *l* isomer is the active form and is often used separately.

2. Semisynthetic derivatives, such as homatropine, which is produced by combining tropine with mandelic acid, and the quaternary ammonium derivatives of atropine, scopolamine, and homatropine (atropine methylnitrate, methscopolamine bromide, and homatropine methylbromide).
3. Synthetic quaternary ammonium compounds, such as methantheline, propantheline, and ipratropium.
4. Synthetic antimuscarinic drugs that are not quaternary ammonium compounds, such as benztropine, trihexypenidyl, and cyclopentolate.

A prototypic chemical structure of each of these types is shown in Table 9-1, and a more extensive list is at the end of the chapter.

MECHANISM OF ACTION

The antimuscarinic drugs—whether the naturally occurring alkaloids or the semisynthetic or synthetic derivatives—are competitive antagonists of ACh at muscarinic receptors. (Review Figure 5-1 for the principal location of muscarinic receptors.) They have an affinity for muscarinic receptor sites but lack intrinsic activity.¹ They occupy the receptor sites and prevent access of ACh, creating a blockade that is generally reversible by increasing the amount of ACh in the area of the receptor, as would occur after the administration of an anticholinesterase drug. Because atropine can antagonize the muscarinic effects of the anticholinesterases and vice versa, each drug can be used as an antidote for the other in case of poisoning. The antimuscarinic drugs are capable of blocking responses to parasympathetic nerve stimulation, to sympathetic nerve stimulation of thermoregulatory sweat glands, to ACh protected from hydrolysis by anticholinesterases, and to direct-acting muscarinic agents, although their capability for inhibiting the latter two is greater than for the first two.

Several explanations have been offered for why atropine is more effective in blocking the pharmacologic effects produced by muscarinic receptor agonists than in blocking physiologic responses evoked by parasympathetic nervous system stimulation. One possibility is that ACh released into the restricted environs of a junctional cleft may overwhelm the antagonist by the high, although temporary, concentrations achieved. A second possibility is that the antimuscarinic drugs facilitate ACh release from cholinergic neurons by blocking presynaptic muscarinic receptors that limit evoked ACh release. A third explanation arises from the fact that physiologic responses to parasympathetic nervous system stimulation are mediated by several neurotransmitters in addition to ACh. Direct electrical stimulation of the parasympathetic nervous system causes the release of ACh and several other

TABLE 9-1

Chemical Structures of Representatives of the Four Classes of Antimuscarinic Drugs

TYPE OF COMPOUND	EXAMPLE	CHEMICAL STRUCTURE
Naturally occurring alkaloid	Atropine	
Semisynthetic derivative of alkaloid	Methscopolamine	
Synthetic quaternary ammonium compound	Propantheline	
Synthetic but not quaternary ammonium compound	Benztropine	

TABLE 9-2

Relative Effects of Atropine and Scopolamine on Various Effectors

	IRIS	CILIARY BODY	SECRETION: SALIVA, SWEAT, BRONCHIAL	BRONCHIAL MUSCLE	GASTROINTESTINAL MUSCLE	HEART	CENTRAL NERVOUS SYSTEM
Atropine	+	+	+	++	++	++	+
Scopolamine	++	++	++	+	+	+	++

neurotransmitters from the postganglionic nerve terminal.⁷ ACh and adenosine triphosphate (ATP) are released from postganglionic parasympathetic nerves. In this setting, ATP, acting on nucleotide receptors, functions as a cotransmitter with ACh.⁹

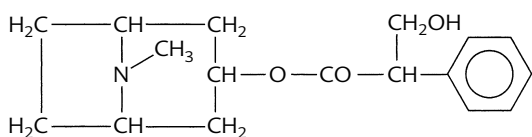
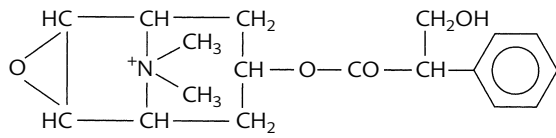
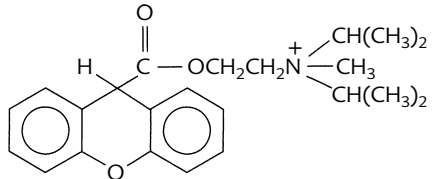
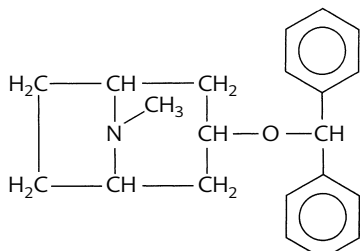
Although atropine is a highly effective antagonist at all muscarinic receptors, evidence has accumulated that there are five muscarinic subtypes, M_1 to M_5 , each with different affinities for certain muscarinic agonists and antagonists, different anatomic distributions, and different second messenger signaling mechanisms (see Chapters 5 and 8). The relatively selective affinity of the tricyclic benzodiazepine pirenzepine for M_1 receptors versus M_2 and M_3 receptors gives it stronger antimuscarinic properties in certain sites (e.g., corpus striatum, cerebral cortex, and enterochromaffin cells) compared with others (e.g., heart and ileum). Pirenzepine, which is available outside of the United States, was the first clinically useful selective muscarinic receptor antagonist. Darifenacin is a selective antagonist at the M_3 receptor and is available for treatment of overactive bladder.¹⁴ The characterization of dif-

ferent muscarinic receptor subtypes continues to provide an impetus for development of selective antagonists.

PHARMACOLOGIC EFFECTS

Therapeutic doses of antimuscarinic drugs produce effects attributable to the blockade of peripheral muscarinic receptors and similar receptors in the central nervous system (CNS) located within the medulla and higher cerebral centers. In the following discussion, atropine and scopolamine, which have always been considered the prototypes for this class of drugs, are principally reviewed, but (1) atropine and scopolamine differ in the relative intensity of their antimuscarinic effects on specific organs (Table 9-2); (2) there is a difference in the susceptibility of various effectors to antimuscarinic agents in general (Table 9-3); (3) because of differences in chemical structure, some antimuscarinic drugs pass readily into the CNS, whereas others do not; (4) there are some major differences among antimuscarinic drugs

TABLE 9-3

Order of Susceptibility of Effectors to Increasing Doses of Antimuscarinic Agents

RESPONSE	DOSE
Secretion (saliva, sweat, bronchial)	Low
Mydriasis, cycloplegia, tachycardia	↓
Loss of parasympathetic control of urinary bladder and gastrointestinal smooth muscle	↓
Inhibition of gastric secretion	High

TABLE 9-4

Onset and Duration of Cycloplegia Induced by Some Topical Antimuscarinic Drugs

DRUG	ONSET (min)	DURATION
Atropine	30-40	≥6 days
Scopolamine	20-30	3-6 days
Homatropine	40-60	1-3 days
Cyclopentolate	25-75	6-24 hr
Tropicamide	20-35	2-6 hr

in the onset and duration of their actions (Table 9-4); and (5) muscarinic receptor subtypes have differing affinities for specific antimuscarinic drugs.

Peripheral Nervous System Actions

The antimuscarinic drugs possess peripheral nervous system and CNS actions, but the nature and intensity of these vary with the individual drug and the dose administered. Most peripheral nervous system effects are caused by an interruption of parasympathetic impulses to a given effector. This interruption results in control of the tissue or organ by the sympathetic nervous system, which often exerts effects opposite to those of the parasympathetic nervous system. An important exception is where the sympathetic effect acts through muscarinic receptors, most notably in the sweat glands. The sympathetic effect of sweating is inhibited by antimuscarinic drugs. The pharmacologic effects observed depend largely on the existing activity of postganglionic cholinergic neurons. Inhibition of sweating and hyperthermia are likely to be observed on a hot day, but no effect on thermoregulation is apparent in a cold environment. Generally, atropine-like drugs block the salivation, lacrimation, urination, and defecation response to cholinergic drugs described in Chapter 8 and the hypotensive and bradycardic effects of muscarinic receptor stimulation. The effects of antimuscarinic agents on specific tissues are described next.

The eye

Atropine-like drugs block muscarinic receptors in the sphincter of the iris and in the ciliary muscle, leading to dilation of the pupil (mydriasis) and paralysis of accommodation (cycloplegia). Photophobia and fixation of the lens occurs for far vision, and vision for near objects is blurred. Intraocular pressure is not significantly affected except in the case of narrow-angle (or angle-closure) glaucoma, for which administration of these drugs may cause a dangerous increase in intraocular pressure. The onset and duration of the mydriatic and cycloplegic effects differ, as shown for cycloplegia in Table 9-4, and to some extent the choice of an agent for an ophthalmologic procedure is influenced by these differences.

Respiratory tract

After administration of antimuscarinic drugs, the bronchial smooth muscle is left under the sole control of the sympathetic nervous system and is relaxed. This relaxation of the smooth muscle decreases airway resistance. Sometimes there is an increase in respiratory minute volume resulting from an increase in the physiologic dead space and medullary stimulation. The bronchoconstriction caused by muscarinic agonists, sulfur dioxide, and certain other bronchial spasmogens is easily reversed by atropine, but bronchoconstriction caused by histamine, 5-hydroxytryptamine, and the leukotrienes is resistant.

Secretion of all glands in the nose, mouth, pharynx, and respiratory tree is inhibited. This suppression of secretory activity in the respiratory tract is the underlying reason for the effectiveness of antimuscarinic drugs in preventing laryngospasm during general anesthesia; these agents are incapable of directly blocking contraction of the laryngeal muscle.

Salivary glands

Parasympathetically mediated salivary secretion is abolished in a dose-dependent manner, whereas salivary gland vasodilation is much less affected. The mouth and throat become unpleasantly dry, to the point that speech and swallowing may become difficult. Dry mouth or xerostomia can lead to numerous adverse effects on the oral cavity (see Chapter 8).

Gastrointestinal tract

Although antimuscarinic drugs are quite effective in preventing the expected motor and secretory responses of the gastrointestinal tract to administered cholinergic drugs, their effects on vagal stimulation are more ambiguous. Antimuscarinic drugs have a marked inhibitory effect on motility throughout the gastrointestinal tract. Interference with the normal parasympathetic impulses to the gastrointestinal tract, as would occur with antimuscarinic drugs and ganglionic blocking agents, causes a profound decrease in the tone of gastrointestinal smooth muscle and in the frequency and amplitude of peristaltic contractions. Regarding secretion, gastric secretory activity in humans is inhibited only at very high doses of belladonna alkaloids, when essentially all other parasympathetic function has been blocked and the patient has an extremely dry mouth, blurred vision, an increased heart rate, and marked inhibition of gastrointestinal motility. At these high doses, atropine reduces gastric acidity, pepsin secretion, and total gastric secretion.

The fact that the gastrointestinal tract, particularly the secretory apparatus, is resistant to belladonna alkaloids and the fact that the therapeutic use of these drugs as antiulcer and antispasmodic agents has been disappointing underscore the finding that transmitters in addition to ACh are involved in the regulation of secretion and motor activity in the gastrointestinal tract (see Chapter 33). Two of these transmitters are ATP and histamine. At high doses, atropine has antihistaminic (H_1) activity, and the antihistamine diphenhydramine has marked antimuscarinic activity, one manifestation of which is xerostomia.

Cardiovascular system

The effects of antimuscarinic drugs differ according to the dose administered and whether the subject is in the erect or recumbent position. With oral doses used to limit salivation (e.g., 0.4 mg to 0.6 mg of atropine in adults), mild bradycardia often results. At these low doses, a selective blockade of pre-junctional muscarinic receptors augments ACh release from postganglionic parasympathetic fibers innervating the heart. In most cases, however, the heart rate increases significantly in humans given more than 0.4 mg intravenously or 1 mg orally. In a standing or upright patient, there is little or no change in cardiac output. As implied in Table 9-2, doses of

scopolamine that cause mydriasis rarely cause tachycardia, whereas atropine administered systemically in doses sufficient to have ocular effects inevitably accelerates the heart rate.

Genitourinary tract

The ureters and the urinary bladder (detrusor muscle) are relaxed by atropine.³ The sphincter and trigone muscles are contracted by atropine. These effects are due to muscarinic receptor blockade. Together these changes in the bladder cause urinary retention in humans. This retention is particularly likely in the presence of prostatic hypertrophy.

Body temperature

Belladonna alkaloids suppress sweating because the sweat glands (other than the apocrine sweat glands as found on the palms of the hand) are innervated by cholinergic fibers of the sympathetic nervous system. The receptors at the neuroeffector sites in the sweat glands are muscarinic. The increase in body temperature that can follow the administration of large doses of atropine or scopolamine may have a CNS component, but the primary cause is the peripheral inhibition of sweating. It is also the most serious and life-threatening result of an overdose of one of these drugs.

Central Nervous System Effects

CNS effects are produced only by antimuscarinic drugs that can penetrate the blood-brain barrier. The quaternary amines, such as methscopolamine and propantheline, have little or no effect on the CNS.

Medulla and higher cerebral centers

Scopolamine and atropine produce complex effects on the CNS. With conventional therapeutic doses of atropine, there is direct stimulation of the CNS, which is generally manifested only as a mild stimulation of respiratory centers located in the vagal nuclei of the medulla. At therapeutic doses, scopolamine usually produces effects ranging from decreased psychological efficiency to drowsiness, sedation, euphoria, and amnesia, but it can also cause excitement, restlessness, hallucinations, and delirium. Atropine is much less active in this respect than scopolamine.

Antitremor activity

Belladonna alkaloids were first used in the treatment of Parkinson's disease in the mid-1800s, long before their mechanism of action was understood and before the biochemical nature of the defect of parkinsonism had been elucidated. Their effectiveness in suppressing tremor was later suggested to result from a "central atropine-ACh antagonism," and more recently it has become apparent that the striatum is the site of cholinergic systems that in parkinsonism are released from an inhibitory balance mediated by dopamine (see Chapter 15).

Vestibular function

Since ancient times, belladonna alkaloids have been the basis of various remedies to treat motion sickness.¹¹ Scopolamine is more effective than atropine. It acts on several areas of the brain, including the vestibular apparatus and the cortex.

ABSORPTION, FATE, AND EXCRETION

Belladonna alkaloids and their tertiary derivatives and analogues are readily absorbed from all parts of the gastrointestinal tract except the stomach, as would be expected with alkaloids that form acid salts. Absorption is more rapid from subcutaneous tissue or muscle than it is from the gastrointestinal tract. The drugs are distributed throughout the body, including the CNS. The fate of most of these drugs in humans

is not well studied, but the kidneys provide the main route for excretion of atropine in changed and unchanged form. Within 24 hours, 27% to 94% of a dose of labeled atropine is excreted, and very little is excreted after 24 hours. A third of the atropine appears as unchanged atropine, and the remainder appears as a metabolite of uncertain identity.⁸ Rabbits possess a genetically determined enzyme, atropinesterase, which explains their singular ability to tolerate large doses of atropine. Various idiosyncratic responses or variations in sensitivity to one or another of the actions of these drugs are not uncommon. Young individuals show a high incidence of idiosyncratic responses; individuals with Down syndrome are more sensitive to the mydriatic effects; and African American individuals develop more exaggerated tachycardia.

Antimuscarinics with a quaternary ammonium structure are incompletely absorbed after oral ingestion and are often given by nonenteral routes. These drugs are largely excluded from the CNS.

GENERAL THERAPEUTIC USES

The therapeutic uses of antimuscarinic drugs all are based on the peripheral and central pharmacologic effects already discussed. It is difficult to obtain a high degree of selectivity in the organ or organs to be affected, however, because antimuscarinic drugs tend to affect many muscarinic sites. Nevertheless, certain drugs are more effective and potentially more useful in a particular therapeutic role than others. The quaternary ammonium compounds, two of which are shown in Table 9-1, differ from atropine and scopolamine in many important respects. Two important differences are (1) they do not readily pass the blood-brain barrier because they are ionized at physiologic pH and they have little or no effect on the CNS, and (2) they have greater ganglionic blocking properties than the nonquaternary compounds. This latter difference may explain why orthostatic hypotension and impotence are sometimes encountered in patients being treated with these drugs.

Ophthalmology

By local administration of antimuscarinic drugs, it is possible to produce mydriasis and cycloplegia of very long duration (atropine), medium duration (scopolamine), and very short duration (tropicamide). Mydriasis is necessary for a thorough examination of the retina and optic disk; cycloplegia is necessary for measurement of the refractive powers of the lens. Mydriasis can be produced alternately with miosis for the purpose of breaking up adhesions that may have developed between the lens and the iris. The topical use of these drugs is strongly contraindicated in patients with a predisposition to narrow-angle glaucoma, and although systemic anticholinergic drugs are usually safe for patients with open-angle glaucoma, they may precipitate a first attack of acute angle-closure glaucoma. Homatropine, cyclopentolate, and tropicamide are the major mydriatics used. The duration of effects ranges from 1 to 3 days for homatropine to 6 hours or less for tropicamide.

Respiratory Tract

Belladonna alkaloids previously were commonly used for the treatment of bronchial asthma, but liabilities, including limited effectiveness and a tendency to inhibit secretions, which often led to the retention of a viscid residuum further obstructing airflow, resulted in their abandonment as soon as replacement therapies became available. Subsequently, the quaternary ammonium compound ipratropium was marketed in aerosol form for the treatment of chronic obstructive pulmonary disease. It is highly effective for patients with chronic bronchitis and has been used in acute asthma and status asthmaticus in patients unresponsive to β_2 -adrenergic receptor

agonists, although it is considered a secondary drug in the treatment of acute asthma.⁵ The inhalation route limits systemic side effects and reduces the risk of inhibiting bronchial secretion.

As antimuscarinic drugs, ipratropium and similar drugs are unique in their preservation of ciliary motility in the bronchial mucosa, an important benefit in preventing the formation of mucous plugs.^{2,17} Tiotropium is a drug similar in action to ipratropium. It also is given by inhalation, but has a longer duration of action than ipratropium and can be administered once a day.^{12,15} The ability of atropine-like drugs to suppress secretion throughout the respiratory tract is advantageous during the administration of general anesthesia because these drugs produce a dry field, lessen the danger of pulmonary aspiration, and help prevent laryngospasm.

Salivary Secretion

Antimuscarinic drugs are widely used to diminish salivary secretion before oral procedures and before surgery, particularly oral surgical procedures. The use of antimuscarinic drugs for this purpose provides a dry oral cavity and diminishes the salivary response during surgery. Atropine is occasionally used to reduce excessive salivary secretion in heavy metal poisoning and parkinsonism.

Gastrointestinal Tract

Antimuscarinic drugs have been used extensively as antispasmodics, as antiulcer agents, and for various disorders characterized by the term *spasticity*. Although their use is often attended by symptomatic relief, they have proved of questionable benefit in the treatment of peptic ulcer, severe dysenteric illnesses, and so-called spasticity syndromes. It has become popular to substitute the synthetic quaternary ammonium compounds for the naturally occurring alkaloids for these therapeutic goals on the questionable basis that side effects would be less severe with the synthetic compounds. As shown in Table 9-3, if reduction in intestinal peristalsis is a therapeutic aim with this kind of drug, tachycardia, blurring of vision, and dryness of mouth must be accepted as inevitable side effects. Pirenzepine, an M₁-selective muscarinic receptor antagonist, has been found to suppress resting and stimulated acid and pepsin secretion without producing as many effects on the heart, bladder, or ocular structures—all locations where receptors other than M₁ muscarinic receptors predominate.

Cardiovascular System

The application of antimuscarinic drugs to the treatment of cardiovascular disorders is limited. They can be used during anesthesia and surgery to prevent vagal reflexes, in cases of myocardial infarction in which there is excessive vagal tone causing sinus or nodal bradycardia, in cases of a hyperactive carotid sinus reflex producing bradycardia and syncope, and in certain cases of digitalis-induced heart block. Some other forms of heart block are also amenable to atropine therapy.

Genitourinary Tract

Belladonna alkaloids have been used to treat various urologic disorders, including renal colic (usually in combination with opioids), nocturnal enuresis, and overactive bladder associated with urge incontinence and urinary frequency. Because the bladder is less susceptible than some other tissues to the action of muscarinic drugs (see Table 9-3), nonselective antimuscarinic drugs have not proved very useful in the treatment of these disorders. Drugs that have additional direct relaxant effects on smooth muscle, such as flavoxate and oxybutynin, are more useful for symptomatic relief of dysuria, urgency, and incontinence associated with inflammatory or neurogenic conditions. Tolterodine, trospium, darifenacin, and solifenacin are additional antimuscarinic drugs used to treat these conditions.^{14,16,18} They apparently have some selectivity for

the urinary bladder.³ For treating nocturnal enuresis in children, tricyclic antidepressants (see Chapter 12) and the anti-diuretic hormone analogue desmopressin (see Chapter 34) are more commonly used than antimuscarinic drugs.

Peanesthetic Medication

Belladonna alkaloids also are used for preanesthetic medication. Scopolamine in particular provides the CNS effects of euphoria, amnesia, and sedation, in addition to the inhibition of salivary and other secretions and the protection that this inhibition furnishes against laryngospasm.

Central Nervous System

Other uses for the CNS effects of antimuscarinic drugs are to prevent motion sickness and to treat Ménière's disease. Scopolamine is an effective drug for severe, brief motion sickness when given prophylactically. It is not particularly effective in preventing nausea and vomiting from most other causes, such as radiation sickness. Scopolamine has been prepared in a transdermal system for the prevention of motion sickness. The patch has an adhesive surface that, when placed on the skin behind the ear, delivers 1.5 mg of scopolamine over 3 days. An effective concentration of the drug in the blood is achieved in about 4 hours. Delivered transdermally, the usual effects of cholinergic blockade are minimized, although there is occasional dryness of the mouth and drowsiness.¹³

In Parkinson's disease (see Chapter 15), the anticholinergics are the oldest drugs used for this condition, and they are still considered useful in the early stages of the disease and in combined therapy with levodopa and other antiparkinsonian drugs. Antimuscarinic drugs are also used to treat Parkinson-like adverse effects of antipsychotic drugs. The antimuscarinic drugs favored for treating Parkinson's disease or Parkinson-like symptoms are the nonquaternary synthetic compounds that gain ready access to the brain and have greater CNS effects than peripheral nervous system effects. These drugs include benztropine, biperiden, trihexyphenidyl, and antihistamines such as diphenhydramine that also have antimuscarinic properties (see Chapter 15).

Antidote to Anticholinesterases

Toxicity from anticholinesterases may result from their use in the treatment of myasthenia gravis (particularly in the early phase of therapy when the patient is not as tolerant to the muscarinic effects of these drugs) or from exposure to an organophosphate insecticide or anticholinesterase nerve gas. These anticholinesterases typically produce a spectrum of peripheral muscarinic and nicotinic effects and CNS effects. Atropine is effective in antagonizing the effects at muscarinic sites and relieves the hypersecretion of salivary, lacrimal, and respiratory glands; bronchoconstriction; gastrointestinal symptoms; sweating; various other manifestations of muscarinic stimulation; and some CNS actions. It does not interfere with the desired effects of anticholinesterases at neuromuscular junctions when these drugs are being used for myasthenia gravis or to reverse neuromuscular blockade induced by curare-like agents (see Chapter 10); atropine also does not prevent the neuromuscular stimulation, followed by respiratory failure, characteristic of excessive nicotinic stimulation. For treatment of acute toxicity with anticholinesterases, very large doses of atropine are used; for treatment of milder symptoms of muscarinic stimulation, as in the treatment of myasthenia gravis, much smaller doses suffice.⁶

Antidote to Poisoning by Mushrooms Containing Muscarine

As stated in Chapter 8, the mushroom *Inocybe lateraria* is poisonous because of its high content of the alkaloid muscarine. Atropine is a specific antagonist of antimuscarinic chemicals found in this and other plant sources.

ADVERSE EFFECTS

Atropine and related drugs, despite wide availability and defined toxicity, have produced few fatal cases of poisoning in adults. Children are more sensitive to atropine, and most reported fatalities have involved children who accidentally ingested eye drops or other medicines that contained atropine or scopolamine. Children are more susceptible to hyperthermia and other toxic effects of atropine; dosages need to be carefully controlled. The colloquialism “hot as a hare, red as a beet, dry as a bone, blind as a bat, and mad as a hatter” vividly conveys the symptoms of atropine intoxication, which are predictable extensions of the pharmacologic effects of this group of drugs. Present are dryness of the mouth, extreme thirst, a burning sensation in the throat, and difficulty in swallowing; dilation of the pupils and cycloplegia with severe impairment of vision and photophobia; flushing of the skin, vasodilation of skin vessels, absence of sweating, and an increase in body temperature in warm environments to 40.5° C (105° F) or greater; urinary retention; and derangements of CNS activity. Toxic CNS effects of atropine and homatropine in children include ataxia that becomes so severe that the patients are unable to sit or stand unassisted; a dysarthric quality of speech; restlessness with constant muttering, shouting, and singing; great confusion; visual hallucinations; and violent, aggressive, and maniacal behavior.

Mild toxic reactions may subside in a few hours, whereas most patients require a day or more for complete recovery. Therapy for atropine poisoning includes physostigmine, which is useful in increasing the amount of ACh in the vicinity of the receptors and acts rapidly to terminate the atropine blockade. Antianxiety drugs such as diazepam may be used to control CNS excitation. Therapy also includes supportive care.

A more recent practice of drug abuse in young adults in certain locales of the United States is the chewing of seeds from the moonflower plant (*Datura innoxia*). Patients present with typical signs of antimuscarinic drug poisoning because of the high level of scopolamine in the plant. These signs include hallucinations; dry, hot, and flushed skin; dry mouth; and tachycardia.⁴

Topical use of antimuscarinic drugs in the eye is absolutely contraindicated in cases of suspected or diagnosed narrow-angle glaucoma. Systemic doses of anticholinergic drugs can be used in patients with open-angle glaucoma but not in patients with narrow-angle glaucoma. As previously mentioned, use of these drugs may precipitate the first attack of acute intraocular hypertension. In prostatic hypertrophy, anticholinergic drugs may cause urinary retention.

DRUG INTERACTIONS

The anticholinergic effect of atropine-like drugs is potentiated by antihistamines (which particularly accentuate the xerostomia), the tuberculostatic drug isoniazid, monoamine oxidase inhibitors, tricyclic antidepressants, and several other drugs. Phenothiazines tend to potentiate the CNS effects of the antimuscarinic drugs. When atropine is given in the presence of propranolol, it is likely to antagonize the slowing of the heart and the increased duration of the atrioventricular nodal refractory period for which propranolol may have been prescribed to achieve. Atropine may also block the vagal actions of the digitalis glycosides.

BOTULINUM TOXIN

Botulinum toxin prevents the release of ACh from nerve endings. It is sometimes used to prevent drooling

TABLE 9-5

Preparations and Oral Dosages Used in Dentistry

DRUG	DOSE	TIME OF ADMINISTRATION*
Atropine sulfate	0.4-1.2 mg	30-60 min
Glycopyrrolate	1-2 mg	30-45 min
Hyosycamine sulfate	0.125-0.5 mg	30-60 min
Propantheline bromide	15-30 mg	30-45 min

*Time before the procedure when the drug is administered.

in certain disease states.¹⁰ It is also used to relieve muscle spasm and cosmetically to smooth facial wrinkles and frown lines. Botulinum toxin is discussed in Chapter 10.

THERAPEUTIC USES IN DENTISTRY

The principal use of anticholinergic drugs in dentistry is to decrease the flow of saliva during dental procedures. Small doses given orally or parenterally approximately 30 minutes to 2 hours before the procedure are effective, but these drugs may also produce side effects that may be objectionable to some patients. The same dose may also be used to diminish salivary flow in heavy metal poisoning. Table 9-5 lists four preparations and oral dosages used in dentistry. Atropine is often selected because it is well absorbed from the gastrointestinal tract.

Atropine and glycopyrrolate are frequently used in oral surgery as intraoperative antisialagogues. They are administered intravenously in doses of 0.4 mg to 0.6 mg and 0.1 mg to 0.2 mg. Because it is a quaternary amine, glycopyrrolate has fewer CNS effects than belladonna alkaloids. Compared with atropine, it is a more selective antisialagogue and less likely to promote tachycardia in conventional doses. During general anesthesia, anticholinergics also diminish secretions in the respiratory tract, reducing the likelihood of laryngospasm, and help prevent reflex vagal slowing of the heart.

IMPLICATIONS FOR DENTISTRY

Not only do dentists occasionally have reason to use antimuscarinic drugs, but also dentists often encounter patients who are taking these agents for any one of the reasons enumerated. Drugs of several different pharmacologic classes have substantial antimuscarinic effects. The most characteristic effects of these drugs that concern dentists are xerostomia and the discomfort that this brings to the patient and the deterioration in oral health. Small doses of pilocarpine often are effective in stimulating salivary flow; however, this strategy is complicated by the fact that pilocarpine may also counter the therapeutic benefit being achieved by the antimuscarinic drug. In cases in which using a muscarinic receptor agonist may antagonize therapy involving an antimuscarinic drug, patients can be advised to drink water, suck on noncariogenic lemon drops, and irrigate the mouth with saliva substitutes to alleviate xerostomia. As discussed in Chapter 8, if saliva flow is reduced, patients need to pay scrupulous attention to oral hygiene, and caries control needs to be more aggressive. If there is progressive deterioration in oral health, consultation with the patient's physician may be helpful in identifying suitable therapeutic alternatives without as much xerostomia. The use of antimuscarinic drugs should be avoided in patients with prostate

hypertrophy and patients with atony in the urinary or gastrointestinal tract.

ANTIMUSCARINIC DRUGS

<i>Nonproprietary (generic) name</i>	<i>Proprietary (trade) name</i>
Naturally occurring alkaloids	
Atropine	Atropisol, Sal-Tropine
Belladonna (tincture and extract)	—
Hyoscyamine	Anaspaz, Levsin
Levorotatory alkaloids of belladonna	in Bellamine
Scopolamine	Isopto Hyoscine, Scopace
Scopolamine (transdermal therapeutic system)	Transderm Scop
Semisynthetic derivatives	
Atropine methylnitrate*	—
Homatropine	Isopto Homatropine
Methscopolamine	Pamine
Synthetic quaternary ammonium compounds	
Anisotropine*	Valpin 50
Clidinium	Quarzan
Glycopyrrolate	Robinul
Hexocyclium*	Tral Filmtabs
Ipratropium	Atrovent
Isopropamide*	Darbid
Mepenzolate	Cantil
Methantheline*	Banthine
Propantheline	Pro-Banthine
Tiotropium*	Spiriva
Tridihexethyl*	Pathilon
Synthetic nonquaternary ammonium compounds	
Benztropine	Cogentin
Biperiden	Akineton
Cyclopentolate	Cyclogyl, in Cyclomydril
Dicyclomine	Bentyl, Byclomine
Flavoxate	Urispas
Oxybutynin	Ditropan
Procyclidine	Kemadrin
Propiverine*	Detrunorm
Tolterodine	Detrol
Trihexyphenidyl	Artane
Tropicamide	Mydracil, Tropicacyl
Tricyclic benzodiazepine	
Pirenzepine*	Gastrozepine

*Not currently available in the United States.

CITED REFERENCES

- Ariëns EJ: Affinity and intrinsic activity in the theory of competitive inhibition. Part 1. Problems and theory. *Arch Int Pharmacodyn Ther* 99:32-49, 1954.
- Belmonte KE: Cholinergic pathways in the lungs and anticholinergic therapy for chronic obstructive pulmonary disease. *Proc Am Thorac Soc* 2:297-304, 2005.
- Chancellor MB, Anderson RU, Boone TB: Pharmacotherapy for neurogenic detrusor overactivity. *Am J Phys Med Rehabil* 85:536-545, 2006.
- DeFrates LJ, Hoehns JD, Sakornbut EL, et al: Antimuscarinic intoxication resulting from the ingestion of moonflower seeds. *Ann Pharmacother* 39:173-176, 2005.
- Easton PA, Jadue C, Dhingra S, et al: A comparison of the bronchodilating effects of a beta-2 adrenergic agent (albuterol) and an anticholinergic agent (ipratropium bromide), given by aerosol alone or in sequence. *N Engl J Med* 315:735-739, 1986.
- Grob D: Anticholinesterase intoxication in man and its treatment. In Koelle GB, editor: *Cholinesterases and anticholinesterase agents. Handbuch der Experimentellen Pharmakologie*. Ergänzungswerk, Bd 15, Berlin, 1963, Springer-Verlag.
- Höckfelt T, Bean A, Ceccatelli S, et al: Neuropeptides and classical transmitters: localization and interaction. *Arzneimittelforschung* 42:196-201, 1992.
- Kalser SC: The fate of atropine in man. *Ann N Y Acad Sci* 179:667-683, 1971.
- Kennedy C, Tasker PN, Gallacher G, et al: Identification of atropine-and P2X1 receptor antagonist-resistant neurogenic contractions of the urinary bladder. *Neuroscience* 27:845-851, 2007.
- Meningaud JP, Pitak-Arnop P, Chikhani L, et al: Drooling of saliva: a review of the etiology and management options. *Oral Surg Oral Med Oral Pathol Oral Radiol Endod* 101:48-57, 2006.
- Nishiike S, Takeda N, Uno A, et al: Cholinergic influence on vestibular stimulation-induced locus coeruleus inhibition in rats. *Acta Otolaryngol* 120:404-409, 2000.
- Panning CA, DeBisschop M: Tiotropium: an inhaled, long-acting anticholinergic drug for chronic obstructive pulmonary disease. *Pharmacotherapy* 23:183-189, 2003.
- Price NM, Schmitt LG, McGuire J, et al: Transdermal scopolamine in the prevention of motion sickness at sea. *Clin Pharmacol Ther* 29:414-419, 1981.
- Solifenacin and darifenacin for overactive bladder. *Med Lett Drugs Ther* 47:23-24, 2005.
- Tiotropium (Spiriva) for COPD. *Med Lett Drugs Ther* 46:41-42, 2004.
- Trospium chloride (Sanctura): another anticholinergic for overactive bladder. *Med Lett Drugs Ther* 46:63-64, 2004.
- van Noord JA, Bantje TA, Eland ME, et al: A randomized controlled comparison of tiotropium and ipratropium in the treatment of chronic obstructive pulmonary disease. The Dutch Tiotropium Study Group. *Thorax* 55:289-294, 2000.
- Wein AJ, Rackley RR: Overactive bladder: a better understanding of pathophysiology, diagnosis and management. *J Urol* 175(3 Pt 2):S5-S10, 2006.

GENERAL REFERENCES

- Gross NJ: Anticholinergic agents in asthma and COPD, *Eur J Pharmacol* 533:36-39, 2006.
- Linden CH, Rippe JM, Irwin RS: *Manual of overdoses and poisonings*, Philadelphia, 2006, Lippincott Williams & Wilkins.
- Lucas-Meunier E, Fossier P, Baux G, et al: Cholinergic modulation of the cortical neuronal network, *Pflugers Arch* 446:17-29, 2003.
- Renner UD, Oertel R, Kirch W: Pharmacokinetics and pharmacodynamics in clinical use of scopolamine, *Ther Drug Monit* 27:655-665, 2005.

Drugs Affecting Nicotinic Receptors*

XI-QIN DING

Early in the sixteenth century, Spanish explorers of the New World encountered a plant extract used by South American natives to poison the tips of their hunting arrows. This extract, known as *curare*, was brought back to Europe, and its lethal action was quickly found to depend on muscular paralysis. Further understanding of the actions of curare did not occur for many years.

In 1856, Bernard reported that the site of action of curare was the junction between nerve and muscle. He found that although curare blocked neuromuscular transmission, it did not impede conduction of impulses along the motor nerve or contraction of a directly stimulated muscle. The active substance used by Bernard in his studies, *d*-tubocurarine, was subsequently purified, and in 1942 it was administered for the first time to a patient undergoing surgery for appendicitis to relax the abdominal musculature. Drugs that block neuromuscular transmission have since found widespread acceptance for their ability to produce muscular flaccidity and are frequently administered as adjuncts to general anesthesia during surgery.

In 1889, Langley showed that nicotine could “paralyze” transmission at autonomic ganglia, and in 1905 he showed that nicotine could stimulate muscle when applied to the motor end plate and that curare could block this effect. These findings led to the adoption of the term *nicotinic* to refer to the receptors present at autonomic ganglia and the neuromuscular junction.

The discovery of curare⁴ led to developments in two different directions: to drugs that affect transmission at nicotinic cholinergic receptors and to drugs that interfere with the mechanisms of skeletal muscle contraction. These two topics are the subjects of this chapter.

DRUGS AFFECTING GANGLIONIC TRANSMISSION

Ganglionic Transmission

Nicotinic receptors (see Chapter 1) play a crucial role in the transmission of autonomic impulses across the ganglionic synapse. As described in Chapter 5, acetylcholine (ACh) is the primary neurotransmitter at sympathetic and parasympathetic ganglia, where it is released by preganglionic neurons and stimulates postganglionic neurons by activating nicotinic N_N receptors. Although it is sometimes convenient to think of autonomic ganglia as simple relay stations between the

central nervous system (CNS) and effector tissues, the existence of other receptors and neurotransmitters within the ganglia indicates that some modulation of the primary nervous inputs may occur. It is also evident that transmission is not the same in sympathetic and parasympathetic ganglia even though N_N receptors are the primary receptors in both cases.

Various pharmacologic and electrophysiologic studies on sympathetic ganglia have led to models of ganglionic transmission that involve at least four classes of receptors: cholinergic nicotinic, cholinergic muscarinic, α -adrenergic, and peptidergic.⁸ Muscarinic and peptidergic receptors mediate slow and late slow excitatory postsynaptic potentials, which seem to facilitate the transmission of high-frequency impulses through the primary nicotinic receptor pathway. Catecholamine-containing (dopamine or norepinephrine) interneurons have been proposed for sympathetic ganglia¹² but are not found in parasympathetic ganglia.²¹ As shown in Figure 10-1, these interneurons may be stimulated by preganglionic muscarinic activity to release catecholamines that hyperpolarize the postganglionic neuron, producing an inhibitory postsynaptic potential. These secondary events of ganglionic transmission only modulate the primary depolarization, by making it more or less likely to occur. Conventional N_N receptor antagonists can inhibit ganglionic transmission completely, but muscarinic antagonists, α -adrenergic antagonists, and peptidergic antagonists cannot do so.

There are two important facts in ganglionic transmission. First, the autonomic ganglia contain neuronal components that are not protected by a structure analogous to the blood-brain barrier, which means that they are affected by many drugs and chemicals that never gain access to central synapses. Second, ACh is the primary transmitter of the ganglionic synapse, and any drug that interferes with the synthesis, release, or inactivation of ACh or with its interaction with the N_N receptor has the capacity to interfere with ganglionic transmission.

Ganglionic Stimulating Drugs

Nicotine

Nicotine, as indicated in Chapter 8, is the principal psychoactive ingredient in tobacco products. As a selective depolarizing drug at nicotinic receptors, this alkaloid stimulates transmission at autonomic ganglia and at nicotinic synapses in the CNS. It also activates various sensory fibers equipped with nicotinic receptors, including mechanoreceptors in the lung, skin, mesentery, and tongue; nociceptive nerve endings; and chemoreceptors in the carotid body and aortic arch. Stimulation of nicotinic receptors in skeletal muscle is easily shown in the laboratory, but it is not evident normally in humans

*The author wishes to recognize Dr. Joel D. Schiff for his past contributions to this chapter.

because initial stimulation is soon followed by inhibition at these nicotinic sites. Nicotine has a dual effect on ganglionic transmission—initial stimulation and subsequent depression (see later).

An important feature of nicotinic receptors is their tendency to become desensitized (i.e., unresponsive) on continuous exposure to agonists or depolarizing antagonists (e.g., succinylcholine, as described later). The actions of nicotine are highly time and concentration dependent, and complex

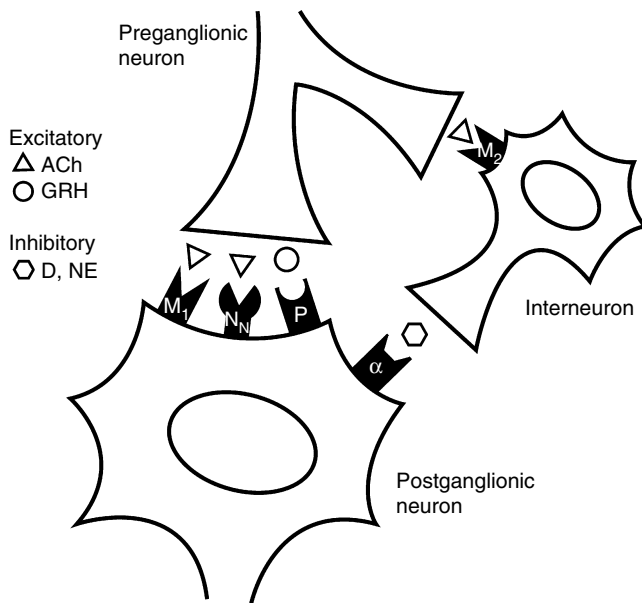

FIGURE 10-1 Synaptic connections in the mammalian superior cervical ganglion. The principal pathway involves nicotinic receptor transmission (N_N) sensitive to conventional ganglionic blocking drugs. Muscarinic receptors (M_1 and M_2), sensitive to atropine blockade, support and inhibit depolarization of the postganglionic neuron. As shown, a catecholamine-containing interneuron may participate in causing inhibition. Corelease of peptides such as gonadotropin-releasing hormone (GRH) produces long-lasting facilitation of transmission. α , α -Adrenergic receptor; ACh, acetylcholine; D, dopamine; NE, norepinephrine; P, peptidergic receptor.

patterns of stimulation and depression are observed. The heart rate may be increased by stimulation of sympathetic ganglia and the adrenal medulla or by inhibition of vagal transmission in the heart, or both. Conversely, blockade of sympathetic transmission to the heart and stimulation of parasympathetic transmission can cause bradycardia. The heart rate may also be affected by central influences and by actions at peripheral sensory sites.

Generally, usual amounts of nicotine absorbed during cigarette smoking cause mild cardiovascular stimulation, increased gastrointestinal activity, and CNS stimulation accompanied in regular users by a feeling of well-being and decreased irritability. With long-term use, tolerance and physical dependence occur. The addictive nature of nicotine is thought to result from its action on the reward pathway—the circuitry in the brain that regulates feelings of pleasure and euphoria.

Acute overdose of nicotine causes nausea and vomiting, abdominal pain, dizziness and confusion, and muscular weakness. If untreated, death may ensue from cardiopulmonary collapse. Nevertheless, the primary health issues regarding nicotine stem from the chronic use of tobacco products. An increased incidence of cancer and cardiovascular and pulmonary disease has been well documented.²⁰ In dentistry, tobacco use has been linked to oropharyngeal carcinoma, leukoplakia, acute and chronic periodontal disease, delayed wound healing, halitosis, and tooth staining.⁵

The only therapeutic use of nicotine is as an adjunct in tobacco cessation programs. Nicotine is administered in multiple forms (Table 10-1) to maintain pharmacologic concentrations of the alkaloid and to prevent tobacco cessation from triggering an acute withdrawal syndrome, which includes irritability, anxiety, sleep disturbances, and cognitive impairment. It also dissociates the self-administration of nicotine from the social, tactile, and oral and olfactory components of tobacco smoking, weakening the psychological link between satisfaction of the nicotine craving and the physical actions of tobacco use. The nicotine dose is reduced in a stepwise fashion over several months, during which time the patient ideally receives continued counseling and motivational assistance to remain abstinent.

Because of the deleterious effects of smoking and smokeless tobacco on oral health, the dentist is encouraged to participate actively in helping patients quit tobacco use.⁵ Such participation may include—in addition to prescribing a

TABLE 10-1

Nicotine-Containing Smoking Deterrents

PRODUCT	PROPRIETARY (TRADE) NAME	NICOTINE CONTENT PER DOSE FORM (mg)	DAILY NICOTINE DOSE (mg)	DURATION (wk)*
Nicotine inhalation system	Nicotrol Inhaler	4 (delivered)	≤64	≤24
Nicotine gum	Habitrol, Nicorette, Nicotrol, Thrive	2 and 4 [†]	≤80	12
Nicotine lozenge	Commit	2 and 4 [†]	≤80	12
Nicotine transdermal system (skin patch) [‡]	NicoDerm CQ	114 76 38	21 14 7	6 2 2
Nicotine nasal spray	Nicotrol NS	0.5 [§]	≤40	≤14

*For the gum, lozenge, and inhalation dosage forms, the number of units used per day is gradually decreased, beginning after 6 weeks of therapy (12 weeks for the inhalation system). The transdermal system uses a sequential schedule, beginning with the strongest patch for individuals smoking more than 10 cigarettes per day (as shown). For individuals who smoke 6 to 10 cigarettes per day, the patch delivering 14 mg/day should be used for 6 weeks, followed by the 7-mg dose for 2 weeks.

[†]The 2-mg dose is used for individuals who smoke less than 25 cigarettes per day.

[‡]Patch is worn 16 to 24 hours a day.

[§]Dose per actuation; 1 to 2 sprays in each nostril (1-mg to 2-mg total dose) is recommended.

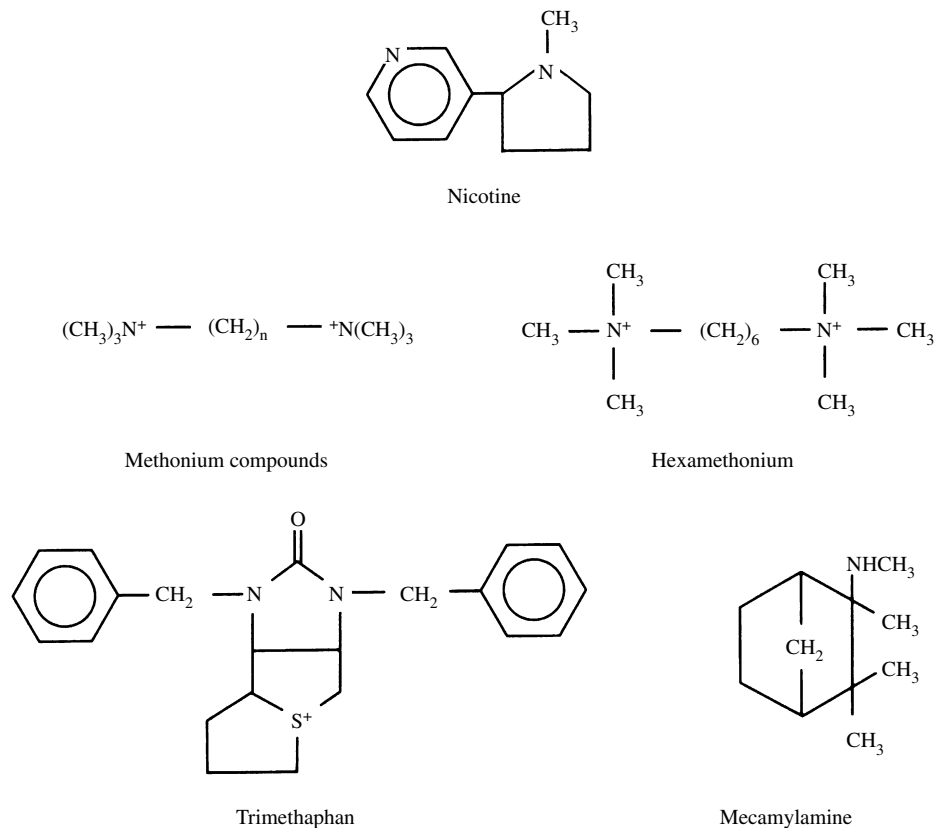

FIGURE 10-2 Structural formulas of nicotine and some nondepolarizing ganglionic blocking agents.

nicotine product—procedures to promote fresh breath and tooth bleaching to remove tobacco stains from teeth, which may provide additional positive psychological feedback to encourage abstinence from tobacco use.

Other ganglionic stimulants

Tetramethylammonium and dimethylphenylpiperazinium are also ganglionic stimulants. They differ from nicotine primarily in the fact that the stimulation is not followed by pronounced ganglionic depolarization blockade. Dimethylphenylpiperazinium is about three times more potent and slightly more ganglion-selective than nicotine.

Ganglionic Blockers

Between 1895 and 1926, numerous compounds having the generic structure shown in Figure 10-2 and termed *methonium compounds* were synthesized. In 1915, Burn and Dale described the ganglionic blocking action of tetraethylammonium. In the 1940s, an entire series of diiodide and dibromide derivatives of these methonium compounds were synthesized; in 1946, Acheson and Moe published a systematic and extensive pharmacologic study of tetraethylammonium. Interest in these drugs arose because they could be used as pharmacologic tools for exploring various aspects of autonomic pharmacology and because, at least at first, they offered the promise of being useful therapeutic agents in the treatment of hypertension, peptic ulcers, and other diseases that seemed to have an autonomic component and that had not yet yielded to therapeutic measures then available.

Classification

Ganglionic blocking agents can be classified on the basis of their chemical structure or mechanism of action into three groups, as follows:

1. **Depolarizing drugs**, such as nicotine, which produce initial stimulation and varying degrees of subsequent block through a mechanism analogous to that of succinylcholine (see later). At higher doses, these agents can stimulate and block other cholinergic receptors, such as those at the neuromuscular junction and in the CNS.
2. **Competitive drugs**, such as trimethaphan and tetraethylammonium, which interfere with the binding of ACh to the nicotinic receptor.
3. **Noncompetitive agents**, such as hexamethonium (C6) and mecamylamine, a secondary amine. Hexamethonium interferes with ganglionic transmission by blocking ion channels that have been opened by ACh, whereas mecamylamine seems to share properties associated with hexamethonium and the competitive blocking agents.

Pharmacologic effects

The discussion in this section is restricted to the pharmacology of the competitive and noncompetitive nondepolarizing blocking agents because clinically used ganglionic blockers belong to these two groups. Nicotine has been discussed previously regarding its ganglionic stimulating properties and its use in tobacco cessation programs.

All the ganglionic blocking drugs, regardless of their structure or their mechanism of action, have the same basic pharmacology, although many of them have additional actions at sites other than ganglionic receptors. An ideal ganglionic blocking agent would be a compound that interferes only with ganglionic transmission, blocks without previous excitation, and does not influence the release of transmitter. Hexamethonium is a prototype agent that meets these criteria.

The pharmacology of the ganglionic blocking drugs is predictable because all parasympathetic and sympathetic

TABLE 10-2

Usual Predominance of Sympathetic or Parasympathetic Tone at Various Effector Sites, with Consequent Effects of Autonomic Ganglionic Blockade

Rights were not granted to include this table in electronic media.
Please refer to the printed publication.

ganglia are blocked by most of the available agents. Ganglia are not equally sensitive to the blocking drugs, however, and some effects are easier to block than others. The effects of ganglionic agents are profoundly influenced by the background tone; that is, the effect of blocking a ganglion is proportional to the rate of nerve transmission through that ganglion at any given time. If vascular tone is high, as it would be in a standing individual, the ganglionic blocking agents would produce a profound decrease in blood pressure, much greater than they would in a recumbent individual, in whom vascular tone would be lower. Finally, as is shown in Table 10-2, because these drugs block sympathetic and parasympathetic actions, the direction and magnitude of their effects are related to which autonomic division provides the dominant baseline control for a given organ.

The eye. Parasympathetic neurons play a dominant role in the regulation of pupillary diameter and activity in the ciliary muscle. Blockade of autonomic ganglia leads to partial, but not maximal, dilation of the pupil and to paralysis of accommodation.

Salivary glands. The salivary glands are predominantly under the control of the parasympathetic nervous system. Ganglionic blockade results in marked xerostomia.

Cardiovascular system. Ganglionic blocking drugs cause a decrease in blood pressure that depends on posture. Normotensive recumbent subjects show the least change; the most prominent alteration in blood pressure occurs in sitting or standing subjects because vascular reflexes play an important role in the maintenance of blood pressure in these circumstances. The blood pressure may decrease by 35%. Changes in heart rate depend on the existing vagal tone, but generally cardiac rate increases slightly in humans. Cardiac output tends to decrease, mainly because of poor venous return and pooling of blood in the extremities. Localized blood flow alterations depend on the location of the vascular bed. In the skin, there is an increase in blood flow that manifests as an increase in surface temperature and a pinkness of the skin. The effects on coronary, pulmonary, muscle, renal, cerebral, and splanchnic circulation are inconsistent because, although vascular resistance may decrease in some of these organs, the reduced cardiac output may not permit a concomitant increase in blood flow.

Respiratory tract. There is inhibition of secretory activity in the respiratory tract and slight bronchial relaxation, but ganglionic blocking drugs do not directly affect respiration.

Gastrointestinal tract. The volume and acidity of gastric secretions that occur spontaneously are strongly inhibited by the ganglionic blocking agents, but there is little effect on secretion induced by histamine. Vagal stimulation is inhibited, and marked inhibition of motility occurs throughout the gastrointestinal tract, leading to paralytic ileus and causing constipation. Sympathetically maintained sphincter tone is also lost, and so the constipation may alternate with diarrhea.

Urinary tract. The parasympathetic component of the efferent arm of the spinal reflex normally responsible for micturition is blocked. As a result, distention of the bladder does not trigger the voiding response, and urinary retention develops because of incomplete bladder emptying.

Sweat glands. Sympathetic stimulation of the eccrine sweat glands is inhibited, so the skin becomes dry and warm and flushed from the vasodilation of skin blood vessels.

Central nervous system. In therapeutic doses, the cationic blocking drugs, including hexamethonium and its congeners, do not gain ready access to the CNS, and they usually have no direct CNS effects. Mecamylamine and other secondary and tertiary amine blocking agents have been reported to produce such effects as tremor, choreiform movements, mental aberrations, and convulsions.

Absorption, fate, and excretion

For ganglionic blocking agents, the question of absorption, fate, and excretion is an academic one because only one drug, mecamylamine, is available in an oral formulation and it is seldom used because of its numerous side effects. Trimethaphan has been administered by intravenous drip; it has a rapid onset and short duration of action.

General therapeutic uses

Because of their multiple side effects, ganglionic blockers are rarely used. For most patients these effects are intolerable except for acute use in recumbent patients. Trimethaphan was used in the past as an adjunct during anesthesia

to produce controlled hypotension and in hypertensive emergencies.

Adverse effects

As is true of other autonomic drugs, toxicity from the ganglionic blocking agents is an extension of their known pharmacologic effects. Some of these effects, such as xerostomia, blurring of vision, and constipation, are annoying but bearable. Other side effects, such as orthostatic hypotension, urinary retention, and sexual impotence, present more significant problems. More severely, the ganglionic blocking agents can produce peripheral circulatory collapse with cerebral and coronary insufficiency, paralytic ileus, and complete urinary retention. The toxic liabilities of the drugs are the major reason for their abandonment in the treatment of hypertension.

Implications for dentistry

The ganglionic blocking agents are no longer in wide use; patients with problems stemming from ganglionic blockade that might ordinarily prove troublesome to the dentist, such as xerostomia and orthostatic hypotension, are not likely to be encountered.

DRUGS AFFECTING NEUROMUSCULAR TRANSMISSION

Neuromuscular Transmission

Nervous control of skeletal muscle contraction is mediated by ACh. In response to a motor neuron action potential, ACh is released from the terminal region of the nerve fiber. The transmitter diffuses across the junctional cleft and binds with the nicotinic N_M receptor on the postjunctional membrane (end plate) of the muscle fiber. As with other nicotinic receptors the N_M receptor has two binding sites for cationic ligands, and the binding of two molecules of ACh to the receptor brings about an increase in the cation permeability of the end plate membrane and a consequent depolarization (excitatory end plate potential) of the junctional region of the muscle fiber. Under normal conditions, the depolarization is sufficient to trigger an action potential in the electrically excitable muscle fiber membrane, and muscular contraction follows.¹⁰ Figure 10-3 shows the physiologic events that occur in a nerve, neuromuscular junction, and

skeletal muscle that lead to contraction of muscle and indicates points along the pathway at which drugs can block these events.

Neuromuscular Junction Blockers

Neuromuscular blocking drugs interfere with the ability of ACh to evoke end plate depolarization at the nicotinic N_M receptor. They are generally separated into two groups according to whether the agents themselves bring about end plate depolarization in the course of their action. The depolarizing and the nondepolarizing blocking agents differ in the mechanisms through which they produce neuromuscular blockade (discussed subsequently).

Nondepolarizing agents

Nondepolarizing, or competitive, neuromuscular blocking drugs include tubocurarine (*d*-tubocurarine) and several other benzylisoquinolines (e.g., atracurium, cisatracurium, and mivacurium); aminosteroids such as pancuronium, rocuronium, and vecuronium; and a few unrelated drugs.¹⁹ Tubocurarine, rocuronium, and vecuronium are monoquaternary amines with a second nitrogen that is partially ionized at physiologic pH; the other clinically available drugs are bisquaternary compounds. Commonly, these drugs incorporate two cationic nitrogen sites into a rigid molecular structure (Figure 10-4). The rank order of potency at the N_M receptor correlates highly with the clinical dose needed to produce 50% twitch depression of the adductor muscle of the thumb (adductor pollicis).¹⁶

All these drugs act by occupying the end plate N_M receptor sites of the muscle fiber, blocking access to these sites by ACh. The drugs themselves do not cause end plate depolarization. Inhibition of neuromuscular transmission is essentially competitive, with the blocking agent and ACh competing for receptor sites on the muscle fiber. By interfering with nervous excitation of muscle without themselves producing any excitation, the nondepolarizing blocking agents cause flaccid paralysis. Because of the very large safety margin in neuromuscular transmission, which results from the 6-fold to 10-fold excess of ACh released from the motor neuron terminal and from the large number of postjunctional receptor sites (resulting in a highly coupled stimulus-response system as described in Chapter 1), about 70% of the ACh receptors must normally be blocked to produce any clinically apparent effect on muscle function.

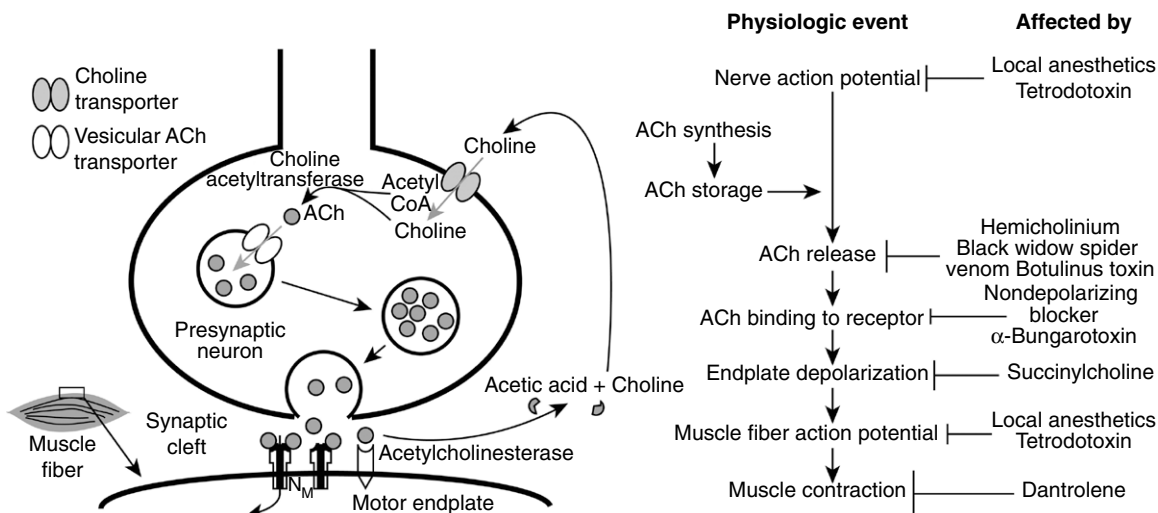

FIGURE 10-3 Physiologic events that occur in a motor nerve, neuromuscular junction, and skeletal muscle, leading to contraction of the muscle, and drugs that can block these events. ACh, Acetylcholine.

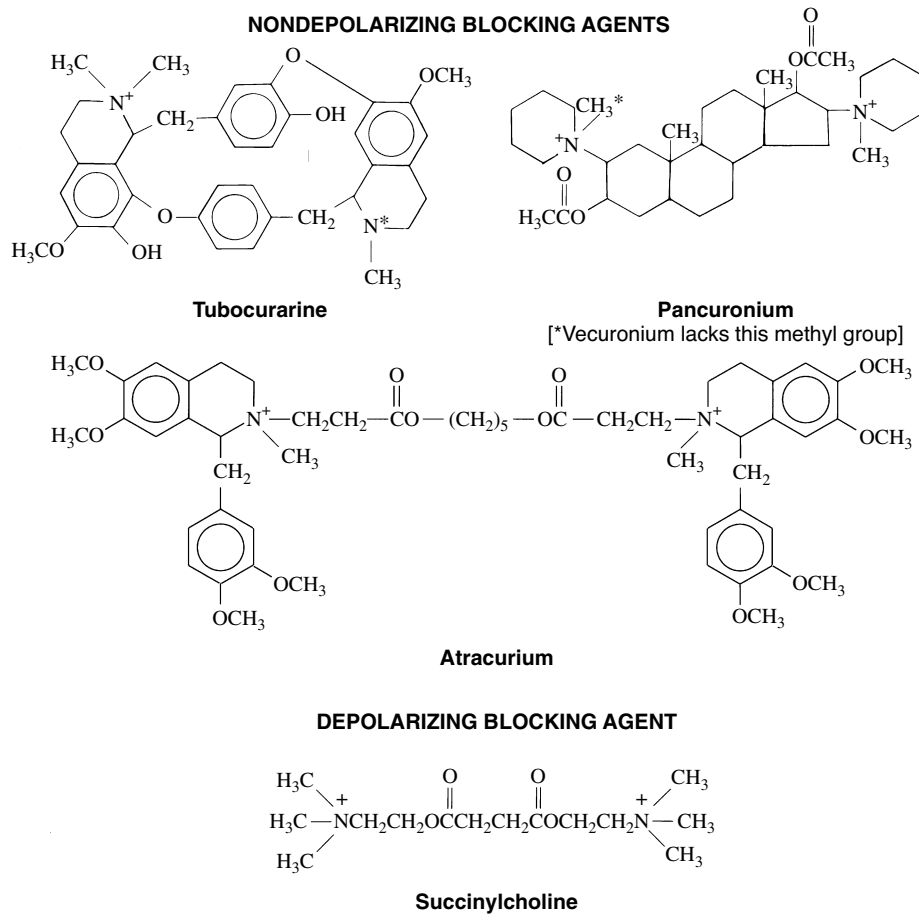

FIGURE 10-4 Structural formulas of some neuromuscular blocking agents.

Although tubocurarine, which was first isolated as the primary active ingredient from arrow poisons used by South American Indians, has the longest history of use and can be thought of as the prototype of this category of drugs, it is no longer used because of its tendency to evoke undesirable side effects. The major side effect seen with curare is hypotension. The excessive hypotension is the result of (1) blockade of autonomic ganglia and (2) release of histamine from mast cells. Histamine release may cause bronchoconstriction in asthmatic patients. Newer congeners with more selective neuromuscular blocking effects are preferred because they are largely devoid of these problems.¹⁹

Depolarizing agents

Similar to most nondepolarizing blockers, succinylcholine (also known as suxamethonium chloride and scoline), the major depolarizing agent, is a bisquaternary compound. In contrast to the nondepolarizing agents, succinylcholine is a much smaller molecule, composed simply of two ACh molecules attached at the acetyl ends (see Figure 10-4). Succinylcholine has a flexible chain linkage between its cationic moieties.

Succinylcholine acts by binding to the cholinergic receptor at the muscle end plate. As the class name suggests, the initial effect of the binding of this agent is a depolarization of the muscle fiber. During the early phase of its action, there is a period of excitation during which the sensitivity of the muscle to ACh is increased. It is common for the drug-induced

depolarization to be great enough to trigger action potentials and fasciculations (i.e., spontaneous twitching) in the muscle fibers. It is believed, however, that the fasciculations reflect activation of prejunctional N_M receptors, causing motor neuron depolarization and ACh release. Postjunctional stimulation by succinylcholine is responsible for an increased muscle tension observable with some muscles, especially the masseter. When exaggerated, masseteric tone can occasionally complicate endotracheal intubation.

The depolarization produced by the blocking agent gradually diminishes, but the end plate membrane potential does not completely return to its resting level. After the transient excitation, and during the period in which end plate depolarization is still prominent, neuromuscular transmission is blocked in what is referred to as a *phase 1 block*. Here, continued depolarization of the motor end plate traps surrounding voltage-gated Na^+ channels in an inactivated state (see Chapter 16 for a discussion of Na^+ channel states) refractory to further stimulation until the membrane potential is restored to normal. Recovery from this form of neuromuscular paralysis occurs quickly after cessation of succinylcholine administration. With continued drug infusion, however, the end plate slowly repolarizes despite the presence of succinylcholine, and there is a gradual transition to a longer lasting *phase 2*, or *desensitization block*. Recovery in this situation is delayed beyond the removal of the depolarizing agent and depends on return of N_M receptors from the desensitized to the resting state.

TABLE 10-3

Pharmacologic Properties of Neuromuscular Receptor-Blocking Agents

DRUGS	ED ₉₅ (mg/kg)*	ONSET (min)	DURATION OF ACTION (min) [†]	GANGLIONIC BLOCKADE	VAGAL BLOCKADE	HISTAMINE RELEASE
Ultrashort-Acting						
Succinylcholine	0.3	1-1.5	5-8	-	-	+
Short-Acting						
Mivacurium	0.08	3-4	12-18	0	0	+
Intermediate-Acting						
Atracurium	0.23	3-4	35-45	0	0	+
Cisatracurium	0.05	4-6	35-45	0	0	0
Rocuronium	0.3	1.5-3	30-40	0	0	0
Vecuronium	0.05	3-4	35-45	0	0	0
Long-Acting						
Pancuronium	0.07	3-4	60-120	0	++	0
Tubocurarine	0.5	2-4	60-120	++	0	++

*The ED₉₅ is the dose that reduces the twitch tension in the adductor pollicis by at least 95% in 50% of individuals. Usual intubating doses are two to three times the ED₉₅.

[†]The duration of action is the time from onset of paralysis to return of 25% of the twitch tension in the adductor pollicis.

++, Moderate effect; +, slight effect; -, opposite effect (i.e., stimulation of ganglionic and vagal transmission); 0, no effect.

Succinylcholine is administered intravenously to produce a short-acting depolarizing block of skeletal muscle lasting about 5 to 10 minutes (Table 10-3). This short action is related to metabolism by plasma and liver pseudocholinesterases to succinic acid and choline. The short duration of action of this compound has made it one of the drugs of choice to relax the laryngeal muscles before intubation and as an adjuvant before electroconvulsive shock therapy. Succinylcholine also stimulates autonomic ganglia and may cause a mild elevation of blood pressure and bradycardia due to ganglionic effects. Rarely, succinylcholine contributes to a syndrome termed *malignant hyperthermia*, which may be related to the initial intense muscular contractions. Succinylcholine tends to elevate ocular, cerebrospinal fluid, and gastrointestinal pressure and may be contraindicated in glaucoma patients, in patients suspected to have brain tumors, and in patients immediately after meals. Succinylcholine is perhaps the leading agent given for anesthetic management in causing anaphylaxis, with a reported incidence of one or two cases per 10,000 administrations.

Pharmacologic effects

The major pharmacologic actions of neuromuscular blocking agents are on the motor end plate of skeletal muscle, and all the therapeutic applications of these drugs stem from those actions. Nevertheless, neuromuscular blocking agents affect many other body systems. Some of the more important of these actions on other sites must be considered when choosing blocking drugs to administer, and additional precautions in their use must be observed.

An ideal neuromuscular blocker would be rapid in onset, consistent in duration of action (even in patients with advanced renal or hepatic disease), and readily reversible in effect. It would be a nondepolarizing drug so that it would not cause muscle fasciculations; it would be free of autonomic and cardiovascular effects; and it would not liberate histamine from muscle or other tissues. Additionally it would not induce tachyphylaxis, so prolonged blockade could be maintained without the need to increase the dosage over time. None of the existing neuromuscular blocking agents fulfills all these

expectations; however, cisatracurium, vecuronium, and rocuronium are notable for their relative lack of effects other than neuromuscular blockade (see Table 10-3).³

Neuromuscular junction. On slow intravenous infusion, depolarizing and nondepolarizing neuromuscular blocking agents first affect the facial muscles and then the other muscles of the head and neck. In a conscious subject, this action produces diplopia, dysarthria, and dysphagia; because of dysphagia, secretions accumulate in the throat, and breathing becomes difficult. In addition, there is an uncomfortable sensation of warmth. As the blockade progresses, the small muscles of the hands and body are affected. Paralysis of the intercostal muscles forces breathing to become entirely diaphragmatic. Finally, complete flaccid paralysis, including paralysis of all respiratory muscles, occurs.

This sequence of effects occurs when maximal doses of neuromuscular blocking agents are administered gradually; lower doses may produce only the earlier manifestations and spare the respiratory muscles from becoming paralyzed. In addition, there is some evidence that succinylcholine preferentially blocks transmission in white muscles, such as the muscles of the limb musculature, with less effect on the slower red muscles, including the muscles of respiration.

Rapid intravenous injection of full paralyzing doses, as is generally performed clinically, produces a different temporal pattern of blockade. In this situation, the upper airway muscles (larynx, tongue, jaw) and the diaphragm are blocked before peripheral muscles, such as the adductor pollicis. The respiratory muscles also recover much more quickly. The faster onset in this case may result from increased blood flow or higher temperature in these muscles; the faster recovery is in keeping with the differential sensitivity to neuromuscular blockade already described.

Central nervous system. None of the neuromuscular blocking drugs described here has any apparent influence on the CNS. The reason for this is the inability of these compounds, all of which are permanent cations with low lipid solubility, to cross the blood-brain barrier.

Neuromuscular blockade does not provide anesthesia or analgesia but can make it impossible for a patient to show outward signs of pain. When these drugs are used as adjuncts to general anesthesia, the depth of the anesthesia must be monitored closely to prevent conscious awareness in a paralyzed patient.

Autonomic nervous system. Because of their selectivity for the N_M receptors of the muscle end plate, neuromuscular blocking drugs as a group have no major influence on the autonomic nervous system. Individual drugs of this category do exert certain specific autonomic influences, however (see Table 10-3).

As mentioned previously, tubocurarine exerts partial blocking activity at autonomic ganglia. Pancuronium is notable for its tendency to increase the heart rate, in part by inhibiting vagal activity and by increasing norepinephrine release in the heart. This side effect has been beneficial in counteracting the bradycardia associated with high doses of opioids used in cardiac surgery. Succinylcholine causes a transient bradycardia as it is administered, probably through a vagomimetic action on the muscarinic receptors of the heart. After administration of succinylcholine, there is a longer period of tachycardia that seems to be the result of muscarinic receptor stimulation of sympathetic ganglia.

Histamine release. Several neuromuscular blocking agents, most prominently tubocurarine, cause the release of histamine from mast cells into the circulation (see Table 10-3). These drugs are capable of producing the histamine-mediated effects of hypotension, edema, bronchospasm, and increased salivary flow. The last two actions may introduce complications during performance of controlled respiration and can be prevented by prior administration of antihistamines. Histamine-related effects can be minimized by avoiding rapid intravenous injection. Neuromuscular blocking drugs with a steroid nucleus (pancuronium, rocuronium, vecuronium) are free of this side effect; cisatracurium is the only currently available benzylisoquinoline without this clinical liability.⁷ Histamine release is generally thought to be a direct result of stimulating nicotinic receptors on the mast cell membrane.^{2,22}

Cardiovascular system. Although none of the neuromuscular blocking drugs has any direct effect on vascular tone, all can produce hypotension by a combination of indirect actions. The release of histamine, as described earlier, causes edema and vasodilation. The loss of skeletal muscle tone as a result of neuromuscular blockade eliminates the skeletal muscle pumping action on the veins of the extremities; there is pooling of blood in capacitance veins and a concomitant reduction in venous return to the heart. In addition to these physiologic effects on the circulation, another factor is the use of assisted or controlled ventilation during the period of muscular paralysis. The increased intrathoracic pressure produced by the respirator during its positive-pressure phase further reduces venous return to the heart. In this respect, alternating positive-pressure and negative-pressure respirators are less problematic than intermittent positive-pressure devices because of the increased venous return in the negative-pressure phase of the former. These causes of hypotension can be treated by positioning the patient with the lower extremities elevated slightly above the heart and by administering isotonic fluids intravenously, possibly in combination with sympathomimetic vasoconstrictors.

Absorption, fate, and excretion

Neuromuscular blocking agents are generally administered intravenously. Intramuscular administration of large doses is effective for most of the agents discussed and may be used in

treating some pediatric patients in whom intravenous injection might present difficulties, but this route does not offer the precision of control or the rapidity of onset of action afforded by the intravenous route. The drugs discussed in this chapter are ineffective when given orally. This was known to be the case for tubocurarine by South American hunters, who readily ate prey felled by arrows laden with the drug.

All the clinically useful blocking agents show their effects within a few minutes after administration (see Table 10-3). Succinylcholine provides excellent intubating conditions (vocal cord relaxation) within 60 to 90 seconds after intravenous injection and gives its maximal effect within 2 minutes. Recovery is apparent after 5 to 10 minutes. The nondepolarizing blockers exhibit slower onsets and longer durations of action. The speed of onset for these drugs is inversely related to blocker potency, presumably because fewer drug molecules of highly potent agents are available to initiate blockade. Rocuronium, the least potent competitive blocker currently available, has been found to produce intubating conditions almost as rapidly as succinylcholine in children, and it is the best alternative to succinylcholine currently available when rapid intubation is required.

Mivacurium, a short-acting agent, has a clinical duration of action of only 15 to 20 minutes after an intubating dose. Here, the clinical duration is defined as the time from onset of muscle blockade until the point at which the twitch response of the adductor pollicis to a supramaximal electrical stimulus has returned to 25% of baseline. (Full recovery does not occur until much later.) Comparative durations for intermediate-acting and long-acting blockers (as classified in Table 10-3) are 30 to 45 minutes and 60 to 120 minutes.¹ With any of the drugs, blockade may be prolonged either by repeated injection or by continuous intravenous infusion.

Succinylcholine and mivacurium are hydrolyzed by plasma pseudocholinesterase, which explains their brief durations of action. Mivacurium is broken down to inactive metabolites, whereas succinylcholine is first converted to succinylmonocholine, a much weaker depolarizing blocking agent, and then to succinic acid and choline. It is possible to inhibit the plasma pseudocholinesterase with hexafluorenum, after which the action of succinylcholine is prolonged much longer.

In some individuals with atypical plasma cholinesterase, succinylcholine and mivacurium persist in the body for several hours. Some of these patients can be identified before drug administration by a cholinesterase activity assay. Purified cholinesterase has been injected intravenously before treatment to obtain a neuromuscular blockade of short duration in these patients.

Long-acting neuromuscular blockers are to a large extent excreted unchanged in the urine and bile; their actions may be greatly prolonged in patients with renal or hepatic failure, and they are largely contraindicated in such patients. Intermediate-acting neuromuscular blockers are also eliminated in the urine and bile. The primary reason for the shorter duration of action of intermediate-acting drugs compared with long-acting agents is their greater redistribution potential. Vecuronium is partially metabolized by the liver; one of its metabolites, the 3-OH derivative, is about 60% as potent as the parent compound. Some of the parent drug and most of the metabolites are excreted by the biliary-fecal route. Vecuronium is suitable for use in patients with renal insufficiency, but it is contraindicated in patients with cirrhosis. Atracurium is hydrolyzed by nonspecific tissue esterases and degraded nonenzymatically by a process known as *Hofmann elimination*. This latter process converts the quaternary nitrogens to the tertiary form, cleaving the molecule and yielding laudanosine, a metabolite with CNS stimulatory properties in high concentrations. Because atracurium is almost completely

inactivated by nonhepatic metabolism, it is useful in patients with reduced hepatic and renal function. Cisatracurium, the most potent of the 10 stereoisomers that compose atracurium, is similarly inactivated; however, its much greater potency means that comparatively less of the laudanoside metabolite is produced.

General therapeutic uses

Since the first clinical use of tubocurarine in 1942, several applications for neuromuscular blocking agents have gained wide acceptance.

Endotracheal intubation. To secure a patent, protected airway, an endotracheal tube is often inserted in patients receiving general anesthesia or patients who are otherwise unconscious or in need of respiratory assistance (or both). Succinylcholine has long been the drug of choice because of its fast onset of action. Rocuronium is the only currently available nondepolarizing blocking drug to approach the rapidity of onset of succinylcholine. This attribute is one reason why rocuronium is currently the most commonly used nondepolarizing blocking drug in clinical use.

Surgery. Neuromuscular blocking agents, especially intermediate-acting competitive blockers, are frequently used as adjuncts to general anesthesia during surgical procedures. The most common indication is to relax the abdominal wall musculature during abdominal surgery. This application is especially useful in procedures such as appendectomy, in which the underlying condition has produced reflex splinting of these muscles. During brain or cerebrovascular surgery in which the patient is sedated but conscious, neuromuscular blockade may be used to suppress cough and sneeze reflexes so that the field of operation remains immobilized.

Tetanus. In mild cases of tetanus, the patient is generally able to sustain respiration except during intermittent spasms. Here, neuromuscular blocking agents are administered to reduce the severity of these spasms. In severe cases of tetanus, in which the rigor of the patient extends to the respiratory musculature, neuromuscular blocking drugs are administered to induce flaccidity so that a mechanical respirator may be used.

Electroconvulsive therapy. In the treatment of depressive illness with electroconvulsive therapy, the therapeutic result is a consequence of the electrical stimulation of the CNS; the massive muscle spasm that accompanies such treatment is of no therapeutic benefit and has the potential for producing bodily injury. Neuromuscular blockade is induced by injection of succinylcholine before the electrical stimulation of the brain. Succinylcholine is used because of its short duration of action and lack of residual side effects.

Other uses. Succinylcholine is used to produce a short-lived muscular relaxation to permit numerous brief nonsurgical manipulations, such as bronchoscopy. In cases of laryngospasm, succinylcholine, often in subintubating doses, may be needed to relax the vocal cords and permit ventilation.

Nondepolarizing blockers facilitate the setting of fractures of extremities or the mandible. Despite the fact that only a brief blockade is needed for such a procedure, succinylcholine is unsuitable because the fasciculations and increased motor tone it can cause may compound the fracture-associated injury.

Nondepolarizing neuromuscular blocking agents are sometimes used in the intensive care unit to facilitate mechanical ventilation of patients. Because this application is associated with a wide range of problems, including deep venous

thrombosis, unrecognized inadequate sedation or analgesia, and prolonged paralysis after stopping the agent, this use should be minimized whenever possible.

Adverse effects

The major risk of overdosage with neuromuscular blocking agents is death from respiratory failure. When any neuromuscular blocking drug is administered, the practitioner must be prepared for the loss of respiratory function and have equipment immediately available for assisted or controlled respiration. In cases of respiratory arrest, ventilation must be maintained with external devices, generally with an endotracheal tube. Paralysis from nondepolarizing agents may be reversed to some extent through administration of an anticholinesterase (e.g., neostigmine), generally accompanied by an antimuscarinic drug (e.g., atropine) to prevent excessive muscarinic receptor-mediated sequelae to the anticholinesterase. The use of an anticholinesterase to reverse the phase 2 block of succinylcholine is also possible; however, with nondepolarizing drugs available covering a wide range of action durations, there should be no need for patient exposure to succinylcholine for a period long enough to produce a phase 2 block.

Arrhythmogenic effects of the neuromuscular blocking drugs stem from their ability to influence autonomic transmission in the ganglia and heart. Of the commonly used drugs, pancuronium is notable for its tendency to increase heart rate. Conversely, transient bradycardia is a known feature of succinylcholine, especially in small children. After a second dose of succinylcholine, bradycardia is more pronounced, and cardiac asystole has been reported. Atropine is administered before succinylcholine to ameliorate this effect. Arrhythmias have also resulted from the tendency of succinylcholine to cause hyperkalemia, especially in burn patients and patients with certain neuromuscular deficits. Sudden death may occur in children with undiagnosed muscular dystrophy. Hypotension and responses to drug-evoked histamine release have been reviewed previously.

Succinylcholine, as the only depolarizing neuromuscular blocking agent in clinical use, initially stimulates muscle contraction. Muscle pain is a common result, especially in ambulatory patients. Masseter spasm occurs in 1% of children and may complicate endotracheal intubation. In rare individuals, masseter spasm may be an early indicator of malignant hyperthermia, which is discussed in the section on dantrolene.

Drug interactions

Many different classes of drugs are capable of interacting either positively or antagonistically with the neuromuscular blocking agents (Table 10-4). The following sections describe the actions of drugs likely to be administered in conjunction with neuromuscular blockers and their effects on the activities of the blocking agents.

Anticholinesterases. Inhibitors of acetylcholinesterase, by blocking the enzymatic hydrolysis of ACh at the motor end plate, increase the amount of transmitter available at the receptor sites. These drugs antagonize the blockade produced by the nondepolarizing blocking agents, which act by competing with ACh for occupancy of receptor binding sites. Their effect when administered in conjunction with succinylcholine is more complex; after a brief period of antagonism, during which the blockade is reduced, they act to intensify the depolarizing neuromuscular blockade. Organophosphates such as echothiophate inhibit plasma cholinesterase and acetylcholinesterase. Systemic absorption of organophosphates prolongs the action of succinylcholine and mivacurium and reduces the effects of the nondepolarizing blocking agents in general. Neostigmine and pyridostigmine, but not edrophonium, also inhibit plasma cholinesterase.

TABLE 10-4

Effect of Various Agents on the Depth of Blockade Produced by Nondepolarizing Blocking Agents and Succinylcholine

AGENT	NONDEPOLARIZING BLOCKER	SUCCINYLCHOLINE
Nondepolarizing blocker	+	–
Succinylcholine	–, +	+
Anticholinesterase	–	+
Hexafluorenum	0*	+
Halothane, isoflurane	+	+
Aminoglycosides	+	+
Phenytoin, carbamazepine (long-term use)	–	0
Magnesium salts	+	+

*May intensify the blockade by mivacurium.

+, Intensification of the blockade; –, reversal or lessening of the blockade; 0, no major effect.

Hexafluorenum, which specifically inhibits plasma pseudocholinesterase without affecting the end plate acetylcholinesterase, prolongs the presence of succinylcholine in the circulation. This action extends the duration of the neuromuscular blockade by succinylcholine, and presumably mivacurium, and decreases the dose necessary to obtain that blockade. In addition to its inhibitory effect on plasma cholinesterase, hexafluorenum is itself a weak nondepolarizing neuromuscular blocker and may slightly potentiate the blockade induced by other nondepolarizing blocking agents.

Sugammadex. Sugammadex is a γ -cyclodextrin derivative designed to encapsulate rocuronium and reverse its neuromuscular blockade.¹⁴ The sugammadex molecule resembles a truncated, hollow cone with a hydrophobic interior capable of binding steroidal blockers such as rocuronium and a hydrophilic exterior that permits intravenous injection. Endogenous steroids lack the quaternary ammonium moiety of rocuronium and are poorly reactive with sugammadex. Vecuronium, which is significantly more potent than rocuronium, is also easily reversed despite reduced binding affinity for sugammadex. The U.S. Food and Drug Administration decided not to approve sugammadex in August 2008 because of concerns regarding allergic reactions. Phase III clinical trials have been allowed to proceed to address the safety of sugammadex further.

General anesthetics. Anesthetics that stabilize excitable membranes, most prominently ether and the halogenated inhalation agents, tend to interact positively with nondepolarizing blocking agents. When ether was used for general anesthesia, doses of tubocurarine had to be reduced by 50% or more.¹⁵ A similar reduction is necessary with isoflurane and pancuronium, but a more modest interaction occurs with sevoflurane and vecuronium.

Antibiotics. Some antibiotics, such as the aminoglycosides, reduce the amount of ACh released by the motor nerve terminal in response to an action potential and augment the muscle relaxation caused by nondepolarizing neuromuscular blocking drugs.^{6,18} Succinylcholine is also potentiated. Other antibiotics that may reduce dosage requirements for neuromuscular blocking agents include the tetracyclines, clindamycin, and the polymyxins.

Sympathomimetics. Catecholamines and other sympathomimetic agents may increase the amount of ACh released from the motor neuron and antagonize the blockade produced by nondepolarizing blocking agents.

Lithium. Lithium salts, used for the prophylaxis and treatment of manic-depressive illness, can slow the onset of neuromuscular blockade caused by succinylcholine but not that caused by the competitive blockers. Lithium also intensifies the blockade by pancuronium but not that by tubocurarine or succinylcholine, and it prolongs the effect of succinylcholine and pancuronium but not that of tubocurarine.

Neuromuscular blocking agents. Administration of a nondepolarizing blocking agent to a patient under the influence of the same drug or a different nondepolarizing blocking drug augments the blockade. This augmentation is usually additive; however, some combinations, such as an aminosteroid with a benzylisoquinoline, exhibit supra-additive effects.²³ This drug interaction is used clinically; a small “priming” dose of one nondepolarizing blocker may be given to hasten the onset of the subsequent paralyzing dose of another.

Administration of a second dose of succinylcholine to a patient already treated with the drug may lighten the blockade for a brief interval, which would correspond to the period of early transient fasciculation that follows administration of any of the depolarizing drugs. The ultimate effect of the second dose is augmentation of the neuromuscular blockade, however. Some tachyphylaxis occurs with repeated administrations.

Combinations of depolarizing and nondepolarizing neuromuscular blocking drugs are generally antagonistic and have little clinical value. Use has been made of this antagonism, however, in the administration of a low dose of nondepolarizing blocker before paralyzing the patient with succinylcholine. In this case, the nondepolarizing agent prevents the fasciculations normally caused by succinylcholine. It is also a frequent practice to use succinylcholine to induce a rapid blockade for tracheal intubation before the production of a long-term blockade with a nondepolarizing agent. The short lifetime of succinylcholine in the body effectively prevents any significant antagonism between the two drugs. Subsequent administration of the nondepolarizing drug generally provides evidence of enhanced neuromuscular blockade.

Applications in dentistry

Dental practice has few indications for the use of neuromuscular blocking agents. Among the situations in which use of these drugs might be appropriate are mandibular fractures, when muscle relaxation is needed to permit manipulation of bone fragments, and trismus, when no more conservative means exist to permit mouth opening for diagnosis and treatment. In addition, succinylcholine or a relatively short-acting nondepolarizing blocking drug is used to aid the insertion of

an endotracheal tube when the use of general anesthesia makes intubation appropriate. In any office where general anesthesia is used, succinylcholine should always be available to treat otherwise intractable laryngospasm.

Other Agents Affecting Neuromuscular Transmission

Many substances, synthetic and of biologic origin, have been found to act by affecting one or more of the processes involved in normal neuromuscular transmission. Some of these drugs are used to treat various conditions of muscular spasms including spasms associated with stroke, multiple sclerosis, and cerebral palsy. These drugs are termed *spasmolytics*. Diazepam, baclofen, tizanidine, and cyclobenzaprine are discussed in Chapter 13.

Diazepam

Diazepam, a benzodiazepine compound, facilitates inhibition of γ -aminobutyric acid (GABA) in the CNS. It has potential action on the GABA_A receptor and acts in part at the level of the spinal cord. It is effective in treating all types of muscle spasms. The major limitation is sedation seen at muscular relaxant doses.

Baclofen

Baclofen is an orally effective agonist for the presynaptic CNS GABA_B receptor. When activated, the presynaptic GABA_B receptor causes a decrease in release of excitatory amino acids (i.e., glutamate) and a corresponding decrease in skeletal muscle tone. Patients experience less sedation than with diazepam. This GABA analogue is used for relief of spasticity caused by multiple sclerosis and traumatic spinal cord injury.

Tizanidine

Tizanidine is a clonidine-like α_2 -adrenoceptor stimulant that reduces skeletal muscle spasticity by a CNS inhibitory action, but with less hypotension than seen with clonidine. Other side effects include sedation, asthenia, and dry mouth.

Cyclobenzaprine

Cyclobenzaprine is related to the tricyclic antidepressants. It is used for short-term (2 to 3 weeks) treatment of muscular spasms associated with musculoskeletal conditions. The mechanism of action of cyclobenzaprine may be to increase brainstem-mediated noradrenergic inhibition of spinal cord neurons. Side effects include atropine-like responses and effects produced by inhibition of catecholamine uptake.

Hemicholinium

Most of the choline produced by the enzymatic hydrolysis of ACh is returned to the motor nerve terminal by a specific transport system and is used in the synthesis of new transmitter. Hemicholinium, by blocking the neuronal uptake of choline, interferes with the synthesis of ACh and acts to deplete the nerve terminal of this substance. The resulting blockade of neuromuscular transmission is gradual in onset but is accelerated by increased motor neuron activity. Because hemicholinium inhibits choline transport in all peripheral cholinergic nerves, it affects transmission at all cholinergic synapses and junctions. Hemicholinium has no clinical applications at present.

Botulinum toxin

The toxin produced by *Clostridium botulinum* acts on the motor nerve terminal to prevent the release of ACh in response to the arrival of an axonal action potential. The toxin interferes with the influx of extracellular Ca⁺⁺ into the nerve terminal. Ca⁺⁺ influx during the action potential is necessary for ACh release. Botulinum toxin affects all peripheral cholinergic nerves.

Botulinum toxin is used in ophthalmology in the treatment of strabismus and certain ocular deviations (tropias). The toxin, applied focally, can produce long-lasting (weeks to months) paralysis of an excessively contracting extraocular muscle, and the hope is that, as function gradually recovers, CNS adaptation will maintain the correction. The toxin is also used to relieve severe blepharospasm. It is injected into the orbicularis oculi, where it blocks spasmodic contractions for 3 months. Another serologically distinct form of botulinum toxin is used for certain types of skeletal muscle dystonias, such as cervical dystonias. In a cosmetic application, botulinum toxin is used to inhibit activity of certain facial muscles, such as those of the forehead, whose contractions cause skin wrinkling.

α -Bungarotoxin

α -Bungarotoxin isolated from the venom of the banded krait and the similar if not identical neurotoxin from the venom of the cobra are capable of binding avidly to the cholinergic receptor proteins of the muscle end plate. The toxin does not cause end plate depolarization, and its effect, although essentially irreversible, is similar to that of nondepolarizing blocking agents. The ability of radiolabeled α -bungarotoxin to bind stoichiometrically with skeletal muscle nicotinic receptors makes it possible to locate and count receptor sites; this has provided a useful technique for research on numerous subjects ranging from denervation supersensitivity to myasthenia gravis.

Tetrodotoxin

Tetrodotoxin, found in many tissues of the puffer fish, or fugu, prevents the propagation of peripheral axon and skeletal muscle action potentials by interfering with electrically activated Na⁺ conductance. Saxitoxin, which is produced by certain strains of dinoflagellates and has been implicated in the occasional contamination of shellfish that consume these organisms, has a similar effect on Na⁺ channels. The mechanism of action of these toxins is similar to that of local anesthetics, but their potencies are a millionfold greater, and they act for 1 day or more after a single exposure.

Dantrolene

Dantrolene (Figure 10-5) is an agent that acts within the skeletal muscle fiber rather than on the neuromuscular junction. Its site of action is the sarcoplasmic reticulum, where it inhibits the depolarization-induced release of Ca⁺⁺ from the cisternae of the sarcoplasmic reticulum into the cytoplasm, interfering with excitation-contraction coupling. The principal therapeutic applications of dantrolene are for the relief of spasticity associated with upper motor neuron disorders and for the prophylaxis and treatment of malignant hyperthermia.⁹

Spastic movements, clonus, and rigidities that result from stroke or cerebral palsy are often relieved by dantrolene; the spasticity of multiple sclerosis is relieved to a lesser extent, possibly because the lesions of this condition are more widespread.¹⁷ Dantrolene is strongly contraindicated in amyotrophic lateral sclerosis because the muscular weakness associated with this condition, when exacerbated by the drug (see later), can lead to respiratory difficulty.¹⁷

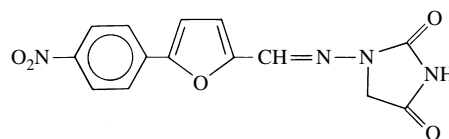

FIGURE 10-5 Structural formula of dantrolene.

Malignant hyperthermia is a genetically transmitted condition in which there is an apparent reduction in the threshold for Ca^{++} release from the sarcoplasmic reticulum of skeletal muscle, often because of a mutation in the ryanodine receptor that forms the Ca^{++} -release channel.^{11,13} Under normal conditions, Ca^{++} is released from the sarcoplasmic reticulum in response to an all-or-none action potential propagating down the transverse tubular system. Because there are no partial depolarizations physiologically, the actual threshold for Ca^{++} release by the sarcoplasmic reticulum is unimportant. A depolarizing neuromuscular blocking drug does produce such a partial depolarization, however, of the muscle fiber membrane.

Succinylcholine and the volatile general anesthetics such as isoflurane, which may also lower the release threshold, can trigger an attack of malignant hyperthermia in which the increased release of Ca^{++} into muscle cytoplasm causes contracture and an enormous acceleration of the cellular metabolism of muscle; the latter generates heat (body temperature can increase by 1° C every 5 minutes and reach 43° C), carbon dioxide (arterial tensions > 100 mm Hg), and lactic acid (arterial blood pH <7.0). The hyperthermia, hypoxemia, and acidosis cause muscle edema and structural damage. In addition, the hyperthermia and resultant sympathetic reflex response increase heart metabolism fivefold to eightfold and can lead to arrhythmias. Before dantrolene, attacks of malignant hyperthermia were frequently (70%) fatal. Dantrolene, by blocking the precipitating event, the release of Ca^{++} from the sarcoplasmic reticulum, can prevent or halt an attack of malignant hyperthermia and has reduced the mortality rate to less than 10%.

Side effects of dantrolene include muscle weakness and hepatotoxicity. The muscle weakness, which is simply an extension of the drug's therapeutic action, generally does not occur at dosages used for treatment of spastic movements, although doses high enough to produce this effect are sometimes needed to achieve symptom remission. Doses of dantrolene that produce muscle weakness are sometimes used in prophylaxis of malignant hyperthermia before surgery on patients with a family history of the condition.

Hepatotoxicity of varying degrees has been reported in approximately 1% of patients taking dantrolene for 60 days or longer. Hepatic function should be monitored during long-term therapy with dantrolene.¹⁷ The minimal effective dose should be used.

Dantrolene is effective when administered intravenously or orally; in the latter case, approximately 20% is absorbed, largely through the small intestine.¹⁷ Metabolism of dantrolene occurs in the liver, largely by 5-hydroxylation of the hydantoin moiety.

AGENTS AFFECTING NICOTINIC TRANSMISSION

<i>Nonproprietary (generic) name</i>	<i>Proprietary (trade) name</i>
Ganglionic stimulants	See Table 10-1
Ganglionic blockers	
Hexamethonium*	—
Mecamylamine	Inversine
Trimethaphan*	Arfonad
Neuromuscular blockers	
<i>Nondepolarizing</i>	
Atracurium	Tracrium
Cisatracurium	Nimbex

<i>Nonproprietary (generic) name</i>	<i>Proprietary (trade) name</i>
Mivacurium*	Mivacron
Pancuronium	Pavulon
Rocuronium	Zemuron
Tubocurarine*	—
Vecuronium	Norcuron
<i>Depolarizing</i>	
Succinylcholine	Anectine, Quelicin
Miscellaneous agents	
Baclofen	Zanaflex
Botulinum toxin type A	Botox
Botulinum toxin type B	Myobloc
Cyclobenzaprine	Flexeril
Dantrolene	Dantrium
Diazepam	Valium
Hexafluorenum*	Mylaxen
Sugammadex*	Bridion
Tizanidine	Lioresal

*Not currently available in the United States.

CITED REFERENCES

- Atherton DP, Hunter JM: Clinical pharmacokinetics of the newer neuromuscular blocking drugs. *Clin Pharmacokinet* 36:169-189, 1999.
- Basta SJ: Modulation of histamine release by neuromolecular blocking drugs. *Curr Opin Anaesthesiol* 5:512-566, 1992.
- Basta SJ, Savarese JJ, Ali HA, et al: Clinical pharmacology of doxacurium chloride: a new long-acting nondepolarizing muscle relaxant. *Anesthesiology* 69:478-486, 1988.
- Booij LHDJ: The history of neuromuscular blocking agents. *Curr Anaesth Crit Care* 11:27-33, 2000.
- Crews KM, Johnson L, Nichols M: Patient management in a tobacco-cessation program in the dental practice. *Compend Contin Educ Dent* 15:1142-1155, 1994.
- Enomoto K-I, Maeno T: Presynaptic effects of 4-aminopyridine and streptomycin on the neuromuscular junction. *Eur J Pharmacol* 76:1-8, 1981.
- Faulds D, Clissold SP: Doxacurium: a review of its pharmacology and clinical potential in anaesthesia. *Drugs* 42:673-689, 1991.
- Gibbins IL, Jobling P, Messenger JP, et al: Neuronal morphology and the synaptic organization of sympathetic ganglia. *J Auton Nerv Syst* 81:104-109, 2000.
- Hopkins PM: Malignant hyperthermia: advances in clinical management and diagnosis. *Br J Anaesth* 85:118-128, 2000.
- Hubbard JJ: Microphysiology of vertebrate neuromuscular transmission. *Physiol Rev* 53:674-723, 1973.
- Jurkat-Rott K, McCarthy T, Lehmann-Horn F: Genetics and pathogenesis of malignant hyperthermia. *Muscle Nerve* 23:4-17, 2000.
- Kawai Y: Noradrenergic synaptic transmission in the superior cervical ganglion. *Kaibogaku Zasshi* 74:167-173, 1999.
- MacLennan DH, Phillips MS: Malignant hyperthermia. *Science* 256:789-794, 1992.
- Naguib M: Sugammadex: another milestone in clinical neuromuscular pharmacology. *Anesth Analg* 104:575-581, 2007.
- Ngai SH: Action of general anesthetics in producing muscle relaxation: interaction of anesthetics with relaxants. In Katz RL, editor: *Muscle relaxants*, New York, 1975, American Elsevier.
- Paul M, Kindler CH, Fokt RM, et al: The potency of new muscle relaxants on recombinant muscle-type acetylcholine receptors. *Anesth Analg* 94:597-603, 2002.
- Pinder RM, Brogden RN, Speight TM, et al: Dantrolene sodium: a review of its pharmacological properties and therapeutic efficacy in spasticity. *Drugs* 13:3-23, 1977.

18. Singh YN, Marshall IG, Harvey AL: The mechanisms of the muscle paralyzing actions of antibiotics, and their interaction with neuromuscular blocking agents. *Rev Drug Metab Drug Interact* 3:129-153, 1980.
19. Sparr HJ, Beaufort TM, Fuchs-Buder T: Newer neuromuscular blocking drugs: how do they compare with established agents? *Drugs* 61:919-942, 2001.
20. Surgeon General: *The health consequences of smoking: nicotine addiction*, Office of Smoking and Health, Department of Health and Human Services Publication No. (CDC) 88-8406, Washington, DC, 1988, US Government Printing Office.
21. Suzuki T, Volle RL: Nicotinic, muscarinic, and adrenergic receptors in a parasympathetic ganglion. *J Pharmacol Exp Ther* 211:252-256, 1979.
22. Watkins J: Adverse reaction to neuromuscular blockers: frequency, investigation, and epidemiology. *Acta Anaesthesiol Scand Suppl* 102:6-10, 1994.
23. Waud BE, Waud DR: Interaction among agents that block end-plate depolarization competitively. *Anesthesiology* 63:4-15, 1985.

GENERAL REFERENCES

- Bevan DR: Fifty years of muscle relaxants, *Acta Anaesthesiol Scand Suppl* 106:2-6, 1995.
- Birmingham AT: Fifth WDM Paton Memorial Lecture, *Br J Pharmacol* 128:1685-1689, 1999.
- Bowman WC: *Pharmacology of neuromuscular function*, ed 2, Boston, 1990, Butterworth.
- Donati F, Bevan DR: Neuromuscular blocking agents. In Barash PG, Cullen BF, Stoelting RK, editors: *Clinical anesthesia*, ed 5, Philadelphia, 2005, Lippincott Williams & Wilkins.
- Naguib M, Lien CA: Pharmacology of muscle relaxants and their antagonists. In Miller RD, editor: *Miller's anesthesia*, ed 6, Philadelphia, 2005, Elsevier.

Introduction to Central Nervous System Drugs*

VAHN A. LEWIS

Drugs that alter synaptic function are likely to have considerable impact on neuronal activity. An understanding of these fundamental mechanisms permits appreciation of the therapeutic actions and side-effect profiles of many of the central nervous system (CNS) drugs in the brain and in the spinal cord. The interested student is encouraged to seek several excellent reviews in this area.^{23,30} The pharmacology of specific CNS drugs is discussed in greater detail in Chapters 12 through 21 and Chapter 23.

INVESTIGATION OF THE BRAIN

Early research on nervous system function involved behavioral studies in whole organisms. Observing the effects of damage to regions of the nervous system provided clues to the function of various nerve and brain structures. The development of the microscope and its use produced an explosion of interest in the cellular anatomy and structure of the normal and diseased brain. Santiago Ramón y Cajal received an early Nobel Prize in Physiology or Medicine (1906) for his use of the microscope to study the brain.

When electronic amplifiers were developed, it became possible to study the collective electrical action of many neurons (e.g., with electroencephalography or stimulus-evoked potential recordings) and individual neurons with extracellular or intracellular electrical recordings. Using these techniques, it became possible to understand the electrical properties of single nerves and synapses and to consider how these actions related to the action of the whole organism engaged in various behaviors. Hodgkin, Huxley, and Eccles shared a Nobel Prize in Physiology or Medicine in 1963 for their work on action potentials and synaptic connections.

Using these techniques, physiologists, chemists, and pharmacologists began to investigate the chemical nature of neurotransmission and brain function. Chemists produced novel agonists that were used by physiologists and pharmacologists to gain additional information about how the brain functions. With such studies, the basis for chemical neurotransmission and its regulation was explored. The biochemistry of the brain has been gradually revealed. The Nobel Prize for Physiology or Medicine in 1970 was awarded to Katz, von Euler, and Axelrod for their discoveries in the area of chemical neurotransmission.

In the last two decades the pace of discovery has accelerated considerably. Experiments that previously took years can

often be performed in days. Genomic approaches allow tens of thousands of biochemical reactions to be studied simultaneously. A key development was the polymerase chain reaction by Mullis at Cetus Corp. Mullis shared the Nobel Prize in Chemistry in 1993 for his part in the invention. The invention of the gene microarray is another technology that is important in this respect.³² The data from these experiments are analyzed using computers rather than manually. These techniques are beginning to reveal how networks of genes, amino acids, proteins, lipids, sugars, and other chemicals interact to mediate the various functions of the brain. A genomic study of tissue from a patient with epilepsy revealed that the seizures were associated with excess glutamate release from the astrocytes.²⁷

Future investigations of the brain may reveal that many chronic brain disorders result from tissue inflammation or breakdown, rather than dysregulation of a particular neurotransmitter. This hypothesis seems to be true in the case of schizophrenia and Alzheimer's disease.^{32,37} In 2008, the Nobel Prize in Chemistry was awarded to Shimomura, Chalfie, and Tsien for the development of the green fluorescent protein technique, which has facilitated understanding of genetic modifications in dense tissue such as the brain. Other powerful techniques applicable to brain research are continually being developed.

The CNS integrates sensory information from the external and internal environments; maintains homeostasis through visceral and somatic secretory and motor activity; and generates memory, thoughts, and emotions. Many common diseases have their origins in CNS dysfunction, including Alzheimer's disease, epilepsy, stroke, anxiety, psychoses, movement disorders, mental impairment, and some forms of chronic pain. In addition, the therapeutic effects or side effects of many drugs arise from alterations in CNS activity. Approximately 20% of the most frequently prescribed medications have their principal sites of action within the CNS (e.g., opioid-containing analgesics, benzodiazepines such as alprazolam, antidepressants such as sertraline and fluoxetine, and sleep aids such as zolpidem), and it is virtually certain that every practicing dentist will perform dental treatment on patients taking these drugs. This chapter reviews the anatomic, cellular, and biochemical organization of the CNS from the perspective of drug actions in the CNS. Table 11-1 lists representative drugs that act on the CNS to produce their therapeutic effects.

ANATOMIC ORGANIZATION OF THE CENTRAL NERVOUS SYSTEM

Several excellent texts are available that provide comprehensive descriptions of the organizational structure and pharma-

*The author wishes to recognize Drs. Kenneth M. Hargreaves, Douglass L. Jackson, and Mark T. Roszkowski for their past contributions to this chapter.

TABLE 11-1

Selected Drug Actions in the Central Nervous System

DRUG CLASS	EXAMPLE DRUG	MAJOR SITE(S) OF ACTION*	MECHANISM†	PHARMACOLOGIC EFFECT
Drugs Commonly Used in Dentistry				
Opioids	Morphine	Deep cortex, PAG, medulla, spinal cord, skin	Presynaptic inhibition	Analgesia
Benzodiazepines	Diazepam	Limbic system, cerebral cortex	GABA potentiation	Anxiety reduction, sedation
Local anesthetics	Lidocaine	Nonselective	Na ⁺ channel blockade	Convulsions, anesthesia
Other Commonly Used Drugs				
Antihypertensives	Clonidine	Medulla	α ₂ -Adrenoceptor stimulation	Reduced sympathetic activity
Inhalation anesthetics	Isoflurane	Reticular formation	Ion channel blockade	General anesthesia
Antiparkinson agents	Levodopa	Basal ganglia	Increased dopamine synthesis	Reduced motor symptoms
Antipsychotics	Haloperidol	Limbic system, reticular formation	Dopamine receptor antagonism	Control of schizophrenia

*Several of these drugs have more than one site of action in the central nervous system.

†Drugs may exert different mechanisms through activation of multiple receptors (see text). GABA, γ-Aminobutyric acid; PAG, periaqueductal gray matter.

ology of the CNS.^{13,23,30,31} This section reviews only the key structural elements of the CNS most pertinent to understanding drug actions and effects.

Cerebral Cortex

Anatomy

The cerebral cortex consists of two hemispheres with deeply enfolded grooves termed *gyri*. The extensive folding of the cerebral cortex increases its surface area. The major divisions of the cortex are the motor cortex (which initiates and coordinates somatic muscle activity); somatosensory cortex (which processes sensory information); frontal, parietal, and temporal association/integration areas; and visual and auditory areas. More recent imaging studies have focused additional attention on deeper cortical structures, such as the cingulate, the midline cortex (the face of the cortex between the two hemispheres), the insula, and the opercular cortex (buried behind the lateral sulcus). Several of these areas are important for experiencing pain and pleasure. Together, cortical regions are involved with voluntary movement and integration of sensation, consciousness, abstract thought, memory, and learning.

A primary organizational feature of the cerebral cortex is its arrangement as a series of densely packed columns of interconnected cells. The columnar organization of the cerebral cortex is probably a major factor in the integration of neural activity. Each column is approximately 0.5 mm to 1 mm in diameter and includes 10,000 to 50,000 interconnected neurons. The classic studies by Penfield and Rasmussen⁴⁰ determined the somatic representation of the human body surface on the sensory cortex (the “sensory homunculus”). These studies indicated that approximately 75% of the sensory cortex processes afferent input from orofacial structures, including the lips, jaws, tongue, and teeth. This predominant cerebral processing of orofacial sensation may contribute to the aversive anxiety that many patients have during the course of dental care.

Pharmacology

Drugs that alter cerebral cortical activity include general anesthetics, antianxiety drugs, sedative-hypnotics, anticonvulsants, antidepressants, and antipsychotics. As detailed subsequently (and in later chapters), the sites of action and the precise

biochemical mechanisms for many of these drugs are still incompletely understood. The clinical consequence of a reduction in cortical activity is generally sedation or unconsciousness, however. Administration of the inhalation anesthetic halothane reduces cerebral activity in the frontal cortex during the induction of general anesthesia.¹⁴ Opioids produce analgesia in part by binding to the cingulate and insular cortex, which play a role in registering the aversive qualities of stimuli.⁵

Limbic System

Anatomy

Another major organizational component of the CNS is the limbic system. It is composed of the amygdala, septum, hippocampus, hypothalamus, olfactory lobes, basal ganglia, and portions of the thalamus. These interrelated structures act to coordinate affective (i.e., emotional) sensations with motor, visceral, and endocrine functions. Many of these structures are reciprocally connected with the cerebral cortex, and some are arranged in loops. Such loops integrate the functions of different parts of the brain but can also play a role in brain disease when disturbances develop along a loop. These loops may play a role in Parkinson's disease and drug abuse. In addition, many behavioral functions ascribed to the limbic system are linked functionally to the reticular formation. Hyperexcitation of the amygdala has been associated with panic attacks.⁴¹ The hypothalamus is important for endocrine function, but it is also an important regulator of cyclic functions such as waking and sleeping, monthly ovulatory function, and longer cycles such as yearly hibernation in animals. The study of these periodic phenomena is termed *chronobiology*.

Pharmacology

Many drugs act in part by modifying the activity of the limbic system. Benzodiazepines act at several discrete sites within this system to potentiate the effects of the neurotransmitter γ-aminobutyric acid (GABA), resulting in a reduction of anxiety and the development of sedation (see Table 11-1).⁵⁰ Benzodiazepines also reduce seizure activity. Endogenous ligands for the benzodiazepine receptor may be involved in the pathogenesis of epilepsy because epileptic patients have a significant reduction in benzodiazepine receptors in the cortex

and limbic system.⁴⁶ If administered in excess, local anesthetics such as lidocaine and the antibiotic penicillin may induce seizure activity.

A major hypothesis for some forms of mental dysfunction (e.g., schizophrenia) proposes an excess in dopaminergic activity. Several antipsychotic drugs are dopamine receptor antagonists and are thought to act at various sites in the limbic system and reticular formation. The clinical consequence of dopamine receptor blockade in these patients is the amelioration of psychotic behavior. Parkinson's disease is associated with a chronic reduction of dopamine activity in the basal ganglia complex.⁵⁵ This disease is commonly managed by the administration of drugs such as levodopa (L-dihydroxyphenylalanine, the amino acid precursor to dopamine) that increase dopamine activity. Dopamine is an important neurotransmitter in the brain reward circuitry located in the basal ganglia, and it plays a role in the development of drug dependence to cocaine and amphetamines and indirectly to other drugs.^{12,19}

Many drugs have a site of action in the hypothalamus and related structures. The estrogens contained in many birth control formulations act in part by inhibiting release of the hypothalamic gonadotropin-releasing hormone and luteinizing hormone and follicle-stimulating hormone, preventing ovulation. In addition, alcohol-induced diuresis results from inhibition of the release of antidiuretic hormone (also known as vasopressin). Diabetes insipidus is the clinical disease caused by chronically diminished release or activity of antidiuretic hormone.

Midbrain and Brainstem

Anatomy

The midbrain and brainstem regions consist of the mesencephalon, pons, medulla, reticular activating system, and most of the cranial nerve nuclei, including the trigeminal nuclei. This region processes sensory information from the viscera, coordinates visceral (i.e., cardiovascular, pulmonary, and gastrointestinal) systems, and integrates various reflexes (e.g., swallowing and vomiting). In addition, the reticular activating system is implicated in the maintenance of arousal and development of sleep. Damage to small areas of the brainstem can be lethal if they interfere with cardiovascular or respiratory control. The reticular activating system is sensitive to many drugs, including most CNS depressants.⁷

Pharmacology

Several drugs have major sites of action within midbrain and brainstem structures. Opioids such as morphine produce analgesia in part by activating opioid receptors located in the periaqueductal gray region, locus coeruleus, and nucleus raphe magnus. In addition, the antihypertensive drug clonidine is an α_2 -adrenergic receptor agonist whose therapeutic effect results in part from stimulating α_2 -adrenergic receptors in the medulla oblongata.

Not all drug effects in the CNS are considered therapeutic. Opioid-induced emesis is caused by activation of receptors located in the chemoreceptor trigger zone of the medulla. This side effect is especially prominent in ambulatory patients, whose walking increases activity in the vestibular system. This interaction between drug effect and neural input is the rationale for instructing patients in acute pain receiving opioid analgesics to avoid excessive motion to minimize nausea and vomiting.

Spinal Cord

The spinal cord is involved with the processing and modulation of general sensory information (e.g., touch, heat, cold, pressure, and pain), somatic motor activity, and skeletal and visceral reflexes. Numerous drugs are thought to activate spinal cord mechanisms. Opioids produce analgesia in part by

stimulating receptors located in the spinal dorsal horn. (An analogous site of action for opioid inhibition of trigeminal pain involves interaction with receptors located in the medullary dorsal horn, as mentioned in Chapter 20.) This site of action is the basis for the administration of opioids through epidural catheters to elicit spinal analgesia. In addition, the epidural administration of local anesthetics such as bupivacaine is commonly used for the production of regional anesthesia in surgical and obstetric procedures. More recent studies suggest that nonsteroidal anti-inflammatory drugs produce analgesia after intrathecal injection, suggesting that these drugs have both central and peripheral sites of action.

Blood-Brain Barrier

The CNS is isolated from the rest of the body by the blood-brain barrier. Endothelial cells of the brain capillary system are modified by numerous tight junctions and are surrounded with extensive perivascular astrocytic processes. These modifications prevent the free diffusion of many substances into the CNS. Lipid solubility is a key factor in dictating the CNS actions of many drugs. Drugs that are highly lipophilic (e.g., thiopental, diazepam, nicotine, and heroin) easily cross the blood-brain barrier and have a rapid onset of action. In contrast, hydrophilic drugs (e.g., dopamine and some antibiotics) are largely excluded by the blood-brain barrier, minimizing their therapeutic effects in the CNS. Many drugs are "relatively" excluded from the brain, meaning that their onset of action may be delayed, but they eventually cause significant CNS effects. Morphine is relatively excluded from the brain and reaches a peak effect about 1 hour after administration.

There are some holes or "windows" in the blood-brain barrier. One such site is near the area postrema. This area is near the vomiting center, and drugs or other chemicals in the blood can quickly pass to the center and produce nausea and vomiting. Other "windows" include the subformal organ and the organum vasculosum of the lamina terminalis.

Transporter proteins can accelerate the movement of some molecules into or out of the brain. The treatment of Parkinson's disease provides an example. An amino acid transport through the blood-brain barrier transports hydrophilic levodopa into the brain.

The blood-brain barrier is not completely developed at the time of birth, and many drugs administered to neonates achieve greater concentrations in the CNS than occur in older children or adults.²⁹ Numerous other conditions can produce a temporary breakdown of the blood-brain barrier, which can increase the penetration of drugs such as morphine and antibiotics into the brain. Some of these conditions include hypertension, inflammation, hypercapnia, osmotic stress, multiple sclerosis, and hyperthermia.

Brain Imaging

Assessment of brain function in health and disease is important for understanding and treatment of various nervous system conditions. Early techniques for assessing brain disorders included x-ray images of the head and monitoring electrical activity on the scalp using electroencephalography. Computer-assisted tomography visualization of the interior of the skull became feasible with the advent of powerful and inexpensive computers. McCormick, who was credited with the development of mathematical algorithms for reconstruction of brain images in the 1960s, shared the 1979 Nobel Prize in Physiology or Medicine with Hounsfield, who developed a working computed tomography (CT) machine, which he used to study the brain. CT allowed the interior of the head to be represented as shades of gray, which basically represent the structures inside the head. Swollen ventricles or hematomas are readily apparent.

Tomographic reconstruction was subsequently extended to other forms of detectable energy. Chemicals labeled with positron emitting isotopes can be visualized based on the geometry of their emitted radiation, which permits back calculation of the point of origin. This technique is referred to as positron emission tomography (PET); a less expensive variant is single-photon emitted computed tomography (SPECT). Most of the energy in the brain is needed for the Na^+, K^+ -ATPase pumps that maintain the membrane potential. Monitoring glucose, oxygen, or adenosine triphosphate (ATP) permits functional assessment of the activity in the brain.⁴⁹ An early functional PET scan used fluorodeoxyglucose to follow glucose use.⁴ Labeling compounds that bind selectively to known proteins, such as the dopamine uptake transporter, permitted the visualization of its brain binding sites.⁵⁵ In Parkinson's disease, these techniques show a loss of dopamine uptake in the basal ganglia. Although these results were exciting, they also were limited to fuzzy images.

Another kind of radiation, radio waves, can be induced to be transmitted from the brain by placing the brain in a powerful magnet that causes the nuclei of atoms to align. When a probing radiofrequency signal is applied, the nuclei shift to an energized state, and when the radio signal is turned off, the nuclei return to a lower energy state and emit radiofrequency radiation that can be localized with greater precision than with earlier techniques. This imaging technique is known as magnetic resonance imaging (MRI). MRI carries additional information about the environment of the molecule releasing the radiation, and water, oxygen, and fatty tissues can be distinguished with MRI. A further refinement of this technique is known as functional MRI. With functional MRI, the function of the tissue (the neural work) can be represented. One popular functional MRI technique is blood oxygenation level dependent (BOLD) functional MRI. BOLD detects levels of oxygen saturation in regions of the brain that vary with brain activity. A further application of the MRI signal is diffusion tensor imaging (DTI). With DTI, it is possible to map nerve pathways within the living brain. This technique uses the constraints in movement of water molecules in long skinny neurons. This technique can be used to determine if damage has occurred to the nerve tracts.

Functional MRI and DTI are primarily experimental techniques at this time but are likely to move into the clinic.³³ One problem with these techniques is temporal resolution; they require a few seconds to get enough information for an image. Magnetoencephalography is a new technique with a temporal resolution of 2 msec and may be useful when faster techniques are needed.

Structural Features of the Neuron

Typically, neurons are composed of three primary regions: the soma, or cell body; the dendrites, which are projections that primarily receive synaptic input from other neurons; and the axon, which transmits information from the cell body to other neurons. Similar to other cells in the body, the soma contains the nucleus and the Golgi apparatus. The various vesicles and proteins that are needed by the cell are primarily synthesized in the cell body and distributed to the other parts of the cell by transport processes. A critical region of the neuron is the axon hillock, the junction between the cell body and the axon. The axon hillock region (initial segment) has enriched numbers of voltage-gated Na^+ channels and is typically the site at which the action potential depolarization begins. The terminal end of the axon may contain arborizations of the axon termed the *telodendria*. This region determines the extent to which the information sent on the axon spreads out (collateralizes) as the signal reaches its target.

Communication within the CNS incorporates digital and analog encoding.^{13,30} The digital encoding consists of the frequency of action potential depolarizations that are conveyed along the plasma membrane of the axon. Axon potentials are termed *all or none*, meaning that when the threshold for triggering an action potential is reached, the cell generates a complete action potential, whose maximal voltage is consistent for its travel down the axon. The major pharmacologic intervention for this form of signal encoding is the use of drugs that block ion channels, preventing the initiation and conduction of action potentials. The blockade of Na^+ channels by local anesthetics is a primary example. The CNS effect is the basis for many of the toxic effects of local anesthetics (e.g., sedation, convulsions).

Typically, axons contain voltage-gated ion channels. These are needed for a patch of the neuron to carry an action potential, a regenerating electrical signal. Regenerating action potentials enable the neuron to send information over long distances without degradation. The sciatic nerve projects from the spinal cord to the tip of the toes, a distance that is equal to thousands of axon diameters. Axons can be unmyelinated or myelinated. Unmyelinated axons act like a burning fuse; the signal is passed from one region of the membrane to the next by the voltage from an active region exceeding the threshold for "depolarization" of the next region causing it to produce its own action potential. This is a relatively slow conduction process. Myelinated axons have regions of the nerve membrane covered by lipid layers that act as electrical insulators. In between the myelinated patches are nodes of Ranvier, which are short gaps of exposed nerve membranes enriched in voltage-gated ion channels. In myelinated neurons, the action potential "hops" down the axon (saltatory conduction) skipping the myelinated regions but depolarizing the nodes. This movement produces a faster nerve conduction rate and saves energy needed to repolarize the nerve membrane.

In the CNS, dendrites typically do not have the components needed to produce action potentials. These regions of the cell typically conduct information by analog (or passive) potentials. Analog signals are voltages developed on the nerve membrane that spread out on the membrane as though it were a leaky cable following Ohm's law. Typically, these signals are large near their source but decline exponentially with distance from the source of the electrical stimulus. For dendrites the source of the electrical stimulus is typically synaptic connections. Analog signals in the dendrites can combine additively so that the voltage wave that reaches the initial segment is an integrated value of all of the signals applied to the dendrites.

Active membrane and passive membrane regions of neurons are distributed by functional need, rather than by the structure of the neuron. Typical neurons in the CNS include the pyramidal cells of the cortex or the cerebellum. These neurons have extensive dendritic arborizations that receive axonal input from many other cells. The integrated information on the dendritic tree is conducted by passive potentials to the cell body and axon hillock. When these potentials reach a depolarization threshold, the axon hillock depolarizes, and the action potential rapidly conducts the signal down the long axon to the telodendria inducing the release of neurotransmitter from the presynaptic nerve endings.

In most cases, the dentist will be concerned with sensory primary afferent neurons. Here the structure is quite different. These cells are termed *bipolar cells* or *pseudobipolar cells*. The part of the neuron that conducts the information from the innervated tissue to the CNS is the axon; the cell body is displaced from the projecting axon by a short stalk in the trigeminal or dorsal root ganglion and is not essential for integrating information. Instead the information is conducted directly from the periphery to the dorsal horn of the spinal cord. For these sensory nerves, the neuron is specialized for

transferring signals from the periphery to the spinal cord with minimal opportunity for integration or crosstalk.

The cell body is the primary source of organelles and transmitter molecules needed by the neurons. Ion channels and other essential molecules need to be transported from the cell body to other parts of the cell by transport processes. The transport process in the neuron is analogous to a toy train. Filaments or microtubules (e.g., tubulin, actin) in the cells act as miniature tracks. Molecules similar to muscle proteins act as tiny locomotives termed *Kinesins*. Organelles or their subunits are attached to the Kinesins and are pulled along the tracks using ATP for energy. By a similar process, the peripheral part of the nerve can also send cargo back to the nucleus. To return materials from the nerve ending to the nucleus (retrograde transport), a different locomotive is used (dynein proteins).

Uncharacteristic of a pyramidal neuron in the brain, the primary afferent neuron releases biologically active compounds at both ends of the cell—that is, within the brainstem but also at the sites of sensory input.⁴³ In the brainstem, these chemicals (glutamate, substance P, calcitonin gene-related peptide) are considered neurotransmitters. These substances are also transported to the site of an injury, however, and mediate inflammation and chemotaxis of inflammatory cells. Similarly, the transient receptor potential vanilloid 1 receptor, a nonspecific ion channel that mediates the burning pain associated with hot chili peppers,⁵⁴ is present in the dorsal root ganglia and transported to the peripheral nerve ending and the spinal cord.²⁶

The use of local anesthetics helps to relieve pain by reducing the release of proinflammatory mediators and hyperalgesia-mediating chemicals. Neurotrophins (e.g., nerve growth factor and brain-derived neurotrophic factor) are synthesized in the skin and macrophages where they bind to receptors at the dermal end of the peripheral nerve. This receptor-neurotrophin complex is engulfed by the nerve ending, and the complex is transported, in a retrograde manner, to the cell body where the complex modulates DNA transcription.^{21,44} Nerve growth factor acutely promotes hyperalgesia (more pain) but, after a delay, stimulates the cell body to produce ion channels, substance P (a pain mediator), and opioid receptors (pain reducers),³⁶ with some increases continuing for days. For this response to occur, the neurotrophins need to be transported to the nucleus, the cell elements synthesized, and the elements transported back to the peripheral nerve, producing the delay. When these mechanisms are activated, they may continue for various periods; durations in the range of days are not uncommon.

These transport systems are significant in many diseases the dentist may encounter. In compressive trigeminal neuralgia, the flow of organelles down the nerves is obstructed, which can cause accumulation of cell elements at the constriction; these are referred to as neuromas and may produce spontaneous pain because of the elevated ion channels present. Herpesvirus is also thought to be transported from the peripheral skin retrogradely to the neuronal cell body where it lodges. Later, often in association with some stressor, the virus blooms and then is transported in an anterograde direction to the skin.¹⁶ In neuropathic pain, action potentials contribute to the induction of $\alpha_2\delta$ Ca^{++} channels in the cell body, which are transported to other cell regions and are associated with mediating the pain.¹⁰ Microtubular-associated proteins are of considerable interest in some serious brain disorders such as Alzheimer's disease. The tau protein is a cross-linking protein between microfilaments that is found in plaques in the brains of these patients.³

Glia

Glia, including oligodendroglia, astroglia (i.e., astrocytes), and microglia, in the brain participate in many functions, including

myelination, regulation of various chemicals such as K^+ and neurotransmitters, regulation of immune function, supporting the blood-brain barrier, and facilitating connections between the nerve cells and their blood supply. A specific example of glial function in the brain is the regulation of glutamine, glutamate, and GABA. Glutamine is the precursor of the neurotransmitter glutamate, and glutamate is the precursor of the neurotransmitter GABA, and the astrocytes regulate the concentrations of these compounds.⁴⁸ Disturbance of this function may play a role in epilepsy.

Brain Blood Supply

Another important component of the brain is its blood supply. Without a blood supply, brain function would be rapidly lost. Strokes, which compromise the normal supply of blood to the brain, can produce ischemia, inflammation, scarring, cell death, and loss of function of the affected tissues. It is suspected that even microstrokes can accumulate and eventually contribute to neurologic disorders by producing inflammation.^{28,30} Microstrokes can result from infections and injuries to the head. Lipid-lowering drugs (e.g., HMG-CoA reductase inhibitors) have been found to reduce the incidence of Alzheimer's disease and Parkinson's disease, suggesting that chronic defects in blood flow may contribute to these disorders.^{39,52}

SYNAPTIC ORGANIZATION OF THE CENTRAL NERVOUS SYSTEM

Information Encoding

At the synapse (Figure 11-1), diffusible chemicals contained in synaptic vesicles are released from the presynaptic neuron to activate receptors located on the postsynaptic neuron. A variable (or analog) response at the postsynaptic membrane occurs because a variable number of vesicles may be released. Factors that alter the number of vesicles released include the frequency of action potential depolarizations that arrive at the presynaptic membrane, its preexisting membrane potential, and its metabolic status. Presynaptic receptors can augment or inhibit neurotransmitter release. It is not uncommon for a neuron to release multiple transmitters such as peptides, amino acids, and others. Postsynaptically there is a confluence of transmitters that determine the response. It has been proposed that numerous transmitters act in reverse (i.e., from the postsynaptic side back to the presynaptic neurons). Some candidates that work "in reverse" are nitric oxide and anandamide (an endogenous cannabinoid).

In addition to chemically mediated signals, direct electrical signaling between neurons and glia is possible (e.g., by gap junctions),⁵¹ but this form of communication is generally of lesser importance in pharmacotherapy. There may be a role for such electrical connections in the action of drugs that modify rapid eye movement sleep and wakefulness, such as anesthetics or modafinil.^{6,20} The understanding of the relationship between glial and neuronal function is incomplete.

Chemical communication between neurons is well suited for mediating either inhibitory or excitatory signals and permits flexible neuronal processing in response to environments that are constantly changing. Another important quality of chemical transmission is the potential for amplification of the signal from a single presynaptic cell to numerous postsynaptic neurons by extensive collateral axonal synaptic connections.

In contrast to the small number of drugs that modulate digital neuronal encoding, numerous drugs modulate analog encoding. Most CNS drugs with a known mechanism of action seem to act primarily by altering synaptic activity. This list includes most receptor agonists and antagonists, catabolic enzyme inhibitors, and drugs that alter the reuptake of neurotransmitters. Before exploring the pharmacologic actions

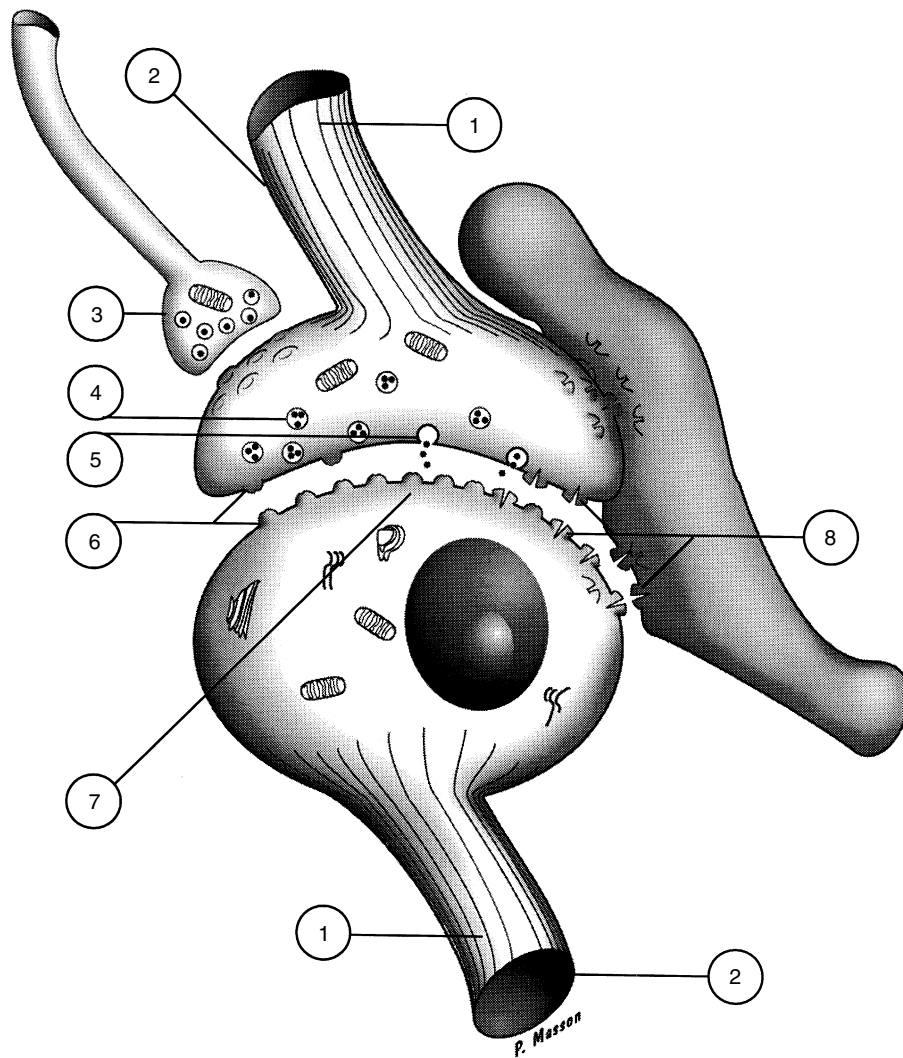

FIGURE 11-1 The major elements involved in synaptic communication, including several sites of drug action. 1, Microtubules are involved in transporting proteins synthesized in the cell body; drugs such as colchicine can disrupt microtubular transport. 2, The neuronal membrane potential is normally negative with respect to the extracellular surface. Depolarization is a major form of digital communication and can be blocked by local anesthetics. 3, Presynaptic neuronal processes can inhibit or facilitate activity of presynaptic neurons. Many drugs, such as opioids, may act in part by presynaptic inhibition. 4, The synthesis or storage of neurotransmitters can be altered by numerous drugs (e.g., levodopa, which serves as a dopamine precursor). 5, The secretion of neurotransmitters is the major component of analog signaling. Drugs such as amphetamine acutely increase release of norepinephrine from a cytoplasmic source. 6, Receptors can exist on presynaptic and postsynaptic membranes and can be affected by either agonists or antagonists. 7, Signal transduction mechanisms mediate receptor events and can be classified as either metabotropic or ionotropic in nature. Drugs such as the methylxanthines (e.g., caffeine) can increase intracellular cyclic adenosine 3',5'-monophosphate concentrations by inhibiting phosphodiesterase. 8, Neurotransmitters are inactivated either by metabolic mechanisms or by uptake into neurons or glia. Drugs can alter synaptic activity by inhibiting reuptake (e.g., tricyclic antidepressants inhibit reuptake of norepinephrine and 5-hydroxytryptamine) or by inhibiting degradation (e.g., physostigmine, which blocks the metabolism of acetylcholine by acetylcholinesterase).

of CNS drugs, it is important to understand the physiologic system of chemical communication between neurons, including neurotransmitters and their synthesis, release into the extracellular space, actions on target cells, and termination of effects.

Synapses take various forms. The typical synapse is described as a small swelling on the end of an axon (a "button") that comes close to the postsynaptic cell structures that contain many receptors. The presynaptic and postsynaptic

components are typically axons onto dendrites. All combinations of synapses between axons, neuron cell bodies (the soma), and dendrites are known (e.g., axoaxonic, dendrodendritic, axosomatic).

For many biogenic transmitters, the presynaptic nerve looks like a beaded necklace, with the synaptic vesicles being observed in the beads. The receptor tissue is not close to the transmitter release points. These synapses are described as *en passant* ("in passage") and seem to be specialized for changing

the function of a region of neurons, rather than a specific cell. A more recently describe synapse is seen in several sensory receptors (retina and auditory apparatus) and is described as a ribbon synapse. The presynaptic nerve ending has many synaptic vesicles lined up near a “ribbon” that seems to regulate their release. These synapses are thought to be specialized for producing prolonged and tonic transmitter release.⁵⁶

Organizational Features of the Synapse

A schematic representation of chemical communication is presented in Figure 11-1. Because the neuron cell body contains all the intracellular organelles necessary for protein synthesis (nucleus, ribosomes, endoplasmic reticulum, and Golgi apparatus), microtubular transport plays an important role in carrying newly synthesized proteins (e.g., enzymes, neuropeptides, and receptors) to the nerve terminals. Drugs that block microtubular transport, such as colchicine, could play an important role in the inhibition of neuronal function, but this effect is primarily associated with adverse drug actions. Presynaptic modification of synaptic activity is a major form of neuronal signal processing. Presynaptic terminals may inhibit or facilitate synaptic activity by altering the membrane potential. Opioids and cannabinoids are thought to act at least in part through a presynaptic mechanism. Activation of opioid receptors reduces the release of neurotransmitter across the synapse. Additional sites for pharmacologic manipulation include the synthesis, release, action, and inactivation of various neurotransmitters. These mechanisms are considered in further detail in the following section.

BIOCHEMICAL ORGANIZATION OF THE CENTRAL NERVOUS SYSTEM

Neurotransmitters

Generally, several criteria must be fulfilled for a substance to be considered a neurotransmitter.^{13,30} The substance must be synthesized in the presynaptic nerve, stored in synaptic vesicles, released by nerve stimulation, and rapidly inactivated. In addition, exogenous application of the substance should mimic the actions of the endogenous transmitter. By some estimates, nearly 100 substances have partially or completely fulfilled these criteria. They can be classified, on the basis of their chemical structure, as amino acids, small organic compounds, large organic complexes, hormones, lipids, small peptides, and gases. Within the CNS, acetylcholine, monoamines, amino acids, peptides, purines, fatty acids, and hormones represent the main classes of chemicals involved in neuronal signaling. Table 11-2 lists important CNS neurotransmitters and important receptor subtypes.

Acetylcholine

Since the discovery that acetylcholine acts as a peripheral neurotransmitter, considerable research has elucidated its role as a CNS neurotransmitter. Lower motor neurons are cholinergic, as are other local circuit neurons in the cerebral cortex, limbic system, and thalamus. Muscarinic and neuronal nicotinic receptor subtypes have been identified in the CNS. Acetylcholine is thought to modulate waking and dream states, respiration, motor activity, pain, vertigo, and memory. Many cholinergic antagonists have prominent CNS effects, such as sedation, amnesia, and hallucinations. Antimuscarinic drugs are used as adjunctive therapy in the management of Parkinson's disease or as a prophylactic treatment to prevent motion sickness. The anticholinesterase physostigmine is used to manage certain acute delirium reactions. Several other anticholinesterases (including donepezil, tacrine, and rivastigmine) have been approved to improve memory in early phases of Alzheimer's disease.

Monoamines

The monoamines, otherwise known as the biogenic amines, constitute a major class of neurotransmitters. Dopamine, norepinephrine, epinephrine, 5-hydroxytryptamine (5-HT), and histamine are the primary members of this class. Dopamine is a major CNS neurotransmitter, functioning in areas of motor control, behavior, waking, sleep, mood, and perception. Dopamine constitutes more than 50% of the total CNS content of catecholamines. The importance of this neurotransmitter is also shown in its critical role in such debilitating CNS diseases as Parkinson's disease, Huntington's disease, and schizophrenia. MPTP (1-methyl-4-phenyl-1,2,3,6-tetrahydropyridine), a by-product of illicit opioid manufacture, has been shown to produce a parkinson-like syndrome in addicts by causing selective destruction of nigrostriatal dopaminergic neurons (see Chapter 15).²⁵

Norepinephrine is the next most common catecholamine (approximately 30% of total CNS catecholamines) and is a neurotransmitter of brainstem neurons within the locus coeruleus, with projections to the cortex, cerebellum, and spinal cord. In addition, norepinephrine is the neurotransmitter of postganglionic neurons of the sympathetic nervous system. Norepinephrine is thought to modulate affective disorders, learning, reward, sleep, and pain perception.

In contrast to dopamine and norepinephrine, concentrations of epinephrine in the CNS are quite low (approximately 5% to 17% of the norepinephrine content) and are localized primarily in cell bodies of the reticular formation. The precise roles of epinephrine in the CNS are still under active investigation.

Neurons containing 5-HT are found primarily near the midline raphe nuclei of the brainstem and project to the cortex, cerebellum, and spinal cord. 5-HT is thought to modulate sleep and waking, pain, and affective states. Neurochemical evidence also reveals another monoamine, histamine, in the hypothalamus and histamine-binding sites in various brain regions, and it is thought to mediate wakefulness, weight control, and attention. Blockade of these binding sites is thought to account for the drowsiness experienced by many individuals who take antihistamines such as diphenhydramine and hydroxyzine.

Amino acids

An additional major class of neurotransmitters consists of amino acids.^{18,23} Research on the neurotransmitter roles of amino acids has been difficult because these substances are integral components of general intermediary metabolism and are present in numerous cell types. Many studies now suggest, however, that amino acids are quantitatively the major neurotransmitters in the CNS. These amino acids can be divided into those that are excitatory, capable of depolarizing neurons (glutamic acid, aspartic acid, cysteic acid, and homocysteic acid), and those that are inhibitory, capable of hyperpolarizing neurons (GABA, glycine, taurine, and β -alanine).

Glutamate is found in high concentrations within the brain and has been shown to have potent excitatory effects. Current evidence indicates that this excitatory amino acid has possible roles in memory, sensory perception, upper motor neurons, and excitatory neuronal damage. Studies conducted in experimental animals suggest that glutamate receptor antagonists may protect against neuronal death and may have therapeutic potential for reducing neuronal damage in stroke victims, patients with Parkinson's disease, and patients with Alzheimer's disease.

CNS-acting drugs, such as the dissociative anesthetic ketamine, are known to affect glutamate neurotransmission by binding to a site on the N-methyl-D-aspartate (NMDA) receptor and impeding the flow of Ca^{++} through the channel of the receptor. The NMDA receptor requires activation by two

TABLE 11-2

Important Central Nervous System Transmitters and Their Receptor and Signaling Characteristics

TRANSMITTER	RECEPTOR SUBTYPE(S)	SIGNALING MECHANISM	EFFECTOR MECHANISM	COMMENTS
Acetylcholine	Nicotinic (muscle, ganglionic, CNS) Muscarinic (M ₁ , M ₃ , M ₅)	Ionotropic G _q protein	↑Na ⁺ , ↑K ⁺ conductances PLC-IP ₃ -DAG, and ↓K ⁺ conductance	Heterotropic pentamer
Cannabinoid: anandamide, 2AG	Muscarinic (M ₂ , M ₄) CB ₁ , CB ₂	G _i protein G _{i/o} protein	↑K ⁺ , ↓Ca ⁺⁺ conductances ↓cAMP, and ↓K ⁺ , ↓Ca ⁺⁺ conductances	Presynaptic, marijuana site of action
Dopamine	D ₁ , D ₅ D ₂ , D ₃ , D ₄	G _s protein G _{i/o} protein	↑cAMP ↓cAMP, ↑K ⁺ conductance	
Norepinephrine	α ₁ α ₂ β ₁	G _q protein G _i protein G _s protein	PLC-IP ₃ -DAG, Ca ⁺⁺ ↓cAMP ↑cAMP	Mostly presynaptic
GABA	GABA _A GABA _B	Ion channel G _{i/o} protein	↑Cl ⁻ conductance ↑K ⁺ , ↓Ca ⁺⁺ conductances*	Heterotropic pentamer
Glutamate-aspartate	NMDA	Ion channel	↑K ⁺ , ↑Na ⁺ , ↑Ca ⁺⁺ conductances	Allosteric (Gly-Glut) triggered heterotetramer (composed of two NR ₁ and two NR ₂ subunits)
	AMPA m-GluR ₁ , m-GluR ₅ m-GluR ₂₋₄ , m-GluR ₆₋₈	Ion channel G _q protein G _{i/o}	↑K ⁺ , ↑Na ⁺ conductances ↑K ⁺ , ↑Na ⁺ conductances Decrease glutamate release	Heterotetrameric receptor Presynaptic
Glycine	GlyR	Ion channel	↑Cl ⁻ conductance	Heterotropic pentamer
Nitric oxide	Guanylate cyclase	cGMP	Protein kinase G	Presynaptic
Opioid peptides	μ, δ, κ, NOP (or ORL 1)	G _{i/o}	Many	Heterodimers possible; presynaptic and postsynaptic
Prostanoids (e.g., prostaglandins)	DP ₁ , DP ₂ , EP ₁₋₄ , FP, IP, TP	G _s , G _i , G _q , G _q , G _s , G _q	Varied	
5-HT (serotonin)	5-HT _{1A-F} 5-HT _{2A-C} 5-HT ₃ 5-HT ₄ , 5-HT ₆ , 5-HT ₇ 5-HT ₅	G _{i/o} protein G _{q/11} protein Ion channel G _s protein G _{i/o} protein	↓cAMP, and ↑K ⁺ conductance ↓K ⁺ conductance ↑Na ⁺ , ↑K ⁺ conductances ↑cAMP ↓cAMP	5-HT _{1B} is presynaptic Heterotropic pentamer

*Responses vary depending on tissue.

Purine and several peptide neurotransmitters and their receptors are not listed. Acetylcholine and norepinephrine receptors are discussed extensively in Chapters 5 to 10. Other receptor classes are discussed in subsequent chapters. Not all receptor subtypes are listed.

2AG, 2-Arachidonoylglycerol; 5-HT, 5-hydroxytryptamine; AMPA, α-amino-3-hydroxy-5-methyl-4-isoxazole propionate; cAMP, cyclic adenosine 3',5'-monophosphate; GABA, γ-aminobutyric acid; Glut, glutamate; Gly, glycine; NMDA, N-methyl-D-aspartate; PLC-IP₃-DAG, phospholipase C-inositol trisphosphate-diacylglycerol.

transmitters simultaneously; glycine and glutamate must bind to activate the receptor. This is termed *allosteric binding*. A second interesting property of the NMDA receptor is that the nerve membrane needs to be already partially depolarized to activate it. When sufficiently depolarized, Mg⁺⁺ ion is expelled, opening the channel to ions, especially Ca⁺⁺. In addition, there are numerous modulatory binding sites for other agents (polyamines). The NMDA receptor may be essential for learning and memory and participates in the phenomena of long-term potentiation. The AMPA (α-amino-3-hydroxy-5-methyl-4-isoxazole propionate) glutamate receptor also responds to glutamate with depolarization, but these receptors act more like typical ion channels, such as nicotinic receptors, through which flow Na⁺ and K⁺ across the membrane. There are also several metabotropic glutamate receptors.

GABA and glycine are believed to be the major inhibitory neurotransmitters in the CNS. GABA is found in high concentrations in the mammalian brain and spinal cord. When

GABA binds to the GABA_A receptor, the result is hyperpolarization of the postsynaptic neuron, mediated by the inward flow of Cl⁻. Antianxiety drugs such as benzodiazepines are thought to function as allosteric facilitators of GABAergic transmission in the CNS. The existence of the allosteric binding sites suggests that there may be endogenous molecules that can modulate this receptor. Several other compounds may also bind to this site, and some of these agents are referred to as *inverse agonists* (β-carbolines, diazepam-binding inhibitor)—they decrease Cl⁻ conductance and can induce seizures. Allopregnanolone (a metabolite of progesterone) binds to another site on the Cl⁻ ion channel, and it is speculated that this steroid may play a role in increased benzodiazepine side effects in young women.

Glycine is thought to function primarily in the spinal cord, the lower brainstem, and perhaps the retina. High concentrations of glycine are found in the ventral horn of the spinal cord, producing an inhibitory feedback effect on the interneurons

and motor neurons in this region. Convulsions induced by the administration of strychnine are thought to occur because of inhibition of glycine receptors. Alcohol, barbiturates, and some anesthetics facilitate GABA-stimulated Cl^- conductance, but these drugs also inhibit AMPA-stimulated, glutamate-stimulated, and acetylcholine-stimulated ion conductances.²⁴

Neuropeptides

Numerous pharmacologically active peptides have been found in neurons. These peptides are capable of causing excitation and inhibition when applied to target tissues. Many neuropeptides are classified into distinct families that share a common amino acid sequence. The opioid peptides constitute an important example. This neuropeptide family includes the endomorphins, endorphins, enkephalins, and dynorphins. With the exception of the endomorphins, members of this family with opioid activity contain the amino acid sequence tyrosine-glycine-glycine-phenylalanine (Tyr-Gly-Gly-Phe).⁹

Peptides differ from the low-molecular-weight neurotransmitters in several regards. The primary difference occurs in their synthesis. In contrast to the low-molecular-weight transmitters, which can be synthesized anywhere within the neuron by cytoplasmic enzymes, peptides depend on mechanisms concentrated in the cell body (e.g., transcription, translation, post-translational processing). Post-translational processing involves splitting of the precursor protein into smaller peptides. A single precursor molecule can yield multiple copies of the active peptide (e.g., proenkephalin) or even several different active peptides (e.g., proopiomelanocortin).¹ In addition, alternative splitting of the precursor may occur in different tissues, in which the precursor may be cleaved in different locations, yielding completely different peptides with totally unrelated functions. This response is tissue-specific and driven by different splicing enzymes.

The neuroactive peptides leave the Golgi apparatus in secretory vesicles that also contain enzymes capable of converting peptides to the final active form. These vesicles are transported to the nerve terminal by axonal transport mechanisms and are released in response to action potentials. The phenomenon of colocalization of such neurotransmitters as amino acids, monoamines, or acetylcholine with neuropeptides and ATP is common, with each chemical exerting a slightly different effect on the target tissue, provided that receptors exist for each mediator.

Purines

ATP, found in purinergic nerves or colocalized with catecholamines or acetylcholine, may act as a neurotransmitter and may modulate the effect of other neurotransmitters. Adenosine also seems to act as an inhibitory neurotransmitter, and its receptors are blocked by the stimulant caffeine.

Fatty acids

Prostaglandins are formed in the CNS from cell-related lipids by the enzymes phospholipase A_2 and cyclooxygenase. As in the periphery, prostaglandins are often synthesized in association with inflammation. Prostaglandins act through G protein-coupled receptor systems to modify various cellular reactions.⁵⁷ Cannabinoid receptors (the receptors that mediate the actions of cannabis [marijuana]) are activated by endogenous lipid-related molecules (anandamide and 2-arachidonoylglycerol). Most of the CB1 (brain cannabinoid) receptors are located presynaptically. For this particular system it seems that the postsynaptic receptor is linked to release of agonist, which modulates the function of the presynaptic neuron.⁴⁷ Research has suggested that there may be interactions between these two fatty acids, with anandamide being a substrate for cyclooxygenase to produce modified cannabinoid agonists.⁴⁵

Gases

Several endogenously synthesized gases are thought to play a role in neurotransmission and other functions in the brain. The best studied is nitric oxide. This gas is synthesized by nitric oxide synthetase from L-arginine. This synthesis is triggered postsynaptically after a neurotransmitter such as glutamate or acetylcholine induces Ca^{++} currents in the postsynaptic cell. The generated nitric oxide diffuses to the presynaptic neuron where it modulates the action of cyclic guanosine monophosphate to alter the release of neurotransmitters.¹⁷ Nitric oxide synthetase is often found to coexist with GABA in neurons. Nitric oxide synthetase can be identified in the brain and in vasculature by immunohistochemical techniques. It is present early in development and may play some role in tissue differentiation. Later, it is found in important brain structures such as the cerebellum, hippocampus, basal ganglia, and basal forebrain.²² There is some concern that, by forming reactive peroxy-nitrites, it may contribute to various disorders, such as atherosclerosis, Parkinson's disease, and brain aging.^{11,35} Other gases such as carbon monoxide¹⁵ and hydrogen sulfide⁴² are proposed to act as neurotransmitters sometimes.

Hormones

Hormones such as thyroid hormone, glucocorticoids, testosterone, and estrogens can produce behavioral side effects. Receptors for these hormones are found in the brain. Hormones are generally thought to act by a genomic action—that is, binding to an intracellular receptor and then altering DNA transcription (usually at many DNA sites). Several hormones have been found, however, to have immediate or nongenomic actions as well. An example is the metabolite of progesterone, allopregnanolone, which binds to the GABA Ca^- channel receptor producing sedation.⁸

RELEASE OF NEUROTRANSMITTER

The release of neurotransmitter from the neuron is mediated by membrane potentials. Membrane depolarization activates voltage-gated Na^+ channels, allowing an influx of Na^+ into the presynaptic cell. The resulting depolarization of the presynaptic terminus activates voltage-gated Ca^{++} channels that exist in greater abundance at the nerve terminal. This Ca^{++} current is known as the secretory potential and initiates mechanisms leading to the release of transmitter from the presynaptic neuron during membrane depolarization.³⁰ Repolarization of the nerve terminal occurs as the Na^+ channels become inactivated and K^+ channels open, leading to an efflux of K^+ out of the presynaptic cell.

Research indicates that there is a clustering of synaptic vesicles at the nerve terminal. The number of vesicles at this site of the neuron is much greater than in other areas of the cell. The vesicles aggregate adjacent to areas of presynaptic membrane thickening known as dense bars. This region of the nerve terminal is termed the *active zone* because it is the site where the neurotransmitter is released from the synaptic vesicles by exocytosis. In response to an action potential, synaptic vesicles fuse with the presynaptic membrane, releasing their contents into the extracellular space of the synapse. The actual mechanics of neurotransmitter release occurs in stages. Synaptic vesicles first must dock with the plasma membrane. After docking, a priming reaction occurs that prepares the vesicle to fuse with the plasma membrane when an action potential is present at the terminal. With the arrival of the action potential and the subsequent increase in Ca^{++} in the terminal, the vesicle fuses with the plasma membrane and releases the vesicle contents into the synapse. The events leading to the fusion of synaptic vesicles to the plasma

membrane occur very quickly (within a fraction of a millisecond) and depend on the presence of a Ca^{++} influx. Changes in the duration of the action potential and the pattern of firing of the action potentials can alter the amount of intracellular Ca^{++} and can affect the number and type of vesicles released, triggered by Ca^{++} .

Many important proteins have been implicated in the process of vesicle docking and fusion. Synaptobrevin, syntaxin, and SNAP-25 are three molecules that are integral to the process and are collectively referred to as the *SNARE complex*. The SNARE complex is necessary for membrane fusion and exocytosis.^{34,53} Three other proteins play crucial roles in this process: SM protein, complexin, and the Ca^{++} sensor synaptotagmin.⁵³ Numerous regulatory proteins, including Rab GTPases, have been implicated in the process of exocytosis. The process described previously is representative of the mechanism for neurotransmitter release from the small clear vesicles that primarily contain the low-molecular-weight neurotransmitters. The larger dense core vesicles, which contain the monoamines and peptides, are thought to release their contents by essentially similar mechanisms, which also depend on the influx of Ca^{++} . Additionally, some of the neurons that release monoamines and peptides do not possess active zones, and the transmitter substances are released at nonspecialized sites of the presynaptic membrane.

One consequence of this mechanism is that the presynaptic membrane gradually gets larger because of the added vesicle membranes. There is a sequestration process of the excess presynaptic membrane that engulfs membrane and materials from the extracellular space (molecules or viruses) (i.e., pinocytosis).

RECEPTOR BINDING AND SIGNAL TRANSDUCTION

The various types of receptors for neurotransmitters, hormones, and drugs that act on the CNS are discussed in the broader context of general receptor pharmacology in Chapter 1. Table 11-2 identifies several neurotransmitters and receptors that are uniquely or closely associated with the CNS.

Many of the receptors can be classified as ion channels, and their action is termed *ionotropic*. These receptors tend to produce an immediate response. All of these ionotropic receptors are formed from protein subunits, which often exist in multiple isoforms. GABA_A receptors are pentamers. The choices for the pentamer composition include six α , four β , one δ , four γ , one ϵ , one π , and three ρ subunit isoforms in potentially thousands of combinations. Although this many receptor types have not yet been observed, it does suggest that there may be many variants.³⁸ Some GABA_A receptor variants are seen in infants and in epileptic patients.

G protein-coupled metabotropic receptors tend to produce effects that last longer than the ionotropic receptors. It is not uncommon for a single transmitter to combine with ionotropic and metabotropic receptors to produce an immediate and more prolonged action in the cell. See Chapter 5 for detailed information on events that follow stimulation of G protein-linked receptors.

A sequence of events follows the agonist binding to receptors linked to G_s . Adenylyl cyclase is stimulated, and cyclic AMP (the second messenger) is generated. Cyclic AMP stimulates the activity of protein kinase A. Protein kinase A can phosphorylate many proteins. One of the products of protein kinase A phosphorylation is the phosphorylated form of cyclic AMP response element binding protein (CREB-PO_4). This phosphorylation enables CREB to modulate DNA transcription, similar to the way an intracellular receptor does. By these intermediary metabolic pathways, a neurotransmitter can alter the immediate activity of the cell through ion channels,

the sensitivity of the cell by phosphorylation, and the long-term function of the cell through alteration of protein synthesis. Pathways such as these provide insight into the mechanisms by which drug tolerance or sensitization may occur.

TERMINATION OF NEUROTRANSMITTER EFFECT

Termination of the neurotransmitter signal is important for efficient functioning of the signaling process. If the neurotransmitter were to remain at the synapse and continue to bind to its receptor, new signals could not get through. Desensitization or downregulation of the receptor would also result from continued exposure to the neurotransmitter. Three mechanisms are involved in signal termination: uptake of the neurotransmitter back into the presynaptic neuron, enzymatic degradation of the neurotransmitter, and diffusion out of the synapse.

Reuptake

Reuptake of the neurotransmitter into the presynaptic cell is an important mechanism for terminating the effects of many transmitters. The existence of high-affinity uptake systems has been shown for norepinephrine (the norepinephrine transporter NET), dopamine (the dopamine transporter DAT), GABA (the GABA transporter GAT), 5-HT (the 5-HT transporter 5-HTT), glycine (the glycine transporter GlyT), and glutamate (the excitatory amino acid transporters EAAT1, EAAT2, and EAAT3). These uptake mechanisms are selective for specific neurotransmitters and rely on carrier or transporter proteins that span the plasma membrane. The transporters depend on the exchange of ions (primarily Na^+) or the hydrolysis of ATP to drive the system. Many antidepressants function by inhibiting the uptake of neurotransmitters such as norepinephrine and 5-HT, leaving a greater concentration of transmitter at the synapse and prolonging its duration of action.

Blockade of uptake mechanisms is also responsible for the effects seen with cocaine administration. Cocaine is a powerful inhibitor of the uptake of norepinephrine and dopamine from the synaptic cleft. Augmentation of dopaminergic transmission in the nucleus accumbens region of the brain has been linked to the euphoria produced by cocaine. A similar increase in synaptic concentrations of norepinephrine over long periods results in several cardiovascular side effects seen with cocaine abuse, such as dysrhythmia and hypertension. The danger of administering exogenous catecholamines to an individual intoxicated with cocaine should be readily apparent.

Enzymatic Degradation

Enzymatic degradation is an efficient method for terminating the effect of neurotransmitters such as acetylcholine and ATP. The enzymes involved in metabolizing acetylcholine and ATP are found primarily on the extracellular face of the plasma membrane of the postsynaptic neuron. The degradation of acetylcholine by acetylcholinesterase on the cell surface in the synaptic cleft is a prototypic example of the regulation of transmitter effect. Anticholinesterases (e.g., physostigmine) are used clinically to inhibit this degradation, increasing the amount of acetylcholine present within the synaptic cleft. Enzymes for metabolizing many other neurotransmitters are found in neurons. Enzymatic inactivation occurs after the neurotransmitter is taken up into the neuron, usually the presynaptic neuron.

The intracellular regulation of neurotransmitter concentrations is tightly controlled and compartmentalized, as shown by the monoamine oxidase system. This enzyme is found on the surface of mitochondria and degrades catecholamines and 5HT in the cytoplasmic pool (see Chapter 5). The monoamine oxidase inhibitors used to treat depression (e.g., isocarboxazid) function by blocking the degradation of the

monoamines within the presynaptic neuron, resulting in an increase in the amount of cytoplasmic monoamines. This effect leads to chronic adaptive receptor changes, which are discussed in Chapter 12.

Receptor-Transmitter Complex Postsynaptic Internalization

An interesting feature of G protein–coupled receptors is that after binding with the transmitter, the receptor is often internalized into the postsynaptic nerve. In some cases, β -arrestin and clathrin-coated pits mediate the receptor endocytosis. When internalized, the receptor can be metabolized in the lysosomes, returned to the cell surface, or possibly transported to the nucleus, as illustrated in Figure 1-12. Removal of the β adrenoceptor from the membrane is thought to be a mechanism for tachyphylaxis (rapid tolerance). Receptors that are internalized after agonist binding include β adrenoceptors, opioid receptors, and receptors for the tachykinins (substance P and the neurokinins).

Diffusion

Diffusion and removal by bulk flow are the simplest methods of terminating the neurotransmitter effect. The kinetics of diffusion depends on the concentration gradient of the neurotransmitter through the synaptic cleft and the affinity of the ligand for its receptor. Diffusion occurs at all synapses to some degree depending on the geometry of the synapse; its relative importance in terminating neurotransmitter action is inversely related to the combined influence of local metabolism and uptake.

TERMINATION OF THE EFFECTS OF CENTRAL NERVOUS SYSTEM DRUGS

Drugs acting in the CNS are largely metabolized to inactive products in the liver, and little metabolism occurs in the brain. Reduction in metabolism by the liver or blockade of the excretion of a drug or its active metabolites by the kidney can prolong the actions of CNS drugs. The CNS receives a high blood flow (estimated at about 750 mL/min), which translates into rapid delivery of drugs from the blood to the brain. Intravenously administered drugs or inhaled drugs can produce effects within seconds of administration.

The blood-brain barrier isolates the brain from the plasma, forming a barrier to the free passage of hydrophilic drugs and creating a separate environment with the pH of the cerebrospinal fluid being slightly acidic (pH 7.3). The brain contains more than double the amount of lipid molecules compared with muscle. This contributes to the high concentration of lipid-soluble drugs in the brain.

The action of highly lipid-soluble drugs in the CNS is often terminated by drug redistribution. After intravenous or gaseous administration, the high blood perfusion of the brain presents large amounts of a lipid-soluble drug to the brain. The drug readily enters the brain because of the blood-brain concentration difference and the high solubility of the drug in the brain lipids, producing a rapid effect. After equilibrium of the concentration of the drug between the plasma and the brain, the drug can be “redistributed” out of the brain to muscle, which is less lipoidal than the brain and less well perfused but has a larger volume than the brain, and then fat, which has a much lower blood flow than does the brain but a considerably larger volume. When this happens, the concentration in the brain may decrease to below a behaviorally effective level before the drug is actually cleared (metabolized or excreted) from the body.

In this case, CNS drugs can show multicompartment elimination. The rapid (or α -phase) elimination is associated with redistribution, followed by a slower, “metabolic” (or β -phase)

elimination. When referring to pharmacokinetic tables for CNS drugs, generally only the slow (β -phase) elimination rate is tabulated; this can lead to confusion by practitioners when the behavioral action is much shorter than the metabolic half-life. In these cases, the redistribution out of the brain determines the clinical offset. On repeated administration, the remaining unmetabolized drug can contribute to the total effect of the second dose (or subsequent doses), however, because it may increase the blood concentrations to a point well above the threshold concentration for a behavioral effect. In some cases, redosing can lead to overdosing when the practitioner is unaware of the phenomenon. This type of toxicity has been an issue with drugs such as thiopental and fentanyl.

Because of the pharmacokinetic impact of the blood-brain barrier and high blood flow to the brain, behavioral responses to drugs acting on the CNS follow a pattern that is illustrated by the barbiturates. Highly lipid-soluble barbiturates enter the brain rapidly, come to a rapid peak of action, and then redistribute out of the brain quickly. This pattern of action leads to a rapid effect; the anesthetic thiopental is a good example (see Figure 2-9). Other examples of drugs with similar pharmacokinetics include the benzodiazepine midazolam and the opioid fentanyl. These agents are also used as intravenous anesthetics based on their pharmacology and pharmacokinetics.

Relatively hydrophilic drugs get into the brain more slowly and tend to peak after a delay. The removal of their CNS effects more closely mirrors their metabolism and excretion. These CNS drugs may be used for daytime sedation or for seizure control because the more stable blood concentration tends to produce a flat, consistent effect. Compared with fentanyl, morphine is relatively hydrophilic. It gets into the brain slowly, has a delayed and lower peak action, and produces a prolonged and less profound level of analgesia compared with fentanyl.

Drugs that diffuse too slowly through the tight junctions of the blood-brain barrier may never reach behaviorally effective concentrations. Drug manufacturers can take advantage of this quality to limit CNS side effects. Histamine contributes to wakefulness. Lipid-soluble H_1 receptor antihistamines (e.g., diphenhydramine) enter the brain easily and block the action of histamine in the brain and produce drowsiness. To reduce this effect, less lipid-soluble antihistamines were developed. These drugs penetrate the blood-brain barrier slowly and only minimally. They are marketed as “nonsedating” antihistamines.

Some drugs that bind tightly to their CNS receptors may continue to act, even though the plasma concentrations of the drugs have virtually returned to zero. The action of irreversibly binding drugs is usually terminated only by receptor turnover. Tight, although not irreversible, binding has been observed for drugs such as morphine-6-glucuronide, pimozide, and alprazolam. Morphine-6-glucuronide is an active metabolite of morphine that is 100 times more potent than morphine, but is excluded from the brain except in cases of renal failure. In renal failure, it enters the brain and may become trapped there because of the blood-brain barrier. There it can produce analgesia and sedation even in the absence of detectable drug or metabolite in the plasma.²

Active transport mechanisms for terminating the actions of drugs in the CNS have been confirmed. As described in Chapter 2, multiple drug resistance proteins (including P-glycoproteins) and related transporters are proteins elaborated by the endothelium of the brain vasculature, kidney, intestines, and liver that facilitate export of molecules out of these organs and out of the body. These transport resistance proteins export several drugs of medical interest, such as β -adrenergic antagonists, anticancer drugs, anticonvulsants, human immunodeficiency virus protease inhibitors, and opioids. Drugs of particular interest to dental practice that

undergo active elimination include morphine, fentanyl, pentazocine, erythromycin, tetracycline, and glucocorticosteroids. Erythromycin and ketoconazole can inhibit these systems, possibly prolonging the CNS actions of other drugs. These transport proteins can be induced by several drugs, including some anticonvulsants, some anticancer drugs, and St. John's wort. Activation of the pregnane xenobiotic receptor can induce P450 oxidative enzymes, phase II synthetic enzymes, and P-glycoprotein simultaneously.

The hypothalamus is important for regulation of circadian and other rhythms, including sleep-wake and reproductive cycles. Drugs administered to patients can interact with these natural hormones and cycles; understanding the chronobiology of hormones may improve the understanding of the effects of drugs administered at different times. Some examples are the observations that anti-inflammatory adrenocorticotropic hormones and analgesic endogenous opiates are released at peak amounts in the morning. Patients often complain more of pain late in the day or at night, and overdose deaths with opioids are more common in the morning.

Pharmacodynamic processes can also affect the duration of action of CNS drugs. Decreased action of a drug with repeated administration of an agent is termed *tolerance* (e.g., opioid tolerance). Tolerance can have many causes, including reduced availability of neuron membrane receptors, modification of the sensitivity of the receptors, altered postreceptor systems (e.g., G proteins, second messengers, phosphorylation of receptors), or changes in gene transcription leading to changes in receptors in nerve synapses. Conversely, the increased action of a drug with repeated administration is termed *sensitization* (e.g., cocaine sensitization). Metabolic tolerance or sensitization can result from induction or inhibition of the metabolic enzymes in the liver, resulting in a change in the amount of drug getting to the brain.

The selection of a CNS drug should be based on the goals of therapy and an understanding of the pharmacology, especially the pharmacodynamics and pharmacokinetics, of the agent.

CITED REFERENCES

- Akil H, Watson SJ, Young E, et al: Endogenous opioids: biology and function. *Annu Rev Neurosci* 7:223-255, 1984.
- Angst MS, Bühler M, Lötsch J: Insidious intoxication after morphine treatment in renal failure: delayed onset of morphine-6-glucuronide action. *Anesthesiology* 92:1473-1476, 2000.
- Avila J, Lucas JJ, Perez M, et al: Role of tau protein in both physiological and pathological conditions. *Physiol Rev* 84:361-384, 2004.
- Basu S, Alavi A: Unparalleled contribution of 18F-FDG PET to medicine over 3 decades. *J Nucl Med* 49:17N-21N, 37N, 2008.
- Baumgartner U, Buchholz HG, Bellosevich A, et al: High opiate receptor binding potential in the human lateral pain system. *Neuroimage* 30:692-699, 2006.
- Beck P, Odle A, Wallace-Huitt T, et al: Modafinil increases arousal determined by P13 potential amplitude: an effect blocked by gap junction antagonists. *Sleep* 31:1647-1654, 2008.
- Bimar J, Bellville JW: Arousal reactions during anesthesia in man. *Anesthesiology* 47:449-454, 1977.
- Birzniece V, Bäckström T, Johansson IM, et al: Neuroactive steroid effects on cognitive functions with a focus on the serotonin and GABA systems. *Brain Res Rev* 51:212-239, 2006.
- Bodnar RJ: Endogenous opiates and behavior: 2007. *Peptides* 29:2292-2375, 2008.
- Boroujerdi A, Kim HK, Lyu YS, et al: Injury discharges regulate calcium channel alpha-2-delta-1 subunit upregulation in the dorsal horn that contributes to initiation of neuropathic pain. *Pain* 139:358-366, 2008.
- Brown GC: Mechanisms of inflammatory neurodegeneration: iNOS and NADPH oxidase. *Biochem Soc Trans* 35(Pt 5):1119-1121, 2007.
- Chang L, Haning W: Insights from recent positron emission tomographic studies of drug abuse and dependence. *Curr Opin Psychiatry* 19:246-252, 2006.
- Cooper JR, Bloom FE, Roth RH: *The biochemical basis of neuropharmacology*, ed 7, New York, 1996, Oxford University Press.
- Cooper JR, Meyer EM: Possible mechanisms involved in the release or modulation of release of neuroactive agents. *Neurochem Int* 6:419-427, 1984.
- Cutajar MC, Edwards TM: Evidence for the role of endogenous carbon monoxide in memory processing. *J Cogn Neurosci* 19:557-562, 2007.
- Diefenbach RJ, Miranda-Saksena M, Douglas MW, et al: Transport and egress of herpes simplex virus in neurons. *Rev Med Virol* 18:35-51, 2008.
- Domek-Lopacinska K, Strosznajder JB: Cyclic GMP metabolism and its role in brain physiology. *J Physiol Pharmacol* 56(Suppl 2):15-34, 2005.
- Fagg GE, Foster AC: Amino acid neurotransmitters and their pathways in the mammalian central nervous system. *Neuroscience* 9: 701-719, 1983.
- Fisher HE, Aron A, Brown LL: Romantic love: a mammalian brain system for mate choice. *Philos Trans R Soc Lond B Biol Sci* 361:2173-2186, 2006.
- Garcia-Rill E, Heister DS, Ye M, et al: Electrical coupling: novel mechanism for sleep-wake control. *Sleep* 30:1405-1414, 2007.
- Groneberg DA, Fischer TC, Peckenschneider N, et al: Cell type-specific regulation of brain-derived neurotrophic factor in states of allergic inflammation. *Clin Exp Allergy* 37:1386-1391, 2007.
- Judas M, Sestan N, Kostovic I: Nitroergic neurons in the developing and adult human telencephalon: transient and permanent patterns of expression in comparison to other mammals. *Microsc Res Tech* 45:401-419, 1999.
- Kandel ER, Schwartz JH, Jessell TM, editors: *Principles of neural science*, ed 4, New York, 2000, McGraw-Hill.
- Krasowski MD, Harrison NL: General anaesthetic actions on ligand-gated ion channels. *Cell Mol Life Sci* 55:1278-1303, 1999.
- Langston JW: MPTP neurotoxicity: an overview and characterization of phases of toxicity. *Life Sci* 36:201-206, 1985.
- Lauria G, Morbin M, Lombardi R, et al: Expression of capsaicin receptor immunoreactivity in human peripheral nervous system and in painful neuropathies. *J Peripher Nerv Syst* 11:262-271, 2006.
- Lee TS, Mane S, Eid T, et al: Gene expression in temporal lobe epilepsy is consistent with release of glutamate by astrocytes. *Mol Med* 13:1-13, 2007.
- Leonard BE: Inflammation, depression and dementia: are they connected? *Neurochem Res* 32:1749-1756, 2007.
- Levine RR: *Pharmacology: drug actions and reactions*, ed 6, Boston, 2000, Little, Brown.
- Levitan IB, Kaczmarek LK: *The neuron: cell and molecular biology*, ed 3, New York, 2002, Oxford University Press.
- Liebman M: *Neuroanatomy made easy and understandable*, ed 4, Rockville, MD, 1991, Aspen.
- Loring JF: Evolution of microarray analysis. *Neurobiol Aging* 27:1084-1086, 2006.
- Malhi GS, Lagopoulos J: Making sense of neuroimaging in psychiatry. *Acta Psychiatr Scand* 117:100-117, 2008.
- Malsam J, Kreye S, Söllner TH: Membrane fusion: SNAREs and regulation. *Cell Mol Life Sci* 65:2814-2832, 2008.
- McCann SM: The nitric oxide hypothesis of brain aging. *Exp Gerontol* 32:431-440, 1997.
- Mousa SH, Cheppudira BP, Shaqura M, et al: Nerve growth factor governs the enhanced ability of opioids to suppress inflammatory pain. *Brain* 130:502-513, 2007.
- Narayan S, Head SR, Gilmartin TJ, et al: Evidence for disruption of sphingolipid metabolism in schizophrenia. *J Neurosci Res* 87:278-288, 2009.
- Olsen RW, Sieghart W: GABA(A) receptors: subtypes provide diversity of function and pharmacology. *Neuropharmacology* 56:141-148, 2009.
- Orr JD: Statins in the spectrum of neurologic disease. *Curr Atheroscler Rep* 10:11-18, 2008.
- Penfield W, Rasmussen T: *The cerebral cortex of man: a clinical study of localization of function*. New York, 1950, Macmillan.

41. Pfliederer B, Zinkirciran S, Arolt V, et al: fMRI amygdala activation during a spontaneous panic attack in a patient with panic disorder. *World J Biol Psychiatry* 8:269-272, 2007.
42. Qu K, Lee SW, Bian JS, et al: Hydrogen sulfide: neurochemistry and neurobiology. *Neurochem Int* 52:155-165, 2008.
43. Rang H, Bevan S, Dray A: Nociceptive peripheral nerves: cellular properties. In Wall PD, Melzack R, editors: *Textbook of pain*, ed 4, New York, 1994, Churchill Livingstone.
44. Reynolds A, Bartletta S, Hendrya I: Molecular mechanisms regulating the retrograde axonal transport of neurotrophins. *Brain Res Rev* 33:169-178, 2000.
45. Ross RA: Allosterism and cannabinoid CB(1) receptors: the shape of things to come. *Trends Pharmacol Sci* 28:567-572, 2007.
46. Savic I, Widen L, Thorell JO, et al: Cortical benzodiazepine receptor binding in patients with generalized and partial epilepsy. *Epilepsia* 31:724-730, 1990.
47. Schlicker E, Kathmann M: Modulation of transmitter release via presynaptic cannabinoid receptors. *Trends Pharmacol Sci* 22:565-572, 2001.
48. Schousboe A, Sarup A, Bak LK, et al: Role of astrocytic transport processes in glutamatergic and GABAergic neurotransmission. *Neurochem Int* 45:521-527, 2004.
49. Shibasaki H: Human brain mapping: hemodynamic response and electrophysiology. *Clin Neurophysiol* 119:731-743, 2008.
50. Sieghart W: GABA_A receptors: ligand-gated Cl⁻ ion channels modulated by multiple drug-binding sites. *Trends Pharmacol Sci* 13:446-450, 1992.
51. Söhl G, Maxeiner S, Willecke K: Expression and functions of neuronal gap junctions. *Nat Rev Neurosci* 6:191-200, 2005.
52. Stepien K, Tomaszewski M, Czuczwar SJ: Neuroprotective properties of statins. *Pharmacol Rep* 57:561-569, 2005.
53. Südhof TC, Rothman JE: Membrane fusion: grappling with SNARE and SM proteins. *Science* 323:474-477, 2009.
54. Szolcsányi J: Forty years in capsaicin research for sensory pharmacology and physiology. *Neuropeptides* 38:377-384, 2004.
55. Varrone A, Marek KL, Jennings D, et al: [(123)I]-CIT SPECT imaging demonstrates reduced density of striatal dopamine transporters in Parkinson's disease and multiple system atrophy. *Mov Disord* 16:1023-1032, 2001.
56. von Kriegstein K, Schmitz F: The expression pattern and assembly profile of synaptic membrane proteins in ribbon synapses of the developing mouse retina. *Cell Tissue Res* 311:159-173, 2003.
57. Yang H, Chen CL: Cyclooxygenase-2 in synaptic signaling. *Curr Pharm Des* 14:1443-1451, 2008.

GENERAL REFERENCES

- Alberts B, Bray D, Lewis J, et al: *Molecular biology of the cell*, ed 4, New York, 2002, Garland.
- Banerjee S, Bhat MA: Neuron-glia interactions in blood-brain barrier formation. *Ann Rev Neurosci* 30:235-258, 2007.
- Harmar AJ, Hills RA, Rosser EM, et al: IUPHAR database of G protein-coupled receptors and ion channels. *Nucl Acid Res* 37(Database issue):D680-D685, 2009. Available at: <http://www.iuphar-db.org/index.isp>. Accessed December 10, 2009.
- Iversen L, Iversen S, Bloom FE, et al: *Introduction to neuropsychopharmacology*, New York, 2009, Oxford University Press.
- Kandel ER, Schwartz JH, Jessell TM: *Principles of neural science*, New York, 2000, McGraw Hill.
- Nestler E, Hyman S, Malenka R: *Molecular basis of neuropharmacology: a foundation for clinical neuroscience*, New York, 2009, McGraw Hill.
- Raichle M, Mintun M: Brain work and brain imaging. *Ann Rev Neurosci* 29:449-476, 2006.
- Wall PD, Melzack R, editors: *Textbook of pain*, ed 3, New York, 1994, Churchill Livingstone.

Psychopharmacology: Antipsychotic and Antidepressant Drugs*

VAHN A. LEWIS

According to the National Institutes of Mental Health, 20% of the population have a diagnosable mental disorder in their lifetime.³⁵ The *Diagnostic and Statistical Manual of Mental Disorders* (DSM-IV) classifies many types of mental disorders.¹⁰ Schizophrenia, which affects 0.5% to 1% of the population, is the most severe of the psychiatric disorders, and disturbances of mood (affective disorders) are the most common. Approximately 10% to 25% of women and 5% to 12% of men have at least one major depressive episode during their lifetimes. Schizophrenia and affective disorders are episodic and progressive disorders. Although appropriate treatment tends to improve the course of a disorder, it rarely produces a cure.

Psychotherapeutic drugs have contributed much to our understanding of mental illness and have reduced hospital bed occupancy by mental patients to a tenth of what it was before their use. Pharmacotherapy has permitted individuals who would otherwise have been hospitalized long-term to be more integrated into society. The Surgeon General's report on mental health has indicated that more people could benefit from treatment with psychotropic agents than are currently being treated.³⁵ In daily practice, the dentist can expect to treat patients taking psychotherapeutic agents for various mental disorders. These agents may contribute to oral pathology or become a factor when rendering dental care.¹⁷ Many patients being treated for mental illness report poor oral health, but it is not all due to their treatments; poor oral health is also correlated to older age, race, unemployment or financial strain, and smoking behavior.²⁷

Brain imaging, molecular biology, and genetic studies promise to improve the understanding of psychotic disorders. Results from such research have identified changes that may relate to the pathology of these conditions. Key findings include the observation of genetic, structural, and functional changes in schizophrenia, bipolar disorder, and depression. Inconsistencies between the symptoms and observable signs still exist that challenge our understanding and treatment of psychiatric disorders. Brain imaging studies have shed some light on this variability. Imaging has shown that the onset of schizophrenia is associated with a patchy loss of cerebral cortex that progresses to a more global and severe loss.³⁷ The symptoms seen in a particular patient may vary depending on where the process starts and how far it continues. For children with early-onset schizophrenia, the cell loss is found in most areas of the cortex 5 years after diagnosis.⁵² Difficulties in categorizing these illnesses can result in inconsistent treatment outcomes.

Psychotic states such as schizophrenia are treated with antipsychotic drugs, sometimes also referred to as *neuroleptics*; depression is treated with antidepressant drugs, and manic illness (and bipolar disorder) is treated with lithium salts and some anticonvulsant drugs. Neuroses (e.g., anxiety), which are less severe psychiatric disorders, are treated with antianxiety agents and are discussed in Chapter 13. Selective serotonin reuptake inhibitor (SSRI) antidepressants are also effective in treating several anxiety disorders, including obsessive-compulsive disorder, panic disorder, post-traumatic stress disorder, and social anxiety disorder. These drugs may be referred to as delayed action antianxiety agents because the effect develops slowly over several weeks. Sympathomimetic stimulants are effective treatments for attention-deficit/hyperactivity disorders and narcolepsy, and they are discussed in Chapter 6. New results from imaging and gene microarray studies reveal differences and similarities between the classification of brain disorders. In an individual patient, various agents may be needed for the particular spectrum of symptoms. Because of the perceived stigma associated with psychiatric illness, the psychiatric disorder itself (which may lead to poor self-insight), or the effects of the psychotropic drugs, patients may forget or be reluctant to discuss their disorder with dentists or to provide complete information regarding their treatment.⁵⁶

MAJOR PSYCHIATRIC DISORDERS

Schizophrenia

In schizophrenia, the patient's ability to function is markedly impaired because of disturbances in thought processes. These disturbances increase the likelihood of adverse social outcomes, such as unemployment, poverty, social isolation, and suicide.⁴

Schizophrenic patients have positive or negative symptoms, or both and memory disorders. Positive symptoms include hallucinations (false perceptions), delusions (false beliefs), and agitation. Negative symptoms include interpersonal withdrawal, loss of drive, and flattened affect (restricted range of emotions). Positive symptoms respond more favorably to the antipsychotic drugs that were developed first (typical or "classic" antipsychotics), whereas negative symptoms are better correlated with demonstrable structural abnormalities in the brain and may be more responsive to newer "atypical" antipsychotic drugs (see later). Schizophrenic patients also have subtle changes in process planning and memory, but these continue to be resistant to treatment.

Neither the etiology nor the pathogenesis of schizophrenia is known. Current thinking suggests that a genetic predisposition and early injury (in utero or early childhood) may set

*The author wishes to recognize Dr. Leslie Felpel for his past contributions to this chapter.

TABLE 12-1

Therapeutic and Adverse Effects Associated with Some Receptors Bound by Common Antipsychotic and Antidepressant Drugs

RECEPTOR OR PROCESS BLOCKED	THERAPEUTIC EFFECT OF BLOCK	ADVERSE EFFECTS RESULTING FROM BLOCKADE OF RECEPTOR OR PROTEIN
Histamine (H ₁) Muscarinic	Sedation, anxiolysis, antiallergy effect Reduction of extrapyramidal side effects	CNS depression, hypotension, dry mouth, weight gain Dry mouth, blurred vision, sinus tachycardia, constipation, urinary retention, memory dysfunction
Adrenoceptor α ₁ -Adrenergic		Memory dysfunction, postural (orthostatic) hypotension, reflex tachycardia, epinephrine reversal, dizziness, dry mouth, weight gain, priapism
α ₂ -Adrenergic	Blockade of presynaptic autoregulation, increasing CNS 5-HT and NE	Priapism
Dopamine (D ₂)	Amelioration of the positive signs and symptoms of psychosis	Extrapyramidal movement disorders, sexual dysfunction, dry mouth, weight gain
5-HT reuptake	Reversal of depression	Gastrointestinal disturbance, sexual dysfunction, activating effects, dry mouth
NE reuptake	Reversal of depression	Dry mouth, urinary retention, erectile dysfunction, CNS stimulation, tremor, proconvulsant
Dopamine reuptake	Antidepressant effect (?)	Psychomotor activation, psychosis, proconvulsant action (?), dependence

5-HT, 5-Hydroxytryptamine; CNS, central nervous system; NE, norepinephrine.

the stage for neurodevelopmental changes that ultimately manifest as behavioral difficulties later in life (often in early adulthood) and that may be triggered by a stressful lifetime event.³⁵ For the disease to manifest itself, the effects of several cumulative factors likely combine to result in the clinical disorder.⁴ Evidence from brain imaging suggests that broad areas of the brain can lose cell mass in this disorder, suggesting a problem in regulation of brain growth, repair, or cell pruning, rather than dysregulation of a single neurotransmitter. Genetic survey chip studies have also identified differences in neuronal structure and function (e.g., myelination, neuroimmune and mitochondrial genes) suggesting a neurodegenerative cause rather than a specific transmitter disruption.³¹

Dopamine hypothesis

The classic “dopamine hypothesis” for schizophrenia, which suggests that schizophrenia is caused by hyperactivity of central dopamine pathways, has been a dominant theme since the early 1960s. Most antipsychotics are dopamine antagonists in various experimental conditions, and agents that release dopamine (e.g., amphetamine) can induce an acute psychotic state similar to schizophrenia. Loss of balance between cerebral cortex inhibition and dopamine-mediated arousal may promote dysregulated thought. The hypothesis does not explain why the therapeutic effect of the antipsychotics takes several weeks to develop, although dopamine blockade is known to occur within hours; why some schizophrenic patients are refractory to antipsychotics; and why some drugs that affect neurotransmitters other than dopamine may have antipsychotic activity.

The role of dopamine in schizophrenia has been complicated by the identification and cloning of several dopamine receptor subtypes and the discovery that other neurochemicals, either independently or by regulating dopamine, may be involved in the disease process. Dopamine innervation is extensive and contributes to the activity in the basal ganglia, cerebral cortex, hippocampus, amygdala, thalamus, and cerebellum. Hyperactive dopaminergic neural pathways offer a simple and attractive mechanism to explain schizophrenia, but this is an incomplete explanation for the disease. It is

TABLE 12-2

Dopaminergic Cell Groups and Their Relationship to Actions and Side Effects of Antipsychotic Drugs

CELL GROUP	RELATIONSHIP/ACTION
Mesolimbic and mesocortical	Considered the major therapeutic targets for antipsychotics
Nigrostriatal	Essential for motor function, related to the motor side effects of antipsychotics
Tuberoinfundibular	Regulation of hormones, especially inhibition of prolactin secretion; thought to mediate side effects such as galactorrhea and infertility
Chemoreceptor trigger zone	Receptors thought to mediate the antiemetic actions of antidopaminergic drugs
Medullary-periventricular	May mediate the actions of antidopaminergic drugs on appetite

justified to assume, however, that the parkinson-like motor disturbances, which are common side effects of the antipsychotics, result from blockade of dopamine transmission in the basal ganglia (Table 12-1). Five dopaminergic cell groups are considered important either for the therapeutic actions of antipsychotic drugs or for side effects of the antipsychotic agents. Table 12-2 summarizes these dopamine cell groups and their proposed relationship to activity.

Other neurotransmitters

Other neurotransmitters have been implicated in psychotic behavior and are of interest regarding the cause of psychotic symptoms. Phencyclidine-induced psychosis is proposed to be an even better model for schizophrenia than the dopamine hypothesis. The predominant action of phencyclidine is

thought to be blockade of N-methyl-D-aspartate (NMDA)-type glutamate (glutamatergic) receptors. NMDA receptors are polyagonist receptors, involving glutamate, glycine, and polyamines. Stimulation of NMDA by glutamate can be therapeutically problematic. There is more recent interest, however, in glycine transporter blockade as a possible indirect alternative to the use of glutamate receptor agonists for therapy for schizophrenia.³⁰ The hallucinogens lysergic acid diethylamide and mescaline can induce hallucinations and delusions and are thought to produce their actions through 5-hydroxytryptamine type 2 (5-HT₂) receptors.² Anticholinergics, cannabinoids, and sigma receptor agonists are other drugs that can induce psychosis-like reactions.

Anatomic changes

Modern brain imaging techniques have identified numerous volume or functional changes in the brain in psychosis. Particular attention has been focused on areas of the association cortex (e.g., frontal, parietal, temporal association areas) or fiber bundles connecting the association cortex. More recent imaging evidence shows, however, that these are not the only areas of the brain involved. Sensory, motor, visual, auditory cortex, and olfactory cortex may be involved. Corticostriatothalamic loops may be involved because of their intimate connection to the cerebral cortex. These loops make numerous connections with limbic structures, such as the amygdala, hippocampus, nucleus accumbens, and basal ganglia, which are connected with the thalamus and back to the cortex. These same areas are involved in mood and thought processes. Dopamine may act as a regulator or modulator of function in many of these structures. If dysfunction of dopaminergic systems were to occur, it is reasonable to expect that alterations in mood, personality, and thought processes would follow.

Genetic and developmental vulnerability

There is evidence for a genetic predisposition to schizophrenia. If both parents are schizophrenic, 46% of the children are likely to become schizophrenic, and if one parent is schizophrenic, 18% of the children show the disorder compared with 1% of the general population. The possibility of early (in utero or childhood) stresses such as infection, exposure to toxic elements, winter birth, starvation, migration travel, or radiation has been correlated to increased vulnerability to the disease.

Affective Disorders

The affective illnesses are expressed as dysregulations of mood. There are many types of affective disorders categorized in DSM-IV, but for purposes of this discussion it is sufficient to consider only depression and mania. Most individuals have had reactive, or secondary, depression with feelings of sadness or grief associated with a personal loss.¹⁰ In normal circumstances, such reactions are related to specific causes, are not incapacitating, and are generally short-lived (1 to 2 weeks). In contrast, for a mentally ill patient, depression is a severe, disabling disorder characterized by reclusiveness and nonverbalization that may last for extended periods (2 to 5 weeks). The patient is sad most of the day; gains little pleasure from activities; and may have other signs, such as weight loss, irritability, insomnia, feelings of guilt, agitation, or difficulty in concentrating.¹⁰

A serious consequence of depression is an increased risk of suicide. Depression is also a risk factor or is comorbid with other diseases, such as sleep disorders, weight changes, sexual disorder, pain disorders, anxiety disorders (and panic attacks), drug abuse, psychoses, myocardial infarction, and coronary artery disease. This kind of depression is called primary, endogenous, unipolar, or major depressive disorder. A variant of depression is seasonal affective disorder, which is triggered

by changes in seasons and can respond to treatment with intense lights.¹⁰

Unipolar depression tends to be more common in women, but the risk of suicide is greatest in elderly men. Triggering factors for depression in women and men overlap, but women tend to be more strongly affected by interpersonal factors, whereas men tend to be more greatly affected by job loss or legal problems. In women, the factors of poor relationships with parents, early marriage, incomplete education, divorce, and financial difficulties can contribute to repeated stressful life events (cycle of adversity). The incidence of mood disorders in women is greatest at times of life when shifts of ovarian hormones occur. A higher incidence of depression can occur at the beginning of menstruation, after childbirth, and in the perimenopausal period. Depression may be more likely during the progesterone-dominated components of the menstrual cycle. Estrogens tend to be antidepressant and facilitate neuronal repair. A genetic risk is evident for mood disorders but so far is not clearly understood. Concordance rates for mood disorders are 46% in monozygotic twins and 20% for dizygotic twins.

Patients with mania exhibit a distinct period of abnormally elevated, expansive, or irritable mood, sometimes requiring hospitalization. Three or more of the following symptoms also suggest a manic episode: (1) inflated self-esteem, (2) decreased need for sleep, (3) talkativeness, (4) flight of ideas, (5) distractibility, (6) increased goal-directed activity, and (7) excessive interest in pleasure.

Manic individuals may also have alternating periods of severe depression, in which case the disorder may be referred to as bipolar (manic-depressive) illness. The first episode of psychopathology is often depression, sleep disorders, or anxiety, but psychopathology later progresses to include manic episodes.¹¹ The incidence of bipolar disorder may be 5% of the population and 45% of community mental health patients.³ Three forms of bipolar disorder have been distinguished. Bipolar I involves cycles of mania and depression. Bipolar II involves cycles of hypomania and depression. Hypomania is a less severe form of mania that does not have psychotic features (e.g., hallucinations). Bipolar III is mania associated with the use of antidepressants. Bipolar II patients only rarely convert to bipolar I, and patients with bipolar II disorder may have the highest risk for suicide.

There is great interest in identifying the underlying brain processes that may help explain depression and bipolar disorders. Heterogeneity in the expression and causes of depression has made this process challenging, however. As shown by imaging, the brain structural changes in depression include changes in the prefrontal cortex, the cingulate⁴⁹ the insula, and the temporal lobe. The hippocampus and amygdala have been implicated.³⁶ Cerebral blood flow and tissue glucose use are poorly correlated with depression in wide regions of the cortex, in contrast to the case for bipolar or normal subjects.¹² In light of these imaging results, it is unlikely that depression is due to a change in a single neurotransmitter. Paradoxically, gene survey results suggest that bipolar disorder is similar to schizophrenia because both are viewed as degenerative disorders,⁴⁹ whereas major depressive disorder may involve a more specific cause—glutamate/ γ -aminobutyric acid imbalance.

Environmental and genetic factors have a role in precipitating depression. Environmental factors (stresses) may act as triggers for depressive episodes by altering the release of mineralocorticoids and glucocorticoids, which under some conditions can predispose to brain damage. Depressive episodes tend to increase the likelihood of further depressive episodes, a phenomenon referred to as *kindling*. Individuals who also have a genetic predisposition for depression act as though they are “prekindled.” Their episodes of depression are less related

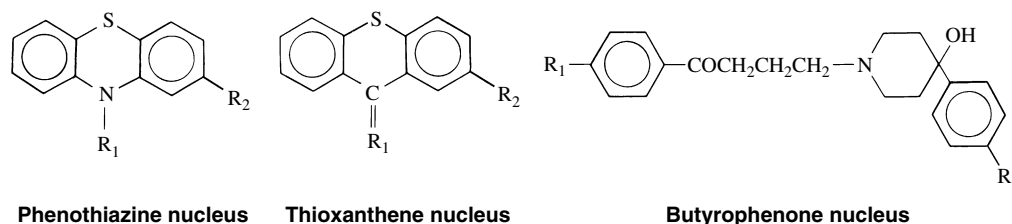

FIGURE 12-1 Structural formulas of representative antipsychotic drugs.

to precipitating stressful causes, are more serious, and are seen more often in younger patients. Late-onset depressions are less related to genetics or stresses and may involve damage in subcortical white and gray matter from disease states such as arteriosclerosis or Parkinson's disease.

Although bipolar disorder shares some characteristics with unipolar depression, there are several differences: the treatment is different for bipolar versus unipolar depression, bipolar disorder has a stronger genetic involvement, and bipolar disorder is thought to involve different observable brain structural changes. Currently, treatment is aimed at the manic phase first, which is treated with lithium salts and anticonvulsants. In addition, these agents may exert a neuroprotective effect and can reduce the extent of brain structural changes occurring in bipolar disease.

Monoamine hypothesis

As in the case of schizophrenia, various theories have been offered to explain the cause of affective disorders, with attention focusing on putative neurotransmitters. The classic monoamine hypothesis (also called the biogenic amine hypothesis or simply amine hypothesis) of affective disorders proposes that depression results from a deficiency of norepinephrine (NE), 5-HT, or both at central synaptic sites. Although little evidence exists that directly substantiates this hypothesis, it is indirectly supported by the fact that most antidepressant drugs increase synaptic concentrations of one or more monoamines, either by blocking the reuptake of monoamine into the presynaptic nerve terminal or by preventing its catabolism by the enzyme monoamine oxidase (MAO) in the nerve terminal after reuptake.

Although these findings are consistent with the monoamine hypothesis of affective disorders, there are several discrepancies. One of the findings most difficult to reconcile with the monoamine hypothesis is that the blockade of amine reuptake by antidepressants and of amine metabolism by MAO inhibitors can be shown almost immediately after drug administration, but full therapeutic effects are not observed until the drugs have been taken continuously for several weeks. In addition, some antidepressants, such as mirtazapine, do not have a significant effect on either monoamine reuptake or MAO inhibitor activity.

Because of these and other findings, new possibilities have been investigated to explain the action of antidepressants. Attention is focusing on presynaptic and postsynaptic structural mechanisms as evidence mounts that the reuptake inhibitors, MAO inhibitors, atypical antidepressants, and even electroconvulsive therapy all produce consistent changes in the relative density or sensitivity of certain receptor processes. The classic monoamine hypothesis is too limited and needs to be modified in accordance with new research findings. Changes in biochemistry of 5-HT, NE, dopamine, acetylcholine, glutamate, γ -aminobutyric acid (GABA), orexin, histamine, dopamine, corticotropin-releasing factor and corticosteroids, ovarian hormones, substance P, and omega-3 fatty acids have been shown. Depression may involve neural degenerative components as well, but these have not yet been well researched.

Historical Development of Antipsychotic and Antidepressant Drugs

Most of the psychotherapeutic properties of the psychoactive drugs were discovered by accident. In 1950, while attempting to develop antihistaminic agents, the Rhône-Pauline Laboratories in France synthesized the phenothiazine chlorpromazine (Figure 12-1). The unusual neuroleptic property of chlorpromazine was noted, and the drug was used to treat schizophrenic patients in 1952. The discovery of chlorpromazine and other phenothiazines made possible the outpatient treatment of psychotic disorders.

A characteristic of many antipsychotic drugs is interference with multiple neurotransmitter systems. In addition to blocking dopaminergic receptors, many can block α -adrenergic and serotonergic receptors and alter functions of cells. These drugs have many side effects that can be related to these multiple receptor actions (see Table 12-1). The next phase of development focused on drugs with selective drug receptor binding. In the case of antipsychotic drugs, action at multiple receptor types may provide therapeutic advantages. The current challenge is to identify which combination of actions is most beneficial.

The antidepressant properties of MAO inhibitors were discovered when it was observed that isoniazid, an antituberculosis drug, produced a euphoric state in patients and was found to be an MAO inhibitor. There are two forms of MAO: MAO-A is present in catecholamine-containing neurons, and MAO-B is found in 5-HT-containing neurons and astrocytes. Selective antidepressant MAO inhibitors inhibit the MAO-A form.

The tricyclic antidepressants (TCAs) were synthesized in an attempt to produce more specific antipsychotic agents (note in Figures 12-1 and 12-5 the chemical similarity of TCAs and phenothiazines). It was soon recognized, however, that imipramine, a prototypic TCA, was more beneficial in treating depression than in treating schizophrenia. TCAs were the mainstay for treating depression for many years. Their use has been limited, however, by the numerous side effects resulting from their actions on many nontherapeutic receptor sites. Efforts to develop better agents have been rewarded with a newer class of drugs, SSRIs, with fewer adverse effects than TCAs and fewer drug interactions than MAO inhibitors. These drugs have revolutionized the use of antidepressant medication. Subsequently, the selective serotonin and NE reuptake inhibitors and the selective NE reuptake inhibitors were developed.²⁶

St. John's wort is a botanical remedy with a long history of use for depression. It is now thought that the active principle is the compound hyperforin (instead of hypericin as had been believed).⁹ It has been characterized as a weak super-reuptake inhibitor with effects on NE, serotonin, dopamine, glycine, GABA, and glutamate reuptake.

Although the psychoactive properties of lithium salts were noted in 1949,⁶ lithium carbonate was not developed and widely recognized as an effective treatment for manic-depressive illness until 1970. More recent studies have focused on a possible neuroprotective role for lithium salts. The anti-

convulsant drugs carbamazepine and valproic acid were investigated for treatment of mania (bipolar disorder) in the early 1980s, and since that time their use and that of other anti-convulsant drugs has been increasing. When used for this purpose, these drugs are referred to as *mood stabilizers*.

Many adjunctive treatments are being evaluated for use in subgroups of patients with depression. Some of the agents used include glucocorticoid inhibitors, estrogens, thyroid, lithium, anticonvulsants, stimulants (e.g., modafinil), yohimbine, sildenafil, bupropion, pramipexole, buspirone, and anti-psychotic agents.

ANTIPSYCHOTIC DRUGS

The principal drugs effective in the treatment of schizophrenia are dopaminergic receptor antagonists. Five dopamine receptors (D_1 through D_5) have been cloned. Some of these receptors express extra long or short variants. The possibility that each of these receptors may subserve a different physiologic function illustrates the complexity of the dopaminergic system. D_1 and D_5 have similar actions and often increase cyclic 3',5'-adenosine monophosphate synthesis, whereas D_2 , D_3 , and D_4 are thought to decrease cyclic 3',5'-adenosine monophosphate synthesis. Interest has now focused on the relative specificity and affinity of the antipsychotic agents for each of the dopamine receptors. The older typical antipsychotics (e.g., phenothiazines) and the atypical agents (e.g., clozapine) are dopamine antagonists. Clinical potency as an antipsychotic drug relates most closely to blocking D_2 receptors (Table 12-3). The affinity of clozapine for the D_1 and D_4 receptors relative to D_2 is proportionally greater, however, than that of the older agents. In postmortem brain samples from schizophrenic patients, there is an increase in the number of D_2 receptors but not D_1 receptors.

Aripiprazole acts by a unique mechanism: it is a partial dopamine agonist, which produces limited dopamine action, but prevents additional stimulation by endogenous dopamine. This drug has been reported to produce fewer extrapyramidal side effects than dopamine antagonists.

Although there is little doubt that dopamine is involved in schizophrenia, other neurotransmitter systems may also play a crucial role in this disease. In addition to dopamine, neurotransmitters such as 5-HT, glutamate, NE, glycine, and GABA have been implicated in schizophrenia, suggesting that this is a very complex and multifaceted illness and that many mechanisms may be involved in the disease process.² Preliminary gene chip microarray analysis has shown changes in signal transduction, transcription, and metabolic

enzymes associated with altered regulation of certain genes in schizophrenia.³¹

Chemistry and Structure-Activity Relationships

Of the several classes of antipsychotics, some are closely related structurally, others share a stereochemical resemblance, and still others seem to be chemically unrelated. The term *typical antipsychotic* is used for drugs that improve chiefly positive symptoms, whereas *atypical psychotic* is used for agents that cause fewer extrapyramidal side effects or improve positive and negative symptoms.

Phenothiazines and thioxanthenes

The basic ring structure of the phenothiazines is illustrated in Figure 12-1. Substitutions at R_1 divide the phenothiazine antipsychotics into three major groups. One group, represented by chlorpromazine, has an aliphatic chain at C_1 . Compounds such as chlorpromazine with three carbons in the chain linked to an amine ($-\text{CH}_2-\text{CH}_2-\text{CH}_2-\text{N}(\text{CH}_3)_2$) have antipsychotic properties, whereas compounds with only two carbons, such as promethazine, are usually more antihistaminic or anticholinergic in nature and possess few antipsychotic effects. A second group, represented by thioridazine, has a piperidine ring at R_1 attached to the carbon chain. These phenothiazines are usually less sedating than the aliphatic agents but more sedating than the next group. A third group, represented by prochlorperazine, contains a piperazine ring on the carbon chain at R_1 . Drugs in this group are the most potent of the three as antipsychotic agents but are also the most likely to produce extrapyramidal side effects. Minor changes in the structure of these molecules can increase or abolish antipsychotic activity. The thioxanthene antipsychotics, represented by thiothixene, are closely related to the phenothiazines and are formed when the nitrogen of the central ring is replaced by a carbon atom.

Butyrophenones

The butyrophenone antipsychotics are not chemically related to the phenothiazines, but contain a stereochemically related nucleus (see Figure 12-1). The only butyrophenone antipsychotic available in the United States is haloperidol. Droperidol, another butyrophenone, is marketed as an antipsychotic in some countries, but is occasionally used in the United States primarily to reduce nausea and vomiting associated with anesthesia and surgery. Combined with the opiate fentanyl, it is also used to achieve deep sedation (see Chapter 48).

Dihydroindolones

The structure of molindone is shown in Figure 12-2. This compound is not structurally related to the phenothiazines,

TABLE 12-3

Comparison of Relative Receptor Antagonist Affinities of Typical and Atypical Antipsychotic Drugs

DRUG	AFFINITY ORDER							
Chlorpromazine	$\alpha_1 \geq$	5-HT ₂ >	D₂ >	D ₁ >	M >	α_2		
Haloperidol	sigma =	D₂ >	D ₁ = D ₄	α_1 >	5-HT ₂			
Clozapine	M >	5-HT _{2,6,7} =	H ₁ =	α_1 =	α_2 =	D ₄ >	D ₁	
Olanzapine	5-HT ₂ >	M ₁ >	α_1 =	D₂ =	H ₁ >	D ₁		
Risperidone	5-HT _{2A} >	D₂ =	α_1 =	α_2 >>	M			
Quetiapine	α_1 =	H ₁ =	D₂ =	5-HT ₂ >	D ₁			
Ziprasidone	5-HT _{2A} =	5-HT _{1A} (agonist) >	D₂ >	α_1 >	H ₁			
Aripiprazole	D₂ (partial agonist) >	5-HT _{1A} (partial agonist) >	5-HT _{2A} >>	5-HT _{2C} >	D ₄ >	α_1 >	H ₁	

The relative affinity for D_2 receptors is shown. Binding to other receptors has also been reported for some of the other drugs. D_2 receptors are **bold** for emphasis.

5-HT, 5-Hydroxytryptamine; α , α -adrenergic; D, dopaminergic; M, muscarinic; H, histaminergic; =, equal to the following receptor type; \geq , greater than or equal to the following receptor type; >, greater than the following receptor type; >>, much greater than the following receptor type.

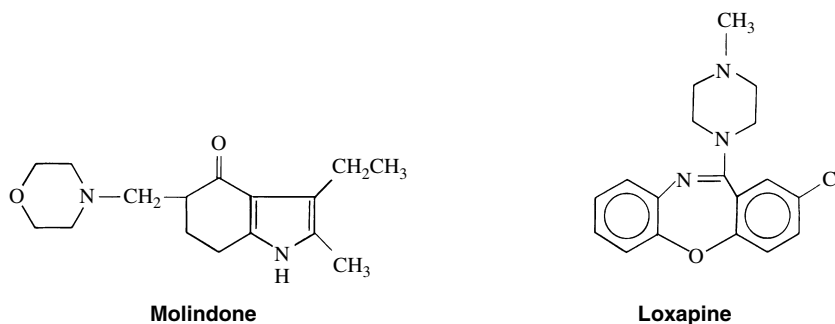

FIGURE 12-2 Structural formulas of molindone and loxapine.

thioxanthenes, or butyrophenones. The pharmacologic and clinical profile of molindone resembles that of the piperazine group of phenothiazines very closely. Ziprasidone, another dihydroindolone, is pharmacologically an atypical antipsychotic and is discussed subsequently.

Dibenzoxazepines

Loxapine (see Figure 12-2) is the only dibenzoxazepine available in the United States. The structure of this compound contains seven members in its central ring and resembles a TCA. Loxapine does not seem to have antidepressant activity, however. Similar to molindone, this drug has a clinical and pharmacologic profile similar to that of piperazine phenothiazines.

Diphenylbutylpiperidines

Pimozide, a diphenylbutylpiperidine derivative, is a modified butyrophenone in which a keto group in the side chain has been replaced with a 4-fluorophenyl moiety. Pimozide is a selective dopamine D_2 antagonist that has antipsychotic properties and typical Parkinson-like side effects. The U.S. Food and Drug Administration (FDA) approved pimozide for the treatment of Tourette's syndrome, a condition characterized by phonic and motor tics, but it has been used in Europe to treat schizophrenia. Penfluridol, another diphenylbutylpiperidine, is undergoing clinical trials in the United States for the treatment of Tourette's syndrome. Both of these agents have long half-lives.

Dibenzodiazepines

Clozapine (Figure 12-3) is the only dibenzodiazepine available in the United States. Its chemical structure closely resembles that of loxapine, but in contrast to loxapine, it is classified as an atypical antipsychotic in light of its low risk for producing extrapyramidal side effects. Clozapine is reported to improve positive and negative symptoms of schizophrenia and may reverse the progression of schizophrenic symptoms. Clozapine also has muscarinic, 5-HT_{2,6,7}, α_1 -adrenergic, and D_1 , D_2 , and D_4 receptor blocking properties. Use of clozapine can be accompanied by significant toxicity, especially agranulocytosis, seizures, and hypotension. Myocarditis and cardiomyopathy may rarely occur.

Thienobenzodiazepines

Olanzapine (Figure 12-4) is an atypical antipsychotic approved for clinical use. Its inhibitory actions at monoamine synapses are similar to the actions of clozapine except that olanzapine has a higher affinity for D_2 receptors (see Table 12-3). It is associated with fewer adverse effects than clozapine, particularly agranulocytosis.

Benzisoxazoles

Risperidone is a neuroleptic agent that combines antagonist action at D_2 and 5-HT₂ receptors (sometimes referred to as a

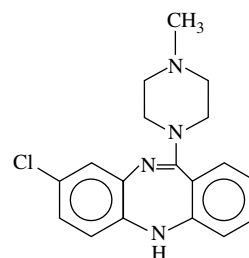

FIGURE 12-3 Structural formula of clozapine.

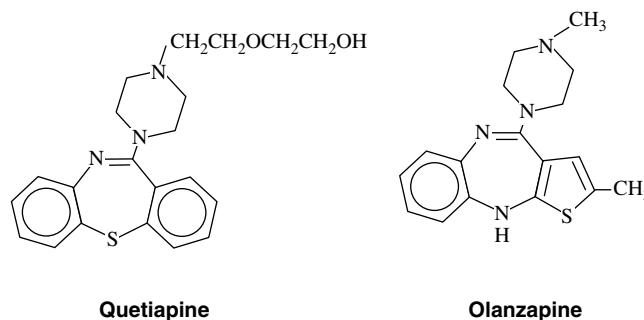

FIGURE 12-4 Structural formulas of quetiapine and olanzapine.

serotonin-dopamine antagonist). This addition to the antipsychotic armamentarium provides therapeutic effects similar to haloperidol, but in low doses it is considered to be atypical because of its relative freedom from extrapyramidal effects. Paliperidone is an active metabolite of risperidone with a pharmacologic profile similar to risperidone.

Other drugs expressing atypical antipsychotic activity

Other atypical antipsychotic drugs are available. Quetiapine (a dibenzothiazepine) (see Figure 12-4) is effective for positive and negative symptoms. Ziprasidone (a dihydroindolone) has actions similar to risperidone. Ziprasidone carries warnings for inducing long QT syndrome. Aripiprazole is a dihydrocarbotyryl derivative with a unique spectrum of action. Aripiprazole has been found to act as a partial agonist at D_2 , D_3 , and 5-HT_{1A} receptors and to act as an antagonist at 5-HT_{2A} receptors. It is reported to produce minimal side effects commonly associated with antipsychotic drugs. This seems to be a matter of degree because typical dopamine-blocking side effects are seen in a few patients.

Miscellaneous antipsychotics

Experimental drugs that show the greatest potential for clinical use are drugs that are highly selective for various receptors or are selective for receptors in specific areas of the brain. The

benzamide derivatives sulpiride, remoxipride, and amisulpride may preferentially block D₂ receptors in the mesolimbic system rather than in the striatum, which may account for their clinical effectiveness with low incidence of extrapyramidal side effects. Sulpiride has been available for use as an antipsychotic in Europe for several years but is still in clinical trials in the United States. Numerous drugs are being used as antipsychotics even though their primary indication is for other conditions, and still others are not currently approved for use in the United States.

The benzodiazepines are primarily used as anti-anxiety and hypnotic drugs, but more recently the clinical indications for this drug group have been expanded to include some psychotic disorders. Diazepam, chlordiazepoxide, alprazolam, clonazepam, and lorazepam all have found clinical usefulness in the treatment of some symptoms of schizophrenia, schizoaffective disorders, assaultiveness, agitation, and delirium. The benzodiazepines seem to have marginal antipsychotic properties when used alone and may be most useful as adjuncts to standard antipsychotic agents.

Pharmacologic Effects

Chlorpromazine is a classic typical antipsychotic drug. Typical antipsychotics include phenothiazines, thioxanthenes, haloperidol, molindone, loxapine, and pimozide. They have similar neuropharmacologic properties and adverse effects. The adverse effects vary in their frequency and severity, however, depending on the drug group. The prototype for the atypical antipsychotics is clozapine.

Antipsychotic effects

Although the precise mechanism of action of antipsychotic drugs is unknown, they all share the ability to block dopamine receptors in the brain. For typical antipsychotic agents, the dose required to alleviate positive symptoms of psychosis is most closely related to affinity of the drug for blocking the D₂ receptor.

There are several dopaminergic pathways in the central nervous system (CNS) (see Table 12-2) that, when antagonized by the antipsychotics, can explain their therapeutic efficacy and some of their side effects. The antipsychotic action may be ascribed to blockade of the mesolimbic/mesocortical tract, which plays an important role in behavior, arousal, salience (i.e. alerting, significance), positive reinforcement, cognitive function, communication, and psychological responses. Although blocking mesolimbic/mesocortical dopamine is thought to be central to antipsychotic efficacy, the inhibition of positive reinforcement may contribute to the high rate of discontinuation of treatment, which averages 74% over 18 months of therapy. Extrapyramidal motor dysfunction results from blockade of the nigrostriatal pathway, and endocrine disorders (amenorrhea, dysmenorrhea) result from the blockade of the hypothalamic-adeno-hypophyseal system. Two effects of antipsychotics may relate to blockade of dopamine receptors in the brainstem. Blockade of dopamine receptors in the medullary chemoreceptor trigger zone is thought to contribute to the antiemetic actions of antipsychotic drugs. Blockade of dopamine receptors in the medulla or brainstem may also play a role in appetite dysregulation. There are also dopamine interneurons in the olfactory bulb and retina. Olfactory changes occur in schizophrenia and Parkinson's disease, but these have not yet been related to dopamine. In the retina, dopaminergic cells may regulate light adaptation.⁵⁵

Compared with older drugs, atypical antipsychotic agents seem to be more effective for the negative symptoms of schizophrenia and tend to produce fewer extrapyramidal side effects. In addition, these drugs (e.g., clozapine) apparently are more effective in treating patients with schizophrenia resistant to other drugs. Exactly why they are more effective

in these cases is not known. Although the typical antipsychotics block nearly all central dopamine pathways, the atypical antipsychotic clozapine may selectively block mesolimbic and mesocortical dopaminergic pathways. This selectivity may explain its effectiveness in the treatment of schizophrenia and the relative absence of extrapyramidal and endocrine side effects.

Several hypotheses are proposed for this selectivity. The first relates the action of these drugs to binding of specific dopamine receptors. Clozapine has a stronger binding to D₁ and D₄ receptors than the classic antipsychotics. D₄ receptors are enriched in the mesolimbic parts of the brain. Some studies have suggested, however, that selective D₄ receptor blockade does not confer atypical properties. Other atypical and classic antipsychotics have significant affinity for the D₃ receptor. The D₃ receptor is also found to be enriched in the mesolimbic brain. The affinity of antipsychotic drugs for the D₃ receptor is generally less, however, than that for the D₂ receptor, and the contribution of the D₃ receptor to schizophrenia is also difficult to assess.

A second hypothesis is that other receptor types, in combination with dopamine blockade, may contribute to the atypical profile of clozapine. Clozapine has various effects on 5-HT receptors. Clozapine is a potent 5-HT_{2A} antagonist, with an affinity greater than that for D₂ receptors. This binding is thought to contribute to the ability of clozapine to relieve the negative symptoms of schizophrenia. Limited affinity for D₂ receptors and greater blockade of 5-HT₂ receptors are common findings for newer agents characterized as atypical antipsychotic drugs (serotonin-dopamine antagonists). Clozapine also binds to muscarinic receptors, which may help reduce extrapyramidal side effects; to histaminergic receptors, which may help reduce anxiety; and to α -adrenergic receptors, which may reduce blood pressure.

A third hypothesis is that by blocking only a fraction of the D₂ receptors, a drug has an atypical spectrum. Patients with Parkinson's disease do not exhibit typical extrapyramidal side effects until approximately 80% of the dopamine neurons in the striatum are damaged. If an antipsychotic agent is effective in reducing psychotic symptoms at doses that occupy less than 70% of the dopamine receptors, it would produce fewer extrapyramidal side effects.

A fourth (but related) hypothesis is that partial dopamine agonists may produce a limited dopaminergic tone to avoid typical side effects but still prevent excessive receptor activation by occupying and competing with endogenously released dopamine that promotes psychotic symptoms. Dopaminergic transmission would be brought into balance. Aripiprazole is the best example of this kind of agent currently available. It has reduced side effects and is being investigated for new indications.

Finally, a fifth hypothesis for atypical antipsychotic action states that the newer agents may rapidly dissociate from the D₂ receptor, which accounts for their atypical effects. Aripiprazole is a partial agonist at D₂, D₃, and 5-HT_{1A} receptors and an antagonist at 5-HT₂ receptors.

The potent anticholinergic activity of clozapine, the 5-HT_{2A} receptor-blocking effect, and the limited occupation of D₂ receptors (<60%) at therapeutic doses all may contribute to its atypical profile. Olanzapine, risperidone, and paliperidone have lower D₂ receptor binding and higher 5-HT₂ receptor binding and are relatively free of dyskinesias.²⁵ Quetiapine has a therapeutic effect and a side-effect profile similar to olanzapine.

Sedative actions

Phenothiazines and related antipsychotics produce sedation on initial administration, but tolerance develops in 1 to 4 weeks, so the patient becomes progressively more alert as

treatment continues. Sedation is the most commonly reported side effect of clozapine. Tolerance does not seem to develop to the antipsychotic action of these drugs. In contrast to sedatives such as barbiturates, chlorpromazine does not depress the reticular formation. It does raise the threshold for incoming sensory stimuli at the level of the reticular formation, however, so that the output of the reticular formation in response to sensory stimuli is depressed. Because schizophrenia may in part be a result of continual "flooding" of the brain by afferent input, reduction of this input by antipsychotics may partly explain their clinical efficacy.

Extrapyramidal effects

The extrapyramidal side effects produced by antipsychotic drugs include acute dystonias, a Parkinson-like syndrome, akathisia, and tardive dyskinesia. The different types of phenothiazines produce varying degrees of extrapyramidal side effects; in descending order of most to least potent are the piperazines, aliphatics, and piperidines. These compounds follow the reverse ranking order regarding their anticholinergic potency, which may explain why fluphenazine and haloperidol, weak anticholinergics, commonly produce extrapyramidal side effects, whereas thioridazine, a more potent anticholinergic drug, produces fewer motor disturbances. More recently, the role of 5-HT₂ receptors in reducing extrapyramidal symptoms and dystonias has been considered. As can be seen in Table 12-3, chlorpromazine is a more potent inhibitor of 5-HT₂ than it is for the muscarinic receptor. In addition, many newer antipsychotic drugs having atypical properties also block 5-HT₂ receptors. Molindone and loxapine are similar to chlorpromazine in their potential for causing extrapyramidal reactions. Haloperidol may have some unique effects on motor function. It is metabolized to a potentially neurotoxic metabolite, which may adversely affect the dopaminergic cells in the substantia nigra, inducing Parkinson's disease. Haloperidol also blocks sigma receptors. Sigma receptors in the red nucleus have been shown to participate in the generation of dystonias (oculogyric crisis and torticollis) associated with neuroleptic use. This observation may be particularly important for facial dystonias because sigma receptors are also expressed in cranial nerve nuclei.

Anti-Parkinson drugs (see Chapter 15) may be used to antagonize certain antipsychotic-induced motor disturbances, but levodopa is not helpful in this regard. Because dopamine receptors are blocked by the antipsychotic drugs, levodopa, the precursor of dopamine, is less effective in treating drug-induced parkinsonism than the anticholinergics, antihistamines, and amantadine, which act through other mechanisms.

Tardive dyskinesia is an extrapyramidal disorder that manifests after long-term antipsychotic therapy. Most of the extrapyramidal side effects of antipsychotic drugs occur during drug administration and disappear when the agent is withdrawn, but tardive dyskinesia develops after prolonged use and may be irreversible. This condition is thought to reflect the development of supersensitive dopamine receptors in the basal ganglia in response to their chronic blockade. Tardive dyskinesia has been estimated to occur in 15% to 20% of patients receiving long-term typical antipsychotic drug therapy. Tardive dyskinesia consists of abnormal, rapid, and alternating movements of the tongue (thrusting) and perioral areas; facial grimacing; tics; nose twitching; and other abnormal movements. It sometimes involves the extremities and torso, and may become severe enough to disrupt eating and breathing patterns. In contrast to other extrapyramidal side effects, tardive dyskinesia does not regress on reduction of the dose or withdrawal of the drug.

This side effect is frequently not seen until the antipsychotic drug is either withdrawn or reduced in dosage. The only consistently effective treatment for tardive dyskinesia has

been increasing the dose of the antipsychotic that caused it in the first place. Such a procedure leads to a vicious cycle and a serious therapeutic dilemma. Typical antipsychotics cause this side effect. Clonazepam may be helpful in mild cases, and botulinum toxin may allow control of overactive muscle groups.⁵⁰ Atypical agents such as clozapine, risperidone, and aripiprazole seem to have a reduced liability for tardive dyskinesia. Aripiprazole may be helpful for treating some cases, but long-term experience is not yet available. The low incidence of extrapyramidal side effects and the apparent absence of tardive dyskinesia are additional reasons for the interest in the atypical antipsychotic drugs.

Seizure threshold

Most of the antipsychotics, including clozapine, reduce the seizure threshold. The incidence of antipsychotic-induced seizures is approximately 1%, but nearly 7% in epileptic patients who receive antipsychotics. The convulsion is usually of the generalized tonic-clonic type. Chlorpromazine is more likely to cause this effect than fluphenazine, thiothixene, or molindone. The reduction of the seizure threshold seems to be inversely related to the antipsychotic potency of the drug and may depend on the particular dopamine receptor blocked (D₁ versus D₂) or possibly on the blockade of sigma receptors or changes in receptor sensitivity associated with long-term dosing. Seizures are more likely in patients with a history of seizures or under conditions where seizures are more likely, such as during withdrawal of sedative-hypnotic drugs.

Other central nervous system actions

Although medullary respiratory centers can be depressed by chlorpromazine, therapeutically active doses normally elicit little or no effect. If a sedative-hypnotic, antianxiety, or opioid drug is given to a patient receiving antipsychotic medication, however, summation of the depressant effects may result in clinically evident respiratory depression. Elderly patients may be more susceptible, and there is an elevated risk of pneumonia and death in elderly patients taking antipsychotics, with "typical" agents having at least as much risk as "atypical" agents. Antipsychotics, including clozapine, may disrupt thermoregulation by an action on the hypothalamus. Either hypothermia or hyperthermia may occur, depending on the ambient temperature.

Antiemetic action

Chlorpromazine is an effective antiemetic and previously was commonly used for this purpose. (Neuroleptics that are still used to treat nausea include prochlorperazine and droperidol.) The antiemetic action is exerted on the chemoreceptor trigger zone rather than on the vomiting center. Motion sickness is less responsive to dopamine antagonists than to anticholinergics and antihistamines.

Endocrine system

Endocrine system alterations result partly from actions on the hypothalamus. Most of the endocrine effects of antipsychotics are related to disturbances in the secretion of pituitary hormones. Particularly prominent is hyperprolactinemia elicited by blockade of dopamine receptors. Stimulation of dopamine receptors in the adenohypophysis normally inhibits prolactin release. Chlorpromazine may cause lactation and amenorrhea or delay ovulation and menstruation in women and cause gynecomastia and impotence or decreased libido in men. For atypical agents, risperidone has the highest incidence of these effects, and clozapine and aripiprazole have the lowest.⁴⁸ The urinary excretion of estrogens, progestins, and 17-hydroxycorticosteroids is decreased by chlorpromazine. Diuretic and antidiuretic effects have been shown in animals and humans, although a weak diuresis seems to be the predominant effect

in humans. The relative lack of effect of clozapine on dopamine receptors of the anterior pituitary accounts for its mild endocrine side effects. Weight gain and diabetogenic effects have been observed for several atypical antipsychotic agents. Olanzapine is most likely to produce weight gain.

Autonomic nervous system

The following side effects of the phenothiazines may result from their antimuscarinic properties: blurring of vision; constipation; and decreased sweating, salivation, gastric secretion, and intestinal tone. Phenothiazines also have antihistaminic, antitryptaminergic, and antiadrenergic properties that complicate further the overall pattern of their CNS and peripheral activities. Dry mouth associated with a series of neuroleptics was found to correlate significantly with their blocking potency at α_1 -adrenergic, H_1 -histaminergic, and D_1 -dopaminergic receptors.⁴⁵ The autonomic effects of haloperidol, molindone, and loxapine are similar, although weaker, than the effects of the phenothiazines. Clozapine and olanzapine have the reported side effect of hypersalivation.⁴⁷ Often this phenomenon is most prominent during sleep; the mechanism responsible for it is unknown. Although the autonomic effects of antipsychotics can be annoying, tolerance usually develops to these reactions.

Cardiovascular system

Orthostatic hypotension is a result of CNS and peripheral (α -adrenergic receptor blocking) actions of antipsychotics (see Table 12-1), whereas tachycardia and increased coronary blood flow derive from central compensatory cardiovascular reflexes. The aliphatic and piperidine phenothiazines and clozapine are the most likely, and the piperazines the least likely, to cause orthostatic hypotension (Table 12-4). In the emergency treatment of phenothiazine-induced vasomotor collapse, epinephrine is contraindicated because the α -adrenergic receptor-blocking action of the phenothiazines may cause "epinephrine reversal" and an even greater reduction in blood pressure. NE or phenylephrine, both of which lack significant β_2 -adrenergic receptor stimulation, is preferred in these circumstances. Chlorpromazine has a direct depressant effect on the heart and an antiarrhythmic action that may be caused in part by its local anesthetic effect. Vascular reflexes mediated by vasomotor centers of the brainstem are depressed by chlorpromazine. Haloperidol rarely causes pronounced hypotensive effects, but tachycardia is a common side effect.

Many antipsychotic and antidepressant agents have been found to cause or exacerbate the condition known as long QT syndrome (see Chapter 24). This syndrome is associated with increased likelihood of torsades de pointes, an arrhythmia that is potentially fatal. The condition is often produced by decreasing the function of cardiac K^+ channels responsible for cardiac repolarization (see Chapter 24). Phenothiazines, butyrophenones, pimozide, thioridazine, mesoridazine, and several atypical antipsychotic agents have been implicated (see Table 12-4). Ziprasidone may have a greater risk for this side effect. Clozapine is also known to block D_4 receptors, which are abundant in the heart. This action may contribute to the cardiovascular risk seen with clozapine.

Absorption, Fate, and Excretion

Metabolism of antipsychotic drugs is complex.⁴³ Most agents are metabolized by the P450 isoforms CYP2D6 or CYP3A4.¹² Other isoforms may also participate (1A2, 2B6, 2C9), and flavin monooxygenases contribute in the liver and in the brain (Table 12-5). Olanzapine is primarily glucuronidated and may possess advantages when oxidative metabolism is reduced. The P450 isoforms CYP2D6 and CYP1A2 are known to have genetic polymorphisms, and preliminary investigations suggest

that patients who are poor metabolizers may have more antipsychotic toxicity than normal metabolizers. Although metabolites for many antipsychotic drugs are active, their antipsychotic effects are usually not as potent as the effects of the parent compounds. The plasma half-lives of the antipsychotic drugs are not true indicators of their long durations of action. Half-lives for the phenothiazines range from 20 to 40 hours, yet the lipid solubilities of the drugs and their metabolites allow them to remain in tissues for prolonged periods.

Adverse Effects

The most troublesome side effects of the antipsychotic agents, particularly the phenothiazines and butyrophenones, are the extrapyramidal disorders consisting of tremor, akathisia, dystonia, bradykinesia, and dyskinesia. Therapy may have to be terminated in patients exhibiting pronounced and intractable motor disturbances. Use of atypical agents may help reduce this problem. The use of an anticholinergic drug, antihistamine, or amantadine can reduce Parkinson-like symptoms and less readily the motor restlessness of akathisia without compromising antipsychotic therapy. Acute dystonic reactions (e.g., torticollis, facial grimacing, oculogyric crisis) are also treated with centrally acting antihistamines and antimuscarinic drugs such as diphenhydramine and benztropine.

Tardive dyskinesia is a problematic neurologic disorder because of its disabling effect and resistance to pharmacologic management. The adverse effect is irreversible or only slowly reversible. The low incidence of extrapyramidal responses to clozapine and atypical agents has given new hope that these disturbing side effects of the antipsychotics can be separated from their therapeutic effect.

Other adverse effects may also be serious enough to necessitate adjustment of the dosage or withdrawal of the medication. These reactions may be manifested as cholestatic jaundice, blood dyscrasias, or dermatologic responses. The latter may take the form of contact dermatitis, urticaria, or photosensitivity.

Clozapine can produce some serious adverse reactions. It was initially withdrawn from the market because it was discovered to cause agranulocytosis in approximately 1% of the patient population. The drug was reintroduced with the provision that all patients receiving it be continually monitored for hematologic changes. Clozapine is also associated with a higher incidence of seizures than the other antipsychotic drugs.²⁰ Orthostatic hypotension and cardiovascular and respiratory collapse have also been documented. Some predisposing factors have been proposed. Excessive sedation and respiratory collapse may be associated with concomitant use of depressant agents, including benzodiazepines. Epinephrine reversal (caused by α -adrenergic receptor blockade by clozapine) can contribute to declines in blood pressure. These toxicities may be more likely during rapid changes in blood concentrations, which may occur from adjustment of drug dosing or the use of other drugs that may displace clozapine from binding sites or alter the metabolism of clozapine.

Normally, less severe side effects of antipsychotics include orthostatic hypotension and syncope, xerostomia, nasal stuffiness, urinary retention, constipation, and alterations in body temperature (usually hypothermia). In prolonged, high-dose therapy with phenothiazines, a blue-gray pigmentation may occasionally occur in skin exposed to direct sunlight.

A potentially debilitating gain in weight has been observed with schizophrenic patients taking antipsychotic agents. This side effect is of increased concern for patients taking the newer atypical agents.⁷ Nearly all the antipsychotics cause weight gain and associated increases in cholesterol and triglycerides (see Table 12-4). Although this weight gain is rarely a severe side effect, it frequently leads to noncompliance.

TABLE 12-4

Principal Side Effects of Antipsychotic Drugs

ANTI-PSYCHOTIC AGENT	APPROXIMATE EQUIVALENT DOSE (mg)	SEDATION	EXTRAPYRAMIDAL SYMPTOMS	ANTICHOLINERGIC EFFECTS	ORTHOSTATIC HYPOTENSION	WEIGHT GAIN	PROLONGED QT INTERVAL/TdP
Conventional (Typical) Agents							
Phenothiazines (aliphatic)							
Chlorpromazine	100	+++	++	++	+++	++	+
Triflupromazine	25	+++	++	+++	++	ND	ND
Piperazines							
Fluphenazine	2	+	+++	+	+	0/+	ND
Perphenazine	10	++	++	+	+	ND	ND
Prochlorperazine	15	++	+++	+	+	ND	ND
Trifluoperazine	5	+	+++	+	+	ND	ND
Piperidines							
Mesoridazine	50	+++	+	+++	++	+++	+
Thioridazine	100	+++	+	+++	+++	+++	++
Thioxanthenes							
Thiothixene	4	+	+++	+	++	ND	ND
Butyrophenones							
Haloperidol	2	+	+++	+	+	+	+
Droperidol*	2.5	++	ND	ND	++	ND	++
Diphenylbutylpiperidine							
Pimozide	1	++	+++	++	+	ND	+
Dihydroindolones							
Molindone	10	++	++	+	+	0	ND
Ziprasidone	20	+	+	+	+	0/+	+
Dibenzoxazepine							
Loxapine	15	+	++	+	+	ND	ND
Novel (Atypical) Agents							
Dibenzodiazepine							
Clozapine	50	+++	+	+++	++	+++	+
Thienobenzodiazepine							
Olanzapine	5	+++	+	+++	++	+++	+
Dibenzothiazepine							
Quetiapine	50	++	+	0	++	++	+
Benzisoxazole							
Risperidone	2	+	+ to ++	0	+	++	+
Dihydrocarbotyrl							
Aripiprazole	15	0/+	0/+	0/-	0/+	0/+	0/-

Level and risk for each adverse effect is indicated by the number of + signs.

*Not used to treat psychosis in the United States.

ND, No data; TdP, torsades de pointes.

TABLE 12-5

Metabolism of Selected Antipsychotic Drugs

	1A2	2B	2C9	2C19	2D6	3A4	FMO
Chlorpromazine	S				S	S	S
Haloperidol					S, Inh	S	
Thioridazine					S, Inh		
Pimozide						S	
Clozapine	S, Ind	Ind	Inh	S, Inh	S	S, Ind	S
Risperidone					S	S	
Olanzapine*	S				S		S
Quetiapine						S	
Ziprasidone						S	
Aripiprazole					S	S	

Data from Flockhart DA: Cytochrome P450 drug interaction table. Indiana University, Department of Medicine, Division of Clinical Pharmacology, 2003. Available at: <http://medicine.iupui.edu/clinpharm/DDIs/>. Accessed July, 27, 2009.

Column headings refer to specific enzymes involved in drug metabolism.

*Primarily glucuronidated.

FMO, Flavin monooxygenases; Ind, inducer; Inh, inhibitor; S, substrate.

Clozapine and olanzapine may be the most likely, and molindone and ziprasidone the least likely, to cause this effect.³² The cause of the weight gain is unknown, but may be associated with the blockade of histamine or dopamine receptors.

A rare but sometimes fatal idiosyncratic effect, usually associated with potent antipsychotics such as haloperidol and fluphenazine, is neuroleptic malignant syndrome. It is characterized by sustained and widespread muscular contractions, fluctuating levels of consciousness, autonomic abnormalities, and fever. Treatment for neuroleptic malignant syndrome includes immediate withdrawal of the drug and supportive measures. Some benefit may be gained from the skeletal muscle relaxant dantrolene. Bromocriptine, a dopaminergic agonist, may also be helpful. Physical cooling to reduce fever may be necessary. It is generally believed that the risk of developing neuroleptic malignant syndrome with clozapine is low, but some cases have been reported. Drug interactions for antipsychotic drugs are summarized in Table 12-6.

The partial agonist antipsychotic aripiprazole is reported to have a low incidence of many of the side effects associated with typical antipsychotic drugs. Aripiprazole is associated with reduced extrapyramidal effects, reduced release of prolactin, minimal weight gain, and little effect on the QT interval.

General Therapeutic Uses

Currently, antipsychotic drugs are primarily used for the treatment of psychotic states. The wide variety of pharmacologic effects of the phenothiazines has led, however, to their use as antiemetics, preoperative medications to relax and calm the patient, antihistamines, and antihelmintics (in veterinary preparations). Antipsychotics may be used to control the manic phase of bipolar disorder. Other applications of the phenothiazines include the control of hallucinations associated with acute alcohol withdrawal and the treatment of intractable hiccough. As mentioned previously, pimozide has special application in the treatment of Tourette's syndrome.

Because of the perceived reduced side effects and improved efficacy of the atypical antipsychotic drugs, an expansion of indications for these agents can be anticipated. Many new indications for these drugs in children have been proposed, including autism, disruptive disorder, juvenile treatment-resistant schizophrenia, and pervasive developmental disorder of childhood. Additional indications in adult patients include borderline personality disorder, delusional disorder, first-

TABLE 12-6

Interactions of Antipsychotic Drugs* with Other Drugs

DENTAL DRUG OR OVER-THE-COUNTER DRUG	POSSIBLE RESPONSE WHEN COMBINED WITH ANTIPSYCHOTIC DRUG
Promethazine	CNS depression
Barbiturates	CNS depression
Benzodiazepines	Cardiovascular and respiratory collapse with clozapine
General anesthetics (inhalation and intravenous)	CNS depression (especially respiratory depression)
Ethanol	CNS depression
Opioid analgesics	CNS depression, respiratory depression (especially with meperidine), miosis
Antihistamines	CNS depression, anticholinergic effect
Epinephrine	Epinephrine reversal, orthostatic hypotension
Anticholinergics	Anticholinergic toxicity: arrhythmias, hallucinations, gastrointestinal inhibition
Metabolic inhibitors (erythromycin, clarithromycin)	Elevation of antipsychotic blood concentrations
Protein-bound drugs	Displacement of clozapine might result in adverse reactions

*Primarily the phenothiazines, thioxanthenes, butyrophenones, molindone, and loxapine.

CNS, Central nervous system.

episode schizophrenia, mood disorders with psychotic features (aripiprazole), obsessive-compulsive disorder, polydipsia syndrome, schizoaffective disorders, and personality problems. Atypical antipsychotic agents should be used with great caution in dementia-related psychosis in elderly patients because their use has been associated with an increased risk of death in this population.²⁴ There are few controlled studies to support these indications except for the use of olanzapine for the treatment of acute mania.

Although dose requirements of antipsychotic drugs for most patients usually fall within a narrow spectrum, dosage may vary considerably. Adjustments in dose are frequently made depending on the patient's clinical response and side effects. Effective plasma concentrations vary widely among patients, and their determination is not helpful. Generally, treatment with antipsychotic agents is uninterrupted and indefinite in duration.

Long-acting depot antipsychotic preparations, such as fluphenazine enanthate, fluphenazine decanoate, and haloperidol decanoate, are convenient in patients for whom compliance is a problem. These injectable forms are effective for 2 to 3 weeks after therapeutic blood concentrations are obtained and stabilized. A reduced total drug dose is frequently possible because problems with absorption from the gastrointestinal tract are bypassed. Generally, depot forms are safe for younger patients in good physical condition. A disadvantage to this mode of administration is that the drug cannot be withdrawn if side effects occur, and therapeutic levels are sometimes difficult to stabilize.

Antipsychotics such as the phenothiazines, thioxanthenes, and butyrophenones were the drugs of choice for decades in the treatment of schizophrenia. Olanzapine, quetiapine, and possibly low doses of risperidone are now the preferred agents

and are of particular use in cases of schizophrenia refractory to older antipsychotics or when administration of other antipsychotics results in unacceptable adverse effects. Because molindone and ziprasidone result in less weight gain than other agents, they may have application when weight gain is a special concern. Clozapine is considered to be a second-line drug primarily because of its propensity to cause agranulocytosis.

Implications for Dentistry

Because many people in the United States at some point in their lives receive pharmacotherapy for mental illness, the dentist inevitably encounters these patients in practice. Many patients are receiving more than one drug for their condition, and they may be taking various other drugs (e.g., alcohol, cough remedies, aspirin, dietary supplements) that may not be revealed in a medical history questionnaire. Many antipsychotics can add to the CNS depressant effects of sedative-hypnotics, antianxiety agents, anesthetics, or opioid analgesics used in the course of dental treatment. Chlorpromazine is known to potentiate the effects of general anesthetics and the respiratory depressant response to opioids (see Table 12-6). The cardiac effects of thioridazine can be potentiated by hydroxyzine, and other antihistamines may pose similar concerns. Antipsychotic and antihistaminic drugs have substantial antimuscarinic activity and may contribute to the long QT syndrome.

Tardive dyskinesia has important implications in dentistry because the facial musculature is prominently involved in the disorder. The abnormal movements of tardive dyskinesia often start in the orofacial musculature, particularly the tongue, which alternately protrudes, retracts, and undergoes a rolling movement. Because the orofacial muscles are primarily affected in the early development of tardive dyskinesia, the patient often believes that the dentist can correct the problem.

Individuals who require treatment with the phenothiazine antipsychotics usually take these drugs for an extended period or for life. Prolonged phenothiazine use can sometimes cause a reduction in leukocyte count, which rarely predisposes the patient to infection and frequent oral candidiasis. The tendency of clozapine to cause agranulocytosis is a factor that can lead to serious susceptibility to infection.

The reduced salivary flow caused by antipsychotics can result in xerostomia and an increased incidence of dental caries. Clozapine and olanzapine may induce hypersalivation, however. This condition is likely to be most pronounced at night. Several treatments have been proposed. Anticholinergics with central (atropine, amitriptyline), peripheral (glycopyrrolate), or local action (sublingual ipratropium) have been proposed. Central inhibition of salivation using clonidine patches (an α_2 -adrenergic receptor agonist) has been tried with some success. In difficult cases, botulinum toxin injections, which block neuron transmission to the parotid gland, have been proposed.⁴² These treatments could contribute to the risk of xerostomia-related dental problems.⁴⁴

ANTIDEPRESSANTS

Numerous mechanisms are responsible for the actions of the known antidepressant drugs (Table 12-7). Most clinically used antidepressants increase the synaptic concentrations of 5-HT or NE or both in the brain, and this relationship has given support to the monoamine hypothesis of affective disorders.⁸ The increase in neurotransmitters can be measured in a few hours from the time that the medications are administered.

Studies of diets deficient in tryptophan, the precursor amino acid for 5-HT, have found that depressed patients taking SSRIs have a return of symptoms of depression within a few hours after eating a tryptophan-deficient diet. Women

TABLE 12-7

Mechanisms of Antidepressant Drugs

MECHANISM	DRUG EXAMPLES
Block 5-HT reuptake	TCA, most second-generation and third-generation drugs, SSRIs
Block NE reuptake	TCA, most second-generation and third-generation drugs
Inhibit MAO	MAO inhibitors, St. John's wort*
Block presynaptic autoreceptors	Mirtazapine
Block dopamine reuptake	Bupropion
Block Na ⁺ gradients needed for many neurotransmitter reuptake transports	St. John's wort
Neuroprotective actions	SSRIs, anticonvulsants, Li ⁺
Facilitate GABA	Alprazolam
Hormone adjustment	Estrogens, levothyroxine

*Only at high doses.

5-HT, 5-Hydroxytryptamine; GABA, γ -aminobutyric acid; MAO, monoamine oxidase; NE, norepinephrine; SSRIs, selective serotonin reuptake inhibitors; TCAs, tricyclic antidepressants.

seem to be more sensitive to tryptophan restriction. Tryptophan restriction does not reverse the effects of NE-selective antidepressants, however. Selective inhibition of NE synthesis with metyrosine triggers symptoms of depression in patients treated with NE reuptake-blocking antidepressants and in untreated patients with latent depression. Patients responding to SSRIs do not exhibit depressive symptoms when taking metyrosine. Normal patients do not show depressive symptoms after either tryptophan depletion or metyrosine treatment. Altogether, these studies suggest 5-HT, NE, or both may play a role in depression; the predominant factor may vary in different patients.

A significant challenge to the monoamine hypothesis is the time required for full antidepressant activity to be expressed, which may vary from 2 to 8 weeks in clinical practice. This time lag is long enough for considerable rearrangement of cellular structure to occur. Part of this delay may simply be related to the pharmacokinetics of the antidepressants, which have half-lives averaging 24 hours. To reach plasma equilibrium, the drugs need, on average, to be taken for at least 4 to 5 days; however, this does not explain the entire delay. The action of antidepressants is closely linked to the neurotransmitters 5-HT and NE. Information on 5-HT in the CNS is particularly instructive about mechanisms of antidepressant action. The raphe nuclei contain the bulk of the 5-HT-synthesizing neurons in the brain, and these project to wide areas of the brain (Table 12-8).²⁹

In the awake animal, raphe 5-HT-containing neurons are generally tonically active with a firing rate of approximately 5 Hz, which is maintained by depolarizing Ca⁺⁺ and hyperpolarizing K⁺ currents. These cells may also respond to phasic activity such as loud sounds. Afferent inputs to the 5-HT cells include tonic excitatory input from catecholamines (NE from the locus coeruleus [LC] and dopamine from the ventral tegmental area) and phasic excitatory glutamate inputs. Noradrenergic input is thought to activate excitatory α_1 receptors on the raphe 5-HT neurons. Extracellular 5-HT is also present and may originate from raphe collateral feedback or possibly from a nonsynaptic source, which might be "leakage" from 5-HT neurons themselves.⁴⁰ A GABA inhibitory afferent input is also known.

TABLE 12-8

Key Serotonergic Pathways in the Action of Selective Serotonin Reuptake Inhibitors (SSRIs)

MIDBRAIN (RAPHE) PROJECTION TO	POSSIBLE SSRI EFFECT	SIGNS OF DYSREGULATION
Prefrontal cortex	Relief of depression	Depression
Hippocampus, limbic cortex	Alleviation of panic disorder	Anhedonia, anxiety, panic, sexual dysfunction
Basal ganglia	Alleviation of obsessive-compulsive disorder	Agitation; extrapyramidal side effects, including akathisia, parkinson-like tremor, and rigidity
Hypothalamus	Alleviation of eating disorder	Bulimia and binge-eating disorders, prolactin dysregulation
Spinal cord (pontine-medullary cell bodies)	Sexual dysfunction	Inhibited ejaculation and orgasm

A current hypothesis to explain some of the therapeutic delay follows. Antidepressant drugs produce an increased serotonergic tone in the raphe nuclei. Because of abundant presynaptic autoregulatory receptors (autoreceptors), however, the release of 5-HT is acutely “turned off” in the raphe nuclei. With continued exposure to the antidepressant drugs, the autoreceptors desensitize or downregulate, allowing increased 5-HT release at the synaptic terminals (“turned on”). This increased release may lead to a downregulation of some terminal field postsynaptic 5-HT receptors. In the brainstem, the raphe nucleus reciprocally innervates the LC and may reciprocally innervate dopaminergic areas such as the ventral tegmental area and cortex. These innervations hint at additional layers of control and interaction. Additionally, the delay in onset of antidepressant action suggests that some form of cellular remodeling may occur.

NE has long been suspected to have involvement with depression. A large amount of the NE in the brain is found in the LC, whose neurons project as far as the forebrain. The LC neurons not only respond to various phasic external stimuli and stress-related stimuli (“fight or flight”) but also participate in tonic brain states, including the sleep-wake cycle and arousal. The LC may be involved in mediating anxiety, depression, panic attacks, and post-traumatic stress disorder. Although numerous peptides can alter the activity of the LC, one of the most interesting influences may be the increased LC firing rate induced by corticotropin-releasing hormone (which may mediate the involvement of corticosteroids in the response to stressful conditions).

NE actions are mediated by several receptor types (α_1 , α_2 , β_1 adrenoceptors) (see Chapter 6). Changes in noradrenergic systems that are linked to depression include alterations in α_2 -receptor number and function in the brain and platelets of depressed patients and decreased cell counts and tyrosine hydroxylase in the LC of suicide victims. Clonidine, an α_2 agonist, can increase the release of growth hormone and thyroid-stimulating hormone in normal patients. In depressed patients, the magnitude of these hormone responses are reduced to approximately 50% of control subjects. The clonidine test may identify the depressive trait.

Long-term antidepressant use reduces postsynaptic β adrenoceptors in the brain without significantly affecting postsynaptic α_1 adrenoceptors. This change apparently occurs because the increases in synaptic NE resulting from presynaptic effects of antidepressants (downregulation of autoregulatory α_2 adrenoceptors) are able to affect adrenoceptors differently (β adrenoceptors downregulate and α_1 adrenoceptors do not). Exactly how these changes benefit a depressed patient is still being investigated; however, the increase in synaptic NE coupled with a change in postsynaptic adrenoceptor profile is likely to be the basis for the therapeutic effects of antidepressant drugs. TCAs, SSRIs, and electroconvulsive therapy all lead to similar changes. The effect of the

antidepressant drugs on 5-HT dynamics is analogous to that on NE dynamics. The mechanism by which antidepressants act seems to depend on differential changes among various receptors and receptor-signaling processes. Although this hypothesis is useful for explaining the actions of several classes of antidepressant drugs, it is not a complete explanation for the actions of all antidepressants.

Efforts to speed up the onset of action of antidepressants based on some of these findings are being investigated. Strategies have included attempts to block somatodendritic 5-HT_{1A} autoreceptors with pindolol (a clinically available β blocker that coincidentally blocks 5-HT_{1A} receptors),⁵ and use of antidepressants that block α_2 -adrenergic or β -adrenergic receptors. Currently, only a few studies have reported efficacy with these approaches.⁶ Early morning sleep deprivation has also been found to produce a rapid, but temporary, reversal of depression and the depression of bipolar disorder. Not all patients respond, however. There have been attempts to prolong the beneficial effect by using bright light therapy. These observations have so far defied explanation.

TCAs and MAO inhibitors, sometimes referred to as first-generation antidepressants, share many characteristics: they are effective in a broad spectrum of depressive syndromes (although 20% to 30% of patients remain unresponsive to pharmacotherapy); they have a delayed onset of therapeutic effect; and they have troublesome side effects. Newer drugs (second-generation and third-generation antidepressants), such as amoxapine, maprotiline, bupropion, trazodone, nefazodone, and mirtazapine, were introduced to overcome the disadvantages of first-generation compounds. This heterogeneous group of agents share antidepressant efficacy but vary in their particular actions, which are listed in Box 12-1.

SSRIs are an important addition to the pharmacologic armamentarium for the treatment of depression. As the group name implies, these drugs have greater pharmacologic selectivity than TCAs and have the potential for therapeutic effectiveness with fewer side effects. SSRIs also require 2 to 3 weeks before therapeutic efficacy is noted. The first drug of this class approved for use in the United States was fluoxetine. Fluoxetine quickly became a very popular drug because it is effective in major depression and refractory depression. It also has fewer side effects compared with previous drugs. More recently approved SSRIs—sertraline, fluvoxamine, paroxetine, and citalopram—exhibit a similar pharmacologic profile, differing from fluoxetine primarily in their pharmacokinetic properties. Because of the relative safety of these agents, investigations of their efficacy in a wide array of behavioral disorders have led to broadened indications for their use. SSRIs may be more beneficial in women, and TCAs may be more beneficial in men.

Although they block 5-HT uptake preferentially, venlafaxine and duloxetine are classified as selective agents that block NE and 5-HT reuptake (selective serotonin and norepinephrine reuptake inhibitors). Atomoxetine and reboxetine are

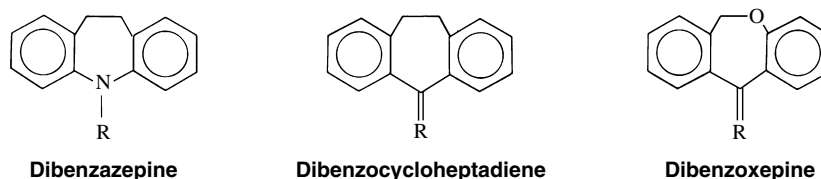

FIGURE 12-5 Structural formulas of the tricyclic rings of the dibenzazepine, dibenzocycloheptadiene, and dibenzoxepine antidepressants.

BOX 12-1

Actions of Antidepressant Drugs

Drugs That Inhibit Reuptake of NE and 5-HT with Similar Potencies (20-fold Difference or Less)

Amitriptyline
 Amoxapine*
 Atomoxetine
 Clomipramine
 Desipramine
 Doxepin
 Duloxetine
 Imipramine
 Nefazodone
 Nortriptyline
 Protriptyline

Drugs That Inhibit 5-HT Reuptake with Greater Potency (>50-fold More than NE Reuptake)

Citalopram
 Fluoxetine
 Fluvoxamine
 Paroxetine
 Sertraline
 Trazodone†
 Venlafaxine†

Drug That Inhibits NE Reuptake with Greater Potency (Approximately 500-fold More than 5-HT Reuptake)

Maprotiline

Drugs That Have Little Effect on Either 5-HT or NE Uptake

Bupropion
 Mirtazapine

*Also blocks dopamine uptake.

†Not classified as a selective serotonin reuptake inhibitor.
 5-HT, 5-Hydroxytryptamine; NE, norepinephrine.

norepinephrine reuptake inhibitors. St. John's wort has a unique action blocking the reuptake of 5-HT, NE, dopamine, GABA, glycine, and glutamate, but with no known receptor-blocking actions.

Tricyclic Antidepressants

Chemistry and structure-activity relationships

A small modification of the phenothiazine ring structure resulted in an entirely new group of drugs, the TCAs. The name of these compounds is derived from the triple-ring structure consisting of two benzene moieties connected through a seven-membered ring (Figure 12-5).

The prototype for TCAs is imipramine, a dibenzazepine derivative. Structural analogues of imipramine include the dibenzocycloheptadienes, in which a carbon atom is substituted for the nitrogen of the central ring, and the dibenzox-

epines, in which an oxygen atom replaces one of the methylene groups of the center ring of the dibenzocycloheptadiene molecule. A prototype drug for the dibenzocycloheptadienes is amitriptyline, and for the dibenzoxepines, doxepin.

Substitutions at R (see Figure 12-5) usually consist of aminopropyl groups that may be either dimethyl or monomethyl amino derivatives. Compounds such as imipramine, amitriptyline, and doxepin have two methyl moieties on the nitrogen atom of the side chain and are tertiary amines. Desipramine, nortriptyline, and protriptyline have one methyl group and are secondary amines.

Pharmacologic effects

Similar to antipsychotic drugs, TCAs have therapeutically useful effects on the CNS and various side effects. Common properties of the antidepressant drugs are blockade of the 5-HT reuptake transporter or NE reuptake transporter or both, histaminergic receptors (H_1), muscarinic receptors, and α_1 -adrenergic receptors, and a local anesthetic action.

Central nervous system. When administered to a normal individual, TCAs initially produce drowsiness, lethargy, and often an increased feeling of anxiety. With continued administration, the individual may have thought disorders and become increasingly confused. Conversely, after TCAs have been administered for approximately 2 to 3 weeks to depressed patients, they become less confused and have an elevation of mood. Untoward CNS effects include dizziness, lightheadedness, and delirium and hallucinations.

All TCAs seem to have in common the ability to inhibit the reuptake of NE or 5-HT or both into central presynaptic nerve terminals. Normally, most of the transmitter is recycled into the presynaptic terminal, stored, and made available for reuse (see Chapter 11). TCAs, by blocking this reuptake, increase the concentrations of NE or 5-HT or both at critical central synapses. This increase in concentration of these biogenic amines leads to the receptor changes discussed earlier and an antidepressant effect.

Autonomic nervous system. TCAs are more potent anticholinergics than their phenothiazine analogues. Dry mouth, constipation, urinary retention, and ophthalmologic changes (blurred vision and mydriasis) are commonly observed, especially with the tertiary amines.³⁸ Paradoxically, excessive sweating is also sometimes reported, although in a large overdose the skin is dry. Sexual dysfunction (including loss of libido, impaired erection and ejaculation, and anorgasmia) is an additional side effect that may lead to patient noncompliance. Peripheral cholinergic and α -adrenergic blockade have been associated with sexual dysfunction. Excess serotonergic tone at some 5-HT receptors may also be responsible for the sexual side effects of these agents (see Table 12-1).

Cardiovascular system. TCAs can cause hypotension and compensatory tachycardia. TCAs affect the heart in a manner similar to the class I antiarrhythmics such as quinidine and procainamide.¹⁸ Prolongation of the QT interval, flattening of

the T wave, and various arrhythmias have been reported. Postural hypotension, particularly in elderly patients, is common, probably because of α_1 -adrenergic receptor blockade. Because TCAs block the reuptake of catecholamines, they can increase the response to endogenously released catecholamines or directly acting sympathomimetic drugs that are actively transported into adrenergic nerve terminals.

Absorption, fate, and excretion

TCAs are readily absorbed from the gastrointestinal tract. The drugs are distributed throughout the body and are tightly bound to plasma and tissue proteins. Many pharmacologically active metabolites are formed in the liver by microsomal oxidation reactions, including N-demethylation. Subsequent glucuronidation inactivates the agents and promotes their excretion. Approximately two thirds of a single dose is eliminated in the urine and one third in the feces over several days. TCAs are metabolized by several isoforms of P450, with particular involvement of CYP1A2, CYP2C19, CYP2D6, and CYP3A4.¹⁵

Adverse effects

TCAs may initially cause anxiety or feelings of fatigue and weakness (Table 12-9), but tolerance develops to these effects.

Although these agents do not elicit the extrapyramidal side effects of the antipsychotic agents, mild tremor may sometimes occur. In some individuals, tics, ataxia, and incoordination have been reported. The anticholinergic effects cause dryness of the mouth, mydriasis, and urinary retention and may contribute to cardiovascular disturbances. Amitriptyline is one of the most potent anticholinergic TCAs; it is about one eighth as potent as atropine.

Acute overdose, sometimes self-inflicted by suicidal patients, is a potentially life-threatening situation and is characterized by CNS excitation and depression, anticholinergic effects, and cardiovascular complications. Life-threatening cardiac arrhythmias are a potential consequence of acute overdose. Even in conventional doses, the incidence of sudden death from myocardial infarction or ventricular arrhythmias is increased in patients with cardiac disease. Several TCAs produce long QT syndrome, which can lead to torsades de pointes. Fatalities have also occurred in children with no apparent preexisting cardiac defect. Blood dyscrasias, skin rashes, photosensitization, and cholestatic jaundice, many of which are manifestations of allergic reactions, have been reported but are less frequent than with the phenothiazines. TCAs may also increase the risk for seizures, with clomipramine among the most likely to produce this effect. The

TABLE 12-9

Major Adverse Effects of Antidepressant Drugs

DRUG	ANTICHOLINERGIC	SEDATION	ORTHOSTATIC HYPOTENSION	PROLONGED QT INTERVAL	SEXUAL DYSFUNCTION	WEIGHT GAIN OR LOSS
Tricyclics—Tertiary Amines						
Amitriptyline	++++	++++	+++	TdP	+	++
Clomipramine	+++	++	++	+		+
Doxepin	++	+++	+++	+	+	++
Imipramine	++	++	+++	+	+	++
Trimipramine	++	+++	++	ND		++
Tricyclics—Secondary Amines						
Amoxapine	+++	++	+	ND		+
Desipramine	+	+	+	+	+	+
Nortriptyline	++	++	+	+	+	+
Protriptyline	+++	+	+	ND		+
Second-Generation and Third-Generation Agents						
Maprotiline	++	++	+	ND		+
Mirtazapine	++	+++	++	TdP	0	++
Trazodone	+	++++	++	+	0	+,-
Nefazodone	0/+	++	+		0	0,+
Bupropion	++	0/+		+/0	0	+,-
Selective Serotonin Reuptake Inhibitors (SSRIs)						
Fluoxetine	0/+	0/+	0/+	+	++	+,-
Paroxetine	0	0/+	0	+/0	++	+,-
Sertraline	0	0/+	0	+/0	++	+,-
Fluvoxamine	0/+	0/+	0	+	++	+,-
Citalopram	0/+	0/+	0/+	+/0	+	+,-
Venlafaxine*	0	0	0	+	++	0,-
Monoamine Oxidase (MAO) Inhibitors						
Tranylcypromine	+	+	0			+
Phenelzine	+	+	+			+

Severity of adverse effects is indicated by the number of + signs.

*May induce hypertension; not classified as an SSRI.

ND, No data; TdP, torsades de pointes resulting from prolonged QT interval.

likelihood of seizures is directly related to the dose taken and a history of previous seizure disorders.⁴¹

Adverse drug interactions are another potential problem for patients treated with antidepressants. Coadministration of TCAs with MAO inhibitors may cause anxiety, vomiting, tremor, convulsions, coma, and death. TCAs may also obtund the antihypertensive action of guanethidine and the sympathomimetic action of amphetamine and tyramine by preventing their uptake into nerve terminals. The effects of clonidine (an α_2 agonist) are also inhibited. Drug interactions that the dentist must consider are discussed subsequently and are similar to interactions listed in Table 12-6.

Monoamine Oxidase Inhibitors

MAO inhibitors include many chemically unrelated compounds that share the ability to antagonize the action of MAO, the enzyme responsible for the metabolic degradation of the naturally occurring monoamines epinephrine, NE, dopamine, and 5-HT. Some of these inhibitors, such as tranylcypromine, are structurally related to amphetamine.

Pharmacologic effects

Similar to TCAs, MAO inhibitors increase the concentration of NE and 5-HT in the CNS. By preventing the catabolic action of MAO, MAO inhibitors allow the buildup of monoamines in the presynaptic nerve terminals (see Chapters 6 and 11). This effect apparently leads to adaptive changes in receptors similar to the changes seen with TCAs. Although these effects are compatible with the monoamine hypothesis of depression, MAO inhibitors are not specific for MAO because they affect other enzymes and have nonenzymatic actions as well. A clear understanding of the mechanism of the antidepressant action of this group of drugs does not exist. The existence of at least two forms of MAO (MAO-A and MAO-B) in the brain and selective inhibitors of MAO-A and MAO-B suggests, however, that selective inhibition of specific forms of MAO will be of potential use in the future. Moclobemide and brofaromine, selective inhibitors of MAO-A, are effective antidepressants; in contrast to most other MAO inhibitors, they are reversible inhibitors of MAO and have many advantages because of their selectivity and shorter duration of action.

MAO inhibitors are generally considered to be less effective and to have more serious side effects and drug interactions than TCAs. These drugs are making a comeback, however, with the discovery that they are effective for atypical depression and that in some of the early studies inappropriate dosages were used. Similar to SSRIs, MAO inhibitors also have antiobsessional, antipanic, and anxiolytic effects. Nevertheless, numerous precautions, particularly regarding drug interactions and dietary restrictions, must be observed with the clinical use of these compounds.

The most prominent autonomic effects of MAO inhibitors are exerted on the cardiovascular system. Hypotension occurs because of reduced NE release from peripheral adrenergic nerves (except in the presence of indirectly acting sympathomimetic drugs). Tachycardia, dry mouth, sweating, hot flashes, diarrhea, constipation, difficulty in micturition, and impotence may also occur. MAO inhibitors antagonize transmission of nerve impulses through autonomic ganglia, and evidence suggests that sympathetic ganglia are more severely affected.

Absorption, fate, and excretion

MAO inhibitors are rapidly absorbed from the gastrointestinal tract. The metabolic fate of MAO inhibitors is not fully known, but the drugs are apparently rapidly metabolized and excreted. The long duration of action (weeks) results from an irreversible inactivation of MAO and can be of concern when

adding new therapies after an MAO inhibitor has been discontinued.

Adverse effects

Most of the original MAO inhibitors have been withdrawn from the market because of their serious side effects. An important adverse reaction to the remaining MAO inhibitors (and a major problem with the original drugs) is hepatotoxicity. MAO inhibitors may also cause orthostatic hypotension and, in overdose, central excitatory manifestations of insomnia, agitation, hyperreflexia, and convulsions.

Drug interactions are of particular concern with MAO inhibitors because they are likely to be serious and potentially fatal. Among the drugs with which MAO inhibitors interact are TCAs and SSRIs, other classes of antidepressants, opioid analgesics (especially meperidine), alcohol and other CNS depressants, indirect-acting or mixed-acting sympathomimetics such as amphetamine or ephedrine, sympathomimetics metabolized predominantly by MAO such as phenylephrine (commonly used in over-the-counter preparations as a nasal decongestant), and monoamine precursors such as levodopa.

In addition to drug interactions, acute hypertensive crises have been precipitated by the ingestion of foods containing naturally occurring pressor amines, such as tyramine, which release NE from nerve endings. Patients treated with MAO inhibitors have elevated stores of NE available for release. In addition, ingested tyramine, which is normally metabolized by enteric and hepatic MAO, reaches the systemic circulation in increased amounts. Foods containing sympathomimetic amines that should be avoided include aged cheeses (especially cheddar and Swiss), fermented alcoholic beverages (particularly Chianti wine), canned fish products, snails, liver, nuts, broad beans, citrus fruits, coffee, and almost any product made with yeast. Hypertensive crises precipitated by such foods are characterized by severe headaches, often localized in the occipital region, and fever. This type of drug interaction is likely to become less important as more selective or reversible MAO inhibitors are developed. The reversible and selective MAO-A inhibitor moclobemide has been reported to produce less of this “cheese effect.”

MAO inhibitors are contraindicated with SSRIs. This combination may precipitate the “serotonin syndrome,” which consists of hyperthermia, facial flushing, dizziness, confusion, headache, sweating, fever, rigidity, myoclonus or tremor, respiratory disturbances, gastrointestinal upset, and mental status changes ranging from delirium to coma. This drug interaction may occur several weeks after termination of fluoxetine because of its slow elimination from the body (half-life of 250 hours for active metabolites of SSRIs).

Second-Generation and Third-Generation Antidepressants

The second-generation and third-generation antidepressants (or atypical antidepressants) include a diverse array of drugs. Amoxapine (Figure 12-6), a dibenzoxazepine resembling TCAs in chemical structure, is the N-demethylated metabolite of the antipsychotic loxapine. Amoxapine shares many properties with the atypical antipsychotic agents and has been shown to have atypical antipsychotic and antidepressant effects, making it useful for patients with psychotic and mood disturbances. Maprotiline is related to the TCAs, but contains a tetracyclic ring structure (see Figure 12-6). Trazodone and nefazodone (see Figure 12-6) are triazole derivatives, trazodone being noted for having 5-HT₂ blocking activity in addition to its reuptake-blocking action. Bupropion, an aminoketone, is structurally dissimilar to all other antidepressants (Figure 12-7). Bupropion is a weak reuptake inhibitor of dopamine and 5-HT and a weak α_2 -adrenergic receptor

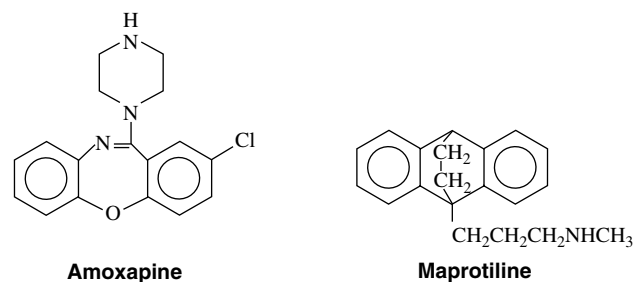

FIGURE 12-6 Structural formulas of amoxapine, maprotiline, trazodone, and nefazodone.

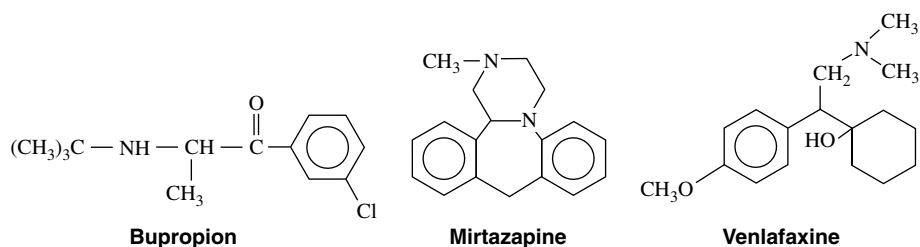
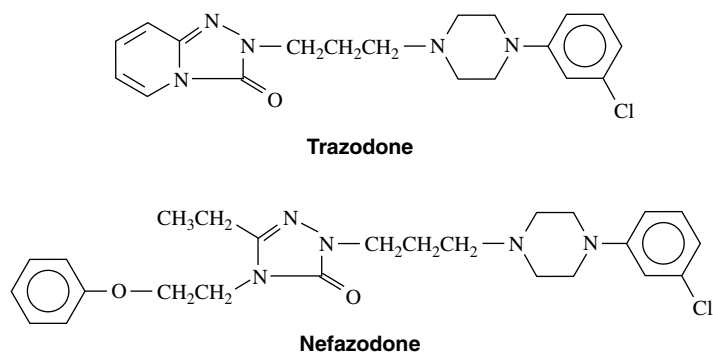

FIGURE 12-7 Structural formulas of bupropion, mirtazapine, and venlafaxine.

blocker. Mirtazapine (see Figure 12-7), a piperazinoazepine, is not thought to block amine reuptake, but is reported to block several additional receptors (histamine H_1 , 5-HT $_2$, 5-HT $_3$, α_2 -adrenergic). There has been some interest in using these agents as adjunct therapy to SSRIs.

Pharmacologic effects

These compounds differ significantly in their selectivity of action on monoamine uptake and neurotransmitter receptors.⁵¹ Amoxapine resembles the secondary amine TCAs in pharmacologic activity, but it also blocks dopamine and 5-HT $_{2A}$ receptors, accounting for its atypical antipsychotic effect. Differences in potency in inhibiting 5-HT and NE transport are summarized in Box 12-1. Mirtazapine is not consistently effective as an antidepressant agent.⁵⁴

Absorption, fate, and excretion

All second-generation agents are well absorbed from the oral route. Peak concentrations of the drugs are reached in approximately 1 to 3 hours. Amoxapine is almost completely metabolized (one hydroxylated metabolite retains pharmacologic activity) and excreted in the urine over several days. Several active metabolites of trazodone are formed, and 70% to 75% of an ingested dose is excreted in the urine within 72 hours after administration. The metabolite *m*-chlorophenylpiperazine, a 5-HT $_2$ agonist, is metabolized by CYP2D6 and is more likely to accumulate if CYP2D6 activity is low or inhibited. Bupropion also yields two active metabolites (including

hydroxybupropion) that may accumulate and contribute to antidepressant activity by acting on NE reuptake. Peak action is seen in 3 hours, with a half-life of approximately 21 hours. Bupropion is metabolized by CYP2B6, which may cause the drug to have an important drug interaction profile. Smoking does not alter its kinetics. Nearly 80% of an orally administered dose is excreted as inactive metabolites in the urine. Mirtazapine is metabolized to several metabolites by several P450 isozymes and is primarily excreted in the urine (75%). Venlafaxine is metabolized to an active metabolite, O-desmethyl venlafaxine, and is eliminated by renal and hepatic routes. The elimination half-life is approximately 5 hours. The antihistamine diphenhydramine has been found to inhibit the metabolism of venlafaxine.

Adverse effects

Amoxapine, maprotiline, trazodone, mirtazapine, and nefazodone share common side effects, including sedation, antimuscarinic and cardiovascular effects, and skin rashes (see Table 12-9). The incidence and severity of these reactions vary considerably, however, among the drugs. Amoxapine is approximately equal to TCAs in cardiotoxicity, whereas maprotiline has less effect on the heart and, in contrast to TCAs, causes a slight bradycardia and a decrease in blood pressure. Bupropion has minimal cardiovascular effects and only infrequently produces orthostatic hypotension. Venlafaxine can cause dose-related hypertensive effects, QT interval prolongation, insomnia, nausea and vomiting, xerostomia,

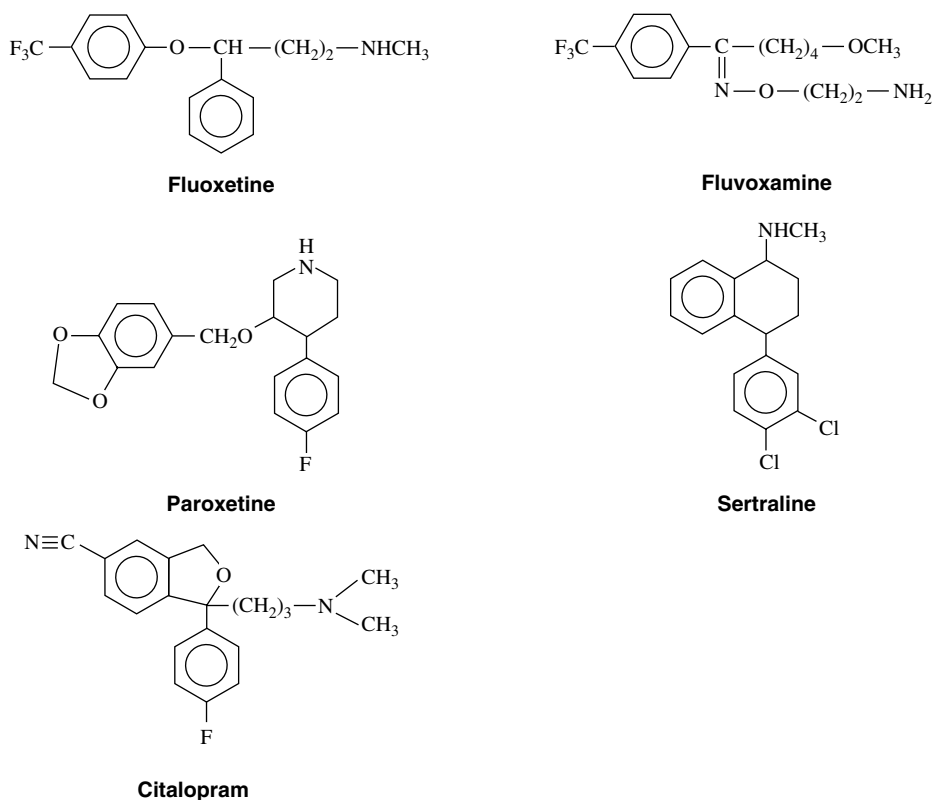

FIGURE 12-8 Structural formulas of the selective serotonin reuptake inhibitors fluoxetine, fluvoxamine, paroxetine, sertraline, and citalopram.

mydriasis, and sexual side effects. It may also increase the likelihood of seizures.

Each of the second-generation and third-generation agents has some unique side effects that can limit clinical usefulness. Because of its antidopaminergic activity, amoxapine produces extrapyramidal side effects and can increase prolactin secretion and cause amenorrhea, gynecomastia, and galactorrhea. Trazodone sometimes produces persistent priapism requiring surgical detumescence, which can result in permanent impotence. Priapism may be related to α_1 -adrenergic and α_2 -adrenergic receptor blockade or 5-HT_{2C} receptor stimulation (by *m*-chlorophenylpiperazine).

Maprotiline and bupropion may trigger seizure activity. Drugs that block the reuptake of catecholamines seem to have a higher incidence of seizures. Bupropion is especially likely to cause convulsions. Bupropion was withdrawn from the market after its initial introduction because of seizures; it was reintroduced at lower recommended doses. Bupropion is contraindicated in patients with epilepsy and in patients who have had bulimia or anorexia nervosa because of an increased risk of seizures in these patients. This drug is marketed (for different purposes) under two trade names, Wellbutrin and Zyban, so patients should not accidentally be given both because of dose-related increased risk for seizures. Other side effects of bupropion include headache and dry mouth, tremor, insomnia, and the possible induction of psychosis. Less commonly, bupropion generates rashes or erythema multiforme (Stevens-Johnson syndrome).

Nefazodone and some of its metabolites are potent inhibitors of CYP3A4, and nefazodone is capable of blocking the metabolism of numerous drugs. Mirtazapine has been associated with agranulocytosis and seizures developing in a few patients. It should not be given with MAO inhibitors. Weight gain is a common side effect of antidepressants and, in many instances, contributes to noncompliance (see Table 12-9).

Mirtazapine and maprotiline, along with the TCAs doxepin, trimipramine, and amitriptyline, are among the most potent blockers of histamine receptors, producing marked sedation and weight gain. The second-generation and third-generation antidepressants produce fewer sexual dysfunctional side effects compared with TCAs or SSRIs. Levodopa and MAO inhibitors increase bupropion toxicity. Ritonavir, an antiviral agent metabolized by CYP2B6, increases bupropion actions. Carbamazepine reduces bupropion blood concentrations.

Selective Serotonin Reuptake Inhibitors

Fluoxetine, fluvoxamine, sertraline, paroxetine, citalopram, and escitalopram (Figure 12-8) are the SSRIs currently approved for use in the United States.

Pharmacologic effects

The selectivity of SSRIs for 5-HT provides a theoretic basis for greater specificity in various depressive states and fewer side effects, and to a significant extent this has been realized clinically. By selectively inhibiting 5-HT reuptake, these drugs cause downregulation of presynaptic inhibitory 5-HT_{1B/D} autoreceptors, which facilitates 5-HT transmission; this leads to postsynaptic changes analogous to those seen with TCAs. Similar to TCAs, SSRIs have been reported to cause downregulation of central β -adrenergic receptors, but this is not a consistent finding. Nevertheless, it again illustrates the complexity of depression and the pharmacologic similarities of effective antidepressants.

Several serotonergic pathways account for various effects of SSRIs (see Table 12-8). SSRIs have been found to be useful for other psychiatric disorders in which 5-HT is thought to play a role, such as obsessive-compulsive disorders, panic disorders, various eating disorders, migraine, social phobia, post-traumatic stress disorder, generalized anxiety disorder, social anxiety disorder, and premenstrual distress disorder.

Absorption, fate, and excretion

The major difference among SSRIs is their pharmacokinetic profile. The elimination half-life of fluoxetine is approximately 45 hours compared with 26 hours for sertraline, 21 hours for paroxetine, and 14 hours for fluvoxamine. Generally, these drugs are metabolized by CYP2D6 and CYP3A4 isozymes. Fluoxetine is metabolized to norfluoxetine, an active metabolite with an extended half-life (7 days) that is also an inhibitor of CYP2D6 and CYP3A4. Paroxetine has active metabolites that contribute to its pharmacologic effect, whereas the metabolites of sertraline and fluvoxamine are inactive. The long half-lives of these compounds, particularly fluoxetine, become clinically relevant when considering drug interactions.

Adverse effects

Compared with TCAs, SSRIs have minimal anticholinergic effects and produce less sedation and less lethality in overdose. Because they have only mild anticholinergic effects, SSRIs may be especially useful in elderly patients.

Side effects have been categorized as early onset or late onset (Box 12-2). The most prominent early side effect of SSRIs is gastrointestinal upset (diarrhea, nausea, vomiting); tolerance to this effect develops over 4 to 6 weeks. Patients may also have anxiety, agitation, and sleep disturbances. Tolerance to sleep disturbances may not occur. Late-onset side effects include weight gain, sexual dysfunction (e.g., anorgasmia and decreased libido), asthenia (weakness), and drug withdrawal symptoms. The intensity of the long-term side effects varies among the SSRIs. Sexual dysfunction is more common with sertraline than fluoxetine.

There have been some reports of dose-related motor side effects, including akathisia, dystonia, dyskinesia, tardive dyskinesia, parkinsonism, and bruxism.¹³ 5-HT_{1,4} receptors are located in the basal ganglia or related structures and may participate in regulating dopamine release. Hyponatremia has been reported in elderly patients, which may reflect the effect of 5-HT on mineralocorticoid function. After prolonged use, patients may have drug withdrawal symptoms. These are more common with shorter acting agents and are lessened by reducing doses slowly over time.

Reports of fluoxetine-induced suicidal contemplation have been given widespread coverage in the media, but this problem has never been confirmed in controlled studies. Baseline (untreated) suicide rates in adolescents are higher than those for adults, and this may contribute to the concern.

BOX 12-2**Side Effects of Selective Serotonin Reuptake Inhibitors****Early Onset, Transient**

Nausea
Anxiety
Agitation
Sleep disturbance/insomnia

Late Onset

Weight gain
Asthenia
Sexual dysfunction
Withdrawal syndrome

Suicide rates tend to be reduced by relieving the depression.^{14,19,46} During initiation of therapy, careful monitoring and counseling may be needed.

Drug interactions

The potential for a life-threatening drug interaction (5-HT syndrome) exists with SSRIs and MAO inhibitors. An interaction of this nature would be particularly problematic clinically when switching from fluoxetine to an MAO inhibitor because of the long duration of action of fluoxetine. Numerous drug interactions are possible because certain SSRIs compete with other drugs for metabolism by the CYP2D6 or CYP3A4 isozymes. Drugs such as cimetidine can interfere with the metabolism of fluoxetine, and fluoxetine can impair the biotransformation of drugs such as propranolol and carbamazepine. Fluoxetine decreases the metabolism of TCAs when used in combination and significantly prolongs their half-life. Increased bleeding has been reported in patients taking warfarin, but this problem is not associated with inhibition of warfarin metabolism.

Other selective amine inhibitors

Venlafaxine, duloxetine, atomoxetine, and reboxetine. Venlafaxine, duloxetine, atomoxetine, and reboxetine are more selective drugs than the TCAs but have actions that also include inhibition of NE reuptake. Venlafaxine and duloxetine inhibit serotonin reuptake more than NE, whereas atomoxetine and reboxetine inhibit NE reuptake more than serotonin. Venlafaxine (see Figure 12-7) acts selectively on 5-HT reuptake at low doses, but blocks NE reuptake at higher doses.⁵¹ Duloxetine inhibits serotonin and NE reuptake but has little effect as a receptor blocker. Both drugs are structurally similar to fluoxetine. Agents that block NE reuptake may improve the antidepressant spectrum of duloxetine and venlafaxine. These agents also are used for relieving chronic pain states. Duloxetine was approved by the FDA for treating major depressive episode and diabetic neuropathy. It is also being promoted for the treatment of fibromyalgia. Atomoxetine is approved for the treatment of attention-deficit disorder.

Absorption, fate, and excretion. Venlafaxine, duloxetine, and atomoxetine are metabolized primarily by CYP2D6. Some are mild inhibitors of CYP2D6. Venlafaxine is metabolized to an active metabolite O-desmethylvenlafaxine whose half life is about twice that of the parent drug. Reboxetine is primarily metabolized by CYP3A4.

Adverse effects. Side effects include dry mouth, insomnia, blurred vision, sweating, and constipation. Reboxetine and atomoxetine can increase heart rate and systolic blood pressure. These drugs can also reduce salivary secretion to approximately one half of control.³⁸ Mixed or pure NE reuptake inhibitors may have reduced sexual side effects. Drug interactions with SSRIs, MAO inhibitors, TCAs, dextromethorphan, and pentazocine and with numerous other substrates of CYP2D6 or CYP3A4 have been reported with these antidepressants. Drug interactions with epinephrine have not yet been reported, although the actions of epinephrine have been increased in some cases.

St. John's Wort

St. John's wort, a traditional herbal remedy, is helpful for treating mild to moderate depression. In ancient Greece and Rome, St. John's wort (*Hypericum perforatum*) was placed above icons for its mystical powers (*hyper* means "above"; *eikon* means "icon"). St. John may refer to the flowering time of the plant around June 24, the Christian feast of the birth

of St. John the Baptist. The drug is available as an herbal preparation from health food stores and pharmacies in the United States and outsells fluoxetine in Germany.

St. John's wort has many biologically active components, including hypericin, hyperforin, and some flavinoids.⁹ Commercially available capsules contain approximately 3% to 5% hyperforin and 0.3% hypericin. It has only more recently been understood that hyperforin may be the most active constituent, so labeling may still refer to hypericin as the active agent.

St. John's wort blocks the reuptake of 5-HT, NE, dopamine, GABA, and glycine with approximately equal potency, a unique therapeutic property. These neurotransmitter symporters use the Na⁺ gradient produced by the Na⁺, K⁺-ATPase pump to transport neurotransmitters into the cell. When a neurotransmitter is in the cell, proton-dependent antiporters pump it into the synaptic vesicles. Hyperforin may reduce the Na⁺ gradient on which the symporters depend, decreasing neurotransmitter uptake.⁹

St. John's wort reaches peak plasma concentrations in approximately 4 hours and has a half-life of approximately 9 hours. There is disagreement as to the relative clinical effectiveness of St. John's wort, despite evidence of an antidepressant action. Commonly noted side effects include gastrointestinal upset, fatigue, dizziness, dry mouth (but less than with other antidepressants), and restlessness. The drug seems to be relatively free of the typical autonomic side effects associated with TCAs. A rare, but possibly dose-related, toxicity is phototoxicity. Cows that eat too much St. John's wort can get severe phototoxic blisters attributed to hypericin. The eye may be susceptible to increased cataract formation because of a related effect.

Drug interactions are of possible concern with St. John's wort and can result from multiple mechanisms. St. John's wort can activate the pregnane X receptor, a member of the steroid/thyroid family of gene promoters that increases CYP3A4 transcription.⁹ This induction is thought to be caused by hyperforin. St. John's wort can inhibit certain cytochrome P450 enzymes. Another mechanism for drug interactions is the induction of intestinal P-glycoprotein, which may reduce absorption of other drugs such as cyclosporine and indinavir. Drug interactions may involve other antidepressants that elevate brain biogenic amines. St. John's wort can also block MAO-A and MAO-B, but this is thought to occur only at higher than therapeutic doses. Drug interactions with cyclosporine, oral contraceptives, warfarin, indinavir, digoxin, nefazodone, sertraline, and paroxetine have been reported.

Potential Antidepressants and Antidepressant Potentiators

Benzodiazepines, although not approved for use as antidepressants, are increasingly being prescribed for affective disorders (anxiety disorders can be comorbid with affective disorders). Alprazolam, a triazolobenzodiazepine marketed as an anti-anxiety agent, seems to have definite antidepressant properties. It is commonly used for the treatment of mild cases of depression and for panic attacks. Clonazepam, an anticonvulsant, is also used sometimes in the treatment of panic attacks (see Chapter 13), and lorazepam, an anti-anxiety drug, may be effective against mania. The response of panic attacks to benzodiazepines suggests that doses higher than those recommended for anxiety are required. Benzodiazepines are less effective than TCAs in severely depressed patients. The disinhibitory effect of the benzodiazepines can provoke paradoxical aggression and suicide attempts in some patients.

Buspirone, a partial 5-HT_{1A} agonist and an effective anti-anxiety agent (see Chapter 13), is being evaluated for the treatment of depression. Other drugs of this class under inves-

tigation for relief of depression and anxiety are gepirone and ipsapirone. Clinical trials indicate that gepirone possesses anti-anxiety and antidepressant activity.

Ovarian hormones can induce biochemical changes in the brain. Estrogen can alter 5-HT, acetylcholine, and catecholamine function, whereas progesterone may alter function at GABA receptors. These effects can lead to changes in mood and memory. In some cases, mood disorders in women can be treated with steroidal hormones. In other cases, steroidal hormones may be useful adjuncts that improve the efficacy of traditional antidepressants.

Drugs such as lithium salts, usually associated with the treatment of bipolar disorder, are sometimes used in unipolar depression when conventional therapy is insufficient. Thyroid replacement therapy may enhance antidepressant therapy in 50% of patients.²⁰ Thyroid hormone can affect the function of catecholamines. Thyroxine is converted to triiodothyronine in the cells of the locus coeruleus. In the cortex, triiodothyronine may be released as a cotransmitter with NE.

Many antidepressant drugs are investigational only or have been approved for use outside the United States. These compounds vary in mechanism of action, side effects, and efficacy. The diversity of the chemical structures and pharmacologic activities of antidepressant drugs suggests that clinical depression is caused by various biochemical alterations. Paradoxically, the drug tianeptine, a selective serotonin reuptake enhancer, is already being marketed in other countries. These drugs are likely to enhance medical care and provide a better understanding of the underlying causes of depression.

General Therapeutic Uses

Antidepressants are primarily indicated for the treatment of depression. The clinician is confronted with various treatments but relatively few absolute indicators of which approach is ideal for each patient. Psychotherapy can be provided as initial therapy and is frequently beneficial; however, it usually takes longer than drug treatment to be effective. A combination of drugs and psychotherapy may be more effective than either treatment alone. Drug selection is ideally based on efficacy, side effects, and cost. Patients may be started on an SSRI (fewer side effects) or on a TCA or other antidepressant if some factor favoring its use over an SSRI is identified. If the patient responds, no further adjustment is necessary. If the patient responds partially or not at all, a different class of drug can be tried. If treatment is still unsatisfactory, combination therapy with antidepressants of different classes may be effective. If all these fail, a trial of electroconvulsive therapy may prove beneficial. Other therapies such as antipsychotic agents, vagal stimulation therapy, and transcranial magnetic stimulation may be tried in extremely resistant cases.

TCAs and newer mixed selective amine agents are used in the treatment of chronic pain, which is a common diagnosis in depressed patients. Although analgesia may result from the antidepressant effect, a direct analgesic action is suggested by the fact that analgesia can be obtained in patients free of depressive illness and at lower doses than those required for relief of depression. Common types of chronic pain syndromes possibly amenable to TCAs include headache, diabetic neuropathy, neuralgias, postherpetic neuralgia, arthritis, and atypical facial pain (see later). Antidepressants should be used with special caution in elderly patients because of the possible exacerbation of cardiovascular disease. In patients older than 50 years, initial doses should be one third of the normal recommended dose, with increases made gradually over a 7- to 14-day period.

The FDA recognizes additional indications for several of these agents. Amitriptyline is indicated for delusions, doxepin for alcoholism, and desipramine for attention-deficit/hyperactivity disorder. Imipramine may be prescribed for the manage-

ment of nocturnal enuresis in older children and incontinence in adults. Although effective, no mechanism has yet been shown for these indications²³; however, their clinical efficacy is greater than that of anticholinergic agents.

Second-generation and third-generation antidepressants may have advantages in some patients. Because of its sedative property, trazodone is useful in agitated depression and in depressed patients who have insomnia. Trazodone, nefazodone, and bupropion may also be of special use in elderly patients because these drugs have mild cardiovascular and anticholinergic side effects. Trazodone has been associated with ventricular dysrhythmias, however, in some patients with cardiac disease. Most second-generation and third-generation antidepressants produce less sexual dysfunction than SSRIs. Nefazodone is indicated for panic disorder and post-traumatic stress disorder. Amoxapine may have special use in psychotic depression, where its activity as a dopamine antagonist may prove beneficial.

Similar to SSRIs, bupropion has very low potential for causing sedation and is useful when daytime alertness is desired. Bupropion (Zyban) is used for smoking cessation²² and may be successful in 44% of patients. (Nicotine formulations are also used for smoking cessation; clonidine and nortriptyline are second-line treatments.) Bupropion, as Zyban, is available in an extended-release dosage form and is effective in doses up to 300 mg/day in divided doses. Treatment is usually continued for 7 to 12 weeks. Other uses for bupropion include attention-deficit/hyperactivity disorder and post-traumatic stress disorder.

MAO inhibitors may be particularly effective in the treatment of atypical affective disorders (e.g., depression with hysteria), panic attacks, and depression coupled with somatic anxiety, and in patients whose conditions are refractory to the other antidepressants. They have been largely replaced, however, by safer, more effective drugs. Moclobemide, a reversible MAO-A-selective drug, produces fewer side effects than older MAO inhibitors.

SSRIs are currently the most commonly prescribed antidepressants. Clinical trials and case reports also suggest that these drugs may be useful in the treatment of obsessive-compulsive disorders (the FDA has approved fluoxetine and paroxetine), bulimia (fluoxetine), panic disorders (paroxetine and sertraline), social phobia (paroxetine), and poststroke depression (citalopram). Post-traumatic stress disorder may also be an indication. To date, these drugs have been found to be effective antidepressants while producing fewer side effects than previous agents. Depression associated with other medical illness or surgery is common. This depression may contribute to adverse treatment responses. SSRIs are effective for treatment of depression in patients with myocardial infarction, diabetes, and Parkinson's disease. SSRIs are generally less effective in chronic pain syndromes than drugs that block NE and 5-HT uptake, although SSRIs may be effective in diabetic neuropathy (citalopram) and migraine pain (paroxetine).

As with the antipsychotics, antidepressants must be administered over a long period and are often continued for several weeks after clinical remission to guard against relapse. Several weeks to 2 months of continuous drug administration are usually necessary before therapeutic effects are noted. This slow onset in effect may be related to alterations in brain neurochemistry or receptors. Drug treatment should continue for at least 6 months. If the patient has had more than one previous depressive episode, treatment should be continued for at least 2 years and in some cases indefinitely. Although it has been claimed that some of the newer agents have a more rapid onset of action than TCAs, this assertion has yet to be consistently confirmed in clinical studies. Similar to other antidepressants, SSRIs may precipitate mania, especially in the bipolar patient.

Tricyclic antidepressants

The anticholinergic side effects of TCAs have important dental implications. Reduced salivary flow increases the risk of dental caries, oral candidiasis, and oral functional abnormalities. Three quarters of patients taking imipramine may report dry mouth compared with one third of patients taking the SSRI sertraline.

Anticholinergic agents should not be administered with TCAs because additive effects can result in toxic reactions (e.g., confusion, agitation, hyperthermia, tachycardia, urinary retention). The use of anti-anxiety agents, barbiturates, and other sedatives should be carefully controlled in patients receiving TCAs because of additive depressant effects on the CNS. The duration of action of barbiturates may be prolonged by TCAs, but the long-term use of barbiturates can reduce half-lives of TCAs by microsomal enzyme induction. Propoxyphene, which has been reported to interfere with several P450 isozymes, may inhibit the metabolism of TCAs and increase their half-lives.

Similar to the antipsychotic agents, the risk of long QT syndrome and torsades de pointes is increased by many antidepressants, so adding other agents that increase this risk should be avoided. These include several of the macrolide (erythromycin, clarithromycin) and fluoroquinolone (moxifloxacin, gatifloxacin) antibiotics, imidazole antifungal agents (ketoconazole, itraconazole), antihistamines, and cholinergic agonists.

Because of the cardiotoxic effects of TCAs and their potentiation of adrenergic drugs, high doses or accidental intravascular injection of local anesthetic solutions may precipitate arrhythmias and hypertension. The use of TCAs is not a contraindication, however, for the use of epinephrine with local anesthetics as long as care is taken not to inject the vasoconstrictor intravenously or in large doses.

Abrupt termination of an antidepressant may lead to withdrawal symptoms. Such patients may exhibit hypersensitivity to touch and pain and may have paresthesias, headache, and muscle spasms.

Monoamine oxidase inhibitors

Various drug interactions involve MAO inhibitors, particularly the irreversible nonselective type. Interactions most relevant for the practicing dentist include the prolongation and enhancement of the CNS effects of the opioid analgesics, barbiturates, and other CNS depressants. MAO inhibitors given in conjunction with meperidine cause potentially fatal reactions, including hyperthermia, excitement, and seizures, in addition to reactions that resemble an opioid overdose. This interaction requires that meperidine not be used concurrently with MAO inhibitors or for several weeks after therapy with MAO inhibitors has ceased. Other opioids, which are not similar chemically to meperidine, may be used with caution.

Hypotension can develop with the concomitant use of general anesthetics and MAO inhibitors. It is prudent to discontinue the use of MAO inhibitors for 2 weeks before surgery. Neither epinephrine nor levonordefrin is potentiated by inhibition of MAO activity.

Second-generation and third-generation antidepressants

Although second-generation and third-generation antidepressants may have fewer side effects than TCAs, their anticholinergic and sedative properties should be kept in mind. Bupropion is exceptional in that central stimulation is more likely than sedation. This side effect may aggravate the condition of an already nervous patient. The drug is reported to produce dry mouth in approximately 25% of patients who use it, including patients in smoking cessation programs. The dentist should recognize that bupropion, although generally

safe, occasionally can produce severe reactions such as seizures or Stevens-Johnson syndrome. The drug should be avoided in patients who pose a risk for these reactions. Long-term success rates in smoking cessation programs, even with pharmacotherapy, are low.

Amoxapine can cause extrapyramidal side effects that can affect prosthodontic care. Drug interactions involving amoxapine and maprotiline are similar to interactions involving first-generation TCAs. Mirtazapine has potential for side effects and drug interactions. Because of its ability to block H_1 histamine receptors, it is sedating and can produce weight gain and xerostomia.

Selective serotonin reuptake inhibitors

The high incidence of gastrointestinal disturbances, particularly nausea and vomiting, during initial treatment with SSRIs can pose clinical problems. Postponement of clinical procedures to a later date may be advisable because tolerance develops to these side effects. Fluoxetine (or its metabolite norfluoxetine) prolongs the duration of action of certain benzodiazepines, probably by decreasing their metabolism. This inhibition may lead to protracted sedation, especially in light of the long half-lives of fluoxetine and its active metabolite. The interaction is most pronounced with benzodiazepines (alprazolam, midazolam, and triazolam) that are metabolized by CYP3A4-catalyzed α hydroxylation on the triazololo ring of these drugs.

Implications for Dentistry

Untreated depression has been correlated with numerous intraoral changes that may predispose depressed patients to dental or oral disease. Known factors include reduced salivary flow, preference for carbohydrates (possibly because of decreased brain 5-HT), higher oral lactobacillus counts, and decreased motivation and interest in oral health maintenance.¹⁷ Depressed patients may be more likely to have periodontitis. Chronic facial pain, burning sensations in the mouth, and temporomandibular joint disorders may be associated with depression.

All drugs used to treat depression have been reported to produce varying degrees of xerostomia and may increase the likelihood for dental caries and other oral health problems.²⁷ Estimates of degree of dry mouth vary widely in the literature for the same drug. The reasons for this variability may include differences in dosage, duration of therapy, and underlying physical status among patients. Although antimuscarinic action has been a principal explanation for dry mouth, other drug actions may also contribute. Changes in salivary function can reflect actions of drugs on the salivary glands, the cardiovascular system, immune function, or the CNS centers controlling these functions. The relative likelihood of xerostomia is much greater with TCAs than with other antidepressants. Other common oral side effects of antidepressants include altered taste sensation, stomatitis, and glossitis.¹⁷

Amitriptyline and other antidepressants are among the more commonly used drugs for facial pain, including atypical facial pain and facial arthralgia (Costen's syndrome and temporomandibular joint dysfunction syndrome). Drug responses vary from patient to patient. Although effective doses are lower than the doses required for the treatment of depression, the same delayed onset to effect (several weeks) has been reported. Similar results have been obtained with dothiepin, an investigational thio derivative of amitriptyline. Dothiepin may have analgesic efficacy for treating idiopathic fibromyalgia, rheumatoid arthritis, and atypical facial pain. The selective NE reuptake blockers such as duloxetine or reboxetine may also be useful in the treatment of chronic pain. Because duloxetine and reboxetine block the reuptake

of NE, concurrent use of vasoconstrictors in dental carpiules could produce exaggerated cardiovascular responses.

ANTIMANICS

Manic disorder or bipolar disorder is a unique diagnostic condition. A genetic component is suspected. Numerous biochemical pathways seem to be altered in manic or bipolar patients in the brain and blood elements. Elevated concentrations of Ca^{++} have been observed in brain cells, platelets, and lymphocytes. Brain mitochondrial function and intracellular pH are decreased, choline/creatine-phosphocreatine ratios are higher than normal, and phosphocreatine and *N*-acetyl aspartate concentrations are decreased in specific brain regions. These results indicate possible neuronal damage and impaired function. Abnormalities on several chromosomes are suspected, and there is an increased maternal transmission rate with several mutations of mitochondrial DNA associated with increased risk of the disorder.

Lithium salts are important for treating mania, but Li^+ alone may be inadequate treatment for half of patients exhibiting bipolar disorder. In addition to the antimanic effects of Li^+ , evidence suggests Li^+ may also exert neuroprotective actions that may be prophylactic in unipolar and bipolar disorders and possibly in neural degenerative disorders such as Alzheimer's disease.³⁹ Other agents can be used to control manic patients temporarily while Li^+ therapy is being instituted and to treat individuals for whom Li^+ alone proves ineffective. Typical and atypical antipsychotic drugs are used in 85% of patients during initiation of therapy.⁵³ Interest has been directed toward the use of established anticonvulsants (valproate and carbamazepine), several new anticonvulsants, omega-3 fatty acids,⁴⁰ Ca^{++} channel blockers, thyroid-stimulating hormone, and thyroid hormone as adjunctive agents in the treatment of bipolar disorder. Ultimately, a variety of drugs is available if needed.

Lithium Salts

Li^+ was observed to be effective for mania by Cade in 1949, but was not generally embraced until the late 1960s.

Pharmacologic effects

The mechanism of action of Li^+ is not established. Many changes resulting from Li^+ administration have been documented, including effects on plasma membrane cation channels, plasma membrane ion pumps, and exchange systems and positive and negative effects on neuronal release of various neurotransmitters.

Although the mechanism of action of Li^+ remains unresolved, two effects of Li^+ offer likely explanations for the therapeutic and possibly adverse effects (Figure 12-9). The first is the inhibitory effect of the ion on phosphomonoesterases involved in inositol signaling pathways. Li^+ inhibits phosphoinositide metabolism by inhibiting inositol monophosphatase, the enzyme responsible for converting inositol monophosphate to inositol. Li^+ also inhibits inositol polyphosphate-1-phosphatase, which catalyzes the 1-dephosphorylation of certain inositol bisphosphates and polyphosphates. Li^+ might inhibit the effect of neurotransmitters that use signaling pathways involving inositol trisphosphate. The effect of inhibiting this pathway could be the depletion of inositol, which would deplete phosphatidylinositol bisphosphate. This effect would reduce signaling through receptors whose signaling involves the use of phosphatidylinositol bisphosphate as a substrate for the formation of inositol trisphosphate and diacylglycerol.

A second effect that may play an important role in the action of Li^+ is inhibition of glycogen synthase kinase- β

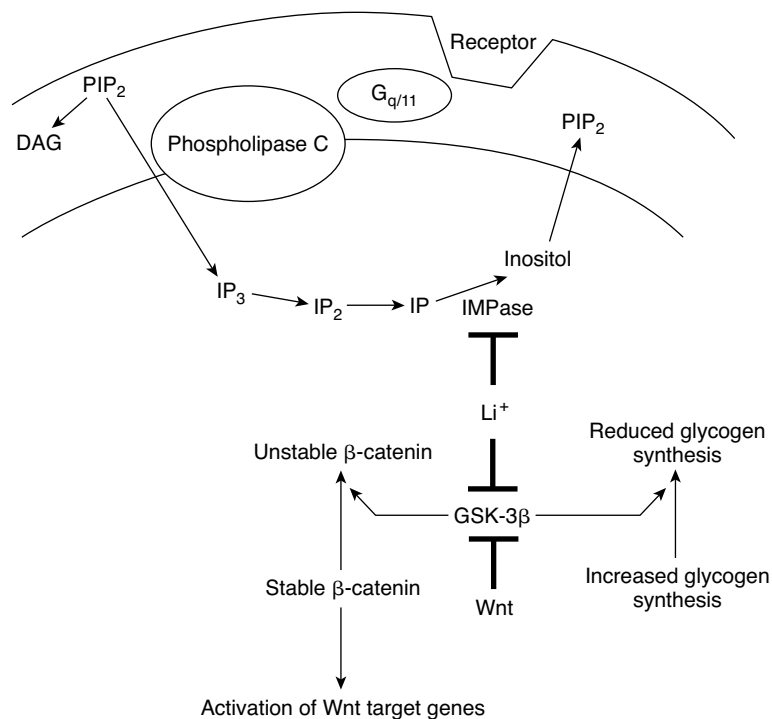

FIGURE 12-9 Two mechanisms by which Li⁺ may mediate its pharmacologic effects. Li⁺ inhibits inositol monophosphatase (*IMPase*) and glycogen synthase kinase-3β (*GSK-3β*). By the first mechanism, Li⁺ inhibits signaling through the inositol pathway by depleting phosphatidylinositol biphosphate (*PIP*₂). The result of this depletion is the inability to produce sufficient inositol-1,4,5 trisphosphate (*IP*₃). By the second mechanism, Li⁺ stabilizes β-catenin, leading to changes in neuronal function, such as receptor signaling and remodeling. In addition, glycogen synthesis is promoted by Li⁺. *DAG*, Diacylglycerol; *IP*, inositol monophosphate; *IP*₂, inositol biphosphate; *Wnt*, glycoprotein that inhibits *GSK-3β*.

(*GSK-3β*). This inhibition can affect at least two intracellular signaling cascades: activation of β-catenin and increased glycogen synthesis.^{1,31} By inhibiting *GSK-3β*, Li⁺ acts like the endogenous inhibitor of *GSK-3β*, which stimulates cell receptors linked to *GSK-3β* (see Figure 12-9). This stimulation results in changes in cell-cell interaction, axonal remodeling, and signaling in neurons. By inhibiting *GSK-3β*, Li⁺ also acts like insulin, which stimulates glycogen synthesis (*GSK-3β* inhibits glycogen synthase).³¹

Clinically, Li⁺ alleviates the manifestations of mania over 1 to 2 weeks. Sleep and appetite disturbances abate, and mood swings are prevented. Li⁺ has little effect on mood in patients who do not have mania. Li⁺ may provide a prophylactic action against future manic attacks. Patients who stop taking Li⁺ may not respond as well to subsequent Li⁺ treatment trials, possibly because of progression of the neurodegenerative process. Li⁺ does not have anticonvulsant actions. When Li⁺ is given in combination with pilocarpine, a severe form of continuous seizures can occur.²¹

Absorption, fate, and excretion

Li⁺ is readily absorbed from the gastrointestinal tract. The cation eventually equilibrates throughout the total body water; no particular affinity for the brain or a specific organ has been detected. Excretion of Li⁺ is primarily through the kidney, and reduced kidney function is associated with greater Li⁺ toxicity if blood concentrations are not carefully monitored.

Adverse effects

Some of the most common side effects of Li⁺ (e.g., gastrointestinal irritation, fine hand tremor, muscular weakness, polyuria, thirst, sleepiness, a sluggish feeling) are often associated with initial therapy and usually fade within 1 to 2 weeks. Thirst, polyuria, and hand tremor occasionally may continue for several months or years. Severe intoxication results in vomiting, diarrhea, unconsciousness, and convulsions. Most

adverse effects of Li⁺ have been found to correlate very closely with serum Li⁺ concentrations. The therapeutic index for Li⁺ is low, and plasma titers of Li⁺ must be carefully monitored to ensure therapeutic effectiveness and avoid toxicity.

Li⁺ inhibits the renal response to antidiuretic hormone and may cause nephrogenic diabetes insipidus. This is the basis for the thirst and polyuria associated with the drug. Renal effects are usually moderate and reversible. Thiazides and other diuretics reduce renal excretion of Li⁺. Dosages of Li⁺ may need to be reduced during concurrent therapy with a diuretic. Na⁺ depletion leads to reduced excretion of Li⁺ and a higher risk of toxicity. Any situation, such as a sodium-restricted diet or sweating, that tends to reduce the Na⁺ load may increase Li⁺ toxicity. Patients must be warned not to begin a sodium-restricted diet without medical surveillance. Cardiovascular disease, renal disease, or severe dehydration can also increase the risk of toxicity from Li⁺.

Li⁺ may cause hypotension and cardiac arrhythmias. If Li⁺ produces electrocardiogram changes, the changes are not usually significant if concentrations remain in the therapeutic range. Li⁺ can also induce hypothyroidism in 20% to 40% of patients.²⁸ Hypothyroidism can be managed with thyroid replacement therapy. In some cases of Li⁺-resistant mania, increasing thyroxine concentrations to 150% of normal may overcome the resistance. With continued Li⁺ therapy, approximately 4% of patients develop diffuse, nontoxic goiters. Patients may have elevated plasma Ca⁺⁺, which may be related to increased renal Ca⁺⁺ reabsorption. Li⁺ inhibits the effect of parathyroid hormone on osteoclasts, however, and parathyroid hormone levels may increase. Li⁺ may cause numerous dermatologic side effects and alopecia. Teratogenic effects, such as cleft palate and deformities of the ear and eye, and cardiac defects are associated with Li⁺ administration during the first trimester of pregnancy.

Simple and convenient methods for measuring Li⁺ have been sought that do not involve taking blood samples. One such method has been the use of salivary measurements to predict serum concentrations. Li⁺ concentrations in saliva are higher than plasma concentrations because the ion is actively

secreted into saliva. Although the saliva/plasma Li^+ ratio varies considerably from patient to patient, within a single patient its variability is low. There is some promise that saliva sampling may be beneficial in Li^+ monitoring.

General therapeutic uses

Li^+ is used for the treatment of mania and as long-term treatment of manic-depressive illness. Initial high (therapeutic) doses are often adjusted downward to maintenance levels, which may partially explain the initial feelings of tiredness. Even so, the delay of onset is such that 7 to 10 days are required before the antimanic effects are noted, and a short course of antipsychotic medication is normally required in cases of fully developed mania. Frequent measurements of Li^+ are required to maintain proper plasma concentrations and are particularly important as a guard against toxicity.

Implications for dentistry

Patients with bipolar disease may have substantial dental pathology. These patients have a greater risk for poor oral hygiene, accumulations of supragingival and subgingival calculus, extensive dental caries, and numerous missing teeth.¹⁶ Some of the dental problems may be related to patient characteristics other than treatment, such as age or financial situation. Hyposalivation from the disease is common (approximately 71%), which may be associated with dental caries.

Nonsteroidal anti-inflammatory analgesics may decrease the renal excretion of Li^+ and lead to toxic plasma concentrations after several days of combined therapy. Although drugs such as piroxicam and indomethacin most readily cause this drug interaction, it is most likely to occur with formulations of ibuprofen, naproxen, and related drugs that are available over-the-counter and likely to be taken without professional supervision. Aspirin can increase the excretion of Li^+ . The combination of Li^+ and pilocarpine must be avoided because of the risk of seizures.

Patients taking Li^+ frequently have a metallic taste that can alter the palatability of food. Most patients taking Li^+ have salivary gland dysfunction and a resultant decrease in salivary flow.³⁴ Polydipsia is common because of Li^+ -induced diuresis and xerostomia. In early phases of Li^+ therapy, facial spasm and transient facial paralysis, especially of the lower jaw, have occurred. Facial pains associated with cluster headaches may respond to treatment with Li^+ .

Other Antimania Drugs

Approximately 50% of patients who have mania do not respond to Li^+ . Characteristics common to many Li^+ -refractory patients include severe mania mixed with either psychotic episodes or anxiety and a history of rapid cycling. Antipsychotic agents are frequently used to help control the florid excitation and delusions early in treatment, and more recently the atypical antipsychotic olanzapine has been approved for this use. Aripiprazole is also being investigated for this use. Carbamazepine, an anticonvulsant discussed in Chapter 14, may be effective in some refractory cases. Carbamazepine has been reserved for patients who do not respond to conventional therapy. Patients who seem to respond most favorably to carbamazepine have severe forms of the disease. A Li^+ /carbamazepine combination is sometimes effective in patients who are refractory to either drug alone. Carbamazepine may also be effective as a prophylactic agent. Valproic acid is another anticonvulsant that has clinical usefulness for the treatment of mania refractory to Li^+ and carbamazepine.

Newer anticonvulsant medications, such as lamotrigine, gabapentin, and topiramate, are being evaluated as adjuncts and have been called mood stabilizers when used in this

context. The benzodiazepines clonazepam and lorazepam, when used in combination with haloperidol, are helpful in calming severely manic patients until Li^+ administration achieves a therapeutic concentration. This combination often permits adequate control without excessive doses of either the antipsychotic or the benzodiazepine. Ca^{++} channel blockers such as verapamil have proved helpful in some cases of Li^+ -refractory mania, but more studies are required to assess their overall usefulness. Similar to Li^+ , verapamil is not a depressant and is of little use for the initial treatment of severely manic patients. Omega-3 fatty acid treatment of bipolar disorder is under study but has not shown consistent efficacy.³³

ANTIPSYCHOTIC AND ANTIDEPRESSANT DRUGS

Nonproprietary (generic) name	Proprietary (trade) name
Phenothiazines	
Acetophenazine*	Tindal
Chlorpromazine	Thorazine
Fluphenazine	Prolixin
Mesoridazine	Serentil
Perphenazine	Trilafon
Prochlorperazine	Compazine
Promazine*	Sparine
Thioridazine	Mellaril
Trifluoperazine	Stelazine
Triflupromazine*	Vesprin
Thioxanthenes	
Chlorprothixene*	Taractan
Thiothixene	Navane
Butyrophenone	
Haloperidol	Haldol
Dibenzoxazepine	
Loxapine	Loxitane
Diphenylbutylpiperidine	
Pimozide	Orap
Dibenzodiazepine	
Clozapine	Clozaril
Benzisoxazole	
Risperidone	Risperdal
Paliperidone	Invega
Thienobenzodiazepine	
Olanzapine	Zyprexa
Dihydroindolones	
Ziprasidone	Zeldox
Molindone	Moban
Dibenzothiazepine	
Quetiapine	Seroquel
Dihydrocarbostyryl	
Aripiprazole	Abilify

Continued

ANTIDEPRESSANT DRUGS

<i>Nonproprietary (generic) name</i>	<i>Proprietary (trade) name</i>
Tricyclics	
Amitriptyline	Elavil, Endep
Clomipramine	Anafranil
Desipramine	Norpramin
Doxepin	Adapin, Sinequan
Dothiepin*	Prothiaden
Imipramine	Tofranil
Nortriptyline	Aventyl, Pamelor
Protriptyline	Vivactil
Trimipramine	Surmontil
Monoamine oxidase (MAO) inhibitors	
Phenelzine	Nardil
Isocarboxazid	Marplan
Tranylcypromine	Parnate
Second-generation and third-generation agents	
Amoxapine [†]	Asendin
Duloxetine	Cymbalta
Maprotiline	Ludomil
Trazodone	Desyrel
Nefazodone	Serzone
Bupropion	Wellbutrin, Zyban
Mirtazapine	Remeron
Reboxetine*	Vestra
Selective serotonin reuptake inhibitors (SSRIs)	
Fluoxetine	Prozac
Fluvoxamine	Luvox
Paroxetine	Paxil
Sertraline	Zoloft
Citalopram	Celexa
Escitalopram	Lexapro
Venlafaxine [‡]	Effexor
Antimanics	
Carbamazepine	Tegretol
Lithium carbonate	Eskalith, Lithobid
Lithium citrate	Cibalith-S
Valproic acid (and derivatives)	Depakene, Depakote

*Not currently available in the United States.

[†]Amoxapine is listed separately from the other tricyclics because it is a second-generation or atypical antidepressant.

[‡]Not classified as an SSRI, but is selective for 5-hydroxytryptamine transport at therapeutic doses.

CITED REFERENCES

- Ackenheil M: Neurotransmitters and signal transduction processes in bipolar affective disorders: a synopsis. *J Affect Disord* 62:101-111, 2001.
- Aghajanian GK, Marek GJ: Serotonin model of schizophrenia: emerging role of glutamate mechanisms. *Brain Res Rev* 31:302-312, 2000.
- Akiskal HS, Bourgeois ML, Angst J, et al: Re-evaluating the prevalence of and diagnostic composition within the broad clinical spectrum of bipolar disorders. *J Affect Disord* 59(Suppl 1):S5-S30, 2000.
- Andreasen NC: Schizophrenia: the fundamental questions. *Brain Res Rev* 31:106-112, 2000.
- Artigas F, Celada P, Laruelle M, et al: How does pindolol improve antidepressant action? *Trends Pharmacol Sci* 22:224-228, 2001.
- Cade JFJ: Lithium salts in the treatment of psychotic excitement. *Med J Aust* 2:349-352, 1949.
- Casey DE, Zorn SH: The pharmacology of weight gain with antipsychotics. *J Clin Psychiatry* 62(Suppl 7):4-10, 2000.
- Charney DS: Monoamine dysfunction and the pathophysiology and treatment of depression. *J Clin Psychiatry* 59(Suppl 14):11-14, 1998.
- Di Carlo G, Borrelli F, Ernst E, et al: St John's wort: Prozac from the plant kingdom. *Trends Pharmacol Sci* 22:292-297, 2001.
- Diagnostic and statistical manual of mental disorders*, ed 4 (DSM-IV), Washington, DC, 1994, American Psychiatric Association.
- Duffy A, Aldaan M, Crawford L, et al: The early manifestations of bipolar disorder: a longitudinal prospective study of the offspring of bipolar parents. *Bipolar Disord* 9:828-838, 2007.
- Dunn RT, Willis MW, Benson BE, et al: Preliminary findings of uncoupling of flow and metabolism in unipolar compared with bipolar affective illness and normal controls. *Psychiatry Res* 140:181-198, 2005.
- Ellison JM, Stanziani P: SSRI-associated nocturnal bruxism in four patients. *J Clin Psychiatry* 54:432-434, 1993.
- Fazel S, Grann M, Ahlner J, et al: Suicides by violent means in individuals taking SSRIs and other antidepressants: a postmortem study in Sweden, 1992-2004. *J Clin Psychopharmacol* 27:503-506, 2007.
- Flockhart DA: Cytochrome P450 drug interaction table. Indiana University, Department of Medicine, Division of Clinical Medicine, 2003. Available at: <http://medicine.iupui.edu/clinpharm/DDIs/>. Accessed, July 27, 2009.
- Friedlander AH, Birch NJ: Dental conditions in patients with bipolar disorder on long-term Li+ maintenance therapy. *Spec Care Dentist* 10:148-151, 1990.
- Friedlander AH, Mahler ME: Major depressive disorder: psychopathology, medical management and dental implications. *J Am Dent Assoc* 132:629-638, 2001.
- Glassman AH: Cardiovascular effects of antidepressant drugs: updated. *Int Clin Psychopharmacol* 13(Suppl 5):S25-S30, 1998.
- Gibbons RD, Brown CH, Hur K, et al: Relationship between antidepressants and suicide attempts: an analysis of the Veterans Health Administration data sets. *Am J Psychiatry* 164:1044-1049, 2007.
- Haller E, Binder RL: Clozapine and seizures. *Am J Psychiatry* 147:1069-1071, 1990.
- Honchar MP, Olney JW, Sherman WR: Systemic cholinergic agents induce seizures and brain damage in Li+-treated rats. *Science* 220:323-325, 1983.
- Hughes JR, Stead LF, Lancaster T: Antidepressants for smoking cessation (Cochrane Review). In *Cochrane Library*, ed 2, Oxford, 2001.
- Hunsballe JM, Djurhuus JC: Clinical options for imipramine in the management of urinary incontinence. *Urol Res* 29:118-125, 2001.
- Jeste DV, Blazer D, Casey D, et al: ACNP White Paper: update on use of antipsychotic drugs in elderly persons with dementia. *Neuropsychopharmacology* 33:957-970, 2008.
- Kapur S, Zipursky RB, Remington G, et al: 5-HT₂ and D₂ receptor occupancy of olanzapine in schizophrenia: a PET investigation. *Am J Psychiatry* 155:921-928, 1998.
- Kent JM: SNaRIs, NaSSAs, and NaRIs: new agents for the treatment of depression. *Lancet* 355:911-918, 2000.
- Kilbourne AM, Horvitz-Lennon M, Post EP, et al: Oral health in Veterans Affairs patients diagnosed with serious mental illness. *J Public Health Dent* 67:42-48, 2007.
- Kusalic M, Engelsmann F: Effect of Li+ maintenance therapy on thyroid and parathyroid function. *J Psychiatr Neurosci* 24:227-233, 1999.
- Larrosa O, de la Llave Y, Barrio S, et al: Stimulant and anticataleptic effects of reboxetine in patients with narcolepsy: a pilot study. *Sleep* 24:282-285, 2001.
- Lechner SM: Glutamate-based therapeutic approaches: inhibitors of glycine transport. *Curr Opin Pharmacol* 6:75-81, 2006.
- Le-Niculescu H, Balaraman Y, Patel S, et al: Towards understanding the schizophrenia code: an expanded convergent functional genomics approach. *Am J Med Genet B Neuropsychiatr Genet* 5:129-158, 2007.

32. Lieberman JA, Kane JM, Johns CA: Clozapine: guidelines for clinical management. *J Clin Psychiatry* 50:329-338, 1989.
33. Lin PY, Su KP: A meta-analytic review of double-blind, placebo-controlled trials of antidepressant efficacy of omega-3 fatty acids. *J Clin Psychiatry* 68:1056-1061, 2007.
34. Markitziu A, Shani J, Avni J: Salivary gland function in patients on chronic Li+ treatment. *Oral Surg Oral Med Oral Pathol* 66:551-557, 1988.
35. Mental health: a report of the Surgeon General, US Public Health Service, 1999. Available at: <http://www.surgeongeneral.gov/library/mentalhealth/home.html>. Accessed July 27, 2009.
36. Moorhead TW, McKirdy J, Sussmann JE, et al: Progressive gray matter loss in patients with bipolar disorder. *Biol Psychiatry* 62:894-900, 2007.
37. Narr KL, Bilder RM, Toga AW, et al: Mapping cortical thickness and gray matter concentration in first episode schizophrenia. *Cereb Cortex* 15:708-719, 2005.
38. Penttila J, Syvalahti E, Hinkka S, et al: The effects of amitriptyline, citalopram and reboxetine on autonomic nervous system: a randomized placebo-controlled study on healthy volunteers. *Psychopharmacology (Berl)* 154:343-349, 2001.
39. Phiel CJ, Klein PS: Molecular targets of lithium action. *Ann Rev Pharmacol Toxicol* 41:789-813, 2001.
40. Pineyro G, Blier P: Autoregulation of serotonin neurons: role in antidepressant drug actions. *Pharmacol Rev* 51:533-591, 1999.
41. Pisani F, Spina E, Oteri G: Antidepressant drugs and seizure susceptibility: from in vitro data to clinical practice. *Epilepsia* 40(Suppl 10):S48-S56, 1999.
42. Prahara SK, Arora M, Gandotra S: Clozapine-induced sialorrhea: pathophysiology and management strategies. *Psychopharmacology (Berl)* 185:265-273, 2006.
43. Prior TI, Chue PS, Tibbo P, et al: Drug metabolism of atypical antipsychotics. *Eur Neuropsychopharmacol* 9:301-309, 1999.
44. Rogers DP, Shramko JK: Therapeutic options in the treatment of clozapine-induced sialorrhea. *Pharmacotherapy* 20:1092-1095, 2000.
45. Sekine Y, Rikihisa T, Ogata H, et al: Correlations between in vitro affinity of antipsychotics to various central neurotransmitter receptors and clinical incidence of their adverse drug reactions. *Eur J Clin Pharmacol* 55:583-587, 1999.
46. Simon GE, Savarino J, Operskalski B, et al: Suicide risk during antidepressant treatment. *Am J Psychiatry* 163:41-47, 2006.
47. Sockalingam S, Shammi C, Remington G: Clozapine-induced hypersalivation: a review of treatment strategies. *Can J Psychiatry* 52:377-384, 2007.
48. Szarfman A, Topping JM, Levine JG, et al: Atypical antipsychotics and pituitary tumors: a pharmacovigilance study. *Pharmacotherapy* 26:748-758, 2006.
49. Tanga Y, Wang F, Xie G, et al: Brief report: reduced ventral anterior cingulate and amygdala volumes in medication-naïve females with major depressive disorder: a voxel-based morphometric magnetic resonance imaging study. *Psychiatry Res Neuroimaging* 156:83-86, 2007.
50. Tarsy D: Tardive dyskinesia. *Curr Treat Options Neurol* 2:205-214, 2000.
51. Tatsumi M, Groshan K, Blakely RD, et al: Pharmacological profile of antidepressants and related compounds at human monoamine transporters. *Eur J Pharmacol* 340:249-258, 1997.
52. Thompson PM, Vidal C, Giedd JN, et al: Mapping adolescent brain change reveals dynamic wave of accelerated gray matter loss in very early-onset schizophrenia. *Proc Natl Acad Sci U S A* 98:11650-11655, 2001.
53. Tohen M, Zhang F, Taylor CC, et al: A meta-analysis of the use of typical antipsychotic agents in bipolar disorder. *J Affect Disord* 65:85-93, 2001.
54. Turner EH, Matthews AM, Linardatos E, et al: Selective publication of antidepressant trials and its influence on apparent efficacy. *N Engl J Med* 358:252-260, 2008.
55. Witkovsky P: Dopamine and retinal function. *Doc Ophthalmol* 108:17-40, 2004.
56. Woods CD: Self-reported mental illness in a dental school clinic population. *J Dent Ed* 67:500-504, 2003.

GENERAL REFERENCES

- Elenkov IJ, Iezzoni DG, Daly A, et al: Cytokine dysregulation, inflammation and well-being, *Neuroimmunomodulation* 12:255-269, 2005.
- Frazer A: Pharmacology of antidepressants, *J Clin Psychopharmacol* 17(Suppl 1):2S-18S, 1997.
- Gray JA, Roth BL: The pipeline and future of drug development in schizophrenia, *Mol Psychiatry* 12:904-922, 2007.
- Hales RE, Yudofsky SC, editors: *The American Psychiatric Publishing textbook of clinical psychiatry*, ed 4, Washington, DC, 2003, American Psychiatric Publishing.
- Holsboer F: Stress, hypercortisolism and corticosteroid receptors in depression: implications for therapy, *J Affect Disord* 62:77-91, 2001.
- Lieberman JA, Stroup TS, McEvoy JP, et al: Effectiveness of antipsychotic drugs in patients with chronic schizophrenia, *N Engl J Med* 353:1209-1223, 2005.
- McDaniel KD: Clinical pharmacology of monoamine oxidase inhibitors, *Clin Neuropharmacol* 9:207-234, 1986.
- Millan MJ: Multi-target strategies for the improved treatment of depressive states: conceptual foundations and neuronal substrates, drug discovery and therapeutic application, *Pharmacol Ther* 110:135-370, 2006.
- Schatzberg AF, Nemeroff CB, editors: *The American Psychiatric Publishing textbook of psychopharmacology*, ed 3, Washington, DC, 2004, American Psychiatric Publishing.
- Sequeira A, Turecki G: Genome wide gene expression studies in mood disorders, *OMICS* 10:444-454, 2006.

Sedative-Hypnotics, Antianxiety Drugs, and Centrally Acting Muscle Relaxants*

JOSEPH A. GIOVANNITTI, JR., AND PAUL A. MOORE

The drugs discussed in this chapter have the common pharmacologic characteristic of being central nervous system (CNS) depressants, and they are capable of inducing various clinical responses, including relief of anxiety, sedative-hypnotic effects, and centrally acting muscle relaxation. Although all such drugs induce CNS impairment, drugs in certain categories have some degree of selectivity that determines their therapeutic indications in medical and dental practice. The ability of these agents to induce sedation, hypnosis, anxiolysis, or muscle relaxation selectively is limited, however, and significant overlap in the clinical indications for these drugs occurs. Pharmacokinetic differences and differences in mechanisms of action often distinguish these agents. The multiple actions and uses of these agents are also discussed in other chapters addressing anticonvulsants (see Chapter 14), general anesthetic agents (see Chapter 18), and antihistamines (see Chapter 22).

The drugs discussed in this chapter can be viewed as having dose-dependent, CNS-depressing effects progressing through anxiolysis, sedation, hypnosis, anesthesia, and ultimately death if the dose is sufficiently high. As anxiolytics, these drugs reduce the anxiety response; as sedatives, they produce relaxation, calmness, and decreased motor activity without loss of consciousness. As hypnotics, they induce drowsiness and a depressed state of consciousness that resembles natural sleep, with decreased motor activity and impaired sensory responsiveness. As anesthetics, these drugs cause a state of unconsciousness from which the patient cannot be aroused. Not all sedative-hypnotics are readily capable of inducing anesthesia, and not all CNS depressants can be used as sedative-hypnotics. General anesthetic agents easily induce unconsciousness and are unsuitable as sedative-hypnotics on an outpatient basis.

Insomnia is the salient feature of the nearly 90 different forms of sleep disorders.¹¹ Epidemiologic studies report that insomnia is widespread, affecting one third of the population. Insomnia is more prevalent among women than men and is more common in elderly individuals than in younger individuals. Nearly half of all Americans older than 65 years experience sleep disorders.⁴¹

Barbiturates were the most commonly prescribed sedative-hypnotics 50 years ago. Today they have been almost entirely replaced by benzodiazepine receptor agonists. One advantage of the benzodiazepines and related drugs over barbiturates is their wider margin of safety. Additional advantages include a slower development of tolerance and physical dependence, minimal induction of hepatic enzyme activity, and generally fewer drug interactions.

Anxiety is one of the most common psychiatric disorders. In the United States, approximately 8% of the population have an anxiety disorder during any given 6-month period. Although most individuals have certain periods and degrees of anxiety, pharmacotherapy is indicated only when anxiety begins to interfere with daily life. Similarly, pharmacotherapy should be considered when situational anxiety, such as might be experienced by a patient in anticipation of an operative or diagnostic procedure, is judged to be sufficient to compromise clinical care.

According to the *Diagnostic and Statistical Manual of Mental Disorders* (DSM-IV),¹⁰ the anxiety disorders comprise various acute and chronic anxiety and phobic states. Specific anxiety disorders include panic disorder with or without agoraphobia, agoraphobia without panic disorder, generalized anxiety disorder, obsessive-compulsive disorder, acute stress disorder, post-traumatic stress disorder, social phobia, specific (simple) phobia, substance-induced anxiety disorder, and anxiety resulting from a general medical condition. The major emphasis in this chapter is on drugs effective against anxiety as a symptom rather than as a specific disorder. Although anti-anxiety drugs have applications for treatment of anxiety disorders in general, other drugs, including tricyclic antidepressants, monoamine oxidase inhibitors, and selective serotonin reuptake inhibitors, are used in the pharmacotherapy of panic disorders, phobic disorders, and obsessive-compulsive disorders. These latter agents are discussed in detail in Chapter 12.

Nearly all CNS depressants, including ethanol, chloral hydrate, opioids, and barbiturates, can be used as antianxiety agents, but nonselective CNS sedation accounts for their anti-anxiety effect. The first drug that seemed to have some selectivity as an antianxiety agent was meprobamate. Originally developed and marketed as a skeletal muscle relaxant in the early 1950s, meprobamate soon became more widely used as an antianxiety agent. The popularity of meprobamate declined rapidly with the introduction of the benzodiazepines in the 1960s. The benzodiazepines became extremely popular drugs because they were found to have anxiolytic selectivity and to be relatively safe even after overt overdose. Nonetheless, sedation is a prominent side effect of the benzodiazepines, and additive CNS depression occurs if other CNS depressants are used concurrently. Their anxiolytic selectivity is best described in relative rather than absolute terms. The possibility that antianxiety and CNS depressant properties are pharmacologically distinguishable has been raised again with the introduction of buspirone, an azapirone derivative, which is an effective antianxiety agent with little or no sedative properties that causes very little additional depression when used with CNS depressants.

The usefulness and effectiveness of any given antianxiety agent varies depending on the patient, the clinical surround-

*The author wishes to recognize Dr. Leslie Felpel for his past contributions to this chapter.

ings, the “chairside” manner of the dentist, the route of administration, and the properties of the chosen drug. Knowledge of the pharmacologic characteristics of the various antianxiety agents is crucial for selecting the proper drug, avoiding drug interactions, and obtaining the desired therapeutic response with minimal adverse side effects.

BENZODIAZEPINES

Benzodiazepines are among the most widely used drug classes in the history of medicine because of their selectivity and margin of safety. Literally thousands of benzodiazepine derivatives have been synthesized, and more than 100 of these have been tested for clinical activity. Currently, several dozen benzodiazepines are marketed throughout the world.

Diazepam was the most frequently prescribed drug in the United States during the 1970s and remained among the 10 most frequently prescribed drugs for nearly two decades. Alprazolam is the most frequently prescribed benzodiazepine today. Surveys indicate that approximately 15% of adults in the United States take one of the benzodiazepines at least once a year. Members of the medical community and the lay press have suggested that the benzodiazepines are overused and that they frequently serve either as a substitute for the practitioner’s time or as a placebo for a population increasingly unwilling to accept a mild state of unhappiness. In response to this problem, manufacturers’ prescribing information warns practitioners that benzodiazepines should not be prescribed for longer than 4 months without a careful reassessment of the patient’s status and that they should not be prescribed for the stress of everyday life.

Chemistry and Structure-Activity Relationships

The structures of the pharmacologically active 1,4-benzodiazepines are shown in Figure 13-1 and Table 13-1. All benzodiazepines currently available in the United States are derived from the basic molecule shown in Table 13-1, to which are added various substituent groups. Slight modifications of the basic structure have produced triazolobenzodiazepines (e.g., alprazolam, triazolam) and imidazobenzodiazepines (e.g., midazolam).

All benzodiazepines with psychopharmacologic activity have an electronegative group at R₇. A chlorine atom seems to confer optimal activity, whereas bromo and nitro substitutions are only weakly anxiolytic. A nitro moiety at R₇ enhances antiseizure properties, however, as illustrated by clonazepam, which is used as an anticonvulsant. Hydrogen or methyl groups at R₇ significantly reduce pharmacologic activity. Substitution at position 5 with any group other than a phenyl ring also reduces activity. Halogenation at R₂’ increases potency; larger alkyl substitutions decrease it. Substitution on the nitrogen at R₁ with a methyl group enhances activity, as do methyl or hydrogen groups at R₃. A biosynthetic pathway for the in vivo formation of diazepam-like benzodiazepines has been proposed.⁷ Whether synthesis occurs naturally is unknown, but benzodiazepines are found in a variety of foods.⁶⁹

Mechanism of Action

Perhaps the most exciting and significant advance in the understanding of anxiety and the mechanism of action of benzodiazepines occurred with the discovery of specific benzodiazepine binding sites in the brain and the understanding that these were in some way linked to the inhibitory neurotransmitter γ -aminobutyric acid (GABA). As shown schematically in Figure 13-2, when the GABA receptor is activated, the Cl⁻ channel opens, allowing Cl⁻ influx, membrane hyperpolarization, and neuronal inhibition. Benzodiazepines, by interacting at high-affinity benzodiazepine binding sites

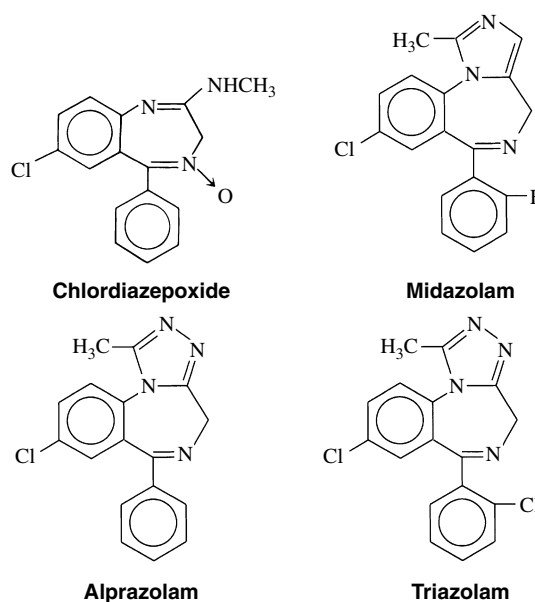

FIGURE 13-1 Structural formulas of chlordiazepoxide, the first benzodiazepine used clinically; midazolam, an imidazobenzodiazepine; and the triazolobenzodiazepines alprazolam and triazolam. Triazolam is derived from alprazolam by the addition of a chlorine atom on the ortho position of the phenyl group. Estazolam is formed from alprazolam by removal of the methyl group of the triazolo ring (not shown).

on the GABA receptor complex, facilitate GABA action. Although devoid of direct GABA-mimetic effects, benzodiazepines increase inhibitory neurotransmission resulting from GABA. Although the exact mechanism by which benzodiazepines accomplish their effect is not fully delineated, it is known that they increase the frequency at which Cl⁻ channels open in response to GABA.⁶⁰ GABA inhibition (chiefly postsynaptic inhibition) is enhanced by benzodiazepines, and any transmitter system modulated by this inhibitory drive is inhibited to a greater extent in the presence of benzodiazepines.

Benzodiazepine receptors are found in the brains of all mammalian species, birds, amphibians, reptiles, and higher fishes. Benzodiazepine receptors are linked to a specific GABA receptor subtype, the GABA_A receptor (see Figure 13-2). Figure 13-3 provides further details on binding domains associated with the GABA_A receptor. Historically, GABA receptors have been classified into two subtypes: the Cl⁻ channel-linked GABA_A receptors and the G protein-linked GABA_B receptors. Benzodiazepine-sensitive GABA_A receptors are activated by GABA agonists, such as muscimol (a hallucinogen), and blocked by GABA antagonists, such as picrotoxin and bicuculline (convulsants).⁷² GABA_B receptors are benzodiazepine and bicuculline insensitive and are activated by baclofen, a centrally acting muscle relaxant.

The benzodiazepine receptor—along with the GABA_A receptor, a barbiturate receptor, the Cl⁻ channel, and binding domains for other drugs—forms a single macromolecular complex. Similar to GABA receptors, benzodiazepine receptors are heterogeneous; there are at least three types: type 1 (BZ₁), type 2 (BZ₂), and the “peripheral type” benzodiazepine receptor. The presence of BZ₁ and BZ₂ receptor types is apparently determined by the subunit composition of the GABA_A macromolecular complex. The BZ₁ receptor may be linked to sleep, whereas the BZ₂ receptor may be linked to cognition and motor function. High-affinity benzodiazepine binding sites are found on specific subunits of the GABA_A

TABLE 13-1

Chemical Structures of Various Benzodiazepines

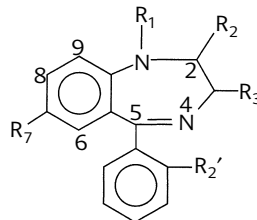

SUBSTITUENT GROUPS

DRUG	R ₁	R ₂	R ₃	R ₇	R _{2'}
Alprazolam	See Figure 13-1				
Chlordiazepoxide	See Figure 13-1				
Clonazepam	—H	=O	—H	—NO ₂	—Cl
Clorazepate	—H	=O	—COOH	—Cl	—H
Diazepam	—CH ₃	=O	—H	—Cl	—H
Estazolam	See Figure 13-1				
Flurazepam	—CH ₂ CH ₂ N(C ₂ H ₅) ₂	=O	—H	—Cl	—F
Halazepam	—CH ₂ CF ₃	=O	—H	—Cl	—H
Lorazepam	—H	=O	—OH	—Cl	—Cl
Midazolam	See Figure 13-1				
Oxazepam	—H	=O	—OH	—Cl	—H
Prazepam	—CH ₂ —◁	=O	—H	—Cl	—H
Quazepam	—CH ₂ CF ₃	=S	—H	—Cl	—F
Temazepam	—CH ₃	=O	—OH	—Cl	—H
Triazolam	See Figure 13-1				

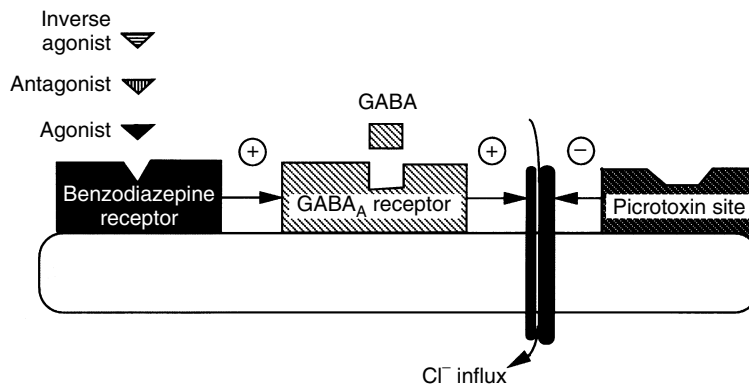

FIGURE 13-2 Schematic of the γ -aminobutyric acid (GABA)_A receptor complex illustrating the sites of action of benzodiazepine agonists, antagonists, and GABA. The benzodiazepine receptor is coupled to the GABA_A receptor so that its activation facilitates (denoted by the *plus sign*) the action of GABA on the Cl⁻ ionophore. Increased Cl⁻ influx leads to hyperpolarization (i.e., inhibition) of the neuron. Benzodiazepine antagonists inhibit the binding of benzodiazepines. Inverse agonists inhibit the constitutive activity of the benzodiazepine-GABA_A receptor complex by binding to the benzodiazepine receptor. Also illustrated is the picrotoxin site, which, when acted on by picrotoxin, antagonizes (*minus sign*) the influx of Cl⁻ and can lead to convulsions. (Adapted from Dubovsky SL: Generalized anxiety disorder: new concepts and psychopharmacologic therapies, *J Clin Psychiatry* 51[suppl 1]:3-10, 1990.)

receptor complex, which, as shown in Figure 13-4, is a pentamer composed of several glycoprotein subunits (α , β , γ). This organization is analogous to the organization of the nicotinic receptor. As illustrated in Figure 13-4, which depicts the most common form of GABA_A receptor complex in the rat brain, a γ subunit is necessary (but insufficient) for benzodi-

azepine binding and pharmacologic effects.⁵⁶ Cloning experiments have shown that there are multiple subtypes of α , β , and γ subunits,³³ which provide a basis for GABA receptor heterogeneity.^{13,49}

The heterogeneity of receptor subunits may offer an explanation for the diverse pharmacologic effects (antianxi-

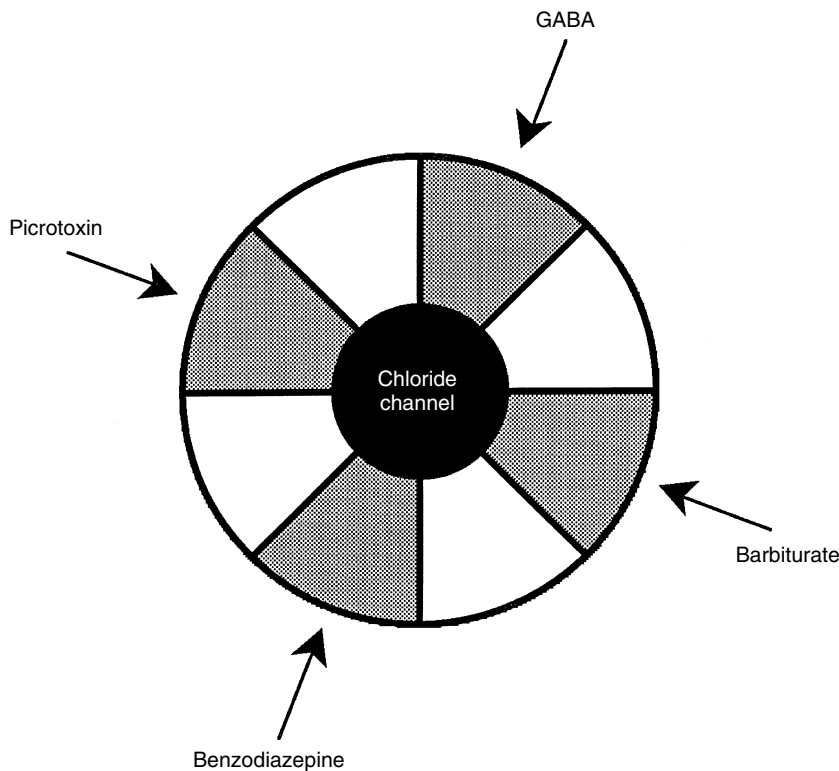

FIGURE 13-3 Arrangement of allosteric binding domains on the γ -aminobutyric acid ($GABA_A$) receptor complex. The complex is composed of five unique subunits. Multiple receptor subtypes are possible on the basis of different combinations of the subunits. Binding sites for picrotoxin (a convulsant), barbiturates, GABA, and benzodiazepines are presented for illustrative purposes. In addition, distinct binding sites for other chemical agents have been identified (shown as blank areas). The figure does not identify which receptor subunits are involved in the binding of each drug. (Adapted from Sieghart W: $GABA_A$ receptors: ligand-gated Cl^- ion channels modulated by multiple drug-binding sites, *Trends Pharmacol Sci* 13:446-450, 1992.)

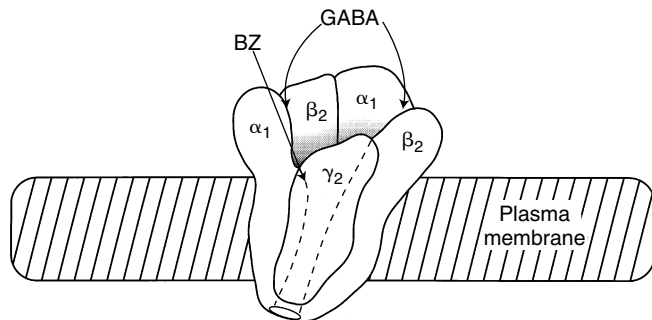

FIGURE 13-4 Structural model of the γ -aminobutyric acid ($GABA$)-benzodiazepine (BZ) receptor complex. The arrangement of the subunits (α , β , γ) forms the Cl^- channel. GABA binding sites are illustrated at the two analogous interfaces between the α and β subunits. The BZ binding site is associated with the interface of the α and γ subunits. (Adapted from Zorumski CF, Isenberg KE: Insights into the structure and function of $GABA$ -benzodiazepine receptors: ion channels and psychiatry, *Am J Psychiatry* 148:162-173, 1991.)

ety, anticonvulsant, sedative, and skeletal muscle relaxant) of benzodiazepines. Determination of the molecular basis of receptor heterogeneity may eventually facilitate the development of benzodiazepines with a greater degree of selectivity in producing each of these effects. At present, none of the clinically available antianxiety benzodiazepines shows selectivity for either BZ_1 or BZ_2 receptors, although the hypnotic benzodiazepine quazepam is likely selective for the BZ_1 receptor.⁵⁰ Zolpidem and zaleplon, two nonbenzodiazepines selective for the BZ_1 receptor, are discussed later in this chapter.

The heterogeneous nature of $GABA_A$ receptors may explain some of the differences in clinical profile between benzodiazepines and barbiturates. In contrast to benzodiazepines, barbiturates increase the duration (but not the frequency) of opening of Cl^- channels activated by GABA and in high concentrations promote Cl^- conductance even in the absence of GABA. Variations of $GABA_A$ receptor responses to benzodiazepines and barbiturates in specific CNS areas may be another factor contributing to their respective pharmacologic profiles.

The benzodiazepine-insensitive $GABA_B$ receptors coupled to G proteins are associated with a decrease in Ca^{++} conduc-

tance and an increase in K^+ conductance and could be expected to cause pharmacologic effects when stimulated or antagonized. $GABA_B$ receptors are less widely distributed than $GABA_A$ receptors but are found in high concentrations in the cerebral cortex and cerebellum. Subtypes of $GABA_B$ receptors may exist. $GABA_B$ receptors have not been studied as extensively as $GABA_A$ receptors, but they may participate in blood pressure regulation⁶¹ in addition to muscle activity and offer a potential site for therapeutic drug action.

The existence of subclasses of benzodiazepine receptors suggests that some agents, with specific activity for individual receptor subtypes, may be more selective than others in terms of their pharmacologic profile. Whether this selectivity results in significant clinical differences is an open question.¹⁴ Quazepam, a long-acting benzodiazepine hypnotic, produces sedation, but seems to have little ataxic effect and may cause less tolerance than other benzodiazepines. Autoradiographic studies have shown selective binding of quazepam to BZ_1 receptors,³¹ which may account for sedation with minimal muscle relaxant effects. Of all currently available benzodiazepines, only quazepam, one of its active metabolites (1-oxoquazepam), and possibly the antianxiety agent halaz-

epam have selectivity for the BZ₁ receptor subtype. These benzodiazepines differ chemically from other benzodiazepines by having a trifluoroethyl substituent (see Table 13-1), which may be responsible for BZ₁ selectivity. Selective activity at the BZ₁ receptor has not been associated with any special clinical benefit of quazepam, however, compared with other benzodiazepines for treating insomnia.

Another potential effect of benzodiazepines is on the “peripheral-type” benzodiazepine receptor, now known as the mitochondrial translocator protein. These peripheral benzodiazepine binding sites, which can be pharmacologically differentiated from central BZ₁ and BZ₂ receptors, have been found not only in the periphery (kidney, lung), but also in the brain. In the CNS, they are most prevalent on glial cells. Their functions include cholesterol transport into mitochondria with the resulting increase in steroid synthesis. The activity of this transporter seems to have important effects in certain brain disorders.

Although the pharmacologic actions of benzodiazepines are closely tied to GABA receptors, numerous other neurotransmitters, including glycine, norepinephrine, and 5-hydroxytryptamine (5-HT), have been suggested to play a role in their action. An interaction between GABA and 5-HT has been shown experimentally with diazepam and tryptaminergic anxiolytics.³⁶ This finding is interesting in light of the mechanism of action of the nonsedating antianxiety agent buspirone (see later), a 5-HT_{1A} partial agonist.

Pharmacologic Effects

Benzodiazepines have clinically useful antianxiety, sedative-hypnotic, amnesic, anticonvulsant, and skeletal muscle relaxant properties. Benzodiazepines previously were thought to differ pharmacologically only in terms of their pharmacokinetics. Although differences in pharmacokinetic properties explain many of their clinical differences, certain benzodiazepines seem to have unique properties.¹⁷ Alprazolam has documented antidepressant and antipanic properties, and diazepam may be more selective as a skeletal muscle relaxant than other benzodiazepines. Diazepam is the only benzodiazepine approved for the treatment of skeletal muscle spasm and spasticity of CNS origin.

Central nervous system

Many of the gross CNS effects of benzodiazepines are similar to the effects of older sedative-hypnotics such as the barbiturates. All benzodiazepines produce a dose-dependent depression of the CNS. Drowsiness and sedation are common manifestations of this central depressant action and may be considered a side effect in some instances and therapeutically useful in others. Some benzodiazepines, such as flurazepam and temazepam, are marketed specifically as hypnotic agents. Although hypnotic benzodiazepines are probably no more specific in promoting sleep than antianxiety benzodiazepines, differences in their pharmacokinetics may make a given benzodiazepine more suitable as either a hypnotic or an anti-anxiety agent.

Although it is difficult clinically to differentiate the CNS effects of benzodiazepines from the effects of other sedative-hypnotics, certain experimental animal models indicate benzodiazepines have selective antianxiety properties. Normally vicious macaque monkeys and rats made highly irritable by lesions placed in the septal area of the brain are tamed and calmed by benzodiazepines. The doses required to produce these effects are one tenth of those that cause ataxia and somnolence. Barbiturates also tame these animals, but the doses required invariably produce incoordination and drowsiness.

Certain benzodiazepines in clinical doses can induce anterograde amnesia, which means that memory of events

occurring for a time after drug administration is not retained.¹² This effect is useful therapeutically in intravenous sedation or monitored anesthesia care. Muscle relaxation and antiseizure activity are additional CNS effects of benzodiazepines. These effects are discussed later in this chapter (muscle relaxation) and in Chapter 14 (antiseizure activity).

Cardiovascular system

In a healthy adult, normal therapeutic doses of benzodiazepines cause few alterations in cardiac output or blood pressure. Greater than normal doses decrease blood pressure, cardiac output, and stroke volume in normal subjects and patients with cardiac disease, but these effects are usually not clinically significant. Benzodiazepines are often prescribed for cardiac patients in whom anxiety contributes to their symptoms.

Respiratory system

As is true of any sedative drug, benzodiazepines are respiratory depressants. In normal doses, benzodiazepines have little effect on respiration in healthy individuals. There have been reports, however, of benzodiazepine-induced respiratory failure in patients with pulmonary disease. Benzodiazepines may cause additive respiratory depressant effects with other CNS depressant drugs. Poor suckling, hypothermia, and a need for ventilatory assistance have been reported in neonates of mothers who received intravenous lorazepam shortly before delivery. Midazolam, used primarily for intravenous sedation and for the induction of anesthesia, can cause respiratory depression and apnea. Clinically significant respiratory depression may occur if an opioid is used in combination with midazolam.¹²

Absorption, Fate, and Excretion

The pharmacokinetics of individual benzodiazepines differ, and there is a wide range in speed of onset and duration of action among these compounds. Benzodiazepines frequently are classified according to their elimination half-life, as illustrated in Table 13-2; however, the elimination half-life of a given drug is only one factor affecting its clinical profile. The rates of drug absorption and tissue distribution and redistribution are often important factors in determining onset and duration of clinical effects after short-term administration. Additionally, there is a wide variation in drug half-lives among patients.

After oral administration, most benzodiazepines are rapidly absorbed and highly bound to plasma protein. Lorazepam, oxazepam, prazepam, and temazepam are more slowly absorbed. Peak blood concentrations are generally obtained in 1 to 3 hours. The lipid solubility of these compounds differs significantly, however, so that a highly lipid-soluble drug such as diazepam exerts its effect more rapidly, whereas lorazepam, which is less lipid-soluble, has a slower onset of action even after systemic absorption. Diazepam also accumulates in body fat because of its lipophilic properties, and it is slowly eliminated from these stores. This characteristic partially accounts for the prolonged half-life of diazepam, which can range from 1 to 4 days.

Many benzodiazepines are converted to pharmacologically active metabolites that have long half-lives (Figure 13-5). Clorazepate and prazepam are nearly completely converted (in the stomach and liver) to the long-acting metabolite desmethyldiazepam (nordazepam) before they enter the systemic circulation. Desmethyldiazepam is a metabolite of many other benzodiazepines, including chlordiazepoxide, diazepam, and halazepam. Flurazepam is also converted to active metabolites in its first pass through the liver. Generally, the products of phase I metabolism are eventually conjugated with glucuronic acid and inactivated and excreted in the urine

TABLE 13-2

Classification of Benzodiazepines on the Basis of Elimination Half-Life after Oral Administration

DRUG	TIME TO PEAK PLASMA CONCENTRATION (hr)	ELIMINATION HALF-LIFE (hr)	MAJOR ACTIVE METABOLITES
Short-Acting to Intermediate-Acting			
Alprazolam	1-2	12-15	α -Hydroxyalprazolam
Estazolam	2	10-24	None
Lorazepam	1-6	10-18	None
Midazolam	0.2-1	2-5	α -Hydroxymidazolam
Oxazepam	1-4	5-15	None
Temazepam	2-3	10-20	None
Triazolam	1-2	1.5-5	α -Hydroxytriazolam
Long-Acting			
Chlordiazepoxide	1-4	5-30	Desmethylchlordiazepoxide Demoxepam Desmethyldiazepam
Clorazepate*	1-2	30-100	Desmethyldiazepam
Diazepam	1-2	30-60	Desmethyldiazepam
Flurazepam*	0.5-1	50-100	N-Desalkylflurazepam
Halazepam	1-3	14	Desmethyldiazepam
Prazepam*	2.5-6	30-100	Desmethyldiazepam
Quazepam	2	40	2-Oxo-quazepam N-Desalkylflurazepam

*Does not reach the circulation as the parent drug in clinically significant amounts. Values reflect the primary metabolite.

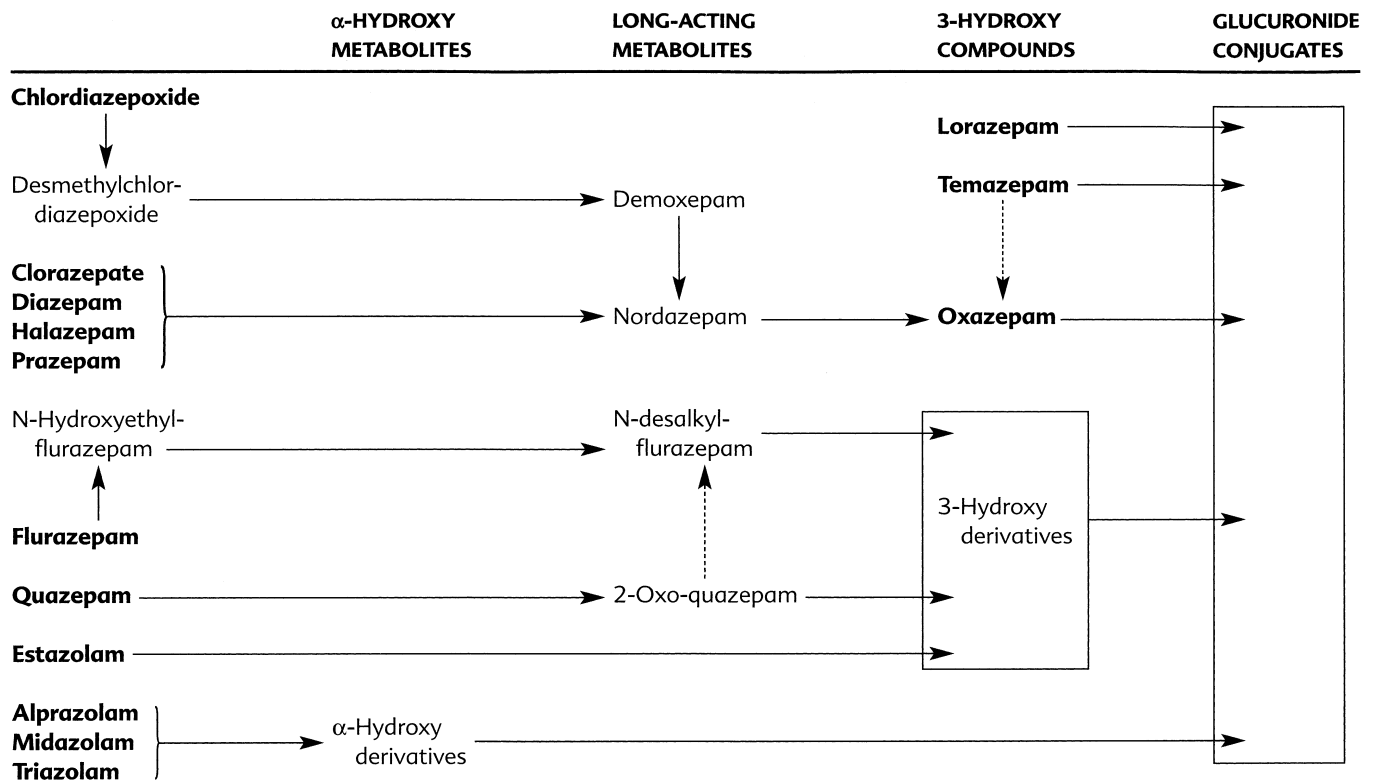

FIGURE 13-5 Metabolism of benzodiazepines. Drugs available for clinical use appear in bold type. With the exception of the prodrugs clorazepate and prazepam, only the glucuronide conjugates are inactive.

and feces. Because the half-lives of the different active metabolites vary considerably, the overall duration of the pharmacologic effect of benzodiazepines also varies considerably. Oxazepam and lorazepam are not converted to active metabolites but are directly conjugated and excreted. These drugs are eliminated rapidly and may be especially useful in patients

who have a deficiency in hepatic microsomal enzymes resulting from liver disease or other reasons.

Alprazolam and triazolam, containing a fused triazolo ring, undergo α -hydroxylation on the methyl group of the ring. This reaction is mediated through hepatic CYP3A4 isoenzymes, and the subsequent conversion to the glucuronide

occurs rapidly in the case of triazolam and accounts for the short duration of action of the drug. Alprazolam and triazolam also undergo 4-hydroxylation of the benzodiazepine ring and then conjugation to the glucuronide. Midazolam, which contains a fused imidazo ring, is quickly metabolized in a similar manner. Midazolam has a rapid onset of action, a high metabolic clearance, a rapid rate of elimination, and a short duration of action. Termination of CNS activity is a result of peripheral redistribution and metabolic transformation. It is converted into several metabolites that have little pharmacologic activity; however, because of extensive first-pass metabolism, the α -hydroxy metabolite may contribute to the sedative effect when midazolam is given orally to children.

The poor oral bioavailability of triazolam, alprazolam, and midazolam of approximately 50% is believed to be due to CYP3A4 metabolism in the gut wall and hepatic first-pass metabolism. Triazolam's availability is improved when administered sublingually.³² Inhibition of CYP3A4 metabolism by coadministration of itraconazole, erythromycin, or grapefruit juice can significantly increase maximum blood concentrations and the area under the curves of these short-acting benzodiazepines.²⁷

Many benzodiazepines are biotransformed to long-acting metabolites. These metabolites, which accumulate with repeated administration, are the cause of lingering residual effects. An active metabolite of flurazepam and quazepam, N-desalkylflurazepam, which accounts for some of the activity of quazepam and nearly all the activity of flurazepam, has an elimination half-life of 50 to 100 hours. In sleep laboratory studies, it has been shown that flurazepam does not reach full effectiveness until the second or third consecutive night of intake. Quazepam decreases sleep latency and facilitates sleep maintenance after a single dose.

Temazepam has a half-life of about 13 hours, and only a very small amount of oxazepam is formed as a metabolite; estazolam has a similar half-life and forms a short-lived active metabolite. Triazolam, with a mean half-life of 2.9 hours, is converted to metabolites that, although active, are rapidly eliminated. Because of their short durations of action, temazepam and triazolam do not generally accumulate even with repeated nightly use. Triazolam is indicated for patients who have difficulty falling asleep but who stay asleep when sleep ensues.

Adverse Effects and Drug Interactions

Drowsiness is the most common side effect of benzodiazepines. The drowsiness may not be an unwanted reaction, but rather a therapeutic benefit in anxiety states that cause insomnia. Other signs and symptoms of dose-dependent CNS depression include ataxia, incoordination, dysarthria, confusion, apathy, muscle weakness, dizziness, and somnolence. Elderly individuals (>65 years old) seem to be particularly susceptible and individuals with a history of alcohol or barbiturate abuse seem to be particularly resistant to the gross CNS depressant properties of benzodiazepines.

Elderly and young patients occasionally respond to benzodiazepines with excitement rather than depression. Excitatory CNS effects may include an increased incidence of nightmares, hyperactivity, insomnia, irritability, agitation, and rage and hostility. Because these responses differ from what would be expected of a CNS depressant, they have been termed *paradoxical reactions*. A paradoxical decrease in seizure threshold, particularly in patients with grand mal epilepsy, has also been observed, even though diazepam is used in acute treatment of status epilepticus. These unusual occurrences of what seems to be a CNS excitatory action may be a disinhibitory effect similar to that observed with alcohol.

Benzodiazepines cause changes in normal sleep patterns. Patients seem to adapt quickly to the nonspecific CNS depression of benzodiazepines. Nonetheless, daytime sedation after

a nighttime dose, referred to as "hangover," is a common side effect, especially of long-acting benzodiazepines. This residual effect may be beneficial in some cases, but undesirable in others.

Adverse effects of benzodiazepines other than those referable to the CNS depressant actions are usually more irritating than life-threatening. Allergic reactions to benzodiazepines usually manifest as minor skin rashes. Because injectable formulations of diazepam contain propylene glycol and ethyl alcohol solvents, intramuscular and intravenous administration can cause local pain, phlebitis, and thrombosis. Phlebitis is more likely to occur if a vein in the hand or wrist is used and may be more common after repeated injections, especially in heavy smokers, elderly individuals, and women taking oral contraceptives. With the introduction of the water-soluble benzodiazepine midazolam, the occurrence of venous complications and pain at the injection site has diminished.

Tolerance and psychological dependence develop frequently with benzodiazepines, but true physical dependence is less common. Nevertheless, the abuse potential of benzodiazepines should not be ignored.⁵¹ Tolerance to the sedative-hypnotic effects of benzodiazepines is slower to develop with longer acting agents. In cases of physical dependence, the severity of withdrawal depends on the dose of the drug being used and the drug's half-life. Rapid discontinuation of benzodiazepines, especially short-acting compounds, can lead to symptoms of withdrawal. Often these symptoms are nearly identical to the symptoms for which treatment was initiated, including anxiety, irritability, insomnia, and fatigue. The symptoms become more severe with high doses and prolonged treatment. Withdrawal can be minimized by reducing the dosage very gradually ($\leq 10\%$ per day over 10 to 14 days) or by the use of longer acting compounds. Withdrawal from lower doses is usually not life-threatening, and symptoms last no longer than 2 weeks. Withdrawal from high doses may be life-threatening because of accompanying convulsions.

Mechanisms involved in the development of tolerance are unknown, but the long-term administration of benzodiazepines to animals causes downregulation of benzodiazepine receptors,⁴⁰ which could be a contributing factor. Diazepam has been particularly popular as a drug of abuse. Because of the strong binding of diazepam to tissue constituents, it is not rapidly removed by dialysis or diuresis in patients with acute overdose. Flumazenil, a benzodiazepine antagonist (described later), can reverse benzodiazepine overdose. Flumazenil can precipitate withdrawal in benzodiazepine-dependent patients, however.

Some short-acting benzodiazepines are especially amnesic; triazolam also causes confusional states and delusions. Because of the prominence of these adverse CNS effects, the United States and several European countries have removed the 0.5 mg tablet form of triazolam from the market. The U.S. Food and Drug Administration (FDA) also approved labeling for triazolam that recommended use only for short-term (7 to 10 days) treatment of insomnia, emphasized the need to monitor patients for bizarre behavioral side effects, and set new limits on the maximum dosage. Triazolam is abused more frequently than either temazepam or flurazepam, probably because of its more rapid absorption.

Despite these problems, one of the major advantages of benzodiazepines compared with other sedatives is their high margin of safety. Death is rare in cases of overdose and is usually the result of a combination of drugs (especially alcohol) with benzodiazepines. The few deaths associated with the use of a benzodiazepine alone have primarily involved elderly patients, very young children, massive iatrogenic overdosing, or suicides.

Benzodiazepines cross the placental barrier. During the first trimester, long-term use of these drugs has been associated with increased fetal malformations, including cleft lip

TABLE 13-3

Adverse Drug Interactions: Anxiolytics and Sedative-Hypnotics

ADVERSE DRUG INTERACTION (SPECIFIC EXAMPLES)	CLINICAL IMPLICATIONS
Anxiolytics and Sedative-Hypnotics with: Other anxiolytics and sedative-hypnotics, alcohol, opioids, antipsychotics, antidepressants, centrally acting muscle relaxants, local and general anesthetics, and other CNS depressants	In combination, CNS depression summates with anxiolytics and sedatives; loss of consciousness, respiratory depression, and death are possible complications
Benzodiazepines with: Carbamazepine, rifampin Cimetidine, diltiazem, verapamil, erythromycin, clarithromycin, protease inhibitors (indinavir, nelfinavir, ritonavir), some azole antimycotics (itraconazole, ketoconazole), and some antidepressants (fluoxetine, fluvoxamine, trazodone)	Increased rate of metabolism reduces bioavailability of several benzodiazepines Decreased rate of metabolism increases bioavailability of some benzodiazepines and significantly augments and prolongs their effects
Chloral Hydrate with: Alcohol Warfarin Furosemide Epinephrine	Each drug limits metabolism of the other; depression is greater than additive Competition for plasma protein binding causes temporary increase in anticoagulant effect Rare reports of diaphoresis, tachycardia, and hypertension Myocardial sensitization and cardiac dysrhythmias
Barbiturates with: Valproic acid and phenobarbital Warfarin	Elimination of barbiturates is decreased; prolonged and enhanced sedation is reported Bleeding risk increases when long-term barbiturate therapy is discontinued Anticoagulant effect of warfarin is reduced with concurrent therapy with phenobarbital

CNS, Central nervous system.

and cleft palate in humans. There is no clear estimate of the risk after single-dose use. All benzodiazepines are classified as pregnancy category D except triazolam, which is pregnancy category X. It is generally agreed that these drugs should be avoided during pregnancy.⁴³ The frequent use of benzodiazepines during late pregnancy may lead to withdrawal in the neonate. Large doses of benzodiazepines given to mothers during labor and delivery may result in respiratory depression, hypotonia, and hypothermia in neonates.

Drug interactions associated with anxiolytic and sedative drugs used in dentistry are listed in Table 13-3. The therapeutic index for benzodiazepines is normally so large that wide ranges of dosing recommendations and blood concentrations do not significantly affect their safety and efficacy. Plasma concentrations after a given dose may normally vary such that a minor shift in elimination from drug interactions is unlikely to result in an overdose. In healthy subjects taking no other medications, plasma concentrations 3 hours after a single 15 mg dose of diazepam have been reported to range from 20 µg/mL to 260 µg/mL.³⁸ A drug interaction that causes a 20% increase in diazepam plasma concentrations is unlikely to have significant toxicity. Most healthy patients can tolerate small variations in a drug's absorption or metabolism that are caused by coadministration of another drug. Combining sedatives is problematic. The combination of ethanol with a benzodiazepine is an important source of serious toxicity.⁶³

Rifampin induces metabolic enzymes in the gut and liver responsible for the metabolism of diazepam, midazolam, and triazolam. A 96% reduction in the bioavailability of midazolam has been reported.² Triazolam is so rapidly and effectively metabolized in the gut that peak plasma concentrations are only 12% of normal.⁶⁸ This interaction is one of the most

pronounced alterations in drug kinetics ever reported. The almost complete loss of triazolam bioavailability and subsequent efficacy is quite significant and warrants use of an alternative anxiolytic, such as oral oxazepam, nitrous oxide inhalation, or an intravenous agent. The anticonvulsant carbamazepine can also induce hepatic enzymes for the oxidative metabolism of benzodiazepines such as alprazolam, triazolam, and midazolam.³ Decreased benzodiazepine plasma concentrations and greatly reduced sedative effects after oral administration of these agents may occur. This interaction may be important in medicine because of loss of seizure control. A loss of sedative efficacy in dentistry may also occur. Benzodiazepines that are metabolized solely through glucuronidation, such as oxazepam, are suitable alternative agents for sedation in these situations.

The Ca⁺⁺ channel blockers verapamil and diltiazem have been shown to inhibit the CYP3A isozymes required for the metabolism of triazolam and midazolam. In controlled clinical trials, a 2-day regimen of these drugs decreased the metabolism and increased the bioavailability of midazolam and triazolam administered orally. Peak blood concentrations were increased twofold to threefold and were associated with increased sedation and performance deficits.¹ Avoidance of this combination is recommended, particularly in elderly patients known to be sensitive to benzodiazepines.

Cimetidine also inhibits the oxidative metabolism of certain benzodiazepines, such as triazolam and alprazolam. Half-life increases of 30% to 63% have been reported.¹⁸ Metabolism of diazepam may also be delayed. An increased and prolonged level of sedation after oral administration may occur because of the decreased first-pass metabolism.⁵² Benzodiazepines that are metabolized directly to the glucuronide

conjugate (e.g., oxazepam) are not affected. Similarly, the antimicrobials erythromycin and clarithromycin and theazole antifungals ketoconazole and itraconazole are potential inhibitors of the hepatic isozymes required for oxidative metabolism of these benzodiazepines. By decreasing the first-pass effect and improving bioavailability, triazolam blood concentrations may increase threefold.⁶⁷ The antiviral agents indinavir, nelfinavir, and ritonavir inhibit hepatic oxidative enzymes required for metabolism of many benzodiazepines. These significant pharmacokinetic drug interactions could potentially cause oversedation and respiratory depression.

Antagonists

Benzodiazepine antagonists are important therapeutic compounds that have the potential to reverse the effects of benzodiazepines. They have no intrinsic activity of their own but do not reverse constitutive benzodiazepine receptor activity. Flumazenil (Figure 13-6) is currently the only benzodiazepine receptor antagonist approved by the FDA.

Flumazenil has clinical application in managing benzodiazepine overdose and in hastening recovery from benzodiazepine sedation or anesthesia after diagnostic procedures or minor

surgery. Although certain precautions must be observed, flumazenil may allow for a shorter monitoring period after surgery and earlier discharge of the patient.²⁰ Flumazenil has been used successfully in reversing benzodiazepine-induced coma, but whether it should be given routinely to comatose patients when the cause of the coma is unknown is unclear. The routine use of flumazenil is not recommended in cases of mixed drug overdose, airway obstruction, or seizure disorders. Flumazenil may increase the risk of cardiac arrhythmias and seizures in patients who have overdosed with tricyclic antidepressants.²² Ventricular arrhythmias have also been precipitated by flumazenil in patients with chloral hydrate overdose.⁵⁵

Flumazenil administered intravenously can generally reverse benzodiazepine-induced sedation in 1 to 2 minutes. Reversal of benzodiazepine sedation by flumazenil may last for several hours. In a study in which patients were sedated with midazolam before dental extraction, flumazenil significantly improved patient assessment regarding state of alertness compared with placebo controls (Figure 13-7) only for the first 30 minutes.⁸ The duration of action of flumazenil (elimination half-life of 45 to 75 minutes) is likely to be shorter than that of a benzodiazepine agonist. Other studies have also noted that the duration of action of flumazenil is shorter than that of midazolam and that sedation and respiratory depression may recur.²⁰ Flumazenil is not a substitute for careful postoperative monitoring.

Another cautionary note is the possibility of flumazenil precipitating withdrawal in patients who are dependent on the benzodiazepines. Signs of benzodiazepine withdrawal include flushes, agitation, tremor, and seizures. Resedation with a benzodiazepine or barbiturate may be required in these circumstances. Although some studies suggest the amnesia from benzodiazepines is reversed by flumazenil, this is not consistently observed.⁹

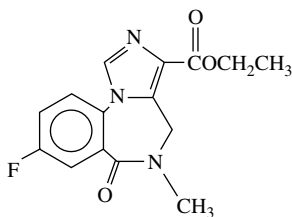

FIGURE 13-6 Structural formula of flumazenil.

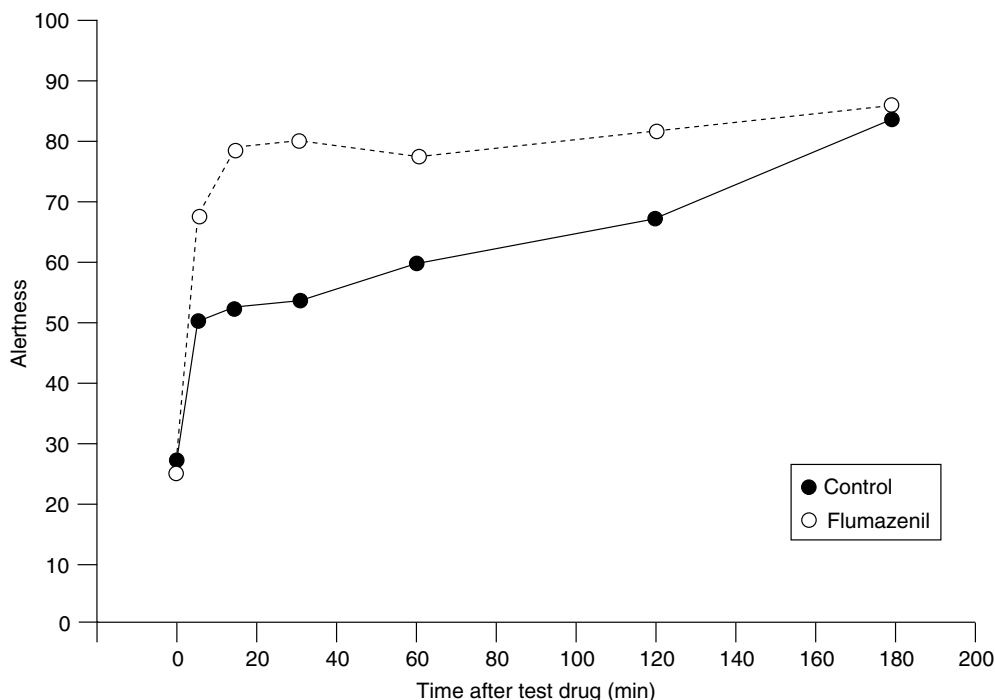

FIGURE 13-7 Reversal of midazolam sedation by flumazenil in patients undergoing a surgical dental extraction. Flumazenil or placebo was administered after intravenous midazolam and dental extraction. Differences between flumazenil and control groups were significant at the $P < .05$ level for the 5-, 15-, and 30-minute time periods. The *dashed line* represents the flumazenil group; the *solid line* represents the midazolam alone. (Adapted from Clark MS, Lindenmuth JE, Jafek BW, et al: Reversal of central benzodiazepine effects by intravenous flumazenil, *Anesth Prog* 38:12-16, 1991.)

General Therapeutic Uses

Not everyone requires pharmacotherapy for anxiety, fear, and apprehension; anxious states are often brought on by a series of events that eventually pass, allowing the anxiety to subside. Pharmacotherapy is indicated only when anxiety becomes chronic, or when it interferes with the individual's functioning. Benzodiazepines and other antianxiety agents are not curative; they merely treat the symptoms of anxiety. The patient then copes more effectively with the situation or responds more favorably to psychotherapy or other pharmacotherapy.

Approximately 35% of patients with a generalized anxiety disorder show marked improvement with benzodiazepines, 40% are moderately improved, and 25% remain unresponsive.¹⁵ These antianxiety agents are useful in the treatment of acute anxiety resulting from transient stress that is environmental, physical, or psychological in origin. For the treatment of long-standing anxiety, benzodiazepines ideally should be used only with appropriate psychotherapy. Sometimes benzodiazepines are prescribed inappropriately and with too little supervision. Despite concerns about the abuse potential of benzodiazepines, patients who have no prior history of drug abuse are unlikely to be at risk. Table 13-4 lists benzodiazepines and other drugs used for the management of acute anxiety.

Although capable of selectively relieving anxiety, benzodiazepines are also CNS depressants capable of producing sedation and hypnosis. Some benzodiazepines—flurazepam, temazepam, triazolam, estazolam, and quazepam—are promoted specifically as hypnotics rather than as antianxiety agents. Whether a benzodiazepine is used primarily as an antianxiety agent or a hypnotic depends on a subtle interplay of the drug's pharmacodynamic properties, its pharmacokinetic characteristics, and the drug formulation.

During natural sleep, humans cycle through several stages of sleep ranging from the deepest stage, categorized as stage IV, to the most active form, known as rapid eye movement (REM) sleep. Benzodiazepines used as hypnotics increase stage II sleep at the expense of stages I, III, and IV and REM sleep. The significance of these changes is unknown, but a goal of the pharmacotherapy of insomnia is to achieve a normal sleep pattern. Sedative-hypnotic benzodiazepines may have an advantage over barbiturates with regard to REM sleep. Low doses of temazepam and flurazepam may leave REM sleep unaffected, and triazolam has such a short duration of effect that an early loss of REM cycles may be made up later in the same sleep period. Slow-wave sleep (as in stage IV) is now recognized as the most important restorative phase of sleep, and benzodiazepine suppression of slow-wave sleep may be equally problematic with long-term administration as the effects of barbiturates on REM sleep.

Because hypnotics are most commonly used for the treatment of patients who have difficulty falling asleep, rapid absorption is essential. Most hypnotic benzodiazepines are rapidly absorbed after oral administration, and various dosage forms have been formulated to hasten absorption.

Discontinuation of a benzodiazepine after long-term administration can lead to a pronounced withdrawal phenomenon and rebound insomnia in which the duration of sleep is reduced, and its quality is affected.⁵⁴ Because this temporary effect can cause patients to assume that the drug is still needed for satisfactory sleep, they should be made aware of the possibility of rebound insomnia if therapy is abruptly terminated. Rebound insomnia need not be an automatic consequence of drug abstinence. Withdrawal symptoms and rebound insomnia can be minimized with longer acting benzodiazepines because of the gradual decline of their active metabolites over time.³¹

TABLE 13-4

Preparations for Treatment of Anxiety

DRUG	USUAL DOSE* (mg)	ROUTE OF ADMINISTRATION
Alprazolam	0.75-4.0 (adult) 0.5-0.75 (elderly)	Oral
Clorazepate	15-60 (adult) 7.5-15 (elderly)	Oral
Chlordiazepoxide	15-100 (adult) 50-100 (adult) 10-20 (elderly)	Oral IM, IV Oral
Diazepam	4-40 (adult) 2-20 (adult) 2-5 (elderly) 0.3-0.6 mg/kg (children)	Oral IM, IV Oral Oral
Halazepam	60-160 (adult) 20-40 (elderly)	Oral Oral
Lorazepam	1.5-10 (adult) 1-2 (elderly) 2-4 (adult)	Oral Oral IM, IV
Midazolam	2-10 (adult) 0.25-1 mg/kg up to 20 mg (children)	IM, IV Oral
Oxazepam	30-120 (adult) 30-60 (elderly)	Oral Oral
Prazepam	20-60 (adult) 10-15 (elderly)	Oral Oral
Triazolam	0.25-0.5 (adult) 0.125 (elderly)	Oral Oral
Hydroxyzine (hydrochloride and pamoate salts) [†]	200-600 (adult) 25-100 (adult) 0.5-0.7 mg/kg (children) 12.5-50 (children >6 yr) 0.6-1.1 mg/kg (children)	Oral IM Oral IM
Meprobamate	1200-2400 (adult) 100-200 (children 6-12 yr)	Oral Oral

*Oral adult and elderly doses represent daily amounts given in divided doses (except triazolam). Parenteral, children, and triazolam doses reflect single administration.

[†]The pamoate salt is reported to be converted to the hydrochloride salt in the stomach, with a resultant prolonged effect, but there is no experimental evidence to support this claim.

IM, Intramuscular; IV, intravenous.

In addition to relief of anxiety and insomnia, benzodiazepines are useful for many other conditions. They are generally accepted as major drugs for the treatment of alcohol withdrawal. Clonazepam has been approved as an anticonvulsant for several types of epilepsy, and diazepam, midazolam, and lorazepam are major drugs for the control of status epilepticus (see Chapter 14). Intravenous diazepam and midazolam are also used to control seizures caused by local anesthetics. The skeletal muscle relaxant properties of diazepam have led to its successful use in the treatment of tetanus and for the relief of the spasticity associated with cerebral palsy. Diazepam has been used as an adjunct in general anesthesia, but midazolam is now more popular (see Chapter 18). Benzodiazepines (especially alprazolam) are useful in the

treatment of depression because of their rapid onset, their anti-anxiety properties (which are often desirable in depression), and their low potential for lethal overdose. Generally, the benzodiazepines are more useful for reactive or neurotic depression, in which anxiety and insomnia are major components, than for severe depression.

BENZODIAZEPINE-LIKE SEDATIVE-HYPNOTICS

The drugs belonging to the classification of benzodiazepine-like sedative-hypnotics—zolpidem, zaleplon, zopiclone, and eszopiclone—are chemically unrelated to the benzodiazepines, but share a similar pharmacology. These drugs are selective GABA receptor agonists at the α_1 -subunit of the Cl^- channel (BZ_1 receptor). This selectivity may dictate why they produce sedation but less memory and cognitive impairment than benzodiazepines and exert little skeletal muscle relaxation or anticonvulsant activity.⁷¹ Biotransformation is by several CYP enzymes in addition to CYP3A4. CYP3A4 inhibitors and inducers have less impact on the clinical effectiveness of this drug class. The drugs are particularly interesting because they establish that the benzodiazepine structure is not an absolute requirement for a compound to act as a benzodiazepine receptor agonist.

Zopiclone and eszopiclone, marketed in Europe and the United States, are newer entries into the rapidly expanding sleep-aid market. Eszopiclone, the S conformation of zopiclone, is similar in its pharmacology to zopiclone. They are rapidly absorbed after oral administration. Their half-lives of approximately 6 hours likely accounts for their ability to improve sleep latency and sleep maintenance. Eszopiclone has been approved in the United States for administration for 6 months for the treatment of insomnia. The drugs undergo extensive metabolism in the liver. Adverse effects of eszopiclone include altered taste and dry mouth.

Zolpidem is a novel short-acting hypnotic having an imidazopyridine structure (Figure 13-8). Zaleplon is a pharmacologically similar drug that belongs to the pyrazolopyridine class of compounds. It has little effect on REM sleep and seems to induce a physiologic pattern of slow-wave sleep. Rebound insomnia at recommended doses, if it occurs, is mild.

Zolpidem and zaleplon have the advantage of being very rapidly absorbed after oral administration, with clinically demonstrable effects occurring in 15 to 20 minutes. Zolpidem has a half-life of approximately 2.5 hours and is metabolized in the liver to inactive metabolites. Zaleplon is similar except its half-life is about 1 hour, and zopiclone and eszopiclone have half-lives of 3.5 to 6.5 hours. Adverse effects include dizziness, drowsiness, and gastrointestinal symptoms.

Increases in hepatic enzymes in the plasma suggest that these drugs may be unsuitable for patients with liver disease. Zolpidem is a sedative-hypnotic of choice for pregnant women (FDA pregnancy category B), whereas zaleplon, zopiclone, and eszopiclone are pregnancy category C. Also in contrast to benzodiazepines, zolpidem, zaleplon, and eszopiclone are not contraindicated in patients with a history of narrow-angle

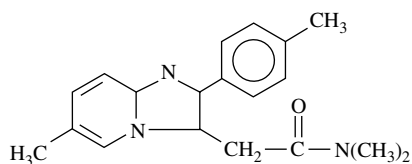

Zolpidem

FIGURE 13-8 Structural formula of zolpidem.

glaucoma. Because of their similarities with benzodiazepines, zolpidem and zaleplon show utility as enteral sedation agents for dentistry. Zaleplon has compared favorably with triazolam as a sedative during oral surgery.²¹ Flumazenil effectively reverses the CNS depression produced by the selective BZ_1 receptor agonists. These properties collectively help explain why these two drugs are now the most commonly prescribed sedative-hypnotics in the United States.

MELATONIN RECEPTOR AGONISTS

Melatonin is naturally secreted by the pineal gland at night according to the light/dark cycle and plays a major role in the maintenance of circadian rhythms and in the regulation of the sleep/wake cycle. Activation of the MT_1 and MT_2 melatonin receptors promotes sleep, regulates reproduction and immunoresponsiveness, and inhibits aging and cancer growth. Agomelatine and ramelteon are melatonin receptor agonists with clinical promise. Ramelteon is the first melatonin receptor agonist approved by the FDA for the treatment of insomnia. It has no appreciable affinity for the GABA receptor complex, and has no anterograde amnesic qualities and cannot be reversed by flumazenil.

Clinical uses for ramelteon include treatment of jet lag, treatment of insomnia, treatment of sleep disturbances associated with depression, tapering of patients from hypnotics (i.e., long-term benzodiazepine use), cancer treatment, and preoperative sedation or anxiolysis. Regarding preoperative sedation or anxiolysis, further comparative evaluation of ramelteon with benzodiazepines is warranted for its potential as a pre-treatment anxiolytic before anesthesia or as a sole therapeutic sedative agent. Ramelteon is metabolized by various CYP enzymes and is susceptible to drug interactions involving inhibition or activation of these enzymes. Inhibitory agents such as fluvoxamine, fluconazole, and ketoconazole may increase the risk of ramelteon-related side effects. Conversely, rifampin may decrease the bioavailability of ramelteon, leading to lack of efficacy.

BARBITURATES

Chemistry and Structure-Activity Relationships

The basic chemical structure of all barbiturates is barbituric acid (Figure 13-9). Barbituric acid, formed by the condensation of urea and malonic acid, lacks CNS depressant activity. To obtain barbiturates that have CNS depressant properties, both hydrogens at C_5 must be replaced by organic groups. Depending on the substituents added, three types of barbiturates are formed (Table 13-5). In the first group, substitutions are made only at C_5 , yielding a large variety of drugs. The addition of a phenyl group at C_5 results in a drug with anti-epileptic activity. If the side chain on C_5 reaches eight carbon atoms, the drug becomes more toxic and assumes convulsant properties. When alkyl groups are substituted at N_3 , the

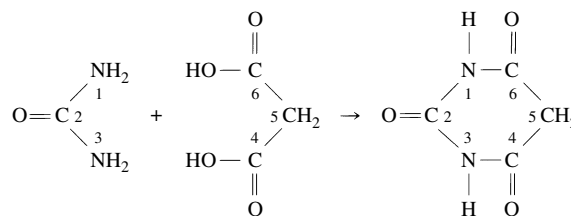

Urea

Malonic acid

Barbituric acid

FIGURE 13-9 Chemical formulation of barbituric acid.

TABLE 13-5

General Barbiturate Ring Structure with Examples of Chemical Formulas of the Three Types of Barbiturates

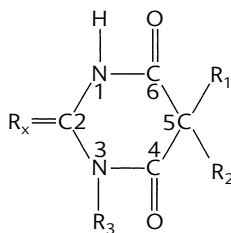

GENERIC NAME	TYPE	R ₁	R ₂	R ₃	R _x
Pentobarbital	Oxybarbiturate	Ethyl	1-Methylbutyl	H	O
Mephobarbital	N-alkylbarbiturate	Ethyl	Phenyl	CH ₃	O
Thiopental	Thiobarbiturate	Ethyl	1-Methylbutyl	H	S

N-alkylbarbiturates are formed. The only N-alkylbarbiturates used clinically are the N-methyl derivatives (mephobarbital and methohexital).

A third class of barbiturates is formed when the oxygen at C₂ of the barbiturate nucleus is replaced with a sulfur atom. Technically, sulfur-substituted drugs are not true barbiturates because, by definition, barbiturates require oxygen at C₂. Sulfur-substituted barbiturates are commonly referred to as thiobarbiturates, whereas true barbiturates are sometimes called oxybarbiturates. Thiopental and thiamylal are examples of thiobarbiturates.

The clinical properties of barbiturates vary considerably depending on the lipid/aqueous partition coefficient. As lipid solubility of the barbiturate increases, hypnotic activity increases, the onset time decreases, and the duration of action decreases. With their extreme lipid solubility, thiopental and thiamylal have an extremely short duration of action and are sometimes used as intravenous anesthetics (see Chapters 18 and 48).

Mechanism of Action

The mechanism by which the barbiturates exert their CNS depressant effect is not completely established, but many pharmacologic effects bear striking similarities to the effects of benzodiazepines. Barbiturates enhance GABA binding and increase the duration of GABA-activated Cl⁻ channel opening by acting at specific barbiturate binding sites on the GABA_A receptor complex (see Figure 13-3), leading to hyperpolarization and decreased neuronal firing.^{37,54} Barbiturates modulate GABA receptor function to prolong presynaptic and postsynaptic inhibition. Although benzodiazepines increase the frequency (as opposed to increasing the duration) of Cl⁻ channel opening, the end result (increased inhibition) is similar for the two groups of compounds. Their similar therapeutic and pharmacologic properties are not surprising. At high concentrations, barbiturates also act directly on the Cl⁻ channel, not requiring the presence of GABA. A third action of barbiturates is inhibition of a specific subset of glutamate receptors. These latter two actions are not shared by benzodiazepines and may help explain the lower margin of safety and steeper dose-response relationship for barbiturates compared with benzodiazepines.

Pharmacologic Effects

The primary pharmacologic effects of barbiturates involve the brain and spinal cord, the cardiovascular system, and the respiratory system.

Central nervous system

As with all sedative-hypnotics, barbiturates depress the CNS to varying degrees, ranging from mild sedation to respiratory arrest and death. Many factors contribute to the level of depression attained, including the specific drug, dose, and route of administration; the patient's initial behavioral state; and the environmental surroundings at the time of administration. It has long been known that the physical environment and the psychological state of the patient influence the effectiveness of sedatives and hypnotics. A barbiturate taken at home before retiring for the evening is more likely to produce the desired sedative or hypnotic effect than the same drug taken at a rock concert.

The behavioral effects of barbiturates indicative of general CNS depression include diminished psychological performance and responsiveness to external stimuli. Subjectively, the patient experiences relaxation, a feeling of well-being, and drowsiness. Coincident with these subjective feelings, the electroencephalogram displays an increase in fast activity (25 Hz to 35 Hz) referred to as *barbiturate activation*. As the dose increases and the patient goes to sleep, an increase in high-amplitude slow waves (2 Hz to 8 Hz) similar to those observed during natural sleep occurs. These high-amplitude slow waves frequently occur in bursts termed *spindles*. Occasional periods of electrical silence occur as toxic doses are approached.

The electroencephalogram patterns recorded after the administration of barbiturates are similar to the patterns observed during natural sleep, but there are important differences. Barbiturates decrease the time spent in REM sleep. REM sleep is the period in which vivid dreaming occurs; it is also believed to be involved in the consolidation of learning. A person deprived of REM sleep "makes up" the loss by increasing the time spent in REM sleep at a subsequent time. A typical pattern would be an increase in the frequency and duration of REM sleep subsequent to the cessation of barbiturate therapy, leading to "restless sleep." The individual may find it difficult to have a good night's sleep for several nights without readministration of a sedative-hypnotic. A vicious cycle may be started. With the exception of moderate doses of certain benzodiazepine receptor agonists, all sedative-hypnotics significantly reduce REM sleep.

Although the barbiturates seem to depress all levels of the CNS, the reticular formation—a complex network of neurons, nuclei, and neural pathways that extends throughout the brainstem—is particularly sensitive to the depressant action of some barbiturates. The reticular formation and its rostral

thalamocortical projections are referred to collectively as the ascending reticular activating system. The importance of the ascending reticular activating system in the modulation of sleep and wakefulness has long been known. Stimulation of appropriate areas of the reticular formation in a sleeping animal causes behavioral arousal and converts the electroencephalogram from a characteristic sleep pattern to that of an awake animal. If the appropriate area of the ascending reticular activating system is experimentally destroyed, the electroencephalogram pattern becomes that of a drowsy or sleeping animal.

Cardiovascular system

At sedative doses, barbiturates do not affect the cardiovascular system. At hypnotic doses, they produce mild hypotension and a decrease in heart rate. Progressive depression of the cardiovascular system develops as the dose of barbiturates is increased beyond the hypnotic range.

Respiratory system

Sedative doses of barbiturates have little effect on respiration, but as doses are increased, the barbiturates become progressive respiratory depressants. Medullary respiratory centers are depressed by toxic concentrations of barbiturates, and eventually even the carotid arch and aortic body receptors are depressed. These depressant effects are most apparent with multiple drug regimens used for intravenous sedation and anesthesia.^{12,42} Barbiturates increase respiratory reflex activity, such as cough, hiccough, sneezes, and laryngospasm, which complicates their use in anesthesia.

Absorption, Fate, and Excretion

Barbiturates are generally available as Na⁺ salts, which are completely absorbed from the gastrointestinal tract and distributed to nearly all tissues of the body. One of the most important factors determining barbiturate distribution to the brain is lipid solubility. Thiopental, which is highly lipid-soluble, readily crosses the blood-brain barrier and, when administered intravenously, attains high concentrations in the CNS in seconds. The high blood flow to the brain also contributes significantly to the entry of thiopental. The placental barrier is equally permeable to the barbiturates, and severe respiratory depression can occur in the fetus if a barbiturate is used during delivery.

Barbiturates such as phenobarbital that are relatively lipid-insoluble penetrate the blood-brain barrier slowly. Phenobarbital, even if it is administered intravenously, may require 15 minutes to produce maximal CNS depression. With oral administration of phenobarbital, sedative effects begin after approximately 1 hour.

Phenobarbital is metabolized by the liver, but 25% to 50% is eliminated unchanged in the urine. Most other barbiturates are transformed completely by the liver to inactive metabolites, which are excreted by the kidney. The primary mechanism by which the CNS effects of the barbiturates are terminated after a single administration is redistribution from the brain to muscle and other body tissues. Subsequent storage of barbiturates occurs primarily in body fat. From this depot, the drugs are slowly released, metabolized, and excreted; this slow turnover of drug accounts for the prolonged depressant effect, or hangover, after general anesthesia with thiopental and after sedation with pentobarbital or phenobarbital. On repeated administration, redistribution becomes increasingly less important, and eventually the duration of effect is determined by the elimination half-life.

Long-term use of barbiturates causes an increase in liver microsomal enzyme activity that results from increased synthesis of enzyme. Increased enzyme activity facilitates the rate of metabolism of many drugs, including the barbiturates

TABLE 13-6

Classification of Barbiturates According to Duration of Action

	ONSET OF EFFECT	DURATION OF EFFECT
Long-acting: phenobarbital	1-3 hr*	10 hr
Short-acting to intermediate-acting: pentobarbital, secobarbital	30-60 min*	3-8 hr
Ultrashort-acting: thiopental	Immediate [†]	15-30 min [‡]

*Oral administration.

[†]Intravenous administration.

[‡]After single intravenous dose.

themselves, and gives rise to numerous drug interactions (see Table 13-3).

The duration of action of barbiturates serves as a useful criterion for classification, as illustrated in Table 13-6. As mentioned previously, the onset and duration of action of barbiturates are inversely related to the agents' respective lipid solubilities.

Adverse Effects and Drug Interactions

The principal toxic reactions associated with the use of the barbiturates result from their effects on the CNS (particularly when combined with other CNS depressants), their abuse potential (see Chapter 51), and their ability to induce hepatic microsomal enzymes. Because barbiturates are CNS depressants, at high doses they can depress respiration and should not be administered to patients whose respiration is already compromised. Additionally, intravenously administered anesthetic barbiturates increase the incidence of respiratory complications such as laryngospasm, coughing, sneezing, and hiccough. Confusion, somnolence, and impaired psychomotor performance are other possible undesired consequences of CNS depression. As is the case with benzodiazepines, many unusual behavioral reactions have been attributed to the barbiturates. Such reactions include attitudinal depression, agitated toxic psychosis, manic behavior, increased anxiety, hostility, and rage. Careful evaluation reveals that the incidence of these paradoxical responses is very small. In many cases, the response may be predictable if the patient has a history of poor impulse control or aggressive and destructive behavior.

Combining two or more CNS depressant drugs is known to produce increased levels of CNS depression. This summation reaction is the basis for some useful drug combinations in dental therapeutics, such as multidrug intravenous sedation in adults and oral sedation in children.^{12,45,46,59} Nevertheless, the risk for adverse effects increases as more CNS depressants are used together. The popularity of "balanced anesthesia" used for general anesthesia is based on the appreciation that CNS depressants have additive effects, and premedication with an opioid such as morphine and the addition of nitrous oxide permit a significant reduction in the concentration of the primary anesthetic gas required for surgical procedures. The use of combinations of CNS drugs also increases the risk of unexpected oversedation and respiratory depression, particularly if opioids are included in the regimen.^{12,45}

Because of the possible severe consequences that may occur with the combination of CNS depressants, dentists routinely inform patients to restrict alcohol consumption after general anesthesia or sedation. This drug interaction has been shown in healthy young adults after general anesthesia

with thiopental.³⁴ When 0.7 g/kg of alcohol was administered to these subjects 4 hours after thiopental administration, performance on psychomotor tests was impaired more than when alcohol alone had been used. This summation reaction has also been demonstrated for oral diazepam³⁵ and sedative antihistamines such as diphenhydramine and promethazine. Alcohol consumption after sedation therapy can cause severe drowsiness and significantly impair psychomotor performance, including driving skills, and must be restricted.

Some medically compromised patients may have reduced activities of drug-metabolizing enzymes because of hepatic disease, age (very young and very old), or genetic factors, and an exaggerated depressant response to a given regimen of sedative-hypnotics may be anticipated. Some drugs, such as valproic acid, reduce the hepatic clearance of the barbiturates, leading to an enhanced response (see Table 13-3). Numerous drug interactions with the barbiturates arise from the ability of these agents to induce hepatic microsomal enzyme activity. Because the dentist administers sedative-hypnotics to patients as single doses or for short regimens, this reaction should not be a problem unless the patient is taking the drugs long-term. If hepatic microsomal enzyme activity has been elevated, the effectiveness of warfarin and other drugs metabolized by this enzyme system is decreased. Many potentially dangerous drug interactions may be prevented simply by obtaining an accurate medical history, keeping a continuous record of drugs (prescribed and self-administered) taken by the patient, and consulting with the patient's physician when the patient's clinical status or drug history is uncertain.⁴²

Barbiturates augment porphyrin synthesis and are strictly contraindicated in patients with acute intermittent porphyria, hereditary coproporphyrin, or porphyria variegata. Barbiturates increase the concentration of δ -aminolevulinic acid synthase, the initial enzyme in the synthesis of porphyrin rings found in hemoglobin and other proteins. Because these forms of porphyria are caused by defective enzymes involved in heme synthesis, blockade of the synthetic pathway downstream from δ -aminolevulinic acid causes porphyrin precursors to build up, leading to an acute exacerbation of the disease.

General Therapeutic Uses

The indications for barbiturates reflect their durations of action and selective effects of some drugs. The long-acting agent phenobarbital is used to manage tonic-clonic seizures and other types of convulsive disorders. Short-acting to intermediate-acting drugs can be prescribed for sedative-hypnotic purposes, although they are much less commonly used since the advent of the benzodiazepines. Short-acting and ultrashort-acting barbiturates are administered as intravenous sedatives and anesthetics, although their use has declined particularly because of the increased use of propofol (see Chapter 18).

CHLORAL HYDRATE AND OTHER SEDATIVE-HYPNOTICS

Various drugs of diverse chemical structure, including chloral hydrate, paraldehyde, ethchlorvynol, glutethimide, and methyprylon, have sedative-hypnotic properties. Except for chloral hydrate, these agents have few clinical indications in dentistry.

Pharmacologic Effects

Chloral hydrate, one of the oldest nonbarbiturate sedative-hypnotics, continues to have dental applications. It is available in a liquid preparation that is convenient for the sedation of uncooperative children. Chloral hydrate is a commonly used sedative in children for painless technical procedures such as



Chloral hydrate **Trichloroethanol**

FIGURE 13-10 Structural formulas of chloral hydrate and its active metabolite trichloroethanol.

diagnostic imaging. Similarly, chloral hydrate is a popular sedative-hypnotic in pediatric dentistry. Although its overall safety record is considered acceptable, the therapeutic index of the drug is actually very small. In addition, severe laryngospasm with cardiorespiratory arrest after aspiration of orally administered chloral hydrate in liquid form has been reported.²⁴

Chloral hydrate is commonly used in combination with other drugs, such as nitrous oxide, hydroxyzine, and promethazine. These agents are useful in augmenting the sedative effect of chloral hydrate and, in the case of promethazine, in relieving the nausea and vomiting produced by chloral hydrate.²⁸ Because of the drug's low therapeutic index, it is imperative that dose calculations be based on weight when it is used for pediatric sedation.⁴⁴ Chloral hydrate has minimal effects on REM sleep, although depression may occur with higher doses. The drug has been successfully used for the treatment of alcohol withdrawal, but benzodiazepines are now preferred.

Absorption, Fate, and Excretion

Chloral hydrate is well absorbed after oral or rectal administration and is rapidly converted by the liver to trichloroethanol, which is responsible for the CNS depressant properties of the parent compound (Figure 13-10). Plasma concentrations of chloral hydrate are nearly undetectable after administration. Trichloroethanol is conjugated with glucuronic acid and excreted in the urine. Trichloroethanol has a half-life of 4 to 12 hours. A portion of chloral hydrate and trichloroethanol is metabolized to dichloroacetic acid and trichloroacetic acid. With long-term administration, chloral hydrate can induce liver enzyme activity and compete for plasma protein binding sites, giving rise to several drug interactions (see later).⁴²

Adverse Effects and Drug Interactions

Chloral hydrate has only minor cardiovascular effects in conventional doses. As the dose is increased beyond the therapeutic range, however, cardiovascular depression may occur. Chloral hydrate can precipitate cardiac arrhythmias in the sensitized heart and in the apparently healthy heart, and it may have been responsible for the reported death of a patient undergoing third molar extractions.³⁰ Chloral hydrate and trichloroethanol have chemical structures (see Figure 13-10) that resemble halothane, an anesthetic known to sensitize the myocardium to adrenergic amines. Trichloroacetic acid may also be cardiotoxic. The respiratory effects of sedative doses of chloral hydrate and the other nonbarbiturates are minimal, but become more severe as the dose is increased.

Chloral hydrate has been implicated in various drug interactions (see Table 13-3). As one might expect, chloral hydrate produces increased CNS depression when administered with other sedatives. The therapeutic advantage of this drug interaction is that it allows practitioners to decrease the dose of both CNS depressants and limit the side effects of the individual drugs. The reduced dosage requirement for chloral hydrate when combined with the sedative antiemetic promethazine has been shown to decrease appreciably the incidence of nausea and vomiting.²⁸ Similarly, the use of nitrous oxide in combination with chloral hydrate deepens the level of sedation. This therapeutic advantage may be lost when

nitrous oxide is used in combination with higher doses of chloral hydrate because the CNS depression may be increased to such an extent that the child's protective reflexes become compromised.⁴⁶

Beyond the expected summation of CNS depressant effects, the combination of chloral hydrate with alcohol is thought to produce a potentiation drug interaction through an alteration of alcohol metabolism. Chloral hydrate and its primary metabolite, trichloroethanol, competitively inhibit alcohol-metabolizing dehydrogenases, elevating alcohol blood concentrations (see Table 13-3). This combination, known as a "Mickey Finn" or "knock-out drops," can induce severe alcohol intoxication with stupor, coma, or death. The interaction is significant because it induces greater than additive effects and may result in a potentially life-threatening CNS depression. The dental indications for chloral hydrate are almost exclusively in pediatric sedation, and alcohol is usually not a concomitantly administered drug.

Chloral hydrate has been implicated in modifying responses to the oral anticoagulants dicumarol and warfarin. Another metabolite of chloral hydrate, trichloroacetic acid, may increase free warfarin plasma concentrations by interfering with its protein binding (normally 98% to 99%). The possible result is a transient and usually small hypoprothrombinemia. Although caution is indicated, these interactions may be clinically insignificant, particularly with single-dose therapy of chloral hydrate.^{42,66} Sedation with benzodiazepine regimens is a recommended alternative.

An unusual interaction characterized by transient diaphoresis, hot flashes, variable blood pressure, and tachycardia has been reported with chloral hydrate and the diuretic furosemide (see Table 13-3).⁴⁸ The mechanism is not well understood, but may relate to enhanced sensitivity to a chloral hydrate metabolite. Although rarely reported, this is a moderately severe reaction and can occur when furosemide is administered within a day of chloral hydrate.

Chloral hydrate and trichloroethanol can be detected in breast milk within 15 minutes and for 24 hours after administration. Peak concentrations in breast milk are sufficient to sedate the breastfeeding infant. A potential caution concerning the widespread use of chloral hydrate in infants and children is that chloral hydrate, trichloroethanol, and trichloroacetic acid all are metabolites of trichloroethylene,⁵⁷ an industrial solvent, environmental contaminant, and carcinogen. Chloral hydrate is also a mutagen and can cause chromosomal damage. Although no indication of human mutagenic or carcinogenic toxicity has been found with therapeutic uses of chloral hydrate, these concerns have decreased the popularity of chloral hydrate for use in pediatric dentistry.

ANTI-HISTAMINES

A common side effect of the first-generation H₁ antihistamines is drowsiness and sedation. This response is caused by antagonism of histamine neurotransmitter receptors within the CNS. Antihistamines such as hydroxyzine, a piperazine derivative, and promethazine, a phenothiazine derivative, have proved to be useful adjuncts in sedation regimens (see Chapter 48). Part of their popularity relates to their ability to augment the sedative effects of other sedative-hypnotics and to reduce the incidence of nausea and vomiting. Similarly, the ethanolamine antihistamine diphenhydramine, although used primarily for the management of allergic reactions, is also marketed as an over-the-counter agent to treat motion sickness and insomnia.

The chemical structure of hydroxyzine, an antihistamine used for its sedative effects, is shown in Figure 13-11. Hydroxyzine's depression of CNS activity seems to be primarily subcortical. Bronchodilator, peripheral antihistaminic,

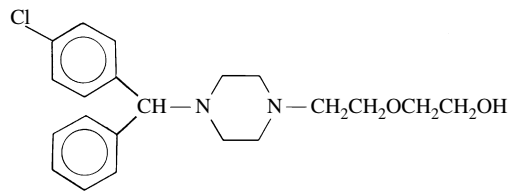

FIGURE 13-11 Structural formula of hydroxyzine.

antiemetic, and analgesic properties have also been clinically shown.

Pharmacologic Effects

All the first-generation H₁ antihistamines produce mild CNS depression. These drugs also have prominent and sometimes beneficial anticholinergic, antihistaminic, and antiemetic properties. Side effects that may be of concern with these compounds at therapeutic doses are primarily drowsiness and dry mouth. Additive effects occur if these drugs are used in conjunction with other CNS depressants.

Hydroxyzine has a very slight depressant effect on the cardiovascular and respiratory systems. Similar to other antihistamines, hydroxyzine has antiarrhythmic properties and may cause bronchodilation. Hydroxyzine seems to have a slight analgesic effect and, when combined with morphine, produces greater analgesia than morphine alone. Hydroxyzine is helpful in diminishing the emetic effects of opioids, but the hydroxyzine-opioid combination produces significant drowsiness. When used as an adjunct to anesthesia, hydroxyzine has been reported to potentiate significantly the effects of barbiturates and opioids such as meperidine; reduction of total doses of these CNS depressant drugs is indicated.

Absorption, Fate, and Excretion

Hydroxyzine is rapidly absorbed from the gastrointestinal tract, and pharmacologic effects may begin within 15 to 30 minutes. Peak concentrations are achieved in 1 to 3 hours. The metabolic fate of hydroxyzine includes hepatic conversion to the lipid-soluble derivative norchlorcyclizine and the water-soluble hydroxyzine N-oxide. Hydroxyzine N-oxide is excreted rapidly, whereas norchlorcyclizine is excreted slowly and tends to accumulate in the body. The second-generation antihistamine cetirizine is an active carboxylated metabolite and contributes to the clinical effect. The terminal elimination half-life for hydroxyzine is approximately 1 day in adults but is considerably shorter in children. A syrup of hydroxyzine has a half-life of about 7 hours in children.

Adverse Effects and Drug Interactions

Hydroxyzine is generally considered to have low toxicity. The CNS depressant effect of hydroxyzine summates with that of other CNS depressants. There are indications that norchlorcyclizine may be dangerous to the fetus, but such an effect has been shown experimentally only at doses 50 to 100 times those considered to be therapeutic. Parenteral hydroxyzine is available for intramuscular injection only. Tissue necrosis is associated with subcutaneous or intra-arterial injections, and hemolysis may occur after intravenous administration.

GENERAL THERAPEUTIC USES OF SEDATIVE-HYPNOTICS

The use of barbiturate sedative-hypnotics to relieve fear and anxiety during dental procedures has been supplanted by use of benzodiazepine receptor agonists. Chloral hydrate and the antihistamine sedatives are still used in pediatric dentistry,⁴⁷

TABLE 13-7

Preparations and Doses of Sedative-Hypnotics

	ROUTE OF ADMINISTRATION	ADULT DOSE (mg)	
		SEDATION	HYPNOSIS
Barbiturates*			
Pentobarbital	O, R, IM, IV	†	100
Secobarbital	O, R, IM, IV	†	100-200
Benzodiazepines			
Clorazepate	O	7.5-15	15-30
Diazepam [‡]	O, IM, IV	2-10	10
Flurazepam	O	15	15-30
Lorazepam	O, IM, IV	1-3	2-4
Quazepam	O	7.5-30	7.5-30
Temazepam	O	7.5-15	15-30
Triazolam	O	0.125-0.25	0.125-0.5
Chloral Derivatives			
Chloral hydrate [§]	O, R		500-1000
Selective GABA_A Receptor Agonists			
Zaleplon	O	†	5-20
Zolpidem	O	†	5-10
Eszopiclone	O	†	1-3
Melatonin Receptor Agonist			
Ramelteon	O	†	8

*Dose for children for preoperative sedation, 2 mg/kg.

[†]Rarely or never used as a daytime sedative.

[‡]Dose for children for preoperative sedation, 0.04-0.6 mg/kg.

[§]Dose for children for preoperative sedation, 50 mg/kg up to 1000 mg.

IM, intramuscular; IV, intravenous; O, oral; R, rectal.

although chloral hydrate poses more risk. Table 13-7 lists agents that are useful as sedative-hypnotics. Barbiturates, particularly ultrashort-acting agents, are useful in anesthesia and intravenous sedation to deepen CNS depression for brief periods. These therapeutic indications for sedative-hypnotic agents are discussed further in Chapters 18 and 48.

AZASPIRODECANEDIONES

Buspirone (Figure 13-12), an azaspirodecanedione derivative structurally unrelated to the benzodiazepines, represents a unique class of antianxiety agents. Buspirone has antianxiety effects that are therapeutically equivalent to the effects of diazepam, but it lacks the more prominent CNS depressant effects and the anticonvulsant and muscle relaxant properties of the benzodiazepines. In addition, buspirone does not augment the sedative effect of ethyl alcohol or other sedatives, and it has little effect on psychomotor or cognitive function. Physical dependence does not occur, and withdrawal does not occur at abrupt cessation. This drug has a more anxiolytic-selective profile than benzodiazepines, representing a major advance in antianxiety therapy and a useful alternative to benzodiazepines.

Although the mechanism of antianxiety action of buspirone is unknown, it seems to diminish serotonergic tone. Buspirone is a partial 5-HT_{1A} agonist at both presynaptic 5-HT_{1A} autoregulatory receptors, which results in decreased 5-HT synthesis and release, and at postsynaptic 5-HT_{1A} receptors, which diminishes the effects of 5-HT.⁷⁰ Studies have shown dense labeling by radiolabeled buspirone of limbic

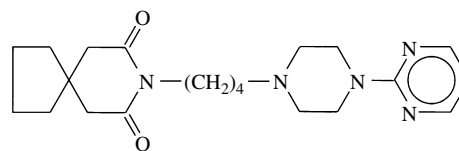

FIGURE 13-12 Structural formula of buspirone.

structures (amygdala, hippocampus, entorhinal cortex) that have high affinity for 5-HT_{1A} ligands. In animal studies, neurotoxins that selectively destroy tryptaminergic systems abolish the activity of buspirone.¹⁶ There is good evidence for a tryptaminergic mechanism for the anxiolytic action of buspirone.²³ Although buspirone does not bind to the GABA-benzodiazepine receptor complex, the benzodiazepine antagonist flumazenil can block the antianxiety effect of ipsapirone,³⁶ a buspirone derivative, suggesting an interaction between benzodiazepine and tryptaminergic systems.

Peak plasma concentrations of buspirone are reached in less than 1 hour, but this may vary from patient to patient. Buspirone is extensively metabolized, with active and inactive metabolites excreted in the urine and feces. The elimination half-life is 2 to 8 hours.

Adverse effects of buspirone, such as headache, dizziness, nervousness, paresthesia, and gastrointestinal upset, are similar to the adverse effects of benzodiazepines but milder. Buspirone does not seem to produce additive sedative effects with the concomitant use of ethanol, a major advantage over benzodiazepines. Additionally, buspirone does not seem to produce significant CNS depression, which may offer a major clinical advantage for patients who, because of their employment, cannot afford an impairment in psychomotor skills. The abrupt withdrawal of buspirone is not associated with rebound anxiety or withdrawal symptoms. There have been reports that patients taking long-term diazepam who are quickly switched to buspirone may exhibit signs of increased anxiety and withdrawal because buspirone does not suppress benzodiazepine withdrawal or show cross-tolerance with benzodiazepines. Switching a patient who is currently on long-term benzodiazepine therapy to buspirone is accomplished by initiating low doses of buspirone and gradually tapering the dosage of benzodiazepine. Another problem associated with the use of buspirone is the long delay (1 to 3 weeks) to onset of clinical effects. This limits its usefulness in clinical dentistry.

CENTRALLY ACTING MUSCLE RELAXANTS

Propanediol and Glycerol Derivatives

The group of propanediol and glycerol derivatives includes several traditional agents, most of which are used as centrally acting muscle relaxants. They have, however, many effects in common with benzodiazepines. Meprobamate, a propanediol carbamate, was considered the agent of choice for the treatment of anxiety in the mid-1950s. With the discovery of the addictive properties of this compound and the introduction of benzodiazepines, its popularity declined rapidly. The pharmacologic profile of meprobamate differs little from barbiturates, although its antianxiety effects are demonstrable at doses that do not markedly diminish motor or intellectual performance. **Meprobamate** is rapidly absorbed from the gastrointestinal tract and reaches a peak plasma concentration in 2 to 3 hours. The half-life of a single dose of meprobamate is approximately 7 to 15 hours. Similar to barbiturates, meprobamate induces hepatic microsomal enzyme activity, but this induction seems to be more selective with meprobamate, and it may not induce its own metabolism. The half-life of meprobamate may be 48 hours with long-term therapy.

Mephenesin, chlorphenesin, methocarbamol, and carisoprodol are used primarily as centrally acting skeletal muscle relaxants. In 1945 the muscle relaxant effects of aryl-glycerol esters in experimental animals were observed; after evaluation of several analogues, mephenesin was introduced for clinical use in 1948. Mephenesin proved to be of limited usefulness because of its short duration of action. Methocarbamol and chlorphenesin have a more prolonged duration of action because of slow metabolic transformation and excretion. Mephenesin and similar drugs have also been shown to reduce polysynaptic spinal reflexes in experimental animals. In humans, these drugs act as mild sedatives and are used primarily to reduce abnormal muscle activity. Nevertheless, these and other centrally acting muscle relaxants are never used at doses that could cause flaccid paralysis of voluntary muscles.

Centrally acting muscle relaxants should be distinguished from several other classes of drugs that can reduce muscular activity through peripheral mechanisms. The neuromuscular blocking agents, such as tubocurarine and succinylcholine, act by blocking transmission at the neuromuscular junction. **Dantrolene, a peripherally acting muscle relaxant, blocks excitation-contraction coupling in skeletal muscle. Curare-like drugs, succinylcholine, and dantrolene have very specific indications for their muscle relaxant properties (see Chapter 10).**

Chemistry and structure-activity relationships

The chemical structures of meprobamate, mephenesin, and carisoprodol are shown in Figure 13-13. Meprobamate and carisoprodol are dicarbamate esters of propanediol, which have additional substituents to increase their potency and absorption.

Pharmacologic effects

Table 13-8 compares pharmacologic characteristics of various classes of drugs discussed in this chapter. Qualitatively,

centrally acting muscle relaxants, sedative-hypnotics, and anti-anxiety drugs are similar pharmacologically, whereas anti-histamines produce sedation that is qualitatively different.

Centrally acting muscle relaxants, of which mephenesin can be taken as the prototype, cause relaxation of voluntary muscle through depression of the CNS. These depressant effects have not been associated with an action on any specific transmitter system or neurologic circuit. Rather, alteration of the excitability of neural membranes in general may be involved. Although early investigations emphasized depression of spinal interneurons as the mechanism of action, these agents generally reduce neural activity in various brain structures, including the brainstem, thalamus, and basal ganglia. Certain agents that do not produce muscle relaxation also show some preferential depression of polysynaptic reflexes; depression of interneurons is not an identifying characteristic of this class. At progressively larger doses, sedation, hypnosis, unconsciousness, and death occur. Elevation of the convulsant threshold can be shown. The drugs are used orally.

The cardiovascular effects of sedative doses of centrally acting muscle relaxants of the mephenesin type are minimal. Adequate cardiovascular performance is usually maintained at doses higher than the doses that produce respiratory depression. The problems of shock and renal failure can complicate recovery from toxic doses of the agents, however.

Miscellaneous Drugs Affecting Skeletal Muscle

Significantly different from the glycerol and propanediol derivatives, **orphenadrine (see Figure 13-13) is an analogue of the antihistamine diphenhydramine.** The pharmacologic profile of orphenadrine, an antihistamine, **differs from that of compounds similar to mephenesin.** Conventional antihistamines, in addition to blocking histamine receptors, are frequently **anticholinergic** and produce **drowsiness and sedation.** **This sedation is of a different character from the sedation produced by mephenesin-like drugs; increasing the dose of an**

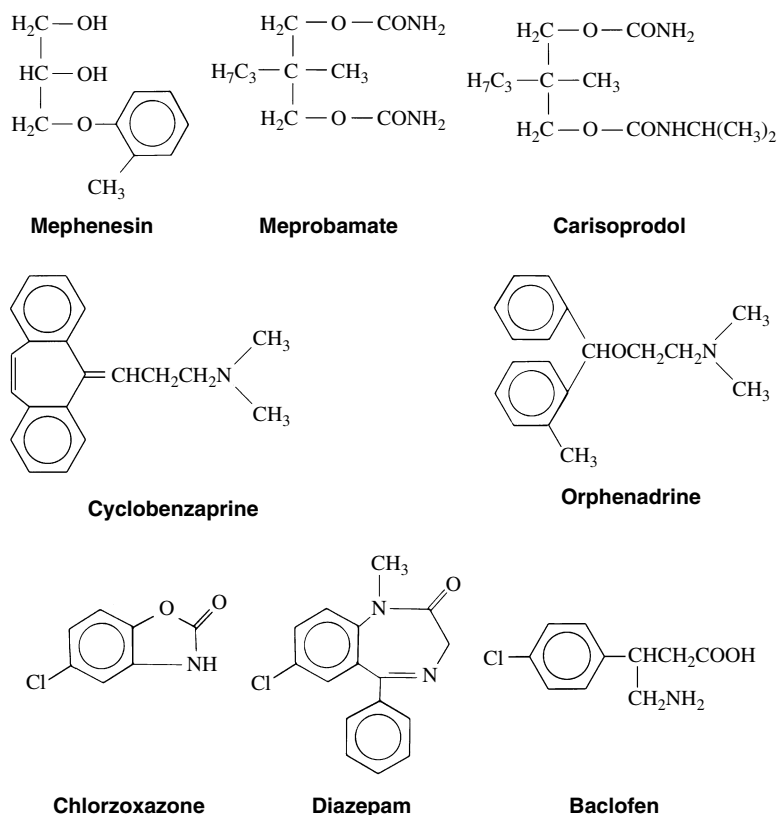

FIGURE 13-13 Structural formulas of some centrally acting muscle relaxants.

TABLE 13-8

Pharmacologic Comparison of Centrally Acting Muscle Relaxants, Sedative-Hypnotics, Antianxiety Drugs, and Antihistamines

PHARMACOLOGIC PROPERTIES	CENTRALLY ACTING MUSCLE RELAXANTS (PROTOTYPE MEPHENESIN)	SEDATIVE-HYPNOTICS (PROTOTYPE PHENOBARBITAL)	ANTIANSXIETY DRUGS (PROTOTYPE DIAZEPAM)	ANTIHISTAMINES (PROTOTYPE DIPHENHYDRAMINE)
Anticholinergic properties	No	No	Mild	Yes
Antihistaminic properties	No	No	No	Yes
Paradoxical low-dose excitement	Yes	Yes	Yes	No
Ataxia	Yes	Yes	Yes	No
Anesthesia	Yes	Yes	Variable	No
Arousal at high doses	Difficult	Difficult	Difficult	Easy
Lethal effect	Respiratory depression	Respiratory depression	Respiratory depression	Convulsions
Convulsant threshold	Raised	Raised	Raised	Lowered
Dependence liability	Yes, but usually mild	Yes	Yes, but usually mild	No

antihistamine leads to hallucinations, delusions, and convulsions. Nevertheless, because the dose-response curve for antihistamines is flat, these drugs have been considered safe and have been widely used in over-the-counter sleep aids for this reason. Likelihood of physical dependence is also minimal. Orphenadrine has been used primarily as an adjunct in the treatment of Parkinson's disease. Compared with the mephenesin group of drugs, no special advantage has been shown for orphenadrine as a muscle relaxant.

Cyclobenzaprine (see Figure 13-13), a structural and pharmacologic analogue of tricyclic antidepressants, is used for the short-term (2 to 3 weeks) treatment of muscle spasm associated with acute painful musculoskeletal conditions. One hypothesis for its mechanism of action is that it increases brainstem norepinephrine-mediated inhibition of ventral motor neurons of the spinal cord. Its effectiveness is similar to that of diazepam, but it produces more xerostomia, drowsiness, tachycardia, and dizziness. Many tricyclic antidepressants have significant antihistaminic effects, and the general pharmacologic properties of cyclobenzaprine are similar to those shown in Table 13-8 for the antihistamines. Metaxalone and chlorzoxazone (see Figure 13-13) are heterocyclic carbamates that show muscle-relaxing properties.

Baclofen has been shown to stimulate GABA_B receptors, which are G_{i/o} protein-linked receptors and are not coupled to Cl⁻ channels in the nerve membrane.⁶ These GABA_B receptors may inhibit motor tone by reducing the release of excitatory amino acid transmitters, reducing Ca⁺⁺ conductance and increasing K⁺ conductance. Blocking the receptor sites for excitatory amino acid transmitters may be a mechanism of action applicable to other centrally acting muscle relaxants. Baclofen, the *p*-chlorophenyl analogue of GABA, is recommended in multiple sclerosis or traumatic spinal cord injury for the relief of spasticity. Baclofen is also used to treat trigeminal neuralgia.

Although many agents are available as centrally acting muscle relaxants, the most commonly used drug for many muscle spasms is diazepam or another long-acting benzodiazepine. Benzodiazepines are thought to act primarily within the CNS, where they increase the response to GABA at GABA_A receptor sites. Benzodiazepines, although they tend to have more sedative properties than some of the drugs used almost exclusively as centrally acting muscle relaxants, have a favorable clinical profile compared with the latter agents because of their relatively strong muscle-relaxing properties and relatively low toxic and physical dependence liabilities.⁵⁴

TABLE 13-9

Comparison of Ataxic and Lethal Doses of Central Depressant Drugs in Mice

AGENT	LD ₅₀ (mg/kg)	ATAXIA ED ₅₀ (mg/kg)	THERAPEUTIC INDEX
Phenobarbital	242	120	2.0
Mephenesin	610	178	3.4
Meprobamate	800	235	3.4
Carisoprodol	980	165	5.9
Chlordiazepoxide	720	100	7.2
Diazepam	620	30	20.7

ED₅₀, Median effective dose; LD₅₀, median lethal dose.

Adverse Effects

Muscle relaxants are generally used at sedative doses, and these drugs have limited effectiveness in the treatment of muscle spasms. Data obtained from experimental animals compare the relative safety of some commonly prescribed muscle relaxants (Table 13-9). The therapeutic index for muscle relaxation and other effects is many times greater for benzodiazepines than for barbiturates. The other clinically useful muscle relaxants have therapeutic indexes between these extremes.

Tolerance and physical dependence develop with the long-term administration of muscle relaxants, but generally withdrawal is mild although qualitatively similar to that seen with other CNS depressant drugs. Side effects associated with centrally acting muscle relaxants are primarily related to effects on the CNS and include drowsiness, dizziness, headache, blurred vision, ataxia, lethargy, paradoxical excitement, and nystagmus. Gastrointestinal symptoms such as vomiting, heartburn, nausea, anorexia, and abdominal distress have been reported. Allergic reactions may also occur and include skin rash, pruritus, and fever. Cyclobenzaprine has some additional side effects that stem from its actions on the autonomic nervous system. Because it has substantial anticholinergic properties, its use should be especially avoided in certain conditions (e.g., narrow-angle glaucoma, prostatic hypertrophy). Because of its effect on norepinephrine reuptake, cyclobenzaprine may also be contraindicated in patients for whom increased sympathetic activity is to be avoided (e.g., in patients

with hyperthyroidism or recovering from a myocardial infarction). A report of a manic episode after cyclobenzaprine use in a patient with a history of psychosis suggests that cyclobenzaprine should also be avoided in such patients.⁴

Baclofen can cause drowsiness, ataxia, and confusion, which may be especially troublesome in elderly individuals. Acute toxicity may lead to respiratory depression and seizures. Sudden withdrawal from therapeutic doses is associated with a high risk of hallucinations and tachycardia. Cessation of therapy should involve tapering the doses over several days.

Drug interactions with the centrally acting muscle relaxants are of several kinds. First, these drugs augment the depressant actions of each other and of the opioids, other sedatives (including ethanol),⁶³ antianxiety drugs, antihistamines, and antidepressants.⁴² Second, drug interactions can occur when these agents induce drug-metabolizing and hormone-metabolizing enzymes of the liver. Although the degree of enzyme induction varies substantially among the various sedatives, caution should be used in patients taking anticoagulants and in patients with porphyria. Third, increased skeletal muscle relaxation should be expected when centrally acting muscle relaxants are given with drugs whose primary pharmacologic activity is neuromuscular blockade (e.g., succinylcholine) or with drugs that have such an activity as a side effect (e.g., aminoglycosides or volatile general anesthetics). Fourth, cyclobenzaprine should not be given to patients taking monoamine oxidase inhibitors or guanethidine and related drugs. (Barbiturates, benzodiazepines, and other sedatives should be used with considerable caution with monoamine oxidase inhibitors.) Fifth, because the muscle relaxant actions of diazepam are partially reversed by aminophylline,⁶⁵ patients being treated with diazepam should avoid the use of xanthine-containing foods.

General Therapeutic Uses

Centrally acting muscle relaxants are used medically as adjuncts to rest, physical therapy, and other measures for the relief of discomfort associated with acute, painful musculoskeletal conditions. They have been promoted for use in skeletal muscle spasms of local origin, multiple sclerosis, cerebral palsy, sprains, strains, fibrositis, rheumatoid spondylitis, bursitis, the urethral syndrome, and arthritis. Drugs such as salicylates and adrenocorticosteroids may be used concomitantly. Longer acting nonsteroidal anti-inflammatory agents are perceived as having an advantage in many of these disorders.

Certain conditions of skeletal muscle, such as muscle spasm or trismus, are believed to be the result of dysfunctional output patterns from the motor areas of the CNS to skeletal muscle. Drugs that could prevent or lessen these neurotropic influences on voluntary muscle would be helpful in physical medicine and dentistry. Centrally acting muscle relaxants, which overlap pharmacologically with antianxiety drugs, represent a diverse group of drugs whose pharmacologic effects include diminished output of nerve impulses to voluntary muscle. Benzodiazepines are sometimes used to alleviate abnormal muscle contractions by depressing polysynaptic CNS pathways, including polysynaptic spinal reflexes. Some newer benzodiazepine partial agonists have a minimal amount of muscle relaxant activity.¹⁷ Full agonist agents such as diazepam should be used if muscle relaxation is desired.

β-ADRENERGIC RECEPTOR-BLOCKING DRUGS

The β-adrenergic receptor-blocking agent propranolol is not approved for the treatment of anxiety, but it is effective in decreasing the peripheral autonomic symptoms of anxiety

(e.g., tremor, tachycardia, palpitation). Propranolol may be used for healthy patients who have disabling situational anxiety, or it may be combined with a benzodiazepine in patients who have the somatic manifestations of anxiety. Propranolol has gained some popularity with performing actors and musicians in preventing “stage fright.” It is neither appropriate nor effective for the treatment of chronic anxiety.

α₂-ADRENERGIC RECEPTOR AGONIST DRUGS

The α₂-adrenergic receptor agonist drugs guanabenz, guanfacine, clonidine, tizanidine, medetomidine, and dexmedetomidine exert their action at central and peripheral α₂ receptors. Centrally, α₂ receptors are located in the brain (locus coeruleus) and the spinal cord. Stimulation of these receptors diminishes sympathetic outflow, which results in sedation, hypnosis, anxiolysis, analgesia, and reduced systemic blood pressure. Peripherally, α₂ receptors are located primarily at the prejunctional site of the sympathetic nerve terminal. Stimulation of these receptors impairs adrenergic transmission and results in reductions of heart rate and blood pressure.

Clonidine was first used as a nasal decongestant that coincidentally was discovered to reduce systemic blood pressure through central brainstem adrenergic stimulation. Clonidine is rapidly and almost completely absorbed after oral administration and may exhibit transient increases in blood pressure after initial dosing because of mild stimulation of peripheral postjunctional α₁ receptors. Sudden withdrawal of clonidine after long-term administration has been associated with rebound hypertension that may occur 20 hours after cessation of the drug. Clinically, clonidine is used as an antihypertensive agent (see Chapter 28). More recently, it has been used as an oral premedicant in patients with significant pretreatment anxiety.²⁵ Its anxiolytic and cardiovascular effects make it useful in the perioperative management of these difficult patients because it has been shown to decrease anesthetic requirements by 40% to 60% and to reduce postoperative analgesic dose requirements. Clonidine is also useful in the treatment of opiate, cocaine, food, and tobacco withdrawal.

The α₂-adrenergic receptor agonist tizanidine is a centrally acting muscle relaxant used for spasticity states, especially multiple sclerosis and spasticity arising from spinal cord injury. Within the spinal cord, the medullary locus coeruleus, and the substantia nigra, α₂ receptors have been shown to contribute to its action.^{62,64} Other centrally acting muscle relaxants—midazolam and baclofen—also depress spinal reflexes when applied directly to the substantia nigra.⁶⁴

Dexmedetomidine is a highly selective (7.3 times that of clonidine) α₂-adrenergic receptor agonist with sedative, hypnotic, and analgesic properties. It exhibits a biphasic blood pressure response in a dose-dependent fashion. Intravenous infusion of low doses results in a reduction of mean arterial pressure owing to selectivity for central and peripheral α₂ receptors. The resultant decreases in heart rate and systemic vascular resistance lead to decreases in cardiac output and systolic blood pressure. Intravenous infusion of high doses or rapid intravenous bolus administration may result in systemic hypertension because of activation of peripheral postjunctional α₂-adrenergic receptors. Dexmedetomidine has minimal, if any, effect on the respiratory system, and similar to clonidine, it significantly reduces analgesic and anesthetic requirements.

Currently, dexmedetomidine has three main clinical applications. Its primary use is as a sedative agent for critically ill patients requiring prolonged sedation and mechanical ventilatory support in a critical care setting. Dexmedetomidine

possesses all of the characteristics of an ideal sedative for intensive care. It lacks respiratory depression, is analgesic and anxiolytic, has a rapid onset and is titratable, and produces sedation with hemodynamic stability. In pediatric patients, dexmedetomidine is very useful in obtunding the emergence delirium sometimes seen after general anesthesia. It produces profound calming without respiratory depression. This is a major advantage over other sedatives and opioids that have commonly been used in this situation. Finally, dexmedetomidine is used as an adjunctive sedative agent for monitored anesthesia care. It can be used with agents such as opioids, benzodiazepines, and propofol to enhance sedation and promote and maintain hemodynamic stability. Because it does not produce respiratory depression, it is very useful in patients for whom this would be a concern. Its rapid distribution half-life (6 minutes) results in fast recovery and allows for faster patient discharge.

There are specific antagonists to α_2 receptor agonist drugs. One such agent, atipamezole, is effective in reversing the clinical effects of these drugs. With the increasing use of dexmedetomidine as a sedative agent in critical care and outpatient anesthesia, further research into the safety and efficacy of this reversal agent is warranted.

IMPLICATIONS FOR DENTISTRY

Drugs Used as Sedative-Hypnotics

Whether used by the dentist or physician, the common desired therapeutic response to these drugs is sedation or hypnosis. Additional therapeutic applications for sedative-hypnotics are discussed in detail in Chapters 14 (anticonvulsant drugs), 18 (general anesthetics), and 48 (management of fear and anxiety).

As a class, benzodiazepines are very safe and highly effective agents for producing sedation and sleep. Zolpidem and zaleplon seem to offer advantages similar to the advantages described for benzodiazepines: they are well tolerated, have a high margin of safety, and have a shallow dose-response profile. In addition, their rapid onset of action makes it possible for the patient to take the drugs immediately before bedtime.

Despite the declining use of barbiturates, they can occasionally be helpful in dentistry. Barbiturates are effective and relatively inexpensive. A wide range in duration of effect can be attained depending on the drug and the dose prescribed. The problems frequently associated with long-term use of barbiturates, such as tolerance and drug interactions, do not generally apply to their short-term use. The barbiturates are contraindicated, however, in pregnancy and latent porphyria (as described previously).

With the exception of benzodiazepines and the pharmacologically related benzodiazepine receptor agonists, nonbarbiturate sedative-hypnotics offer little advantage over barbiturates. Although antihistamines are not considered to cause physical dependence, most nonbarbiturate, nonbenzodiazepine sedative-hypnotics have abuse potential, cause dependence, depress the CNS, and may be more troublesome than barbiturates in overdose. Because of these limitations, few nonbarbiturate, nonbenzodiazepine sedative-hypnotics are used in dentistry. The primary exceptions are chloral hydrate, which is still used for sedation in young children, and the antihistamines hydroxyzine, diphenhydramine, and promethazine.

The use of nonbarbiturate sedatives other than those already described is not warranted for dental practice because they offer no significant advantages. The clinician is best advised to recognize the names of nonbarbiturate sedative-hypnotics and to be aware of the potential for drug interac-

tions with other CNS depressants. In addition, the use of any of the hypnotic drugs for insomnia should be limited to short-term treatment at the lowest effective dose. An ongoing FDA program encourages physicians and dentists to restrict the prescribing of hypnotics and advises that the underlying cause of insomnia be sought and treated by nonpharmacologic means, if possible. The warning also includes the risk of sedative-induced complex sleep disorders, such as sleep-driving. Preparations and doses for clinically useful sedative-hypnotics are listed in Table 13-7. These doses should be used only as guidelines because each patient has different requirements, and dosages should be individualized. Eszopiclone seems to have a greater tendency than most other sedatives to cause unpleasant taste.

Many of the problems associated with the sedative-hypnotics, such as tolerance to sedative effects, addiction, abuse, rebound sleep disturbances, and the induction of hepatic microsomal enzyme activity, result from long-term use. Sedative-hypnotic drugs are indicated only for short-term use in dentistry; many of the usual factors limiting their use are not pertinent. This assertion is not to imply that problems do not arise with the administration of sedative-hypnotics in dental practice, but only that they are minimized. Although overdose with sedative-hypnotics would be unlikely with the amount of drug required for most dental situations, a potential problem exists if the patient combines the prescribed sedative-hypnotic with other CNS depressants, such as alcohol. It is the clinician's responsibility to ensure that the patient is made cognizant of the danger of combining other CNS depressants, particularly alcohol, with these drugs.

Certain patients require special precautions. Elderly patients are at special risk for impaired cognitive and motor function after the administration of a sedative-hypnotic. Patients with impaired liver function also fall into this category. Patients with sleep apnea, which is more common among obese and elderly individuals (especially men), should be treated cautiously because any hypnotic may exacerbate this condition. A complete medical history, including input from a spouse, might alert the practitioner to the possibility of such complications. The use of sedative-hypnotics is generally contraindicated in pregnant patients, especially during the first trimester. Because patients with a history of drug abuse are at a higher risk of becoming dependent on sedative-hypnotics, the minimally effective dose should be prescribed and only when absolutely necessary.

Although barbiturates produce significant depression of the CNS, to the point of unconsciousness, they are not analgesics. A patient receiving sedative doses may exhibit increased responsiveness to painful stimuli. When pain is present or evoked, the patient may become aroused, agitated, and delirious. If pain is a contributing factor to either anxiety or insomnia, an analgesic is required to obtain sedation or hypnosis.

Drugs Used to Treat Anxiety

Antianxiety agents are important in dentistry for the premedication of apprehensive adult patients, patients exhibiting mild neurosis, and uncooperative children. Antianxiety agents, particularly intravenous midazolam and diazepam, are used as adjuncts to local anesthesia. The effectiveness of intravenous diazepam in the relief of intraoperative anxiety in a patient population undergoing surgical removal of impacted third molars is illustrated in Figure 13-14. Although intravenous sedation with diazepam usually lasts approximately 45 minutes, the duration of anxiety relief may be 3 hours.²⁶ Midazolam and diazepam cause anterograde amnesia so that patients often cannot recall the procedures performed. Both drugs also depress the gag reflex and are major drugs for the treatment of seizures induced by local anesthetic overdose.

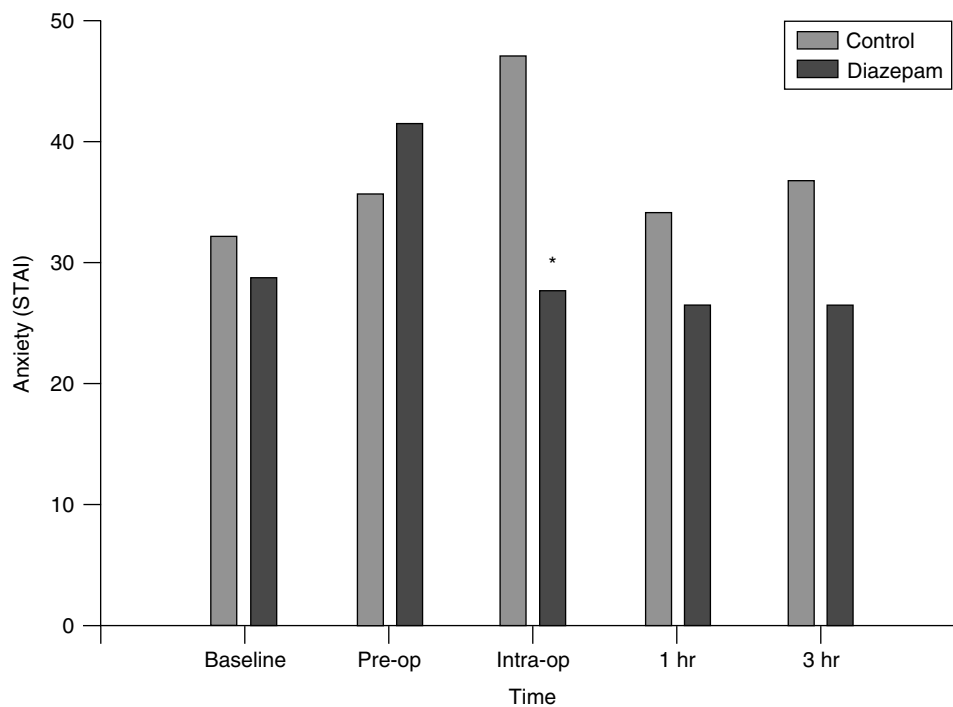

FIGURE 13-14 Effects of placebo and diazepam on reported anxiety with a state-trait anxiety index (STAI) in patients undergoing surgical removal of impacted third molars. Patients were treated with placebo solution or diazepam (0.3 mg/kg) 5 minutes before surgery. All patients also received standard local anesthesia with 2% lidocaine containing 1:100,000 epinephrine. Anxiety was assessed before ingestion and before, during, and after surgery. *Significantly different from control ($P < .01$). (Adapted from Hargreaves KM, Dionne RA, Mueller GP, et al: Naloxone, fentanyl, and diazepam modify plasma beta-endorphin levels during surgery, *Clin Pharmacol Ther* 40:165-171, 1986.)

Midazolam is popular as a preoperative sedative because it is prepared in a water-soluble form and produces little irritation on injection. In contrast to diazepam, residual CNS depression and anxiety relief extending beyond the period of clinical recovery are not commonly observed when midazolam is administered as a single agent. Careful observation of the patient is mandatory in attempting to reverse benzodiazepine-induced sedation with flumazenil. Careful attention must be paid to the manufacturer's recommended dose, time interval of administration, and prolonged patient monitoring time.

One of the more perplexing questions for the practicing dentist is which oral benzodiazepine to choose from the ever-expanding list. There is little doubt of the clinical effectiveness of these drugs in various dental procedures,^{19,59} but there are no unusual characteristics associated with any one benzodiazepine that would make it clearly superior to the others. Essentially, any benzodiazepine is suitable as an antianxiety agent if the pharmacokinetics of that drug are kept in mind. The major decision to be made in the treatment of the anxious patient is which drug possesses the best pharmacokinetic profile for a given use. Although there is no simple rule of thumb, the pharmacokinetic characteristics of individual compounds to a large extent dictate the optimal dose schedule. Oxazepam and lorazepam are potentially useful drugs in patients with liver disease because they are converted to inactive glucuronides, and the conjugation reaction is often affected less by hepatic disease than other steps in drug metabolism. Although buspirone offers many advantages for the treatment of anxiety, its usefulness in dentistry is limited by its delayed onset of effect. Other azaspiroines currently undergoing clinical trials may offer anxiety relief with a short onset time.

Because of its short half-life and rapid onset, triazolam has been recently recommended as a safe and effective enteral

preoperative sedative in the United States. Given the large number of patients who avoid dental care because of fear and anxiety, general dentists, with minimal advanced anesthesia training, have found enteral triazolam to fulfill the need for a safe sedation protocol.²⁹ The typical adult dose is 0.125 mg to 0.250 mg administered orally or sublingually 30 to 45 minutes before the dental procedures. Its efficacy in reducing anxiety before venipuncture and in reducing the doses of agents used for intravenous sedation has been shown.⁵⁹ Clinical research suggests that the sublingual route for triazolam administration may be slightly more efficacious secondary to slightly higher plasma concentrations compared with the oral route.⁵ Indications and contraindications for administering oral or sublingual triazolam to anxious dental patients are discussed in Chapter 48.⁵²

The primary concern of the dentist in using an antianxiety agent should be excessive CNS depression. CNS depression may result from the antianxiety agent alone or its combination with other CNS depressants that the dentist may plan to give or that the patient may already have taken. The antianxiety agents summate with anesthetics, antipsychotics, antidepressants, opioid analgesics, and sedative-hypnotics. Alcohol may markedly increase the CNS depressant effects of benzodiazepines. If CNS depressant drugs are used for deep sedation and general anesthesia in the dental clinic, suction and monitoring equipment, emergency drugs, and a means to deliver oxygen under positive pressure must be readily available. The practitioner should have appropriate advanced training in anesthesia techniques. The benzodiazepine antagonist flumazenil offers the opportunity to reverse benzodiazepine-induced sedation after dental procedures,^{9,19,20} hastening postoperative patient recovery. Flumazenil is also a rapidly acting antidote for benzodiazepine intoxication. The possibil-

ity of re sedation and recurrence of respiratory depression because of its short half-life has been described. The best practice in the use of benzodiazepines is to limit their administration so that an emergency antidote is never required.

The patient should be reminded that antihistamines, even the small amounts contained in over-the-counter preparations promoted as cold remedies or for insomnia, may add to the CNS depressant effect of antianxiety agents. Because of benzodiazepine-induced psychomotor impairment, the dentist should caution patients on the hazards of driving an automobile or operating potentially dangerous machinery for 24 hours after drug administration.

Chloral hydrate has been implicated in serious adverse effects when used as a sedative in dentistry. There is a risk of overdose. In addition, a prolonged recovery may occur. Chloral hydrate also increases the risk for cardiac arrhythmias. These adverse effects require special caution in its use.

Numerous factors influence the choice of an antianxiety drug. This chapter has covered some of the more important ones that the dentist should consider when making a selection. The therapeutic use of drugs for anxiety relief in dentistry is reviewed further in Chapter 48. In practice, the dentist should become familiar and comfortable with a few antianxiety drugs and select from these according to the drugs' pharmacokinetics, the particular treatment to be rendered, and the needs of the patient. The potential for the development of more specific antianxiety agents should serve as a stimulus for the practicing dentist to stay current in the field of antianxiety medication. Knowledge of the pharmacologic profile of the existing drugs may also prevent the dentist from being misled by dubious claims of specificity for newly introduced agents.

Table 13-4 lists preparations and doses recommended for anxiety control. The doses indicated should be viewed only as guidelines; each patient requires individualized treatment. The minimum effective dose should be administered.

Drugs Used as Centrally Acting Muscle Relaxants

Although the indications are limited, centrally acting muscle relaxants may be valuable therapeutic agents for some dental procedures.⁵⁸ Diazepam is generally preferred because of its good muscle-relaxing properties, prolonged action, and safety. Diazepam administered for 1 week may be useful in reducing postprocedural trismus and may be effective as an adjunct for treating muscle spasms of the head and neck, as in temporomandibular disorders. The causes of temporomandibular pain are complex, however, involving multiple interacting factors, such as patient anxiety, muscle spasms, occlusal problems, and joint dysfunction. The effectiveness of therapy with centrally acting muscle relaxants is greater if anxiety or muscle spasm primarily causes the dysfunction. Because the relationship between CNS activity and peripheral muscle tone is complex, it is unlikely that the centrally acting muscle relaxants would produce either consistent or predictable results. There are still few double-blind studies that show the benefit of such treatment; what is clear from such studies is that the incidence of improvement from placebos is high. The use of centrally acting muscle relaxants should be monitored carefully, and long-term therapy beyond a few weeks is generally not indicated.

Although combinations of centrally acting muscle relaxants and peripherally analgesic drugs may be valuable, fixed-dose combinations often provide suboptimal doses of the analgesic drug (see Chapter 47). Prescribing full therapeutic doses of each agent is warranted if the use of a combination is indicated. In addition, better results have been obtained from longer acting agents on a once-daily or twice-daily dosing schedule. The interaction between sensory and motor systems suggests that a multiple drug treatment approach could be useful. The idea that hyperalgesia produces a significant

increase of noxious sensory afferent input from injured muscle has been documented.³⁹ The decrease in peripheral sensory thresholds produced by hyperalgesia is the result of many different inflammatory compounds, which implies that anti-inflammatory drugs of some kind may be useful by reducing the inflammation.

The concept of extensive convergence of afferents from skin, muscle, joints, and other tissues onto brain sensory nuclei, which can result in decreased sensory thresholds and increased referred pain, has also been documented.⁵³ The use of analgesics to reduce peripheral and spinal (or trigeminal) hyperalgesia and centrally acting muscle relaxants to reduce brain excitation may help to reduce muscle spasm; this may explain why analgesics combined with muscle relaxants can sometimes produce a better effect than either one given alone. Centrally acting muscle relaxants generally are not the primary treatment for every type of facial pain. Trigeminal neuralgia (tic douloureux) requires specific therapies (see Chapter 23).

DRUGS USED AS ANTIANXIETY AGENTS

<i>Nonproprietary (generic) name</i>	<i>Proprietary (trade) name</i>
Benzodiazepines	
Alprazolam	Xanax
Chlordiazepoxide	Librium
Clorazepate	Tranxene
Diazepam	Valium
Halazepam*	Paxipam
Lorazepam	Ativan
Midazolam	Versed
Oxazepam	Serax
Prazepam*	Centrax
Triazolam	Halcion
Azaspirodecanediones	
Buspirone	BuSpar
Propanediol carbamates	
Meprobamate	Miltown, Equanil
Chlormezanone*	Trancopal

*Not currently available in the United States.

DRUGS USED AS SEDATIVE-HYPNOTICS

<i>Nonproprietary (generic) name</i>	<i>Proprietary (trade) name</i>
Barbiturates	
Amobarbital	Amytal
Aprobarbital*	Alurate
Butobarbital	Butisol
Butalbital	in Fiorinal
Mephobarbital	Mebaral
Pentobarbital	Nembutal
Phenobarbital	Luminal
Secobarbital	Seconal
Benzodiazepines	
Estazolam	ProSom
Flurazepam	Dalmane
Quazepam	Doral

Continued

DRUGS USED AS SEDATIVE-HYPNOTICS—cont'd

<i>Nonproprietary (generic) name</i>	<i>Proprietary (trade) name</i>
Temazepam	Restoril
Triazolam	Halcion
Antihistamines	
Hydroxyzine hydrochloride	Atarax
Hydroxyzine pamoate	Vistaril
Promethazine	Phenergan
Diphenhydramine	Benadryl, Nytol
Others	
Acetylcarbromal	Paxarel
Chloral hydrate	Aquachloral Suppnettes
Dexmedetomidine	Precedex
Eszopiclone	Lunesta
Ethchlorvynol*	Placidyl
Glutethimide*	Doriden
Methypylon*	Noludar
Paraldehyde*	Paral
Ramelteon	Rozerem
Zaleplon	Sonata
Zolpidem	Ambien

*Not currently available in the United States.

DRUGS USED PRIMARILY AS MUSCLE RELAXANTS

<i>Nonproprietary (generic) name</i>	<i>Proprietary (trade) name</i>
Benzodiazepines	
Diazepam	Valium
Miscellaneous	
Baclofen	Lioresal
Carisoprodol	Soma
Chlorphenesin	Maolate
Chlorzoxazone	Paraflex
Cyclobenzaprine	Flexeril
Mephenesin*	—
Meprobamate	Miltonin, Equanil
Metaxalone	Skelaxin
Methocarbamol	Robaxin
Orphenadrine	Norflex
Tizanidine	Zanaflex

*Not currently available in the United States.

CITED REFERENCES

- Backman JT, Olkkola KT, Aranko K, et al: Dose of midazolam should be reduced during diltiazem and verapamil treatments. *Br J Clin Pharmacol* 37:221-225, 1994.
- Backman JT, Olkkola KT, Neuvonen PJ: Rifampin drastically reduces plasma concentrations and effects of oral midazolam. *Clin Pharmacol Ther* 59:7-13, 1996.
- Backman JT, Olkkola KT, Ojala M, et al: Concentrations and effects of oral midazolam are greatly reduced in patients treated with carbamazepine or phenytoin. *Epilepsia* 37:253-257, 1996.
- Beeber AR, Manring JM Jr: Psychosis following cyclobenzaprine use. *J Clin Psychiatry* 44:151-152, 1983.
- Berthold CW, Dionne RA, Corey SE: Comparison of sublingually and orally administered triazolam for premedication before surgery. *Oral Surg Oral Med Oral Pathol Oral Radiol Endod* 84:119-124, 1997.
- Bowery NG: GABA_B receptor pharmacology. *Annu Rev Pharmacol Toxicol* 33:109-147, 1993.
- Bringmann G: A first biosynthetic proposal for the in vivo formation of naturally occurring diazepam-like 1,4-benzodiazepines. *J Neural Transm* 88:77-82, 1992.
- Clark MS, Lindenmuth JE, Jafek BW, et al: Reversal of central benzodiazepine effects by intravenous flumazenil. *Anesth Prog* 38:12-16, 1991.
- Curran HV, Birch B: Differentiating the sedative, psychomotor and amnesic effects of benzodiazepines: a study with midazolam and the benzodiazepine antagonist, flumazenil. *Psychopharmacology* 103:519-523, 1991.
- Diagnostic and statistical manual of mental disorders*, ed 4 (DSM-IV), Washington, DC, 1994, American Psychiatric Association.
- Diagnostic Classification Steering Committee of the American Sleep Disorders Association: *The international classification of sleep disorders: diagnostic and coding manual*, Rochester, MN, 1990, American Sleep Disorders Association.
- Dionne RA, Yagiela JA, Moore PA, et al: Comparing efficacy and safety of four intravenous sedation regimens in dental outpatients. *J Am Dent Assoc* 132:740-751, 2001.
- Doble A: New insights into the mechanism of action of hypnotics. *J Psychopharmacol* 13(4 suppl 1):S11-S20, 1999.
- Doble A, Martin IL: Multiple benzodiazepine receptors: no reason for anxiety. *Trends Pharmacol Sci* 13:76-81, 1992.
- Dubovsky SL: Generalized anxiety disorder: new concepts and psychopharmacologic therapies. *J Clin Psychiatry* 51(suppl):3-10, 1990.
- Eison AS, Eison MS, Stanley M: Serotonergic mechanisms in the behavioral effects of buspirone and gepirone. *Pharmacol Biochem Behav* 24:701-707, 1986.
- Facklam M, Schoch P, Bonetti EP, et al: Relationship between benzodiazepine receptor occupancy and functional effects in vivo of four ligands of differing intrinsic efficacies. *J Pharmacol Exp Ther* 261:1113-1121, 1992.
- Fee JPH, Collier PS, Howard PJ, et al: Cimetidine and ranitidine increase midazolam bioavailability. *Clin Pharm Ther* 41:80-84, 1987.
- Finder RL, Moore PA: Benzodiazepines for intravenous conscious sedation: agonists and antagonists. *Compendium* 14:972, 974, 976-980, 1993.
- Finder RL, Moore PA, Close JM: Flumazenil reversal of conscious sedation induced with intravenous fentanyl and diazepam. *Anesth Prog* 42:11-16, 1995.
- Ganzberg SI, Dietrich T, Valerin M, et al: Zaleplon (Sonata) oral sedation for outpatient third molar extraction surgery. *Anesth Prog* 52:128-131, 2005.
- Geller E, Crome P, Schaller MD, et al: Risks and benefits of therapy with flumazenil (Anexate) in mixed drug intoxications. *Eur Neurol* 31:241-250, 1991.
- Gorman JM: New molecular targets for antianxiety interventions. *J Clin Psychiatry* 64(suppl 3):28-35, 2003.
- Granoff DM, McDaniel DB, Borkowf SP: Cardiorespiratory arrest following aspiration of chloral hydrate. *Am J Dis Child* 122:170-171, 1971.
- Hall DL, Rezvan E, Tatakis DN, et al: Oral clonidine pretreatment prior to venous cannulation. *Anesth Prog* 53:34-42, 2006.
- Hargreaves KM, Dionne RA, Mueller GP, et al: Naloxone, fentanyl, and diazepam modify plasma beta-endorphin levels during surgery. *Clin Pharmacol Ther* 40:165-171, 1986.
- Hersh EV, Moore PA: Drug interactions in dentistry: the importance of knowing your CYP's. *J Am Dent Assoc* 135:298-311, 2004.
- Haupt MI, Weiss NJ, Koenigsberg SR, et al: Comparison of chloral hydrate with and without promethazine in the sedation of young children. *Pediatr Dent* 7:41-46, 1985.

29. Jackson DL, Johnson BS: Inhalational and enteral conscious sedation for the adult dental patient. *Dent Clin North Am* 46:781-802, 2002.
30. Jastak JT, Pallasch T: Death after chloral hydrate sedation: report of case. *J Am Dent Assoc* 116:345-348, 1988.
31. Kales A, Bixler EO, Vela-Bueno A, et al: Comparison of short and long half-life benzodiazepine hypnotics: triazolam and quazepam. *Clin Pharmacol Ther* 40:378-386, 1986.
32. Kroboth PD, McAuley JW, Kroboth FJ, et al: Triazolam pharmacokinetics after intravenous, oral and sublingual administration. *J Clin Psychopharm* 15:259-262, 1995.
33. Levitan ES, Schofield PR, Burt DR, et al: Structural and functional basis for GABA_A receptor heterogeneity. *Nature* 335:76-79, 1988.
34. Lichtor JL, Zacny JP, Coalson DW, et al: The interaction between alcohol and residual effects of thiopental anesthesia. *Anesthesiology* 79:28-35, 1993.
35. Linnola M, Mattila MJ: Drug interaction on psychomotor skills related to driving: diazepam and alcohol. *Eur J Clin Pharmacol* 5:186-194, 1973.
36. Lopez-Rubalcava C, Saldivar A, Fernandez-Guasti A: Interaction of GABA and serotonin in the anxiolytic action of diazepam and serotonergic anxiolytics. *Pharmacol Biochem Behav* 43:433-440, 1992.
37. MacDonald RL, Olsen RW: GABA_A receptor channels. *Annu Rev Neurosci* 17:569-602, 1994.
38. Mandelli M, Tognoni G, Garattini S: Clinical pharmacokinetics of diazepam. *Clin Pharmacokinet* 3:72-91, 1978.
39. Mense S: Physiology of nociception in muscles. *Adv Pain Res Ther* 17:67-85, 1990.
40. Miller LG, Greenblatt DJ, Barnhill JG, et al: Chronic benzodiazepine administration, I: tolerance is associated with benzodiazepine receptor downregulation and decreased γ -aminobutyric acid_A receptor function. *J Pharmacol Exp Ther* 246:170-176, 1988.
41. Monjan AA: Sleep disorders of older people: report of a consensus conference. *Hosp Community Psychiatry* 41:743-744, 1990.
42. Moore PA: Adverse drug interactions in dental practice: interactions associated with local anesthetics, sedatives and anxiolytics. Part IV of a series. *J Am Dent Assoc* 130:541-554, 1999.
43. Moore PA: Selecting drugs for the pregnant dental patient. *J Am Dent Assoc* 129:1281-1286, 1998.
44. Moore PA: Therapeutic assessments of chloral hydrate premedication for pediatric dentistry. *Anesth Prog* 31:191-196, 1984.
45. Moore PA, Finder RL, Jackson DL: Multidrug intravenous sedation: determinants of the sedative dose of midazolam. *Oral Surg Oral Med Oral Pathol Oral Radiol Endod* 84:5-10, 1997.
46. Moore PA, Mickey EA, Hargreaves JA, et al: Sedation in pediatric dentistry: a practical assessment procedure. *J Am Dent Assoc* 109:564-569, 1984.
47. Moore PA, Studen-Pavlovich D: Pharmacosedation for pediatric patients. In Fonseca RJ, editor: *Oral and maxillofacial surgery*, vol 1, Philadelphia, 2000, Saunders.
48. Pevonka MP, Yost RL, Marks RG, et al: Interaction of chloral hydrate and furosemide: a controlled retrospective study. *Drug Intel Clin Pharm* 11:332-335, 1977.
49. Rudolph U, Crestani F, Mohler H: GABA(A) receptor subtypes: dissecting their pharmacological functions. *Trends Pharmacol Sci* 22:188-194, 2001.
50. Rush CR, Ali JA: A follow-up study of the acute behavioral effects of benzodiazepine-receptor ligands in humans: comparison of quazepam and triazolam. *Exp Clin Psychopharmacol* 7:257-265, 1999.
51. Salzman C: The APA Task Force report on benzodiazepine dependence, toxicity, and abuse. *Am J Psychiatry* 148:151-152, 1991.
52. Sanders LD, Whitehead C, Gildersleve CD, et al: Interaction of H₂-receptor antagonists and benzodiazepine sedation: a double-blind placebo-controlled investigation of the effects of cimetidine and ranitidine on recovery after intravenous midazolam. *Anaesthesia* 48:286-292, 1993.
53. Sessle BJ: Central nervous system mechanism of muscular pain. *Adv Pain Res Ther* 17:87-105, 1990.
54. Shader RI, Greenblatt DJ: Use of benzodiazepines in anxiety disorders. *N Engl J Med* 328:1398-1405, 1993.
55. Short TG, Maling T, Galletly DC: Ventricular arrhythmia precipitated by flumazenil. *BMJ* 296:1070-1071, 1988.
56. Smith AJ, Simpson PB: Methodological approaches for the study of GABA_A receptor pharmacology and functional responses. *Anal Bioanal Chem* 377:843-851, 2003.
57. Smith MT: Chloral hydrate warning. *Science* 250:359, 1990.
58. Stanko JR: Review of oral skeletal muscle relaxants for the craniomandibular disorder (CMD) practitioner. *Cranio* 8:234-243, 1990.
59. Stopperich PS, Moore PA, Finder RL, et al: Oral triazolam pre-treatment for intravenous sedation. *Anesth Prog* 40:117-121, 1993.
60. Study RE, Barker JL: Cellular mechanisms of benzodiazepine action. *JAMA* 247:2147-2151, 1982.
61. Sved AF, Tsukamoto K: Tonic stimulation of GABA_B receptors in the nucleus tractus solitarius modulates the baroreceptor reflex. *Brain Res* 592:37-43, 1992.
62. Takahashi T, Koyama N: Effects of tizanidine, a central muscle relaxant, upon spinal reflexes [in Japanese]. *Masui* 41:751-765, 1992.
63. Tanaka E: Toxicological interactions between alcohol and benzodiazepines. *J Toxicol Clin Toxicol* 40:69-75, 2002.
64. Turski L, Klockgether T, Schwarz M, et al: Substantia nigra: a site of action of muscle relaxant drugs. *Ann Neurol* 28:341-348, 1990.
65. Turski L, Schwarz M, Turski WA, et al: Effect of aminophylline on muscle relaxant action of diazepam and phenobarbitone in genetically spastic rats: further evidence for a purinergic mechanism in the action of diazepam. *Eur J Pharmacol* 103:99-105, 1984.
66. Udall JA: Warfarin-chloral hydrate interaction: pharmacological activity and clinical significance. *Ann Intern Med* 81:341-344, 1974.
67. Varhe A, Olkkola KT, Neuvonen PJ: Oral triazolam is potentially hazardous to patients receiving systemic antimycotics ketoconazole or itraconazole. *Clin Pharm Ther* 56:601-607, 1994.
68. Villikka K, Kivisto KT, Backman JT, et al: Triazolam is ineffective in patients taking rifampin. *Clin Pharm Ther* 61:8-14, 1997.
69. Wildmann J: Increase of natural benzodiazepines in wheat and potato during germination. *Biochem Biophys Res Commun* 157:1436-1443, 1988.
70. Yocca FD: Neurochemistry and neurophysiology of buspirone and gepirone: interactions at presynaptic and postsynaptic 5-HT_{1A} receptors. *J Clin Psychopharmacol* 10(3 suppl):6S-12S, 1990.
71. Zolpidem for insomnia, *Med Lett Drugs Ther* 35:35-36, 1993.
72. Zorumski CF, Isenberg KE: Insights into the structure and function of GABA-benzodiazepine receptors: ion channels and psychiatry. *Am J Psychiatry* 148:162-173, 1991.

GENERAL REFERENCES

- Alger BE, Möhler H, editors: *Pharmacology of GABA and glycine neurotransmission*. In *Handbook of experimental pharmacology*, vol 150, New York, 2001, Springer.
- Biggio G, Costa E, editors: *GABA and benzodiazepine receptor subtypes: molecular biology, pharmacology, and clinical aspects*. In *Advances in biochemical psychopharmacology*, vol 46, New York, 1990, Raven Press.
- Halbreich U, Montgomery SA: *Pharmacotherapy for mood, anxiety, and cognition disorders*, Washington, DC, 2000, American Psychiatric Press.
- McKim WA: *Drugs and behavior: an introduction to behavioral pharmacology*, ed 5, Upper Saddle River, NJ, 2003, Prentice Hall.
- Miller RD: *Miller's anesthesia*, ed 6, Philadelphia, 2005, Churchill Livingstone.
- Olsen RW, Venter JC: *Benzodiazepine/GABA receptors and chloride channels: structural and functional properties*, New York, 1986, Alan R. Liss.
- Raffa RB: Thermodynamics of benzodiazepine receptor interactions. In Raffa RB, editor: *Drug receptor thermodynamics: introduction and applications*, Chichester, England, 2001, John Wiley & Sons.
- Smith MC, Riskin BJ: The clinical use of barbiturates in neurological disorders, *Drugs* 42:365-378, 1991.
- Trimble MR, Hindmarch I: *Benzodiazepines*, Philadelphia, 2000, Wrightson Biomedical.

Anticonvulsants*

VAHN A. LEWIS

Epilepsy comprises a group of disorders characterized by the periodic and abnormal discharge of nervous tissue. Violent involuntary muscle contractions, or *convulsions*, are characteristic of most forms of epilepsy, and the epileptic attack, accompanied in most cases by convulsions, is called a *seizure*. The abnormal neuronal discharge causes electroencephalogram (EEG) disturbances and various changes in activity of tissues, receptors, or brain oxygenation that can be detected by a variety of tomographic methods (e.g., positron emission tomography [PET], single photon emission computed tomography, functional magnetic resonance imaging [MRI] and blood oxygen level dependent [BOLD] functional MRI, magnetoencephalography) Various epileptic syndromes exist, each defined by such factors as cause, seizure type, age of onset, and clinical manifestations. Seizures can have many causes and constitute evidence of an underlying neurologic disorder, not a disease per se. The signs and symptoms of these syndromes frequently overlap, and differential diagnosis of the form of epilepsy is sometimes difficult.

Anticonvulsants are being used for some nonseizure disorders, such as chronic neuropathic pain (including migraine) and bipolar disorder. When used to treat pain, these agents may be referred to “analgesics.” Their actions and use are significantly different from opiates or nonsteroidal anti-inflammatory drugs. When used to treat bipolar disorder, anticonvulsants have been referred to as “mood stabilizers.” Anticonvulsants have also been evaluated in some disorders of impulse control, such as impulsive aggressiveness.

CLASSIFICATION OF EPILEPTIC DISORDERS

The classification proposed in 1989 by the Commission on Classification and Terminology of the International League Against Epilepsy (ILAE) is complex because of the variable characteristics of many epileptic syndromes. A simplified approach more suited to this discussion limits consideration to the seizures themselves (Table 14-1). Seizure patterns are broadly divided into two major groups: (1) *partial seizures*, in which convulsions begin in a localized region of the brain, involve restricted areas of the body, are initially unilateral, and yield EEG recordings of rhythmic activity that is restricted at least initially to one hemisphere, and (2) *generalized seizures*, with convulsions often involving the entire body and EEG recordings having characteristic bilateral patterns. A modified ILAE classification scheme is under development to classify

epilepsy based on Axis 1, descriptive terminology for ictal events; Axis 2, seizure description; Axis 3, syndromes and diseases; and Axis 4, life impairment.¹⁰

Generalized Seizures

The most common type of generalized seizure is *tonic-clonic* (grand mal), which has a sudden onset (sometimes preceded by an aura, a brain sensation recognized by the patient), beginning with the so-called epileptic cry caused by the forcing of air through the tonically contracted muscles of the larynx. This cry is followed by a loss of consciousness, loss of postural tone, and tonic-clonic contraction of skeletal muscles. Autonomic responses commonly include sweating, loss of sphincter control (often resulting in urination and defecation), pupillary dilation, and loss of light reflexes. The EEG pattern displays bilateral, synchronous high-voltage polyspike activity. Injury may occur as a result of the uncontrolled movements or loss of postural tone. Tongue biting and fracturing of teeth may result from the powerful contraction of the muscles of mastication. After the tonic-clonic contractions, the patient usually awakens, is confused and lethargic, and goes to sleep for approximately 30 minutes. On reawakening, the patient is again lethargic, confused, and disoriented and often has headache and muscle ache. Grand mal epilepsy is often responsive to pharmacotherapy.

A second common form of generalized seizure is *absence* seizure, which characteristically occurs in childhood. There are several varieties of absence seizures. The most common form (petit mal) is characterized by an abrupt but very short (5 to 10 seconds) loss of consciousness, often with minor muscular twitching (commonly restricted to the eyelids and face), and a 3-Hz spike-and-wave EEG pattern but no loss of postural control. Severe cases may involve hundreds of seizures per day. The term *absence* is appropriate because of the brief loss of consciousness and the vacant stare of the patient during a seizure. Similar to tonic-clonic seizures, absence seizures are often responsive to pharmacotherapy.

Uncommon types of generalized seizures include (1) *myoclonic*, characterized by sudden, brief, and violent spasms of one or more muscles or muscle groups, and (2) *atonic*, characterized by a sudden, brief loss of muscle tone. These varieties are usually associated with diffuse and severe progressive diseases of the brain and are often refractory to drug treatment. Rarely seizures are precipitated by triggers, such as catamenial seizures (associated with menstruation) or reflex seizures, which can be triggered by tones, visual stimulation (e.g., video games, flashing lights), or touching.

Generalized seizures occurring in the form of repeated or continuous attacks are referred to as *status epilepticus*. Tonic-clonic status epilepticus is rare but life-threatening. Status

*The author wishes to recognize Dr. Leslie Felpel for his past contributions to this chapter.

TABLE 14-1

Classification of Epileptic Seizures

CLASSIFICATION	CLINICAL ASPECTS
I. Partial (focal, local) seizures	Involves one side of brain at onset
A. Simple partial seizures (e.g., Jacksonian)	Consciousness not impaired; specific or localized motor, sensory
B. Complex partial seizures (e.g., psychomotor, temporal lobe)	Consciousness impaired, automatisms, autonomic or psychological signs or symptoms; patients may report aura beforehand
C. Partial seizures evolving to generalized seizures	See generalized seizures; patients may report aura beforehand
II. Generalized seizures	Involve both sides of brain at onset
A. Tonic-clonic seizures (grand mal)	Consciousness is lost; bilateral sharp tonic contraction of muscles, generalized from onset, followed by clonic contractions; patient may report aura before seizure
B. Absence seizures (e.g., petit mal)	Consciousness impaired, postural muscles not impaired, EEG spike and slow wave complexes at approximately 3 Hz
C. Myoclonic seizures	Sudden, brief contractions of individual muscles or groups producing shocklike spasms in muscles of face, trunk, and extremities
D. Clonic seizures	Repetitive clonic jerking (alternating contractions of opposing muscles)
E. Tonic seizures	Violent muscular contraction (simultaneous contraction of flexors and extensors) with limbs in strained position
F. Atonic seizures (astatic)	Sudden loss of muscle tone, consciousness sometimes lost, patients sustain fall injuries
III. Unclassified seizures	Cannot be classified because of insufficient data or atypical pattern of seizure

Adapted from Commission on Classification and Terminology of the International League Against Epilepsy, *Epilepsia* 22:489–501, 1981. EEG, Electroencephalogram.

epilepticus may develop in patients with convulsive disorders, with acute disease affecting the brain (meningitis, encephalitis, toxemia of pregnancy, uremia, acute electrolyte imbalances), after abrupt withdrawal of depressant or anticonvulsant medication (barbiturates, benzodiazepines, opioids), or rarely after local anesthetic administration. Status epilepticus can occur in the absence of a prior history of seizures. The drugs most widely used to treat status epilepticus are intravenous benzodiazepines (lorazepam, diazepam, and midazolam), phenytoin, fosphenytoin, phenobarbital, and valproic acid.^{17,35,48} In refractory status epilepticus, the patient may have to undergo general anesthesia (e.g., midazolam, propofol, thiopental, and pentobarbital). An anesthetic dose of pentobarbital or propofol is effective and has a more rapid onset than phenobarbital. Because large doses of these drugs are usually required, there is the danger of respiratory depression and respiratory arrest, especially with barbiturates or propofol. Grand mal status epilepticus is best treated in a hospital setting.

Partial Seizures

The partial epilepsy syndromes are divided into three broad categories. The first type, called *simple partial seizure*, is characterized by seizures limited to certain muscles or involving specific sensory changes, psychic symptoms, or autonomic activity. The seizure may remain localized, or it may spread to contiguous brain tissue, causing progressive symptoms as the wave of depolarization “marches” along the cerebral cortex. This latter seizure type is referred to as *Jacksonian epilepsy*, after John Hughlings Jackson, who first described the phenomenon. The motor version begins with contraction of an isolated muscle, followed by the gradual involvement of other muscles. Jacksonian sensory epilepsy gives rise to sensations from various areas of the body. By definition, the affected individual remains conscious.

A second type of partial seizure, known as *complex partial seizure*, usually originates in the temporal or frontal lobe but spreads to broader areas, frequently in a bilateral pattern. Consciousness is impaired, flashbacks or psychotic-like behavior may occur, and autonomic dysregulation and automatisms

(involuntary, repetitive, and coordinated movements) are common.

A third type of partial seizure is one that progresses to a generalized attack. The initial inciting seizure may be simple or complex. The final clinical result depends on the type of generalized seizure that is triggered. Partial seizures are more refractory to drugs than common generalized seizures.

Secondary Seizures

Seizures may be caused by a fundamental disorder in the ability of the brain to regulate excitation because of genetic causes or abnormal development. Seizures may also occur, however, as a symptom of another medical condition. Seizures in an otherwise normal individual may be precipitated by inhibition of the respiratory chain (e.g., anoxia, metabolic poisons), hyperbaric oxygen, intoxication, fever, cerebral infection or inflammation, traumatic brain injury, repeated electrical brain stimulation, drug use, systemic administration of local anesthetics, overdose of stimulant or antidepressant drugs, or withdrawal of depressant drugs (e.g., alcohol, barbiturates, opioids). These seizures may resolve after resolution of the underlying cause or may continue if the insult or seizures have resulted in brain injury.

PATHOPHYSIOLOGY

The pathophysiologic characteristics of epilepsies are not well understood. Idiopathic epilepsy has a primary genetic basis, with some influence of environmental factors.²⁶ The various types of epilepsies share many features but also differ in many respects. The fact that many anticonvulsant drugs are selective for specific seizure types¹² suggests that the origin and progression of all seizures are not identical. Several hypotheses have been proposed to explain why seizures occur. These hypotheses focus on defects in (1) ionic conductance of the neuronal membrane, including Na⁺, Ca⁺⁺, K⁺, Cl⁻, and H⁺; (2) inhibitory neuronal circuits, especially those involving the inhibitory neurotransmitter γ -aminobutyric acid (GABA); (3)

excitatory mechanisms, especially those involving the excitatory neurotransmitter glutamate; (4) altered synaptic function; (5) depressed energy metabolism; and (6) other processes supporting presynaptic or postsynaptic function, such as other neurotransmitters with modulatory roles, peptides, hormones, growth factors, second messengers, nuclear changes, glial function, and gap junctional function.

Different brain structures may participate as seizure sources. The cortex is often involved. In complex partial epilepsy, unusual activity in the temporal lobe and limbic structures is found. A more recent gene chip study identified abnormal release of glutamate from astrocytes as a significant change in temporal lobe epileptic foci.²⁸ For absence seizures, changes in the thalamus, basal ganglia, and substantia nigra pars reticulata may be involved.⁵⁰ Audiogenic seizures seem to involve the mesencephalon and basal ganglia.

Diagnostic imaging is being used to help localize the sites of abnormal brain function in epilepsy. Positron labeled 2-[¹⁸F]fluoro-2-deoxy-D-glucose has been approved as an aid for diagnosis of epilepsy by PET. Generally, epileptic zones show hypometabolism in the ictal state. Another PET imaging technique involves the use of the benzodiazepine antagonist flumazenil, which visualizes generally decreased binding in epileptic tissues.⁴⁰ Additional tracers and imaging techniques are being developed.

In otherwise normal brains, seizures can sometimes be initiated by repeated electrical stimulations, a phenomenon called *kindling*. Epilepsy may result when a genetic predisposition or environmental factor triggers a seizure, which is followed by additional processes such as seizure-induced neuronal death and abnormal postseizure tissue repair. Repeated seizures can produce cumulative damage. By studying patients, animal models of epilepsy, and the mechanism of action of the anticonvulsant drugs, new ideas for therapy are developed. Individual anticonvulsants often have more than one possible pharmacologic action that may explain their anticonvulsant effect.

ANTICONVULSANT THERAPY

Anticonvulsants control, but do not cure epilepsy. They may play a neuroprotective role, however, by limiting cumulative pathology resulting from the seizures. The primary objective of anticonvulsant therapy is to suppress seizures while causing minimal impairment of central nervous system (CNS) function or other deleterious side effects. With the currently available anticonvulsants, significant seizure control can be obtained in 70% to 80% of cases. Many patients with epilepsy have to take medication for life to ensure control of seizures.

Phenobarbital, introduced in 1912, was the first drug used extensively to treat seizures. Between 1938 and 1960, numerous anticonvulsant agents were introduced, including the hydantoins, succinimides, and primidone. Between 1960 and 1992, several novel anticonvulsants were introduced (e.g., carbamazepine, valproic acid, clonazepam, clorazepate). With the passages of the Expedited Drug Approval Act and Prescription Drug User Fee Act in 1992, the approval process was facilitated, and 10 agents have since been introduced (with several more currently in clinical trials). Many of these drugs have been approved as adjunctive agents for use with earlier drugs in the treatment of "partial onset seizures"; these indications have broadened with increased experience in their use. In some cases the newer agents are referred to as second-generation and third-generation agents, and in several cases newer agents are related to older agents, such as phenytoin and fosphenytoin; carbamazepine and oxcarbazine; and meprobamate, felbamate, and fluorofelbamate (the last mentioned in premarketing trials).³⁴

Drugs are described as having characteristic spectra for treating the various forms of seizures (Figure 14-1). Prescribing antiepileptic drugs for conditions outside their spectra may lead to problems beyond simple therapeutic failure. In particular, absence seizures can be exacerbated by many of

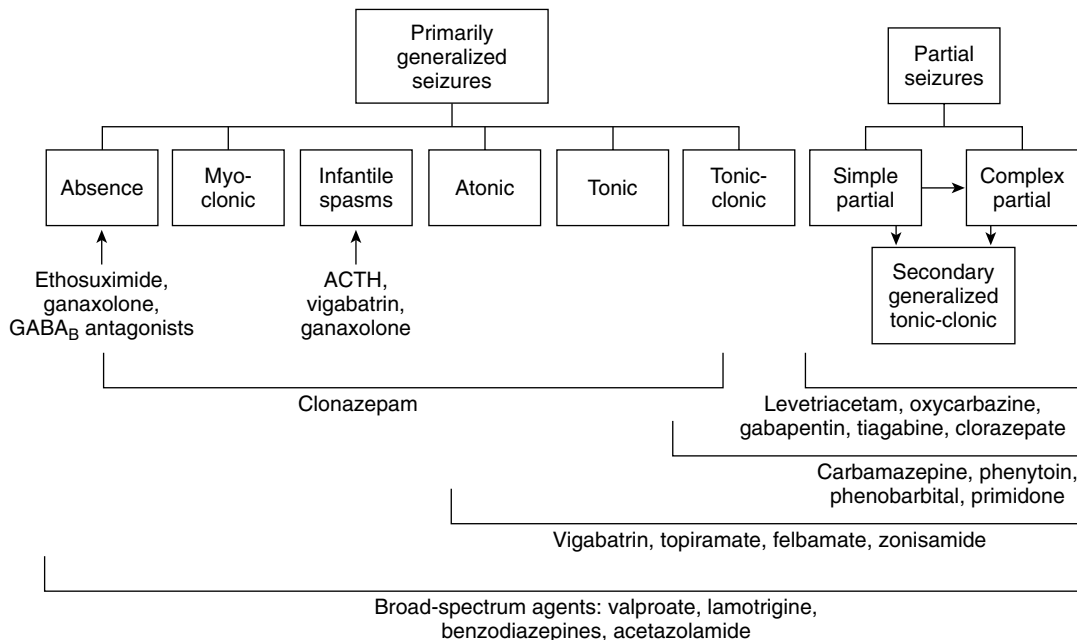

FIGURE 14-1 Therapeutic spectra of anticonvulsant drugs. Anticonvulsant agents need to be matched to the convulsive disorder being treated. Phenytoin, phenobarbital, carbamazepine, oxycarbazine, vigabatrin, gabapentin, and tiagabine are ineffective in, but can aggravate, absence and myoclonic seizures. Benzodiazepines and acetazolamide have broad spectra, but tolerance develops to their actions, so they cannot be used for maintenance therapy. ACTH, Adrenocorticotropic hormone; GABA_B, γ-aminobutyric acid_B receptor.

the drugs used to treat tonic-clonic seizures. Some children “outgrow” absence epilepsy but have a tendency to develop other forms of epilepsy in later years. The discovery of valproic acid, which can control many forms of epilepsy, was a major breakthrough for patients in whom absence seizures convert to tonic-clonic seizures. The careful withdrawal of anticonvulsant therapy in children with a history of tonic-clonic epilepsy, but who have been seizure-free for several years, is sometimes successful. Finally, adults whose seizures were few in number before initiation of treatment and are well controlled with a single anticonvulsant may be weaned after 2 years of therapy with a reasonable expectation (>50%) of avoiding relapse.

Different anticonvulsant drugs can be used for different aspects of seizure disorders. *Anticonvulsant* is a term that has been used for agents that terminate seizures or status epilepticus events.¹⁷ Antiepileptogenic agents are used to prevent the development of epilepsy after a seizure-triggering event. The term *anti-ictogenic* refers to drugs that prevent the reoccurrence of seizures in an individual with a diagnosis of epilepsy. In this context, benzodiazepines are used as anticonvulsants for the emergency treatment of seizures in the dental office, although their use as anti-ictogenic drugs is limited by the development of tolerance to their anticonvulsant actions.

Typically about 50% of patients respond to traditional agents, and between 20% and 40% of the remainder respond to the addition of a supplemental agent. The drugs used to treat epilepsy and their proposed mechanisms of action and current indications are summarized in Table 14-2.

Because anticonvulsants are often taken for prolonged periods, the likelihood of detecting and documenting side effects and adverse reactions is greater than for agents used for shorter periods. Anticonvulsants may have long lists of potential adverse reactions, but the incidence of many of these reactions is low. Adverse reactions can result from the direct action of the drug, such as dizziness, drowsiness, and ataxia. These dose-related reactions are common but not usually dangerous. Reported adverse reactions may also include withdrawal phenomena, which make the reactions seem paradoxical. Some reactions reflect manifestations of allergic reactions, which may range from a rash to life-threatening Stevens-Johnson syndrome. Other adverse reactions are detected by standard blood tests; these range from benign elevation of liver enzymes to serious hepatic failure.

Several antiepileptic drugs can alter liver enzyme function. A cluster of adverse reactions and drug interactions can result from induction of hepatic enzymes, which may alter the metabolism of (1) the inducing anticonvulsant agent; (2) other drugs, altering their half-lives or toxicity; (3) vitamins (folate, vitamins D or K), which can produce vitamin deficiency disorders such as megaloblastic anemia, decreased bone density, fetal toxicity, or bleeding disorders; and (4) hormones (thyroid hormone or birth control pills). Drug effects on liver microsomal enzyme activity are summarized in Box 14-1. Carbamazepine, phenobarbital, phenytoin, and primidone are well-documented induction agents for the oxidative cytochrome P450 pathway and for phase II synthetic or conjugation elimination pathways (including uridine diphosphate glucuronosyltransferase [UGT]) and in some cases for P-glycoprotein or multidrug resistance proteins (MDR), which may play a role in multiple anticonvulsant drug resistance and poor seizure control. Phenobarbital, phenytoin, carbamazepine, felbamate, lamotrigine, gabapentin, and topiramate bind to P-glycoproteins that seem to facilitate their elimination from the brain. Lamotrigine selectively inhibits UGT. Valproate and topiramate may inhibit oxidative enzymes, prolonging the actions of other drugs. Oxcarbazepine and phenytoin may also inhibit some liver enzymes, as shown in Box 14-1.

BOX 14-1

Adverse Effect of Antiepileptic Drugs on Liver Microsomal Enzymes

Drugs That Can Induce Liver Microsomal Enzymes

Phenobarbital
Phenytoin
Carbamazepine
Oxcarbazepine*
Lamotrigine

Drugs That Can Inhibit Liver Microsomal Enzymes

Oxcarbazepine[†]
Topiramate
Valproic acid
Phenytoin[†]

*Induces to a lesser degree than carbamazepine.

[†]Inhibition and induction have been reported. This is possible because different cytochrome P450 enzyme classes are involved in each effect.

Additional adverse reactions associated with anticonvulsant drugs include gingival overgrowth, aplastic anemia, hepatotoxicity, renal stones, visual disturbances, and fevers. These may represent pharmacogenomic processes or poorly understood aspects of their pharmacologic features in susceptible patients. Sometimes the reaction is manifested as teratogenicity or cancer; these delayed toxicities are dose independent, but host dependent. More recent studies have found new evidence that anticonvulsant drug use contributes to an increased incidence of birth defects.¹⁹ Behavioral, neurologic, and psychiatric reactions are common and can occur with several of the anticonvulsants. Drugs that facilitate GABA or inhibit glutamate pathways may be more likely to induce amnesia.

Anticonvulsant drugs can paradoxically promote seizure activity or precipitate new seizure types. Carbamazepine can increase absence and other seizures. Other anticonvulsants that may exacerbate seizures include phenytoin, phenobarbital, vigabatrin, oxycarbazine, lamotrigine, gabapentin, felbamate, and tiagabine.¹² Increased seizure frequency is more likely in patients with severe seizure disorders.

Newer agents are expected to have more favorable safety profiles based on their different mechanisms of action and their lessened interaction with the microsomal drug metabolizing system. A full understanding of the clinical toxicology of drugs can take years to develop, however. In the case of vigabatrin, early reports about the drug can be found in the 1970s, but the first report of patients commonly ($\geq 30\%$) developing irreversible visual field defects was published in 1997.¹⁵ Gabapentin was found to have a low side-effect profile in evaluation trials but is now being used at doses that are many times greater than were typically studied. Experts have noted that much of what is known about the new anticonvulsant drugs has been derived from manufacturer-sponsored trials. Differences in studied patient populations, dosages used, and the end points reported make clinically meaningful comparisons problematic; larger comparison studies by independent groups are still needed.⁹

CHEMISTRY AND STRUCTURE-ACTIVITY RELATIONSHIPS

Figure 14-2 shows the common structure present in all the clinically effective anticonvulsants developed before 1960. Substitution at position 1 of the ring results in the various classes of anticonvulsants indicated in Table 14-3.

TABLE 14-2

Mechanisms of Action and Uses for Anticonvulsant Drugs

DRUG	ION CHANNEL INHIBITION		INCREASED GABA EFFECT	DECREASED EXCITATORY AMINO ACID EFFECT	USES*			COMMENTS
	Na ⁺	Ca ⁺⁺			SEIZURE TYPE	ABSENCE	OTHER	
Hydantoins								
Phenytoin	x		x	x	TC, CP, SE		NP (T), rarely cardiac arrhythmias	Prompt and extended-dose forms
Fosphenytoin	x		x	x	SE			IM and IV form for injection
Ethotoin	x		x	x	TC, CP			
Mephenytoin	x		x	x	TC, CP, JM			
Iminostilbenes								
Carbamazepine	x		x		TC, CP		BI, T, other NP	Prodrug; action similar to carbamazepine
Oxcarbazepine	x				P, P-AJ			
Barbiturates								
Phenobarbital			x	x [†]	TC, CF, SE		LA, F	
Primidone			x	x [†]	TC, CP, focal			
Mephobarbital			x	x [†]				
Carboxylic Acid								
Valproic acid	x	TT	x (?)	x (?)	TC, SE, P	x	BI, NP, F, M, MY AD, AK	First broad-spectrum anticonvulsant
Succinimides								
Ethosuximide		TT				x		
Methsuximide		x				x		
Phensuximide		x				x		
Oxazolinediones								
Trimethadione		x				x		Rarely used because of serious toxicity
Benzodiazepines								
Lorazepam			x	x (?)	SE		LA	
Clonazepam			x	x (?)	CP (?)	x	AK	
Clorazepate			x	x (?)	P			
Diazepam			x	x (?)	SE		LA	
Midazolam			x	x (?)	SE		F	May be effective after buccal administration but can reduce respiration rate
Carbonic Anhydrase Inhibitors								
Acetazolamide [‡]						x	CT	Rapid tolerance
Newer Agents								
Lamotrigine	x		HVA	x (?)	P-AJ, LG	x	NP, BI, AK	Restricted LG use in children <16 years old
Gabapentin		$\alpha 2\delta$	x		P		NP (T) (PN)	May be useful for neuropathic pain
Pregabalin		$\alpha 2\delta$	x		P		NP (D,PN), FY	
Vigabatrin			x		P-AJ, CP, LG, WS			Irreversible GABA transaminase inhibitor
Felbamate	x	HVA	x		NMDA			Use limited by toxicity
Tiagabine			x		P-AJ			Blocks GABA reuptake
Topiramate	x	HVA	x	x [†]	P, TC		NP (M), AK	Unique monosaccharide structure
Zonisamide	x	TT	x		P-AJ			Sulfonamide-like structure, some antidepressant-like action and carbonic acid inhibition
Levetiracetam		x			P-AJ, MY, TC			SV2 protein inhibitor

*Several anticonvulsants are used to treat bipolar disorder, neuralgia (and chronic pain), and impulse control disorders. They may be referred to by the term *mood stabilizers*.

[†]Derived from the sulfonamides.

[‡] α -Amino-3-hydroxy-5-methyl-4-isoxazole propionate (AMPA) or kainate glutamate process inhibition.

AD, Aggression in dementia; AJ, adjunctive use; AK, akinetic; $\alpha 2\delta$, alpha 2 delta subunit; BI, bipolar disorder; CF, corticofocal; CP, complex partial psychomotor; CT, catamenial; D, diabetic neuropathy; F, febrile; FY, fibromyalgia; HVA, high voltage activated; IM, impulse disorder; JM, Jacksonian motor; LA, local anesthetic-induced seizures; LG, Lennox-Gastaut syndrome (children); M, migraine; MY, myoclonic; NMDA, N-methyl-D-aspartate; NP, neuropathic pain; P, partial seizures; PN, postherpetic neuropathy; SE, status epilepticus; SV2, synaptic vesicle protein 2; T, trigeminal neuralgia; TC, tonic-clonic; TT, T-type; WS, West's syndrome (children).

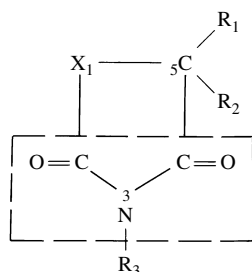

FIGURE 14-2 Basic ring structure common to classic anti-convulsants.

TABLE 14-3

Classes of Anticonvulsants According to Substitution at Position X_1 of the Chemical Structure (See Figure 14-2)*

ANTICONVULSANT	SUBSTITUTION
Barbiturates	—CO—NH—
Hydantoin	—NH—
Succinimides	—CH ₂ —

*See Figure 14-2.

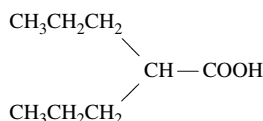

FIGURE 14-3 Structural formula of valproic acid.

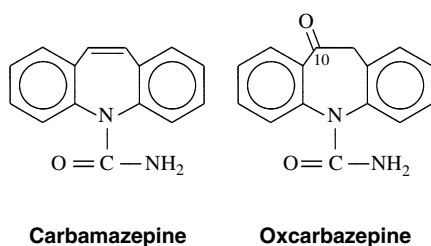
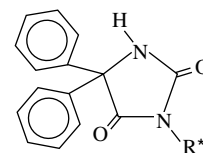

FIGURE 14-4 Structural formulas of carbamazepine and oxcarbazepine.

A phenyl ring at R_1 or R_2 , such as appears in phenytoin, is a highly desirable, although not crucial substituent for protection against tonic-clonic epilepsy. An alkyl substituent at R_1 or R_2 , such as appears in ethosuximide, is desirable (but not crucial) for control of absence seizures. A great deal of detailed structure activity information was obtained to identify opportunities for developing improved agents. More recent discoveries have included several agents with unrelated structures, however. Valproic acid is *n*-dipropylacetic acid (Figure 14-3), a simple branched-chain carboxylic acid, and carbamazepine (Figure 14-4) is chemically related to the tricyclic antidepressants and is used in the treatment of certain affective disorders (see Chapter 12).

HYDANTOINS

Phenytoin (diphenylhydantoin) is one of the first drugs to be discovered through an organized scientific search for a



Phenytoin

$R^* = \text{H}$

Fosphenytoin

$R^* = -\text{OPO}_3^- + 2 \text{Na}^+$

FIGURE 14-5 Structural formulas of phenytoin and fosphenytoin.

therapeutically effective compound. Introduced in 1938, phenytoin was immediately recognized as a breakthrough in anticonvulsant therapy because it suppressed seizures without causing as much sedative effect as phenobarbital. Phenytoin is an effective anticonvulsant against tonic-clonic and partial seizures and an important pharmacologic tool that has increased understanding of the underlying mechanisms responsible for epileptic syndromes. Mephenytoin and ethosuximide are hydantoin related to phenytoin but are now rarely used. Fosphenytoin, the newest hydantoin, is a phosphorylated prodrug that is rapidly converted to phenytoin by endogenous phosphatase enzymes. It is water soluble and is better tolerated by parenteral administration. The structures of phenytoin and fosphenytoin are shown in Figure 14-5.

Pharmacologic Effects

Although the mechanism of action responsible for the anticonvulsant effect of phenytoin is not established, many of its known pharmacologic properties may contribute to it. In neurophysiologic studies, phenytoin prevents the spread of abnormal neuronal depolarization from the epileptic focus to surrounding normal neuronal populations, but spontaneous discharge at the focus is not depressed. Additionally, phenytoin suppresses the duration of neuronal afterdischarge. Phenytoin may reduce the spread of neuronal activity and afterdischarge by blocking post-tetanic potentiation, a phenomenon in which synaptic transmission is enhanced as a result of repetitive presynaptic activation (as would occur at an abnormally firing epileptic focus).

The major site of action of phenytoin seems to be at the Na^+ channel, and various actions have been shown at this site. The only mechanism evident at concentrations equivalent to therapeutic plasma concentrations (10 $\mu\text{g}/\text{mL}$ to 20 $\mu\text{g}/\text{mL}$) is a reduction, however, in sustained high-frequency neuronal firing caused by phenytoin binding reversibly to inactivated Na^+ channels.²⁷ Phenytoin delays the neuronal recovery process whereby Na^+ channels cycle from the refractory, inactivated state to the responsive, closed configuration, which is required before an action potential can be generated again. Phenytoin binding to inactivated Na^+ channels is frequency and voltage dependent so that it becomes greater as neuronal depolarization and firing frequency increase. These properties are ideally suited for anticonvulsant activity because high-frequency neuronal discharge is characteristic of the epileptic disorders.

High extracellular K^+ , typically found during seizures, also increases the effectiveness of phenytoin. Normal (slower) neuronal activity is unaffected by phenytoin, which may explain its minimal sedative effects. At slightly greater than therapeutic concentrations, phenytoin interferes with Ca^{++} channels and the interaction of Ca^{++} and calmodulin, which disrupts Ca^{++} -dependent phosphorylation of proteins necessary for neurotransmitter release from presynaptic nerve terminals. There are also some reports of phenytoin facilitating GABA or inhibiting glutamate processes.⁸ Phenytoin has also

been found to alter the metabolism of some growth factors, which could play a role in neuroprotective actions of the drug (see later).

Although many mechanisms have been shown for phenytoin, prolonging Na⁺ channel inactivation is the most compelling explanation for its anticonvulsant effect. This action is one of the few that occur at therapeutic concentrations, and the characteristics of this mechanism are ideally suited for anticonvulsant activity.

Absorption, Fate, and Excretion

Phenytoin is absorbed slowly from the gastrointestinal tract. The absorption rate varies with the individual, but differences in formulation of the dosage unit account for much of this fluctuation. The U.S. Food and Drug Administration (FDA) requires that phenytoin capsules be labeled as "extended" or "prompt" depending on their absorption rate. An extended-action capsule has slow absorption, with peak blood concentrations obtained in 4 to 12 hours. A prompt-action capsule has rapid absorption, with peak concentrations occurring in 1.5 to 3 hours. Because noncompliance is a major problem in anticonvulsant therapy, it is sometimes advisable to administer the total daily dose of phenytoin at one time. Once-a-day administration is inappropriate for suspensions of phenytoin (commonly used for children) because plasma concentrations may reach toxic values. Changing from one dosage form or manufacturer to another has led to suboptimal plasma concentrations from differences in bioavailability.

Phenytoin given by intravenous injection can produce thrombophlebitis, arrhythmia, and hypotension. These side effects are largely caused by the vehicle needed to solubilize phenytoin for injection. Intramuscular injection of phenytoin may precipitate in the muscle, cause pain, and be poorly absorbed. Fosphenytoin is a water-soluble analogue that may be given intravenously or intramuscularly. After intramuscular administration, it produces much less pain and is absorbed rapidly.³⁵

Phenytoin is highly protein bound (90%), which may play a role in interactions with drugs that compete for plasma protein binding sites. Phenytoin is inactivated in the liver to its primary metabolite, the parahydroxyphenyl derivative. Phenytoin can induce drug-metabolizing enzymes, including CYP3A4 and UGT. After conjugation with glucuronic acid, phenytoin and its metabolites are eliminated in the urine. Phenytoin removal from the brain may be facilitated by P-glycoproteins and MDR proteins, which may be induced in epileptic tissue. Phenytoin is also excreted by the salivary glands, which may be a contributing factor in producing gingival overgrowth (hyperplasia) (see later). With peak concentrations seen at 3 to 12 hours, the elimination half-life of phenytoin (and fosphenytoin) generally ranges from 6 to 24 hours. Near the effective dose, phenytoin often exhibits capacity-limited metabolism because the enzymes responsible for its metabolism are readily saturated. The drug's half-life can become longer, and, if blood concentrations are increased beyond the saturation threshold, rapid drug accumulation may increase the likelihood of adverse reactions.

Adverse Effects

Ataxia, nystagmus, incoordination, and unsteadiness occur with phenytoin overdose. These sequelae may result from phenytoin-induced changes on Purkinje cells of the cerebellum (such changes may also be caused by repeated seizures). Drowsiness, lethargy, diplopia, confusion, and (rarely) hallucinations are other manifestations of phenytoin toxicity. Phenytoin in usual doses has little detrimental effect on the cardiovascular system; however, it can cause cardiovascular

collapse, irreversible coma, and death if administered in massive intravenous doses.

Phenytoin promotes gingival overgrowth in approximately 10% to 30% of all patients. Gingival overgrowth is usually more severe in children, for whom its incidence may be 50%. The primary mechanism responsible for this side effect is unknown. Several hypotheses have been proposed involving inflammation, bacterial plaque, the presence of teeth or dental implants, gingival fibroblast phenotype, epithelial growth factor, collagenase activation, folic acid deficiency, Na⁺/Ca⁺⁺ flux, and perhaps salivary delivery of phenytoin into the mouth.² It has been observed more recently that phenytoin increases platelet-derived growth factor B and its mRNA from macrophages that are thought to induce gingival fibroblast proliferation and local angiogenesis.²⁰ The transforming growth factor- β pathway involving Grb1, SOS-RAS-ERK1/2, AP1, and Ca⁺⁺ signaling pathways has been implicated in hereditary gingival overgrowth and may play a role in drug-induced gingival overgrowth.¹³ The result is an increase in fibroblast cell growth with increased interstitial ground substance.³⁸ Other drugs that induce gingival overgrowth include the immunosuppressant cyclosporine and the dihydropyridine Ca⁺⁺ channel blocking drugs. A more recent investigation has found that all of these drugs have the ability to reduce apoptosis (programmed cell death), suggesting that reduced cell loss rates could also play a role in gingival overgrowth.²⁴ Figure 14-6 represents a possible model of gingival overgrowth.

Phenytoin may also cause numerous other side effects as summarized in Table 14-4. Phenytoin interferes with the metabolic activation of vitamins D and K, and the absorption of Ca⁺⁺. Although the resultant effect on bone metabolism is usually subclinical, overt cases of rickets and osteomalacia have been observed.³³ Vitamin D or K supplements may prevent these conditions.^{19,33} Vitamin K modulates the synthesis of osteocalcin and matrix Gla proteins, which influence Ca⁺⁺ metabolism in bone. Children born to mothers who have received phenytoin (often in combination with phenobarbital, carbamazepine, or valproic acid) throughout their pregnancy are at increased risk of congenital malformation.¹⁸ The most common anomalies are cleft lip, cleft palate, and congenital heart disease. These developmental defects, a delay in psychomotor development, prenatal and postnatal growth deficiencies, impaired intellectual performance, and genitourinary and skeletal deformations are collectively referred to as the *fetal hydantoin syndrome*. Although none of the well-studied anticonvulsants is completely devoid of teratogenic potential, animal data suggest that, of the older drugs, carbamazepine and phenobarbital may be safer anticonvulsants to use in pregnancy.⁴⁵

BARBITURATES

Phenobarbital is one of the oldest, least expensive, least toxic, and most effective anticonvulsants available. Because of its sedative effect and the introduction of newer drugs, the use of phenobarbital for treating epileptic disorders has waned. Phenobarbital offers an appreciable spectrum of anticonvulsant activity because of its effectiveness against many tonic-clonic and partial seizures.

Barbiturates other than phenobarbital are occasionally used for the treatment of epilepsy. Mephobarbital is less sedating than phenobarbital, although its anticonvulsant properties result largely from its metabolic conversion to phenobarbital. Primidone, a deoxybarbiturate relative of phenobarbital, is used for generalized and partial seizures, particularly seizures refractory to other drugs. The use of primidone is limited because of its marked sedative properties immediately after administration.

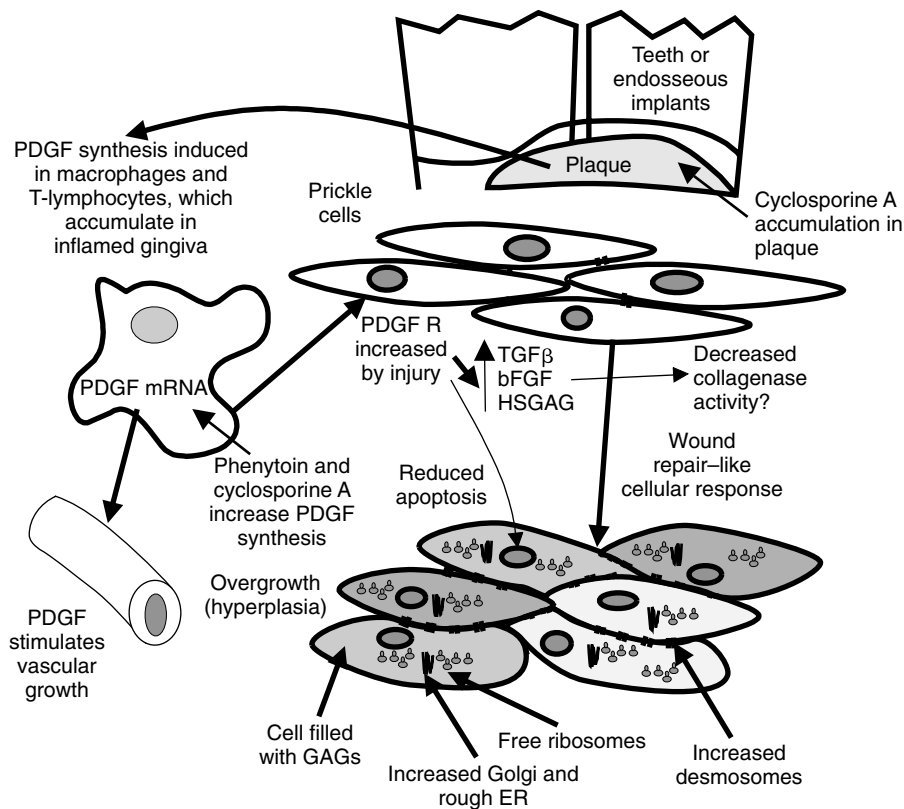

FIGURE 14-6 Effect of phenytoin and cyclosporine on gingival overgrowth. Predisposing factors include the presence of teeth or implants, inflammation, and overgrowth-inducing drugs. Phenytoin increases by sixfold platelet-derived growth factor (*PDGF*) mRNA in reparative/proliferative macrophages.³⁸ *PDGF* is thought to increase angiogenesis and wound repair. Increases in fibroblastic growth factors, such as transforming growth factor- β (*TGF* β) and basic fibroblast growth factor (*bFGF*), and production of heparin sulfate glycosaminoglycan (*HSGAG*) are induced by *PDGF* acting on its receptor (*R*). Prickle cells in the gingiva become filled with glycosaminoglycans (*GAGs*), rough endoplasmic reticulum (*ER*), and ribosomes, and their connective desmosomes proliferate (bottom).

TABLE 14-4

Adverse Reactions Reported for Anticonvulsant Drugs

DRUG	ADVERSE REACTIONS
Phenytoin and fosphenytoin	Gingival hyperplasia, hirsutism, megaloblastic anemia, osteomalacia, sedation, ataxia, gastrointestinal disturbances, behavioral changes
Carbamazepine and oxcarbazepine	Sedation, weakness, ataxia, diplopia, gastrointestinal disturbances, skin rash, behavioral changes, aplastic anemia (rare)
Phenobarbital	Sedation, weakness, ataxia, reduced cognition, respiratory depression, blood dyscrasias, megaloblastic anemia, osteomalacia, drug dependence
Valproic acid	Sedation, weakness, ataxia, gastrointestinal disturbances, weight gain, hepatotoxicity (especially in children <2 years old), spina bifida if given during pregnancy, visual disturbances, pancreatitis, hyperammonemia
Ethosuximide	Sedation, weakness, gastrointestinal disturbances, ataxia, behavioral changes, lupus erythematosus (rare)
Diazepam	Sedation, weakness, nystagmus, ataxia, drug dependence, drug tolerance
Lorazepam	Same as diazepam
Midazolam	Same as diazepam
Chlorazepate	Same as diazepam
Clonazepam	Same as diazepam
Gabapentin	Sedation, weakness, ataxia, rash, tremor
Lamotrigine	Sedation, weakness, ataxia, diplopia, rash, headache, gastrointestinal disturbances, Stevens-Johnson syndrome (1% of children)
Topiramate	Sedation, weakness, ataxia, visual disturbances, paresthesias, kidney stones, breast pain
Tiagabine	Sedation, weakness, ataxia, gastrointestinal disturbances, tremor
Vigabatrin	Sedation, weakness, ataxia, psychotic reactions, visual disturbances, blood dyscrasias
Zonisamide	Sedation, weakness, ataxia, gastrointestinal disturbances, skin rashes, Stevens-Johnson syndrome, renal tubule acidosis, renal stones
Levetiracetam	Sedation, weakness, ataxia, exacerbation of behavioral problems, withdrawal reactions

Pharmacologic Effects

The barbiturates are CNS depressants and exert a marked inhibitory effect on repetitive neuronal activity in CNS pathways. Similar to phenytoin, phenobarbital limits the spread of seizure discharge, but it also raises the threshold for activa-

tion of epileptic foci. As discussed in Chapter 13 (which also addresses the general pharmacology of these drugs), the barbiturates enhance the binding of GABA to postsynaptic GABA_A receptors and increase the time that GABA-activated Cl⁻ channels are open. They also activate Cl⁻ channels inde-

pendently of GABA. Inhibition of the excitatory effects of glutamate (possibly kainate and α -amino-3-hydroxy-5-methyl-4-isoxazole propionate [AMPA] receptor types) may also be a major antiepileptic mechanism. Other mechanisms seem to play lesser roles. Barbiturates block the transcellular transport of Na^+ and K^+ , which could explain their membrane-stabilizing properties. Similar to phenytoin, barbiturates interfere with Ca^{++} channels and inhibit Ca^{++} entry into presynaptic nerve terminals.

Absorption, Fate, and Excretion

Phenobarbital is completely but slowly absorbed from the gastrointestinal tract. About half of the drug is bound to plasma protein. Approximately 30% of phenobarbital is excreted unchanged in the urine, and the rest is inactivated by the liver. Phenobarbital is a substrate for several cytochrome P450 isozymes. As discussed in Chapter 2, phenobarbital can also induce CYP2A, CYP2B, CYP2C, CYP3A, and CYP6A isoforms; reduced nicotinamide adenine dinucleotide cytochrome P450 reductase; UGT⁴⁴, P-glycoproteins; and MDR proteins (see Chapter 2). The plasma half-life of phenobarbital ranges between 50 and 140 hours. Because of its long half-life, very small fluctuations in plasma concentrations occur over a 24-hour period. Primidone is metabolized to phenobarbital, which can be detected in the plasma in approximately 24 to 48 hours, and phenylethylmalonamide, which also has anticonvulsant properties and is measurable in plasma within 1 to 2 hours and has a 10- to 18-hour half-life.

Adverse Effects

The major adverse effects of phenobarbital are discussed in Chapter 13. The most common initial effect of phenobarbital and the other barbiturates is sedation. (A paradoxical excitatory reaction may sometimes occur in children and elderly patients.) Tolerance usually develops to the sedative effect. Similar to phenytoin, phenobarbital can cause megaloblastic anemia and osteomalacia, which have been successfully treated with folic acid and vitamins D and K. Phenobarbital seems to be free of teratogenic effects, but when phenobarbital is given with phenytoin (a commonly used combination), teratogenicity seems to increase.

The most common side effects of primidone are primarily a result of its CNS depressant properties. Complications include sedation, dizziness, ataxia, and nystagmus. Various blood dyscrasias and rashes similar to conditions described for phenytoin can occur.

CARBAMAZEPINE

Carbamazepine is an iminostilbene derivative (see Figure 14-4) closely related chemically to the tricyclic antidepressants. It differs from the tricyclic antidepressant imipramine by the presence of a double bond in the central ring and a shorter side chain. Carbamazepine is a major anticonvulsant drug and is highly effective against tonic-clonic and partial seizures. It also lacks dysmorphic side effects (e.g., gingival hypertrophy, acne, hirsutism) common to phenytoin. Similar to phenytoin, carbamazepine is indicated for the treatment of trigeminal neuralgia; carbamazepine has been the most commonly used drug for this disorder. Carbamazepine is also effective for other neuropathic pains, such as glossopharyngeal neuralgia, postherpetic neuralgia, diabetic neuropathy, causalgia, and hemifacial spasm, but it is not a typical analgesic because it is ineffective for other types of pain. As discussed in Chapter 12, carbamazepine is sometimes effective in the treatment or prophylaxis of affective disorders.

A keto analogue, oxcarbazepine, has a therapeutic profile similar to carbamazepine. It may have fewer side effects than carbamazepine and is well tolerated. Oxcarbazepine is a prodrug, requiring metabolic reduction to the 10-hydroxy metabolite before it becomes active. Oxcarbazepine has been approved as monotherapy for partial seizures in patients older than 4 years and adjunctive therapy for children between 2 and 4 years old.

Pharmacologic Effects

Similar to phenytoin, carbamazepine reduces experimentally induced sustained high-frequency neuronal firing at doses that produce clinically relevant plasma concentrations.³¹ This effect, similar to that of phenytoin, seems to result from carbamazepine binding to inactivated Na^+ channels, slowing neuronal recovery after activation. This action has been confirmed by using neurophysiologic techniques, such as cell membrane voltage clamping. Carbamazepine also reduces Ca^{++} and Na^+ flux across the neuronal membrane. As with other anticonvulsants, various mechanisms may contribute to its anticonvulsant effect. Nevertheless, limitation of sustained repetitive neuronal firing offers the most likely explanation for the drug's antiepileptic properties. Because of its structural similarity to antidepressants, effects on monoamine reuptake function might be expected, but these effects, if any, seem to be minor.

Absorption, Fate, and Excretion

Carbamazepine is absorbed slowly, reaching peak plasma concentrations in 4 to 8 hours. It is distributed throughout the body; highest concentrations occur in the liver, kidneys, and brain. The drug is transported out of the brain by P-glycoproteins and MDR proteins. Carbamazepine is metabolized by cytochrome P450 3A4 and can induce CYP3A4 and UGT, leading to drug interactions and a significant reduction in its own half-life, which is 25 to 65 hours initially and 12 to 17 hours after long-term administration. CYP3A4 inhibitors (e.g., erythromycin) can increase the duration of action of carbamazepine. At least one metabolite of carbamazepine, carbamazepine-10,11-epoxide, has anticonvulsant properties and is stable. Carbamazepine is inactivated by further oxidation and conjugation before being excreted in the urine.

The carbamazepine analogue oxcarbazepine (see Figure 14-4) is rapidly converted to the 10-hydroxy metabolite, which exerts peak activity from 3 to 13 hours and has a 9-hour half-life. Oxcarbazepine is a mild CYP3A4 inducer and, similar to but to a lesser degree than carbamazepine, can accelerate the metabolism of several drugs, including oral contraceptives.

Adverse Effects

The most common signs and symptoms of overdose with carbamazepine are dizziness, diplopia, drowsiness, headache, ataxia, and slurred speech. Convulsions may be precipitated by acute intoxication with carbamazepine, and it exacerbates absence and myoclonic seizures. Various types of involuntary motor activity in elderly patients have been reported, and hallucinations have occurred. Skin rashes have been reported. Certain Asian populations seem to have an increased risk for Stevens-Johnson syndrome. If leukopenia occurs, it is usually mild. Other hematologic reactions to carbamazepine are rare but sometimes life-threatening. Aplastic anemia is of particular concern, and agranulocytosis has also occurred.

VALPROIC ACID

Valproic acid (dipropylacetic acid), approved by the FDA in 1978, is a broad-spectrum anticonvulsant particularly effective against absence seizures but also useful for other general-

ized forms of epilepsy (e.g., tonic-clonic, myoclonic) and partial seizures. Interest has focused on valproic acid because it has a simple chemical structure (see Figure 14-3) unrelated to that of traditional anticonvulsant drugs and was the first drug effective against absence and tonic-clonic seizures. It has also been approved for treatment of mania in bipolar disorder and for migraine pain.

Pharmacologic Effects

Similar to phenytoin and carbamazepine, valproic acid reduces sustained high-frequency neuronal firing at therapeutic doses.²⁷ Valproic acid apparently binds to a different site on the Na⁺ channel than phenytoin, but the final result is similar. As discussed for phenytoin, inhibition of Na⁺ channels represents a plausible action because the drug effect is frequency and voltage dependent, becoming more prominent at increasing rates of neuronal depolarization.

Experimental studies have shown that supertherapeutic doses of valproic acid increase brain GABA concentrations by interfering with enzymes involved with GABA. Valproic acid is a weak inhibitor of GABA transaminase, the first enzyme in the catabolic pathway, and a more potent inhibitor of succinic semialdehyde dehydrogenase, the next enzyme in the pathway. Valproic acid may also increase brain GABA by stimulating glutamic acid decarboxylase, the major synthetic enzyme for GABA. Other research has found an association between valproate anticonvulsant activity and reductions of the excitatory neurotransmitter aspartate in the brain.²⁷

The salutary effect of valproic acid on absence seizures is most likely associated with the drug's ability to inhibit Ca⁺⁺ influx through T-type Ca⁺⁺ channels. This mechanism is discussed later in the section on the succinimides. In addition to seizures, valproic acid is approved for the treatment of bipolar disorder, and its divalproex extended-release form is approved for the prevention of migraine headaches.

Absorption, Fate, and Excretion

Valproic acid is completely absorbed from the gastrointestinal tract and is highly bound to plasma proteins. The absorption rate depends on the formulation (capsules, tablets, or syrup); food may delay absorption. Divalproex sodium, a combination of valproic acid and its Na⁺ salt, is supplied in capsules that are designed to be opened and sprinkled on soft food. This product is a convenient dosage form for children and elderly patients.

Valproic acid crosses membrane barriers and is found in the fetus, milk, liver, kidney, and brain. It also accumulates in growing bone. Valproic acid is thought to enter the brain through a saturable process, and brain concentrations can be increased by blocking the MDR protein with probenecid. Valproic acid undergoes complex oxidation and conjugation before excretion in the urine with 10 or more metabolites. It inhibits its own metabolism and that of other drugs, such as phenobarbital. This effect can contribute to drug accumulation and drug interactions. Valproic acid inhibits the metabolism of some substrates metabolized by CYP2C9 and UGT. Experimental data suggest that valproic acid can induce CYP3A4 and MDR glycoproteins; however, this has not been widely acknowledged.⁴ The half-life of valproic acid is approximately 5 to 20 hours, with peak blood concentrations at 1 to 4 hours.

Adverse Effects

The most common manifestations of valproic acid toxicity are appetite disturbances, indigestion, heartburn, nausea, and weight change. The gastrointestinal reactions are usually temporary. Tremor is also a common adverse effect, especially at higher doses. Valproic acid can cause fatal hepatic dysfunction, and children are particularly susceptible. The likelihood

of this apparently idiosyncratic effect decreases with age, being most common in children younger than 2 years and uncommon after age 10 years. Irreversible hepatotoxicity seems to be caused by a toxic metabolite (2-n-propyl-4-pentenoic acid). Because its production is known to be increased by enzyme-inducing anticonvulsants, combined therapy of valproic acid and such anticonvulsants puts the patient at increased risk of liver damage. More commonly, valproic acid may cause a reversible hepatotoxicity that is dose dependent.

Another serious toxicity associated with valproate is life-threatening pancreatitis. Pancreatitis can occur in children or adults and may follow a rapid course. This reaction may occur any time when taking the medication. Presenting signs include abdominal pain, nausea, vomiting, or anorexia. If pancreatitis is diagnosed, the drug should be stopped. Other serious side effects, such as neurologic and hematologic toxicity, are rare. High doses of valproic acid may cause platelet disorders, leading to bruising of the skin and, occasionally, gingival bleeding. Platelet dysfunction usually is not severe, however, and the patient is asymptomatic. Valproic acid is associated with neural tube defects, and its use during pregnancy results in a significantly higher risk of spina bifida. Surveys have found the teratogenic risk may be higher than that for other anticonvulsants.⁴⁷

SUCCINIMIDES

Ethosuximide is a major drug for the treatment of absence seizures. The use of related succinimides (methsuximide, phensuximide) is restricted to patients refractory to ethosuximide because these agents are less effective or more toxic, or both. Another agent, the oxazolidinedione trimethadione, has also been used in absence seizures but is rarely used today because of its toxicity.

Pharmacologic Effects

Ethosuximide prevents absence seizures in approximately 50% of patients and reduces their frequency in another 40% to 45%. The mechanism of action of ethosuximide is not firmly established; however, its administration leads to a dose-dependent inhibition of low-threshold Ca⁺⁺ currents carried by T-type Ca⁺⁺ channels.⁷ Low-threshold Ca⁺⁺ currents are an important factor in oscillatory behavior of thalamic neurons, and the thalamus is known to play an important role in generating the 3-Hz spike-and-wave rhythms that characterize petit mal epilepsy. This effect occurs at clinical concentrations and is the best explanation yet proposed for the mechanism of action of drugs effective against absence seizures.

Absorption, Fate, and Excretion

The succinimides are absorbed from the gastrointestinal tract, metabolized in the liver (by CYP3A4), and excreted as metabolites in the urine. The plasma half-life of ethosuximide is approximately 30 hours in children and 45 to 60 hours in adults. Ethosuximide passes membrane barriers rapidly and appears in cerebrospinal fluid, milk, saliva, and fetal tissues. Salivary titers accurately reflect plasma concentrations and may be useful to monitor blood levels.

Adverse Effects

The succinimides commonly cause gastrointestinal distress, headache, dizziness, and skin rash. More serious reactions have been reported but are rare, especially with ethosuximide. Nevertheless, blood counts are recommended at no greater than monthly intervals because potentially fatal bone marrow depression may occur. Patients with hematopoietic toxicity may exhibit fever, sore throat, and coagulopathy, as indicated

by oral and cutaneous petechiae. Ethosuximide is less teratogenic than valproate, of the two, and is preferred in pregnancy.⁴⁵

DRUGS AFFECTING γ -AMINO BUTYRIC ACID TRANSMISSION

GABAergic mechanisms seem to contribute to seizure susceptibility in numerous animal models of epilepsy. Impaired GABAergic function can be shown in rats, mice, gerbils, and baboons genetically prone to epilepsy. Although faulty GABAergic mechanisms have not been convincingly shown in humans, cerebrospinal fluid concentrations of GABA are reduced in epileptic patients, and surgically removed epileptic brain tissue exhibits decreased GABAergic activity. Drugs that are antagonists at GABA_A receptors (bicuculline, picrotoxin) are potent convulsants, whereas drugs that facilitate GABAergic mechanisms (benzodiazepines) are anticonvulsants. Flumazenil, a benzodiazepine receptor antagonist, has been reported to precipitate seizures in patients who have an elevated seizure risk or are taking anticonvulsant benzodiazepines or tricyclic antidepressants,⁴¹ or received midazolam to treat local anesthetic toxicity.⁵³ Abnormal flumazenil binding, imaged with PET, is used to target abnormal epileptogenic tissue for surgical removal.²³ Inverse agonists at the benzodiazepine receptors can also act as convulsants because they reduce the contribution of constitutively active (active without agonist) benzodiazepine receptors. This effect leads to decreased Cl⁻ channel conductance, resulting in depolarization.

Similar to other neurotransmitter pathways, the GABA_A receptor system has multiple sites that may lend themselves to pharmacologic control (Figure 14-7).⁵ Presynaptically, neurotransmitter synthesis, storage, and release mechanisms may be targeted. Additionally, GABA reuptake transporters, autoreceptors, and catabolic enzymes are found presynaptically. Some GABAergic neurons contain cotransmitters, such as enkephalin or substance P. Postsynaptically, multiple forms of GABA_A receptors (ligand-gated ion channels) are found. The ligand-gated ion channel can be composed of various component isoforms. At this time six α , four β , three γ , three ρ , and

individual δ , ϵ , π , and θ subunit isoforms have been identified. Each ion channel is a mixture of five of these subunits, with the most predominant isoform being two α_1 , two β_2 , and one γ_2 . Some changes in ion channel composition have been seen in epileptic brain.⁶ A postsynaptic machinery for controlling the numbers and types of receptors has been described, and there are postsynaptic second messenger processes and receptor phosphorylation.²⁹

Cooperative relationships may exist between GABA receptors and other receptor types that produce adaptive changes.⁵ These processes may include the basis for developing tolerance to the actions of some antiepileptic drugs. In addition, GABA uptake proteins and metabolic enzymes may be found in glial cells and some perineural structures.⁵ GABA also acts through GABA_B receptors (metabotropic receptors; see Chapter 13).

Benzodiazepines

Most benzodiazepine agonists have anticonvulsant properties. The pharmacologic profiles of these drugs and the mechanisms by which they facilitate GABAergic transmission are discussed in detail in Chapter 13. Diazepam, clonazepam, clorazepate, midazolam, and lorazepam are the principal benzodiazepines used clinically in the United States as anticonvulsants. Midazolam, clonazepam, and lorazepam have higher affinities for the benzodiazepine receptor and may be more effective anticonvulsants.³⁷ Diazepam is effective in terminating the life-threatening continual convulsion of status epilepticus and for the treatment of local anesthetic-induced seizures. Intravenous lorazepam (0.1 mg/kg) was found to be more effective than phenytoin alone (18 mg/kg) for the treatment of generalized status epilepticus⁴⁸ and successfully treated a greater percentage of patients than diazepam. The actions of lorazepam can be slow to develop but are longer lasting than diazepam. Intravenous midazolam has also been found to be effective in the treatment of status epilepticus and local anesthetic excitotoxicity. Buccal midazolam is also effective and can be administered more quickly and conveniently than rectal diazepam emulsion, and its actions are seen more quickly.^{1,52} Clonazepam is generally effective for absence seizures and childhood myoclonic epilepsy and is sometimes

FIGURE 14-7 Proposed sites of actions for drugs acting at the γ -aminobutyric acid (GABA) synapse. GABA inhibits the postsynaptic neuron by acting on a receptor (GABA_A) on the Cl⁻ channel. Benzodiazepines act to facilitate the action of GABA postsynaptically by interacting with a separate site on the Cl⁻ channel. The action of GABA can be terminated by reuptake or catabolism. GABA is taken back into the presynaptic nerve terminals and glial cells by a Na⁺-driven symporter protein. Tiagabine blocks this GABA transporter. GABA α -oxoglutarate transaminase (GABA-T) terminates the action of GABA by converting it to succinic semialdehyde (SSA). Vigabatrin inhibits GABA-T.

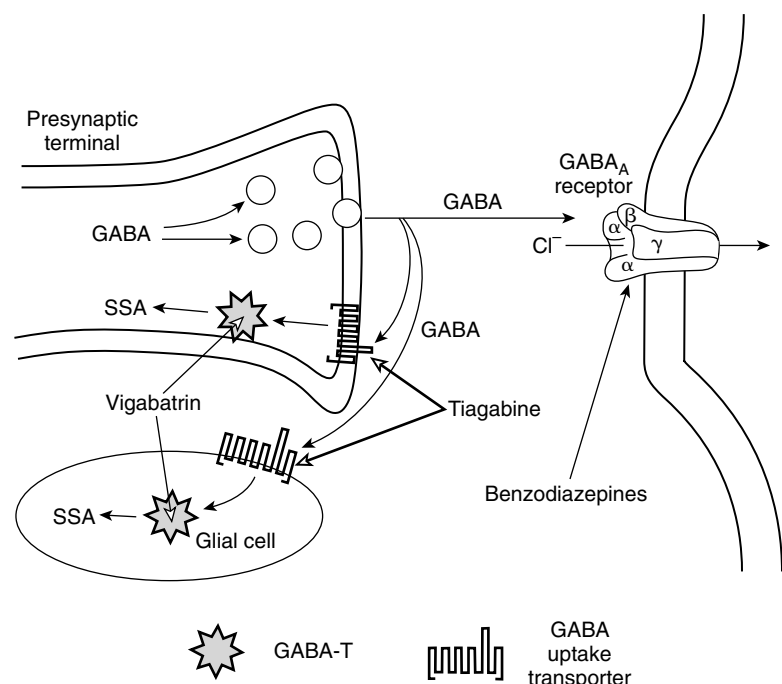

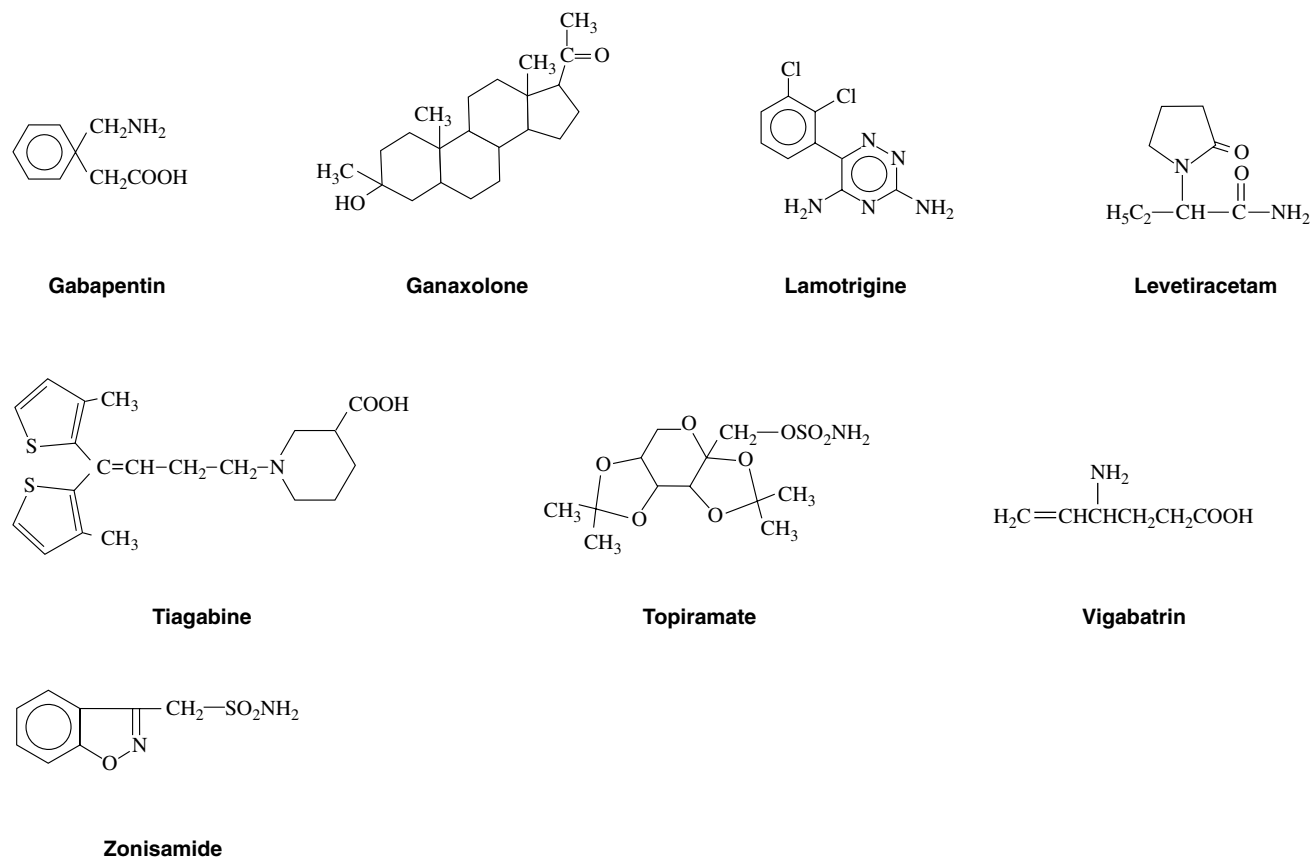

FIGURE 14-8 Structural formulas of newer antiepileptic drugs.

effective for complex partial seizures and reflex epilepsies (photosensitive epilepsy). Clonazepam is indicated as adjunctive therapy in the management of partial seizures.

Similar to phenytoin, benzodiazepines prevent the spread of the seizure discharge but have little effect on neuronal firing at the seizure focus. The anticonvulsant effect of benzodiazepines is thought to be exerted through modification of GABA-mediated systems, as is the case for their antianxiety effect. Different GABA_A receptor subtypes might be involved, however. GABA_A and GABA_B mechanisms are believed to be involved in absence seizures.⁴²

The absorption, fate, and excretion of benzodiazepines are discussed in Chapter 13. There are no differences in these properties when these drugs are used as anticonvulsants compared with when they are used as antianxiety agents. Desmethyldiazepam, the major metabolite of clonazepam and diazepam, has anticonvulsant properties. Although the benzodiazepines are useful adjuncts to the conventional anticonvulsants for seizure prophylaxis, patients seem to develop tolerance to their antiseizure effect quickly. The benzodiazepines may have greatest clinical usefulness in short-term therapy, such as when anticonvulsant medication is being changed or for emergency treatment.

The predictable adverse effects of drowsiness, dizziness, ataxia, nystagmus, dysarthria, and hypotonia occur with all benzodiazepines. Respiratory depression can be an issue when intravenous agents are used. Serious side effects are very rare. The administration of clonazepam occasionally precipitates a different variety of seizure from the one being treated. The teratogenic potential of the benzodiazepines is discussed in Chapter 13. There is little evidence that clonazepam is teratogenic, but it is recommended that use of the compound

during pregnancy be limited to cases in which the clinical situation warrants the risk.

Nitrazepam, used primarily as a hypnotic, is prescribed in some countries as an anticonvulsant, particularly for the treatment of infantile spasms (see neurosteroids later). Nitrazepam is not available in the United States. The 1,5-benzodiazepines, including clobazam, also are unavailable in the United States. They have anticonvulsant properties and adverse effects similar to the 1,4-benzodiazepines.

Vigabatrin

The inhibitory effect of GABA may be increased by mechanisms other than facilitating its action, as occurs with the benzodiazepines. Inhibition of enzymes responsible for the catabolism of GABA results in increased brain concentrations of GABA.⁴⁹ Vigabatrin (γ -vinyl GABA) (Figure 14-8) is an irreversible inhibitor of the enzyme GABA transaminase. Vigabatrin is considered an adjunctive anticonvulsant and is effective for drug-refractory epilepsy. It is more effective for simple and complex partial seizures than for generalized seizures. The drug is rapidly absorbed by the oral route, reaching peak blood concentrations in 0.75 to 2 hours. It does not bind appreciably to plasma protein. Vigabatrin has no active metabolites and is excreted by the kidneys. Its plasma half-life is 4 to 7 hours, but irreversible inhibition of GABA transaminase lasts for several days after the drug is cleared, prolonging the antiepileptic effect. Adverse effects of vigabatrin include sedation, fatigue, weight gain, amnesia, and visual field defects, which include hemi-field or concentric field contractions and may be related to retinal damage produced by edema. The defects may be more common in men and seem to be related to

the total drug exposure.¹⁵ They persist after drug withdrawal. Psychosis may occur infrequently.

Tiagabine

Tiagabine (see Figure 14-8), approved in 1996 as an adjunct for refractory complex epilepsy, is a nipecotic acid derivative that inhibits GABA uptake. Tiagabine is readily absorbed, with a peak blood concentration reached in 45 minutes. This drug is metabolized in the liver by CYP3A4 and possibly CYP1A2, 2C19, and 2D6 to inactive 5-oxo metabolites and is also glucuronidated. Tiagabine has a half life of 7 to 9 hours. Side effects include dizziness, fatigue, sleepiness, nausea, tremor, and difficulty concentrating.

Neurosteroids

In addition to its receptor for benzodiazepines, the GABA_A receptor complex has a separate binding site for steroid molecules. Steroid hormones generally are thought to act through steroid nuclear binding proteins that modify DNA translation in the cell nucleus. Some steroids, such as allopregnenolone, also act on these cell surface receptors to facilitate the action of GABA on the GABA_A receptor of the Cl⁻ ion channel.

Infantile spasm with a "chaotic" EEG is a serious epileptic condition of early life that is refractory to most anticonvulsants and has a poor prognosis. Historically, it has been effectively treated with adrenocorticotropic hormone. More recent studies have shown that vigabatrin and the neurosteroid ganaxolone²⁵ are also effective for this condition. Ganaxolone (see Figure 14-8) is a pregnenolone derivative without progestational hormonal activity. It exerts anticonvulsant activity against complex partial seizures, has an anticonvulsant spectrum that suggests usefulness in absence seizures, and is anticonvulsant in an animal model of catamenial epilepsy.³⁶ It is thought to act on selective GABA_A component isoforms. Other, newer anticonvulsant drugs that are being evaluated for treatment of infantile spasms include topiramate, lamotrigine, and zonisamide.⁵⁴

MISCELLANEOUS ANTICONVULSANTS

Gabapentin and Related Drugs

Gabapentin (see Figure 14-8) is a GABA analogue specifically designed to cross the blood-brain barrier. It is effective as an adjunct for patients with refractory partial seizures. Gabapentin does not interact with GABA receptors, uptake, or metabolism. It may influence synthesis or release of GABA, and it increases GABA concentrations in certain regions of the brain. Gabapentin also binds to an L-type Ca⁺⁺ channel subunit, $\alpha 2\delta$. It inhibits depolarizing high voltage-activating Ca⁺⁺ channel currents at therapeutic concentrations.⁴³ Analogues that bind more tightly to the $\alpha 2\delta$ subunit seem to be more potent anticonvulsants for partial seizures. Gabapentin is ineffective in the treatment of absence seizure, but has proved useful in the treatment of chronic pain conditions, such as postherpetic neuralgia, diabetic neuropathy, trigeminal neuralgia, and pain associated with multiple sclerosis. The Ca⁺⁺ channel $\alpha 2\delta$ subunit is upregulated in peripheral nerves with chronic nerve injury.³⁰ The drug is used orally and has saturable absorption. Elevations of the dose do not produce equivalent increases in blood concentration. It is not bound to plasma protein, is excreted almost entirely by the kidneys, and has a plasma half-life of 4 to 7 hours. The drug is generally well tolerated. Adverse effects include fatigue, dizziness, headache, nausea, and ataxia.

Pregabalin is similar to gabapentin; however, pregabalin has greater affinity for the $\alpha 2\delta$ subunit of the calcium ion

channels and may have greater efficacy for treating neuropathic pain where these subunits are upregulated. It has been approved for the treatment of postherpetic pain, diabetic neuropathy, adjunctive treatment of partial onset seizures, and fibromyalgia. It has been studied as a treatment of oral surgery pain¹⁶ and was found to produce some pain relief. It has also been studied as a treatment for general anxiety disorder.

GABA-mimetic Agents

Drugs that successfully mimic GABA in the CNS include progabide, a GABA agonist available in Europe. Progabide is effective in rodent models and some human forms of epilepsy, but it can cause serious adverse effects. Despite its toxicity, progabide has been used to treat simple and complex partial and generalized tonic-clonic, atonic, and myoclonic seizures in patients refractory to other anticonvulsants. GABA agonists generally have a lack of specificity and theoretically could result in GABA receptor downregulation.

Felbamate

In 1993 the FDA approved felbamate, a meprobamate derivative, for use in refractory partial seizures and as adjunctive therapy in children for seizures associated with Lennox-Gastaut syndrome, a disease resistant to most antiepileptic drugs. Shortly thereafter, felbamate was linked to aplastic anemia and acute hepatic failure, and an advisory by the FDA recommended against its use except in cases in which withdrawal or avoidance of the drug represented a serious risk for the patient.

Lamotrigine

Lamotrigine (see Figure 14-8) is a phenyltriazine derivative that inhibits Na⁺ influx in rapidly firing neurons. The drug has also been shown to inhibit the release of glutamate from the cortex of rat brain.⁴⁹ Lamotrigine exerts anticonvulsant effects in several experimental models of epilepsy and in patients with partial and generalized tonic-clonic seizures. The drug has also been approved for the treatment of mania in bipolar disorder. The drug is used orally and is well absorbed from the gastrointestinal tract. The plasma half-life is approximately 24 hours, but induction of liver microsomal enzymes by such drugs as phenobarbital, phenytoin, and carbamazepine may decrease the half-life to approximately 12 hours. Conversely, valproic acid may increase the half-life of lamotrigine up to 60 hours by inhibiting its metabolism. Lamotrigine usually has mild side effects, including ataxia, dizziness, diplopia, and rash. Stevens-Johnson syndrome has been reported in 0.8% to 2% of young children using the drug.⁹ The drug is approved for treatment of Lennox-Gastaut syndrome in children older than 2 years. Lamotrigine binds to melanin and may accumulate in the eyes and other tissues containing melanin. No adverse consequences of this binding have been reported.

Carbonic Anhydrase Inhibitors

Acetazolamide and other carbonic anhydrase inhibitors are primarily effective against absence seizures but are also useful for the control of seizures that have a tendency to recur at a specific time of the menstrual cycle (catamenial epilepsy). Tolerance develops rapidly, however, so the carbonic anhydrase inhibitors are primarily used as adjunctive agents. The diuretic and natriuretic effects of acetazolamide are well known. By inhibiting carbonic anhydrase (located in glial cells), carbon dioxide is allowed to accumulate in the brain, which can decrease intracellular Na⁺ and increase intracellular K⁺. This ionic shift results in neuronal hyperpolarization and decreased excitability, which is thought to block the spread of seizure discharge.

Topiramate

Topiramate (see Figure 14-8) is a broad-spectrum anticonvulsant currently approved for partial onset seizures, monotherapy of tonic-clonic seizures, treatment of Lennox-Gastaut syndrome, and prophylaxis of migraine headaches. The drug exerts multiple actions, including frequency-dependent blockade of Na⁺ channels, benzodiazepine-like potentiation of GABA activity, and inhibition of kainate receptors for glutamate. Absorption after oral ingestion is rapid; an elimination half-life of approximately 20 hours permits twice-daily dosing. It may specifically inhibit CYP2C19.¹¹ Topiramate is reported to be more effective than several newer anticonvulsants; however, it also produces more side effects; this may reflect the dosages used to evaluate the drug rather than minimally effective doses. CNS depression is the most common side effect. Topiramate can compromise short-term memory function.

Zonisamide

Zonisamide (see Figure 14-8) was developed in Japan and is now available in the United States. Zonisamide is structurally related to the sulfonamides. It is completely absorbed, with peak concentrations occurring in 4 to 6 hours. Primarily metabolized by CYP3A4, blood concentrations may vary if inducing antiepileptic drugs are used concurrently. Zonisamide may act by multiple mechanisms, including blocking of Na⁺ and T-type Ca⁺ channels; the drug binds to the GABA_A channel but does not alter Cl⁻ currents. Zonisamide facilitates dopaminergic and serotonergic transmission. The drug also is a weak carbonic anhydrase inhibitor. Zonisamide was studied as adjunctive therapy for the treatment of partial onset seizures and found to improve therapy. Because it is a sulfonamide, it can produce numerous allergic reactions in patients who are sensitive to sulfonamides. These reactions include skin rashes (Stevens-Johnson syndrome), epidermal necrolysis, and agranulocytosis. The incidence of these events is very low. Other unusual side effects include a propensity to produce renal acidification²¹ and renal stones and, rarely, dehydration and hyperthermia in children during hot weather.

Levetiracetam

Levetiracetam (see Figure 14-8) is a pyrrolidine derivative that is rapidly absorbed (1 hour to peak) after oral administration and is less than 10% bound to plasma proteins. Steady state is reached in 2 days with twice-daily dosing. The half-life is approximately 7 hours, and the drug is metabolized by a non-cytochrome P450 route and is eliminated by renal excretion. The drug has a unique anticonvulsant profile; it is effective in some common tests predictive of efficacy in partial seizures but not in other tests. Its mechanism is unknown, but in the brain it binds stereoselectively to a functionally important synaptic plasma membrane protein (SV2). Levetiracetam was evaluated as adjunct therapy for adult partial onset seizures and found to reduce seizures in a dose-dependent manner. It has also been approved for the treatment of myoclonic epilepsy. Typical side effects included somnolence and fatigue, coordination difficulties, and exacerbation of behavioral problems. Most of the side effects were reported in the first month of therapy. This drug should be terminated gradually to avoid withdrawal reactions. Drug interactions with this agent seem to be minimal.

Magnesium Salts

Although not used in treating epilepsy, magnesium sulfate is used to prevent or control convulsions of eclampsia and severe preeclampsia of pregnancy. The drug acts on the CNS to decrease excitability and acts to reduce activity at the neuromuscular junction. Its mechanism of action is not well defined.

In addition, magnesium reduces cardiac and smooth muscle activity and reduces blood pressure, which is beneficial in eclampsia and preeclampsia.

Experimental Drugs

Although many seizures can be controlled with anticonvulsant medication, approximately 20% remain resistant to treatment. Recognizing this need, the Epilepsy Branch of the National Institute of Neurological Disorders and Stroke began clinical trials in 1968 of numerous drugs, including drugs already approved for other uses in the United States. Carbamazepine, clonazepam, valproic acid, and clorazepate were made available between 1974 and 1981 as a result of these efforts. Further government, industrial, and academic support for anticonvulsant drug research resulted in the creation of a formal government program, the National Anticonvulsant Drug Development Program and Antiepileptic Screening Project, which has introduced a series of potential anticonvulsant drugs. Significant advances in understanding the synthesis and regulation of receptors, ion channels, drug elimination mechanisms, and other components of cells have revealed many new opportunities for intervention.

One approach involves excitatory neuronal mechanisms. Abnormal distribution patterns of excitatory amino acid receptors have been shown in the hippocampus and parahippocampal gyrus of humans with temporal lobe epilepsy. A novel anticonvulsant strategy is to decrease excitatory neurotransmitter drive. Evidence exists that classic anticonvulsants may have this ability. Phenytoin, carbamazepine, benzodiazepines, and lamotrigine may decrease the synaptic release of excitatory amino acids.

Several excitatory amino acid antagonists exist. Their variety is due to not only the fact that competitive and noncompetitive antagonists exist, but also that metabotropic glutamate receptors (which modulate intracellular second messengers) and three major classes of glutamate-gated ion-channel receptors (N-methyl-D-aspartate [NMDA], kainate, and AMPA) exist. These receptors all are stimulated by glutamate but can be distinguished according to their preferred agonists and antagonists. The phosphonic acid derivatives 2-amino-5-phosphonovaleric acid (AP5) and 2-amino-7-phosphonoheptanoic acid (AP7) are competitive NMDA antagonists that are potent anticonvulsants in experimental epilepsy models. Because AP5 and AP7 are restricted by the blood-brain barrier, derivatives of AP5 and AP7 have been developed to enter the CNS more effectively. Side effects (impairment of learning and memory, behavioral changes) may limit the use of these compounds. Noncompetitive NMDA antagonists (e.g., phencyclidine) are effective anticonvulsants, but side effects (hallucinations, ataxia, altered sensory perception, interference with memory, and behavioral disturbances) are prominent.

Despite their problems, NMDA antagonists are effective in preventing the development of seizure kindling. The excitotoxic effect of glutamate is well known, and data suggest that nitric oxide, a highly reactive local hormone, may be the agent responsible for glutamate-induced cell death. An excitotoxic effect may play a role in epilepsy. Selective antagonists of AMPA are under study (Talampanel and NS1209) that may be useful as anticonvulsant or antielectrogenic agents; however, sedation may prevent their use as anti-ictogenic drugs. (Barbiturates also have significant sedative action.) Other unique approaches include retigabine, a facilitator of the opening of inhibitory potassium channels; antiepilepsirine, which increases extracellular serotonin; and harkoseride, a blocker of the strychnine-insensitive glycine site on the NMDA receptor complex.

Novel approaches to anticonvulsant therapy may include other endogenous compounds. Adenosine, inosine, hypoxan-

thine, β -endorphin and other endogenous opioids, somatostatin, cholecystokinin, neuropeptide Y, and prostaglandins have been investigated. Additional approaches may be suggested by gene array studies, which have found changes in glial function that may become targets in the future.

NONPHARMACOLOGIC TREATMENTS

Surgical treatment of seizure disorders is possible when the focus is localized and located in nonessential brain tissue. Removal of poorly healed and abnormally functioning brain tissue can produce "cures." This procedure is performed with growing success because of the availability of improved diagnostic imaging techniques, such as 2- ^{18}F fluoro-2-deoxy-D-glucose and ^{11}C -flumazenil coupled with EEG.

A nonpharmacologic approach to the treatment of seizures has resulted from studies showing that stimulation (by implanted pulse generators) of the vagus nerve blocks experimentally induced seizures, and this technique is now commercially available.⁵¹ Vagal stimulation has obvious implications regarding cholinergic drugs.

Another approach for the treatment of childhood epilepsy is a ketogenic diet. A ketogenic diet is high in fats and low in carbohydrates and proteins. These diets must be carefully controlled but have been found effective in some patients. Genetic mapping studies suggest that ketogenic diets may bolster mitochondria and energy metabolism.³

GENERAL THERAPEUTIC USE

The goal of anticonvulsant therapy is to obtain complete control of epileptic seizures with the fewest drugs and at the least toxic and lowest possible dose. Approximately 80% of all patients can be seizure-free if drug plasma concentrations are properly monitored, and the appropriate dose adjustments are made. Initial anticonvulsant therapy sometimes necessitates frequent alterations in dose and a trial-and-error approach until the seizure responds to a specific anticonvulsant. Even after seizures are initially controlled, the continued administration of anticonvulsant drugs may lead to the development of tolerance. The addition of other anticonvulsants necessitates dosage adjustments. Anticonvulsant therapy is not static, routine, and completely predictable, but rather subject to a variety of ever-changing factors.

Febrile seizures, induced by high fevers, are the most frequent seizures in children. Propensity for these seizures may have a genetic basis, be related to particular diseases (influenza), or be caused by immaturity of CNS excitation control. Children with febrile seizures rarely develop other seizure disorders or continue to have seizures. Short-term treatment with diazepam, phenobarbital, or intranasal midazolam has been used. In some patients in whom febrile seizures are recurrent, prophylactic phenobarbital or diazepam may be prescribed to prevent seizures in future fevers. Rarely, patients may need longer term continuous phenobarbital or valproic acid treatment.

Although anticonvulsant medications have substantial toxic potential, uncontrolled seizures also carry important risks. Repeated seizures can result in loss of memory and mental function. For several of the newer anticonvulsants that facilitate GABA or inhibit excitatory amino acid function, there is the potential for additional drug-induced compromise of memory function.

Anticonvulsants can be valuable in treating patients with various chronic pain problems. Neuropathic pain results from abnormalities in nerve fiber conduction, such as neuralgia, causalgia, and phantom pain. Beneficial actions of anticonvul-

sants may be related to blockade of Na^+ and Ca^{++} channels, activation of GABAergic transmission, and inhibition of NMDA and other glutamate receptors. Agents that have proved effective in these conditions include carbamazepine, phenytoin, sodium valproate, gabapentin, and clonazepam.⁹

Traditional anticonvulsants (carbamazepine and valproic acid) and "mood stabilizers" (a synonym used in psychiatry for some newer anticonvulsants) are sometimes valuable adjuncts in treating the manic phase of bipolar disorder. Other anticonvulsant drugs may also be useful; however, in one study adjunctive gabapentin was no more effective than placebo.³²

IMPLICATIONS FOR DENTISTRY

Dentists should expect to be confronted at some time by a seizing patient in the dental office. It is extremely helpful if an emergency plan has been previously developed and practiced before having to deal with convulsions clinically. One of the best ways to manage seizures is to prevent them. Appointments should be planned for times when an epileptic patient has high blood concentrations of anticonvulsant medication. The dentist should verify that the patient has taken his or her medications before the appointment. Careful attention to local anesthetic doses and avoiding accidental intravascular injections by practicing aspiration before administration are important. If the patient's seizure is of the reflexive type, avoiding the triggering stimuli is important. The dentist should ask the patient before treatment if he or she is aware of any triggering stimuli. Finally, attention to the patient's fear and apprehension can limit the risk of inciting an attack.

Some patients sense the onset of seizure activity in the form of auras. If a patient reports an aura, the dentist should prepare for a seizure by removing all instruments from the patient's mouth and pulling back trays or other objects from which the patient might sustain injury. The patient should be placed in the supine position. If no seizure occurs, the patient can determine when to proceed. If the patient does have a seizure, the dentist must protect the patient from injury and falls. No attempt should be made to open the patient's mouth during a tonic-clonic seizure because this can induce additional injuries. Seizures generally end in 2 to 5 minutes, after which the patient is disoriented or falls asleep for 30 or more minutes. If the patient is snoring or seems to have an obstructed airway, the head, neck, and jaw should be positioned to ensure a clear airway.

If a second seizure occurs, it may indicate status epilepticus. Seizures induced by local anesthetic overdoses tend to be prolonged and may require anticonvulsant treatment. Animal experiments suggest that benzodiazepines and phenobarbital are highly effective for treating local anesthetic-induced seizures, whereas carbamazepine, phenytoin, and valproate may increase seizure activity.³⁹ Emergency medical services should be called if the seizure recurs or is prolonged or if respiration is compromised. Patients may need supportive care after a seizure, which would include treatment of any wounds that may have occurred and dealing with incontinence.

In most cases, seizures are brief and self-limiting. Occasionally pharmacotherapy may be required, however. Part of the dentist's emergency plan should include a properly stocked emergency cart and staff trained in the use of the medications. Anticonvulsant medications should ideally be administered by the intravenous route; however, this is not always possible in the dental office. New products have improved this situation. A rectal gel dosage form of diazepam (Diastat) is available that can produce anticonvulsant blood concentrations in approximately 15 minutes. This product has been formulated

for use by laypeople for the emergency treatment of seizures at home and simplifies emergency treatment if an intravenous line is unavailable. The disadvantage of this approach is that many individuals are uncomfortable with the route of administration. Midazolam has been tried and found effective in the treatment of status seizures and can be administered intravenously, intramuscularly, intranasally, or intrabuccally.⁵² Seizure control is almost immediate with intravenous administration. The buccal route would be natural in the dental office.

Because diazepam and midazolam have relatively short durations of action, the use of a longer acting agent, such as lorazepam, phenytoin, or phenobarbital, may be needed in the hospital to provide prolonged seizure control. Fosphenytoin may have some advantages over traditional agents. Fosphenytoin at 15 mg/kg to 20 mg/kg phenytoin equivalents is tolerated better and can be effective 10 to 60 minutes after intramuscular injection into the gluteus maximus.³⁵ The volume of fosphenytoin to achieve this dose ranges from 20 mL to 40 mL, which should be divided into smaller volumes and then administered bilaterally. Care should be taken to avoid injections into the sciatic nerve or inferior gluteal vessels.

As described in this chapter, patients receiving anticonvulsants are subject to various adverse effects. Common or significant adverse effects that are pertinent for the everyday practice of dentistry should be noted. Most anticonvulsant drugs produce some degree of CNS depression. The clinician should be aware of the additive effect of other CNS depressants, such as local and general anesthetics, antianxiety agents, antidepressants, and opioid analgesics. Some newer agents may also interfere with memory. Patients should receive written treatment instructions, which should also be provided to appropriate guardians. Blood dyscrasias are rare but serious side effects seen with most anticonvulsant agents; they may increase the patient's susceptibility to infection. Aplastic anemia may manifest as increased gingival bleeding, whereas agranulocytosis may be identified by pharyngitis or oral mucosal lesions. The fact that some anticonvulsants alter mineral metabolism should be considered when confronted with anomalies in tooth development or advanced bone loss. Several anticonvulsants can produce teratogenic effects. The defects produced can involve the facial and oral structures. Practitioners should be alert for new drug-related adverse effects and report them to the FDA Medwatch program.

Several side effects specific to individual anticonvulsant agents are clinically relevant to dentistry. Phenytoin-induced gingival overgrowth is a well-known example. Overgrowth most commonly occurs in the anterior mandibular region, especially in the case of "mouth breathers," and develops to the greatest extent in the interdental papillae between the incisors. Edentulous areas of the alveolar mucosa do not undergo hypertrophy or do so to a lesser extent than other areas. Phenytoin-induced overgrowth may totally or partially obscure the crowns of teeth, which hampers mastication and oral hygiene, is aesthetically unpleasant, and necessitates periodic resection. Because of the angiogenesis induced, the gingival tissue is quite vascular; surgery by cautery or laser is often preferred. The rate of development of gingival overgrowth can be diminished by proper oral hygiene.

Considerable evidence exists that the use of phenytoin to enhance wound healing holds promise.⁴⁶ There is interest in applying modern knowledge of growth factors to aid in the healing of periodontitis and other oral wounds. Because phenytoin is widely available and inexpensive, it might be helpful in some cases. Research in this area is clearly needed.

Anticonvulsants may increase hepatic microsomal enzyme activity, which can reduce the blood concentration of other drugs metabolized by the same enzyme system. Of relevance

to dentistry is the effect of enzyme induction on antibiotics (e.g., tetracycline) and other agents (midazolam, triazolam) used in clinical practice. Drugs that inhibit CYP3A4 (e.g., erythromycin) can lead to unexpected elevations of anticonvulsant drugs and potential toxicity. The microsomal enzyme-inducing anticonvulsants can reduce the effectiveness of oral contraceptives. Valproic acid can inhibit CYP3A4 drug metabolism. It can also inhibit platelet aggregation, so increased monitoring of patient use of aspirin or nonsteroidal anti-inflammatory drugs may be warranted.

Some short-term effects directly involve the mouth. Carbamazepine-induced taste disorders have been reported, but these are apparently subsided with time.¹⁴ Xerostomia has also been reported. Primidone is known to cause the unusual side effect of localized gingival pain. This response has led patients and dentists to assume erroneously that the pain is of pathologic rather than pharmacologic origin. Clonazepam has been reported to produce hypersalivation in some patients. A complete medical history is essential for proper dental treatment.

It is often recommended that a patient with epilepsy be treated cautiously to reduce emotional upset and help prevent the precipitation of a seizure. Except when seizures are not well controlled, individuals with epilepsy need not be handled differently from other patients. Because of the lingering stigma associated with epilepsy, these patients may be reluctant to reveal their disease. A seizure disorder may be ascertained only by a clinician who is alert to subtle clues offered by anticonvulsant-induced side effects and by careful questioning of the patient.

Anticonvulsants may be used in the treatment of chronic orofacial pain problems, such as trigeminal neuralgia or burning mouth syndrome. Carbamazepine has been the first-choice drug for the treatment of trigeminal neuralgia. Some patients also respond to other anticonvulsants. Burning mouth syndrome is currently a treatment challenge and may involve pathologic and psychological components. Current treatments include clonazepam, capsaicin, and antidepressant therapy.

Finally, saliva offers a readily available and potentially useful tool for monitoring concentrations of several antiepileptic drugs. Saliva/plasma correlations have been described for carbamazepine, phenobarbital, phenytoin, and ethosuximide. Stability of the samples for some drugs is high and allows the samples to be mailed to a laboratory for analysis, potentially making drug monitoring faster and less expensive.²²

ANTICONVULSANTS

<i>Nonproprietary (generic) name</i>	<i>Proprietary (trade) name</i>
Hydantoins	
Ethotoin	Peganone
Fosphenytoin	Cerebyx
Mephénytoin*	Mesantoin
Phenytoin	Dilantin
Barbiturates	
Mephobarbital	Mebaral
Phenobarbital	Luminal
Primidone [†]	Mysoline
Succinimides	
Ethosuximide	Zarontin
Methsuximide	Celontin
Phensuximide*	Milontin

Continued

ANTICONVULSANTS—cont'd

Nonproprietary (generic) name	Proprietary (trade) name
Oxazolinediones	
Paramethadione*	Paradione
Trimethadione*	Tridione
Benzodiazepines	
Clobazam*	Frisium
Clonazepam	Klonopin
Clorazepate	Tranxene, Gen-Xene
Diazepam	Valium, Diastat
Midazolam	Versed
Nitrazepam*	Mogadon
Lorazepam	Ativan
Others	
Acetazolamide	Diamox
Carbamazepine	Tegretol
Felbamate [†]	Felbatol
Gabapentin	Neurontin
Pregabalin	Lyrica
Lamotrigine	Lamictal
Levetiracetam	Keppra
Oxcarbazepine	Trileptal
Tiagabine	Gabitril
Topiramate	Topamax
Valproic acid	Depakene, Depakote [§]
Vigabatrin*	Sabril
Zonisamide	Zonegran
Phenacemide*	Phenurone

*Not currently available in the United States.

[†]Not a true barbiturate.

[‡]Restricted use.

[§]Divalproex, a stable compound of valproic acid, and sodium valproate.

CITED REFERENCES

- Baysun A, Aydin OF, Atmaca E, et al: A comparison of buccal midazolam and rectal diazepam for the acute treatment of seizures. *Clin Pediatr* 44:771-776, 2005.
- Brown RS, Beaver WT, Bottomly WK: On the mechanism of drug-induced gingival hyperplasia. *J Oral Pathol Med* 20:201-209, 1991.
- Bough KJ, Wetherington J, Hassel B, et al: Mitochondrial biogenesis in the anticonvulsant mechanism of the ketogenic diet. *Ann Neurol* 60:223-235, 2006.
- Cervený L, Svecova L, Anzenbacherova E, et al: Valproic acid induces CYP3A4 and MDR1 gene expression by activation of constitutive androstane receptor and pregnane X receptor pathways. *Drug Metab Dispos* 35:1032-1041, 2007.
- Cherubini E, Conti F: Generating diversity at GABAergic synapses. *Trends Neurosci* 24:155-162, 2001.
- Coulter DA: Epilepsy-associated plasticity in γ -aminobutyric acid receptor expression, function and inhibitory synaptic properties. *Int Rev Neurobiol* 45:237-252, 2001.
- Coulter DA, Huguenard JR, Prince DA: Characterization of ethosuximide reduction of low-threshold calcium current in thalamic neurons. *Ann Neurol* 25:582-593, 1989.
- Cunningham MO, Dhillon A, Wood SJ, et al: Reciprocal modulation of glutamate and GABA release may underlie the anticonvulsant effect of phenytoin. *Neuroscience* 95:343-351, 2000.
- Devinsky O, Cramer J: Safety and efficacy of standard and new antiepileptic drugs. *Neurology* 55(Suppl 3):S5-S10, 2000.
- Engel J: A proposed diagnostic scheme for people with epileptic seizures and with epilepsy: Report of the ILAE task force on classification and terminology. Available at: <http://www.ilae-epilepsy.org/Visitors/Centre/ctf/overview.cfm>.
- French JA, Gidal BE: Antiepileptic drug interactions. *Epilepsia* 41(Suppl 8):S30-S36, 2000.
- Genton P: When antiepileptic drugs aggravate epilepsy. *Brain Dev* 22:75-80, 2000.
- Hakkinen L, Csiszar A: Hereditary gingival fibromatosis: characteristics and novel putative pathogenic mechanisms. *J Dent Res* 86:25-34, 2007.
- Halbreich U: Tegretol dependency and diversion of the sense of taste. *Isr Ann Psychiatry Related Disciplines* 12:328-332, 1974.
- Hardus P, Verduin WM, Engelsman M, et al: Visual field loss associated with vigabatrin: quantification and relation to dosage. *Epilepsia* 42:262-267, 2001.
- Hill CM, Balkenohl M, Thomas DW, et al: Pregabalin in patients with postoperative dental pain. *Eur J Pain* 5:119-124, 2001.
- Holtkamp M: The anaesthetic and intensive care of status epilepticus. *Curr Opin Neurol* 20:188-193, 2007.
- Holmes LB, Harvey EA, Coull BA, et al: The teratogenicity of anticonvulsant drugs. *N Engl J Med* 344:1132-1138, 2001.
- Howe AM, Lipson AH, Sheffield LJ, et al: Prenatal exposure to phenytoin, facial development, and possible role for vitamin K. *Am J Med Genet* 58:238-244, 1995.
- Iacopino AM, Doxey D, Cutler CW, et al: Phenytoin and cyclosporine A specifically regulate macrophage phenotype and expression of platelet-derived growth factor and interleukin-1 in vitro and in vivo: possible molecular mechanism of drug-induced gingival hyperplasia. *J Periodontol* 68:73-83, 1997.
- Inoue T, Kira R, Kaku Y, et al: Renal tubular acidosis associated with zonisamide therapy. *Epilepsia* 41:1642-1644, 2000.
- Jones MD, Ryan M, Miles MV, et al: Stability of salivary concentrations of the newer antiepileptic drugs in the postal system. *Ther Drug Monit* 27:576-579, 2005.
- Juhász C, Chugani DC, Muzik O, et al: Relationship of flumazenil and glucose PET abnormalities to neocortical epilepsy surgery outcome. *Neurology* 56:1650-1658, 2001.
- Kantarci A, Augustin P, Firatli E, et al: Apoptosis in gingival overgrowth tissues. *J Dent Res* 86:888-892, 2007.
- Kerrigan JF, Shields WD, Nelson TY, et al: Ganaxolone for treating intractable infantile spasms: a multicenter open-label, add-on trial. *Epilepsy Res* 42:133-139, 2000.
- Kjeldsen MJ, Kyvik KO, Christensen K, et al: Genetic and environmental factors in epilepsy: a population-based study of 11,900 Danish twin pairs. *Epilepsy Res* 44:167-178, 2001.
- Kwan P, Sills GJ, Brodie MJ: The mechanisms of action of commonly used antiepileptic drugs. *Pharmacol Ther* 90:21-34, 2001.
- Lee TS, Mane S, Eid T, et al: Gene expression in temporal lobe epilepsy is consistent with increased release of glutamate by astrocytes. *Mol Med* 13:1-13, 2007.
- Lin Y-F, Angelotti TP, Dudek EM, et al: Enhancement of recombinant $\alpha 1\beta 1\gamma 2L$ γ -aminobutyric acid_A receptor whole-cell currents by protein kinase C is mediated through phosphorylation of both $\beta 1$ and $\gamma 2L$ subunits. *Mol Pharmacol* 50:185-195, 1996.
- Luo ZD, Chaplan SR, Higuera ES, et al: Upregulation of dorsal root ganglion $\alpha 2\delta$ calcium channel subunit and its correlation with allodynia in spinal nerve-injured rats. *J Neurosci* 21:1868-1875, 2001.
- McLean MJ, Macdonald RL: Carbamazepine and 10, 11-epoxy-carbamazepine produce use- and voltage-dependent limitation of rapidly firing action potentials of mouse central neurons in cell culture. *J Pharmacol Exp Ther* 238:727-738, 1986.
- Pande AC, Crockatt JG, Janney CA, et al: Gabapentin in bipolar disorder: a placebo-controlled trial of adjunctive therapy. Gabapentin Bipolar Disorder Study Group. *Bipolar Disord* 2(3 Pt 2):249-255, 2000.
- Pedreira JD, Canal ML, Carvajal J, et al: Influence of vitamin D administration on bone ultrasound measurement in patients on anticonvulsant therapy. *Eur J Clin Invest* 30:895-899, 2000.
- Perucca E, French J, Bialer M: Development of new antiepileptic drugs: challenges, incentives, and recent advances. *Lancet Neurol* 6:793-804, 2007.
- Pryor FM, Gidal B, Ramsay RE, et al: Fosphenytoin: pharmacokinetics and tolerance of intramuscular loading doses. *Epilepsia* 42:245-250, 2001.

36. Reddy DS, Rogawski MA: Enhanced anticonvulsant activity of ganaxolone after neurosteroid withdrawal in a rat model of catamenial epilepsy. *J Pharmacol Exp Ther* 294:909-915, 2000.
37. Rey E, Treluyer JM, Pons G: Pharmacokinetic optimization of benzodiazepine therapy for acute seizures: focus on delivery routes. *Clin Pharmacokinet* 36:409-424, 1999.
38. Saito K, Mori S, Iwakura M, et al: Immunohistochemical localization of transforming growth factor β , basic fibroblast growth factor and heparan sulfate glycosaminoglycan in gingival hyperplasia induced by nifedipine and phenytoin. *J Periodont Res* 31:545-555, 1996.
39. Sawaki K, Ohno K, Miyamoto K, et al: Effects of anticonvulsants on local anaesthetic-induced neurotoxicity in rats. *Pharmacol Toxicol* 86:59-62, 2000.
40. Sood S, Chugani HT: Functional neuroimaging in the preoperative evaluation of children with drug-resistant epilepsy. *Childs Nerv Syst* 22:810-820, 2006.
41. Spivey WH: Flumazenil and seizures: analysis of 43 cases. *Clin Ther* 14:292-305, 1992.
42. Staak R, Pape H-C: Contribution of GABA_A and GABA_B receptors to thalamic neuronal activity during spontaneous absence seizures in rats. *J Neurosci* 21:1378-1384, 2001.
43. Stefani A, Spadoni F, Giacomini P, et al: The effects of gabapentin on different ligand- and voltage-gated currents in isolated cortical neurons. *Epilepsy Res* 43:239-248, 2001.
44. Sueyoshi T, Negishi M: Phenobarbital response elements of cytochrome P450 genes and nuclear receptors. *Annu Rev Pharmacol Toxicol* 41:123-143, 2001.
45. Sullivan FM, McElhatton PR: A comparison of the teratogenic activity of the antiepileptic drugs carbamazepine, clonazepam, ethosuximide, phenobarbital, phenytoin, and primidone in mice. *Toxicol Appl Pharmacol* 40:365-378, 1977.
46. Talas G, Brown RA, McGrouther DA: Role of phenytoin in wound healing—a wound pharmacology perspective. *Biochem Pharmacol* 57:1085-1094, 1999.
47. Tomsona T, Battino D: Teratogenicity of antiepileptic drugs: state of the art. *Curr Opin Neurol* 18:135-140, 2005.
48. Treiman DM, Meyers PD, Walton NY, et al: A comparison of four treatments for generalized convulsive status epilepticus. Veterans Affairs Status Epilepticus Cooperative Study Group. *N Engl J Med* 339:792-798, 1998.
49. Upton N: Mechanisms of action of new antiepileptic drugs: rational design and serendipitous findings. *Trends Pharmacol Sci* 15:456-463, 1994.
50. Velisková J, Moshé SL: Update on the role of substantia nigra pars reticulata in the regulation of seizures. *Epilepsy Curr* 6:83-87, 2006.
51. Vonck K, Boon P, Van Roost D, et al: Anatomical and physiological basis and mechanism of action of neurostimulation for epilepsy. *Acta Neurochir Suppl* 97(Pt 2):321-328, 2007.
52. Walker DM, Teach SJ: Update on the acute management of status epilepticus in children. *Curr Opin Pediatr* 18:239-244, 2006.
53. Watanabe S, Satumae T, Takeshima R, et al: Opisthotonos after flumazenil administered to antagonize midazolam previously administered to treat developing local anesthetic toxicity. *Anesth Analg* 86:677-678, 1998.
54. Wong M, Trevathan E: Infantile spasms. *Pediatr Neurol* 24:89-98, 2001.

GENERAL REFERENCES

- Davis KL, Martin E, Turko IV, et al: Novel effects of nitric oxide. *Annu Rev Pharmacol Toxicol* 41:203-236, 2001.
- Dworkin RH, O'Connor AB, Backonja M, et al: Pharmacologic management of neuropathic pain: evidence-based recommendations. *Pain* 132:237-251, 2007.
- Holtkamp M, Meierkord H: Anticonvulsant, antiepileptogenic, and antiictogenic pharmacostategies. *Cell Mol Life Sci* 15:2023-2041, 2007.
- Löscher W, Potschka H: Role of multidrug transporters in pharmacoresistance to antiepileptic drugs. *J Pharmacol Exp Therap* 301:7-14, 2002.
- Lowenstein DH: Seizures and epilepsy. In Braunwald E, Fauci AS, Kasper DL, et al, editors, *Harrison's principles of internal medicine*, ed 16, New York, 2006, McGraw-Hill.
- Maehara T: Neuroimaging of epilepsy. *Neuropathology* 27:585-593, 2007.
- Mavrogiannis M, Ellis JS, Thomason JM, et al: The management of drug-induced gingival overgrowth. *J Clin Periodontol* 33:434-439, 2006.
- Perucca E, French J, Bialer M: Development of new antiepileptic drugs: challenges, incentives, and recent advances. *Lancet Neurol* 6:793-804, 2007.
- Stefan H, Feuerstein TJ: Novel anticonvulsant drugs. *Pharmacol Ther* 113:165-183, 2007.
- VNS Therapy. Available at: <http://www.vnstherapy.com/>. Accessed August 5, 2009.
- Wong IC, Lhatoo SD: Adverse reactions to new anticonvulsant drugs. *Drug Saf* 23:35-56, 2000.
- Xue H: Identification of major phylogenetic branches of inhibitory ligand-gated channel receptors. *J Mol Evol* 47:323-333, 1998.
- Yaksh TL: Calcium channels as therapeutic targets in neuropathic pain. *J Pain* 7(1 Suppl 1):S13-S30, 2006.

Anti-Parkinson Drugs*

VAHN A. LEWIS

Parkinson's disease, first clearly described in 1817 by James Parkinson, is a chronic, progressive, degenerative disease of the central nervous system (CNS). The disease rarely occurs before age 40 years but affects approximately 1% of the population older than 50 years. Parkinson's disease has an insidious onset, beginning with mild signs such as slight unilateral weakness of the hand, mild tremor, and subtle changes in speech and writing. The essential signs of clinical parkinsonism are resting tremor, rigidity, bradykinesia, and postural instability. Because of the bradykinesia and postural instability, patients may develop a "shuffling gait" to reduce the likelihood of falling. Patients with Parkinson's disease appear to have reduced tone in their facial muscles and have been said to have a "masklike" facial appearance. Some patients also exhibit a tremor of the hands that is reminiscent of the way pharmacists once made "pills," called a "pill-rolling tremor." The motion of the arms and neck may become stiff, and such movement is in a stepwise fashion, referred to as "cogwheel rigidity." Control of respiratory muscles and the larynx is impaired, so that breathing capacity is reduced, and the voice develops a monotonous quality.

Prodromal symptoms such as orthostatic hypotension, urinary retention, constipation, incontinence, excessive sweating, and pain are harbingers of possible Parkinson's disease development. Loss of olfaction for particular odors (e.g., gasoline, banana, pineapple, smoke, cinnamon)¹⁹ appears before any motor abnormality develops. Disorders of the autonomic nervous system are common. Subtle changes in motor function may occur, such as changes in speech, handwriting changes, or reduced arm swinging during walking. The patient may have various ill-defined sensory symptoms consisting of numbness, tingling, abnormal temperature sensation, and visual disturbances.⁸ Higher rates of anxiety disorder (40%) are reported in Parkinson patients (e.g., panic disorder, generalized anxiety, and social phobia), and the anxiety issues may precede the motor symptoms.⁵⁷ Pain and chronic pain are common in Parkinson's disease, primarily related to dyskinesias⁶⁶ but may also represent diseased central sensorimotor interactions.⁵⁹ Sleep disturbances, including increased daytime sleepiness, abnormal rapid eye movement (REM) sleep, and increased motor activity during REM sleep (e.g., restless legs syndrome [RLS]), have been identified. Drooling commonly occurs and is mainly caused by difficulty in swallowing (dysphagia) rather than excessive salivation. Dysphagia may be severe and can result in death by asphyxia, aspiration, or pneumonia.

Although Parkinson indicated that the senses and intellect were "uninjured" in parkinsonism, the disease is associated with mental slowing that can be reversed with treatment. In addition, the incidence of dementia is approximately three times greater in patients with Parkinson's disease than in age-matched control subjects. Symptoms of depression may develop.⁸ Approximately 30% of patients report hallucinations or delusions.

Parkinson's disease may be primary, secondary, or Parkinson's plus. The primary or idiopathic form is the typical elderly-onset disorder with motor signs and primary damage to the dopamine cells in the basal ganglia. Idiopathic Parkinson's disease has been associated in patients older than 50 years, and the incidence increases with increasing age. The degenerative progression of idiopathic Parkinson's disease proceeds at irregular rates, and a subclinical form of the disorder may exist for years before the patient has the motor signs associated with Parkinson's disease. Higher incidences are seen in certain occupations, such as physicians, dentists, teachers, technicians, and agricultural workers.³⁴ Some cases of primary Parkinson's disease may have a genetic contribution and are usually seen in patients younger than 50 years. Candidate loci have been identified on chromosomes 1, 2, 4, 6, and 12.⁷ Secondary Parkinson's disease is preceded by cerebral infections (syphilis, influenza), toxic chemicals (e.g., carbon monoxide, manganese, pesticides), cerebral hypoxia (vascular defects), traumatic brain injury,³³ or antipsychotic drugs. The best-documented infectious source was the influenza epidemic of the late 1910s, which contributed to a delayed epidemic of cases as the patients aged.

Parkinson's plus disorders are a group of maladies in which the signs and symptoms of Parkinson's disease contribute to a larger disorder (e.g., multiple system atrophy) that often involves more extensive brain damage in the brainstem and cerebral cortex. In many cases, the exact cause of the parkinsonism is unknown. Certain activities and chemicals may reduce the risk of Parkinson's disease, including physical exercise, statin anticholesterol drugs, low-fat diets, smoking,^{22,64} caffeine (coffee, tea),³⁸ and moderate alcohol consumption.

NEUROBIOLOGY AND PATHOPHYSIOLOGY

Although the actual cause of Parkinson's disease remains undetermined, advances have been made in understanding of the neuropathology of parkinsonism, the central control of movement, and the role of neurotransmitters in motor control and extrapyramidal function. The classic motor signs of Parkinson's disease occur when there is a 60% to 80% loss

*The author wishes to recognize Dr. Leslie Felpel for his past contributions to this chapter.

of dopamine in the basal ganglia. The cause of the loss can vary with the patient, however.

Lewy bodies are neuron inclusion bodies found in the brains of patients with idiopathic Parkinson's disease and some other neurologic disorders. These inclusion bodies contain α -synuclein, ubiquitin, and in some cyclin-dependent kinase 5 (cdk5) and leucine-rich repeat kinase 2 (LRRK2).⁷ The role of α -synuclein has been associated with synapses and nuclei ("sy" + "nuclei" + "n"), cell membrane, mitochondrial membranes, and possibly reuptake transporters.² Excess formation of α -synuclein is termed a *synucleinopathy*. Ubiquitin is associated with the ubiquitin-proteasome catabolic system involved with removal of damaged or misfolded proteins (e.g., synuclein). The cdk5 enzyme has a role in regulating microtubular structural proteins that mediate neuronal function. The accumulation of cdk5 also may contribute to inflammatory changes in the brain.¹⁷ LRRK2 has been found in some genetic Parkinson's disease cases in Asia. Lewy bodies decrease neuron survival of the affected cells, which may trigger increased microglial mediated inflammation and cell destructive activity.⁵²

By studying the pattern of α -synuclein inclusions, it has been observed that the common sporadic form of Parkinson's disease starts in the brainstem and olfactory tract before motor symptoms appear. The most sensitive neurons apparently are small neurons with long axons, typical of catecholamine and other autonomic neurons. Early damage occurs in the dorsal motor nucleus of the vagus, spinal cord,¹¹ and olfactory neurons. Prodromal autonomic and olfactory symptoms coincide with the development and spread of α -synuclein accumulations. As the disorder progresses, the lesions ascend to involve brainstem, thalamus, basal ganglia, limbic, and finally cortical structures.¹⁰ When sufficient damage to dopamine cells occurs, clinical motor signs become evident. The overt symptoms generally progress over 10 to 20 years and may terminate in severe invalidism. Life expectancy is reduced because of the usual complications associated with long-term invalidism. There is growing interest in developing neuroprotective treatments that might be useful before these debilitating changes occur.

Hereditary Parkinson's diseases are familial disorders usually seen in patients younger than 50 years old. Most of the known genetic differences that predispose to Parkinson's disease are associated with changes in α -synuclein, ubiquitin-proteasome, or mitochondrial function; the number of possibilities continues to increase with further research (Table 15-1). Autosomal dominant loci tend to induce the disease, whereas recessive factors often contribute to expression

but may not act alone. Mutations that affect the function of dopamine neurons can cause Parkinson's symptoms directly, whereas in other cases Lewy bodies are conspicuous and may lead to subsequent damage of the dopamine cells.

Environmentally induced Parkinson's disease is a result of a toxic agent from the environment or brain trauma that damages the basal ganglia. A dramatic upsurge of interest in environmental factors as a cause for Parkinson's disease occurred when several young drug abusers developed severe parkinsonian symptoms after self-administering a drug that they thought was a heroin analogue. The compound, 1-methyl-4-phenyl-1,2,3,6-tetrahydropyridine (MPTP), was a by-product of a faulty synthesis of the opiate analgesic alpha-prodine. Later work established that the chemical causing the toxicity was actually 1-methyl-4-phenylpyridinium (MPP+), a metabolite of MPTP. MPP+ toxicity stems from its transportation into cells by catecholamine reuptake transporters and subsequent interference with mitochondrial energy production. Acute MPP+ selectively destroys dopamine neurons in the substantia nigra, and this replicates many of the motor disorders of Parkinson's disease, although not the synucleinopathy.⁴ In some models, chronic or continuous MPTP administration can compromise the ubiquitin-proteasome system and can lead to the accumulation of α -synuclein.²⁴ MPTP-induced damage is reduced in α -synuclein knockout mice, suggesting that these inclusions may potentiate the toxin's damage.⁴⁰

Various environmental agents may contribute to the development of Parkinson's disease, and various pyridines are present in the environment in insecticides, herbicides, and contaminants. The insecticides rotenone and paraquat (structurally related to MPP+) have been found to produce a Parkinson-like syndrome in rats.⁵¹ Antipsychotic drugs often produce reversible Parkinson-like signs. The antipsychotic agent haloperidol is metabolized to a pyridinium metabolite that increases oxidative damage in experimental animals,³⁹ raising the possibility of irreversible damage. Mitochondrial respiratory complexes may be compromised by MPP+, and mitochondrial complex I has been found to be prone to functional compromise. It is unclear whether mitochondrial disorders are a feature of idiopathic Parkinson's disease, however.³⁶ Another important environmental toxin is the metal manganese, and miners and users of some manganese products may develop secondary Parkinson's disease.

Changes in Brain Function in Parkinson's Disease

Motor function in the spinal cord and trigeminal nucleus is directly controlled by motor regions of the cerebral cortex. A

TABLE 15-1

Inheritance of Parkinson's Disease

LOCUS	GENE	INHERITANCE	AFFECTED SYSTEM	AGE OF ONSET	LEWY BODIES
Park 1	<i>SNCA</i>	D	α -Synuclein	40s	Diffuse
Park 2	<i>Parkin</i>	R	Ubiquitin-E3-ligase	20-40	Few or none
Park 3	<i>Chr2p13</i>	D	Ubiquitin	60	Tangles and plaques
Park 4	<i>SCNA</i>	D	α -Synuclein—multiple copies	30	Fulminant
Park 5	<i>UCHL-1</i>	D	Ubiquitin, proteasome	50	?
Park 6	<i>PINK</i>	R	Mitochondria	30-40	?
Park 7	<i>DJ-1</i>	R	Oncogene localized to the cytoplasm and mitochondria	30-40	?
Park 8	<i>LRRK2</i>	D	Mitochondria	60	No
Park 13	<i>HTRA2</i>	D	Mitochondria	Late	
	<i>NURR1</i>	D	Orphan steroid/retinoic acid receptor	Late	Yes

Data from Belin AC, Westerlund M: Parkinson's disease: a genetic perspective. *FEBS J* 275:1377-1383, 2008; Bogaerts V, Theuns J, van Broeckhoven C: Genetic findings in Parkinson's disease and translation into treatment: a leading role for mitochondria? *Genes Brain Behav* 7:129-151, 2007; and Gasser T: Update on the genetics of Parkinson's disease. *Mov Disord* 22(Suppl 17):S343-S350, 2007.
D, Dominant; R, recessive.

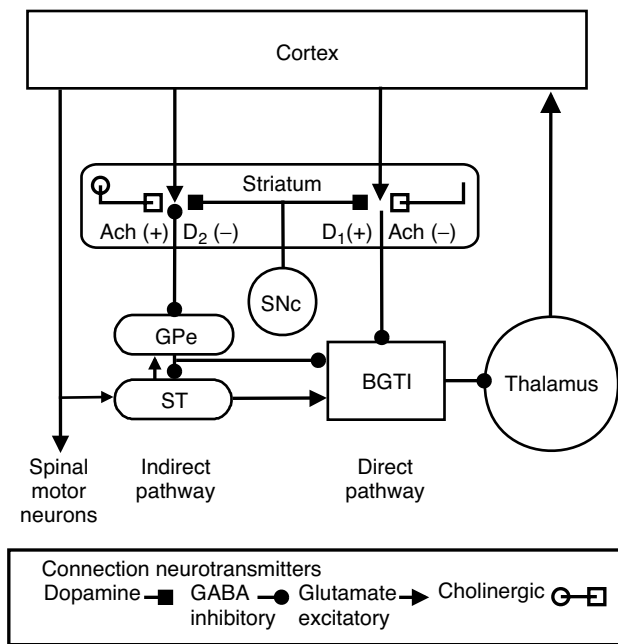

FIGURE 15-1 Movement controlled by the cortex under the influence of the thalamus and basal ganglia. The thalamus relays excitatory input to the cortex. Glutamatergic cortical fibers project to the striatum, activating GABAergic neurons. The GABAergic output from the basal ganglia is funneled through the basal ganglia thalamic inhibitor (BGTI), which exerts an inhibitory action on the thalamus. By the direct pathway, cortical input inhibits the BGTI and disinhibits the thalamus output. The indirect pathway, involving the globus pallidus externus (GPe) and the subthalamic nucleus (ST), is complex but generally leads to an increase in inhibitory output from the BGTI. Excitatory D₁ dopamine receptors are believed to modulate the output of the direct pathway, whereas inhibitory D₂ receptors modulate the output of the indirect pathway. Dopamine neuron cell bodies are located in the substantia nigra pars compacta (SNc). Acetylcholine (ACh) is found in large interneurons within the striatum and opposes the effects of dopamine. GABA, γ -Aminobutyric acid.

model of basal ganglia function is shown in Figure 15-1. Motor activity in the cerebral cortex is stimulated by thalamocortical input, which is modulated by many factors, including sensory feedback, memory readout, and emotional response. The basal ganglia modulate the thalamocortical processing through a γ -aminobutyric acid (GABA)-mediated inhibitory input derived from the substantia nigra pars reticulata and the internal part of the globus pallidus, nuclei whose functions seem to be similar and for this discussion are referred to as the *basal ganglia thalamic inhibitor* (BGTI). The output of the BGTI is influenced by two pathways within the basal ganglia, the direct and indirect. The direct pathway generally inhibits the BGTI and disinhibits the thalamic drive and increases motor activity. The indirect pathway, involving excitatory input from the subthalamic nucleus, inhibits movement by facilitating BGTI outflow.

Dopamine from the substantia nigra pars compacta (SNc) innervates the direct and indirect pathways in the striatum.⁴ In the direct pathway, it acts on D₁ receptors, which increase GABA inhibition of the BGTI. In the indirect pathway, dopamine acts on D₂ receptors, which inhibit GABA outflow to the indirect pathway. In the case of Parkinson's disease, a loss of dopamine neurons from the SNc leads to dysregulation of the indirect pathway by the subthalamic nucleus, producing activation of the BGTI and inhibition of movement (bradyki-

nesia or akinesia). Damage anywhere in these loops may result in localized motor abnormalities such as dystonias. Parallel cortico-basal ganglia-thalamic circuits are proposed that subservise aspects of executive and emotional thinking, which may help explain some of the psychiatric symptoms (e.g., depression, hallucinations) observed in some patients with Parkinson's disease.^{47,54}

The tremor associated with Parkinson's disease has been more difficult to explain. Research has suggested that the interaction between the subthalamic nucleus and the external segment of the globus pallidus may be one source of tremor. Other studies suggest a role for the thalamus in tremor generation. Tremors may also represent a dysregulation of the communication between the cerebellum and basal ganglia and other parts of the brain. Other research has found a relationship between acetylcholine, norepinephrine, or serotonin^{18,25} levels and tremors.

Parkinson's tremors predominate when the patient is resting, whereas cerebellar loop damage tremors predominate during movements. Cortical-striatal-thalamic loops, impaired in Parkinson's disease, are associated with deficits in internally guided motor activity—difficulty with volitional behavior. A second motor control circuit, the cerebellar-thalamic-cortical loop, is thought to be more important for reacting to externally guided behavior. Evidence has accumulated more recently that these systems communicate at many levels—cortical,⁴⁶ thalamic,³⁷ and midbrain.³

Hints for a role of the cerebellum in Parkinson's disease include the observation that patients can sometimes initiate blocked motor behaviors when presented with externally applied cues, such as an external target to guide a foot to initiate walking. In addition, patients with Parkinson's disease freeze in conjunction with certain external stimuli, such as passing through a doorway. Functional brain imaging suggests that the cerebellum is hyperactive in patients with Parkinson's disease and possibly trying to compensate for the basal ganglia deficiency.^{20,42}

Although Parkinson's disease is primarily associated with movement problems, there may be additional changes. Responses to sensory stimuli, measured in the basal ganglia, tend to have large receptive fields. This tendency suggests that the basal ganglia may participate in poorly localized sensations such as pain.⁶⁰ As noted earlier, changes in olfaction and pain are early signs of the disorder. Pain sensation may be altered in Parkinson's disease, including reductions in discriminative, affective, and cognitive dimensions.¹⁴ Patients differ on the direction of the sensory changes. In some cases, pain responding may be reduced, whereas in others diffuse and annoying spontaneous pains may be present, often associated with muscle pain. The basal ganglia may participate in the actions of opiates because the globus pallidus is rich in opiate receptors.⁶

Neuroprotection

Neuroprotective strategies for the treatment of Parkinson's disease have evolved from theories regarding the cause of the disease. The free radical hypothesis is based on the concept that free radicals (generated from oxidative reactions) react with membrane lipids and cause lipid peroxidation, cell injury, and subsequent cell death. Mitochondrial damage and inhibition of oxidative phosphorylation also occur as a result of free radical attack.⁹ Figure 15-2 illustrates the relationship between dopamine metabolism and the generation of reactive oxygen species. In addition, the damaged neurons may lose resistance to the toxic effects of the afferent excitatory neurotransmitter glutamate (afferents from the cortex, pedunculo-pontine nucleus, and subthalamic nucleus), whose toxicity is mediated by excessive Ca⁺⁺ flux and nitric oxide synthesis (Figure 15-3). In the most severe case, these reactions can lead to apoptosis and cell death.

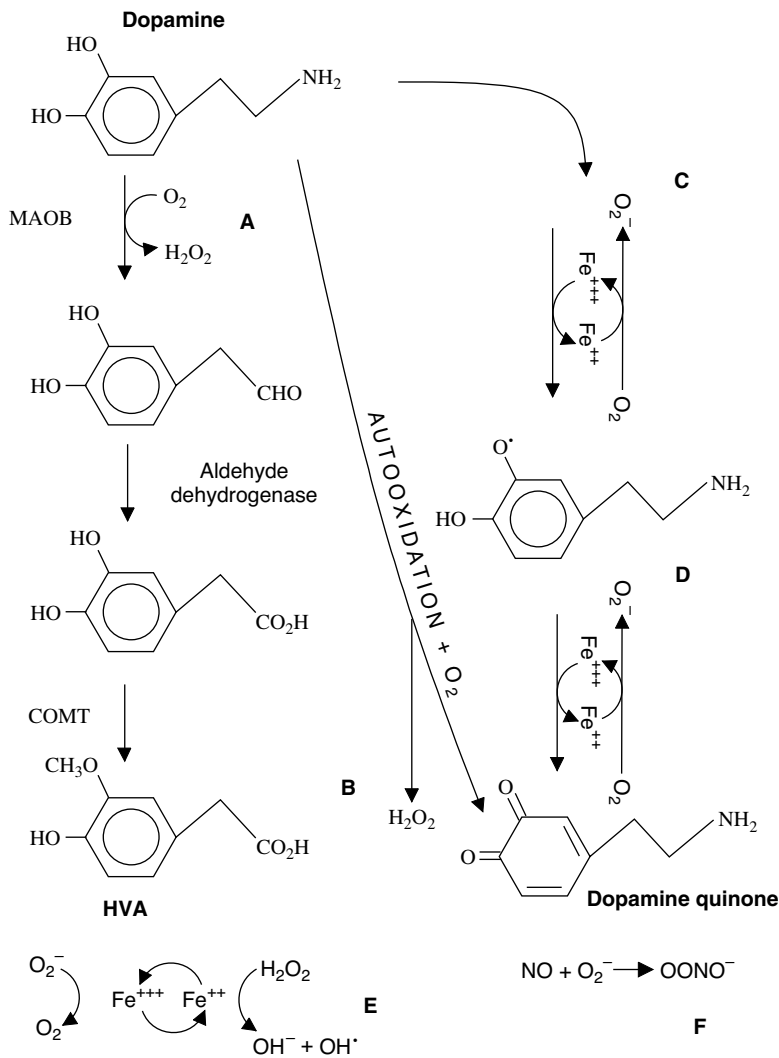

FIGURE 15-2 Dopamine metabolism and the oxidative challenge to the substantia nigra pars compacta. Metabolism of dopamine can generate hydrogen peroxide (H_2O_2) at steps A and B. In the presence of Fe^{3+} (pathologically elevated in the substantia nigra of patients with Parkinson's disease), increased generation of reactive hydroxy ions ($OH^•$), superoxide species (O_2^-), and free radicals occurs (steps C, D, and E). Finally, additional reactions may occur between these active oxygen species and nitric oxide to generate toxic peroxynitrite free radicals ($OONO^-$) (step F). Dysregulation of these reactions may lead to oxidative damage in dopaminergic nerves. COMT, Catechol-O-methyltransferase; HVA, homovanillic acid; MAO-B, monoamine oxidase B.

The brain is usually protected from damage caused by free radicals because it contains protective substances (e.g., glutathione, ascorbic acid, melatonin, vitamin E) and enzymes (e.g., glutathione peroxidase, superoxide dismutase) that prevent free radical buildup. The SNc of patients with Parkinson's disease has reduced concentrations of glutathione and glutathione peroxidase. This decrease occurs early in the disorder and can by itself decrease mitochondrial complex I function.

Free radical scavenger drugs such as vitamin E have been administered experimentally, albeit so far without much success. The monoamine oxidase (MAO) B inhibitor selegiline offers a potential, but as yet unproved, neuroprotective action by inhibiting the breakdown of dopamine. The pituitary hormone melatonin has antioxidant and proglutathione actions and has been found to be protective in the MPP⁺ model. Other vitamins may influence neuroprotective processes. Vitamin A and D receptors (RXR and VDR) are concentrated in the substantia nigra, and deficiencies may contribute to Parkinson symptoms. The NURR1 genetic defect affects the RXR receptor. Inadequate levels of vitamins A and D may potentiate the degree of Parkinson symptoms in addition to increasing the risks of bone fractures associated with falls.^{49,63}

Late-stage Parkinson's disease is quite resistant to treatment; drugs become ineffective, and tissue grafts and implants lose efficacy. Examples of irreversible neural degenerative cascades⁴⁵ may provide a framework for understanding why Parkinson's disease continues to progress (pathologic remodel-

ing, gliosis, or vascular problems) despite attempts to replace dopamine. Earlier interventions that could prevent such irreversible changes are needed.

Tomographic Imaging in Parkinson's Patients

Tomographic imaging techniques are useful for investigations into causes, disturbed brain processing, and diagnostic information about Parkinson's disease.⁴¹ Systems used to image brain changes in patients with Parkinson's disease include positron emission tomography; single photon emission computed tomography, which can assess ligand binding within the brain; and functional magnetic resonance imaging (fMRI) and the related blood oxygen level-dependent (BOLD) fMRI. These all are indirect measures of brain tissue function.¹⁶ Transcranial ultrasound has been useful for finding changes in substantia nigra iron levels. Table 15-2 summarizes several imaging ligands and how they are used to assess the function of the basal ganglia and other related brain regions. In particular, β -CIT has been used to visualize dopamine uptake transporters in the basal ganglia. These images distinctly outline the caudate-putamen region of the brain and show that in Parkinson's disease the labeling in the basal ganglia is reduced either unilaterally or bilaterally.

Unified Parkinson's Disease Rating Scale

Parkinson's disease signs and symptoms can be semiquantitatively estimated with the Unified Parkinson's Disease Rating

TABLE 15-2

Imaging Techniques Used to Evaluate Parkinson's Disease

NAME	USES
¹⁸ Fluoro-DOPA	Labels levodopa-to-dopamine conversion and presynaptic dopamine
Beta-CIT, (2 beta-carbomethoxy-3 beta-(4-iodophenyl)tropane)	Selectively labels DAT
SCH 39166 and NNC 756	Selective D ₁ receptor binding
Raclopride	Selectively binds to dopamine D ₂ receptors
d-Methylphenidate	Sensitive to dopamine system loss in basal ganglia
WAY100635	Labeling 5-HT _{1A} , shown to be inversely related to Parkinson's tremor
Fluorodeoxyglucose	Labels glucose (energy) use for differential diagnosis between Parkinson's disease and MSA
¹⁵ Oxygen	PET oxygen use technique for assessment of Parkinson's disease and MSA
PK11195	PET marker of PBBS, which are selectively expressed by activated microglia associated with brain inflammation
fMRI and BOLD fMRI	Indirect activity measure based on blood desaturation in brain active regions. Used to assess relative activity in different brain regions. May be useful to assess MSA
Transcranial ultrasound	Used to identify iron accumulation in substantia nigra in pre-Parkinson's disease or early Parkinson's disease

Data from references 16, 18, 26, and 29.

5-HT_{1A}, 5-Hydroxytryptamine type 1A; BOLD, blood oxygen level-dependent; DAT, dopamine transporter; fMRI, functional magnetic resonance imaging; MSA, multiple system atrophy; PBBS, peripheral benzodiazepine sites; PET, positron emission tomography. Positron emitters include ¹²³I, ¹⁸F, or ¹¹C.

Scale (UPDRS). This scale evaluates four separate dimensions of the disorder: I, Mentation, Behavior, and Mood (4 items); II, Activities of Daily Living (13 items); III, Motor Examination (14 items); and IV, Complications of Therapy (A, Dyskinesias; B, Clinical Fluctuations ["on" or "off"; see below], and C, Other). This scale, or parts of it, has been used to estimate the impact of treatments on patients with Parkinson's disease.

Using only Part III, Motor Examination, an individual without Parkinson's disease would score 0 or a low value. For a Parkinson's patient whose symptoms have been reduced with treatments and who feels "on" (i.e., able to move freely), the score is less than 8. Patients feel "off" when the score is greater than 20.¹³ One sample of Parkinson's patients⁶⁵ averaged around 41 in the untreated state and around 22 in the group with levodopa treatment. Some of these patients also received subthalamic nucleus deep brain stimulation, and their scores also decreased about 20 points on deep brain stimulation alone. There is considerable variation in responding, such that one patient may improve from 56 to less than 8, whereas another patient may show no improvement or

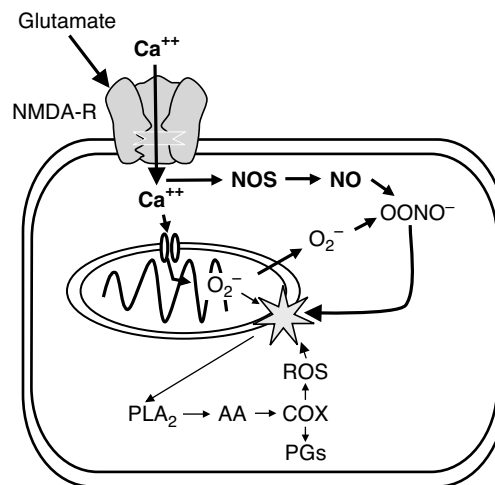

FIGURE 15-3 Ca⁺⁺-mediated oxidative stress in nerves with glutamate (or glutamatergic) receptors. Activation of N-methyl-D-aspartate (NMDA) receptors (*NMDA-R*), one type of glutamate receptor permits Ca⁺⁺ currents to enter the cell. Intracellular Ca⁺⁺ is normally reduced by sequestration in mitochondria and endoplasmic reticulum (not shown). Excess Ca⁺⁺ stimulates nitric oxide synthase (*NOS*), which catalyzes the synthesis of nitric oxide (*NO*). Excessive Ca⁺⁺ currents are thought to compromise the function of mitochondria and permit the generation of free radicals and superoxide (O_2^-), which can react with *NO* to produce the toxic peroxynitrite radical ($OONO^-$), which can damage the mitochondria and cell membranes. Damaged membranes can be metabolized further by phospholipase A₂ (*PLA*₂), producing arachidonic acid (*AA*), a substrate for cyclooxygenase (*COX*). Additional reactive oxygen species (*ROS*) are generated in the synthesis of prostaglandins (*PGs*) from *AA*. These reactions may contribute to the sensitivity of the substantia nigra pars compacta neurons to premature cell death.

worsening. Some patients respond to placebo with improvement of motor function.³² Over time without treatment, a typical patient's score increases about 6 points per year as the disease progresses.²³ Published UPDRS scores for several Parkinson's disease treatments are summarized in Table 15-3.

DOPAMINE REPLACEMENT AS A BASIS FOR THERAPY

In the 1960s, investigators discovered high concentrations of dopamine in two areas of the extrapyramidal system: the striatum and the SNc. Patients with Parkinson's disease were found to have low concentrations of dopamine in these areas, which can now be shown in living patients using appropriate tomographic imaging. The drug reserpine was known to reduce catecholamines and produce characteristic Parkinson's disease-like effects (extrapyramidal signs). Levodopa (L-3,4-dihydroxyphenylalanine, the precursor of dopamine) was shown to reverse reserpine-induced bradykinesia, and a link between dopamine and extrapyramidal motor function was established.

The clinical effectiveness of intravenously administered levodopa on Parkinson's disease was soon discovered, but its oral effectiveness was limited. Much of the drug (97% to 99%) is metabolized before gaining access to the CNS, which led to adverse side effects such as nausea, vomiting, and cardiovascular problems.

Carbidopa, a dopa-decarboxylase inhibitor, prevents much of the peripheral metabolism of levodopa (Figure 15-4). Carbidopa does not cross the blood-brain barrier, so it does

TABLE 15-3

Selected Anti-Parkinson Drugs and Their Approximate Effect on Unified Parkinson's Disease Rating Scale (UPDRS) Motor Examination Scores

AGENT	REDUCTION OF UPDRS III
Levodopa	22
Deep brain stimulation	20
Apomorphine*	10
Bromocriptine	5
Pergolide	5
Pramipexole	4
Ropinirole	5
Rotigotine	5
Amantadine	6
Selegiline	2
Rasagiline	5
Tocopherol (vitamin E)	0
Melatonin	0
Placebo	0-5

*Intraperitoneal.

not inhibit the CNS synthesis of dopamine from levodopa. Systemically administered levodopa is transported into the brain through the blood-brain barrier by a saturable amino acid transporter. Combining levodopa with carbidopa permits the use of lower doses of levodopa with greater effectiveness in parkinsonism compared with levodopa alone. It has been found that catechol-O-methyltransferase (COMT) may become upregulated in patients taking carbidopa. This discovery prompted the development of COMT inhibitors to inhibit further the peripheral metabolism of levodopa. Another enzyme important in catecholamine metabolism is MAO. MAO-B inhibitors may also help reduce the amount of levodopa required to reduce Parkinson's symptoms.

The classic dopaminergic/cholinergic imbalance concept of Parkinson's disease explains various clinical and pharmacologic responses, but clinical parkinsonism is more complicated than an imbalance between two neurotransmitters. There are many other neurotransmitters in the basal ganglia, including norepinephrine, 5-hydroxytryptamine (5-HT), GABA, adenosine, and glutamate. Peptides such as enkephalins (indirect pathway) and substance P (direct pathway) coexist with GABA in some striatal efferent neurons. Although the role of these substances in Parkinson's disease is unknown, they offer possible pharmacologic approaches for therapy. There are occasional reports of parkinsonism being exacerbated or improved by agents acting on these other receptor systems.

Dopamine is a neurotransmitter in numerous areas of the brain, and the side effects of its supplementation can be understood in the context of its actions. Dopamine can act to amplify the effects of stimulation and can modulate functions of numerous cortical and subcortical structures. Dopamine in the basal ganglia is crucial for regulating motor tone, and its loss is associated with motor stiffness. Dopamine modulates learning and memory. The mesolimbic dopamine and basal ganglia seem to be associated with drive, salience, and reward. Drugs that increase the actions of dopamine can cause dependence.

Increased dopamine release in the basal ganglia is produced by such behaviors as eating food, listening to music,⁴⁶ and sexual activity. In fear-mediating brain regions (e.g., amygdala), dopamine may act to make fearful stimuli more salient.² Dopamine cells fire more during waking than sleep, suggesting a role in sleep-wake cycles. This relationship is complicated by the multiple dopamine receptors, some of

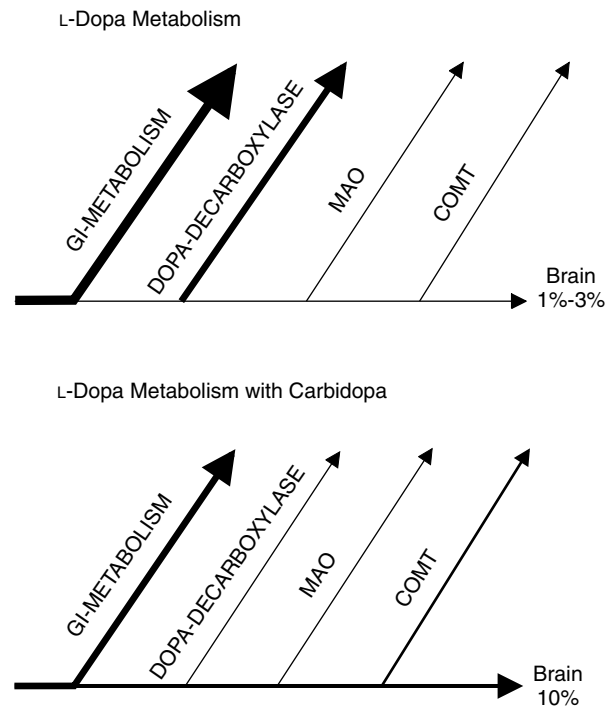

FIGURE 15-4 Levodopa (L-dopa) metabolism alone and with a dopa-decarboxylase inhibitor. L-Dopa can be eliminated by several mechanisms before it reaches the brain. Substantial elimination occurs in the gastrointestinal (GI) tract and peripheral tissues. Carbidopa reduces L-dopa metabolism outside the brain. A higher percentage (10% versus 1% to 3%) of the dose of L-dopa gets to the brain when administered with carbidopa. To reduce metabolism of dopamine further, catechol-O-methyltransferase (COMT) inhibitors may be added; these drugs also reduce 3-O-methyldopa competition for levodopa transport into the brain. MAO, Monoamine oxidase.

which seem to promote sleepiness.⁴⁸ Dopamine may modulate appetite, but again the relationship is not simple. Dopamine neurons inhibit the release of prolactin by an action on the hypothalamus. Dopamine is associated with the chemoreceptor trigger zone where it produces an emetic action. Dopamine neurons are also found in the eye and olfactory tract. Dopamine is also a precursor for the neurotransmitter norepinephrine and so may alter blood pressure or cardiovascular function. Dopamine has a vasodilatory action in the kidney. Similar to many neurotransmitters, dopamine has many and varied actions.

There are several types of dopamine receptors, D₁₋₅ with two important variants: a D₂ short version associated with a presynaptic autoreceptor that decreases dopamine release, and a D₂ long version that acts as a postsynaptic receptor. D₅ is thought to be similar to D₁ in function, and D₃ and D₄ are similar to D₂. Dopamine D₂ type receptors are thought to be more important than D₁ and D₅ receptors for anti-Parkinson effectiveness, but stimulation of both groups of receptors seems to be involved in the therapeutic efficacy of levodopa.

DRUG THERAPY FOR PARKINSON'S DISEASE

Table 15-4 presents an overview of the drugs used in the treatment of Parkinson's disease. Dopamine replacement with levodopa is the principal treatment. Patients do not always respond uniformly to levodopa, however, and adjunct agents can be beneficial. The relative effectiveness of selected therapies is shown in Table 15-3. Dopamine agonists gradually lose

TABLE 15-4

Overview of Drugs and Procedures Used in the Treatment of Parkinson's Disease

DRUG OR PROCEDURE	PURPOSE	COMMENTS
Levodopa	Transported into brain then converted to dopamine	Natural precursor to dopamine; side effects include nausea, vomiting, dystonias, and postural hypotension
Carbidopa (with levodopa)	Blocks metabolism of levodopa in peripheral circulation	Reduces dose of levodopa and its peripheral side effects
Tolcapone, entacapone	Nitrocatechol COMT inhibitors; help spare levodopa from peripheral metabolism and from competition for brain amino acid transporters	Tolcapone may induce hepatic failure; possible drug interactions between COMT inhibitors and dental drugs
Selegiline (also called deprenyl) and rasagiline	Blocks MAO-B irreversibly; modest improvement of symptoms; may reduce synthesis of active oxygen metabolites; may slow progression of disease	Possible drug interaction with opiates, antidepressants, foods, and other drugs
Dopamine Receptor Agonists		
Bromocriptine, pergolide, lisuride, apomorphine, pramipexole (D ₂ , D ₃), ropinirole (D ₂ , D ₃), rotigotine (D ₁ , D ₂ , D ₃)	Act directly on dopaminergic receptors; newer agents used to initiate therapy; also used in "off" cycles; used when loss of presynaptic dopaminergic neurons is great	Use limited by postural hypotension, nausea, sedation; may contribute to confusion, sleep disorders, wake disorder, hallucinations, psychosis, impulsiveness
Anticholinergics (Antimuscarinic)		
Trihexyphenidyl, benzotropine, biperiden, procyclidine, diphenhydramine	Balance CNS dopamine/acetylcholine ratios	Can cause dry mouth, constipation, urinary retention, triggering of acute-angle glaucoma, impaired memory, and hallucinations
Other		
Amantadine	Increases release of dopamine; blocks dopamine reuptake and NMDA receptors	Also used as an antiviral agent
Antidepressants		
Tricyclic antidepressants, SSRIs, other antidepressants	Used to treat depression associated with disease; may be useful in treating levodopa-induced depression	Antidepressants may worsen Parkinson's symptoms in some patients
Procedures		
Brain stimulation	Used to relieve essential tremor	Commercial stimulator unit has been marketed
Surgical lesions for Parkinson's disease	Unilateral stereotaxic lesions are introduced to control levodopa dystonias and parkinsonism tremor, rigidity, or bradykinesia	Some risk of stroke, paralysis, and visual field defects
Fetal transplants, stem cells, special cell culture implants	Used to replace dopamine cells	More effective in younger patients

CNS, Central nervous system; COMT, catechol-O-methyltransferase; MAO-B, monoamine oxidase B; NMDA, N-methyl-D-aspartate; SSRIs, selective serotonin reuptake inhibitors.

efficacy, and dementia may follow, which is not reversible with dopamine agonists.

Levodopa

Levodopa (Figure 15-5) is a neutral amino acid formed from L-tyrosine, and it is a precursor of the endogenous catecholamines, including dopamine and norepinephrine. The major metabolic fate of levodopa is decarboxylation to dopamine by aromatic L-amino acid decarboxylase, commonly referred to as dopa decarboxylase. COMT is an enzyme that can methylate levodopa and reduce its transport into the brain. COMT inhibitors have been developed to reduce this problem.

Pharmacologic effects

The CNS and peripheral nervous system actions of levodopa are indirect and thought to result from its conversion to dopamine. In practice, levodopa is almost always given with a

decarboxylase inhibitor to increase the percentage of levodopa delivered to the CNS and to reduce peripheral toxicity from levodopa. Stalevo is a fixed combination of levodopa, a decarboxylase inhibitor, and a COMT inhibitor (levodopa/carbidopa/entacapone).

Central nervous system. Because Parkinson's disease is characterized by a dopamine deficiency, the obvious therapeutic strategy would be to restore dopamine concentrations to normal. Dopamine does not cross the blood-brain barrier, however, and is ineffective when administered systemically. The immediate amino acid precursor of dopamine, levodopa, is readily transported into the brain and is decarboxylated to dopamine in nigrostriatal neurons. The newly synthesized dopamine is sequestered in vesicles in the neuron terminals in the striatum, where it is available for release. Despite this seemingly physiologic approach, levodopa is not curative.

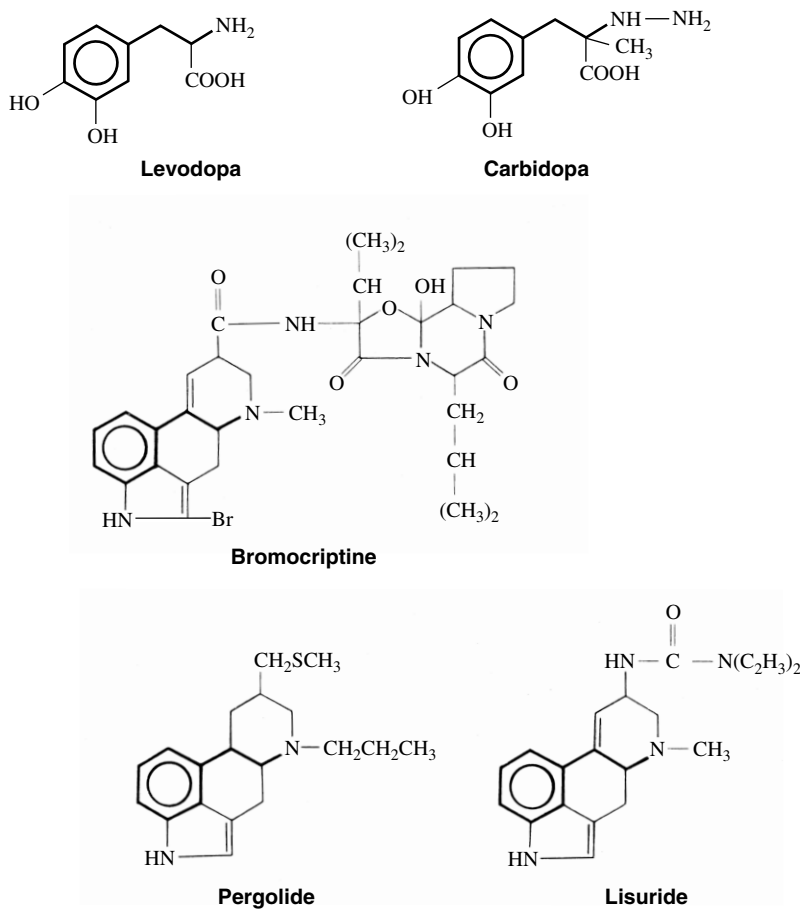

FIGURE 15-5 Structural formulas of some dopamine-related drugs used in the treatment of Parkinson's disease. The dopamine backbone contained within these structures is emphasized.

Postmortem examinations of the brains of Parkinson's patients indicate that morphologic changes in the CNS are similar regardless of whether patients are treated with levodopa.

A beneficial response to levodopa is obtained in approximately 75% of patients. Signs of parkinsonism, including bradykinesia, rigidity, and to a lesser extent tremor, are typically controlled, but the clinical efficacy decreases with time.

Patients receiving long-term levodopa therapy commonly experience a "wearing-off" effect, which refers to an apparent decrease in the length of time that a given dose of levodopa exerts its therapeutic effect. Another complication of long-term levodopa therapy is the "on-off" phenomenon. The patient has periods in which the levodopa is effective in reducing parkinsonian symptoms, but in which abnormal involuntary movements (AIMs) occur as levodopa side effects. AIMs may take the form of dyskinesias, which may correlate with the maximum plasma concentration of levodopa (peak-dose dyskinesia), or of dystonias, which are not strictly related to plasma concentrations of levodopa. This "on" state alternates with an "off" state in which there is a lack of therapeutic response to the drug, characterized by rigidity and akinesia. Oscillations in performance are so disabling and troublesome that, in an attempt to control them, patients may increase their total dose of levodopa to the point of abuse and dependence, leading to the consequences of severe AIMs.

The mechanisms responsible for these unusual responses are unknown, but may relate to variations in drug absorption or receptor changes. Loss of dopaminergic input (denervation) to the striatum produces some increased sensitivity of post-synaptic dopamine receptors (denervation supersensitivity) to dopamine. D₁ receptor and stimulated adenylyl cyclase activity is increased by denervation and by long-term levodopa.¹²

D₂ receptors are increased in early Parkinson's disease,⁶⁷ but neither D₁ nor D₂ receptors are increased in the postmortem brain tissue of these individuals. Receptor desensitization may play a role in the diminishing response to levodopa and in the "on-off" effect. Support for this concept is provided by the observation that withdrawal of levodopa for 2 to 3 weeks (drug holiday) may permit its reinstatement at a greatly reduced dose and with less therapeutic fluctuation.¹⁵

Levodopa-induced dyskinesias are a common problem, and various factors may be involved in their generation. Current efforts to minimize abnormal movements are focusing on variables such as dose, dosing schedules, prolonged-release dose forms, and the degree of D₁ and D₂ receptor activation caused by dopaminergic agents.

Although levodopa initially improves the mental status of a patient with Parkinson's disease, a progressive dementia may still occur. A concern that levodopa might generate toxic metabolites has not been confirmed in studies. Patients started on levodopa therapy show an immediate benefit, and there is no evidence for any acceleration of neural damage.²³ More recent reports suggest that direct dopamine agonists may protect β-CIT binding better than levodopa before overt parkinsonian symptoms, but further study is needed to verify such results.

Levodopa-induced behavioral changes are dose dependent and subside with dose reduction, but parkinsonian symptoms then worsen. The atypical antipsychotic agent clozapine may be useful for treating levodopa-induced psychosis because of a reduced potential for parkinsonian side effects.⁶⁸ Newer atypical antipsychotic drugs may also be useful and are not associated with the serious hematologic effects linked to the use of clozapine (see Chapter 12). Paradoxically, centrally

acting acetylcholinesterase inhibitor drugs may be helpful in some cases of levodopa-induced psychosis.¹ Ondansetron, a 5-HT₃ receptor antagonist (used as an antiemetic agent), has been found to diminish levodopa-induced visual hallucinations and psychotic symptoms.

Cardiovascular system. A moderate degree of tachycardia and hypotension may occur with levodopa therapy. These effects are caused by dopamine formed by the metabolism of levodopa outside the CNS. Dopamine may also be responsible for the increased incidence of arrhythmia and hypertension reported with levodopa therapy, but age-related coronary heart disease is also likely to contribute. The incidence of levodopa-induced sinus tachycardia and atrial and ventricular extrasystoles is low and can be reduced further with the addition of a peripherally acting decarboxylase inhibitor (carbidopa) or COMT inhibitors. Severe hypertension from levodopa is more likely to result from a drug interaction with one of the nonselective MAO inhibitors.

Gastrointestinal tract. Levodopa is rapidly converted to dopamine in the gastrointestinal tract and elsewhere. Dopamine causes significant nausea, which can be reduced by the coadministration of systemic levodopa metabolism inhibitors.

Absorption, fate, and excretion

Levodopa is absorbed from the gastrointestinal tract, but approximately 95% of the drug is converted to dopamine in the small intestine and liver. Individuals with reduced gastric acidity may have reduced absorption.⁵⁰ Only 1% of orally administered levodopa reaches the brain. When the drug is combined with a peripherally acting decarboxylase inhibitor, the dose of levodopa can be reduced by 80%. The enzymes MAO and COMT found in the nervous system and various tissues metabolize dopamine further, and inactive metabolites are excreted in the urine. Agents that block these enzymes are available. A diminished response to levodopa may occur when it is taken with a meal high in protein, perhaps related to competition for saturable amino acid carrier transport systems in the CNS. Protein-restricted diets are sometimes advocated.⁶²

Adverse effects

Initially, most patients treated with levodopa experience nausea, vomiting, and orthostatic hypotension. Tolerance develops to these side effects, reducing the need for therapeutic intervention. These symptoms are greatly reduced if a decarboxylase inhibitor is given concurrently. The most perplexing and perhaps most disabling toxic effect of levodopa is the appearance of AIMs. AIMs are often restricted initially to the orofacial muscles and include abnormal mouth movements, protrusion and retraction of the tongue, chewing motions, facial grimacing, and abnormal movements of the head. The limb and trunk musculature may be involved with continued treatment. AIMs often occur at dosages of levodopa

that are just at the threshold for control of the parkinsonian symptoms. Although they are relieved by a reduction in levodopa dose, this strategy results in increased parkinsonian symptoms.

On initial therapy, levodopa often produces anxiety, insomnia, nightmares, and nervousness. More serious psychiatric side effects occur in a few patients and can result in delirium, depression, and psychotic states.

Levodopa Combined with Decarboxylase Inhibitors

Aromatic L-amino acid decarboxylase is responsible for the enzymatic decarboxylation of levodopa to dopamine. Carbidopa is a commonly used decarboxylase inhibitor. The decarboxylase inhibitors do not penetrate the blood-brain barrier and inhibit only the peripheral conversion of levodopa to dopamine, including the conversion that occurs in the intestinal lumen (see Figure 15-4). Carbidopa allows an 80% decrease in the dosage of levodopa necessary to control parkinsonian symptoms. AIMs, particularly movements of the orofacial muscles, are not significantly diminished by the administration of carbidopa with levodopa, and there are indications that AIMs become more frequent and start earlier. There also seems to be little difference between the mental disturbances produced by levodopa alone and those produced by this drug combination. Carbidopa is relatively nontoxic but is inactive as an anti-Parkinson drug in the absence of levodopa.

The levodopa-carbidopa combination is not recommended in pregnancy or in patients younger than 18 years. Carbidopa is available as a single agent or formulated with levodopa in a fixed ratio of 10 mg/100 mg, 25 mg/100 mg, and 25 mg/250 mg (carbidopa/levodopa) and controlled-release preparations with fixed ratios of 25 mg/100 mg and 50 mg/200 mg (carbidopa/levodopa). Packaged alone (but used in combination with levodopa), carbidopa is useful for patients who require either greater or lesser amounts of the drug than provided in the standard ratios.

Catechol-O-Methyltransferase Inhibitors

COMT and MAO are two major catabolic enzymes for catecholamines. Therapeutic blockade of dopamine decarboxylase with carbidopa can induce an increased metabolism of levodopa by COMT to 3-O-methyldopa. This loss of levodopa and greater competition by 3-O-methyldopa for levodopa transporters reduces the effectiveness of levodopa treatment. The nitrocatechols tolcapone and entacapone (Figure 15-6) reversibly inhibit COMT and enhance or extend the effect of levodopa in patients who have advanced or fluctuating Parkinson's disease. Typically, the levodopa dose can be reduced by approximately 30% when a COMT inhibitor is added.

Tolcapone is administered three times a day and inhibits peripheral and central COMT. It is absorbed in 2 hours, is highly protein bound, and is extensively glucuronidated to an inactive metabolite. Tolcapone has been occasionally associated with severe hepatotoxicity and death. Patients using this agent need to be carefully selected and need to have their hepatic function monitored. Entacapone is a peripherally

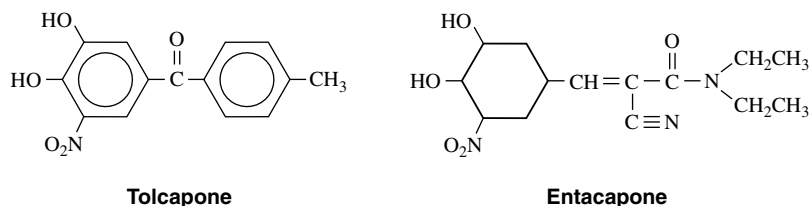

FIGURE 15-6 Structural formulas of the nitrocatechol catechol-O-methyltransferase (COMT) inhibitors tolcapone and entacapone.

acting drug and is administered in conjunction with the levodopa-carbidopa combination. Entacapone is approximately 35% absorbed and extensively protein bound (98%). Entacapone is isomerized and glucuronidated and eliminated in the bile (90%). Its half-life (1 to 2 hours) is similar to that of levodopa.

The main adverse effects of the COMT inhibitors are related to increased dopaminergic effects, such as dyskinesia, hallucinations, orthostatic hypotension, sleep disorders, and gastrointestinal side effects (e.g., nausea, vomiting). Reduction of the levodopa dose may be required to minimize these side effects. Drug interactions of concern with COMT inhibitors include the catecholamines (e.g., epinephrine), drugs that interfere with biliary excretion (including ampicillin and erythromycin), drugs with sedative actions (anxiolytics, sedative antihistamines, barbiturates, opioid agonists, antipsychotics, and many tricyclic antidepressants), and nonselective MAO inhibitors.

Monoamine Oxidase Type B Inhibitors

Selegiline and rasagiline are “selective” irreversible inhibitors of MAO-B, the major MAO enzyme in the striatum.⁶⁹ Because MAO-A is not inhibited, peripheral catecholamine metabolism is less affected. The rationale for using a selective MAO-B inhibitor is to elevate brain dopamine concentrations, while causing little or no effect on norepinephrine or 5-HT.

Selegiline is used as adjunct therapy to levodopa-carbidopa in an attempt to slow the progression of parkinsonian symptoms. It has been evaluated more recently as monotherapy in early-stage Parkinson’s disease, and it improves motor function and reduces freezing.³⁰ Selegiline is metabolized to amphetamine and methamphetamine in the brain and liver. Very often patients report that they feel better after selegiline therapy, possibly because of an amphetamine-like action. More recent studies seem to confirm selegiline’s efficacy; however, its benefits are modest and decline as the disease progresses. There may be small protective effect (9%) on β -CIT binding (see Table 15-2).

Rasagiline is an MAO-B inhibitor that is not metabolized to toxic amphetamine metabolites and is severalfold more potent than selegiline. Rasagiline is metabolized by hepatic metabolism to glucuronides and by cytochrome P450 CYP1A2. To reduce first-pass metabolism, this agent is available in orally disintegrating tablets for buccal administration.

Adverse effects of selegiline and rasagiline include nausea, dry mouth, confusion, occasional visual hallucinations, dizziness, headache, and insomnia, especially at higher doses. The combined use of these agents at high doses and levodopa results in an increased incidence of dyskinesia and psychoses. For selegiline, the effect may result from the formation of toxic quantities of an amphetamine metabolite. Although MAO-B inhibitors are thought to have fewer drug interactions than MAO-A inhibitors, clinical data have found that when the dose is increased, typical MAO A drug interactions, such as the “cheese effect,” may be seen. The U.S. Food and Drug Administration (FDA) labels warn against combining with most foods that contain elevated tyramine. They are contraindicated with meperidine, methadone, propoxyphene, and dextromethorphan and caution is urged with any other opiates. MAO-B inhibitors are contraindicated with most antidepressants. Caution is advised with any sympathomimetic amines.

Direct Dopamine Receptor Agonists

The discovery of dopamine receptor subtypes, recognition of the limits of levodopa therapy, and advances in knowledge of the neurochemistry of normal and parkinsonism-altered nerve pathways have stimulated the search for dopamine agonists for the treatment of Parkinson’s disease. Because these agents act directly on postsynaptic dopamine receptors, they comple-

ment levodopa. These drugs offer several advantages over levodopa: (1) They do not require metabolic conversion to an active compound, (2) they do not require the presence of nigrostriatal neurons or nerve impulses for their activity, (3) they have longer durations of action than levodopa with fewer “on-off” changes, (4) they are more selective than levodopa on specific subpopulations of dopamine receptors, and (5) they are less likely to generate damaging free radicals. The UPDRS benefit from the direct dopamine receptor agonists is less than that for levodopa or brain stimulation (see Tables 15-3 and 15-4 to compare the relative benefit of various Parkinson’s treatment agents). Direct dopamine agonist dosing is often limited by side effects, such as nausea and vomiting.

Bromocriptine, pergolide, and lisuride are amine ergot derivatives that share a common dopamine-like substructure, as shown in Figure 15-5. These agents may be used alone or in combination with levodopa-carbidopa. Efficacy tends to decline as the disease progresses. Bromocriptine is the oldest and best studied of this group of drugs. It is a potent D₂ receptor agonist and a weak D₁ antagonist. When combined with levodopa therapy, it may alleviate the “on-off” phenomenon, and it can be useful in patients who are unresponsive to levodopa-carbidopa. Patients placed on bromocriptine cannot stop taking levodopa-carbidopa because a dramatic increase in parkinsonian symptoms would otherwise occur.

Pergolide is a potent D₁, D₂, and D₃ receptor agonist. As a result of its prolonged action, pergolide may decrease levodopa-induced dyskinesias and increase the “on” time after the patient begins “on-off” fluctuations. A third ergot derivative, lisuride, is more potent than bromocriptine. Lisuride is primarily a D₂ receptor agonist, but it is a 5-HT receptor agonist as well; it is unavailable in the United States.

Adverse effects of these amine ergot agents are similar and include AIMs, mental changes (confusion and psychosis), and orthostatic hypotension. Oral side effects include xerostomia, sialadenitis, dysgeusia, stomatitis, gingivitis, glossitis, periodontal abscesses, dysphagia, and jaw pain. Rare side effects include pleural or retropleural fibrosis (associated with 5-HT_{2A} or 5-HT_{2B} agonist activity³⁵) and livedo reticularis, a reddish skin eruption of the lower extremities. The adverse effects are generally reversible on withdrawal of the drug. In some patients, pergolide may cause hallucinations, cardiac arrhythmias, hepatotoxicity, worsened dyskinesias, and sudden episodes of “freezing” and somnolence. Lisuride seems also to cause somnolence and greater psychiatric changes than bromocriptine, which may result from its tryptaminergic properties.

Pramipexole, ropinirole, and rotigotine are non-ergot-derived dopamine receptor agonists (Figure 15-7). Their anti-parkinsonian effect is thought to be caused by activity at the D₂ or D₃ receptor, but may also include a neuroprotective component. These agents can be used as initial monotherapy (reduced risk of dyskinesia compared with levodopa) or as an adjunct to levodopa therapy to smooth out its fluctuating propensity (“on-off” phenomena). Rotigotine is thought to stimulate D₁ dopamine receptors as well.

Pramipexole is cleared primarily by renal excretion (96%), whereas ropinirole is metabolized mainly by the CYP1A2 isoform. Ciprofloxacin can inhibit CYP1A2 and significantly increase ropinirole blood concentrations. Rotigotine has been marketed as a time-release patch to reduce blood level fluctuations and may be helpful when compliance or inability to use an oral dosage form is an issue. It is eliminated primarily by conjugation and renal excretion, but also to a certain extent by oxidative dealkylation.

Pramipexole and ropinirole have also been approved for the treatment of RLS. RLS is a sensorimotor disorder associated with strong urges to move the legs, usually in men at night. There is an elevated incidence of RLS in patients on

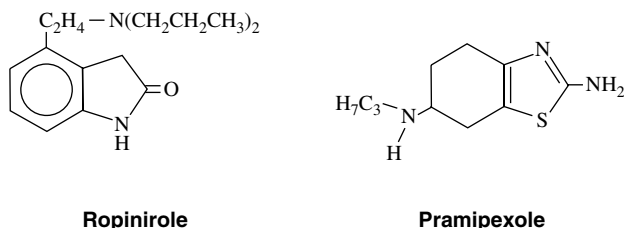

FIGURE 15-7 Structural formulas of ropinirole and pramipexole.

kidney dialysis, but it may also be seen before the development of Parkinson's disease and in other disorders, including bipolar disease. Dopamine agonists have a limited effect in RLS, prompting some to question whether their use is justified in light of side effects such as sudden sleep onset or increases in compulsive or aggressive behaviors. Previous treatments for RLS have included levodopa, opioids, benzodiazepines, clonidine, and baclofen. Anticonvulsants such as lamotrigine may also be useful in some patients. Aripiprazole is commonly used for RLS.

Several side effects have been noted with direct dopamine receptor agonists. Postural hypotension and peripheral edema can occur. Asthenia (weakness), fatigue, and somnolence are reported.

Some patients, usually older patients with more severe disease, have daytime sleepiness and have fallen asleep during daytime activities, including driving.⁶⁸ An explanation for this problem is that agonists at D_1 receptors seem to produce a waking effect, whereas D_2 (short form) presynaptic dopamine autoreceptors increase sleepiness, and postsynaptic D_2 (long form) receptors mediate waking. D_3 receptor stimulation is also thought to produce sleepiness. Low doses of D_2 receptor agonists are thought to stimulate predominantly the presynaptic D_2 short receptors.⁴⁸

Insomnia, hallucinations, and panic attacks have also been reported. Motor side effects include dyskinesias and extrapyramidal reactions. Some patients have experienced increased behavioral drive and have difficulty controlling gambling, sexual activity, and appetite.⁵⁵ Gastrointestinal side effects of nausea, constipation, xerostomia, sialorrhea, and dysgeusia have been reported. Rotigotine has a higher incidence of skin reactions associated with the patch adhesives and the drug.

Direct-acting dopamine agonists alone may begin to lose their clinical effectiveness after 1 or 2 years. Switching to a different dopamine agonist, when one begins to fail, sometimes restores clinical efficacy. Dopamine agonists have typically been used as adjuncts in anti-Parkinson therapy. In combination with levodopa-carbidopa, they allow reduction in the levodopa dose, which may diminish "on-off" responses and other side effects. Most clinical trials with dopamine agonists have been conducted on patients who are taking other anti-Parkinson drugs or whose conditions are refractory to conventional treatments. The fact that any of these patients respond to the dopamine agonists at all is encouraging.

Apomorphine has been recognized as a direct dopamine agonist since 1951. It has been rarely used clinically, however, because of nausea. It has been "rediscovered" and approved by the FDA as an agent to reverse "off" periods; subcutaneous injection may be more efficacious than oral therapy for this indication.

Drugs with Antimuscarinic Activity

Before the discovery of levodopa, the standard drugs for the treatment of Parkinson's disease were the antimuscarinic agents. Antimuscarinic drugs act to restore the dopaminergic/cholinergic balance by antagonizing the action of acetylcho-

line; they may also inhibit dopamine uptake. The antimuscarinic drugs are not highly effective antiparkinson agents, but tremor often responds better to these drugs than to levodopa-carbidopa.

The antimuscarinic drugs produce sedation and, in high doses, can elicit visual hallucinations and changes in mood. Trihexyphenidyl has been reported to have abuse potential, and Parkinson's patients may "fake" parkinsonian signs to obtain the drug. Toxic doses of antimuscarinic drugs can cause severe mental disturbances, including excitement, confusion, hallucinations, delirium, depression, coma, and medullary paralysis. Because of muscarinic receptor blockade, these drugs may produce xerostomia; increase intraocular pressure in closed-angle glaucoma; and cause tachycardia, palpitations, arrhythmias, urinary retention, constipation, and tachypnea.

Muscarinic and nicotinic acetylcholine receptors are found in the striatum. Although nicotinic treatments are not generally used, cigarette smoking, which might be considered an inhalation drug delivery system for nicotine, is reported to be Parkinson's disease protective.⁶³ This is paradoxical because many of the components of smoke are known to be damaging (e.g., carbon monoxide) or to produce inflammation.⁵

Miscellaneous Drugs

Amantadine

The anti-Parkinson effects of amantadine, an antiviral agent, were discovered when the drug was used to treat a viral infection in a patient who had Parkinson's disease. The mechanism of action of amantadine is unknown. It has been proposed that the drug (1) prevents dopamine reuptake and facilitates the release of dopamine; (2) has weak anticholinergic properties; and (3) blocks the glutamate N-methyl-D-aspartate (NMDA) receptor, which could contribute to reducing excitation-induced neurotoxicity and dyskinesias. Other amantadine analogues (e.g., memantine) are being tested for anti-Parkinson activity. Blockade of glutamatergic transmission with excitatory amino acid antagonists is a new approach to anti-Parkinson therapy. A glutamate-dopamine balance may exist in the basal ganglia, which can be improved with glutamate antagonists. These agents may also be neuroprotective. Glutamate antagonists can adversely affect memory formation, however.

Amantadine is usually prescribed in combination with levodopa-carbidopa because an additive effect has been shown when these drugs are used together. When given alone, its efficacy diminishes after several weeks. Amantadine is probably best used (1) alone at the early stages of Parkinson's disease, when symptoms are troublesome but not severe; (2) alone for the management of patients who do not respond well to levodopa; or (3) in combination with levodopa-carbidopa when a more beneficial response is required.

Approximately 80% to 90% of amantadine is excreted unchanged in the urine, and accumulation occurs in patients with impaired renal function. This accumulation may lead to the toxic manifestations of confusion, hallucinations, toxic psychosis, convulsions, and coma. Similar to the direct-acting dopamine agonists, amantadine may cause livedo reticularis of the lower extremities. More common side effects include anorexia, insomnia, nausea, vomiting, dizziness, AIMs, lightheadedness, edema, and sweating. These side effects are not severe and are limited further by the development of tolerance. Riluzole is approved for the treatment of amyotrophic lateral sclerosis; it has NMDA glutamate antagonist properties and some blocking of Na^+ and Ca^{++} channels. These are properties that are thought to be valuable in reducing neurodegenerative processes that may play a role in Parkinson's disease. Although animal studies seem promising, studies in humans have not yet shown clinical advantages.^{31,43}

Antioxidants

Selegiline (also known as deprenyl) and tocopherol formed the basis of the DATATOP (Deprenyl and Tocopherol Antioxidant Therapy of Parkinsonism) study,⁵³ a large clinical project designed to test the effectiveness of selegiline and antioxidants in Parkinson's disease. The results of studies with tocopherol have shown no significant benefit either alone or with selegiline.

 β -Adrenergic receptor blockers

Propranolol and nadolol have been found to be useful in the treatment of parkinsonian tremor. The fact that nadolol is excluded from entry into the brain suggests that peripheral β -adrenergic receptors have a role in parkinsonian tremor. Because brain norepinephrine release may also be decreased in parkinsonism, L-threo-3,4-dihydroxyphenylserine, a norepinephrine precursor transported into the brain, has been used successfully to reduce depression in the Parkinson's plus, or multiple system atrophy disorder.

Benzodiazepines

The benzodiazepine clonazepam may be effective in treating some aspects of Parkinson's disease, presumably because of its GABAergic activity. Although baclofen and other GABA_B agonists have not been effective in Parkinson's disease, the known and prominent GABAergic pathways of the basal ganglia suggest that manipulation of GABAergic transmission might be a valid approach to the treatment of this disease.

Antidepressants

Antidepressants may be useful in parkinsonian patients who may exhibit depression. Older agents can also contribute antimuscarinic actions, which may reduce tremors. Newer selective agents can be used when increased anticholinergic actions are not wanted.

Antipsychotic drugs

As noted earlier, patients with Parkinson's disease may experience psychotic-like signs either from the disease or from the drugs used to treat the disease. Atypical antipsychotic drugs have been found to be helpful because of their minimal extrapyramidal effects.

General Therapeutic Uses

There can be little doubt that the combination of levodopa and carbidopa is the most effective antiparkinson treatment available to date. Because of the serious side effects associated with levodopa therapy and its limited period of effectiveness, however, other drugs and drug combinations are commonly used. Some physicians initiate therapy with selegiline, a dopamine agonist, amantadine, or antimuscarinic agents. When the disease is judged to be moderate, levodopa-carbidopa and a COMT inhibitor can be added, although there is no objective evidence to delay treatment with levodopa until the disease has progressed. There is still a strong interest in drugs that may provide a neuroprotective effect and reduce progression of the disease. Finally, the continual use of levodopa often results in unresponsiveness to the drug. At this stage, drug holidays are attempted, and adjunctive agents are added.¹⁵

SURGICAL THERAPY

Advances in brain imaging techniques have resulted in improvements of surgical approaches to the treatment of Parkinson's disease. Ablation of the globus pallidus or thalamus or stimulation of the thalamus, globus pallidus, pedunculopontine, and subthalamic nucleus (subthalamic nucleus-deep brain stimulation) can reduce motor disturbances in Parkinson's patients.

Before surgery, it is not always predictable whether ablation or stimulation will be effective. The presumed effect of surgery is to reduce excessive excitatory neuronal activity or to increase inhibitory tone by stimulation. The efficacy seems to be similar to levodopa, and the benefits apparently are related to dopamine function.⁶⁵ Efferent pathways of the subthalamic nucleus seem to be excitatory and mediated by glutamate, as are corticostriatal pathways. Brain stimulation in the globus pallidus or subthalamic nucleus can reduce tremor associated with parkinsonism. Deep brain electrodes must be surgically placed, and the patient has a battery-powered neurostimulator implanted near the collarbone.

Another approach to the treatment of Parkinson's disease involves the grafting of small pieces of brain tissue or the patient's own adrenal medullary tissue (chromaffin autograft) into the caudate nucleus or putamen.²¹ These tissues release catecholamines, primarily epinephrine and norepinephrine, but in the absence of adrenocortical influences, the synthesis of epinephrine slows, and the dopamine/norepinephrine ratio increases. A suggested advantage of such grafts is that they could also release growth factors, which may be deficient in patients with Parkinson's disease. These patients show initial improvement, but long-term results have not been overwhelmingly positive. Some patients continue to improve for 5 years. There is also interest in developing dopamine-releasing cells using stem cell culturing techniques.

DRUGS USED FOR OTHER MOVEMENT DISORDERS

Several disorders less common than Parkinson's disease also cause movement disabilities. These diseases include Huntington's disease (Huntington's chorea), Gilles de la Tourette's syndrome (Tourette's syndrome), Wilson's disease, and dystonic syndromes. Although these movement disorders are more refractory to pharmacotherapy than Parkinson's disease, some drugs are beneficial, and they have furthered our understanding of the role of the basal ganglia in motor control.

Huntington's disease, probably the best known of these disorders, is characterized by choreic hyperkinesias and dementia. Huntington's disease is caused by a genetic error in the huntingtin gene and subsequent abnormal synthesis of a huntingtin protein that contains excess polyglutamine repeats. The pathologic change in Huntington's disease is degeneration of GABAergic neurons in the striatum and the expression of choreas: a reduced ability to stop unwanted "motor programs" expressed as uncontrolled movements of large muscle groups (shoulder or head), leading to awkward and unwanted movements. The strategy followed in parkinsonism of "replacing" the missing neurotransmitter has not proved effective in Huntington's disease because GABA receptor agonists and various inhibitors of GABA catabolism have been clinically disappointing. Adjusting the dopamine/acetylcholine balance by antagonizing dopamine is more effective. The antipsychotic drugs, which are potent dopamine antagonists, may be useful for certain chorea symptoms. A dopamine-depleting drug, tetrabenazine, has also been useful in Huntington's disease. In advanced stages of the disease, pharmacotherapy is ineffective.

Tourette's syndrome is characterized by phonic and motor tics and complex mannerisms. The pathophysiology of Tourette's syndrome is not well understood; however, it may share properties with obsessive-compulsive disease that has been associated with orbital frontal cortex disorders and basal ganglia disorder associated with motor program regulation.¹ Symptoms of Tourette's syndrome are responsive to antipsychotic medication (e.g., haloperidol, fluphenazine, and pimozide). The effectiveness of these compounds is short-lived,

however. Many novel approaches are being investigated, including various atypical antipsychotic agents. Paradoxically, the dopamine receptor agonist pergolide has been found to be effective and well tolerated (but with some risk of cardiac valve damage). In addition, some beneficial results have been reported with clonidine, an α_2 -adrenergic receptor agonist.⁵⁶

Wilson's disease, an inherited disorder of copper metabolism, is characterized by damage to the liver; a characteristic brown stain at the edge of the cornea; and various motor disorders, including akinesia, rigidity, and dystonia. Wilson's disease can generally be managed by chelating excess copper with penicillamine. If treatment is begun late in the course of the disease, however, penicillamine may not control the neurologic symptoms. At this point, levodopa and the anticholinergic antiparkinson drugs are useful.

Many common dystonic syndromes, such as torsion dystonia and spasmodic torticollis, are largely refractory to pharmacotherapy. Low doses of levodopa and high doses of bromocriptine and lisuride have mild beneficial effects, especially in young patients. Because of the effectiveness of antimuscarinic agents and drugs that interrupt cholinergic transmission, it has been suggested that cholinergic hyperactivity might be responsible for the dystonias, but the underlying pathology and cause of these syndromes remain unknown. High doses of antimuscarinic antiparkinson agents are also helpful in young patients, probably because these patients can tolerate the side effects better. Botulinum toxin A, which inhibits the release of acetylcholine from cholinergic neurons, may be useful in treating certain dystonias. Antimuscarinic drugs may also be useful for treating focal dystonias.⁴⁴

IMPLICATIONS FOR DENTISTRY

Parkinson's Disease

Patients with untreated Parkinson's disease face many potential challenges to maintaining adequate oral health. Orofacial motor impairments of Parkinson's disease include disorders of mastication, swallowing, and speech, and may be different from motor impairments in the extremities and may not respond to pharmacotherapy in the same manner. Jaw muscle function is altered with reduced voluntary and rhythmic activity. The rate of movement and strength of jaw muscles are improved with treatment.⁵⁸ Parkinson's patients have difficulty in sustaining repetitive motions, such as those used for tooth brushing or flossing. Electric toothbrushes can help circumvent some of the problem, although a patient with motor freezing may still have difficulty and need assistance. Oral tremor or dyskinesias can also make oral health care challenging for the dentist, and prosthetic restoration may pose additional challenges because of the presence of uncontrolled oral movements.

Oral dyskinesias are possibly exacerbated by dental disorders, and some investigators have reported improvements by dental treatment or improved denture function.⁴⁴ Assessment of the value of these treatments should be tempered by realization that the course of Parkinson's disease can be episodic and to some extent influenced by placebo treatments.³²

Patients with Parkinson's disease may have a xerostomia or less often sialorrhea and experience nausea and vomiting more frequently than other patients, with possible adverse effects on oral health. Reduced gastric acid in elderly patients may prompt caregivers to administer levodopa with acidic juices, with potential impact on enamel and dentin. Patients with Parkinson's disease who can perform regular dental hygiene procedures do not have an elevated risk for dental disorders.²⁷

Parkinson's patients report higher levels of anxiety, which may be associated with the disease and possibly some of the

treatments. Parkinsonian patients may react slowly to pain and not provide rapid feedback about progressive tissue damage. They have difficulty maintaining postural stability and normal walking gait and may be more prone to falling; assistance entering and leaving the office should be considered. In addition to motor freezing, these patients may have difficulty comprehending or remembering prolonged instructions; written or taped treatment plans and medication instructions should be provided to the patient and responsible accompanying parties. Orthostatic hypotension can be present, so patients should be allowed to change position slowly and stabilize their blood pressure. During a procedure, consideration should be given to the patient's difficulty with swallowing. Aggressive saliva control and not tipping the patient too far back in the dental chair can be helpful.

Parkinson's disease is a motor function disorder, and so caution should be used with agents that could compromise motor function further. Various agents used in dentistry should be carefully considered and dosed. Drugs that may depress respiratory function need to have their doses adjusted appropriately for the weight, age, and physical condition of the patient. Opiates, barbiturates, skeletal muscle relaxant agents (peripherally and centrally acting), and some antibiotics (clindamycin⁶¹ and aminoglycosides) should be used with caution.

Levodopa

It has been recommended that patients be scheduled for treatment within 60 to 90 minutes of the patient's levodopa dosage to reduce their disability during treatment. For some patients this timing may lead to a higher incidence of dyskinesias during the visit because of pulsatile exposure of the brain to elevated dopamine at the peak of the absorption curve. Facial movements induced by levodopa may cause numerous dental problems, including inflammation, damage to oral structures, protrusion of anterior teeth (because of tongue thrusting), and difficulty in wearing and retaining dentures. Dyskinesias can become so severe that they interfere with swallowing, speech, and respiration.

Levodopa and other antiparkinsonian agents can cause dysgeusia, or alteration in the sensation of taste, possibly explained by the loss of olfaction. This reaction is not seen when levodopa is combined with a decarboxylase inhibitor.

Tolerance usually develops to levodopa-induced orthostatic hypotension. Nonetheless, the patient may still have episodes of hypotension, perhaps more frequently after dosage adjustments. Orthostatic hypotension can be a particular problem for the dentist because of the reclining position of the patient during dental care. If orthostatic hypotension persists, reducing the levodopa dosage may be required to control it.

Many drug interactions involving levodopa are of potential concern to the dentist. It is believed by some investigators that levodopa sensitizes the heart to epinephrine-induced arrhythmias. The mechanism responsible for this effect is unknown, but the excitatory action of levodopa on the heart may result from an action of dopamine on cardiac β_1 -adrenergic receptors. Although some practitioners believe that this interaction provides a valid contraindication for the use of local anesthetics with vasoconstrictors in patients taking levodopa, the clinical significance of these interactions is not established. The use of phenothiazines (including promethazine), hydroxyzine, and metoclopramide as antiemetics should be discouraged for patients undergoing levodopa therapy. Such agents can exacerbate the motor irregularities of Parkinson's disease because of their dopamine receptor-blocking properties. A peripheral dopamine receptor antagonist, domperidone, is a useful antiemetic, but it is currently unavailable in the United States. Analgesics may be used with levodopa, but if

general anesthesia is required, consultation with the patient's physician is recommended. Pyridoxine (vitamin B₆), which is present in over-the-counter multivitamin preparations, antagonizes the anti-Parkinson effect of levodopa because it enhances levodopa's conversion to dopamine in the periphery. This antagonism does not occur when a peripheral decarboxylase inhibitor is coadministered with levodopa.

Levodopa and anticholinergic drugs can induce hallucinations. Addition of adjunctive agents such as carbidopa elevate dopamine in the CNS and contribute to this adverse effect.

Dopaminergic Agonists, Amantadine, and Selegiline

Side effects of dopaminergic agonists, amantadine, and selegiline are generally related to their effect of stimulating (directly or indirectly) dopaminergic receptors. If a patient has recently been started on any of these medications, transient nausea and vomiting may occur. A patient scheduled for dental work at this time is more susceptible to gagging, nausea, and vomiting. Because of hypotension on initial therapy, the same precautions described for levodopa apply. Dopamine agonists can cause oral dyskinesia similar to dyskinesias produced by levodopa. The new selective dopamine agonists may induce daytime sleepiness in some patients; caution should be used if sedative or opioid therapy is planned. In some cases, ergot-derived dopamine agonists may be used, which can produce possible cardiac valvular damage; this may lead to heart sounds of regurgitation. In some cases, antibiotic prophylactic coverage may be required. These issues are similarly seen in patients being treated for RLS.²⁵

Although MAO-B inhibitors are thought to produce a selective MAO block, package warnings of possible drug interactions with meperidine, other opiates, antidepressants, and many foods suggest that careful screening for potential drug and food interactions is important. Some MAO-B inhibitors are available in buccally dissolving "oral disintegrating tablets." No adverse reports have been associated with this route of administration yet; however, dentists are in a position to evaluate adverse oral effects.

Catechol-O-Methyltransferase Inhibitors

COMT inhibitors have caused drug interactions such as tachycardia, an increase in blood pressure, or arrhythmias with vasoconstrictors (e.g., epinephrine), and increased sedative effects with anti-anxiety drugs, sedating antihistamines, opioid analgesics, and other drugs with CNS depressant properties. Several antibiotics (e.g., ampicillin, erythromycin) used by dentists can reduce the elimination of entacapone by interference with biliary excretion.

Anticholinergic Agents

A patient taking antimuscarinic agents may have typical antimuscarinic side effects. Xerostomia may increase the incidence of caries, impair swallowing, increase the likelihood of soft tissue disease in the oral cavity, and make speech difficult. Drugs with which the anti-Parkinson anticholinergics might summate include antihistamines, tricyclic antidepressants, and other drugs with antimuscarinic effects. Adverse reactions and drug interactions involving antimuscarinic drugs are discussed further in Chapter 9.

ANTI-PARKINSON DRUGS	
<i>Nonproprietary (generic) name</i>	<i>Proprietary (trade) name</i>
Anticholinergics	
Benztropine	Cogentin
Biperiden	Akineton

<i>Nonproprietary (generic) name</i>	<i>Proprietary (trade) name</i>
Procyclidine	Kemadrin
Trihexyphenidyl	Artane, Trihexy-2
Other drugs with anticholinergic activity	
Diphenhydramine	Benadryl
Ethopropazine*	Parsidol
Dopamine precursor and decarboxylase inhibitors	
Carbidopa	Lodosyn
Levodopa	Dopar, Larodopa
Levodopa + benserazide*	Madopar
Levodopa + carbidopa	Sinemet
Levodopa + carbidopa + entacapone	Stalevo
Dopamine receptor agonists	
Apomorphine	Apokyn
Bromocriptine	Parlodel
Pergolide	Permax
Pramipexole	Mirapex
Ropinirole	Requip
Rotigotine	Neupro
Other anti-Parkinson drugs	
Amantadine	Symmetrel
Memantine	Namenda
Riluzole	Rilutek
Entacapone	Comtan
Rasagiline	Azilect
Selegiline (L-deprenyl)	Eldepryl
Tolcapone	Tasmar

*Not currently available in the United States.

SOME DRUGS FOR OTHER MOVEMENT DISORDERS

<i>Nonproprietary (generic) name</i>	<i>Proprietary (trade) name</i>
Clonidine	Catapres
Fluphenazine	Prolixin
Gabapentin	Neurontin
Haloperidol	Haldol
Nadolol	Corgard
Pimozide	Orap
Primidone	Mysoline
Propranolol	Inderal
Tetrabenazine	Xenazine

CITED REFERENCES

1. Albin RL, Mink JW: Recent advances in Tourette syndrome research. *Trends Neurosci* 29:175-182, 2006.
2. Alcaro A, Huber R, Panksepp J: Behavioral functions of the mesolimbic dopaminergic system: an affective neuroethological perspective. *Brain Res Rev* 56:283-321, 2007.
3. Aravamuthan BR, Muthusamy KA, Stein JF: Topography of cortical and subcortical connections of the human pedunculopontine and subthalamic nuclei. *Neuroimage* 37:694-705, 2007.
4. Barcia C, Bautista V, Sánchez-Bahillo A, et al: Changes in vascularization in substantia nigra pars compacta of monkeys rendered parkinsonian. *J Neural Transm* 112:1237-1248, 2005.

5. Barr J, Sharma CS, Sarkar S, et al: Nicotine induces oxidative stress and activates nuclear transcription factor kappa B in rat mesencephalic cells. *Mol Cell Biochem* 297:93-99, 2007.
6. Baumgärtner U, Buchholz HG, Bellosevich A, et al: High opiate receptor binding potential in the human lateral pain system. *Neuroimage* 30:692-699, 2006.
7. Belin AC, Westerlund M: Parkinson's disease: a genetic perspective. *FEBS J* 275: 1377-1383, 2008.
8. Bodis-Wollner I: Neuropsychological and perceptual defects in Parkinson's disease. *Parkinsonism Relat Disord* 9(Suppl 2):S83-S89, 2003.
9. Bogaerts VI, Theuns J, van Broeckhoven C: Genetic findings in Parkinson's disease and translation into treatment: a leading role for mitochondria? *Genes Brain Behav* 7:129-151, 2007.
10. Braak H, Bohl JR, Muller CM, et al: Stanley Fahn Lecture 2005. The staging proceeding for inclusion body pathology associated with sporadic Parkinson's disease reconsidered. *Mov Disord* 21:2042-2051, 2006.
11. Braak H, Sastre M, Bohl JR, et al: Parkinson's disease: lesions in dorsal horn layer I, involvement of parasympathetic and sympathetic pre- and postganglionic neurons. *Acta Neuropathol* 113:421-429, 2007.
12. Cash R, Raisman R, Ploska A, et al: Dopamine D-1 receptor and cyclic AMP-dependent phosphorylation in Parkinson's disease. *J Neurochem* 49:1075-1083, 1987.
13. Charles PD, Esper GJ, Davis TL: A definition of "on": patient diaries compared to the UPDRS. *Parkinsonism Relat Disord* 5:99-101, 1999.
14. Chudler EH, Dong WK: The role of the basal ganglia in nociception and pain. *Pain* 60:3-38, 1995.
15. Corona T, Rivera C, Otero E, et al: A longitudinal study of the effects of an L-dopa drug holiday on the course of Parkinson's disease. *Clin Neuropharmacol* 18:325-332, 1995.
16. Dagher A, Nagano-Saito A: Functional and anatomic magnetic resonance imaging in Parkinson's disease. *Mol Imaging Biol* 9:234-242, 2007.
17. Dhariwala FA, Rajadhyaksha MS: An unusual member of the cdk family: cdk5. *Cell Mol Neurobiol* 28:351-369, 2008.
18. Doder M, Rabiner EA, Turjanski N, et al: Tremor in Parkinson's disease and serotonergic dysfunction: an 11C-WAY 100635 PET study. *Neurology* 60:601-605, 2003.
19. Double KL, Rowe DB, Hayes M, et al: Identifying the pattern of olfactory deficits in Parkinson disease using the brief smell identification test. *Arch Neurol* 60:545-549, 2003.
20. Doya K: Complementary roles of basal ganglia and cerebellum in learning and motor control. *Curr Opin Neurobiol* 10:732-739, 2000.
21. Drucker-Colin R, Verdugo-Diaz L: Cell transplantation for Parkinson's disease: present status. *Cell Mol Neurobiol* 24:301-316, 2004.
22. Elbaz A, Tranchant C: Epidemiologic studies of environmental exposures in Parkinson's disease. *Neurol Sci* 262:37-44, 2007.
23. Fahn S; Parkinson Study Group: Does levodopa slow or hasten the rate of progression of Parkinson's disease? *J Neurol* 252(Suppl 4):IV-37-IV-42, 2005.
24. Fornai F, Schlüter OM, Lenzi P, et al: Parkinson-like syndrome induced by continuous MPTP infusion: convergent roles of the ubiquitin-proteasome system and alpha-synuclein. *Proc Natl Acad Sci U S A* 102:3413-3418, 2005.
25. Friedlander AH, Mahler ME, Yagiela JA: Restless leg syndrome manifestations, treatment and dental implications. *J Am Dent Assoc* 137:755-761, 2006.
26. Fujita M, Imaizumi M, Zoghbi SS, et al: Kinetic analysis in healthy humans of a novel positron emission tomography radioligand to image the peripheral benzodiazepine receptor, a potential biomarker for inflammation. *Neuroimage* 40:43-52, 2008.
27. Fukayo S, Nonaka N, Shimizu, T, et al: Oral health of patients with Parkinson's disease: factors related to their better dental status. *Tohoku J Exp Med* 201:171-179, 2003.
28. Gasser T: Update on the genetics of Parkinson's disease. *Mov Disord* 22(Suppl 17):S343-S350, 2007.
29. Gerhard A, Pavese N, Hotton G, et al: In vivo imaging of microglial activation with [11C](R)-PK11195 PET in idiopathic Parkinson's disease. *Neurobiol Dis* 21:404-412, 2006.
30. Giladi N, McDermott MP, Fahn S, et al: Freezing of gait in PD: prospective assessment in the DATATOP cohort. *Neurology* 56:1712-1721, 2001.
31. Gilgun-Sherki Y, Melamed E, Ziv I, et al: Riluzole, an inhibitor of glutamatergic transmission, suppresses levodopa-induced rotations in 6-hydroxydopamine-lesioned rats. *Pharmacol Toxicol* 93:54-56, 2003.
32. Goetz CG, Leurgans S, Raman R; Parkinson Study Group: Placebo-associated improvements in motor function: comparison of subjective and objective sections of the UPDRS in early Parkinson's disease. *Mov Disord* 17:283-288, 2002.
33. Goldman SM, Tanner CM, Oakes D, et al: Head injury and Parkinson's disease risk in twins. *Ann Neurol* 60:65-72, 2006.
34. Goldman SM, Tanner CM, Olanow CW, et al: Occupation and parkinsonism in three movement disorders clinics. *Neurology* 65:1430-1435, 2005.
35. Gornemann T, Hubner H, Gmeiner P, et al: Characterization of the molecular fragment that is responsible for agonism of pergolide at serotonin 5-HT2B and 5-HT2A receptors. *J Pharmacol Exp Ther* 324:1136-1145, 2008.
36. Hanagasi HA, Ayribas D, Baysal K, et al: Mitochondrial complex I, II/III, and IV activities in familial and sporadic Parkinson's disease. *Int J Neurosci* 115:479-493, 2005.
37. Hoshi E, Tremblay L, Féger P, et al: The cerebellum communicates with the basal ganglia. *Nat Neurosci* 8:1491-1493, 2005.
38. Hu G, Bidel S, Jousilahti P, et al: Coffee and tea consumption and the risk of Parkinson's disease. *Mov Disord* 22:2242-2248, 2007.
39. Kawashima H, Iida Y, Kitamura Y, et al: Binding of 4-(4-chlorophenyl)-1-[4-(4-fluorophenyl)-4-oxobutyl]pyridinium ion (HPP+), a metabolite of haloperidol, to synthetic melanin: implications for the dopaminergic neurotoxicity of HPP+. *Neurotoxicity Res* 6:535-542, 2004.
40. Klivenyi P, Siwek D, Gardian G, et al: Mice lacking alpha-synuclein are resistant to mitochondrial toxins. *Neurobiol Dis* 21:541-548, 2006.
41. Laihininen A, Halsband U: PET imaging of the basal ganglia. *J Physiol Paris* 99:406-413, 2006.
42. Lewis MM, Slagle CG, Smith AB, et al: Task specific influences of Parkinson's disease on the striato-thalamo-cortical and cerebello-thalamo-cortical motor circuitries. *Neuroscience* 147:224-235, 2007.
43. LeWitt PA: Clinical trials of neuroprotection for Parkinson's disease. *Neurology* 63(7 Suppl 2):S23-S31, 2004.
44. Lobbezoo F, Naeije M: Dental implications of some common movement disorders: a concise review. *Arch Oral Biol* 52:395-398, 2007.
45. Marc RE, Jones BW, Anderson JR, et al: Neural reprogramming in retinal degeneration. *Invest Ophthalmol Vis Sci* 48:3364-3371, 2007.
46. Menon V, Levitin DJ: The rewards of music listening: response and physiological connectivity of the mesolimbic system. *Neuroimage* 28:175-184, 2005.
47. Middleton FA, Strick PL: Basal ganglia and cerebellar loops: motor and cognitive circuits. *Brain Res Rev* 31:236-250, 2000.
48. Monti JM, Monti D: The involvement of dopamine in the modulation of sleep and waking. *Sleep Med Rev* 11:113-133, 2007.
49. Newmark HL, Newmark J: Vitamin D and Parkinson's disease—a hypothesis. *Mov Disord* 22:461-468, 2007.
50. Ogawa N: Factors affecting levodopa effects in Parkinson's disease. *Acta Med Okayama* 54:95-101, 2000.
51. Ossowska K, Smialowska M, Kuter K, et al: Degeneration of dopaminergic mesocortical neurons and activation of compensatory processes induced by a long-term paraquat administration in rats: implications for Parkinson's disease. *Neuroscience* 141:2155-2165, 2006.
52. Ouchi Y, Yoshikawa E, Sekine Y, et al: Microglial activation and dopamine terminal loss in early Parkinson's disease. *Ann Neurol* 57:168-175, 2005.
53. Parkinson Study Group: Effects of tocopherol and deprenyl on the progression of disability in early Parkinson's disease. *N Engl J Med* 328:176-183, 1993.
54. Postuma RB, Dagher A: Basal ganglia functional connectivity bases on a meta-analysis of 126 positron emission tomography and functional magnetic resonance imaging publications. *Cerebral Cortex* 16:1508-1521, 2006.
55. Potenza MN, Voon V, Weintraub D: Drug Insight: impulse control disorders and dopamine therapies in Parkinson's disease. *Nat Clin Pract Neurol* 3:664-672, 2007.
56. Rampello L, Alvano A, Battaglia G, et al: Tic disorders: from pathophysiology to treatment. *Neurology* 253:1-15, 2006.

57. Richard IH: Anxiety disorders in Parkinson's disease. *Adv Neurol* 96:42-55, 2005.
58. Robertson LT, Hammerstad JP: Jaw movement dysfunction related to Parkinson's disease and partially modified by levodopa. *J Neurol Neurosurg Psychiatry* 60:41-50, 1996.
59. Schestatsky P, Kumru H, Valls-Solé J, et al: Neurophysiologic study of central pain in patients with Parkinson disease. *Neurology* 69:2162-2169, 2007.
60. Scott DJ, Heitzeg MM, Koeppe RA, et al: Variations in the human pain stress experience mediated by ventral and dorsal basal ganglia dopamine activity. *J Neurosci* 26:10789-10795, 2006.
61. Schulze J, Toepfer M, Schroff KC, et al: Clindamycin and nicotinic neuromuscular transmission. *Lancet* 354:1792-1793, 1999.
62. Simon N, Gantcheva R, Bruguerolle B, et al: The effects of a normal protein diet on LevoDOPA plasma kinetics in advanced Parkinson's disease more options. *Parkinsonism Relat Disord* 10:137-142, 2004.
63. Tafti M, Ghyselinck NB: Functional implication of the vitamin A signaling pathway in the brain. *Arch Neurol* 64:1706-1711, 2007.
64. Tanner CM, Goldman SM, Aston DA, et al: Smoking and Parkinson's disease in twins. *Neurology* 58:581-588, 2002.
65. Taylor Tavares AL, Jefferis GS, Koop M, et al: Quantitative measurements of alternating finger tapping in Parkinson's disease correlate with UPDRS motor disability and reveal the improvement in fine motor control from medication and deep brain stimulation. *Mov Disord* 20:1286-1298, 2005.
66. Tinazzi M, Del Vesco C, Fincati E, et al: Pain and motor complications in Parkinson's disease. *J Neurol Neurosurg Psychiatry* 77:822-825, 2006.
67. Thobois S, Vingerhoets F, Fraix V, et al: Role of dopaminergic treatment in dopamine receptor down-regulation in advanced Parkinson disease—a positron emission tomographic study. *Arch Neurol* 61:1705-1709, 2004.
68. Weintraub D, Hurtig HI: Presentation and management of psychosis in Parkinson's disease and dementia with Lewy bodies. *Am J Psychiatry* 164:1491-1498, 2007.
69. Youdim MB, Edmondson D, Tipton KF: The therapeutic potential of monoamine oxidase inhibitors. *Nat Rev Neurosci* 7:295-309, 2006.

GENERAL REFERENCES

- Adler CH, Ahlskog JE, editors: *Parkinson's disease and movement disorders: diagnosis and treatment guidelines for the practicing physician*, Totowa, NJ, 2000, Humana Press.
- Alcaro A, Huber R, Panksepp J: Behavioral functions of the mesolimbic dopaminergic system: an affective neuroethological perspective, *Brain Res Rev* 56:283-321, 2007.
- Alexander RE, Gage TW: Parkinson's disease: an update for dentists, *Gen Dent* 48:572-582, 2000.
- Allain H, Bentué-Ferrer D, Akwa Y: Disease-modifying drugs and Parkinson's disease, *Prog Neurobiol* 84:25-39, 2008.
- Cookson MR: The biochemistry of Parkinson's disease. *Annu Rev Biochem* 74:29-52, 2005.
- Cozzens J: Surgery for Parkinson's disease, *Dis Mon* 53:227-242, 2007.
- Davis KL, Martin E, Turko IV, et al: Novel effects of nitric oxide, *Annu Rev Pharmacol Toxicol* 41:203-236, 2001.
- Huang Y, Cheung L, Rowe D: Genetic contributions to Parkinson's disease, *Brain Res Brain Res Rev* 46:44-70, 2004.
- Kaneko S, Hikida T, Watanabe D, et al: Synaptic integration mediated by striatal cholinergic interneurons in basal ganglia function, *Science* 289:633-637, 2000.
- Tolosa E, Wenning G, Poewe W: The diagnosis of Parkinson's disease, *Lancet Neurol* 5:75-86, 2006.
- Wallace KB, Starkov AA: Mitochondrial targets of drug toxicity, *Annu Rev Pharmacol Toxicol* 40:353-388, 2000.

Local Anesthetics

JOHN A. YAGIELA

Local anesthetics are agents that reversibly block nerve conduction when applied to a circumscribed area of the body. Although numerous substances of diverse chemical structure are capable of producing local anesthesia, most drugs of proven clinical usefulness (identified by the suffix *-caine*) share a fundamental configuration with the first true local anesthetic, cocaine. For centuries, natives of the Peruvian highlands have relied on the leaves of the coca bush to prevent hunger, relieve fatigue, and uplift the spirit. European interest in the psychotropic properties of *Erythroxylon coca* led to the isolation of cocaine by Niemann in 1859 and to a study of its pharmacology by von Anrep in 1880. Although Niemann and von Anrep reported on the local anesthetic action of cocaine, credit for its introduction into medicine belongs to Karl Koller, a Viennese physician. In 1884, Koller was familiarized with the physiologic effects of cocaine by Sigmund Freud. Koller recognized the drug's great clinical significance and demonstrated its pain-relieving action in several ophthalmologic procedures. The benefits of cocaine were widely appreciated; within 1 year, local anesthesia had been successfully administered for various medical and dental operations.

Knowledge of cocaine's potential for adverse reactions soon followed its general acceptance as a local anesthetic. Several deaths attributed to acute cocainization testified to the drug's low therapeutic index. The abuse liability of cocaine was dramatically illustrated by the self-addiction of William Halsted, a pioneer in regional nerve blockade. A chemical search for safer, nonaddicting local anesthetics was instituted by Einhorn and associates in 1892, culminating 13 years later in the synthesis of procaine. Since then, numerous improvements in the manufacture of local anesthetic solutions have been made, and many useful agents have been introduced into clinical practice. Because no drug is currently devoid of potentially serious toxicity, however, the search for new and better local anesthetic agents continues.

CHEMISTRY AND CLASSIFICATION

Certain physicochemical characteristics are required of a drug intended for clinical use as a local anesthetic. One prerequisite is that the agent must depress nerve conduction. Because an axon whose cytoplasmic contents have been completely removed can still transmit action potentials, a drug must be able to interact directly with the axolemma to exert local anesthetic activity. A second important consideration is that the agent must have lipophilic and hydrophilic properties to be effective by parenteral injection. Lipid solubility is essential for penetration of the various anatomic barriers existing between an administered drug and its site of action, including

the nerve sheath. Water solubility ensures that, when injected in an effective concentration, a drug does not precipitate on exposure to interstitial fluid. These requirements have placed important structural limitations on the clinically useful local anesthetics.

Structure-Activity Relationships

The typical local anesthetic molecule can be divided into three parts: (1) an aromatic group, (2) an intermediate chain, and (3) a secondary or tertiary amino terminus (Figure 16-1). All three components are important determinants of a drug's local anesthetic activity. The aromatic residue confers lipophilic properties on the molecule, whereas the amino group furnishes water solubility. The intermediate portion is significant in two respects. First, it provides the necessary spatial separation between the lipophilic and hydrophilic ends of the local anesthetic. Second, the chemical link between the central hydrocarbon chain and the aromatic moiety serves as a suitable basis for classification of most local anesthetics into two groups, the esters ($-\text{COO}-$) and the amides ($-\text{NHCO}-$). This distinction is useful because there are marked differences in allergenicity and metabolism between the two drug categories.

Minor modifications of any portion of the local anesthetic molecule can significantly influence drug action. The addition of a chlorine atom to the ortho position on the benzene ring of procaine yields chlorprocaine, a more lipophilic local anesthetic four times as potent as the parent compound yet half as toxic when injected subcutaneously. Table 16-1 lists several important physicochemical properties of local anesthetics and how they correlate with clinical activity.

Influence of pH

By virtue of the substituted amino group, most local anesthetics are weak bases with a negative logarithm of the acid ionization constant ($\text{p}K_a$) ranging from 7.5 to 9.0. A local anesthetic intended for injection is usually prepared in salt form by the addition of hydrochloric acid. Not only is water solubility improved, but also stability in aqueous media is increased. When injected, the acidic local anesthetic solution is quickly neutralized by tissue fluid buffers, and a fraction of the cationic form is converted to the nonionized base. As determined by the Henderson-Hasselbalch equation (Figure 16-2), the percentage of drug converted depends primarily on the local anesthetic $\text{p}K_a$ and the tissue pH. Because only the base form can diffuse rapidly into the nerve, drugs with a high $\text{p}K_a$ tend to be slower in onset than similar agents with more favorable dissociation constants. Tissue acidity may also impede the development of local anesthesia. Products of inflammation can lower the pH of the affected tissue and limit formation

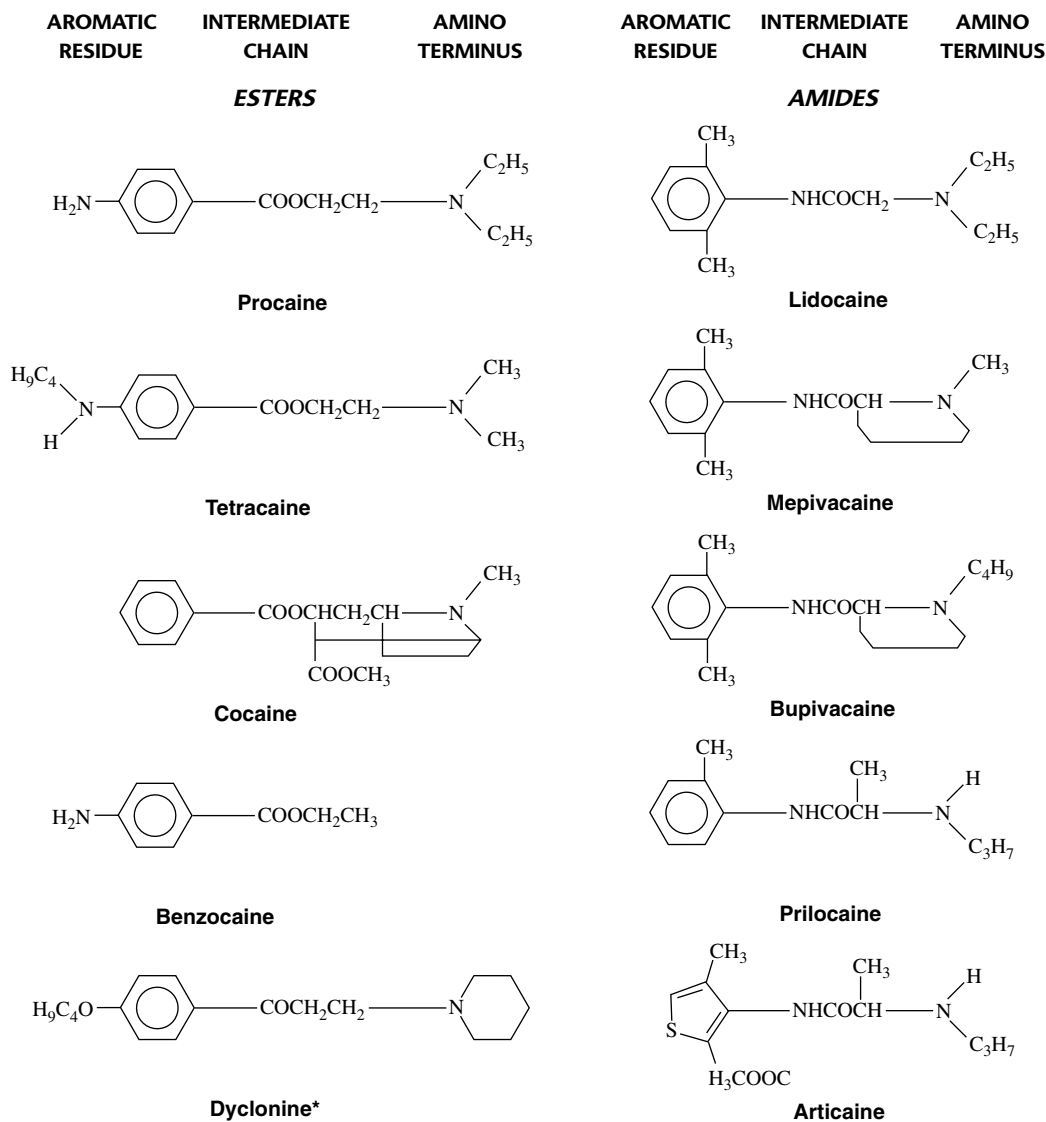

FIGURE 16-1 Structural formulas of some commonly used local anesthetics. *Dyclonine is a ketone.

TABLE 16-1

Physicochemical Correlates of Local Anesthetic Activity

DRUG	OCTANOL/ BUFFER DISTRIBUTION COEFFICIENT*	ANESTHETIC POTENCY (TONIC BLOCK)	DURATION OF ANESTHESIA	MOLECULAR WEIGHT	PHASIC BLOCK†	pK _a *	RATE OF ONSET
Procaine	3	Low	Short	236	Moderate	8.9	Moderate
Articaine‡	17	Moderate	Moderate	284	Moderate	7.8	Fast
Mepivacaine	42	Moderate	Moderate	246	Moderate	7.7	Fast
Prilocaine	55	Moderate	Moderate	220	Low	7.8	Fast
Lidocaine	110	Moderate	Moderate	234	Moderate	7.8	Fast
Ropivacaine	186	High	High	274	Moderate	8.1	Moderate
Bupivacaine	560	High	High	288	High	8.1	Moderate
Tetracaine	541	High	High	264	Moderate	8.4	Moderate

*Measurements made at 36° C except for prilocaine and ropivacaine, which are extrapolated from values taken at 25° C. (Data from Strichartz GR, Sanchez V, Arthur GR, et al: Fundamental properties of local anesthetics, II: measured octanol/buffer partition coefficients and pK_a values of clinically used drugs, *Anesth Analg* 71:158-170, 1990.)

†Relative tendency to cause phasic (use-dependent) block in peripheral nerve. (Data from Courtney KR: Structure-activity relations for frequency-dependent sodium channel block in nerve by local anesthetics, *J Pharmacol Exp Ther* 213:114-119, 1980.)

‡Data from Septocaine with epinephrine 1:100,000 Septocaine with epinephrine 1:200,000 (package insert), New Castle, DE, Rev. 05/06, Septodont.

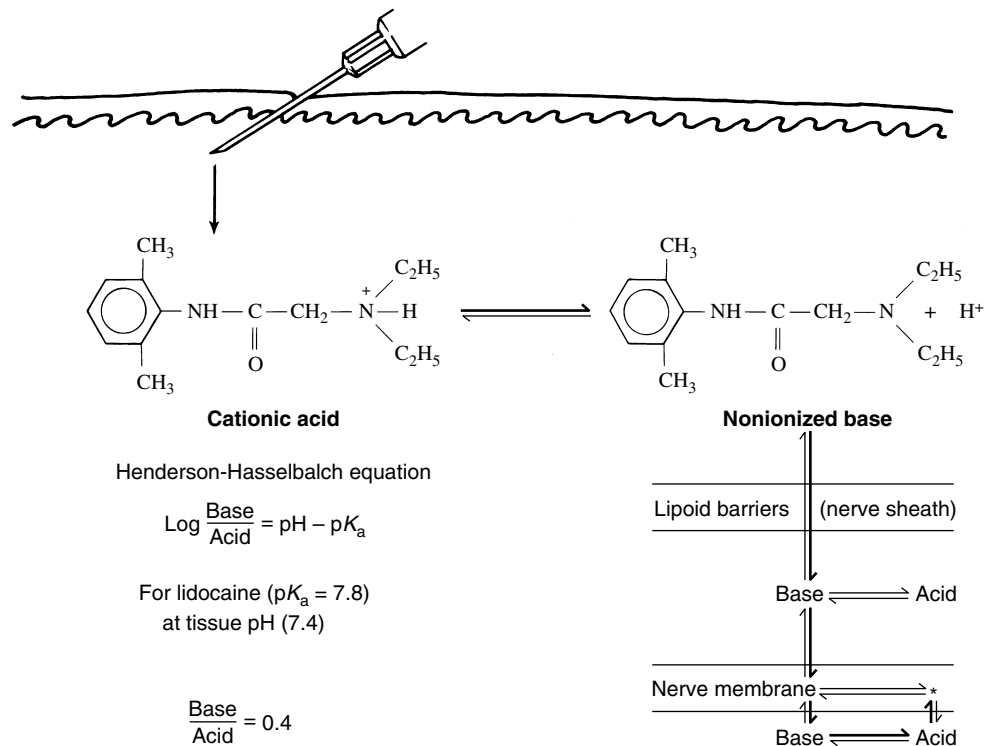

FIGURE 16-2 Distribution of a local anesthetic during nerve block. On injection of a local anesthetic solution, a portion of the cationic acid is converted to the free base. Calculated for lidocaine is the base-to-acid ratio in the extracellular fluid at equilibrium. *Dark arrows* depict the major pathway followed by a local anesthetic in reaching its site of action (*asterisk*) within the nerve membrane. Although the acid form is responsible for most of the blocking activity, the contribution of the nonionized base (*light arrows* within the axolemma) must not be overlooked.

of the free base. Ionic entrapment of the local anesthetic in the extracellular space delays the onset of local anesthesia and may render effective nerve blockade impossible.

Numerous attempts have been made to augment local anesthesia by capitalizing on the influence of pH. Theoretically, alkalinization should increase local anesthetic activity by promoting tissue penetration and nerve uptake. Many topical agents are marketed in the base form to improve diffusion across epithelial barriers. Although it has been shown experimentally that alkalinization of local anesthetic solutions just before use enhances nerve blockade, practical considerations have limited routine clinical application. Even so, extracellular fluid has in most instances sufficient buffering capacity to negate differences in local anesthetic pH soon after injection.

An alternative approach to modifying drug distribution is through the addition of carbon dioxide. Carbonation of a local anesthetic solution can increase the rate of onset and sometimes the depth of anesthesia. It has been suggested that the hydrocarbonate salt of the local anesthetic penetrates membranes more rapidly than the conventional formulation and that the injected carbon dioxide diffusing into the nerve trunk lowers the internal pH and concentrates local anesthetic molecules by ion trapping.⁵⁵ There is also evidence that carbon dioxide may potentiate local anesthetic activity by a direct effect on the nerve membrane.^{15,19} Although promising, carbonated local anesthetic solutions are unavailable in the United States, and a study of carbonated lidocaine used for mandibular anesthesia failed to reveal any significant benefit compared with lidocaine hydrochloride.²²

MECHANISM OF ACTION

Local anesthetics block the sensation of pain by interfering with the propagation of peripheral nerve impulses. The generation and the conduction of action potentials are inhibited. Electrophysiologic data indicate that local anesthetics do not significantly alter the normal resting potential of the nerve membrane; instead they impair certain dynamic responses to nerve stimulation.

Effects on Ionic Permeability

The quiescent nerve membrane is impermeable to Na⁺. Excitation of the neuron by an appropriate stimulus temporarily increases Na⁺ conductance and causes the nerve cell to become less electronegative regarding the outside. If the transmembrane potential is sufficiently depressed, a critical threshold is reached at which the depolarization becomes self-generating. Local electrotonic currents induce a rapid influx of Na⁺ through activated Na⁺-selective channels traversing the nerve membrane. The inward Na⁺ current creates an action potential of approximately +40 mV, which is propagated down the nerve. The action potential is quite transient at any given segment of membrane; loss of Na⁺ permeability (inactivation of the Na⁺ channels) and an outward flow of K⁺ (in nonmyelinated axons) quickly repolarize the membrane. These events are reviewed in Figure 16-3.

Local anesthetics interfere with nerve transmission by blocking the influence of stimulation on Na⁺ conductance. A developing local anesthetic block is characterized by a progressive reduction in the rate and degree of depolarization and a

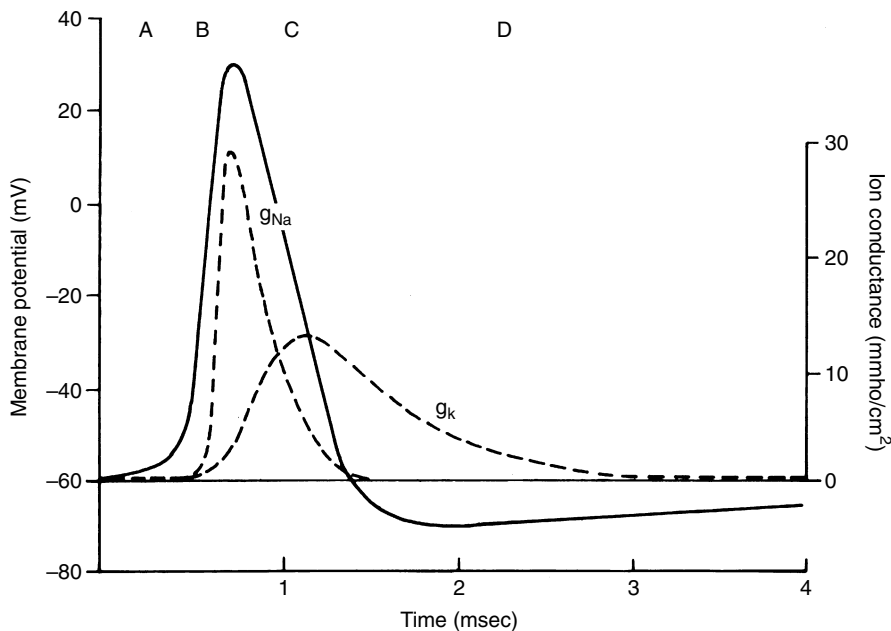

FIGURE 16-3 The action potential. Dashed lines indicate the Na^+ (g_{Na}) and K^+ (g_{K}) conductance changes responsible for membrane depolarization and recovery. *A*, Resting state; Na^+ channels are in the resting (closed) configuration. *B*, Depolarization phase; Na^+ channels open. *C*, Repolarization phase; Na^+ channels become inactivated, and the nerve becomes refractory to stimulation. *D*, Recovery phase; Na^+ channels convert from the inactivated to the resting state, and the nerve regains the ability to conduct action potentials.

slowing of conduction. When the depolarization is retarded sufficiently such that repolarization processes develop before the threshold potential can be reached, nerve conduction fails.¹

Site of Action

Several sites exist within the nerve membrane where drugs could potentially interfere with Na^+ permeability. It was argued that local anesthetics could interact with membrane lipids to impair Na^+ channel function, just as had long been proposed for general anesthetics (see Chapter 17).⁸⁶ In recent years, evidence has accumulated that conventional local anesthetics interact directly with Na^+ channels to inhibit nerve conduction.^{18,88} Each Na^+ channel is composed of several subunits. The α subunit is the largest component (260 kDa) and forms the actual channel,²⁰ whereas the smaller β subunits help to stabilize the channel complex within the membrane.⁵⁶ As depicted in Figure 16-4, the α subunit consists of four homologous domains (I to IV), each of which is composed of six structurally similar helical segments (S1 to S6) that traverse the plasma membrane. Collectively, the S4 segments of each domain constitute the voltage sensor of the “m” or “activation” gate, which opens in response to a depolarizing stimulus. Each S4 segment contains positively charged amino acid residues, specifically arginine and lysine, at every third position of the α helix. In the “helical screw model” of activation,²¹ depolarization causes the outward conformational rotation of the S4 segments, which can be detected experimentally as the small gating currents that precede the action potential. Local anesthetic blockade of the Na^+ channel is characterized by a reduction in the peptide movements responsible for these gating currents.⁶³ Lidocaine tends to trap the S4 segment of domain III in the external, depolarized configuration and to retard movements of the S4 segment of domain IV.⁷⁷ As a consequence, the Na^+ channel remains in an inactivated configuration that precludes normal opening.

As the active site for local anesthetics resides within the Na^+ channel, access becomes an important issue. In this regard, studies with permanently charged local anesthetics have proved enlightening.⁴⁴ Conversion of the amino terminus of certain local anesthetics (e.g., lidocaine) to the quaternary form (e.g., QX-314) yields permanently charged cations largely incapable of crossing the nerve membrane. Although ineffective when applied externally to the axolemma, these experimental compounds show full blocking activity on inter-

nal administration. They gain access to the receptor by traveling up an aqueous route within the Na^+ channel, which must be fully open or at least partially activated to permit their entry from the cytoplasm. Lipophilic molecules, such as benzocaine or the uncharged form of lidocaine, can reach the channel and receptor site by traversing a hydrophobic route, which may include the membrane lipid and hydrophobic portions of the Na^+ channel.

Specific mutations of the S6 segment of domain IV of the Na^+ channel greatly alter local anesthetic blockade.⁶⁸ Replacement of the phenylalanine amino acid midway down the S6 helix with an alanine residue reduces by 99% the apparent binding affinity of the local anesthetic etidocaine to open and inactivated channels. A similar, although smaller, effect occurs when the tyrosine located 11 Å and two turns inward on the same side of the S6 helix is replaced with alanine. Because these aromatic amino acids can interact with local anesthetics through hydrophobic and van der Waals interactions, and their spatial separation conforms to the length of the typical local anesthetic molecule (10 Å to 15 Å), they are believed to be part of and to identify the local anesthetic receptor site. Mutation studies have also shown specific amino acid residues on the S6 segments of domains I and III that appear to form part of the receptor site (Figure 16-5).⁹⁴

As previously mentioned, local anesthetics block nerve conduction by impeding the gating mechanisms that underlie cycling of the Na^+ channel. Other actions that could contribute to nerve blockade include a physical occlusion of the channel, an allosterically mediated change in channel conformation, and (at least with local anesthetic cations) a distortion of the local electrical field.⁵⁷ Some of these actions may be complementary, as binding of a cationic local anesthetic molecule to the putative receptor site places its positive charge adjacent to the most constricted portion of the channel and stabilizes the S4 domain III segment (and to a lesser degree the S4 domain IV segment) in the extruded position.⁶² Figure 16-6 depicts the Na^+ channel as it cycles through its primary configurations in response to a depolarizing stimulus and postulated interactions with neutral and charged local anesthetic species.⁵

Similarities in molecular structure among voltage-gated ion channels provide the basis by which local anesthetics influence the movement of ions other than Na^+ . Inhibition of specific K^+ and Ca^{++} currents may contribute to various local anesthetic effects, including the blockade of nociception.

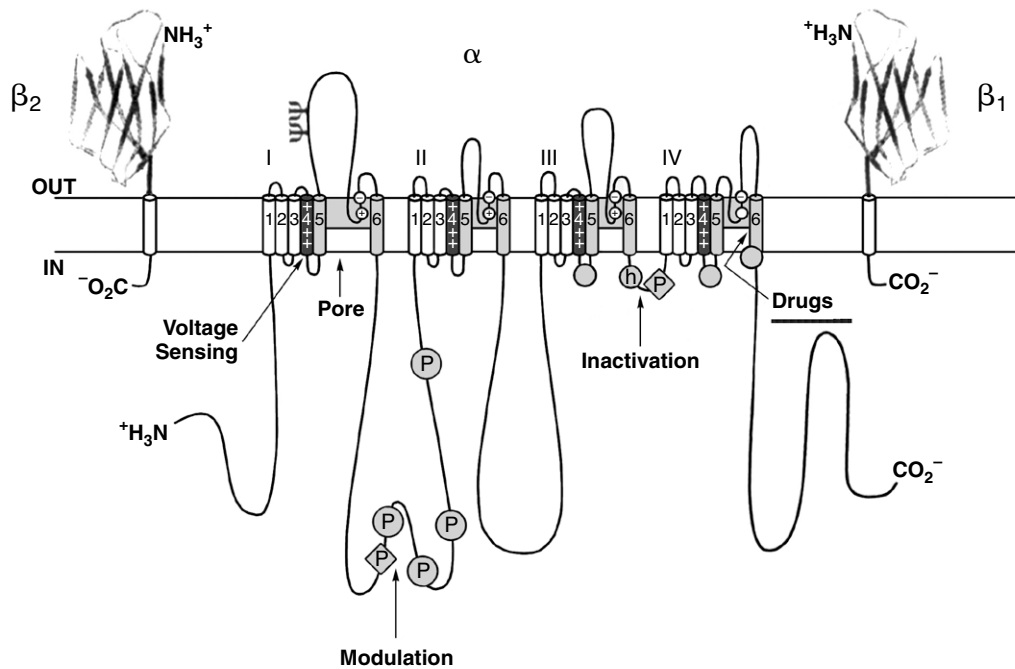

FIGURE 16-4 Functional structure of the Na^+ channel (linear representation). The four primary domains of the α subunit are indicated by Roman numerals, with the six helical segments (designated S1 through S6, left to right) of each domain shown spanning the membrane. A portion of each of the S5-S6 linkages lines the outer portion of the pore and confers ion selectivity to the channel. The inner portion is lined by the S6 and (to a lesser extent) S5 helices. Outward rotation of the positively charged S4 cylinders and coupled movements of the S6 segments open the pore. Concurrently, portions of the S4-S5 linkages of domains III and IV, which help form the inner mouth of the channel, and the S6 segment of domain IV create a receptor (unlettered circles) for a hydrophobic triad of amino acid residues (isoleucine-phenylalanine-methionine; IFM motif) in the intracellular loop between domains III and IV, which constitutes the inactivation, or *h*, gate (*h*). Binding of the *h* gate to its receptor inactivates the channel within about 1 ms. Each *P* indicates a phosphorylation site for protein kinase A (circles) and protein kinase C (diamonds). Phosphorylation of the *h* gate slows inactivation; phosphorylation of other sites reduces channel activation. The ψ symbols indicate glycosylation sites. The β subunits (β_1 and β_2) modulate Na^+ channel electrophysiology and serve as cell adhesion molecules, stabilizing the α subunit in the nerve membrane by interacting with other β subunits and with contactin and ankyrin proteins. (Adapted from Catterall WA: From ionic currents to molecular mechanisms: the structure and function of voltage-gated sodium channels, *Neuron* 26:13-25, 2000.)

Use-Dependent Block

Conventional local anesthetics inhibit high-frequency trains of impulses more readily than they do single action potentials. This phenomenon, variously referred to as use-dependent or frequency-dependent conduction block, phasic or transitional block, or Wedensky inhibition, is an important pharmacologic attribute of local anesthetics and one vital to the elucidation of their interaction with the Na^+ channel.

It has been stated that quaternary derivatives of local anesthetics retain nerve-blocking activity when they are injected intra-axonally, but are ineffective by external administration. Because these drugs can reach their site of action within the Na^+ channel only when the channel is open to the cytoplasm, repetitive stimulation of the nerve should increase exposure of the receptor site to the anesthetic—and lead to increasing drug action—until a steady state is established between the bound drug within the channel and the free drug in the axoplasm. A similar, although less extensive use dependency could be anticipated for lidocaine and related drugs that are partially ionized at physiologic pH.

Numerous studies have proved that high-frequency stimulation increases the magnitude of channel blockade by local anesthetics. Within certain limits, the degree of axonal block is strongly and continuously dependent on the stimulus rate

regardless of equilibration time. A concentration of lidocaine that reduces a compound action potential by 40% at a stimulation rate of 1 Hz causes a depression of 80% after 15 seconds at 40 Hz.¹⁴ These results, as embodied in the modulated receptor hypothesis of local anesthesia, suggest that stimulation of the nerve membrane not only exposes the site of action to local anesthetic cations, but also increases temporarily the affinity of the channel receptor for them.

As originally proposed by Hille,⁴⁴ the modulated receptor hypothesis holds that both the charged and neutral forms of local anesthetics bind preferentially to open and inactivated Na^+ channels. The binding reciprocally tends to stabilize the channels in the inactivated state. If stimulations are sufficiently infrequent, time is available after each depolarization for the slower-than-normal transition from inactivated to resting channels to take place. This conversion reduces local anesthetic binding and permits a net diffusion of neutral anesthetic molecules out of the channels. The remaining anesthetic bound to closed channels provides a basal or tonic block. Conversely, repeated stimuli do not allow for full recovery between depolarizations; anesthetic binding remains enhanced, Na^+ channels in the inactive configuration accumulate, and use-dependent block ensues. Subsequent refinements to the modulated receptor hypothesis include discoveries that the increased affinity

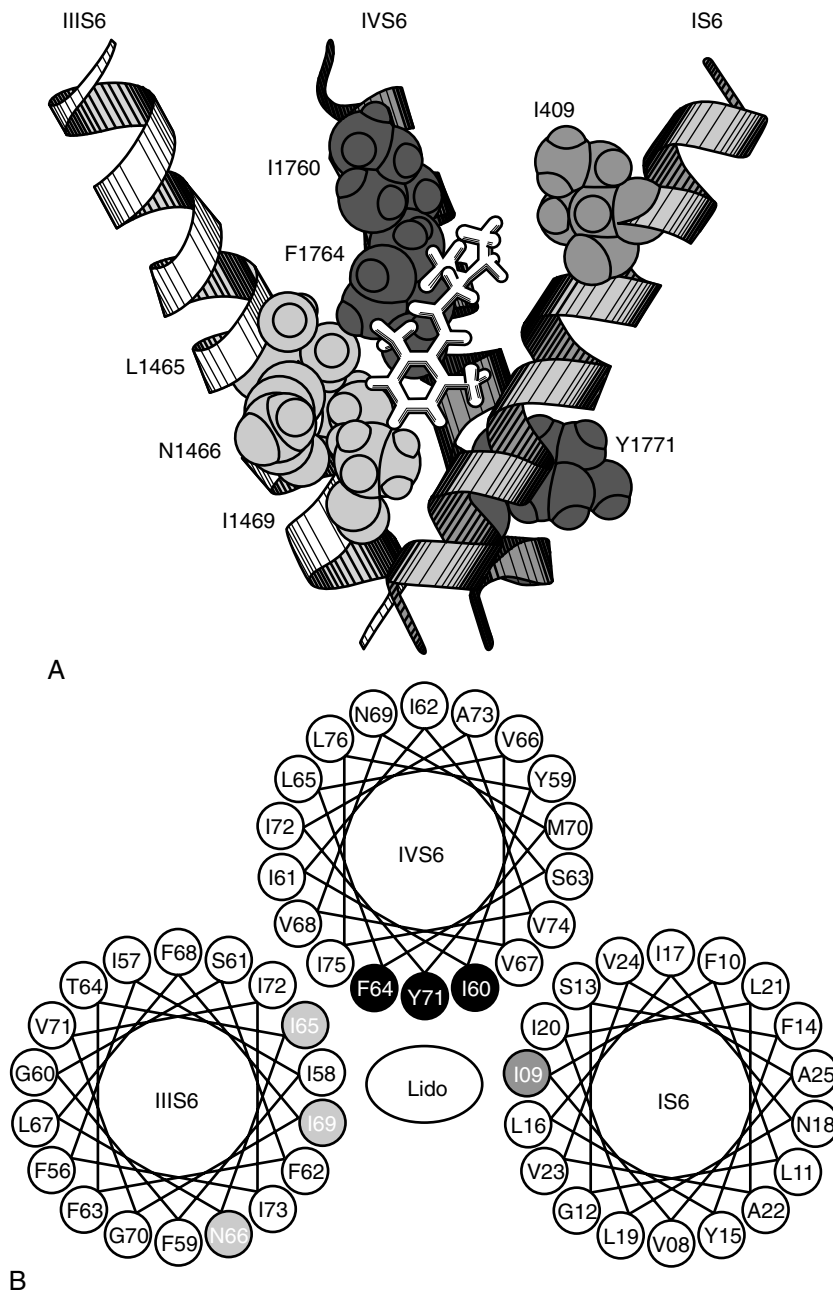

FIGURE 16-5 Proposed local anesthetic binding to the S6 transmembrane segments of domains I (IS6), III (IIS6), and IV (IVS6). **A**, Three-dimensional model. The local anesthetic lidocaine is shown in stick representation; amino acid residues important to local anesthetic binding are shown in space-filling representation. For each amino acid illustrated, the letter identifies the amino acid present (F, phenylalanine; I, isoleucine; L, leucine; N, asparagine; Y, tyrosine), and the number indicates its position on the α -subunit polypeptide. One isoleucine (I1760) does not bind lidocaine per se but blocks its potential exit through a hydrophilic pathway. **B**, α -Helical representation showing the axial positions of the amino acids (solid circles) whose mutation causes reduction in the affinity of lidocaine (Lido) for the inactivated Na⁺ channel. (Adapted from Yarov-Yarovoy V, McPhee JC, Idsvoog D, et al: Roles of amino acid residues in transmembrane segments IS6 and IIS6 of the Na⁺ channel α subunit in voltage-dependent gating and drug block, *J Biol Chem* 277:35393-35401, 2002.)

state of the receptor caused by depolarization of the membrane is not synonymous with the classically defined open or inactivated forms of the channel but may include closed but partially activated channels and several “slow” inactivated configurations promoted by local anesthetic binding.

Marked differences in use dependency have been recorded for various local anesthetics.²⁴ Benzocaine and related nonionized compounds show little phasic block and then only at very high stimulus rates. Conventional local anesthetics exhibit an approximate 10-fold range in frequency dependence, with phasic block becoming clinically significant at 2.5 Hz for lidocaine and at 0.5 Hz for bupivacaine. Permanently charged local anesthetic derivatives develop use-dependent blocks with stimulus rates of 2.4 per minute (0.04 Hz). Basic knowledge gained by the study of use dependency is increasingly being applied to clinical questions involving local anesthetic efficacy and toxicity and to related classes of drugs, such as

various antiarrhythmic and anticonvulsant agents that also exhibit phasic block. Ultimately, new drugs and modes of therapy are expected to arise from the pharmaceutical exploitation of this phenomenon.

Differential Nerve Block

Clinically, neurons vary according to fiber size and type in their susceptibility to local anesthetics. Autonomic functions subserved by preganglionic B and postganglionic C fibers are readily disrupted by local anesthetics, whereas motor control dependent on larger A fibers is not. Sensory neurons are quite heterogeneous in size and exhibit a wide range of sensitivity. Modalities listed in increasing order of resistance to conduction block include the sensations of pain, cold, warmth, touch, and deep pressure. Generally, the more susceptible a fiber is to a local anesthetic agent, the faster it is blocked, and the longer it takes to recover.

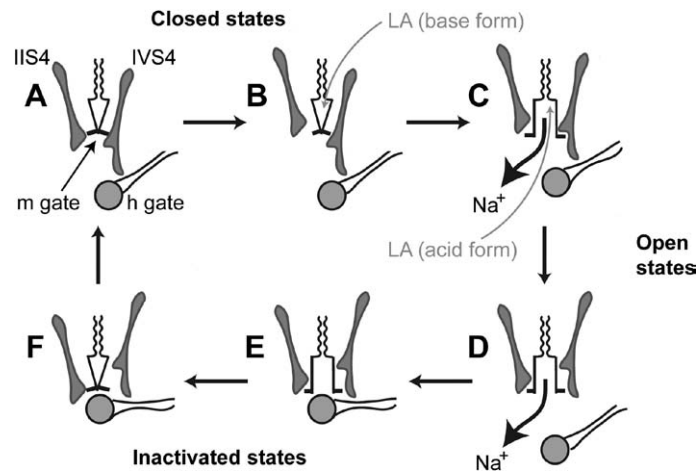

FIGURE 16-6 Normal Na^+ channel cycling and local anesthetic blockade. Shown for domains II and IV are the S4 segments (*IIS4* and *IVS4*) surrounding their respective S5-S6 linkages (*scalloped lines*) and S6 segments (helping to form the activation, or *m*, gate). **A**, In the basal resting state, the S4 segments of all domains are fully deactivated, forced inward by the negative resting polarity. The *m* gate is fully closed. **B**, With partial depolarization of the membrane, the S4 segments of domains I, II, and III rotate outward independently. The *m* gate remains closed. Noncharged local anesthetics can gain access to the channel at any stage of the channel cycle by traversing a hydrophobic pathway. **C**, Conduction begins when the S4 segment of domain IV moves part way out. The steric hindrance on the *m* gate is relieved, and the gate opens sufficiently for influx of Na^+ . Charged local anesthetic molecules can reach the receptor only when the channel is in an open configuration. **D**, Subsequent movement of the S4 domain IV segment allows the channel to open fully. The immediate area assumes a positive polarity as Na^+ rushes inward. This movement also exposes the receptor site for the inactivation, or *h*, gate. **E**, Inactivation of the channel by docking of the *h* gate to its receptor automatically follows. The influx of Na^+ is terminated. **F**, As the local internal Na^+ concentration dissipates, and the membrane begins to repolarize, the S4 segments of domains I and II return to their resting configurations. At this point, the *m* and *h* gates are closed. Return to the normal resting state occurs as the S4 domain returns to its fully resting state, evicting the *h* gate from its binding site in the process. (Adapted from Armstrong CM: Na channel inactivation from open and closed states, *Proc Natl Acad Sci U S A* 103:17991-17996, 2006.)

Critical length

The clinical observations already described (and best seen after spinal or epidural anesthesia) should not be construed as proof that large myelinated axons are inherently more resistant to local anesthetics than smaller fibers. A careful study of individual axons by Franz and Perry³⁵ revealed that the minimum blocking concentration of procaine is not directly related to fiber diameter. A differential block, in which small C and A fibers were affected but larger A fibers were not, could be obtained but only when the length of compound nerve exposed to procaine was restricted in length. On the basis of these findings, the authors concluded that differential sensitivities of fibers of unequal diameter result from variations in the "critical length" that must be exposed to a local anesthetic for conduction to fail.

In myelinated nerves, action potentials are propagated from one node of Ranvier to the next in a saltatory fashion, with a safety factor sufficient to require at least three consecutive nodes to be completely blocked before impulse transmission is interrupted. Because internodal distance is directly related to fiber diameter, small neurons may seem to be more sensitive clinically than large fibers to conduction block. As a local anesthetic diffuses into the nerve trunk, it reaches an effective concentration over a length required to inhibit small axons (i.e., block three nodes) before it spreads sufficiently to block large fibers. Anatomic barriers to diffusion, nonuniform distribution of drug, or the use of a minimal amount of local anesthetic may preclude some large axons from ever being affected. As local anesthesia fades, small neurons are the last to recover because circumscribed areas of drug concentrations adequate for their inhibition remain

along the nerve after the more substantial areas required for large axons have broken up.

When the concentration of local anesthetic is insufficient to block three adjacent nodes completely, anesthesia may still occur if a larger train of nodes is partially blocked.^{34,69} As long as more than 70% of the Na^+ channels in a node are inhibited, the resulting action potential at that node is reduced in size. Progressive declines in the action potentials of partially blocked nodes along the axon ultimately result in failure of conduction if a sufficient length of nerve is exposed to the drug. As shown in Figure 16-7, smaller neurons are again more readily blocked because of the shorter length required for exposure of the requisite number of nodes.⁶⁹

The critical length hypothesis may also be applied to unmyelinated axons as a group. Differences in modes of impulse transmission preclude direct comparisons based on fiber size between myelinated and unmyelinated axons. Smaller in diameter, C fibers nevertheless have approximately the same apparent critical length as small myelinated axons.

Use-dependent block

In addition to anatomic and physiologic variables, the pattern of impulse traffic normally carried in situ by the different nerve fibers may contribute greatly to a differential nerve block.⁷³ Noxious stimuli and sympathetic nervous system transmissions are encoded in rapid bursts of impulses, whereas motor function usually involves low-frequency discharges. Local anesthetics whose use-dependent characteristics fall within this frequency range tend to block pain sensations and autonomic responses preferentially.

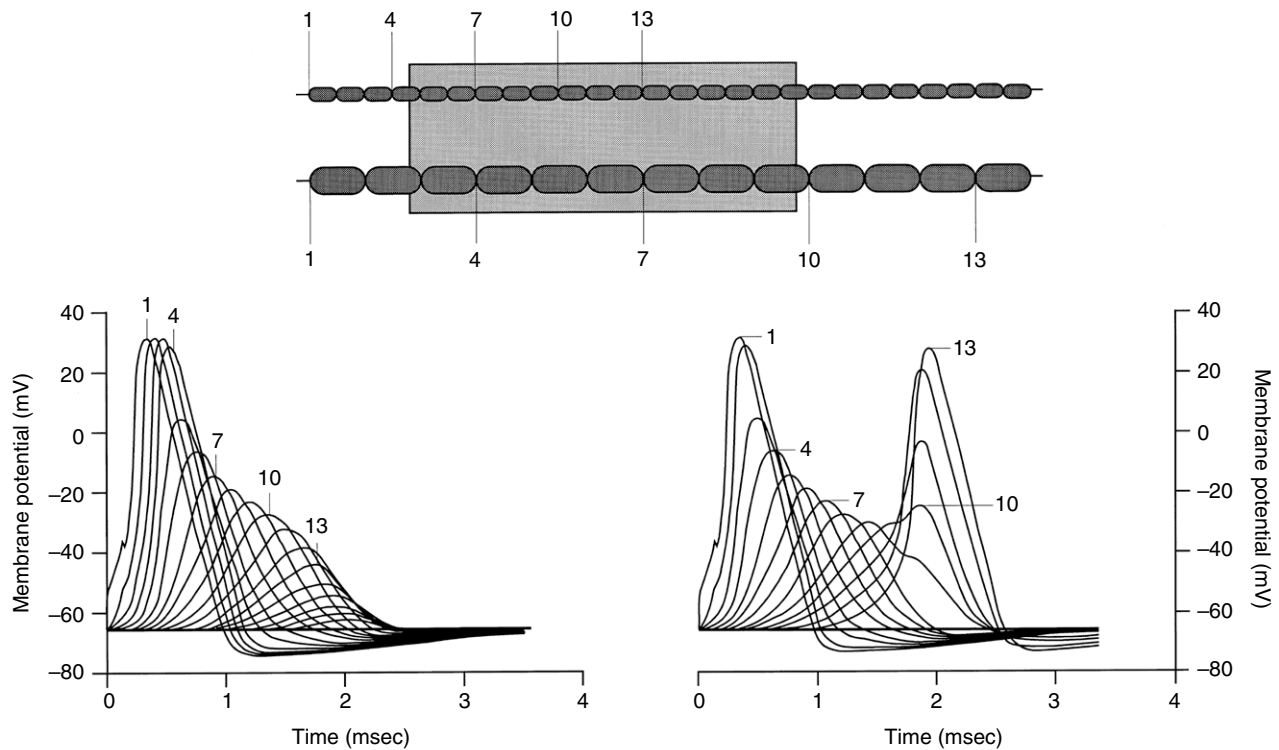

FIGURE 16-7 Differential nerve block. Two adjacent myelinated axons, differing in diameter and internodal distance by a factor of 2, are exposed to a local anesthetic (*gray zone*). Impulses arising from successive nodes of the small axon are plotted on the left. Exposure of 14 nodes to a specific concentration of local anesthetic causes conduction to fail. Identical exposure of the larger axon (*right*) results in seven nodes being affected, an insufficient number to prevent conduction at this local anesthetic concentration. (Adapted from Raymond SA, Thalhammer JG, Strichartz GR: Axonal excitability: endogenous and exogenous modulation. In Dimitrijevic, Wall PD, Lindblom U, editors: *Altered sensation and pain*, Basel, Switzerland, 1990, Karger.)

Peripheral nerve organization

The location of various axons within a nerve trunk has an important bearing on the rate and sometimes the depth of local anesthesia. In major nerve blocks, the epineurium and perineurium limit the spread of anesthetic solution by bulk flow, and the drug must rely more on diffusion to reach the axons within the nerve. Diffusion takes considerable time with nerves that are 1 mm in diameter or greater, and the net result is that the outer, or mantle, fibers are blocked well before the inner core fibers have been exposed to an effective concentration of drug. Removal of the agent by the bloodstream, particularly by intraneuronal blood vessels, may prevent anesthesia of core fibers altogether. Generally, the more proximal tissues supplied by a nerve are more readily affected by local anesthetics because the axons that serve them are located peripherally. The nonuniform distribution of various fiber types within a particular nerve may lead to differential blockade of sensory, motor, and autonomic axons innervating a given structure.

Local anesthetic selectivity

Local anesthetics vary in their relative inherent ability to block sensory versus motor fibers. A good example of this form of differential block involves bupivacaine and etidocaine. Both of these drugs are highly lipid-soluble agents capable of producing prolonged nerve blockade. Bupivacaine can elicit sensory anesthesia at one third the concentration required for motor blockade, whereas etidocaine shows no selectivity of effect.⁷⁹ Because maintenance of uterine muscle contractility is important in childbirth, bupivacaine is the preferred agent for epidural anesthesia during labor and delivery.

The mechanism behind such differential effects of local anesthetics has not been elucidated. One possibility relates to the drugs' relative tendency to block different K⁺ channel subtypes. A local anesthetic (presumably etidocaine) with a strong ability to block voltage-gated K⁺ channels important in reversing neuronal depolarization might be expected to work against itself in nonmyelinated axons subserving the perception of pain. In such nerves, inhibition of K⁺ efflux would give Na⁺ efflux a better chance of reaching threshold and propagating the action potential. A selective blockade of K⁺ influx through K⁺ channels that specifically control the resting membrane potential of small, nociceptive axons would result in partial membrane depolarization and a potentiation of Na⁺ channel inactivation and local anesthetic blockade.⁴⁹

Inflammation

The failure to obtain satisfactory clinical pain relief in inflamed tissues is a well-known and undesirable form of differential nerve block. Clinically, this phenomenon is encountered in a patient who exhibits profound local anesthetic effect except in the specific area requiring treatment. If inflammation lowers the pH at the injection site, diffusion of the drug into the axolemma would be impaired, as described previously. There is some evidence, however, that the buffering capacity of inflamed tissues is not always reduced⁶⁷ and that other reasons for local anesthetic failure must exist in these conditions.

Increased blood flow and decreased catecholamine effectiveness in inflamed tissues may speed removal of the local anesthetic from the injection site. Alteration of Na⁺ channel number, function, or type may offset the ability of local anesthetics to block nerve conduction. Analogous changes in the expression or activity of other ion channels involved in

nociception may have a similar effect.⁵² Neuromediators and other products released or synthesized during inflammation may increase responsiveness of nociceptors and/or enhance nerve conduction in response to painful stimuli. These include histamine, prostaglandin E₁, kinins, adenine nucleotides, and substance P.

PHARMACOLOGIC EFFECTS

Although primarily used to depress peripheral nerve conduction, local anesthetics are not selective and may interfere with impulse transmission in any excitable tissue. Most prominent of the systemic effects of local anesthetics are effects related to the cardiovascular system and the central nervous system (CNS), but virtually any organ with dependence on nervous or muscular activity may be affected. Local anesthetics may also influence various tissues through actions unrelated to specific disturbances in Na⁺ conductance.

Central Nervous System

Local anesthetics readily pass from the peripheral circulation into the brain. Because CNS neurons are particularly sensitive to local anesthetics, blood concentrations incapable of altering peripheral nervous activity may profoundly influence CNS function.

Sensitive psychomotor tests and subjective reports of mild drowsiness indicate that systemic effects caused by local anesthetics can occur with plasma concentrations that are achieved in dental patients.⁶ Analgesic and anticonvulsant effects also occur in subtoxic concentrations. Initial signs and symptoms of a toxic effect are often excitatory in nature and consist of a feeling of lightheadedness and dizziness, followed by visual and auditory disturbances, apprehension, disorientation, and localized involuntary muscular activity. Depressant responses, such as slurred speech, drowsiness, and unconsciousness, may also occur and are especially prominent with certain drugs (e.g., lidocaine). As higher blood concentrations of drug are attained, muscular fasciculations and tremors intensify and develop into generalized tonic-clonic convulsions. On termination, seizure activity is often succeeded by a state of CNS depression identical to general anesthesia. With excessively large doses, respiratory impairment becomes manifest; if untreated, death by asphyxiation may ensue.

The CNS excitation sometimes observed after local anesthesia is intriguing because the sole action ascribed to these agents is one of depression. Studies involving the topical application of local anesthetics to exposed cortical or spinal cord neurons document that the only direct effect of procaine and related drugs is to inhibit electrical activity.²⁶ The apparent stimulation observed clinically may be explained on the basis that inhibitory cortical neurons or synapses are highly susceptible to transmission block. Initial disruption of these pathways results in a disinhibition of excitatory neurons, manifested clinically as stimulation. Electroencephalographic studies indicate that local anesthetic seizures begin in the amygdala.^{37,76} Disinhibition of this part of the limbic system allows high-voltage discharges to occur, which spread throughout the brain. A more recent finding that local anesthetics can block a family of K⁺ channels (whose inhibition increases neuronal excitability) raises the possibility that CNS stimulation and cardiac arrhythmias may arise in part from direct neuronal excitation.⁴⁹

Cardiovascular System

Local anesthetics can exert various effects on the cardiovascular system. Some influences are beneficial and serve as a basis for the use of selected agents in the treatment of cardiac arrhythmias; others are not helpful and merely serve to accentuate

systemic toxicity. In almost all instances, however, the observed effects result from the interplay of direct actions of local anesthetics on the myocardium and peripheral vasculature as well as CNS actions indirectly mediated through the autonomic nervous system.

Myocardium

At nontoxic concentrations, local anesthetics differ in their electrophysiologic influences on the heart. Lidocaine shortens the action potential duration and the effective refractory period in Purkinje fibers, whereas procaine acts in the opposite direction. Both drugs increase the effective refractory period relative to the action potential duration, however, and decrease cardiac automaticity, especially in ectopic pacemakers.

Presumably because of their ability to block Ca⁺⁺ channels and evoked Ca⁺⁺ release from the sarcoplasmic reticulum and to reduce myofibrillar responsiveness to available Ca⁺⁺, local anesthetics depress myocardial contractility in a dose-dependent manner.⁵⁹ With conventional doses of lidocaine, this effect is minor and sympathetic reflexes and direct vascular effects produce a compensatory increase in peripheral resistance, which prevents a decrease in blood pressure. Through a centrally mediated disinhibition of sympathetic nervous activity, heart rate and arterial blood pressure may become elevated coincident with CNS excitation. Conversely, mepivacaine has been reported in moderate doses to decrease peripheral vascular resistance and increase cardiac output,⁴⁸ which suggests that local anesthetics may exert dissimilar patterns of direct and indirect effects on the heart at subtoxic blood concentrations.

Local anesthetics in doses toxic to the heart are qualitatively similar in action. Membrane excitability and conduction velocity are depressed throughout the heart. Sinus bradycardia and impairment of myocardial contractility contribute to a reduction in cardiac output. These effects are magnified by hypoxia, but even if respiration is supported artificially, circulatory collapse occurs after excessively large doses.

Reports in humans suggest and experiments in several other species confirm that bupivacaine and certain other highly lipophilic local anesthetics are cardiotoxic compared with less lipophilic congeners. Serious ventricular arrhythmias and cardiovascular collapse are more likely to occur, and resuscitation is more problematic. One explanation for these observations involves use-dependent blockade.²⁴ As indicated in Table 16-2, bupivacaine has a high molecular weight for a local anesthetic. That, coupled with its lipophilic tendency and perhaps its high pK_a, enables the drug to exert a strong phasic block at normal heart rates. Inhibition of K⁺ and Ca⁺⁺ channels may also contribute to the arrhythmogenic potential of bupivacaine in toxic concentrations. Finally, intracerebroventricular injection of bupivacaine can cause intractable arrhythmias in animals, indicating a CNS contribution to the drug's cardiac toxicity.¹⁰

Peripheral vasculature

The effects of local anesthetics on blood vessels are complex and dose dependent.^{4,12} Dilute solutions enhance spontaneous myogenic contractions and peripheral resistance in certain vascular beds, presumably by increasing the cytoplasmic concentration of Ca⁺⁺ within smooth muscle fibers. Coincidentally, local anesthetics reduce vascular tone related to autonomic function by diminishing neurotransmitter release and smooth muscle responsiveness. Subconvulsive doses of local anesthetics exert minor influences on the peripheral vasculature as a whole. Toxic blood concentrations may cause arteriolar dilation and profound hypotension.

The net effect on any vasculature bed depends on the local anesthetic, its concentration, and the existing sympathetic tone in the tissue. A therapeutically relevant estimate of local

TABLE 16-2

Comparison of Local Anesthetics Used in Dentistry

PREPARATION CONTENTS	PROPRIETARY (TRADE) NAME	MAXIMUM DOSE*		DURATION OF ANESTHESIA (SOFT TISSUE)	
		(mg/kg)	(mg)	MAXILLARY INFILTRATION (min)	INFERIOR ALVEOLAR BLOCK (min)
2% Lidocaine hydrochloride; 1:100,000 epinephrine	Xylocaine with epinephrine, 1:100,000	7	500	170	190
2% Lidocaine hydrochloride; 1:50,000 epinephrine	Xylocaine with epinephrine, 1:50,000	3.5 [†]	250 [†]	170	190
2% Lidocaine	Xylocaine	4.5	300	40 [‡]	100 [‡]
2% Mepivacaine hydrochloride; 1:20,000 levonordefrin	Carbocaine 2% with Neo-Cobefrin	6.6	400	150	190
3% Mepivacaine hydrochloride	Carbocaine	6.6	400	90	165
4% Prilocaine hydrochloride; 1:200,000 epinephrine	Citanest Forte	8	600	140	205
4% Prilocaine hydrochloride	Citanest	8	600	105	175
0.5% Bupivacaine hydrochloride; 1:200,000 epinephrine	Marcaine with epinephrine	—	90	340	440
4% Articaine hydrochloride; 1:100,000 epinephrine	Septocaine with epinephrine, 1:100,000	7	—	200	230
4% Articaine hydrochloride, 1:200,000 epinephrine	Septocaine with epinephrine, 1:200,000	7	—	180	200

*The maximum dose is the smaller of the two values (e.g., 7 mg/kg lidocaine up to a maximum dose of 500 mg).

[†]Lower doses than those approved by the U.S. Food and Drug Administration are recommended on the basis of the high epinephrine content.

[‡]Lidocaine without epinephrine produces unreliable pulpal anesthesia, especially of the maxilla.

anesthetics listed in decreasing order of vasodilatory potential includes procaine, bupivacaine, lidocaine, articaine, prilocaine, mepivacaine, ropivacaine, and cocaine. With the possible exception of ropivacaine, local anesthetics administered submucosally inhibit myogenic activity and autonomic tone clinically and cause vasodilation in the area of injection. Cocaine is unique in its ability to decrease local blood flow after topical application to mucosal surfaces. Cocaine potentiates the vasoconstrictive effect of catecholamines by inhibiting their transport into adrenergic nerve terminals.

Miscellaneous Effects

Aside from their influences on cardiovascular and CNS function, local anesthetics exert few systemic effects in concentrations compatible with life. Transmission at the neuromuscular junction and at autonomic ganglia may be affected, but intrarterial administration is usually required for these effects to be observed in vivo. Various smooth muscle actions and antibacterial, antihistaminic, and antimuscarinic effects have also been reported.²⁷ Local anesthetics have been shown to influence the metabolism of arachidonic acid and to inhibit platelet aggregation.¹⁶

In tissue culture, local anesthetics can disrupt numerous cellular functions—locomotion, endocytosis, exocytosis, axonal transport, cell fusion, and maintenance of normal morphology. These effects have been ascribed to disturbances of the cytoskeleton (microtubules and microfilaments). Various Ca⁺⁺-dependent and calmodulin-dependent enzymatic activities and membrane transport systems are also susceptible to local anesthetic influences.⁸⁷ The toxicologic and therapeutic implications of these actions are mostly yet to be determined.

Vasoconstrictor Effects

Vasoconstrictors are often added to local anesthetic solutions to impede systemic absorption of the anesthetic agent (see Chapter 6). Epinephrine in concentrations of 5 µg/mL to 20 µg/mL (1:200,000 to 1:50,000) is most commonly used for this purpose, but other sympathomimetic amines, including levonordefrin, norepinephrine, and phenylephrine, are or have been used. Localization of the anesthetic solution in the

area of injection by epinephrine is often highly beneficial. The duration of local anesthesia may be prolonged several times, and the success rate and intensity of nerve block may be improved. Systemic toxicity may be reduced because less drug may be needed, and anesthetic metabolism is more likely to keep pace with drug absorption. During surgery, hemostasis afforded by the infiltration of a local anesthetic solution containing epinephrine may also be advantageous.

Normally, sympathomimetic drugs included in anesthetic formulations produce no pharmacologic effects of clinical consequence other than localized arteriolar constriction. Low doses of epinephrine, such as those contained in one or two dental cartridges of lidocaine with 1:100,000 epinephrine (18 µg to 36 µg), decrease total peripheral resistance by 20% to 30%, but a commensurate increase in cardiac output supported by increases in stroke volume, heart rate, or both leaves the mean blood pressure unchanged. Injudicious dosage, accidental intravascular injection, or adverse drug interactions may promote clinically noticeable effects on the CNS and sympathetic nervous system. Heart rate and systolic blood pressure may be elevated by epinephrine, causing uncomfortable palpitation and pain in the chest. Restlessness and apprehension similar to the effects produced by local anesthetics in overdose may also occur. Phenylephrine, a relatively pure α -adrenergic agonist, avoids most of the direct cardiac stimulation associated with epinephrine, but it may significantly elevate systolic and diastolic pressures and reflexively slow the heart for an extended period. Other sympathomimetics, such as norepinephrine and levonordefrin, are intermediate in their systemic effects.

As a guideline for cardiac patients, the New York Heart Association recommended in 1955 that the amount of epinephrine administered during any one session not exceed 200 µg (equivalent to 20 mL of a 1:100,000 epinephrine solution).⁸¹ Current evidence indicates that this amount is excessive for patients with compromised cardiovascular systems and that more restrictive guidelines should be followed (see Chapter 6). Several studies have shown that the intraoral injection of 20 µg of epinephrine effectively doubles the preoperative plasma concentration and that higher

doses produce proportionately greater elevations.⁸⁵ At doses approaching 200 µg, the resulting epinephrine titers can surpass titers associated with heavy exercise, surgery, and pheochromocytoma.^{25,28} Increases in cardiac work become significant, and myocardial ischemia and cardiac arrhythmias are more likely to occur.

ABSORPTION, FATE, AND EXCRETION

Pharmacokinetic considerations regarding local anesthetics are vital because the balance between the uptake of a local anesthetic into the systemic circulation and its removal through redistribution, metabolism, and excretion in large measure determines the drug's toxic potential.

Absorption

The rate of absorption depends on several factors, including the dosage and pharmacologic profile of the drug used, the presence of a vasoconstrictor agent, and the nature of the administration site. The more drug that is injected, the higher its resultant blood concentration. Less obvious are the qualitative influences of the anesthetic solution and how these interact with the site of administration. Drugs with potent vasodilating properties, such as procaine and lidocaine, may significantly enhance their own uptake, particularly when injected into a highly vascular space. Inclusion of epinephrine or another vasoconstrictor is especially important in these instances. Drugs that are not strong vasodilators, such as mepivacaine and prilocaine, do not markedly accentuate their own absorption and do not require as much vasoconstrictor to limit uptake.

Absorption after topical application varies widely. Although intact skin and keratinized mucosa are relatively impermeable, local anesthetics are readily absorbed from most mucosal surfaces. Instillation of tetracaine into the piriform fossa results in a peak plasma concentration one third to one half that obtained after rapid intravenous infusion. By comparison, absorption of lidocaine from the tracheobronchial tree is much slower. Regardless of the site of application, sympathomimetic agents in standard doses are ineffective topically in delaying absorption. Uptake may be minimized, however, by using local anesthetics prepared in the form of an ointment or gel instead of an aqueous spray.

Distribution

On entering the circulation, a local anesthetic is partially (5% to 95%) bound by plasma proteins— α_1 -acid glycoprotein in particular and albumin to a much lesser extent—and red blood cells. Plasma protein binding is directly correlated with the hydrophobicity of the local anesthetic.⁸⁴ Because the concentration of α_1 -acid glycoprotein is influenced by many factors (see Chapter 2), the fractional binding of local anesthetics differs among individuals and within the same individual at different times. Factors that acutely depress binding include respiratory acidosis and possibly the coadministration of other basic drugs.

After distribution throughout the intravascular space, the unbound drug is free to diffuse into the various tissues of the body. So-called barriers to diffusion are ineffective against local anesthetics. In addition to entering the CNS, these drugs readily cross the placenta and occasionally may induce severe cardiac depression in the fetus.

Distribution to peripheral tissues is a major means for the removal of amide and slowly metabolized ester local anesthetics from the bloodstream and for keeping their plasma concentrations below the toxic range. By virtue of the pulmonary circulation, the lung plays a unique role in this process when a local anesthetic is injected intravenously.⁴⁷ Initially, 90% of

the drug may be taken up by the lung. Although most of the agent diffuses back into the bloodstream within the first minute after injection, the evanescent buffering action of the lung can nevertheless reduce the peak arterial blood concentration by a factor of 3.

Metabolism and Excretion

The metabolic fate of a particular agent largely depends on the chemical linkage between the aromatic residue and the rest of the molecule. Ester drugs are inactivated by hydrolysis. Derivatives of *p*-aminobenzoic acid (e.g., procaine and tetracaine) are preferentially metabolized in the plasma by pseudocholinesterase; the ratio between plasma and tissue hydrolysis with other esters is variable. Products of hydrolytic cleavage may undergo further biotransformation in the liver before being eliminated in the urine. The half-life for the hydrolysis of procaine is normally less than 1 minute and less than 2% of the drug is excreted unchanged by the kidneys.

Metabolism of amide drugs primarily occurs in the liver. The initial reaction is usually N-dealkylation of the tertiary amino terminus, principally by CYP3A4 and CYP1A2.^{64,89} The resultant secondary amine of most amides is susceptible to hydrolysis by hepatic amidase activity, but conjugation, hydroxylation, and further dealkylation may also occur. Hepatic blood flow seems to be the rate-limiting factor governing metabolism of lidocaine and some other amides; elimination half-lives range from 1.5 to 3.5 hours. Inactivation of prilocaine, a secondary amine, is unusual because dealkylation is not required before hydrolysis can take occur, which may explain why almost half of its metabolism is extrahepatic. Articaine is also atypical because it is inactivated in the blood and other tissues by hydrolysis of an ester side chain required for local anesthetic activity. With an initial plasma half-life of approximately 25 minutes, articaine is removed from the circulation faster than other injected amides. The rapid biotransformation of articaine to articainic acid (an essentially inactive metabolite) coupled with an unusually extensive tissue distribution significantly reduces the potential for cumulative toxicity after repeat dosing.⁷⁸

Some local anesthetic metabolites retain significant pharmacologic activity and may contribute to drug toxicity. Much of the sedative effect of lidocaine has been attributed to its de-ethylated metabolites monoethylglycinexylidide and glycinexylidide.⁸² As with the ester compounds, minimal amounts (1% to 20%) of administered amides appear in the urine as unmetabolized compounds.

Differences in biotransformation of the various local anesthetics are sometimes clinically relevant. Individuals with certain genetically based defects in pseudocholinesterase activity are unusually sensitive to procaine and other esters (but presumably not articaine); conventional doses of these drugs may occasionally lead to toxic reactions. Alternatively, severe hepatic disease or reduced hepatic blood flow may produce systemic intolerance to lidocaine and presumably other local anesthetics dependent on adequate liver function for their metabolism.

ADVERSE EFFECTS

Modern local anesthetic solutions are quite safe when used by competent personnel. Nevertheless, a substantial amount of literature describing various adverse reactions attests to the potential toxicity of these agents, particularly when they are used in a cavalier manner.

Systemic Toxicity

Most serious toxic effects are related to excessive blood concentrations caused by inadvertent intravascular injection or

the administration of large quantities of drug. Convulsions, respiratory arrest, and cardiovascular collapse represent the greatest hazards to health. Such reactions can usually be prevented by observing three precautions: (1) administer the smallest dose that provides effective anesthesia; (2) use proper injection techniques, including aspiration; and (3) use a vasoconstrictor-containing solution when not contraindicated by patient history or operative need. If an adverse response occurs despite these procedures, immediate therapy must be provided. The patient should be placed in the supine position and oxygen administered. This procedure is often all that is needed for mild toxic reactions, epinephrine responses, or syncopal attacks.

Convulsions are usually self-limiting and require no treatment other than supporting ventilation and protecting the patient from bodily harm. Pharmacologic intervention is necessary, however, when the seizures are so intense or prolonged that hypoxia threatens to ensue. The most satisfactory method of seizure control in the dental environment is the intravenous administration of a rapidly acting benzodiazepine.⁶¹ Experimental evidence and clinical experience indicate that intravenous diazepam (0.1 mg/kg to 0.3 mg/kg) or midazolam (0.03 mg/kg to 0.1 mg/kg) can eliminate local anesthetic convulsions without producing significant adverse effects on ventilation or circulation. Small intravenous doses of a rapidly acting barbiturate (e.g., thiopental) may also terminate local anesthetic seizures, but they tend to potentiate the postconvulsive depressant phase of local anesthetic toxicity. Succinylcholine, a neuromuscular blocker without CNS depressant action, is sometimes used in refractory cases. Neuromuscular blockade treats only the outward manifestations of a convulsion; electrical disturbances within the CNS progress unimpeded. An immediate ability to institute artificial ventilation is a mandatory prerequisite for succinylcholine's use because the drug paralyzes the muscles of respiration.

Various agents have been administered prophylactically in attempts to prevent seizures. Most anticonvulsants examined have been disappointing in this regard, but diazepam has been shown in cats to double the median convulsant dose of lidocaine without causing undesirable CNS disturbances.²⁹ Midazolam seems to provide a similar benefit, and consequently either drug is a premedication of choice when the administration of a large quantity of local anesthetic is anticipated. Some drugs previously commonly used for preoperative sedation, including meperidine and promethazine, may increase the likelihood of local anesthetic convulsions.

Treatment of severe toxic reactions is largely symptomatic and consists of reversing respiratory and circulatory disruptions as they occur. Because most deaths attributed to local anesthetics are related to tissue anoxia, support of ventilation is of paramount importance. Arterial hypotension is controlled by the coadministration of intravenous fluids and sympathomimetic agents. Cardiopulmonary resuscitative techniques are necessary when cardiac function is disrupted.

Local Tissue Responses

Commercially available local anesthetics are relatively nonirritating to tissues. Many reactions described in the past were caused not by local anesthetics, but by metallic or alcoholic contaminants that gained access to the solutions during or after manufacture. Local anesthetic concentrations necessary to damage peripheral nerves usually far exceed the concentrations required for transmission blockade. Accidental intraneural injection may lead to nerve damage, however, from the combination of undiluted local anesthetic, strong hydrostatic pressure, and direct physical injury. High-concentration agents, such as 4% solutions of prilocaine or articaine, are significantly more likely to cause long-lasting or permanent nerve injury when administered for inferior alveolar nerve

block.⁴⁰ Exposure of unsheathed neurons to these concentrations results in an irreversible increase in intracellular Ca^{++} and necrotic cell death.⁴⁶

Conventional anesthetic preparations may induce focal necrosis in skeletal muscle tissue approximating the injection site.⁹³ The damage occurs rapidly after a single administration and is completely reversed in several weeks. In certain circumstances, local anesthetics may also impede cell motility, depress collagen synthesis, and delay wound healing.

Adverse tissue responses to injected local anesthetic preparations are usually caused or augmented by vasoconstrictor additives. Epinephrine creates tissue hypoxia by reducing local blood flow while increasing oxygen consumption. Although tissue injury may be induced by any of the sympathomimetics currently used, norepinephrine is particularly apt to cause ischemic necrosis. The injection of local anesthetic with a vasoconstrictor has been described historically as especially hazardous in areas supplied by terminal arteries (e.g., nose, digits, and penis). More recent research has shown, however, the safety of epinephrine used with local anesthetics in digital nerve blocks and for injections of the nose and ear.^{42,60} In dentistry, tissue irritation may result in an increased incidence of postanesthetic pain at the injection site in patients receiving local anesthetic formulations containing vasoconstrictors.

Idiosyncratic Reactions

In rare instances, patients have had toxic reactions to small amounts of local anesthetic. Some of these reactions may represent an abnormal susceptibility to the local anesthetic. Most often, these responses are anxiety related, associated with the vasoconstrictor, or the result of inadvertent intravascular injection. Regarding the last possibility, it has been accidentally determined that the convulsant dose of lidocaine in humans is only 10 mg when the drug is injected into the vertebral artery.⁵⁰

Amide local anesthetics were previously thought by some authorities to be causative agents for malignant hyperthermia (MH). This conclusion was based on a few anecdotal cases of supposed MH and on the ability of lidocaine-like drugs to potentiate contracture of skeletal muscle in various experimental situations. Subsequently, direct evidence indicated that no injectable local anesthetic is a triggering agent. Lidocaine has no effect on porcine MH, and it has not caused problems when used for local anesthesia in patients with a history of MH.⁹⁰ Amide local anesthetics are safe for routine dental use in patients susceptible to MH, and lidocaine may be used for the treatment of ventricular arrhythmias during an acute episode of MH.

Allergic Phenomena

Local anesthetics rarely cause allergic reactions; however, when one does occur, an ester derivative of *p*-aminobenzoic acid is usually involved. Methylparaben, a preservative used in certain local anesthetic preparations (but not in dental cartridges), may also occasionally serve as an antigenic stimulant. Historically, most documented cases of allergy—in the form of contact dermatitis—occurred in dentists and other health care professionals exposed to ester agents on a regular basis. Urticarial eruptions, erythematous rashes, and other dermatologic responses represent typical manifestations of local anesthetic allergy in patients and are regularly treated with antihistamines. Anaphylactic responses of a serious nature require epinephrine.

Since 1976, evidence has accumulated that certain individuals, mostly asthmatic patients, are intolerant of sulfites, including the bisulfite and metabisulfite preservatives used in local anesthetic solutions with vasoconstrictors. Although the original case report⁶⁶ seems to have had an immunologic basis, subsequent findings suggest that most affected individuals are

hyperreactive to sulfites that are inhaled or ingested but not injected. These reactions are more properly classified as idiosyncratic and do not contraindicate the use of sulfite-containing local anesthetics except perhaps in some patients with steroid-dependent asthma. Isolated case reports of bisulfite allergy occurring after the intraoral administration of local anesthesia constitute the rare absolute contraindication.⁷²

Despite the low incidence of verifiable allergy to local anesthetic solutions in patients, a high percentage of individuals have medical histories of presumptive local anesthetic hypersensitivity. Many of these cases undoubtedly represent anxiety or toxic reactions misdiagnosed as immunologic in origin. Such mistakes are particularly apparent when amides are involved because most investigations have shown these compounds to be virtually nonallergenic.⁷ When a single agent is involved, substitution with another local anesthetic is the simplest method of resolving the problem if consideration is given to the fact that esters may exhibit cross-allergenicity with each other and with methylparaben.

Drug selection becomes more difficult when a patient has a reported allergy to all conventional agents. Diphenhydramine (1% with 1:100,000 epinephrine) and other antihistamines have been used with some success in such instances, but their overall suitability as local anesthetics is limited. An alternative approach is to screen for drug allergy. Although sensitivity testing methods are generally unreliable and may be potentially dangerous, a regimen of intracutaneous injections graduating to full challenge tests in a supervised medical setting has proved useful in identifying local anesthetic formulations that can be administered safely.³⁰

Use During Pregnancy

Local anesthetics are generally regarded as safe for use throughout pregnancy. Studies of women receiving local anesthesia for emergency procedures in the first trimester and/or routine dental procedures in the second trimester have supported this view.⁵⁴ Animal studies are also largely negative, although bupivacaine has been shown to cause fetal death at five times the maximum recommended human dose. The U.S. Food and Drug Administration (FDA) has classified lidocaine and prilocaine in pregnancy risk category B, and articaine, mepivacaine, and bupivacaine in category C (see Chapter 3).

The possibility has been raised that local anesthetics may affect behavioral development in offspring. Injection at midgestation of a single intramuscular dose of local anesthetic equivalent to the maximum recommended human dose was found to produce developmental delays and behavioral deficits in rats.⁸⁰ These results have not been verified in primates but are sobering in the face of an estimate that 23% of all children are exposed to local anesthetics sometime in utero.

DRUG INTERACTIONS

Because of their influences on excitable membranes, local anesthetics are potentially capable of interacting with a wide spectrum of therapeutic agents. The CNS depressant effects of local anesthetics summate with the effects of the general anesthetics, barbiturates, and opioid analgesics, yielding interactions with therapeutic and toxicologic significance. Lidocaine combined with another antiarrhythmic drug may generate profound disturbances in cardiac automaticity and conduction, far in excess of what either compound would have caused if given alone. Although feeble by itself, the neuromuscular blocking activity of local anesthetics has been used to advantage in preventing succinylcholine-induced fasciculations and in reducing the dose of succinylcholine

required during surgery for adequate muscle relaxation. Elucidation of the role of CYP3A4 and CYP1A2 enzymes in the metabolism of amide local anesthetics has led to the discovery that inhibitors of these enzymes, such as erythromycin (CYP3A4) and fluvoxamine (CYP1A2), can modestly increase plasma concentrations of lidocaine and related agents.⁶⁴

In coronary care units, where large doses of lidocaine may be infused intravenously to treat ventricular arrhythmias, the coadministration of cimetidine,^{45,70} a histamine H₂-receptor blocker, or propranolol,⁹ a β -adrenoceptor antagonist, has led to lidocaine toxicity. Both agents seem to inhibit the oxidation of lidocaine directly; propranolol also reduces hepatic blood flow and delivery of the local anesthetic to the liver.

A unique interaction may occur between certain esters and the sulfonamides. Procaine and several other local anesthetics (benzocaine, tetracaine) are metabolized to yield *p*-aminobenzoic acid. The antibacterial action of sulfonamides is competitively antagonized by this metabolite.

Although the potential for interactions involving local anesthetics is great, clinical manifestations appear infrequently outside the hospital and then only when very large doses are used or when unusual patient factors are present. Much more likely to occur are interactions between various drugs and the vasoconstrictors used during local anesthesia. Epinephrine may generate ventricular arrhythmias during general anesthesia. Similarly, catecholamines can induce undesirable changes in cardiac action and blood pressure in patients taking tricyclic antidepressants and related norepinephrine transporter inhibitors, cocaine, nonselective β -adrenergic blockers, digoxin, inhibitors of catechol-O-methyltransferase, or adrenergic neuron-blocking drugs (e.g., guanethidine). Compounds with prominent α -adrenoceptor-blocking activity, such as the phenothiazine and butyrophenone antipsychotics, may lead to hypotension if coadministered in large doses with epinephrine.

Despite statements to the contrary in local anesthetic product information approved by the FDA, local anesthetics containing epinephrine may be used without special reservation in patients taking monoamine oxidase (MAO) inhibitors. Exogenous catecholamines are mostly degraded by the enzyme catechol-O-methyltransferase; inhibition of MAO has little impact on their respective metabolic fates or cardiovascular actions.¹³ Of the vasoconstrictors used with local anesthetics, only phenylephrine is contraindicated with concomitant MAO therapy.

The most important interaction featuring vasoconstrictors is the intended one: inhibition of local anesthetic uptake from the injection site. Animal data suggest, however, that this is not the only interaction that can occur involving the anesthetic agent and its vasoconstrictor partner. Acute lethality studies document that epinephrine potentiates the toxicity of several local anesthetics administered intravenously.^{2,91} By protecting against local anesthetic depression of blood pressure, the vasoconstrictor allows a greater-than-normal fraction of anesthetic to reach the brain and spinal cord.⁹² It is unknown if this interaction occurs in humans.

Largely because of the cardiovascular stimulation associated with the sympathomimetic amines, attention has been focused on noncatecholamine alternatives for vasoconstriction. Of these, several analogues of the antidiuretic hormone vasopressin have proved suitable, and one, felypressin (2-phenylalanine-8-lysine vasopressin), is used in Europe and elsewhere as a vasoconstrictor for local anesthesia. Although felypressin is not as effective as epinephrine and cannot be relied on for surgical hemostasis, it avoids the drug interaction problems of the catecholamines. Local toxicity is also reduced because felypressin does not stimulate tissue oxygen consumption. Local anesthetics with felypressin are unavailable in the United States.

GENERAL THERAPEUTIC USES

Local anesthetics are widely used for pain relief. By obviating the necessity of general anesthesia, these drugs have been instrumental in reducing the mortality and morbidity associated with various operative procedures. They also render valuable service by obviating the pain of sunburn, toothache, and other ailments. In addition, local anesthetics are increasingly being used for purposes unrelated to pain control.

Techniques of Anesthesia

The onset, quality, extent, and duration of local anesthesia vary markedly with the technique of administration used. As might be expected, no single agent is capable of performing all the clinical duties local anesthetics are expected to fulfill.

Surface application

Local anesthetics are prepared for topical use in several different forms. Aqueous solutions and sprays are especially suited for coverage of large surfaces; anesthesia of small areas is often best accomplished with an ointment or viscous gel. Although penetration of the intact epidermis is insignificant, uptake by injured skin or by mucous membranes can be rapid. Topical activities are often not related to efficacies determined for other administration sites; tetracaine and lidocaine are useful topically as single agents, whereas mepivacaine, prilocaine, and procaine are not. Benzocaine, ineffective parenterally, is well adapted for surface anesthesia because of its slow systemic absorption and relative safety.

Infiltration, field block, and nerve block

Inhibition of transmission in circumscribed portions of the peripheral nervous system is accomplished by the techniques of infiltration, field block, and nerve block. Infiltration anesthesia is performed by injecting a local anesthetic into the area to be anesthetized. In this manner, the nerve endings exposed to the anesthetic solution are quickly made unresponsive. Field block refers to the subcutaneous or submucosal injection of anesthetic agents where the extent of anesthesia extends distal to the tissues infiltrated with drug. In dentistry, anesthesia of the tooth pulp after supraperiosteal injection is a form of field block because the local anesthetic does not gain access to the pulp but nevertheless renders it insensitive to stimulation. Nerve block is produced by depositing a local anesthetic solution close to the appropriate nerve trunk but proximal to the intended area of anesthesia. After a certain latency period required for penetration of the local anesthetic into the nerve interior, sensations are lost in all tissues innervated by the distal portion of the affected nerve. Although infiltrations, field blocks, and single nerve blocks usually anesthetize discrete areas, compound injections (e.g., brachial plexus or sciatic-femoral blocks) may affect large segments of the body, including whole limbs. All of the many local anesthetics suitable for infiltration are also useful for field and nerve blocks.

Spinal anesthesia

Deposition of a local anesthetic solution in the subarachnoid space can be used to produce surgical anesthesia in all structures of the body below the diaphragm. Injection is ordinarily made inferior to the first lumbar vertebra to avoid possible injury to the spinal cord. When introduced, the drug mixes with the cerebrospinal fluid and begins to spread throughout the subarachnoid space. The extent of cephalad diffusion of the local anesthetic, and the level of anesthesia obtained, is governed by several factors, including the dose, specific gravity (baricity), and volume of local anesthetic solution administered; the size and position of the spinal canal; and the degree of cerebrospinal fluid mixing imposed by the rate of injection

and by movements of the patient. Tetracaine, lidocaine, and bupivacaine are most commonly used for spinal anesthesia in the United States, but numerous other agents are also used.

Epidural block

Local anesthetic infusion into the potential space between the dura mater and the connective tissue lining of the vertebral canal provides an effective alternative to subarachnoid anesthesia. Patient resistance to epidural injection is less of a problem, and the neurologic difficulties sometimes encountered after spinal block are avoided. Epidural anesthesia is comparatively slow in onset, however, and requires considerably more total drug than its subarachnoid counterpart. The level of anesthesia is also less predictable and more difficult to control. Bupivacaine, ropivacaine, and lidocaine are especially popular for epidural anesthesia, but virtually any local anesthetic available for nerve blockade may be used.

Intravascular injection

Local anesthetics are sometimes introduced directly into a blood vessel to effect short-term regional analgesia. One popular technique consists of injecting an anesthetic solution (e.g., 0.5% lidocaine) intravenously into a limb previously exsanguinated by elevation or with an Esmarch bandage. Isolation of the local anesthetic solution from the systemic circulation is accomplished by placing a pneumatic tourniquet proximal to the injection site. Egress of the local anesthetic from the vascular compartment to peripheral tissues is so rapid that releasing the tourniquet 5 minutes after injection does not result in toxic blood concentrations. Other techniques that use intravascular local anesthetics have also occasionally been practiced. Lidocaine may be mixed with drugs known to be irritating in an attempt to alleviate the pain associated with their intravascular injection.

Treatment of Cardiac Arrhythmias

Lidocaine, procainamide (the amide congener of procaine), and several local anesthetic-like drugs (e.g., flecainide and mexiletine) have established roles in the therapeutic management of cardiac arrhythmias, especially of ventricular origin. The antiarrhythmic properties of these agents are discussed in Chapter 24.

Other Uses

Local anesthetics are sometimes administered intravenously to produce or to supplement general anesthesia. As an adjunctive agent, lidocaine has been used to prevent postoperative muscle pain caused by succinylcholine and to depress airway reflexes and sympathetic nervous system responses during endotracheal intubation and extubation and other procedures affecting the bronchial tree. Local anesthetics have also been used, with mixed success, to treat protracted cough and laryngospasm and as intravenous analgesic and anticonvulsant medications. An adhesive patch containing 5% lidocaine is approved for relief of postherpetic neuralgia. Finally, the anti-inflammatory effect of lidocaine has been used to manage postoperative paralytic ileus.

USES IN DENTISTRY

It would be difficult to overstate the profound influence of local anesthesia on the practice of dentistry. Most of the complex restorative procedures routinely performed on conscious patients would be inconceivable without effective pain control. By eliminating nociceptive sensations associated with dental care, local anesthetics improve patient acceptance of dental treatment and thereby contribute significantly to oral

health. Because local anesthetics are so frequently used and, for many practitioners, represent the only drugs administered parenterally, the toxicity and efficacy of these agents is of particular interest and concern.

Safety in Dentistry

Without question, local anesthesia is often considerably safer in dentistry than in medicine. Dosages used for injection in the oral cavity are often less than one tenth the dosages used for compound nerve block or for epidural injection. Recipients of dental anesthesia are usually in better systemic health than some medical patients requiring surgery and usually undergo only minor operative stress. Nevertheless, reports occasionally appear describing instances of death from local anesthesia in dental practice.

Statistics related to local anesthetic toxicity in dentistry are meager and subject to error. Mortality figures range from 1 death in 1.4 million local anesthetic administrations⁷⁴ to 1 in 45 million.⁷⁵ These values are open to question. It is possible that some deaths from local anesthetics go unreported and that others are mistakenly identified as myocardial infarctions or cerebrovascular accidents. It is also quite likely that some deaths imputed to local anesthetics are caused by procedural stress or are merely accidents of time and place and are not causally related to drug administration at all. Tabulations of nonfatal adverse reactions directly attributable to local anesthetics in clinical practice are limited; however, Persson⁶⁵ recorded adverse effects in 2.5% of 2960 patients given one to two cartridges of various anesthetic agents. Because most of the complications observed—pallor, unrest, sweating, fatigue, palpitation, nausea, and fainting—are common manifestations of acute anxiety, it is evident that many adverse effects ascribed to local anesthesia are actually generated by the process of injection and not by the drugs themselves.

Most nonpsychogenic systemic reactions in adult patients probably arise from accidental intravascular injections. In view of the small amount of local anesthetic (e.g., <100 mg of lidocaine) routinely administered for most procedures, toxic overdosage seems unlikely; allergic responses are also considered rare, particularly with the amide drugs in current use. Aspiration tests indicate that the needle is placed inside a blood vessel in approximately 3% of all injections and much more frequently during blockade of the inferior alveolar and posterior superior alveolar nerves. Negative aspiration does not guarantee that the needle lumen is outside the vessel; using inadequate force or time for aspiration, or placing the lumen against a vessel's intimal lining, can prevent blood from entering the anesthetic cartridge.

In view of the fact that lidocaine is routinely given intravenously in quantities that exceed the amount in a dental cartridge without producing toxic manifestations in cardiac patients, it was proposed that local anesthetics injected intrarterially within the oral cavity may gain direct access to the CNS by passing regressively down the branches and trunk of the external carotid artery and into the internal carotid artery.³ This hypothesis would seem to account for adverse reactions associated with small amounts of drug, but studies in rats have shown that internal carotid injections are less toxic than intravenous administrations.⁹¹ The explanation for this finding is that the circle of Willis is not patent physiologically in the normal brain, precluding drug entry into the medulla where it can depress respiration. It is possible that toxic reactions in dentistry might occur only in patients with an abnormal cerebral circulation, but a more plausible explanation is that intravenous injection of even the small amounts of drug in a single dental cartridge can cause adverse responses in sensitive individuals, particularly if the drug is given rapidly, and a vasoconstrictor is present in the solution.

Notwithstanding the previous discussion, there are two situations in which the chances for toxic overdose are of concern: local anesthesia in small children and administration of large doses during deep sedation or light general anesthesia. Maximum dosage limits are quickly reached in young patients. The injection of two cartridges of 3% mepivacaine exceeds the maximum recommended dose for a 15-kg child, and inattention to such limits has needlessly resulted in fatalities.^{11,43} The combination of CNS depression, possible respiratory acidosis, and a tendency to perform dental procedures in multiple quadrants increases the risk of systemic toxicity in adults and children receiving sedation or anesthesia. When overdoses of sedative, analgesic, and local anesthetic agents are given together, fatal outcomes may be expected.³⁸

Drug Selection

Selection of a local anesthetic for dental application must include considerations of efficiency, safety, and individual patient and operative needs. That such factors are difficult to evaluate is illustrated by the diversity of results obtained in various clinical trials. One of the few areas of agreement is that the introduction of the amide lidocaine in 1948 marked a significant advance over the ester preparations then available. For routine use, 2% lidocaine hydrochloride with 1:100,000 epinephrine remains a standard dental anesthetic.

Besides lidocaine, four additional amides are available in dental cartridges that possess similar advantages in stability, nonallergenicity, and efficacy over the ester agents (see Table 16-2). Mepivacaine, introduced in 1957, is generally equivalent to lidocaine in its pharmacologic profile. Two distinctive features of mepivacaine are its topical ineffectiveness and its use as a 3% solution without a vasoconstrictor. Prilocaine, used clinically for the first time in 1960, is a less potent and less toxic alternative to lidocaine. Similar to mepivacaine, it is not used topically as a single agent but is effective for dental application without epinephrine.

Articaine, the only thiophene-based amide local anesthetic, was first tested in humans in 1970 and is now available for dental use in the United States, Canada, and Europe. An issue of current interest is whether the marketed formulations of 4% articaine with 1:100,000 or 1:200,000 epinephrine are equivalent or superior to other amide preparations. Although properly controlled clinical trials have not generally shown increased efficacy with standard injections, many dentists believe articaine increases the likelihood of obtaining adequate pain relief in cases in which other agents have failed.^{39,54} More recently, several studies have indicated clinical superiority of articaine over lidocaine (both with epinephrine) when injected supraperiosteally for mandibular anesthesia.^{41,71}

Bupivacaine was used initially in 1963 but not marketed in a dental cartridge until 1983. It exhibits a slightly slower onset time than the other amides but is similarly efficacious after nerve block and has a much longer duration of action, making it well suited for providing postoperative pain relief in oral surgery. The bupivacaine preparation intended for dental use is a 0.5% solution with 1:200,000 epinephrine.

One significant dissimilarity among the amide preparations concerns the presence or absence of a vasoconstrictor additive. Local anesthetic formulations without epinephrine-like drugs are particularly useful when sympathomimetic amines are contraindicated. Plain solutions are additionally promoted on the basis of a shorter duration of action. Although soft tissue anesthesia is comparatively brief after maxillary injection with 3% mepivacaine or 4% prilocaine (both without vasoconstrictor), differences in duration after mandibular nerve block are trivial (see Table 16-2). Because the period of pulpal anesthesia is often 20% to 25% that of soft tissue anesthesia, the limited maxillary duration of these agents is sometimes disadvantageous. For restorative procedures aver-

aging 25 minutes in length, 4% prilocaine, which compares favorably with 2% lidocaine with epinephrine in onset and depth of anesthesia, fails approximately one fifth of the time to provide adequate pain relief toward the end of the procedure.¹⁷

The use of local anesthetics without vasoconstrictors in pediatric dentistry warrants special comment. It is sometimes said that the shorter duration of soft tissue symptoms with plain local anesthetic solutions should reduce the incidence of self-inflicted tongue, cheek, and lip trauma. Such claims are dubious because blockade of the lingual, inferior alveolar, and buccal nerves that supply most of the tissues at risk is not significantly shortened by these preparations. No studies relating a reduction in traumatic cheilitis to the use of plain solutions have been reported. Consideration of systemic toxicity should limit the pediatric dental use of local anesthetics without vasoconstrictors.²³ Because the safety margin of local anesthetics is quite low in small children, it is advisable to use a preparation containing a vasoconstrictor if not doing so would result in more total drug being administered. Injection of phentolamine may be a superior alternative strategy to reducing the incidence of accidental soft tissue injury (see Chapter 7).

Other than amide compounds being advocated over esters, it is difficult to suggest a particular local anesthetic for routine dental application. If a proposed treatment requires a considerable volume of drug or necessitates a prolonged operation, formulations such as lidocaine with epinephrine are indicated. Small volumes of lidocaine with 1:50,000 epinephrine can be advantageous when surgical hemostasis is desired. Articaine with epinephrine may be considered for situations in which the drug's short plasma half-life and possible increased efficacy may prove advantageous. Bupivacaine with epinephrine would be a good choice for nerve block if a truly extended effect is desired. A plain local anesthetic solution might be more appropriate, however, for short procedures involving the maxillary arch.

When special patient factors or operative needs are not present, drug selection is best founded on the respective anesthetic efficacies and potential toxicities of the agents available. Because no local anesthetic preparation has emerged that is definitely superior to the rest in affording pain relief, use of any particular drug should be dictated largely by its relative likelihood of avoiding untoward responses. Estimates of systemic toxicity of local anesthetics as used in dentistry have not been published. Accepting that serious adverse reactions in most patients are caused by intravascular injections, one could predict by considering just the local anesthetic moieties involved that a 3% mepivacaine solution would be 50% more toxic than an equal volume of 2% mepivacaine with levonordefrin.²³ As described previously, however, some evidence suggests that sympathomimetic amines may potentiate the intravascular toxicity of concomitantly administered local anesthetics, making conclusions at this point impossible. Until definitive information about the intravascular toxic potentials of the various local anesthetic formulations becomes available, the recommendation of any single preparation for general use over all the others cannot be made.

PREPARATIONS AND DOSAGE

Agents for Parenteral Administration

Local anesthetics intended for injection within the oral cavity are supplied in 1.7-mL and 1.8-mL single-dose cartridges. (These differences largely relate to changed regulations by the FDA for reporting cartridge volume, not to true volume disparities. It is safest to assume a volume of 1.8 mL for dosage calculation purposes.) Pyrogen-free distilled water with

sodium chloride added for osmotic balance serves as the local anesthetic vehicle. Local anesthetic solutions in cartridges range in pH from less than 3.0 to greater than 6.0; preparations with vasoconstrictors are adjusted to a lower pH than are plain formulations to enhance stability of the sympathomimetic amine constituents. Citric acid and sodium metabisulfite (or an equivalent antioxidant) are also included to help prevent vasoconstrictor breakdown. (Oxidation of the catecholamine compounds produces acids that tend to lower the pH over time.) Some local anesthetics contain methylparaben. Useful for its antimicrobial action in multidose vials, methylparaben serves no purpose in dental cartridges and has been omitted. Currently available local anesthetics marketed for dentistry in the United States and Canada are discussed next.

Lidocaine hydrochloride

Lidocaine is an aminoethylamide derivative of xylylidine. It is several times more potent and toxic than procaine and provides local anesthesia that is by comparison more prompt, more extensive, and longer lasting. The administration of 2% lidocaine hydrochloride with 1:100,000 epinephrine is most suitable for routine dental use, but the drug is also available as a plain solution and with 1:50,000 epinephrine. Although 2% lidocaine with vasoconstrictor provides satisfactory dental anesthesia in normal circumstances, it has sometimes proved ineffective in rendering extremely sensitive teeth completely pain-free. A concentrated solution of 5% lidocaine with 1:80,000 epinephrine has been shown to produce effective anesthesia in most instances when conventional local anesthetic preparations have failed.³² Lidocaine is the only amide marketed as a single agent for topical anesthesia in dentistry. Formulations of lidocaine hydrochloride include a 2% gel, a 2% viscous solution, a 4% solution, and in Canada a 10% topical spray. Lidocaine base is marketed in a 2.5% and 5% ointment and solution and a 10% aerosol spray. A mucosal adherent patch 2 cm long × 1 cm wide and containing 46.1 mg of lidocaine is also available.

Mepivacaine hydrochloride

Mepivacaine is an amide product of xylylidine and N-methyl-pipecolic acid. Similar in many respects to lidocaine, mepivacaine hydrochloride is marketed in a 2% concentration with 1:20,000 levonordefrin and as a 3% solution without vasoconstrictor. In contrast to some ester local anesthetics, cross-allergenicity is rare between mepivacaine and related agents.

Prilocaine hydrochloride

In contrast to other amide anesthetics, prilocaine is a secondary amino derivative of toluidine. Less potent than lidocaine, prilocaine hydrochloride is marketed as a 4% solution with and without 1:200,000 epinephrine. Because the systemic toxicity of prilocaine is approximately half that of lidocaine, toxic effects on a milliliter basis are essentially equal. Instances of cyanosis observed after large doses of prilocaine (>400 mg) result from its metabolic breakdown to *o*-toluidine, an inducer of methemoglobinemia. Prilocaine has also been associated with a greater incidence of nerve damage after inferior alveolar nerve block injections than seen with lidocaine or mepivacaine.

Articaine hydrochloride

Articaine is unique among the amides because it is based on a thiophene ring structure. Marketed in North America in a 4% concentration with 1:100,000 or 1:200,000 epinephrine, articaine has become a popular agent for routine use in dentistry. The rapid hydrolysis of the ester side chain helps reduce toxicity associated with slow absorption from the injection site; conversely, the high concentration of the agent may accentuate the danger of intravascular injection and the risk

of nerve damage in the immediate area of injection, especially affecting the lingual and inferior alveolar nerves after inferior alveolar nerve blocks.

Bupivacaine hydrochloride

Bupivacaine is a homologue of mepivacaine rendered highly lipid-soluble by replacement of the N-methyl group with a butyl chain. Bupivacaine is approximately four times as potent and as toxic as mepivacaine; it also has a slightly higher pK_a and a slower onset of action. For dentistry, 0.5% bupivacaine hydrochloride is available with 1:200,000 epinephrine. Bupivacaine with epinephrine given for nerve block produces operative anesthesia several times longer than that afforded by other drugs. Additionally, the formulation provides post-operative analgesia averaging 8 hours in the mandible and 5 hours in the maxilla. Bupivacaine is less effective and shorter acting than lidocaine (both with epinephrine), however, for pulpal anesthesia after maxillary supraperiosteal injection. Bupivacaine is so lipid-soluble that the agent is largely absorbed by the mucosal tissues, leaving little free drug to diffuse into bone.

Ropivacaine hydrochloride

In contrast to the previous agents, ropivacaine is currently unavailable in dental cartridge form. Ropivacaine is a derivative of mepivacaine in which a propyl chain replaces the N-methyl moiety. The formulation is unusual in that only the S-enantiomer is present (mepivacaine is a racemic mixture), which is thought to reduce cardiac toxicity. In dentistry, 0.75% ropivacaine has been shown to produce long-lasting local anesthesia after inferior alveolar nerve block.^{8,33} Ropivacaine may be useful when vasoconstrictors are contraindicated and a longer duration of action than that produced by 3% mepivacaine is desired.

Agents Limited to Surface Application

Topical anesthetics are used in the oral cavity for various purposes. Formulations marketed as pressurized sprays produce widespread surface anesthesia appropriate for making impressions or intraoral radiographs. Such preparations are potentially hazardous, however, and only products with metered valve dispensers to help prevent inadvertent overdose should be used. Topical liquids, which avoid the possibility of aerosol inspiration, may also be used for anesthetic coverage of large surface areas. Nonaqueous topical preparations are suitable for most other procedures. Common local anesthetic vehicles include lanolin, petrolatum, sodium carboxymethylcellulose, and polyethylene glycol.

Benzocaine

Benzocaine is a derivative of procaine in which the amino terminus is lacking. Poorly soluble in aqueous fluid, benzocaine tends to remain at the site of application and is not readily absorbed into the systemic circulation. Because of its low toxic potential, benzocaine is especially useful for anesthesia of large surface areas within the oral cavity. Benzocaine is not totally innocuous, however; cases of methemoglobinemia have been reported after the administration of very large doses, especially in unmeasured spray form. Benzocaine is available in a variety of preparations; a 20% concentration in the form of an aerosol spray, gel, ointment, paste, and solution is most commonly advocated for intraoral use. A mucosal gel patch (containing 36 mg per 2 cm long × 1 cm wide patch) is also available.

Tetracaine hydrochloride

Tetracaine is an ester derivative of *p*-aminobenzoic acid in which a butyl chain replaces one of the hydrogens on the *p*-

amino group. The drug has approximately 10 times the toxicity and potency of procaine. It is no longer available for injection in dentistry; for surface application it is most commonly marketed as a 2% hydrochloride salt in combination with 14% benzocaine and 2% butamben in an aerosol spray, solution, gel, and ointment under the proprietary name Cetacaine. Tetracaine is one of the most effective topical anesthetics, but the drug's toxic potential after surface application should dictate caution in its use.

Dyclonine hydrochloride

Dyclonine is unusual because it has a ketone linkage between the aromatic moiety and the rest of the anesthetic molecule. Available in lozenge form for topical use, dyclonine hydrochloride is not administered by injection because of its propensity for producing tissue irritation. Dyclonine may be used in patients allergic to derivatives of *p*-aminobenzoic acid.

Chlorobutanol

Chlorobutanol is a weak local anesthetic usually formulated with other agents. The drug is used primarily in obtundent dressings to relieve acute pulpitis and postextraction wound pain.

Cocaine hydrochloride

Cocaine, the first anesthetic used in dentistry and medicine, is a naturally occurring benzoic acid ester. The pharmacologic characteristics of cocaine are unique among the local anesthetics because the drug inhibits the uptake of catecholamines by adrenergic nerve terminals. Cocaine potentiates the action of endogenously released and exogenously administered sympathomimetic amines. As a result, cocaine may cause pupillary mydriasis, vascular constriction, and other manifestations of sympathetic nervous system activity. Cocaine is also a powerful CNS stimulant and a popular drug of abuse (see Chapter 51). Restricted to therapeutic applications in which its vasoconstricting property is of special benefit (as in intranasal surgery), cocaine has no place in the routine practice of dentistry.

Lidocaine/prilocaine

Marketed under the acronym of EMLA, a eutectic mixture of 2.5% lidocaine and 2.5% prilocaine is available in the form of a cream for topical anesthesia of the skin. When placed under an occlusive dressing for 1 hour, EMLA obtunds the pain of venipuncture and is useful in young children and other patients intolerant of needle insertion. Although this formulation is not intended for topical anesthesia of the oral cavity (it has a poor taste and unfavorable physical characteristics for intraoral use), several investigations have proved its superiority over other topical anesthetics in relieving pain associated with manipulation of oral tissues. EMLA significantly relieved the discomfort of palatal injections after a 5-minute application⁸³ and allowed deeper probing of the gingival sulcus without discomfort than did 5% topical lidocaine.³¹

An intraoral preparation with the same active ingredients of EMLA has been marketed with the trade name of Oraqix. A low-viscosity fluid at room temperature, the anesthetic mixture becomes an elastic gel after being applied to the gingival sulcus to provide local anesthesia for periodontal scaling and root planing.³⁶ The packaging of Oraqix is intended to avoid the possibility of administering the drug by parenteral injection. The overall effect is a 50% reduction of treatment pain.⁵³

Compound topical anesthetics

In recent years, topical anesthetic preparations have been made and sold by various compounding pharmacies across the United States, often through the Internet.⁵¹ A typical example

is TAC 20 percent Alternate, which contains 20% lidocaine, 4% tetracaine, and 2% phenylephrine. Although such products offer the possibility of improved efficacy over existing formulations (because of their concentrated strengths of multiple agents), they have not been approved by the FDA—which deems them to be illegal—and have not been rigorously tested for safety, efficacy, or stability. Several deaths have occurred with some formulations, and it seems a prudent course is to avoid them generally until regulatory approval is obtained.

LOCAL ANESTHETICS

Nonproprietary (generic) name	Proprietary (trade) name
Agents for parenteral administration	
Articaine	Septocaine, Astracaine,* Astracaine Forte,* Septanest,* Septanest SP,* Ultracaine D-S,* Ultracaine Forte D-S,* Zorcaine
Bupivacaine	Marcaine, Sensorcaine, Vivacaine
Chloroprocaine	Nesacaine
Etidocaine*	Duranest
Levobupivacaine	Chirocaine
Lidocaine	Xylocaine, Lignospan, Lignospan Forte, Octocaine
Mepivacaine	Carbocaine, Isocaine, Polocaine, Scandonest
Prilocaine	Citanest, Citanest Forte
Procaine	Novocain
Ropivacaine	Naropin
Tetracaine	Pontocaine
Agents limited to surface application	
Benzocaine	Americaine, Gingicaine, Hurricane, Topicale, in Cetacaine
Butamben	Butesin Picrate, in Cetacaine
Cocaine	—
Dibucaine	Nupercainal
Dyclonine	in Sucrets
Lidocaine/prilocaine	EMLA, Oraqix
Pramoxine	Prax, Tronothane
Proparacaine	Alcaine, Ophthaine

*Not currently available in the United States.

CITED REFERENCES

- Adriani J, Naraghi M: The pharmacologic principles of regional pain relief. *Annu Rev Pharmacol Toxicol* 17:223-242, 1977.
- Åkerman B: Effects of felypressin (Octopressin) on the acute toxicity of local anesthetics. *Acta Pharmacol Toxicol* 27:318-330, 1969.
- Aldrete JA, Narang R, Sada T, et al: Reverse carotid blood flow—a possible explanation for some reactions to local anesthetics. *J Am Dent Assoc* 94:1142-1145, 1977.
- Altura BM, Altura BT: Effects of local anesthetics, antihistamines, and glucocorticoids on peripheral blood flow and vascular smooth muscle. *Anesthesiology* 41:197-214, 1974.
- Armstrong CM: Na channel inactivation from open and closed states. *Proc Natl Acad Sci U S A* 103:17991-17996, 2006.
- Armstrong PJ, Morrison LM, Noble D, et al: Effects of I.V. lignocaine on psychological performance and subjective state in healthy volunteers. *Br J Anaesth* 67:532-538, 1992.
- Arora S, Aldrete JA: Investigation of possible allergy to local anesthetic drugs: correlation of intradermal with intramuscular injections. *Anesthesiol Rev* 3:13-16, 1976.
- Axelsson S, Isacson G: The efficacy of ropivacaine as a dental local anesthetic. *Swed Dent J* 28:85-91, 2004.
- Bax NDS, Tucker GT, Lennard MS, et al: The impairment of lignocaine clearance by propranolol—major contribution from enzyme inhibition. *Br J Clin Pharmacol* 19:597-603, 1985.
- Bernards CM, Artu AA: Hexamethonium and midazolam terminate dysrhythmias and hypertension caused by intracerebroventricular bupivacaine in rabbits. *Anesthesiology* 74:89-96, 1991.
- Berquist HC: The danger of mepivacaine 3% toxicity in children. *J Calif Dent Assoc* 3:13, 1975.
- Blair MR: Cardiovascular pharmacology of local anesthetics. *Br J Anaesth* 47:247-252, 1975.
- Boakes AJ, Laurence DR, Teoh PC, et al: Interactions between sympathomimetic amines and antidepressant agents in man. *BMJ* 1:311-315, 1973.
- Bokesch PM, Post C, Strichartz G: Structure-activity relationship of lidocaine homologs producing tonic and frequency-dependent impulse blockade in nerve. *J Pharmacol Exp Ther* 237:773-781, 1986.
- Bokesch PM, Raymond SA, Strichartz G: Dependence of lidocaine potency on pH and PCO₂. *Anesth Analg* 66:9-17, 1987.
- Borg T, Modig J: Potential anti-thrombotic effects of local anesthetics due to their inhibition of platelet aggregation. *Acta Anaesthesiol Scand* 29:739-742, 1985.
- Brown G, Ward NL: Prilocaine and lignocaine plus adrenaline. *Br Dent J* 126:557-562, 1969.
- Butterworth JF IV, Strichartz GR: Molecular mechanisms of local anesthesia: a review. *Anesthesiology* 72:711-734, 1990.
- Catchlove RFH: Potentiation of two different local anesthetics by carbon dioxide. *Br J Anaesth* 45:471-474, 1973.
- Catterall WA: From ionic currents to molecular mechanisms: the structure and function of voltage-gated sodium channels. *Neuron* 26:13-25, 2000.
- Catterall WA: Structure and function of voltage-sensitive ion channels. *Science* 242:50-61, 1988.
- Chaney MA, Kerby R, Reader A, et al: An evaluation of lidocaine hydrocarbonate compared with lidocaine hydrochloride for inferior alveolar nerve block. *Anesth Prog* 38:212-216, 1991.
- Chin KL, Yagiela JA, Quinn CL, et al: Serum mepivacaine concentrations after intraoral injection in young children. *J Calif Dent Assoc* 31:757-764, 2003.
- Clarkson CW, Hondeghem LM: Mechanism for bupivacaine depression of cardiac conduction: fast block of sodium channels during the action potential with slow recovery from block during diastole. *Anesthesiology* 62:396-405, 1985.
- Cotton BR, Henderson HP, Achola KJ, et al: Changes in plasma catecholamine concentrations following infiltration with large volumes of local anaesthetic solution containing adrenaline. *Br J Anaesth* 58:593-597, 1986.
- Covino BG: Local anesthesia. *N Engl J Med* 286:975-983, 1972.
- Covino BG, Vassallo HG: *Local anesthetics—mechanisms of action and clinical use*, New York, 1976, Grune & Stratton.
- Cryer PE: Physiology and pathophysiology of the human sympathoadrenal neuroendocrine system. *N Engl J Med* 303:436-444, 1980.
- de Jong RH, Heavner JE: Local anesthetic seizure prevention: diazepam versus pentobarbital. *Anesthesiology* 36:449-457, 1972.
- deShazo RD, Nelson HS: An approach to the patient with a history of local anesthetic hypersensitivity: experience with 90 patients. *J Allergy Clin Immunol* 63:387-394, 1979.
- Donaldson D, Meehan JG: A comparison of the effects of EMLA cream and topical 5% lidocaine on discomfort during gingival probing. *Anesth Prog* 42:7-10, 1995.
- Eldridge DJ, Rood JP: A double-blind trial of 5 per cent lignocaine. *Br Dent J* 142:129-130, 1977.
- El-Sharawy E, Yagiela JA: Anesthetic efficacy of different ropivacaine concentrations for inferior alveolar nerve block. *Anesth Prog* 53:3-7, 2006.
- Fink BR: Mechanisms of differential axial blockade in epidural and subarachnoid anesthesia. *Anesthesiology* 70:851-858, 1989.

35. Franz DN, Perry RS: Mechanisms for differential block among single myelinated and nonmyelinated axons by procaine. *J Physiol (London)* 236:193-210, 1974.
36. Friskopp J, Nilsson M, Isacson G: The anesthetic onset and duration of a new lidocaine/prilocaine gel intra-pocket anesthetic (Oraqix) for periodontal scaling/root planing. *J Clin Periodontol* 28:453-458, 2001.
37. Garfield JM, Gugino L: Central effects of local anesthetic agents. In Strichartz GR, editor: *Local anesthetics. Handbook of experimental pharmacology*, vol 81, Berlin, 1987, Springer-Verlag.
38. Goodson JM, Moore PA: Life-threatening reactions after pedodontic sedation: an assessment of narcotic, local anesthetic, and antiemetic drug interaction. *J Am Dent Assoc* 107:239-245, 1983.
39. Haas DA, Harper DG, Saso MA, et al: Lack of differential effect by Ultracaine (articaine) and Citanest (prilocaine) in infiltration anesthesia. *J Can Dent Assoc* 57:217-223, 1991.
40. Haas DA, Lennon D: A 21 year retrospective study of reports of paresthesia following local anesthetic administration. *J Can Dent Assoc* 61:319-320, 323-326, 329-330, 1995.
41. Haase A, Reader A, Nusstein J, et al: Comparing anesthetic efficacy of articaine versus lidocaine as a supplemental buccal infiltration of the mandibular first molar after an inferior alveolar nerve block. *J Am Dent Assoc* 139:1228-1235, 2008.
42. Häfner HM, Röcken M, Breuninger H: Epinephrine-supplemented local anesthetics for ear and nose surgery: clinical use without complications in more than 10,000 surgical procedures. *J Dtsch Dermatol Ges* 3:195-199, 2005.
43. Hersh EV, Helpin ML, Evans OB: Local anesthetic mortality: report of case. *ASDC J Dent Child* 58:489-491, 1991.
44. Hille B: Local anesthetics: hydrophilic and hydrophobic pathways for the drug-receptor reaction. *J Gen Physiol* 69:497-515, 1977.
45. Jackson JE, Bentley JB, Glass SJ, et al: Effects of histamine-2 receptor blockade on lidocaine kinetics. *Clin Pharmacol Ther* 37:544-548, 1985.
46. Johnson ME, Saenz JA, DaSilva AD, et al: Effect of local anesthetic on neuronal cytoplasmic calcium and plasma membrane lysis (necrosis) in a cell culture model. *Anesthesiology* 97:1466-1477, 2002.
47. Jorfeldt L, Lewis DH, Löfström JB, et al: Lung uptake of lidocaine in healthy volunteers. *Acta Anaesthesiol Scand* 23:567-574, 1979.
48. Jorfeldt L, Löfström B, Pernow B, et al: The effect of local anaesthetics on the central circulation and respiration in man and dog. *Acta Anaesthesiol Scand* 12:153-169, 1986.
49. Kindler CH, Paul M, Zou H, et al: Amide local anesthetics potently inhibit the human tandem pore domain background K⁺ channel TASK-2 (KCNK5). *J Pharmacol Exp Ther* 306:84-92, 2003.
50. Kozody R, Ready LB, Barsa JE, et al: Dose requirement of local anaesthetic to produce grand mal seizure during stellate ganglion block. *Can Anaesth Soc J* 29:489-491, 1982.
51. Kravitz ND: The use of compound topical anesthetics: a review. *J Am Dent Assoc* 138:1333-1339, 2007.
52. Lee Y, Lee C-H, Oh U: Painful channels in sensory neurons. *Mol Cells* 20:315-324, 2005.
53. Magnusson I, Jeffcoat MK, Donaldson D, et al: Quantification and analysis of pain in nonsurgical scaling and/or root planing. *J Am Dent Assoc* 135:1747-1754, 2004.
54. Malamed SF, Gagnon S, Leblanc D: Efficacy of articaine: a new amide local anesthetic. *J Am Dent Assoc* 131:635-642, 2000.
55. Martin R, Lamarche Y, Têtreault L: Effects of carbon dioxide and epinephrine on serum levels of lidocaine after epidural anaesthesia. *Can Anaesth Soc J* 28:224-227, 1981.
56. McEwen DP, Meadows LS, Chen C, et al: Sodium channel β_1 subunit-mediated modulation of Nav1.2 currents and cell surface density is dependent on interactions with contactin and ankyrin. *J Biol Chem* 279:16044-16049, 2004.
57. McNulty MM, Edgerton GB, Shah RD, et al: Charge at the lidocaine binding site residue Phe-1759 affects permeation in human cardiac voltage-gated sodium channels. *J Physiol* 581(Pt 2):741-755, 2007.
58. Michalowicz BS, DiAngelis AJ, Novak MJ, et al: Examining the safety of dental treatment in pregnant women. *J Am Dent Assoc* 139:685-695, 2008.
59. Mio Y, Fukuda N, Kusakari Y, et al: Bupivacaine attenuates contractility by decreasing sensitivity of myofilaments to Ca²⁺ in rat ventricular muscle. *Anesthesiology* 97:1168-1177, 2002.
60. Mohan PP, Cherian PT: Epinephrine in digital nerve block. *Emerg Med J* 24:789-790, 2007.
61. Munson ES, Wagman IH: Diazepam treatment of local anesthetic-induced seizures. *Anesthesiology* 37:523-528, 1972.
62. Muroi Y, Chanda B: Local anesthetics disrupt energetic coupling between the voltage-sensing segments of a sodium channel. *Anesth Analg* 105:1657-1664, 2008.
63. Neumcke B, Schwarz W, St. Adampfli R: Block of Na channels in the membrane of myelinated nerve by benzocaine. *Pflügers Arch* 390:230-236, 1981.
64. Orlando R, Piccoli P, De Martin S, et al: Effect of the CYP3A4 inhibitor erythromycin on the pharmacokinetics of lignocaine and its pharmacologically active metabolites in subjects with normal and impaired liver function. *Br J Clin Pharmacol* 55:86-93, 2003.
65. Persson G: General side effects of local dental anaesthesia. *Acta Odontol Scand Suppl* 53:1-140, 1969.
66. Prenner BM, Stevens JJ: Anaphylaxis after ingestion of sodium bisulfite. *Ann Allergy* 37:180-182, 1976.
67. Punnia-Moorthy A: Buffering capacity of normal and inflamed tissues following the injection of local anaesthetic solutions. *Br J Anaesth* 61:154-159, 1988.
68. Ragsdale DS, McPhee JC, Scheuer T, et al: Molecular determinants of state-dependent block of Na⁺ channels by local anesthetics. *Science* 265:1724-1728, 1994.
69. Raymond SA, Steffensen SC, Gugino LD, et al: The role of length of nerve exposed to local anesthetics in impulse blocking action. *Anesth Analg* 68:563-570, 1989.
70. Roberts RK, Heath CA, Johnson RF, et al: Effect of H₂-receptor antagonists on steady-state extraction of indocyanine green and lidocaine by the perfused rat liver. *J Lab Clin Med* 107:112-117, 1986.
71. Robertson D, Nusstein J, Reader A, et al: The anesthetic efficacy of articaine in buccal infiltration of mandibular posterior teeth. *J Am Dent Assoc* 138:104-112, 2007.
72. Schwartz HJ, Sher TH: Bisulfite sensitivity manifesting as allergy to local dental anesthesia. *J Allergy Clin Immunol* 75:525-527, 1985.
73. Scurlock JE, Meymaris E, Gregus J: The clinical character of local anesthetics: a function of frequency-dependent conduction block. *Acta Anaesthesiol Scand* 22:601-608, 1978.
74. Seldin HM: Survey of anesthetic fatalities in oral surgery and a review of the etiological factors in anesthetic deaths. *J Am Dent Soc Anesthesiol* 5:5-12, 1958.
75. Seldin HM, Recant BS: The safety of anesthesia in the dental office. *J Oral Surg* 13:199-208, 1955.
76. Seo N, Oshima E, Stevens J, et al: The tetraphasic action of lidocaine on CNS electrical activity and behavior in cats. *Anesthesiology* 57:451-457, 1982.
77. Sheets MF, Hanck DA: Outward stabilization of the S4 segments in domains III and IV enhances lidocaine block of sodium channels. *J Physiol* 582(Pt 2):317-334, 2007.
78. Simon MA, Vree TB, Gielen MJ, et al: Similar motor block effects with different disposition kinetics between lidocaine and (+ or -) articaine in patients undergoing axillary brachial plexus block during day case surgery. *Int J Clin Pharmacol Ther* 37:598-607, 1999.
79. Sinclair CJ, Scott DB: Comparison of bupivacaine and etidocaine in extradural blockade. *Br J Anaesth* 56:147-153, 1984.
80. Smith RF, Wharton GG, Kurtz SL, et al: Behavioral effects of mid-pregnancy administration of lidocaine and mepivacaine in the rat. *Neurobehav Toxicol Teratol* 8:61-68, 1986.
81. Special Committee of the New York Heart Association, Inc: Use of epinephrine in connection with procaine in dental procedures. *J Am Dent Assoc* 50:108, 1955.
82. Strong JM, Parker M, Atkinson AJ: Identification of glycinexylidide in patients treated with intravenous lidocaine. *Clin Pharmacol Ther* 14:67-72, 1973.
83. Svensson P, Petersen JK: Anesthetic effect of EMLA occluded with orahesive oral bandages on oral mucosa: a placebo-controlled study. *Anesth Prog* 39:79-82, 1992.
84. Taheri S, Cogswell LP III, Gent A, et al: Hydrophobic and ionic factors in the binding of local anesthetics to the major variant of

- human α_1 -acid glycoprotein. *J Pharmacol Exp Ther* 304:71-80, 2003.
85. Troullos ES, Goldstein DS, Hargreaves KM, et al: Plasma epinephrine levels and cardiovascular response to high administered doses of epinephrine contained in local anesthesia. *Anesth Prog* 34:10-13, 1987.
 86. Trudell JR: A unitary theory of anesthesia based on lateral phase separations in nerve membranes. *Anesthesiology* 46:5-10, 1977.
 87. Volpi M, Sha'afi RI, Epstein PM, et al: Local anesthetics, mepacrine, and propranolol are antagonists of calmodulin. *Proc Natl Acad Sci U S A* 78:795-799, 1981.
 88. Wang GK: Binding affinity and stereoselectivity of local anesthetics in single batrachotoxin-activated Na^+ channels. *J Gen Physiol* 96:1105-1127, 1990.
 89. Wang JS, Backman JT, Taavitsainen P, et al: Involvement of CYP1A2 and CYP3A4 in lidocaine N-deethylation and 3-hydroxylation in humans. *Drug Metab Dispos* 28:959-965, 2000.
 90. Wingard DW, Bobko S: Failure of lidocaine to trigger porcine malignant hyperthermia. *Anesth Analg* 58:99-103, 1979.
 91. Yagiela JA: Intravascular lidocaine toxicity: influence of epinephrine and route of administration. *Anesth Prog* 32:57-61, 1985.
 92. Yagiela JA: Vasoconstrictors: their role in local anesthetic toxicity. *J Jpn Dent Soc Anesthesiol* 21:261-278, 1993.
 93. Yagiela JA, Benoit PW, Buoncristiani RD, et al: Comparison of myotoxic effects of lidocaine with epinephrine in rats and humans. *Anesth Analg* 60:471-480, 1981.
 94. Yarov-Yarovsky V, McPhee JC, Idsvoog D, et al: Roles of amino acid residues in transmembrane segments IS6 and IIS6 of the Na^+ channel α subunit in voltage-dependent gating and drug block. *J Biol Chem* 277:35393-35401, 2002.

GENERAL REFERENCES

- Berde CB, Strichartz GR: Local anesthetics. In Miller RD, editor: *Miller's anesthesia*, ed 6, Philadelphia, 2005, Churchill Livingstone.
- Cousins MJ, Bridenbaugh PO, Carr DB, et al, editors: *Cousins and Bridenbaugh's neural blockade in clinical anesthesia and pain medicine*, ed 4, Philadelphia, 2008, Lippincott Williams & Wilkins.
- Covino BG, Vassallo HG: *Local anesthetics—mechanisms of action and clinical use*, New York, 1976, Grune & Stratton.
- Liu SS, Joseph RS Jr: Local anesthetics. In Barash PG, Cullen BF, Stoelting RK, editors: *Clinical anesthesia*, ed 5, Philadelphia, 2006, Lippincott Williams & Wilkins.
- Strichartz GR, editor: Local anesthetics. *Handbook of experimental pharmacology*, vol 81, Berlin, 1987, Springer-Verlag.

Principles of General Anesthesia

JOHN A. YAGIELA AND DANIEL A. HAAS

HISTORY

The pioneering use of anesthetics is credited to two dentists: Horace Wells and his one-time pupil and partner, William T.G. Morton, who practiced dentistry in New England in the early 1800s. Their achievements were preceded by the contributions of many others and came at a time when still others were carrying out experiments that would lead them to compete for recognition as the discoverers of anesthesia.

The history of anesthesia is no doubt as old as humankind itself, for surely since the dawn of time people have sought ways to alleviate pain. Records spanning thousands of years make it clear that patients about to undergo painful procedures have sought recourse in prayer; magic; the intervention of witch doctors and medicine men; techniques such as compression of nerves and blood vessels; and various plant products such as opium, mandragora, and coca. Modern anesthesiology had its beginnings in the eighteenth and early nineteenth centuries. The development of physics and chemistry led to the discovery of elements and simple molecules, including numerous gases. Joseph Priestley, an English scientist, is credited with the discovery of carbon dioxide, oxygen, and, in 1772, nitrous oxide. Although he thought oxygen might have some medical use, Priestley was unaware of the anesthetic properties of nitrous oxide. In 1795, Humphry Davy, a 17-year-old surgeon's assistant in England who later became a distinguished scientist himself, began experiments with nitrous oxide. He inhaled the gas and used it on one occasion to relieve the pain of his erupting third molar (although at this time nitrous oxide was still considered to be extremely poisonous). He noted in his published studies of nitrous oxide the giddiness, pleasurable sensations, relaxation of muscles, and diminution of pain that were produced by inhalation of the gas. In 1799, Davy constructed the first machine for the storage and inhalation of nitrous oxide.

The development of anesthesia was carried further by Michael Faraday, Davy's student, who in 1818 noted the anesthetic properties of diethyl ether (then known as "sweet vitriol"), and by Henry Hills Hickman, an English surgeon who carried out painless surgery on laboratory animals with carbon dioxide gas as the anesthetic. In 1824, Hickman published a pamphlet, "A Letter on Suspended Animation," in which he suggested that patients could be made unconscious before surgery.

In the United States in the early 1800s, there was scientific and popular interest in ether and nitrous oxide. Itinerant entertainers who called themselves professors went about delivering lectures on these substances and demonstrating their effects. One of the earliest of these demonstrations was

conducted in 1824 by Joseph Dorfeuille, a museum director from Cincinnati, who gave nitrous oxide to a dozen spectators. "Laughing gas" parties and "ether frolics" became common among medical students; because of his experiences at such an ether party, William E. Clarke, one such medical student, administered ether from a towel to a young woman having a tooth extracted in Rochester, New York. This use of ether in 1842 is the first on record.

Crawford W. Long, a Georgia physician who had been trained at the University of Pennsylvania Medical School, had attended ether frolics while a student, and, later in 1842, he used ether when he removed two small tumors from the neck of James Venable, a friend who had previously experienced the effects of inhaling ether. Credit for the first use of ether in a nondental procedure belongs to Dr. Long. His anesthetic fee, also the first on record, was \$2. Because Long wanted to include observations of the effects of ether in major surgical procedures, he did not publish reports of his pioneering use of ether until 1849, 3 years after the accounts of Morton's use of ether had appeared. A letter from Long written in 1844 suggests that he was visited by a dentist and a surgeon from Boston, that the dentist was Morton or Wells, and that it was from Long that they learned the technique of administering ether during surgery.

On December 10, 1844, Horace Wells attended a demonstration, staged by Gardner Quincy Colton in Hartford, Connecticut, of the effects of "laughing gas." One subject who volunteered to take the gas injured himself in the leg. Wells noticed that he was unaware of his injury and apparently had no pain until the effects of the gas wore off. The next day, Wells persuaded John Riggs, a prominent Hartford dentist, to remove one of his own teeth while under nitrous oxide anesthesia administered by "Professor" Colton. Wells claimed that he felt no more than a pinprick. Wells then obtained permission to demonstrate his technique before a class at the Harvard Medical School and administered nitrous oxide to a student, who proceeded to scream loudly while his tooth was being removed. The boy later said he had felt no pain. Discouraged by the apparent failure of his demonstration and by the hostile reception that followed, Wells became ill and was unable to practice dentistry on a regular basis. He nevertheless continued to administer nitrous oxide, with mixed success, for dental and medical operations. Wells also experimented with ether in 1845 and with chloroform when its anesthetic effect became known (in November 1847). Wells died in January 1848 when he became deranged by overexposure to chloroform and committed suicide while in jail for having accosted a prostitute. Nitrous oxide was abandoned after his death until 1863, when Colton reintroduced its use for dental extractions.

William T.G. Morton of Boston, a former student and partner of Wells, had begun to use ether topically for its local numbing effect on his dental patients. With the help of his chemistry professor at Harvard, Charles T. Jackson, Morton refined his technique and successfully administered anesthesia to a patient for the extraction of a molar tooth. Convinced of the importance of his discovery, he obtained an invitation to demonstrate his technique for John C. Warren, a surgeon at Massachusetts General Hospital. On October 16, 1846, Morton prepared a young patient for the surgical removal of a large mandibular tumor. Morton is credited with the discovery of anesthesia and the custom of saying, "Doctor, your patient is now ready."

Morton was anxious to patent the substance he called "Letheon," but several physicians from the Massachusetts General Hospital thought it unsuitable to patent a medical discovery and indicated that they would not continue to use it if its chemical nature remained a secret. Morton then offered to make known the nature of the substance and to serve as an anesthetist at various hospitals. He abandoned his medical studies and his dental practice and became the first professional anesthetist. In 1846, Holmes addressed a letter to Morton suggesting that the term *anesthesia* be given to the state produced by ether and that the agent itself be called an *anesthetic*.

After Morton's demonstration in Boston, the use of anesthesia spread rapidly despite opposition from various groups, many of whom still believed that there was something spiritually ennobling about pain, particularly the pain of childbirth. In 1847, James Young Simpson first used ether in his obstetric practice and in the same year successfully delivered a child using chloroform. Later, when Queen Victoria delivered her seventh child while under chloroform anesthesia, most ecclesiastic opposition was stilled.

No new anesthetic agents were added until the 1920s and 1930s, when ethylene, cyclopropane, and divinyl ether were introduced. Since the early 1950s, a series of halogenated agents containing fluorine have been introduced clinically and have essentially replaced other inhalation agents except nitrous oxide.

Intravenous agents, mainly the thiobarbiturates (e.g., thiopental), became popular in the late 1930s. Other ultra-short-acting barbiturates were added to the list and were supplemented in the late 1960s by ketamine and the neuroleptanalgesic combination of droperidol-fentanyl. Additional newer intravenous anesthetics include etomidate, midazolam, and propofol.

Neuromuscular blocking drugs were added to the practice of anesthesia in 1942 with the introduction of curare to facilitate endotracheal intubation and relaxation of muscles for abdominal surgery. Opioid anesthesia, in which morphine and subsequently fentanyl and its congeners found use as principal agents in obtunding autonomic responses to surgical stimulation, originated with cardiac surgery in the late 1950s. Dexmedetomidine, a centrally acting α_2 -adrenergic receptor agonist related pharmacologically to clonidine, represents yet another approach to providing sedation and analgesia during operative procedures.

Finally, the use of nitrous oxide by dentists has exhibited a cyclic pattern of popularity every 25 to 30 years since Wells first used it. Nitrous oxide is currently enjoying an extended fifth cycle as a sedative agent. As an agent for general anesthesia, nitrous oxide is slowly losing popularity, however, for reasons described subsequently and in Chapter 18.

COMMON TERMS

Consciousness is the mental state in which the individual is capable of a rational response to commands and has all

protective reflexes intact, including the ability to maintain a patent airway.

Sedation describes a state of partial or complete awareness of the environment but with a significant reduction of anxiety and restlessness. As described in Chapter 48, three levels of sedation have been defined: minimal sedation, in which the patient responds normally to verbal command; moderate sedation, in which the patient responds purposefully to verbal command either alone or accompanied by light tactile stimulation; and deep sedation, in which the patient cannot be easily aroused but responds purposefully after repeated or painful stimulation.

Analgesia refers to a reduced perception of and responsiveness to noxious stimuli (i.e., stimuli that are described as painful) but without amnesia or loss of consciousness. Other modes of sensory perception remain intact (e.g., vision and hearing).

Amnesia refers to a loss of memory of the surgical experience, although the patient may be aware of the environment during surgery.

Anxiolysis indicates a selective reduction or elimination of fear and apprehension produced without amnesia or loss of consciousness.

Induction is the phase of anesthesia beginning with the administration of anesthetic and continuing until the desired level of patient unresponsiveness is reached.

Unconsciousness is the state in which the patient is no longer aware of the environment and does not respond to familiar or non-noxious stimuli such as calling the patient's name.

Unresponsiveness refers to a loss of reaction to noxious and non-noxious sensory stimuli.

Muscle relaxation is a reduction or loss of central nervous system (CNS) regulation of skeletal muscle tone and reflexes that produces a state of flaccid paralysis and unresponsiveness of muscle to stretching and surgical cutting.

Surgical anesthesia is the state of unconsciousness, unresponsiveness, anxiolysis, amnesia, analgesia, and muscle relaxation that allows the goals of surgery to be accomplished.

Maintenance is the process of keeping a patient in surgical anesthesia.

Recovery is the phase of anesthesia beginning when surgery is complete and the delivery of the anesthetic is terminated and ending when the anesthetic has been eliminated from the body.

Emergence refers to the stage of recovery during which the patient is regaining consciousness.

Minimum alveolar concentration (MAC) is the alveolar concentration of anesthetic at which 50% of patients do not respond to a standard surgical stimulus. MAC is used for quantifying the relative potencies of inhalation anesthetics.

GOALS OF ANESTHESIA

General anesthesia may be defined as "a drug-induced reversible depression of the CNS resulting in the loss of response to and perception of all external stimuli."⁴ In practice, this simple definition is inadequate because it neglects the contributions of unconsciousness, amnesia, immobility, and autonomic stability to the anesthetic state and the fact that general anesthetics differ significantly in the effects they achieve.

A complete anesthetic is one that produces unconsciousness, unresponsiveness, amnesia, analgesia, and muscle relaxation by itself without eliciting undue homeostatic disturbances in the patient. An example of such a complete anesthetic is diethyl ether (known simply as ether). Although there are other complete anesthetics, the tendency in modern anes-

biology is to use a combination of drugs to take advantage of the best properties of each and to minimize unwanted side effects. Combining anesthetics from different drug classes allows for a reduction in the dose of each agent as the majority of such interactions are supra-additive in nature.

Among the agents that may be used preoperatively are the antimuscarinic drugs to minimize salivation, laryngospasm, and reflex bradycardia and various analgesics and CNS depressants to provide preoperative pain relief, sedation, and amnesia. Drugs that are used during the administration of general anesthesia in addition to the primary anesthetic may include nitrous oxide; intravenous opioids (which lessen the total required dose of anesthetic and increase analgesia); midazolam or another amnestic drug to prevent recall; drugs that paralyze skeletal muscle; antiemetics such as ondansetron to limit postoperative nausea and vomiting; and, if necessary, drugs that help maintain cardiovascular stability and renal function.

The primary goals of general anesthesia are to preserve the life of the patient, to provide the operator with an adequate surgical field, and to obtund pain. A general anesthetic ideally should (1) provide a smooth and rapid induction; (2) produce a state of unconsciousness or unresponsiveness; (3) produce a state of amnesia; (4) maintain essential physiologic functions while blocking reflexes that might lead to bronchospasm, salivation, and arrhythmias; (5) produce skeletal muscle relaxation, but preferably not of the respiratory muscles, through the blockade of various efferent impulses; (6) block the conscious perception of sensory stimuli so that there is adequate analgesia to perform the procedure; and (7) provide a smooth, rapid, and uneventful emergence and recovery with no long-lasting adverse effects.

The goals of anesthesia for general surgery also apply to dental surgery, but there are some important differences. Dental patients are generally outpatients; in most circumstances, particularly situations not involving extensive oral surgery, the procedures are not as traumatic as general surgical procedures, and it is neither necessary nor desirable to render the patient unconscious. Although general anesthesia is sometimes necessary, specific techniques have been developed for producing sedation in dental patients (see Chapter 48).

MECHANISMS OF ANESTHESIA

Since the introduction of general anesthetics, considerable efforts have been directed toward discovering the mechanism of action of these agents. Our incomplete knowledge of the structure and behavior of membrane constituents and subcellular organelles, neurotransmitters, and neurologic circuits, coupled with an imperfect understanding of behavioral states relevant to clinical anesthesia such as consciousness, sleep, pain, and anxiety, makes elucidation of what causes anesthesia extremely difficult. Information has been gleaned for each of the above-mentioned functions, however, and is summarized in the following sections.

Molecular Mechanisms of Action

Many investigators have sought to describe the action of the extremely diverse chemicals known to be general anesthetics by their ability to perturb the molecular structure and function of neurons. Most early anesthetic agents seemed to be indiscriminate in affecting biophysical properties of cellular and subcellular membranes, and for many years it was generally agreed that there were no specific receptors for general anesthetics (and therefore no direct antagonists) as there are for neurotransmitters. In this setting, a universal mechanism of action of general anesthesia based on the physicochemical properties of anesthetic agents was postulated. More recently, many actions of general anesthetics have been documented,

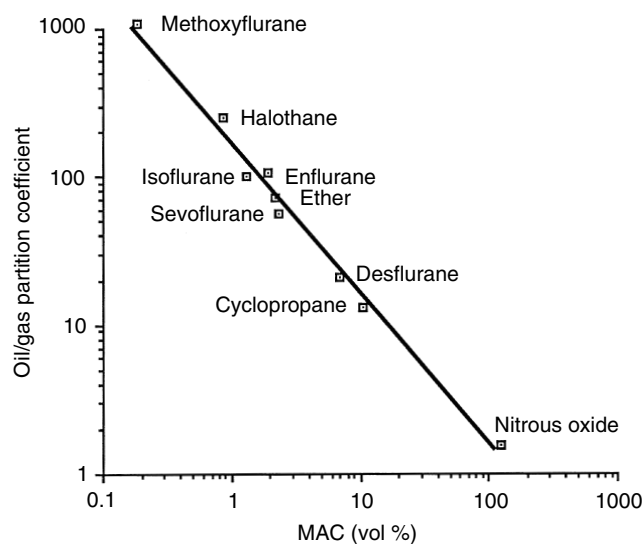

FIGURE 17-1 Linear correlation between anesthetic potency and lipid solubility. Potency is indicated by the minimum alveolar concentration (MAC) and lipid solubility by the olive oil/gas partition coefficient.

and it is now believed that diverse molecular perturbations may result in unconsciousness and lack of response to external stimuli.

Correlates of anesthetic potency

Various mechanistic theories of general anesthesia began to appear shortly after the landmark demonstration of ether-induced insensibility by Morton, but the first important observation was made independently by Meyer in 1899 and Overton in 1901, who emphasized the correspondence between the lipid solubility of an agent and its anesthetic potency (Figure 17-1). The Meyer-Overton correlation suggested that anesthesia begins when any chemical substance has attained a certain molar concentration in the hydrophobic phase of the cell membrane. When olive oil is used to represent the hydrophobic medium, this concentration is approximately 50 mmol/L. Experiments with different lipid media indicate that the best fit between solubility and anesthetic potency is obtained with lipids that are amphiphilic (i.e., they have polar and nonpolar attributes) and can serve as hydrogen bond acceptors. These characteristics are descriptive of membrane phospholipids and cholesterol.

In 1954, Mullins, in his critical volume hypothesis, modified the original correlation to include consideration of the volume of the hydrophobic region occupied by the anesthetic agent. He reasoned that large anesthetic molecules would have greater effects on the membrane than would smaller molecules.

Membrane lipid theories

Numerous investigators since Mullins have sought to link the notion of a critical number or volume of anesthetic molecules with plasma membrane disturbances that could result in general anesthesia. Until the early 1980s, most attention was directed at the lipid bilayer of the plasma membrane, specifically the ability of anesthetics to cause membrane expansion, lipid fluidization, or lateral phase separation. With each of these effects, it was postulated that, as a result of the alteration in the lipid bilayer, the neuronal membrane becomes unable to facilitate the changes in protein configuration that are required for such essential steps in the transmission of nerve impulses as ion gating, synaptic transmitter release, and binding of the transmitter to the receptor.³¹

The membrane expansion theory was a natural outgrowth of the critical volume hypothesis. It holds that the absorption of anesthetic molecules by the lipid phase causes the membrane to expand, preventing important intrinsic membrane constituents from functioning properly. Measurements indicate that the expansion associated with general anesthesia is approximately 0.4%. Fluidization, or disordering, of lipids by anesthetic agents was noted in studies of lipid bilayers prepared with phospholipid and cholesterol to mimic cell membranes. Parallel shifts in measures of lipid fluidization and the activity of membrane-bound enzymes suggested that this perturbation of the normal lipid structure may result in functional changes sufficient to disrupt nerve transmission. The lateral phase separation theory was based on the idea that membrane lipids exist in two states: a high-volume, disordered sol state and a compact, ordered gel state.³¹ The ability of lipids to convert from the sol to the gel configuration, or to be compressed laterally within the membrane, was thought to accommodate conformational changes that need to occur for the opening of ion channels.

These lipid perturbation theories were supported by findings that hyperbaric pressures and certain convulsant drugs antagonize anesthesia, presumably by reversing membrane expansion or re-establishing order. It is now understood, however, that pressure or drug reversal of anesthesia arises from a physiologic antagonism of anesthetic action brought on by independent neurologic stimulation. Different anesthetics are affected differently by the same pressure, including chloral hydrate, whose anesthetic effect is immune to pressure reversal. Evidence has also mounted to cast doubt on membrane expansion or lipid perturbation per se as a cause of anesthesia. Direct measurements of the expansion of lipid bilayers and red blood cell membranes in response to anesthetic concentrations of ethanol and halothane yield values that are effectively insignificant, and other measurements have shown nonanesthetic long-chain alcohols to cause membrane expansion similar to that of inhalation anesthetics. Regarding fluidization or sol-gel transformations, changes equivalent to those associated with anesthesia can be attained by temperature elevations less than 1° C.³²

Calculations based on the Meyer-Overton relationship argue in general against a significant effect of anesthetic drugs on membrane lipids. At concentrations sufficient to produce surgical anesthesia, there is only about one molecule of drug in the membrane for every 60 to 80 molecules of the much larger lipid constituents. Unless anesthetic molecules are distributed unevenly in the membrane (e.g., concentrated in lipids adjacent to ion channels) or the lipid phase serves as a barrier to the diffusion of anesthetic agents (i.e., limiting access of anesthetics to their effector site) or as a reservoir for them (i.e., retaining anesthetic molecules where they have direct access to their effector sites), it is unlikely that membrane lipids play a major role in the mechanism of anesthesia.

Mechanisms involving membrane proteins

Membrane proteins constitute a second hydrophobic environment with which anesthetic molecules may interact.⁹ The idea that membrane proteins are the targets of anesthetic action is attractive for several reasons. First, it is consistent with the mode of action of most drugs that influence the CNS. Second, allosteric selection (described in Chapter 1) of a protein conformation by the binding of even a single small molecule can have pronounced effects on protein function. Third, it can best explain differences in action among the various anesthetics by assuming that these agents exert different effects on the same protein or influence different proteins altogether.

Although technical difficulties have long inhibited direct examination of anesthetic drug interactions with membrane proteins, the firefly enzyme luciferase provided a good initial

model for study.⁷ Luciferase is a water-soluble protein that produces light when it cleaves its substrate, luciferin. For a wide variety of agents, anesthetic potency correlates directly with the ability to inhibit luciferin binding and prevent light emission. The binding site on the enzyme is amphiphilic in nature and capable of accepting a hydrogen bond. Similarly, numerous potential sites exist for direct anesthetic interactions with proteins: hydrophobic regions within globular or folded polypeptides, between polypeptides joined in an oligomeric structure, and at the protein-lipid or protein-water interface.

The synthesis of a water-soluble four-stranded α -helical protein bundle similar in structure to peptides forming ligand-gated ion channels has allowed characterization of direct anesthetic-protein interactions.¹⁴ A hydrophobic cavity within the bundle binds halothane best when the cavity is lined with methionine and aromatic acid residues. Halothane binding stabilizes the protein in a conformation that putatively promotes anesthesia.

A close correspondence between the anesthetic potencies of stereoisomers of halothane and isoflurane and their ability to perturb ion channel function provides strong evidence that these membrane proteins are the immediate targets for general anesthetic action. It is now firmly established that certain classes of general anesthetics inhibit or activate specific ligand-gated ion channels in clinically relevant concentrations. Binding studies indicate a specific active site for volatile anesthetics on neuronal nicotinic receptors.^{2,19} Specific mutations on the M₂ domains of the nicotinic receptor, which correspond to the α -helix segments that form the aqueous pore of the receptor's ion channel, enhance the blocking action of anesthetics such as isoflurane and alcohols such as octanol.⁵ It is postulated that hydrophobic general anesthetic agents bind at a discrete site in the vicinity of the mutation loci. The more polar alcohols gain access to the same site preferentially after channel opening, suggesting that the binding site is within the channel itself. Inhibition of nicotinic receptors in skeletal muscle probably contributes to the ability of volatile anesthetics to enhance muscle relaxation. Actions at neuronal nicotinic receptors promote effects such as amnesia, hyperalgesia, and excitation observed at subanesthetic concentrations of volatile anesthetics and barbiturates.

The γ -aminobutyric acid_A (GABA_A) receptor has been implicated in the CNS depressant effect of most anesthetic drugs.^{4,30} Specific binding sites for benzodiazepines, barbiturates, other intravenous anesthetics, and volatile anesthetics have been described.⁴ Stimulation of these receptor sites increases the activity of GABA at its own separate site; many agents other than benzodiazepines can also open the GABA_A Cl⁻ channel in the absence of GABA. Hyperpolarization of the affected neuron inhibits neuronal activity. Glycine receptors constitute another group of inhibitory receptors that are activated by at least some general anesthetics (inhalation anesthetics, alcohols, thiopental, and propofol) in clinically relevant concentrations.

Excitatory receptors blocked by specific anesthetic agents include N-methyl-D-aspartate (NMDA), kainate, and α -amino-3-hydroxy-5-methyl-4-isoxazole propionate (AMPA) receptors. Ketamine and nitrous oxide¹³ selectively inhibit NMDA receptors, whereas barbiturates and certain inhalation anesthetics block AMPA and kainate receptors.⁴

In addition to the classic ligand-gated ion channels described previously, other ion channels may be involved in the actions of specific general anesthetics. Several types of 2-pore-domain K⁺ channels (identified by their acronyms TREK1, TREK2, TASK1, TASK3, and TRESK) are variably activated by inhalation anesthetics.^{4,6} These channels are responsive to intracellular second messengers and are believed to regulate background neuronal excitability and neurotransmitter release. Several types of Ca⁺⁺ channels and Na⁺ are

TABLE 17-1

Anesthetic Properties and Target Receptors of Anesthetics

ANESTHETIC	HYPNOSIS	AMNESIA	ANALGESIA	IMMOBILITY	GABA	GLYCINE	NMDA	AMPA	2-P K**	5-HT	M	N _N
Group 1												
Etomidate	++	++	0	+	++	+	0	0	++	0	-	-
Propofol	++	++	0	+	++	++	+/-	-	0	0	-	-
Thiopental	++	++	0	+	++	+	0	--	0	-	--	-
Group 2												
Ketamine	+	+	++	+	+	0	--	0		+	--	-
Nitrous oxide	+	+	++	+	+	+	--	-	++	--	-	--
Group 3												
Desflurane	++	++	+	++	++		--	0	+		+/-	
Isoflurane	++	++	+	++	++	++		--	++	++	-	-
Sevoflurane	++	++	+	++	++	++	--	--	+	--	-	-

*Each 2-pore K⁺ (2-P K⁺) channel subtype is affected differently by individual anesthetics.

++, Strong potentiation or positive effect; +, weak potentiation or positive effect; +/-, weak potentiation or inhibition; 0, no effect; -, weak inhibition; --, strong inhibition; 5-HT, 5-hydroxytryptamine; AMPA, α -amino-3-hydroxy-5-methyl-4-isoxazole propionate; GABA, γ -aminobutyric acid; M, muscarinic; NMDA, N-methyl-D-aspartate; N_N, nicotinic (neuronal).

inhibited by clinical concentrations of drugs and may contribute an inhibitory influence on neurotransmitter release.

Several G protein-coupled receptors (GPCRs) are influenced by clinical concentrations of general anesthetics. An important example is the α_2 -adrenergic receptor effector system. Stimulation of this system by the selective α_2 agonist dexmedetomidine significantly potentiates the anesthetic potency of volatile anesthetics. Similar potentiation can be obtained by drugs that stimulate opioid receptors or block nitric oxide synthase.¹⁵ Demonstration of a blocking action of halothane on the GPCR rhodopsin underscores the possibility that similar interactions with other GPCRs may support the effects of inhalation anesthetics on consciousness, nociception, and various autonomic effects observed during general anesthesia.

Table 17-1 categorizes anesthetics into three groups based on their relative abilities to provoke hypnosis and amnesia, provide analgesia, and cause immobility (unresponsiveness). Group 1 drugs, including most intravenous induction agents, are noted for their ability to stimulate GABA transmission. Group 2 agents are characterized by their selective inhibition of NMDA receptor-mediated transmission. Group 3 anesthetics, representing the volatile anesthetics, noted for their ability to produce immobility, combine the clinical attributes and molecular targets of the previous groups.

Other sites

Several investigators have raised the possibility that proteins other than membrane receptors/ion channels may be involved in the mechanism of anesthesia. Certain anesthetics have been shown to impair the ability of synaptosomes (isolated nerve terminals) to sequester and retain catecholamine neurotransmitters and of mitochondria to produce adenosine triphosphate (ATP) and to take up Ca⁺⁺. Although the latter effect has been used to explain the finding that anesthetics hyperpolarize cells in direct relation to their anesthetic potency,²³ a lack of correlation between catecholamine influences and general anesthesia and a failure of ATP concentrations in the brain to decrease during anesthesia provide arguments against a primary role for these other sites in producing anesthesia. Nevertheless, demonstration of altered responses to volatile anesthetics in nematodes (*Caenorhabditis elegans*) expressing mutated proteins responsible for synaptic exocytosis (i.e., SNARE complex proteins) or closely associated with various

membrane channels (i.e., stomatin) promotes the likelihood for a site of action involving neurotransmitter release.^{21,25}

Children with the same specific mitochondrial mutation found in nematodes bred to be highly sensitive to inhalation anesthetics display a similarly unusual sensitivity to sevoflurane anesthesia.²⁰ This finding suggests that a specific anesthetic effect on mitochondrial function cannot be ignored as a possible mechanism of action.

Neurophysiologic Mechanisms of Anesthesia

Molecular influences of general anesthetics may provide a fundamental explanation of their pharmacodynamic properties, but are not useful in describing the selective changes in consciousness, pain perception, and muscle relaxation observed clinically. Much research has been directed toward determining the neurologic sites and pathways affected by the various anesthetics. A first step to unraveling these more complex issues is to identify the component of the neuronal circuit most affected by anesthetic action. Studies of the sympathetic nervous system have conclusively shown that synaptic transmission is much more susceptible to anesthetic block than axonal conduction.¹⁷ Nevertheless, this finding does not rule out an axonal contribution to general anesthesia. Anesthetic agents in clinical concentrations can diminish the amplitude of the action potential, which may impair synaptic transmission prejunctionally by reducing the evoked release of neurotransmitter. Conduction block is strongest at branch points of small-diameter axons and becomes even more prominent as the frequency of nerve transmission increases.

Evidence in favor of a direct presynaptic site of action includes some observations that anesthetics depress excitatory neuroeffector responses to prejunctional nerve stimulation, but not to iontophoretic application of the appropriate neurotransmitter. Release of epinephrine and norepinephrine from chromaffin cells by K⁺ or acetylcholine has also been reported to be reduced by various anesthetics.²⁶ The most likely mechanism of action for this effect is a depression of Ca⁺⁺ influx through presynaptic voltage-gated Ca⁺⁺ channels or interference with the proteins involved in vesicle docking and neurotransmitter release.

A postsynaptic action at specific sites in the CNS is supported by decreased responses to directly applied stimulatory neurotransmitters such as acetylcholine, aspartate, and gluta-

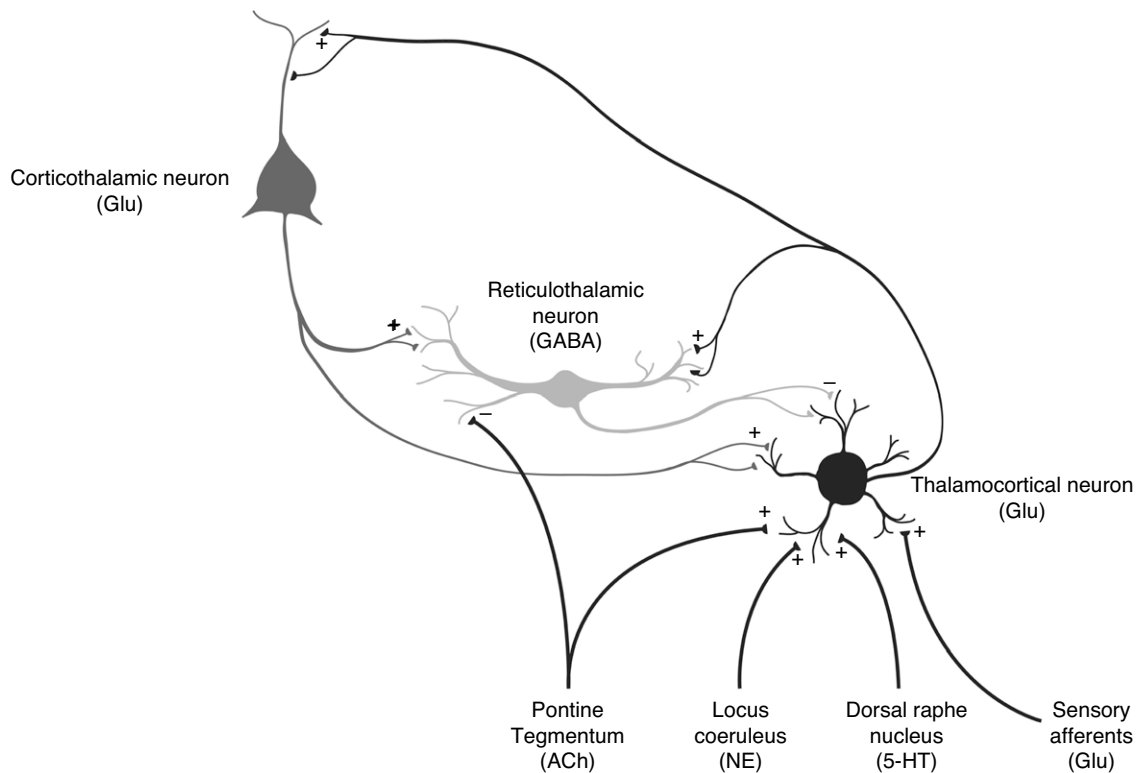

FIGURE 17-2 Thalamocortical pathways in consciousness and general anesthesia. In this simplified scheme, sensory stimuli and ascending arousal inputs from the reticular formation (including the dorsal raphe nucleus, locus coeruleus, and pontine tegmentum) activate (+) thalamocortical neurons and promote integrated transfer of information to the cerebral cortex. This transfer is aided by pontine inhibition (-) of reticulothalamic neurons, which relieves their tonic suppression of thalamocortical neurons. General anesthetics, among other actions, block the ascending arousal pathways, facilitate reticulothalamic inhibition of thalamocortical neurons, and disrupt normal processing of sensory information. Bereft of external activation, thalamocortical neurons spontaneously discharge in oscillatory bursts termed *sleep spindles*. Synchronous recruitment of cortical neurons produces slow δ waves on the electroencephalogram analogous to that seen in deep sleep. Major neurotransmitters released by each neural system are listed in parentheses. 5-HT, 5-hydroxytryptamine; ACh, acetylcholine; Glu, glutamate; NE, norepinephrine.

mate. At the neuromuscular junction, general anesthetics seem to reduce the sensitivity of the motor end plate to acetylcholine by increasing the closing rate of ion channels opened by nicotinic receptor activation and by increasing receptor desensitization. Conversely, numerous anesthetics increase transmission at inhibitory synapses by increasing activation of GABA_A receptors and Cl⁻ conductance. In addition, inhalation anesthetics and some intravenous agents may affect GABA_B receptors and activate an inhibitory K⁺ current.

A crucial unknown in the study of general anesthesia is the site at which unconsciousness is produced. Areas in the CNS that have been implicated in this primary anesthetic action include the dorsal lamina of the spinal cord (substantia gelatinosa), the reticular system (including the midbrain reticular formation), sensory relay nuclei of the thalamus, and cortical areas.

Much attention has been directed toward the role of the mesencephalic reticular activating formation. This system, which receives various nonspecific sensory inputs, is a major center supporting consciousness and alertness of higher brain centers. As the activity of the system is depressed, the ascending influences on the limbic system and cortical structures are reduced, and unconsciousness ensues. Gross lesions that abolish the arousal effect of the reticular formation as recorded on electroencephalography (EEG) may leave the animal behaviorally awake. This complex of neurons may also respond quite differently to various anesthetics. Barbiturates and most

volatile anesthetics cause depression of spontaneous electrical activity, whereas ketamine alters the pattern of firing. All agents seem to block neuronal responses in the reticular formation to sensory input.

General anesthetics in clinically relevant concentrations may also exert direct effects on various nuclei of the thalamus, the hippocampus, the olfactory cortex, and various circuits in the cerebral cortex. Most reactions are consistent with the inhibition of excitatory neuronal pathways or facilitation of inhibitory influences, or both. As with the reticular formation, however, net excitatory reactions also occur depending on the anesthetic administered and region studied.

Numerous investigators have argued for a central role of thalamocortical-corticothalamic loop circuits in maintaining consciousness.^{6,12} As illustrated in Figure 17-2, these circuits are highly active in the conscious state and are associated with high-frequency, low-amplitude brain waves on EEG. Direct sensory input and ascending excitatory stimuli arising from the reticular activating system help maintain this activity. Loss of excitatory tone and release of inhibitory stimuli in response to general anesthetic administration reveals rhythmic depolarizations of thalamocortical neurons that recruit numerous neurons to fire synchronously. The resulting δ waves on EEG are reflective of deep sleep and occur in concert with loss of consciousness.

Amnesia, which may be present in an awake patient or absent in an apparently unconscious patient, is most closely

Stage, plane	Respiration		Blood pressure and pulse ↓---N---↑	Reflexes		Pupil size	Muscle tone ↓---N---↑
	Inter- costal	Diaphragm		Pharyngeal, laryngeal	Ocular		
I—Analgesia (dental surgery)							
II—Delirium (no surgery)				Swallow Retch Vomit	Lid		
III, Plane 1 (dental and thoracic surgery)					Conjunc- tival		
Plane 2 (abdominal surgery)					Corneal		
Plane 3 (deep abdominal surgery)				Laryngeal Bronchial	Pupil light reflex		
Plane 4 (no surgery)							
IV—Medullary paralysis Death							

FIGURE 17-3 Guedel's scheme of progressive central nervous system depression produced by the anesthetic ether. Changes in physiologic functions are shown for the different stages and planes of Guedel's classification. Examples of surgery that can be performed at these anesthetic levels are given in parentheses.

linked to anesthetic-induced suppression of the limbic system structures (e.g., amygdala, hippocampus). Drugs that potentiate the actions of GABA are likely to have specific amnestic properties.

Because of its role in modulating pain, the spinal cord has been studied as a possible site of anesthetic action. Investigators have shown that the analgesic action of nitrous oxide involves the laminar structures (substantia gelatinosa) of the dorsal horns, often referred to as the gateway for nociceptive impulses into the CNS. The similarity of analgesia produced by opioids, nitrous oxide, and ketamine suggests a common mode of action. Cross-tolerance to the analgesic effect of morphine and nitrous oxide and the ability to block nitrous oxide analgesia with the opioid antagonist naloxone indicate that nitrous oxide may release endogenous opioid substances.³⁵ That the endogenous opioid system cannot be invoked as a mechanism of anesthesia generally is shown by the failure of naloxone to block the analgesic action of several anesthetics and the anesthetic action of nitrous oxide (and other drugs).^{18,29}

The analgesic action of nitrous oxide involves α_1 -adrenergic and α_2 -adrenergic receptor activation. Blockade of either α_1 receptors by prazosin or α_2 receptors by yohimbine negates the analgesic effect of nitrous oxide in animals.²⁴ A possible sequence of events underlying nitrous oxide (and ketamine) analgesia is as follows: (1) nitrous oxide inhibition of NMDA receptors,¹³ (2) release of endogenous opioid neurotransmitters,³⁵ (3) activation of descending norepinephrine pathways,³⁶ (3) activation of α -adrenergic receptors in the spinal cord,²⁴ and (4) inhibition of the classic nociceptive pathways. The analgesic action of isoflurane and dexmedetomidine may also be explained by their ability to stimulate α_2 receptors.¹⁶

Immobility is a central component of anesthesia. In addition to the ability of general anesthetics to elicit analgesia by influencing sensory processing in the dorsal horn, specific inhibition of spinal motor neurons also contributes to a lack of observable response to noxious and non-noxious stimuli.

Behavioral Manifestations of Anesthesia

Progressive depression

In 1920, Guedel⁸ divided the course of ether anesthesia into a sequence of four stages and subdivided the third, or surgical, stage further into four planes (Figure 17-3). Each of these stages and planes represented a progressive and deepening depression of the CNS. In modern anesthesiology, these observations are no longer used in their entirety because the anesthetic signs are obscured by the presence of other drugs used before and during the anesthetic period, and because different anesthetics create different patterns of responses. Nevertheless, Guedel's scheme is useful in describing some of the effects caused by various anesthetic drugs. The classic stages of anesthesia, as described by Guedel, are stage I, analgesia; stage II, delirium; stage III, surgical anesthesia (planes 1, 2, 3, and 4); and stage IV, medullary paralysis.

Stage I starts with the beginning of anesthetic administration and ends with the loss of consciousness. The patient is unresponsive to mild pain-provoking stimuli and is able to respond to verbal commands. This stage is followed by delirium in stage II, during which uncontrolled movements, retching, and laryngospasm can occur. It is desirable to traverse this stage rapidly; propofol or another intravenous anesthetic is often given to bypass this stage and induce anesthesia immediately. Stage III has been subdivided, as indicated previously, into four planes in order of increasing depth of anesthesia by

using various indices, including the diameter of the pupil; loss of ocular, oropharyngeal, and other reflexes; muscle relaxation; depth and regularity of respiration; and separation of the thoracic and abdominal (diaphragmatic) phases of respiration. *Stage IV* begins with the disappearance of the purely diaphragmatic respiration of stage III plane 4 and ends with complete respiratory and circulatory collapse, culminating in death if the anesthetic is not discontinued and the patient given support for the cardiopulmonary systems.

The recovery from general anesthesia is the reverse of the process of induction. The patient progressively regains reflexes, and a short period of excitement similar to that previously encountered during stage II may occur, followed by emergence to consciousness with residual analgesia.

Although the stages of anesthesia can be useful in a descriptive sense, the further subdivision of the surgical stage into planes is no longer useful. Anesthetic agents currently used do not produce the same pattern of concentration-dependent changes in autonomic, motor, and reflex activity observed with ether, and many adjunctive drugs used during anesthesia tend to obscure these same signs. Muscular relaxation can hardly be used to gauge the depth of anesthesia if a neuromuscular blocking agent has been administered, and the arterial blood pressure cannot be useful if an adrenergic amine has been given to prevent hypotension. Nevertheless, measures autonomic function, such as progressive reduction of blood pressure and alterations in heart rate, can be valuable guides to the patient's status during anesthesia in the absence of medications that specifically obscure these functions.

In modern anesthesiology, the depth of anesthesia is determined to some extent by the needs of surgery. Because there is a diversity of purposes in surgery, along with various types of anesthetic agents, an assessment of the desirable depth of anesthesia is made for each type of procedure. If the procedure necessitates a bloodless field, as in plastic surgery, anesthetic agents may be chosen for their hypotensive properties. The end point of anesthesia becomes the production of hypotension, and other indices of depth, such as respiratory movements, have little direct bearing on the choice of anesthetic depth for the surgical procedure.

The effects of anesthetic agents depend on the degree of sensory input and the dose of the anesthetic used. With surgical stimulation, the respiratory and cardiovascular systems tend to be less depressed, and the patient can appear to be in a lighter plane of anesthesia than the injected dose or inspired concentration would indicate.

Selective depression

Generally, volatile anesthetic agents follow Guedel's scheme of progressive anesthesia. Certain discrepancies noted with these agents and experience with injectable drugs (e.g., ketamine), however, make clear the fact that surgical anesthesia is not synonymous with generalized CNS depression.³⁴ A quantitative autoradiographic analysis of brain glucose metabolism graphically demonstrates this point.¹¹ Although thiopental reduces metabolic activity throughout the rat brain in vivo, etomidate selectively depresses the forebrain, and ketamine has a mixed effect, inhibiting some areas but more strongly stimulating others, such as the hippocampus. This work and complementary neurophysiologic investigations indicate that amnesia and a loss of responsiveness to painful stimuli can occur with or without comprehensive CNS depression. In the latter case, the psychomotor unresponsiveness of surgical anesthesia apparently devolves from a functional disorganization of the activated neurons' interactions with one another. Although motor output may be enhanced, as shown by muscular rigidity, coordinated motor activity is gone, resulting in an unresponsive surgical patient.

UPTAKE AND DISTRIBUTION OF INHALATION ANESTHETICS

The depth of anesthesia produced by an inhalation anesthetic depends on the concentration of the anesthetic agent in the brain. The speed of induction and the speed of recovery follow the rate at which the concentration of the agent changes in the brain. During induction, the gas must move from the anesthetic apparatus to the pulmonary alveoli, from the alveoli to the blood, and from the blood to the brain. On termination of anesthesia, the inhaled gas moves in the opposite direction across the same interfaces. The principal force governing this movement of anesthetic gas is the diffusion or concentration gradient, and the behavior of the gases as they move from one compartment to another across biologic interfaces is defined by two gas laws. Dalton's law deals with the partial pressure (or tension) of gases and states that in a mixture the partial pressure of each component gas is directly related to its concentration in the mixture. Henry's law describes the solubility of gases in liquids and states that the quantity that will dissolve in a liquid is proportional to the partial pressure of that gas in direct contact with the liquid.

The partition coefficient is an expression of the relative solubility of a substance in two immiscible phases. When applied to anesthetic gases, it compares the relative amount of gas dissolved in one phase when one part is present in the other phase. The blood/gas partition coefficient of 2.5 for halothane indicates that 2.5 parts of halothane are dissolved in blood for every part contained in an equal volume of alveolar air. These relationships are shown schematically in Figure 17-4.

As mentioned earlier, during induction the various compartments of the body are brought into equilibrium regarding the inhaled anesthetic gas. When equilibrium is reached, the tensions of the anesthetic gas in the inspired air, alveolar air, arterial blood, body tissues, and mixed venous blood become equal, but the concentrations vary in concert with the relative solubility of the agent in each compartment. The speed with which equilibrium is achieved is influenced by many variables,

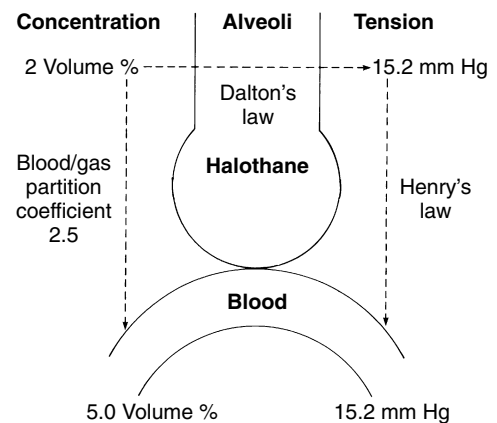

FIGURE 17-4 Effect of the blood/gas partition coefficient and the tension (partial pressure) exerted by halothane 2% (by volume) in the inspired air. Across the top of the diagram is the statement of Dalton's law that 2% (by volume) of halothane exerts 15.2 mm Hg pressure ($0.02 \times 760 \text{ mm Hg} = 15.2 \text{ mm Hg}$) at 1 atmosphere pressure. Application of Henry's law indicates that, at equilibrium, the tension of the gas in the inspired air equals the tension of the gas in the blood (right), but the concentration dissolved in the blood is the product of the concentration in the air and the blood/gas partition coefficient (2% [by volume] \times 2.5 = 5% [by volume], left).

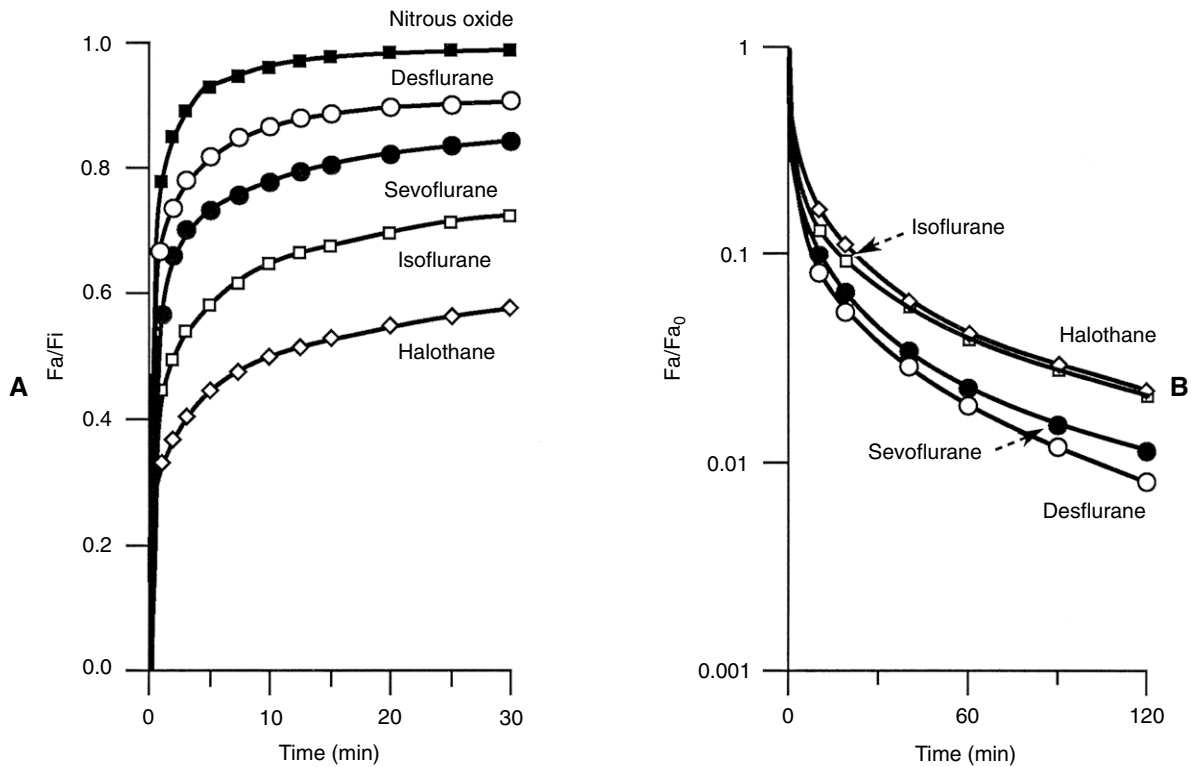

FIGURE 17-5 Rate of change of alveolar anesthetic tension during induction (A) and recovery (B). For induction, the ratio of the alveolar concentration (F_a) to the inspired concentration (F_i) is plotted against the time of drug administration. For recovery, the ratio of F_a to the F_a at the end of drug administration (F_{a_0}) is plotted against the time after termination of anesthetic delivery. (Adapted from Yasuda N, Lockhart SH, Eger EI II, et al: Comparison of kinetics of sevoflurane and isoflurane in humans, *Anesth Analg* 72:316-324, 1991.)

and each of these is considered subsequently, particularly regarding how it affects the alveolar concentration.

The alveolar concentration of an inhalation anesthetic is of pivotal importance to the onset of anesthesia. Because the brain is extremely well perfused, the tension of an inhaled anesthetic in the brain closely follows that of the arterial blood, which itself is equilibrated with the alveolar tension as the blood passes through the pulmonary microvasculature. Within broad limits, anything that increases delivery of anesthetic to the alveoli, and increases its partial pressure, would hasten anesthesia, and anything that enhances its removal from the lungs—in other words, anything that increases overall systemic uptake—would reduce its alveolar partial pressure and delay anesthesia.

The rate of change of alveolar concentration for some common anesthetic agents during induction and emergence is shown in Figure 17-5. Initially, the alveolar concentration increases quickly as the inspired gas mixes with the air in the lungs. Mathematically, this process can be defined as follows:

$$F_a/F_i = 1 - e^{-T \cdot \dot{V}_a / \text{FRC}}$$

where F_a is the alveolar concentration, F_i is the inspired concentration, T is the time in minutes, \dot{V}_a is the minute alveolar ventilation, and FRC is the functional residual capacity of the lungs. For a gas that is extremely insoluble in blood, F_a usually reaches 95% of F_i within 2 minutes given a healthy individual breathing normally. Inhalation anesthetics by their nature all are at least somewhat soluble in blood, however. The rate of increase in F_a slows as removal by the pulmonary circulation becomes a significant fraction of the inhaled gas. The removal

of anesthetic from the lungs by the pulmonary circulation can be expressed as follows:

$$\dot{V}_b = \lambda \cdot Q \cdot (P_a - P_v) / P_B$$

where \dot{V}_b is the anesthetic uptake, λ is the blood/gas partition coefficient, Q is the cardiac output, P_a and P_v are the alveolar and venous tensions, and P_B is the barometric pressure. The function $(P_a - P_v) / P_B$ represents the gradient for diffusion and approaches zero as the body becomes equilibrated with the inspired gas. At that point $F_a = F_i$.

Concentration in Inspired Air

The greater the concentration of the anesthetic gas in the inspired air, the more rapid is the induction of anesthesia. This inspired tension normally is not held constant during induction. With irritating agents such as isoflurane, the tension is increased slowly. With sevoflurane, which is nonirritating, or in situations in which acceleration of the speed of induction is desired, the concentration at the outset may be two to three times what it would be during the maintenance phase of anesthetic administration. This technique, sometimes referred to as *overpressurization*, is analogous to administering a loading dose of drug (see Chapter 2).

Ventilation Rate and Depth

The greater the ventilation of the lungs, the more anesthetic is delivered to the alveoli and to the brain, resulting in a more rapid induction. This factor is most significant during the initial phase of induction when the air of the lungs is mixing with, and being replaced by, the inspired gases. As the primary

TABLE 17-2

Properties of Inhalation Anesthetics

ANESTHETIC	BLOOD/GAS PARTITION COEFFICIENT*	BRAIN/BLOOD PARTITION COEFFICIENT	FAT/BLOOD PARTITION COEFFICIENT	MAC (%)†
Desflurane	0.42	1.3	27	6
Nitrous oxide	0.47	1.1	2.3	104
Sevoflurane	0.65	1.7	48	2.05
Isoflurane	1.4	1.6	45	1.15
Enflurane	1.8	1.4	36	1.68
Halothane	2.5	1.9	51	0.75
Ether	12	1.1	3.7	1.92
Methoxyflurane	15	1.4	38	0.16

*All coefficients are taken at 37°C.

†MAC is defined as the alveolar concentration (in volume %) of a gas necessary to prevent a skeletal muscle response to a standard surgical stimulus in 50% of patients.

physiologic variable influencing the delivery of anesthetic to the lung, it is also important in replacing gas removed from the alveoli by the pulmonary circulation. In this regard, alveolar ventilation is of less importance with insoluble agents such as nitrous oxide and desflurane, which achieve high (near equilibrium) blood tensions rapidly, than it is with more soluble drugs such as halothane, which equilibrate with the blood more slowly. In patients who are breathing spontaneously, high concentrations of inhalation anesthetics can decrease anesthetic uptake by inhibiting ventilatory drive. This action can help protect against overmedication during induction when overpressurization is being used.

Concentration and Second Gas Effects

The concentration effect occurs when nitrous oxide, a relatively nonpotent anesthetic, is administered in high concentrations (e.g., 75%) during induction of general anesthesia. Initially, nitrous oxide is taken up rapidly by the pulmonary circulation. This uptake would create a vacuum in the lungs were it not for the fact that fresh gas flows into the alveoli to replace the absorbed nitrous oxide. The net result is that alveolar ventilation is effectively increased, and more agent is available for absorption into the circulatory uptake than would otherwise be the case. A second, related contribution to the concentration effect is that the alveolar concentration of nitrous oxide does not decrease as greatly between breaths as one would expect. If half of the alveolar nitrous oxide was absorbed when breathing 75% nitrous oxide, replacement by additional gas flow would keep the alveolar concentration of nitrous oxide around 65%. A potent anesthetic given in a concentration of 0.75% with air, for comparison, would yield an alveolar concentration of only 0.38% after removal of half of the drug by the circulation because there would be essentially no flow of gas needed to maintain the ambient barometric pressure in the lungs.

Although the concentration effect is negligible with potent drugs given in low concentrations, if a potent anesthetic is administered along with nitrous oxide, it too will be delivered to the alveoli in increased amounts as gas rushes inward to replace the nitrous oxide absorbed by pulmonary blood. This phenomenon is called the *second gas effect*. Oxygen delivery to the lungs is also enhanced during induction of anesthesia by the second gas effect when nitrous oxide is administered in high concentrations.

Solubility in Blood

Blood solubility is a major factor in the rate of induction of anesthesia. Solubility is generally expressed as the blood/gas

partition coefficient, which, as previously mentioned, is the ratio of the concentration of the anesthetic gas in arterial blood to that in the alveolar air at 37° C when the partial pressures in the two compartments are the same. The anesthetic gases are generally divided into three groups: agents of low solubility in blood (e.g., desflurane, nitrous oxide), agents of intermediate solubility (e.g., halothane, isoflurane), and agents of high solubility (e.g., methoxyflurane, ether). The blood/gas partition coefficients for the respective anesthetics are shown in Table 17-2.

If an agent is poorly soluble in blood, as is true of nitrous oxide and desflurane, only a small percentage of it is removed from the alveolar air before equilibrium is reached between pulmonary blood and alveolar gas. The alveolar concentration of gas increases quickly, the attainment of anesthetic concentrations in the brain is rapid, and the induction phase is short. With agents of very high blood solubility, such as ether, large fractions of gas are removed from the alveolar air, and large amounts have to be delivered over time from the inspired air before the uptake abates significantly. The alveolar tension increases slowly, and induction is similarly slow. Agents of intermediate solubility have an induction time slower than that of nitrous oxide and faster than that of ether.

Inasmuch as recovery or emergence is essentially a reversal of the process of induction, anesthetics that are insoluble in blood leave the blood very rapidly after the anesthetic gas is removed from the inspired air, and recovery is very rapid. Conversely, recovery is slow with ether. High solubility is not completely disadvantageous, however, because transient fluctuations of the anesthetic's concentration in the inspired air during maintenance has little effect on the depth of anesthesia.

Cardiac Output and Blood Flow

Cardiac output influences anesthetic uptake and onset of anesthesia in opposite ways. On the one hand, if the cardiac output is very high, it removes large quantities of gas from the alveoli and reduces the alveolar tension, delaying the achievement of equilibrium between inspired air and arterial blood. On the other hand, a high cardiac output delivers a greater amount of anesthetic to the tissues as a whole, hastening the rate at which the body comes to equilibrium with the arterial blood. Because the brain follows the arterial partial pressure of anesthetics closely, increasing total cardiac output generally slows the induction of general anesthesia.

The tissue uptake of an anesthetic agent depends on several parameters: the local blood flow, the arterial gas

tension, and the blood/tissue coefficient, which varies according to the amount of lipid present. As shown in Table 17-2, halothane is 1.9 times as concentrated in the brain and 51 times as concentrated in fat as it is in blood. Muscle tissue has an affinity for anesthetic agents similar to that of the brain. Lipids have a high affinity for anesthetic agents, and fatty tissues act as a reservoir for anesthetic gases.

The uptake of anesthetic gases proceeds sequentially into three main compartments of the body, based on differences in vascularity and lipid content of the tissues. Initially, the most active compartment is the vessel-rich group (VRG), consisting of the heart, liver, kidneys, lungs, and brain. As previously stated, equilibration between blood and brain is usually very rapid because the brain receives a large share of the cardiac output and because the brain/blood coefficient is relatively low (see Table 17-2). Nitrous oxide is initially absorbed into the VRG compartment at a rate of 1 L/min for the first 10 to 15 minutes. The uptake decreases to less than 0.5 L/min over the next 1 to 1½ hours, during which time the anesthetic fills the muscle compartment. If anesthetic administration is continued beyond this time, the uptake rate decreases still further (to <0.1 L/min) until the fat group of tissues is equilibrated. The sequence of halothane uptake is similar to that of nitrous oxide except that considerably more time is needed for equilibration of each compartment.

In patients who are mechanically ventilated, high concentrations of anesthetic may hasten anesthesia by inhibiting cardiac output. During induction, this effect increases the danger of overmedication when overpressurization is being used.

ELIMINATION AND METABOLISM OF ANESTHETIC GASES

The same factors that determine the uptake of anesthetic gas and the rate of induction are also important during the elimination phase. This process is initiated by the removal of the gas from the inspired air mixture so that the inspired air tension of anesthetic gas decreases to zero. When this happens, the anesthetic begins to diffuse from the blood through the alveoli, and as the blood tension decreases, there is a decrease in tissue tension. The less soluble the agent, the more completely and quickly the anesthetic is removed from the blood and tissues, and the more rapid is the recovery.

Although Figure 17-5 seems to suggest that recovery is a near mirror image of induction, several important differences do exist. The delivery of anesthetic to the lungs is not under the control of the clinician, but is a function of the cardiopulmonary status of the patient. Also, many differences arise because anesthesia is normally terminated well before equilibrium with the inspired gas is attained in the various tissue compartments, at least for anesthetics other than nitrous oxide. Often muscle and fat continue to absorb anesthetic from blood and the VRG for some time after administration has ceased. A possible outcome of this redistribution is a rapid recovery from short anesthetic courses.

Nevertheless, the high fat/blood partition coefficients of most agents indicate that anesthetic retention may last for many hours and that recovery from prolonged anesthesia can be delayed. A final disparity between induction and recovery is the influence of metabolism. It was long believed that inhalation anesthetics were eliminated through the lungs without any metabolic transformation. It is now recognized, however, that most agents are biotransformed in the liver, some quite extensively; 20% to 40% of administered halothane is metabolized in humans to trifluoroacetic acid, Cl⁻, and Br⁻. Because the enzymes responsible for this metabolism are capacity limited, this percentage may increase during the recovery phase, hastening emergence from anesthesia.

Approximately 50% of methoxyflurane is metabolized, resulting in plasma F⁻ concentrations that can cause nephrotoxicity, severely limiting the use of this drug. Table 18-2 lists, for each currently used, the percentage of agent metabolized.

CHEMICAL PROPERTIES OF INHALATION ANESTHETICS

The wide diversity of chemical substances capable of producing the anesthetic state precludes any uniform statements regarding their chemical properties. Although numerous drugs can produce general anesthesia, the volatile liquids or gases are often preferred because the administration by inhalation permits rapid and precise control of the dose.

None of the current halogenated anesthetics or the obsolete agents chloroform and trichloroethylene presents a flammability or explosion hazard under normal circumstances. Ether is flammable and explosive, however. Cyclopropane, a three-carbon cyclic hydrocarbon, is a highly explosive gas. The only inorganic anesthetic in use, nitrous oxide, is not flammable but supports combustion of other substances.

Other chemical reactions besides fire and explosion can occur with anesthetic agents. Ether, when exposed to air (oxygen) and light, forms peroxides that reduce the ignition temperature for the anesthetic. Chloroform in the presence of high temperature or flame is converted to phosgene, an extremely toxic, irritating gas. Brass and aluminum are subject to corrosion when exposed to halothane and water. Trichloroethylene is decomposed by soda lime used to absorb carbon dioxide in closed systems; the resultant product is toxic and explosive. Sevoflurane also breaks down on exposure to traditional carbon dioxide absorbents, when administered in low flows, yielding fluoromethyl-2,2-difluoro-1-(trifluoromethyl) vinyl ether, more simply known as compound A. Although there is little evidence of human toxicity, some question remains regarding prolonged exposure to high concentrations of compound A. Finally, volatile inhalation agents are absorbed in soda lime and in the rubber or plastic connections used in the administration system, and are difficult to leach out of the anesthetic circuit.

PHARMACOLOGIC EFFECTS OF INHALATION ANESTHETICS

The pharmacology of individual anesthetic agents is discussed in Chapter 18. Included here for discussion are the major effects common to inhalation anesthetics in general.

Cardiovascular System

All inhalation agents depress myocardial contractility; the extent is related to the potency of the particular agent used, its concentration, and the duration of anesthesia. As a group, the halogenated anesthetics are the worst offenders in affecting contractility and in sensitizing the automaticity and conducting properties of the myocardium to norepinephrine and epinephrine. Cardiac rates are variably influenced, and the anesthetic effects are often masked by the preoperative administration of atropine or glycopyrrolate, both of which block activity of the vagus nerve. Agents that can directly excite discharge of the sympathoadrenal axis include ether, nitrous oxide, cyclopropane, desflurane, and possibly isoflurane. Other agents may indirectly increase sympathetic tone by depressing respiration or arterial blood pressure. Nevertheless, baroreceptor sensitivity, as measured by a change in heart rate in response to a vasoactive drug, is generally depressed.

Inhalation agents tend to decrease peripheral vascular resistance, although nitrous oxide may increase it mildly, and

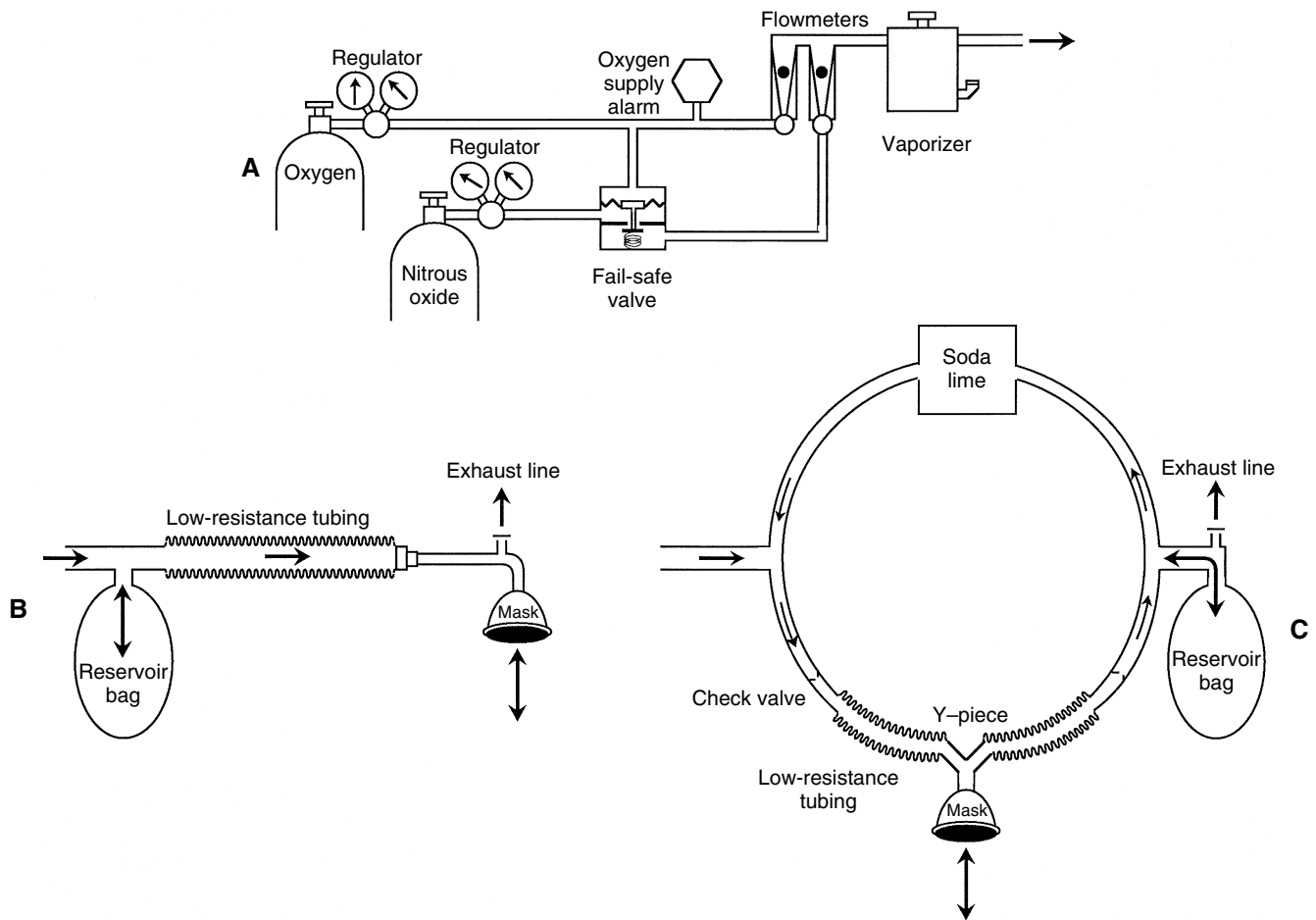

FIGURE 17-6 Major delivery systems for anesthesia. A, Diagram of the essential features of an anesthesia machine. A dedicated nitrous oxide–oxygen machine lacks the vaporizer. B, Mapleson A (or Magill) anesthetic circuit. Rebreathing of exhaled gas in a spontaneously ventilating patient does not occur if the fresh gas flow is at least 100% of the minute ventilation. C, Circle system anesthetic circuit. Partial or full rebreathing is made possible by the removal of exhaled carbon dioxide (as with soda lime).

the effect of halothane is mild in concentrations up to 3 MAC. When it was in clinical use, cyclopropane was preferred for patients in shock states because of its minimal effect on vascular smooth muscle. Isoflurane strongly relaxes vascular smooth muscle, producing a hypotension that can be useful in procedures such as surgical repair of an intracranial aneurysm.

Respiration

The effect of most anesthetics on the respiratory centers in the brain is depression; the amount of respiratory depression is related to the type and concentration of anesthetic used. Respiratory depression with inhalation anesthetics, measured by decreased medullary responsiveness to carbon dioxide tensions, is associated with a progressive decline in tidal volume. This effect is accompanied by a pronounced increase in respiratory rate. The most sensitive component of respiration to inhalation anesthetics is the ventilatory response to hypoxemia. Peripheral chemoreceptors that normally respond to low oxygen tensions are strongly inhibited by concentrations of 0.1 MAC and become completely inoperative during general anesthesia. Hypercarbia resulting from depressed ventilatory exchange excites the sympathoadrenal system, causing a release of catecholamines. When breathing is impaired, increased oxygen tensions or mechanical respiratory assistance may be necessary.

Liver

Liver function tests indicate that almost all inhalation anesthetic agents cause some alterations in hepatic function. In most cases, the effects are reversible and not serious. Halothane has been associated with serious hepatic necrosis, however, especially if the patient has had prior anesthesia with halothane or has preexisting liver disease. There is evidence that a reactive metabolite, trifluoroacetyl chloride, combines with hepatic proteins to form antigens that can trigger a fulminant allergic reaction.

Kidney

General anesthetics depress glomerular filtration and urine output by reducing renal blood flow. These alterations in renal function are transitory and readily reversible. The release of F^- from methoxyflurane has occasionally produced serious renal damage, which has led to its discontinued use in North America.

Skeletal Muscle

Although most general anesthetics produce muscle relaxation by their actions on spinal cord and brainstem motor reflex centers, the volatile anesthetic agents have an additional effect on the neuromuscular junction. Ether is most prominent in this respect and can produce sufficient muscle relaxation by itself for surgical procedures. Even agents with a lesser degree of action, such as isoflurane, can decrease the dose of a neu-

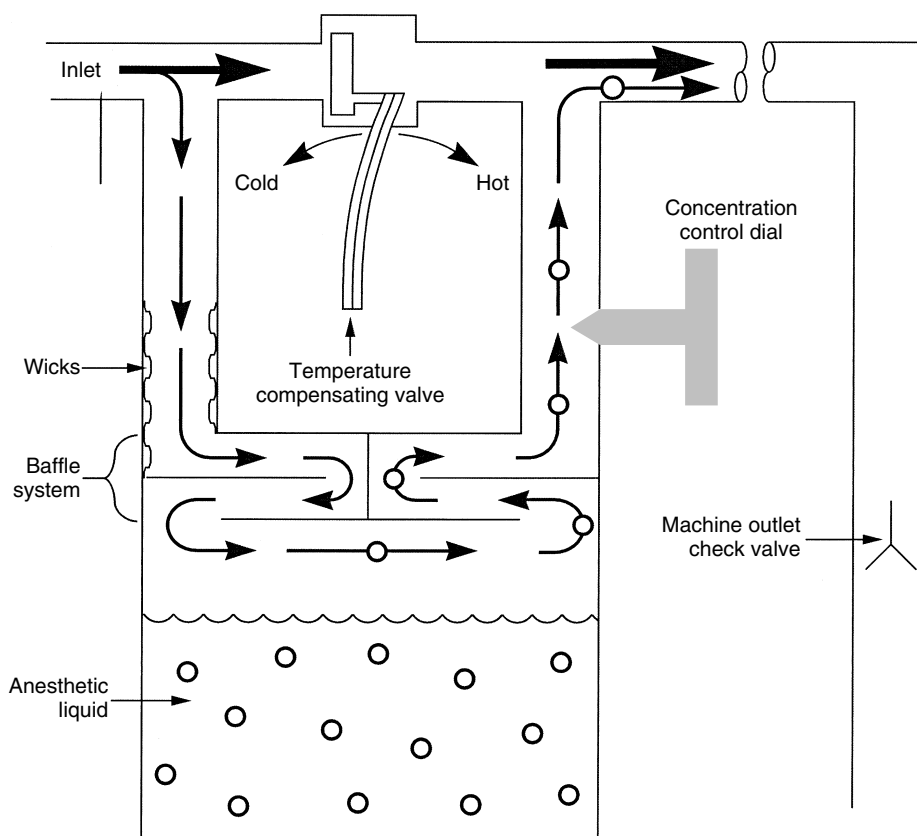

FIGURE 17-7 Temperature-compensated, variable-bypass vaporizer. (Redrawn from Brockwell RC, Andrews JJ: Delivery systems for inhaled anesthetics. In Barash PG, Cullen BF, Stoelting RK, editors: *Clinical anesthesia*, Philadelphia, 2006, Lippincott Williams & Wilkins.)

romuscular blocker by 65%. Cholinesterase inhibition by neostigmine does not antagonize this effect as it does for such nondepolarizing blocking agents as tubocurarine and vecuronium.

ADMINISTRATION OF ANESTHETIC GASES

Various delivery systems have been used since the inception of anesthesia; these range from simple techniques such as the open-drop method on a facemask or nose cone to anesthetic machines that incorporate numerous technical devices. Figure 17-6 illustrates the major components of modern delivery systems, including the nonbreathing system used for nitrous oxide administration in dentistry, and the circle system commonly used in the hospital in which the patient rebreathes at least a portion of the exhaled gas.

Anesthesia delivery systems incorporate the following features: (1) gases, including oxygen, stored in either local tanks or a central delivery system; (2) regulators to control the pressure of gases delivered; (3) safety systems that warn of dangerous pressures and shut off flow if oxygen delivery is interrupted; (4) mixing valves (adjustable flowmeters) to regulate the percentages of gases; (5) vaporizers to volatilize anesthetic liquids; (6) carbon dioxide absorber system (not required for nonbreathing systems); (7) reservoir bag, ventilator, or both; (8) assorted tubing and one-way valve systems; (9) facemask, laryngeal mask, or endotracheal tube; and (10) vacuum exhaust line.

Central to the administration of volatile general anesthetics is the temperature-compensated, variable-bypass vaporizer

(Figure 17-7). This device provides the simple selection of anesthetic concentration because it automatically compensates for changes in total gas flow and for changes in the ambient temperature. In the case of desflurane, which boils at 23° C, the vaporizer must be heated electrically to 39° C to ensure controlled delivery.

Several considerations in the administration of anesthetic gases in modern anesthesiology should be mentioned. First, although some older agents (e.g., ether and cyclopropane) were highly effective, certain deficits caused their abandonment in favor of newer agents, such as isoflurane, which do not share the same problems. In particular, the explosive character of cyclopropane has caused its use to be banned. Second, some newer agents, such as desflurane, are expensive, so closed systems for their administration are favored. Third, retrospective surveys have provided evidence that operating room personnel (surgeons, anesthesiologists, nurses) and dentists and their employees exposed to nitrous oxide may be adversely affected by trace amounts of inhalation anesthetics. Specifically, exposed health care workers reported a higher incidence of hepatic, renal, and neurologic disorders; increased congenital malformations in children born to exposed women; and increased spontaneous abortions in exposed women and wives of exposed men.¹

Animal studies indicate that nitrous oxide is the agent of major concern and that the threshold concentration of nitrous oxide for producing a biologic response is approximately 500 ppm to 1000 ppm.³³ Although retrospective studies that used examination of public health registries could find no link between working in an operating room (or being exposed to anesthetic gases) and increased risk of miscarriage or congeni-

BOX 17-1

Steps to Reduce Nitrous Oxide Exposure

Facility and Equipment Preparation

- Purchase scavenging nitrous oxide delivery systems with air sweeper capabilities
- Check plumbing for leaks by pressure retention of closed system
- Check all fittings for leaks with disclosing solution or nitrous oxide analyzer
- Ensure exhaust system vents to the outside away from air intake
- Maximize room air circulation
- Consider use of a local exhaust system

Daily Use

- Adjust vacuum setting to manufacturer's maximum recommended value
- Place hood on nose before administering nitrous oxide
- Adjust flow to patient's minute respiratory volume
- Instruct patient to exhale through nose
- Instruct patient not to talk
- Use rubber dam whenever possible
- Use high-vacuum suction when mouth is open
- Administer 100% oxygen for 3 to 5 minutes before removing hood

Monitoring

- Inspect delivery apparatus each day of use, particularly the reservoir bag
- Periodically monitor exposure by passive dosimetry or nitrous oxide analyzer
- Record monitoring results

tal malformation,^{3,10} Rowland and coworkers^{27,28} have linked reproductive toxicity in dental assistants to nitrous oxide exposure of more than 3 to 5 hours per week. Most authorities therefore favor using anesthetic delivery devices in conjunction with scavenger exhaust systems and ventilation systems that remove leaked anesthetic gases from the vicinity of the patient.²² Because many dentists function as anesthetist and surgeon, the nonbreathing flow machine is most commonly used. Its simplicity of operation and compatibility with minimal-moderate sedation is coupled with the major disadvantage of exposing operator personnel to potentially high concentrations of anesthetic gases (i.e., nitrous oxide) unless a concerted effort is made to minimize pollution, as is outlined in Box 17-1. The National Institute for Occupational Safety and Health has prepared a monograph to assist dentists in minimizing exposure to nitrous oxide in the workplace.²²

CITED REFERENCES

1. Cohen EN, Gift HC, Brown BW, et al: Occupational disease in dentistry and chronic exposure to trace anesthetic gases. *J Am Dent Assoc* 101:21-31, 1980.
2. Dilger JP, Vidal AM, Mody HI, et al: Evidence for direct actions of general anesthetics on an ion channel protein: a new look at a unified mechanism of action. *Anesthesiology* 81:431-442, 1994.
3. Ericson HA, Kallen AJB: Hospitalization for miscarriage and delivery outcome among Swedish nurses working in operating rooms 1973-1978. *Anesth Analg* 64:981-988, 1985.
4. Evers AS: Cellular and molecular mechanisms of anesthesia. In Barash PG, Cullen BF, Stoelting RK, editors: *Clinical anesthesia*, ed 5, Philadelphia, 2006, Lippincott Williams & Wilkins.
5. Forman SA, Miller KW, Yellen G: A discrete site for general anesthetics on a postsynaptic receptor. *Mol Pharmacol* 48:574-581, 1995.
6. Franks NP: General anaesthesia: from molecular targets to neuronal pathways of sleep and arousal. *Nat Rev Neurosci* 9:370-386, 2008.
7. Franks NP, Lieb WR: Mechanisms of general anesthesia. *Environ Health Perspect* 87:199-205, 1990.
8. Guedel AE: *Inhalation anesthesia: a fundamental guide*, New York, 1937, Macmillan.
9. Hemmings HC Jr, Akabas MH, Goldstein PA, et al: Emerging molecular mechanisms of general anesthetic action. *Trends Pharmacol Sci* 26:503-510, 2005.
10. Hemminki K, Kyyronen P, Lindbohm ML: Spontaneous abortions and malformations in the offspring of nurses exposed to anaesthetic gases, cytostatic drugs, and other potential hazards in hospitals, based on registered information of outcome. *J Epidemiol Commun Health* 39:141-147, 1985.
11. Hibbard LS, McGlone JS, Davis DW, et al: Three-dimensional representation and analysis of brain energy metabolism. *Science* 236:1641-1646, 1987.
12. Ishizawa Y: Mechanisms of anesthetic actions and the brain. *J Anesth* 21:187-199, 2007.
13. Jevtovic-Todorovic V, Todorovic SM, Mennerick S, et al: Nitrous oxide (laughing gas) is an NMDA antagonist, neuroprotectant and neurotoxin. *Nat Med* 4:460-463, 1998.
14. Johansson JS, Scharf D, Davies LA, et al: A designed four- α -helix bundle that binds the volatile general anesthetic halothane with high affinity. *Biophys J* 78:982-993, 2000.
15. Johns RA, Moscicki JC, DiFazio CA: Nitric oxide synthase inhibitor dose-dependently and reversibly reduces the threshold for halothane anesthesia. *Anesthesiology* 77:779-784, 1992.
16. Kingery WS, Agashe GS, Guo TZ, et al: Isoflurane and nociception: spinal α 2A adrenoreceptors mediate antinociception while supraspinal α 1 adrenoreceptors mediate pronociception. *Anesthesiology* 96:367-374, 2002.
17. Koblin DD: Mechanisms of action. In Miller RD, editor: *Miller's anesthesia*, ed 6, Philadelphia, 2005, Saunders.
18. Levine LL, Winter PM, Nemoto EM, et al: Naloxone does not antagonize the analgesic effects of inhalation anesthetics. *Anesth Analg* 65:330-332, 1986.
19. Lin L, Koblin DD, Wang HH: Saturable binding of anesthetics to nicotinic acetylcholine receptors: a possible mechanism of anesthetic action. *Ann N Y Acad Sci* 625:628-644, 1991.
20. Morgan PG, Hoppel CL, Sedensky MM: Mitochondrial defects and anesthetic sensitivity. *Anesthesiology* 96:1268-1270, 2002.
21. Morgan PG, Kayser E-B, Sedensky MM: C. *elegans* and volatile anesthetics (May 3, 2007). *WormBook*, ed: The C. *elegans* Research Community, WormBook, doi/10.1895/Wormbook.1.1401. Available at: http://wormbook.org/chapters/www_anesthetics/anesthetics.html. Accessed January 8, 2010.
22. National Institute for Occupational Safety and Health: *Hazard controls, HC3: control of nitrous oxide in dental operatories*, DHHS Publication No. [NIOSH] 96-107, Cincinnati, 1996. U.S. Department of Health and Human Services, Public Health Service, Centers for Disease Control and Prevention, National Institute for Occupational Safety and Health.
23. Nicoll RA, Madison DV: General anesthetics hyperpolarize neurons in the vertebrate central nervous system. *Science* 217:1055-1057, 1982.
24. Orii R, Ohashi Y, Guo T, et al: Evidence for the involvement of spinal cord α 1 adrenoreceptors in nitrous oxide-induced antinociceptive effects in Fischer rats. *Anesthesiology* 97:458-465, 2002.
25. Perouansky M, Hemmings HC, Jr: Presynaptic actions of general anesthetics. In Antognini JE, Carstens EE, Raines DE, editors: *Neural mechanisms of anesthesia*, Totowa, NJ, 2003, Humana.
26. Pocock G, Richards CD: Cellular mechanisms of general anaesthesia. *Br J Anaesth* 6:116-128, 1991.
27. Rowland AS, Baird DD, Shore DL, et al: Nitrous oxide and spontaneous abortion in female dental assistants. *Am J Epidemiol* 141:531-538, 1995.
28. Rowland AS, Baird DD, Weinberg CR, et al: Reduced fertility among women employed as dental assistants exposed to high levels of nitrous oxide. *N Engl J Med* 327:993-997, 1992.

29. Smith RA, Wilson M, Miller KW: Naloxone has no effect on nitrous oxide anesthesia. *Anesthesiology* 49:6-8, 1978.
30. Tanelian DL, Kosek P, Mody I, et al: The role of the GABAA receptor/chloride channel complex in anesthesia. *Anesthesiology* 78:757-776, 1993.
31. Trudell JR: A unitary theory of anesthesia based on lateral phase separations in nerve membranes. *Anesthesiology* 46:5-10, 1977.
32. Trudell JR: Biophysical concepts in molecular mechanisms of anesthesia. In Fink BR, editor: *Molecular mechanisms of anesthesia. Progress in anesthesiology*, vol 2, New York, 1980, Raven Press.
33. Vieira E, Cleaton-Jones P, Moyes D: Effects of low intermittent concentrations of nitrous oxide on the developing rat fetus. *Br J Anaesth* 55:67-69, 1983.
34. Winters WD: Effects of drugs on the electrical activity of the brain: anesthetics. *Annu Rev Pharmacol Toxicol* 16:413-426, 1976.
35. Yang JC, Clark WC, Ngai SH: Antagonism of nitrous oxide analgesia by naloxone in man. *Anesthesiology* 52:414-417, 1980.
36. Zhang C, Davies MF, Guo TZ, et al: The analgesic action of nitrous oxide is dependent on the release of norepinephrine in the dorsal horn of the spinal cord. *Anesthesiology* 91:1401-1407, 1999.

GENERAL REFERENCES

- Barash PG, Cullen BF, Stoelting RK, editors: *Clinical anesthesia*, ed 5, Philadelphia, 2006, Lippincott Williams & Wilkins.
- Frost EAM: *Essays on the history of anesthesia*, Georgetown, CT, 1985, McMahon.
- Miller RD, editor: *Miller's anesthesia*, ed 6, Philadelphia, 2005, Saunders.
- Schüttler J, Schwilden H, editors: *Modern anesthetics. Handbook of experimental pharmacology*, vol 182, New York, 2008, Springer.
- Wolfe RJ, Menczer LF, editors: *I awaken to glory*, Canton, MA, 1994, Science History Publications/USA.

Agents Used in General Anesthesia and Sedation

DANIEL A. HAAS AND JOHN A. YAGIELA

General anesthesia can be induced by many compounds of diverse chemical structure, including inorganic compounds, halogenated hydrocarbons, simple alcohols, aromatic agents, steroids, and other drugs that affect the central nervous system (CNS). General anesthetics are available as gases, volatile liquids, and solutions suitable for parenteral injection. When administered in lower doses, many of these same drugs may cause clinically useful sedation. This chapter describes the pharmacologic features of drugs used in general anesthesia and various levels of sedation. The application of these agents in dentistry, in particular for sedation, is reviewed in Chapter 48.

INHALATION AGENTS

Gases and volatile liquids are the oldest known anesthetic agents and have been the most widely used. Today, the only commonly used gas is nitrous oxide. Although general anesthetic agents administered by inhalation are often divided into gases and volatile liquids, there are few differences between these two classes of substances other than boiling point (Table 18-1) and solubility in various tissues (see Table 17-2). Regarding boiling point, which determines the vapor pressure of the gaseous phase, liquids need vaporizers, which produce and maintain an adequate amount of anesthetic in the inspired air. Because tissue solubility (i.e., solubility in brain membranes) is normally greater with the volatile liquids than gases, a smaller concentration of volatile agent is required in the inspired air to produce general anesthesia. An ideal inhalation anesthetic should possess numerous characteristics as outlined in Box 18-1.⁴⁴

Nitrous Oxide

Nitrous oxide is arguably the oldest general anesthetic agent (see Chapter 17 for a review of the discovery of anesthesia) and the only gaseous anesthetic currently in use. Nitrous oxide is also the only inorganic substance used clinically as an anesthetic. Several features unique to nitrous oxide among available agents include a minimum alveolar concentration (MAC) greater than 100%, strong analgesic properties in subanesthetic concentrations, and minimal relaxation of skeletal muscle.

Physical and chemical properties

Nitrous oxide is a colorless, nonirritating gas with a pleasant, mild odor and taste. The structural formula is shown in Figure 18-1. Its blood/gas partition coefficient of 0.47 means that it is poorly soluble in blood. It is nonflammable but can support combustion in the absence of oxygen. It is available in pressurized steel cylinders as a liquid in equilibrium with its gas

phase. As the nitrous oxide gas is delivered from the cylinder, liquid nitrous oxide spontaneously vaporizes to replace the lost gas phase. Cylinder pressure is maintained unaltered by this process until all the liquid has vaporized, at which point approximately four fifths of the contents have been released. This vaporization process requires heat, which is provided from the cylinder and the air around it, causing the tank to become cold.

Anesthetic properties

Because of its very low solubility in blood, a state of equilibrium between the alveolar and arterial tensions is quickly reached, allowing induction and awakening to occur very rapidly. The primary disadvantage of nitrous oxide as a general anesthetic is its lack of potency, as reflected by its high MAC of approximately 105%. (A concentration >100% value unobtainable at ambient conditions is achieved by placing the subject in a hyperbaric chamber.) At normal concentrations and when given with adequate amounts of oxygen, nitrous oxide is incapable of producing full surgical anesthesia by itself, and it is most commonly used as a supplement to volatile anesthetics. To ensure adequate oxygenation of the patient, nitrous oxide is normally not used at a concentration greater than 70%. When it is administered with other anesthetic agents, the maintenance concentration normally used is 50% to 70%.

In dentistry, nitrous oxide is usually administered in subanesthetic concentrations of 20% to 50% to provide mild-to-moderate sedation and analgesia. Concentrations above this range may impair the patient's ability to maintain consciousness and lead to a greater incidence of adverse effects, such as nausea or dysphoria. At a 40% concentration, there is good hard and soft tissue analgesia. Awareness of sensory input is reduced, with the exception that sounds may seem louder and qualitatively different.⁹⁴

When nitrous oxide is used with a more potent agent, it is possible to reduce the concentration of the other drug and still achieve a more rapid induction and a shorter recovery period. This phenomenon is a reflection of the fact that the MAC of the rapidly acting nitrous oxide is additive with that of other, slower acting inhalation anesthetics. The addition of 70% nitrous oxide, which is approximately 0.6 MAC, reduces the MAC of halothane from 0.75% to 0.29% and the MAC of isoflurane from 1.15% to 0.5%, each approximately a 60% reduction. In addition, the concentration and second gas effects described in Chapter 17 can help hasten the onset of anesthesia.

Cardiovascular effects. In contrast to the volatile anesthetics in current use, nitrous oxide does not usually produce any clinically significant cardiovascular effects. It has a weak, dose-

Inhalation agents

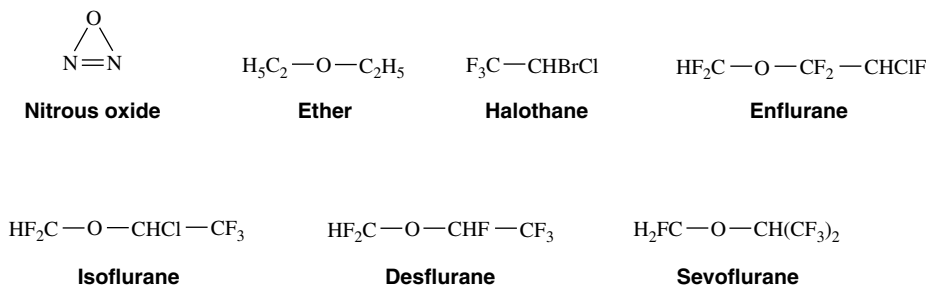

Intravenous agents

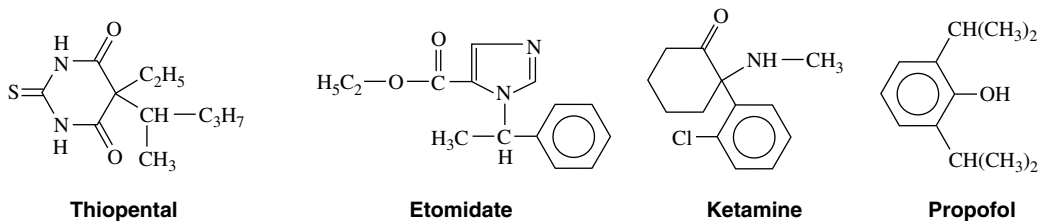

FIGURE 18-1 Structural formulas of anesthetic drugs.

TABLE 18-1

Physical Properties of Inhalation Anesthetics

AGENT	MOLECULAR WEIGHT	BOILING POINT (°C [1 atm])	VAPOR PRESSURE (mm Hg [20° C])
Nitrous oxide	44	-88.5	38,770 (gas)
Desflurane	168	23.5	669
Ether	74.1	34.6	440
Isoflurane	184.5	48.5	238
Halothane	197.4	50.2	243
Sevoflurane	200	58.6	157

BOX 18-1

Ideal Characteristics of an Inhalation Agent

- Stable in light, alkali, and soda lime
- Nonflammable
- Highly potent, allowing use with high concentrations of oxygen
- Low solubility in blood to allow rapid induction and rapid recovery
- No or minimal biotransformation
- No toxicity
- Nonirritating to respiratory mucosa
- Minimal cardiovascular and respiratory effects

dependent myocardial depressant effect and a mild sympathomimetic effect.⁴⁶ These opposing influences tend to cancel each other, leading to minimal to no change in cardiac output. Patients at increased risk of the cardiac depressant effects of nitrous oxide include patients with chronic hypertension, left ventricular failure, and advanced atherosclerotic disease.

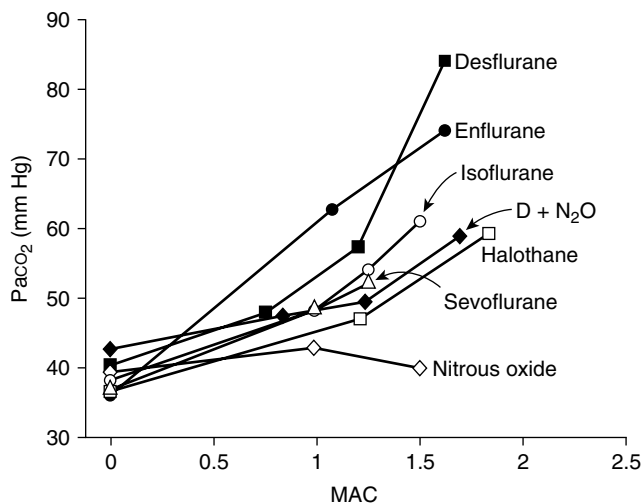

FIGURE 18-2 Arterial carbon dioxide tension (P_{aco_2}) in spontaneously breathing volunteers as a function of the minimum alveolar concentration (MAC). (Adapted from Doi M, Ikeda K: Respiratory effects of sevoflurane, *Anesth Analg* 66:241-244, 1987; Eger EI II: Isoflurane: a review, *Anesthesiology* 55:559-576, 1981; and Lockhart SH, Rampil IJ, Yasuda N, et al: Depression of ventilation by desflurane in humans, *Anesthesiology* 74:484-488, 1991.)

Respiratory effects. Nitrous oxide is not a strong respiratory depressant (Figure 18-2), but it decreases tidal volume and increases respiratory rate. Even so, there is likely to be less respiratory depression than would be caused by an equal depth of anesthesia induced by a single potent anesthetic drug. Although nitrous oxide has little effect on respiration in normal individuals, whose ventilation is regulated by the arterial carbon dioxide tension (P_{aco_2}), patients with severe chronic obstructive pulmonary disease whose ventilatory drive depends on the arterial oxygen tension may become severely hypoxic on exposure to even sedative concentrations

of anesthetic.¹⁰¹ Even if hypoxemia is prevented by the high concentration of oxygen that is being coadministered (which by itself blunts the hypoxic drive for respiration), hypoventilation and respiratory acidosis are likely outcomes.

Elimination. Nitrous oxide is eliminated unchanged in the exhaled gas; however, 0.004% undergoes reductive metabolism to nitrogen by bacteria in the gastrointestinal tract.

Adverse effects

When used for sedation, nitrous oxide usually provides a feeling of relaxation, along with the possible symptoms of body warmth, tingling of the hands and feet, circumoral numbness, auditory effects, and euphoria. As the dose increases, the patient is more likely to develop adverse symptoms such as dysphoria and nausea.^{27,28} Some patients may develop acute tolerance to these effects.⁷⁵

For general anesthesia, high concentrations are used, and because its solubility in blood greatly exceeds that of nitrogen, nitrous oxide increases the volume of any enclosed air pocket in the body. There are several situations in which this property can be problematic: with a pneumothorax or lung bullae, injection of air into the ventricles during a pneumoencephalogram, an obstructed bowel, a blocked eustachian tube (with potential damage to the tympanic membrane), or after eye surgery that uses intraocular gases. With respect to vitreoretinal surgery, such as the surgical repair of retinal detachments and macular holes, perfluoropropane or sulfur hexafluoride is introduced within the eye to act as a tamponading agent. These gases may persist in the eye for up to 3 months. Administration of general anesthesia during this interval has led to case reports of irreversible loss of vision.^{9,35,96} These case reports suggest that nitrous oxide should be avoided in patients who have had vitreoretinal surgery with intraocular gas infusion in the past 3 months.

High concentrations of nitrous oxide may also result in a considerable accumulation of dissolved gas within the body, and when the administration is stopped, large volumes of nitrous oxide diffuse from the blood into the lung alveoli, diluting oxygen. This temporary reduction in the amount of alveolar oxygen is termed *diffusion hypoxia* and can be prevented by administering 100% oxygen for 3 to 5 minutes after the cessation of nitrous oxide.

Nitrous oxide is not acutely toxic, but it can affect DNA synthesis by inducing changes in folate and amino acid metabolism. Its administration leads to an increase in homocysteine and 5-methyltetrahydrofolate.³³ Nitrous oxide oxidizes the cobalt atom in vitamin B₁₂, which renders inactive the vitamin B₁₂-dependent enzyme methionine synthase. Methionine synthase is required to form the essential amino acid methionine (from homocysteine) and to transform 5-methyltetrahydrofolate into an active form for subsequent reactions. The enzyme is quickly inactivated in vivo by brief exposures to nitrous oxide.^{25,56} This inactivation increases with the nitrous oxide concentration and duration of exposure, is permanent, and requires synthesis of new enzyme for restoration of normal metabolism.^{55,80} Methionine deficiency is believed to be associated with degenerative nervous system changes. It has been suggested that preoperative administration of methionine may counteract some of the adverse effects of nitrous oxide on the hematologic and nervous systems,¹⁷ and methionine has been used in the treatment of nitrous oxide-induced neuropathy.⁹¹

Continuous inhalation of nitrous oxide can result in altered hematopoiesis because of the suppression of DNA synthesis. Patients exposed to 50% nitrous oxide for 6 hours may begin to show evidence of impaired thymidylate metabolism; hematopoietic changes suggestive of pernicious anemia occur after 24 hours of continuous inhalation.¹ Intermittent

exposures have a cumulative effect if spaced more frequently than once every 3 to 4 days.⁷¹ These findings have limited the use of nitrous oxide as an analgesic agent for extended use and for procedures that must be repeated often, such as debridement of burned skin.

The inhibition of methionine synthesis by nitrous oxide has been associated with an increased risk of myocardial ischemia in patients undergoing vascular surgery.⁴ Patients at special risk include patients with genetic mutations that cause a deficiency in 5,10-methylenetetrahydrofolate reductase activity.⁷⁰ This enzyme generates the 5-methyltetrahydrofolate required for methionine synthesis; its deficiency potentiates the pathway block caused by nitrous oxide. Pretreatment with B vitamin supplements for 1 week before anesthesia can prevent the hyperhomocysteinemia believed to cause these adverse effects.

Similar to other mood-altering drugs, nitrous oxide may be abused by individuals with access to the drug, including members of the dental profession. This abuse is associated with myeloneuropathic changes indicative of a pernicious anemia-like syndrome: numbness and paresthesia, muscular weakness and incoordination, altered spinal reflexes, impotence, and shooting sensations on flexion of the neck (Lhermitte's sign).⁶²

Nitrous oxide has been shown to inhibit the release of luteinizing hormone-releasing hormone by the hypothalamus, which theoretically may impair fertility.^{59,60} Potential reproductive toxicity has also been proposed to be caused by the sympathomimetic effects of nitrous oxide leading to vasoconstriction and diminished uterine blood flow.^{36,68} Clinical use in pregnant women carries no apparent increased risk to the fetus, however, over other acceptable forms of pain control.^{23,67} Long-term exposure has been strongly implicated in other reproductive abnormalities, such as spontaneous abortion¹⁹ and impaired fertility,⁷⁹ but these effects have not been substantiated by controlled prospective studies.

The possibility that long-term exposure to trace concentrations of nitrous oxide may be a health hazard to dental office and operating room personnel is discussed in Chapter 17.¹⁹ An early report of inhaled concentrations of as little as 50 ppm over a 2-hour span causing impairment in audiovisual performance tasks¹² has not been reproduced.^{21,89} Nevertheless, this finding prompted the National Institute for Occupational Safety and Health to recommend 25 ppm as a maximum permissible time-weighted exposure limit per anesthetic administration for all health care workers. This level may not be achievable with some existing scavenging systems,¹⁰⁰ so other measures (e.g., using rubber dam, using high-velocity suction, limiting the patient's talking) must be used to minimize the gas escaping into the room. As discussed in Chapter 17, the issue of controlling waste anesthetic gas in the workplace continues to evolve.

Therapeutic uses

Nitrous oxide is a widely used inhalation anesthetic and continues to play a major role in the delivery of medical and dental anesthesia. It is valuable in reducing the concentration of volatile anesthetics during inhalation anesthesia and as a component of "balanced anesthesia."* Historically, nitrous oxide was first used for dental surgery, but with the advent

**Balanced anesthesia* is a term used to describe a concept in which combinations of drugs are used to produce general anesthesia, with each drug chosen for a specific effect. In this context, the following drugs might be selected: nitrous oxide for its analgesic and anesthetic actions, a benzodiazepine for amnesia, a neuromuscular blocking drug for muscle relaxation, and an opioid for additional analgesia and hemodynamic stability.

of local anesthetics, it was replaced as the drug of choice for providing pain control sufficient for most dental procedures. Since the late 1950s, there has been an upsurge in the use of nitrous oxide, not to provide dental anesthesia, but to provide relief from anxiety in the form of minimal-moderate sedation. In this role, it is often the agent of first choice. Its therapeutic application in dentistry is described in Chapter 48. Conversely, its use for general anesthesia in medicine is declining because of the increasing reliance on intravenous anesthesia coupled with concerns about occupational exposure to the gas. In these settings the potential for nitrous oxide to increase homocysteine concentrations and the risk of postoperative vascular thrombosis, myocardial ischemia, and stroke become significant.

Ether

Ether (diethyl ether) was the most widely used volatile anesthetic in the century that followed the first successful demonstration of general anesthesia in 1846. As described in Chapter 17, the sequential effects of ether inhalation were the basis for Guedel's stages of anesthesia. Ether has been superseded by newer inhalation agents and is rarely used as a general anesthetic in North America. A brief description is included because of its historical importance.

Ether is flammable, explosive, and an irritating liquid with a pungent odor. This last property, combined with a blood/gas partition coefficient of 12.1, makes its induction and recovery periods slow and unpleasant. Ether's advantages are its ability to produce good analgesia and muscle relaxation and to maintain respiration and circulation, its relative freedom from myocardial sensitization and organ toxicity, and its ease of administration. The drug's main disadvantages are its flammability and explosive potential, slow induction, slow recovery, irritation to the upper airway causing copious mucus secretion, and prominent emetic properties.

Halothane

Halothane was one of the most widely used anesthetics after its introduction into clinical anesthesia in 1956 in the United Kingdom and in 1958 in the United States. Its use in developed countries has greatly declined with the introduction of newer volatile agents; halothane is no longer marketed in the United States. Nevertheless, halothane is the only volatile

anesthetic recognized by the World Health Organization as an essential medicine, and it remains the standard with which other inhalation anesthetics are compared.

Physical and chemical properties

Halothane is a halogenated hydrocarbon; it is nonflammable, has a characteristic sweet odor, and is available in brown glass bottles with thymol added to maintain chemical stability. Its physical and solubility properties are summarized in Tables 17-2 and 18-1.

Anesthetic properties

Table 18-2 compares the pharmacologic properties of halothane with other inhalation anesthetics. With a MAC of 0.75%, halothane is a potent general anesthetic that can be administered with excess amounts of oxygen. With its blood/gas partition coefficient of 2.5, the induction time of halothane is faster than that of older drugs such as ether, but slower than that of nitrous oxide and the newer volatile agents currently in use. Halothane has poor analgesic properties; at surgical anesthetic levels, an unconscious patient may respond to a noxious stimulus with increased motor activity and alteration of autonomic parameters. For this reason, halothane is most often used with nitrous oxide or an opioid analgesic or both. Because halothane produces incomplete muscle relaxation, it is also often combined with neuromuscular blocking agents.

Cardiovascular effects. Halothane decreases the mean arterial blood pressure, primarily as a result of decreased cardiac output, and at 1 MAC it decreases by 25% (Figure 18-3). The decrease in cardiac output is greater than that found with equipotent amounts of isoflurane. Halothane, similar to other volatile general anesthetics, has a direct, significant, and dose-dependent depressant effect on myocardial contractility and, to a lesser degree, on vascular smooth muscle.⁸¹ The negative inotropic effect is attributed to a decrease in the influx of Ca^{++} through the slow channels of the sarcolemma, a decrease in Ca^{++} accumulation in the sarcoplasmic reticulum, and a decrease in Ca^{++} sensitivity of contractile proteins.

Halothane exerts a direct negative chronotropic effect at the sinoatrial node as a result of reduced cardiac sympathetic activity and vagal predominance. This depression leads to a

TABLE 18-2

Pharmacologic Properties of Inhalation Anesthetics

ATTRIBUTE OR EFFECT	NITROUS OXIDE	HALOTHANE	ISOFLURANE	DESFLURANE	SEVOFLURANE
Analgesia	Good	Poor	Moderate	Moderate	Moderate
Muscle relaxation	None	Moderate	Good	Good	Moderate
Heart rate	May increase	Unchanged	Increased	Increased	Unchanged
Myocardial depression	Mild	Marked	Moderate	Moderate	Moderate
Cardiac output	Unchanged	Decreased	Unchanged	Unchanged	Decreased
Vascular resistance	Unchanged	Slightly decreased	Decreased	Decreased	Decreased
Blood pressure	Unchanged	Decreased	Decreased	Decreased	Decreased
Arrhythmogenic potential	None	High	Low	Low	Low
Respiratory depression	Mild	Moderate	Moderate-marked	Marked	Moderate-marked
Respiratory rate	Slightly increased	Increased	Increased	Increased	Increased
Tidal volume	Decreased	Decreased	Decreased	Decreased	Decreased
Bronchi	No effect	Dilation	Dilation	Brief constriction	Dilation
Airway irritation	None	Mild	Moderate	Marked	Mild
EEG activity	No effect	Depressed	Depressed	Depressed	Depressed
Renal function	No effect	Decreased	Decreased	Decreased	Decreased
Biotransformation	0.004%	20-40%	0.2%	0.02%	2-5%
Hepatotoxicity	None	Reported	Rare	Rare	None

EEG, Electroencephalography.

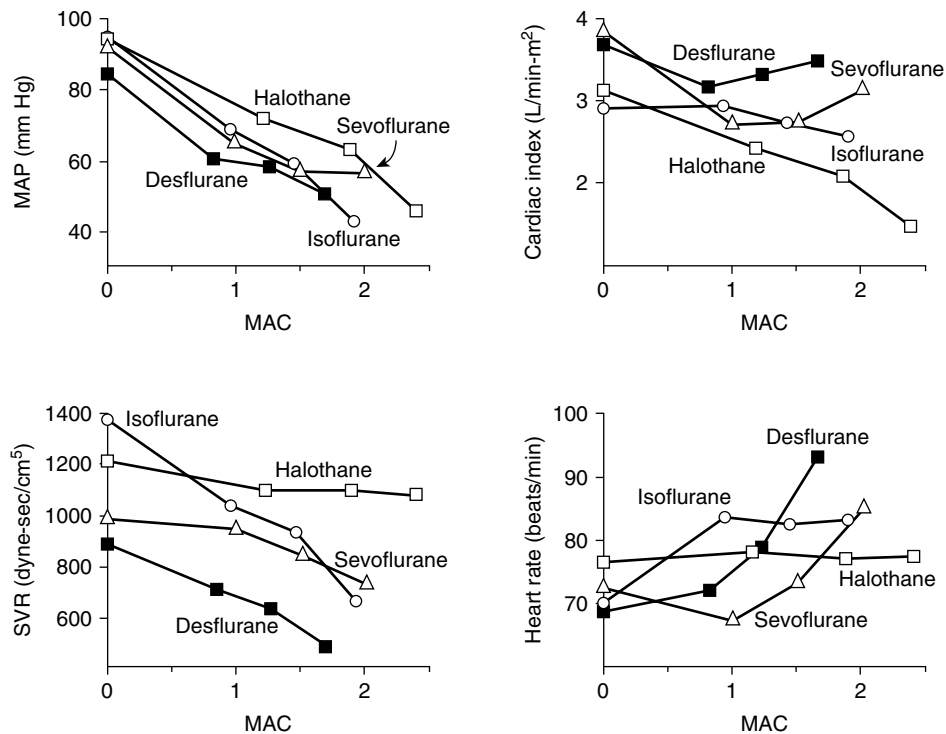

FIGURE 18-3 Cardiovascular effects of inhalation anesthetics as a function of the minimum alveolar concentration (MAC). HR, Heart rate; MAP, mean arterial blood pressure; SVR, systemic vascular resistance. (Adapted from Malan TP Jr, DiNardo JA, Isner RJ, et al: Cardiovascular effects of sevoflurane compared with those of isoflurane in volunteers, *Anesthesiology* 83:918-928, 1995; and Weiskopf RB, Cahalan MK, Eger EI II, et al: Cardiovascular actions of desflurane in normocarbic volunteers, *Anesth Analg* 73:143-156, 1991.)

slowing of the heart rate and possible junctional rhythms. Halothane also depresses the baroreceptor reflex and suppresses the expected increase in heart rate caused by hypotension.⁵ Halothane is a vasodilator; the peripheral systemic vascular resistance may be decreased, especially in patients with high sympathetic tone (e.g., patients with congestive heart disease or hypertension).

There is no stimulation of sympathoadrenal discharge with halothane and no increase in plasma catecholamines. Halothane sensitizes the myocardium to catecholamines, however, which can predispose to cardiac dysrhythmias,⁷ and this effect may be potentiated further by thiopental or hypercarbia. Dysrhythmias can occur as a result of catecholamines released endogenously in response to an elevated P_{aCO_2} or surgical stress, or after the injection of pressor agents given to augment blood pressure. Of direct relevance to dentistry is the use of epinephrine as the vasoconstrictor in local anesthetics and gingival retraction cords. For submucosal administration, it is recommended to limit exogenous epinephrine administration to 1 $\mu\text{g}/\text{kg}$ if halothane is used with thiopental and 2 $\mu\text{g}/\text{kg}$ if used alone.¹⁸ Avoidance of hypoxia, hypercarbia, and electrolyte abnormalities also reduces the likelihood of this adverse event.

Respiratory effects. Halothane induces dose-dependent respiratory depression. At light anesthetic levels, breathing becomes shallow and rapid, and the P_{aCO_2} is maintained at a concentration 25% higher than normal (see Figure 18-2). Tidal volume decreases. As with all inhalation anesthetics, the ventilatory response to carbon dioxide is diminished, and controlled ventilation is frequently necessary in deeper planes of anesthesia. Halothane virtually eliminates the respiratory stimulant effect of hypoxia at concentrations ≥ 0.1 MAC. Halothane is an

effective bronchodilator, which is beneficial in the asthmatic patient.

Other effects. Halothane depresses the cerebral metabolic rate. Intracranial pressure usually increases, as does cerebral blood flow. The production of cerebrospinal fluid is decreased, but so too is its absorption. Halothane relaxes uterine smooth muscle. Halothane also causes a dose-dependent decrease in renal blood flow and glomerular filtration, which is thought to parallel the decrease in cardiac output.

Metabolism. A significant portion ($\geq 20\%$) of the administered halothane is biotransformed in the liver, primarily by oxidation by the cytochrome P450 microsomal oxidase system.^{14,24} Reduction accounts for 2% of the metabolism. In contrast to other inhalation anesthetics, hepatic metabolism is an important contributor to the elimination of halothane. The metabolites include trifluoroacetic acid, which may be responsible for toxic effects in the liver (as described later), and Cl^- and Br^- .

Adverse effects

Halothane has been associated with delayed hepatotoxicity, which may manifest as one of two syndromes.^{29,32} The first is a mild, self-limited form of liver dysfunction that may occur after an initial exposure and has an incidence approximating 20%. This disturbance, usually recognized by an increase of liver enzymes in the plasma, may result from a direct effect of the drug or its metabolites. It may be exacerbated by liver hypoxia because it is strongly associated with impaired hepatocyte oxygenation because of preexisting liver disease, hypoxemia, or decreased hepatic blood flow.

The second syndrome, known as halothane hepatitis, is characterized by the development of massive hepatic failure

with a high mortality rate.¹⁰ This latter syndrome has an incidence approximating 1:10,000 in adults (1:100,000 in children) and is associated with repeated exposure to halothane. The clinical features of halothane hepatitis include gastrointestinal upset, jaundice, fever, rash, eosinophilia, and serum autoantibodies.^{5,77} This more fulminant form is caused by an immunologic mechanism. The oxidative metabolism of halothane leads to a reactive trifluoroacetyl halide metabolite. This metabolite induces antigenic changes to hepatic microsomal proteins, producing neoantigens and subsequent autoantibodies. Because of this syndrome, halothane is generally contraindicated in adults, especially individuals who have previously been exposed to halothane, or in any patient regardless of age who has shown signs of liver toxicity on previous exposure to halothane or related anesthetics.^{32,78} Halothane is also contraindicated for any abdominal surgery likely to decrease the alveolar ventilation or liver blood flow.

Malignant hyperthermia is a rare adverse effect of general anesthesia involving halothane, other volatile anesthetic agents, and the neuromuscular blocking drug succinylcholine. In the United States, the incidence of malignant hyperthermia is 1:50,000 in adults and 1:15,000 in children. It is a genetic disorder of multifactorial etiology. Most cases are associated with mutations in the ryanodine receptor (type 1), which forms a Ca^{++} channel in the sarcoplasmic reticulum and is involved in Ca^{++} -induced Ca^{++} release. Malignant hyperthermia can be associated with the following disorders: central core disease; Duchenne's muscular dystrophy; King-Denborough syndrome; other myopathies; and musculoskeletal congenital defects, such as cleft palate, scoliosis, clubfoot, ptosis, strabismus, cryptorchidism, and congenital hernias.^{11,92}

An acute crisis of malignant hyperthermia is a hypercatabolic reaction that often manifests initially as masseter or generalized muscle rigidity; other early signs include elevation of oxygen use and carbon dioxide production, tachypnea, and tachycardia. Cardiovascular instability, cardiac dysrhythmias, electrolyte disturbances, and elevation in temperature are other classic signs. The body temperature, often unaffected early in an acute attack, progressively increases to alarming and sometimes fatal levels. The elevated heat production, associated with increased Ca^{++} concentrations in the myoplasm and hypermetabolic activity of skeletal muscle, is responsible for the hyperthermia.⁴¹

Immediately on recognition, all triggering agents should be discontinued, and hyperventilation with 100% oxygen should be instituted. Dantrolene, an inhibitor of Ca^{++} transport (see Chapter 10), must be administered intravenously as soon as possible because this drug provides lifesaving, definitive treatment.⁴⁰ Dantrolene should be administered as a bolus intravenously at a dose of 2 mg/kg to 3 mg/kg and then titrated in response to the patient's clinical condition. If present, metabolic acidosis and any dysrhythmias or electrolyte disturbances should be treated. Cooling in the form of cold intravenous solutions, packing the patient in ice, and ice water lavage of body cavities should be performed to increase heat loss and reduce body temperature. Effective treatment rendered quickly after prompt recognition of malignant hyperthermia has reduced its mortality rate from 70% to less than 10%.

Therapeutic uses

Halothane was one of the most widely used general anesthetics in the two decades after its clinical introduction. Although its use has greatly diminished with the introduction of newer inhalation and intravenous agents, halothane may still be considered when a child is to be induced by inhalation because it does not have a strong odor and is nonirritating to the respiratory tract. Its primary drawback is its potential hepatotoxicity.

Isoflurane

After its release in the United States in 1981, isoflurane became the most widely used volatile anesthetic. It is an isomer of enflurane, which was a halogenated methyl ethyl ether introduced into clinical use in the United States in 1972, but since withdrawn from use. Isoflurane combines the desirable cardiovascular properties of enflurane with a freedom from seizure activity and less respiratory depression and hepatic metabolism. Although the newer, less soluble volatile anesthetics have made inroads in its use, isoflurane is less expensive and remains a useful anesthetic for many purposes.

Physical and chemical properties

The blood/gas partition coefficient of 1.4 for isoflurane results in a more rapid onset of action compared with halothane. Isoflurane is chemically stable, nonflammable, and marketed in brown glass bottles. The vapor is pungent and irritating to breathe.

Anesthetic properties

Isoflurane may be thought of as an improved but less potent (MAC of 1.15%) version of halothane. Induction should theoretically be relatively rapid with isoflurane, but it is limited by its pungent odor, which, if induction is allowed to proceed too rapidly, leads to breath holding, laryngospasm, and coughing. This problem is usually overcome by inducing the patient with an intravenous agent. Isoflurane is sufficiently potent to provide muscle relaxation adequate for any surgical procedure, but neuromuscular blocking agents are normally used instead of the high concentrations of anesthetic needed to secure muscle relaxation. As with other potent inhalation anesthetics, isoflurane increases the action of the nondepolarizing neuromuscular blocking drugs.

Cardiovascular effects. Similar to all volatile anesthetics, isoflurane produces a dose-dependent depression of myocardial contractility, but it is considerably less than that seen with halothane. Isoflurane also causes coronary vasodilation, mostly at the distal (resistance) arterioles.⁷⁴ Although this effect may be beneficial for heart muscle, it was also proposed to cause "coronary steal" in patients with ischemic heart disease, a situation in which blood flow is redistributed from myocardial tissues supplied by atherosclerotic arteries to areas with healthy coronary vessels. Coronary steal develops only when the coronary perfusion pressure is decreased, is more likely to occur with excessive tachycardia, and is most probably not a special concern with isoflurane. Cardiac output is well maintained with isoflurane (see Figure 18-3), even though stroke volume is decreased, by virtue of an increase in the heart rate, showing isoflurane's greater preservation of baroreceptor reflexes. Decreases in arterial blood pressure are similar to the decreases produced by halothane, however, because of the greater vasodilator effect of isoflurane. Isoflurane does not significantly sensitize the heart to dysrhythmias; the permissible injected dose of epinephrine during isoflurane anesthesia is three times that with halothane.

Respiratory effects. Respiratory depression is greater than that with halothane (see Figure 18-2) and manifests as a decreased ventilatory response to hypercapnia with a complete loss of sensitivity to hypoxia. Isoflurane increases respiratory rate only up to 1 MAC. Bronchodilation is similar to halothane.

Other effects. Isoflurane depresses cerebral metabolism in a manner similar to halothane. It is a less powerful cerebral vasodilator, however, and causes little change in the cerebrospinal fluid pressure. Isoflurane does not significantly alter

cerebrospinal fluid production. All these effects intracranially are beneficial in neurosurgery.

Metabolism. In contrast to halothane, biotransformation of isoflurane is quite low ($\leq 0.2\%$). This finding suggests that it is neither nephrotoxic nor hepatotoxic, a conclusion supported by observations that repeated and prolonged exposures to isoflurane have not caused hepatorenal injury in animals. It is biotransformed by the same enzymatic pathway as halothane. Although there are a few case reports of hepatic necrosis after isoflurane administration,^{15,39} it is currently believed that isoflurane is highly unlikely to be responsible for postoperative hepatotoxicity.⁷⁷

Therapeutic uses

Isoflurane is a suitable drug whenever a potent inhalation anesthetic is to be administered except when a mask induction of anesthesia is contemplated. In pediatric patients, induction with isoflurane is more likely to elicit coughing, salivation, and laryngospasm⁶⁹ than induction with halothane. These effects can be prevented by prior administration of an intravenous induction agent. Isoflurane has numerous advantages: it is chemically stable, nonflammable, and potent; induction is rapid, and muscle relaxation is adequate; and it is not dysrhythmogenic or toxic to the kidneys or liver. Isoflurane depresses the cardiovascular and respiratory systems. It is also contraindicated in patients with a history of malignant hyperthermia.

Desflurane

Desflurane, approved for clinical use in 1992, is the first volatile anesthetic agent whose blood/gas partition coefficient (0.42) compares favorably with that of nitrous oxide (0.47). The theoretic advantages desflurane should have regarding rapid induction and recovery of anesthesia are partially offset by the drug's tendency to irritate the airway during induction. Nevertheless, desflurane is particularly suited for ambulatory anesthesia and is commonly used for other situations in which an inhalation anesthetic is indicated. Also, the increased cost of desflurane is counterbalanced by the faster recovery of the patient.

Physical and chemical properties

Desflurane is chemically very similar to isoflurane, with only a single substitution of fluorine for a chlorine atom (see Figure 18-1). Desflurane shows marked chemical stability, possibly because of the additional fluorine, which provides resistance to breakdown in soda lime and to biotransformation. The anesthetic has a high vapor pressure of 664 mm Hg at 20°C, becomes a gas (vapor pressure 760 mm Hg) at 23°C, and is not flammable at concentrations less than 17%. The low potency and high volatility of desflurane requires the use of a heated vaporizer to enable the delivery of this agent.¹³

Anesthetic properties

The low solubility of desflurane in blood results in rapid onset, recovery, and adjustment of anesthetic depth, similar to that found with nitrous oxide.^{31,102} A propensity to cause breath holding, coughing, and laryngospasm during mask induction precludes its routine use as a primary induction agent.

With a MAC of 6% (in middle-aged adults), desflurane is less potent than the other volatile agents. Its physiologic effects are similar, however, to those induced by isoflurane. The systemic vascular resistance, mean arterial blood pressure, and stroke volume are reduced, but the cardiac output is maintained by a progressive increase in heart rate.⁹⁷ As shown in Figure 18-3, discernible increases in heart rate occur as the anesthetic concentration exceeds 1.25 MAC. Similar to isoflurane, desflurane theoretically may cause coronary steal in

hypotensive cardiac patients.³⁰ There is no significant sensitization of the myocardium to catecholamines. Desflurane causes a dose-related decrease in tidal volume and, despite an increase in the respiratory rate, a significant depression of minute ventilation. As with other halogenated ethers, respiratory depression is reduced if desflurane is used with nitrous oxide for anesthesia (see Figure 18-2).

Desflurane is contraindicated in patients susceptible to malignant hyperthermia because it can trigger the syndrome in the swine model and has been linked to malignant hyperthermia in the clinical setting. Because desflurane is notable for having minimal biotransformation, it has a very low likelihood for causing serious hepatotoxicity.⁵⁴

Therapeutic uses

Despite its favorable blood/gas partition coefficient, desflurane is not indicated for the induction of anesthesia, especially in pediatric patients and patients with heart disease. When anesthesia has been achieved with other agents, desflurane may be administered for maintenance purposes. Desflurane then permits a more rapid control over the depth of anesthesia than other inhalation agents and a more rapid recovery, allowing for a more precise duration of general anesthesia.

Sevoflurane

First synthesized in the United States in 1968, sevoflurane became widely used in Japan in 1990 and available for clinical use in the United States in 1995. A pleasant odor, lack of airway irritation, and rapid onset of action make sevoflurane an attractive alternative to halothane for mask induction of anesthesia in pediatrics.⁶³

Physical and chemical properties

Sevoflurane is characterized by a low blood/gas partition coefficient (0.65) and chemical stability under normal storage conditions. A potential drawback is the agent's reactivity to chemicals (e.g., soda lime) used as carbon dioxide absorbents.

Anesthetic properties

As would be expected, the low solubility of sevoflurane results in rapid onset, recovery, and adjustment of anesthetic depth. Similar to other volatile agents in current use, sevoflurane is relatively potent, with a MAC of 2%. Sevoflurane undergoes oxidative defluorination by the hepatic enzyme CYP2E1. This same enzyme may also be largely responsible for the degradation of isoflurane and desflurane.³⁰ The degree of biotransformation is approximately 2% to 3%, with plasma inorganic F⁻ concentrations similar to those previously found in patients with renal dysfunction after methoxyflurane anesthesia. However, plasma F⁻ declines much more rapidly with sevoflurane, a lack of renal metabolism precludes excessive formation of F⁻ in kidney cells, and there is no evidence of nephrotoxicity in humans.^{20,37} Sevoflurane is not believed to be hepatotoxic because it is not broken down to yield the trifluoroacetyl halide metabolite.

The cardiovascular effects induced by sevoflurane are intermediate between those of halothane and isoflurane.^{30,43} At 1 MAC, sevoflurane causes a decrease in cardiac output, peripheral vascular resistance, and arterial blood pressure. At greater than 1 MAC, further decreases in peripheral vascular resistance and myocardial contractility are partially offset by an increase in heart rate. Sevoflurane does not significantly sensitize the myocardium to catecholamines. There is a decrease in alveolar ventilation similar to that observed with isoflurane.

Therapeutic uses

Sevoflurane has the advantages of a rapid onset, good control over the depth of anesthesia, and a rapid recovery, as previ-

ously noted for desflurane. One important advantage of sevoflurane over desflurane is that it is much less irritating to the respiratory tract, which, combined with its rapid induction and maintenance of heart rate, makes it suitable for induction of anesthesia in children.^{47,82} A potential drawback is that it breaks down in soda lime to compound A,^{93,103} greatly limiting its potential use in low-flow systems with conventional carbon dioxide absorbers. This problem can be circumvented by avoiding low gas flows (<2 L/min) or by using specific carbon dioxide absorbents without this characteristic. One other drawback is the potential for emergence delirium when used in pediatric patients.⁶³

INTRAVENOUS AGENTS

Intravenous agents are used widely in anesthesiology. Historically, their primary role was as induction agents for inhalation general anesthesia, for which they were usually administered as a single dose. In recent years, they also have been commonly used for maintenance in total intravenous anesthesia and for various modes of sedation, as described in Chapter 48. Total intravenous anesthesia has increased in popularity because of (1) the introduction of drugs combining rapid redistribution with shorter elimination half-lives, (2) freedom from the risk of malignant hyperthermia associated with volatile anesthetics, and (3) continued concern regarding occupational exposure to inhalation agents. For this technique, the drugs are ideally administered by continuous infusion, with intermittent boluses as needed to adjust the anesthetic depth rapidly.

The primary clinical advantage of intravenous agents is their rapid distribution into the vessel-rich group of tissues, which includes the brain. (Reduced cardiovascular depression is an additional advantage.) The rapid uptake into the CNS facilitates a rapid onset of action. The high lipid solubility of these drugs allows for a smooth and rapid induction. For most intravenous anesthetics, the termination of effect depends largely on redistribution of the drug out of the brain. Metabolic inactivation generally assumes a more central role when the agent is administered over an extended period. With the exception of the benzodiazepines and dexmedetomidine, these drugs can easily induce anesthesia, at which time maintenance may be carried out by either inhalation agents or continued infusion of the intravenous drug. Suggested ideal properties for an intravenous anesthetic drug are listed in Box 18-2.^{42,98}

Although short-acting and ultrashort-acting barbiturates were previously widely administered to produce all modes of

anesthesia and sedation, drugs from other classes are now used more frequently. These agents include various combinations of anti-anxiety drugs, opioids, and anesthetics such as propofol and ketamine. The relatively short action of most of these drugs and their relative freedom from emetic properties (except for opioids and ketamine) make their use especially suited for sedation or general anesthesia in dentistry. The basic pharmacologic features of many intravenous agents are discussed elsewhere in this book, and a more complete review of their use in the control of fear and anxiety for the dental patient is provided in Chapter 48.

Barbiturates

Ultrashort-acting barbiturates were the first drugs widely adopted as intravenous anesthetics. Much of what is known about intravenous anesthesia was developed through their use. Barbiturates available for this purpose include thiopental and methohexital. The use of both drugs has greatly diminished since the introduction of propofol, described subsequently.

Thiopental

Thiopental, the thiobarbiturate analogue of pentobarbital, is the most commonly used intravenous barbiturate in medicine and is prototypic of the group. Its molecular structure is depicted in Figure 18-1.

Physical and chemical properties. Thiopental, a weak acid (pK_a 7.4), is available as the sodium salt. When reconstituted for injection, the solution is buffered to a pH of 10 to 11. When injected, the alkalinity is neutralized, and approximately half the drug converts to the highly lipophilic free acid. Because of their high lipid solubility, the ultrashort-acting barbiturates have the ability to penetrate all tissues after injection. The amount of drug entering a given tissue primarily depends on the regional blood flow. How this property influences tissue uptake is illustrated in Figure 2-9. The vessel-rich group of tissues, which includes the brain, receives the highest proportion of the cardiac output relative to tissue mass and attains the highest concentration of thiopental. Later, as the agent is redistributed to more poorly perfused tissues, such as muscle and then fat, a progressive decline in the blood and brain concentrations occurs. With a redistributional half-life of 4.6 to 8.5 minutes, the concentration of thiopental in the CNS diminishes from the peak value at 1 minute to less than 10% at 30 minutes. Thiopental is biotransformed in the liver to inactive products; only 1% is eliminated unchanged by the kidney. The mean metabolic half-life in adults is 11.6 hours but may exceed 24 hours in obese patients and in late preg-

BOX 18-2

Characteristics of an Ideal Intravenous Anesthetic Agent

PHYSICAL PROPERTIES	PHARMACOKINETIC PROPERTIES	PHARMACODYNAMIC PROPERTIES
Soluble in water	Rapid onset of action	Reliable induction of anesthesia
Stable in solution	Ability to titrate	Anxiolytic at subanesthetic doses
Stable to light exposure	Predictable duration of effect	Analgesic at subanesthetic doses
Absence of pain on injection	Short duration of effect	Amnestic at subanesthetic doses
No local irritation	Short elimination half-life	Antinauseant at subanesthetic doses
Long shelf life	Rapid recovery	Minimal respiratory effects
	Rapid biotransformation	Minimal cardiovascular effects
	Inactive metabolites	No effects on other systems
	Nontoxic metabolites	High therapeutic index
		Small interindividual variation
		No allergy

nancy.⁴⁸ Thiopental is approximately 80% bound to plasma proteins.

Anesthetic properties. Thiopental is primarily an induction agent, although it may also be used for maintenance in short surgical procedures or to treat seizures or elevated intracranial pressure. Induction is smooth and rapid, with the patient losing consciousness within seconds after a rapid bolus intravenous injection. Generally, however, induction is accomplished by administering the drug over a 30-second period, after which inhalation anesthesia is initiated. After a single dose, the patient regains consciousness in 10 to 20 minutes. Repeated doses required for extended anesthesia may cause cumulative effects and a prolonged recovery period (see Figure 2-18).

CARDIOVASCULAR EFFECTS. Induction doses in a normovolemic patient decrease blood pressure by 10 mm Hg to 20 mm Hg, followed by a reflex increase in heart rate of 15 to 20 beats/min. Selective venodilation is largely responsible for the hypotension; total peripheral resistance remains unchanged, and myocardial depression is modest. After high doses, there is a more marked depressant effect on the cardiovascular system, which reduces blood pressure and may alter the redistribution pattern of the drug. Profound hypotension and cardiac arrest may occur during induction of anesthesia in a hypovolemic or septic patient. Extra caution with elderly patients is warranted to avoid cardiovascular collapse. Intraoperatively, heart rate and blood pressure may increase as a result of painful stimuli, partly because the barbiturates are hyperalgesic. Thiopental is not inherently dysrhythmic.

RESPIRATORY EFFECTS. Respiratory depression occurs in a dose-dependent manner and accounts for the major toxic effects of the barbiturates. Tidal volume is decreased, respiratory rate is usually depressed, and patients are predisposed to apnea, especially if other respiratory depressants are coadministered. Coughing, laryngospasm, and bronchospasm may develop as a result of irritation from premature manipulation of the airway or insertion of an endotracheal tube. Histamine release and increased sensitivity of the pharynx to stimulation may contribute to these adverse effects, although barbiturates are considered to be safe in patients with asthma.

OTHER EFFECTS. Thiopental is hyperalgesic at subanesthetic doses and may necessitate concurrent use of an analgesic. Cerebral blood flow is decreased as a result of a reduction in mean arterial pressure. Cerebral metabolic rate and intracranial pressure are decreased as well. Thiopental is an anticonvulsant.

Therapeutic uses. The usual induction doses are approximately 4 mg/kg for adults and 6 mg/kg in infants. Thiopental is irritating to tissue, so care must be taken to prevent intra-arterial injection or extravasation, either of which may result in tissue necrosis. The high alkalinity of the solution and the chemical nature of the drug itself are responsible for this effect. Intra-arterial injection may cause intense vasospasm. As with all barbiturates, thiopental is contraindicated in patients with certain forms of porphyria (acute intermittent, variegate, and hereditary coproporphyrin types).⁵¹ The drug should be used cautiously in elderly patients and in patients with acute asthma, congestive heart failure, and shock states. Although thiopental is able to induce the synthesis of several important microsomal enzymes, it is unlikely that single induction doses would result in clinically significant drug interactions.

Methohexital

Methohexital, a methylated barbiturate, is used less commonly than thiopental for the induction of general anesthesia

in hospital operating rooms, but has been used more widely for anesthesia in dentistry. The two drugs are similar except that methohexital is 2.5 times more potent, has a shorter half-life in distribution and elimination, and has a shorter duration of action. The sleep time after a single dose is 5 to 7 minutes, and the mean elimination half-life is 3.9 hours. Methohexital is biotransformed in the liver, with a clearance rate three times greater than that of thiopental.⁴⁸ Excitatory phenomena, such as hiccoughs, spontaneous movements, and seizures, occur more frequently than with other barbiturates used clinically. These excitatory phenomena represent the primary disadvantage of methohexital. Methohexital does not induce histamine release. Although it is more likely than thiopental to cause pain on intravenous injection, methohexital in a 1% concentration is much less damaging after intra-arterial injection or extravasation into local tissues. Its primary advantage is the rapid recovery and lower cumulative effect compared with thiopental, making it more suitable for outpatient procedures. Methohexital also is much more stable when reconstituted with sterile water; a 1% solution can be stored at room temperature and used for 6 weeks (versus 1 week for thiopental when refrigerated). Manufacturers state that unused reconstituted drug should be discarded after 24 hours, however, to avoid concerns about loss of sterility.

Propofol

Propofol (2,6-diisopropylphenol) is unrelated to any other general anesthetic. Its structure is illustrated in Figure 18-1. Propofol is formulated in an oil-in-water emulsion containing soybean oil, glycerol, and egg lecithin.

Anesthetic properties. Clinically, the pharmacokinetic properties of propofol include a rapid onset of action; an initial distributional half-life of 1 to 8 minutes, which results in an extremely short duration of action; and a terminal elimination half-life reported to be as short as 2 hours. It is extensively conjugated in the liver to inactive glucuronide and sulfate metabolites, with less than 0.3% of an administered dose appearing in the urine as the unchanged drug. Propofol's extensive plasma (98%) and tissue protein binding contributes partly to an enormous steady-state volume of distribution of 2 L/kg to 12 L/kg.⁹⁰ The clearance of propofol exceeds the hepatic blood flow, implying that continued tissue uptake and extrahepatic metabolism are factors in its removal from the blood.⁸⁵ After a continuous 10-day infusion of propofol that produces tissue saturation, the volume of distribution approaches 60 L/kg with a metabolic half-life of 1 to 3 days. After bolus administration, the plasma concentrations of propofol and thiopental are similar initially, but propofol subsequently disappears from the bloodstream more rapidly.⁹⁰

CARDIOVASCULAR EFFECTS. Propofol can depress mean arterial pressures by 20% to 30% without eliciting a reflex increase in heart rate. This finding may be attributed to the drug's ability to decrease myocardial contractility, to dilate the peripheral vasculature, to depress baroreflex activity, and possibly to inhibit the sympathetic nervous system.⁸⁴ Effects on cardiac output vary, depending on the $Paco_2$. Clinically, these hemodynamic effects are transient and rarely require pharmacologic correction.⁴⁹ The cardiovascular effects are well tolerated in healthy patients, but significant hypotension may ensue in elderly patients, hypovolemic patients, or patients with limited cardiac reserve.⁹⁰

RESPIRATORY EFFECTS. Apnea is the most significant respiratory effect of propofol, with a reported incidence varying from 22% to 45% after an induction dose. Other respiratory effects include decreased sensitivity to carbon dioxide, decreased laryngeal reflexes, and decreased functional residual capacity.

Propofol does not release histamine and generally is safe for use in asthmatic patients.

OTHER EFFECTS. Propofol decreases cerebral blood flow, cerebral metabolic rate and oxygen consumption, and intracranial pressure. Although it is believed to have anticonvulsant properties,⁶ there are reports of grand mal seizures, opisthotonus (spasm of back muscles inducing an arched back and hyperextension of the neck), and unusual muscle activity with propofol.^{34,83} The drug should be administered cautiously to epileptic patients. The most common adverse reaction is pain on injection, which is noted more frequently when propofol is administered in the small veins on the dorsum of the hand. The incidence of pain may be reduced by using larger veins (e.g., antecubital veins), diluting the drug with a rapidly flowing intravenous line, or mixing the drug with lidocaine. Propofol is associated with less postoperative nausea and vomiting compared with inhalation anesthetics, and it has antiemetic properties in low doses.⁹⁰ Propofol may have anti-pruritic properties.⁶ There is no analgesic effect.

Therapeutic uses. Propofol's major advantage is its extremely rapid recovery in patients.² In addition to induction, propofol can be used for maintenance of general anesthesia or for intravenous sedation. The dose for induction is 2 mg/kg to 2.5 mg/kg. For total intravenous anesthesia, a maintenance infusion rate of 50 µg/kg/min to 300 µg/kg/min is recommended, depending on the age and health of the patient. If used alone, a dose of 25 µg/kg/min to 75 µg/kg/min should maintain moderate sedation in healthy adults after an initial infusion of 100 µg/kg/min to 150 µg/kg/min for 3 to 5 minutes. Doses must be reduced in elderly patients, debilitated patients, and when propofol is used with other CNS depressants. An allergy history to any of the emulsion constituents (e.g., soybeans) potentially contraindicates the use of propofol. Because the soybean vehicle is an excellent bacterial culture medium, strict antiseptic technique should be used when administering propofol, and any unused portion should be discarded after 6 hours.

Infusion of propofol is also used long-term in intensive care units to provide sedation. A rare syndrome has been described when propofol is administered in high doses (>4 mg/kg/hr) for long durations (≥48 hours). This potentially fatal "propofol infusion syndrome" involves only critically ill patients,⁵² primarily children.⁸ The main features of this syndrome include acidosis, bradyarrhythmia, and rhabdomyolysis of cardiac and skeletal muscle, signs that mimic mitochondrial myopathies.⁹⁹ The use of propofol in lower doses or shorter durations has not been associated with these outcomes.

Ketamine

Ketamine, a relative of the psychedelic drug phencyclidine (PCP, angel dust), produces a unique state known as dissociative anesthesia, which is characterized by profound analgesia, amnesia, and catalepsy.⁹⁸ This excitatory state is quite different from that seen after administration of other general anesthetic agents previously discussed. It has been suggested that this dissociative state is a result of a functional and electrophysiologic dissociation between the thalamocortical and limbic systems. In this state, it is believed that the brain fails to transduce correctly afferent impulses because of disruption in normal communications between the sensory cortex and the association areas. The molecular structure of ketamine is shown in Figure 18-1.

Ketamine is an antagonist of the N-methyl-D-aspartate (NMDA) class of glutamate receptors, which is largely responsible for its anesthetic and behavioral effects.⁵⁷ NMDA inhibition produces catalepsy, consistent with the effect of ketamine administration. Ketamine also produces profound analgesia,

which seems to be at least partially mediated by µ opioid receptors, in addition to its binding to the phencyclidine binding site on the NMDA receptor.⁸⁸

Anesthetic properties. The onset of action and peak plasma concentrations occur within 1 minute after intravenous administration, 5 to 15 minutes after intramuscular injection, and 30 minutes after oral ingestion. The distributional half-life ranges from 11 to 16 minutes, and the elimination half-life is 2 to 3 hours. Ketamine is highly lipid-soluble, and little binds to plasma proteins (12%), which facilitates rapid transfer across the blood-brain barrier. The duration of anesthesia is about 5 to 10 minutes after a bolus intravenous infusion and 10 to 20 minutes after intramuscular injection. The dissociative state resembles catalepsy, in which the eyes may remain open with slow nystagmus and intact corneal and pupillary reflexes. Most protective reflexes are maintained. Varying degrees of skeletal muscle hypertonus may be present, along with nonpurposeful skeletal muscle movements that are independent of surgical stimulation.

CARDIOVASCULAR EFFECTS. Ketamine differs from most anesthetic agents in that, in a normal patient, it stimulates the cardiovascular system, producing increases in heart rate, cardiac output, and blood pressure.⁴² The mechanism for this effect is not well understood because ketamine can depress myocardial contractility directly and enhance vasodilation. Ketamine's induction of central sympathetic stimulation and its ability to inhibit catecholamine uptake usually overrides the negative inotropism.⁶⁵ Its ability to maintain arterial blood pressure is useful in hypovolemic patients and patients in cardiogenic shock.

Caution should be used when ketamine is administered to critically ill patients or patients who have chemical-induced or trauma-induced sympathectomy, in which case it may lead to myocardial depression and cardiovascular collapse. Ketamine increases pulmonary vascular resistance and may exacerbate pulmonary hypertension or cor pulmonale. The sympathomimetic and cardiovascular stimulating effects contraindicate the use of ketamine in patients in whom an elevation of blood pressure or heart rate should be avoided, such as patients with cerebrovascular accident, significant hypertension, or advanced ischemic heart disease.

RESPIRATORY EFFECTS. Compared with other anesthetic agents, ketamine seems to be unique in its ability to maintain functional residual capacity on induction of anesthesia,⁸⁷ decreasing the chances of intraoperative hypoxemia.³⁸ During ketamine anesthesia in spontaneously breathing patients, the minute ventilation may be maintained at the same level as in the awake state.⁹⁵ Ventilatory responses to hypercarbia and airway reflexes seem to be preserved. Ketamine has other beneficial effects on the respiratory apparatus, including increased lung compliance and decreased airway resistance. Ketamine is safe for asthmatic patients because it causes bronchodilation and does not induce histamine release. Ketamine is a potent stimulator of salivary and tracheobronchial secretions, however, and antimuscarinics are often administered concurrently.

OTHER EFFECTS. In doses less than those used to induce general anesthesia, ketamine may produce sedation, analgesia, and amnesia. Excitatory activity in the thalamus and limbic systems, without clinical evidence of seizure activity, has been recorded. This electrical activity does not seem to spread to the cortex, and ketamine has been shown to have anticonvulsant properties.⁷⁸ Ketamine strongly dilates cerebral blood vessels, increasing cerebral blood flow by 60% to 80%, which increases intracranial pressure in patients with compromised intracranial compliance.

Emergence phenomena have been the most frequently reported adverse effects of ketamine. These reactions, occurring in <5% of patients in some studies and >30% of patients in others, include a feeling of floating, vivid dreams, hallucinations, and delirium. The incidence is related to the dose and rate of drug administration and is reduced when benzodiazepines are administered concomitantly.⁵⁸ The frequency of emergence delirium is less in children than in adults.

Therapeutic uses. Ketamine may be administered by the intravenous, intramuscular, oral, and rectal routes. Induction of anesthesia may be achieved typically by an intravenous dose of 1 mg/kg to 2 mg/kg or intramuscularly at a dose of 4 mg/kg to 6 mg/kg. Intramuscular injection may be necessary when a patient is unable to cooperate. Anesthesia can be maintained by repeated injections or by using a continuous infusion, the latter in a dose of 15 µg/kg/min to 90 µg/kg/min. Smaller doses or infusion rates are useful for sedation and analgesia. Ketamine is safe for use in malignant hyperthermia patients, although it may induce some signs (e.g., muscle rigidity, tachycardia) that mimic the early stages of a crisis. Ketamine is usually administered with drugs such as midazolam or propofol to reduce the incidence of untoward excitatory effects.

Etomidate

Etomidate, a carboxylated imidazole derivative, is chemically and pharmacologically unrelated to other intravenous anesthetics. Its pharmacokinetic profile is similar, however, to that of thiopental. Onset of anesthesia is rapid, and the duration of action is brief after conventional doses.

Etomidate is believed to modulate the action of the inhibitory neurotransmitter γ -aminobutyric acid (GABA) on GABA_A receptors. The amplitude and duration of inhibitory currents are increased. Etomidate has the advantages over thiopental of causing only mild respiratory depression and little effect on the cardiovascular system. Induction doses of 0.3 mg/kg elicit a mild (15%) decrease in total peripheral resistance, which is mirrored by similar decrements in cardiac output and myocardial oxygen consumption. Coronary blood flow is mildly increased. Nevertheless, this drug is noted for its cardiovascular stability. Several significant liabilities limit the use of etomidate, however. The drug inhibits adrenocorticosteroid synthesis after prolonged administration; causes severe pain on injection in up to 50% of patients; and is associated with a high incidence of nausea and vomiting, thrombophlebitis, involuntary myoclonic movements, hypertonus, and hiccough. These adverse events have greatly limited the clinical application of etomidate for general anesthesia to the small group of patients who require the cardiovascular stability afforded by it.

Dexmedetomidine

Serendipitous findings that clonidine, an α_2 -adrenoceptor agonist used to treat hypertension (see Chapters 6 and 28), significantly reduces the MAC of inhalation anesthetics and produces significant analgesia independently of the opioid system generated attempts to develop congeners for use as sedatives and anesthetic adjuncts. The first successful outcome of this effort was dexmedetomidine, approved by the U.S. Food and Drug Administration (FDA) in 1999 for sedation of initially intubated and mechanically ventilated patients in the intensive care unit. Administration is usually initiated with a loading infusion of 1 µg/kg for the first 10 minutes, followed by a maintenance infusion of 0.2 µg/kg/hr to 0.7 µg/kg/hr. In 2008, dexmedetomidine was approved for preoperative and intraoperative sedation of nonintubated patients.

Structurally similar to etomidate (see Figure 18-1), dexmedetomidine is approximately seven times more selective

than clonidine for the α_2 -adrenergic receptor. Stimulation of the α_{2A} -adrenoceptor subtype in the nucleus tractus solitarius and locus coeruleus of the brainstem reduces sympathetic outflow and elicits sedation. Similarly, release of excitatory neurotransmitters by nociceptive afferent axons in the dorsal horn is inhibited, reducing pain. Activation of α_{2A} -adrenoceptors by dexmedetomidine facilitates K⁺ efflux through inwardly rectifying K⁺ channels, depresses a slow depolarizing current termed *I_h*, and inhibits voltage-gated Ca⁺⁺ channels in affected neurons.^{16,86}

Dexmedetomidine has several pharmacokinetic advantages over clonidine. After bolus injection, dexmedetomidine displays a distributional half-life of about 6 minutes (versus 11 minutes for clonidine) and an elimination half-life of 2 hours (versus 9 hours for clonidine). The drug is completely transformed to inactive metabolites in the liver, most of which are excreted in the urine. A significant range in context-sensitive half-times exists, with values ranging from 4 minutes after a 10-minute infusion to 4 hours after an 8-hour infusion.

Clinically, dexmedetomidine is remarkable for its ability to produce a natural sleep from which the patient can be easily aroused. The sedation is characterized by anxiolysis, profound analgesia, blunting of cardiovascular responses to stress, and freedom from respiratory depression. Although intravenous injection initially can cause a transient increase in peripheral vascular resistance and arterial blood pressure by stimulating vascular α_2 receptors, the subsequent response is a decrease in blood pressure and heart rate in response to the centrally mediated sympatholytic and vagal-stimulating effects. Cardiovascular responses are minimized by slow infusion of low doses. The most common side effects of dexmedetomidine in approved doses are hypotension, bradycardia, and xerostomia. Large, accidental overdoses may produce significant vasoconstriction, profound bradycardia, and decreases in cardiac output possibly leading to cardiovascular collapse. The potential for cardiovascular derangements precludes the use of dexmedetomidine as a sole agent for general anesthesia, and the delayed recovery after prolonged infusions limits its use in outpatient surgery to short procedures. The development of atipamezole, a selective α_2 -adrenoceptor antagonist used to reverse the effects of dexmedetomidine in veterinary medicine, suggests that such agents may become available to terminate the effects of dexmedetomidine in humans.⁷³

Benzodiazepines

Benzodiazepines have enjoyed widespread use as adjuncts to general anesthesia, as induction agents in patients with serious cardiovascular abnormalities, and as agents for all levels of sedation. Their pharmacologic advantages have given them a major role in the management of fear and anxiety in dentistry (see Chapter 48). As described in Chapter 13, all benzodiazepines are capable of producing in varying degrees anxiolysis, sedation, anterograde amnesia, skeletal muscle relaxation, and anticonvulsant activity. There is minimal depression of the cardiovascular and respiratory systems when benzodiazepines are administered alone in therapeutic doses, reflecting the fact that benzodiazepines have a wide safety margin in the absence of interacting drugs.⁷⁶ These agents are useful for their ability to attenuate the stress response and associated catecholamine release.²⁶

Although all benzodiazepines share similar pharmacodynamic effects, they are differentiated by their pharmacokinetic characteristics. The agents most commonly used in anesthesia and dentistry are diazepam, midazolam, triazolam, and lorazepam. Although rarely used alone for general anesthesia because they lack analgesic properties and may be insufficient to induce or maintain general anesthesia in some

patients, benzodiazepines are routinely used with other agents in balanced anesthesia for their superior sedative and amnestic effects and relative freedom from cardiovascular depression.

Diazepam

Diazepam, the prototypic benzodiazepine, has had a long and successful history of use as an agent for sedation when administered orally or intravenously. In recent years, diazepam has been superseded by other oral and parenteral benzodiazepines considered to have superior properties. Diazepam is classified as a long-acting agent, with an elimination half-life that increases from 20 to 70 hours in rough concert with the patient's age. A high lipid solubility means that diazepam is taken up by adipose tissue, which may cause postanesthesia drowsiness as the drug is slowly released from fat. Nevertheless, the drug is relatively short acting when used in a single dose. The duration of effect of an intravenous injection of diazepam is approximately 1 hour, similar to that of the short-acting midazolam. Diazepam has a rapid onset of action (<1 minute intravenously), with a distributional half-life of 10 to 15 minutes. Peak plasma concentrations are achieved in 30 to 120 minutes when the drug is given orally.

Intramuscular administration does not significantly improve absorption. Diazepam is not water soluble; in the United States it is solubilized with propylene glycol, which predisposes to phlebitis when the formulation is administered intravenously into small-caliber veins. Propylene glycol also contributes to the delayed and variable absorption from intramuscular sites. An emulsion of diazepam in soybean oil, glycerol, and various lipids is available outside the United States that minimizes these problems.

Although efficacious, diazepam's drawbacks are the long elimination half-life, active metabolites, and common formulation in an irritating vehicle for parenteral administration. For induction of general anesthesia, intravenous doses of 0.3 mg/kg to 0.5 mg/kg are appropriate.

Midazolam

Midazolam, the first water-soluble benzodiazepine, is prepared in an aqueous vehicle buffered to a pH of 3.5. Below a pH of 4, the benzodiazepine ring is open, making the molecule highly polar. Above a pH of 4, as is found physiologically, the ring closes, making midazolam very lipid-soluble and leading to a rapid onset of action. This pharmaceutical sleight of hand eliminates the problem of thrombophlebitis on intravenous administration and improves uptake after intramuscular administration, both important advantages over diazepam. Midazolam is biotransformed into metabolites with no significant activity (although they may contribute sedative effects after oral administration), another advantage over diazepam.

Midazolam is classified as a short-acting agent because its elimination half-life is approximately 1.7 to 2.6 hours in young adults. Cimetidine, erythromycin, and other CYP3A4 enzyme inhibitors may slow intestinal and hepatic biotransformation, resulting in higher-than-expected midazolam concentrations in the plasma after oral administration and prolonged drug effects with all routes of administration. Of special interest to dentistry, interactions between oral midazolam and erythromycin leading to oversedation have been reported.^{45,72} The usual intravenous dose for induction of general anesthesia is 0.2 mg/kg, but in common practice midazolam is usually provided as an anxiolytic premedication, or as an adjunctive agent to smooth the overall process.

Lorazepam

Lorazepam is classified as an intermediate-acting benzodiazepine, but its effects after a single administration last considerably longer than for other benzodiazepines used in anesthesia. The drug is most useful as an oral or parenteral premedicant,

where its slow onset of action is not a significant problem. The usual induction dose is 0.1 mg/kg.

Triazolam

Triazolam has effective anxiolytic, hypnotic, and amnestic properties, with a rapid onset of action after oral use that peaks within 90 minutes. The drug has a short elimination half-life of 1.5 to 5.5 hours, and it is converted into inactive metabolites. CYP3A4 inhibitors may block hepatic biotransformation, resulting in higher than expected plasma concentrations. Triazolam is available only for oral use.

Opioids

The opioid analgesics play a major role in facilitating the delivery of general anesthesia and sedation, primarily as adjuncts used in combination with other agents. They also have a role as regional analgesics when administered as part of an epidural or spinal anesthetic. As described in more detail in Chapter 20, all opioids share the properties of analgesia; sedation; mood alteration; and the potential for tolerance, physical dependence, and addiction. Their antitussive effect may be valuable in the immediate postoperative period or for procedures such as bronchoscopy. Nausea and vomiting are common adverse effects and are characteristically exacerbated if the patient is ambulatory. Opioids decrease the MAC of inhalation anesthetics.

An important action is respiratory depression caused by a dose-dependent decrease in the response of the medullary respiratory center to carbon dioxide. High doses can totally block spontaneous respiration, sometimes without inducing unconsciousness. In susceptible patients, this effect may be seen in low to medium doses. Clinically, the respiratory depression manifests as a decrease in the breathing rate, with an overall decrease in minute ventilation and a compensatory increase in tidal volume. The P_{aCO_2} is elevated in a dose-dependent manner. Because of these respiratory effects, opioids must be administered with extreme caution to patients with respiratory disorders, such as chronic obstructive pulmonary disease.

Specific sedation techniques with opioids are discussed in more detail in Chapter 48. Opioid doses should be reduced in elderly patients, in patients with preexisting respiratory disease, and in patients with significant hepatic disease. Several drugs, most notably sufentanil, may be used as primary agents for cardiac anesthesia. Their cardiac stability is attributable to a lack of negative inotropic effects. The anesthetic properties of individual opioids used for anesthesia and sedation are discussed next.

Morphine

Morphine, the prototypic opioid analgesic, has been widely used as an adjunct to general anesthesia. It has been administered by numerous techniques, including high doses with oxygen or as a supplement to inhalation agents, to obtain profound analgesia. When used as an adjunct to general anesthesia, the recommended dose of morphine is 0.1 mg/kg intravenously. Because of advantages (discussed subsequently) found in the newer opioids, many centers favor these other medications over morphine when used during general anesthesia. Morphine still has wide acceptance, however, as an inexpensive choice for analgesia during general anesthesia.

Anesthetic properties. Peak action after intravenous administration takes ≥ 20 minutes (Table 18-3). This delay reflects morphine's poor lipid solubility and limited ability to cross the blood-brain barrier.

CARDIOVASCULAR EFFECTS. Morphine exerts little direct effect on cardiovascular function. This discovery led to the use of morphine for a time as a primary anesthetic for patients with

TABLE 18-3

Comparison of Opioids Used for Sedation/Anesthesia

DRUG (PROPRIETARY [TRADE] NAME)	EQUIPOTENT DOSE (mg)	TIME TO PEAK ANALGESIC EFFECT (min)	DURATION OF ANALGESIA	PROTEIN BINDING (%)	ELIMINATION HALF-LIFE (hr)
Morphine	10	20	4-5 hr	30	2-3
Meperidine (Demerol)	80	5-7	2-4 hr	60	2.5-4
Fentanyl (Sublimaze)	0.1	3-5	30-60 min	85	3-4
Alfentanil (Alfenta)	0.7	1-2	10-15 min	92	1-2
Sufentanil (Sufenta)	0.015	3-5	15-30 min	93	2-3
Remifentanyl (Ultiva)	0.05	1-2	5-10 min	70	0.05-0.1
Pentazocine (Talwin)	60	15-30	2-3 hr	65	2-3
Nalbuphine (Nubain)	10	30	3-4 hr	50	2-5
Butorphanol (Stadol)	2	30	2-4 hr	80	2.5-4

significant cardiovascular disease. High doses, such as 1 mg/kg, significantly decrease systemic vascular resistance and mean arterial pressure, however, predisposing the patient to orthostatic hypotension. Hypotension may also result from morphine-induced histamine release, bradycardia, or a sympatholytic action. Bradycardia is believed to be caused by stimulation of the vagal nuclei in the brainstem. There may also be a direct depressant effect at the sinoatrial node of the heart. The hypotensive actions of morphine lead to an increased requirement for fluid administration. In combination with nitrous oxide, morphine administration can result in cardiovascular depression, decreased cardiac output, and hypotension.

RESPIRATORY EFFECTS. The maximum respiratory depression from morphine occurs approximately 30 minutes after intravenous injection. Increased intracranial pressure may also result because of hypercarbia. Morphine should not be used in patients for whom increased intracranial pressure is a concern, such as patients with an intracranial lesion or traumatic head injury.

OTHER EFFECTS. Emesis is a result of direct stimulation of the chemoreceptor trigger zone. There is also decreased gastrointestinal motility and increased secretions (which contributes to the direct emetic effect). Sphincter tone is increased, which in the case of the sphincter of Oddi (which controls the bile duct flow into the duodenum) can lead to increased bile pressure and epigastric distress that may mimic anginal pain.

Therapeutic uses

Precautions apply to asthmatic patients because of the histamine release and cough suppression. The same precautions are relevant to patients with a history of chronic obstructive pulmonary disease or other causes of decreased respiratory reserve. As with the administration of all opioids, severely ill or elderly patients are generally more susceptible to the depressant effects of morphine. Chest wall rigidity has been reported and tends to occur when morphine is administered rapidly and in combination with nitrous oxide.

Meperidine

For many years, meperidine was the most widely used opioid for outpatient sedation and anesthesia in dentistry. This synthetic opioid has approximately one tenth the potency of morphine and has atropine-like properties in addition to its opioid agonist effects. The vagolytic actions may result in a decrease in upper respiratory tract secretions and an increase in heart rate, although these effects are minimal in the usual doses administered for sedation. At equianalgesic doses,

meperidine has the same effects as morphine except that it differs from morphine in having a shorter duration of action, more complex biotransformation, and greater lipid solubility. Meperidine has a high hepatic extraction ratio, leading to a strong first-pass effect if the drug is administered orally.

Cardiovascular effects of meperidine administration include hypotension caused by a direct negative inotropism, decreased systemic vascular resistance, and decreased venous return. Orthostatic hypotension is commonly seen because of interference with compensatory sympathetic reflexes. As with morphine, meperidine is contraindicated when histamine release or increased intracranial pressure is undesirable and when decreased respiratory reserve exists.

Meperidine is biotransformed into several metabolites. One of them, normeperidine, has a long elimination half-life, can accumulate, and has been associated with CNS toxicity. The adverse reaction manifests as excitation, including agitation, seizures, and hallucinations, particularly in patients with hepatic and renal disease.

Exaggerated toxic responses to meperidine are especially likely in patients concurrently taking monoamine oxidase (MAO) inhibitors or amphetamines. Potential interactions between meperidine and amphetamines include increased risk of hypotension, possibly leading to cardiovascular collapse, severe respiratory depression, and convulsions. Potential interactions between meperidine and MAO inhibitors can be similar but are particularly characterized by unpredictable excitatory effects such as seizures, delirium, rigidity, coma, and hypertension leading to cardiovascular collapse. Meperidine is contraindicated in patients having taken an MAO inhibitor within the past 3 weeks. The ability of meperidine to increase 5-hydroxytryptamine concentrations at serotonergic synapses within the CNS has also led to concerns about interactions regarding serotonin reuptake inhibitors, such as fluoxetine, paroxetine, sertraline, venlafaxine, citalopram, and others.

Fentanyl

The synthetic opioid agonist fentanyl is approximately 100 times as potent as morphine and is characterized by a rapid onset and short duration of action after a single dose. It is most commonly administered intravenously but may be given intramuscularly, transmucosally in the oral cavity, and, for chronic pain, transdermally. Fentanyl's high lipid solubility contributes to its rapid onset because it readily crosses the blood-brain barrier. It also contributes to rapid redistribution and significant accumulation in peripheral tissues. The subsequent slow release of fentanyl from muscle and fat lengthens the terminal half-life to beyond that of morphine. (See Figure 2-18 for an illustration of the influence of infusion duration

on the plasma half-life of fentanyl.) Histamine is not released, which makes it preferable in patients predisposed to bronchospasm.

Intravenous doses of less than 10 µg/kg can be given as an adjunct to volatile agents in general anesthesia to minimize cardiovascular responses to specific stimuli such as pain, anxiety, or endotracheal intubation. Doses of 50 µg/kg to 150 µg/kg have been used alone to produce general anesthesia. These large doses are used because of the hemodynamic stability as a result of the lack of direct myocardial depression, absence of histamine release, and suppression of stress responses to surgery. Rapid administration of fentanyl is associated with bradycardia, an event more common in children. It is a potent respiratory depressant, but this lasts only 5 to 15 minutes if doses less than 100 µg are given. Chest wall rigidity has been reported but is unlikely to occur if fentanyl is administered at a rate of 1 µg/kg/min or less. The incidence of nausea is reported to be less than with morphine or meperidine.

Alfentanil

An analogue of fentanyl, alfentanil is 5 to 10 times less potent and is characterized by a rapid elimination half-life. This property contributes to a duration of action that is much shorter than that of fentanyl after prolonged infusion. Alfentanil has an especially rapid onset of action because of its low pK_a causing most of the drug to be uncharged at plasma pH. The drug can be used for induction of anesthesia after bolus administration and maintenance by infusion. For bolus administration, recovery is more rapid than with fentanyl or sufentanil, whereas no significant differences occur with short infusions. Because alfentanil is not prone to significant accumulation after continuous infusion, it is an opioid of choice for total intravenous anesthesia in the outpatient setting.

Sufentanil

Sufentanil is 5 to 10 times as potent as fentanyl and has a more rapid recovery after prolonged intravenous infusion. It is more lipid-soluble than fentanyl but has a smaller volume of distribution and a shorter elimination half-life. Cardiovascular effects are similar to effects found with fentanyl; however, sufentanil produces better hemodynamic stability during cardiac anesthesia and exhibits a more favorable ratio of analgesia to respiratory depression. Histamine is not released. High doses of sufentanil may reduce the dose of neuromuscular blocker required. As with fentanyl and alfentanil, sufentanil can be used for induction of anesthesia after bolus administration and maintenance by infusion.

Remifentanil

Remifentanil is also an opioid agonist used as an adjunct in general anesthesia. It is structurally unique because it contains ester linkages, which lead to distinctive pharmacokinetic characteristics. Compared with fentanyl, remifentanil has a more rapid onset and offset of action. Entry into brain tissue is hastened by a comparatively high percentage of drug in the nonionized state. The ultrashort duration of action is not caused by redistribution of the drug but by its unique metabolic inactivation by nonspecific esterases in the blood and tissue. A small volume of distribution also helps to hasten metabolism. One of the most notable characteristics of remifentanil is its invariant context-sensitive half-life, which approximates 3 to 4 minutes regardless of the duration of infusion.⁵³ The drug is almost always given by intravenous infusion because less controlled administration results in unstable effects and easily leads to chest wall rigidity or respiratory depression or both. Addition of remifentanil to a propofol infusion has been shown to provide a more rapid recovery and reduced use of propofol.⁶¹

Opioid agonist-antagonists

Opioid agonist-antagonists are sometimes used for anesthesia and sedation in lieu of pure opioid agonists. Although the analgesic and respiratory depressant effects of the agonist-antagonists are similar to the effects of morphine and other agonists in conventional doses, a ceiling effect occurs as the dose is increased. These drugs are not indicated as replacements for high-dose opioids as used in open-heart surgery. Pentazocine, butorphanol, and nalbuphine all have been administered for outpatient sedation procedures.

Pentazocine depresses myocardial contractility, but myocardial oxygen demand is greater than normal because of increases in peripheral resistance, systolic blood pressure, and plasma catecholamines. Although the antagonist action of pentazocine is weak, it is sufficient to precipitate opioid withdrawal reactions in physically dependent individuals. Adverse reactions include a potential for psychotomimetic effects, such as disorientation, confusion, depression, hallucinations, and dysphoria. Doses that produce sedation have also been associated with diaphoresis and dizziness. Butorphanol shares many of the cardiovascular and psychotomimetic side effects of pentazocine, although it is less likely to precipitate withdrawal in an opioid-dependent individual. Nalbuphine is a strong μ receptor antagonist, but it does not increase blood pressure or heart rate, which makes it the agonist-antagonist of choice in patients with cardiac disease. The strong ability of nalbuphine to reverse the sedative and analgesic effects of pure opioids can lead to marked and potentially dangerous withdrawal reactions in patients dependent on opioids.

Other Agents Used for Sedation

Numerous drugs described elsewhere in this book have application in sedation. They are summarized next, and details of their application in sedation for dentistry are included in Chapter 48.

Antihistamines

Many H_1 antagonists possess sedative, antiemetic, and anticholinergic properties, which make them beneficial for use as sedatives. Promethazine is a phenothiazine antihistamine sometimes used for oral and intramuscular sedation, particularly of pediatric patients. It has an onset of action of 15 to 60 minutes after oral ingestion, 20 minutes after rectal administration, and 20 minutes after intramuscular injection. The sedative effect lasts 2 to 8 hours.

There have been several reports of death after convulsive seizures when the combination of promethazine, an opioid, and a local anesthetic was administered. These outcomes may have been caused by a lowering of the convulsive threshold or by respiratory depression in an overly sedated and under-monitored patient. Nevertheless, they emphasize the need for reduced doses when CNS depressants are administered together. Other side effects include extrapyramidal reactions, exaggerated effects in elderly patients, and an intensification of side effects in patients taking MAO inhibitors.

Hydroxyzine is another antihistamine with clinically useful anxiolytic and antiemetic properties. It is rapidly absorbed, with an onset of action of 15 to 30 minutes, a terminal half-life of 20 to 25 hours, and a duration of 4 to 6 hours. It may be administered orally or intramuscularly. Hydroxyzine is relatively free of toxic effects, but anticholinergic side effects such as xerostomia may occur.

Alcohols

Chloral hydrate has been widely used as a sedative agent in pediatric dentistry and for minor procedures such as diagnostic imaging.²² Its use is fading because the benzodiazepines have proved to be safer alternatives. Chloral hydrate is well absorbed; peak effects occur in approximately 1 hour; the

duration of action is 4 to 8 hours; and it has an elimination half-life of 8 to 10 hours. Chloral hydrate is biotransformed into the active metabolite trichloroethanol, which is primarily responsible for its effects. It can cause gastrointestinal disturbances (nausea, vomiting, and diarrhea) and has the potential for cardiac dysrhythmogenicity and decreased myocardial contractility in higher doses. Deep sedation may be induced, especially if other CNS depressants, including nitrous oxide, are coadministered.⁶⁴ Chloral hydrate is contraindicated in patients with marked hepatic impairment, severe renal disease, gastritis or gastric ulcers, severe cardiac disease, or acute intermittent porphyria. At a recommended dose of 50 mg/kg up to a maximum of 1 g, chloral hydrate is approximately as effective as diazepam for oral sedation in children.³ Larger doses are more effective; however, the level of CNS depression moves beyond that of moderate sedation, and complete recovery can take more than 24 hours in sensitive patients.⁶⁶ Reduced doses must be used if chloral hydrate is combined with another sedative.

Antimuscarinic drugs

Scopolamine, similar to atropine, has been used as a premedication for its antimuscarinic properties, usually in combination with an opioid or a barbiturate. It can also be used to produce minimal-moderate sedation with marked amnesia. Scopolamine has no analgesic properties and may produce excitation and delirium in a painful situation.

ANESTHETIC ADJUVANTS AND PREMEDICATION

Numerous drugs may be used for premedication or as anesthetic adjuvants. The pharmacologic features of the neuromuscular blocking agents, which are frequently used during anesthesia to provide greater muscle relaxation, are discussed in Chapter 10. Many of the sedatives, analgesics, antihistamines, and antimuscarinics previously mentioned in this chapter and reviewed elsewhere in the book are administered

to the patient minutes to several hours before anesthesia and surgery. Table 18-4 lists commonly used drugs for premedication.

Indications for premedication include relief of anxiety; induction of sedation, analgesia, and amnesia; vagal blockade; reduction of secretions in the upper respiratory tract; and prevention of nausea and vomiting. Premedicants are also used to decrease the acidity and volume of gastric secretions. Finally, they are administered to reduce the dose of the general anesthetic agent needed for a smooth induction.

An effective method of alleviating preoperative anxiety is the preoperative visit by the anesthesiologist, which allows information to be given to the patient and permits questions to be answered. The following classes of drugs, whose pharmacologic features are described elsewhere in this text, are routinely used as adjuncts to the careful psychological preparation of the patient.

Opioid analgesics offer analgesia, euphoria, and sedation. Complicating problems include respiratory depression, nausea and vomiting, gastric retention, and reduced sympathetic tone. Benzodiazepines can relieve anxiety without significant effects on respiration or cardiovascular function. They are also effective in providing amnesia and sedation. The antimuscarinics atropine, glycopyrrolate, and scopolamine may be used as premedicants to block vagal reflexes and inhibit salivation and respiratory tract secretion. They may also oppose the bradyarrhythmias that may accompany the use of other drugs in anesthesia, such as succinylcholine. Scopolamine also has central effects leading to sedation and amnesia. Glycopyrrolate does not cross the blood-brain barrier, is a more efficacious antisialagogue than atropine, and is less likely to induce tachycardia. H₁ and H₂ antihistamines may be given for premedication. H₁ antagonists, such as hydroxyzine or promethazine, offer antiemetic effects and some sedation. H₂ antagonists, such as cimetidine or ranitidine, decrease gastric secretion and acidity. These effects are important in certain patients because general anesthesia eliminates the usual protective reflexes that prevent aspiration after regurgitation of stomach contents.

TABLE 18-4

Agents Used for Premedication in General Anesthesia

DRUG (PROPRIETARY [TRADE] NAME)	ADULT DOSE (mg)	ROUTE OF ADMINISTRATION	INDICATIONS
Antimuscarinics			
Atropine	0.5	IV, IM	Secretion decrease, vagal blockade
Glycopyrrolate (Robinul)	0.2	IV, IM	Secretion decrease
Scopolamine	0.3	IV	Secretion decrease, sedation, amnesia
Antihistamines			
Hydroxyzine (Atarax, Vistaril)	25-100	Oral	Anxiolysis, sedation, antiemetic effect
Promethazine (Phenergan)	25-50	IM	Sedation, antiemetic effect
Ranitidine (Zantac)	150	Oral	Aspiration prophylaxis
Benzodiazepines			
Diazepam (Valium)	5-20	Oral, IV	Anxiolysis, sedation, amnesia
Lorazepam (Ativan)	0.5-4	Oral, IV	Anxiolysis, sedation, amnesia
Midazolam (Versed)	2-5	IM, IV*	Anxiolysis, sedation, amnesia
Triazolam (Halcion)	0.125-0.5	Oral	Anxiolysis, sedation, amnesia
Prokinetic Metoclopramide (Reglan)	5-15	IV	Aspiration prophylaxis
Opioids			
Fentanyl (Sublimaze)	0.025-0.1	IV	Sedation, analgesia
Meperidine (Demerol)	50-100	IM	Sedation, analgesia
Morphine	5-10	IM	Sedation, analgesia

*Midazolam is also administered orally and intranasally to children.

The dopaminergic antagonist metoclopramide is also sometimes administered to speed gastric emptying.

Postoperative nausea and vomiting are common adverse events after general anesthesia. To improve comfort and safety, patients who are predisposed to nausea and vomiting may be given one of a wide variety of antiemetics, which include the dopamine antagonists droperidol and prochlorperazine; anticholinergics/antihistamines, such as scopolamine and hydroxyzine; the adrenocorticosteroid dexamethasone; and 5-HT₃ antagonists, including ondansetron, granisetron, and dolasetron. Although droperidol is an effective antiemetic, its use has been greatly limited after the FDA placed restrictions on its use based on reports of its association with prolonged QT interval and related arrhythmias. The applicability of these reports to the small, prophylactic doses of droperidol used in anesthesiology has been widely questioned.⁵⁰

AGENTS USED IN GENERAL ANESTHESIA AND SEDATION

Nonproprietary (generic) name	Proprietary (trade) name
Inhalation agents	
<i>Gases</i>	
Nitrous oxide	—
<i>Volatile liquids</i>	
Desflurane	Suprane
Ether*	—
Halothane*	Fluothane
Isoflurane	Forane
Sevoflurane	Ultane
Injectable agents	
<i>Barbiturates</i>	
Methohexital	Brevital
Thiopental	Pentothal
<i>Alkylphenol</i>	
Propofol	Diprivan
<i>Arylcycloalkylamine</i>	
Ketamine	Ketalar
<i>Carboximidazole</i>	
Etomidate	Amidate
<i>α₂-Adrenoceptor agonist</i>	
Dexmedetomidine	Precedex
<i>Benzodiazepines (intravenous drugs)</i>	
Diazepam	Valium
Lorazepam	Ativan
Midazolam	Versed
<i>Opioids</i>	
See Table 18-3	
<i>Others</i>	
See Table 18-4	

*Not currently available in the United States.

CITED REFERENCES

- Amess JA, Burman JF, Rees GM, et al: Megaloblastic haemopoiesis in patients receiving nitrous oxide. *Lancet* 2:339-342, 1978.
- Apfelbaum JL, Grasela TH, Hug CC, Jr, et al: The initial clinical experience of 1819 physicians in maintaining anesthesia with propofol: characteristics associated with prolonged time to awakening. *Anesth Analg* 77:S10-S14, 1993.
- Badalaty MM, Houpt MI, Koenigsberg SR, et al: A comparison of chloral hydrate and diazepam sedation in young children. *Pediatr Dent* 12:33-37, 1990.
- Badner NH, Beatie WS, Freeman D, et al: Nitrous oxide-induced increased homocysteine concentrations are associated with increased postoperative myocardial ischemia in patients undergoing carotid endarterectomy. *Anesth Analg* 91:1073-1079, 2000.
- Berthoud MC, Reilly CS: Adverse effects of general anaesthetics. *Drug Saf* 7:434-459, 1992.
- Borgeat A, Wilder-Smith OHG, Suter PM: The nonhypnotic therapeutic applications of propofol. *Anesthesiology* 80:642-656, 1994.
- Bosnjak ZJ, Turner LA: Halothane, catecholamines, and cardiac conduction: anything new? *Anesth Analg* 72:1-4, 1991.
- Bray RJ: Propofol infusion syndrome in children. *Pediatr Anaesth* 8:491-499, 1998.
- Briggs M, Wong D, Groenewald C, et al: The effect of anaesthesia on the intraocular volume of the C3F8 gas bubble. *Eye* 11:47-52, 1997.
- Brown BR, Jr, Gandolfi AJ: Adverse effects of volatile anaesthetics. *Br J Anaesth* 59:14-23, 1987.
- Brownell AKW: Malignant hyperthermia: relationship to other diseases. *Br J Anaesth* 60:303-308, 1988.
- Bruce DL, Bach MJ: Effects of trace anaesthetic gases on behavioural performance of volunteers. *Br J Anaesth* 48:871-876, 1976.
- Caldwell JE: Desflurane: clinical pharmacokinetics and pharmacodynamics. *Clin Pharmacokinet* 27:6-18, 1994.
- Carpenter RL, Eger EI II, Johnson BH, et al: The extent of metabolism of inhaled anesthetics in humans. *Anesthesiology* 65:201-205, 1986.
- Carrigan TW, Straughen WJ: A report of hepatic necrosis and death following isoflurane anesthesia. *Anesthesiology* 67:581-583, 1987.
- Chiu TH, Chen MJ, Yang YU, et al: Action of dexmedetomidine on rat locus coeruleus neurons: intracellular recording in vitro. *Eur J Pharmacol* 285:261-268, 1995.
- Christensen B, Guttormsen AB, Schneede J, et al: Preoperative methionine loading enhances restoration of the cobalamin-dependent enzyme methionine synthase after nitrous oxide anesthesia. *Anesthesiology* 80:1046-1056, 1994.
- Christensen LQ, Bonde J, Kampmann JP: Drug interactions with inhalational anaesthetics. *Acta Anaesthesiol Scand* 37:231-244, 1993.
- Cohen EN, Brown BW, Wu ML, et al: Occupational disease in dentistry and chronic exposure to trace anaesthetic gases. *J Am Dent Assoc* 101:21-31, 1980.
- Cozzen PF, Kharasch ED, Czerner SF, et al: Low-flow sevoflurane compared with low-flow isoflurane anesthesia in patients with stable renal insufficiency. *Anesthesiology* 97:578-584, 2002.
- Cook TL, Smith M, Starkweather JA, et al: Behavioral effects of trace and subanesthetic halothane and nitrous oxide in man. *Anesthesiology* 49:419-424, 1978.
- Coté CJ: Sedation for the pediatric patient: a review. *Pediatr Clin North Am* 41:31-58, 1994.
- Crawford JS, Lewis M: Nitrous oxide in early human pregnancy. *Anaesthesia* 41:900-905, 1986.
- Dale O, Brown BR, Jr: Clinical pharmacokinetics of the inhalational anaesthetics. *Clin Pharmacokinet* 12:145-167, 1987.
- Deacon R, Lumb M, Perry J, et al: Selective inactivation of vitamin B12 in rats by nitrous oxide. *Lancet* 2:1023-1024, 1978.
- Dionne RA, Goldstein DS, Wirdzek PR: Effects of diazepam premedication and epinephrine-containing local anesthetic on cardiovascular and plasma catecholamine responses to oral surgery. *Anesth Analg* 63:640-646, 1984.
- Dohrn CS, Lichtor JL, Finn RS, et al: Subjective and psychomotor effects of nitrous oxide in healthy volunteers. *Behav Pharmacol* 3:19-30, 1992.
- Dwyer R, Bennett HL, Eger EI II, et al: Effects of isoflurane and nitrous oxide in subanesthetic concentrations on memory and responsiveness in volunteers. *Anesthesiology* 77:888-898, 1992.

29. Dykes MHM: Is halothane hepatitis chronic active hepatitis? *Anesthesiology* 46:233-235, 1977.
30. Eger EI II: New inhaled anesthetics. *Anesthesiology* 80:906-922, 1994.
31. Eger EI II: The clinical use of desflurane. *Yale J Biol Med* 66:491-500, 1993.
32. Elliott RH, Strunin L: Hepatotoxicity of volatile anaesthetics. *Br J Anaesth* 70:339-348, 1993.
33. Ermens AAM, Refsum H, Ruprecht J, et al: Monitoring cobalamin inactivation during nitrous oxide anesthesia by determination of homocysteine and folate in plasma and urine. *Clin Pharmacol Ther* 49:385-393, 1991.
34. Finley GA, MacManus B, Sampson SE, et al: Delayed seizures following sedation with propofol. *Can J Anaesth* 40:863-865, 1993.
35. Fu AD, McDonald HR, Elliott D, et al: Complications of general anesthesia using nitrous oxide in eyes with preexisting gas bubbles. *Retina* 22:569-574, 2002.
36. Fujinaga M, Baden JM, Suto A, et al: Preventive effects of phenoxybenzamine on nitrous oxide-induced reproductive toxicity in Sprague-Dawley rats. *Teratology* 43:151-157, 1991.
37. Gentz BA, Malan TP, Jr: Renal toxicity with sevoflurane: a storm in a teacup? *Drugs* 61:2155-2162, 2001.
38. Gooding JM, Dimick AR, Tavakoli M, et al: A physiologic analysis of cardiopulmonary responses to ketamine anesthesia in noncardiac patients. *Anesth Analg* 56:813-816, 1977.
39. Gregoire S, Smiley RK: Acute hepatitis in a patient with mild factor IX deficiency after anaesthesia with isoflurane. *Can Med Assoc J* 135:645-646, 1986.
40. Gronert GA, Milde JH, Theye RA: Dantrolene in porcine malignant hyperthermia. *Anesthesiology* 44:488-495, 1976.
41. Gronert GA, Milde JH, Theye RA: Role of sympathetic activity in porcine malignant hyperthermia. *Anesthesiology* 47:411-415, 1977.
42. Haas DA, Harper DG: Ketamine: a review of its pharmacologic properties and use in ambulatory anesthesia. *Anesth Prog* 39:61-68, 1992.
43. Harkin CP, Pagel PS, Kersten JR, et al: Direct negative inotropic and lusitropic effects of sevoflurane. *Anesthesiology* 81:156-167, 1994.
44. Heijke S, Smith G: Quest for the ideal inhalation anaesthetic agent. *Br J Anaesth* 64:3-6, 1990.
45. Hiller A, Olkkola KT, Isohanni P, et al: Unconsciousness associated with midazolam and erythromycin. *Br J Anaesth* 65:826-828, 1990.
46. Hohner P, Reiz S: Nitrous oxide and the cardiovascular system. *Acta Anaesthesiol Scand* 38:763-766, 1994.
47. Holzki J, Kretz FJ: Changing aspects of sevoflurane in paediatric anaesthesia: 1975-1999. *Paediatr Anaesth* 9:283-286, 1999.
48. Hudson RJ, Stanski DR, Burch PG: Pharmacokinetics of methohexital and thiopental in surgical patients. *Anesthesiology* 59:215-219, 1983.
49. Hug CC, Jr, McLeskey CH, Nahrwold ML, et al: Hemodynamic effects of propofol: data from over 25,000 patients. *Anesth Analg* 77:S21-S29, 1993.
50. Jackson CW, Sheehan AH, Reddan JG: Evidence-based review of the black-box warning for droperidol. *Am J Health Syst Pharm* 64:1174-1186, 2007.
51. Jensen NF, Fiddler DS, Striipe V: Anesthetic considerations in porphyrias. *Anesth Analg* 80:591-599, 1995.
52. Kang TM: Propofol infusion syndrome in critically ill patients. *Ann Pharmacother* 36:1453-1456, 2002.
53. Kapila A, Glass PSA, Jacobs JR, et al: Measured context-sensitive half-times of remifentanyl and alfentanil. *Anesthesiology* 83:968-975, 1995.
54. Koblin DD: Characteristics and implications of desflurane metabolism and toxicity. *Anesth Analg* 75:S10-S16, 1992.
55. Koblin DD, Tomerson BW: Dimethylthiourea, a hydroxyl radical scavenger, impedes the inactivation of methionine synthase by nitrous oxide in mice. *Br J Anaesth* 64:214-223, 1990.
56. Koblin DD, Waskell L, Watson JE, et al: Nitrous oxide inactivates methionine synthetase in human liver. *Anesth Analg* 61:75-78, 1982.
57. Koek W, Woods JH, Winger GD: MK-801, a proposed non-competitive antagonist of excitatory amino acid neurotransmission, produces phencyclidine-like behavioral effects in pigeons, rats and rhesus monkeys. *J Pharmacol Exp Ther* 245:969-974, 1988.
58. Kothary SP, Zsigmond EK: A double-blind study of the effective antihallucinatory doses of diazepam prior to ketamine anesthesia. *Clin Pharmacol Ther* 21:108-109, 1977.
59. Kugel G, Letelier C, Zive MA, et al: Nitrous oxide and infertility. *Anesth Prog* 37:176-180, 1990.
60. Kugel G, Zive M, Agarwal RK, et al: Effect of nitrous oxide on the concentrations of opioid peptides, substance P, and LHRH in the brain and β -endorphin in the pituitary. *Anesth Prog* 38:206-211, 1991.
61. Lacombe G, Leake J, Clokie CML, et al: Comparison of remifentanyl with fentanyl for deep sedation for oral surgery. *J Oral Maxillofac Surg* 64:215-222, 2006.
62. Layzer RB, Fishman RA, Schafer JA: Neuropathy following abuse of nitrous oxide. *Neurology* 28:504-506, 1978.
63. Lerman J: Inhalation agents in pediatric anaesthesia—an update. *Curr Opin Anesthesiol* 20:221-226, 2007.
64. Litman RS, Kottra JA, Verga KA, et al: Chloral hydrate sedation: the additive sedative and respiratory depressant effects of nitrous oxide. *Anesth Analg* 86:724-728, 1998.
65. Lundy PM, Lockwood PA, Thompson G, et al: Differential effects of ketamine isomers on neuronal and extraneuronal catecholamine uptake mechanisms. *Anesthesiology* 64:359-363, 1986.
66. Malviya S, Voepel-Lewis T, Prochaska G, et al: Prolonged recovery and delayed side effects of sedation for diagnostic imaging studies in children. *Pediatrics* 105:E42, 2000.
67. Mazze RI: Nitrous oxide during pregnancy. *Anaesthesia* 41:897-899, 1986.
68. Mazze RI, Fujinaga M, Baden JM: Halothane prevents nitrous oxide teratogenicity in Sprague-Dawley rats; folic acid does not. *Teratology* 38:121-127, 1988.
69. McAteer PM, Carter JA, Cooper GM, et al: Comparison of isoflurane and halothane in outpatient paediatric dental anaesthesia. *Br J Anaesth* 58:390-393, 1986.
70. Nagele P, Zeugswetter B, Wiener C: Influence of methylenetetrahydrofolate reductase gene polymorphisms on homocysteine concentrations after nitrous oxide anesthesia. *Anesthesiology* 209:36-43, 2008.
71. Nunn JF, Sharer NM, Gorchein A, et al: Megaloblastic haemopoiesis after multiple short-term exposure to nitrous oxide. *Lancet* 1:1379-1381, 1982.
72. Olkkola KT, Aranko K, Luurila H, et al: A potentially hazardous interaction between erythromycin and midazolam. *Clin Pharmacol Ther* 53:298-305, 1993.
73. Pertovaara A, Haapalinna A, Sirviö J, et al: Pharmacological properties, central nervous system effects, and potential therapeutic applications of atipamezole, a selective α_2 -adrenoceptor antagonist. *CNS Drug Rev* 11:273-288, 2005.
74. Priebe HJ: Coronary circulation and factors affecting coronary "steal." *Eur J Anaesthesiol* 8:177-195, 1991.
75. Ramsay DS, Brown AC, Woods SC: Acute tolerance to nitrous oxide in humans. *Pain* 51:367-373, 1992.
76. Rao S, Sherbaniuk RW, Prasad K, et al: Cardiopulmonary effects of diazepam. *Clin Pharmacol Ther* 14:182-189, 1973.
77. Ray DC, Drummond GB: Halothane hepatitis. *Br J Anaesth* 67:84-99, 1991.
78. Reder BS, Trapp LD, Troutman KC: Ketamine suppression of chemically induced convulsions in the two-day-old white leghorn cockerel. *Anesth Analg* 59:406-409, 1980.
79. Rowland AS, Baird DD, Weinberg CR, et al: Reduced fertility among women employed as dental assistants exposed to high levels of nitrous oxide. *N Engl J Med* 327:993-997, 1992.
80. Royston BD, Nunn JF, Weinbren HK, et al: Rate of inactivation of human and rodent hepatic methionine synthase by nitrous oxide. *Anesthesiology* 68:213-216, 1988.
81. Rusy BF, Komai H: Anesthetic depression of myocardial contractility: a review of possible mechanisms. *Anesthesiology* 67:745-766, 1987.
82. Sarner JB, Levine M, Davis PJ, et al: Clinical characteristics of sevoflurane in children: a comparison with halothane. *Anesthesiology* 82:38-46, 1995.

83. Saunders PRI, Harris MNE: Opisthotonus and other unusual neurological sequelae after outpatient anaesthesia. *Anaesthesia* 45:552-557, 1990.
84. Searle NR, Sahab P: Propofol in patients with cardiac disease. *Can J Anaesth* 40:730-747, 1993.
85. Shafer SL: Advances in propofol pharmacokinetics and pharmacodynamics. *J Clin Anesth* 5(6 Suppl 1):14S-21S, 1993.
86. Shirasaka T, Kannan H, Takasaki M: Activation of a G protein-coupled inwardly rectifying K⁺ current and suppression of I_h contribute to dexmedetomidine-induced inhibition of rat hypothalamic paraventricular nucleus neurons. *Anesthesiology* 107:605-615, 2007.
87. Shulman D, Beardsmore CS, Aronson HB, et al: The effect of ketamine on the functional residual capacity in young children. *Anesthesiology* 62:551-556, 1985.
88. Smith DJ, Bouchal RL, deSanctis CA, et al: Properties of the interaction between ketamine and opiate binding sites in vivo and in vitro. *Neuropharmacology* 26:1253-1260, 1987.
89. Smith G, Shirley AW: Failure to demonstrate effect of trace concentrations of nitrous oxide and halothane on psychomotor performance. *Br J Anaesth* 49:65-70, 1977.
90. Smith I, White PF, Nathanson M, et al: Propofol: an update on its clinical use. *Anesthesiology* 81:1005-1043, 1994.
91. Stacy CB, Di Rocco A, Gould RJ: Methionine in the treatment of nitrous-oxide-induced neuropathy and myeloneuropathy. *J Neurol* 239:401-403, 1992.
92. Strazis KP, Fox AW: Malignant hyperthermia: a review of published cases. *Anesth Analg* 77:297-304, 1993.
93. Strum DP, Johnson BH, Eger EI II: Stability of sevoflurane in soda lime. *Anesthesiology* 67:779-781, 1987.
94. Tekavec MM: Nitrous oxide sedation with auditory modification. *Anesth Prog* 23:181-186, 1976.
95. Tokics L, Strandberg A, Brismar B, et al: Computerized tomography of the chest and gas exchange measurements during ketamine anaesthesia. *Acta Anaesthesiol Scand* 31:684-692, 1987.
96. Vote GJ, Hart RH, Worsley DR, et al: Visual loss after use of nitrous oxide gas with general anesthetic in patients with intraocular gas still persistent up to 30 days after vitrectomy. *Anesthesiology* 97:1305-1308, 2002.
97. Warltier DC, Pagel PS: Cardiovascular and respiratory actions of desflurane: is desflurane different from isoflurane? *Anesth Analg* 75:S17-S31, 1992.
98. White PF, Way WL, Trevor AJ: Ketamine—its pharmacology and therapeutic uses. *Anesthesiology* 56:119-136, 1982.
99. Wolf A, Weir P, Segar P, et al: Impaired fatty acid oxidation in propofol infusion syndrome. *Lancet* 357:606-607, 2001.
100. Wood C, Ewen A, Goresky G, et al: Exposure of operating room personnel to nitrous oxide during paediatric anaesthesia. *Can J Anaesth* 39:682-686, 1992.
101. Yacoub O, Doell D, Kryger MH, et al: Depression of hypoxic ventilatory response by nitrous oxide. *Anesthesiology* 45:385-389, 1976.
102. Yasuda N, Lockhart SH, Eger EI II, et al: Kinetics of desflurane, isoflurane, and halothane in humans. *Anesthesiology* 74:489-498, 1991.
103. Young CJ, Apfelbaum JL: A comparative review of the newer inhalational anaesthetics. *CNS Drugs* 10:257-310, 1998.

GENERAL REFERENCES

- Barash PG, Cullen BF, Stoelting RK, editors: *Clinical anesthesia*, ed 5, Philadelphia, 2005, Lippincott Williams & Wilkins.
- Evers AS, Crowder CM, Balse JR: General anesthetics. In Brunton L, Lazo J, Parker K, editors: *Goodman and Gilman's the pharmacological basis of therapeutics*, ed 11, New York, 2006, McGraw-Hill.
- Miller RD, editor: *Miller's anesthesia*, ed 6, Philadelphia, 2005, Elsevier.

Introduction to Antinociceptive Drugs

HYUNGSUK KIM AND RAYMOND A. DIONNE

Pain has always been a barrier to dentistry, serving as a continuing motivation for the use of drugs to prevent, block, or attenuate pain in the perioperative period. Despite the efficacy of local anesthesia, many procedures can result in substantial postoperative discomfort and edema, limiting mouth opening for several days. Poorly controlled pain in the perioperative period also contributes to anxiety about future dental therapy, leading to postponed or canceled appointments.^{2,10,16} Effective control of orofacial pain facilitates the delivery of care, reduces anxiety about dentistry, and may even improve dental health by promoting preventive and routine dentistry as an alternative to general neglect with episodic care for acute problems. Emerging basic and clinical studies have shown that the use of antinociceptive drugs to attenuate perioperative pain can prevent the development of hyperalgesia manifesting as increased pain hours to days after a procedure. The availability of safe, effective antinociceptive drugs now permits effective prevention and management of perioperative pain for the mutual benefit of the patient and the dental practitioner.

The multiplicity of pain mechanisms and the difficulty of separating nociceptive processing from physiologic pain perception represent significant barriers to improving pain therapy. In addition to the molecular events associated with tissue injury, inflammation, development of sensitization, and activation of ascending and descending pathways, it is now recognized that gender and genetic factors also contribute to individual variation in pain perception, processing, and evaluation of nociceptive input. Because of this mechanistic complexity, use of analgesic drugs in fixed doses that have been validated in a relatively homogeneous patient sample may not result in effective therapy when used in a patient population with wide genetic diversity in pain processing and drug metabolism. Although individual variation in the human pain experience is traditionally explained by various factors such as cultural or psychological influences, more recent studies in animal and human pain models show phenotypic differences in pain sensitivity that may result from genetic factors.^{6,22,26,38,44} This genetic variation among patients, along with other sources of variation, provides a physiologic rationale for individualizing pain treatment.

The management of chronic pain has a long history of therapeutic misadventures, including the misuse of drugs for symptomatic relief of chronic orofacial pain. There is still no generally accepted agreement about the cause of chronic orofacial pain; its natural history; the need for aggressive treatment; and the effectiveness, safety, and indications for most clinical practices. Differences of opinion on these issues are often fostered by a lack of appreciation of the difference between clinical observations, which may form the basis for

therapeutic innovation, and the need to verify the efficacy and safety of treatments in studies that control for factors that can mimic clinical success. Drug classes for the treatment of pain associated with temporomandibular joint (TMJ) disorders range from short-term treatment with nonsteroidal anti-inflammatory drugs (NSAIDs) and muscle relaxants for pain of presumed muscular origin to long-term administration of antidepressants and anticonvulsants for less well-characterized pain (see Chapter 23). The management of pain associated with TMJ disorders rests on the same principles that apply to the use of all drugs: demonstrated efficacy for the indication, an acceptable incidence of adverse reactions for the condition being treated, and safety when used in numerous patients for prolonged periods.

Growing numbers of elderly people in the population increase the prevalence of age-related painful conditions, such as osteoarthritis and various neuropathies. Improvements in the management of cancer increase life expectancy but are accompanied by an increase in the cumulative incidence of cancer-related pain and painful conditions associated with cancer treatment (e.g., chemotherapy, radiotherapy, surgery). In these patients with a complicated history, currently available analgesic modalities are often not helpful or effective. Despite astonishing advances in understanding of the neurobiology of pain, pain continues to produce severe distress, dominating and disrupting the lives of many patients from lack of adequate pain relief or the consequences of its treatment.

PATHWAYS OF OROFACIAL PAIN

Pain Transduction and Transmission in the Periphery

Noxious stimuli, which can produce tissue damage, are detected by the terminal endings of two major classes of nociceptive (pain-detecting) afferent nerve fibers (Figure 19-1). These nociceptors are distributed throughout the skin, oral mucosa, and tooth pulp. A δ fibers are fast-conducting, lightly myelinated neurons responding primarily to noxious mechanical stimuli. A δ fibers are thought to mediate the initial sensation of pain, which has a sharp perceptual quality. The second group of nociceptive fibers comprises C fibers, which are slowly conducting unmyelinated neurons that respond to thermal, mechanical, and chemical stimuli. C fibers likely mediate secondary pain, which occurs after the initial sharp, pricking pain and is generally described as having a dull, aching, or burning perceptual quality. There are approximately three to five times more C fibers than A δ fibers.²⁹ Other classes of cutaneous fibers have been described but are not as well characterized.

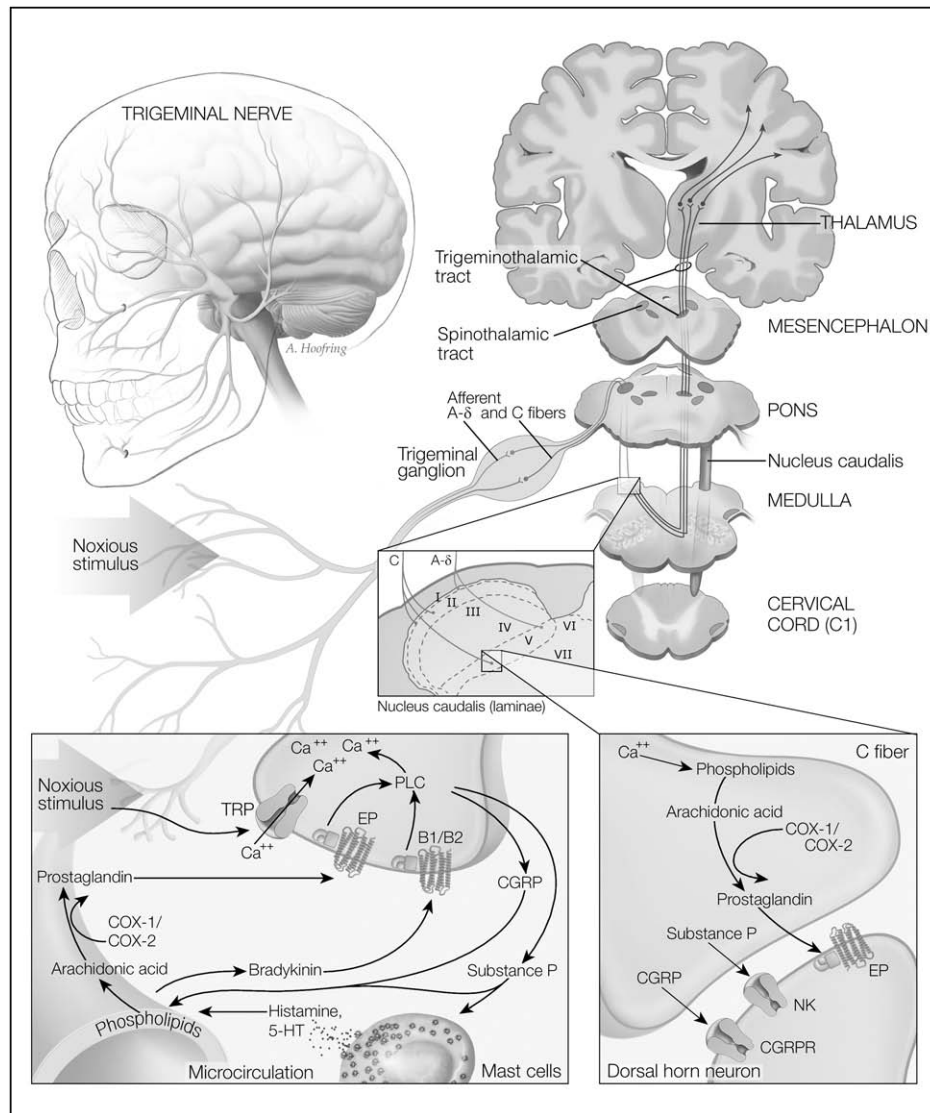

FIGURE 19-1 Diagram of trigeminal nociceptive pathways. After a noxious stimulus is applied in the orofacial region, multiple chemical mediators are released from damaged cells and from local nerve terminals and inflammatory cells (*lower left*). Some mediators act on their receptors and directly activate nociceptors, evoking pain. Others act together to produce a sensitization of the nervous system. Small A δ and C afferents synapse with nociceptive-specific trigeminothalamic neurons in the nucleus caudalis (*center*). By the released neurotransmitters from the primary afferents (*lower right*), trigeminothalamic neurons are activated, and noxious information is transmitted directly to the thalamus and ultimately to the cerebral cortex.

The detection of noxious stimuli in the orofacial region and the encoding of pain are conveyed primarily by nerves of the trigeminal system. The **trigeminal nerve, or fifth cranial nerve, is the largest of the cranial nerves; its three branches (ophthalmic, maxillary, and mandibular branches) innervate most of the face and anterior scalp.** The trigeminal nerve also innervates the mucous membranes and gingivae of the mouth; the teeth and jaws; the anterior two thirds of the tongue; the nasopharynx, nasal cavities, and sinuses; and a portion of the meninges. The **facial (seventh cranial) nerve** encodes pain from the skin of the mastoid region and the external auditory meatus; most of the sensory function of this nerve is involved in taste sensation. The **glossopharyngeal (ninth cranial) nerve** innervates the back of the tongue, tonsillar region, tympanic cavity, and antrum and oronasal portions of the pharynx. The vagus (tenth cranial) nerve

innervates the larynx and parts of the pharynx, ear, and external auditory meatus. These cranial nerves provide the peripheral innervation necessary for the detection of orofacial and dental pain.¹⁹

Pain Modulation in the Brainstem

The A δ and C fibers from the orofacial region **transmit nociceptive signals primarily by the branches of the trigeminal nerve to the trigeminal nucleus caudalis;** noxious information from additional regions is conveyed by other cranial nerves. Most clinical and laboratory data indicate that the **nucleus caudalis is the principal brainstem relay site for trigeminal nociceptive information.**³⁶ The nucleus caudalis is **located in the medulla;** its laminated structure, types of cells, and function in processing pain signals are similar to the area on the dorsal aspect of the spinal cord termed the *dorsal horn*.

As previously stated, the small-diameter afferents carrying nociceptive information from the various craniofacial tissues predominantly terminate in laminae I, II, and V of the nucleus caudalis. By contrast, primary afferent A fibers conducting low-threshold mechanosensitive (tactile) information terminate primarily in the most rostral components of the trigeminal brainstem complex and in laminae III to VI of the nucleus caudalis. More recent studies have also revealed increases in immunocytochemical markers of neuronal activity in caudalis neurons after noxious stimulation of craniofacial tissues.³⁶ Additionally, numerous studies using microelectrode recording have shown that many neurons in the nucleus caudalis are activated by cutaneous nociceptive input from the craniofacial region. For these reasons, the nucleus caudalis has been termed the *medullary dorsal horn*.³⁷

The medullary and spinal dorsal horns contain four major components related to the processing of noxious stimuli: central terminals of afferent fibers, local circuit neurons, projection neurons, and descending neurons. The first component, primary nociceptive afferents (A δ and C fibers), enter the medullary dorsal horn by way of the trigeminal tract. Nerves that enter the spinal dorsal horn traverse the lateral aspect of the tract of Lissauer. For medullary and spinal dorsal horns, A δ and C fibers terminate mainly in laminae I, IIa, and V. The primary nociceptive afferents transmit information by the synaptic release of neuropeptides (e.g., substance P, calcitonin gene-related peptide [CGRP]) and amino acids (e.g., glutamate).

The second component of the dorsal horn—the local circuit neurons—consists of two major subtypes, the islet cells and stalked cells. Islet cells are found throughout lamina II and are thought to be inhibitory interneurons possibly using γ -aminobutyric acid (GABA) or enkephalin as neurotransmitters. Stalked cells are found primarily at the junction between laminae I and II and have been proposed to be excitatory interneurons conveying nociceptive output from primary afferents to projection neurons located in lamina I. The local circuit neurons play a crucial role in conveying and modulating nociceptive signals from the primary afferents to the projection neurons.

Projection neurons constitute the third component of the dorsal horn. Their function, and that of the descending neurons, is described later. Projection neurons and local circuit neurons can be divided into two major classes: wide dynamic range and nociceptive-specific neurons. The wide dynamic range neurons are activated by weak mechanical stimuli but respond maximally to intense and potentially tissue-damaging stimuli. In contrast, nociceptive-specific neurons respond only to intense noxious forms of mechanical, thermal, or chemical stimuli.

Pain Perception and Modulation by the Cerebral Cortex

Two major projections carrying noxious information from the medullary and spinal dorsal horns are the trigeminothalamic tract and the spinothalamic tract. These tracts are composed of axons from the wide dynamic range and nociceptive neurons. These axons cross to the contralateral side of the medulla or spinal cord and ascend rostrally to the thalamus. From the thalamus, additional neurons convey this information to the cerebral cortex (see Figure 19-1).

Axonal collaterals of the trigeminothalamic and spinothalamic tracts terminate in the rostral medullary reticular formation and the periaqueductal gray. The projection and local circuit neurons encode information about the location, intensity, duration, and type of noxious input.

The fourth component of the dorsal horn is composed of the terminal endings of descending neurons. These neurons form an important component of the endogenous pain modu-

latory system. Because the cerebral cortex is an important center for integrating all perceptual modalities together with higher functions, such as expectation and recall of previous events, it is not surprising that the cortex is involved in pain perception and response. Evidence suggests that the cerebral cortex is involved with the sensory discriminative aspect of pain and that it may serve as the most rostral activator of the endogenous analgesic system.¹⁹

PERIPHERAL MECHANISMS OF PAIN AND ANALGESIC DRUG ACTIONS

Activation of Nociceptors

Most noxious stimuli are transduced into electrical activity at the peripheral terminals of A δ and C fibers by specific receptors or ion channels sensitive to heat, mechanical stimuli, protons, or cold. Ligand-gated channels expressed on nociceptive neurons include excitatory amino acid receptors, GABA receptors, nicotinic acetylcholine receptors, serotonergic (tryptaminergic or 5-hydroxytryptamine) receptors, and adenosine triphosphate P2X receptors. These receptors permit primary nociceptive neurons to respond to a wide range of mediators.²⁸

Among the many channel types that modulate the passage of charged ions across cell membranes, Ca⁺⁺ channels are particularly important in cellular homeostasis and activity, and the surface of each cell holds thousands of these channels that precisely control the timing and entry of Ca⁺⁺. Small conformational changes cause these channels to open, allowing more than 10 million ions per second to flow through each channel. The opening of Ca⁺⁺ channels is the crucial link between cell depolarization and Ca⁺⁺ entry, which can result in local intracellular Ca⁺⁺ concentrations up to 100 μ mol/L. The subsequent binding of Ca⁺⁺ to intracellular molecules can lead to many significant responses, including triggering of neurotransmitter release, the activation of second messenger systems, and Ca⁺⁺ spikes (action potentials in which the depolarizing current is carried predominantly by Ca⁺⁺).²⁸

Transient receptor potential (TRP) channels are the vanguard of sensory systems, responding to temperature, touch, pain, osmolarity, and other stimuli. TRPV1, also known as the *vanilloid receptor 1*, is a Ca⁺⁺-permeable channel that is opened by heat (>43° C) and decreased pH. TRPV1 contributes to acute thermal nociception and hyperalgesia after tissue injury. TRPV2, which is 50% identical to TRPV1 in primary structure, may mediate high-threshold (>52° C) noxious heat sensation, perhaps through lightly myelinated A δ nociceptors. The ankyrin-like protein with transmembrane domains 1 channel is a Ca⁺⁺-permeable, nonselective channel distinguished by approximately 14 amino-terminal ankyrin repeats. It is activated by noxious cold temperature (<15° C) but bears little similarity to the menthol-sensitive TRPV8 channel. It is found in a subset of nociceptive sensory dorsal root ganglion neurons in the company of capsaicin-sensitive TRPV1 channels.⁴

Activation of nociceptors is not the only way to trigger pain. After peripheral tissue injury or damage to the nervous system, low-threshold sensory fibers, which normally produce only innocuous sensations such as light touch, can begin to produce pain—a substantial change in the normal functional specificity of the sensory system. Although this pain no longer represents the presence of a damaging external stimulus, to the individual it feels as if the pain arises in the periphery from a noxious stimulus. With inflammation, components of the “inflammatory soup” such as bradykinin or prostaglandins bind to G protein-coupled receptors and induce activation of protein kinases A and C in nociceptor peripheral terminals, which phosphorylate ion channels and receptors. As a result,

the threshold for activation of transducer receptors such as TRPV1 is reduced.

One of the best-established pronociceptive substances derived from nerve endings is substance P. Substance P causes vasodilation and extravasation of plasma proteins from capillaries, which contribute to the edema associated with inflammation and to the generation of bradykinin from kininogen. Because the neurokinin-1 receptor is the major receptor for substance P, neurogenic inflammation is markedly attenuated by receptor antagonists specific for this receptor. Another putative mediator of neurogenic inflammation is CGRP, which produces vascular leakage and vasodilation leading to inflammation and tenderness. Immune cells may be involved in inflammatory pain, cancer pain, and pain after nerve injury. They are activated in the periphery and within the central nervous system (CNS) in response to tissue damage, inflammation, or mechanical nerve lesions. The immune reaction may increase nociception through the release of cytokines, but granulocytes and monocytes can also promote analgesia by secreting β -endorphin and enkephalin.

Inflammatory Pain

Inflammation represents a complex series of physiologic reactions required for normal healing after physical injury or infection. Mediators formed during the evolution of the inflammatory process contribute to the genesis of acute pain by stimulating or sensitizing primary afferent neurons by peripheral and central mechanisms. The biochemical composition of the local environment of inflamed tissue is complex. Protons, cytokines, prostanoids, leukotrienes, neuropeptides, histamine, bradykinin, and free radicals are ingredients of the inflammatory soup that defines the biochemical environment of inflamed tissue. Although each of these molecular species may directly or indirectly contribute to inflammation, inflammatory pain probably results from an interplay of neuronal signals generated by inflammatory mediators, resulting in synergistic biochemical interactions with primary afferent neurons.

If a particular biochemical in the inflammatory soup is a primary contributor to the genesis of inflammatory pain, drugs that block its actions or synthesis should provide significant analgesia. Agents that block the actions of histamine or substance P and the synthesis of bradykinin or prostaglandins all possess analgesic activity in animal models of inflammation. In addition, combinations of these agents can exert summative effects, consistent with the view that the total composition of the inflammatory soup governs the genesis and maintenance of inflammatory pain.

Analgesic Mechanisms Acting Primarily in the Periphery

Pharmacologic management of pain can be accomplished by blocking either the nociceptive input at the receptor or the nociceptive impulse along the peripheral nerve. As previously mentioned, various biochemicals at inflammatory sites affect nociceptive input by direct or indirect mechanisms. Prostaglandins, especially PGE₂, sensitize nociceptive nerve endings and potentiate the actions of other inflammatory mediators such as bradykinin. Sensitization of peripheral nociceptors is minimized in the absence of PGE₂, and pain sensations are attenuated. Drugs designed to block prostaglandin synthesis or function should be effective analgesics for some inflammatory pain.

Aspirin-like drugs, which include aspirin, acetaminophen, and NSAIDs, exert their actions in damaged tissue. These drugs inhibit generation of the pain signal and accompanying sensitization at the nerve ending through blockade of prostaglandin synthesis.^{13,14} In addition, NSAIDs have been reported to possess moderate efficacy for inhibiting postoperative

edema.⁴⁵ There seems to be a maximal effect, or ceiling effect, however, beyond which additional increments of drugs do not produce significantly greater analgesia. This ceiling effect probably reflects the contribution of other inflammatory mediators that are unaffected by aspirin-like drugs.

The physiologic mechanism for the synthesis of prostaglandins is the activation of phospholipase A₂ and cyclooxygenase during the process of tissue damage (e.g., during surgery). This information has an important practical application—pretreating patients with NSAIDs before surgery. The rationale for this therapy is the blockade of enzymes before the initiation of tissue damage. Although the advantages of pretreatment have been most clearly established for ibuprofen,²¹ several other drugs, including flurbiprofen, have been shown to reduce pain. Pretreating patients with ibuprofen delays the onset and reduces the magnitude of postoperative pain. This therapeutic strategy emphasizes how clinicians can improve patient care by knowledge of pain physiology.¹⁹

Inhibition of prostaglandin synthesis can also be accomplished by administering glucocorticoids. This group of steroids has very potent anti-inflammatory activity. Glucocorticoids inhibit all phases of inflammation, including capillary dilation, migration of leukocytes, and phagocytosis. Steroids have been shown to activate synthesis of a protein inhibitor of phospholipase A₂ called *lipocortin*.²⁷ Blockade of arachidonic acid formation by inhibiting phospholipase A₂ is an early step in the cascade and prevents formation of cyclooxygenase and lipoxygenase end products. In addition, glucocorticoids induce the synthesis of angiotensin-converting enzyme, a peptidase that degrades bradykinin and decreases the capillary permeability, probably from the increased synthesis of peptides promoting vascular stability or the reduced release of proteolytic enzymes.⁵ These multiple mechanisms for the suppression of inflammatory mediators probably account for the impressive anti-inflammatory efficacy of steroids.

Another approach to peripheral pain management is to block the nociceptive impulse as it moves along the nerve axon. Local anesthetics prevent the propagation of action potentials in peripheral nerves by interfering with Na⁺ channel permeability (see Chapter 16). Nociceptive A δ and C fibers are very susceptible to blockade by local anesthetics. Local anesthetics with increased potency and prolonged duration of action have been developed on the basis of their enhanced physicochemical properties, such as increased lipid solubility and greater protein binding. Sustained blockade of A δ and C fibers can result in prolonged suppression of postoperative pain.

Many studies indicate that the immune system can interact with peripheral sensory nerve endings to inhibit pain within inflamed tissue. In contrast to the traditional view that opioid antinociception is mediated exclusively within the CNS, peripheral opioid receptors have been discovered and shown to mediate analgesic effects when activated by locally applied opioid agonists.⁴¹ Opioid receptors are present on peripheral sensory nerves and are upregulated during the development of inflammation. Their endogenous ligands—opioid peptides—are expressed in resident immune cells within peripheral inflamed tissue. These findings have led to the concept that endogenous opioid peptides can be secreted from immunocytes, occupy opioid receptors on sensory nerves, and produce analgesia by inhibiting either the excitability of these nerves or the release of excitatory, proinflammatory neuropeptides.⁴² It seems that peripheral opioid receptors can modulate sensory nerve impulses in a way similar to spinal presynaptic opioid receptors. The local application of exogenous opioids¹¹ or enzyme inhibitors preventing the degradation of endogenous opioid peptides may provide a new approach to pain management by producing analgesia without central side effects.

CENTRAL MECHANISMS OF PAIN AND ANALGESIC DRUG ACTIONS

Neurotransmitters Involved in Nociceptive Signaling

The central endings of trigeminal nociceptive primary afferents within the nucleus caudalis contain certain excitatory amino acids (e.g., glutamate) and neuropeptides (e.g., substance P, CGRP) that transmit the nociceptive signals to the second-order trigeminal neurons. In lamina II, the axons of most substantia gelatinosa neurons arborize locally within the trigeminal brainstem complex and release neuromodulatory substances such as enkephalin or GABA. The substantia gelatinosa receives a mix of inputs from other areas in the brain and craniofacial afferent input, and it is one of the main sites where peripheral afferents and brain centers modulate somatosensory transmission.³⁷ Glutamate is a particularly important excitatory neurotransmitter in trigeminal nociceptive mechanisms.¹² It is released from the central endings of trigeminal nociceptive afferents and activates caudalis nociceptive neurons. This process involves two different ionotropic receptors for glutamate—N-methyl-D-aspartate (NMDA) and α -amino-3-hydroxy-5-methyl-4-isoxazole propionic acid (AMPA) receptors—as well as metabotropic receptors.

Substance P and the neurokinin-1 receptor are also concentrated in afferent endings in the superficial and deep laminae of the nucleus caudalis, where the nociceptive neurons predominate. Noxious craniofacial stimulation is reported to result in the release of substance P within the nucleus caudalis, presumably from the nociceptive afferent terminals within the substantia gelatinosa, and the released substance P acts through neurokinin receptors to produce a delayed but sustained excitation of the nociceptive neurons.

Central Convergence of Neurons Signaling Pain

Many nociceptive and wide dynamic range neurons can be excited by stimulation of cutaneous or mucosal receptive fields and seem to play an important role in the localization, detection, and discrimination of superficial noxious stimuli. These same neurons can also be excited by peripheral afferents from other tissues such as cerebral blood vessels, tooth pulp, TMJ, or muscle. The extensive convergent afferent input patterns are particularly characteristic of nociceptive-specific and wide dynamic range neurons in the nucleus caudalis. The presence of a cutaneous and a deep receptive field for most of these neurons may explain the poor localization of deep pain and contribute to the spread and referral of pain typical of deep pain conditions involving the TMJ and associated musculature. The poor localization of pain and the frequent occurrence of pain referral with toothache and headache may also be related to analogous convergence patterns from tooth pulp and cerebrovascular afferents onto the nociceptive neurons.

Development of Central Sensitization

The convergence of afferent input may also contribute to central neuronal changes that can be induced by inflammation or injury of peripheral tissues or nerves. Several chemicals released from the peripheral tissue or primary afferent nerve endings by tissue injury or inflammation can increase the excitability of peripheral nociceptors. This increase in excitability produces a barrage of nociceptive primary afferent input into the CNS. Peripheral nerve damage or lesions can also increase nociceptive afferent input. Whatever the cause, this nociceptive afferent barrage can lead to prolonged functional alterations in the nucleus caudalis (and spinal dorsal horn) collectively termed *central sensitization*. The nociceptive afferent activity caused by damage or inflammation of tooth pulp, TMJ, or muscle induces spontaneous activity, receptive field expansion, lowering of the activation threshold, and enhancement of responses of caudalis nociceptive-specific and

wide dynamic range neurons that may include a gradually augmenting response to a series of repeated noxious stimuli.³⁷

These alterations indicate that the afferent inputs and brainstem circuitry are not “hard-wired” but reflect neuroplastic changes in the receptive fields and response properties of the nociceptive neurons. The changes are thought to result, at least in part, from the unmasking and increased efficacy of the extensive convergent afferent input to the nociceptive neurons noted earlier. The responses of the neurons to this input are enhanced, and their receptive fields are enlarged, reflecting a greater amount of more effective input. This central sensitization apparently is produced by a cascade of events that starts with the nociceptive afferent barrage causing the release centrally of a number of chemical mediators such as substance P (mentioned previously). These substances prolong neuronal depolarization and increase the excitability of the nociceptive neurons by actions at glutamate receptors and G protein-coupled receptors.

Activation of these receptors is associated with removal of the voltage-dependent Mg^{++} block of the NMDA receptor, the entry of Ca^{++} into the neurons, phosphorylation of the NMDA receptor, and a change in neuronal kinetics. These changes may also involve other ionotropic and metabotropic excitatory amino acid receptors, neurotrophins, and kinases active in the phosphorylation of receptors. A loss of central inhibitory processes may contribute to the increased neuronal excitability that is characteristic of central sensitization.⁷

The increased central excitatory state depends on peripheral nociceptive afferent input for its initiation but may not fully depend on peripheral afferent drive for its maintenance. Central sensitization can last days or weeks and is thought to contribute to persistent pain and to the spontaneous pain and tenderness that characterize many clinical cases of injury or inflammation. Central sensitization can explain the hyperalgesia that is a feature of many persistent pain conditions, by virtue of the increase in excitability to A δ -fiber and C-fiber nociceptive input that it produces in central nociceptive neurons. It also may cause low-threshold mechanosensitive afferent input (which is not normally associated with pain) to serve as nociceptive signals after peripheral injury or inflammation and could contribute to the allodynia that is often associated with pain conditions. Peripheral sensitization can also contribute to hyperalgesia and allodynia by increasing the excitability and decreasing the activation threshold of primary afferents. Many pain conditions may involve a mixture of peripheral and central sensitization phenomena.³⁷

Central Effects of Opioid Drugs

Traditional pharmacologic pain management usually involves the administration of opioid analgesics. Parenteral opioid analgesics are the standard of care for severe pain in hospitalized patients. The profound analgesic efficacy of opioid drugs results from their ability to mimic the actions of the family of endogenous opioid peptides. Because endogenous opioids and their receptors are present at all levels of the endogenous analgesic system, opioid drugs can activate this system to suppress the transmission of nociceptive signals at the medullary and spinal dorsal horns. The oral efficacy of most opioid drugs is poor. An additional problem with opioids is their propensity to cause nausea in ambulatory patients. Opioids for most orofacial pain are limited, therefore, to an adjunctive role. Generally, the combination of an aspirin-like drug with an opioid increases analgesia at the cost of an increased incidence of side effects.¹⁹

Three opioid receptor classes are generally recognized, and experimental observations indicate that a common mechanism of opioid action is the cellular inhibition of neuronal activity. Although the opioid inhibitory effects may be cell dependent, accumulating evidence suggests a link to the receptor-mediated suppression of voltage-gated Ca^{++} chan-

nels, the activation of inwardly rectifying K⁺ channels, and the inhibition of adenylyl cyclase activity. Opioid effects in sensory neurons are inhibitory and excitatory, however, and opioids can suppress a Na⁺-dependent inward current. High levels of endogenous opioid peptides and opioid receptors are found within the periaqueductal gray, rostral ventral medulla, and dorsal horn, and neurons in these areas can be activated by opioids. Because opioid receptors generally produce inhibitory effects on neuronal firing, the ability of endogenous opioid peptides or opioid drugs to activate neurons within these brain regions depends on an anatomic arrangement in which opioid receptors inhibit GABAergic (inhibitory) interneurons. Neurons of the rostral ventral medulla that project to the dorsal horn activate enkephalinergic interneurons that are located in the dorsal horn.²⁸

GABA is present in highly diverse inhibitory interneurons and projection neurons throughout the brain. The wide-ranging and ubiquitous role of GABA as an inhibitory transmitter is supported by evidence linking numerous neuropsychiatric disorders with altered GABA function and the degradation of GABAergic neurons. In the past, the action of GABA was considered to be solely inhibitory, on the basis of the observation that GABA receptor activation moves the membrane potential of a cell away from the action potential threshold. The role of GABA is more complex, however. During development, GABA may also function as an excitatory transmitter causing neuronal depolarization.

Analgesic Actions of Antidepressant Drugs

Descending noradrenergic projections from the locus coeruleus or from related noradrenergic nuclei in the dorsal pons inhibit dorsal horn neurons and contribute to descending analgesia. The role of norepinephrine in descending analgesia may explain the analgesic effects of tricyclic antidepressants, including those of selective norepinephrine reuptake inhibitors, which are often effective in the treatment of neuropathic pain. Although many individuals with chronic neuropathic pain have depression, the analgesic effects of these agents are clearly independent of their antidepressant effects because the analgesic effects occur at lower doses and after shorter periods of treatment.

MOLECULAR-GENETIC INFLUENCES ON PAIN AND ANALGESIC DRUG ACTIONS

Progress is being made in discerning the molecular and cellular mechanisms that operate in sensory pathways to generate the neural signals that we ultimately interpret as pain.³⁵ It is now possible to assess entire pathways that might be relevant to disease or to drug responses at the DNA, mRNA, and protein levels.

Mendelian traits exist when a single mutation at a locus results in large, often discrete phenotypic effects. In contrast to mendelian traits, pain is one of the complex traits in which many genes are involved, each with usually a small effect. Moderate heritability estimates combined with findings that specific polymorphisms in humans are linked to responses to painful stimuli^{25,39,43} may be sufficient evidence to support a genetic contribution to pain sensitivity. For traits such as individual differences in pain sensitivity, variations are generally not attributable to different alleles at a single locus. Rather, many different genes, each with allelic variations, contribute to the total observed variability in a trait, with no particular gene having a single large effect. An individual phenotype results from the sum total of the effects of all the numerous contributing loci.³⁴ Certain genes, such as those for opioid receptors or cytochromes P450, are involved in many different types of pain. The lack of concordance between pain sensitivities suggests, however, that there is not one “global”

insensitive—or sensitive—pain phenotype. Remarkably little is known about the genetic architecture underlying pain. Since the completion of the human genome sequence, genetic variation discovery projects (SNP Consortium, International HapMap project) are presenting new opportunities for unraveling the complex genetic basis of nonmendelian disorders on the basis of large-scale, genome-wide association studies.

Sensory input in humans is filtered through an individual's genetic composition and through prior learning, current physiologic status, idiosyncratic appraisals, expectations, current mood state, and the sociocultural environment.⁴⁶ These influences manifest as variability in pain sensitivity, perception, and tolerance. The relative contribution and interaction of these many factors to individual variations in pain is currently unknown. One of the underlying mechanisms mediating the influence of environmental factors on pain sensitivities is the epigenetic phenomenon. Although epigenetic changes such as methylation or acetylation of DNA do not induce sequence deterioration, they still influence expression of genes and eventually alter phenotypes. It is likely that expression of genes related to pain also can be affected by these epigenetic factors. Even monozygotic twins show tremendous differences in their epigenetic profiles, and this fact may explain behavioral differences between genetically identical twins.¹⁵ The first evidence of epigenetic modification of pain in animals was reported more recently.³

Adverse reactions to prescription drugs cause at least 100,000 deaths each year in the United States and are responsible for more than 10% of hospital admissions in some European countries.¹ The study of pharmacogenetics that relate heritability to individual variation in drug response (see Chapter 4) is expected to lead increasingly to associations between genotype and analgesic drug response that have prognostic value. Genetic predictors are most likely to be used to avoid adverse effects or select which of several alternative drugs would have the highest efficacy. Initial pharmacogenetic findings have already been reported for analgesics, including cyclooxygenase inhibitors and opioid-like drugs.* On the basis of these findings, it is likely that no single analgesic can reduce all forms of pain in all patients. Even for the individual patient with a given painful condition, molecular genetic mechanisms underlying the pain and analgesic responses to it may change over time.

Further progress in analyzing an individual's genomic and epigenomic profiles using next-generation sequencing technologies is being made.²⁰ De novo whole genome sequencing or epigenetic profiling of unique individuals—such as a person absolutely insensitive to capsaicin³¹—may provide deep insights of pain mechanisms. As knowledge of molecular and cellular mechanisms accumulates along with advanced technologies, it is likely that patients in the future will be given individually tailored prescription drugs on the basis of their genetic and epigenetic profiles to treat common diseases or to reduce the risk of adverse reactions.¹⁷

THERAPEUTIC STRATEGIES FOR USING ANTINOCICEPTIVE DRUGS

Pain Prevention

Interfering with nociceptive input into the CNS, especially in the perioperative period, also interferes with processes that contribute to the development of central sensitization. The consequence of central sensitization is that innocuous sensations may be interpreted as painful (central hyperalgesia) and may persist long after the initiating stimulus has ended. This phenomenon and the related process of sensitization of nociceptors are probably additive and contribute to the intensity

*References 1, 23, 24, 30, 32, 33, 40 and 47.

and the duration of pain postoperatively. Recognition of the possible clinical importance of the development of central sensitization has led to attempts to block its development and minimize postoperative pain and reduce analgesic use during recovery. The ability to reduce analgesic use is particularly desirable in ambulatory patients who are much more sensitive to the adverse effects of opioid drugs. Decreasing pain and adverse drug effects makes the postoperative period less unpleasant, enhances return to normal function, and likely alleviates apprehension about future clinical procedures.

Translating these observations and hypotheses into the management of pain in the dental environment can be readily achieved with currently available drugs. The use of either a NSAID or a long-acting local anesthetic before a dental procedure results in less pain during the first 4 to 8 hours postoperatively^{8,9} and seems to attenuate pain intensity over the first 2 to 3 days thereafter.¹⁸ The administration of a NSAID before pain onset suppresses the release of inflammatory mediators such as prostaglandins that contribute to the sensitization of peripheral nociceptors. Patients have a much slower onset and less intense pain postoperatively after NSAID pretreatment, lessening nociceptive input and the development of central sensitization. The combination of NSAID pretreatment and the use of a long-acting local anesthetic greatly reduce pain after oral surgery; many patients report little pain in the first 6 to 7 hours postoperatively and reduced pain at 24 and 48 hours compared with standard treatment.

Pain Management

NSAIDs such as ibuprofen are among the most widely used drugs for dental pain and are generally more efficacious than aspirin, acetaminophen, or oral opioids in most studies, presumably because of the inflammatory cause of most dental pain and the prominent anti-inflammatory effects of NSAIDs. When possible, NSAID therapy is preferable for ambulatory patients who generally have a high incidence of side effects when given an opioid. NSAIDs also modestly suppress swelling after surgical procedures, providing additional therapeutic benefit without the potential liabilities of administering steroids. These considerations and the vast clinical experience gained through 25 years of clinical experience with ibuprofen make NSAIDs the drug class of choice for dental pain for patients who do not have any contraindications to their use.

Limitations to orally administered NSAIDs for dental pain include delayed onset compared with an injectable opioid, the inability to relieve severe pain consistently, and an apparent lack of effectiveness when given repeatedly for chronic pain. For patients who do not receive satisfactory relief from a NSAID alone, combining it with an opioid may provide additive analgesia but will also be accompanied by more frequent side effects. Chapters 20 and 21 review the pharmacology of opioids and NSAIDs, and the clinical use of these agents for acute pain is discussed in Chapter 47.

CITED REFERENCES

- Abbott A: With your genes? Take one of these, three times a day. *Nature* 425:760-762, 2003.
- Berggren U, Meynert G: Dental fear and avoidance: causes, symptoms, and consequences. *J Am Dent Assoc* 109:247-251, 1984.
- Chiechio S, Zammataro M, Morales ME, et al: Epigenetic modulation of mGlu2 receptors by histone deacetylase inhibitors in the treatment of inflammatory pain. *Mol Pharmacol* 75:1014-1020, 2009.
- Clapham DE: TRP channels as cellular sensors. *Nature* 426:517-524, 2003.
- Di Rosa M, Calignano A, Carnuccio R, et al: Multiple control of inflammation by glucocorticoids. *Agents Actions* 17:284-289, 1986.
- Diatchenko L, Slade GD, Nackley AG, et al: Genetic basis for individual variations in pain perception and the development of a chronic pain condition. *Hum Mol Genet* 14:135-143, 2005.
- Dickenson A: Pharmacology of pain transmission and control. In Campbell JN, editor: *Pain 1996—an updated review*, Seattle, 1996, IASP Press.
- Dionne RA, Campbell RA, Cooper SA, et al: Suppression of postoperative pain by preoperative administration of ibuprofen in comparison to placebo, acetaminophen, and acetaminophen plus codeine. *J Clin Pharmacol* 23:37-43, 1983.
- Dionne RA, Cooper SA: Evaluation of preoperative ibuprofen for postoperative pain after removal of third molars. *Oral Surg Oral Med Oral Pathol* 45:851-856, 1978.
- Dionne RA, Gordon SM, McCullagh LM, et al: Assessing the need for anesthesia and sedation in the general population. *J Am Dent Assoc* 129:167-173, 1998.
- Dionne RA, Lepinski AM, Gordon SM, et al: Analgesic effects of peripherally administered opioids in clinical models of acute and chronic inflammation. *Clin Pharmacol Ther* 70:66-73, 2001.
- Dubner R, Basbaum A: Spinal dorsal horn plasticity following tissue or nerve injury. In Wall RD, Melzack R, editors: *Textbook of pain*, London, 1994, Churchill Livingstone.
- Ferreira SH, Moncada S, Vane JR: Prostaglandins and the mechanism of analgesia produced by aspirin-like drugs. *Br J Pharmacol* 49:86-97, 1973.
- Flower RJ, Blackwell GJ: Anti-inflammatory steroids induce biosynthesis of a phospholipase A2 inhibitor which prevents prostaglandin generation. *Nature* 278:456-459, 1979.
- Fraga MF, Ballestar E, Paz MF, et al: Epigenetic differences arise during the lifetime of monozygotic twins. *Proc Natl Acad Sci U S A* 102:10604-10609, 2005.
- Gatchel RJ, Ingersoll BD, Bowman L, et al: The prevalence of dental fear and avoidance: a recent survey study. *J Am Dent Assoc* 107:609-610, 1983.
- Goldstein DB, Tate SK, Sisodiya SM: Pharmacogenetics goes genomic. *Nat Rev Genet* 4:937-947, 2003.
- Gordon SM, Brahim JS, Dubner R, et al: Attenuation of pain in a randomized trial by suppression of peripheral nociceptive activity in the immediate postoperative period. *Anesth Analg* 95:1351-1357, 2002.
- Hargreaves KM, Milam SB: Mechanisms of orofacial pain and analgesia. In Dionne RA, Phero J, Becker D, editors: *Management of pain and anxiety in the dental office*, ed 2, Philadelphia, 2002, Saunders.
- Ionita-Laza I, Lange C, Laird NM: Estimating the number of unseen variants in the human genome. *Proc Natl Acad Sci U S A* 106:5008-5013, 2009.
- Jackson DL, Moore PA, Hargreaves KM: Preoperative nonsteroidal anti-inflammatory medication for the prevention of postoperative dental pain. *J Am Dent Assoc* 119:641-647, 1989.
- Kim H, Neubert JK, San Miguel A, et al: Genetic influence on variability in human acute experimental pain sensitivity associated with gender, ethnicity and psychological temperament. *Pain* 109:488-496, 2004.
- Kim H, Ramsay E, Lee H, et al: Genome-wide association study of acute post-surgical pain in humans. *Pharmacogenomics* 10:171-179, 2009.
- Lee YS, Kim H, Wu TX, et al: Genetically mediated interindividual variation in analgesic responses to cyclooxygenase inhibitory drugs. *Clin Pharmacol Ther* 79:407-418, 2006.
- MacGregor AJ: The heritability of pain in humans. In Mogil J, editor: *The genetics of pain*, Seattle, 2004, IASP Press.
- Mogil JS, Wilson SG, Chesler EJ, et al: The melanocortin-1 receptor gene mediates female-specific mechanisms of analgesia in mice and humans. *Proc Natl Acad Sci U S A* 100:4867-4872, 2003.
- Munck A, Guyre PM, Holbrook NJ: Physiological functions of glucocorticoids in stress and their relation to pharmacological actions. *Endocr Rev* 5:25-44, 1984.
- Nestler EJ, Hyman SE, Malenka RC, editors: *Molecular neuropharmacology: a foundation for clinical neuroscience*, New York, 2001, McGraw-Hill.
- Ochoa J, Mair WG: The normal sural nerve in man, I: ultrastructure and numbers of fibres and cells. *Acta Neuropathol* 13:197-216, 1969.

30. Papafili A, Hill MR, Brull DJ, et al: Common promoter variant in cyclooxygenase-2 represses gene expression: evidence of role in acute-phase inflammatory response. *Arterioscler Thromb Vasc Biol* 22:1631-1636, 2002.
31. Park JJ, Lee J, Kim MA, et al: Induction of total insensitivity to capsaicin and hypersensitivity to garlic extract in human by decreased expression of TRPV1. *Neurosci Lett* 411:87-91, 2007.
32. Rakvag TT, Klepstad P, Baar C, et al: The Val158Met polymorphism of the human catechol-O-methyltransferase (COMT) gene may influence morphine requirements in cancer pain patients. *Pain* 116:73-78, 2005.
33. Reyes-Gibby CC, Shete S, Rakvag T, et al: Exploring joint effects of genes and the clinical efficacy of morphine for cancer pain: OPRM1 and COMT gene. *Pain* 130:25-30, 2007.
34. Risch NJ: Searching for genetic determinants in the new millennium. *Nature* 405:847-856, 2000.
35. Scholz J, Woolf CJ: Can we conquer pain? *Nat Neurosci* 5(Suppl):1062-1067, 2002.
36. Sessle BJ: Acute and chronic craniofacial pain: brainstem mechanisms of nociceptive transmission and neuroplasticity, and their clinical correlates. *Crit Rev Oral Biol Med* 11:57-91, 2000.
37. Sessle BJ, Iwata K: Central nociceptive pathways. In Sessle BJ, Lavigne GJ, Lund JP, et al, editors: *Orofacial pain: from basic science to clinical management. The transfer of knowledge in pain research to education*, ed 2, Chicago, 2008, Quintessence.
38. Shabalina SA, Zaykin DV, Gris P, et al: Expansion of the human mu-opioid receptor gene architecture: novel functional variants. *Hum Mol Genet* 18:1037-1051, 2009.
39. Solovieva S, Kouhia S, Leino-Arjas P, et al: Interleukin 1 polymorphisms and intervertebral disc degeneration. *Epidemiology* 15:626-633, 2004.
40. Stamer UM, Lehnen K, Hothker F, et al: Impact of CYP2D6 genotype on postoperative tramadol analgesia. *Pain* 105:231-238, 2003.
41. Stein C, Hassan AH, Lehrberger K, et al: Local analgesic effect of endogenous opioid peptides. *Lancet* 342:321-324, 1993.
42. Stein C, Schaffer M, Cabot PJ, et al: Opioids and inflammation. In Borsook D, editor: *Molecular neurobiology of pain*, Seattle, 1997, IASP Press.
43. Strachan T, Read AP, editors: *Human molecular genetics*, New York, 2004, Garland Science.
44. Tegeder I, Costigan M, Griffin RS, et al: GTP cyclohydrolase and tetrahydrobiopterin regulate pain sensitivity and persistence. *Nat Med* 12:1269-1277, 2006.
45. Troullos ES, Hargreaves KM, Butler DP, et al: Comparison of nonsteroidal anti-inflammatory drugs, ibuprofen and flurbiprofen, with methylprednisolone and placebo for acute pain, swelling, and trismus. *J Oral Maxillofac Surg* 48:945-952, 1990.
46. Turk DC: Remember the distinction between malignant and benign pain? Well, forget it. *Clin J Pain* 18:75-76, 2002.
47. Ulrich CM, Bigler J, Sibert J, et al: Cyclooxygenase 1 (COX1) polymorphisms in African-American and Caucasian populations. *Hum Mutat* 20:409-410, 2002.

Opioid Analgesics and Antagonists

MICHAEL H. OSSIPOV, GERALD F. GEBHART, AND FRANK PORRECA

Opioids are primarily used for the relief of pain and consequently find widespread application in dentistry. Opioids also possess therapeutically useful antitussive (cough suppressant) and antidiarrheal effects in addition to several undesirable effects, including sedation and somnolence, unwanted constipation, nausea and vomiting, respiratory depression, and urinary retention. Repeated use of opioids for control of pain can lead to analgesic tolerance and physical and sometimes psychological dependence. These shortcomings notwithstanding, no other drugs are more efficacious as analgesics than opioids. Three groups of opioid agents are discussed in this chapter: pure agonists, pure antagonists, and agonist-antagonists, which are compounds that in the same molecule possess agonist and antagonist properties. Drugs that are pure agonists and those that are mixed agonist-antagonists are used principally for relief of pain; pure antagonists prevent or reverse the effects of pure agonists and mixed agonist-antagonists and are used principally to reverse opioid intoxication.

OPIOID ANALGESICS

Morphine, the prototypic opioid analgesic, and codeine are natural phenanthrene alkaloids contained in opium, which is derived from the poppy plant *Papaver somniferum*. The unripe seed capsules of the plant are incised, and the milky exudate is collected, dried, and powdered. Opium powder contains 5% to 20% morphine and 0.5% to 2.5% codeine, depending on the source, and many other alkaloids. None of the other alkaloids is therapeutically useful in pain control; one constituent, papaverine, has been used as a smooth muscle relaxant.

The first documented descriptions of *Papaver somniferum* appeared in approximately 1550 BC in the Ebers papyrus of ancient Egypt.³⁵ Later, in the third century BC, writings of the Greek philosopher Theophrastus contained references to poppy juice. The active analgesic and constipative principle of the poppy plant was not isolated, and the drug was not named (after Morpheus, the Greek god of sleep) until 1806, when Sertürner first isolated morphine from opium and described its properties. Currently available opioid analgesics in addition to morphine and codeine are either semisynthetic congeners of morphine (e.g., hydromorphone, oxycodone, hydrocodone, and oxycodone) or entirely synthetic (e.g., meperidine, fentanyl, methadone, and propoxyphene).

Basis of Opioid Action

The mechanisms by which opioids act at specific central nervous system (CNS) and peripheral sites to produce their

effects are fairly well understood. In the early 1970s, binding sites in the CNS were discovered that stereospecifically, saturably, and reversibly combined with opioids.³⁷ These receptors were later shown to be the natural effectors of opioid action; that is, specific pharmacologic effects were produced by binding of opioids to these receptors. The discovery of opioid receptors naturally raised questions about their biologic significance, spurring research that led to the discovery of endogenous opioid receptors and peptides. Subsequently, several families of endogenous opioid peptides and numerous opioid receptors have been characterized.

Endogenous opioid peptides

There are four families of endogenous opioid peptides: endomorphins, endorphins, enkephalins, and dynorphins. Figure 20-1 illustrates their biologic derivations and structural relationships. The pentapeptide enkephalins—methionine-enkephalin (met-enkephalin) and leucine-enkephalin (leu-enkephalin)—were the first endogenous opioids to be discovered.¹³ These peptides were subsequently shown to be potent opioid receptor agonists in the same biologic systems in which morphine is active. Initially, the enkephalins were thought to be derived from a larger 91-amino acid peptide, β -lipotropin, but it is now clear that β -lipotropin gives rise to a separate group of opioid peptides, the endorphins (see later).

Endomorphin-1 and endomorphin-2 are newly discovered endogenous opioid peptides.⁴⁷ Both are short tetrapeptides ($\text{NH}_2\text{-Tyr-Pro-Trp/Phe-Phe-CONH}_2$) and structurally distinct from the other opioid peptides (see later). The endomorphins have been localized to areas in the CNS associated with pain processing (e.g., spinal dorsal horn, trigeminal nucleus, midbrain periaqueductal gray) and in the endings of sensory neurons that terminate in the spinal dorsal horn. Although the genes for the endorphins, enkephalins, and dynorphins are known, the gene for the endomorphins has yet to be isolated.

The precursor of the enkephalins, proenkephalin, is present in the CNS and the adrenal medulla. Although proenkephalin in the brain is similar, if not identical, to proenkephalin in the adrenal medulla, processing of the large precursor polypeptide differs in the two locations. In the brain, cleavage of proenkephalin is generally more complete, and free enkephalins are the predominant products (four copies of met-enkephalin, one copy of leu-enkephalin, and one copy each of a heptapeptide and an octapeptide). In the adrenal medulla, large enkephalin-containing polypeptides predominate.

Prodynorphin is the common precursor for several larger opioid peptides, three dynorphins and two neomorphins, all of which share with the enkephalins the same N-terminal amino acid sequence: $\text{NH}_2\text{-Tyr-Gly-Gly-Phe-Met/Leu}$. The

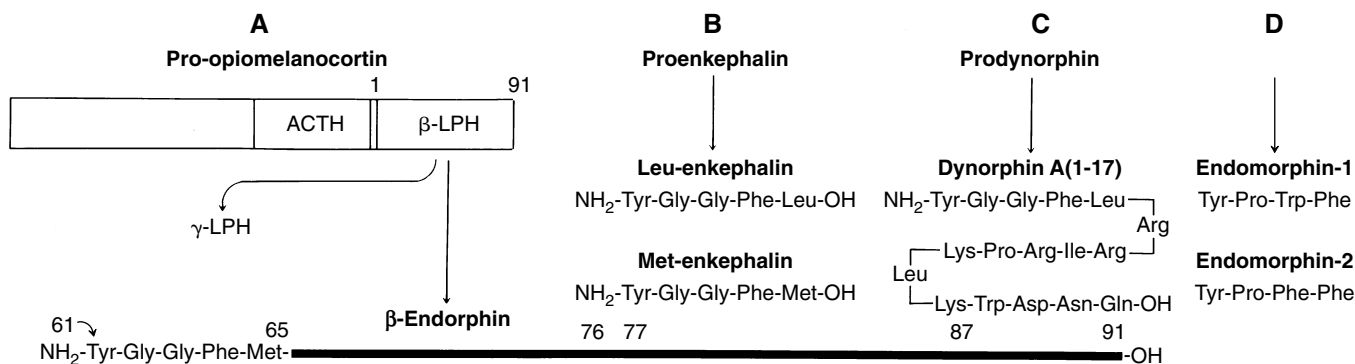

FIGURE 20-1 Derivations and structures of endogenous opioids. **A**, Endorphins. Proteolysis products of the pituitary hormone β -lipotropin (β -LPH), endorphins are ultimately derived from the precursor molecule pro-opiomelanocortin. Other peptides of biologic importance obtained from pro-opiomelanocortin include adrenocorticotropin (ACTH), γ -lipotropin (γ -LPH), and several melanotropins (not shown). The initial amino acid sequence of β -endorphin is shown (at bottom left) to illustrate its structural relationship to the enkephalins and dynorphins; the numbers refer to amino acid residues of β -LPH. **B**, Enkephalins. In addition to met-enkephalins and leu-enkephalins, proenkephalin may give rise to at least two other biologically active molecules, a heptapeptide and an octapeptide, both of which contain met-enkephalin as part of their structure. **C**, Dynorphins. A common precursor, prodynorphin, yields several dynorphins, including dynorphin A(1-17) (shown here), dynorphin A(1-8), dynorphin B(1-13), and at least two other peptides, α -neoendorphin and β -neoendorphin. **D**, Endomorphins. The precursor for these two endogenous opioid peptides is unknown.

products of prodynorphin are often found in association with the enkephalins within the CNS.

The endorphins are a group of endogenous peptides that are larger in size and are distributed differently in the CNS than the endomorphins, enkephalins, or dynorphins. The precursor for the endorphins, pro-opiomelanocortin, gives rise to several important hormones, including adrenocorticotropin hormone and β -lipotropin, which are further processed to form biologically active products. The most important opioid derived from β -lipotropin is β -endorphin, the 30-amino acid carboxy terminal sequence of β -lipotropin. Shorter cleavage products of β -endorphin, such as α -endorphin and γ -endorphin, have been isolated from the pituitary, but their function is uncertain.

Sites in the CNS where opioid peptides are located differ for the different peptides, confirming that they are involved in different functions. It is a mistaken impression that all opioid peptides in all locations are involved in the modulation of pain. Neurons containing endomorphins are not as widely distributed in the CNS as neurons containing other opioid peptides, but endomorphins are located in pain-processing areas where they are considered to function as neurotransmitters that act at opioid receptors. Neurons containing enkephalins are widely distributed throughout the brain (e.g., striatum, limbic system, midbrain, and medulla) and the spinal cord where they, too, are considered to function principally as neurotransmitters.²² Prodynorphin-derived peptides are abundant in the pituitary, hypothalamus, midbrain, and striatum. Differential processing of proenkephalin and prodynorphin in various brain areas leads to different products having different functions.

The endomorphins, enkephalins, and dynorphins are stored in nerve terminals and are quickly destroyed by peptidases (aminopeptidase N [EC 3.4.11.2] and neutral endopeptidase [EC 3.4.24.11]) when released. β -Endorphin is present in high concentrations in the intermediate lobe of the pituitary and in neurons in the mediobasal hypothalamus, whose axons terminate in the amygdala, periaqueductal gray matter, and brainstem. β -Endorphin coexists with adrenocorticotropin hormone in pituitary secretory granules, and both peptides can be released simultaneously. β -Endorphin is believed

to function more as a neurohormone than as a neurotransmitter, mediating diverse autonomic and psychological responses to pain and stress.

Opioid receptors

Three opioid receptors have been cloned: mu (μ), kappa (κ), and delta (δ) (Table 20-1).^{15,32} They share considerable structural homology (approximately 60% to 65%), contain seven membrane-spanning α -helical segments, and are coupled to transducing G proteins (Figure 20-2). G proteins couple opioid receptors to intracellular effectors and exist as heterotrimers; there is structural and functional diversity in the three G protein subunits. Each heterotrimer consists of an α subunit isoform (of which there are at least 18) and a dimer of β - γ subunits (which also exist in multiple isoforms) that link with specific (and potentially diverse, given the numbers of isoform combinations that are possible) effector systems. Specifically, opioid receptors couple in this way with adenylyl cyclase and ion channels to reduce neurotransmitter release (see later).

The amino acid sequences of the three opioid receptors are most homologous in the transmembrane domains and intracellular loops; the sequences share little homology in the extracellular loops and N- and C-termini. Each receptor is distributed differently in the CNS, peripheral nervous system, and smooth muscle of the gastrointestinal tract. A receptor with high sequence homology to the three cloned opioid receptors, termed *ORL-1* (for opioid receptor-like, an "orphan" receptor), has been discovered.^{21,33} Despite its structural similarity to opioid receptors, opioids do *not* bind to *ORL-1* with high affinity. A heptadecapeptide termed *orphanin FQ* (or nociceptin), which is structurally similar to the endogenous opioid peptide dynorphin, seems to be the endogenous ligand for *ORL-1* (which has been renamed the *N/OFQ receptor [NOP]*). Nociceptin does not act at any of the three cloned opioid receptors, however, and the nociceptin-NOP ligand-receptor complex may instead function to facilitate pain at some sites.

Another heptadecapeptide, termed *nocistatin*, is also derived from the same gene that gives rise to nociceptin. Nocistatin is reported to "block" the effects of nociceptin, but nocistatin does not displace nociceptin from its receptor

TABLE 20-1

Characterization of Opioid Receptors and Their Ligands

	RECEPTOR SUBTYPE		
	μ	κ	δ
Proprietary central nervous system distribution*	Cerebral cortex Striatum Hippocampus Dorsal horn Midbrain	Cerebral cortex Striatum Hippocampus Dorsal horn Midbrain	Cerebral cortex Striatum Hippocampus Dorsal horn Amygdala
Pharmacologic functions	Analgesia Sedation Miosis Euphoria Constipation Respiratory depression Pruritus	Analgesia Sedation Miosis Dysphoria Micturition Diuresis Hallucinations	Analgesia Emotion/reward Seizures (?)
Prototypic ligands	Morphine Methadone	Dynorphin A Ethylketocyclazocine	Enkephalins Deltorphin II
Effects of Binding			
Morphine	Ag	Ag (weak)	—
Etorphine	Ag	Ag	Ag
Buprenorphine	Pag	Ant	?
Butorphanol	Pag (weak)	Ag	?
Pentazocine	Ant (weak)	Ag	—
Nalbuphine	Ant	Ag	—
Naloxone	Ant	Ant	Ant (weak)

*Opioid receptors are also present in the autonomic nervous system, peripheral nerves, and gastrointestinal tract, where they can mediate effects on heart rate, nociception, and gastrointestinal motility.

Ag, Agonist; Ant, antagonist; Pag, partial agonist.

(ORL-1),²⁶ indicating that the opposing effects of nocistatin are produced at a yet to be identified receptor.⁴⁹ It is believed now that nocistatin exerts an inhibitory effect through a pre-synaptic G_i/G_o -coupled receptor not related to either the opioid receptors or the NOP receptor.⁵

The μ receptor is the site at which all the currently available pure agonists act to produce analgesia. Morphine and other similar pure agonists have greatest affinity for μ receptors in the CNS and peripheral nervous system and lower affinity for δ and κ receptors. Among the endogenous opioid peptides, the endomorphins have the highest affinity for the μ receptor; β -endorphin and the enkephalins also exert some of their effects at μ receptors. Two subtypes of μ receptor have been characterized by pharmacologic means: μ_1 , which is associated with supraspinal analgesia, and μ_2 , which subserves spinal analgesia, respiratory depression, and gastrointestinal actions. Pharmacologic studies have also implied the existence of two subtypes of δ receptor, at which the endogenous enkephalins are considered to be the prototypic agonists, although the enkephalins also interact with μ receptors. The δ receptor is also involved in analgesia, mainly through spinal mechanisms, and in causing, along with μ receptors, opioid reinforcement (see Chapter 51).

Dynorphins, representing the third class of endogenous opioid peptides, have been proposed to be ligands for the κ receptor, of which three subtypes have been characterized pharmacologically. Two κ receptors mediate spinal (κ_1) and supraspinal (κ_3) analgesia and are principally responsible for the analgesic effects of the mixed agonist-antagonist group of opioid analgesics currently available. Although the endomorphins selectively bind to the μ opioid receptor,⁴⁸ other endogenous opioids and clinically available drugs do not bind

selectively to specific opioid receptors. Although morphine and other pure agonists preferentially bind at μ receptors, they can produce effects at δ and κ opioid receptors as well, particularly as the dosage is increased.

Despite pharmacologic evidence for the existence of multiple subtypes of opioid receptors, only one of each opioid receptor has been cloned. There is no evidence at present for the existence of genes other than those that give rise to the already cloned μ , δ , and κ receptors. It is possible that not all opioid receptor genes have been cloned, but molecular mechanisms and other factors most likely explain the pharmacologic diversity of effects produced by various ligands at opioid receptors. Receptor isoforms may be produced by alternative splicing in the coding regions of the three cloned opioid receptors.⁷ Variant mRNAs have been reported for all three opioid receptors, although their expression is typically very low, and it is not clear that splice variants can be distinguished pharmacologically. It seems more likely that other mechanisms (e.g., post-translational regulation, variable activation of receptors by different ligands, receptor dimerization, intracellular interactions with proteins associated with different effectors) explain the pharmacologic diversity of opioid receptor subtypes. Many G protein-coupled receptors exist as dimers (two receptors linked), and heterodimerization of δ and κ receptors could result in a complex pharmacologic profile.

The sigma (σ) receptor, initially considered to be an opioid receptor, is now known to mediate the dysphoric and psychotomimetic effects of opioids and those of phencyclidine, a nonopioid hallucinogen. This phencyclidine receptor has been identified as an inhibitory component of the N-methyl-D-aspartate receptor complex, which modulates opioid tolerance and dependence.

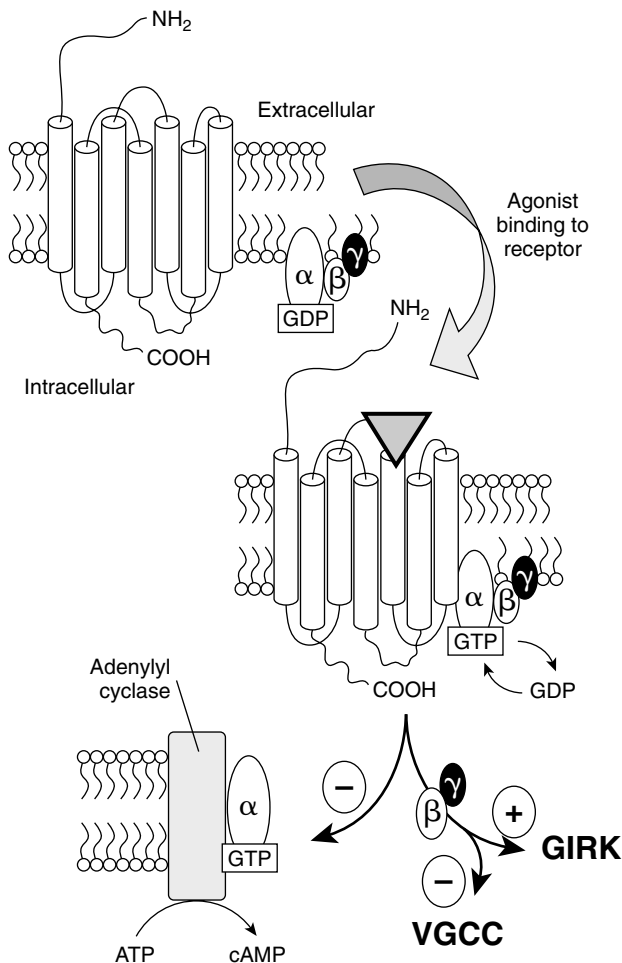

FIGURE 20-2 Diagram of a G protein–coupled opioid receptor. Opioids bind within the hydrophobic membrane-spanning domains of the receptor. Opioid agonist effects at the receptor are mediated by G proteins, an α subunit associated with guanosine diphosphate (GDP), and a β - γ dimer. When an opioid agonist binds, the conformation of the receptor is changed as the membrane-associated G proteins assemble with the receptor. GDP is exchanged with guanosine triphosphate, and this activated G_{α} complex negatively regulates adenylyl cyclase. The β - γ dimer activates conductance in a G protein inwardly rectifying K^{+} (GIRK) channel and inhibits voltage-gated Ca^{++} channels (VGCC) in the cell membrane. (See Chapters 1 and 5 for more details on signal transduction.) ATP, Adenosine triphosphate; cAMP, cyclic 3'5'-adenosine monophosphate.

Physiologic functions

Much remains to be learned about the physiologic roles of the endomorphins, enkephalins, dynorphins, and endorphins. It is established that enkephalins, present principally in local circuits or interneurons in the CNS, have an inhibitory effect on other cells. Endogenous opioids tonically modulate the secretion of gonadotropins from the pituitary. When the opioid receptor antagonist naloxone is administered to normal subjects, the plasma concentrations of luteinizing hormone and follicle-stimulating hormone are increased because naloxone releases hypothalamic neurons from a tonic endogenous opioid inhibition.

Considerable attention has been given to the notion that endogenous opioid peptides tonically modulate nociception (pain). One would expect occupation of opioid receptors by naloxone to prevent any action by endogenous opioid pep-

tides and lower the response threshold for pain if endogenous opioids tonically modulated nociception. A number of studies have shown that the administration of naloxone to normal human volunteers does not affect their resting pain thresholds or responses to experimental pain stimuli. In other situations, naloxone has been reported to attenuate the analgesic effects of acupuncture and of placebo administration after minor oral surgery and to be hyperalgesic in humans after major surgery.³¹ From these and other findings,⁸ it seems that endogenous antinociceptive opioid systems are normally quiescent but can become physiologically active and affect pain processing when significant injury or stress is present. It seems that endogenous opioid activity can be enhanced by the anticipation of pain relief, producing naloxone-reversible placebo effects that diminish the perception of pain (i.e., elicit analgesia).⁶

Sites and mechanism of action

Among the many effects of opioids, analgesia has been most thoroughly studied. We now know that opioids acting at opioid receptors in the periphery and at spinal and supraspinal sites can produce clinically effective analgesia. Knowledge of the central sites of opioid action came first; documentation of direct peripheral analgesic actions of opioids is relatively recent.³⁸

Early investigators attempted to determine the central locus of morphine's analgesic action by administering morphine directly into selected brain sites. These studies succeeded in identifying an area of the brainstem surrounding the cerebral aqueduct as a site important to morphine analgesia. Corollary studies found that electrical stimulation of this same area in the midbrain in animals and humans produced a potent, long-lasting analgesia partially mediated by endogenous opioids.¹¹ Morphine and other opioid agonists acting at this site produce analgesia by engaging a descending system of pain inhibition.⁸

As illustrated in Figure 20-3, information about pain from nociceptors—that is, peripheral receptors in skin, muscle, joints, and viscera that respond to pain-producing stimuli—can be influenced at the first central synapse (spinal or medullary dorsal horn) by this descending system of pain inhibition. It is important to appreciate two features of this pain-modulating system: the descending pathway from the midbrain is indirect (there is a synaptic relay in the medulla or the dorsolateral pons or both), and although engaged by an opioid acting at opioid receptors in the midbrain, the neurotransmitters in the spinal cord or medullary dorsal horn that ultimately inhibit pain transmission are nonopioids such as 5-hydroxytryptamine (5-HT, serotonin) and norepinephrine.⁸ Engagement of the descending pain inhibitory circuit is also responsible for placebo-induced analgesia.

A second means by which morphine and other opioid agonists modulate pain is by acting at opioid receptors in the brain at sites not associated with activation of the descending pain inhibitory system. Actions of opioids at these brain sites do not affect the response threshold to a painful stimulus but rather influence the interpretation of and emotional reaction to the stimulus.³¹ This so-called motivational-affective component of the response to pain is discussed later in this chapter.

A final means by which morphine and other opioid agonists produce analgesia is by acting at opioid receptors located on the peripheral and central terminals of nociceptors. Opioid receptors are located on the terminals of these specialized nerve fibers, typically A δ and C fibers, which connect the periphery directly with the CNS. Analgesic effects of opioids can be produced by direct administration of an opioid into a joint or, more commonly, the epidural or intrathecal space.⁴⁶

Opioids can act at several sites, each of which can contribute independently to the analgesia produced. When given

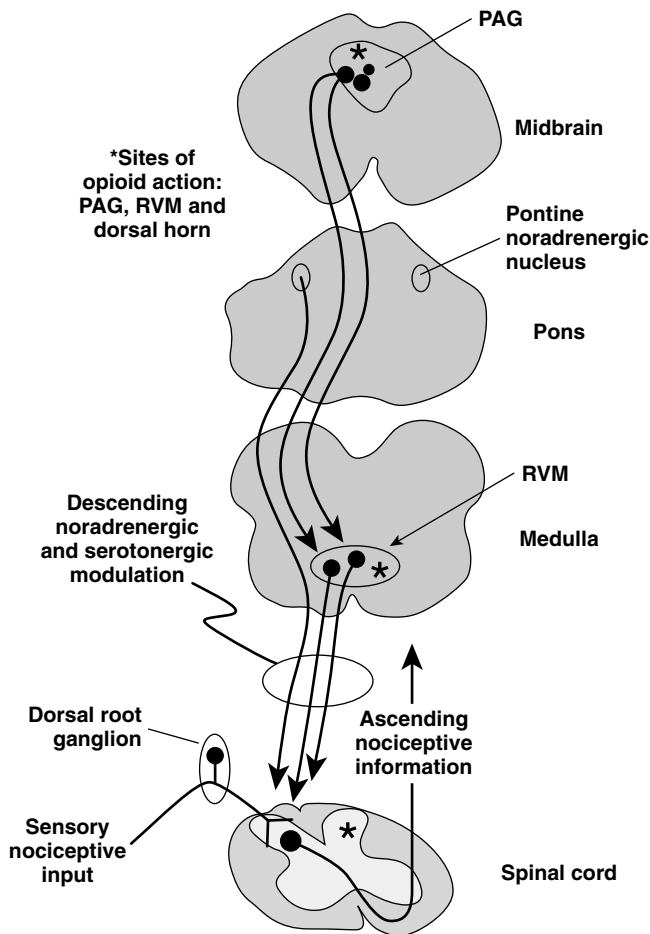

FIGURE 20-3 Descending pain-modulating pathways from the brainstem to the spinal cord. Descending influences, whether activated in the midbrain periaqueductal gray (PAG) or rostral-ventral medial medulla (RVM) by endogenous or exogenous opioids (*) or stimulation, are mediated at the level of the spinal cord by noradrenergic and serotonergic receptors.

systemically, opioids have access to all potential sites of action, and the analgesia produced is likely a product of peripheral, spinal, and supraspinal interactions with opioid receptors. These mechanisms are likely to be synergistic resulting in increased opioid potency and, consequently, reduced toxicity. This knowledge can be used to improve pain control and limit the incidence or severity of undesirable opioid effects. Because pain modulation descending from the brainstem is mediated in the spinal cord by norepinephrine and 5-HT, the direct effects of an opioid given into the epidural space can be enhanced by epidural administration of an α -adrenoceptor agonist such as clonidine.²⁴

Tricyclic antidepressants, which block the reuptake of norepinephrine and 5-HT, are also effective adjuvants (although antidepressants such as amitriptyline also possess analgesic efficacy unrelated to their effects on monoamine reuptake). This strategy allows reduction of the dose of opioid without compromising the analgesia produced. Two drugs, tramadol and tapentadol, produce analgesic actions by engaging multiple mechanisms, including activity at the opioid receptors and inhibition of reuptake of norepinephrine or serotonin or both. By requiring less opioid for adequate pain control, undesirable opioid effects, such as urinary retention, respiratory depression, sedation, and development of analgesic tolerance, can be reduced. It has also been documented that

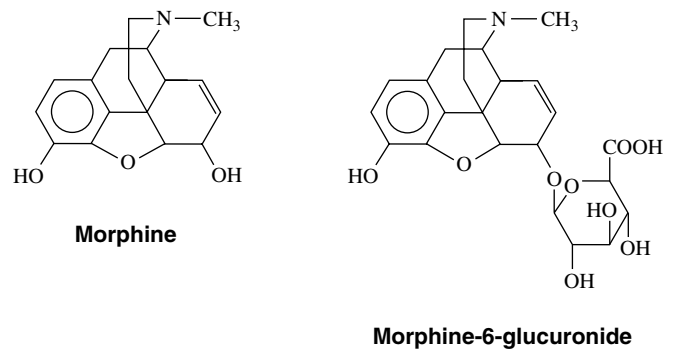

FIGURE 20-4 Structural formulas of morphine and its active metabolite morphine-6-glucuronide.

administration of very low doses of morphine directly into the knee joint after arthroscopic knee surgery can control postoperative pain.³⁸

The mechanisms by which opioids produce their effects are best established for direct actions at opioid receptors located on neurons. Actions commonly produced at all three opioid receptors include inhibition of adenylyl cyclase, inhibition of Ca^{++} conductance, activation of K^{+} conductance, and inhibition of neurotransmitter release (see Figure 20-2). Acute inhibition of adenylyl cyclase by an opioid leads to a decrease in intracellular cyclic 3',5'-adenosine monophosphate, decreasing an inward, nonselective cation current and decreasing cell excitability. All three opioid receptors also activate a G protein inwardly rectifying K^{+} conductance and inhibit voltage-activated Ca^{++} currents, both events mediated by G protein β - γ subunits. Because Ca^{++} influx is required for the stimulus-secretion coupling of neurotransmitter release, opioids decrease the release of excitatory neurotransmitters, such as glutamate, substance P, and calcitonin gene-related peptide, from nociceptor terminals and attenuate the transmission of nociceptive information at the first central synapse. Because opioids activate this G protein-rectifying K^{+} conductance, they produce a relative hyperpolarization of neurons, making them more difficult to excite.

Morphine

The structure of morphine is shown in Figure 20-4. Morphine is the prototypic opioid analgesic (pure agonist) and the one about which most is known. Morphine is widely used for pain control and can be given by virtually any route of administration. All opioid analgesics share with morphine the ability to produce analgesia, respiratory depression, constipation, gastrointestinal spasm, and physical dependence; none has yet been shown to be significantly different from or superior to morphine regarding its important pharmacologic features. The incidence of untoward effects (e.g., respiratory depression) and the intensity of action of pure agonists are qualitatively similar and differ little when compared at doses that produce equivalent analgesia. Consequently, morphine is discussed in greater detail than other opioid analgesics, and what is stated for morphine applies in general to other pure agonists. Significant differences that exist between morphine and other opioids are mentioned as each individual agent is discussed.

Central pharmacologic effects

The CNS effects of morphine are a combination of stimulation and depression and include analgesia, drowsiness, euphoria-dysphoria, respiratory depression, suppression of the cough reflex, pupillary constriction, suppression of the secretion of some (luteinizing hormone) and enhancement of other (prolactin) pituitary hormones, and initial stimulation of the

medullary chemoreceptor trigger zone for emesis followed by depression of vomiting.

Analgesia. The analgesia produced by morphine and other pure agonists occurs without loss of consciousness. When opioids are administered for relief of pain (or for a cough or diarrhea), they provide only symptomatic relief without alleviation of the cause of the pain (or cough or diarrhea). The analgesia produced by opioid analgesics is dose-dependent and selective in that other sensory modalities (e.g., vision, audition) are unaffected at therapeutic doses. The standard parenteral analgesic dose of morphine, 10 mg/70 kg of body weight, is considered a therapeutic dose for relief of moderate-severe pain. Because pain is a highly subjective and personal experience, however, adequate pain relief is best achieved by titrating the dose to the needs of the patient.

As already discussed, the sites of opioid-produced analgesia include the periphery and spinal and supraspinal brain areas. It is generally accepted that opioid-induced analgesia involves the sensory-discriminative and motivational-affective components of pain. The sensory-discriminative component of pain is associated with identification and localization of the source of pain, whereas the motivational-affective component of pain is related to one's reaction to pain.³³ Pain is not a simple sensation associated with a single pain pathway from the periphery to the cortex, but rather, it is a complex experience that can be influenced by the environment in which the pain arises: prior experience and expectation; attention, anxiety, mood, and stress levels; and other societal, emotional, and cognitive contributions. The nociceptive component of pain may not be as much affected by opioid analgesics as is the reaction to pain. A common report from patients after receiving an opioid for relief of pain is that the pain is still present, but that it is not discomforting. Clinical impressions and patients' reports suggest a prominent action by opioid analgesics on the motivational-affective component of pain, presumably resulting from opioid actions at opioid receptors within the limbic system of the brain.

An additional significant feature of opioid analgesics is that they are generally more effective against continuous, dull, aching pain than sharp, intermittent pain. It is also known that sensitivity to pain and the ability to clear morphine decrease with age, whereas the elimination half-life of morphine increases with age; the pain relief provided by morphine typically increases with age.^{14,28}

Respiratory depression. Morphine and its congeners depress respiration in a dose-related fashion. Respiratory depression represents the principal undesirable, potentially life-threatening effect of opioids as a group. Opioids are capable of depressing the tidal volume and the rate of respiration. In humans, morphine decreases the response of brainstem respiratory centers to the carbon dioxide tension of the blood. It also significantly depresses pontine and medullary centers that regulate respiratory frequency.² Irregular rhythms and periodic breathing are common after toxic doses of morphine or its congeners, and the normal respiratory rate of 16 to 18 breaths/min may be reduced to 3 to 4 breaths/min. All currently available opioid analgesics are capable of depressing respiration in a manner similar to that of morphine when administered in doses that produce equal analgesia.

Cough suppression. Morphine and other pure agonists are effective antitussives; codeine is widely used in cough preparations for this purpose. Morphine itself is not commonly used as a cough suppressant. Opioids exert their antitussive effect by depressing an area in the brainstem. Although the brainstem sites for the respiratory depressant and antitussive effects of opioids are anatomically close, there is no apparent rela-

tionship between opioid depression of one or the other because suppression of the cough reflex occurs at opioid doses lower than those required to produce an analgesic effect or to depress respiration.

Pupillary reaction. At therapeutic doses, morphine and most of its congeners produce pupillary constriction (miosis) in humans. The emphasis on humans is significant because in some other species, such as cats, in which opioids exert primarily an excitatory effect, the pupils are dilated by morphine. The miosis produced by opioids results from a central effect mediated by the oculomotor nerve and not from a direct action on the circular or radial muscles of the iris of the eye. Although tolerance to opioids has not yet been discussed, it is appropriate to indicate here that tolerance to the pupillary-constricting effect of morphine and some other opioids does not develop to any appreciable extent. Consequently, long-term users of morphine and heroin continue to have constricted pupils, although they likely will have developed tolerance to many other opioid effects.

Nausea and vomiting. Opioids directly stimulate the chemoreceptor trigger zone in the medulla and can produce emesis. Opioids are commonly given before, during, and after surgery, and nausea and vomiting are highly undesirable. After the initial period of stimulation, however, opioids depress the brainstem medullary center for vomiting. This subsequent depression occurs at therapeutic concentrations and is virtually total; other opioid analgesics or emesis-inducing agents administered during this time are generally ineffective in causing emesis. There is also apparently a vestibular component to the nausea produced by morphine and its congeners because nausea occurs more frequently in ambulatory than in recumbent patients.

Peripheral pharmacologic effects

Morphine exerts important influences on smooth muscle tone that have therapeutic and toxic implications. The drug also affects gastrointestinal activity by reducing glandular secretions and by promoting absorption of fluid from the gastrointestinal lumen.

Gastrointestinal tract. The use of opium for relief of diarrhea and dysentery antedated by centuries the use of opium for relief of pain. Opioids exert significant effects on smooth muscle all along the gastrointestinal tract. The overall action of morphine and its congeners is constipating, an effect that is useful therapeutically. Opioid analgesics, acting principally at opioid receptors in the gastrointestinal tract but also at opioid receptors in the CNS,⁴¹ increase smooth muscle tone and decrease propulsive motility throughout the gastrointestinal tract. In the large intestine, muscle spasms can result from the marked increase in muscle tone and nonpropulsive muscle contractions. Spasm of the smooth muscle of the biliary tract, which can be very painful, can also occur after the administration of therapeutic doses of morphine and related drugs.

Morphine and other pure agonists delay gastric emptying. In addition, gastric acid secretion is usually depressed, and pancreatic, biliary, and intestinal secretions are routinely depressed by opioid administration. Inhibiting intestinal hypersecretion and promoting reabsorption are important contributors to the beneficial effect of morphine in the treatment of diarrhea.

Other smooth muscle. Morphine and other pure agonists also increase muscle tone in smooth muscle of organs other than those of the gastrointestinal tract, such as the ureters, urinary bladder, uterus, and bronchioles, but at therapeutic doses the effect of opioids on these muscles is generally unremarkable.

Urinary retention, characterized by urgency and increased tone of the bladder sphincter, is common after all routes of opioid administration. In addition to effects on tone and contractility of smooth muscle, opioids also possess antidiuretic effects. Although opioids increase uterine tone, they do not generally influence the duration of labor. Likewise in the bronchial musculature, opioids administered at usual therapeutic doses do not produce significant bronchoconstriction, even though they may aggravate an asthmatic condition or precipitate an asthmatic attack resulting in part from histamine release.

In large doses, opioid effects on all these smooth muscles may be significant. Contraction of the ureter contributes to cessation of urine flow; increased uterine tone significantly prolongs labor and may increase neonatal morbidity rates; and bronchoconstriction occurs.

Cardiovascular system. The effects of morphine and other pure agonists on blood pressure, heart rate, and cardiac work are generally minor at analgesic doses. The vasomotor center of the medulla is relatively unaffected by opioid analgesics, and blood pressure is maintained near normal even after intoxicating doses of opioids. The decrease in blood pressure observed during acute opioid intoxication is primarily caused by hypoxia that results from opioid-induced respiratory depression.

Morphine and several other opioid analgesics release histamine and produce some vasodilation of the peripheral vasculature, often resulting in an overall sensation of warmth accompanied occasionally by itching of the face and nose. There also seems to be a poorly understood contribution by the CNS to peripheral vasodilation. The resultant decrease in peripheral resistance is the primary cause of the orthostatic hypotension and fainting that occur occasionally in some recumbent patients when the head-up position is suddenly assumed. Opioids have no direct effect on the vasculature and circulation of the brain, but cerebral vasodilation is a common consequence of opioid administration. Cerebral vasodilation is considered to be a consequence of the respiratory depression produced by morphine and its congeners and the subsequent retention of carbon dioxide in the blood. The result is an increase in cerebrospinal fluid pressure, which requires that opioids be used cautiously in cases of cranial trauma and head injury, where cerebrospinal fluid pressure may already be elevated. Morphine is also occasionally used in the treatment of pulmonary edema, where it is quite effective. The mechanism by which morphine exerts this beneficial action is unclear, but morphine seems to inhibit adrenergic tone centrally, promoting redistribution of blood to the periphery and reducing pressure in the pulmonary veins and capillaries without causing concomitant reduction of systemic arterial pressure.

Peripheral analgesia. An increasingly important peripheral action of opioids—analgesia—is now appreciated.³⁸ As indicated earlier in this chapter, opioid receptors are located on the central and peripheral terminals of nociceptors. When tissue is insulted and inflamed, peripheral opioid receptors upregulate (increase in number or are inserted into peripheral nociceptor terminals in greater number). This event is presumably part of the normal response to tissue insult where endogenous opioid peptides contained in monocytic cells or lymphocytes, attracted to the site of injury, are released to modulate pain associated with the tissue insult. Therapeutically, the upregulation of opioid receptors can be taken advantage of by application of exogenous opioid agonists directly to the site of insult (e.g., intra-articular injection of morphine, topical application of μ opioid receptor agonists).

Acute opioid intoxication

Death from acute intoxication by an opioid analgesic is the result of profound, direct respiratory depression. The cardinal

signs of acute opioid intoxication (overdose) represent an extension of the pharmacologic features of these drugs: stupor, constricted pupils, and depressed respiration. As the severity of intoxication increases, coma ensues, and the blood pressure, initially maintained close to normal, steadily decreases if the hypoxia associated with the respiratory depression is unaltered. Measures must be instituted to support respiration in cases of intoxication; pupillary dilation and shock, both caused by persistent hypoxia, precede death in the absence of alteration in the respiratory status of an intoxicated individual.

The essential principle of treatment of acute opioid intoxication is restoration of adequate ventilation. Restoration of ventilation is most rapidly and dramatically achieved by administration of an opioid receptor antagonist (e.g., naloxone), but in the absence of immediately effective opioid receptor antagonism, a patent airway must be established, and efficient pulmonary gas exchange must be restored, by artificial respiration if necessary. Restoration of adequate pulmonary ventilation prevents the hypoxic cardiovascular sequelae of opioid intoxication. Although opioid antagonists have not yet been discussed, it is important to interject two notes of caution regarding their use in cases of opioid intoxication. First, the duration of action of naloxone, the standard opioid receptor antagonist, is shorter than that of most opioid analgesics (which have been given or taken in excess). Consequently, an opioid-intoxicated individual typically requires continued monitoring and readministration of additional naloxone as necessary. Second, administration of an opioid receptor antagonist to an acutely intoxicated, opioid-dependent individual can precipitate a withdrawal syndrome that cannot readily be attenuated during the period of action of the antagonist.

Tolerance

Tolerance is a decreased effect of a drug as a consequence of prior administration of that drug. Increasingly greater doses of drug must be administered over time to produce an effect equivalent to the effect produced on initial administration. Tolerance does not develop uniformly to all opioid effects. Generally, tolerance develops to the depressant effects of opioids but not to the stimulant effects. Tolerance develops to opioid-induced analgesia, euphoria, drowsiness, and respiratory depression but not, to any appreciable extent, to opioid effects on the gastrointestinal tract or the pupil.

In the therapeutic setting, the initial indication that tolerance has developed is generally reflected in a shortened duration or reduced analgesic effect. The rate at which tolerance develops is a function of the dose and the frequency of administration and perhaps other, nonpharmacologic factors. Although some patients remain normally sensitive, most patients treated for 5 to 7 or more days exhibit tolerance to the analgesic (and other) effects of opioids. Generally, the greater the opioid dose and the shorter the interval between doses, the more rapidly tolerance develops. Tolerance can develop to such an extent that the lethal dose of the opioid is increased significantly. For any individual, however, there always exists an opioid dose capable of producing death by respiratory depression, regardless of the extent to which tolerance has developed.

The mechanisms by which tolerance develops to opioids are controversial. One hypothesis points to a role of internalization of G protein-coupled receptors, which include opioid receptors, after being bound by an agonist. Internalization is a multistep process in which opioid receptors are uncoupled from their heterotrimeric G proteins, phosphorylated by a receptor kinase, and targeted for endocytosis by clathrin-coated pits.³⁹ When in the intracellular endosomal compartment, opioid receptors can be recycled for reinsertion into the

cell membrane, sustaining agonist activity (i.e., diminishing tolerance), or degraded, which can result in receptor downregulation (a reduction in the number of receptors) and enhancing opioid tolerance.²⁰ Although acute desensitization is common to virtually all G protein-coupled receptors and occurs rapidly (seconds to minutes) after occupation of a receptor by its agonist, the time course of these cellular effects does not seem to match loss of agonist activity observed in humans. Tolerance may represent longer term desensitization and downregulation of receptor-effector coupling by mechanisms not yet fully understood.²⁰

In a second hypothesis, more recent studies point to neuroplastic changes in the neuraxis as underlying tolerance to the analgesic action of opioids. Persistent exposure to opioids triggers an activation of pain modulatory pathways from the brainstem that can promote the increased responses of spinal cord neurons to input from peripheral nociceptor afferents.^{16,27} This situation results in increased transmission of painful signals arriving from peripheral sites and an increase in pain signals that are transmitted to the brain. This increase in “gain” requires increased doses of opioids to produce inhibition and to offset the augmented pain. The consequence is a requirement for increased doses of opioids resulting in a rightward displacement of the dose-response function and the manifestation of analgesic tolerance.^{16,27}

Dependence

In contrast to tolerance, which becomes apparent during repeated drug administration, dependence is apparent only in the absence of drug. Dependence can be physical or psychological. *Physical dependence*, as defined by the American Society of Addiction Medicine, is a state of physiologic adaptation that is manifested by a drug class-specific withdrawal syndrome that can be produced by abrupt cessation of the drug, rapid dose reduction, decreasing blood content of the drug, or administration of an antagonist. Just as the rate of development of tolerance to opioids is dose related, so too is the development of physical dependence. The greater the opioid dose and the longer the duration of administration, the greater the degree of physical dependence and the more intense the withdrawal syndrome. The mechanisms underlying the development of tolerance to and physical dependence on opioids are not fully understood. Although tolerance and physical dependence develop concurrently, they develop through different mechanisms and are apparently not related phenomena.

Physical dependence results from adaptations at cellular, synaptic, and systemic levels that in some ways are analogous to adaptive processes better understood as nervous system plasticity in the context of learning and memory (i.e., *long-term potentiation*).³⁴ The underlying cellular and synaptic mechanisms that contribute to the development of opioid physical dependence are unknown.

Psychological dependence is more difficult to define and measure. Psychological dependence contributes more to drug-seeking behavior than physical dependence and contributes significantly to addiction. As defined by the American Society of Addiction Medicine, *addiction* is the extreme of compulsive drug use and is characterized by continued use, impaired control over drug use, and craving despite harm. Physical dependence can exist in the absence of psychological dependence, and it is inappropriate to identify as “addicted” an individual who becomes physically dependent after repeated opioid administration during hospitalization. All three phenomena—tolerance, physical dependence, and psychological dependence—are reversible, although psychological dependence provides a strong drive to drug abuse. It is now well documented that drugs that release or prolong the actions of the monoamine neurotransmitter dopamine in the meso-

cortical or mesolimbic systems potentially activate endogenous reward pathways in the brain. Although the commonly abused drugs are structurally and pharmacologically heterogeneous (e.g., nicotine, alcohol, opioids, cannabinoids, cocaine), they all possess the ability to activate the mesocorticolimbic system, a brain network important to initiating and maintaining drug craving.

Opioid analgesics are often rated in terms of “dependence liability” to indicate opioids considered to be more likely to produce significant physical dependence than others (Table 20-2). It is unclear how significant the differences are among opioid analgesics when they are compared at equianalgesic doses given by the same route of administration and at appropriate intervals. When opioid analgesics are compared in terms of how they are generally used therapeutically, however, differences in dependence liability are apparent. Morphine has a greater dependence liability than codeine when both are used in traditional therapeutic modes (i.e., morphine given parenterally for moderate-severe pain and codeine given orally for mild-moderate pain).

Health professionals and patients alike are concerned about the use of opioids for pain control, particularly in cases of persistent pain. This “opiophobia” is a reaction to fear of dose escalation, which is caused by the development of tolerance and erroneously interpreted as a sign of physical dependence (also erroneously termed “addiction”) associated with treatment for pain that lasts more than a few days. Most knowledge about analgesic tolerance and physical dependence derives from studies that use models of acute pain or repeated dosing with opioids in the absence of persistent pain. More recent clinical investigations and observations in patients with chronic pain have led to modification of views on the potential importance of analgesic tolerance and physical dependence to adequate pain control.^{29,42} It has been found that dose escalation for pain control is usually required only at the start of therapy (i.e., when titrating the dose to provide adequate analgesia), and that dose requirements tend to stabilize thereafter for long periods. It is of utmost importance to stress that development of analgesic tolerance, in and of itself, is not a sign of dependence.

Absorption, fate, and excretion

Morphine in particular and most opioids in general are not nearly as effective when given orally as when given parenterally in the same dose. For morphine, oral administration for relief of pain is approximately one third to one sixth as potent as the same dose given parenterally. Because absorption of morphine is good after oral administration, most of the difference in effect between the oral and parenteral routes is caused by metabolic inactivation during morphine’s first pass through the liver. The primary pathway for the metabolism of morphine is conjugation with glucuronic acid, and the principal metabolite is morphine-3-glucuronide (approximately 55% of the administered dose). Morphine is also glucuronidated at the 6 position (approximately 10% of the administered dose; see Figure 20-4). Morphine-6-glucuronide has a high affinity for the μ receptor and is a potent and efficacious analgesic, especially when injected to bypass the blood-brain barrier.^{9,30} Because it accumulates in the bloodstream, morphine-6-glucuronide may be largely responsible for the analgesic effects of morphine administered on a long-term basis.

Most of the conjugated morphine is eliminated from the body by the kidney; only small amounts of free morphine are found in the urine. Some morphine glucuronide also appears in the bile, and a small percentage is eventually excreted in the feces. Morphine does not generally accumulate in tissues; the total excretion of an administered dose is usually approximately 90% complete in the first 24 hours.

TABLE 20-2

Comparison of Opioid Analgesics

NONPROPRIETARY (GENERIC) NAME	PROPRIETARY (TRADE) NAME	USUAL THERAPEUTIC DOSE (mg)	ROUTE OF ADMINISTRATION	DURATION (hr)	DEPENDENCE LIABILITY
Alfentanil	Alfenta	0.5-2*	IV	0.5	High
Buprenorphine [†]	Buprenex	0.3-0.6	IM, IV	4-6	Low
Butorphanol [†]	Stadol	1-4	IM	3-4	Low
		0.5-2	IV	2-4	Low
		1-2	Nasal	3-4	Low
Codeine	—	30-60	Oral	4-6	Low-moderate
Dezocine [†]	Delgan	5-20	IM	3-6	Low
		2.5-10	IV	2-4	Low
Fentanyl	Sublimaze	0.05-0.1	IM	1-1.5	High
		0.05-0.1*	IV	0.5-1	High
Heroin [‡]	—	3-5	IM	3-4	High
Hydrocodone	Dicodid	5-10	Oral	4-6	Moderate
Hydromorphone	Dilaudid	1-4	IM, SC	4-6	High
		2-4	Oral	4-6	High
Levorphanol	Levo-Dromoran	2-3	SC, oral	4-5	High
Meperidine	Demerol	50-150	IM, SC	3-4	High
		50-150	Oral [§]	3-4	Moderate
Methadone	Dolophine	2.5-10	IM, SC	3-5	Moderate
		5-15	Oral	4-6	Moderate
Morphine	—	10-15	IM, SC	4-5	High
		20-60	Oral	3-5	Moderate
Nalbuphine [†]	Nubain	10	IM, IV, SC	3-6	Low
Oxycodone	In Percodan	5-10	Oral	4-5	High
Oxymorphone	Numorphan	1-1.5	IM, SC	4-6	High
		0.5	IV	4-6	High
Pentazocine [†]	Talwin	30	IM, IV, SC	3-4	Low
	Talwin NX	50	Oral	3-4	Low
Propoxyphene	Darvon	32-65	Oral [§]	4-6	Low-moderate
Sufentanil	Sufenta	0.01-0.025*	IV	0.5-1	High
Tramadol	Ultram	50-100	Oral	4-6	Low

Estimates of duration and dependence liability are based on information in the literature and are not definitive.

*Larger doses may be used for general anesthesia.

[†]Mixed agonist-antagonist.

[‡]Heroin is a Schedule I drug and is unavailable for routine clinical use.

[§]The efficacy of oral meperidine and propoxyphene is controversial.

IM, Intramuscular; IV, intravenous; SC, subcutaneous.

Although morphine is subject to significant first-pass metabolism after oral administration, it is widely used orally for the management of chronic pain (e.g., management of cancer pain). The oral dose of morphine in liquid form can range from less than 10 mg every 4 hours to 2500 mg every 4 hours; most patients require no more than 200 mg/day. Morphine is also available for oral use in controlled-release tablets to produce longer lasting analgesia (e.g., 12 hours). Regarding the wide dose ranges reported necessary for pain control in cases of chronic pain, it first must be appreciated that chronic pain is controlled by titration of the dose to prevent pain breakthrough and, second, that analgesic tolerance is likely present or will develop. Dosages of morphine required to manage chronic pain can be quite high. In terminally ill patients, there should be no concern about the development of physical dependence.

General therapeutic uses

Pain is a common symptom that initiates a visit to a dentist or physician. Pain is almost always present after invasive procedures or surgery. Morphine and other pure agonist opioid analgesics are the most efficacious analgesic drugs known and are without peer in their ability to control pain. As emphasized earlier, these drugs provide only symptomatic relief of

pain without influencing its underlying cause. The opioids, when administered at therapeutic doses to produce analgesia, also produce a drowsiness from which the patient is generally easily aroused and a tranquilization. There is without doubt a significant antianxiety or sedating component in the analgesic effect of opioids. Although nausea and vomiting, respiratory depression, constipation, and tolerance and physical dependence can be drawbacks to their use, opioids undeniably produce an important combination of desirable effects (e.g., analgesia and sedation) in patients with pain.

Aside from their application for pain relief, opioids can be useful in inducing sleep, provided that sleeplessness is caused by pain or coughing. Opioid analgesics should not be used for nighttime sedation in the absence of coughing or pain. Morphine is also effective in the treatment of pulmonary edema. The use of morphine and other opioids in anesthesia is discussed at the end of this section.

Codeine

Codeine, similar to morphine, is a naturally occurring alkaloid present in opium powder. It differs from morphine only in that a methoxy substitution ($-\text{OCH}_3$) replaces the hydroxyl group at position 3 of the molecule (Figure 20-5). This subtle structural change provides codeine with significant oral effec-

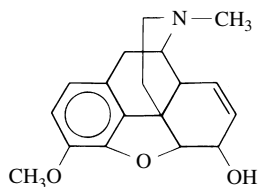

FIGURE 20-5 Structural formula of codeine.

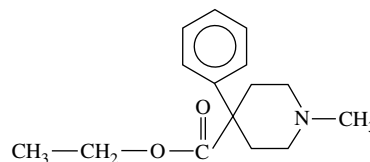

FIGURE 20-6 Structural formula of meperidine.

tiveness. Codeine is primarily used as an orally administered analgesic and antitussive. Similar to morphine, codeine is metabolized primarily by the liver and is excreted chiefly in the urine, largely in inactive forms. Additionally, a small percentage (approximately 10%) of codeine is demethylated at position 3 to form morphine, and free and conjugated morphine are found in small quantities in the urine after therapeutic doses of codeine. This conversion, plus the fact that codeine itself binds poorly to the μ receptor, has led to consideration of codeine as a prodrug insofar as its analgesic action is concerned.

As with all opioid analgesics, the analgesic and antitussive actions of codeine (and its respiratory depressant and sedative effects) are central in origin. Codeine is frequently classified as a weak or mild opioid analgesic. That codeine is a mild analgesic incapable of providing an analgesic effect equivalent to morphine is an erroneous, but widely held, impression. Morphine as an analgesic is about 12 times more potent than codeine when both drugs are administered intramuscularly. This ratio simply means that approximately 120 mg of codeine is required to produce an analgesic effect equivalent to 10 mg of morphine. At present, however, doses of codeine greater than 60 mg (orally) are not commonly used and are not officially recognized as generally safe and effective by the U.S. Food and Drug Administration (FDA). Consequently, the impression remains that codeine has limited analgesic efficacy and that a dose of 60 mg of codeine represents an "analgesic ceiling" above which increasing doses would not provide greater analgesic effect. This widely held belief, although supported by legal regulation, is inconsistent with clinical evaluations regarding the analgesic efficacy of codeine.¹²

The recommended analgesic dose of codeine is 30 to 60 mg orally; the recommended antitussive dose is 15 to 20 mg orally. At these doses, the side effects of codeine are few and generally insignificant; nausea, constipation, dizziness, and sedation are most frequently observed. At greater doses, the incidence of nausea and vomiting is increased, a particularly undesirable effect in individuals who have undergone dental surgery. Among the opioids, codeine is especially suitable for relief of pain in ambulatory individuals because it is orally effective; can provide significant analgesia and relief of dull, continuous pain; and can be taken for relatively long periods with little or no risk of physical dependence. A dose of 60 mg of codeine taken three to four times daily over 6 to 8 weeks is not associated with the development of significant physical dependence. Tolerance develops to the analgesic effect of codeine over time, however, and it is likely that the dose will need to be gradually increased.

The demonstrated analgesic usefulness of codeine in some situations that show little or limited response to nonopioid analgesics makes codeine a useful drug for certain pain states. Dental pain associated with inflammation should not be treated with codeine alone because neither codeine nor any of the other opioids has anti-inflammatory properties. Rather, aspirin or another nonsteroidal anti-inflammatory drug alone or in combination with codeine is appropriate for cases of dental pain involving or arising from inflammation.

Dihydrocodeine, Oxycodone, and Hydrocodone

Dihydrocodeine (contained in Synalgos DC), oxycodone (contained in Percodan), and hydrocodone (contained in Vicodin) are phenanthrene opioids similar in structure to morphine and codeine. Similar to codeine, these drugs have a methoxy substitution ($-\text{OCH}_3$) for the hydroxy group at position 3 of the basic morphine molecule. They have good oral efficacy and are primarily used as oral analgesics. They do not differ significantly from morphine in terms of their important pharmacology. Oxycodone is approximately equipotent with morphine when given parenterally; it is used only in oral preparations, however, in the United States. An oral dose of 5 mg of oxycodone is approximately equivalent to 30 to 60 mg of codeine. A controlled-release preparation of oxycodone (OxyContin) has been the subject of controversy because of abuse potential and toxicity. The abuse potential for this form of oxycodone seems to be caused, at least in part, by the higher net quantity of the drug present in the controlled-release formulation. Hydrocodone is slightly less potent than oxycodone; as an antitussive, it is approximately 2.5 times more potent than codeine. The usual analgesic dose of dihydrocodeine is half that of codeine.

Meperidine

Meperidine is a synthetic phenylpiperidine analgesic drug that is structurally dissimilar to morphine (Figure 20-6). Meperidine was initially developed as an atropine-like drug but was subsequently discovered to possess significant analgesic efficacy. In 1939, it was introduced as an analgesic, sedative, and antispasmodic drug effective against most types of pain and supposedly free of many of morphine's undesirable properties. Over time, however, it has become clear that meperidine does not differ significantly from morphine in its important pharmacology, and in therapeutic doses (80 to 100 mg parenterally) it produces analgesia, sedation, respiratory depression, and the other CNS actions common to opioids as a class. Meperidine is approximately one eighth to one tenth as potent as morphine; when given parenterally at equianalgesic doses, the degree of sedation and respiratory depression is the same for both drugs. Because it retains some atropine-like action, pupillary constriction is less with meperidine, as is the incidence of spasm of the biliary tract. Similar to other opioid analgesics, meperidine can be spasmogenic to the smooth muscle of the gastrointestinal tract, but it differs from other opioids in that it is generally not considered to be valuable in the treatment of diarrhea. A meperidine congener, diphenoxylate (contained in Lomotil), is widely used for that purpose.

Meperidine, more than other pure agonists, is used as an analgesic in labor and delivery. Its peak analgesic effect occurs soon after parenteral administration, and its duration of action is short (3 to 4 hours). Maternally administered meperidine can produce neonatal respiratory depression, and the content of normeperidine, an active metabolite, in fetal blood increases over time; studies have not reported additional neonatal risks when meperidine was used, however.¹⁹

Meperidine is often mistakenly considered to be a useful oral analgesic drug at approximately the same dose given

parenterally (50 to 100 mg). Its oral effectiveness is approximately one fourth of its parenteral effectiveness; approximately four times the dose of meperidine must be administered orally to produce analgesia equivalent to the analgesia achieved with parenteral meperidine. The duration of action of meperidine is shorter than that of morphine, necessitating more frequent administration of meperidine for relief of continuing pain. Acute intoxication associated with meperidine also differs from intoxication associated with morphine in that CNS excitation, produced by the normeperidine metabolite and manifested as tremors and convulsions, can occur instead of the stupor and coma typically associated with morphine intoxication.

Finally, meperidine is commonly abused by health professionals who mistakenly believe that meperidine has a lower dependence liability and is easier to stop using than morphine. Meperidine dependence has been widely documented since the drug was first introduced, and meperidine has significant abuse potential.

Methadone

Methadone is a synthetic pure agonist opioid analgesic qualitatively similar in its pharmacology to other opioids. The diphenylheptane structure of methadone is shown in Figure 20-7; although it does not resemble morphine, methadone is induced by steric factors to assume the configuration that apparently is required for agonist interaction with μ -opioid receptors. Methadone is approximately equipotent to morphine and, aside from methadone's greater oral efficacy, differs little from morphine. Similar to morphine, methadone produces analgesia, sedation, respiratory depression, miosis, antitussive effects, and subjective effects similar to those of morphine. It also is constipating and can cause biliary tract spasm. It is well absorbed from the gastrointestinal tract and eventually becomes localized in the lung, kidney, and liver, where it undergoes extensive biotransformation. The major metabolites of methadone are excreted in the urine and in the bile, along with small quantities of unchanged drug.

Because methadone is a potent, orally effective analgesic agent, it was initially restricted by law for use in the treatment of opioid addiction. Methadone possesses a combination of properties that make its use in maintenance programs superior to other opioids. As already indicated, methadone has significant oral efficacy. Although its duration of action is similar to that of morphine after a single administration, methadone exhibits a persistent effect when given repeatedly. Methadone's duration of action is effectively increased, permitting single daily dosage to suppress withdrawal symptoms in opioid-dependent individuals.

The term *blockade* was used when the use of methadone in maintenance programs for heroin addicts was initially reported. Blockade of the effects of heroin and a disappearance of "drug hunger" in heroin addicts after the administration of relatively high doses of methadone were claimed. This description is misleading, however, because it promotes the interpretation that methadone's action is equivalent to recep-

tor antagonism, endowing methadone with a pharmacologic property it does not possess. Methadone is not an opioid receptor antagonist; it is a pure agonist, as are the other opioids discussed in this section. The use of methadone (or any other opioid agonist) in maintenance programs relates to cross-tolerance and cross-dependence and not to some unique ability of methadone to "block" heroin's effects.

Cross-tolerance among opioids means that if an individual has become tolerant to the effects of one opioid (e.g., heroin), he or she will also exhibit tolerance to the effects of other opioids. When cross-dependence exists, an individual physically dependent on one opioid can be switched to a different opioid to prevent the expression of withdrawal symptoms. These are general statements of principles that apply to the opioids as a class because the μ receptor is the principal receptor at which these agonists act. In practice, because there are differences among opioid agonists, cross-tolerance and cross-dependence are incomplete. As used in maintenance programs, methadone simply represents the substitution of one opioid for another, and methadone is used rather than other opioids primarily because it can be given orally and has an extended duration of action.

Propoxyphene

Propoxyphene is a synthetic opioid analgesic structurally related to methadone. Propoxyphene was initially introduced and legally classified as a "non-narcotic" analgesic. Currently, it is listed in Schedule IV of the Controlled Substances Act of 1970, whereas codeine, the opioid with which propoxyphene is usually compared, is listed in Schedule II. It has been amply shown that propoxyphene is subject to abuse and that physical dependence does develop during high-dose, long-term use. Overall, the dependence liability of propoxyphene is estimated to be slightly less than that of codeine.

Despite the foregoing, propoxyphene is either as efficacious or less efficacious than aspirin or acetaminophen for relief of pain.²³ Its toxicity is considerably more worrisome than that of these analgesics or of codeine, however, and its clinical use is diminishing. Although propoxyphene produces CNS effects that seem qualitatively similar to the CNS effects of codeine and other opioids, it is not generally agreed that analgesia is one of those central actions, at least at the doses commonly used. Nevertheless, propoxyphene has been widely used as an analgesic, and it is claimed that approximately 65 mg of propoxyphene hydrochloride or 100 mg of propoxyphene napsylate is equivalent in analgesic efficacy to 65 mg of codeine.

The currently recognized use of propoxyphene is for treatment of mild-moderate pain, and propoxyphene is often prescribed in place of codeine, apparently because of unjustified overconcern regarding the dependence liability of codeine. Acute intoxication with propoxyphene occurs at doses close to the therapeutic range, however, and can produce respiratory and CNS depression, confusion, hallucinations, and symptoms not typically associated with opioids, such as CNS excitation, convulsions, cardiotoxicity, and nephrogenic diabetes insipidus. Propoxyphene is also associated with an elevated degree of lethality, and its toxicity is enhanced by alcohol consumption. Its toxicity is due principally to the toxic metabolite, norexpropoxyphene. For this reason, its use is not recommended in patients with renal insufficiency, patients with hepatic disorders, and elderly patients. Its low risk-to-benefit ratio has earned it a "black box" warning from the FDA, and it is being withdrawn from the market in the United Kingdom.¹

Fentanyl and Congeners

Fentanyl, alfentanil, sufentanil, and remifentanil are 4-anilopiperidines (Figure 20-8). They are potent analgesics with

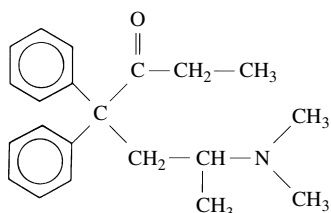

FIGURE 20-7 Structural formula of methadone.

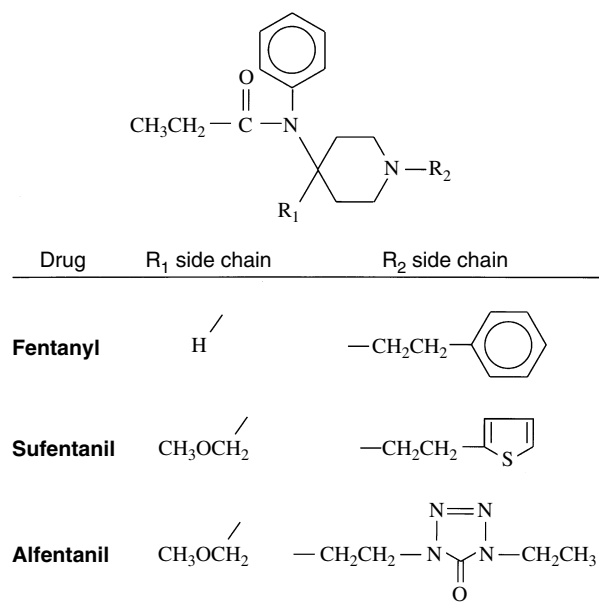

FIGURE 20-8 Structural formulas of fentanyl, sufentanil, and alfentanil.

relatively short durations of action used often as intravenous supplements during general anesthesia with inhalation or intravenous anesthetic drugs or as the principal component of balanced anesthesia (e.g., with nitrous oxide and a neuromuscular blocking drug), especially for cardiac surgery. The primary advantage of these more potent opioids is the cardiovascular stability they provide during surgery.³

Analgesic anesthesia with morphine dates to the turn of the twentieth century, when morphine was combined with scopolamine for surgery. Meperidine was subsequently tested because of the incomplete amnesia, histamine release, hypotension, and postoperative respiratory depression associated with the high doses of morphine that were required during surgery. Meperidine presented other disadvantages (e.g., poor cardiovascular stability), however, and has since been replaced by fentanyl and its congeners, all of which are more effective than morphine in reducing the endocrine and metabolic responses to surgery and maintaining cardiovascular stability.

Although these newer agents have found widespread application in current anesthetic practice, particularly for cardiac surgery, they are not without limitations. The most serious disadvantage associated with opioids used as analgesic anesthetics is that they are not anesthetics, and their use is associated with a high incidence of signs of inadequate anesthesia (e.g., sweating, pupillary dilation, or opening of the eyes during surgery). Use of the term *anesthetic* to describe the pharmacologic characteristics of these agents is inappropriate. In addition, awareness during surgery and inadequate amnesia after surgery are common. Other disadvantages include hypertension after sternotomy (which can result in myocardial ischemia and infarction); bradycardia (which can be prevented by pretreatment with atropine); respiratory depression; and muscle rigidity, particularly of the abdominal and thoracic cavities. Although these opioids provide improved cardiovascular stability during induction and throughout an operation, the "anesthesia" produced may be incomplete.

Fentanyl is much more lipid-soluble than morphine, which largely accounts for its more rapid onset and shorter duration of action; fentanyl is also 80 to 100 times more

potent than morphine. The speed of onset allows fentanyl to play a role in the induction of anesthesia. Sufentanil is 5 to 10 times more potent than fentanyl, whereas alfentanil is less potent than fentanyl. Similar to fentanyl, these drugs are rapidly acting when given parenterally and have short durations of action. Because of its rapid onset and short duration of action even after repeated administrations, alfentanil has become a drug of choice for outpatient anesthesia. Remifentanyl, the newest of the anesthetic opioids, is quickly broken down in the bloodstream and tissues by esterases. It has the shortest duration of action of all 4-anilopiperidine opioids and may play a special role in brief procedures when a temporary analgesic effect is desired.

In addition to its use in cardiac surgery, fentanyl is currently available in two unique dosage forms for pain control. Because fentanyl is lipophilic, it is available as an adherent skin patch for transdermal delivery of drug. This formulation, used principally for treatment of chronic pain (e.g., cancer pain), provides continuous drug delivery in therapeutic concentrations with reduced incidence of constipation and nausea.^{4,10} Patients with chronic pain often have what is termed *breakthrough pain* while taking opioids for pain control. Fentanyl formulated as a lollipop is available for rapid onset (sublingual absorption) analgesia to control episodes of breakthrough pain.

Other Opioids

A number of opioid analgesics, some listed in Table 20-2, have not been discussed because they offer little or no therapeutic advantage over morphine or codeine and for the most part are not widely used. New opioid analgesics continue to be developed, particularly agents with mixed agonist-antagonist properties (see later), and it is likely that some of these will find clinical application.

MIXED AGONIST-ANTAGONISTS AND OPIOID RECEPTOR ANTAGONISTS

Drugs possessing agonist and antagonist efficacy were first synthesized 100 years ago. They possessed predominant antagonist effects (e.g., nalorphine) and were initially used to reverse or block the effects of pure opioid agonists. Today, naloxone and naltrexone, both of which are pure opioid receptor antagonists, have supplanted the use of nalorphine, a mixed agonist-antagonist used for years as an opioid receptor antagonist to reverse acute opioid intoxication. Naloxone is used almost exclusively to reverse the effects of opioid agonists (e.g., in acute opioid intoxication); naltrexone is used in the maintenance of detoxified opioid abusers. An injectable extended-release formulation of naltrexone that needs to be administered only once monthly has been approved for the control and prevention of alcohol abuse.^{18,40}

The number of mixed agonist-antagonists has grown since the early 1950s because it was hoped that such drugs would be potent analgesics devoid of dependence and abuse liability. Chemical manipulation of the opioid structure produced compounds with varying agonist and antagonist properties. It was anticipated that the correct combination of such properties would yield a potent and efficacious analgesic drug that would not be abused. It was quickly learned, however, that drugs having agonist and antagonist properties were often unsuitable for clinical use as analgesics because of undesirable dysphoric side effects. The opioid receptor-blocking aspect of their pharmacologic profile does not prevent their abuse or free these drugs from tolerance and dependence.

In carefully controlled studies in animals, mixed agonist-antagonists have been established to possess reinforcing properties that lead to self-administration. In this respect, the

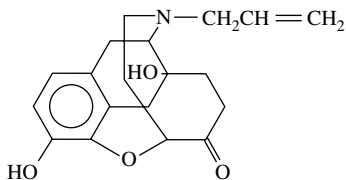

FIGURE 20-9 Structural formula of naloxone.

mixed agonist-antagonists are similar to pure opioid agonists (e.g., morphine), although they have less reinforcing efficacy than the pure opioid agonists. Tolerance develops to the agonist, but not antagonist, effects of these drugs. Subjects who repeatedly use mixed agonist-antagonists may become physically dependent, just as can occur with repeated use of morphine and other pure opioid agonists, although the withdrawal symptoms differ from symptoms produced by morphine-like agonists.

Naloxone, Naltrexone, and Nalmefene

Naloxone (Figure 20-9), naltrexone, and nalmefene are the opioid receptor antagonists currently available that are essentially devoid of opioid agonist effects. In addition to antagonizing the effects of opioids, these drugs can block the agonist actions of most mixed agonist-antagonists. This is an important point because the respiratory depression produced by pentazocine, a mixed agonist-antagonist, is reversible by naloxone, naltrexone, and nalmefene but not by mixed agonist-antagonist drugs used as analgesics. The principal use of pure opioid receptor antagonists is in the treatment of acute opioid intoxication. These pure opioid antagonists are specific and rapidly improve ventilation. These antagonists are not general respiratory stimulants, however. Conversely, they do not diminish respiration further if administered to individuals with respiratory depression produced by other drugs (e.g., barbiturates and alcohol). The lack of response to naloxone, naltrexone, or nalmefene in a case of respiratory depression of unknown cause would be highly suggestive of nonopioid drug intoxication.

Naloxone, which is not effective when given orally, has an almost immediate onset and a short duration of action (1 to 4 hours) when given parenterally. Additional doses may be required at 20- to 60-minute intervals, especially if naloxone is being used to reverse intoxication by a long-acting opioid agonist. Naltrexone differs from naloxone in that it is effective orally and has a remarkably long duration of action. A single oral dose can suppress the effects of opioid agonists for 48 to 72 hours. These attributes suggest that naltrexone may be useful in the maintenance of an opioid-free state in detoxified, formerly opioid-dependent individuals. A single daily administration of the drug can effectively block the action of 25 mg of heroin injected intravenously 24 hours after the last dose of naltrexone. Naltrexone may also prove useful in treating morphine overdose because it might obviate the need to monitor the patient for a relapse of respiratory depression. Nalmefene is an orally active drug that has an even longer duration of action than naltrexone.⁴⁰

Mixed Agonist-Antagonists

Pentazocine

Pentazocine is an agonist at κ opioid receptors and a partial agonist or weak antagonist at μ receptors. A benzomorphan derivative, pentazocine is structurally related to morphine (Figure 20-10), but it has an allyl-like substitution on the nitrogen of the piperidine ring (as do many opioid receptor antagonists). Pentazocine is an early product of continuing efforts to develop efficacious opioid analgesics with little or

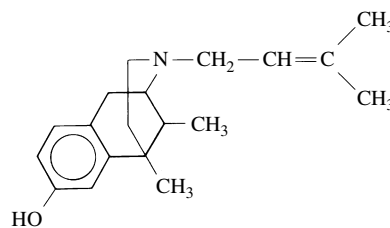

FIGURE 20-10 Structural formula of pentazocine.

no dependence liability or abuse potential. Pentazocine was initially promoted as being free of dependence liability, but similar to other mixed agonist-antagonist and pure agonist opioids, it produces its major effects on the CNS and gastrointestinal tract and induces morphine-like subjective effects and euphoria. Physical and psychological dependence can develop to pentazocine, and the drug has been widely abused. Pentazocine tablets for oral use were crushed and self-administered intravenously, often in combination with the antihistamine tripeleminamine, to produce a euphoric effect. To prevent this use of pentazocine in the United States, the opioid receptor antagonist naloxone (0.5 mg) was added to the formulation, and the proprietary name of the drug was changed to Talwin NX.

Because naloxone has little effect when taken orally, use of pentazocine as directed produces the desired analgesia. When used intravenously, however, the amount of naloxone present in the formulation is sufficient to antagonize completely the CNS effects of pentazocine. In contrast to codeine (or other pure agonists), pentazocine does not suppress withdrawal symptoms in individuals dependent on other opioids, but it also cannot antagonize morphine-induced respiratory depression. Pentazocine can precipitate signs of withdrawal in an opioid-dependent individual, however, because of its residual antagonist activity at μ receptors.

Pentazocine is well absorbed from the gastrointestinal tract. It is metabolized primarily in the liver to glucuronide conjugates, although small quantities of free pentazocine are excreted in the urine. It is approximately one third as potent an analgesic as morphine when given intramuscularly. As used orally, generally in place of codeine, approximately 50 mg of pentazocine is considered equivalent to 60 mg of codeine for relief of pain. Pentazocine's ability to relieve pain at greater doses is not comparable to that of pure opioid agonists. Generally, the maximal analgesic effect of mixed agonist-antagonist analgesics is less than that of morphine or other pure opioid agonists. At therapeutic doses, pentazocine exhibits effects on the CNS and gastrointestinal tract that are qualitatively similar to effects of other opioids (e.g., dizziness, nausea, and sedation and analgesia). In contrast to most other opioids, pentazocine can increase heart rate and blood pressure. In toxic doses, it produces dysphoric effects and characteristic opioid-like respiratory depression, although the respiratory depression does not increase proportionately with increasing doses as it does for pure opioid agonists.

Butorphanol

Butorphanol, buprenorphine, and nalbuphine are traditionally grouped together as examples of drugs with a mixture of opioid agonist and antagonist properties. These drugs are significantly different from each other, however, and such a grouping may not be justified. The major thrust in developing compounds having predominant effects at the κ opioid receptor was the belief that such drugs would retain significant analgesic activity but would be devoid of the respiratory depression and dependence liability associated

with morphine-like drugs whose prominent analgesic and respiratory depressant effects are produced at the μ opioid receptor. This effort has been partially successful. Although at therapeutic doses these drugs cause respiratory depression equivalent to that produced by 10 mg of morphine, the depression does not increase proportionately with increasing doses. The analgesia does not increase either, however.

Butorphanol is a morphinan derivative approximately four to six times more potent than morphine as an analgesic. Butorphanol is an agonist at κ opioid receptors and a weak partial agonist at the μ receptor. The drug is unlikely to precipitate withdrawal symptoms in opioid-dependent individuals, but it shows no cross-dependence either. As an analgesic substitute for morphine, butorphanol has a low abuse potential, and respiratory depression tends to plateau beyond therapeutic doses. Butorphanol has been tested as an analgesic anesthetic (similar to the pure agonist fentanyl), but because it has a tendency, similar to pentazocine, to increase cardiac work, it is not well suited for this application. Another limitation of butorphanol is the possibility of dysphoric side effects.

Butorphanol is subject to significant first-pass metabolism; approximately 80% of an oral dose is metabolized initially, and bioavailability after oral administration is low. Based on this pharmacologic profile, butorphanol, which was already available in an injectable form for obstetric use, was marketed as a nasal spray formulation as a nonscheduled drug for acute pain in 1992 and was most often used for migraine headache in the United States. Within 3 years of the release of the noninjectable formulation, reports of adverse reactions increased about sevenfold and included reports of dependence and addiction. It has since been declared a Schedule IV narcotic by the Drug Enforcement Administration.¹⁷

Nalbuphine

Nalbuphine is structurally related to naloxone, but is equipotent with regular analgesic doses of morphine. It has a pronounced antagonist action at the μ receptor, which distinguishes it from other available mixed agonist-antagonists. Nalbuphine is an agonist at κ opioid receptors, but produces few dysphoric reactions. Because of its unique blend of agonistic and antagonistic efficacy, nalbuphine has been used to reverse respiratory depression produced by other opioids without causing a loss of analgesia. Its greatest application is in debilitated surgical patients for whom the abrupt loss of pain relief caused by naloxone reversal can be life-threatening. Also beneficial in this setting is the fact that nalbuphine produces minimal myocardial depression. Nevertheless, opioid reversal even with nalbuphine is potentially dangerous in a patient at risk of heart attack. Nalbuphine should not be considered a replacement for naloxone for treatment of drug overdose in other settings.

Nalbuphine is marketed only as an injectable solution in the United States, and it is rarely used outside the hospital setting. Probably because it is uncommon to encounter nalbuphine outside such controlled environments, it is rarely found in forensic analyses and remains at present as the only opioid analgesic not scheduled under the Controlled Substances Act.

Buprenorphine

Buprenorphine is a strong partial agonist at the μ opioid receptor and is 25 to 50 times more potent an analgesic than morphine. It differs from other agonist-antagonists in that it is a potent κ receptor antagonist and has fewer psychotomimetic effects than pentazocine or butorphanol. Its agonistic effects are qualitatively similar to the effects of morphine, and buprenorphine produces a physical dependence described by former addicts as morphine-like. Buprenorphine possesses two properties, however, that place it in a unique niche,

making it useful as an analgesic and in the treatment of opioid dependence. Buprenorphine binds to the μ receptor with an affinity two orders of magnitude greater than that of morphine and readily displaces morphine from the receptor. Because it is a partial agonist, its pharmacologic effect is limited in range, and increasing the dose of buprenorphine beyond the maximally effective dose only serves to occupy the μ receptors without increasing the pharmacologic effect. Buprenorphine acts as an antagonist at higher doses.

Because of this combination of properties, buprenorphine can be used to produce a moderately strong analgesic effect and serves to limit the activity of stronger opioids. Consequently, administration of buprenorphine to an opioid-dependent individual can precipitate an immediate abstinence syndrome, even as it can relieve withdrawal symptoms caused by prior opioid withholding. Buprenorphine mimics the effects of morphine in drug-free patients, but antagonizes pure agonists on coadministration.

Dezocine

Dezocine, an aminotetralin derivative, is a μ receptor antagonist and a κ receptor agonist. The drug may increase the cardiac index and pulmonary vascular resistance but lowers peripheral vascular resistance and is generally benign to the heart. In conventional doses, the potency and duration of action of dezocine are similar to those of morphine.

Novel Compounds

Tramadol is an aminocyclohexanol derivative, and it is used as a racemic mixture. The (+) enantiomer of tramadol is a weak agonist at the μ opioid receptor and inhibits the reuptake of serotonin. The (–) enantiomer of tramadol is a norepinephrine reuptake inhibitor. Additionally, the O-demethylated metabolite is a potent κ receptor agonist. All of these properties contribute to the analgesic actions of this drug. The analgesia caused by tramadol is only partially reversed by naloxone. As a perioperative analgesic, tramadol can relieve moderate-severe pain and is generally well tolerated.³⁶ The most common adverse effects include nausea, vomiting, and drowsiness; effects on respiratory or cardiovascular parameters are not clinically relevant at recommended doses in adults or children. Seizures have been reported for tramadol. The drug is used orally and has a terminal half-life of approximately 7 hours. Tramadol, which is not scheduled as a controlled substance, is generally regarded as lacking abuse liability. Some reports of abuse have occurred in previously opioid-dependent individuals.⁴⁴

Tapentadol is a compound that is related mechanistically to tramadol and approved more recently for the management of acute pain. In contrast to tramadol, tapentadol is not a racemate and has strong μ opioid agonist activity and norepinephrine reuptake inhibition. Its potency is greater than that of tramadol and similar to morphine. The dual mechanism of action may contribute to an improved side-effect profile with diminished nausea and vomiting and constipation.⁴³

USE OF OPIOIDS IN THE CONTROL OF PAIN

A full discussion of the differentiating features of acute and chronic pain is beyond the scope of this chapter, but some comment is required to understand better the use of opioids in the clinical management of pain. Opioid agonists and mixed agonist-antagonists can be used satisfactorily as analgesics for the relief of acute pain. The long-term use of opioids in clinical pain states raises questions, however, regarding the choice of opioid, the route of administration, and the role played by the development of tolerance and physical depen-

dence in therapy.^{29,42} The use of mixed agonist-antagonists in chronic pain management is limited. Escalating doses of pentazocine and related drugs are associated with undesirable psychotomimetic effects. More importantly, the antagonistic properties of mixed agonist-antagonists at the μ receptor restrict the ability to switch between pure agonists and mixed agonist-antagonists for the control of pain.

Heroin was initially considered the drug of choice for management of cancer pain, but it has been established that heroin offers no therapeutic advantage over morphine. Heroin is a prodrug that is metabolized to morphine. Although bioavailability of morphine is limited because of first-pass metabolism, the dose can be adjusted for successful pain control by oral administration in liquid or sustained-release tablet form. Methadone is a useful alternative to morphine, but because its plasma half-life averages 24 hours, methadone accumulates with repeated dosing, and greater care is required with its use.

Oral administration is generally considered optimal for the treatment of chronic pain, but epidural, intrathecal, and intravenous routes of administration are also used, more recently in situations of patient-controlled analgesia. Although an exaggerated fear of “addicting” patients exists, as well as concern that allowing patients to self-administer opioids for the control of pain will lead to uncontrolled use, studies indicate that the total amount of opioid that is self-administered by patient-controlled analgesia is usually no more and often less than that given conventionally by health professionals. The use of patient-controlled analgesia gives patients control over when to treat their pain and has been found to provide psychological benefit.

The fear of addiction held by health professionals and patients often limits adequate opioid dosing for the control of pain. Physical dependence undeniably develops with repeated opioid administration, but evidence that psychological dependence and opioid abuse are a consequence of long-term medical use of opioids is virtually nonexistent.

USES IN DENTISTRY

Opioids used in dentistry are primarily those available for oral administration, including codeine, hydrocodone, oxycodone, and pentazocine. Morphine, meperidine, and fentanyl are used parenterally (as described in Chapter 47). Although these drugs all possess therapeutically useful actions in addition to analgesia, they are used in dentistry exclusively for pain relief. Pain of dental origin frequently arises from or is accompanied by inflammation, however. Because opioids are not anti-inflammatory, nonopioid analgesic drugs with anti-inflammatory efficacy (e.g., aspirin, ibuprofen) are often the first choice for relief of pain. Opioids are particularly useful when additional pain control is required. Combinations of opioids with acetaminophen, aspirin, or ibuprofen are commonly used and are rational because different, complementary central and peripheral mechanisms of pain relief are invoked. Although aspirin and ibuprofen have anti-inflammatory efficacy, acetaminophen is not anti-inflammatory and is not a good choice when it is desired to reduce inflammation and pain.

Of opioids available for use in dentistry, codeine, hydrocodone, and oxycodone are the most commonly used. Tramadol is gaining acceptance as an analgesic after dental procedures and is a safe and effective alternative for individuals who cannot tolerate opioids in combination with acetaminophen or nonsteroidal anti-inflammatory drugs.^{25,45} As previously indicated, the analgesic efficacy of propoxyphene is questionable, and its use is now generally discouraged. Similarly, the efficacy and utility of meperidine given orally in conventional doses are also being reconsidered.

IMPLICATIONS FOR DENTISTRY

The opioid analgesics are subject to abuse, and significant physical and psychological dependence can develop. The pharmacologic and sociologic aspects of opioids are discussed in Chapter 51. Additional implications for dentistry relate to the possible interactions of opioids with other drugs that dentists may prescribe or that patients may be taking for medical reasons. Drug interactions with orally administered opioids are uncommon or not usually of great clinical importance when they do occur. There are recognized interactions, however, between opioids and CNS depressants, neuroleptics, tricyclic antidepressants, monoamine oxidase inhibitors, local anesthetics, and oral anticoagulants that can be clinically significant, particularly if opioids are given parenterally.

Generally, the coadministration of CNS depressants produces summation of effects and occasionally a greater than anticipated depression (i.e., supra-additive effect). Opioids and phenothiazines (e.g., chlorpromazine) are known to produce at least additive CNS depression, including respiratory depression. This combination may also produce a greater incidence of orthostatic hypotension than either drug administered alone. Increased hypotension has also been reported with combinations of opioids and tricyclic antidepressants. When combinations of opioids and other CNS depressants are used in dentistry, the drugs are commonly given by intravenous infusion, and the effects can be titrated to the desired level. When used orally, doses should have a sufficient margin of safety to avoid dose-dependent toxicity. The clinical significance of these interactions, particularly at the doses of opioids used orally in dentistry, is uncertain.

The coadministration of local anesthetics and parenteral opioid analgesics is a common and generally safe practice. Large doses of these classes of drugs display supra-additive toxicity, however. It is likely that respiratory acidosis caused by an opioid can increase the entry of a local anesthetic into the CNS.

Interaction of opioids with oral anticoagulants has been reported to result in an enhanced response to the latter, but the clinical significance has not been established, and it is unlikely that short-term opioid administration has an appreciable effect on the patient's response to oral anticoagulants.

A well-documented interaction of meperidine and monoamine oxidase inhibitors results in severe and immediate reactions that include excitation, rigidity, hypertension, and sometimes death. Chemically unrelated opioids are unlikely to cause a similarly violent reaction.

OPIOID ANALGESICS AND ANTAGONISTS

<i>Nonproprietary (generic) name</i>	<i>Proprietary (trade) name</i>
Agonist analgesics	
Alfentanil	Alfenta
Codeine*	—
Dihydrocodeine	In Synalgos DC
Fentanyl	Sublimaze
Fentanyl transdermal system	Duragesic
Fentanyl transmucosal system	Fentanyl Oralet
Hydrocodone*	Dicodid
Hydromorphone	Dilaudid
Levomethadyl	ORLAAM

Continued

OPIOID ANALGESICS AND ANTAGONISTS—cont'd

<i>Nonproprietary (generic) name</i>	<i>Proprietary (trade) name</i>
Levorphanol	Levo-Dromoran
Meperidine	Demerol
Methadone	Dolophine
Morphine	—
Opium	Pantopon, Paregoric
Oxycodone	Oxycontin; in Percodan
Oxymorphone	Numorphan
Propoxyphene	Darvon
Remifentanyl	Ultiva
Sufentanyl	Sufenta
Mixed agonist-antagonist analgesics	
Buprenorphine	Buprenex
Butorphanol	Stadol
Dezocine	Dalgan
Nalbuphine	Nubain
Pentazocine	Talwin; in Talwin NX
Antagonists	
Nalmefene	Revox
Naloxone	Narcan; in Talwin NX
Naltrexone	Revia, Vivitrol
Others	
Methotrimeprazine	Levoprome
Tramadol	Ultram
Tapentadol	Nucynta

*Also used as antitussive or cough suppressant.

CITED REFERENCES

- Barkin RL, Barkin SJ, Barkin DS: Propoxyphene (dextropropoxyphene): a critical review of a weak opioid analgesic that should remain in antiquity. *Am J Ther* 13:534-542, 2006.
- Borison HL: Central nervous system respiratory depressants-narcotic analgesics. *Pharmacol Ther [B]* 3:227-237, 1977.
- Bovill JG, Sebel PS, Stanley TH: Opioid analgesics in anesthesia: with special reference to their use in cardiovascular anesthesia. *Anesthesiology* 61:731-755, 1984.
- Donner B, Zenz M, Strumpf M, et al: Long-term treatment of cancer pain with transdermal fentanyl. *J Pain Symptom Manage* 15:168-175, 1998.
- Fantin M, Fischetti C, Trapella C, et al: Nocistatin inhibits 5-hydroxytryptamine release in the mouse neocortex via presynaptic Gi/o protein linked pathways. *Br J Pharmacol* 152:549-555, 2007.
- Fields H: State-dependent opioid control of pain. *Nat Rev Neurosci* 5:565-575, 2004.
- Gavériaux-Ruff C, Peluso J, Befort K, et al: Detection of opioid receptor mRNA by RT-PCR reveals alternative splicing for the δ - and κ -opioid receptors. *Mol Brain Res* 48:298-304, 1997.
- Gebhart GF, Proudfit HK: Descending modulation of pain processing. In Hunt S, Koltzenburg M, editors: *The neurobiology of pain*, Oxford, 2004, Oxford University Press.
- Grace D, Fee JP: A comparison of intrathecal morphine-6-glucuronide and intrathecal morphine sulfate as analgesics for total hip replacement. *Anesth Analg* 83:1055-1059, 1996.
- Grond S, Zech D, Lehman KA, et al: Transdermal fentanyl in the long-term treatment of cancer pain: a prospective study of 50 patients with advanced cancer of the gastrointestinal tract or the head and neck region. *Pain* 69:191-198, 1997.
- Hosobuchi Y, Adams JE, Linchitz R: Pain relief by electrical stimulation of the central gray matter in humans and its reversal by naloxone. *Science* 197:183-186, 1977.
- Houde RW, Wallenstein SL, Beaver WT: Clinical measurement of pain. In de Stevens G, editor: *Analgesics*, New York, 1965, Academic Press.
- Hughes J: Isolation of an endogenous compound from the brain with pharmacological properties similar to morphine. *Brain Res* 88:295-308, 1975.
- Kaiko RF, Wallenstein SL, Rogers AG, et al: Narcotics in the elderly. *Med Clin North Am* 66:1079-1089, 1982.
- Kieffer BL: Molecular aspects of opioid receptors. In Dickenson AH, Besson J-MR, editors: *The pharmacology of pain. Handbook of experimental pharmacology*, vol 130, Berlin, 1997, Springer.
- Laulin JP, Celerier E, Larcher A, et al: Opiate tolerance to daily heroin administration: an apparent phenomenon associated with enhanced pain sensitivity. *Neuroscience* 89:631-636, 1999.
- Loder E: Post-marketing experience with an opioid nasal spray for migraine: lessons for the future. *Cephalalgia* 26:89-97, 2006.
- Mannelli P, Peindl K, Masand PS, et al: Long-acting injectable naltrexone for the treatment of alcohol dependence. *Expert Rev Neurother* 7:1265-1277, 2007.
- Marcus MME, Gogarten W, Van Aken H: Opioids in obstetrics. In Stein C, editor: *Opioids in pain control*, Cambridge, 1999, Cambridge University Press.
- Martini L, Whistler JL: The role of mu opioid receptor desensitization and endocytosis in morphine tolerance and dependence. *Curr Opin Neurobiol* 17:556-564, 2007.
- Meunier JC, Mollereau C, Toll L, et al: Isolation and structure of the endogenous agonist of opioid receptor-like ORL-1 receptor. *Nature* 377:532-535, 1995.
- Miller RJ: Peptides as neurotransmitters: focus on the enkephalins and endorphins. *Pharmacol Ther* 12:73-108, 1981.
- Miller RR, Feingold A, Paxinos J: Propoxyphene hydrochloride: a critical review. *JAMA* 213:996-1006, 1970.
- Mogensen T, Eliassen K, Ejlersen E, et al: Epidural clonidine enhances postoperative analgesia from a combined low-dose epidural bupivacaine and morphine regimen. *Anesth Analg* 75:607-610, 1992.
- Moore PA: JADA Continuing Education: pain management in dental practice: tramadol vs. codeine combinations. *J Am Dent Assoc* 130:1075-1079, 1999.
- Okuda-Ashitaka E, Ito S: Nocistatin: a novel neuropeptide encoded by the gene for the nociceptin/orphanin FQ precursor. *Peptides* 21:1101-1109, 2000.
- Ossipov MH, Lai J, King T, et al: Underlying mechanisms of pronociceptive consequences of prolonged morphine exposure. *Biopolymers* 80:319-324, 2005.
- Owen JA, Sitar DS, Berger L, et al: Age-related morphine kinetics. *Clin Pharmacol Ther* 34:364-368, 1983.
- Portenoy RK: Tolerance to opioid analgesics: clinical aspects. *Cancer Surv* 21:49-65, 1994.
- Portenoy RK, Thaler HT, Inturrisi CE, et al: The metabolite morphine-6-glucuronide contributes to the analgesia produced by morphine infusion in patients with pain and normal renal function. *Clin Pharmacol Ther* 51:422-431, 1992.
- Price DD: Psychological mechanisms of pain and analgesia. *Progress in pain research and management*, vol 15, Seattle, 1999, IASP Press.
- Raynor K, Kong H, Chen Y, et al: Pharmacological characterization of the cloned kappa-, delta-, and mu-opioid receptors. *Mol Pharmacol* 45:330-334, 1994.
- Reinscheid RK, Nothacker HP, Bourson A, et al: Orphanin FQ: a neuropeptide that activates an opioid-like G protein-coupled receptor. *Science* 270:792-794, 1995.
- Salmanzadeh F, Fathollahi Y, Semnani S, et al: Dependence on morphine impairs the induction of long-term potentiation in the CA1 region of rat hippocampal slices. *Brain Res* 965:108-113, 2003.
- Sapira JD: Speculations concerning opium abuse and world history. *Perspect Biol Med* 18:379-398, 1975.
- Scott LJ, Perry CM: Tramadol: a review of its use in perioperative pain. *Drugs* 60:139-176, 2000.
- Simon EJ: The opiate receptors. *Neurochem Res* 1:3-28, 1976.
- Stein C, Cabot PJ, Schafer M: Peripheral opioid analgesia: mechanisms and clinical implications. In Stein C, editor: *Opioids in pain control*, Cambridge, 1999, Cambridge University Press.

39. Sternini C, Spann M, Anton B, et al: Agonist-selective endocytosis of mu opioid receptor by neurons in vivo. *Proc Natl Acad Sci U S A* 93:9241-9246, 1996.
40. Tambour S, Quertemont E: Preclinical and clinical pharmacology of alcohol dependence. *Fundam Clin Pharmacol* 21:9-28, 2007.
41. Thorn SE, Wattwil M, Lindberg G, et al: Systemic and central effects of morphine on gastroduodenal motility. *Acta Anesthesiol Scand* 40:177-186, 1996.
42. Twycross RG: Opioids. In Wall PD, Melzack R, editors: *Textbook of pain*, London, 1999, Churchill Livingstone.
43. Tzschentke TM, Christoph T, Kogel B, et al: (-)-(1R,2R)-3-(3-dimethylamino-1-ethyl-2-methyl-propyl)-phenol hydrochloride (tapentadol HCl): a novel mu-opioid receptor agonist/norepinephrine reuptake inhibitor with broad-spectrum analgesic properties. *J Pharmacol Exp Ther* 323:265-276, 2007.
44. Woody GE, Senay EC, Geller A, et al: An independent assessment of MEDWatch reporting for abuse/dependence and withdrawal from Ultram (tramadol hydrochloride). *Drug Alcohol Depend* 72:163-168, 2003.
45. Wynn RL: Non-traditional analgesics for dental pain. *Gen Dent* 56:122-124, 2008.
46. Yaksh TL: The spinal actions of opioids. In Hertz A, editor: *Opioids II. Handbook of experimental pharmacology*, vol 104, Berlin, 1993, Springer-Verlag.
47. Zadina JE, Hackler L, Ge L, et al: A potent and selective endogenous agonist for the μ -opiate receptor. *Nature* 386:499-502, 1997.
48. Zadina JE, Martin-Schild S, Gerall AA, et al: Endomorphins: novel endogenous mu-opiate receptor agonists in regions of high mu-opiate receptor density. *Ann N Y Acad Sci* 897:136-144, 1999.
49. Zeilhofer HU, Reinscheid RK, Okuda-Ashitaka E: Nociceptin, nocistatin and pain. In Dostrovsky JO, Carr DB, Koltzenburg M, editors: *Proceedings of the 10th World Congress on Pain. Progress in pain research and management*, vol 24, Seattle, 2003, IASP Press.

GENERAL REFERENCES

- Dickenson AH, Besson J-MR, editors: *The pharmacology of pain. Handbook of experimental pharmacology*, vol 130, Berlin, 1997, Springer.
- Dostrovsky J, Carr DB, Koltzenburg M, editors: *Proceedings of the 10th World Congress on Pain*, Seattle, 2003, IASP Press.
- Peptides* 21:891-1154, 2000. (issue devoted to nociceptin/orphanin FQ/ORL-1 receptor system)
- Reisine T: Opiate receptors, *Neuropharmacology* 34:463-472, 1995.
- Stein C, editor: *Opioids in pain control*, Cambridge, 1999, Cambridge University Press.
- Taylor DA, Fleming WA: Unifying perspectives of the mechanisms underlying the development of tolerance and physical dependence to opioids, *J Pharmacol Exp Ther* 297:11-18, 2001.
- Williams JT, Christie MJ, Manzoni O: Cellular and synaptic adaptations mediating opioid dependence, *Physiol Rev* 81:299-343, 2001.
- Zakreuzewska JM, Harrison SD, editors: *Assessment and management of orofacial pain. Pain research and clinical management*, vol 14, Amsterdam, 2002, Elsevier.

Nonopioid Analgesics, Nonsteroidal Anti-inflammatory Drugs, and Antirheumatic and Antigout Drugs

ELLIOT V. HERSH, PAUL J. DESJARDINS, CLARENCE L. TRUMMEL, AND STEPHEN A. COOPER

Nonopioid analgesics, nonsteroidal anti-inflammatory drugs (NSAIDs), and agents used in the control of rheumatoid arthritis and gout represent a diverse group of chemical compounds whose mechanism of action typically involves the inhibition of one or more components of the inflammatory response. Acute pain, which typically accompanies inflammatory insults, results from various dental surgical procedures and can often be controlled by the use of the nonopioid analgesic acetaminophen or NSAIDs such as ibuprofen. In addition, NSAIDs play an important role in the symptomatic relief of the inflammation and pain that accompany arthritis. These agents do not eliminate or reduce the underlying causes of the arthritic disease, however, and joint damage can continue to progress despite the long-term use of these drugs.

Disease-modifying antirheumatic drugs (DMARDs) play a major role in the management of rheumatoid arthritis. They represent a group of chemically unrelated agents that have additional uses in medicine, ranging from the treatment of malaria and cancer to the prevention of transplanted organ rejection. In some instances, these agents can slow and arrest some of the pathologic changes seen in rheumatoid arthritis. They are fraught with serious adverse effects, however, and many patients cannot tolerate their long-term use.

CAUSE OF INFLAMMATION

Inflammation typically represents the response to tissue injury and includes products of activated mast cells, leukocytes, and platelets; prostaglandins (PGs); leukotrienes; and complement-derived products. The clinical features of inflammation include *tumor* (edema), *rubor* (redness), *calor* (heat), *dolor* (pain), and loss of function.

Although inflammation is often thought of as only a pathologic event, it serves a normal homeostatic function. In the case of tissue injury from minor trauma or a dental surgical procedure, the inflammatory process results in a series of well-regulated humoral and cellular events leading to localization of injury, removal of noxious agents, repair of physical damage, and restitution of function in the injured tissue. In patients unable to mount a competent inflammatory response, such as patients with agranulocytosis induced by some cancer chemotherapeutic drug regimens (see Chapter 42), the results are often fulminant infection and death.

The inflammatory response is not always beneficial to the host. If it becomes excessive or chronic, as is the case with rheumatoid arthritis, it may result in the progressive destruction of joint tissue and a host of untoward systemic effects.

Drugs are now being developed with relatively favorable therapeutic indices that show promise in halting some of the destructive inflammatory events of chronic rheumatic diseases.

Inflammation can be divided into three phases: acute inflammation, subacute inflammation, and chronic inflammation. In acute inflammation, small preformed inflammatory mediators such as histamine are released, causing vasodilation and increased capillary permeability. In the subacute stage, inflammatory cells migrate and invade the site. PGs, leukotrienes, platelet-activating factor (PAF), and cytokines also play major roles. The third, or chronic, stage of inflammation involves the lymphocytic phase of injury cleansing and repair. Cytokines, especially interleukins and tumor necrosis factor- α (TNF- α), are prominent in this stage. In reality these phases are not distinct entities. Components of the subacute phase participate in the acute inflammatory process, and acute inflammatory mediators are present in chronic inflammatory disorders such as arthritis. Even so, this classification still offers a useful way to categorize this highly complex process. The following section briefly reviews some of the key mediators of the inflammatory process. Table 21-1 provides a more complete list of inflammatory mediators.

Tissue Mediators

Histamine

Histamine is the first mediator for which a role in the inflammatory process was clearly established. This vasoactive amine is formed by decarboxylation of histidine and is widely distributed in the body. Although some free histamine exists in tissues, most is stored in mast cell and basophil granules in a physiologically inactive form. (For a more complete discussion, see Chapter 22.) Various physical and chemical stimuli, such as antigens, complement fragments, or simple mechanical trauma, can cause extrusion of the granules and release of active histamine into the extracellular fluid.

One of the most characteristic actions of histamine is dilation of vessels of the microcirculation and a marked, but transient, increase in the permeability of capillaries and post-capillary venules, reflecting an activation of H_1 receptors in these tissues. These vascular changes are similar to the changes that occur in tissue after injuries of all sorts. The evidence that histamine released from the ubiquitous mast cell is responsible for the initial permeability changes seen in an inflammatory response is extensive. The histamine content of tissue fluid at the site of injury increases within minutes after the insult and then decreases. Concurrent with these changes, mast cells in the area of damage are found to be degranulated.

TABLE 21-1

Classification of Some Endogenous Mediators of Inflammation

MAJOR GROUPS	MAJOR MEDIATORS
Tissue	
Lymphocyte products	MCP-1 GM-CSF Other chemoactive factors Interferon- γ Interleukins Skin reactive factor
Macrophage products	Interleukin-1 Interferon- γ TNF- α PAF
Mast cell products	Histamine Cytokines TNF- α Leukotrienes Prostaglandin D ₂ PAF
Eosinophil products	Lysosomal enzymes Major basic protein Other cationic proteins Leukotrienes PAF
Others	Reactive metabolites of oxygen Endogenous pyrogens from leukocytes Leukocytosis factors
Plasma	
Kinin system	Bradykinin
Complement system	C3 fragments C5 fragments C5b67 complex Membrane attack complex
Clotting system	Fibrinopeptides Fibrin degradation products

GM-CSF, Granulocyte-macrophage colony-stimulating factor; MCP-1, monocyte chemoattractive protein-1; PAF, platelet-activating factor.

It has been shown that prior depletion of tissue histamine stores by various means or pretreatment with classic antihistamines (H_1 receptor blockers) reduces the initial vascular response to injury.¹⁰¹ Inhibition of initial histamine-dependent events does not block the further development of the inflammatory response, however.

In patients with chronic inflammation caused by rheumatoid arthritis, increased concentrations and penetration depth of mast cells in synovial tissue are found, possibly related to the expression of stem cell factor by synovial fibroblasts. Astemizole, a potent antihistamine, does not affect the clinical course of this disease.¹³⁹ The role played by histamine in inflammation is early, transient, and nonessential for subsequent events that may lead to lasting tissue alterations.

Antihistamines have little use as general anti-inflammatory agents. In certain situations, such as immediate allergic reactions, large amounts of histamine are released locally or systemically from sensitized mast cells and basophils as a consequence of antigen-antibody reactions. In these instances, antihistamines that block the H_1 receptor are useful in reducing symptoms attributable to histamine. As discussed in Chapter 22, antihistamines that block the action of histamine at the H_2 receptor have a supporting role in the manage-

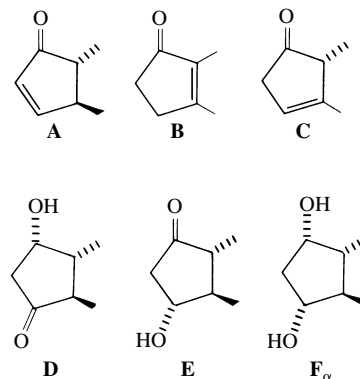
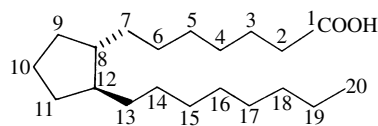

FIGURE 21-1 Molecular structure of prostaglandins (PGs). *Top*, Structure of prostanoic acid, a hypothetical compound of which the PGs can be considered analogues. *Bottom*, Basic ring structures of PG groups A through F.

ment of anaphylaxis and a major role in the treatment of gastric hyperacidity conditions.

Prostaglandins

The PGs are a unique family of closely related acidic lipids found in all tissues. The basic structure of all PGs is a prostanoic acid skeleton composed of a 20-carbon polyunsaturated fatty acid with a five-member ring at C8 through C12 (Figure 21-1). Similar to the leukotrienes described subsequently, PGs are derived from arachidonic acid and similar 20-carbon polyunsaturated fatty acids that are liberated from the cell membranes of local tissues by the action of acylhydrolases, principally phospholipase A₂, and, in platelets, diacylglycerol lipase. Inflammatory cells, including human monocytes and mast cells, also have the ability to generate PGs. Although multiple oxygenation products are derived from arachidonic acid, the PG molecules all contain a five-membered carbon ring. The alphabetical PG nomenclature (A-F) is based on the structure of this cyclopentane ring. PGE and PGF $_{\alpha}$ differ only in the presence of a ketone or hydroxyl group at C9. Also in the nomenclature, a subscript 1 indicates the presence of a double bond at C13 to C14 (PGE₁), a subscript 2 indicates the presence of an additional double bond at C5 to C6 (PGE₂), and a subscript 3 indicates the presence of a third double bond at C17 to C18 (PGE₃).

A key event in the acute inflammatory process is the liberation of arachidonic acid from damaged cell membranes on exposure to phospholipase A₂ (Figure 21-2).⁵⁵ This step can be inhibited indirectly by a powerful group of anti-inflammatory agents known as glucocorticoids, which are described in detail in Chapter 35. From this point, the oxidative metabolism of arachidonic acid can proceed along two divergent pathways. One pathway uses the enzyme cyclooxygenase (COX), also known as PG endoperoxide synthase, and the second pathway uses the enzyme lipoxygenase. Virtually all cells in the body, with the exception of red blood cells, contain the COX enzyme, whereas lipoxygenase seems to be limited to inflammatory cells (neutrophils, mast cells, eosinophils, and macrophages).

COX catalyzes the transformation of arachidonic acid to the short-lived cyclic endoperoxide PGG₂. PGG₂ is converted

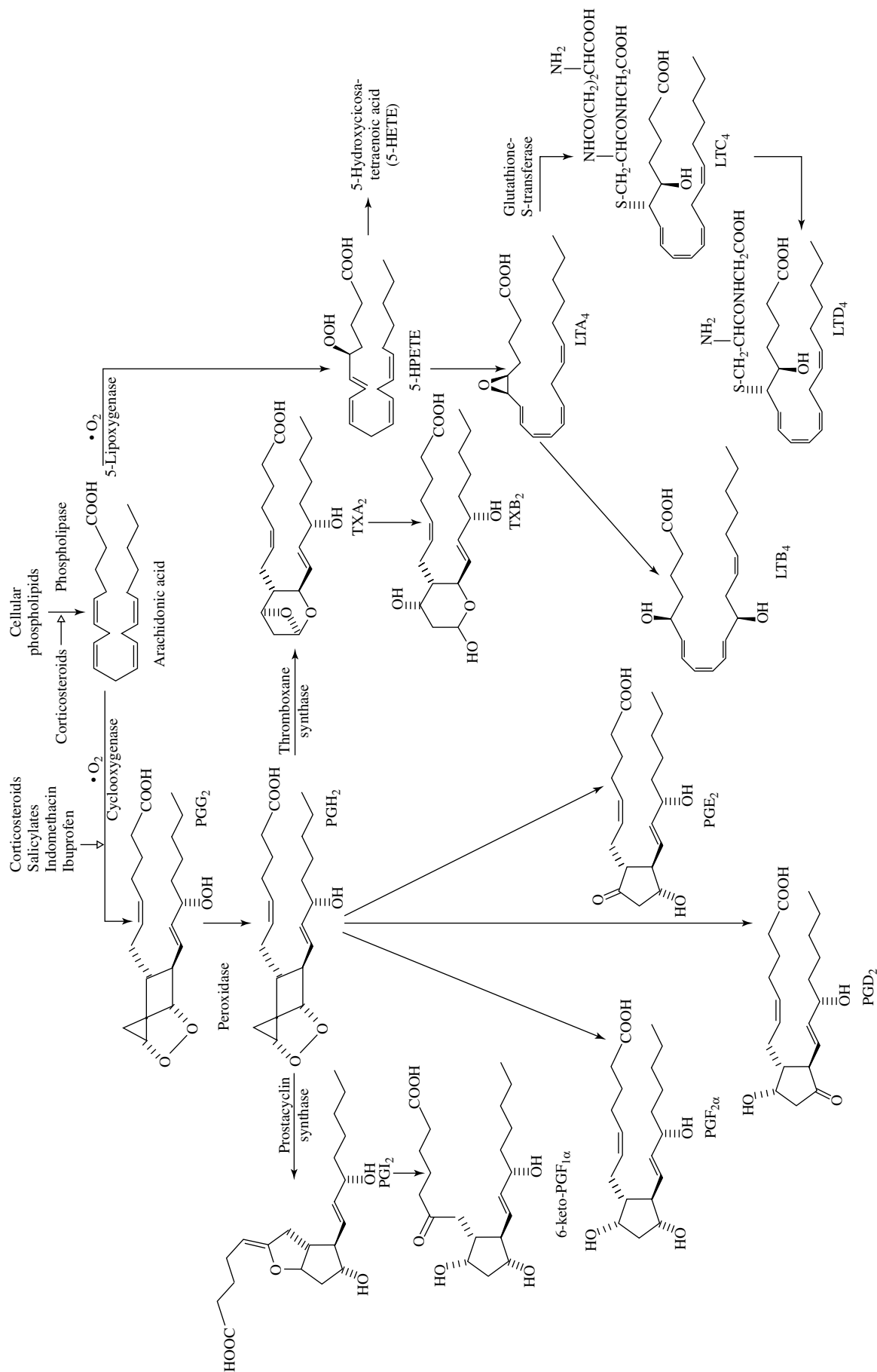

FIGURE 21-2 Pathways of arachidonic acid metabolism to prostaglandins (PGs) and related compounds and to leukotrienes (LTs). The cyclooxygenase pathway leads to the formation of the cyclic endoperoxides PGG₂ and PGH₂ and subsequently to prostacyclin (PGI₂), thromboxane (TX), or the stable PGs (E₂, F_{2α}, and D₂). The lipoxygenase pathway yields 5-hydroperoxyeicosatetraenoic acid (5-HPETE) and subsequently leukotrienes A₄, B₄, C₄, and D₄. The open arrows indicate the metabolic steps that are inhibited by corticosteroids or nonsteroidal anti-inflammatory drugs such as aspirin and ibuprofen. Not shown are LTE₄ and LTF₄ and other lipoxygenase pathways.

to PGH_2 by peroxidation, which is an additional function of COX. Unstable and potentially tissue-toxic oxygen radicals can be liberated by this process. From this point, PGH_2 is converted to the stable PGs E_2 and $\text{F}_{2\alpha}$, thromboxanes, or prostacyclin (PGI_2) by appropriate enzymes.

It is now well established that COX exists in two isoforms. Both are 72-kDa proteins but differ in terms of their sequence homology (approximately 60%) and their genomic regulation.^{47,149,150} COX-1 is regarded as the constitutive or housekeeping isoform and is the major isoform found in healthy tissues. It is always present in a number of tissues, including the central nervous system (CNS), gastric mucosa, platelets, and kidneys.³⁶ In the gastric mucosa, COX-1 plays a major role in the synthesis of PGs involved in the formation of the mucous protective barrier (so-called cytoprotection) against stomach acid. In platelets, COX-1 is the key enzyme involved in thromboxane production and its subsequent platelet aggregatory properties necessary for proper hemostasis.

COX-2 is, for the most part, an inducible isoform upregulated by such products as cytokines, growth factors, and mitogens in human monocytes, macrophages, endothelial cells, chondrocytes, synoviocytes, and osteoblasts.³⁶ It is associated with elevated concentrations of PGs during inflammation, pain, and fever. Figure 21-3 illustrates some of the physiologic roles of the COX isoforms. Although initially it was hoped the COX-2 products participated only in inflammatory and other pathologic processes, it is now known that oxidation products of the COX-2 isoform help regulate some normal physiologic processes, including the maintenance of adequate water and Na^+ excretion by the kidneys, the inhibition of excessive platelet aggregation, and dilation of certain vascular beds.⁷⁷

PGs and the other active metabolites of the intermediate endoperoxides (e.g., PGI_2 and thromboxane A_2 [TXA_2]) exert a multitude of effects in almost every biologic process examined so far. These processes include smooth muscle contraction and relaxation, vascular permeability, renal electrolyte and water transport, gastrointestinal (GI) and pancreatic secretion, various CNS and autonomic nervous system functions, release of hormones (e.g., growth hormone, steroids,

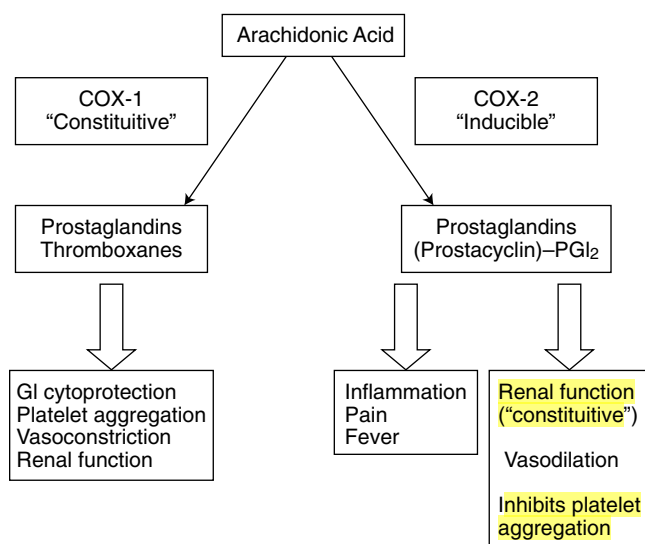

FIGURE 21-3 Some physiologic roles of the cyclooxygenase (COX) isoforms. Renal, vascular, and platelet functions are influenced by both COX isoforms. GI, Gastrointestinal. (From Hersh EV, Lally ET, Moore PA: Update on cyclooxygenase inhibitors: has a third COX isoform entered the fray? *Curr Med Res Opin* 21:1217-1226, 2005.)

and gonadotropins), luteolysis and parturition, lipolysis, bone resorption, and platelet aggregation. Not only are the affected processes diverse and the effects complex, but also the different PGs and related molecules sometimes seem to have antagonistic actions. PGE_2 and PGI_2 generally cause vasodilation and inhibit platelet aggregation, whereas TXA_2 causes vasoconstriction and induces platelet aggregation. The effects of $\text{PGF}_{2\alpha}$ on vascular tone depend on the vascular bed.

Qualitative and quantitative differences in response to the PGs exist among mammalian species, further complicating elucidation of the biologic roles of these substances. It is axiomatic that generalizations about the actions of PGs and related compounds are misleading; the response to a given agent must be considered in the context of the particular tissue involved, the assay system used, and the species of experimental animal.

There is abundant evidence that PGs and the intermediate endoperoxides are mediators of inflammation.^{42,107} Arachidonic acid and other fatty acid precursors of PGs present in the membrane phospholipid of cells can be released by hydrolase enzymes activated by direct cellular damage or by any nondestructive perturbation of the membrane, whether physical, chemical, hormonal, or neurohumoral. PG synthesis can ensue as shown in Figure 21-2. In acute inflammatory reactions, PGs appear in fluids and exudates later (2 to 12 hours after injury) than some other mediators, such as histamine and bradykinin. PGs are being formed at a time when tissue damage and disintegration are more prominent. It is possible that some of the PG content found in sites of inflammation is derived from infiltrating neutrophils and macrophages because these cells are capable of PG synthesis.¹

When released in tissue, PGs may contribute to the inflammatory response in multiple ways. The evidence that they do so can be summarized as follows⁴²: (1) PGs are found in experimentally or naturally produced inflammatory fluids; (2) neutrophils and macrophages produce PGs during phagocytosis; (3) PGI_2 and PGE_2 injected intradermally are potent inducers of vasodilation and of increased vascular permeability, an effect that is greatly augmented by the presence of histamine or 5-hydroxytryptamine and may last for several hours; (4) minute amounts of PGI_2 and PGE_2 injected intradermally markedly increase the pain sensitivity to other mediators, such as bradykinin and histamine; (5) PGE_2 is pyrogenic when injected into the cerebral ventricles or anterior hypothalamus, suggesting a mediator function; (6) a severe disabling arthritis is produced in animals by injecting PGs into the knee joint, and rheumatoid synovial cells produce PGs in culture; and (7) certain anti-inflammatory drugs that are potent inhibitors of PG synthesis reduce experimentally produced inflammation.

Although PGs stimulate certain inflammatory events, they inhibit or modulate others. The fact that PGs inhibit the proliferation and release of certain inflammatory mediators from neutrophils and activated lymphocytes and the fact that some effects of PGE_2 are opposed by $\text{PGF}_{2\alpha}$ provide evidence of a modulating function.

The precise roles of PGs in the inflammatory process are far from established, but these unique compounds clearly have the potential to act as mediators, modulators, or both. If both functions are involved, PGs could occupy a central regulatory position. A balance between enhancement and suppression of inflammatory events could be achieved by local regulation of PG metabolism because in some systems PGs have been shown to be either stimulatory or inhibitory depending on their concentration. Altering the relative concentrations of PGE_2 and $\text{PGF}_{2\alpha}$ could provide an additional means of balance because different PGs have diverse and occasionally antagonistic actions in the same system (e.g., PGE_2 causes bronchodilation, whereas $\text{PGF}_{2\alpha}$ causes broncho-

constriction; PGI₂ inhibits platelet aggregations, whereas TXA₂ stimulates platelet aggregation).

Leukotrienes

The term *slow-reacting substance* (SRS) was first applied to a lipid-soluble material produced by treatment of lung tissue with cobra venom. This material was characterized by its production of a slow, prolonged contraction of a smooth muscle preparation in contrast to the rapid and transient action of histamine. A chemically and biologically similar material was subsequently found in the lungs of sensitized guinea pigs challenged with specific antigen *in vitro*.¹⁵³ This material was designated as the *SRS of anaphylaxis* (SRS-A) to distinguish it from SRS produced by nonimmunologic mechanisms. Studies of the biologic properties of SRS-A indicated that it might be an important mediator of anaphylactic and other immediate allergic reactions. SRS-A can be found in most tissues, especially in the lung, after appropriate antigenic challenge. It is released along with histamine and other active products from mast cells.

Although SRS-A was known for some time to be an acidic, sulfur-containing lipid of low molecular weight, elucidation of its exact structure and biosynthesis was delayed until intensive study of the metabolism of arachidonic acid showed that SRS-A belonged to a class of compounds known as *leukotrienes*.^{103,132} Leukotrienes are formed by the conversion of arachidonic acid to noncyclic, 20-carbon carboxylic acids with one or two oxygen substitutes and three conjugated double bonds (see Figure 21-2). The critical step in the biosynthetic pathway is generation of a 5,6-epoxide of arachidonic acid (leukotriene A₄) by the combined actions of 5-lipoxygenase and leukotriene A synthase. Leukotriene A₄ may be converted to leukotriene B₄ by a hydrolase enzyme or, alternatively, to leukotriene C₄ by the addition of glutathione. Removal of glutamate from leukotriene C₄ generates leukotriene D₄.

These lipid-peptide derivatives apparently account for all the biologic activity of SRSs found in immediate allergic reactions. Leukotrienes C₄ and D₄ constitute SRS-A. Asthmatic reactions may also involve other leukotrienes, however. The ability of cells to produce leukotrienes seems to be limited to the lung, leukocytes, blood vessels, and epicardium. In contrast, all cells except erythrocytes can convert arachidonic acid to PGs and related compounds by the action of COX.

Leukotrienes C₄ and D₄ are potent *in vivo* and *in vitro* constrictors of bronchial smooth muscle in the guinea pig. Both compounds have similar effects in human bronchial muscle preparations, in which they are approximately 1000 times more potent than histamine. Because these leukotrienes also increase vascular permeability, it seems likely that either one or both play a role in the bronchial constriction and mucosal edema of asthma. Leukotriene B₄ can enhance chemotactic and chemokinetic responses in human neutrophils, monocytes, and eosinophils.⁶⁰ These findings suggest that leukotrienes may be involved in localized inflammatory processes and in asthma. Drugs that block leukotriene receptors or inhibit leukotriene synthesis by blocking the enzyme lipoxygenase are used in the treatment of asthma (see Chapter 32).

Lysosomal products

The lysosomes of neutrophils contain various enzymatic and nonenzymatic factors that play important roles in the manifestations and sequelae of inflammatory reactions (Box 21-1). During phagocytosis of bacteria or foreign material by neutrophils, the contents of lysosomes are released into the extracellular environment. They are also released on lysis of the cell. Cationic proteins from lysosomes contribute to the inflammatory process by triggering mast cell degranulation, which leads to increased vascular permeability. Other lyso-

BOX 21-1

Factors in the Neutrophil with Inflammatory Potential

Tissue-damaging enzymes	Elastase Cathepsins B and G Collagenase Other proteases
Microbicidal enzymes	Myeloperoxidase Lysozyme
Permeability factors	Leukotrienes PAF Leukokinin-forming enzyme
Leukotactic factors	Basic peptides Leukotrienes PAF C5-cleaving enzyme Basic peptides (chemotactic for monocytes)

PAF, Platelet-activating factor.

somal enzymes may contribute to the inflammatory response in several ways. Several of these enzymes have the potential to damage host tissues. Collagen, elastin, mucopolysaccharides, basement membrane, and other structural elements may be degraded. Lysosomal proteases cause the production of kinin-like substances from plasma kininogen and can generate chemotactic factors for neutrophils from complement, as described in a later section. Leukotrienes and PAF are also released by neutrophils. Neutrophils may play a central role in perpetuating the inflammatory response by their dual ability to cause tissue damage and to elaborate specific mediators of inflammation. Another source of lysosomal factors, especially in chronic inflammatory lesions, may be the mononuclear phagocyte, or macrophage, the lysosomes of which contain substances similar to those of the neutrophil.¹ These substances are released into the extracellular environment on activation of macrophages by various soluble factors, such as leukotriene B₄, C5a complement factor, and PAF, and during the process of phagocytosis of bacteria or other particulate matter.

Lymphocyte products

Delayed allergic reactions may be involved in some inflammatory processes, especially chronic processes in which there is a persistent antigenic stimulus (e.g., in tuberculosis). These reactions are mediated by factors called *cytokines* (*lymphokines* if derived from lymphocytes), which are produced by sensitized thymus-dependent lymphocytes, or T cells, after specific antigenic challenge. Although many putative cytokines have been described, their role in inflammatory reactions with an immune component is not firmly established. Some of the better studied cytokines that may function in inflammation-related events are (1) interleukins that stimulate the function of T cells and bursa-dependent lymphocytes (B cells); (2) monocyte chemoattractive protein-1, which promotes accumulation of monocytes; (3) granulocyte/macrophage colony-stimulating factor; (4) other chemotactic factors that are specific attractants for neutrophils, macrophages, basophils, and eosinophils; (5) interferon- α , which has antiviral and macrophage activation properties; and (6) skin reactive factor, which mimics a delayed allergic reaction when injected into normal skin (i.e., it causes increased vascular permeability and migration of mononuclear cells).

Macrophage products

Similar to lymphocytes, macrophages apparently have little involvement in acute inflammatory responses, but they play a very prominent role in chronic inflammation and are crucial in the immune response. In addition to their phagocytic activity, macrophages have a major secretory function in established inflammatory lesions. Secretory products include the constituents of lysosomes (see earlier), reactive metabolites of oxygen, interferon- α , interleukin-1 (IL-1), and TNF- α . The latter two substances are crucial mediators of the complex interplay between macrophages and lymphocytes, which largely determines the course and eventual outcome of an inflammatory process. IL-1 is produced by macrophages exposed to bacterial, viral, and fungal products; antigens; or macrophage activation factor. It may have several roles, but chief among these seems to be the stimulation of differentiation of a pre-T-lymphocyte population to T cells capable of responding to an antigen processed and presented by macrophages.

Another mediator of inflammation produced by macrophages and other cells is PAF. PAF is a closely related family of substances derived from phosphatidylcholine generated in the metabolism of arachidonic acid. It is also synthesized in other cells, including mast cells and eosinophils. Platelets also contain PAF. PAF initiates various actions, including platelet activation, vasodilation, vascular permeability, neutrophil chemotaxis, and discharge of lysosomal enzymes. It also contributes to allergic and inflammatory responses.

Mast cell products

Mast cells release numerous inflammatory mediators in addition to histamine, including cytokines (e.g., TNF- α), leukotrienes, PGD₂, and PAF. Mast cells can become activated by IgE antibodies that bind to the plasma membrane and sensitize the mast cell to specific allergens. Several allergic reactions, including allergic asthma, involve this mechanism. Basophils have many of the same characteristics as mast cells.

Eosinophil products

Eosinophils release many enzymes and toxins that can lead to tissue destruction. Major basic protein is a toxic substance that can cause tissue damage and destruction of parasites. Eosinophils also release leukotrienes and PAF.

Plasma Mediators

Kinins

The term *kinins* refers primarily to two small peptides that are similar in structure and actions: bradykinin and lysyl-bradykinin (or kallidin). Bradykinin can be considered the prototype. It is a linear nonapeptide with a molecular weight of 1060 Da. As with the release of histamine, almost any process causing tissue injury can trigger the series of events leading to the production of bradykinin. Bradykinin exists in plasma as an inactive precursor (kininogen) and is released in a cascade of reactions beginning with activation of Hageman factor (clotting factor XII). Hageman factor can be activated by exposure to numerous substances, including cartilage, collagen, basement membrane, sodium urate crystals, proteolytic enzymes, and bacterial lipopolysaccharides. Hageman factor activates an enzyme called *prekallikrein* to yield kallikrein. Kallikrein cleaves bradykinin from kininogen, an α_2 -globulin precursor. (In addition, activated Hageman factor triggers the clotting cascade by activating factor XI and the fibrinolytic system by activating plasminogen proactivator, ultimately yielding plasmin.) Kinins may also be produced extravascularly from tissue kininogen. After release, bradykinin is rapidly metabolized by enzymes present in plasma and tissues.

Bradykinin has striking pharmacologic effects in humans and animals. It is a potent but transient vasodilator of arteries and veins by a direct action on smooth muscle. Intradermal

injection of bradykinin causes marked increases in vascular permeability; in this regard, it is more potent than histamine on a molar basis. Bradykinin applied to a blister base or injected intradermally or intra-arterially in humans evokes sharp pain. Experimental pain can also be produced by a bradykinin-like substance isolated from human blister fluid and from synovial fluid obtained from acutely inflamed joints. In extraction sockets, local concentrations of immunoreactive bradykinin and PGs increase in patients after the removal of impacted third molar teeth.^{129,159} All these phenomena implicate bradykinin in various aspects of acute inflammatory reactions, including acute pain.

Complement system

The complement system plays an important role in the inflammatory process. In humans, this system consists of at least 20 component proteins that react in a fixed sequence (Figure 21-4). An immune complex on a cell surface activates the first component, C1, and a cascade of events results in the formation of a complex that leads to membrane damage and cell lysis.

This so-called classic pathway of complement activation can be initiated by most antigen-antibody complexes and by nonimmune factors such as trypsin and plasmin. Other substances, such as complex polysaccharides, aggregated IgA, and

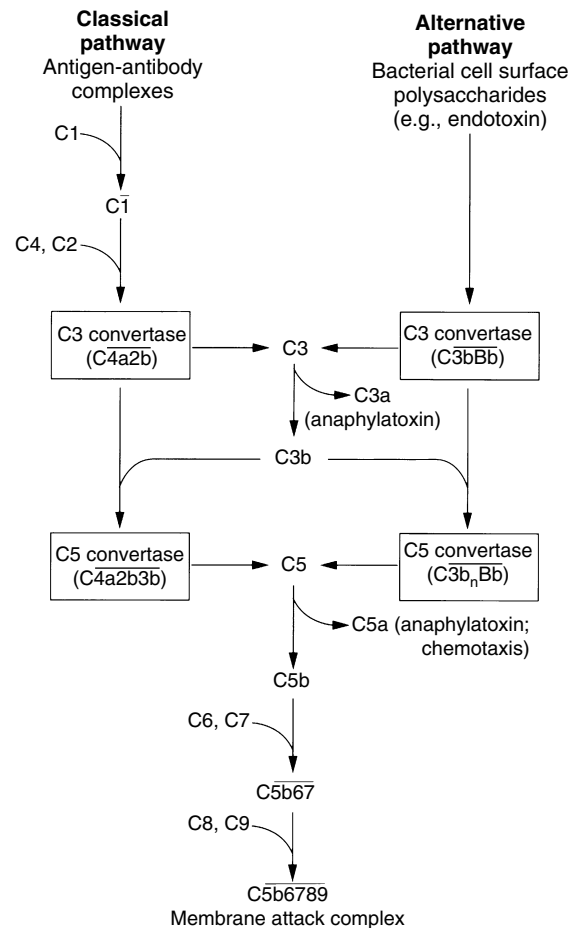

FIGURE 21-4 Complement cascade. The classic and alternative pathways of complement activation are shown. Activated components are designated by a horizontal bar above the component number (e.g., $\overline{C5b67}$). The steps by which bacterial polysaccharides interact with several plasma proteins (B, D, and properdin) to generate the C3 convertase of the alternative pathway, C3bBb, are not shown.

bacterial endotoxin, may trigger an alternative pathway in which the first component to be activated is C3, followed by the usual components in the activation scheme.

In addition to the above-mentioned direct cellular damage, certain fragments produced during the cascade of complement activation have important biologic properties. Two of them (C3a and C5a) cause increased vascular permeability by inducing the release of histamine from mast cells. These substances are referred to as *anaphylatoxins* and have been implicated in anaphylaxis and other allergic reactions. The C5a anaphylatoxin is also a potent chemotactic factor. Neutrophils, monocytes, and eosinophils exhibit directed locomotion in response to it. Enhancement of phagocytosis and release of lysosomal enzymes have been attributed to other components of the activation scheme.

Complement fragments can be produced by mechanisms extrinsic to the complement system (e.g., by plasmin, trypsin, and bacterial proteases). This action suggests that complement fragments may participate in tissue injury and in the subsequent inflammatory response without classic or alternative complement activation.

Nitric oxide

The small gaseous molecule nitric oxide (NO) apparently plays a regulatory and a proinflammatory role in various inflammatory conditions, including arthritis, asthma, and inflammatory bowel disease.^{38,95,127} In mammalian cells (similar to COX), two isoforms of the NO-producing enzyme nitric oxide synthetase are constitutively expressed, and a third inducible isoform, inducible nitric oxide synthetase (iNOS), is upregulated in response to bacterial products and proinflammatory cytokines.^{92,94} Compounds that inhibit iNOS expression or activity possess anti-inflammatory properties.^{94,133} Currently approved drugs that target the nitric oxide system, such as nitroglycerin to treat angina (see Chapter 26) and the male erectile dysfunction drug sildenafil (Viagra) (see Chapter 28), increase NO levels; specific iNOS inhibitors are being developed to treat various inflammatory disorders.

NONSTEROIDAL ANTI-INFLAMMATORY DRUGS

NSAIDs include some of the most frequently taken medications. Because these agents share a common mechanism of action, they exert qualitatively similar therapeutic and toxic effects. For the treatment of pain and inflammation that accompany various dental surgical procedures, the short-term use (typically ≤ 1 week) of NSAIDs has generally proved to be highly efficacious and safe. Compared with opioid-combination drugs (described later in this chapter), NSAIDs lack various undesirable CNS depressant effects that contribute to the high incidence of drowsiness, dizziness, and nausea commonly seen with opioid-containing agents. This favorable efficacy and safety profile has led the U.S. Food and Drug Administration (FDA) to approve three NSAIDs (ibuprofen, naproxen sodium, and ketoprofen) in addition to aspirin for over-the-counter (OTC) use. Use of these drugs under OTC package insert guidelines mandates no more than 10 days of consecutive dosing for pain and only 3 days for fever, plus absolute maxima on single and daily doses that are lower than the prescription use of these drugs.⁸¹

When treating chronic inflammatory conditions such as rheumatoid arthritis, the duration of NSAID therapy is typically measured in months or years, and the daily doses required to control the arthritic symptoms are often twofold to threefold higher than doses required to control acute pain. This type of therapy leads to a greatly increased incidence of minor and major side effects, requiring more vigilant monitoring of these patients.

The development of NSAIDs that are highly selective COX-2 inhibitors seemed to offer a safety advantage regarding some of the more serious adverse effects seen with long-term NSAID therapy, specifically GI ulcers, perforations, and bleeds.^{16,143} More recent studies showing increased cardiovascular risk with long-term use of these agents compared with placebo in colon polyp prevention trials^{19,151} and increased cardiovascular risk with 10 days of dosing in the treatment of patients with pain after coronary artery bypass graft (CABG) surgery¹¹⁹ have led to the removal of several of these drugs from the worldwide marketplace.

Salicylates

The salicylates are among the oldest known drugs. Hippocrates recommended the consumption of the juices of the poplar and willow bark some 2400 years ago, which later were discovered to contain salicin (a glycoside of salicylic alcohol), for the treatment of the pain of childbirth. In 60 AD, Dioscorides reported that a boiled extract of willow bark could be used to treat various maladies, including corns, gout, and earache. In a report to the Royal Society in London in 1763, the Reverend Edward Stone made one of the earliest references to the antipyretic effect of willow bark extracts. The active principle of willow and poplar preparations, salicylic acid, was first extracted in 1835 from natural sources and later prepared by chemical synthesis. Kolbe was credited with the first full-scale commercial synthesis of salicylic acid and its derivative sodium salicylate. In 1853, Charles Frederich von Gerhardt was the first to synthesize aspirin (acetylsalicylic acid) by treating sodium salicylate with acetyl chloride. Despite the untoward GI effects of large doses of salicylic acid and sodium salicylate, the development of salicylates culminated in the introduction of aspirin into medicine in 1899 by Heinrich Dresser of the Bayer Company of Germany. The popularity of aspirin was immediate, and today it remains one of the most consumed drugs in the world.

Several additional salicylates have also been marketed. Choline salicylate, magnesium salicylate, and their combination product are ion complexes of salicylate. Salsalate is an ester composed of two salicylate molecules, which are freed as the molecule is hydrolyzed. These salicylate formulations are said to have fewer GI side effects than aspirin. Because released salicylate is the active moiety of all these drugs, however, the rest of their pharmacology is quite similar to aspirin. The structure of aspirin and some of the related salicylates is shown in Figure 21-5. Aspirin may be considered a prototype of the NSAIDs and is the standard of reference against which these agents are compared and evaluated.

Mechanism of action

The efficacy of salicylates and all related NSAIDs as analgesic, anti-inflammatory, and antipyretic agents results from their ability to inhibit COX activity, preventing the synthesis and release of COX products, most prominently the PGs. All salicylates and almost all the currently available NSAIDs, with the exception of the highly selective COX-2 inhibitors, inhibit COX-1 and COX-2. Most of these nonselective COX-inhibiting NSAIDs, including aspirin, are more potent or at least equipotent inhibitors of COX-1,^{128,169} which accounts for some of the more important adverse effects of these drugs. Figure 21-6 shows the relative COX-2 versus COX-1 selectivity of some representative NSAIDs. As shown in this figure, aspirin is an approximately 100-fold more selective inhibitor of COX-1 than COX-2. The published COX selectivities of individual drugs vary with the assay system being used.

Aspirin uniquely inactivates COX by irreversibly acetylating the enzyme. Acetylation occurs on serine 530 of COX-1.¹⁰⁵ A comparable serine on COX-2, serine 516, is also acetylated by aspirin. The later modification not only inhibits

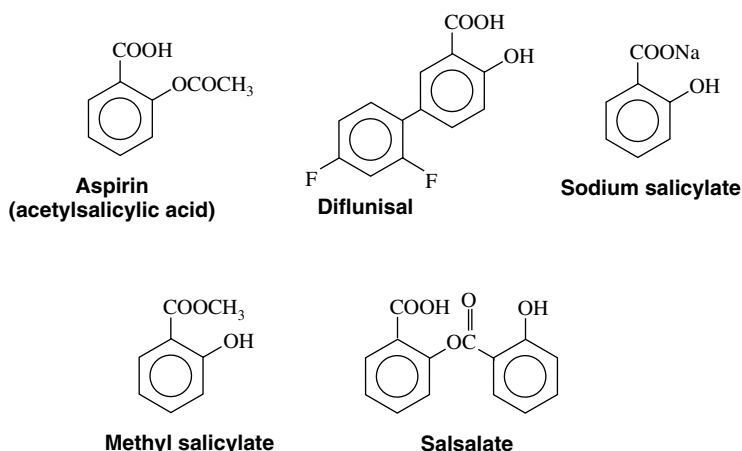

FIGURE 21-5 Structural formulas of aspirin and other salicylates.

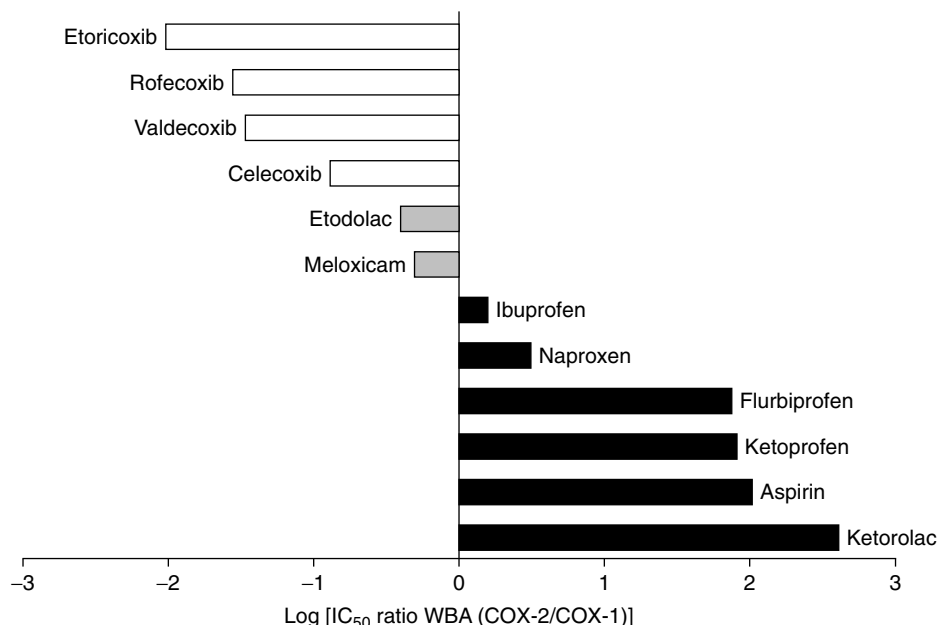

FIGURE 21-6 The ratio of the log of inhibitory concentrations (IC_{50}) of various nonsteroidal anti-inflammatory drugs needed to block 50% of COX-2 activity versus 50% of COX-1 activity in the whole blood assay (WBA). The zero line indicates equipotency. Bars on the right represent drugs with greater selectivity for COX-1, whereas bars on the left represent drugs with greater selectivity for COX-2. (Adapted from Riendau D, Percival MD, Brideau C, et al: Etoricoxib [MK-0663]: preclinical profile and comparison with other agents that selectively inhibit cyclooxygenase-2, *J Pharmacol Exp Ther* 296:558-566, 2001; Warner TD, Guiliano F, Vojnovic I, et al: Nonsteroid drug selectivities for cyclo-oxygenase-1 rather than cyclo-oxygenase-2 are associated with human gastrointestinal toxicity: a full in vitro analysis, *Proc Natl Acad Sci U S A* 96:7563-7568, 1999.)

PG production during inflammation, but also enables COX-2 to produce 15-hydroxyeicosatetraenoic acid.^{98,123} This metabolite may be associated with certain adverse effects. Other salicylates and NSAIDs do not acetylate COX but are reversible competitive inhibitors of the enzyme. Because PGs are not stored, but rather are synthesized immediately before release, the reduction of PG concentrations by NSAIDs can be observed quickly.

The potency of the salicylates as inhibitors of PG synthesis in vitro correlates well with their ability to alleviate carrageenin-induced inflammation in animals (Table 21-2). In humans, anti-inflammatory doses of aspirin (3 g daily), sodium salicylate (3 g daily), or indomethacin (100 mg daily) reduce the output of PG metabolites in the urine by more than 75%, indicating a close correlation of the inhibition of COX with

anti-inflammatory effects.⁷¹ Although inhibition by COX is the major mechanism of action of the NSAIDs, participation in other anti-inflammatory mechanisms may occur and account for some of the variation in clinical response seen with these drugs. Salicylates may inhibit cell migration and some functions of neutrophils. A reduced production of rheumatoid factor may also occur by stimulation of suppressor T-cell activity. Other mechanisms contributing to anti-inflammatory effects include reduced capillary permeability, reduced antibody production, and alterations in connective tissue synthesis. The relative potencies against COX-1 and COX-2 also account for important differences among various NSAIDs.

Inhibition of PG synthesis at the site of injury or inflammation can explain at least some of the analgesic effect of

TABLE 21-2

Anti-inflammatory and Cyclooxygenase Inhibitory Activity of Some NSAIDs Compared with Acetaminophen

DRUG	INHIBITION OF PROSTAGLANDIN SYNTHESIS (IC_{50} , μ M)	REDUCTION OF CARRAGEENIN-INDUCED RAT PAW EDEMA (ED_{50} , mol/kg)	PEAK PLASMA CONCENTRATION (μ mol/L)	PLASMA-PROTEIN BINDING (%)
Indomethacin	0.17	0.017	5	90
Phenylbutazone	7.25	0.325	230-500	98
Aspirin	37	0.833	280-300	50-80
Acetaminophen	660	Inactive	350	25

Adapted from Arrigoni-Martelli E: *Inflammation and antiinflammatories*, New York, 1977, Spectrum Publications.
 ED_{50} , Median effective dose; IC_{50} , median inhibitory concentration.

aspirin. Although PGs themselves do not seem to cause pain when injected locally, PGE_2 and $PGF_{2\alpha}$ do sensitize pain receptors to other mediators such as histamine and bradykinin. In this connection, aspirin and related drugs can prevent the writhing response elicited by bradykinin but not that produced by PGs. This finding is explained by the fact that the salicylates and all other NSAIDs inhibit the synthesis of PGs induced by bradykinin but not the binding of PGs to their receptors. Animal experiments have revealed that NSAIDs also have central analgesic actions, which may involve the inhibition of COX or other unknown mechanisms at the level of the spinal dorsal horn or at higher levels of the CNS.^{106,110} The antipyretic effect of aspirin and similar drugs is also mediated by the reduction of PGE_2 synthesis as a result of inhibition of COX.

General therapeutic effects

Aspirin has clinically useful analgesic, antipyretic, anti-inflammatory, and antiplatelet effects. The analgesic effect sought and attained with aspirin is probably caused in many cases by its anti-inflammatory actions, a fact not usually appreciated by its users. In addition to their widespread use for the symptomatic relief of acute pain and fever, salicylates (most commonly aspirin) are important drugs in the treatment of numerous chronic inflammatory diseases. Some of the major therapeutic uses of aspirin are considered next.

Acute pain. It is difficult to separate the analgesic and anti-inflammatory effects of NSAIDs because most painful conditions have an inflammatory component. There is little doubt that the cascade of reactions leading to the formation of PGs is integrally involved with the inflammatory response and that aspirin's efficacy in treating inflammation and pain is closely related to its inhibition of PG synthesis. By using microdialysis techniques, it has been shown that after dental surgery the analgesic effects of NSAIDs correlate with a local reduction in PG synthesis.^{121,129} Nevertheless, several observations suggest that the analgesic and anti-inflammatory effects of NSAIDs may occur by different mechanisms. First, there is a different time course for the onset of analgesic and anti-inflammatory effects. Clinically significant analgesia usually occurs within 1 hour of drug administration, whereas anti-inflammatory effects sometimes take several days or weeks to reach maximum levels because chronic inflammatory processes may be occurring that cannot be quickly reversed by inhibiting PG production. Also, the maximal human analgesic effect usually occurs at lower doses than the antirheumatic and other anti-inflammatory effects.

Aspirin is an effective analgesic for almost any type of acute dental pain. Double-blind, controlled studies of the relief of pain after the surgical extraction of third molars have shown that 650 mg of aspirin is substantially more effective

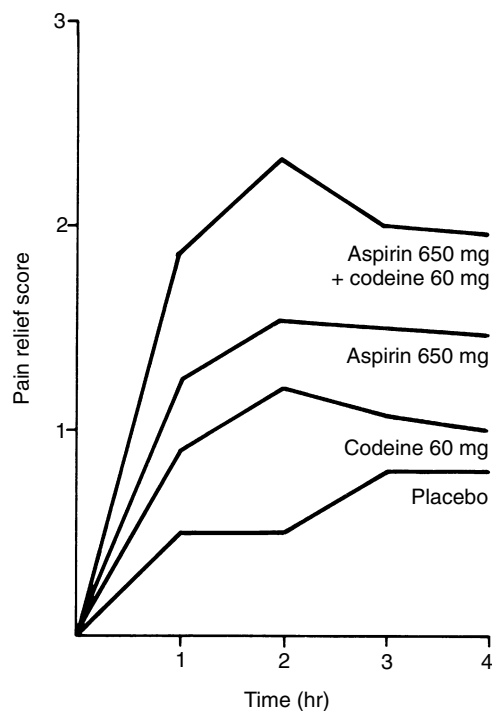

FIGURE 21-7 Time-effect curves for placebo, aspirin, codeine, and an aspirin-codeine combination. The mean pain relief scores are plotted against time in hours. (Adapted from Cooper SA, Engel L, Ladov M, et al: Analgesic efficacy of an ibuprofen-codeine combination, *Pharmacotherapy* 2:162-167, 1982.)

than 60 mg of codeine in relieving postoperative pain (Figure 21-7).³¹ Most controlled clinical studies have established that, regardless of the cause of the pain, aspirin (650 mg) provides equal or greater pain relief than codeine in standard doses (60 mg).¹² Aspirin and other NSAIDs and acetaminophen have what is known as a ceiling or plateau effect in the treatment of acute pain. In other words, there is a dose-response for pain relief up to 650 to 1000 mg of aspirin, but increasing the dose beyond these amounts does not enhance the analgesic effect further and does increase the likelihood for toxic effects.

Rheumatic fever. One of the early uses of salicylates was in the treatment of rheumatic fever. Aspirin markedly reduces the acute inflammatory components of the disease, such as fever, joint pain, swelling, and immobility. Salicylates do not affect other aspects of the disease, however, such as the proliferative reaction in the myocardium leading to scarring, and they do not alter the progression of the disease.

Although anti-inflammatory drugs, including corticosteroids (see Chapter 35), may be used to reduce inflammation, antibiotic therapy is the major therapeutic strategy.

Rheumatoid arthritis. Rheumatoid arthritis is a chronic systemic disease of unknown origin. Several tissues and organs may be involved, but in most patients the chief clinical and pathologic features result from **chronic inflammation of synovial membranes**. Irreversible joint injury (subluxation, loss of motion, or ankylosis) results from formation of chronic granulation tissue that causes erosions of articular cartilage, subchondral bone, ligaments, and tendons. Extra-articular manifestations, such as subcutaneous or subperiosteal nodules of granulation tissue, peripheral neuropathy, and chronic skin ulcers, occur to a variable extent and seem to result from generalized focal vasculitis. Patients with rheumatoid arthritis are at increased risk of developing cardiovascular disease, including myocardial infarction (MI).¹⁶⁸

The cause of the inflammatory response in rheumatoid arthritis is obscure, but the inflammatory events result largely from an autoimmune reaction. Rheumatoid arthritis is considered an autoimmune disease with many contributing factors. Lymphocytes that have become activated produce TNF- α and IL-1. These cytokines lead to the release of other inflammatory mediators, such as the PGs. Anti-immunoglobulins, referred to as the **rheumatoid factor and found in rheumatoid synovial fluid**, can form complexes with IgG. These complexes may activate complement, which triggers a number of inflammatory phenomena in the joint tissues, including histamine release, production of factors chemotactic for neutrophils and mononuclear cells, cell membrane damage, and PG synthesis. The antigen-antibody complexes also activate antigen-presenting cells, which stimulate T cells, leading to the further release of cytokines. Neutrophils and macrophages accumulate in the synovial fluid and are found to contain aggregated IgG, rheumatoid factor, complement fragments, and fibrin; these substances are apparently acquired by phagocytosis. Lysosomal materials are released that amplify the inflammatory reaction and may directly damage tissues. Cytokines produced by the lymphocytic cell infiltrate may also help propagate the reaction and participate in tissue destruction.

Salicylates (usually as aspirin) are still widely used in the clinical management of rheumatoid arthritis. The pain and inflammation of rheumatoid arthritis can often be controlled with salicylates alone (or with another NSAID).¹⁵² Salicylates produce a measurable reduction of inflammation in the joints and associated tissues, a lessening of symptoms, and improved mobility. Salicylates may also reduce neutrophil activity in addition to inhibiting PG synthesis. Clinical observation suggests that salicylate therapy can diminish or delay the development of crippling associated with the disease. This benefit is not a direct effect of the drug on the progression of the disease, but relates more to reduction of pain and subsequent facilitation of mobility. In addition to salicylates, the basic therapeutic regimen in rheumatoid arthritis includes rest, physical measures (primarily heat), and exercise.

When salicylate therapy is ineffective or is not well tolerated, other drugs, such as the NSAIDs ibuprofen and naproxen, or corticosteroids, can be used. Salicylates and related NSAIDs do not slow or arrest the joint destruction and extra-articular manifestations characteristic of the disease. For disease progression to be affected, DMARDs, which include gold compounds, sulfasalazine, penicillamine, antimalarials, methotrexate, azathioprine, cyclosporine, leflunomide, and TNF- α inhibitors, must be used.

In rheumatoid arthritis, salicylates are given in doses sufficient to control the symptoms, often 3 to 6 g/day. The degree of suppression of inflammation increases with the plasma salicylate concentration even beyond the point of tox-

icity. Patients with severe arthritis tolerate tinnitus and other mild toxic manifestations to obtain the anti-inflammatory effects gained by high plasma titers of salicylate. A regular dose interval to maintain constant effective blood concentrations is important. Evaluation of drug therapy in rheumatoid patients may be complicated by the spontaneous remissions and exacerbations characteristic of this disease.

Other inflammatory diseases. Aspirin is a commonly used anti-inflammatory agent in other inflammatory diseases, including juvenile rheumatoid arthritis, ankylosing spondylitis, psoriatic arthritis, Reiter's syndrome, and degenerative joint disease (osteoarthritis). The arthralgia and fever of mild lupus erythematosus may be alleviated by aspirin. Acute episodes of inflammation in isolated joints, tendons, or bursa caused by trauma are also best treated with aspirin given in full doses immediately after the injury.

Fever. Fever is typically a symptom of a disease process, usually a viral or bacterial infection brought about by exogenous (microbial products) and endogenous pyrogens.^{40,156} It is believed that exogenous pyrogens stimulate host cells to produce endogenous pyrogens, of which IL-1 has been the best characterized.^{51,156} IL-1 is thought to act on the anterior hypothalamus, generating the local release of PGs.^{51,155} Injection of PGs into the brain of various animal species is known to increase body temperature.⁵³ The PGs and possibly other non-PG endogenous pyrogens elevate the thermal set-point of the body so that it retains the ability to regulate closely its temperature, but at a higher temperature than normal.^{40,156}

By inhibiting the synthesis of PGs in the hypothalamus, aspirin, other NSAIDs, and acetaminophen are thought to reduce the thermal set-point toward normal. The decrease in body temperature also involves the ability of aspirin and other antipyretics to induce a vasodilation of superficial blood vessels. Because of its association with Reye's syndrome, aspirin is no longer recommended to treat most febrile episodes in children.

Prophylaxis against platelet aggregation. The correlation between the ability of aspirin-like compounds to inhibit simultaneously platelet aggregation and the production of PGs has been known for almost 40 years.¹⁴⁸ Aspirin inhibits the synthesis of TXA₂ by irreversible acetylation of the COX enzyme in platelets.^{73,130} Lacking a nucleus, platelets cannot generate new enzyme, and the ability of affected platelets to produce TXA₂ is permanently blunted during their 10-day lifetimes. Most platelet COX acetylation may occur presystemically as platelets pass through gut capillaries before the hydrolysis of aspirin to salicylate (a weak and reversible inhibitor of COX) in the gut and the liver.¹²⁵ This possibility may partially explain the relative lack of effect of low-dose aspirin on the antiaggregatory PGI₂ molecule produced by the systemic vascular endothelium.

The fact that endothelial cells, by possessing a nucleus, can generate new COX enzyme after aspirin administration may also contribute to the relatively selective and complete block of TXA₂ synthesis over PGI₂. This selective block of TXA₂ synthesis in platelets provides the rationale for using long-term low-dose aspirin therapy to prevent MI and occlusive stroke in at-risk patients. Other salicylates and NSAIDs are either much weaker or only reversibly inhibit COX in platelets and have limited therapeutically beneficial antiplatelet effects.

In 1998, the FDA published a set of indications for aspirin prophylaxis that include definitive dosing guidelines for each condition (Table 21-3).⁴⁴ Vascular indications include the reduction of death or nonfatal stroke in patients who have had ischemic strokes or transient ischemic attacks, reduction of vascular mortality in patients with acute MI, reduction of

TABLE 21-3

Antiplatelet Indications and Dosing Guidelines for Aspirin

INDICATIONS	RECOMMENDED DAILY DOSE	DURATION OF THERAPY
Vascular Indications		
Ischemic stroke and TIA	50-325 mg	Indefinitely
Suspected acute MI	160-162.5 mg taken as soon as MI is suspected, then once daily	For 30 days after MI (after 30 days, consider further treatment if previous MI)
Prevention of recurrent MI	75-325 mg	Indefinitely
Unstable angina pectoris	75-325 mg	Indefinitely
Chronic stable angina pectoris	75-325 mg	Indefinitely
Revascularization Procedures in Selected Patients		
CABG surgery	325 mg starting 6 hr after procedure	1 yr
PTCA	325 mg 2 hr before surgery; maintenance therapy 160-325 mg	Indefinitely
Carotid endarterectomy	80-650 mg twice daily started before surgery	Indefinitely

CABG, Coronary artery bypass graft; MI, myocardial infarction; PTCA, percutaneous transluminal coronary angioplasty; TIA, transient ischemic attack.

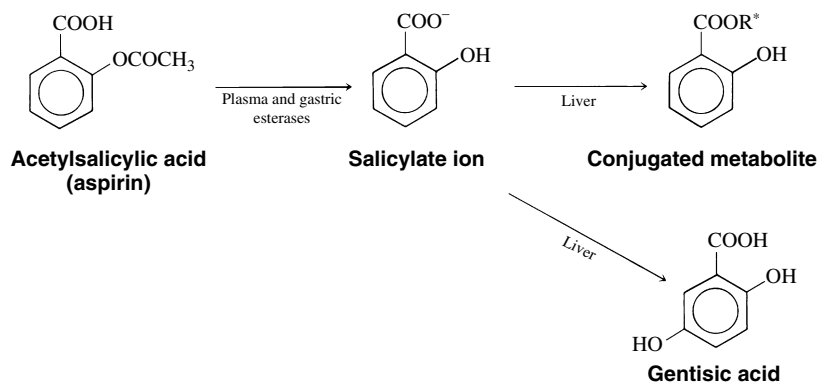

FIGURE 21-8 Metabolic fate of aspirin. R*, Glycine or glucuronate. (The phenolic glucuronide metabolite is not shown.) The glycine conjugate is called salicyluric acid.

combined risk of death and nonfatal MI in patients with previous MI or unstable angina, and reduction of the combined risk of MI and sudden death in patients with chronic stable angina. The recommended daily dose for all these indications is low (≤ 325 mg/day) compared with the analgesic and anti-inflammatory uses of the drug. Aspirin also is indicated for patients who have undergone revascularization procedures, including CABG surgery, percutaneous transluminal coronary angioplasty, and carotid endarterectomy, when there are pre-existing conditions for which aspirin is already indicated.

Absorption, fate, and excretion

When aspirin is taken orally, it is rapidly absorbed from the stomach and small intestine. Aspirin is a weak acid, with a pK_a of approximately 3.5, which favors its absorption in the stomach. Most absorption occurs in the small intestine, however, because of its much larger surface area. The rate-limiting steps in the absorption of aspirin are the disintegration and dissolution of the tablet. These two steps can be greatly influenced by the manufacturing process, which determines factors such as particle size and compression of the tablet. Buffering the tablet increases the rate of dissolution, but the fastest absorption is obtained when aspirin is dissolved in hot water before ingestion. Other factors, such as gastric emptying time, gastric contents, and level of autonomic activity of the patient, may also influence the rate of absorption.^{100,102}

Aspirin has a 15-minute half-life.¹²⁴ Because its acetylation of COX in the platelet is irreversible, however, the full extent of its antiplatelet action depends on the life span of

the platelet (8 days) and not on the short half-life of aspirin.^{4,124} It is quickly metabolized by gastric and plasma esterases to salicylate ion (Figure 21-8). Although some aspirin becomes bound to plasma proteins, 80% to 90% of the salicylate ion is bound for a short time, principally to albumin. Salicylate is distributed throughout most body fluids and tissues. It can be isolated from spinal, peritoneal, and synovial fluids; saliva; breast milk; and sweat. Salicylate freely crosses the placenta from mother to fetus.

The elimination half-life of sodium salicylate is 2 to 3 hours after a single analgesic dose. The liver is the main site of biotransformation, and conjugation is the primary route. Because the metabolism of salicylate is capacity limited, large repeated doses or single toxic ingestions result in plasma half-lives of 5 to 30 hours. When describing the duration of analgesic and anti-inflammatory action of aspirin, its ultimate dosing interval reflects the summed half-lives of the parent molecule and the active metabolite, salicylate. Salicylate, in contrast to the parent aspirin molecule, is only a reversible inhibitor of COX (most notably in the platelet), however. The three primary products of salicylate conjugation are salicyluric acid (the glycine conjugate), the ether or phenolic glucuronide, and the acyl or ester glucuronide. A small portion (<1%) is oxidized to gentisic acid (see Figure 21-8). Free salicylate and the salicylate metabolites are excreted by glomerular filtration and by active proximal tubular secretion in the kidney. In normal humans, approximately 10% of ingested salicylate appears unchanged in the urine; however, this fraction may decrease to 2% or increase to 30% with urinary acidosis or alkalosis. A higher percentage of free salicylate is excreted at

higher doses because the liver is unable to maintain the same percentage of metabolism at higher doses of salicylates.

Adverse effects

The severity of side effects that can accompany aspirin ingestion depends on the overall health of the patient, the length of dosing, and the total daily intake of drug. When used under OTC package insert guidelines (for ≤ 10 days and ≤ 4 g/day), most reported side effects are more annoying than serious, with dyspepsia and nausea occurring in 10% of patients. In addition, occult bleeding (hidden amounts of blood in the stool), which is usually less than 10 mL/day, develops in more than 70% of patients ingesting the drug. The bleeding is thought to originate from direct capillary and mucosal damage as aspirin disintegrates in contact with gastric tissues and from the ability of aspirin to inhibit COX-1, which interferes with cytoprotective mechanisms and platelet aggregation. Although this occult bleeding is usually of little clinical significance, aspirin and all related NSAIDs are contraindicated in patients with active GI ulcers because their ingestion may lead to sudden, potentially fatal GI hemorrhage.

With more long-term, high-dose regimens of aspirin and other nonselective NSAIDs used in the treatment of various inflammatory disorders, the inhibition of COX-1 leads to several common and predictable effects, the occurrence of which varies with each drug. The inhibition of PGI₂ and PGE₂ synthesis and the resulting loss of their protective effects on the gastric mucosa lead to a significant increase in GI problems, the most serious of which include significant gastric bleeding, symptomatic peptic ulcers, and GI perforations and obstructions. The incidence of these more serious events ranges from 1% to 5% of patients per year. Even long-term low-dose (81 mg/day) aspirin therapy is associated with an increased risk of serious GI events, at a rate of 0.1% to 0.2% of patients per year.¹²⁴ This increase in GI complications has led experts to question the widespread use of low-dose aspirin therapy in patients without significant cardiovascular or cerebrovascular risks. Nonaspirin salicylates generally elicit fewer adverse effects in the GI tract but cannot be used for platelet antiaggregatory therapy. Most of the other NSAIDs have some antiplatelet effect based on inhibition of the production of TXA₂, but the effects are not as pronounced as with aspirin because aspirin is an irreversible inhibitor of COX.

The antiplatelet effects of aspirin can lead to pronounced increases in bleeding time. As previously discussed, this effect is long lasting compared with other NSAIDs because aspirin irreversibly acetylates COX-1 in the non-nucleated platelet. Even a single dose of aspirin can increase the bleeding time for several days. A theoretic concern is the fact that this prolongation of bleeding time can promote intraoperative and postoperative hemorrhage in dental surgical patients. Limited data suggest extractions and periodontal surgery may be performed without special risk in patients kept on aspirin therapy. Although the risk/benefit ratio of discontinuing long-term cardioprotective low-dose aspirin therapy before dental surgery remains controversial, from a medicolegal standpoint it should not be done without the approval of the patient's physician. The remote but real chance of a patient having MI or occlusive stroke shortly after a dental practitioner interrupts low-dose aspirin therapy dictates medical consultation. In addition, aspirin therapy may be reinstated when a clot is established.

The adverse effects of aspirin and other NSAIDs on the kidney are well known. Normal renal function is partly dependent on PG synthesis. It is believed that COX-1 and COX-2 are important in producing PGs involved in reducing water and Na⁺ reabsorption at the ascending loop of Henle and maintaining proper dilation of the renal vasculature (see Figure 21-3).¹⁷ With NSAID therapy, dose-dependent water and Na⁺ retention manifested by peripheral edema, elevation

in blood pressure, and rarely congestive heart failure is thought to follow the inhibition of PGE₂ synthesis. Renal artery vasoconstriction, possibly causing acute renal ischemia and kidney failure, is ascribed to an inhibition of PGI₂ synthesis. Acute renal failure is more likely to develop in patients with preexisting renal insufficiency, congestive heart failure, or dehydration because the renal arterioles are more dependent on PGs to maintain normal perfusion of the glomeruli.¹¹⁷ Acute renal failure is also more likely when NSAIDs are given concurrently with an angiotensin-converting enzyme (ACE) inhibitor because the lack of angiotensin II weakens reactive constriction of the efferent arteriole, a normal protective response for maintaining glomerular filtration in patients with reduced renal blood flow.

NSAIDs are likewise responsible for chronic renal toxicity, commonly known as *analgesic-associated nephropathy*. This disorder sometimes occurs with long-term use of high doses of NSAIDs and is characterized by papillary necrosis and chronic interstitial nephritis. The mechanism may be related to the acute ischemic response described earlier, but the cause has not been definitely established. It is estimated that serious renal problems requiring hospitalization occur in 0.5% to 1% of long-term NSAID users.

The use of aspirin in children with viral infections has been associated with Reye's syndrome.⁸⁴ First described in 1963, Reye's syndrome is an acute childhood illness that produces metabolic encephalopathy and liver disease.¹²⁶ Typically, a child is recovering from influenza or varicella when the acute encephalopathic symptoms of lethargy, agitation, delirium, and seizures appear. Without aggressive supportive treatment, the disease progresses to deep coma, brainstem dysfunction, and death in 80% to 90% of cases.⁸⁴ Even with heroic treatment, the mortality rate can exceed 30%, and survivors can be left with permanent brain damage. Clinical reviews and case-controlled studies performed in the 1970s and 1980s reported a strong association between the development of Reye's syndrome and the ingestion of aspirin in children and teenagers with viral infections.^{85,104,171} Aspirin and related salicylates are contraindicated for the treatment of flulike symptoms, chickenpox, gastroenteritis, and, in the opinion of most pediatricians, any febrile respiratory condition in children or teenagers. Acetaminophen and ibuprofen have not been associated with the development of Reye's syndrome.⁸¹

Toxicity caused by aspirin overdose is common. The symptoms and severity depend on the dose. Chronic toxicity caused by salicylates results in a syndrome termed *salicylism*, which is characterized by tinnitus, nausea, vomiting, headache, hyperventilation, and mental confusion. Aspirin is one of the more frequently used drugs for attempted suicide. The drug is commonly involved in accidental poisoning, especially in children, because it is found in almost every household and proper precautions for its storage are often neglected. Serious clinical manifestations of acute aspirin overdose typically occur at doses greater than 6 to 10 g in adults or when intake exceeds 150 to 200 mg/kg of body weight.

The cardinal signs and symptoms of acute aspirin overdose include nausea, vomiting, tinnitus, hyperthermia, and hyperventilation. Hyperventilation arises in part from a direct stimulation of respiratory centers in the brain and from a compensatory increase in respiration in response to excessive carbon dioxide produced by large doses of aspirin partially uncoupling oxidative phosphorylation. This uncoupling also accounts for the paradoxical (because therapeutic doses of aspirin are used for antipyresis) increase in body temperature.¹⁸ The hyperventilation eventually can lead to respiratory alkalosis, which may be followed by a combined respiratory and metabolic acidosis accompanied by dehydration. Acidosis is more prominent as the level of overdose increases. Acidosis is also more likely to occur in children and infants. Impaired

vision, hallucinations, delirium, and other CNS effects may be evident, and the situation is considered life-threatening.

The treatment of aspirin overdose is primarily palliative and supportive. Chronic toxicity usually is treated simply by withholding the drug temporarily and then reinstating therapy at lower doses. Acute toxicity often requires respiratory support, gastric lavage, maintenance of electrolyte balance (e.g., K^+ replacement if necessary), maintenance of plasma pH, and alkalization of the urine with intravenous bicarbonate. Alkalization of the urine increases the percentage of ionized salicylate in the glomerular filtrate. Salicylate reabsorption is reduced, and renal clearance is increased up to fourfold. The carbonic anhydrase inhibitor acetazolamide may also be used to promote urinary alkalization.

Allergic reactions to aspirin can also occur. Many patients confuse side effects such as nausea or tinnitus with true allergic responses manifested by skin rashes, hives, angioedema, or anaphylaxis. Patients with a history of skin eruptions caused by aspirin ingestion should be cautioned to avoid all proprietary compounds containing aspirin or any salicylate to avoid more serious anaphylactic reactions.

Intolerance to salicylates can occur, with symptoms ranging from rhinitis to severe asthma. This reaction does not seem to be immune mediated even though it resembles drug allergy in clinical presentation. Aspirin intolerance is more common in patients with preexisting asthma or nasal polyps. The incidence of this reaction in asthmatic patients has been reported as high as 20%. Patients with a history of asthma, allergic disorders, or nasal polyps should be questioned to ensure that they can tolerate aspirin and other NSAIDs. The bronchoconstriction may be caused by a shift in the arachidonic acid cascade when the COX enzyme is blocked. This inhibition prevents arachidonate metabolism from producing bronchodilating PGs, primarily PGE_2 .¹⁶⁰ The lipoxygenase pathway predominates and produces leukotrienes that constrict bronchioles in sensitive individuals, mimicking the asthmatic attack.^{22,39} Other manifestations of aspirin intolerance include urticaria (hives) and angioedema. Switching from aspirin to another salicylate or even another NSAID does not prevent the reaction; acetaminophen is the only antipyretic analgesic that may be used safely in patients with aspirin intolerance. The clinician should be aware that, although relatively rare, there are reports of aspirin-intolerant asthmatic patients also displaying severe respiratory symptoms when ingesting therapeutic doses of acetaminophen.⁷

Contraindications and precautions

Aspirin is contraindicated or at least must be used with caution in numerous medical conditions (Table 21-4). Serious internal bleeding can result from the ingestion of aspirin by a patient with an ulcer. Patients with compromised liver function should use aspirin cautiously because, when used on a long-term basis, aspirin increases the prothrombin time, which could aggravate bleeding problems. Low doses of aspirin can increase plasma urate concentrations and exacerbate gouty arthritis as a result of competition between salicylate and uric acid at the active secretion sites in the proximal tubule of the kidney or by an increase in uric acid reabsorption. High doses of aspirin may increase or decrease plasma glucose concentrations by stimulating epinephrine and glucocorticoid release or by depleting liver glycogen. Salicylates may also increase insulin secretion because PGE_2 inhibits insulin secretion.⁶⁶

Asthma patients, patients with nasal polyps, and patients with chronic allergic disorders (e.g., urticaria) should use aspirin cautiously because, as previously mentioned, up to 20% of these patients have reported intolerance to aspirin, other salicylate drugs, and other NSAIDs. Aspirin (and other NSAIDs) is contraindicated in patients with aspirin intoler-

TABLE 21-4

Contraindications to the Use of Aspirin and Other Salicylates

DISEASE STATE	POSSIBLE ADVERSE EFFECT OF ASPIRIN
Ulcer	Internal bleeding, possible hemorrhaging
Asthma	Asthmatic attack resembling an allergic reaction
Diabetes	High doses may cause hyperglycemia or hypoglycemia
Gout	Low doses increase plasma urate; high doses decrease plasma urate
Influenza	Reye's syndrome in children
Hypocoagulation states	Excessive bleeding

ance. True allergy, mediated by IgE, usually involves allergy to only one class of NSAID (i.e., salicylates or propionic acids but not both). From a clinical perspective, it is often difficult to distinguish aspirin intolerance from a true aspirin allergy based on the patient's description of the event, whereas in the case of true aspirin allergy, a nonsalicylate NSAID could theoretically be used safely.

Aspirin is not absolutely contraindicated in pregnancy, but it should be used with caution. In the third trimester, aspirin tends to prolong labor by inhibiting the synthesis of PGs involved in initiating uterine contractions. Aspirin has also been reported to increase blood loss at the time of delivery and may cause premature closure of the ductus arteriosus in the fetus. Some evidence also suggests that, in very high doses, aspirin can have teratogenic effects.

A number of drug interactions may involve aspirin (Table 21-5). Because of its effects on blood glucose, aspirin can interact adversely with insulin or oral hypoglycemic agents, causing unpredictable changes in blood glucose concentrations. Aspirin and other salicylates compete with oral hypoglycemic drugs for binding sites on plasma proteins. This interaction theoretically leads to higher amounts of unbound oral hypoglycemic in the plasma and an enhanced hypoglycemic effect. Internal bleeding may occur if aspirin, which causes GI irritation and inhibition of platelet aggregation, is used in conjunction with anticoagulants such as warfarin and heparin. In addition, warfarin can be displaced from plasma proteins by aspirin. As with oral hypoglycemic drugs, this competition for binding is more of a theoretic concern than a practical issue (as discussed in Chapter 2). Another potentially dangerous drug combination is aspirin and alcohol because alcohol sensitizes the gastric mucosa to aspirin. Aspirin and other NSAIDs also increase the toxicity of methotrexate and valproic acid and can decrease the effect of certain antihypertensive drugs (e.g., β -adrenoreceptor blockers, diuretics, and ACE inhibitors). Long-term low doses of aspirin used for antiplatelet therapy do not seem to interact with antihypertensive drugs.¹²⁴

Diffunisal

Diffunisal is a difluorophenyl derivative of salicylic acid (see Figure 21-5) with anti-inflammatory, analgesic, and antipyretic activity. Although structurally related to salicylates, diffunisal is not hydrolyzed in vivo to salicylate and is unique among the salicylates. Similar to other salicylates, diffunisal blocks the synthesis of PGs by inhibiting COX. Diffunisal is approximately 10-fold more potent than aspirin in suppressing PG formation in rats.

TABLE 21-5

Drug Interactions Involving Aspirin

DRUG	POSSIBLE INTERACTION WITH ASPIRIN
Warfarin	Internal bleeding, possible hemorrhaging
Heparin	Internal bleeding, possible hemorrhaging
Insulin	Aspirin may cause hyperglycemia or enhancement of hypoglycemic effect
Sulfonylureas (oral hypoglycemic agents)	Enhancement of hypoglycemic effect
Phenytoin, valproic acid	Increased free plasma concentration of phenytoin, valproic acid
Methotrexate	Increased free plasma concentration of methotrexate
Ethanol	Internal bleeding, possible hemorrhaging
Probenecid, sulfapyrazone	Decreased uricosuric effect, reappearance of gout
ACE inhibitors, β -adrenergic blockers, diuretics	Loss of antihypertensive effect

ACE, Angiotensin-converting enzyme.

The drug is well absorbed after oral administration, with peak blood concentrations occurring in 2 to 3 hours. It is highly bound to plasma protein. Diflunisal has a long plasma half-life (8 to 12 hours versus 2.5 hours for salicylate), which permits dosing intervals of 12 hours. The drug is excreted in the urine, with two soluble glucuronide conjugates accounting for approximately 90% of the administered dose.

Diflunisal is indicated for the treatment of mild-moderate pain and for osteoarthritis and rheumatoid arthritis. In postoperative dental pain, 500 to 1000 mg of diflunisal produces greater analgesia than aspirin or acetaminophen (both 650 mg), and peak effects are comparable to those obtainable with fixed combinations containing optimal doses of opioids.^{57,59} Because diflunisal has an extended duration of action and a relatively slow onset of action in acute pain models, the recommended dosage regimen is a 1000-mg loading dose followed by 500 mg every 8 to 12 hours. The effectiveness of diflunisal in osteoarthritis seems to be comparable to that of aspirin.

In terms of adverse effects, diflunisal qualitatively resembles aspirin. Effects on the GI tract range from nausea and epigastric pain to peptic ulcer and GI bleeding. Diflunisal is less problematic in this respect than aspirin, however. Platelet function and bleeding time are affected in a dose-related fashion but to a lesser degree than with aspirin because diflunisal is a competitive, reversible inhibitor of COX. Similar to aspirin, diflunisal prolongs the prothrombin time in patients receiving oral anticoagulants, perhaps by competitive displacement of coumarins from protein binding sites. Diflunisal does not penetrate the blood-brain barrier as well as aspirin does, and diflunisal causes fewer CNS effects, including tinnitus. For this same reason, it is not used as an antipyretic.

Other NSAIDs

Many NSAIDs chemically unrelated to the salicylates are now available. They all inhibit COX, but they vary in their relative

potencies against COX-1 and COX-2.^{128,172} Some NSAIDs may have other anti-inflammatory actions in addition to inhibiting COX.¹²⁰ Many of these NSAIDs have been evaluated in postoperative dental pain and have been found to be superior to optimal doses of either aspirin or acetaminophen in terms of peak analgesic effect and duration of effect. For more long-term use, as in the treatment of rheumatoid arthritis, the choice of an NSAID for therapy is largely empiric and often based on what drug is best tolerated and best relieves symptoms in the individual patient. Most of these drugs are arylalkanoic or heteroarylalkanoic acid derivatives and are discussed according to their chemical classification. The more recently developed highly selective COX-2 inhibitors are discussed separately.

Propionic acid derivatives

Among NSAIDs, the substituted phenylpropionic acid derivatives constitute the largest group of aspirin alternatives (Figure 21-9). In addition to their anti-inflammatory indications in treating the symptoms of rheumatoid arthritis, osteoarthritis, and degenerative joint disease, ibuprofen, naproxen, ketoprofen, and fenoprofen are also approved as analgesic agents. The short-term use of ibuprofen, naproxen, and ketoprofen is available without a prescription for relief of headache, fever, dysmenorrhea, and mild-moderate musculoskeletal and postoperative pain. In patients with rheumatoid arthritis and osteoarthritis, the propionic acid derivatives and other NSAIDs reduce joint swelling, pain, and morning stiffness, and they improve mobility as measured by an increase in walking time. When used in patients treated with corticosteroids, these agents may permit reduction of the steroid dose.

Similar to aspirin and other NSAIDs, these drugs inhibit PG synthesis by nonselective inhibition of COX. Their ability to inhibit COX and prevent the effect of PGs on uterine smooth muscle makes them useful in the treatment of dysmenorrhea. Although they share a common pharmacologic profile, some unique characteristics exist among individual drugs. Naproxen seems to be especially effective in reducing leukocyte activity in inflammation, and ketoprofen seems to prevent lysosomal enzyme release by stabilizing the membranes of lysosomes.

Because propionic acid derivatives as a group are less likely than analgesic and anti-inflammatory doses of aspirin to cause GI or bleeding disturbances, they have increasingly been used in place of aspirin. Although the highly selective COX-2 inhibitors challenged the preeminence of ibuprofen and naproxen for several years in antiarthritic therapy because of an even lower risk of serious GI events, their cardiotoxic potential in selected patients has greatly diminished their use. Propionic acid NSAIDs are almost completely absorbed from the GI tract. The rate of absorption is generally rapid but can be altered for some drugs by the presence of food in the stomach. Peak blood concentrations are reached in 1 to 4 hours. All these agents are highly bound (>90%) to plasma proteins; they are theoretically capable of interfering with the binding of other drugs such as phenytoin or sulfonamides. The drugs are variably metabolized and conjugated, and they are largely excreted in the urine.

Ibuprofen, fenoprofen, and ketoprofen have short plasma half-lives (1 to 4 hours), whereas naproxen has a plasma half-life of approximately 15 hours, which allows less frequent dosing. Flurbiprofen has an intermediate half-life of approximately 6 hours; the half-life of oxaprozin is approximately 50 hours. A brief overview of some of the individual drugs follows, with an emphasis on the analgesic use of these drugs in patients with postsurgical dental pain.

Ibuprofen. Ibuprofen was the first single-entity oral analgesic to be approved by the FDA that showed a greater peak anal-

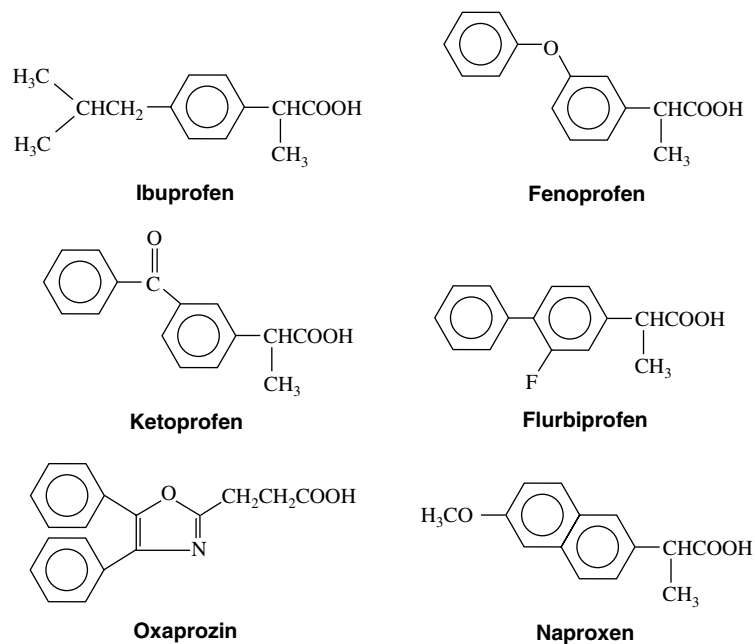

FIGURE 21-9 Structural formulas of some propionic acid derivatives.

gesic effect than 650 mg of aspirin.^{26,34} It is also available as a nonprescription drug. The recommended prescription analgesic dose of ibuprofen is 400 to 600 mg every 4 to 6 hours with a maximum daily dose of 2400 mg. When used OTC without a health professional's guidance, the maximum daily dose should not exceed 1200 mg. In one study, a 400-mg dose of ibuprofen was more effective than a combination of 650 mg of aspirin with 60 mg of codeine when evaluated over 4 hours (Figure 21-10).³¹ In another study, an ibuprofen liquigel formulation containing 200 mg of solubilized potassium ibuprofen displayed greater peak analgesic effects and a longer duration of action than 1000 mg of acetaminophen.⁸⁰ Doses of ibuprofen larger than 400 mg have not consistently shown enhanced analgesic efficacy in nonrheumatic pain, although a meta-analysis of various analgesic interventions in postsurgical dental pain studies reported a modest increase in pain relief (at least with the first dose of drug) with 600 mg of ibuprofen compared with 400 mg of ibuprofen.¹⁰

Ibuprofen administered preoperatively or immediately postoperatively can delay the onset and lessen the severity of postoperative pain.^{46,166,170} Such treatment may be particularly useful when there is a high likelihood of moderate-severe postoperative discomfort. For rheumatic pain and inflammation, doses of ibuprofen can range from 1200 to 3600 mg daily. Ibuprofen is widely used as an antipyretic and is second to acetaminophen as the most used antipyretic in pediatric patients. Dosages for antipyresis are based on the child's age and body weight.

Ibuprofen is a weak organic acid and is highly (approximately 99%) bound to plasma albumin. It is extensively metabolized and then excreted as the metabolites or their conjugates in the urine, with an elimination half-life of approximately 2 hours.

Naproxen. Naproxen is approved for various inflammatory conditions and for the relief of pain. It is the only NSAID manufactured as the pure active *S*-enantiomer. It is available as the free acid and as the sodium salt, the latter of which is more rapidly absorbed from the GI tract and is the preferred form for analgesic use. The sodium salt of naproxen at a 220-mg dose is available OTC with a maximum recommended daily dose of 660 mg (440 mg if the individual is

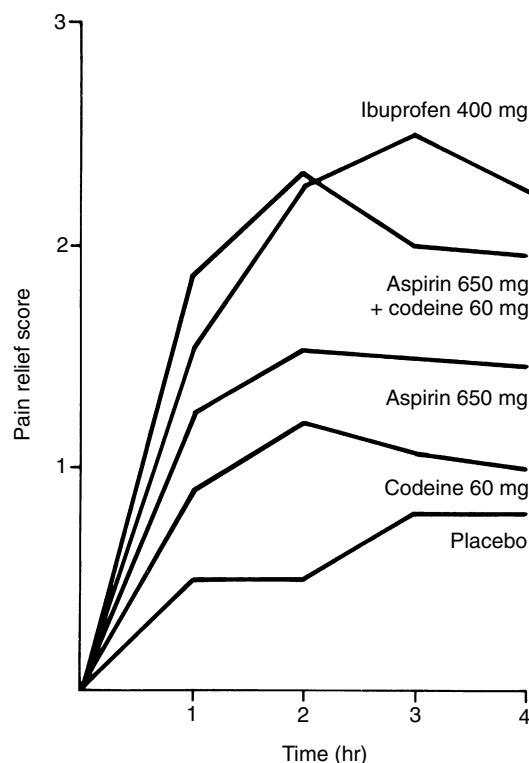

FIGURE 21-10 Time-effect curves for placebo, codeine, aspirin, aspirin plus codeine, and ibuprofen. Mean pain relief scores are plotted against time in hours. (Adapted from Cooper SA, Engel L, Ladov M, et al: Analgesic efficacy of an ibuprofen-codeine combination, *Pharmacotherapy* 2:162-167, 1982.)

older than 65 years). Naproxen sodium by prescription can be taken at a dose of 1375 mg/day. In one study of postsurgical dental pain, a 220-mg dose of naproxen sodium was equivalent in analgesic efficacy and duration to 200 mg of ibuprofen.⁹¹ In two other studies, 440 mg of naproxen

sodium was superior to 1000 mg of acetaminophen in peak analgesia and duration and equivalent in efficacy to 400 mg of ibuprofen.^{62,90} At doses of 440 to 550 mg, naproxen sodium displays a duration of action of 8 to 12 hours, which is the recommended dosing interval. This extended duration of action is explained by its long half-life of approximately 15 hours.

Naproxen is more irritating to the GI tract than ibuprofen, possibly because of its greater selectivity for blocking COX-1.⁸¹ The drug is partially metabolized, and its clearance is almost entirely renal. Similar to ibuprofen, naproxen is highly bound to plasma albumin.

Fenoprofen. Fenoprofen is marketed with analgesic and anti-inflammatory indications. The recommended dose of 200 mg every 4 to 6 hours is likely to be superior to 650 mg of aspirin. Similar to the other propionic acid derivatives, fenoprofen is extensively (approximately 99%) and reversibly protein bound. It has a mean plasma half-life of approximately 2.5 hours in healthy adults. Most of the drug is excreted by the kidney as hydroxylated and conjugated metabolites.⁶⁹

Ketoprofen. Ketoprofen is FDA-approved as an analgesic and is effective for the symptomatic management of rheumatoid arthritis, osteoarthritis, and dysmenorrhea. Similar to the other propionic acid derivatives, it inhibits PG synthesis. Ketoprofen has also been shown to inhibit leukotriene synthesis in at least two in vitro cell culture systems. In addition, ketoprofen stabilizes lysosomal membranes and has an anti-bradykinin effect. It is more potent than ibuprofen, with 25 to 50 mg of ketoprofen about equally effective for mild-moderate pain as 400 mg of ibuprofen. In one dental pain study, 100 mg of ketoprofen was significantly more effective than 400 mg of ibuprofen, although this represents an unapproved suprathreshold analgesic dose of ketoprofen (Figure 21-11).²⁸

Although a 12.5-mg dose is approved for OTC use, ketoprofen has been reported to be more irritating to the GI tract than aspirin.⁸¹ Ketoprofen is extensively bound to plasma proteins (approximately 99%), and it has an elimination half-life of 2 to 4 hours in young and middle-aged adults. It is conjugated with glucuronic acid in the liver and is excreted by the kidney. For nonarthritic pain, doses of 25 to 50 mg three or four times daily are usually sufficient. For arthritic pain, daily doses may approach 300 mg.

Flurbiprofen. Flurbiprofen has no unique advantages over ibuprofen. It is much more potent, however, with 50 to 100 mg of flurbiprofen being equal in effectiveness to 400 mg of ibuprofen.¹⁰⁹ Although approved by the FDA as an antiarthritic drug, flurbiprofen does not possess an analgesic indication. Of particular interest to periodontists is that flurbiprofen (in addition to some other NSAIDs) taken on a long-term basis has been shown to slow the progression of alveolar bone resorption in different experimental models of periodontal disease.^{86,175,176}

Oxaprozin. Oxaprozin is currently approved for rheumatoid arthritis and osteoarthritis only. With a half-life of approximately 50 hours, it is typically dosed once a day. In contrast to other members of the propionic acid class, oxaprozin produces a significant incidence of photosensitivity, manifested as vesicular eruptions on sun-exposed skin. Similar to other NSAIDs, oxaprozin is associated with a prolongation of bleeding time, which may persist for more than 8 days after the last dose because of its long half-life.

Adverse effects. Although the incidence with some propionic acid derivatives may be less than with aspirin, various GI

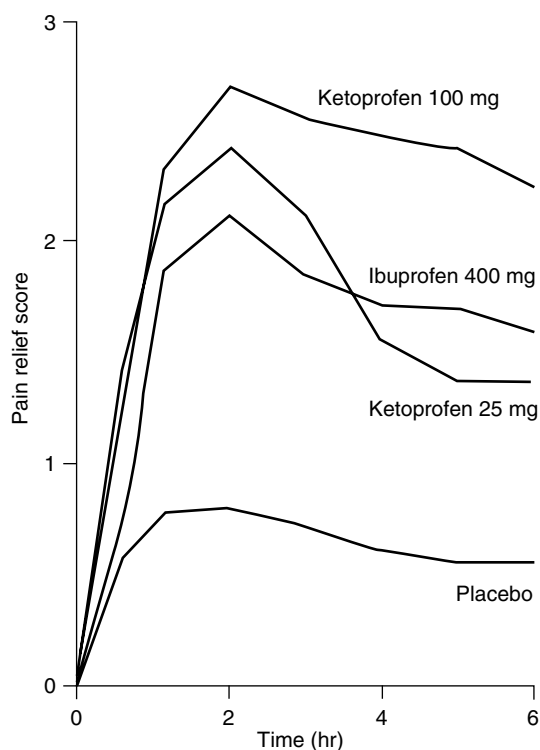

FIGURE 21-11 Time-effect curves for placebo, ketoprofen, and ibuprofen. The mean pain relief scores are plotted against time in hours. (Adapted from Cooper SA, Berrie R, Cohn P: Analgesic efficacy of ketoprofen 25 and 100 mg compared to ibuprofen 400 mg, *Clin Pharmacol Ther* 39:187, 1986.)

disturbances (epigastric pain, nausea, vomiting, gastric bleeding, and constipation or diarrhea) can occur, and these drugs should be used with caution in patients with a history of peptic or duodenal ulcer. Long-term, high-dose administration for arthritic conditions is far more likely to produce serious adverse events than short-term administration for acute pain. Meta-analyses of OTC doses of ibuprofen (800 to 1200 mg/day) or naproxen sodium (440 to 880 mg/day) taken for 10 days or less have revealed a side-effect profile no worse than placebo.^{9,89} Propionic acid derivatives can injure the gastric mucosa, however, by suppressing COX-1 activity and decrease the cytoprotection afforded by PGI₂ and PGE₂.

CNS effects may include headache, dizziness, drowsiness, vertigo, and visual and auditory disturbances including tinnitus. Skin rashes are common, and immediate allergic reactions have been reported. All NSAIDs can lead to anaphylactoid reactions in aspirin-intolerant patients (i.e., patients susceptible to aspirin-induced asthma). These agents decrease platelet aggregation and adhesiveness and increase bleeding time, although to a lesser degree than aspirin; they should be avoided in patients with bleeding disorders and used with caution in patients receiving anticoagulants. These drugs may promote Na⁺ retention, and their use may lead to the formation of edema in susceptible individuals. They can interfere with the antihypertensive effects of β -adrenergic blockers, ACE inhibitors, and diuretics if they are administered for more than 1 week.⁸⁸ In elderly patients, especially during long-term therapy, the dosage of the propionic acid NSAIDs may have to be reduced by 50%.

More recent epidemiologic reports indicate an increased risk of GI bleeding when these drugs and other NSAIDs are taken concomitantly with antidepressants of the selective serotonin reuptake inhibitor (SSRI) class, such as fluoxetine

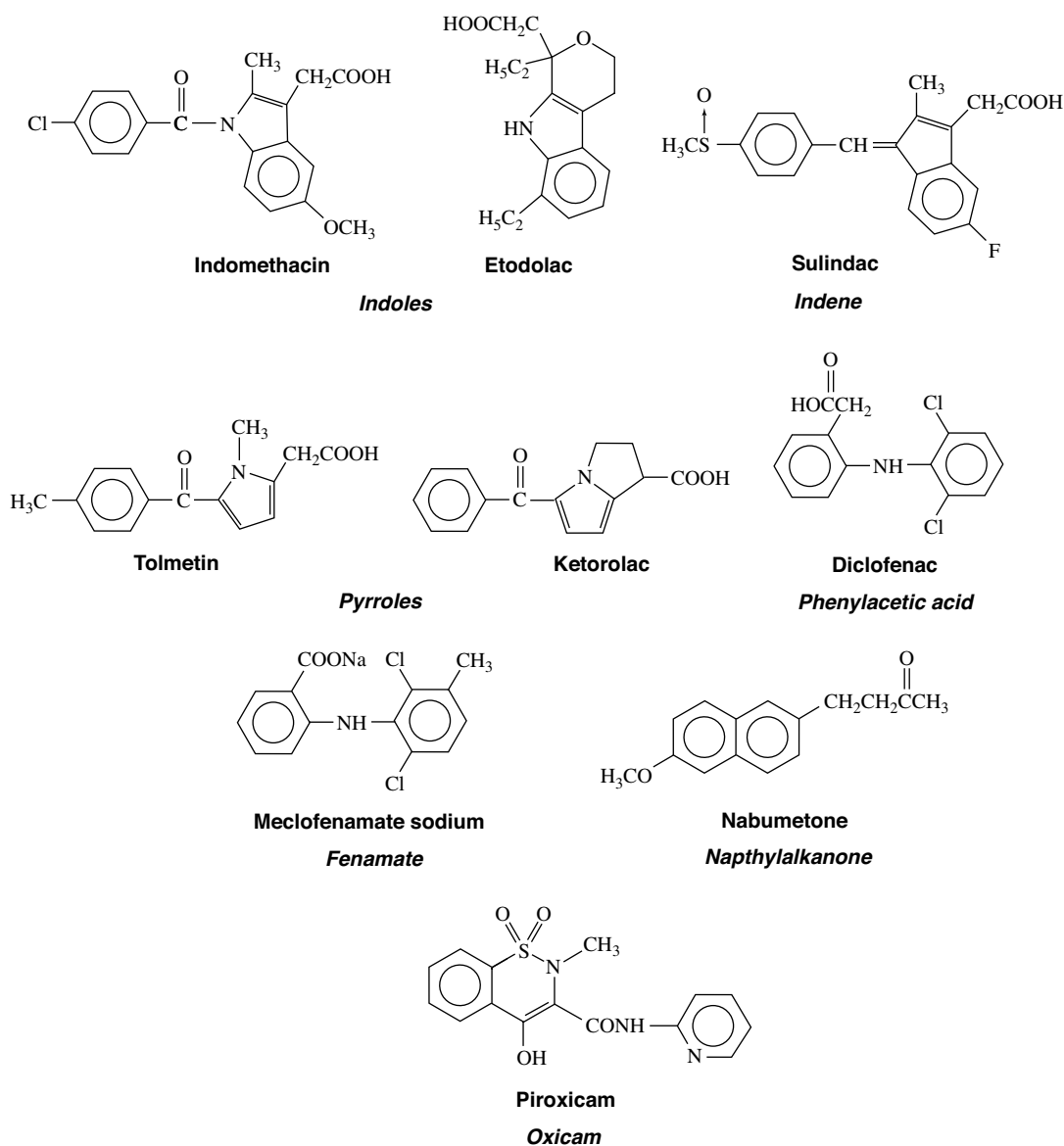

FIGURE 21-12 Structural formulas of various arylalkanoic and heteroarylalkanoic acid derivatives. The chemical categories are noted.

(Prozac) and paroxetine (Paxil).⁸² SSRIs seem to block the reuptake of serotonin in the platelet as they do in neurons in the CNS¹⁴⁰; this reduces the ability of platelets to store serotonin. Similar to the COX-1 arachidonic acid product thromboxane A₂, serotonin stimulates platelet aggregation. The combined intake of SSRIs and NSAIDs can result in an additive or supra-additive antiplatelet effect.

Another more recent concern has been the reported ability of NSAIDs such as ibuprofen to inhibit the antiplatelet and cardioprotective effects of low-dose aspirin.²³ Because ibuprofen and other NSAIDs are reversible inhibitors of COX and aspirin is rapidly metabolized to salicylate, which is also a reversible COX inhibitor, the competition of NSAIDs with aspirin for the COX-1 binding site could inhibit the antiplatelet effects of aspirin under certain conditions. In an experimental paradigm that resembled the typical cardioprotective use of aspirin (i.e., a patient already taking low-dose aspirin and then having ibuprofen, 400 mg, introduced three times daily for ≤1 week), there was no diminution of aspirin's antiplatelet activity, indicating that short-term use of ibuprofen was acceptable in these patients.³⁷

Indole and indene derivatives

The indole and closely related indene derivatives include several drugs useful in the treatment of acute and chronic inflammatory diseases.

Indomethacin. Indomethacin is a methylated indole acetic acid with powerful anti-inflammatory properties. Its chemical structure is shown in Figure 21-12. Indomethacin is a potent inhibitor of COX (see Table 21-2) and a more potent anti-inflammatory drug *in vivo* than aspirin. Similar to the salicylates, it influences numerous biochemical and cellular events that may be involved in the inflammatory process; some of these events may or may not be mediated by PGs.

Clinically, indomethacin produces antipyretic and analgesic effects, the latter being most notable when the pain is associated with an inflammatory condition. Because of its toxic potential, however, indomethacin should not be used as an antipyretic or simple analgesic. An exception is its use as an antipyretic in Hodgkin's disease. Indomethacin is reserved for cases of rheumatoid arthritis, ankylosing spondylitis, and osteoarthritis in which less dangerous drugs are ineffective or

are not tolerated. Indomethacin has also been used as a short-term anti-inflammatory agent in the treatment of bursitis, tendinitis, and acute attacks of gouty arthritis. The drug is occasionally administered as a tocolytic (to halt premature labor) and to promote the closure of a patent ductus arteriosus. The mechanism in both cases is inhibition of PG production. There are no indications for indomethacin in dentistry.

Indomethacin is well absorbed from the GI tract, and peak plasma concentrations are reached in 1 to 2 hours. The drug is largely bound to plasma proteins. After a single dose, most of the drug is eliminated in the urine as various metabolites during the next 24 hours. Its plasma half-life is approximately 2.5 hours.

Adverse effects are common with indomethacin therapy. GI disturbances such as epigastric pain, nausea, and diarrhea, occur frequently. The drug may also cause perforation of the esophagus, stomach, and duodenum, and the resultant hemorrhage can be fatal. The drug is contraindicated in patients with active GI lesions or a history of such lesions. CNS effects, including severe headache and confusion, also occur. Psychosis is possible. In addition to dermatologic and allergic reactions, leukopenia, aplastic anemia, thrombocytopenia, and hepatitis have been reported; some of these reactions have also proved fatal. Indomethacin has the potential to interact with many drugs. Simultaneous administration of indomethacin and oral anticoagulants may be hazardous.

Etodolac. The NSAID etodolac (see Figure 21-12) is approved in the United States for the treatment of acute pain and for managing the signs and symptoms of rheumatoid arthritis and osteoarthritis. Although it is classified as a nonselective NSAID, etodolac apparently is approximately threefold more selective for the inducible COX-2 isoenzyme than for the constitutive COX-1 isoenzyme (see Figure 21-6).^{67,128,172} This relative activity is thought to explain the lower incidence of GI side effects and ulceration seen with long-term dosing compared with other nonselective NSAIDs.¹¹⁸

Peak plasma concentrations are reached in 1 to 2 hours after oral administration. Etodolac has a plasma half-life of approximately 7 hours, and 200 to 400 mg is taken every 6 to 8 hours for the relief of pain. The daily dose should not exceed 1200 mg. Etodolac has been studied in postsurgical dental pain. Onset of analgesia occurs approximately 30 minutes after oral administration, and its duration is 4 to 6 hours.^{64,79} In patients with postimpaction dental pain, 200 mg of etodolac provides peak analgesia comparable to 650 mg of aspirin but longer in duration. In half of patients, doses of 400 mg generally provide relief for 5 to 6 hours before remedication is required. An extended-release formulation of etodolac, which can be administered once a day, is available for the treatment of arthritic conditions. Its onset of action is too slow, however, to be used in the treatment of acute postsurgical pain.⁷⁹

Sulindac. Sulindac, an indene derivative, is also a sulfoxide (see Figure 21-12). Sulindac is a prodrug that must be reduced to the sulfide before it becomes active as an NSAID. Peak plasma concentrations are reached in approximately 2 hours. Sulindac sulfide has a half-life of approximately 15 hours. Its long half-life probably results from the fact that the drug undergoes enterohepatic circulation. Extensive metabolism yields a sulfone and several conjugates. Sulindac is used to treat rheumatoid arthritis and other inflammatory diseases and is occasionally prescribed as a tocolytic and for treatment of acute gout.

Pyrrole derivatives

The pyrrole acetic acids include tolmetin and ketorolac. Although tolmetin is not used in clinical dentistry, ketorolac is used because of its parenteral dosage form.

Tolmetin. Tolmetin, whose structure is shown in Figure 21-12, has anti-inflammatory, antipyretic, and analgesic properties. It is used to treat various inflammatory diseases. Tolmetin has pharmacokinetic properties similar to those of other NSAIDs (well absorbed from the GI tract, highly bound to plasma proteins, and highly metabolized). Peak plasma concentrations are reached approximately 20 minutes to 1 hour after oral dosing. It has a half-life of about 5 hours.

Ketorolac. Ketorolac (see Figure 21-12) was the first injectable NSAID approved in the United States. It is also available in tablet form for oral use, but only after initial intramuscular or intravenous injection. It is recommended that the total course of therapy with ketorolac not exceed 5 days. These limitations follow the drug's high incidence of GI ulceration and bleeding complications compared with other NSAIDs. The more than 400-fold selectivity for inhibiting COX-1 over COX-2 (see Figure 21-6) probably accounts for ketorolac's enhanced toxicity. Although ketorolac is marketed as a racemic mixture, only the S-enantiomer is an active analgesic.

Injectable ketorolac has an important application in postoperative pain management in patients who are unable to consume oral analgesics or when the pain is severe and injectable opioids are contraindicated. Clinical trials have shown that, in some circumstances, parenteral ketorolac is as effective as standard doses of intramuscular morphine or meperidine, is longer lasting, and has fewer adverse effects.¹⁷⁸ In patients with moderate-severe postoperative pain, 30 mg of intramuscular ketorolac is comparable to 12 mg of morphine and equal or superior to 100 mg of meperidine.^{63,122,179}

The oral and the intramuscular forms are well absorbed. Similar to other NSAIDs, ketorolac is highly bound (approximately 99%) to plasma proteins. Plasma concentrations of 0.3 µg/mL are estimated to be required for effective analgesia; when plasma concentrations exceed 5 µg/mL, side effects are frequent. Onset of analgesia after parenteral ketorolac is similar to that after injectable opioids. The S- and R-isomers have half-lives of about 2.5 and 5 hours and are metabolized largely to oxidized and conjugated products.

Initial intramuscular doses of 30 to 60 mg of ketorolac are recommended, followed by 15 to 30 mg every 6 hours with a maximum daily dose not to exceed 120 mg. The initial intravenous dose is 15 to 30 mg. Oral doses are recommended at 4- to 6-hour intervals. Oral ketorolac (10 mg) has also been evaluated in postoperative dental pain and found to be superior to 650 mg of aspirin, 600 mg of acetaminophen, and combinations of 600 mg acetaminophen/60 mg codeine or 1000 mg acetaminophen/10 mg hydrocodone; it is at least as effective as 400 mg of ibuprofen.^{58,61}

Clinical studies have shown that ketorolac does not produce several of the common adverse effects associated with opioid analgesics. It does not depress respiration or cardiovascular function and causes less constipation and drowsiness than equivalent doses of opioids. As with other NSAIDs, physical dependence and tolerance do not develop. The most common adverse effects after ketorolac are drowsiness, dyspepsia, GI pain, and nausea. Peptic ulcers and GI bleeding have occurred after ingestion of oral ketorolac. Renal toxicity has also been associated with ketorolac. The drug is contraindicated before surgery because its intense antiplatelet effect is likely to result in increased intraoperative bleeding, which reflects its potent COX-1-blocking activity. In ophthalmologic conditions, ketorolac is instilled as a topical preparation to treat ocular itching associated with seasonal allergic conjunctivitis.

Diclofenac. Diclofenac is a phenylacetic acid derivative (see Figure 21-12). It has pharmacokinetic properties and a mech-

anism of action similar to other NSAIDs. Although similar to etodolac, it is approximately twofold to threefold more selective for COX-2 than COX-1, probably explaining its relative inability to inhibit platelet aggregation. It undergoes significant first-pass metabolism in the liver and, in addition to inhibiting COX, may reduce the concentration of arachidonic acid in some inflammatory cells.²¹ Diclofenac reaches peak plasma concentrations in 2 to 3 hours after oral administration and has a half-life of 1 to 2 hours. The drug is used to treat inflammatory conditions, pain, and dysmenorrhea. At 50 to 100 mg, it has proved effective in the relief of pain after third molar extraction.^{20,74} A solubilized potassium formulation of the drug is also under investigation for treating various painful conditions.⁷⁸ Diclofenac is also available in topical gel and patch formulations to treat localized joint and muscle pain and as eye drops to treat ocular inflammation.

The adverse effects are similar to other NSAIDs; however, elevation of hepatic enzymes in the plasma is more common and indicates a higher likelihood of producing hepatotoxic effects. In an effort to reduce the ulcerogenic potential of long-term diclofenac therapy, a formulation combining diclofenac with the PG analogue misoprostol has been developed. A 6-month study of long-term NSAID use indicated that misoprostol reduced the incidence of serious drug-induced GI complications by 40%.¹⁴⁴ Misoprostol is an abortifacient and must be used with extreme care in women of childbearing potential. The reader is referred to Chapter 33 for a more complete discussion of misoprostol and other GI drugs.

Fenamates

The fenamates are a group of aspirin-like drugs derived from N-phenylanthranilic acid. The structure of meclofenamate sodium is shown in Figure 21-12. Mefenamic acid is another member of this group approved in the United States. Mefenamic acid is indicated for the relief of moderate pain (therapy not to exceed 1 week) and for relief of primary dysmenorrhea, and meclofenamate is indicated for mild-moderate pain, dysmenorrhea, and arthritis. The plasma half-lives range from 2 to 4 hours. Meclofenamate has one active metabolite whose elimination half-life is 15 hours.

Mefenamic acid inhibits the synthesis and activity of PGs. In doses of 250 to 500 mg, its analgesic properties are comparable to those of aspirin. It is superior to aspirin, however, for the treatment of severe dysmenorrhea. The potential for serious blood dyscrasias and GI side effects (dyspepsia, diarrhea) limits the use of mefenamic acid to short-term, intermittent administration.

Meclofenamate has been extensively studied as an oral analgesic in the short-term management of acute postsurgical dental pain. In three independent dental studies, 100 mg of meclofenamate seemed to be more effective than 650 mg of aspirin and 600 mg of acetaminophen combined with 60 mg of codeine and as effective as 400 mg of ibuprofen.^{32,45,76} Even the short-term clinical use of meclofenamate and mefenamic acid may be limited, however, by a high (25%) incidence of GI disturbances ranging from gastric pain to diarrhea. The ability of these drugs to produce stomach cramping and diarrhea after 1 week or less of dosing has been shown in two dental pain studies.^{33,76} In addition, fenamates have adverse effects typical of other NSAIDs (tinnitus, gastric bleeding, and impairment of platelet function). More serious toxicities in the form of abnormal renal and hepatic function, hemolytic anemia, and bowel inflammation have been documented.

Oxicams

Piroxicam (see Figure 21-12), the first member of the relatively new class of NSAIDs known as oxicams to be marketed in the United States, is approved for the treatment of rheu-

matoid arthritis and osteoarthritis. Although it has also been used to treat pain and dysmenorrhea, its onset of analgesic action is too slow for piroxicam to be routinely used for the treatment of dental postoperative pain. Similar to other NSAIDs, piroxicam inhibits platelet aggregation and promotes GI bleeding. All these effects are attributed to the inhibition of COX-1.

Piroxicam is at least as effective as aspirin for the treatment of rheumatoid arthritis and seems to be better tolerated. Its major advantage is pharmacokinetic in nature. Piroxicam is well absorbed, with peak plasma concentrations occurring 3 to 5 hours after administration. The drug is highly bound to plasma protein, undergoes considerable enterohepatic recycling, and is eventually eliminated in the urine after being extensively metabolized. The average plasma half-life for piroxicam is 50 hours. This slow elimination rate permits administration of a single daily dose, an advantage for any drug that must be taken on a long-term basis. It also requires 2 weeks for full therapeutic concentrations to be achieved after the initiation of therapy.

The side effects of piroxicam are similar to those of other NSAIDs. In addition to GI upset and the possibility of ulceration and hemorrhage, peripheral edema and renal damage may occur. Similar to other NSAIDs, this drug should not be administered to a patient susceptible to aspirin-induced bronchospasm.

Meloxicam, a congener of piroxicam, is the newest oxicam derivative to be approved in the United States. Similar to etodolac, meloxicam is a weakly preferential blocker of COX-2,⁵² displaying approximately twofold selectivity over COX-1 in whole blood assay systems (see Figure 21-6).¹²⁸ It is currently approved by the FDA for the treatment of osteoarthritis but has too slow an onset to be used for acute postsurgical dental pain. In clinical studies of osteoarthritis and rheumatoid arthritis, 7.5 to 15 mg/day of meloxicam has displayed equivalent anti-inflammatory efficacy to 100 mg/day of diclofenac, 750 mg/day of naproxen, or 20 mg/day of piroxicam. In addition, meloxicam seems to produce a lower incidence of serious GI toxicity than most other NSAIDs, probably as a result of its relative sparing of COX-1 activity.⁷² GI ulceration and bleeding can still occur, however.

Meloxicam has an elimination half-life of 15 to 20 hours, which enables once-a-day dosing. The major path of metabolism is through hepatic CYP2C9 enzymes; there is a theoretic possibility that inhibitors of this enzyme system, such as metronidazole or fluconazole, could cause meloxicam to accumulate in the blood.

Nabumetone

Nabumetone (see Figure 21-12) is a prodrug that is converted to the active naphthylalkanone metabolite 6-methoxy-2-naphthylacetic acid (6MNA) in vivo. The half-life of the active metabolite is approximately 24 hours. Because clinical reports originally suggested that nabumetone produced less GI toxicity than anti-inflammatory doses of aspirin, naproxen, or indomethacin, it was thought to be a selective COX-2 inhibitor. More recent research has revealed, however, that 6MNA is actually a threefold to fivefold more potent blocker of COX-1 than COX-2.^{128,172} At therapeutic doses of nabumetone, COX-1-blocking effects, including GI ulceration and platelet inhibition, can occur. The drug is indicated to treat the signs and symptoms of osteoarthritis and rheumatoid arthritis.

Pyrazolones

Phenylbutazone is a congener of the pyrazolones antipyrine, aminopyrine, and dipyron. The latter agents were used historically as analgesics, antipyretics, and anti-inflammatory

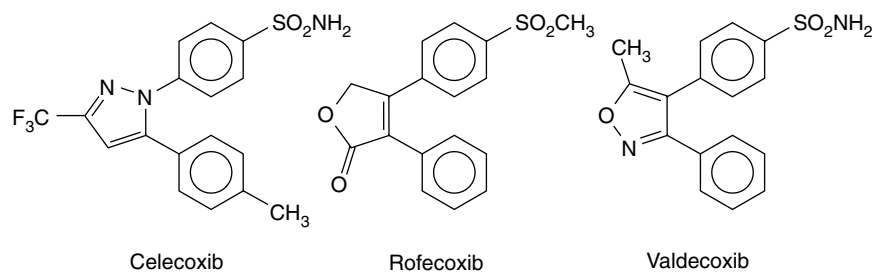

FIGURE 21-13 Structural formulas of cyclooxygenase-2-selective inhibitors.

drugs, but their toxicity and the introduction of phenylbutazone in 1948 led to their abandonment (except for the use of antipyrine as a topical analgesic for earache). More recently, phenylbutazone has also been withdrawn voluntarily by its manufacturer because of its well-documented, serious, and sometimes fatal adverse reactions and the availability of alternative NSAIDs. The most serious of these side effects is bone marrow depression, leading to agranulocytosis, thrombocytopenia, leukopenia, or aplastic anemia. Blood dyscrasias occur most frequently during high-dose therapy and may be manifested initially by fever, stomatitis, and sore throat. GI disturbances associated with COX-1 inhibition are common and range from mucosal irritation to frank ulceration and hemorrhage.

Other adverse reactions include skin rashes, hepatitis, jaundice, purpura, and hematuria. Phenylbutazone causes Na^+ retention by the kidney; the resultant edema may be significant in patients with congestive heart failure or hypertension. Phenylbutazone is a good candidate for drug interactions because of its tendency to promote bleeding and GI disturbances. Phenylbutazone is also known to inhibit hepatic microsomal enzymes. It is still widely used as an anti-inflammatory agent in veterinary medicine.

Selective Cyclooxygenase-2 Inhibitors

The introduction into the U.S. marketplace of the drugs celecoxib, rofecoxib, and valdecoxib was initially thought to be a major advance in NSAID therapy because these drugs are highly selective for inhibiting the inducible COX-2 isoform while sparing the constitutive COX-1 isoform. In contrast to preferential or semiselective COX-2 inhibitors, such as etodolac, diclofenac, and meloxicam, whose COX-2 selectivity does not exceed twofold to threefold, celecoxib, valdecoxib, and rofecoxib display COX-2 selectivity in the range of 8-fold to 35-fold in whole blood assay systems (see Figure 21-6).^{77,128} Two other members of this drug class, which were never approved in the United States, etoricoxib and lumiracoxib, have reported COX-2 selectivity in the 100-fold to 200-fold range.⁷⁷

The selectivity of these so-called coxibs led to roughly a 50% to 60% reduction in serious GI complications—including symptomatic ulcers and GI bleeds, perforations, and obstructions—compared with standard NSAIDs (e.g., ibuprofen, naproxen, diclofenac) in long-term safety studies in arthritic patients.^{16,137,143} This reduction represented a major potential health cost savings because clinically important gastroduodenal ulceration has been reported to occur in 6% of patients on long-term NSAID therapy and result in more than 100,000 hospitalizations and 16,000 deaths annually.¹⁴⁶ Short-term NSAID use for treating acute postsurgical dental pain is typically measured in a few days,^{33,76,81} however, and is rarely associated with serious GI side effects, and the safety advan-

tage of highly selective COX-2 inhibitors in this patient population would be dubious at best. The widely publicized increase in cardiovascular risk (MI and stroke) in patients with long-term use (18 months) of rofecoxib and in the most “fragile” patients who underwent CABG surgery with only 10 days use of valdecoxib led to the removal of both these drugs from the worldwide marketplace.^{19,119}

Celecoxib

With the removal of rofecoxib and valdecoxib from the market, celecoxib currently is the only FDA-approved highly selective COX-2 inhibitor available for use in the United States. Celecoxib (Figure 21-13) is a novel diaryl substituted pyrazole that possesses a sulfonamide group. Its COX-2 selectivity in whole-blood assays is almost eightfold. It is highly protein bound (approximately 97%) and has a plasma elimination half-life of 10 to 12 hours. Its metabolism is mediated primarily by CYP2C9, yielding three inactive metabolites: a primary alcohol, the corresponding carboxylic acid, and its glucuronide metabolite. In randomized trials in patients with rheumatoid arthritis and osteoarthritis, the therapeutic responses seen with celecoxib are equal to the responses seen with nonselective and COX-2 preferential NSAIDs, including naproxen, ibuprofen, and diclofenac.^{50,136,145}

The recommended dose of celecoxib for arthritic conditions is 100 to 200 mg/day. In contrast to the results of arthritis studies, 200 mg of celecoxib was inferior to 400 mg of ibuprofen in terms of analgesic onset and peak effects in patients with acute postsurgical dental pain.¹⁰⁸ An initial loading dose of 400 mg (followed by 200 mg every 12 hours) provides a quicker onset and greater peak effects and is considered the recommended dosing regimen for acute postsurgical pain.²⁴ At 400 mg, celecoxib’s duration of action is longer than that of an equal dose of ibuprofen, but its analgesic onset is still slower.

An additional FDA indication for celecoxib is to reduce the number of adenomatous colorectal polyps in patients with familial adenomatous polyposis. This is a genetic condition in which more than 90% of affected individuals develop colorectal cancer. Celecoxib at 400 mg twice per day, which is the recommended dose for this indication, reduced the number of polyps by roughly 25% after 6 months of therapy.¹⁵⁴ COX-2 is known to be overexpressed in human colorectal adenomas and adenocarcinomas,⁴⁸ and the ability of celecoxib to inhibit COX-2 probably explains its usefulness in this condition. In a large trial of subjects who were high polyp formers, with an average age of 60 years and almost half with cardiovascular disease or related risk factors (angina, previous MI, hypertension, or poor lipid profile), celecoxib at 200 mg and 400 mg taken twice per day increased the risk of a serious cardiovascular event (MI, stroke, or heart failure) by 2.5-fold and 3.4-fold compared with placebo after 36 months of treatment.¹⁵¹

FIGURE 21-14 Time-effect curves for placebo, celecoxib, ibuprofen, and rofecoxib. The mean pain relief scores are plotted against time in hours. (Adapted from Malmstrom K, Daniels S, Kotey P, et al: Comparison of rofecoxib and celecoxib, two cyclooxygenase-2 inhibitors, in postoperative dental pain: a randomized, placebo- and active-comparator-controlled clinical trial, *Clin Ther* 21:1653-1663, 1999.)

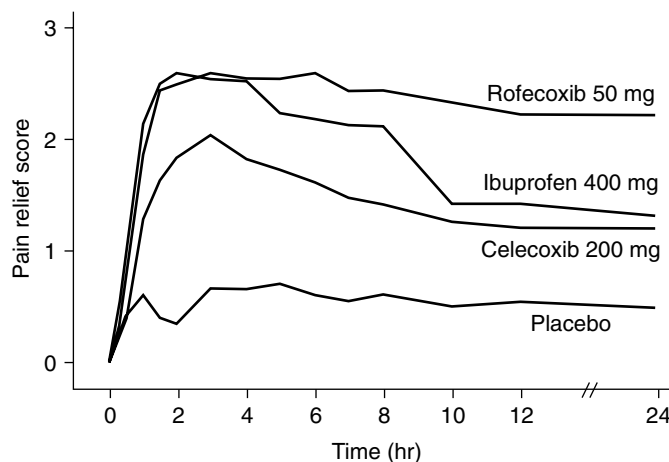

The enhanced GI safety of celecoxib with long-term administration must be balanced with the increased cardiovascular risk that has also been shown with long-term, high-dose use. In a major celecoxib study, 400 mg of celecoxib twice a day, which is two times the maximum approved antiarthritic dose, resulted in a reduction of GI ulceration, perforations, and bleeds after 6 months by half compared with large therapeutic doses of ibuprofen or diclofenac.¹⁴³ Because celecoxib is a selective COX-2 inhibitor, it has less effect on COX-1 and does not inhibit platelet aggregation or increase bleeding time, which may enhance its GI safety further with long-term dosing.⁹⁹ Many patients with arthritis also require cardioprotective dosages of aspirin, however. These patients must be reminded that they must take their low-dose aspirin therapy in addition to their antiarthritic dosages of the COX-2 inhibitor. Concomitant low-dose aspirin seems to diminish greatly, if not abolish, the GI-sparing effect of celecoxib and other highly selective COX-2 inhibitors.^{137,143}

Despite celecoxib's COX-2 selectivity, patients still must be warned of the potential for the drug to cause serious GI toxicity. Because COX-2 plays a normal constitutive role in the kidney (see Figure 21-3), celecoxib and other COX-2 inhibitors can cause renal toxicity, including Na⁺ and water retention, hypertension, and acute renal failure. Similar to other NSAIDs, celecoxib may interfere with the antihypertensive effects of ACE inhibitors, diuretics, and β -adrenergic blockers. In patients with aspirin intolerance, the use of COX-2 inhibitors may precipitate potentially life-threatening asthmatic or allergic-type reactions. Because celecoxib is a sulfonamide, patients with documented allergies to other sulfonamides (including the thiazide diuretics) should avoid celecoxib. Drug interactions involving celecoxib resemble interactions of aspirin and other NSAIDs. As with other NSAIDs, reports of significant bleeding episodes have occurred in patients taking warfarin who subsequently received celecoxib.¹¹ Drugs that are inhibitors of CYP2C9, such as fluconazole and metronidazole, may significantly increase celecoxib blood concentrations.

Rofecoxib

Rofecoxib is a diaryl substituted furanone (see Figure 21-13) with COX-2 selectivity of approximately 35-fold in whole blood assays and was the first highly selective COX-2 inhibitor FDA-approved for the treatment of acute pain in addition to more long-term use for treatment of arthritis.^{128,172} Its pharmacokinetic properties, including an elimination half-life of 17 hours, made it suitable for once-daily oral administration.

Although rofecoxib contained a sulfur atom in its structure, it was not a sulfonamide and could be given safely to patients with documented sulfonamide allergies. Similar to celecoxib, it did not inhibit platelet aggregation or interfere with the antiplatelet effect of aspirin.⁶⁸

Rofecoxib was indicated for the treatment of osteoarthritis and for the management of acute pain, including primary dysmenorrhea. The recommended anti-inflammatory dose of rofecoxib was 12.5 to 25 mg once a day, whereas the analgesic dose was 50 mg once per day. In large-scale studies of osteoarthritis of the hip or knee, rofecoxib displayed therapeutic equivalency to diclofenac and to ibuprofen.^{43,136}

In acute postsurgical dental pain, 50 mg of rofecoxib was equivalent to 400 mg of ibuprofen in analgesic onset and peak analgesic effect but had a much longer duration of action (24 hours for rofecoxib versus 8 hours for ibuprofen).^{49,108,116} Rofecoxib was also more efficacious than 200 mg of celecoxib in analgesic onset, duration, and peak effects (Figure 21-14).¹⁰⁸

The major GI safety advantages of rofecoxib were related to its ability to block COX-2 selectively. In a major study involving more than 8000 patients with rheumatoid arthritis, the administration of rofecoxib at twice the maximum antiarthritic dose for up to 1 year resulted in an approximate 60% reduction in GI ulcerations, perforations, obstructions, and bleeds compared with a standard dose of naproxen of 500 mg twice a day.¹⁶ The possibility of increased cardiovascular risk of long-term rofecoxib, 50 mg, compared with naproxen arose in this study. Considering that rheumatoid arthritis patients are at higher risk of MI than the general public, that the mean age of patients in this study was almost 60 years, and that patients on cardioprotective doses of aspirin were not allowed to enter the study, the overall incidence of this event was considered low. Although it occurred in 0.1% of subjects taking naproxen and 0.4% of subjects taking rofecoxib, it was thought that the increased incidence of this event in the rofecoxib group really reflected a cardioprotective effect of naproxen and not a cardiotoxic effect of rofecoxib.

Naproxen, being at least 10-fold selective in blocking COX-1 and having a relatively long half-life, has been shown to possess profound but reversible antiplatelet activity.⁹³ The cardiovascular risk of rofecoxib was clearly identified when a placebo-controlled polyp reduction trial of rofecoxib, 25 mg, was performed in patients with a mean age of 59 years, 28% of them judged to be at high cardiovascular risk.¹⁹ For the first 18 months of use, the incidence of MI and other ischemic events was similar between groups. After 18 months, more events occurred in the rofecoxib group with a cumulative incidence at

36 months of approximately 4.5% in the rofecoxib group and only 2% in the placebo group. When these results became known, the manufacturer of rofecoxib voluntarily withdrew the drug from the worldwide marketplace in September 2004.

Valdecoxib and parecoxib

Valdecoxib (see Figure 21-13) was approved by the FDA in 2002 as an oral anti-inflammatory agent and had shown promise as an analgesic agent, including the treatment of postsurgical dental pain.⁴¹ It possessed approximately 30-fold selectivity for the COX-2 isoform.¹²⁸ The results of a short-term postsurgical pain study involving valdecoxib and its intravenous prodrug parecoxib in patients who had undergone CABG procedures revealed that only 10 days of therapy with valdecoxib or a combination of 3 days of therapy with parecoxib followed by 7 days of therapy with valdecoxib significantly increased the incidence of serious postsurgical cardiovascular events compared with a third group of CABG surgery patients not taking either drug for postsurgical pain control.¹¹⁹ These results, plus an unusually high incidence of serious skin reactions including Stevens-Johnson syndrome reported in patients on valdecoxib therapy, led to the removal of valdecoxib from the marketplace in April 2005. Parecoxib was never approved by the FDA.

Other COX-2 inhibitors

Two other COX-2 inhibitors have been developed more recently. The first member of this group, etoricoxib, possesses 106-fold COX-2 selectivity.¹²⁸ It is available in Europe but was denied approval by the FDA in the United States on April 12, 2007, because it seemed to offer no significant benefit with regards to cardiovascular risk compared with other highly selective COX-2 inhibitors that had been removed from the market.

Lumiracoxib with more than 200-fold COX-2 selectivity,⁷⁷ although approved in Europe, was denied FDA approval because of concerns regarding cardiovascular risk. In addition, Canada and Australia removed the drug from their marketplace because of many reports of serious liver toxicity, including a few reports of liver failure requiring transplants.

Implications for Dentistry

The major use of aspirin and other NSAIDs in dentistry is to relieve pain associated with pathologic processes (e.g., pulpitis, dentoalveolar abscesses) or after surgical procedures. In both situations, the anti-inflammatory actions of the NSAID may contribute significantly to the therapeutic effect sought. Aspirin at doses of 650 to 1000 mg is an acceptable drug for mild-moderate dental pain. For more traumatic surgical procedures, such as the removal of impacted third molars, the newer NSAIDs at dosages that approach their analgesic ceiling are more efficacious and sometimes better tolerated than aspirin. Postsurgical dental pain studies that have used ceiling analgesic doses of NSAIDs, such as ibuprofen at 400 mg and naproxen sodium at 550 mg, have displayed efficacy at least equal to that obtained with opioid combination drugs. In addition, NSAIDs produce far fewer side effects of drowsiness, dizziness, nausea, and vomiting than opioid-containing analgesics. The recommended dosing schedules of NSAIDs for acute pain of dental origin are shown in Table 21-6.

There are few instances in which the use of the highly selective COX-2 inhibitor celecoxib can be recommended. In most instances, traditional NSAIDs such as ibuprofen or naproxen are used only for a few days in the dental setting, which mitigates any GI benefit associated with the long-term use of celecoxib. In addition, these traditional NSAIDs are probably more efficacious and cost-effective. One possible exception would be in the treatment of temporomandibular

joint (TMJ) pain, in which the duration of NSAID therapy is measured in weeks and significant GI toxicity of NSAIDs becomes a greater concern.¹¹⁴ Still, it would behoove the clinician not to prescribe celecoxib to patients with cardiovascular risk factors, including previous MI or stroke, unstable angina, or poorly controlled hypertension on the basis of concern about increased cardiovascular risk of highly selective COX-2 inhibitors as a whole. In addition, although naproxen has shown efficacy in TMJ pain, celecoxib has not.¹⁶¹ The TMJ may be involved in systemic inflammatory diseases that would be treated with NSAIDs. The TMJ can also be singly affected by an acute or chronic inflammatory process, the cause of which may be known (e.g., trauma, immobilization, malocclusion) or unknown (e.g., nonspecific osteoarthritis). In these cases, an NSAID may be used in conjunction with other therapies such as heat, exercise, bite splints, and joint surgery.

Contraindications to NSAIDs must be heeded. Salicylates must be avoided in children or teenagers with viral infections or suspected viral infections. The antiplatelet effect of NSAIDs, especially aspirin and ketorolac, must be considered if the patient is at risk from a bleeding abnormality or anticoagulant therapy. Many NSAIDs antagonize the effect of probenecid and sulfapyrazone. Hypersensitivity to aspirin may indicate a risk of NSAIDs in general, including COX-2 inhibitors. The elimination of methotrexate and lithium is reduced with NSAIDs⁸²; other drug interactions may occur because of the ability of NSAIDs to displace drugs from plasma albumin and otherwise alter their pharmacokinetic properties. The common adverse effects for NSAIDs on the GI tract and CNS should be considered, especially when the patient is taking drugs with overlapping toxicity. NSAIDs can block the therapeutic effects of several antihypertensive drugs. Drugs potentially antagonized by NSAIDs include β -adrenoreceptor blockers, ACE inhibitors, and diuretics.

ACETAMINOPHEN

Acetaminophen (N-acetyl-*p*-aminophenol) is the only aniline derivative currently in clinical use. It is widely promoted as the antipyretic analgesic of choice when aspirin cannot be used because of gastric problems or other contraindications. For many years, phenacetin (an acetaminophen analogue) was a common constituent of analgesic preparations, including numerous aspirin-phenacetin-caffeine combinations. Phenacetin has disappeared from use in the United States because of several studies linking long-term administration of such combinations with renal damage. Phenacetin is also capable of producing CNS disturbances (e.g., sedation), hemolytic anemia, and methemoglobinemia.

Chemistry and Classification

The history of acetaminophen dates back to the late 1800s, when the antipyretic activity of aniline derivatives was discovered and several congeners, including acetaminophen, were synthesized. Two other aniline derivatives, acetanilid and phenacetin, became popular, and acetaminophen was put aside. Chemists eventually realized that acetaminophen was an active metabolite of both of these drugs (Figure 21-15), but it was not until the mid-1900s that acetaminophen became commercially successful.

Mechanism of Action

Acetaminophen has analgesic and antipyretic activity that is essentially equivalent to that of aspirin. The drug's mechanism of action also seems to stem from an inhibition of PG synthesis, although there may be some differences in the spectrum of COX enzymes that are inhibited.¹⁵⁷ It has been suggested

TABLE 21-6

Nonopioid Analgesics Approved for Acute Pain

NONPROPRIETARY (GENERIC) NAME	PROPRIETARY (TRADE) NAME	ANALGESIC DOSAGE*	MAXIMUM DAILY DOSE*
Aspirin	ASA, others	650-1000 mg q4-6h	4000 mg
Diflunisal	Dolobid	1000 mg to start, then 500 mg q8-12h	1500 mg
Acetaminophen	Tylenol, others	650-1000 mg q4-6h	4000 mg
Ibuprofen	Motrin, Rufen, others	400 mg q4-6h	2400 mg
Ibuprofen (OTC)	Advil, Nuprin, others	200-400 mg q4-6h	1200 mg
Naproxen	Naprosyn	500 mg to start, then 250 mg q6-8h	1250 mg
Naproxen sodium	Anaprox	550 mg to start, then 275 mg q6-8h	1375 mg
Naproxen sodium (OTC)	Aleve	220-440 mg q8h	660 mg
Fenoprofen	Nalfon	200 mg q4-6h	1200 mg
Ketoprofen	Orudis	25-75 mg q6h	300 mg
Ketoprofen (OTC)	Orudis KT, Actron	12.5-25 mg q4-6h	75 mg
Diclofenac	Cataflam	50 mg q8h	150 mg
Meclofenamate	Meclomen	50-100 mg q6h	400 mg
Mefenamic acid	Ponstel	500 mg to start, then 250 mg q6h	1250 mg
Etodolac	Lodine	200-400 mg q6-8h	1200 mg
Ketorolac	Toradol	15-30 mg IV or 30-60 mg IM to start, then 15-30 mg IV or IM q6h; 20 mg orally 6 hr after last parenteral dose, then 10 mg q4-6h [†]	60-120 mg IM or IV; 40 mg orally
Celecoxib	Celebrex	400 mg to start, then 200 mg q12h	600 mg

*Doses are for acute pain only. Higher doses are sometimes used for control of inflammatory disorders.

[†]Therapy limited to 5 days.

IM, Intramuscularly; IV, intravenously; OTC, over-the-counter.

FIGURE 21-15 Structures and major metabolic pathways of acetaminophen, phenacetin, and acetanilid. R*, Glucuronide (major) and sulfate (minor) conjugates. N-acetyl-benzoquinoneimine, produced in high amounts in acetaminophen overdose, forms a conjugate with glutathione that results in depletion of glutathione.

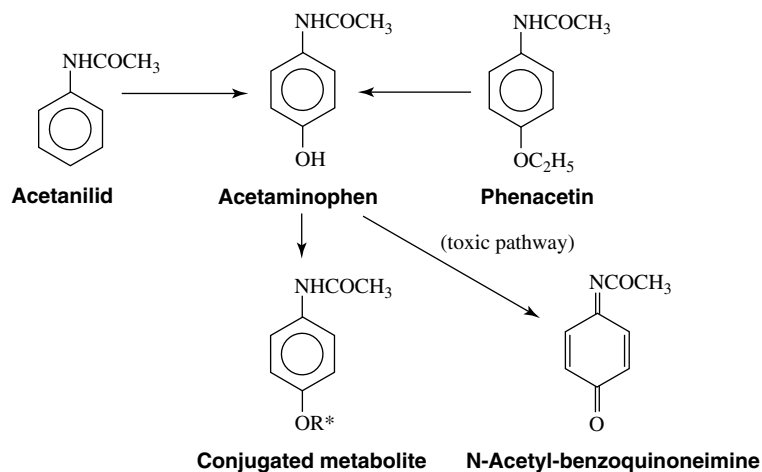

that acetaminophen may be more active than aspirin as an inhibitor of CNS COX and less active in the periphery, although more recent reports of a newly characterized CNS isoform in humans termed COX-3¹⁷³ have not been supported by additional research.⁷⁷ This CNS selectivity of acetaminophen is based largely on the differences in the therapeutic and toxic effects of aspirin and acetaminophen, rather than on direct experimental evidence.

Acetaminophen has very weak anti-inflammatory effects compared with aspirin. Acetaminophen may be a more selective inhibitor of neuronal PG synthesis than aspirin. More recent evidence suggests that a peripheral mechanism of acetaminophen may be partially responsible for its analgesic effects.¹¹⁵ The presence of peroxides from leukocytes in inflamed tissues leads to inhibition of acetaminophen,

however, caused by the peroxides combining with acetaminophen. This inhibition may severely limit any effect of acetaminophen on inflammation. Other proposed mechanisms of action for acetaminophen do not involve PGs and include the activation of spinal serotonergic pathways and the inhibition of nitric oxide synthase.^{15,164}

Pharmacologic Effects

Compared with aspirin, acetaminophen exerts few important effects on specific organs or systems. The potency and efficacy of acetaminophen as an antipyretic are similar to those of aspirin. At therapeutic doses, acetaminophen has little if any effect on the cardiovascular or respiratory systems. Acetaminophen does not inhibit platelet aggregation, cause occult bleeding or gastric irritation, affect uric acid excretion, or have

as many drug interactions as aspirin. In overdose, the organ most affected is the liver. Acute renal toxicity may also occur. With long-term use, analgesic nephropathy is possible, but the risk is low.

Absorption, Fate, and Excretion

Acetaminophen is well absorbed in the small intestine after oral administration. The drug is evenly distributed throughout the body fluids and tissues, and it freely crosses the placenta. The half-life is approximately 2 to 4 hours, and the primary site of biotransformation (by glucuronide conjugation) is the liver (see Figure 21-15). Other minor metabolites include a conjugate with sulfate and various hydroxylated metabolites. A highly reactive and hepatotoxic metabolite, N-acetyl-*p*-benzoquinoneimine (NAPQI), is usually of little significance. In the case of acetaminophen overdose, the accumulation of this metabolite can be disastrous, however. The binding of acetaminophen to plasma proteins is variable but rarely exceeds 40% of the total drug. Elimination is through the kidneys by glomerular filtration and active proximal tubular secretion. There is no competition for secretion with organic acids such as uric acid and aspirin.

General Therapeutic Uses

Although acetaminophen is approximately equipotent to aspirin as an analgesic and an antipyretic, it is not a true anti-inflammatory drug, and aspirin and other NSAIDs are far superior for conditions such as rheumatoid arthritis. For patients in whom aspirin and other NSAIDs are contraindicated, acetaminophen is usually the drug of choice. Tables 21-4 and 21-5 list some of the disease states and potentials for drug interactions that make acetaminophen a more acceptable antipyretic analgesic than aspirin or related NSAIDs. Although acetaminophen is not used to reduce inflammation, it can be effective in treating pain resulting from inflammation. Because of its low toxicity at therapeutic dosages (≤ 4 g/day), acetaminophen is still considered first-line therapy for osteoarthritis, despite the fact that NSAIDs are generally more efficacious.^{2,136} Acetaminophen remains the antipyretic of choice in children and teenagers because, in contrast to aspirin, it is not associated with the development of Reye's syndrome.

Therapeutic Uses in Dentistry

The wide publicity given to the adverse effects of aspirin has caused increasing numbers of dentists to substitute acetaminophen for aspirin in the treatment of postoperative dental pain, even though the anti-inflammatory effects of acetaminophen are minor. In clinical studies, aspirin and acetaminophen are similar in their effectiveness in relieving pain after the extraction of third molars (Figure 21-16).^{29,30}

Acetaminophen has a positive dose-effect curve for analgesia up to 1000 mg. On the basis of this finding, some clinicians are recommending the use of 1000 mg of acetaminophen rather than the customary 650-mg dose. In contrast, concerns about liver toxicity have led others to recommend restrictions against the larger dose. For postsurgical dental pain, acetaminophen is most often used in combination with an opioid analgesic agent (see later). In contrast to NSAIDs, acetaminophen has not proved useful as a preemptive analgesic agent, presumably because it does not block sensitization of pain pathways owing to tissue damage.

Adverse Effects

The potential for adverse effects from acetaminophen seems to be confined to situations in which there is an acute or chronic overdose with the drug. At therapeutic doses, acetaminophen does not cause nausea, inhibit platelet aggregation, prolong prothrombin time, or produce the other side effects associated with the use of aspirin or NSAIDs. Allergy

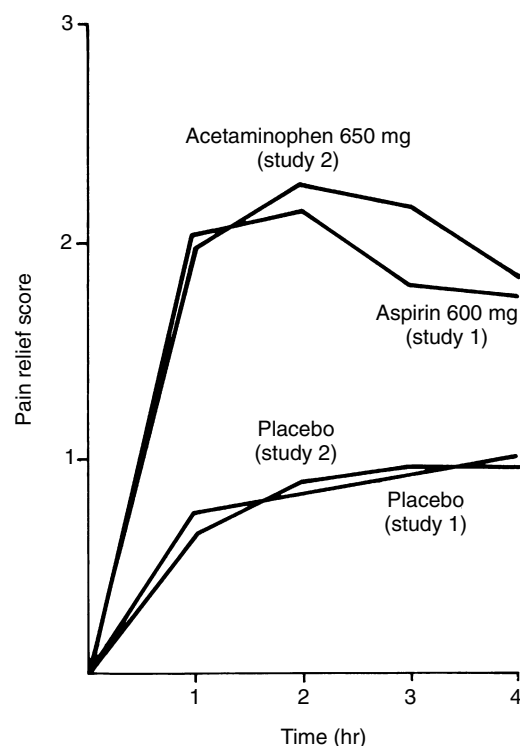

FIGURE 21-16 Time-effect curves for placebo, aspirin, and acetaminophen. The mean pain relief scores are plotted against time in hours. (Adapted from Cooper SA, Breen JF, Giuliani RL: Replicate studies comparing the relative efficacies of aspirin and indoprofen in oral surgery outpatients, *J Clin Pharmacol* 19:151-159, 1979; Cooper SA, Breen JF, Giuliani RL: The relative efficacy of indoprofen compared with opioid-analgesic combinations, *J Oral Surg* 39:21-25, 1981.)

to acetaminophen is rare and is generally manifested as skin eruptions. Acetaminophen rarely has been associated with neutropenia, thrombocytopenia, and pancytopenia. In contrast to phenacetin, acetaminophen rarely produces methemoglobinemia.

Acute overdose from acetaminophen has become a problem because of the extent of its use.¹⁵⁸ In 1992, acetaminophen-containing products accounted for more than 40% of all OTC analgesic drugs sold in the United States, and they remain popular today.⁸² Acetaminophen is frequently used in suicide attempts because of its availability in sizable quantities. The therapeutic index for acetaminophen is high; it is estimated that 6 g or more must be ingested within a relatively short time for hepatotoxicity to occur. In children younger than 10 years, a therapeutic overdose, which typically involves multiple dose miscalculations on the part of the parent administering the drug, has also led to severe hepatotoxicity. The degree of liver damage is directly related to the amount of drug ingested, and individuals with preexisting liver disease are most susceptible.

Hepatotoxicity seems to result from the formation of the highly reactive metabolite NAPQI, which normally reacts rapidly with glutathione and, as a result, is largely neutralized (see Figure 21-15). In acetaminophen overdose, this metabolite depletes glutathione and accumulates, resulting in the alkylation of liver proteins and cellular injury. When enough liver cells are damaged, clinical signs of toxicity, such as nausea and jaundice, appear.¹⁵⁸ Clinicians should also be aware that in patients who have consumed supratherapeutic doses of acetaminophen alone or combined with an opioid for

many days, as sometimes happens with untreated toothache pain, an early sign of liver injury may be intraoral bleeding because the blood coagulation factors are synthesized in the liver. In contrast to the rapid onset of toxic signs seen after an overdose with aspirin or related NSAIDs, clinical manifestations of acetaminophen poisoning may not appear until several days after ingestion of the drug, making diagnosis and treatment much more difficult than with aspirin overdose.

Severe hepatotoxicity after acetaminophen overdose is life-threatening. There is a satisfactory treatment for acetaminophen overdose if initiated in sufficient time. Gastric lavage may be beneficial if started within a few hours of drug ingestion, even before clinical signs of toxicity appear. N-acetyl cysteine is an effective treatment in many cases of toxicity. It enables the formation of new glutathione and dramatically reduces mortality rates. To be effective, N-acetyl cysteine must be administered as soon as possible, but usually not more than 36 hours after ingestion. A better response is obtained if N-acetyl cysteine is given within 10 hours. N-acetyl cysteine is administered orally or intravenously. At present, acetaminophen overdose is a more dangerous and difficult management problem than aspirin overdose. The clinician should not be lured into a false sense of security because of acetaminophen's relative lack of adverse effects at therapeutic doses. To some extent, the dramatic increase in reported cases of acetaminophen toxicity results from a reluctance of the health professions to realize the potential hazards of this drug and to warn their patients of the consequences of misuse.

Warning labels appear on all acetaminophen products concerning the potential adverse drug interaction between it and alcohol.⁸¹ As with acetaminophen overdosage, chronic alcohol use is associated with hepatotoxicity. The theoretic basis of the interaction is that in patients who consume alcohol, CYP2E1 is highly induced. More CYP2E1 would be available to promote the conversion of acetaminophen to NAPQI (see Figure 21-15).¹⁴⁷ In addition, hepatic glutathione, usually available to bind and inactivate NAPQI, tends to be depleted in alcoholics. Counterbalancing this is the fact, however, that when patients are actively consuming alcohol, CYP2E1 is preferentially occupied by alcohol and not acetaminophen, which may limit the production of NAPQI.

This protective effect of alcohol has been shown in suicidal patients showing little hepatotoxicity after ingesting acute overdoses of acetaminophen in combination with large quantities of alcohol.⁸¹ Theoretically, patients may be at greatest risk of hepatotoxicity when, after acute alcohol consumption (which may be as little as a few drinks every day), they stop drinking and begin taking acetaminophen for fever, pain, or a hangover.^{58,82} In this scenario, CYP2E1 is induced, alcohol is no longer present, and the enzyme is free to convert a large portion of the acetaminophen to NAPQI. Studies in normal volunteers who received alcohol infusions to increase their blood alcohol levels to 0.1% (greater than legally intoxicated in most states) showed that the administration of 1000 mg of acetaminophen 8 hours after this infusion (when most of the alcohol would be cleared but CYP2E1 would still be upregulated) produced an amount of NAPQI equivalent to ingesting 1200 mg of acetaminophen, far less than the 6 g needed for hepatotoxicity.¹⁶³

Whether more chronic alcohol consumption (≥ 3 drinks per day for an extended period) followed by a period of abstinence and the ingestion of high therapeutic doses of acetaminophen challenge could produce toxic levels of NAPQI is open to debate. Patients who are alcoholics are likely to exhibit reduced glutathione stores, preexisting liver damage, and malnutrition, which may predispose the alcoholic further to acetaminophen-induced hepatotoxicity, although cases of

acetaminophen toxicity in alcoholics invariably involve an overdose of the analgesic.¹³¹

COMBINATION ANALGESICS

Nonopioids

Aspirin and acetaminophen are sometimes combined in proprietary compounds (Table 21-7). There is little evidence, however, that either analgesia or antipyresis is enhanced by this combination. A ceiling effect still occurs when the total amount of aspirin and acetaminophen approaches 1 g. The rationale for combining an NSAID with acetaminophen, although still debated, seems to have some justification based on the fact that acetaminophen has some actions that are distinct from the actions of NSAIDs. In pain following impacted third molar surgery, the combination of 100 mg of enteric-coated diclofenac with 1000 mg of acetaminophen provides a superior analgesic effect than either drug alone, or a combination of 1000 mg of acetaminophen plus 60 mg of codeine.²⁰ The formulation of diclofenac used in this study, however, was less effective than typically observed in clinical trials.

Many of these combinations also contain caffeine. Caffeine is considered to be an analgesic adjuvant.⁹⁷ Caffeine does not seem to have analgesic effects when used alone. When 65 to 100 mg of caffeine is combined with traditional analgesics (aspirin, acetaminophen, or ibuprofen), however, it improves their analgesic efficacy.^{56,97} The mechanism for this adjuvant effect is unknown but may include the ability of caffeine to block adenosine receptors at free nerve endings or in mast cells, to enhance central catecholamine effects, or to increase the absorption of weak acids such as aspirin.¹³⁴ The central vasoconstrictive effects of caffeine probably help alleviate certain types of headache.

Opioid and Nonopioid Analgesics

There is a sound scientific basis for combining NSAIDs or acetaminophen with opioids. The former drugs combat pain principally by interfering with production of biochemical mediators that cause sensitization of nerve endings at the site of injury or spinal cord, whereas the opioids alter CNS perception and reaction to pain. These complementary actions support the use of the drugs in combination.¹⁶⁷ In addition to the fact that these combinations seem reasonable, abundant clinical data exist to support the validity of their combined use.^{12,112,113} There is a common misconception, however, that such combinations produce a synergistic phenomenon—that is, a total effect greater than the sum of individual effects expected from both drugs. No evidence currently supports this belief, and, at best, there is a purely additive effect when drugs from these two classes of analgesics are combined. If any synergism does exist, it probably involves toxic effects rather than analgesia.

Another misconception is that the opioid component in an oral analgesic combination is the major contributor to the preparation's overall effectiveness. Clinical studies indicate the opposite, showing that the nonopioid component is an equal or, more often, greater contributor to the overall efficacy of the combination for most types of pain. When comparisons are limited to studies evaluating dental pain, there is no question that the aspirin-like drugs provide most of the pain relief.^{27,31} The opioids are, however, most often the cause of side effects.^{12,35}

The clinical significance of the opioids is that they provide additional analgesia beyond the ceiling effect of the NSAID or acetaminophen alone, and they contribute a centrally mediated sedative effect. The most effective combinations are

TABLE 21-7

Analgesic Combinations Used in Dentistry

NONPROPRIETARY (GENERIC) NAME	PROPRIETARY (TRADE) NAME	CONTAINS (mg)			AVERAGE ADULT DOSE	SCHEDULE
		ASA	APAP	OTHER INGREDIENTS		
ASA, caffeine	Anacin	400	—	Caffeine, 32	2 q4h	OTC
ASA, APAP, caffeine	Excedrin	250	250	Caffeine, 65	1-2 q4h	OTC
ASA, codeine	Empirin with codeine					
	#2	325	—	Codeine, 15	2 q4h	Rx III
	#3	325	—	Codeine, 30	1-2 q4h	Rx III
	#4	325	—	Codeine, 60	1 q4h	Rx III
APAP, codeine	Tylenol with codeine					
	#2	—	300	Codeine, 15	2 q4h	Rx III
	#3	—	300	Codeine, 30	1-2 q4h	Rx III
	#4	—	300	Codeine, 60	1 q4h	Rx III
APAP, hydrocodone	Lortab 5/500, Vicodin	—	500	Hydrocodone, 5	1-2 q4-6h	Rx III
	Lorcet Plus	—	650	Hydrocodone, 7.5	1 q4-6h	Rx III
	Lorcet 10/650	—	650	Hydrocodone, 10	1 q4-6h	Rx III
	Vicodin HS	—	660	Hydrocodone, 10	1 q4-6h	Rx III
	Vicodin ES	—	750	Hydrocodone, 7.5	1 q4-6h	Rx III
	Maxidone	—	750	Hydrocodone, 10	1 q4-6h	Rx III
ASA, oxycodone	Percodan-demi	325	—	Oxycodone, 2.44*	1-2 q6h	Rx II
	Percodan	325	—	Oxycodone, 4.88*	1 q6h	Rx II
APAP, oxycodone	Percocet 5/325	—	325	Oxycodone, 5	1-2 q4-6h	Rx II
	Tylox	—	500	Oxycodone, 5	1-2 q4-6h	Rx II
	Percocet 7.5/500	—	500	Oxycodone, 7.5	1-2 q4-6h	Rx II
	Percocet 10/650	—	650	Oxycodone, 10	1 q4-6h	Rx II
ASA, pentazocine	Talwin Compound	325	—	Pentazocine, 12.5	2 q4-6h	Rx IV
APAP, pentazocine	Talacen	—	650	Pentazocine, 25	1 q4-6h	Rx IV
APAP, propoxyphene N	Darvocet N 100	—	650	Propoxyphene N, 100	1 q4h	Rx IV
APAP, tramadol	Ultracet	—	325	Tramadol, 37.5	2 q4-6h	Rx
ASA, caffeine, butalbital	Fiorinal	325	—	Caffeine, 40	1-2 q4h	Rx III
				Butalbital, 50		
APAP, caffeine, butalbital	Fioricet	—	325	Caffeine, 40	1-2 q4h	Rx III
				Butalbital, 50		
ASA, caffeine, butalbital, codeine	Fiorinal with codeine	325	—	Same as Fiorinal, plus codeine, 30	1-2 q4h	Rx III
ASA, caffeine, dihydrocodeine	Synalgos-DC	356.4	—	Caffeine, 30	1-2 q4h	Rx III
				Dihydrocodeine, 16		
ASA, caffeine, propoxyphene HCl	Darvon Compound	389	—	Caffeine, 32.4	1-2 q4h	Rx IV
ASA, meprobamate	Equagesic	325	—	Meprobamate, 200	1-2 q4h	Rx IV
Ibuprofen, hydrocodone	Vicoprofin	—	—	Ibuprofen, 200	1 q4-6h	Rx III
				Hydrocodone, 7.5		
Ibuprofen, oxycodone	Combunox	—	—	Ibuprofen, 400	1 q6h	Rx II
				Oxycodone, 5		

Note: No attempt has been made to present a complete listing of drug combinations or proprietary preparations (which are available in a variety of dosage forms). Such listings can be found in various sources, including *Facts and Comparisons* and *Physicians' Desk Reference*. Many of the combinations provide sub-optimal amounts of aspirin or acetaminophen. In such cases, taking two tablets instead of one would remedy this problem. With some drug preparations such as Empirin or Tylenol with codeine #4, however, taking two tablets would result in administration of an excessive amount of the opioid analgesic, and unwanted side effects could occur.

*Formulation contains a mixture of two different oxycodone salts.

APAP, Acetaminophen; ASA, aspirin; HCl, hydrochloride; OTC, over-the-counter; Rx, prescription.

those that use the optimal amount of an aspirin-like drug combined with the appropriate dose of an opioid analgesic.

Analgesic Combinations That Include a Sedative

Some proprietary compounds combine peripherally acting analgesics with either a sedative or a sedative and an opioid analgesic. The rationale is that patients with pain usually have anxiety, which a sedative drug may help alleviate. Such fixed-dose combined drugs provide a convenient method to administer an analgesic and sedative with one prescription. The use of fixed-dose combinations, however, makes it difficult to adjust the dosage of the various constituents to the individual needs of a patient. Another good argument against fixed-dose

combined drugs is that they increase the potential for adverse drug interactions. This problem is compounded further if the patient receives psychoactive drugs (intravenous sedatives) during treatment that could have effects that carry over into the postoperative period.

Sedatives found in fixed-dose combined drugs are butalbital, meprobamate, and the antihistamines phenyltoloxamine and pyrilamine. There is little published evidence that sedative drugs either adversely affect the pain threshold or in any way contribute to the analgesic efficacy of the combination. They are capable, however, of blunting behavioral responses, which sometimes may be mistaken for an increase in the pain threshold.

Oral Analgesic Combinations Used in Dentistry

Although the pharmacologic features of opioids are discussed thoroughly in Chapter 20, it is appropriate to mention here some of the combinations of opioids and peripherally acting analgesics that are widely used in dentistry. Many opioid analgesics have poor oral/intramuscular (PO/IM) potency ratios because of low oral bioavailability. After oral administration, several opioids are rapidly absorbed into the portal system and mostly transformed to inactive metabolites on their first pass through the liver. To equal the effect of 10 mg of morphine administered intramuscularly, about 60 mg of oral morphine would have to be given, in accord with the drug's PO/IM potency ratio of 0.16. A low PO/IM potency ratio also means that unpredictable and sometimes dangerous effects may occur because individuals show great variability in their metabolic efficiencies. The highest PO/IM potency ratio for any of the commonly used centrally acting analgesics is about 0.5 for drugs such as codeine, hydrocodone, oxycodone, and propoxyphene.

Another general problem with opioid analgesics is their relatively high incidence of undesirable side effects. They all cause nausea and CNS depression, which become more intense as the dosage is increased. Mild CNS depression manifested as sedation may sometimes be useful, but ambulatory dental patients generally want to be able to function normally after they leave the dental office.

Codeine is a commonly used opioid in combination analgesics. Its effective oral dose range is 30 to 90 mg, 30 mg providing only minimal analgesia, 60 mg providing a little more analgesia with considerably more nausea and sedation, and 90 mg approaching the dose at which intolerable side effects occur. Codeine is available in combination with aspirin or acetaminophen. For most patients, 600 to 650 mg of either drug combined with 60 mg of codeine should provide adequate pain relief for most acute dental pain situations.^{12,31,32}

Hydrocodone and oxycodone are close but more potent analogues of codeine.¹³ Hydrocodone/acetaminophen combinations (see Table 21-7) are now the most widely prescribed analgesics in the United States. A formulation combining 200 mg of ibuprofen with 7.5 mg of hydrocodone is also being marketed, but the 200-mg ibuprofen dose is suboptimal. In patients with severe pain, 10 mg of oxycodone combined with either aspirin or acetaminophen is an effective oral analgesic combination, although side effects such as nausea, dizziness, and sedation should be expected. A more recently introduced preparation of 400 mg of ibuprofen with 5 mg of oxycodone possesses optimal concentrations of both components. Typical opioid side effects should be expected. In addition, as with other analgesic preparations containing oxycodone, this combination is considered a Schedule II narcotic by the U.S. Drug Enforcement Administration (see Table 21-7).

Propoxyphene (hydrochloride or napsylate) is also popular in analgesic combinations. Its therapeutic efficacy is questionable, however. Some investigators have found that propoxyphene is slightly less potent than codeine, whereas others claim it is no more effective than a placebo. Propoxyphene combinations with aspirin or acetaminophen are listed in Table 21-7. It is usually assumed that 65 mg of propoxyphene hydrochloride is needed to achieve significant analgesia over and above the effect of aspirin or acetaminophen with which it is combined.

Pentazocine, an opioid with mixed agonist-antagonist activity, is available in combination with aspirin and with acetaminophen. It offers no therapeutic advantages over codeine. At the recommended dose of 50 mg, pentazocine is about as effective as 60 mg of codeine. Most combinations provide only for a maximum of 25 mg of pentazocine per

tablet, however. The drug can produce a withdrawal syndrome in opioid-dependent patients.

Other opioid or opioid-like drugs may be used in combination, but most drug combinations on the market include codeine, hydrocodone, oxycodone, propoxyphene, or pentazocine combined with either aspirin or acetaminophen (see Table 21-7). Opioids such as morphine, meperidine, and oxymorphone have such low PO/IM potency ratios that they are of little use in routine oral analgesic therapy. In general, single-entity opioid analgesics are not the drugs of choice for the management of acute dental pain in ambulatory patients.

Implications for Dentistry

Abundant evidence suggests that dental pain is most amenable to treatment by NSAID analgesics and acetaminophen, and these drugs have become the mainstay for management of acute dental pain. Their use is associated, however, with some risks that are readily reduced by understanding the pharmacologic characteristics of these drugs, including the contraindications and precautions to be followed in selected populations. Opioid combination drugs are most useful in patients with a strong emotional component to their pain, in whom the mood-altering and sedative effects of the opioid are most desirable. Side effects of drowsiness, impaired psychomotor function, and nausea are common with these drugs and should be expected. In addition, the practicing dentist must be aware of drug-seeking patients, who often request a prescription including a specific opioid, most often oxycodone. Chapter 47 presents a more detailed approach for selecting an appropriate analgesic for particular dental indications.

MISCELLANEOUS AGENTS FOR RHEUMATOID ARTHRITIS

Several groups of compounds unrelated to NSAIDs and to adrenal corticosteroids considered in Chapter 35 are useful in suppressing the signs and symptoms of rheumatoid arthritis. Although these drugs are relatively toxic, it is now known that structural damage to joints and extra-articular manifestations of the disease, including lymphadenopathy, vasculitis, splenomegaly, and conjunctivitis, can occur early in the disease process. Although they provide symptomatic relief, NSAIDs alone do not slow or arrest the progression of the disease. These additional drugs as a whole are often referred to as *disease-modifying antirheumatic drugs* because they can alter the progression of the disease.¹¹¹ Of these, methotrexate in particular is now considered a first-line drug in the treatment of rheumatoid arthritis.

Gold Compounds

Medicinal preparations containing gold historically have been used to treat certain inflammatory conditions. Because of their toxicity, their use is now restricted to rheumatoid arthritis, and the use of gold in this condition has also greatly declined. Gold compounds are generally indicated in active cases where the arthritis steadily progresses despite an adequate regimen of NSAIDs, other DMARDs, rest, and exercise therapy. In such cases, chrysotherapy (therapy with aurothioglucose or auranofin) usually induces a partial or complete remission of the disease and not merely a palliation of symptoms. Parenteral gold has been shown to reduce the number of bony erosions in joint tissue.¹⁴² The duration of these remissions is highly variable, however.

The exact mechanism by which gold formulations suppress inflammation is unknown. Gold compounds inhibit PG synthesis, suppress cellular immune reactions, inhibit lysosomal hydrolases, inactivate the classic and alternative com-

plement pathways, and, in particular, diminish the phagocytic activity of mononuclear cells. The relationship of these diverse actions to the observed clinical effects is unclear. In contrast to the NSAIDs, gold salts have no antipyretic or analgesic properties in nonrheumatic conditions.

Because conventional gold salts such as aurothioglucose are not well absorbed by the GI tract, the dosage is given by intramuscular injection. The distribution of gold is complex and depends on the dose and dosing interval. The plasma half-life increases with each subsequent dose because of tissue binding, and months may be required for mean blood concentrations to reach a plateau. After some period of constant weekly injections, gold accumulates in various tissues to such an extent that it may be continuously excreted for many months after administration has ceased. More than half of an administered dose is eventually eliminated in the urine, and the remainder is eliminated in the feces.

Parenteral chrysotherapy is complicated by numerous, occasionally serious adverse reactions. The toxicity of aurothioglucose may be manifested initially by mucocutaneous lesions, including pruritus, dermatitis (ranging from mild to severe), stomatitis (including glossitis), colitis, and vaginitis. Blood dyscrasias, including leukopenia, agranulocytosis, and aplastic anemia, have been reported. A nitritoid reaction, resembling the orthostatic hypotension, facial flushing, and nausea often seen with nitroglycerin administration, may occur shortly after the injection. Toxic effects involving the liver, kidney (proteinuria), and CNS can also occur. Taste disturbances caused by gold compounds may be a primary reason a patient with rheumatoid arthritis visits the dentist. These adverse effects seem to be dose-related and may develop at any time during chrysotherapy.

Auranofin is an orally effective form of gold. It seems to be less toxic than parenteral chrysotherapy; the major adverse effect is diarrhea, rather than skin rash and bone marrow depression. The latter problems can still occur, however. Auranofin also seems to be less effective than the injectable form of gold. The choice between auranofin and aurothioglucose is based on the seriousness of the illness, responsiveness to previous therapy, and desire to avoid injections.

Antimalarial Agents

Chloroquine and, more frequently, hydroxychloroquine have anti-inflammatory effects, including the impairment of neutrophil locomotion and eosinophils chemotaxis, that have been used in the treatment of rheumatoid arthritis and lupus erythematosus.⁹⁶ The drugs are generally administered in conjunction with other anti-inflammatory agents for the relief of mild early rheumatoid arthritis, or they may be used as alternatives to gold compounds or penicillamine (see later) in more severe cases. Clinical improvement is usually very slow, requiring 3 to 6 months. After this time, if there is no evidence of benefit, the drug is discontinued.

Serious ocular toxicity has been caused by these drugs; the retinopathy is dose-related and may progress even after therapy is discontinued. This effect has made antimalarial drugs controversial as antirheumatic agents and mandates regular ophthalmologic testing during therapy.⁶ Other toxic effects include GI, dermatologic, and neuropsychiatric disturbances.

Penicillamine

Penicillamine, a degradation product of penicillin used as a chelating agent in the treatment of heavy metal poisoning (see Chapter 52), was first reported in 1970 to be effective in rheumatoid arthritis. Because of its toxicity, use of penicillamine in rheumatoid arthritis has greatly declined. Its mode of action is unknown; penicillamine has immunosuppressive and immunostimulant properties but is devoid of antibacterial

activity. Penicillamine, similar to gold compounds, is indicated in cases of rheumatoid arthritis that are refractory to other compounds. As with chrysotherapy, penicillamine must be administered for several months before clinical improvement is noted. Side effects are frequent, usually occurring early in therapy. Skin rash similar to that caused by ampicillin is common, as are GI reactions, stomatitis, and taste disturbances. Nephropathy and thrombocytopenia also occur to a lesser extent. The drug must be withdrawn from approximately one third of patients because of adverse reactions.⁸³

Sulfasalazine

Sulfasalazine is a sulfonamide derivative that has been used for the treatment of ulcerative colitis and, in a delayed-release form, for the management of rheumatoid arthritis. In Europe, it is often the initial DMARD that is used after rheumatoid arthritis is diagnosed. The agent has anti-inflammatory and immunomodulatory effects. After oral administration, sulfasalazine is hydrolyzed by enteric bacteria to yield the sulfonamide sulfapyridine and 5-aminosalicylate. Although 5-aminosalicylate is the active moiety against ulcerative colitis, there is no consensus regarding the drug's mechanism of action in rheumatoid arthritis. GI disturbances are the most frequently observed side effects; blood dyscrasias occurring early in therapy are among the most serious. Stevens-Johnson syndrome, hepatitis, and peripheral neuropathy have also occurred with use of sulfasalazine. Patients who have a history of allergy to sulfonamides or salicylates should not receive sulfasalazine.

Immunosuppressants and Antineoplastics

The immunosuppressants azathioprine and cyclosporine (see Chapter 41) and the antineoplastics cyclophosphamide and methotrexate (see Chapter 42) are effective in relieving the symptoms and slowing the disease progression of rheumatoid arthritis.⁸ Methotrexate (combined with NSAIDs to treat pain and inflammation) has become the initial DMARD of choice in rheumatoid arthritis patients. Compared with gold, anti-malarials, and penicillamine, methotrexate's onset of action is more rapid, and it tends to have better efficacy than these compounds or the immunosuppressants azathioprine or cyclosporine.^{25,87,174} Symptomatic improvement from methotrexate therapy administered once weekly can be seen in 3 weeks. As with other DMARDs, NSAIDs can be used in conjunction with methotrexate as a bridge to provide symptomatic relief in the first few weeks of treatment. Because methotrexate, cyclophosphamide, azathioprine, and cyclosporine are general systemic immunosuppressants and affect many components in the inflammatory response, the exact mechanism by which such drugs ameliorate rheumatoid arthritis is unknown.

In the treatment of rheumatoid arthritis, the dosages of these drugs are less than those used in antineoplastic therapy or organ rejection therapy, so the incidence of serious adverse effects is also less. These drugs can still cause serious toxicity in these patients, however, such as promoting infections, blood dyscrasias, nephrotoxicity, and neoplastic transformation. In the oral cavity, cyclosporine can induce gingival hyperplasia, whereas methotrexate and cyclophosphamide can induce stomatitis and mucositis. Because one action of methotrexate is to reduce folic acid synthesis in highly proliferating tissues, its side effects can be minimized by the concomitant administration of folic acid or leucovorin.

The concomitant use of NSAIDs can displace methotrexate from plasma proteins and increase free methotrexate blood concentrations and toxicity. This pharmacokinetic interaction seems most important with high-dose methotrexate therapy used in cancer and not low-dose methotrexate therapy used in the treatment of rheumatoid arthritis.⁷⁰ In

addition, because cyclosporine is metabolized by the CYP3A4 isoenzyme, inhibitors of this enzyme, such as erythromycin, clarithromycin, and the azole antifungal drugs, can dramatically increase cyclosporine blood concentrations and associated toxicities, including irreversible nephrotoxicity.⁷⁵

Leflunomide is an immunomodulatory drug that inhibits dihydroorotate dehydrogenase, an enzyme involved in pyrimidine synthesis. The resulting antiproliferative and anti-inflammatory activity is useful in the treatment of active rheumatoid arthritis and produces similar benefits to that of methotrexate. An active metabolite of leflunomide, termed M1, is responsible for essentially all of the drug's action. Because M1 has a half-life of approximately 2 weeks, a loading dose schedule must be used to achieve therapeutic concentrations in several days (rather than the 2 months normally required). Adverse effects attributed to leflunomide include alopecia, skin rash, myelosuppression, and elevated liver enzymes. The drug should not be taken with other hepatotoxic drugs; coadministration of rifampin can significantly elevate the concentration of M1. A pregnancy category X agent, leflunomide is fetotoxic and contraindicated in pregnant women.

Biologic Agents

Advances in biotechnology have led to the development of biologic agents that selectively target specific pathogenic components of the immune response without causing generalized immunosuppression. Two intravenously administered agents, infliximab and etanercept, and one subcutaneously administered agent, adalimumab, target TNF- α . Infliximab is a chimeric IgG1 monoclonal antibody composed of human constant and murine variable regions,¹⁴¹ adalimumab is a fully human monoclonal anti-TNF- α ,¹⁶⁵ whereas etanercept is a dimeric fusion protein consisting of the extracellular ligand-binding portion of the TNF receptor linked to the Fc portion of human IgG1.¹⁷⁷ All three drugs bind specifically to TNF- α and inhibit the binding of TNF- α to its receptor located on various inflammatory cell types. Through this action, the biologic activity of TNF- α is neutralized, including the ability of TNF- α to induce IL-1 and IL-6, enhance leukocyte migration, and activate neutrophils and eosinophils.

These drugs are typically used in patients with the most advanced forms of the disease and in whom methotrexate therapy has failed to alleviate the symptoms. Infliximab and adalimumab are generally given in combination with low-dose methotrexate therapy, whereas etanercept can be administered alone or in combination with low-dose methotrexate therapy. Infliximab is also approved for the treatment of the signs and symptoms of Crohn's disease; adalimumab is also approved for the treatment of psoriatic arthritis, ankylosing spondylitis, and Crohn's disease; and etanercept is also approved for the treatment of psoriatic arthritis, ankylosing spondylitis, and moderate-severe plaque psoriasis. Although these drugs are not generalized immunosuppressants, serious and sometimes fatal infections have been reported in patients receiving any of these agents. Many of these events have occurred in patients who were receiving concomitant immunosuppressive therapy with drugs such as methotrexate or azathioprine. Infusion reactions, such as chills, fever, and urticaria, have also been reported and are more likely to occur in patients who have antibodies develop to these drugs.

Other biologic agents with targets distinct from TNF- α have also been introduced to treat the signs and symptoms of rheumatoid arthritis. Abatacept was approved in 2006 for the treatment of moderate-severe rheumatoid arthritis in adults that is refractory to other treatments. It is given intravenously and cannot be given concomitantly with TNF- α inhibitors because of the increased risk of serious infections. The drug

is a soluble fusion protein that consists of the extracellular domain of the human cytotoxic T-lymphocyte antigen 4 linked to the Fc portion of human IgG. It blocks T-cell activation, which seems to be a key component of the disease.¹³⁵ In one pivotal trial involving rheumatoid arthritis patients who had failed methotrexate, abatacept was equal in efficacy to infliximab but with less serious adverse events.¹³⁵

Rituximab is approved to treat CD20 B-cell-positive non-Hodgkin's lymphoma and in combination with methotrexate to reduce signs and symptoms in adults with moderately to severely active rheumatoid arthritis who have had an inadequate response to one or more TNF- α antagonists. It is a genetically engineered chimeric murine/human monoclonal antibody directed against the CD20 antigen on B lymphocytes, which when given by intravenous infusion can result in a selective depletion of these cells for many months.¹³⁸ Severe infusion reactions manifested by hypoxia, pulmonary infiltrates, MI, and death have been reported. The development of severe mucocutaneous reactions and the activation of the JC virus leading to progressive multifocal leukoencephalopathy have also been reported after rituximab infusions.

Anakinra is indicated to reduce signs and symptoms and to slow the progression of structural damage in moderately to severely active rheumatoid arthritis, in patients ≥ 18 years old who have failed one or more DMARDs. The drug is given subcutaneously once daily and can be used alone or in combination with DMARDs other than TNF- α -blocking agents. It is an interleukin-1 receptor antagonist. Adverse effects include transient injection site reactions, the development of respiratory tract infections including pneumonia, and headache and nausea.⁵⁴

Implications for Dentistry

Most rheumatoid arthritis patients presenting for dental care are receiving one or more DMARDs to slow the progression of their disease and invariably exhibit some degree of immunosuppression. Before any dental surgical procedure, consultation with the patient's rheumatologist is advised to discuss the need for a presurgical or postsurgical antibiotic course. In addition, patients with rheumatoid arthritis who have also had a prosthetic joint replacement may require a prophylactic antibiotic regimen that has been approved by the American Academy of Orthopedic Surgeons and the American Dental Association: either 2 g of amoxicillin, cephalexin, or cephadrine or, in penicillin-allergic individuals, 600 mg of clindamycin 1 hour before the procedure (see Chapter 49).³ All rheumatoid arthritis patients receiving DMARDs should maintain a high degree of oral hygiene to prevent the development of serious intraoral infections.

DRUGS USED TO TREAT GOUT

Gout is an inflammatory disease that stems from elevated concentrations of uric acid in blood and other body fluids. Such elevations may be the result of either increased production (metabolic gout) or decreased excretion (renal gout) of uric acid. Decreased excretion is usually the major contributing factor. Reduced elimination may be caused by an inability to excrete uric acid properly, resulting from renal disease or from certain drugs that reduce renal excretion of uric acid. Overproduction may be associated with a primary defect in purine metabolism, such as a deficiency in the enzyme phosphoribosyl transferase, or be caused by certain hematologic disorders, leukemias, cancer chemotherapy, or effects of ethanol.

Essentially all the clinical manifestations of gout derive from the precipitation of sodium urate from extracellular

fluids when and where it exceeds the limits of solubility. These manifestations can be divided into four categories: acute gouty arthritis, tophaceous deposits (sodium urate deposits in cartilage, bone, bursae, and subcutaneous tissue in and around joints), uric acid nephrolithiasis, and gouty kidney with various degrees of impairment of renal function. Of all these, gouty arthritis is most frequently the first clinical manifestation of the disease. Intensive study of the mechanism of gouty arthritis has shown it to be an inflammatory reaction to sodium urate microcrystals deposited in synovial fluid. Precisely how these crystals initiate inflammation is unknown. The generation of reactive oxygen species has been proposed.^{65,162} The crystals can activate Hageman factor and in this way initiate the chain of events leading to bradykinin formation.

Numerous neutrophils accumulate in the synovium, possibly because of a chemotactic effect of uric acid. These neutrophils actively phagocytize urate crystals, leading to release of lysosomal enzymes and increased lactic acid production. Both these events tend to propagate the inflammatory response, the former by damaging tissue and the latter by lowering the local pH and fostering further urate deposition. A glycoprotein released by neutrophils after the ingestion of urate crystals has been shown to replicate the histopathologic characteristics of gout on injection into normal joints.

Although the overall pathogenesis of gouty arthritis is understood, many specific events are still obscure. It is known that acute gouty arthritis often follows a precipitating event. Surgery, injury, alcohol ingestion, dietary excess, emotional crisis, or even the minor stress of walking can elicit an acute attack, but it is unknown how these events are related to urate crystal deposition. Another unknown is the reason why less than 10% of gout occurs in women.

Acute gouty arthritis is clinically characterized by severe inflammation of the joint and periarticular tissues. One or several joints may be involved simultaneously, as shown by marked swelling, redness, heat, and intense pain. Lymphadenitis is occasionally present. There may also be systemic signs of inflammation, including fever, leukocytosis, and an increased erythrocyte sedimentation rate. Without treatment, the arthritis gradually subsides over 1 to 2 weeks. The rate of recurrence varies after an initial attack, but in most patients recurrence is common, usually within 1 year. With increasing age, the incidence of attacks increases, as does the severity, duration of inflammation, and number of joints affected. In

time, the patient may rarely be free of gouty arthritis, and the pain, swelling, and stiffness can result in total and permanent disability.

The treatment of gout may involve multiple agents acting at different sites and having distinctly different objectives. Because the pathologic manifestations of the disease result from an elevated extracellular uric acid titer, a rational therapeutic maneuver is to reduce urate concentrations. Two approaches toward this end are currently available: the use of uricosuric drugs to increase renal urate clearance and the use of allopurinol to inhibit urate synthesis.

The uricosuric agents most often used are probenecid and sulfipyrazone (Figure 21-17). Both of these anionic compounds can enhance urate retention by blocking its renal tubular secretion or by participating in an anion exchange reaction with urate. At higher doses, these agents block the quantitatively more important process of tubular reabsorption of urate, increasing the urinary excretion of uric acid and decreasing plasma urate concentrations. Uricosuric drugs are used primarily in chronic gout to prevent the formation of new tophi and slowly to mobilize urate deposits in old lesions. They are not useful in treating attacks of gouty arthritis because mobilization of previously deposited urates may initially increase the severity of the attack. The use of uricosuric drugs may lead to the formation of renal urate stones in the presence of a high plasma uric acid concentration.

Maintenance of an alkaline diuresis during therapy with uricosuric agents is important. The pK_a of uric acid is 5.6, and the solubility of the nonionized form is low. An alkaline environment minimizes intrarenal deposition. Probenecid and sulfipyrazone are initially given in low doses, which are gradually increased until the desired serum urate concentration is obtained (usually 6 mg/dL); a maintenance dose is then established. Both drugs are generally well tolerated. The most common adverse effects are GI disturbances and allergic reactions ranging from dermatitis to anaphylaxis. Although the salicylates are uricosuric at high doses, they are no longer used for this purpose. Because salicylates at ordinary doses may decrease urate excretion (see Table 21-4), they should be used cautiously in patients with gout.

Allopurinol (see Figure 21-17) and its metabolite alloxanthine (oxypurinol) are inhibitors of the enzyme xanthine oxidase. Most of the effect on uric acid seems to be caused by alloxanthine because it has a considerably longer half-life

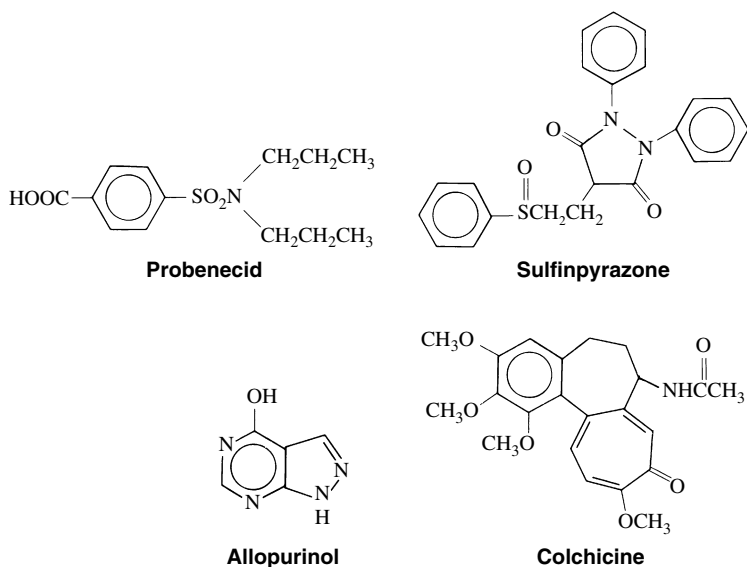

FIGURE 21-17 Drugs used in the prevention and treatment of gout.

than allopurinol. Also, although allopurinol is a competitive inhibitor, alloxanthine is a noncompetitive inhibitor of xanthine oxidase, with a higher potency than allopurinol. Xanthine oxidase catalyzes the oxidation of hypoxanthine to xanthine and then to uric acid. The action of allopurinol is to reduce the biosynthesis of uric acid and lower blood and urine concentrations. The uric acid precursors do not accumulate in body fluids because they are sufficiently cleared by the kidney.

Similar to the uricosuric agents, allopurinol is indicated for chronic rather than acute gout. It may be preferred in the more severe forms over the uricosuric agents. As with the uricosuric agents, allopurinol may initially increase the number of acute attacks of gouty arthritis, unless colchicine prophylaxis, as described subsequently, is used. The toxic effects of allopurinol include allergic reactions involving the skin (e.g., exfoliative, urticarial, and purpuric lesions) and blood (e.g., leukopenia, thrombocytopenia, agranulocytosis). There is a modest incidence of gastric irritation. Febuxostat, a new xanthine oxidase inhibitor, has been approved recently by the FDA. In one clinical trial comparing it with allopurinol, it was more effective in lowering serum urate concentrations than standard daily doses of allopurinol.¹⁴ It was not compared to allopurinol used in doses adjusted to ensure optimal clinical effect. Because febuxostat is inactivated in the liver, it may be the preferred drug in patients with renal impairment.

In addition to efforts aimed at reducing the extracellular uric acid concentration, another aspect of therapy for gout is management of acute arthritis. This goal entails the short-term use of anti-inflammatory agents, some of which (indomethacin, naproxen, and sulindac) have already been described. Although these drugs have no specific actions in gouty arthritis, they can effectively relieve the pain, tenderness, and swelling in affected joints.

The most widely used drug to treat severe gouty arthritis is colchicine, a plant alkaloid with a long history of use in gout (see Figure 21-17). When given at the first indication of an attack, colchicine effects a striking reduction of the emerging signs and symptoms of arthritis. Pain begins to disappear within 4 to 12 hours after oral medication and is completely gone after 24 to 48 hours. Intravenous administration leads to a more rapid onset of action and is preferred for some patients. Colchicine is relatively specific for this condition; the drug has little effect on other inflammatory conditions, and it does not have inherent analgesic properties. Colchicine may also be given prophylactically to prevent recurrent attacks.

The anti-inflammatory effects of colchicine are believed to derive from its well-known antimetabolic activity. It arrests mitosis in metaphase by binding to microtubular protein and preventing spindle formation. By a similar action, colchicine disrupts fibrillar microtubules in neutrophils and other motile cells. The involvement of the microtubular system in cell locomotion could explain colchicine's inhibition of neutrophil migration and phagocytic activity in inflamed joints.⁵ This action is thought to inhibit the neutrophil's engulfment of uric acid crystals, preventing the subsequent release of destructive lysosomal enzymes into the extracellular environment.

Colchicine is rapidly absorbed from the GI tract. The drug is partially metabolized in the liver, and the metabolites and unchanged drug are excreted in the feces for 10 days after a single dose. This finding may explain why the GI tract is a frequent site of adverse reactions.

The most common untoward effects of colchicine are nausea, vomiting, and diarrhea. Diarrhea is an important sign because it may signal more serious toxic reactions, such as hemorrhagic gastroenteritis. The GI effects of colchicine may result from direct toxicity to intestinal mucosal cells. Long-term use of colchicine may lead to bone marrow depression, myopathy, and alopecia.

NSAIDS, ANALGESIC COMBINATIONS, AND ANTIRHEUMATIC AND ANTIGOUT DRUGS

<i>Nonproprietary (generic) name</i>	<i>Proprietary (trade) name</i>
Salicylates*	
Choline magnesium trisalicylate	Trilisate
Choline salicylate	Arthropan
Magnesium salicylate	Magan, Mobidin
Salsalate	Amigesic, Disalcid
Sodium salicylate	—
Sodium thiosalicylate	Asproject, Rexolate
Other NSAIDs*	
Celecoxib	Celebrex
Diclofenac	Voltaren
Flurbiprofen	Ansaid
Indomethacin	Indocin
Meloxicam	Mobic
Nabumetone	Relafen
Oxaprozin	Daypro
Phenylbutazone [†]	Butazolidin
Piroxicam	Feldene
Sulindac	Clinoril
Tolmetin	Tolectin
Analgesic combinations	
See Table 21-7	
Other antirheumatic drugs	
Abatacept	Orencia
Adalimumab	Humira
Anakinra	Kineret
Auranofin	Ridaura
Aurothioglucose	Solganal
Azathioprine	Imuran
Chloroquine	Aralen
Cyclophosphamide	Cytoxan
Cyclosporine	Sandimmune
Etanercept	Enbrel
Gold sodium thiomalate	Aurolate, Myochrysin
Hydroxychloroquine	Plaquenil
Infliximab	Remicade
Leflunomide	Arava
Methotrexate	Rheumatrex
Penicillamine	Cuprimine
Rituximab	Rituxan
Sulfasalazine	Azulfidine
Antigout drugs	
Allopurinol	Zyloprim
Colchicine	—
Probenecid	Benemid
Febuxostat	Uloric
Sulfapyrazone	Anturane

*See also Table 21-6.

[†]Not currently available in the United States.

CITED REFERENCES

- Allison AC: Role of macrophage activation in the pathogenesis of chronic inflammation and its pharmacological control. *Adv Inflamm Res* 7:201–221, 1984.
- American College of Rheumatology Subcommittee on Osteoarthritis Guidelines: Recommendations for the medical management of osteoarthritis of the hip and knee. *Arthritis Rheum* 43:1903–1915, 2000.
- American Dental Association; American Academy of Orthopedic Surgeons: Antibiotic prophylaxis for dental patients with total joint replacements. *J Am Dent Assoc* 134:895–899, 2003.
- Antiplatelet Trialists' Collaboration: Collaborative overview of randomised trials of antiplatelet therapy, I: prevention of death, myocardial infarction, and stroke by prolonged antiplatelet therapy in various categories of patients. *BMJ* 308:81–106, 1994.
- Asako H, Kubes P, Baethge BA, et al: Colchicine and methotrexate reduce leukocyte adherence and emigration in rat mesenteric venules. *Inflammation* 16:45–56, 1992.
- Aylward JM: Hydroxychloroquine and chloroquine: assessing the risk of retinal toxicity. *J Am Optom Assoc* 64:787–797, 1993.
- Baldassarre S, Schandene L, Choufani G, et al: Asthma attacks induced by low doses of celecoxib, aspirin, and acetaminophen. *J Allergy Clin Immunol* 117:215–217, 2006.
- Bannwarth B, Labat L, Moride Y, et al: Methotrexate in rheumatoid arthritis: an update. *Drugs* 47:25–50, 1994.
- Bansal V, Dex T, Proskin H, et al: A look at the safety profile of over-the-counter naproxen sodium: a meta-analysis. *J Clin Pharmacol* 41:127–138, 2001.
- Barden J, Edwards JE, McQuay HJ, et al: Relative efficacy of oral analgesics after third molar extraction. *Br Dent J* 197:407–411, 2004.
- Battistella M, Mamdami MM, Juurlink DN, et al: Risk of upper gastrointestinal hemorrhage in warfarin users treated with non-selective NSAIDs or COX-2 inhibitors. *Arch Intern Med* 165:189–192, 2005.
- Beaver WT: Mild analgesics: a review of their clinical pharmacology. *Am J Med Sci* 250:577–604, 1965.
- Beaver WT, Wallenstein SL, Rogers A, et al: Analgesic studies of codeine and oxycodone in patients with cancer, part I. *J Pharmacol Exp Ther* 207:92–100, 1978.
- Becker MA, Schumacher HR Jr, Wortmann RL, et al: Febuxostat compared with allopurinol in patients with hyperuricemia and gout. *N Engl J Med* 353:2450–2461, 2005.
- Björkman R, Hallman KM, Hedner T, et al: Acetaminophen blocks spinal hyperalgesia induced by NMDA and substance P. *Pain* 57:259–264, 1994.
- Bombardier C, Laine L, Reicin A, et al: Comparison of upper gastrointestinal toxicity of rofecoxib and naproxen in patients with rheumatoid arthritis. *N Engl J Med* 343:1520–1528, 2000.
- Brater DC: Effects of nonsteroidal anti-inflammatory drugs on renal function: focus on cyclooxygenase-2-selective inhibition. *Am J Med* 107:65S–70S, 1999.
- Brenner BE, Simon RR: Management of salicylate intoxication. *Drugs* 24:335–340, 1982.
- Bresalier RS, Sandler RS, Quan H, et al: Cardiovascular events associated with rofecoxib in colorectal adenoma chemoprevention trial. *N Engl J Med* 352:1092–1102, 2005.
- Breivik EK, Barkvoll P, Skovlund E: Combining diclofenac with acetaminophen or acetaminophen-codeine after oral surgery: a randomized, double-blind single-dose study. *Clin Pharmacol Ther* 66:625–635, 1999.
- Brooks PM, Day RO: Nonsteroidal anti-inflammatory drugs—differences and similarities. *N Engl J Med* 324:1716–1725, 1991.
- Burka JF, Paterson NAM: Evidence for lipoxygenase pathway involvement in allergic tracheal contraction. *Prostaglandins* 19:499–515, 1980.
- Catella-Lawson F, Reilly MP, Kapoor SC, et al: Cyclooxygenase inhibitors and the antiplatelet effects of aspirin. *N Engl J Med* 345:1809–1817, 2001.
- Cheung R, Krishnaswami S, Kowalski K: Analgesic efficacy of celecoxib in postoperative oral surgery pain: a single-dose, two-center, randomized, double-blind, active- and placebo-controlled study. *Clin Ther* 29(Suppl 2):498–510, 2007.
- Cohen S, Rustein J, Luggen M, et al: Comparison of the safety and efficacy of cyclosporine A and methotrexate in refractory rheumatoid arthritis: a randomized, multicentered, placebo-controlled trial. *Arthritis Rheum* 36:S56, 1993.
- Cooper SA: The relative efficacy of ibuprofen in dental pain. *Compend Cont Ed Dent* 7:578–588, 1986.
- Cooper SA, Beaver WT: A model to evaluate mild analgesics in oral surgery outpatients. *Clin Pharmacol Ther* 20:241–250, 1976.
- Cooper SA, Berrie R, Cohn P: Comparison of ketoprofen, ibuprofen, and placebo in a dental surgery model. *Adv Ther* 5:43–53, 1988.
- Cooper SA, Breen JF, Giuliani RL: Replicate studies comparing the relative efficacies of aspirin and indoprofen in oral surgery outpatients. *J Clin Pharmacol* 19:151–159, 1979.
- Cooper SA, Breen JF, Giuliani RL: The relative efficacy of indoprofen compared with opioid-analgesic combinations. *J Oral Surg* 39:21–25, 1981.
- Cooper SA, Engel J, Ladov M, et al: Analgesic efficacy of an ibuprofen-codeine combination. *Pharmacotherapy* 2:162–167, 1982.
- Cooper SA, Firestein A, Cohn P: Double-blind comparison of meclizolam sodium with acetaminophen, acetaminophen with codeine, and placebo for relief of postsurgical dental pain. *J Clin Dent* 1:31–34, 1988.
- Cooper SA, Hersh EV, Betts NJ, et al: Multidose analgesic study of two mefenamic acid formulations in a postsurgical dental pain model. *Analgesia* 1:65–71, 1994.
- Cooper SA, Needle SE, Kruger GO: Comparative analgesic potency of aspirin and ibuprofen. *J Oral Surg* 35:898–903, 1977.
- Cooper SA, Precheur H, Rauch D, et al: Evaluation of oxycodone and acetaminophen in treatment of postoperative dental pain. *Oral Surg Oral Med Oral Pathol* 50:496–501, 1980.
- Crofford LJ: COX-1 and COX-2 tissue expression: implications and predictions. *J Rheumatol* 24(Suppl 49):15–19, 1997.
- Cryer B, Berlin RG, Cooper SA, et al: Double-blind, randomized, parallel, placebo-controlled study of ibuprofen effects on thromboxane B2 concentrations in aspirin-treated healthy adult volunteers. *Clin Ther* 27:185–191, 2005.
- Cuzzocrea S: Role of nitric oxide and reactive oxygen species in arthritis. *Curr Pharm Res* 12:3551–3570, 2006.
- Dahlen SE, Hedqvist P, Hammarström S, et al: Leukotrienes are potent vasoconstrictors of human bronchi. *Nature* 288:484–486, 1980.
- Dane AK: Treatment of fever in 1982: a review. *Am J Med* 74(Suppl):27–35, 1983.
- Daniels SE, Desjardins PJ, Talwalker S, et al: The analgesic efficacy of valdecoxib vs. oxycodone/acetaminophen after oral surgery. *J Am Dent Assoc* 133:611–621, 2002.
- Davies P, Bailey PJ, Goldenberg MM, et al: The role of arachidonic acid oxygenation products in pain and inflammation. *Annu Rev Immunol* 2:335–357, 1984.
- Day R, Morrison B, Luza A, et al: A randomized trial of the efficacy and tolerability of the COX-2 inhibitor rofecoxib vs. ibuprofen in patients with osteoarthritis. Rofecoxib/Ibuprofen Comparator Study Group. *Arch Intern Med* 160:1781–1787, 2000.
- Department of Health and Human Services, Food and Drug Administration: Internal analgesic, antipyretic, and antirheumatic drug products for over-the-counter human use; final rule for professional labeling of aspirin, buffered aspirin, and aspirin in combination with antacid drug products. *Fed Reg* 63:56802–56819, 1998.
- Desjardins PJ, Cooper SA, Mardirossian G: Meclizolam sodium in dental pain. *Clin Pharmacol Ther* 41:212, 1987.
- Dionne RA, Cooper SA: Delaying the onset of postoperative dental pain by pretreatment with ibuprofen. *Oral Surg Oral Med Oral Pathol* 45:851–856, 1978.
- Dubois RN, Abramson SB, Crofford L, et al: Cyclooxygenase in biology and disease. *FASEB J* 12:1063–1073, 1998.
- Eberhart CE, Coffey RJ, Radhika A, et al: Up-regulation of cyclooxygenase 2 gene expression in human colorectal adenomas and adenocarcinomas. *Gastroenterology* 107:1183–1188, 1994.

49. Ehrlich EW, Dallob A, De Lepeleire I, et al: Characterization of rofecoxib as a cyclooxygenase-2 isoform inhibitor and demonstration of analgesia in the dental pain model. *Clin Pharmacol Ther* 65:336-347, 1999.
50. Emery P, Zeidler H, Kvein TK, et al: Celecoxib versus diclofenac in long-term management of rheumatoid arthritis: randomised double-blind comparison. *Lancet* 354:2106-2111, 1999.
51. Endres S, van der Meer JWM, Dinarello CA: Interleukin-1 in the pathogenesis of fever. *Eur J Clin Invest* 17:469-474, 1987.
52. Engelhardt G: Pharmacology of meloxicam, a new non-steroidal anti-inflammatory drug with an improved safety profile through preferential inhibition of COX-2. *Br J Rheumatol* 35(Suppl 1):4-12, 1996.
53. Ferriera SH, Vane JR: New aspects of the mode of action of nonsteroid anti-inflammatory drugs. *Annu Rev Pharmacol* 14:57-73, 1974.
54. Fleischmann RM, Tesser J, Schiff MH, et al: Safety of extended treatment with anakinra in patients with rheumatoid arthritis. *Ann Rheum Dis* 65:1006-1012, 2006.
55. Flower RJ, Blackwell GJ: The importance of phospholipase-A2 in prostaglandin biosynthesis. *Biochem Pharmacol* 25:285-291, 1976.
56. Forbes JA, Beaver WT, Jones KF, et al: Effect of caffeine on ibuprofen analgesia in postoperative oral surgery pain. *Clin Pharmacol Ther* 49:674-684, 1991.
57. Forbes JA, Beaver WT, White H, et al: Diflunisal: a new oral analgesic with an unusually long duration of action. *JAMA* 248:2139-2142, 1982.
58. Forbes JA, Butterworth GA, Burchfield WH, et al: Evaluation of ketorolac, aspirin, and an acetaminophen-codeine combination in postoperative oral surgery pain. *Pharmacotherapy* 10(6 Pt 2):77S-93S, 1990.
59. Forbes JA, Kolodny AL, Beaver WT, et al: A 12-hour evaluation of the analgesic efficacy of diflunisal, acetaminophen, an acetaminophen-codeine combination, and placebo in postoperative pain. *Pharmacotherapy* 3(2 Pt 2):47S-54S, 1983.
60. Ford-Hutchinson AW, Bray MA, Doig MV, et al: Leukotriene B₂, a potent chemokinetic and aggregating substance released from polymorphonuclear leukocytes. *Nature* 286:264-265, 1980.
61. Fricke J, Halladay SC, Bynum L, et al: Pain relief after dental impaction surgery using ketorolac, hydrocodone plus acetaminophen, or placebo. *Clin Ther* 15:500-508, 1993.
62. Fricke JR, Halladay SC, Francisco CA: Efficacy and safety of naproxen sodium and ibuprofen for pain relief after oral surgery. *Curr Ther Res* 54:619-627, 1993.
63. Fricke JR Jr, Angelocci D, Fox K, et al: Comparison of the efficacy and safety of ketorolac and meperidine in the relief of dental pain. *J Clin Pharmacol* 32:376-384, 1992.
64. Gaston GW, Mallow RD, Frank JE: Comparison of etodolac, aspirin and placebo for pain after oral surgery. *Pharmacotherapy* 6:199-205, 1986.
65. Ghio AJ, Kennedy TP, Rao G, et al: Complexation of iron cation by sodium urate crystals and gouty inflammation. *Arch Biochem Biophys* 313:215-221, 1994.
66. Giugliano D, Ceriello A, Saccomanno F, et al: Effect of salicylate, tolbutamide, and prostaglandin E2 on insulin responses to glucose in noninsulin-dependent diabetes mellitus. *J Clin Endocrinol Metab* 61:160-166, 1985.
67. Glaser K, Sung ML, O'Neill K, et al: Etodolac selectively inhibits prostaglandin G/H synthetase 2 (PGHS-2) versus human PGHS-1. *Eur J Pharmacol* 281:107-111, 1995.
68. Greenberg HE, Gottesdiener K, Huntington M, et al: A new cyclooxygenase-2 inhibitor, rofecoxib (VIOXX), did not alter the antiplatelet effects of low-dose aspirin in healthy volunteers. *J Clin Pharmacol* 40:1509-1515, 2000.
69. Gruber CM Jr: Clinical pharmacology of fenoprofen: a review. *J Rheumatol* 3(Suppl 2):8-17, 1976.
70. Haas DA: Adverse drug interactions in dental practice: interactions associated with analgesics. Part I in a series. *J Am Dent Assoc* 130:397-407, 1999.
71. Hamberg M: Inhibition of prostaglandin synthesis in man. *Biochem Biophys Res Commun* 49:720-726, 1972.
72. Hawkey C, Kahan A, Steinbruck K, et al: Gastrointestinal tolerability of meloxicam compared to diclofenac in osteoarthritis patients. International MELISSA Study Group. MELoxicam Large-scale International Study Safety Assessment. *Br J Rheumatol* 37:937-945, 1998.
73. Hennekens CH, Buring JE, Sandercock P, et al: Aspirin and other antiplatelet agents in the secondary and primary prevention of cardiovascular disease. *Circulation* 80:749-756, 1989.
74. Henriskson P, Thilander H, Wahlander LA: Absorption and effect of diclofenac-sodium after surgical removal of a lower wisdom tooth. *Curr Ther Res Clin Exp* 31:20-26, 1982.
75. Hersh EV: Adverse drug interactions in dental practice: interactions involving antibiotics. Part I of a series. *J Am Dent Assoc* 130:236-251, 1999.
76. Hersh EV, Cooper SA, Betts N, et al: Single dose and multidose study of ibuprofen and meclofenamate sodium after third molar surgery. *Oral Surg Oral Med Oral Pathol* 76:680-687, 1993.
77. Hersh EV, Lally ET, Moore PA: Update on cyclooxygenase inhibitors: has a third COX isoform entered the fray? *Curr Med Res Opin* 21:1217-1226, 2005.
78. Hersh EV, Levin LM, Adamson D, et al: Dose-ranging analgesic study of ProSorb diclofenac potassium in postsurgical dental pain. *Clin Ther* 26:1215-1227, 2004.
79. Hersh EV, Levin LM, Cooper SA, et al: Conventional and extended-release etodolac for postsurgical dental pain. *Clin Ther* 21:1333-1342, 1999.
80. Hersh EV, Levin LM, Cooper SA, et al: Ibuprofen liquigel for oral surgery pain. *Clin Ther* 22:1306-1318, 2000.
81. Hersh EV, Moore PA, Ross GL: Over-the-counter analgesics and antipyretics: a critical assessment. *Clin Ther* 22:500-548, 2000.
82. Hersh EV, Pinto A, Moore PA: Adverse drug interactions involving common prescription and over-the-counter analgesic agents. *Clin Ther* 29(Suppl 2):2477-2497, 2007.
83. Hochberg MC: Auranofin or D-penicillamine in the treatment of rheumatoid arthritis. *Ann Intern Med* 105:528-535, 1986.
84. Hurwitz ES: Reyes syndrome. *Epidemiol Rev* 11:249-253, 1989.
85. Hurwitz ES, Barrett MJ, Bregman D, et al: Public Health Service study of Reye's syndrome and medications: report of main study. *JAMA* 257:1905-1911, 1987.
86. Jeffcoat MK, Williams RC, Reddy MS, et al: Flurbiprofen treatment of human periodontitis: effect on alveolar bone height and metabolism. *J Periodontol Res* 23:381-385, 1988.
87. Jeurissen ME, Boerbooms AM, van de Putte LB, et al: Methotrexate versus azathioprine in the treatment of rheumatoid arthritis: a forty-eight week, randomized, double-blind trial. *Arthritis Rheum* 34:961-972, 1991.
88. Johnson AG, Nguyen TV, Day RO: Do nonsteroidal anti-inflammatory drugs affect blood pressure? A meta analysis. *Ann Intern Med* 121:289-300, 1994.
89. Kellstein DE, Waksman JA, Furey SA, et al: The safety profile of nonprescription ibuprofen in multiple-dose use: a meta-analysis. *J Clin Pharmacol* 39:520-532, 1999.
90. Kierch TA, Halladay SC, Hormel PC: A single-dose, double-blind comparison of naproxen sodium, acetaminophen, and placebo in postoperative dental pain. *Clin Ther* 16:394-404, 1994.
91. Kierch TA, Halladay SC, Koschick MS: A double-blind, randomized study of naproxen sodium, ibuprofen, and placebo in postoperative dental pain. *Clin Ther* 15:845-854, 1993.
92. Kleinent H, Paulz A, Linker K, et al: Regulation of the expression of inducible nitric oxide synthetase. *Eur J Pharmacol* 500:255-266, 2004.
93. Knijff-Dutmer EAJ, Kalsbeek-Batenburg EM, Koerts J, et al: Platelet function is inhibited by non-selective non-steroidal anti-inflammatory drugs but not by cyclo-oxygenase-2-selective inhibitors in patients with rheumatoid arthritis. *Rheumatology* 41:458-461, 2002.
94. Korhonen R, Lahti A, Hämäläinen M, et al: Dexamethasone inhibits inducible nitric oxide synthetase expression and nitric oxide production by destabilizing mRNA in lipopolysaccharide-treated macrophages. *Mol Pharmacol* 62:698-704, 2002.
95. Kulios G, Valatas V, Ward SG: Nitric oxide in inflammatory bowel disease, a universal messenger in an unsolved puzzle. *Immunology* 113:427-437, 2004.
96. Landewe RB, Miltenberg AM, Verdonk MJ, et al: Chloroquine inhibits T cell proliferation by interfering with IL-2 production and responsiveness. *Clin Exp Immunol* 102:144-151, 1995.

97. Laska EM, Sunshine A, Mueller F, et al: Caffeine as an analgesic adjuvant. *JAMA* 251:1711–1718, 1984.
98. Lecomte M, Laneuville O, Ji C, et al: Acetylation of human prostaglandin endoperoxide synthase-2 (cyclooxygenase-2) by aspirin. *J Biol Chem* 269:13207–13215, 1994.
99. Leese PT, Hubbard RC, Karim A, et al: Effects of celecoxib, a novel cyclooxygenase-2 inhibitor, on platelet function in healthy adults: a randomized, controlled trial. *J Clin Pharmacol* 40:124–132, 2000.
100. Leonards JR: The influence of solubility on the rate of gastrointestinal absorption of aspirin. *Clin Pharmacol Ther* 4:476–479, 1963.
101. Levy DA: Histamine and serotonin. In Weissman G, editor: *Mediators of inflammation*, New York, 1974, Plenum Press.
102. Levy G, Leonards JR: Absorption, metabolism, and excretion of salicylates. In Smith MJH, Smith PK, editors: *The salicylates*, New York, 1966, Interscience.
103. Lewis RA, Austen KF: The biologically active leukotrienes: biosynthesis, metabolism, receptors, functions, and pharmacology. *J Clin Invest* 73:889–897, 1984.
104. Linnemann CC, Shea L, Partin JC, et al: Epidemiologic and viral studies 1963–1974. *Am J Epidemiol* 101:517–526, 1975.
105. Loll PJ, Picot D, Garavito RM: The structural basis of aspirin activity inferred from the crystal structure of inactivated prostaglandin H2 synthase. *Nat Struct Biol* 2:637–643, 1995.
106. Malmberg AB, Yaksh TL: Antinociceptive actions of spinal nonsteroidal anti-inflammatory agents on the formalin test in the rat. *J Pharmacol Exp Ther* 263:136–146, 1992.
107. Malmstern CL: Prostaglandins, thromboxanes, and leukotrienes in inflammation. *Semin Arthritis Rheum* 15(2 Suppl 1):29–35, 1985.
108. Malmstrom K, Daniels S, Kotey P, et al: Comparison of rofecoxib and celecoxib, two cyclooxygenase-2 inhibitors, in postoperative dental pain: a randomized, placebo- and active-comparator-controlled clinical trial. *Clin Ther* 21:1653–1663, 1999.
109. Mardirossian G, Cooper SA: Comparison of flurbiprofen and aspirin for postsurgical dental pain. *J Oral Maxillofac Surg* 43:106–109, 1985.
110. McCormack K: The spinal actions of nonsteroidal anti-inflammatory drugs and the dissociation between their anti-inflammatory and analgesic effects. *Drugs* 47(Suppl 5):28–45, 1994.
111. Menkes CJ: Effects of disease-modifying anti-rheumatic drugs, steroids and non-steroidal anti-inflammatory drugs on acute-phase proteins in rheumatoid arthritis. *Br J Rheumatol* 23(Suppl 3):14–18, 1993.
112. Moertel CG, Ahmann DL, Taylor WF, et al: A comparative evaluation of marketed analgesic drugs. *N Engl J Med* 286:813–815, 1972.
113. Moertel CG, Ahmann DL, Taylor WF, et al: Relief of pain by oral medications: a controlled evaluation of analgesic combinations. *JAMA* 229:55–59, 1974.
114. Moore PA, Hersh EV: Celecoxib and rofecoxib: the role of COX-2 inhibitors in dental practice. *J Am Dent Assoc* 132:451–456, 2001.
115. Moore UJ, Seymour RA, Rawlins MD: The efficacy of locally applied aspirin and acetaminophen in postoperative pain after third molar surgery. *Clin Pharmacol Ther* 52:292–296, 1992.
116. Morrison BW, Christensen S, Yuan W, et al: Analgesic efficacy of the cyclooxygenase-2-specific inhibitor rofecoxib in post-dental surgery pain: a randomized, controlled trial. *Clin Ther* 21:943–953, 1999.
117. Murray MD, Brater DC: Renal toxicity of the nonsteroidal anti-inflammatory drugs. *Annu Rev Pharmacol Toxicol* 33:435–465, 1993.
118. Neustadt DH: Double blind evaluation of the long-term effects of etodolac versus ibuprofen in patients with rheumatoid arthritis. *J Rheumatol* 47(Suppl):17–22, 1997.
119. Nussmeier NA, Whelton AA, Brown MT, et al: Complications of the COX-2 inhibitors parecoxib and valdecoxib after cardiac surgery. *N Engl J Med* 352:1081–1091, 2005.
120. Oates JA, Fitzgerald GA, Branch RA, et al: Clinical implications of prostaglandin and thromboxane A2 formation. *N Engl J Med* 319:761–767, 1988.
121. O'Brien TP, Roszkowski MT, Wolff LF, et al: Effect of a nonsteroidal anti-inflammatory drug on tissue levels of immunoreactive prostaglandin E2, immunoreactive leukotriene B4, and pain after periodontal surgery. *J Periodontol* 67:1307–1316, 1996.
122. O'Hara DA, Fragen RJ, Kinzer M, et al: Ketorolac tromethamine as compared with morphine sulfate for treatment of postoperative pain. *Clin Pharmacol Ther* 41:556–561, 1987.
123. O'Neill GP, Mancini JA, Kargman S, et al: Overexpression of human prostaglandin G/H synthase-1 and -2 by recombinant vaccinia virus: inhibition by nonsteroidal anti-inflammatory drugs and biosynthesis of 15-hydroxyeicosatetraenoic acid. *Mol Pharmacol* 45:245–254, 1994.
124. Patrono C, Collier B, Dalen JE, et al: Platelet-active drugs: the relationships among dose, effectiveness and side effects. *Chest* 119(1 Suppl):39S–63S, 2001.
125. Pedersen AK, Fitzgerald GA: Dose-related kinetics of aspirin, presystemic acetylation of platelet cyclooxygenase. *N Engl J Med* 311:1206–1211, 1984.
126. Reye RDK, Morgan G, Baral J: Encephalopathy and fatty degeneration. *Lancet* 2:749–752, 1963.
127. Ricciardolo FL, Sterk PJ, Gaston B, et al: Nitric oxide in health and disease of the respiratory system. *Physiol Rev* 84:731–765, 2004.
128. Riendeau D, Percival MD, Brideau C, et al: Etoricoxib (MK-0663): preclinical profile and comparison with other agents that selectively inhibit cyclooxygenase-2. *J Pharmacol Exp Ther* 296:558–566, 2001.
129. Roszkowski MT, Swift JQ, Hargreaves KM: Effect of NSAID administration on tissue levels of immunoreactive prostaglandin E2, leukotriene B4, and (S)-flurbiprofen following extraction of impacted third molars. *Pain* 73:339–345, 1997.
130. Roth GJ, Majerus PW: The mechanism of the effect of aspirin on human platelets. I: acetylation of a particulate fraction protein. *J Clin Invest* 56:624–632, 1975.
131. Rumack BH: Acetaminophen hepatotoxicity: the first 35 years. *Clin Toxicol* 40:3–20, 2002.
132. Samuelsson B, Hammarström S: Leukotrienes: a novel group of biologically active compounds. *Vitam Horm* 39:1–30, 1982.
133. Sareila O, Hämäläinen M, Nissinen E, et al: Orazipone inhibits activation of inflammatory transcription factor NF- κ B and STAT1 and decreases nitric oxide production in response to inflammatory stimuli. *J Pharmacol Exp Ther* 324:858–866, 2008.
134. Sawynok J, Yaksh TL: Caffeine as an analgesic adjuvant: a review of pharmacology and mechanisms of action. *Pharmacol Rev* 45:43–85, 1993.
135. Schiff M, Keiserman M, Codding C, et al: Efficacy and safety of abatacept or infliximab versus placebo in ATTEST: a phase III, multi-centre, randomised, double-blind, placebo-controlled study in patients with rheumatoid arthritis and an inadequate response to methotrexate. *Ann Rheum Dis* 67:1096–1103, 2008.
136. Schnitzer TJ: Osteoarthritis management: the role of cyclooxygenase-2-selective inhibitors. *Clin Ther* 23:313–326, 2001.
137. Schitnizer TJ, Burmester GR, Mysler E, et al: Comparison of lumiracoxib with naproxen and ibuprofen in the Therapeutic Arthritis Research and Gastrointestinal Event Trial (TARGET), reduction in ulcer complications: randomized controlled trial. *Lancet* 364:665–674, 2004.
138. Schuna AA: Rituximab for the treatment of rheumatoid arthritis. *Pharmacotherapy* 27:1702–1710, 2007.
139. Schwartz LB: The mast cell. In Ruddy S, Harris ED Jr, Sledge CB, et al, editors: *Kelley's textbook of rheumatology*, ed 5, Philadelphia, 2001, Saunders.
140. Serebruany VL: Selective serotonin reuptake inhibitors and increased bleeding risk: are we missing something? *Am J Med* 119:113–116, 2006.
141. Siegel SA, Shealy DJ, Nakada MT, et al: The mouse/human chimeric monoclonal antibody cA2 neutralizes TNF in vitro and protects transgenic mice from cachexia and TNF lethality in vivo. *Cytokine* 7:15–25, 1995.
142. Sigler JW, Bluhm GB, Duncan H, et al: Gold salts in the treatment of rheumatoid arthritis: a double-blind study. *Ann Intern Med* 80:21–26, 1974.
143. Silverstein FE, Faich G, Goldstein JL, et al: Gastrointestinal toxicity with celecoxib vs. nonsteroidal anti-inflammatory drugs for osteoarthritis and rheumatoid arthritis: the CLASS study—a randomized controlled trial. *JAMA* 284:1247–1255, 2000.

144. Silverstein FE, Graham DY, Senior JR, et al: Misoprostol reduces serious gastrointestinal complications in patients with rheumatoid arthritis receiving nonsteroidal anti-inflammatory drugs: a randomized, double-blind, placebo-controlled trial. *Ann Intern Med* 123:241–249, 1995.
145. Simon LS, Weaver AL, Graham DY, et al: Anti-inflammatory and upper gastrointestinal effects of celecoxib in rheumatoid arthritis: a randomized controlled trial. *JAMA* 282:1921–1928, 1999.
146. Singh G: Recent considerations in nonsteroidal anti-inflammatory drug gastropathy. *Am J Med* 105(1B):31S–38S, 1998.
147. Slattery JT, Nelson SD, Thummel KE: The complex interaction between ethanol and acetaminophen. *Clin Pharmacol Ther* 60:241–246, 1996.
148. Smith JB, Willis AL: Aspirin selectively inhibits prostaglandin production in human platelets. *Nature* 231:235–237, 1971.
149. Smith WL, DeWitt DL: Biochemistry of prostaglandin endoperoxide H synthetase-1 and synthetase-2 and their differential susceptibility to nonsteroidal anti-inflammatory drugs. *Semin Nephrol* 15:179–194, 1995.
150. Smith WL, Garavito RM, Dewitt DL: Prostaglandin endoperoxide H synthetases (cyclooxygenases)-1 and -2. *J Biol Chem* 271:33157–33160, 1996.
151. Solomon SD, McMurray JVV, Pfeffer MA, et al: Cardiovascular risk associated with celecoxib in a clinical trial for colorectal adenoma prevention. *N Engl J Med* 352:1071–1080, 2005.
152. Spencer-Green G: Drug treatment of arthritis: update on conventional and less conventional methods. *Postgrad Med* 93:129–140, 1993.
153. Stechschulte DJ, Orange RP, Austen KF: Detection of slow reacting substance of anaphylaxis (SRS-A) in plasma of guinea pigs during anaphylaxis. *J Immunol* 111:1585–1589, 1973.
154. Steinbach G, Lynch PM, Phillips RK, et al: The effect of celecoxib, a cyclooxygenase-2 inhibitor, in familial adenomatous polyposis. *N Engl J Med* 342:1946–1952, 2000.
155. Stitt JT: Neurophysiology of fever. *Fed Proc* 141:286–292, 1981.
156. Styrt B, Sugarman B: Antipyresis and fever. *Arch Intern Med* 150:1589–1597, 1990.
157. Symposium on analgesics. *Arch Intern Med* 141(Spec Iss):271–406, 1981.
158. Symposium on paracetamol and the liver-overdosage and its management. *J Int Med Res* 4(Suppl):149–154, 1976.
159. Swift JQ, Garry MG, Roszkowski MT, et al: Effect of flurbiprofen on tissue levels of immunoreactive bradykinin and acute postoperative pain. *J Oral Maxillofac Surg* 51:112–116, 1993.
160. Szczeklik A, Gryglewski RJ: Prostaglandins and aspirin-sensitive asthma. *Am Rev Respir Dis* 118:799–800, 1978.
161. Ta LE, Dionne RA: Treatment of painful temporomandibular joints with a cyclooxygenase-2 inhibitor: a randomized placebo-controlled comparison of celecoxib to naproxen. *Pain* 111:13–21, 2004.
162. Thomas MJ: Urate causes the human polymorphonuclear leukocyte to secrete superoxide. *Free Rad Biol Med* 12:89–91, 1992.
163. Thummel KE, Slattery JT, Ro H, et al: Ethanol and production of the hepatotoxic metabolite of acetaminophen in healthy adults. *Clin Pharmacol Ther* 67:591–599, 2000.
164. Tjölens A, Lund A, Hole K: Antinociceptive actions of spinal nonsteroidal anti-inflammatory agents on the formalin test in the rat. *J Pharmacol Exp Ther* 263:136–146, 1992.
165. Tracey D, Klareskog L, Sasso EH, et al: Tumor necrosis factor antagonist mechanisms of action: a comprehensive review. *Pharmacol Ther* 117:244–279, 2008.
166. Troullos ES, Hargreaves KM, Butler DP, et al: Comparison of the non-steroidal anti-inflammatory drugs, ibuprofen and flurbiprofen, with methylprednisolone and placebo for acute pain, swelling, and trismus. *J Oral Maxillofac Surg* 48:945–952, 1990.
167. Urquhart E: Analgesic agents and strategies in the dental pain model. *J Dent* 22:336–341, 1994.
168. Van Doornum S, Brand C, King B, et al: Increased case fatality rates following a first acute cardiovascular event in patients with rheumatoid arthritis. *Arthritis Rheum* 54:2061–2068, 2006.
169. Vane JR, Botting RM: New insights into the mode of action of anti-inflammatory drugs. *Inflammation Res* 44:1–10, 1995.
170. Vogel RI, Desjardins PJ, Major KVO: Comparison of presurgical and immediate postsurgical ibuprofen on postoperative periodontal pain. *J Periodontol* 63:914–918, 1992.
171. Waldman RJ, Hall WN, McGee H, et al: Aspirin as a risk factor in Reye's syndrome. *JAMA* 247:3089–3094, 1982.
172. Warner TD, Guiliano F, Vojnovic I, et al: Nonsteroid drug selectivities for cyclo-oxygenase-1 rather than cyclo-oxygenase-2 are associated with human gastrointestinal toxicity: a full in vitro analysis. *Proc Natl Acad Sci U S A* 96:7563–7568, 1999.
173. Warner TD, Mitchell JA: Cyclooxygenase-3 (COX-3): filling in the gaps toward a COX continuum? *Proc Natl Acad Sci U S A* 99:13371–13373, 2002.
174. Weinblatt ME, Kaplan H, Germain BF, et al: Low-dose methotrexate compared with auranofin in adult rheumatoid arthritis: a thirty-six week, double-blind trial. *Arthritis Rheum* 33:330–338, 1990.
175. Williams RC, Jeffcoat MK, Howell TH, et al: Ibuprofen: an inhibitor of alveolar bone resorption in beagles. *J Periodontol Res* 23:225–229, 1988.
176. Williams RC, Jeffcoat MK, Kaplan ML, et al: Flurbiprofen: a potent inhibitor of alveolar bone resorption in beagles. *Science* 227:640–642, 1985.
177. Wooley PH, Dutcher J, Widmer MB, et al: Influence of a recombinant soluble tumor necrosis factor receptor FC fusion protein on type I-I collagen-induced arthritis in mice. *J Immunol* 151:6602–6607, 1993.
178. Wynn RL: Ketorolac (Toradol) for dental pain. *Gen Dent* 40:476–479, 1992.
179. Yee JP, Koshiver JE, Allbon C, et al: Comparison of intramuscular ketorolac tromethamine and morphine sulfate for analgesia of pain after major surgery. *Pharmacotherapy* 6:253–261, 1986.

GENERAL REFERENCES

- Baxter K, editor: *Stockley's drug interactions*, ed 8, London, UK, 2007, Pharmaceutical Press.
- Borchers AT, Keen CL, Cheema GS, et al: The use of methotrexate in rheumatoid arthritis. *Semin Arthritis Rheum* 34:465–483, 2004.
- Dale MM, Foreman JC, Fan T-PD, editors: *Textbook of immunopharmacology*, ed 3, Boston, 1994, Blackwell Scientific.
- Dart RC, Kuffner EK, Rumack BH: Treatment of pain of fever with paracetamol (acetaminophen) in the alcoholic patient: a systemic review. *Am J Ther* 7:123–134, 2000.
- Famaey JP, Paulus HE, editors: *Therapeutic applications of NSAIDs: subpopulations and new formulations*, New York, 1992, Marcel Dekker.
- Firestone GS, Budd RC, Harris ED Jr, et al, editors: *Kelley's textbook of rheumatology*, ed 8, Philadelphia, 2008, Saunders.
- Glaser KB, Vadas P: *Phospholipase A2 in clinical inflammation: molecular approaches to pathophysiology*, Boca Raton, FL, 1995, CRC Press.
- Graves DT, Jiang Y: Chemokines, a family of chemotactic cytokines. *Crit Rev Oral Biol Med* 6:109–118, 1995.
- Jackson JL, Roszkowski MT, Moore PA: Management of acute postoperative pain. In Fonseca RJ, editor; Frost D, Hersh EV, Levin LM, volume editors: *Oral and maxillofacial surgery, vol 1: anesthesia/dentoalveolar surgery/office management*, Philadelphia, 2000, Saunders.
- Prescott LF: *Paracetamol (acetaminophen): a critical biographical review*, Bristol, PA, 1996, Taylor & Francis.
- Rainsford KD, Powanda MC, editors: *Safety and efficacy of non-prescription (OTC) analgesics and NSAIDs*, Hingham, MA, 1998, Kluwer Academic Publishers.

Histamine and Histamine Antagonists

CLARENCE L. TRUMMEL

HISTAMINE

Histamine, or β -aminoethylimidazole, is one of a heterogeneous group of biologically active, naturally occurring substances whose physiologic roles are becoming increasingly better understood. In addition to histamine, this group includes another amine (5-hydroxytryptamine), polypeptides (angiotensin, bradykinin, and kallidin), and lipid-derived substances (prostaglandins, leukotrienes, and platelet-activating factor). These compounds have been collectively termed *autacoids*. This designation, derived from the Greek *autos* ("self") and *akos* ("cure"), is sufficiently nonspecific yet still acknowledges the endogenous origin and biologic activities of these substances and their important role in the body's economy.

Histamine was the first autacoid to be discovered. After its synthesis in 1907, a series of studies by Dale and Laidlaw¹⁰ of the pharmacologic properties of histamine suggested that this substance might be involved in inflammatory and anaphylactic reactions. Dale and Laidlaw¹⁰ observed that the local application of histamine caused redness, swelling, and edema, mimicking a mild inflammatory reaction. They also determined that large doses of histamine given systemically produced profound vascular changes similar to those seen in shock of traumatic or anaphylactic origin. Although the presence of histamine in animal tissues had been suggested, it was not until 1927 that histamine was conclusively shown to be a natural constituent of mammalian tissues and not the result of bacterial action.² This finding provided important support for the work of Lewis and Grant,²³ who had shown earlier that a histamine-like substance ("H substance") was released in the skin after various injuries, including antigen-antibody reactions.

These early studies and the studies that followed established that histamine is involved in various pathophysiologic phenomena seen after injury to tissue. Since then, a large amount of detailed information regarding the synthesis, storage, release, and actions of histamine has been generated. Despite this knowledge base, our understanding of the role of histamine in the complex response of cells to injurious stimuli and the relation of this compound to other autacoids is meager. It is increasingly evident that this ubiquitous amine is involved in physiologic processes other than reaction to injury. These processes include gastric secretion,⁸ neurotransmission in the central nervous system (CNS),^{36,43} and local control of the microcirculation.⁵⁵

Formation, Distribution, and Release

Histamine is widely distributed in nature and is found in plants, bacteria, and animals. Nearly all mammalian tissues contain histamine or have the ability to form it. The histamine content of different tissues varies greatly. In humans and most

other mammals, the highest concentrations are found in lung, skin, and intestinal mucosa; organs such as the pancreas, spleen, liver, and kidney have a low histamine content (Table 22-1). The physiologic significance of this pattern of distribution is unknown. Although some tissue histamine may be derived from dietary sources or synthesized by bacteria in the gastrointestinal tract, most of it seems to be formed *in situ*.

Histamine is synthesized in mammalian tissues by the intracellular decarboxylation of the amino acid histidine (Figure 22-1). This conversion may be catalyzed either by aromatic L-amino acid decarboxylase or by histidine decarboxylase. Histidine decarboxylase is specific for L-histidine, requires pyridoxal phosphate, and seems to be primarily responsible for the synthesis of histamine in humans.

Histamine is found in most tissues in the mast cell and in blood in a related cell, the basophil.^{39,44} These cells synthesize histamine and store it as a proteinaceous complex with heparin or chondroitin sulfate in membrane-bound secretory granules. Histamine in this form is physiologically inactive but can be discharged from the cell by a process called *exocytosis*, or *degranulation*. The first step in this process is activation of the cell by an appropriate stimulus. When the cell is activated, a complex series of events leading to degranulation occurs. These events require an increase in cytosolic Ca^{++} and metabolic energy and involve activation of Ca^{++} -dependent protein kinases (protein kinase C and Ca^{++} /calmodulin-dependent protein kinase), assembly of microtubules, and, finally, fusion of the perigranular membrane with the cell membrane. The granule contents are released into the extracellular environment and dissociate to yield histamine, heparin, several proteases, and chemoattractants such as tumor necrosis factor α . In addition to release of these preformed mediators, activation of mast cells activates phospholipase A in the cell membrane, which hydrolyzes phospholipid esters to yield arachidonic acid. The arachidonic acid is metabolized by the cyclooxygenase pathway to various prostaglandins and thromboxanes and by the lipoxygenase pathway to various leukotrienes.

A small amount of histamine not stored in mast cells or basophils is found in several sites. One of these sites is certain neurons in the hypothalamus. The function of these histaminergic neurons is unknown. Another site of non-mast cell histamine is the enterochromaffin-like cell in the gastric mucosa. These cells synthesize and release histamine, which subsequently stimulates gastric acid secretion by mucosal parietal cells (see Chapter 33). Certain neoplasms collectively known as *carcinoid* can also secrete various bioactive substances, including histamine.⁹ These substances likely contribute to the so-called carcinoid syndrome, a prominent feature of which is cutaneous flushing and bronchoconstrictive attacks

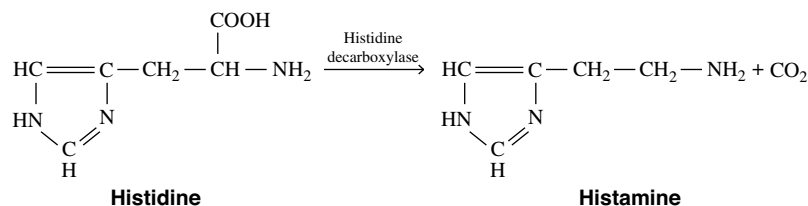

FIGURE 22-1 Conversion of histidine to histamine.

TABLE 22-1

Distribution and Content of Histamine in Various Human Tissues and Cells

TISSUE OR CELL	HISTAMINE CONTENT*
Lung	33 ± 10
Mucosa (nasal)	15.6 (range 5-38.5)
Stomach	14 ± 4
Duodenum	14 ± 0.9
Skin (face)	30.4
Skin (abdomen)	6.6
Pancreas	4.8 ± 1.5
Spleen	3.4 ± 1
Bone marrow	3.3 ± 1.5
Kidney	2.5 ± 1.2
Liver	2.2 ± 0.8
Heart	1.6 ± 0.1
Thyroid	1 ± 0.1
Skeletal muscle	0.9 ± 0.1
Peripheral nerves	2-11
CNS tissue	0-0.2
Whole blood	16-89 µg/L
Plasma	2.6 µg/L (range 0-15)
Basophils	1080 µg/10 ⁹ cells
Eosinophils	160 µg/10 ⁹ cells
Neutrophils	3.0 µg/10 ⁹ cells
Lymphocytes	0.6 µg/10 ⁹ cells
Platelets	0.009 µg/10 ⁹ platelets

From Van Arsdel PP Jr, Beall GN: The metabolism and functions of histamine, *Arch Intern Med* 106:714-733, 1960. Copyright 1960, American Medical Association.

*Means or means ± standard error expressed as µg/g unless otherwise indicated.

CNS, Central nervous system.

similar to that seen after the intravascular administration of histamine.

Various conditions (or stimuli) can trigger the release of histamine from mast cells and basophils. These can be grouped into three categories: tissue injury, allergic reactions, and drugs and other foreign compounds.

Tissue injury

Any physical or chemical agent that nonspecifically injures tissue, particularly skin or mucosa, causes the immediate release of histamine from mast cells in the affected area. Depending on the severity of injury, histamine continues to be released for several minutes and seems to be largely responsible for the initial sharp increase in vascular permeability that is characteristic of acute inflammation. This histamine-dependent change in permeability is transient (≤30 minutes)

but is followed in 2 to 4 hours by a more prolonged increase in permeability lasting up to 4 hours. Although inhibitors of histamine release or inhibitors of the subsequent action of histamine can block the initial phase of vascular permeability after injury, they have little effect on the secondary or delayed phase, suggesting that autacoids or factors other than histamine mediate the secondary phase.⁵⁴ The mechanism by which a nonspecific injury triggers mast cell degranulation is unclear. It could depend on direct physical damage to mast cells, or alternatively it may involve the initial production of factors such as activated complement components or vasoactive polypeptides, which stimulate histamine release.^{21,31}

Allergic reactions

Presentation of a specific antigen to a previously sensitized subject can trigger immediate allergic reactions, ranging in intensity from mild (localized edema, erythema, and itching) to severe (marked decrease in blood pressure and bronchospasm). The pathophysiologic manifestations of such reactions are caused largely by the release of histamine (Figure 22-2). This release occurs as a consequence of the binding of specific antigens to allergen-specific reaginic (IgE) antibodies attached to the plasma membranes of mast cells and basophils transmembrane high-affinity receptors termed *FcεRI*.²⁹ Binding of antigen and antibody may cause conformational changes in the membrane, leading to an increase in Ca⁺⁺ permeability. In any case, this antigen-antibody interaction is an appropriate stimulus for the series of events leading to degranulation of these cells.

Drugs and other foreign compounds

Although drugs that are antigenic (e.g., penicillin) can cause histamine release, a large group of drugs and other chemicals can trigger histamine release directly without a requirement for previous sensitization through an immune response. For convenience, these agents can be classified as basic histamine releasers, macromolecular compounds, and enzymes.²¹ The basic histamine releasers include aliphatic and arylalkyl amines, amides, amidines, diamidines, quaternary ammonium compounds, alkaloids, piperidine derivatives, pyridinium compounds, antimalarial drugs, dyes, and basic polypeptides. The prototypic histamine releaser compound 48/80 and numerous therapeutic agents of interest, such as tubocurarine and morphine, fall into this category.

Dextran is an example of a macromolecular compound that causes histamine release. Several enzymes, such as phospholipase A, have been shown to initiate mast cell degranulation, a fact that may explain the release of histamine caused by various insect and snake venoms. The mechanisms by which chemicals trigger histamine release vary. Some agents, typified by the Ca⁺⁺ ionophore compound 48/80, act by stimulating an energy-dependent degranulation process with characteristics similar to anaphylactic histamine release. Other histamine releasers are effective in the absence of energy sources and seem to act by a detergent-like effect on cell membranes.

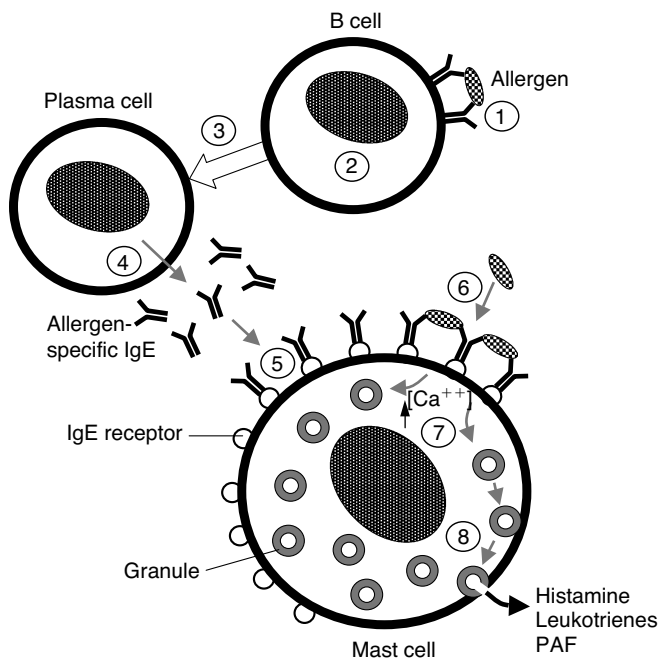

FIGURE 22-2 Schematic representation of mast cell degranulation and histamine release from mast cells after antigenic challenge. B cells bind allergen (1) via surface immunoglobulin and are induced (2) by TH2 cells (not shown) to proliferate and differentiate into plasma cells (3), which produce allergen-specific IgE (4). IgE binds through the Fc portion of the molecule to very-high-affinity receptors on mast cells (5). On subsequent exposure, the antigen binds to and cross-links IgE (6), leading to rapid influx of Ca^{++} and cell activation (7). Granules containing histamine fuse with the cell membrane and “degranulate” (8), releasing histamine, platelet-activating factor (PAF), and leukotrienes extracellularly.

Metabolism

Histamine of either exogenous or endogenous origin is rapidly inactivated by two routes.⁴¹ The more important of these is methylation of the imidazole ring by the enzyme histamine-N-methyltransferase, which is widely distributed throughout the body. The resultant product is converted to methylimidazole acetic acid by monoamine oxidase. The other route involves the oxidative deamination of histamine by diamine oxidase to produce imidazole acetic acid, much of which is subsequently conjugated with ribose. All these metabolites are inactive and, along with a small amount of free histamine, are excreted by the kidney.

Large oral doses of histamine have little effect because histamine is rapidly degraded by intestinal bacteria. Any free histamine that is absorbed is largely inactivated in the intestinal wall and in the liver.

Pharmacologic Effects

Most of the important effects of histamine can be attributed to its actions on smooth muscle and glands. In general, histamine causes relaxation of vascular smooth muscle in smaller blood vessels. It also causes the constriction of some larger blood vessels, the contraction of nonvascular smooth muscle, and the stimulation of secretion of exocrine glands, especially glands of the gastric mucosa. These actions are independent of innervation. Different species show considerable variation in the sensitivity of target tissues to histamine. The bronchial smooth muscle of the guinea pig is highly sensitive to histamine, and fatal bronchospasm occurs at concentrations that

have minimal effects in other species, including humans. Within a single species, the actions of histamine are usually reproducible.

The existence of compounds that can selectively block the actions of histamine strongly supports the existence of four histamine receptors, H_1 , H_2 , H_3 , and H_4 .^{16,18} Although the first two seem to be unique (i.e., have selective agonists and antagonists), the H_3 and H_4 receptors share a degree of homology and are more difficult to distinguish pharmacologically from one another.⁴⁷ All four histamine receptors are G protein-linked receptors. H_1 receptors are associated with $\text{G}_{q/11}$, and stimulation of these receptors leads to an increase in intracellular Ca^{++} and Ca^{++} -dependent protein kinase activity. H_2 receptors are linked to G_s , and stimulation of these receptors brings about an increase in intracellular cyclic adenosine 3',5'-monophosphate (cAMP). H_3 and H_4 receptors seem to stimulate $\text{G}_{i/o}$ proteins, leading to reduced cAMP (see Chapters 1 and 5 for more details on the specifics of signal transduction involving G proteins).

H_1 receptors primarily mediate effects on smooth muscle, leading to vasodilation, increased vascular permeability, and contraction of nonvascular smooth muscle. These effects are blocked by the “classic” antihistamines, such as pyrilamine. H_2 receptors mediate the stimulation of gastric acid secretion. H_2 receptors may be involved in other effects, such as direct cardiac stimulation and vasodilation seen after high doses of histamine, based on studies showing that H_2 -blocking agents specifically antagonize these effects.^{5,6}

H_3 receptors have been identified in various cells, including presynaptic sites on histaminergic neurons in the CNS and prejunctional sites in gastric mucosa, cardiovascular system, and the enterochromaffin-like cells of the stomach. The function of H_3 receptors is not firmly established, but these receptors seem to antagonize stimulatory effects mediated by the activation of H_1 receptors. Their prejunctional location suggests a role as autoregulatory receptors in many tissues. Activation of H_3 receptors on adrenergic nerve terminals in the myocardium inhibits the release of norepinephrine.^{19,22} The more recently identified H_4 histamine receptor is found primarily on cells of hematopoietic origin, particularly mast cells, basophils, and eosinophils. Activation of H_4 receptors on these cells induces changes in cell shape, chemotaxis, and upregulation of various cell-adhesion molecules.^{17,24}

Cardiovascular system

The effects of histamine on the circulatory system are complex and vary markedly according to species. In most mammals, histamine causes some constriction of large arterial and venous vessels. Histamine also constricts arterioles and increases blood pressure in rats and rabbits. In contrast, the intravenous administration of histamine in humans and carnivores causes dilation of terminal arterioles, capillaries, and postcapillary venules and leads to a sharp decrease in peripheral resistance and a consequent decrease in blood pressure. The dilation of these vessels is caused by histamine stimulation of H_1 receptors on endothelial cells, resulting in the release of nitric oxide, which causes the relaxation of smooth muscle of the arterioles and precapillary sphincters. Stimulation of H_1 receptors also leads to activation of phospholipase A_2 and the generation in endothelial cells of prostacyclin, which contributes to the vasodilation.

Histamine also stimulates H_2 receptors on vascular smooth muscle cells, leading to relaxation of small blood vessels. The subsequent increase in arteriolar and capillary blood flow causes a passive dilation of postcapillary venules that is accompanied by an increase in their permeability. This increased permeability is initiated by distention or stretching of the venules and by a contractile response of the endothelial cells caused directly by histamine; both phenomena contribute to

“gaps” between the endothelial cells of the venules and exposure of the basement membrane. These gaps permit the movement of plasma protein and fluid through the basement membrane into the extravascular space, causing the formation of edema.

In addition to hypotension, arteriolar dilation induced by histamine leads to cutaneous flushing, especially over the face and upper trunk, and an increase in skin temperature. A short-lived but intense headache caused by dilation of cerebral vessels also occurs. This “histamine headache” is similar in quality and duration to the headache produced by other potent vasodilators, such as amyl nitrite.

The effect of histamine on the terminal vasculature can be illustrated by injection of 10 to 20 μg of the amine into the skin. At the site of the injection, there is first immediate reddening, reflecting vasodilation. This reddening is followed shortly by a zone of erythema, or “flare,” extending as an irregular halo for 1 cm or more beyond the original red spot. The flare is presumed to be caused by reflex vasodilation of adjacent small vessels, resulting from the axon reflex, and is abolished by disruption of the peripheral sensory nerves. Finally, the central spot is replaced by a disk of localized edema, or wheal, resulting from increased capillary permeability, and is accompanied by pain and itching. These events constitute the classic triple response first described by Lewis and Grant.²³ A similar response is elicited by the intradermal injection of antigen in a sensitized individual.

Hypotension resulting from moderate doses of histamine is transient because reflex circulatory mechanisms come into play, and the drug is rapidly inactivated. When histamine is given in large doses, there is a progressive decrease in blood pressure that resembles traumatic or surgical shock. This decrease is a consequence of vasodilation and increased capillary permeability. The increased capillary permeability leads to loss of plasma from the vascular compartment and a decrease in the effective blood volume. Venous return to the heart is diminished, so cardiac output declines despite compensatory tachycardia. There may also be dyspnea caused by bronchoconstriction. In normal humans, circulatory depression is predominant. Without adequate treatment, death may ensue from histamine shock.

In an intact animal, histamine can cause cardiac stimulation, principally the result of reflex mechanisms triggered by the histamine-induced decrease in peripheral vascular resistance. Histamine also has some direct positive chronotropic and inotropic effects on the heart. The receptors responsible are largely H_2 receptors.²²

Nonvascular smooth muscle

Histamine generally stimulates contraction of nonvascular smooth muscle to a variable degree depending on the species and tissue. In humans, the smooth muscle of the bronchioles and gastrointestinal tract is most sensitive to this action; the smooth muscle of other organs, such as the uterus and bladder, is affected to a much lesser extent. Individuals with asthma are highly susceptible to histamine and may have marked bronchial constriction from doses that would cause only minor increases in the airway resistance of normal subjects.

Exocrine glands

Histamine is a potent stimulator of gastric secretion in most species. Low doses of histamine that have minimal effects on blood pressure elicit near-maximal secretion of acid and pepsin by the gastric mucosa. On the basis of this sensitivity of gastric secretory cells to histamine, the presence of histamine in gastric mucosa and gastric fluid, and the presence of H_2 receptors on the acid-secreting parietal cells, it is accepted that histamine plays a major physiologic role in gastric secretion. This conclusion is strongly supported by the discovery

of H_2 receptor antagonists (see later), which block histamine-stimulated gastric secretion and reduce basal secretion and secretion induced by some other physiologic agents, such as acetylcholine and gastrin.

The relationships among histamine and the potent gastric secretagogues acetylcholine and the polypeptide hormone gastrin are complex (see Figure 33-1). As previously noted, histamine is synthesized by the enterochromaffin-like cells in the gastric mucosa, and its release from these cells is triggered by either gastrin or acetylcholine. The fact that H_2 receptor antagonists inhibit stimulation of gastric secretion by histamine, gastrin, or acetylcholine lends support to the possibility that the latter two agents act by releasing histamine from enterochromaffin-like cells, which acts directly on the parietal cells through H_2 receptors.³³ Identification of specific receptors for gastrin and acetylcholine on the parietal cell, plus an ability of gastrin to augment (although moderately) histamine-induced secretion, indicates, however, that gastrin can also cause release of H^+ by acting directly on parietal cells and independently of histamine.

Histamine also stimulates the secretion of catecholamines by the chromaffin cells of the adrenal medulla. This action is of little significance in normal patients, but in patients with pheochromocytoma, release of a large amount of catecholamines occurs. Although histamine can enhance salivary and lacrimal gland secretion, this effect is minimal unless large doses are used.

General Therapeutic Uses

Currently, no valid therapeutic applications exist for histamine. It is of limited use as a diagnostic tool in the assessment of gastric acid production. In this test, histamine is given subcutaneously in a dose (usually 1 mg) that stimulates gastric secretion without causing major effects on blood vessels or smooth muscle. The gastric fluid is subsequently sampled, and its acid content is determined. An isomer of histamine, betazole, can also be used in this test. Betazole has less H_1 receptor activity than histamine and offers the advantage of causing a lesser degree of unwanted side effects for a given degree of gastric stimulation. Pentagastrin, a potent synthetic analogue of gastrin, has essentially supplanted histamine and betazole for the clinical evaluation of gastric secretion. Another use of histamine (in aerosol form) is in testing for nonallergic bronchial hyperreactivity in asthmatics.

Adverse Effects

The toxic effects of histamine are largely predictable on the basis of its pharmacologic actions. In normal individuals, these effects are dose-dependent. The more prominent manifestations of histamine toxicity are cutaneous flushing; hypotension; headache; visual disturbances; dyspnea; and gastrointestinal disturbances such as nausea, vomiting, and diarrhea. Massive doses may lead to shock and circulatory failure. Histamine, even in low doses, may have serious adverse consequences in elderly individuals or patients with cardiovascular disease, asthma, or recent gastrointestinal bleeding.

HISTAMINE ANTAGONISTS

Histamine antagonists, or antihistamines, encompass a large group of compounds with the characteristic ability to block the actions of histamine. These compounds do not alter the formation, release, or degradation of histamine but competitively antagonize it at receptor sites. As described earlier, four groups of antihistamines are now known by their ability to block selectively effects of histamine mediated by the various receptors. These groups of antihistamines are appropriately termed H_1 , H_2 , H_3 , and H_4 receptor antagonists. The generic

term *antihistamine* is often used to refer to the “classic” antihistamines, or H_1 antagonists.

Early interest in histamine as a mediator of certain pathologic processes of an allergic nature spurred interest in agents that could block histamine. The first such compound, a derivative of phenoxyethylamine, was reported by Bovet and Staub in 1937.⁵ Although this substance could adequately protect guinea pigs against injected histamine or anaphylactic shock, it was too toxic for human use. Other, less toxic compounds with antihistaminic activity were immediately sought. By 1946, numerous compounds with therapeutically useful properties had been found, including phenbenzamine, pyrileamine, diphenhydramine, and tripeleminamine. During the following 20 years, hundreds of other compounds with antihistaminic properties were developed.

As the pharmacologic properties of antihistamines were studied, it became apparent that they had no effect on histamine-induced gastric acid secretion. In 1972, a potent antagonist of histamine-induced gastric secretion, burimamide, was discovered.³ The subsequently developed congeners of burimamide—the H_2 receptor antagonists—quickly became an important new class of therapeutic agents and tools for further investigation of the role of histamine in health and disease.

Antagonists of H_3 and H_4 receptors have more recently been identified. In animal studies, specific H_3 receptor antagonists, such as thioperamide, have shown numerous CNS effects, such as increased alertness, improved attention and learning, and antiepileptic effects.⁴² Although these pharmacologic effects may have obvious human applications, H_3 and H_4 antagonists have not yet been approved for clinical use in the United States. Specific antagonists of H_4 receptors exert anti-inflammatory effects in vitro and in animals, suggesting a potential use in the treatment of inflammatory disorders.^{50,51}

H₁ Receptor Antagonists

Chemistry and classification

Most antihistamines with the ability to block H_1 receptors contain a side chain that resembles the ethylamino group in histamine. These H_1 receptor antagonists, or H_1 antihistamines, can be represented by the following general formula:

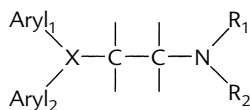

In this representation, *aryl* is a heterocyclic aromatic group that may or may not be separated from X by a methylene

group. X is a carbon, oxygen, or nitrogen atom that connects the side chain to the aryl groups. R_1 and R_2 are usually, but not always, methyl groups. The ethylene group in the side chain may also be part of a heterocyclic system containing nitrogen, as in cyclizine. A general conclusion from examination of structure-activity relationships is that a basic nitrogen atom is essential, whether it exists in an aliphatic side chain, as in diphenhydramine, or in a ring structure, as in meclizine (Table 22-2).

By using the general formula just presented, most H_1 antihistamines can be grouped according to the substitution made at the X position. Six distinct classes are recognized: (1) alkylamines, in which X is carbon; (2) ethanolamines, in which X is oxygen; (3) ethylenediamines, in which X is nitrogen; (4) piperazines, in which X is carbon linked to a piperazine ring; (5) phenothiazines, in which X is nitrogen as part of a phenothiazine nucleus; and (6) piperidines, in which X is carbon linked to a piperidine ring. Levocabastine is a piperidine but does not fit the structural chemistry in the six above-listed categories. Azelastine, used only topically on the nasal mucosa, is a phthalazinone and is structurally unrelated to these other categories.

The chemical structures of representative compounds of each of the major classes of H_1 antihistamines are shown in Table 22-2. Despite their structural heterogeneity, the older antihistamines have only minor differences in pharmacologic properties, and these are mainly in potency, duration of action, and intensity of effects on other systems. In the last two decades, several H_1 antihistamines have been developed that differ from older antihistamines in that they are largely devoid of effects on the CNS.^{1,48} Because of this difference, this group of agents, which are predominantly piperidine derivatives and include fexofenadine, levocabastine, and loratadine, are often termed *second-generation antihistamines* to distinguish them from the older, or first-generation, antihistamines. Other second-generation H_1 antihistamines include acrivastine (an alkylamine), cetirizine (a piperazine), and azelastine (a phthalazinone).

Pharmacologic effects

H_1 antihistamines exert various effects. Although the basis of some of these effects is obscure, many clearly result from histamine antagonism. These agents can inhibit the contraction of gastrointestinal and bronchial smooth muscle, the increase in capillary permeability, and the flare and itch components of the “triple response.” Although H_1 antihistamines do not block histamine-induced gastric secretion, they do antagonize the increased secretions of the salivary and lacrimal glands and the increased release of epinephrine from the

TABLE 22-2

Chemical Classification, Representative Structures, and Dosages of Major H_1 Antihistamines

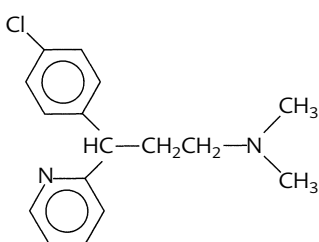
CLASS	REPRESENTATIVE COMPOUND* (PROPRIETARY NAME)	USUAL ADULT DOSE (ORAL)	DURATION OF ACTION	SOME OTHER COMPOUNDS IN THE SAME CLASS
Alkylamines	 <p>Chlorpheniramine maleate (Chlor-Trimeton, others)</p>	4 mg	4-6 hr	Acrivastine (in Semprex-D): 8 mg, 6-8 hr Brompheniramine maleate (Dimetane): 4 mg, 4-6 hr Dexchlorpheniramine maleate (Polaramine): 2 mg, 4-6 hr Tripolidine hydrochloride (Actidil): 2.5 mg, 4-6 hr

Continued

TABLE 22-2

Chemical Classification, Representative Structures, and Dosages of Major H₁ Antihistamines—cont'd

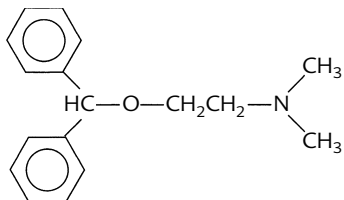
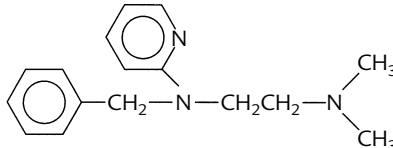
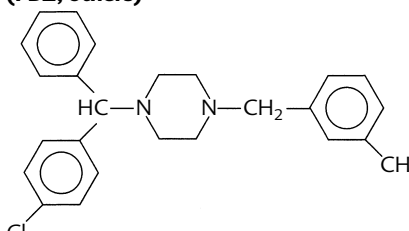
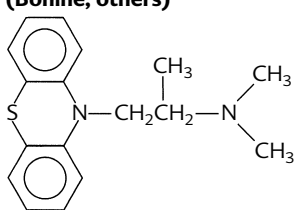
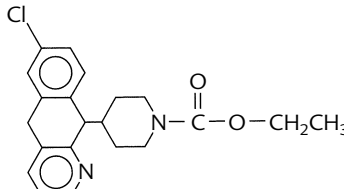
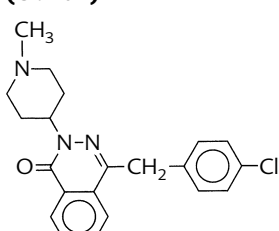
CLASS	REPRESENTATIVE COMPOUND* (PROPRIETARY NAME)	USUAL ADULT DOSE (ORAL)	DURATION OF ACTION	SOME OTHER COMPOUNDS IN THE SAME CLASS
Ethanolamines	 Diphenhydramine hydrochloride (Benadryl, others)	25-50 mg	6-8 hr	Carbinoxamine maleate (in Carbiset): 4-8 mg, 6-8 hr Clemastine fumarate (Tavist): 1.34-2.68 mg, 8-12 hr Dimhydrinate (Dramamine): 50-100 mg, 4-6 hr Doxylamine succinate (Unisom): 12.5-25 mg, 4-6 hr
Ethylenediamines	 Tripelennamine citrate (PBZ, others)	25-50 mg	4-6 hr	Pyrilamine maleate (Nisaval): 25-50 mg, 6-8 hr
Piperazines	 Meclizine hydrochloride (Bonine, others)	25-50 mg	24 hr	Buclizine hydrochloride (Bucladin-S): 50 mg, 4-12 hr Cetirizine hydrochloride (Zyrtec): 5-10 mg, 24 hr Cyclizine hydrochloride (Marezine): 50 mg, 4-6 hr Hydroxyzine hydrochloride (Atarax, others): 50-100 mg, 6-24 hr Hydroxyzine pamoate (Vistaril): 50-100 mg, 6-24 hr
Phenothiazines	 Promethazine hydrochloride (Phenergan)	12.5-25 mg	4-12 hr	Methdilazine hydrochloride (Tacaryl): 8 mg, 6-12 hr Trimeprazine tartrate (Temaril): 2.5 mg, 6 hr
Piperidines	 Loratadine hydrochloride (Claritin)	10 mg	24 hr	Azatadine maleate (Optimine): 1-2 mg, 8-12 hr Cyproheptadine hydrochloride (Periactin) [†] : 4 mg, 6-8 hr Fexofenadine hydrochloride (Allegra): 60 mg, 12 hr Levocabastine hydrochloride (Livostin): topical Phenindamine tartrate (Nolahist): 25 mg, 4-6 hr
Phthalazinones	 Azelastine hydrochloride (Astelin)	274 μg (topical nasal application; per nostril)	8-12 hr	

Second-generation H₁ antihistamines are acrivastine, azelastine, cetirizine, desloratadine, fexofenadine, levocabastine, levocetirizine, and loratadine. H₁ histamine receptor blockers used in ophthalmology are emedastine, epinastine, ketotifen, and olopatadine.

*Each structural formula is of the free base form.

[†]Also a serotonin-receptor antagonist.

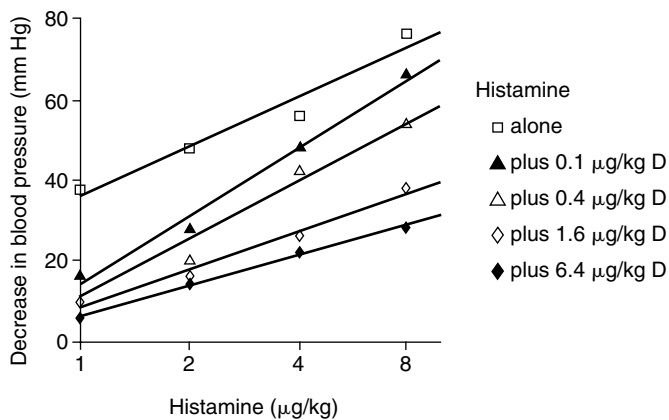

FIGURE 22-3 Log dose-response curves illustrating competitive antagonism of histamine by diphenhydramine (D). Decreases in blood pressure (*ordinate*) by graded intravenous doses of histamine (*abscissa*) were determined in anesthetized dogs. The animals received diphenhydramine (0.1 to 6.4 µg/mL) followed by the same graded doses of histamine. (Data from Chen G, Russell D: A quantitative study of blood pressure response to cardiovascular drugs and their antagonists. *J Pharmacol Exp Ther* 99:401-408, 1950.)

adrenal medulla stimulated by histamine. As with many other pharmacologic inhibitors, the basic mechanism of action can be explained in terms of a competitive blockade of receptors; that is, antihistamines seem to interact with the H₁ receptors on the target cell, resulting in a decreased availability of these receptors for histamine. This interaction is reversible, or competitive, because the inhibition produced by a given concentration of antihistamine can be overcome by increasing the concentration of histamine (Figure 22-3).

No evidence indicates that antihistamines interfere with the synthesis, release, or biotransformation of histamine. Cetirizine seems to be unique among antihistamines because it has been reported to have antieosinophilic activity, so it inhibits the late phase of inflammation in addition to the more immediate histaminic effects.^{49,52}

The action of H₁ antihistamines in antagonizing histamine is specific; that is, H₁ antihistamines “reverse” the effects of histamine by inhibiting its further action, but they have no directly opposing actions of their own. In contrast, epinephrine nonspecifically antagonizes histamine by exerting its own distinct effects, such as vasoconstriction, bronchodilation, and decreased gastrointestinal motility. This type of antagonism is sometimes referred to as *physiologic*. The distinction is important in understanding why a physiologic antagonist such as epinephrine is a more effective agent than an antihistamine in treating systemic histamine toxicity.

As previously indicated, the bronchial smooth muscle of the guinea pig is exquisitely sensitive to histamine, and low doses can trigger lethal bronchospasm. The prior administration of an H₁ antihistamine such as pyrilamine can protect the respiratory smooth muscle of these animals, however, from a dose of histamine that is more than 100 times the lethal dose. These agents can similarly protect guinea pigs against the effects of released histamine during experimental anaphylaxis. A different situation prevails in humans. Although H₁ antihistamines can antagonize the histamine-induced contraction of human respiratory muscle *in vitro*, these agents are ineffective in relieving bronchospasm associated with asthma, anaphylaxis, and other allergic reactions. This ineffectiveness is caused partly by the involvement of autacoids other than histamine in mediating allergic bronchospasm in humans.

These substances include leukotrienes and kinins, against which classic antihistamines show little antagonism.

In the human vascular system, H₁ antihistamines are effective in antagonizing the increased capillary permeability and consequent edema formation induced by histamine, but their effects on the vasodilation caused by histamine are more complex. H₁ antihistamines can prevent the vasodilation elicited by small doses of histamine; however, a combination of H₁ and H₂ antagonists is required to block large doses. This finding indicates that both receptor subtypes mediate the vascular effects of histamine, with the autacoid having a higher affinity for H₁ receptors.^{35,47} The minor direct cardiac stimulation produced by histamine is little affected by H₁ antihistamines because this cardiac stimulation results largely from H₂ receptor stimulation.

Sedation is a common feature of therapeutic doses of all H₁ antihistamines except second-generation agents. It is usually manifested by drowsiness and may be accompanied by lassitude, fatigue, dizziness, and incoordination. Sedation is mediated by the inhibition of H₁ receptors in the brain.³⁸ The ability to cause sedation varies widely among the available first-generation H₁ antihistamines. The most active are the ethanolamines and phenothiazines, whereas the alkylamines have a low incidence of drowsiness.⁴⁶ Another clinically useful CNS effect of first-generation H₁ antihistamines is inhibition of nausea and vomiting, especially associated with motion sickness. These agents also possess mild anti-Parkinson activity. Large doses of first-generation H₁ antihistamines can cause CNS stimulation that may result in convulsions. Some degree of stimulation—restlessness or insomnia—may occasionally be encountered even at therapeutic doses.

The mechanism of the CNS effects of H₁ antihistamines is not fully known, although histamine is present in the brain and is thought to play a role as a neurotransmitter. H₁ receptor antagonists have been shown to block histamine-induced depolarizations in human cortical brain slices³⁸; this could explain the sedative effects of antihistamines. Although some degree of tolerance to the sedative effects of H₁ antihistamines usually develops with long-term use, no concomitant decrease in their peripheral antihistaminic effects has been observed. It has been suggested that the anti-motion sickness and the anti-Parkinson activities of H₁ antihistamines are caused by a central cholinergic receptor-blocking action.

Antimuscarinic activity is a feature of most first-generation H₁ antihistamines. The decrease in salivary secretion associated with their use is largely related to this action. Second-generation H₁ antihistamines have little or no antimuscarinic activity. Most antihistamines have some degree of local anesthetic activity. This property is most notable in diphenhydramine, promethazine, pyrilamine, and tripropenamine and has been used clinically in dentistry.^{29,53}

Absorption, fate, and excretion

As a group, older H₁ antihistamines are well absorbed after either oral or parenteral administration. The onset of action occurs 15 to 60 minutes after an oral dose. Effects are typically maximal in 1 to 2 hours, with a duration of 4 to 6 hours, although the duration is longer for some agents (see Table 22-2). In contrast, most second-generation H₁ antihistamines have a considerably longer duration of action. Loratadine is transformed to an active metabolite with an average elimination half-time of greater than 24 hours, which allows once-daily dosing.

After absorption, first-generation H₁ antihistamines are widely distributed in body fluids. Loratadine and other second-generation agents cross the blood-brain barrier poorly, however, and are barely detectable in brain tissue.⁷ This failure to gain access to the CNS largely explains the nearly complete absence of sedation with these drugs. Levo-

cabastine is a second-generation H₁ antihistamine that is administered topically only.

Although the biotransformation of first-generation H₁ antihistamines has not been studied intensively, the activity of this group seems to be terminated by conversion to inactive metabolites through hydroxylation in the liver.³⁴ The second-generation antihistamine cetirizine is a metabolite of the first-generation agent hydroxyzine.

Second-generation antihistamines are extensively metabolized in the liver by the CYP3A4 microsomal enzyme (see Chapter 2). In some cases, such as with loratadine, these result in active metabolites.⁴⁵ Concurrent administration of other agents metabolized by this same enzyme can reduce the biotransformation of these particular antihistamines. Other second-generation H₁ antihistamines (e.g., acrivastine and cetirizine) are not metabolized to an active form and are largely excreted unchanged in the urine.

General therapeutic uses

The introduction of antihistamines into clinical medicine stimulated great interest in these agents and their application in pathologic states presumed to be caused by histamine release. The early enthusiasm for antihistamines often led to their irrational use in various clinical situations. Although subsequent experience has brought about a better appreciation of the therapeutic indications and limitations of antihistamines, they are still often used when their clinical efficacy is doubtful or when other agents might be more appropriate.

The most prominent use of H₁ antihistamines is in countering the manifestations of various allergic conditions—that is, reactions resulting from antigen-antibody combination in which histamine release occurs. The antihistamines have no effect on the interaction of antigens and antibodies or on the release of histamine that may be triggered by this interaction but act by competitively antagonizing the binding of liberated histamine to its receptor. This mechanism of action has several implications for the therapeutic use of antihistamines. It means that these agents cannot alter the allergic basis of a given disease but can provide relief only from some of the symptoms. It also means antihistamines are most effective when given before the release of histamine. After histamine release has occurred, an antihistamine can reduce only further undesirable effects, in contrast to physiologic antagonists, which can reverse them. Finally, the competitive nature of antihistamine action means that the effectiveness of these agents in a given situation depends on the relative concentrations of agonist and antagonist. When substantial amounts of histamine are released either locally or systemically, the adverse effects of the antihistamine may preclude attainment of a sufficient concentration of antagonist to be clinically effective.

The clinical applications of H₁ antihistamines can be summarized as follows:

1. H₁ antihistamines are generally useful in the treatment of nasal allergies of either a seasonal (e.g., hay fever) or perennial (nonseasonal) nature because they relieve rhinorrhea, sneezing, lacrimation, and itching of the eyes and nasal mucosa.⁶ Azelastine is effective for 12 hours when applied topically to the nasal mucosa.²⁷ This route of administration minimizes unwanted systemic effects such as drowsiness. In chronic or vasomotor (nonallergic) rhinitis, H₁ antihistamines are less effective.⁴⁶ Antihistamines are often combined with decongestants such as pseudoephedrine for the management of allergic symptoms in the upper respiratory tract.
2. Numerous allergic dermatoses can be treated with H₁ antihistamines.^{14,46} Acute and chronic urticaria responds favorably to these agents. Angioedema also responds to antihistamine therapy, although a severe attack involving

the larynx almost certainly requires epinephrine for proper management of this serious complication. H₁ antihistamines may be useful in controlling the itching associated with eczematous pruritus, atopic or contact dermatitis, and insect bites. In some situations (e.g., atopic dermatitis), topical corticosteroids are usually more effective, however. Although antihistamines are topically effective in treating pruritus and urticaria, topical application can also cause an allergic dermatitis.

3. In systemic anaphylaxis, H₁ antihistamines have no primary therapeutic role because they cannot control either the marked hypotension or the bronchospasm associated with a severe anaphylactic reaction. Here the agent of choice is the physiologic antagonist epinephrine. Antihistamines and corticosteroids may be given parenterally as an adjunct to the physiologic antagonist, but only after life-threatening problems are controlled. Antihistamines are of some value in treating the itching and urticarial lesions of serum sickness, although other manifestations such as arthralgia are little affected.
4. H₁ antihistamines have little effect on the acute manifestations of bronchial asthma. The pathogenesis of bronchial asthma is complex, and, as indicated earlier and in Chapter 32, mediators of bronchial muscle constriction other than histamine are involved. β -Adrenergic receptor agonists and corticosteroids are the primary drugs used to alleviate an acute asthmatic episode. Antihistamines have been used in an attempt to decrease preasthmatic cough in children, although the efficacy of this therapy is not established.
5. H₁ antihistamines, particularly chlorpheniramine, combined with nasal decongestants and analgesics, are widely used for symptomatic relief of the common cold. There are dozens of such preparations on the market, which indicates the popularity of these nostrums. Unless the cold is superimposed on an allergic rhinitis, any relief obtained from this combination stems largely from the drying of the mucosa caused by the anticholinergic action of the antihistamine and the actions of the vasoconstrictor and analgesic. Antihistamines alone are of no proven value in either preventing or shortening the duration of the common cold.
6. A CNS action of first-generation H₁ antihistamines can be used to prevent or treat nausea and vomiting induced by motion. In general, these agents exert less anti-motion sickness activity than do anticholinergics such as scopolamine. The effectiveness of individual antihistamines varies widely; promethazine, diphenhydramine, dimenhydrinate, and cyclizine are probably the most effective of all. The more effective agents also tend to have greater sedative effects, however, a fact that must be considered in selecting an anti-motion sickness drug. H₁ antihistamines may also be useful in counteracting nausea and vomiting in vestibular disturbances such as Ménière's disease and other forms of vertigo. They are less effective than prochlorperazine or ondansetron for the control of nausea and vomiting after general anesthesia or associated with pregnancy, malignant diseases, radiation sickness, and various drugs.
7. Various over-the-counter (OTC) preparations sold as hypnotics include H₁ antihistamines because of their sedative effect. Because the amounts of antihistamine in such preparations are low, they are of limited value in inducing sleep. Even in higher doses the antihistamines are less effective sedatives, however, than benzodiazepines and other sedative-hypnotics. Promethazine is used as an adjunct to general anesthesia to produce drowsiness and to prevent or control nausea and vomiting induced by anesthetic agents and opioid analgesics.

8. Some miscellaneous uses of H₁ antihistamines include reduction of tremors and muscle rigidity in Parkinson's disease; treatment of headaches of unknown cause; and control of nonhemolytic, nonpyrogenic reactions to blood transfusion. They are also useful in relieving acute dystonias caused by phenothiazines and other neuroleptics.

Uses in dentistry

H₁ antihistamines are used in dentistry primarily for their CNS actions, rather than for their specific antihistaminic effects. Promethazine, hydroxyzine, and diphenhydramine may be used in minimal-moderate sedation procedures and as premedication for deep sedation and general anesthesia (see Chapters 18 and 48). The sedative effect is increased by the concomitant administration of an opioid analgesic; meperidine and fentanyl are commonly used for this purpose.²⁵ The preoperative administration of these agents may also cause some inhibition of salivary and bronchial secretions, although more effective anticholinergic drugs should be used if control of secretions is essential. A particular benefit of antihistamines is their ability to reduce postoperative nausea and vomiting in the outpatient setting.

Although H₁ antihistamines have some local anesthetic activity, and their feasibility as local anesthetic agents for dental procedures has been shown, they have not been used much for this purpose because far more effective agents (e.g., lidocaine) are available. The local anesthetic activity of antihistamines may be useful when a patient is allergic to conventional local anesthetics.

H₁ antihistamines can be used as secondary agents in the management of systemic anaphylactic reactions that may occur in the course of dental therapy. They can also be valuable in the treatment of allergic lesions of the oral mucosa and as adjuncts in treating angioneurotic edema of the orofacial region.

Adverse effects

At therapeutic doses, H₁ antihistamines are relatively free of serious adverse reactions. The most common side effects result from CNS depression, which is generally manifested as drowsiness, diminished alertness, lethargy, and decreased motor coordination. The incidence of sedation varies with individual agents, but in general the ethanolamines and the phenothiazines are the most sedating, the ethylenediamines are intermediate, and the alkylamines and piperazines are the least sedating. As previously mentioned, loratadine and other second-generation H₁ antihistamines are essentially devoid of sedative or other CNS effects. Sedation caused by antihistamines may be a serious liability in a patient whose daily activities require mental alertness and coordination. In such cases, a reduction of dosage or substitution of agents may be necessary. Gastrointestinal disturbances—nausea, vomiting, and epigastric distress—also occur but are uncommon. The anticholinergic properties of antihistamines occasionally cause insomnia, tremors, nervousness and irritability, palpitation, tachycardia, dry mouth, blurred vision, urinary retention, and constipation. The incidence of these effects is dose-related.

Serious disturbances of cardiac rhythm have occurred in patients receiving astemizole or terfenadine, second-generation H₁ antihistamines of the piperidine class.⁵⁵ These arrhythmias largely involve prolongation of the QT interval, resulting in polymorphic ventricular tachycardia (torsades de pointes) (see Chapter 24), the consequences of which can be fatal. Such cardiotoxic effects usually occur when plasma concentrations of the drugs are increased as a result of either excessive doses or altered hepatic metabolism. The latter can occur as a result of impaired liver function or the concurrent administration of certain drugs, especially the macrolide antibiotics (erythromycin and, to a lesser extent, clarithromycin) and azole antifungals (ketoconazole and itraconazole) that

bind to the CYP3A4 enzyme and interfere with metabolism of antihistamines. Because of this uncommon but serious problem, terfenadine and astemizole were voluntarily withdrawn from the U.S. market in the past decade. Although loratadine is metabolized by CYP3A4, it does not seem to increase the QT interval alone or in the presence of drugs that interact with terfenadine and astemizole. Fexofenadine, cetirizine, and acrivastine have not been associated with these arrhythmias or drug interactions.

Large doses of antihistamines can cause marked stimulation of the CNS manifested by hallucinations, excitement, and motor disturbances such as tremors and convulsions. Deaths from overdose almost invariably occur outside a therapeutic setting (e.g., accidental poisoning in the home).

Allergic reactions to H₁ antihistamines can occur; they are more frequent after topical application than after oral administration and can complicate the treatment of allergic lesions of the skin or oral mucosa. Allergic reactions can take the form of urticarial, eczematous, bullous, or petechial rashes; fixed drug eruptions; or, more rarely, anaphylaxis.

As with most drugs, various blood dyscrasias (hemolytic anemia, agranulocytosis, pancytopenia, and thrombocytopenia) have been reported after the use of antihistamines. Patients receiving long-term antihistamine therapy should be periodically monitored. Although certain piperazine H₁ antihistamines have been shown to be teratogenic in some laboratory animal models, there is no clinical evidence to indicate that antihistamines cause birth defects in humans. Use of these drugs should be avoided, however, during the first trimester of pregnancy. Doxylamine was suspected to cause birth defects when used as an antiemetic drug during pregnancy. Several studies have shown no increase in birth defects with doxylamine, although it cannot be ruled out that the drug is weakly teratogenic.

Because of their sedative properties, H₁ antihistamines can potentiate the CNS depressant effects of other agents, such as barbiturates, opioid analgesics, general anesthetics, and alcohol. Although such an interaction may be deliberately sought, as in the preanesthetic use of promethazine, these combinations should otherwise be avoided or monitored closely. Because antihistamines have antimuscarinic properties, they can produce manifestations of excessive cholinergic blockade if given during therapy with other anticholinergic drugs. Such manifestations (e.g., dry mouth, constipation, blurred vision) are more likely to be troublesome than serious. Long-term use can have important consequences; if dry mouth persists, it can lead to a higher incidence of caries. Second-generation H₁ antihistamines do not have antimuscarinic effects.

Antihistamines are variably excreted in breast milk. Because infants, especially newborns and premature infants, are at higher risk of adverse effects, the use of antihistamines in nursing women should be avoided. Antihistamines, similar to other anticholinergic drugs, may inhibit lactation.

Preparations and doses of drugs used in dentistry

The therapeutic utility of H₁ antihistamines can be encompassed by relatively few agents. Because numerous preparations are available, the clinician has the task of selecting the most effective drug with the fewest side effects. Because there are few quantitative data on which to base this choice, the clinician should select one or two well-known representatives of each class and become familiar with their therapeutic indications and limitations. These selections can be modified when convincing evidence of an advantage offered by another agent becomes available. Because they lack sedative and anticholinergic effects, second-generation H₁ antihistamines seem to meet this criterion. These drugs are expensive, however, and are often best reserved for patients who are intolerant

of established first-generation drugs. In dentistry, the unique pharmacologic profile of second-generation agents precludes them from most applications because sedative and anticholinergic effects are usually desirable outcomes.

Oral doses of examples of each of the major classes of H₁ antihistamines are given in Table 22-2. For more prescribing information, the reader should consult a standard reference for this purpose.³⁰

H₂ Receptor Antagonists

Chemistry and classification

H₂ receptor antagonists, or H₂ antihistamines, are basically structural analogues of histamine (Figure 22-4). Two changes in the histamine molecule are necessary to achieve H₂ receptor-blocking activity.¹³ One is modification of the imidazole ring or its substitution by a furan or thiazole ring. A second modification is the presence of a flexible connecting chain linked to a polar substituent capable of hydrogen binding.

The first compound discovered to have the ability to block H₂ receptors was burimamide.³ Its poor oral absorption and partial-agonist properties led to a search for active congeners. The first of these to be tested was metiamide.⁴ Although metiamide is orally effective, it caused a reversible neutropenia during clinical trials. Because the thiourea moiety in the side chain of metiamide was believed to be responsible for this adverse effect, the thiourea group was replaced by a cyanoguanidine group. The resultant compound, cimetidine, became available for clinical use in 1977.²⁰ Shortly thereafter, ranitidine was approved. It differs from cimetidine and earlier H₂ antagonists in that it is not an imidazole derivative but instead contains a furan ring. Later, two other H₂ receptor antagonists, famotidine and nizatidine, were approved for use. In contrast to either cimetidine or ranitidine, famotidine and nizatidine are based on a thiazole ring structure (see Figure 22-4).

Several differences between H₁ and H₂ antihistamines are obvious. H₁ antihistamines have aryl or heteroaryl rings that

are highly lipophilic and bear little resemblance to the imidazole ring of histamine. Their side chains usually have an ammonium group and are mostly positively charged at physiologic pH. In contrast, H₂ antihistamines have a modified imidazole or other heterocyclic ring and a polar but uncharged side chain. H₂ antihistamines are hydrophilic; this property may account for their weak CNS and local anesthetic properties.¹³

Pharmacologic effects

H₂ antihistamines are potent competitive antagonists of histamine. Because H₂ receptors are strongly implicated in the secretory function of the gastric mucosa, these compounds cause a marked reduction in H⁺ output, pepsin activity, and the total volume of gastric secretion (Figure 22-5). Inhibition of secretion can be attained in the fasting state and after stimulation with food, histamine, betazole, pentagastrin, or caffeine.

Although H₂ receptors are found in many tissues, including vascular and bronchial smooth muscle, H₂ antihistamines have few important effects on physiologic function other than gastric secretion. In certain situations, such as antagonism of a histamine-induced hypotension, a combination of H₁ and H₂ antihistamines is more effective than either alone, which suggests that in such situations H₁ and H₂ receptors are involved.³⁵

Absorption, fate, and excretion

Except for famotidine, H₂ antihistamines are rapidly and completely absorbed after oral administration. All undergo a variable degree of first-pass metabolic degradation in the liver, resulting in an oral bioavailability of approximately 50% for cimetidine, ranitidine, and famotidine and more than 90% for nizatidine. After absorption, H₂ antihistamines are generally distributed in the total body water. Therapeutic concentrations are reached in approximately 1 to 2 hours. The elimination half-life is 2 to 3.5 hours except for nizatidine, which has

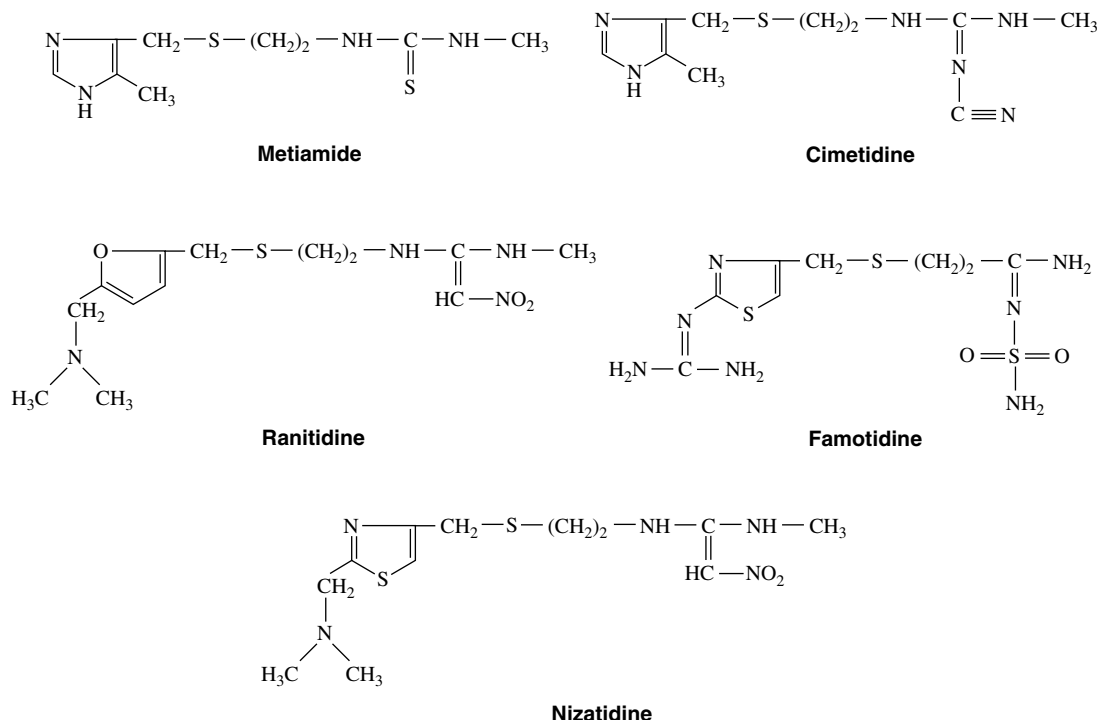

FIGURE 22-4 Structural formulas of some H₂ receptor antagonists.

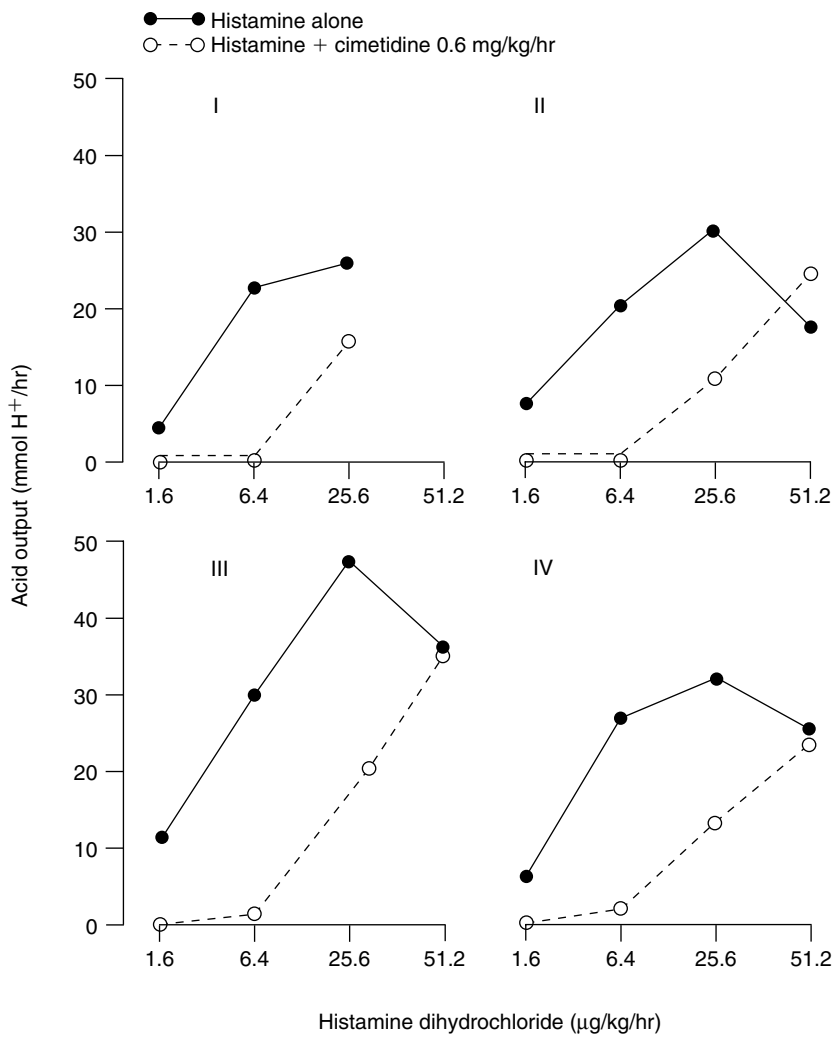

FIGURE 22-5 Inhibition of histamine-stimulated gastric acid production by cimetidine in humans. Histamine dihydrochloride in doses of 1.6 to 51.2 $\mu\text{g}/\text{kg}/\text{hr}$ was infused intravenously with or without cimetidine at a dose of 0.6 mg/kg/hr for 105 minutes. When cimetidine was given, its administration was begun 15 minutes before the histamine infusion was started. Gastric juice was collected at 15-minute intervals and analyzed for acid concentration; the last four 15-minute intervals were used to establish the dose-response curves. Data shown are individual results from four normal adult subjects (I-IV). (From Aadland E, Berstad A: Inhibition of histamine- and pentagastrin-stimulated gastric secretion by cimetidine in man. In Creutzfeldt W, editor: *Cimetidine*, Amsterdam, 1978, Excerpta Medica Foundation.)

a half-life of 1 to 1.5 hours. Urinary excretion of the parent compound accounts for 60% to 70% of the injected dose of each drug. The remainder is oxidized, the sulfoxide being a major metabolite, and excreted in the urine and feces. Cimetidine (300 mg), the least potent agent, reduces basal gastric acid secretion by at least 80% for 4 to 5 hours, whereas famotidine (20 mg), the most potent, lasts for 10 to 12 hours. Because of the relative safety of these drugs, increased doses can be used to extend the duration of effect.

General therapeutic uses

It has now been shown that *Helicobacter pylori* plays a role in the pathogenesis of most peptic ulcer disease. This organism is a gram-negative rod that can colonize the mucosal surface of the stomach and evoke an inflammatory gastritis. Two lines of evidence implicate *H. pylori* in peptic ulcer disease. First, it is found in most cases (70% to 90%) of active gastric or duodenal ulcers. Second, eradication of the organism by appropriate antimicrobial therapy often leads to remission of symptoms, healing of ulcers, and prevention of recurrence. The fact that *H. pylori* may be found in healthy individuals suggests that other risk factors are involved also in the genesis of this disease. These observations have altered conventional therapy of peptic ulcer disease; anti-infective measures aimed at *H. pylori* are now frequently combined with control of gastric acid secretion by H₂ antihistamines. The reader is referred to a consensus review for a more detailed discussion of the association between peptic ulcer disease and *H. pylori*

infection and the anti-infective strategies for elimination of this putative pathogen.³² Chapter 33 also discusses antibiotic therapy for *H. pylori*.

H₂ antihistamines are used clinically for their marked ability to inhibit basal and stimulated secretion of gastric acid. They are approved for use in a wide variety of gastrointestinal disorders in which reduction of acid secretion may relieve symptoms, lead to healing, and prevent recurrence of previously resolved disease. Specifically approved indications include duodenal ulcer disease (active or in maintenance), active gastric ulcer disease, gastroesophageal reflux disease, and pathologic hypersecretory conditions (e.g., systemic mast cell disease and Zollinger-Ellison disease).^{12,37} H₂ antihistamines are generally given orally, but parenteral forms (except for nizatidine) are also available for acute suppression of gastric acid secretion. Oral dosage may be divided into once-daily or twice-daily administration; if once daily, the dose is best given at bedtime to block nocturnal gastric acid secretion.

A major use of H₂ antihistamines is treatment of active benign gastric ulcers and prophylaxis and treatment of active duodenal ulcers. All the currently available agents (cimetidine, ranitidine, famotidine, and nizatidine) have been shown to be equally effective in appropriate doses in suppressing gastric acid secretion (by up to 90%) and accelerating the healing of duodenal and, to a lesser extent, gastric ulcers.¹¹ Healing of ulcers generally occurs within 2 to 4 months of therapy; if healing is not achieved in this period, further therapy is unlikely to be successful. Although cimetidine and

other H₂ antihistamines have been used to treat upper gastrointestinal bleeding caused by liver disease, such as cirrhosis, little evidence supports their effectiveness in these conditions. Finally, H₂ antihistamines may be used before general anesthesia, particularly in patients with gastrointestinal obstruction, to elevate gastric pH and reduce the danger of aseptic pneumonia if gastric contents are aspirated during induction.

After their introduction more than 20 years ago, H₂ receptor antagonists became one of the most widely prescribed groups of drugs in the world. Their use has declined considerably in recent years because of the introduction of proton pump inhibitors (see Chapter 33). The U.S. Food and Drug Administration now allows OTC marketing of all four currently available H₂ antihistamines for symptomatic relief of occasional heartburn, acid indigestion (hyperchlorhydria), or "sour" stomach. This decision reflected the extensive use of H₂ antihistamines previously dispensed by prescription for nonapproved conditions, while acknowledging the relative safety of these agents in unsupervised use. Such OTC use may risk delaying diagnosis of more serious disease, however, such as peptic ulcer or gastric cancer.

As noted earlier, the management of gastroesophageal reflux disease and gastroduodenal ulcers currently relies mostly on proton pump inhibitors because of their superiority in the more clinically significant forms of these disorders. Consequently, the prescription use of H₂ antihistamines has declined. Because of their more rapid onset of action and lower cost, H₂ antihistamines are still preferred for patient-based treatment of mild or infrequent symptoms of acid-peptic disorders.

Adverse effects

The initial impression that cimetidine was generally free of serious adverse effects has been validated by the passage of time and extensive clinical use. More recently introduced H₂ antihistamines seem to be similarly well tolerated by most patients. It has also become apparent that cimetidine and, to a lesser extent, other H₂ antihistamines can cause various toxic reactions and side effects.^{26,40} Most untoward responses seem to have no obvious relation to blockade of H₂ receptors. This assumption may simply result from an incomplete understanding of the presence and function of H₂ receptors in tissues other than the gastric mucosa.

The most common adverse effects of cimetidine are manifested in the CNS. These are highly variable and range from minor symptoms (dizziness, lethargy, and fatigue) to more serious disturbances (mental confusion, delirium, focal twitching, hallucinations, and seizures). The CNS effects often seem to be dose-related and are most commonly seen in elderly patients or patients with impaired liver or kidney function.

Cimetidine exerts many effects on endocrine function that are generally minor and reversible on cessation of therapy. The most notable of these is gynecomastia; others are elevation of serum prolactin concentrations, galactorrhea, loss of libido, impotence, and reduction in sperm counts. Small but definite increases in serum creatinine concentrations occur in most patients treated with cimetidine. This effect is not associated with other changes in renal function and ceases when the drug is withdrawn. The depression of granulocytes associated with metiamide does not seem to be a problem with cimetidine, but transient leukopenia, granulocytopenia, and thrombocytopenia have been reported. It is difficult to implicate cimetidine as a direct bone marrow suppressant because the cases reported almost always involve the concomitant use of other drugs or the existence of other serious systemic diseases. Although cimetidine enhances cell-mediated immune reactions, no evidence suggests that this phenomenon is related to any of the observed clinical responses.

The occurrence of gastric cancer in patients treated with cimetidine has led to the suggestion that the agent may be carcinogenic. This possibility has not been proved, and present information is insufficient to label cimetidine as a carcinogen.

Although cimetidine initially seemed to have no significant drug interactions, subsequent clinical reports and laboratory studies indicate that this is not the case. Cimetidine has been shown to increase blood concentrations of numerous drugs, including anticoagulants of the warfarin type, tricyclic antidepressants, various benzodiazepines, phenobarbital, theophylline, propranolol and other β -adrenoceptor blockers, Ca⁺⁺ channel blockers, lidocaine, estradiol, and phenytoin, creating a risk of toxicity. The basis of these interactions seems to be competitive inhibition by cimetidine of the hepatic mixed-function oxidase enzymes responsible for the metabolism of these drugs.¹⁵ Also, a cimetidine-induced decrease in hepatic blood flow may depress the entry of drugs into the liver and slow metabolism. Patients receiving cimetidine together with any from a long list of drugs should be carefully monitored; if appropriate, reduction of dosages or use of alternative agents should be considered.

Ranitidine, famotidine, and nizatidine seem to have fewer adverse effects than cimetidine. These drugs do not exert significant antiandrogenic effects, and they do not influence serum prolactin concentrations. Impotence and gynecomastia do not occur with their use. Mental disturbances are less likely with these drugs, and they have not been reported to elevate serum creatinine concentrations. Because the binding of these agents to cytochrome P450 enzymes is much less firm than that of cimetidine, they do not significantly inhibit the microsomal metabolism of other drugs.

ANTIHISTAMINES

<i>Nonproprietary (generic) name</i>	<i>Proprietary (trade) name</i>
H₁ receptor antagonists—first-generation	
<i>Alkylamines</i>	
Brompheniramine	In Dimetane, Bromphen
Chlorpheniramine	Chlor-Trimeton, in Teldrin
Dexbrompheniramine	In Disobrom, in Drixoral
Dexchlorpheniramine	Polaramine
Pheniramine	In Dristan, in Triaminic
Tripolidine	Actidil, Tripohist
<i>Ethanolamines</i>	
Clemastine	Tavist
Dimenhydrinate*	Dramamine, Marmine
Diphenhydramine	Benadryl, Somnex
Doxylamine	Unisom
Carbinoxamine	Palgic, in Rondec
Phenyltoloxamine	In Comhist LA, in Phenylgesic
<i>Ethylenediamines</i>	
Pyrilamine	In Midol Complete
Tripelennamine	PBZ
<i>Piperazines</i>	
Buclizine	Bucladin-S
Cyclizine	Marezine
Hydroxyzine	Atarax, Vistaril
Meclizine	Antivert, Bonine

ANTI-HISTAMINES—cont'd

Nonproprietary (generic) name	Proprietary (trade) name
-------------------------------	--------------------------

Phenothiazines

Methdilazine	Tacaryl
Promethazine	Phenergan

Piperidines

Azatadine	Optimine
Cyproheptadine	Periactin
Ketotifen [†]	Zaditor
Phenindamine	Nolahist

Others

Emedastine [†]	Emadine
Epinastine [†]	Elestat
Olopatadine [†]	Patanol

H₁ receptor antagonists—second-generation (nonsedating)*Alkylamine*

Acrivastine	In Semprex-D
-------------	--------------

Piperazines

Cetirizine	Zyrtec
Levocetirizine	Xyzal

Piperidines

Desloratadine	Clarinex
Fexofenadine	Allegra
Levocabastine [†]	Livostin
Loratadine	Claritin

Phthalazinone

Azelastine [‡]	Astelin, Azalex
-------------------------	-----------------

H₂ receptor antagonists

Cimetidine	Tagamet
Famotidine	Pepcid
Nizatidine	Axid
Ranitidine	Zantac

*The chlorotheophylline salt of diphenhydramine.

†For topical ophthalmic use.

‡For topical use.

CITED REFERENCES

- Barnett A, Kreutner W: Pharmacology of non-sedating H₁ antihistamines. *Agents Actions* 33(Suppl):181-196, 1991.
- Best CH, Dale HH, Dudley JW, et al: The nature of the vasodilator constituents of certain tissue extracts. *J Physiol (London)* 62:397-417, 1927.
- Black JW, Duncan WA, Durant CJ, et al: Definition and antagonism of histamine H₂-receptors. *Nature* 236:385-390, 1972.
- Black JW, Duncan WA, Emmett JC, et al: Metiamide—an orally active histamine H₂-receptor antagonist. *Agents Actions* 3:133-137, 1973.
- Bovet D, Staub A: Action protectrice des éthers phénoliques au cours de l'intoxication histaminique. *Compt Rend Soc de Biol* 124: 547-549, 1937.
- Busse W: New directions and dimensions in the treatment of allergic rhinitis. *J Allergy Clin Immunol* 82:890-900, 1988.
- Carter CA, Wajciechowski NJ, Hayes JM, et al: Terfenadine, a nonsedating antihistamine. *Drug Intell Clin Pharm* 19:812-817, 1985.
- Code CF: Reflections on histamine, gastric secretion, and the H₂ receptor. *N Engl J Med* 296:1459-1462, 1977.
- Crawford JM: The gastrointestinal tract. In Cotran RS, Kumar V, Collins T, editors: *Robbins' pathologic basis of disease*, ed 6, Philadelphia, 1999, Saunders.
- Dale HH, Laidlaw PP: Histamine shock. *J Physiol (London)* 52:355-390, 1919.
- Deakin M, Williams JG: Histamine H₂-receptor antagonists in peptic ulcer disease: efficacy in healing peptic ulcers. *Drugs* 44:709-719, 1992.
- Famotidine (Pepcid). *Med Lett Drugs Ther* 29:17-18, 1987.
- Ganellin CR, Durant GJ, Emmett JC: Some chemical aspects of histamine H₂-receptor antagonists. *Fed Proc* 35:1924-1930, 1976.
- Goldsmith P, Dowd PM: The new H₁ antihistamines: treatment of urticaria and other clinical problems. *Dermatol Clin* 11:87-95, 1993.
- Hansten PD: Drug interactions of gastrointestinal drugs. In Lewis JH, editor: *A pharmacologic approach to gastrointestinal disorders*, Baltimore, 1994, Williams & Wilkins.
- Hill SJ: Distribution, properties and functional characteristics of three classes of histamine receptors. *Pharmacol Rev* 42:45-83, 1990.
- Hofstra CL, Desai PJ, Thurmond RL, et al: Histamine H₄ receptor mediates chemotaxis and calcium mobilization of mast cells. *J Pharmacol Exp Ther* 305:1212-1221, 2003.
- Hough LB: Genomics meets histamine receptors: new subtypes, new receptors. *Mol Pharmacol* 59:415-419, 2001.
- Imamura M, Poli E, Omonivi AT, et al: Unmasking of activated histamine H₃ receptors in myocardial ischemia: their role as regulators of exocytotic norepinephrine release. *J Pharmacol Exp Ther* 271:1259-1266, 1994.
- Jacobs RS, Catania H: Cimetidine. *Drug Intell Clin Pharm* 11:723-726, 1977.
- Lagunoff D, Martin TW, Read G: Agents that release histamine from mast cells. *Annu Rev Pharmacol Toxicol* 23:331-351, 1983.
- Levi R, Allan G, Zavecz JH: Cardiac histamine receptors. *Fed Proc* 35:1942-1947, 1976.
- Lewis T, Grant RT: Vascular reactions of the skin to injury, II: the liberation of a histamine-like substance in injured skin; the underlying causes of factitious urticaria and of wheals produced by burning; and observations upon the nervous control of certain skin reactions. *Heart* 11:209-265, 1924.
- Ling P, Ngo K, Nguyen S, et al: Histamine H₄ receptor mediates eosinophil chemotaxis with cell shape change and adhesion molecule up-regulation. *Br J Pharmacol* 142:161-178, 2004.
- Malamed SF: *Sedation: a guide to patient management*, ed 4, St Louis, 2003, Mosby.
- McGuigan JE: A consideration of the adverse effects of cimetidine. *Gastroenterology* 80:181-192, 1981.
- McTavish D, Sorkin EM: Azelastine: a review of its pharmacodynamic and pharmacokinetic properties and therapeutic potential. *Drugs* 38:778-800, 1989.
- Metcalf DD, Costa JJ, Burd PR: Mast cells, and basophils. In Gallin JI, Goldstein IM, Snyderman R, editors: *Inflammation: basic principles and clinical correlates*, ed 2, New York, 1992, Raven Press.
- Meyer RA, Jakubowski W: Use of tripeleminamine and diphenhydramine as local anesthetics. *J Am Dent Assoc* 69:112-117, 1964.
- Mosby's drug consult for health professions*, St Louis, 2006, Elsevier.
- Nathan C: Points of control in inflammation. *Nature* 420:846-856, 2002.
- NIH Consensus Development Panel on *Helicobacter pylori* in peptic ulcer disease: *Helicobacter pylori* in peptic ulcer disease. *JAMA* 272:65-69, 1994.
- Parsons ME: The antagonism of histamine H₂-receptors in vitro and in vivo with particular reference to the actions of cimetidine. In Burland WL, Simkins MA, editors: *Cimetidine. Proceedings of the Second International Symposium on Histamine H₂-Receptor Antagonists*, Amsterdam, 1977, Excerpta Medica Foundation.
- Peets EA, Jackson M, Symchowicz S: Metabolism of chlorpheniramine maleate in man. *J Pharmacol Exp Ther* 180:464-474, 1972.
- Powell JR, Brody MJ: Identification and blockade of vascular H₂ receptors. *Fed Proc* 35:1935-1941, 1976.
- Prell GD, Green JP: Histamine as a neuroregulator. *Annu Rev Neurosci* 9:209-254, 1986.
- Ranitidine (Zantac). *Med Lett Drugs Ther* 24:111-113, 1982.
- Reiner PB, Kamondi A: Mechanisms of antihistamine-induced sedation in the human brain: H₁ receptor activation reduces a

- background leakage potassium current. *Neuroscience* 59:579-588, 1994.
39. Riley JF, West GB: The occurrence of histamine in mast cells. In Rocha e Silva M, editor: *Histamine and antihistaminics, part 1. Handbook of experimental pharmacology*, vol 18, Berlin, 1966, Springer-Verlag.
 40. Sawyer D, Conner CS, Scalley R: Cimetidine: adverse reactions and acute toxicity. *Am J Hosp Pharm* 38:188-197, 1981.
 41. Schayer RW: Catabolism of histamine in vivo. In Rocha e Silva M, editor: *Histamine and antihistaminics, part 1. Handbook of experimental pharmacology*, vol 18, Berlin, 1966, Springer-Verlag.
 42. Schwartz J-C, Arang JM: Histamine. In Davis KL, Charney D, Coyle JT, et al, editors: *Neuropsychopharmacology: the fifth generation of progress*, Philadelphia, 2002, Lippincott Williams & Wilkins.
 43. Schwartz J-C, Barbin G, Duchemin A-M, et al: Histamine receptors in the brain and their possible functions. In Ganellin CR, Parsons ME, editors: *Pharmacology of histamine receptors*, Bristol, 1982, Wright-PSG.
 44. Schwartz LB: Mast cells: function and contents. *Curr Opin Immunol* 6:91-97, 1994.
 45. Simons FE: Advances in H₁-antihistamines. *N Engl J Med* 351:2203-2217, 2004.
 46. Simons FE, Simons KJ: Clinical pharmacology of H₁-antihistamines. *Clin Allergy Immunol* 17:141-178, 2002.
 47. Skidgel RA, Erdös EG: Histamine, bradykinin, and their antagonists. In Brunton LL, Lazo JS, Parker KL, editors: *Goodman & Gilman's the pharmacological basis of therapeutics*, ed 11, New York, 2006, McGraw-Hill.
 48. Sorkin EM, Heel RC: Terfenadine: a review of its pharmacologic properties and therapeutic efficacy. *Drugs* 29:34-56, 1985.
 49. Spencer CM, Faulds D, Peters DH: Cetirizine: a reappraisal of its pharmacological properties and therapeutic use in selected allergic disorders. *Drugs* 46:1055-1080, 1993.
 50. Thurmond RL, Deais PJ, Dunford PF, et al: A potent and selective histamine H₄ receptor antagonist with antiinflammatory properties. *J Pharmacol Exp Ther* 309:404-413, 2004.
 51. Thurmond RL, Gelfand WW, Dunford PF: The role of histamine H₁ and H₄ receptors in allergic inflammation. *Nat Rev Drug Discov* 7:4-53, 2008.
 52. Townley RG: Cetirizine: a new H₁ antagonist with antieosinophilic activity in chronic urticaria. *J Am Acad Dermatol* 25:668-674, 1991.
 53. Welborn JF, Kane JP: Conduction anesthesia using diphenhydramine hydrochloride. *J Am Dent Assoc* 69:706-709, 1964.
 54. Willoughby DA: Mediation of increased vascular permeability in inflammation. In Zweifach BW, Grant L, McClusky RT, editors: *The inflammatory process*, vol 2, ed 2, New York, 1973, Academic Press.
 55. Woolsey RL, Chen Y, Freiman JP, et al: Mechanism of the cardiotoxic actions of terfenadine. *JAMA* 269:1532-1536, 1993.
 56. Zweifach BW: Microcirculation. *Annu Rev Physiol* 35:117-150, 1973.

GENERAL REFERENCES

- Chan FKL, Lau JYW: Treatment of peptic ulcer disease. In Feldman M, Friedman LS, Brandt LJ, editors: *Sleisenger & Fordtran's gastrointestinal and liver disease: pathophysiology, diagnosis, management*, ed 8, Philadelphia, 2006, Saunders.
- Gallin JI, Snyderman R, editors: *Inflammation: basic principles and clinical correlates*, ed 3, Philadelphia, 1999, Lippincott Williams & Wilkins.
- Simons FER, editor: *Histamine and H₁-receptor antagonists in allergic disease*, ed 2, New York, 2002, Marcel Dekker.

Drugs for Treating Orofacial Pain Syndromes

ROBERT L. MERRILL

PHARMACOLOGY AND CHRONIC PAIN

The management of chronic orofacial pain, as compared with acute pain, requires an in-depth knowledge of pharmacology and pharmacotherapy because chronic pain disorders are a heterogeneous group of conditions with various pathologic mechanisms and characteristics requiring diverse families of medications for treatment. Dentists do not generally use these medications because dentistry has traditionally focused on acute pain problems. The pharmacologic characteristics of opioids are discussed in Chapter 20, and the pharmacologic characteristics of acetaminophen and nonsteroidal anti-inflammatory drugs (NSAIDs) are discussed in Chapter 21. Treatment of acute pain in dentistry is addressed in Chapter 47.

With more recent advances in understanding chronic pain disorders and recognition that these disorders affect the orofacial region, dentists are now being educated to manage chronic pain and use medications traditionally used only in a medical setting. This chapter reviews the medications used for chronic orofacial pain disorders and relates them to known or putative disorders and pain mechanisms.

When a patient is evaluated for chronic orofacial pain, the clinician must determine which of various potential conditions may be the source of the pain. In general, after eliminating intracranial and extracranial sources, the clinician has narrowed the differential diagnosis to musculoskeletal, neurovascular, and peripheral or central neuropathic pain, or combinations of these. These categories of pain have different pathophysiologic mechanisms and require different treatment modalities or strategies. Intertwined with the pain issues are psychological issues that have developed in conjunction with chronic pain. These issues must be dealt with to optimize treatment of pain and obtain a beneficial outcome.

Often medications used to treat one condition may be useful for another. Tricyclic antidepressants (TCAs), used to treat depression, are useful in prophylaxis of migraine and may be the most effective drugs for treating certain neuropathic or musculoskeletal pain disorders. In addition, medications may be used differently in each of the pain categories. To understand chronic orofacial pain, the clinician needs to understand the mechanisms behind the various conditions because this knowledge may be helpful in choosing the medications that would be most beneficial for the patient. This chapter reviews the medications used to treat these categories of chronic pain and elaborates on the general and specific mechanisms of action, if known, for each of the medications listed. This chapter does not discuss the use of opioids for chronic pain other than to indicate that in cases of intractable pain resulting from cancer or other conditions such as chronic

neuropathy resulting from failed temporomandibular joint (TMJ) surgery, long-term use of opioids may be the only option for helping the patient, although this is rare because opioids are generally less effective in treating neuropathic pain than several other drugs.

SEROTONIN (5-HYDROXYTRYPTAMINE)

To understand chronic pain and its pharmacologic management, it is necessary to understand the 5-hydroxytryptamine (5-HT) system and its impact on pain modulation. Besides chronic pain, alteration in 5-HT function has been implicated in numerous other clinical conditions, including affective disorders, obsessive-compulsive disorders, schizophrenia, anxiety states, phobic disorders, eating disorders, migraine, and sleep disorders. Serotonin receptors are found on presynaptic and postsynaptic neurons. The two key presynaptic neurons are 5-HT_{1A} and 5-HT_{1D}. The postsynaptic 5-HT receptors include 5-HT_{1A}, 5-HT_{1D}, 5-HT_{2A}, 5-HT_{2C}, 5-HT₃, and 5-HT₄. Presynaptic receptors function as autoreceptors, controlling the release of serotonin and serotonergic action potentials. The 5-HT_{1A} receptor is a somatodendritic autoreceptor that slows action potentials. The presynaptic 5-HT_{1D} autoreceptor detects 5-HT being released into the synaptic cleft and inhibits its further release; the 5-HT_{1D} receptor is also called a *terminal autoreceptor*.

A wide range of drugs affects 5-HT neurotransmission, including antidepressants (TCAs, selective serotonin reuptake inhibitors [SSRIs], and heterocyclic antidepressants), hallucinogens, anxiolytics, antiemetics, antimigraine agents, atypical antipsychotics, and appetite suppressants. Many other drugs not generally considered to affect the 5-HT system nevertheless have an assumed effect on 5-HT receptors because of the influence they have on conditions that are linked to 5-HT dysregulation, such as migraine.

Historical Aspects of Serotonin

Since 1868, serum (*sero-*) from blood clots was known to possess a substance that caused blood vessels to constrict, increasing their smooth muscle tone (*-tonin*). Subsequent physiologic studies of this vasoconstrictive activity vacillated between some unknown substance and epinephrine as the cause. Eventually, the issue was clarified when it was observed that the serum constricted frog vascular and rabbit intestinal preparations, whereas epinephrine caused only relaxation of the gut. Because no evidence of epinephrine was found in the blood plasma, it was assumed that vasoconstriction was caused by a substance in the coagulated blood, and by the early 1900s the source of that substance was identified with platelets.

Janeway and associates²⁰ did a thorough investigation of the vasoconstrictive substance and noted that it was not present in uncoagulated or citrated blood, that it was definitely associated with platelets, that it was soluble in water more than ether or chloroform, and that the factor did not depend on the clot formation but on the disintegration of the platelets in the clot. The substance itself was eventually isolated and named *serotonin* by Rapport and colleagues in 1948.³⁶ Shortly after this, Rapport and colleagues identified the agent as 5-HT, and Hamlin and Fischer¹⁸ reported synthesizing it in 1951.

Meanwhile, in Italy, in a separate series of studies, Erspamer and Asero⁸ isolated a substance from the mucosa of rabbit stomach and found that it was abundant in the enterochromaffin cells of the gut, could be extracted with alcohol and acetone, was an amine that affected smooth muscle, and was deactivated by deamination. Erspamer and Asero named it *enteramine*. By 1952, serotonin and enteramine had been chemically identified as 5-HT, eventually leading to international wrangling over the naming of 5-HT. It was argued that "enteramine" was inaccurate because the substance was found in places other than the gut, and "serotonin" was equally inadequate from the points of origin and pharmacologic action. In 1986, when the International Serotonin Club was organized, American researchers prevailed over the European contingent in naming the substance *serotonin* by arguing that serotonin was the most widely accepted name, 5-hydroxytryptamine was too long, and 5-HT was only an abbreviation (but one used here).

5-HT and Pain

Stimulation of the periaqueductal gray (PAG) was shown to modulate nociception on a spinal level.²⁸ This effect is known as *stimulation-produced analgesia (SPA)*. Although a number of areas have been studied in animals, human studies of necessity have been limited. In humans, stimulation of the midbrain region of the PAG and areas slightly more rostral in the periventricular gray matter of the hypothalamus are known to produce SPA. Neurosurgeons were able to show SPA in humans by stimulating the equivalent human midbrain sites. Researchers had determined that electrical stimulation of brainstem PAG produced analgesia in animals. Although the

exact boundaries of the responsive area were not clearly defined, the sites most responsive to SPA were: ventral to the midbrain cerebral aqueduct; in the PAG; sites lateral to this structure; the rostroventral medulla (RVM), including the midline nucleus raphe magnus (NRM) and reticular formations; the hypothalamus; the frontal lobe; and the spinal cord. Areas outside of the midbrain have not been systematically studied.

Most of the projections from the RVM/PAG are tryptaminergic. Injection of morphine in the PAG also has a similar antinociceptive effect and is thought to be mediated by activation of a raphe-spinal pathway. Other studies have implicated descending 5-HT fibers and other non-5-HT-containing fibers in this process. Increased production of 5-HT in the bulbospinal 5-HT neurons supports the role of 5-HT in modulation of pain in these pathways. Studies of the raphe pathways have confirmed that with such stimulation there is a concomitant increase in 5-hydroxyindoleacetic acid (5-HIAA), a major metabolite of 5-HT, in the dorsal horn, implicating activation and degradation of 5-HT in the process.

Anatomic Distribution

5-HT is a biogenic monoamine and is widely distributed throughout the plant and animal kingdom. In mammals, the highest concentrations are found in the enterochromaffin cells of the gastrointestinal mucosa, central nervous system (CNS), and blood platelets. The structure of 5-HT is shown in Figure 23-1. Its most notable features are the hydroxyl group on position 5 of the indole nucleus and the primary amine nitrogen that can accept a proton, making the compound hydrophilic and unable to pass the blood-brain barrier easily. Rapport and colleagues³⁶ found the substance in the brain, indicating that it must be synthesized and perform some unidentified function there. It was subsequently assumed that 5-HT was associated with psychiatric disorders such as depression and schizophrenia when it was shown that the psychedelic drug lysergic acid diethylamide (LSD) antagonized 5-HT function. 5-HT is now known to be involved in many behavioral and psychiatric disorders, such as schizophrenia, obsessive-compulsive disorder, depression, and anxiety, and drugs that have an effect on the 5-HT system have been beneficial in treating these disorders (see Chapter 12).

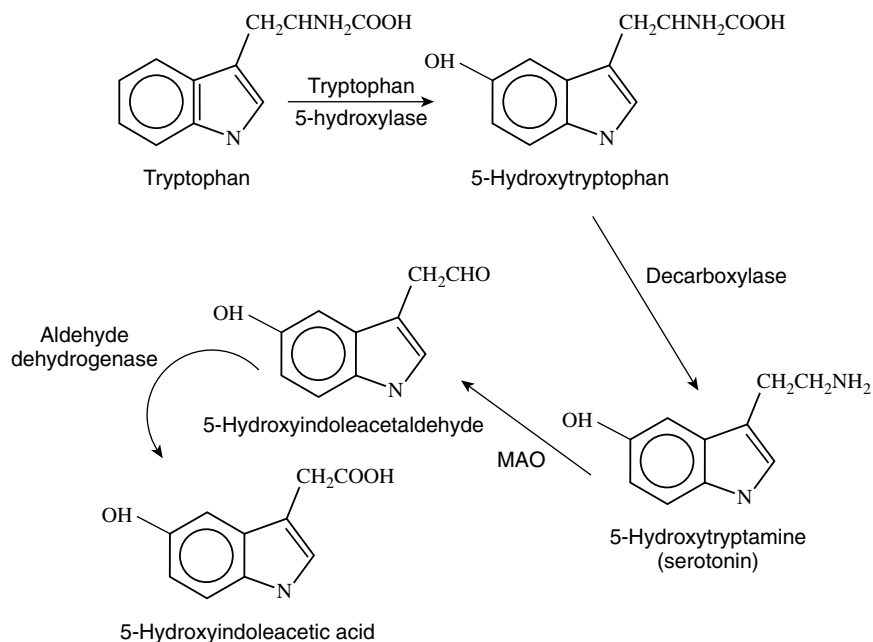

FIGURE 23-1 Biosynthesis and metabolism of serotonin. MAO, Monoamine oxidase.

Despite earlier suggestions that 5-HT was a neurotransmitter synthesized in the brain, the actual localization of 5-HT neurons was not determined for at least 10 more years. By using lesioning and fractionation techniques, 5-HT was grossly associated with specific neuronal elements, but it was impossible to observe the relationship directly until fluorescence histochemical techniques were developed. This process had inherent problems, however, that made identification a significant challenge. Dahlström and Fuxe,⁷ using immunocytochemical techniques, localized 5-HT-associated neurons in nine discrete clusters of cells along the midline of the upper brainstem and pons. These 5-HT-containing cell bodies, designated B1 to B9, corresponded for the most part to the dorsal raphe nuclei. Only approximately 40% to 50% of the dorsal raphe nuclei are serotonergic neurons, and some serotonergic nuclei are found outside the midline raphe nuclei area, although the major brain concentration is in the dorsal raphe nuclei.

Additional studies have shown that the lateral and dorsolateral pontine tegmentum, which contain many noradrenergic neurons, are also involved in nociceptive modulation when stimulated, and these sites send projections to the PAG, the RVM, and the spinal cord. The projections from the lateral and dorsolateral pons are noradrenergic and possess important α_2 -adrenergic receptors. In animal studies, norepinephrine (NE) applied directly to the spinal cord blocks response to nociception through selective inhibition of the nociceptive dorsal horn neurons (see Chapter 20). Lesioning the white matter of the dorsolateral funiculus of the spinal cord blocks the inhibitory effect of SPA and confirms the existence of a descending modulatory pathway that travels through the dorsolateral funiculus. Further studies of the dorsolateral funiculus projections to the spinal cord have found that most of the brainstem projections arise in the RVM and dorsolateral pons, with few projections from the PAG. This finding implies that the PAG projections must be relayed through the RVM. This has been confirmed by studies showing that the major neuronal input to the RVM is from the PAG and adjacent structures, and lesioning or blocking RVM cells eliminates the analgesic effect obtained from PAG stimulation.

Anti-5-HT antibody labeling has identified 5-HT in all dorsal horn laminae, but the highest densities are found in laminae I, II, IV, V, and X. The RVM projections terminate mainly in laminae I, II, and V. These areas are important for pain because this is where the central terminals of afferent nociceptors and cell bodies of second-order neurons are found. This dorsal horn area is the major “switchboard” for pain, and stimulation of the PAG and RVM modulates nociceptive activity here (see Chapter 20).

Immunocytochemical studies have also found 5-HT reactive cells in the area postrema, the caudal locus coeruleus, and around the interpeduncular nucleus. Through lesioning studies, it has been observed that the caudal clusters project mainly to the medulla and spinal cord, the rostral clusters project to the telencephalon and diencephalon, and the more centrally located clusters project rostrally and inferiorly. In general, 5-HT cells send axons through virtually every part of the CNS, however, and more recent findings indicate a lack of pattern to this innervation.

Transmission of sensory and particularly nociceptive messages by afferent fibers entering the dorsal horn of the spinal cord is under control of pathways originating in the ventromedial medulla. It had been observed that neurons from the medullary raphe nuclei and particularly the NRM project predominantly to the dorsal horn, including the superficial laminae and the area around the central canal, and are involved in a descending inhibitory pathway for modulation of nociceptive input. Because the area was found to have an abundance of 5-HT-containing neurons, researchers postulated that

5-HT was a descending pain modulatory system neurotransmitter. 5-HT-containing neurons are located in the rostroventromedial medulla and caudal pons, and particularly in the NRM, the nucleus paragigantocellularis, and the ventral portion of the nucleus gigantocellularis. More recent studies have described other descending projections from the bulbomesencephalon to the spinal cord that do not contain 5-HT and are more numerous within the medulla and caudal pons, indicating that descending modulation is not limited to 5-HT fibers.²⁴

Immunocytochemical studies of antibodies directed against 5-HT have shown that two distinct types of 5-HT neurons innervate the cerebral cortex of many mammals. The studies have found fine axons with small varicosities originating from the dorsal raphe nuclei and beaded axons with large spherical varicosities originating from the median raphe nuclei. Apparently the two types of axons have different regional and laminar distributions and exhibit different sensitivities to neurotoxic drugs such as 3,4-methylenedioxymethamphetamine, commonly referred to as “ecstasy.” The fine axons seem to be more sensitive to the neurotoxic effects, with loss of functions that may be long-term or permanent. Cooper and associates⁶ suggested that laboratory animal findings may relate to humans’ use of the drug because the doses commonly used by recreational drug users are similar to what are used in animal studies. Ecstasy users have shown a 26% decrease in 5-HIAA, the 5-HT metabolite. The decrease in metabolite may indicate a decrease of 5-HT function in the brain related to loss of some 5-HT neurons. The functional distinction between these two types of neurons generally remains unclear, however.

Synthesis, Storage, and Fate

5-HT is synthesized from the amino acid L-tryptophan (see Figure 23-1). Although platelets contain large amounts of 5-HT, it only accumulates rather than being synthesized there. Synthesis in the CNS involves active transport of tryptophan through the blood-brain barrier. Tryptophan is derived primarily from the diet, and its elimination from the diet can profoundly decrease brain 5-HT. In addition, the active transport of tryptophan is affected by its concentration in the blood and the relative concentration of other amino acids that are transported by the same active transport mechanism. L-Tryptophan is converted in serotonergic neurons containing the enzyme tryptophan hydroxylase (L-tryptophan-5-monoxygenase).

The initial synthesis step is hydroxylation of tryptophan at the 5 position to form 5-hydroxytryptophan (see Figure 23-1). Tryptophan hydroxylase, the enzyme responsible for this reaction, occurs in low concentrations in most tissues, including the brain, and has proved to be difficult to isolate.

Tryptophan hydroxylase has a rate-limiting requirement for oxygen. In addition, mounting evidence suggests that the system adjusts to the amount of tryptophan available. It has been shown that drug treatments affecting the 5-HT system are soon counteracted by a built-in feedback mechanism involving regulation of the synthesis of 5-HT. Short-term treatment with lithium salts initially increases tryptophan uptake, resulting in increased amounts of tryptophan being converted to 5-HT; however, with long-term treatment, increased uptake is still measured, but the synthesis of 5-HT from the increased tryptophan returns to pretreatment levels.

5-Hydroxytryptophan is rapidly decarboxylated to form 5-HT by the aromatic enzyme L-amino acid decarboxylase, which is the same enzyme that catalyzes the decarboxylation of L-dopamine in catecholamine neurons (see Figure 23-1). Because the rate of the reaction is so rapid and requires less substrate than the initial reaction, the action of tryptophan hydroxylase in the first step is regarded as the rate-limiting

step in the synthesis of 5-HT, and drugs targeting the action of the decarboxylase have not been shown to be effective.

The synthesis of 5-HT is markedly increased with the electrical stimulation of serotonergic soma. This is the result of enhanced conversion of tryptophan to 5-HT and depends on extracellular Ca^{++} . Because, as discussed previously, the rate-limiting step is the action of tryptophan hydroxylase on tryptophan, it is likely that Ca^{++} affects the Ca^{++} -dependent phosphorylation of the enzyme, increasing its availability.

Storage and release

Similar to other monoamines, 5-HT is stored in vesicles within the cell. Drugs such as reserpine and tetrabenazine that inhibit the activity of the transporter mechanism within the vesicular membrane deplete the brain content of 5-HT. The storage of 5-HT in vesicles requires an active transport mechanism to transfer the molecule from the cytosol to the storage vesicle.

Metabolism

5-HT is also metabolized in the liver by the enzyme monoamine oxidase (MAO) (see Figure 23-1). The product of this reaction is 5-hydroxyindoleacetaldehyde, which is oxidized further by aldehyde dehydrogenase to form the final acid metabolite, 5-HIAA, which is excreted (see Figure 23-1). It had been suggested that increased levels of either of the metabolites of 5-HT or the concentration of 5-HT itself would affect its metabolism, but it has been noted that using MAO inhibitors to block metabolism does not affect the synthesis of 5-HT, and concentrations increase to three times greater than controls. If the elimination of 5-HIAA is blocked by the drug probenecid, the 5-HIAA levels continue to increase without apparent feedback inhibition. The implication of these findings is that the synthesis of 5-HT is not affected by changes in concentrations of its metabolites.

Reuptake and transport across body membranes

Presynaptic reuptake of 5-HT from the synaptic cleft is a major mechanism for controlling the synaptic concentration and action of 5-HT. The presynaptic terminals of serotonergic neurons contain high-affinity uptake sites that are involved in this process by using a plasma membrane transporter protein that can transport 5-HT in either direction depending on the concentration gradient. The transporter proteins involved in this process are composed of 12 membrane-spanning proteins that are Cl^- and Na^+ dependent. Although older TCAs inhibit the reuptake of 5-HT, they also have a variable capacity to inhibit NE reuptake and affect other systems and receptors (see Chapter 12). SSRIs that have shown great utility in moderating depression, anxiety, and obsessive-compulsive disorders also inhibit the 5-HT transporter proteins. These medications are more 5-HT selective with more limited effects on the NE transporter.

5-HT Receptors and Pain

In 1957, Gaddum and Picarelli¹¹ reported two separate 5-HT receptors in peripheral smooth muscle preparations studied in vitro. Since then, there has been an exponential development of information relating to 5-HT receptor types and functions, and numerous receptor subtypes have been identified and cloned more recently. Nevertheless, the complete picture of how 5-HT and its receptors modulate pain remains obscure. There are now seven main family groups of receptors, but current understanding attributes most of the 5-HT actions relative to pain to the families designated 5-HT₁, 5-HT₂, 5-HT₃, 5-HT₄, and 5-HT₇. Each receptor family is operationally and structurally distinct, each having its own separate transducing system.

Although other more recently identified 5-HT receptors also show characteristics indicative of separate classes or fami-

lies of 5-HT receptors, not all receptors for 5-HT are fully included in the classification system at this time because of a lack of needed characterization through cDNA cloning and amino acid sequencing of their proteins or data concerning their operational and transductional characteristics. This situation applies to the 5-HT_{1E}, 5-HT_{1F}, 5-HT₅, and 5-HT₆ receptors, which have been cloned and their amino acid sequence defined, although their operational and transductional characteristics are unclear, and the final nomenclature is unsettled. Fourteen different 5-HT receptor subtypes have been identified.

As mentioned, seven classes or families of 5-HT receptors have been identified and designated 5-HT₁, 5-HT₂, 5-HT₃, 5-HT₄, 5-HT₅, 5-HT₆, and 5-HT₇. Each class has subtypes (with the exception of 5-HT₃), and all have been identified in the brain. Localization of the receptors in the CNS and spinal cord is variable, and not all 5-HT receptors are found in all locations. Within the spinal cord itself there is variability in the location of different receptors. Because 5-HT₁, 5-HT₂, and 5-HT₃ receptors have the highest distribution in the dorsal horn, it is assumed that they are involved in sensory processing. In general, the 5-HT₁ family is assumed to be inhibitory, and the other classes are thought to be excitatory; however, 5-HT₂ and 5-HT₃ receptors have been linked to an antinociceptive response as measured by some animal models. Much work is still to be done before the 5-HT-modulating system is fully understood.

The 5-HT_{1D} receptor, also called the *terminal autoreceptor*, is found on the presynaptic button. It turns off the release of serotonin in response to the presence of serotonin in the synaptic cleft. The receptor is also found on postsynaptic neurons and has been implicated in migraine pathophysiology. The 5-HT_{1A} receptor, also known as a *somatodendritic autoreceptor*, is found primarily on the dendrites and cell bodies of the serotonin neurons but performs a similar function in regulating the release of serotonin. When these receptors are activated or stimulated by serotonin or drugs that mimic serotonin action, the receptor causes a blockade of serotonin release. When the receptors are blocked by receptor blocking medications, the receptor is no longer able to inhibit serotonin release. Serotonin release is also modulated by an α_2 -adrenergic heteroreceptor on the terminus of the serotonin neurons. This receptor is activated by NE resulting in the inhibition of serotonin release.

5-HT₁ receptors

The 5-HT₁ family of receptors (Table 23-1) produces its cellular action by inhibiting adenylyl cyclase and opening K^+ channels. Binding studies with autoradiographic ligands have shown binding sites throughout the spinal cord gray matter, raphe nuclei, and substantia gelatinosa, with the higher concentrations in laminae I and II of the dorsal horn and lower in lamina VII in the ventral horn. The hippocampus, the substantia nigra, and dorsal raphe contain the highest concentrations.

5-HT_{1A} receptor. Taiwo and Levine⁴² showed that 5-HT_{1A} receptors are implicated in peripheral mechanical hyperalgesia. They reported that the hyperalgesia could be blocked by selective 5-HT_{1A} antagonists injected locally. It was also shown in various pain models that the 5-HT₁₋₃ receptors all mediated pain. Powell and Dykstra³⁵ suggested that 5-HT_{1A} receptor agonists may reduce the effects of morphine in an electrical shock model for pain. This same effect was not seen with agonists at 5-HT₂, 5-HT₃, or α_2 -adrenergic receptors.

Autoradiographic studies have shown that half of the spinal cord binding sites involve the 5-HT_{1A} receptor, with the greatest concentration in the superficial layers of the dorsal horn in the lumbar cord, rather than in the cervicotho-

TABLE 23-1

5-Hydroxytryptamine (5-HT) Receptor Subtypes, Drugs, and Antimigraine Medications

5-HT RECEPTOR	DRUG	AGONIST/ ANTAGONIST	ACTION IN MIGRAINE
5-HT _{1B/1D}	Triptans, DHE	Agonists	Action on cranial neurovascular receptor to cause vasoconstriction or stimulation of inhibitory receptor to stop release of neuroinflammatory mediators; abort migraine
5-HT _{1F}	Triptans, DHE, ergotamine	Agonists	Blockade of neurogenic dural inflammation
5-HT ₂	Methysergide, cyproheptadine, DHE	Antagonists	Migraine prophylaxis

DHE, Dihydroergotamine.

racic segments. The 5-HT_{1A} receptor has been implicated in anxiety, but may also be involved in migraine. Antianxiety drugs such as buspirone act as agonists on this receptor.

5-HT_{1B} receptor. 5-HT_{1B} is a postsynaptic vascular receptor found primarily on cerebral blood vessels and to a smaller extent on coronary arteries and trigeminal ganglia neurons. Stimulation of the 5-HT_{1B} receptor results in numerous smooth muscle contraction actions such as vasoconstriction, closing of atrioventricular shunts, and bronchoconstriction, and platelet aggregation. Although there are a few receptors on coronary arteries, 5-HT_{1B} agonists cause some degree of coronary artery constriction.

5-HT_{1D} receptor. As indicated previously, the 5-HT_{1D} receptor functions as a presynaptic autoreceptor on trigeminovascular sensory afferent fibers, modulating neurotransmitter release such as 5-HT, substance P (SP), acetylcholine, NE, and calcitonin gene-related peptide (CGRP). 5-HT_{1D} is the most widespread 5-HT receptor in the brain and is thought to be the main 5-HT receptor involved in migraine. As discussed previously, the 5-HT₁ family of receptors is inhibitory through action of the G_i protein. Activation of the 5-HT_{1D} receptors on subdural blood vessels involved in migraine pathophysiology decreases or stops action potential formation, resulting in the aborting of migraine.

5-HT₂ receptors

5-HT_{2A} receptors are found in layers three and five of the cerebral cortex, the subcortical gray matter, the brainstem, and the spinal cord. These receptors, similar to the other non-5-HT₁ family of receptors, are excitatory. Activation of 5-HT₂ receptors results in closure of K⁺ channels and activation of phospholipase C. The 5-HT_{2B} receptor has been associated with cerebrovascular endothelium, and it has been suggested that migraine is caused by sensitization of these receptors. 5-HT bioavailability increases during development of the migraine attack and is attended by production and release of nitric oxide (NO). Nitroglycerin, a donor of NO, is known to cause headache when used to control angina, and this effect is blocked by indomethacin, which antagonizes the effect of NO. Patients who have analgesic rebound headache have a greater density of postsynaptic 5-HT₂ receptors on platelet membranes than migraine patients who do not have analgesic rebound headache. The implication is that chronic ingestion of analgesics may cause a depletion of 5-HT and concomitant upregulation of 5-HT₂ receptors, leading to more headache.

Although the exact role of 5-HT neuronal modulation is still unclear in migraine, the medications that seem to give the most benefit have definite 5-HT activity. The role of 5-HT in platelets during the ictal phase of migraine is apparently

important but remains to be defined. All aspects of the 5-HT system seem to come into play during a migraine attack and not only the 5-HT₁ receptors, but also 5-HT₂ receptors. It has been observed that some of the most commonly used compounds in migraine prophylaxis—propranolol, pizotifen, methysergide, cyproheptadine, amitriptyline, and chlorpromazine—have an antagonistic effect on specific subtypes of the 5-HT₂ receptor family, now known as the 5-HT_{2B}/5-HT_{2C} (formerly 5-HT_{1C}) receptors. This hypothesis is supported by previous observations that the 5-HT₂ receptor agonist m-chlorophenylpiperazine (m-CPP) triggers migraine in susceptible individuals when it is administered at doses high enough to activate 5-HT_{2B/2C} receptors.²¹

5-HT₃ receptor

The 5-HT₃ receptor is found mainly in the lower brainstem and on the presynaptic terminals of small-diameter unmyelinated nociceptive afferents in substantia gelatinosa where they may be involved in pain processing. The 5-HT₃ receptor is the only ion-gated cation channel receptor in the 5-HT receptor family. It causes increased conductance for Na⁺, K⁺, and Ca⁺⁺ and depolarization of the involved cell membrane. It has been shown that 5-HT₃ receptors participate in the nociceptive activity in the dorsal horn and are probably involved in the antinociceptive effect when 5-HT is administered intrathecally. This receptor has also been implicated in emesis associated with migraine. The “triptans,” which have been developed for symptomatic treatment of migraine through their agonist action on the 5-HT_{1D/1B} receptors, also are antagonists of the 5-HT₃ receptor, relieving nausea.

5-HT₄ receptors

In contrast to the inhibitory effects of the 5-HT₁ receptors, the 5-HT₄ family of receptors is positively coupled to adenylyl cyclase, provoking second messenger activation of cyclic adenosine 3',5'-monophosphate (cAMP). This receptor has high concentration in the gut, and antagonists of the receptor prevent development of increased bowel activity that would be stimulated by 5-HT or 5-hydroxy-L-tryptophan sensitization. Ghelardini and colleagues¹³ reported that 5-HT₄ agonists had an antinociceptive effect, raising pain thresholds in mice and rats.

5-HT₇ receptors

The 5-HT₇ receptor subtype activates adenylyl cyclase with consequent closure of K⁺ channels. The 5-HT₇ receptor was shown more recently to mediate cerebrovascular smooth muscle relaxation, independent of any mechanism in the endothelium. Because of its action on the regulation of vascular tone, it has been proposed to have a role in migraine. This role has been supported by observations that 5-HT₇ receptor-linked relaxation has been observed in dog basilar

and middle cerebral arteries, together with other circumstantial evidence such as the high affinity of antimigraine drugs for the 5-HT₇ receptor and the high expression of 5-HT₇ transcripts in animal and human brain vessels. 5-HT₇ receptor mRNA and second messenger cAMP levels were elevated in cultured smooth muscle cells from human brain vessels, possibly indicating that this same mechanism is operating in the human brain. This mechanism would allow for 5-HT₇ receptor action affecting dilation of meningeal blood vessels without direct interaction with dural blood vessel endothelium and may indicate a role for 5-HT₇ receptors in human brain blood vessels during the migraine attack.

Signal transduction pathways

Researchers have identified two major 5-HT receptor-linked signal transduction pathways. One pathway regulates ion channels, and the other is a multistep enzyme-mediated pathway. The second pathway requires a G protein to link the receptor to the internal effector molecule. In the case of the 5-HT₁ family of receptors, the link is G_i protein because the response is inhibition of adenylyl cyclase.

As noted previously, the 5-HT₂ G protein-linked family of receptors is coupled to phospholipase C, leading to a variety of intracellular actions. The G protein-type linkage of the 5-HT₂ receptor to its second messenger system is G_q. Activation of adenylyl cyclase was the first signal transduction pathway to be linked to metabotropic 5-HT receptor activity, but the specific receptor linkages to 5-HT₄, 5-HT₆, and 5-HT₇ were not identified until more recently. The 5-HT₄ receptor has been found in the human atrium and guinea pig ileum; 5-HT₆ found in the cortex has been shown to have a high affinity for TCA drugs, and 5-HT₇ is found in the brain and heart.

As noted earlier, the 5-HT₃ receptor differs from the other 5-HT receptors because it does not have G protein linkage but is associated directly with a ligand-gated ion channel. The receptor has been found on peripheral sensory, autonomic, and enteric neurons and in the cortex, hippocampus, and area

postrema, mediating excitation by inducing neurotransmitter release.

Physiologic Function and Drug Intervention

The 5-HT system modulates activity in diverse regions of the brain and spinal cord. It is suggested that the system coordinates various sensory and motor patterns associated with behavioral states. 5-HT activity is highest during waking and lowest during sleep. Descending neurons are involved in pain modulation in the dorsal horn and motor activity in the ventral horn. 5-HT activity is absent during rapid eye movement sleep when physical movement is limited, although the animal is in a state of heightened internal arousal. The increased 5-HT activity during waking periods aids in enhancing motor neuron excitability.

The raphe nuclei 5-HT neurons display spontaneous discharge activity of one to five spikes per second, releasing 5-HT into the presynaptic cleft. The neurons possess negative feedback autoreceptors that limit the amount of discharge and release of 5-HT. The autoreceptors seem to function only when the discharge and release of 5-HT reaches levels greater than the normal background activity inherent in the neurons. Dysfunction of the autoreceptor regulation has been associated with some forms of neuropathy, and the autoreceptor may provide a therapeutic target for medications. Although in some areas microelectroscopically administered 5-HT can have an excitatory effect on the discharge rate, the most common response in 5-HT-containing neuron tracts is inhibition of the discharge rate.

5-HT released from neurons has presynaptic and postsynaptic receptor effects. There are many options for affecting the availability of 5-HT directly, either by inhibiting the processes that decrease its availability or by enhancing the processes that make it available (Figure 23-2). Figure 23-2 shows sites of interaction with known drugs that influence the 5-HT system. Of all the options, reuptake blockade of 5-HT by TCAs is the most common mechanism of 5-HT active medications prescribed for the treatment of depression and chronic

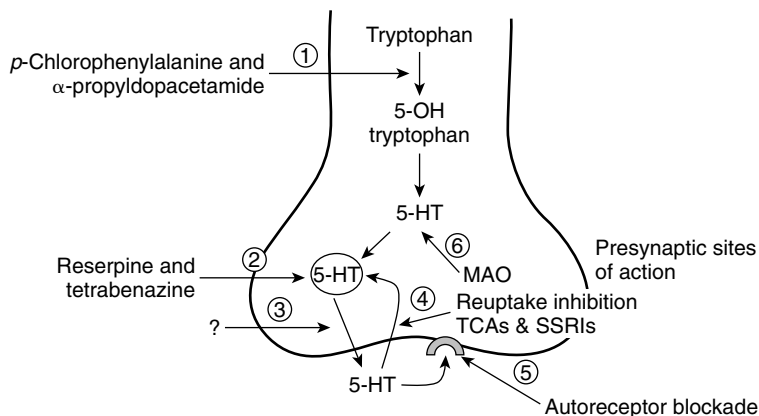

FIGURE 23-2 Possible drug sites for influencing 5-HT neurotransmission. The sites of potential drug action on the 5-hydroxytryptamine (5-HT) neuron are enumerated from 1 to 6. Site 1 represents the modulation of enzymatic action forming the 5-HT precursor and ultimately 5-HT from tryptophan. Site 2 is a potential target for drugs that affect the storage vesicles of 5-HT. Reserpine and tetrabenazine are known to interrupt the storage and cause release of 5-HT. Site 3 targets the release mechanism itself; however, there are currently no known agents that act to interrupt or increase the action of the transporter proteins that carry the 5-HT molecule across the membrane. Site 4 involves the reuptake mechanism that brings 5-HT back into the intracellular environment to be repackaged in the vesicles. Numerous drugs inhibit the reuptake of 5-HT (see Chapter 12). Site 5 refers to the 5-HT autoreceptor. Blockade of this receptor site allows for more presynaptic release of 5-HT. Site 6 focuses on the action of monoamine oxidase that converts the free 5-HT to the metabolic product 5-HIAA. Monoamine oxidase (MAO) inhibitors such as phenelzine block this action. SSRIs, Selective serotonin reuptake inhibitors; TCAs, tricyclic antidepressants.

pain; however, the issue of availability of 5-HT to help modulate pain has yet to be settled.

DRUGS FOR ACUTE TREATMENT OF MIGRAINE

Sicuteri and associates⁴⁰ were the first to note a relationship between 5-HT and migraine in their report on the significant increase in 5-HIAA in the urine of migraine subjects during attacks. Subsequent data did not show a consistent increase in 5-HIAA in all patients with migraine. Nevertheless, the relationship between migraine and 5-HT became solidified at that time and has been elucidated further to the present. Further studies have noted increases in plasma 5-HT, decreases in 5-HT platelet content, and increases in 5-HIAA content in cerebrospinal fluid in migraine patients. These observations support the theory that migraine is caused by chronic 5-HT dysregulation. Further support for the role of 5-HT in migraine has come from clinical positron emission tomography scan studies in patients during migraine attacks showing increased blood flow in the highly serotonergic dorsal raphe nucleus area.

Ergot Derivatives

In the Middle Ages, epidemics of a gangrenous disorder known as “holy fire” or “St. Anthony’s fire” were afflicting communities in Europe. The condition was so named because of the attendant burning experienced by the sufferer. The disorder soon became associated with the grain of rye that had been contaminated with the ergot fungus *Claviceps purpurea*. In 1918, the ergot alkaloid ergotamine was isolated from the fungus and was found to have sympatholytic activity (see Chapter 7). Shortly thereafter, it was proposed for use as a therapeutic agent for migraine.

Ergotamine has a complex mode of action involving a variety of receptor activities, not only with 5-HT receptors, but also with dopamine and NE receptors. The vasoconstrictive effect, the most notable characteristic of this medication, can become problematic with overuse, leading to claudication of extremities. The major vasoconstrictive activity is noted in the carotid circulation; the cephalic arteriovenous anastomoses; the pulmonary, cerebral, temporal, and coronary arteries; and the blood pressure. These effects are short-lived, although constriction of leg arteries can last 8 hours. Chronic overuse becomes a problem, and clinicians need to monitor users carefully.

Ergot derivatives are nonselective partial agonists and antagonists at 5-HT receptors, having high affinity for the 5-HT_{1B}, 5-HT_{1D}, 5-HT_{1F}, and 5-HT₂ receptors and low to moderate affinity for the 5-HT_{1C} and 5-HT₃ receptors. It is currently believed that their primary mode of action in alleviating migraine attacks is through their action on the 5-HT_{1B/1D} receptors, inhibiting neurogenic inflammation and nociceptor activity. Table 23-1 lists some 5-HT receptors and related medications and some indications for the drugs.

Ergotamine

Ergotamine is a nonselective 5-HT partial agonist/antagonist and acts at multiple receptors accounting for therapeutic and adverse effects. For migraine, ergotamine acts primarily as a 5-HT_{1D} receptor agonist, inhibiting depolarization of the dural blood vessel-associated nociceptors. The beneficial effect of ergotamine in treating migraine likely occurs by blocking neurogenic inflammation possibly through prejunctional inhibition of neuropeptide release. Ergotamine is commonly available as Cafergot, a tablet or suppository that is a combination of ergotamine and caffeine. Patients should be instructed regarding the possibility of developing rebound headache if using ergotamine more than two times per week.

BOX 23-1

Contraindications and Side Effects of Ergot Alkaloids

Contraindications

- Pregnancy
- Breastfeeding
- Renal impairment
- Liver impairment
- Uncontrolled hypertension
- Drug allergy
- Peripheral vascular disease

Common Side Effects

- Nausea
- Vomiting
- Restlessness
- Irritability
- Palpitation
- Nervousness
- Rebound headache
- Claudication
- Numbness of fingers and toes
- Myalgia
- Leg weakness

Other Precautions

Avoid concomitant use of triptans and β blockers

Ergotamine is used as an abortive drug at the onset of the migraine attack. Typically, abortive medications have to be taken early in the onset of the migraine because absorption and distribution are impaired as the gastric symptoms of migraine increase. The combination of caffeine with ergotamine speeds gastric absorption, getting the medication into the system more rapidly. In addition to the adverse effects listed in Box 23-1, ergotamine can cause gangrene and damage to blood vessels. The drug is given for short periods at carefully controlled doses.

Dihydroergotamine

Dihydroergotamine was introduced in 1945, approximately 10 years after ergotamine. Past and more recent studies have determined that the vasoconstrictive effect is significantly greater than the arterial effect. It is a nonselective 5-HT receptor partial agonist/antagonist. In addition, it is a nonselective antagonist at dopaminergic receptors with partial agonist/antagonist activity at α adrenoceptors. The half-life of dihydroergotamine is approximately 10 hours, which is longer than ergotamine and all but one of the triptans. This longer half-life may explain the lower likelihood for rebound adverse effects in headache compared with ergotamine and the shorter acting triptans (see later). This longer half-life makes dihydroergotamine a useful medication for chronic migraine, which tends to return within hours of treatment with either ergotamine or the triptans with shorter half-life.

Dihydroergotamine comes in a parenteral form and as a nasal spray. The parenteral form can be used intravenously, intramuscularly, or subcutaneously. The nasal form has a bioavailability of less than 65%, which may significantly limit its ability to abort a headache in many patients. This medication has definite advantages over the triptans with short half-life and is associated with lower vasoconstrictive potential. Dihydroergotamine is useful in the hospital to treat protracted unresponsive migraine. Side effects and contraindications for

dihydroergotamine, ergotamine, and the other ergot alkaloids are listed in Box 23-1. Methylergonovine and methysergide, semisynthetic ergot alkaloids, are discussed subsequently.

Triptans

The new family of triptan antimigraine drugs represents the most dramatic advance in the understanding and treatment of migraine. They are classified as 5-HT_{1B/1D} receptor agonists. Discovery of the first of these drugs, sumatriptan, came after the 5-HT_{1B/1D} receptor was linked with migraine. When it became apparent that the receptor had an inhibitory G protein-linked action on the host vascular and nociceptor neurons, agonist agents were sought that could act with the receptor to stop the attack. Sumatriptan was originally thought to act primarily on nociceptor 5-HT_{1D} receptors, but action was also noted on dilated dural blood vessels. Sumatriptan-sensitive sites of action in the pain transmission pathway have been identified centrally and suggested as additional putative antimigraine targets for brain-penetrant triptan derivatives. Sumatriptan has selective affinity for 5-HT receptor subtypes, 5-HT_{1B} and 5-HT_{1D}. More recent development of 5-HT receptor subtype-specific compounds and antibodies has allowed a more precise identification of the vascular and neuronal sites of action, providing a basis for a more targeted therapeutic approach.

Moskowitz^{29,30} developed the concept of neurovascular inflammation in the trigeminovascular system as a migraine mechanism. He observed that sumatriptan's action on peripheral neuronal 5-HT_{1D} receptors blocked subsequent release of neuropeptides such as SP and CGRP that were responsible for the development of neurovascular inflammation with concomitant swelling of the dural blood vessels. Moskowitz then proposed that the blood vessel dilation and plasma extravasation noted during the migraine attack was an epiphenomenon of the migraine and not the cause of the migraine, as had been proposed by Graham and Wolff.¹⁷

The 5-HT_{1B} receptor was discovered in humans after the discovery of the 5-HT_{1D} receptor. It is expressed on human brain blood vessels where it induces contraction of dural blood vessels. An untoward observation of the effect of sumatriptan is the induced contraction of human coronary arteries, which also is most likely mediated by the 5-HT_{1B} receptors. Although the cardiac effect is not severe, it is a concern and has led to some more recent efforts to find a compound that would not have an agonistic effect on the coronary 5-HT_{1B} contractile receptors.

Centrally located 5-HT receptor targets in the trigeminal nucleus caudalis have also become the focus of research as potential targets for intervention in acute treatment of migraine. 5-HT_{1B} and 5-HT_{1D} receptors have been identified in the nucleus caudalis. On the basis of protein and mRNA localization studies, presynaptic 5-HT_{1B/1D} and postsynaptic 5-HT_{1F} receptors have been identified. These central 5-HT receptors may be potential sites of action for the new generation of brain-penetrant triptan derivatives (e.g., naratriptan, zolmitriptan, rizatriptan). Identification of the exact nature of these central receptors should be possible when selective receptor subtype compounds become available. Besides the effect on migraine, one of the great benefits for patients with migraine is the relief from nausea that is obtained with the use of triptans. This effect may be caused by additional 5-HT receptors in the nucleus tractus solitarius and area postrema, regions of the brain where the blood-brain barrier does not exist. These areas could be accessible even to non-brain-penetrating compounds such as sumatriptan, which could explain some of their antiemetic effects. In addition, as noted previously, the triptans act as 5-HT₃ receptor antagonists, which gives the drugs an antiemetic effect.

TABLE 23-2

Triptans

TRIPTAN AND DOSAGE FORMS	T _{max} (hr)	HALF-LIFE (hr)
Almotriptan, 6.25, 12.5 mg	2.6	3-4
Eletriptan, 20, 40 mg	2.8	4
Frovatriptan, 2.5 mg	2-3	26
Naratriptan, 1, 2.5 mg	2-3	6
Rizatriptan, 5, 10 mg	1	2-3
Sumatriptan, 25, 50, 100 mg	2	2
Sumatriptan, 20 mg nasal	1-1.5	2
Sumatriptan, 6 mg injectable	5-20 min	2
Zolmitriptan, 2.5, 5 mg	1	3

T_{max}, Time to maximal plasma concentration.

Sumatriptan was the first of the family of triptans to be introduced for the symptomatic treatment of migraine. This agent was designed to act selectively on the 5-HT_{1D/1B} receptor involved in migraine pathophysiology. Seven triptans are currently on the market: sumatriptan, naratriptan, rizatriptan, frovatriptan, almotriptan, eletriptan, and zolmitriptan. There are variable differences between these drugs relating to speed of onset, recurrence rate of headache, side-effect profile, and duration of effect, but they all have the same caveats regarding precautions and contraindications. Sumatriptan has the shortest half-life (approximately 2 hours) of all the triptans. This may be a factor in considering recurrence of headache. Within the triptan group, naratriptan and frovatriptan seem to have a recurrence rate comparable to that of dihydroergotamine.

The time to maximal plasma concentration (T_{max}) for a drug can be crucial when it is used to treat migraine. It is recommended that abortive medications be taken as soon as possible at the onset of the migraine attack to increase the likelihood for successful treatment. If the T_{max} for a drug is too slow, not enough of the drug gets into the system to stop the headache before it is fully developed. Current understanding of migraine pathophysiology has shown that the trigeminal nociceptors become sensitized during the early phase of the migraine attack, and the sensitization spreads rapidly to the CNS. After the trigeminal nucleus caudalis has become sensitized, the medications used to abort the headache attacks are less effective. The current recommendation is to take the abortive medication at the onset of the headache and not to wait because efficacy is significantly decreased. The T_{max} and half-lives of the triptans are listed in Table 23-2.

Sumatriptan

One advantage of sumatriptan is the range of delivery options. For some patients, speed is crucial, and a delivery system that optimizes speed of delivery and bioavailability is a definite advantage. Nausea decreases gastric absorption, slowing the intake of the medication into the system. This problem can be bypassed with the nasal spray or the injection. Both of these modalities increase the bioavailability of the medication, enhancing the likelihood of successful intervention. The nasal form of sumatriptan is more effective and more rapid in onset than the nasal form of dihydroergotamine, but the recurrence rate is higher because of the half-life of sumatriptan compared with dihydroergotamine.

Naratriptan

The main advantage of naratriptan is its long half-life of 6 hours; this is shorter than dihydroergotamine but longer than most triptans except frovatriptan. The biggest disadvantage of

naratriptan is a delayed onset of action of 2 to 3 hours. For the typical migraine that develops over $\frac{1}{2}$ to 1 hour, this medication may not help because central sensitization may have occurred before the optimal blood concentration of the drug is reached. Studies have looked at using this medication as an add-on, 2 hours after taking a medication with a shorter half-life, such as sumatriptan, to achieve a longer sustained period of relief and to diminish the likelihood of recurrence. Additional use as a prophylactic agent in menstrual migraine during the migraine vulnerability period is being studied. The recommendation has been made to start the medication 3 days before the onset of menses and to continue for 6 days.³

Zolmitriptan

Zolmitriptan has a longer half-life than sumatriptan and a more rapid T_{max} . Although the manufacturers indicated that this drug can be taken further into the attack, the recommendation nevertheless is to take the drug as early as possible into the attack to avoid central sensitization. Zolmitriptan is also available in a “melt” version, which is liquefied in the mouth before it enters the stomach, and in an intranasal system, which is absorbed by the highly vascular nasal mucosa.

Rizatriptan

Rizatriptan has a rapid onset of action similar to zolmitriptan and a T_{max} that is reached in 1 hour. It comes in a tablet form and as a dissolvable wafer that melts on the tongue. Rizatriptan (10 mg) has greater efficacy than other oral triptans in freedom from migraine headache pain 2 hours after dosing. The dissolvable form is recommended for patients with nausea.

Frovatriptan

Frovatriptan has a 26-hour half-life, the longest of all of the triptans. This long half-life may be a distinct benefit for migraines that last longer than 4 hours, and Géraud and colleagues¹² reported that frovatriptan had the lowest recurrence rate of all the triptans. The T_{max} of frovatriptan is 2 to 4 hours for a single dose (2.5 mg), which is slower than most of the other triptans. This medication may not be as effective for migraine that develops rapidly because of this pharmacokinetic property. Frovatriptan is also used to prevent menstrually related migraine in a similar manner to naratriptan. It is recommended that the patient start the medication 2 to 3 days before menses and continue for 6 days.

Eletriptan

Eletriptan is well absorbed after oral administration and has shown a peak plasma concentration occurring approximately 1.5 hours after dosing. In patients with severe migraine, the median T_{max} is 2 hours. This rapid peak time is definitely an advantage for migraine that develops rapidly. The drug's terminal half-life is approximately 4 hours, and Géraud and colleagues¹² reported that it had a relatively low recurrence rate compared with rizatriptan, sumatriptan, and zolmitriptan.

Almotriptan

Almotriptan has a half-life of 3 to 4 hours and a low recurrence rate compared with rizatriptan, sumatriptan, and zolmitriptan. Very little has been reported on the 24-hour sustained-release preparation of almotriptan. Almotriptan has been reported to have significantly lower adverse events compared with the other triptans. Similar to frovatriptan, almotriptan is used to prevent menstrual migraine.¹⁴

Contraindications to ergot derivatives and triptans

Box 23-2 lists the most common contraindications, precautions, and adverse reactions noted with the triptans.

BOX 23-2

Contraindications, Precautions, and Adverse Reactions to Triptans

Contraindications and Cautions

- Drug allergy
- Prinzmetal's (variant) angina
- Pregnancy
- Breastfeeding
- Diabetes
- Hepatic disease
- Uncontrolled hypertension
- Coronary artery disease
- Basilar migraine
- Use of MAO inhibitor within 14 days
- Hemiplegic migraine
- Peripheral vascular disease
- Cerebrovascular disease
- Impaired liver function
- Use of ergot derivatives or other anti-5-HT medications

Adverse Reactions

Common

- Asthenia
- Chest pain
- Neck tightness
- Jaw tightness
- Dizziness
- Flushing
- Paresthesias

Uncommon

- Anaphylaxis
- Coronary vasospasm
- Acute myocardial infarction
- Cardiac arrest
- Ventricular tachycardia
- Hypertensive crisis
- Stroke

5-HT, 5-Hydroxytryptamine; MAO, monoamine oxidase.

Isometheptene

Isometheptene is a vasoconstrictor similar in action to ergotamine. Midrin is a proprietary combination medication that contains isometheptene plus acetaminophen and dichloralphenazone. This combination is useful in treating mild-moderate migraine headache. The mechanism of action probably relates to a sympathomimetic vasoactivity of isometheptene plus the analgesic effect of acetaminophen. Dichloralphenazone has a mild tranquilizing effect and possibly a central pain inhibitory effect. The medication has to be taken orally at the onset of headache because delay significantly inhibits the likelihood that it will be effective. It is used for symptomatic treatment of migraine and tension-type headache and may be combined with an NSAID to increase its effectiveness. This drug should not be used with patients taking MAO inhibitors (see Chapter 12). In addition, it should not be used in patients with partial spinal cord lesions because provocation of hypertensive crises has been reported with use of sympathomimetic medication in these patients. It should not be used concurrently with any of the triptans.

Antiemetics

Phenothiazine derivatives are neuroleptics used to give symptomatic migraine relief. Specifically, they can control the

nausea and gastric irritation that accompanies the migraine attack because the medications aid in gastric clearance and gut motility and promote absorption, which is helpful when migraine medications are taken orally. They are available in tablet, suppository, and parenteral forms. The neuroleptics are antagonists at the dopamine D₂ receptor (see Chapter 12). They may cause extrapyramidal reactions such as tardive dyskinesia, although the incidence is low for metoclopramide, promethazine, and prochlorperazine, the most commonly used agents for nausea. The antiemetic drugs commonly used specifically to reduce emetic symptoms of migraine are prochlorperazine, metoclopramide, promethazine, and trimethobenzamide.

Clinical Treatment of Migraine

Before deciding on a treatment approach, the frequency of headache must be determined. If a patient is experiencing headache less than once per week, it is appropriate to consider only symptomatic management of the headache unless the infrequent headache is so severe and disabling that it requires more specific interventions. If the headache frequency is more than once per week, preventive medication management needs to be considered. In addition, if the patient has been taking analgesics more than twice per week to treat the headaches, they are likely to develop medication-overuse headache, which requires specialized interventions to manage the headache.

The most common approach to treatment of migraine is termed *stepped care*. This treatment strategy starts the patient at the lowest level of therapeutic care, then escalates step by step if the patient does not respond at each given level. The lowest level of therapeutic care usually involves simple over-the-counter analgesics. If this medication fails to help the headache, the patient is given a prescription for a combination analgesic. If this medication is insufficient, a migraine-specific medication, usually in tablet form, is often given. If this medication fails, an injectable medication can be used. The problem with this approach is the delay in effective treatment, wasted follow-up visits, failed prescriptions, discouragement, and finally abandonment of care.

Headache specialists now recommend a stratified care approach to headache management. This approach immediately takes into account the severity and disability of the migraine attacks and gives the patient the medication appropriate for that situation. This treatment approach limits the long delay in achieving therapeutic benefits.

General guidelines for selecting medications for symptomatic relief of migraine should consider the health status of the patient and the severity and longevity of each attack (Box 23-3). Cost factors also become important, particularly in lower socioeconomic areas where patients may have inadequate health coverage and may be unable to afford some of the expensive medications more recently made available.

DRUGS FOR MIGRAINE PROPHYLAXIS AND OTHER CHRONIC PAIN SYNDROMES

The following sections discuss drugs used for prophylaxis of migraine and management of other chronic pain conditions, such as cluster headaches, musculoskeletal disorders, and neuropathic pain. Although the use of the medications in each of the conditions may generally be the same, some particular differences are highlighted in the sections under discussion when relevant. Medication selection is still empiric; however, as understanding of the pathophysiologic characteristics of the

BOX 23-3

Medications for Aborting Mild, Moderate, and Severe Migraine Headache in a Stratified Treatment Approach

MILD HEADACHE	MODERATE HEADACHE	SEVERE HEADACHE
Acetaminophen	NSAIDs	Ergotamine
NSAIDs	Isometheptene	suppositories
Isometheptene	Ergotamine	plus a
Prochlorperazine or metoclopramide	Nasal DHE	prochlorperazine
for nausea	Prochlorperazine or metoclopramide	suppository
Caffeine	for nausea	Subcutaneous/
	Oral/nasal	nasal
	sumatriptan	sumatriptan
	Oral naratriptan	Oral naratriptan
	Oral rizatriptan	Oral rizatriptan
	Oral zolmitriptan	Oral zolmitriptan
		DHE
		intramuscularly

DHE, Dihydroergotamine; NSAIDs, nonsteroidal anti-inflammatory drugs.

various disorders and the drug interaction on receptor targets expands, medications will be selected according to what receptors the clinician wants to target.

5-HT Receptor Blockers

Methysergide and methylergonovine act at 5-HT receptors, but they may have other actions. They are considered antiserotonin medications because they block the 5-HT₂ receptor. Methysergide, a semisynthetic ergot alkaloid, prevents plasma extravasation in rat dura mater only after long-term administration, an effect that is not noted in short-term use of the drug. Saxena³⁹ found that methysergide produced only minimal cranial vasoconstriction in vivo during acute migraine attacks. These findings support the observation that methysergide is a better prophylactic agent than an abortive agent. Methylergonovine is an active metabolite of methysergide and is present at a three times greater concentration than methysergide. Its half-life is approximately 220 minutes, in contrast to the half-life of methysergide of only 60 minutes. Methysergide has an oral bioavailability of 13% because of its extensive first-pass hepatic metabolism to methylergonovine. Methylergonovine is rapidly absorbed orally and has a bioavailability of 60%.

Methylergonovine, the primary metabolite of methysergide, probably accounts for most of methysergide's action in the prophylactic management of chronic migraine and cluster headache. These medications are thought to act as agonists on the trigeminovascular afferent 5-HT_{1D} receptors to decrease pain fiber activity and are most useful in resistant migraine and medication-overuse headache. They have peripheral vasoconstrictive activity, although not as great as ergotamine. They also may cause vasoconstriction of the arteries in the carotid bed, where there is a greater concentration of 5-HT_{1B} receptors, but the triptans have a greater vasoconstrictive effect on these 5-HT_{1B} receptors, which may explain why they are better abortive medications.

Long-term use of methysergide and methylergonovine has been associated with retroperitoneal, pleuropericardial, and

subendocardial fibrosis. Because most patients using these medications do not develop these complications, it is believed that the fibrotic reactions are idiosyncratic. Nevertheless, protocols for medication use have been recommended in the literature and include giving the patient a drug-free holiday every 6 months and obtaining magnetic resonance imaging or computed tomography with enhancement for retroperitoneal fibrosis and chest radiograph for pleuropulmonary fibrosis. Patients placed on methysergide or methylergonovine should be warned about the possibility of a fibrotic reaction. Because of these potentially extremely serious side effects, methysergide and methylergonovine are reserved for the most recalcitrant chronic headaches. Both drugs are started at the lowest available dose for the formulation and titrated slowly to a maximum daily dose. The patient should be given a drug-free holiday of 30 days after 6 months of use and evaluated as indicated previously for fibrotic reactions.

Tricyclic Antidepressants

Opioids, aspirin, acetaminophen, NSAIDs, or combinations have been the most widely prescribed medications for treatment of headache and other pain, but use of TCAs for the treatment of chronic pain, including headaches, is the next most common. Of all the antidepressants, the first-generation TCAs have been shown to be effective in preventive treatment of neuropathic pain, migraine, and tension-type headache. The most commonly used drug of this class for neuropathic pain is amitriptyline. The effect of TCAs on pain is distinct from the modulation of depression. It had been thought that 5-HT reuptake inhibition was the primary mode of action until the SSRIs were developed and found to provide little or only modest benefit for chronic pain or headache. The mode of action of TCAs may relate to 5-HT receptor activity presynaptically and postsynaptically, but the exact action is still debated. TCAs may downregulate 5-HT₂ receptors that have been associated with excitatory perivascular inflammation. In addition, drugs that inhibit the reuptake of 5-HT and NE seem to have greater benefit than drugs that exclusively inhibit reuptake of either one or the other. Pain relief for some pain conditions is modest, and the side effects, such as sedation and parasympatholytic effects, are particularly bothersome for some patients.

The results of a meta-analysis supported the conclusion that the pain-modulating effect of antidepressants is independent of their antidepressant effect.³² The benefit for pain occurred within a few days of initiating therapy, whereas the benefit for depression took a much longer time to occur and at a higher dose. It is possible that the 5-HT reuptake blockade alone is insufficient to relieve pain, but enhances the pain-relieving effects of NE reuptake blockade. This would explain why amitriptyline, which inhibits 5-HT reuptake more than NE, is more effective in treating pain than a medication such as desipramine, which inhibits reuptake primarily of NE (see Chapter 12). The drugs that inhibit reuptake of 5-HT also ameliorate obsessive-compulsive disorder, but drugs that primarily inhibit NE uptake, such as desipramine, do not.

The choice of a TCA is based on the reported efficacy for migraine and the side-effect profile of the medication. The anticholinergic side effects are the most troubling for patients and are often the major factor that causes patients to discontinue use of the medication (see Chapter 12). The tertiary amines have stronger anticholinergic effects than the secondary amines, but have greater efficacy for pain. The secondary amines are less effective for headache and pain, but are better tolerated.

Caution should be exercised when administering TCAs to elderly patients and patients with a history of cardiac irregularity. It is generally recommended that patients older than

50 years have an electrocardiogram before starting the medication. TCAs should be used with caution in severely depressed and suicidal patients because the margin of safety for overdosing is low as a result of the cardiac conduction-blocking effects (see Chapter 12).

TCAs are typically started at the lowest dose, followed by a slow increase in dose. The patient is advised of the side effects, such as sedation and dry mouth. Weight gain can be a significant problem for most of the TCAs, although protriptyline was associated with modest weight loss in one study that used it for tension-type headache.⁵ Many of the side effects decrease as the patient accommodates to the medication. Different dosage forms and different drugs can be used to reduce the risk of sedation.

Selective Serotonin Reuptake Inhibitors

Although the analgesic effects of SSRIs have been disappointing, SSRIs may be useful in the overall management of headache and other pain syndromes. If a patient is taking a TCA and getting relief from pain, but the consequent sedation is bothersome, addition of fluoxetine, an SSRI, in the morning may help to relieve the sedation, allowing the patient to continue to have the benefit of the TCA. The combination of a TCA with fluoxetine is being used in treating fibromyalgia, probably because of the additional effect of 5-HT reuptake inhibition with drugs that inhibit reuptake of 5-HT and NE. Addition of another medication that increases 5-HT availability has to be done cautiously, however, because some patients may have 5-HT toxicity or serotonin syndrome develop, a potentially fatal side effect of having too much 5-HT in the system (see Chapter 12).

Another use of the SSRIs relates to their effect on anxiety and obsessive-compulsive behavior. Often patients who have chronic pain syndromes have concomitant anxiety or become fixated on their pain. It has been suggested that the addition of an SSRI with the medication used to ameliorate the pain may benefit these patients because it decreases the obsessive component of the pain, allowing the patients to shift their focus away from the pain issues.

Other Antidepressants

Numerous antidepressants are not SSRIs or TCAs but may have utility for chronic pain, although no direct effect on the pain itself. Venlafaxine is a serotonin-NE reuptake inhibitor class antidepressant that is more potent as a 5-HT reuptake blocker than as an NE reuptake blocker and has fewer anticholinergic side effects than TCAs (see Chapter 12). Venlafaxine has been noted to be effective in treating chronic pain, neuropathic pain, and migraine.²⁵ Venlafaxine also has a significant anxiolytic effect and can be useful in modulating patients' anxiety relative to their pain. Use of the extended-release form may have fewer side effects. Duloxetine, a serotonin-NE reuptake inhibitor, has also been studied in migraine patients. It was found to be effective in reduction of headache, but the effect was tied to the concomitant presence of anxiety.⁴³

Trazodone, a heterocyclic antidepressant, is more selective as a 5-HT reuptake inhibitor; it has not shown utility for headache or other pain, but it is useful as a sleep medication. Trazodone has been associated with priapism in men and should be used with caution. It may cause hypotension or syncope, and patients should be closely monitored during the initial phase of treatment. Nefazodone, an analogue of trazodone, is also useful for inducing and maintaining sleep. In addition, nefazodone is a 5-HT₂ receptor antagonist and has been shown to have a benefit for headache, but it has been discontinued in the United States.

Mirtazapine has not been shown to be useful for the treatment of pain or headache, but because it is very sedating, it

TABLE 23-3

β Blockers Useful in Preventing Migraine

NONPROPRIETARY (GENERIC) NAME	ANTIMIGRAINE EFFICACY	RECEPTOR SELECTIVITY	CNS PENETRATION
Propranolol	++++	β ₁ , β ₂	Good
Nadolol	++++	β ₁ , β ₂	Poor
Timolol	++	β ₁ , β ₂	Good
Atenolol	+++	β ₁	Poor
Metoprolol	+	β ₁	Good

CNS, Central nervous system.

is useful as a sleep adjuvant. This medication can cause significant weight gain and should be used with caution.

β-Adrenergic Receptor Blockers

β Blockers are widely used drugs in the prevention of migraine (Table 23-3). They have not been found useful for preventing tension-type headache and are not as useful as Ca⁺⁺ channel blockers in prophylaxis of cluster headache. The choice of a β blocker is governed by consideration of potential side effects and the patient's health history. The two β blockers with poor CNS penetration are not lipophilic and are thought to be accompanied by fewer side effects such as depression. Also, these medications are not metabolized in the liver and will not be affected by concomitant use of medications that are affected by the cytochrome P450 enzyme system. The two β blockers with selective β₁ activity are safer to use with patients having a history of asthma; nevertheless, patients should be closely monitored because the selectivity is not exclusive. Because of the risk of stroke, β blockers should not be used with patients who have basilar migraine or other headaches with significant neurologic symptoms.

The mechanism of action of the β blockers is undetermined. It was originally assumed that their effect was caused by their vasoactivity, but this is probably only part of the picture. Table 23-3 lists the β blockers with their relative antimigraine efficacy.

Antiseizure Medications

Topiramate, valproic acid, and gabapentin are also used for prophylaxis against migraine. They are discussed subsequently.

Ca⁺⁺ Channel Blockers

The most widely used Ca⁺⁺ channel blocker for migraine and cluster headache is verapamil. The exact mechanism of action is unknown, however. It is hypothesized that Ca⁺⁺ channel blockers act on the nociceptive system by interfering with the Ca⁺⁺-dependent release of substance P (SP) and possibly other neurotransmitters from sensory nerve terminals. Ca⁺⁺ channel blockers may also interfere with neurovascular inflammation and the initiation and propagation of Ca⁺⁺-dependent spreading of cortical depression, which is a pathophysiologic feature of migraine. Ca⁺⁺ channel blockers block the transmembrane influx of Ca⁺⁺ through slow, voltage-dependent ion channels into neurons innervating muscle (see Chapter 26). The inhibitory effect does not affect all Ca⁺⁺-dependent functions but mainly affects vascular and cardiac functions. Ca⁺⁺ influx can have a cytotoxic effect, a factor that may be involved in migraine during phases of cerebral ischemia, and Ca⁺⁺ channel blockers are thought to have a protective influence on this process. NO, which is also involved in chronic pain states, is produced through an intracellular mechanism involving Ca⁺⁺ influx after N-methyl-D-aspartate (NMDA) receptor activation, and the Ca⁺⁺ channel blockers may decrease the produc-

tion of NO by inhibiting that influx. It has also been noted that 5-HT_{1D/1B} agonists such as sumatriptan abolished NMDA receptor-evoked NO signaling in the brain cortex.⁴¹

Use of Ca⁺⁺ channel blockers for the prevention of migraine is not as well founded as β blockers. Verapamil is one of the most effective medications available for prophylactic management of cluster headache. In general, the patient is started on a low dose, which slowly titrated up to tolerance. The sustained-release versions generally require increased dosing and may not be as effective for headache management as the shorter acting versions. Problems with bradycardia and hypotension require close monitoring of the patient.

Antihistamines

Except for cyproheptadine and hydroxyzine, antihistamines (see Chapter 22) have not shown particular effectiveness in managing headache. Cyproheptadine has numerous nonhistaminic actions that may account for its effectiveness, such as Ca⁺⁺ channel-blocking activity and 5-HT₂ antagonism, making it useful for preventing migraine and managing serotonin syndrome. Cyproheptadine is an important drug for managing childhood migraine. The effect of cyproheptadine in ameliorating headache may be caused by the same mechanism as methylergonovine and methysergide; however, the definitive mechanism is unclear. The combination of propranolol with cyproheptadine may have a more beneficial effect on migraine than either drug alone. Sedation, weight gain, and anticholinergic side effects tend to limit the usefulness of the drug.

Hydroxyzine is also used in the management of headache and is commonly given with an opioid in emergency departments to abort acute migraine attacks. More recent studies have shown, however, that this approach is not as effective as using dihydroergotamine with metoclopramide or an injectable triptan. It is often used as part of the treatment protocol for headache caused by analgesic overuse.

Indomethacin and Indomethacin-Responsive Headaches

A group of uncommon primary headaches shows dramatic remission after the administration of the anti-inflammatory drug indomethacin. Because of this unique response, the International Headache Society Classification Committee has included a positive response to indomethacin in the diagnostic criteria for this group of headache disorders. The headaches that are responsive to indomethacin are listed in Box 23-4.

The fact that some of these headache disorders dramatically respond to indomethacin, whereas others respond variably and less so, has led to speculation regarding the putative pathophysiologic characteristics of these headaches and a mechanism of indomethacin that is unique from other NSAIDs. Indomethacin is a cyclooxygenase-1 and cyclooxygenase-2 inhibitor similar to other NSAIDs, but the one outstanding difference is its unique ability to alter

BOX 23-4**Indomethacin-Responsive Headache Disorders**

Exertional or cough headache
 Coital headache
 Hemicrania continua
 Chronic paroxysmal hemicrania
 Idiopathic stabbing headache

cerebral blood flow without inducing vasospasm. It has been observed that indomethacin is able to modulate cerebral blood flow through nitric oxide pathways.

Adrenocorticosteroids

Adrenocorticosteroids (see Chapter 35) are useful in the treatment of acute inflammatory pain, headache, and some neuropathic pain. Steroids are used in topical, oral, and injectable forms.

Although corticosteroids are more effective in treatment of cluster headache, they have been found to be useful in treating intractable migraine that has not responded to other forms of therapy. Normally, a high initial dose of a steroid is given, and the drug is tapered over a 1- or 2-week period. This regimen usually terminates the migraine, allowing for the institution of appropriate medications to manage the headache. There has been concern more recently regarding avascular necrosis with steroid therapy; although the condition is rare, appropriate consent forms should be obtained when using this group of drugs.

Steroids are thought to act through many mechanisms on chronic pain syndromes: steroid modulation of γ -aminobutyric acid (GABA_A) receptors located outside the blood-brain barrier suppresses neurogenic inflammation and CGRP-induced and SP-induced plasma extravasation.³¹ Drugs that modulate GABA_A receptors may provide a means of targeting the efferent nerves with specific therapies. Steroid hormones modulate neurogenic inflammation related to migraine, cluster headache, and arthritis. Steroids completely block neurogenic extravasation that is mediated by release of neuropeptides such as CGRP and SP. Steroids have also been noted to have an effect on Ca⁺⁺ channels, showing some selectivity in their blocking effects on different high-voltage activated Ca⁺⁺ currents. Some of these effects probably involve directly blocking Ca⁺⁺ channels.

Injectable and oral steroid therapy is effective in management of acute and chronic TMJ inflammation. Intra-articular corticosteroids reduce pain and swelling associated with inflammatory disease of muscles and joints. Patients who have inflamed TMJs are typically started on a protocol including soft diet, moist heat, NSAIDs, and possibly steroids to suppress the joint inflammation.

Cortisone and hydrocortisone injected into the joint are beneficial, but they tend to diffuse out of the joint rapidly, not giving a sustained effect. The disodium phosphate ester of betamethasone is used with the insoluble acetate ester form, imparting a rapid effect from the phosphate ester and a sustained effect from the acetate ester. Triamcinolone acetonide and triamcinolone hexacetonide also have very low solubility and a long duration. Three injections may be given in a joint, but there should be an interval of 4 weeks between injections.

After nerve injury in which the afferent sensory fibers are crushed or severed, the proximal portion of the nerve is stimulated by nerve growth factor to repair and re-establish a connection with the distal portion. In this process, the proximal

terminal forms a mass of neuronal sprouts termed a *neuroma*. The sprouts generate spontaneous ectopic discharges signaling pain centrally. Application of steroids has been shown to reduce the neuronal activity. The reduction in spontaneous discharge is not caused by a reduction in the number of sprouts, but probably arises from a stabilization of the neuronal membrane conductivity. A steroid such as dexamethasone may be injected into the area of the neuroma. Multiple injections with local anesthetic and steroid are often needed to stop the spontaneous discharge.

Corticosteroid therapy is used to control symptoms of acute herpes zoster infection, and experience has shown that the infection is not disseminated with the use of steroids. Esmann and coworkers,⁹ in a double-blind study, showed that steroids were no better than placebo in preventing development of postherpetic neuralgia after zoster infection; however, Keczkcs and Basheer²² showed that treatment with prednisolone after the development of postherpetic neuralgia reduced the duration of the neuralgia. The study by Keczkcs and Basheer²² also showed that treatment with carbamazepine was no more effective than placebo in modulating the herpetic pain.

DRUGS FOR MUSCULOSKELETAL PAIN**Centrally Acting Muscle Relaxants**

Centrally acting skeletal muscle relaxants are indicated for relief of acute painful musculoskeletal conditions of local origin, but they should be used only as an adjunct to a physical medicine program that includes physical therapy, moist heat and ice, and other nonpharmacologic therapies. Few studies show the efficacy of muscle relaxants, and many clinicians are skeptical about their widespread use because of a lack of evidence of benefit apart from the sedative effects of the drugs. There are many causes for muscle spasms, and muscle relaxants are not effective for all causes (see Chapter 13). The following drugs are generally considered to have muscle-relaxant abilities:

1. *Carisoprodol*. Carisoprodol is metabolized to meprobamate and has habituating potential with development of physical and psychological dependence. In 1987, the National Institute on Drug Abuse reported that carisoprodol was ranked 54th of 234 abused drugs. The recommendation is to use it only on a short-term basis.
2. *Cyclobenzaprine*. Cyclobenzaprine is a tricyclic compound similar to TCAs. It has similar anticholinergic side effects as TCAs. It is typically chosen for use for patients with myalgia and myofascial pain. It is recommended that this medication be used with caution in older patients and be used only for a short period. This drug could be chosen for patients with moderate muscle pain who are not sleeping well. Disturbed sleep is often an accompaniment of musculoskeletal pain, and normalizing the quality and duration of sleep can have a beneficial effect on the pain. The medication is typically taken once a day at bedtime.
3. *Methocarbamol*. Methocarbamol is a skeletal muscle relaxant that is most effective for muscle spasticity. Side effects include seizures, drowsiness, sedation, nausea, and blurred vision.
4. *Metaxalone*. Metaxalone is a skeletal muscle relaxant for acute painful muscle problems. Side effects include leukopenia, hepatotoxicity, rash, dizziness, headache, and nausea.
5. *Baclofen*. Baclofen is primarily a skeletal muscle relaxant, useful in spasticity states. It also has some anticonvulsant activity, making it useful as an alternative drug for trigeminal neuralgia. Side effects include confusion, blurred vision, abdominal pain, and fatigue. In contrast to carba-

mazepine, baclofen is not metabolized in the liver. Baclofen is a GABA_B receptor agonist. Activation of GABA_B receptors produces analgesia in acute and chronic pain models. Data indicate that a possible mechanism for this effect is a GABA_B receptor–induced blockade of neurokinin-1 receptor gene expression in the spinal cord. GABA is an important neurotransmitter that mediates inhibition in the CNS. Approximately 30% to 50% of all synapses are defined as GABAergic. GABA is a neurotransmitter in cortical and hippocampal interneurons. Three pharmacologically different receptor subtypes have been identified: GABA_A, GABA_B, and GABA_C. The GABA_A receptor is postsynaptic and localized in central and peripheral sympathetic neurons. GABA_B is a presynaptic receptor located on central nerve terminals. Its agonist is baclofen. The GABA_A receptor acts directly on a Cl⁻ ionophore, whereas GABA_B activity is mediated by a G_i protein (see Chapter 13).

6. **Tizanidine.** Tizanidine acts as a central muscle relaxant and has an antinociceptive effect. It is an α_2 -adrenergic receptor agonist similar to clonidine that inhibits the release of NE centrally—that is, in the locus coeruleus and spinal cord. Although it is used primarily as a muscle relaxant, one study found it useful for treatment of chronic daily headache.³⁸ Because of its α_2 -agonist activity, it is being used as an intrathecal agent to block sympathetically mediated pain through its effect on the α_2 -adrenergic autoreceptors in the sympathetic nervous system. Tizanidine is metabolized in the liver and has been reported to cause elevations in liver enzymes, so the clinician should obtain baseline blood samples to determine alanine aminotransferase and aspartate aminotransferase levels before use and check them during use to ensure the medication is not causing an increase in the enzymes. Common side effects include dry mouth, somnolence, asthenia, and dizziness. The most serious reactions to this medication include hepatotoxicity, bradycardia, and hallucinations. Because of its α_2 -receptor agonist activity, it can reduce heart rate and blood pressure long-term, so these vital signs should be monitored during its use.

Nonsteroidal Anti-inflammatory Drugs

NSAIDs are discussed in Chapter 21. Most NSAIDs are similar in action; use in orofacial pain is usually limited to acute conditions. Two NSAIDs, ketorolac and indomethacin (see earlier), have characteristics that are uniquely useful for headache conditions, however, in addition to their use in musculoskeletal pain.

NSAIDs are often used long-term for TMJ arthritides, but not without adverse effects. (The newer cyclooxygenase-2 inhibitors, thought to be largely free of adverse gastric effects, are also not used long-term without problems.) Besides altering platelet function, long-term use of NSAIDs may have a detrimental effect on the endogenous reparative process within the joint. For the most part, NSAIDs are used as temporary measures to stabilize acute flare-ups of pain, and long-term use is not usually recommended.

Injectable ketorolac is a valuable tool for managing acute inflammatory pain conditions and migraine attacks and is a preemptive agent after procedures that are likely to cause postprocedure inflammation, such as TMJ mobilization with lysis, lavage, and manipulation. Ketorolac should not be used in patients whose serum creatinine is greater than 5 mg/dL. The injectable form of ketorolac offers a more rapid and effective medication in acute pain. One study on migraine found that 60 mg of ketorolac intramuscularly was equivalent to 100 mg of meperidine plus 50 mg of hydroxyzine. Overuse of the medication can cause acute renal failure and should be limited to 5 days of therapy.

Indomethacin was discussed previously under migraine medications.

Benzodiazepines

The benzodiazepines are not generally used in the management of chronic pain because they are not analgesic. Diazepam is used for short periods, however, as a muscle relaxant and as an antianxiety agent for patients with acute myogenous pain. Clonazepam does not have as great a potential for inducing habituation and is used in chronic neuropathic pain because of its function as an antiseizure medication. Clonazepam is a drug of choice for treatment of burning mouth syndrome. The mechanisms of action for this condition is not understood, but is not considered to be due to medicating anxiety. The benzodiazepine-type medications act on the GABA_A chloride channel (see Chapter 13), which has a wide range of activity in the CNS, including modulating seizures, increasing behavioral effects with alcohol, anxiolysis, sedation, and muscle relaxation.

DRUGS FOR NEUROPATHIC PAIN

Trigeminal neuralgia is the most common neuropathy seen in the orofacial region. Although Jurjani described trigeminal neuralgia in the mid-1100s and postulated that it was caused by vascular compression of the involved nerves, André in 1756 wrote the first comprehensive description of trigeminal neuralgia and coined the term *tic douloureux*. His first patient had had several teeth extracted in an attempt to treat an infection in the maxilla. After the last extraction, André wrote:

What had been regarded as the end of a mild and tolerable ailment, became the source of the sharpest and most uncomfortable pains, I would say the start of a tic douloureux that assailed her night and day, deprived her of sleep, and forbade her some of the bodily functions necessary for life. In fact these periodic agitations became so frequent that they rarely allowed five or six minutes of peace during an entire hour. The patient could not drink, eat, cough, spit or wipe her face without renewing all her pains.

In 1853, Trousseau, a French neurologist, proposed that the episodes of tic douloureux were caused by paroxysmal depolarization in the trigeminal pathways similar to the cortical depolarization occurring with epilepsy. He suggested that drugs used to treat epilepsy would be useful for the neuralgic epilepsy. It was not until 1942, however, that another French neurologist, Bergouignan, first tested the drug phenytoin on patients with trigeminal neuralgia. In the early 1960s, Blom, a Swedish neurologist, performed a trial with carbamazepine and found it to be effective for most of his patients. Subsequent studies showed that both these drugs depressed synaptic transmission after maxillary nerve stimulation in the spinal trigeminal nucleus.

The current understanding of neuropathic pain includes many disorders that are not discussed in detail here. Trigeminal neuropathy is grossly broken down into disorders involving peripheral and central sensitization mechanisms. Box 23-5 lists the diagnostic criteria for the various neuropathic pain conditions found in the orofacial region. It is crucial to make an accurate diagnosis before instituting treatment. The selection of medications is a complex issue that involves an understanding of the mechanism of the pain. Trigeminal neuralgia and central neuropathic pain conditions are treated by systemic medications. Surgical interventions are often considered if the disorder does not respond to medication.

BOX 23-5**Diagnostic Criteria for Orofacial Neuropathic Pain****C-Fiber Sensitization**

Continuous variable aching pain
 History of trauma to area
 No obvious local cause
 Pain aggravated by local stimuli (hyperalgesia and allodynia)
 Normal radiograph
 Positive response to somatic block
 Response to thermography not defined
 Sympathetic block does not define this disorder

Traumatic Neuralgia

Continuous, variable aching pain
 May be punctuated by sharp jolts of pain
 History of trauma to area
 No obvious local cause
 Pain aggravated by local stimuli (hyperalgesia and allodynia)
 Equivocal somatic block (may be varying degree of sympathetic involvement)
 Normal radiograph
 Response to thermography depends on sympathetic involvement
 Response to sympathetic anesthetic block is equivocal

Trigeminal Neuralgia

Episodic sharp, electric-like pain with periods of remission
 No obvious local cause
 Pain is triggered with minor stimulation
 Normal radiograph
 Normal thermogram
 Positive somatic block
 Sympathetic block does not define this disorder

Sympathetically Mediated Pain (Atypical Odontalgia)

Continuous, variable, diurnal aching pain
 History of trauma to area

Complex Regional Pain Syndrome (II or III?)

Pain present >4 mo
 Pain aggravated by local stimuli (hyperalgesia and allodynia)
 No obvious local cause
 Normal radiograph
 Equivocal response to somatic block
 Positive response to sympathetic block (>60%) is not a defining characteristic

Sympathetically Independent Pain

Continuous, variable, diurnal pain
 History of trauma to area
 Pain present >4 mo
 Pain aggravated by local stimuli (hyperalgesia and allodynia)
 No obvious local cause
 Normal radiograph
 Negative response to somatic block
 Negative response to sympathetic block, although not a defining characteristic

Peripheral neuropathies are often treated by application of agents to the site of pain. Systemic medications are often added to the regimen for better pain management. The following sections discuss the medications used to treat neuropathic pain.

Antiseizure Drugs

The mechanisms responsible for the action of antiseizure medications vary and depend on the type of medication. The medications most effective for trigeminal neuralgia are use-dependent Na⁺ channel blockers; however, these medications are not usually the most effective for other chronic peripheral and central neuropathies.

Carbamazepine

Carbamazepine is considered the gold standard for the management of trigeminal neuralgia, but it is also used to treat other neuropathic pain conditions and headache. Although valproic acid is the only anticonvulsant that has been approved for the treatment of migraine and has shown benefit, other anticonvulsants such as carbamazepine have been used successfully in selected cases. For neuropathic pain, the primary mode of action of carbamazepine is thought to be its action as a use-dependent Na⁺ channel blocker, inhibiting repetitive neuronal discharge. Structurally, it is similar and related to TCAs.

Before taking carbamazepine, the patient should have baseline laboratory values for liver function and complete blood count, platelet, and differential. An extended-release form of carbamazepine is available. This medication requires only a twice-per-day dosing schedule, which is more convenient for the patient and aids in compliance. Initially, liver function tests should be obtained every 30 days to check liver response to the medication (see Chapter 14). Carbamazepine induces CYP3A4 and other subfamilies of the cytochrome P450 system, causing increased metabolism of the drug with lowered serum levels. The result of this effect is noted after 1 to 2 weeks of therapy and requires increasing the dose to obtain better pain control. The inductive effect also reduces the effect of several other drugs.

Gabapentin

Gabapentin has been used for seizures since the mid-1980s but did not become available in the United States until the 1990s. Its use in pain has become a great subject of interest, and numerous articles have described the benefits of gabapentin for treating various chronic pain disorders, including trigeminal neuralgia, diabetic neuropathy, peripheral neuropathy, and migraine. Gabapentin is a structural analogue of GABA and was developed as a GABA agonist; however, its mode of action is not through action on GABA receptors. Gabapentin decreases hyperalgesia in the formalin test, a model for centralized neuropathy. It has been hypothesized that the $\alpha_2\delta$ subunit of voltage-dependent Ca⁺⁺ channels maintains mechanical hypersensitivity in neuropathic pain, and recent studies have shown that gabapentin selectively interacts with these units to reduce activity¹⁰; however, this may not correlate with its therapeutic effects.

Gabapentin crosses membrane barriers using the L-amino acid transporter system. A small amount is also known to cross by passive diffusion. It concentrates in the brain cytosol at a ratio of 10:1 compared with the extracellular space. An analgesic effect is attained rapidly, but its anticonvulsant effect is delayed, indicating probable different mechanisms for the two effects.

Gabapentin is excreted unchanged in the kidney. It has few interactions with other medications, and the side-effect profile is benign compared with other antiseizure drugs. Gabapentin is also useful for management of migraine headache.

Valproic acid

Valproic acid was the first antiepilepsy medication approved by the U.S. Food and Drug Administration (FDA) for migraine. Valproic acid is structurally different from other anticonvulsants, and its mechanism of antiseizure and analgesic action is related to inhibition of Na⁺ channels, inhibition of T-type Ca⁺⁺

channels, and facilitation of GABAergic neurotransmission by inhibiting GABA aminotransferase and activating glutamic acid decarboxylase. In seizures, valproic acid may have direct effects on neuronal membranes, inhibiting kindling and reducing excitatory neurotransmission by the amino acids (see Chapter 14). Valproic acid has been shown to block development of neurogenic inflammation in the Moskowitz model of migraine.²⁶ Valproic acid is also used as a mood stabilizer in manic-depressive disorders (see Chapter 12).

Lamotrigine

Lamotrigine is a novel anticonvulsant drug that is useful for trigeminal neuralgia through its action as a Na⁺ channel blocker. The cellular mechanism of Na⁺ channel blockade is the same mechanism by which carbamazepine and phenytoin exert their action; however, it is unlikely that Na⁺ channel blockade is the only cellular mechanism of lamotrigine.

Topiramate

The antiseizure drug topiramate is a monosaccharide derivative that modulates voltage-dependent Na⁺ conductance, potentiates GABA-evoked currents, and blocks the kainate and α -amino-3-hydroxy-5-methyl-4-isoxazole propionate (AMPA) subtypes of the glutamate receptor. The Na⁺ channel effect and blocking of the metabotropic AMPA and kainate receptor may account for the ability of this medication to suppress trigeminal neuralgia and other neuropathic pain states.⁴⁴ Topiramate has been shown to have antihyperalgesic and antinociceptive activity in animal models of neuropathic pain. Topiramate is approved by the FDA for partial-onset seizures, primary generalized tonic-clonic seizures, and migraine prophylaxis. The dose range for adults is 200 to 400 mg/day in two divided doses for epilepsy, 50 to 300 mg/day for adjunctive treatment of bipolar disorder, and 50 to 200 mg/day for migraine prophylaxis.

Side effects include sedation, dizziness, nervousness, ataxia, nausea, weight loss, metabolic acidosis, kidney stones, and secondary angle-closure glaucoma. The sprinkle capsule formulation allows topiramate to be taken with a tablespoon of soft food if needed. Important drug interactions occur with carbamazepine, phenytoin, and valproate, which can decrease topiramate levels owing to increased clearance. Topiramate may increase the clearance of phenytoin and valproate and reduce the effectiveness of oral contraceptives. A modest side effect of topiramate is weight loss. A loss of about 6 kg after 12 to 18 months of use can occur, and this can be augmented with higher doses. It has been observed that the weight changes are greatest in patients with more weight to lose.

Oxcarbazepine

Oxcarbazepine is structurally similar to carbamazepine, and its mechanism may involve similar use-dependent inhibition of voltage-dependent Na⁺ action potentials. Compared with carbamazepine, oxcarbazepine has an increased tolerability and safety margin. It does not require liver enzymes or complete blood count monitoring, but electrolytes should be checked for Na⁺ concentrations because oxcarbazepine can induce hyponatremia. Oxcarbazepine can be titrated more rapidly than carbamazepine, which is an advantage for patients in an acute phase of trigeminal neuralgia.

Phenytoin

Phenytoin was the first antiseizure medication used to treat neuropathic pain. Its mode of action is similar to carbamazepine. Phenytoin suppresses ectopic discharge of neuromas when applied topically. This effect is probably moderated by a reduction in high-frequency repetitive firing of action potentials by blocking Na⁺ channels.²⁷ Phenytoin is available as an

intravenous preparation that has been shown to be beneficial in managing acute flare-ups of neuropathic pain.

Pregabalin

Pregabalin has been approved for the treatment for painful diabetic neuropathy and postherpetic neuralgia, and more recently it was approved for the treatment of fibromyalgia. Pregabalin is an active S-enantiomer of racemic 3-isobutyl γ -aminobutyric acid. The mechanism of action for pain is still to be determined. Similar to gabapentin, it is not metabolized in the liver and has no interaction with cytochrome P450 isoenzyme system, and it has no reported drug-drug interactions. The most common side effects are dizziness and somnolence. Pregabalin has been shown to improve slow-wave delta sleep and may be useful in sleep disorders associated with poor-quality delta sleep. In these cases, taking most of the dose at bedtime can be useful.

Pregabalin has been designated as a Schedule V controlled substance because of its potential for abuse and dependence. Patients with neuropathy are started at 50 mg three times daily and may be titrated to 300 mg daily within 1 week based on efficacy and tolerability. It is generally dosed at one third to one sixth the dose of gabapentin and is considered more potent than gabapentin. Most patients taking pregabalin need to take it only two times per day. In general, pregabalin can reduce neuropathic pain and anxiety within 1 week of initiation.²

Tiagabine

Tiagabine is a potent and selective GABA reuptake inhibitor with antiallodynic effects noted in rodent models of neuropathic pain (see Chapter 14). The antinociceptive effect was related to inhibition of GABA reuptake and resultant increased extracellular GABA levels. Because pretreatment of experimental animals with a GABA_B receptor antagonist eliminated the antinociceptive effect of tiagabine, GABA_B receptors may be involved in the tiagabine effect. The antiallodynic effects were dose dependent, with significant increases in threshold response to tactile stimulation.

Tiagabine has been compared with valproic acid as having efficacy for prophylactic management of migraine. The mechanism of action probably relates to its GABAergic characteristics. For trigeminal neuralgia, tiagabine is used as an add-on drug in combination with another antiseizure medication when better control of the pain is needed. For migraine, tiagabine is used as a prophylactic agent to decrease the frequency and intensity of migraine attacks.

N-Methyl-D-Aspartate (NMDA) Receptor Antagonists

It has been shown that 90% of C fibers contain glutamate and probably release glutamate and SP from their peripheral terminals when the stimulus is sufficiently long lasting, at least for several seconds to minutes. Glutamate is an agonist at the NMDA and AMPA receptors, but cannot activate the NMDA receptor without the presence of the co-agonist glycine. The NMDA receptor has been considered a potential target for modulating chronic pain; however, current NMDA receptor antagonists have severe side effects, limiting their usefulness. Blocking the glycine site may provide a target without the profound side effects accompanying the currently available NMDA receptor antagonists. The Ca⁺⁺ channel is normally blocked by Mg⁺⁺, which is displaced, opening the channel to Ca⁺⁺ influx when the receptor is activated. This event is responsible for the secondary allodynia noted in neuropathic pain. Ketamine is a voltage-dependent blocker of the NMDA receptor channels.

BOX 23-6*Potential Mechanisms of Drugs Used to Treat Pain*

MECHANISM	DRUG
5-HT reuptake inhibition	TCAs
NE reuptake inhibition	TCAs
Na ⁺ channel blockade	Carbamazepine, valproic acid, lamotrigine, phenytoin, topiramate, oxcarbazepine
Ca ⁺⁺ channel blockade	Valproic acid, gabapentin (?)
GABAergic neurotransmission	Gabapentin, valproic acid, baclofen, carbamazepine, topiramate, tiagabine
NMDA receptor antagonism	Ketamine, dextromethorphan
Substance P depletion	Capsaicin
AMPA receptor antagonism	Topiramate

AMPA, α -Amino-3-hydroxy-5-methyl-4-isoxazole propionate; 5-HT, 5-hydroxytryptamine; NE, norepinephrine; NMDA, N-methyl-D-aspartate; TCAs, tricyclic antidepressants.

The NMDA receptor is an obvious target for pain intervention because it is known to have a role in long-term potentiation and central sensitization. Ketamine and dextromethorphan are NMDA channel blockers and are effective in reducing NMDA-mediated responses in the dorsal horn nociceptive system. More recent studies have shown that dextromethorphan and ketamine are able to reduce temporal summation hyperalgesia and spontaneous discharge in neuropathic pain.

These agents are used when other medications have failed to provide adequate relief in centralized neuropathies. Ketamine is a strong NMDA receptor antagonist, but its side effects are more disturbing. Dextromethorphan has fewer attendant problems associated with its use but is only a weak NMDA receptor antagonist with inconsistent benefits. Nevertheless, its antagonistic activity on the NMDA receptor has been reported to be useful for treating chronic pain. Sedation, dizziness, and rash are the most common side effects.

Ketamine may have some use in management of chronic nonresponsive neuropathy; however, as indicated, the side effects become intolerable or difficult to manage. Ketamine is available only for intramuscular or intravenous administration, but it has been used orally. It is a dissociative anesthetic that is used to provide sedation and anesthesia for short surgical procedures (see Chapter 18). Patients may have adverse psychological effects, including hallucinations, nightmares, delusions, dissociative reactions, and schizophreniform psychosis.

The NMDA receptor blocker memantine was approved for the treatment of Alzheimer's disease in 2003. The drug is classified as an NMDA receptor antagonist. The excitatory amino acid glutamate has been implicated in excitotoxic cell death, and levels of glutamate are linked to the activation of the NMDA receptor. NMDA receptor activity and glutamate have also been implicated in migraine. Some evidence suggests that memantine may be useful in the prophylaxis against migraine. The mechanisms of many relevant drugs used to treat pain are summarized in Box 23-6.

Drugs That Act at α -Adrenergic Receptors

Atypical odontalgia is a central neuropathic orofacial pain condition that is influenced by the sympathetic nervous system.¹⁶ In studies by Graff-Radford and Solberg,¹⁶ 60% of the patients diagnosed with atypical odontalgia responded to

sympathetic nervous system blockade, relieving their tooth site pain and fulfilling the criteria for a diagnosis of sympathetically maintained pain. Pain conditions associated with sympathetically maintained pain include reflex sympathetic dystrophy and causalgia. Historically, treatment has involved sympathetic ganglion blockade with local anesthetics or clonidine to stop sympathetic outflow and relieve pain.

Phentolamine, an α -adrenergic receptor antagonist, acts on injured nociceptors to reduce sympathetically mediated pain. Continued nociceptor activity is mediated through local sympathetic fiber release of NE, stimulating the α_1 -adrenergic receptors and activating the affected nociceptors. α_2 -adrenergic receptors function as autoreceptors on the peripheral terminals of the postganglionic sympathetic nerve. When these receptors are activated, the release of NE from the sympathetic fibers is reduced. Tizanidine, similar to clonidine, is an α_2 -adrenergic receptor agonist that decreases sympathetic release of NE. In sympathetically mediated pain states, it is desirable either to block α_1 -adrenergic receptor activity to reduce the postjunctional effect of NE or to stimulate α_2 -adrenergic receptors to reduce NE release. These drugs also are useful in decreasing sympathetically mediated symptoms associated with narcotic withdrawal, such as anxiety, tachycardia, tremor, and sweating.

Topical Agents

Topical application of medications to the skin to treat pain has its roots in ancient literature and lore. To treat headache, Aretaeus recommended rubbing the head with rubefacient plants to provoke localized sweating, thought to aid in eliminating humors causing the headache. Compounding pharmacists are able to combine medications in bases such as pleuronic lecithin organogel (PLO) for application to the external skin surface or in bases such as Orabase for intraoral application. Direct application of topical agents to localized areas of inflammation, irritation, and pain offers several advantages: placement of medications directly over the treatment area potentially decreases side effects, and the direct effect of topical agents on the local receptors may have greater effect than systemic medications.

PLO is a gel base that is able to penetrate the epidermal barrier, carrying the agent through the epidermis to the affected locus. Some systemic absorption occurs, but it is significantly less than would be obtained by systemic administration. The combinations of medications are virtually limitless, but the underlying principle for choosing agents to include in the mixture should be based on the assumed pathologic state underlying the painful condition. If the clinician is managing an inflamed TMJ, and the patient is unable or unwilling to take a systemic anti-inflammatory drug, an NSAID such as ketoprofen could be included in a PLO base to be applied over the inflamed joint. Presumably the NSAID would decrease pain and inflammation by inhibiting prostaglandin synthesis locally, avoiding significant systemic effects.

In the past, chronic peripheral trigeminal neuropathy defied treatment, but recent understanding of the pathophysiology characteristics of the condition has led to development of treatment approaches with topical agents that inhibit peripheral sensitizing mechanisms such as C-fiber sensitization. When capsaicin-responsive vanilloid receptors were discovered on small-diameter unmyelinated nociceptors (assumed to be C fibers), it was realized that these receptors could be the target for topical intervention. Under new nomenclature, the capsaicin-responsive vanilloid receptors are now described as *TRPV1 receptors*. Activation causes the affiliated nociceptors to release SP. Long-term application depletes SP stores and temporarily inhibits the neuron's ability to synthesize more. Persistent application of capsaicin desensitizes

tizes chronic peripheral neuropathy, rendering relief from pain. Intraoral application is enhanced by fabricating an acrylic stent to cover the affected area when applying a capsaicin mixture. Capsaicin 0.025% is mixed in Orabase-B paste to give a sticky quality to the paste, helping to hold the stent in place and limiting the dispersion of the agent throughout the mouth. Nevertheless, for conditions such as trigeminal neuralgia, systemic drugs or surgical procedures are usually required.

Topical ketoprofen combined with other agents is useful in applications over inflamed muscles and joints. Ketoprofen 10% to 20% can be mixed in a PLO base and applied three to four times per day after wiping the area with a moist washcloth. In this situation, ketoprofen has a local anti-inflammatory effect without gastric irritation because of systemic inhibition of cyclooxygenase-1. Patients should be cautioned regarding the potential for developing photosensitivity because of the sensitizing properties of the benzophenone moiety of ketoprofen. Ultraviolet light exposure of skin covered with ketoprofen cream promotes the photolysis of erythrocytes. In addition, the drug is able to induce photoperoxidation of linoleic acid, and ketoprofen may induce DNA damage. There is a concern that repeated use of ketoprofen or other topical agents could lead to sensitization, with the possibility of incurring a greater risk of systemic allergic reactions with oral NSAIDs or other drugs.

The most common neuropathies in the orofacial region include trigeminal neuralgia, traumatic trigeminal neuropathy, postherpetic neuralgia, diabetic neuropathy, cancer-induced neuropathy, and AIDS-induced neuropathy. All these neuropathies have common pain mechanisms and similar treatment protocols. Peripheral nerve damage leads to peripheral sensitization and changes in the CNS. Topical medications are useful for neuropathic pain from peripheral sensitization and may be useful for centralized neuropathy with peripheral pain trigger zones.

To deliver a drug in the orofacial region by topical application, the agent has to penetrate the natural barriers that the facial skin and oral mucosal tissues provide. The pharmaceutical industry has found different ways to improve the absorption of topical medications, such as increasing the time and contact between the medications and the target tissues and developing different delivery systems such as creams, gels, dissolvable tablets, chewing gum, adhesive patches, polymeric devices, mouth rinses, and medicated lipsticks. The use of topical drug delivery is quite familiar to the dental profession because the application of creams, gels, and rinses to mucosal sites is a daily activity in dental practice.

The medications often used for oral and perioral neuropathies are topical anesthetics and, more recently, capsaicin. Other compounds, such as NSAIDs, sympathomimetic agents, and NMDA antagonists, are now being used with variable success. Although it is possible to have other agents, such as carbamazepine, baclofen, or amitriptyline, compounded for local delivery, their use in peripheral conditions is controversial because their mechanism of action has been described as central, and a peripheral mechanism of action has not been clearly established.

The use of intraoral topical medications is accompanied by some inconveniences. These agents tend to dissolve in saliva and spread throughout the mouth and down the throat. If the topical agent does not have mucosal adhesive properties, it quickly washes away from the area where it is being applied. Several strategies and delivery systems are being used to counter this problem. The following medications are delivered through the skin by a transdermal carrier or by placing in a material such as Orabase that adheres to the mucous tissue to enhance and maintain tissue/medication contact for longer periods.

Capsaicin

Capsaicin can be applied in a 0.025% concentration to the affected area five to six times per day. Capsaicin is known to reduce C-fiber activity where applied. Initial applications cause the typical burning sensation noted when eating spicy food. The burning lasts approximately 10 minutes and then begins to resolve. Repeated application inhibits C-fiber activity, causing immediate release of SP and decreasing further production. The capsaicin should be mixed with Orabase paste in equal parts before application.

Clonidine

Clonidine is an α_2 -adrenoceptor agonist that is used to reduce sympathetic activity in the target area. This agent should be compounded by a pharmacist to deliver approximately 0.1 mg of clonidine in three applications per day. Clonidine is used for neuropathies that have sympathetic involvement. Thermographic examination of the painful area may show as a cold area, indicating possible sympathetic mediation.

Ketamine

Ketamine (200 mg/mL) is applied in a transdermal or mucoadhesive base. Chronic peripheral neuropathic pain may be driven by NMDA receptor activity—hence the rationale for the use of this drug. Although controversial at present, there are reports of NMDA receptor activity in the peripheral area where nerve damage has occurred. Inhibiting NMDA activity may be the reason for these agents providing some benefit.

Eutectic mixture of local anesthetics

The eutectic anesthetic preparation consists of 2.5% prilocaine and 2.5% lidocaine; although effective, it has the inconvenience of a low melting point, rendering it liquid even at room temperature. Covering the application site with an occlusive dressing keeps the anesthetic in the desired area and, if used intraorally, protects the cream from salivary contamination. In the oral mucosa, this mixture is a superior topical anesthetic agent for pain reduction if given sufficient time of contact with the area to be anesthetized.

The rationale for the use of these agents is to decrease self-perpetuating C-fiber activity. It is thought that if the activity can be reduced for a long enough period, C-fiber function will normalize and not re-establish abnormal activity.

OTHER DRUGS USED FOR OROFACIAL PAIN

Sodium Hyaluronate

Sodium hyaluronate is derived from hyaluronic acid and is available for injection into small joints. Hyaluronic acid is a normal constituent of synovial fluid, responsible for the viscoelastic properties of the fluid. Hyaluronic acid is decreased in osteoarthritis, and use of these products produces viscosupplementation that benefits the joint by augmenting the viscosity of the joint fluid and stimulating endogenous production of hyaluronic acid. The agent also binds to specific hyaluronic acid receptors on the chondrocytes and synovocytes, acting as a free radical scavenger and reducing the cellular production of prostaglandin E_2 and bradykinin.

Botulinum Toxin Type A and B

Botulinum toxin type A (BoNT-A) is used for involuntary movement disorders such as dystonia, blepharospasm, torticollis, and other myotonic and dystonic disorders. BoNT-A causes an irreversible presynaptic blockade of the release of acetylcholine at the motor end plates, inhibiting muscle ability to contract; however, collateral sprouting of motor axons restores function within 3 to 6 months. The effect on muscle pain occurs rapidly, although benefit for the muscle spasms

may take 2 to 3 weeks to develop fully; however, it may provide more benefit for the patient than the drug's effect on muscle spasm. Previous treatment for these problems relied on oral medications that were not particularly beneficial. When the toxin was used for muscles involved in the face, it was noted that face wrinkles were eliminated for the 3- to 4-month duration of the muscle end plate block.

Migraine patients who were having these injections for forehead wrinkles began reporting that their migraines had subsided for the duration of the drug's effect. The effectiveness of botulinum toxin for migraine and other headaches is currently being studied.¹ Evidence suggests that there is some benefit for refractory myofascial pain.³⁴ For a review of BoNT-A in chronic pain, see the article by Göbel and colleagues.¹⁵

Botulinum toxin type B (BoNT-B) is relatively new as a therapeutic agent. It has properties different from BoNT-A. The anticholinergic side effects of BoNT-B are greater than with BoNT-A, injections of BoNT-B were reported to be more painful, and dysphagia occurred more frequently in injections in the facial region.^{4,19,23,33,37}

IMPLICATIONS FOR DENTISTRY

This chapter has reviewed the medications used to treat several pain syndromes, including chronic orofacial pain conditions. The medications traditionally used by dentists to treat their patients are generally limited to antibiotics, anti-inflammatory agents, opioids, local or general anesthetics, and sedatives. These medications are used to treat acute pain, inflammation, and infections or to anesthetize patients for surgical procedures. With the development of the field of orofacial pain and the increased understanding of painful non-tooth-related conditions that are seen in the orofacial environment, the dental pharmacopeia has expanded to include a vast array of medications that have not generally been considered previously. This array will continue to expand as more pharmaceuticals are developed, and the understanding of orofacial pain disorders and their mechanisms broadens.

ANTIMIGRAINE DRUGS AND DRUGS FOR NEUROPATHIC AND OTHER PAIN SYNDROMES

<i>Nonproprietary (generic) name</i>	<i>Proprietary (trade) name</i>
Ergots	
Dihydroergotamine	Migranal, DHE 45
Ergotamine	Ergomar, in Cafergot
Methylergonovine	Methergine
Methysergide	Sansert
Triptans	
Almotriptan	Axert
Eletriptan	Relpax
Frovatriptan	Frova
Naratriptan	Amerge
Rizatriptan	Maxalt
Sumatriptan	Imitrex
Zolmitriptan	Zomig
Antiemetics	
Metoclopramide	Reglan
Prochlorperazine	Compazine

<i>Nonproprietary (generic) name</i>	<i>Proprietary (trade) name</i>
Promethazine	Phenergan
Trimethobenzamide	Tigan
TCA's (see Chapter 12)	
β-Adrenergic receptor blockers (see Chapter 7)	
Ca⁺⁺ channel blockers (see Chapter 26)	
Antihistamines (see Chapter 22)	
Centrally acting muscle relaxants	
Baclofen	Lioresal
Carisoprodol	Soma
Cyclobenzaprine	Cyclobenz
Metaxalone	Skelaxin
Methocarbamol	Robaxin
Tizanidine	Zanaflex
Benzodiazepines (see Chapter 13)	
NSAIDs (see Chapter 21)	
Antiseizure drugs (see Chapter 14)	
NMDA antagonists	
Dextromethorphan	Delsym
Ketamine	Ketalar
Memantine	Namenda
α-Adrenergic receptor antagonists	
Clonidine	Catapres
Tizanidine	Zanaflex
Topical drugs*	
Pleuronic lecithin organogel	—
Capsaicin	Zostrix
Others	
Botulinum toxin-A	Botox
Botulinum toxin-B	Myobloc
Dichloralphenazone	In Midrin
Indomethacin	Indocin
Isometheptene	In Midrin
Sodium hyaluronate	Hyalgan

*See also local anesthetics, Chapter 16. NMDA, N-methyl-D-aspartate; NSAIDs, nonsteroidal anti-inflammatory drugs; TCAs, tricyclic antidepressants.

CITED REFERENCES

- Binder WJ, Brin MF, Blitzler A, et al: Botulinum toxin type A (BOTOX) for treatment of migraine headaches: an open-label study. *Otolaryngol Head Neck Surg* 123:669-676, 2000.
- Blommel ML, Blommel AL: Pregabalin: an antiepileptic agent useful for neuropathic pain. *Am J Health Syst Pharm* 64:1475-1482, 2007.
- Brandes JL, Smith T, Diamond M, et al: Open-label, long-term tolerability of naratriptan for short-term prevention of menstrually related migraine. *Headache* 47:886-894, 2007.
- Chapman MA, Barron R, Tanis DC, et al: Comparison of botulinum neurotoxin preparations for the treatment of cervical dystonia. *Clin Ther* 29:1325-1337, 2007.
- Cohen GL: Protriptyline, chronic tension-type headaches, and weight loss in women. *Headache* 37:433-436, 1997.

6. Cooper JR, Bloom FE, Roth RH: *The biochemical basis of neuropharmacology*, ed 7, New York, 1996, Oxford University Press.
7. Dahlström A, Fuxe K: Evidence of the existence of monoamine-containing neurons in the central nervous system, I: demonstration of monoamines in the cell bodies of brainstem neurons. *Acta Physiol Scand* 62(Suppl 232):1-55, 1964.
8. Erspamer V, Asero B: Identification of enteramine, the specific hormone of the enterochromaffin cell system, as 5-hydroxytryptamine. *Nature* 169:801-802, 1952.
9. Esmann V, Geil JP, Kroon S, et al: Prednisolone does not prevent post-herpetic neuralgia. *Lancet* 2:126-129, 1987.
10. Field M, Hughes J, Singh L: Further evidence for the role of the $\alpha 2\delta$ subunit of voltage dependent calcium channels in models of neuropathic pain. *Br J Pharmacol* 131:282-286, 2000.
11. Gaddum JH, Picarelli ZJ: Two kinds of tryptamine receptor. *Br J Pharmacol* 12:323-328, 1957.
12. Géraud G, Keywood C, Senard JM: Migraine headache recurrence: relationship to clinical, pharmacological, and pharmacokinetic properties of triptans. *Headache* 43:376-388, 2003.
13. Ghelardini C, Galeotti N, Casamenti F, et al: Central cholinergic antinociception induced by 5HT4 agonists: BIMU 1 and BIMU 8. *Life Sci* 58:2297-2309, 1996.
14. Goadsby PJ, Massiou H, Pascual J, et al: Almotriptan and zolmitriptan in the acute treatment of migraine. *Acta Neurol Scand* 115:34-40, 2007.
15. Göbel H, Heinze A, Heinze-Kuhn K, et al: Botulinum toxin A in the treatment of headache syndromes and pericranial pain syndromes. *Pain* 91:195-199, 2001.
16. Graff-Radford SB, Solberg WK: Atypical odontalgia. *J Cranio-mandib Disord Facial Oral Pain* 6:260-265, 1992.
17. Graham JR, Wolff HG: Mechanism of migraine headache and action of ergotamine tartrate. *Arch Neurol Psychiatry* 39:737-763, 1938.
18. Hamlin K, Fischer F: The synthesis of 5-hydroxytryptamine. *J Am Chem Soc* 73:5007-5008, 1951.
19. Hirst GR, Watkins AJ, Guerrero K, et al: Botulinum toxin B is not an effective treatment of refractory overactive bladder. *Urology* 69:69-73, 2007.
20. Janeway T, Richardson H, Park E: Experiments on the vasoconstrictor action of blood serum. *Arch Intern Med* 563-603, 1918.
21. Johnson KW, Phebus LA, Cohen ML: Serotonin in migraine: theories, animal models and emerging therapies. *Prog Drug Res* 51:219-244, 1998.
22. Keczkas K, Basheer AM: Do corticosteroids prevent post-herpetic neuralgia? *Br J Dermatol* 102:551-555, 1980.
23. Kranz G, Sycha T, Voller B, et al: Pain sensation during intradermal injections of three different botulinum toxin preparations in different doses and dilutions. *Dermatol Surg* 32:886-890, 2006.
24. Kwiat GC, Basbaum AI: The origin of brainstem noradrenergic and serotonergic projections to the spinal cord dorsal horn in the rat. *Somatosens Mot Res* 9:157-173, 1992.
25. Lang E, Hord AH, Denson D: Venlafaxine hydrochloride (Effexor) relieves thermal hyperalgesia in rats with an experimental mononeuropathy. *Pain* 68:151-155, 1996.
26. Leniger T, Wiemann M, Bingmann D, et al: Different effects of GABAergic anticonvulsants on 4-aminopyridine-induced spontaneous GABAergic hyperpolarizations of hippocampal pyramidal cells-implication for their potency in migraine therapy. *Cephalalgia* 20:533-537, 2000.
27. Macdonald RL, Kelly KM: Antiepileptic drug mechanisms of action. *Epilepsia* 36(Suppl 2):S2-S12, 1995.
28. Morgan MM, Sohn JH, Liebeskind JC: Stimulation of the periaqueductal gray matter inhibits nociception at the supraspinal as well as spinal level. *Brain Res* 502:61-66, 1989.
29. Moskowitz MA: Basic mechanisms in vascular headache. *Neurol Clin* 8:801-815, 1990.
30. Moskowitz MA: The trigeminovascular system. In Olesen J, Tfelt-Hansen P, editors: *The headaches*, New York, 1993, Raven Press.
31. Nohr D, Schafer MK-H, Persson S, et al: Calcitonin gene-related peptide gene expression in collagen-induced arthritis is differentially regulated in primary afferents and motoneurons: influence of glucocorticoids. *Neuroscience* 93:759-773, 1999.
32. Ongghena P, Van Houdenhove B: Antidepressant-induced analgesia in chronic non-malignant pain: a meta-analysis of 39 placebo-controlled studies. *Pain* 49:201-219, 1992.
33. Pappert EJ, Germanson T: Myobloc/Neurobloc European Cervical Dystonia Study Group: Botulinum toxin type B vs. type A in toxin-naive patients with cervical dystonia: randomized, double-blind, noninferiority trial. *Mov Disord* 23:510-517, 2008.
34. Porta M: A comparative trial of botulinum toxin type A and methylprednisolone for the treatment of myofascial pain syndrome and pain from chronic muscle spasm. *Pain* 85:101-105, 2000.
35. Powell KR, Dykstra LA: The role of serotonergic receptors in the effects of mu opioids in squirrel monkeys responding under a titration procedure. *Psychopharmacology* 126:42-49, 1996.
36. Rapport M, Green A, Page I: Serum vasoconstrictor (serotonin), IV: isolation and characterization. *J Biol Chem* 176:1243-1251, 1948.
37. Rossi RP, Strax TE, Di Rocco A: Severe dysphagia after botulinum toxin B injection to the lower limbs and lumbar paraspinal muscles. *Am J Phys Med Rehabil* 85:1011-1013, 2006.
38. Saper JR, Winner PK, Lake AE: An open-label dose-titration study of the efficacy and tolerability of tizanidine hydrochloride tablets in the prophylaxis of chronic daily headache. *Headache* 41:357-368, 2001.
39. Saxena PR: Historical aspects of 5-hydroxytryptamine: discovery and receptor classification. In Olesen J, Saxena PR, editors: *5-Hydroxytryptamine mechanisms in primary headaches*, New York, 1992, Raven Press.
40. Sicuteri F, Testi A, Anselmi B: Biochemical investigations in headache increase in hydroxyindoleacetic acid excretion during migraine attacks. *Arch Allergy Appl Immunol* 19:55-58, 1961.
41. Stepien A, Chalimoniuk M, Strosznajder J: Serotonin 5HT1B/1D receptor agonists abolish NMDA receptor-evoked enhancement of nitric oxide synthase activity and cGMP concentration in brain cortex slices. *Cephalalgia* 19:859-865, 1999.
42. Taiwo YO, Levine JD: Serotonin is a directly-acting hyperalgesic agent in the rat. *Neuroscience* 48:485-490, 1992.
43. Taylor AP, Adelman JU, Freeman MC: Efficacy of duloxetine as a migraine preventive medication: possible predictors of response in a retrospective chart review. *Headache* 47:1200-1203, 2007.
44. Tremont-Lukats IW, Megeff C, Backonja MM: Anticonvulsants for neuropathic pain syndromes: mechanisms of action and place in therapy. *Drugs* 60:1029-1052, 2000.

GENERAL REFERENCES

- Cooper JR, Bloom FE, Roth RH: Serotonin (5-hydroxytryptamine), histamine and adenosine. In *The biochemical basis of neuropharmacology*, ed 8, New York, 2003, Oxford University Press.
- Evans RW, Mathew NT: *Handbook of headache*, Philadelphia, 2000, Lippincott Williams & Wilkins.
- Ferrari MD: Systemic biochemistry. In Olesen J, Tfelt-Hansen P, Welch KMA, editors: *The headaches*, New York, 1993, Raven Press.
- Frazer A, Hensler JG: Serotonin. In Siegel GJ, Agranoff BW, Albers RW, et al, editors: *Basic neurochemistry: molecular, cellular and medical aspects*, ed 6, Philadelphia, 1999, Lippincott-Raven.
- Saper JR, Silberstein SD, Gordon CD, et al, editors: *Handbook of headache management: a practical guide to diagnosis and treatment of head, neck and facial pain*, ed 2, Philadelphia, 1999, Lippincott Williams & Wilkins.
- Saper JR, Silberstein SD, Gordon CD, et al: Treatment of intractable, severe migraine: parenteral treatment protocols, hospitalization, and referral guidelines. In Saper JR, Silberstein SD, Gordon CD, et al, editors: *Handbook of headache management: a practical guide to diagnosis and treatment of head, neck and facial pain*, ed 2, Philadelphia, 1999, Lippincott Williams & Wilkins.

Antiarrhythmic Drugs

FRANK J. DOWD

Antiarrhythmic drugs are used to correct or reduce the risk of cardiac arrhythmias (dysrhythmias). They are classified into several categories on the basis of their mechanisms of action and resulting cardiac effects. All antiarrhythmic agents influence impulse generation or impulse conduction in the heart and cause definable electrophysiologic effects.

BASIC CARDIAC ELECTROPHYSIOLOGY

Under normal conditions, the chambers of the heart contract as synchronized rhythmic units driven by electrical impulses generated in and conducted throughout the heart. The normal pacemaker impulse is generated in the sinoatrial (SA) node and travels through the atria to each muscle cell, to the atrioventricular (AV) node, and through specialized conduction pathways in the common bundle of His, bundle branches, and Purkinje network to reach the ventricular muscle cells. Figure 24-1 illustrates representative action potentials for an SA nodal cell, an atrial muscle cell, an AV nodal cell, a Purkinje fiber, and a ventricular muscle cell. Three experimental measures are used to characterize the electrophysiologic properties of the heart: automaticity, refractoriness, and conduction velocity. Many of the antiarrhythmic effects of drugs result from changes in these parameters, which are reflected by action potential alterations in various regions of the heart.

Automaticity

Automaticity describes the unique ability of cells of the SA node, AV node, and specialized conducting system to exhibit spontaneous phase 4 depolarization and impulse generation. An increase in automaticity refers to an increase in the rate of impulse generation, and, conversely, a decrease in automaticity refers to a decrease in the rate of impulse generation. Under normal conditions, the pacemaker cells of the SA node exhibit the most rapid generation of impulses, making the SA node the controlling pacemaker of the heart. The rate at which pacemaker cells initiate impulses is a function of the rate of phase 4 depolarization, the maximum diastolic potential (MDP), and the magnitude of the threshold potential (Figure 24-2). An increase in the rate of phase 4 depolarization in the SA node increases heart rate, whereas a change in the threshold voltage to a more positive value or an increase in the MDP (hyperpolarization) decreases the heart rate. These functions are under nervous and hormonal control and can be altered by injury or drugs.

Refractoriness

The period after the initiation of an action potential during which another action potential cannot be initiated and propagated regardless of stimulus is known as the *effective refractory period* (ERP) (see Figure 24-2). A change in the action potential

duration (APD) is accompanied by a similar change in the duration of the ERP, although the ratio of change may not be 1:1. If the ERP is lengthened with respect to the APD, the cardiac cells will have repolarized more completely before they respond to a stimulus. Many drugs with antiarrhythmic effects prolong the duration of the ERP, and some decrease it.

Conduction Velocity

Conduction velocity in cardiac fibers is altered by several factors, including anatomic characteristics, the electrophysiologic state, pathologic conditions, and many antiarrhythmic drugs. The rate of phase 0 depolarization strongly influences the conduction velocity. The rate (or slope) of phase 0 depolarization (measured as the change in voltage per unit of time [dV/dt]) depends on the membrane potential during phase 4. The more negative the membrane potential at the beginning of phase 0 depolarization, the greater is the maximal dV/dt for phase 0. In this sense, what happens in phase 4 influences what happens in phase 0.

Ion Channels

Ions and the channels that control their movements play major roles in the various phases of cardiac depolarization and repolarization. Figure 24-3 illustrates the membrane action potential in an SA nodal cell and a Purkinje fiber—two characteristically different action potentials—and the flow of ions through specific channels in the Purkinje fiber.

In Purkinje fibers and in atrial and ventricular myocardium, depolarization in phase 0 results from an initial, “fast channel” current of Na^+ in the inward direction. Na^+ channels also contribute to the pacemaker current in phase 4 of pacemaker cells. Another major inward current, carried by Ca^{++} and conducted through “slow channels,” contributes to the plateau phase (phase 2) of the action potential. Ca^{++} channels are of two types, T and L. These channels remain open for different periods during the action potential and respond differently to antiarrhythmic drugs.

Outward K^+ currents are responsible for repolarizing the muscle fiber in phase 3 and, by slowly deactivating in phase 4, contribute to spontaneous depolarization in pacemaker cells, notably the SA node, AV node, and (sometimes) His-Purkinje fibers. (Na^+ and Ca^{++} also play roles in depolarization during phase 4.) As K^+ conductance through inwardly rectifying K^+ (K_{ir}) channels decreases, and Na^+ and Ca^{++} conductance increases, spontaneous depolarization during phase 4 occurs. Another major difference between pacemaker cells (e.g., cells of the SA and AV nodes) and nonpacemaker cells (e.g., cardiac muscle cells) is the slope of phase 0. Phase 0 has a much lower slope in pacemaker cells, where the major membrane event governing depolarization in phase 0 is Ca^{++} influx through slow channels. As indicated, the faster phase 0 depolarization of the myocardium and Purkinje fibers is caused primarily by

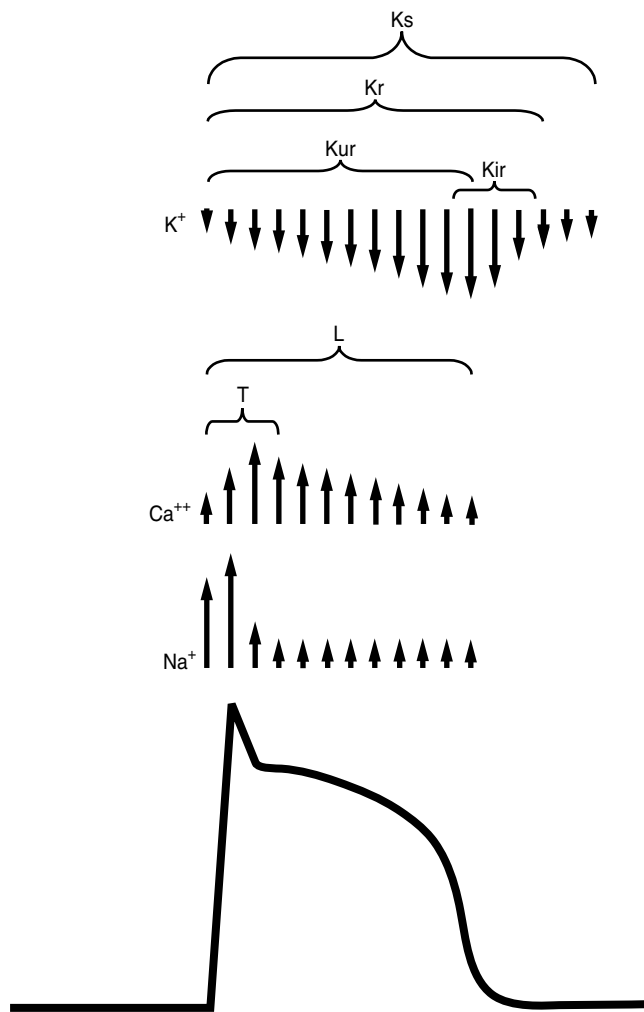
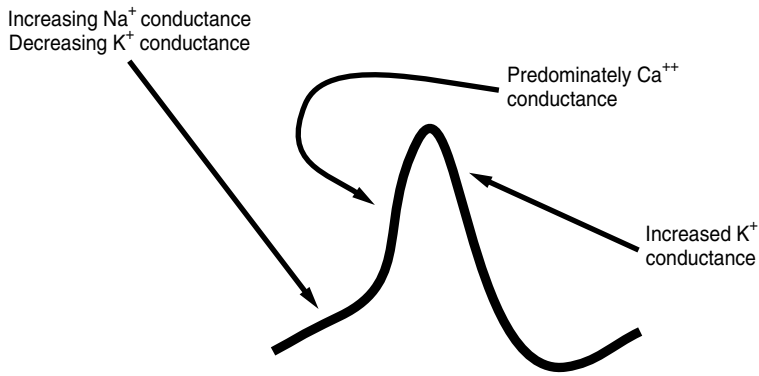

FIGURE 24-3 Characteristic membrane action potentials from a sinoatrial (SA) nodal cell (*top*) and from a Purkinje fiber (*bottom*). The relative magnitudes of the various ionic fluxes, as they apply to the Purkinje fiber, are shown by the length of the *arrows* above the Purkinje fiber; \uparrow indicates a depolarizing current, and \downarrow indicates a repolarizing current. Differences in ion fluxes for the SA node are described. Predominate channel subtype activities for Ca^{++} and K^+ channels are shown above the respective arrows. In the SA (and atrioventricular) node, phase 0 is slower than in the Purkinje fibers and myocardium because phase 0 primarily depends on Ca^{++} influx. There is no discernible phase 2 in the SA node. Phase 3 in the SA node depends on K^+ efflux, as in the other cells of the heart. Phase 4 for SA nodal cells results, in part, from the pacemaker current largely provided by an increase in Na^+ conductance and a gradual decrease in K^+ conductance.

nomic nervous system activity, by hormones, or by drugs. Changes in the MDP and threshold potential voltage can also affect automaticity. Abnormal impulse generation may also be triggered by afterpotentials that occur in cardiac pacemakers affected by drugs, disease, or other disturbances (see Figure 24-2). The induced afterdepolarizations may be early (before repolarization is complete) or delayed (after full repolarization has occurred) and can result in sustained tachyarrhythmias.¹ Excessive intracellular Ca^{++} is a major contributor to delayed afterpotentials, whereas delayed repolarization increases the risk for early afterdepolarizations in some cells.

An important example of an alteration in impulse conduction that is easily induced in experimental animals is the phenomenon known as *reentry*. Figure 24-4 shows how a reentrant rhythm may develop. As illustrated, conduction in branch *A* is normal, whereas impulses in branch *B* can proceed in only the reverse direction (unidirectional block). A normally conducted impulse through branch *A* can be conducted in retrograde fashion through branch *B* to re-excite an area of tissue (point *R*) that was previously excited by the normal path of conduction. For this “circus movement” to occur, the tissue at point *R* must have repolarized to a point at which

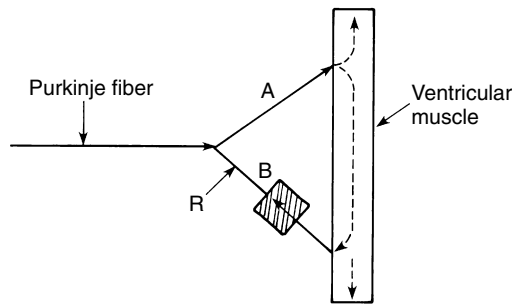

FIGURE 24-4 Reentry in the presence of unidirectional block. The hatched area in path *B* indicates a unidirectional block of impulse conduction.

excitation is possible (which usually means that the retrograde conduction is relatively slow). A wave of re-excitation traveling in a circular path through fiber *A*, the contractile cardiac muscle, and fiber *B* can result in a self-sustaining arrhythmia. Reentry is usually a major contributor to atrial fibrillation, an arrhythmia especially common in elderly individuals.

Another type of conduction abnormality, known as *heart block*, occurs in response to impaired conduction in the AV node or conducting tissues of the ventricular myocardium. In its simplest form (first-degree block), there is excessive delay between atrial and ventricular depolarizations, resulting in a prolonged PR interval. In more advanced forms, some (second-degree block) or all (third-degree block) of the impulses from the SA node are prevented from reaching the ventricles, resulting in a ventricular rate that is lower than the atrial rate.

Disturbances in the relationship of the fast and slow electrical responses of certain cardiac cells may play an important role in the genesis of arrhythmias. The *fast response* refers to the rapid phase 0 depolarization caused by rapid Na^+ influx (see Figure 24-3). This kind of activity is seen in atrial and ventricular muscle fibers and specialized conducting fibers. In addition to the rapid inward current carried by Na^+ , the fast fibers exhibit a second, slower inward current carried by Ca^{++} . The slower current does not normally constitute a major factor in phase 0 depolarization of the atrial and ventricular myocardium and Purkinje fibers, but it persists after rapid depolarization and is responsible for the prolonged plateau phase characteristic of these fibers. Fibers located in the SA and AV nodes, the AV ring fibers, and the mitral and tricuspid valve leaflets show the slow response in phase 0, during which the depolarization is carried largely by the inward Ca^{++} current.

Although the fast fibers exhibit rapid yet sustained depolarization, remain refractory, and conduct impulses safely, the slow fibers exhibit a slow rate of depolarization, low resting potential, and low impulse amplitude, resulting in slow conduction and susceptibility to aberrant stimulation. In some disease states, the fast response may become inactivated, leaving the slow response dominant. These conditions favor the genesis of arrhythmias because of the low safety factor associated with the slow response. In the heart, an intricate relationship exists between conduction velocity, path length, refractory period duration, and impulse generation that, when altered through one or more mechanisms, may result in the development of arrhythmias.

Certain arrhythmias can be traced to defects in one or more ion channels. The long QT syndrome results from delayed repolarization in the ventricle. A delayed repolarization can be caused by any depolarizing current, such as a Na^+ current, that lingers into phase 3 of the action potential. It can also result from reduced activity of a repolarizing K^+

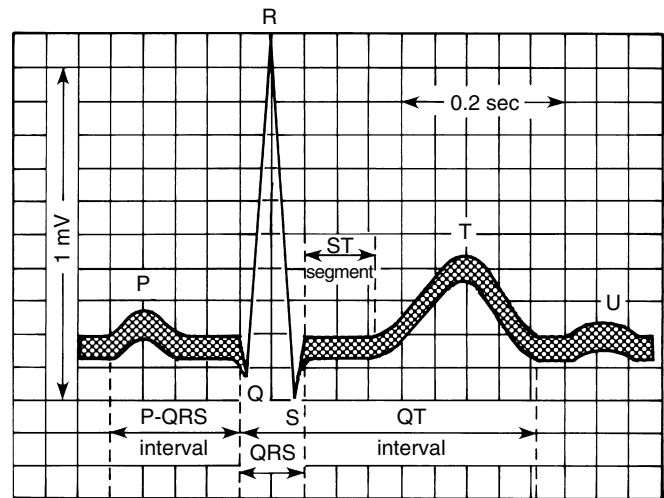

FIGURE 24-5 Normal ECG. *P*, Atrial depolarization; *QRS*, ventricular depolarization; *T*, ventricular repolarization. The *U* wave corresponds to interventricular repolarization. (From Milnor WR: *The ECG*. In Mountcastle VB, editor: *Medical physiology*, ed 14, St Louis, 1980, Mosby.)

current. A defect in the *Kr* (rapid activating current) channel is the basis for one type of familial long QT syndrome that can devolve into *torsades de pointes*, a potentially life-threatening ventricular tachyarrhythmia (see later).¹⁰ *Torsades de pointes* may also be elicited by drugs that inhibit *Kr* channels and increase the QT interval. These include numerous antiarrhythmic agents and some drugs of other classes. Whether the delay in repolarization is caused by a hereditary defect or by a drug, it leads to a net enhancement of inward cationic flow, which can trigger early afterdepolarizations (see Figure 24-2). Because the cells in the wall of the ventricle are not equally affected, multiple waves of reentry can occur, initiating *torsades de pointes*. Effort is under way to develop more selective K^+ channel inhibitors as potential antiarrhythmic drugs. *Torsades de pointes* is a major risk of drugs that selectively block *Kr* channels. Hypokalemia and hypomagnesemia increase the risk of developing *torsades de pointes*.¹⁶

ELECTROCARDIOGRAPHY AND COMMON ARRHYTHMIAS

Arrhythmias are generally classified as supraventricular (originating in the atria or conducting system not in the ventricle) or ventricular. A few of the most common arrhythmias are described. For comparison, a diagram of a normal electrocardiogram (ECG) is provided in Figure 24-5. In Figure 24-5, also note the P-QRS (or PR), QT, and ST intervals and the duration of the QRS complex. Figure 24-6 contains representations of ECGs recorded during arrhythmias of ventricular and supraventricular origin.

The first arrhythmia illustrated is a simple sinus tachycardia caused by rapid impulse generation (i.e., increased automaticity) in the SA node. Higher rates of atrial activity often involve reentry, as in atrial flutter (approximately 300 beats/min) or fibrillation (400 to 700 beats/min).⁷ Under these conditions, second-degree heart block occurs, as characterized by the failure of some atrial depolarizations to initiate a QRS complex. In a third-degree block (also shown), there is complete dissociation between atrial and ventricular contractions. The ventricular arrhythmias are caused by the development of ectopic foci or reentrant conduction in the ventricles. The

first one shown in Figure 24-6 is ventricular tachycardia. In ventricular fibrillation, the most immediately life-threatening arrhythmia, erratic depolarization of different areas of the ventricle totally disorganizes myocardial contraction, renders the heart ineffective, and causes the cardiac output to plummet. Immediate treatment of ventricular fibrillation, usually including defibrillation (precordial direct current shock), must be provided to avert sudden death.

Torsades de pointes (literally meaning “twisting of points”) is a polymorphic ventricular tachycardia characterized by bizarre shapes in the ventricular depolarization complexes on the ECG (Figure 24-7). As mentioned previously, it often occurs in patients with defective K^+ channel (e.g., K_r) activity and occurs with certain drugs that delay repolarization of

ventricular muscle cells, often by blocking K_r channels. In both cases, QT prolongation precedes and leads to torsades de pointes. In Figure 24-7, an excessively long QT interval is followed by a ventricular tachycardia in which each depolarization has a different configuration.

ANTIARRHYTHMIC DRUGS

Antiarrhythmic drugs are used to modify, or restore to normal, aberrant electrophysiologic properties of cardiac muscle. Arrhythmias may result from various disease conditions or drug treatments. In all arrhythmias, some facet of the normal electrophysiologic system that governs cardiac contraction is behaving abnormally. Several methods of treating arrhythmias are used today. Nonpharmacologic interventions for cardiac arrhythmias include electrical cardioversion, automatic implantable cardioverter devices, ablation therapy, and pacemakers.

The type of arrhythmia is a major factor in the selection of an antiarrhythmic drug. Enhanced impulse generation can be reduced by drugs that slow phase 4 depolarization by reducing the inward Na^+ current or the inward Ca^{++} current. The treatment of reentry includes drugs that reduce Na^+ channel and Ca^{++} channel activity, which slows conduction velocity. Drugs that block K^+ channels, prolonging repolarization and the refractory period, may also be useful.

Drugs used in the treatment of cardiac arrhythmias are not easily classified because they often have more than one action. Drugs within each class vary in their magnitudes of action or types of effects produced.^{1,14} The most common scheme, originally proposed by Vaughan and Williams,¹⁴ classifies drugs according to certain specific properties. Type I drugs, such as quinidine, lidocaine, and flecainide, depress Na^+ current.¹ The type I agents are subdivided further according to their relative effects on phase 0 depolarization, conduction velocity, and APD. Na^+ channels exist in at least three states: closed, open, and inactivated. At resting membrane potentials the Na^+ channels are closed except for a Na^+ “leak” associated with phase 4 depolarization for cells that display automaticity. During rapid depolarization (phase 0, especially in Purkinje fibers and ventricular muscle), the Na^+ channels are open. The Na^+ channels convert to the inactivated state before returning to the resting, closed state. The inactivated state occurs mostly in phase 2 and 3 of the action potential.

Class IA and IC drugs bind more selectively to the open state of the channel. Class IB drugs bind more selectively to the inactivated state of the channel. Because the Purkinje fibers and ventricular myocardial cells have longer plateau

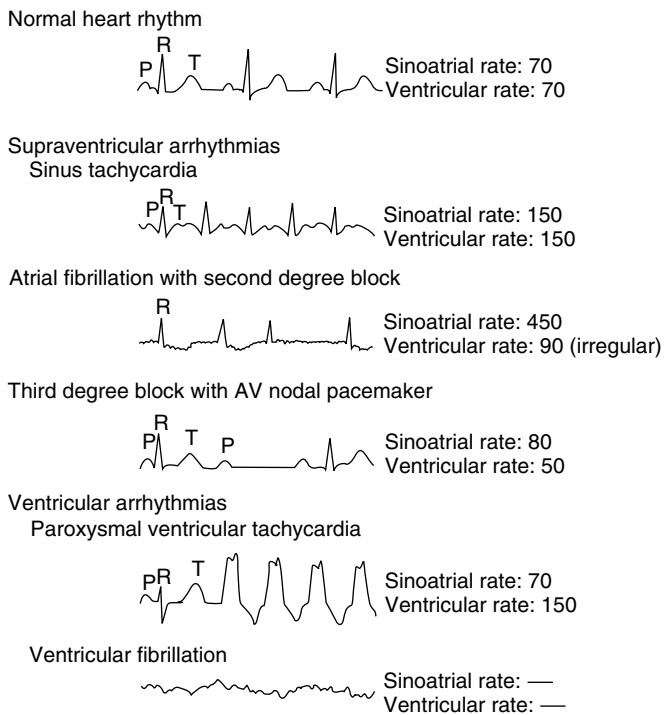

FIGURE 24-6 Various cardiac rhythms as recorded by the ECG. Arrhythmias are classified as supraventricular or ventricular in origin. Rates are given in beats per minute. (Adapted from Shepard RS: *Human physiology*, Philadelphia, 1971, Lippincott.)

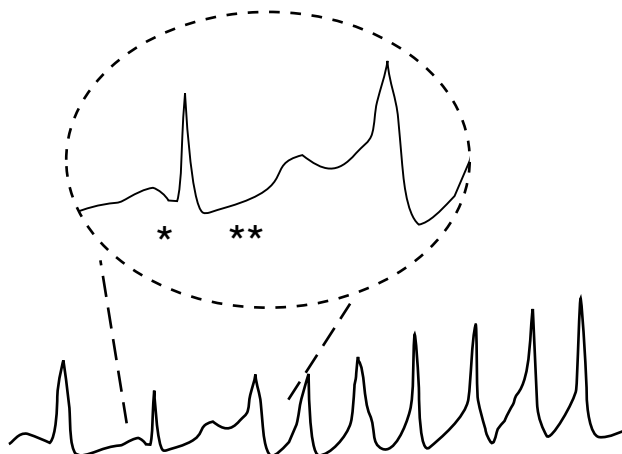

FIGURE 24-7 ECG pattern of torsades de pointes. As seen in the enlarged section, the relatively normal P wave and QRS complex (*) are followed by a prolonged QT interval (**) and initiation of polymorphic ventricular tachycardia (section not enlarged).

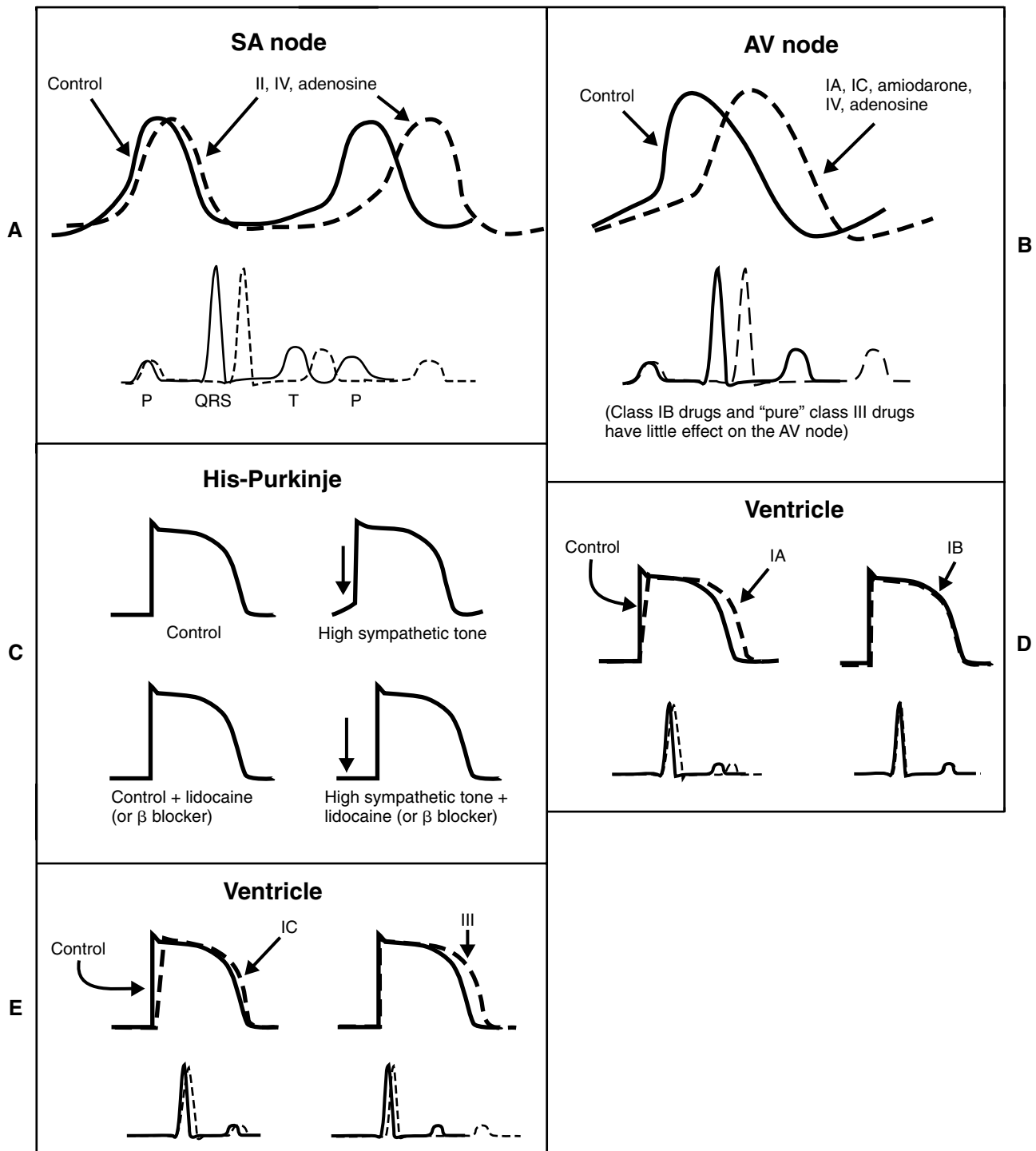

FIGURE 24-8 Effect of the various antiarrhythmic drug classes on the action potentials in the heart. Where relevant, the corresponding ECG pattern is also shown. Omitted drug classes have little effect on the action potentials depicted. The changes shown do not imply the same magnitude of change for each drug class. Amiodarone is specifically identified because, although it is classified as a class III drug, it has additional actions. **A**, Sinoatrial (SA) node. Note the delay in appearance of the QRS complex, T wave, and subsequent P wave caused by the identified drugs. **B**, Atrioventricular (AV) node. Various drugs delay conduction through the node. **C**, His Purkinje system. Active drugs reduce phase 4 depolarization (arrows). **D** and **E**, Ventricular muscle. In **D**, class IB drugs minimally alter the ECG pattern in normal cardiac rhythms.

phases (phase 2), class IB drugs are able to block Na^+ channels more effectively in these tissues because the Na^+ channels remain in an inactivated state longer during systole. Inasmuch as ischemic ventricular tissue is more depolarized, it, too, is especially sensitive to Na^+ channel blockade by class IB drugs.

Quinidine-like, or class IA, drugs depress phase 0 depolarization at all heart rates. They prolong the APD of the ventricle because they also inhibit K^+ (chiefly K_r) channels (Figure 24-8). Class IB agents, such as lidocaine, block Na^+ channels more selectively, but the rapid onset and recovery

of Na⁺ channel blockade results in little accumulated lidocaine effect on phase 0 and conduction velocity in healthy tissue at normal heart rates. In damaged or rapidly firing cells, lidocaine causes a frequency-dependent or use-dependent block to reduce the slope of phase 0 and lowers phase 4 in ectopic pacemakers and in Purkinje fibers under high sympathetic tone.¹ The faster the heart rate, the greater is the effect of lidocaine. (Use-dependent block is discussed in Chapter 16.) In contrast to other class I agents, lidocaine and related class IB antiarrhythmics may actually shorten the APD. Flecainide and other class IC antiarrhythmics are characterized by their profound depression of phase 0 depolarization and slowing of conduction in the atria, AV node, and ventricles at normal heart rates. This pronounced effect results from their slow dissociation from Na⁺ channels and accumulation of the channel-blocking effect over several contraction cycles. There is little or no prolongation of the APD.

Propranolol and related β-adrenergic-blocking agents constitute class II drugs and inhibit cardiac stimulation brought on by β-adrenergic agonists. They depress phase 4 depolarization (see Figure 24-8). The class III group, including amiodarone and sotalol, block K⁺ channels (chiefly Kr channels) and prolong the APD by delaying phase 3 repolarization. Verapamil and other class IV drugs selectively block Ca⁺⁺ channels (L type) and depress slow fiber conduction (phase 0 of the SA and AV nodes) and phase 4 depolarization (see Figure 24-8). Drugs that cannot be classified by the Vaughan-Williams scheme include digitalis and adenosine.

Table 24-1 outlines the various categories of antiarrhythmic agents. The drugs vary widely in their clinical usefulness. Class IA drugs are less commonly used today, partly because of the introduction of class IC and class III drugs. In Table 24-1 the action responsible for the classification of each drug, which is usually its major action, is circled. In the discussion of individual agents that follows, reference should also be made to Table 24-2 for the electrophysiologic actions of representative antiarrhythmic drugs. The net effects of the relevant drug classes and various action potentials in the heart are shown in Figure 24-8. Pharmacokinetic data for specific drugs are given in Table 24-3. The use of digoxin for certain kinds of arrhythmias is discussed in Chapter 25.

Quinidine

Quinidine is effective in the treatment of some atrial and (to a lesser extent) ventricular tachyarrhythmias. It was used clinically before its antiarrhythmic properties were discovered. During treatment with quinine and quinidine for patients with malaria, the reversal of atrial fibrillation was noted in some patients. Widespread use of quinidine for supraventricular arrhythmias followed reports from Wenckebach¹⁵ in 1914.

Quinidine, the *d* isomer of quinine, is found in the bark of the cinchona tree, which is indigenous to certain regions of South America. Synthesis of this compound has been accomplished, but the synthesized drug is expensive, and quinidine is still isolated from the natural source. Its structural formula is shown in Figure 24-9.

Pharmacologic effects

Quinidine reduces automaticity and conduction velocity and increases refractoriness. Automaticity is depressed through an increase in the threshold potential and a decrease in the slope of spontaneous diastolic depolarization (phase 4) in pacemaker fibers, particularly at sites other than the SA node. Quinidine has the potential to slow or abolish tachyarrhythmias. Quinidine decreases the slope of phase 0 depolarization and decreases conduction velocity in cells such as those of the AV node and ventricular myocardium (see Figure 24-8). By this effect, quinidine may inhibit reentrant pathways. Quini-

dine influences automaticity and conduction velocity by blocking Na⁺ channels, particularly channels in the open state. The rate of recovery from quinidine block is intermediate between class IB and IC antiarrhythmic drugs (see Table 24-1). Therapeutic dosages increase refractoriness by prolonging the duration of the ERP in the ventricle and His-Purkinje system. This effect depends on blockade of K⁺ channels, especially Kr channels, and has the potential for preventing or abolishing reentrant rhythms.

In addition to its direct actions on the heart, quinidine exerts a vagolytic action. As a consequence of its antivagal influence on the SA node, quinidine, especially given intravenously, may increase the heart rate. Because the ERP in the atria is decreased by vagal stimulation, quinidine increases the ERP directly and indirectly. The antivagal action of quinidine on AV nodal conduction is of special importance. By this mechanism, quinidine may increase the conduction velocity and decrease the refractory period of the AV node, which presents a hazard in treating atrial tachyarrhythmias because rapid atrial impulses are more readily conducted to the ventricles. This risk is greatest when the drug is used intravenously.

The ECG changes that result from quinidine administration are predictable from the electrophysiologic effects previously discussed (see Figure 24-8). The antivagal property tends to elicit sinus tachycardia, but mostly at high doses; SA nodal block may result from the drug's direct depressant effects. Increased durations of the QRS complex and the QT interval result from decreases in ventricular conduction velocity and lengthening of the ventricular ERP.

In large doses, quinidine causes peripheral vasodilation by blocking α-adrenergic receptor blockade. Hypotension is a possible outcome.

Absorption, fate, and excretion

Absorption of quinidine after oral administration is rapid and nearly 100%. Depending on the salt formulation, maximum plasma concentrations are reached within 2 hours. Given intramuscularly, peak concentrations occur in 60 minutes. When quinidine is injected intravenously, it should be administered slowly because its therapeutic effects are not instantaneous, and overdose might occur. Adverse hemodynamic effects are more common with intravenous use. Other pharmacokinetic characteristics are listed in Table 24-3.

Adverse effects

Quinidine can precipitate various ventricular arrhythmias, including torsades de pointes (see Figure 24-7). As a result of its depressive effects on ion conductance throughout the heart, quinidine modestly reduces myocardial contractility, which might be important in the management of a patient with congestive heart disease. Quinidine can cause a group of symptoms collectively referred to as *cinchonism*: blurred vision, tinnitus, tremor, vertigo, and lightheadedness. Nausea, vomiting, and diarrhea are the most common side effects of the drug. The negative inotropic and stronger peripheral vasodilatory effects of quinidine may occasionally lead to hemodynamic deterioration, resulting in hypotension, syncope, and a decrease in coronary blood flow, especially in patients with impaired myocardial function. Intravenous use of the drug presents an added risk of hypotension and syncope.

Immune-mediated reactions may develop with quinidine therapy. Responses include hematologic reactions (thrombocytopenia, hemolytic anemia, agranulocytosis), cutaneous reactions (rash, angioneurotic edema), and very rarely bronchial asthma and anaphylactic shock. Immunologically mediated thrombocytopenia can readily lead to hemorrhagic episodes.

TABLE 24-1

Actions of Antiarrhythmic Drugs

DRUG*	BLOCK Na ⁺ CHANNELS			BLOCK β RECEPTORS	BLOCK K ⁺ CHANNELS	BLOCK Ca ⁺⁺ CHANNELS	OTHER ACTIONS
	SLOW	MEDIUM	FAST				
Class IA							
Quinidine		⊗			×	×	α-Adrenergic blockade, vagolytic action
Procainamide		⊗			×		Ganglionic blockade
Disopyramide		⊗			×		Muscarinic blockade
Class IB							
Lidocaine			⊗				
Mexiletine			⊗				
Class IC							
Flecainide	⊗				×		
Propafenone	⊗			×		×	Vagolytic action
Moricizine	⊗						
Class II							
Propranolol			×	⊗			
Esmolol				⊗			
Class III							
Amiodarone			⊗	×	⊗	×	α-Adrenergic blockade, muscarinic blockade
Ibutilide [†]					⊗		
Dofetilide					⊗		
Bretylum					⊗		Catecholamine release, adrenergic nerve blockade
Sotalol				×	⊗		
Class IV							
Verapamil			×			⊗	α-Adrenergic blockade
Diltiazem						⊗	
Miscellaneous							
Adenosine							A ₁ -receptor stimulation

*The distinguishing characteristics for the main classes of antiarrhythmic drugs are the following: class I drugs block Na⁺ channels. The subclassification is based on the characteristics of the block. The terms *slow*, *medium*, and *fast* refer to the rates of onset of, and recovery from, Na⁺ channel blockade. Class II drugs block β-adrenergic receptors. Class III drugs block K⁺ channels. Class IV drugs block Ca⁺⁺ channels. The major action responsible for the classification of each drug is circled.

[†]Ibutilide is exceptional because its major action, not shown, is to increase conductance through a slow Na⁺ channel.

TABLE 24-2

Effects of Antiarrhythmic Drug Classes

DRUG CLASS	SINOATRIAL AUTOMATICITY	ATRIOVENTRICULAR CONDUCTION VELOCITY	ECG CHANGES			AFFINITY FOR Na ⁺ CHANNELS IN ISCHEMIC TISSUES	ANTIARRHYTHMIC USE	
			PR	QRS	QT		SUPRAVENTRICULAR	VENTRICULAR
IA	↓	↑*, ↓	↓*, ↑	↑↑	↑↑	+	Yes	Yes
IB	0	0	0	0	0	+++ [†]	No	Yes
IC	0	↓	↑	↑↑↑	0	+	Yes	Yes
II	↓↓	↓↓	↑↑	0	0	+ [‡] , 0	Yes	Yes
III	↓↓	↓	↑↑	0	↑↑↑	+ [§] , 0	Yes	Yes
IV	↓↓ [¶]	↓↓	↑↑ [¶]	0	0	+ [¶] , 0	Yes	No
Miscellaneous (adenosine)	↓↓ [¶]	↓↓↓	↑↑ [¶]	0	0	0	Yes	No

This table does not include unique qualities of individual drugs that may contrast with the qualities of other drugs within the same class. *ECG changes* refer to an increase or decrease in the respective intervals. The number of *plus signs* or *arrows* indicates the relative magnitude of effect or relative affinity for Na⁺ channels in ischemic tissue; zero indicates no or little effect.

*From antimuscarinic and antivagal effects.

[†]Ischemic tissue is more depolarized and has a higher percentage of inactivated Na⁺ channels. Class IB drugs bind most selectively to inactivated Na⁺ channels.

[‡]Propranolol and esmolol can block Na⁺ channels in depolarized cells.

[§]Amiodarone has more blocking effects on Na⁺ channels than other class III drugs.

[¶]Direct cardiac effect of the drug; does not include reflex effects from vasodilation.

[¶]Verapamil can block Na⁺ channels in the depolarized state, whereas diltiazem has little effect.

TABLE 24-3

Pharmacokinetic Properties of Antiarrhythmic Drugs

DRUG CLASS	DRUG	ELIMINATION HALF-LIFE (hr)	PLASMA PROTEIN BINDING (%)	URINARY EXCRETION (%)
IA	Quinidine	4-10	85	20
	Procainamide	3-4	20	60
	Disopyramide	4-10	20 to 60	50
IB	Lidocaine	1.5-2	65	<2
	Mexiletine	10-12	55	10
IC	Flecainide	12-27	40	25
	Propafenone	6-30	90	<2
	Moricizine	2-4	95	<1
II	Esmolol	0.2	55	<2
	Propranolol	4-6	90	<2
III	Amiodarone	25-100 days	>90	<1
	Bretium	5-10	5	>90
	Sotalol	7-15	0	>90
	Ibutilide	2-12	40	<5
	Dofetilide	8-10	65	80
IV	Verapamil	3-7	90	<5
	Diltiazem	4-8	75	<5
Miscellaneous	Adenosine	<10 sec	0	0

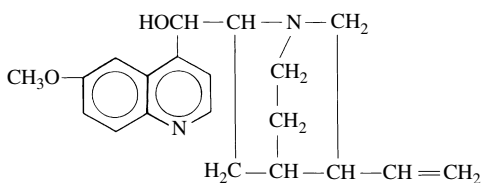

FIGURE 24-9 Structural formula of quinidine.

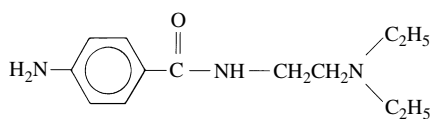

FIGURE 24-10 Structural formula of procainamide.

Procainamide

Procainamide is a drug whose antiarrhythmic mechanism of action resembles that of quinidine. The chemistry of procainamide resembles that of procaine; however, chemically, procainamide differs from procaine by having an amide linkage instead of an ester linkage (Figure 24-10). Although effective against some ventricular and supraventricular arrhythmias, procainamide is now prescribed less often than many other antiarrhythmic drugs because of its adverse effects. It is still used intravenously, however, for acute suppression of ventricular arrhythmias.

Pharmacologic effects

The effects of procainamide on the heart are similar to the effects of quinidine. Automaticity and conduction velocity are decreased, whereas refractoriness is increased. Similar to quinidine, procainamide can be described as a cardiac depressant.

Procainamide exerts much less of an antivagal effect than does quinidine, but ganglionic blockade has been reported.

The most frequently observed change induced by procainamide in the ECG is an increase in the duration of the QRS complex. Lengthening of the QT and PR intervals is also observed. There are few additional effects on the cardiovascular system when procainamide is administered orally. Intravenous infusion causes a decrease in blood pressure because of peripheral vasodilation and myocardial depression and occasionally results in centrally mediated mental confusion and hallucination.

Absorption, fate, and excretion

After oral administration, procainamide is rapidly and essentially completely absorbed, with peak plasma concentrations being reached in approximately 90 minutes. Maximum plasma concentrations occur 15 to 60 minutes after intramuscular administration. Because of its short half-life, procainamide is often given in a slow-release preparation.

The major metabolite of procainamide, N-acetylprocainamide (NAPA), also has antiarrhythmic properties. Normally, approximately 25% of an administered dose of procainamide is acetylated in the liver to yield NAPA, but rapid acetylators or patients with renal disease convert more of the drug to this form. NAPA has a plasma half-life of 6 hours and is eliminated by renal excretion.

Adverse effects

Similar to quinidine, procainamide can promote ventricular tachycardia when used to treat atrial tachyarrhythmias. It can also elicit other ventricular arrhythmias when given in high doses or to susceptible patients. Hypotension is common with rapid intravenous injection.

The most frequent side effects after oral administration are anorexia, nausea, and vomiting. Other, more rarely seen effects are diarrhea, weakness, flushing, a bitter taste, and CNS manifestations such as hallucinations and depression. Allergic reactions have been reported, and cross-sensitivity to

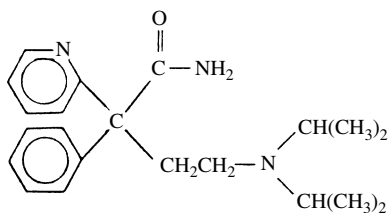

FIGURE 24-11 Structural formula of disopyramide.

procaine and other derivatives of p-aminobenzoic acid should be expected. Allergic reactions associated with procainamide include rashes, fever, chills, neutropenia, and agranulocytosis. The most noteworthy immunologically based reaction is a syndrome similar to systemic lupus erythematosus. Symptoms of lupus occur in 30% of patients receiving long-term oral procainamide therapy (more frequently with slow acetylators) and include arthralgia, fever, and occasionally pleuropericarditis, but not renal involvement. Antinuclear antibodies are present in a high percentage of patients taking procainamide; however, it is widely held that withdrawal of the drug is required only when lupus-like symptoms occur. The syndrome usually disappears after drug withdrawal. NAPA is not associated with a lupus-like reaction.

Disopyramide

Disopyramide (Figure 24-11) has actions similar to those of quinidine and procainamide, although it is structurally unrelated to either agent. Its effectiveness in the treatment of premature extrasystoles and tachycardias of supraventricular and ventricular origin has been established. The drug is only occasionally used today.

Pharmacologic effects

Similar to quinidine, disopyramide decreases the rate of diastolic depolarization (phase 4), particularly in ectopic pacemaker cells; it also decreases the upstroke velocity of the action potential (phase 0) in cardiac fibers and increases the ERP. Disopyramide tends to lessen automaticity and conduction velocity. One difference between disopyramide and other class IA agents is that the PR interval and QRS complex are less affected by disopyramide. Another is that disopyramide is more likely to depress cardiac contractility. Disopyramide also has antimuscarinic effects.

Absorption, fate, and excretion

Disopyramide is almost completely absorbed within several hours after oral administration. Other pharmacokinetic characteristics are listed in Table 24-3.

Adverse effects

The most common side effects of disopyramide are dose-dependent and largely result from its antimuscarinic action. Side effects include urinary retention; dryness of the mouth, nose, throat, or eyes; blurred vision; constipation; nausea; and skin rash. Rarely, acute psychosis, cholestatic jaundice, hypoglycemia, and agranulocytosis have occurred, but these disappear on drug withdrawal. As with other class IA antiarrhythmic drugs, various arrhythmias may develop with overdose. Disopyramide is contraindicated in patients with cardiomyopathy or congestive heart failure because of its relatively pronounced negative inotropic effect.

Lidocaine

Lidocaine has been used as a local anesthetic for more than half a century. In contrast to procaine, it has also long been a

primary drug for arresting and preventing certain ventricular arrhythmias in emergency situations. For additional discussion of its pharmacologic characteristics, see Chapter 16.

Pharmacologic effects

Lidocaine decreases automaticity but is devoid of antimuscarinic activity. Although quinidine affects electrical activity throughout the heart, lidocaine preferentially influences ventricular function. Lidocaine acts by blocking Na⁺ channels, particularly inactivated Na⁺ channels. This effect on Na⁺ channels is rapidly reversed, which restricts its use-dependent blocking effect to patients with rapid heart rates. Because lidocaine has a preferential effect on Na⁺ channels in the inactivated state, it preferentially inhibits automaticity in ischemic tissue where membrane depolarization or an enhanced frequency of excitation occurs, such as in the His-Purkinje system (see Table 24-2). Lidocaine also reduces delayed afterdepolarizations seen with digoxin toxicity. Lidocaine does not slow repolarization, but instead may hasten it. In contrast to the action of quinidine and procainamide, lidocaine tends to shorten the ERP. The drug has little effect on conduction velocity and phase 0.

Lidocaine is usually administered intravenously for the treatment of ventricular ectopic rhythms. Because lidocaine must be administered parenterally, it is largely restricted to emergency situations and hospital settings. Its use is contraindicated in supraventricular arrhythmias because it is largely ineffective against these arrhythmias and excessive ventricular rates may result.

Absorption, fate, and excretion

As an antiarrhythmic, lidocaine is usually given intravenously by injection or infusion. After intravenous administration, the plasma concentration initially decreases rapidly, followed by a slower decline. For this reason, various loading regimens are used to achieve therapeutic plasma concentrations quickly. Lower constant perfusion rates are subsequently used. Administration is monitored by measurement of plasma concentrations, and the patient is closely observed for neurologic side effects. α_1 -Acid glycoprotein and albumin contribute to plasma protein binding. Lidocaine is broken down in the liver to various metabolites, including N-ethylglycine and 2,6-xylidine; 2,6-xylidine is metabolized further to 4-hydroxy-2,6-xylidine and largely excreted in the urine. At least two intermediary metabolites, glycinexylidide and monoethylglycinexylidide, have pharmacologic activity.

Adverse effects

Lidocaine exhibits only minor effects on the autonomic nervous system. Arterial pressure is not depressed by lidocaine as much as it is by quinidine. After acutely high dosages or prolonged infusion, lidocaine may cause convulsions and respiratory depression. (These reactions occur only rarely, however, with the dosages and routes of administration used in dentistry.) Cardiac arrest may occur if lidocaine is administered to a patient with preexisting heart block.

Phenytoin

Phenytoin (diphenylhydantoin) has been used since 1938 for the treatment of grand mal epilepsy and other seizure disorders. Although it has been used as an antiarrhythmic drug (class IB), it is now rarely used for this purpose. For a general discussion of its pharmacologic features, see Chapter 14.

Mexiletine

Mexiletine is a class IB antiarrhythmic drug structurally related to lidocaine (Figure 24-12). The electrophysiologic properties of mexiletine are similar to those of lidocaine. Conduction velocity in the diseased AV node and ventricular

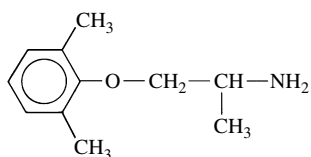

FIGURE 24-12 Structural formula of mexiletine.

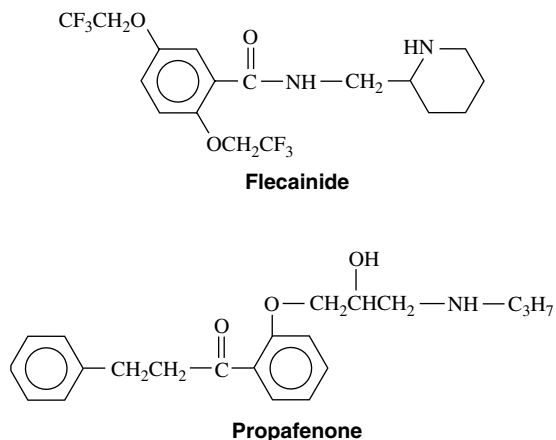

FIGURE 24-13 Structural formulas of flecainide and propafenone.

myocardium is more likely to be slowed than with lidocaine. Mexiletine is used primarily to treat life-threatening ventricular arrhythmias.

Mexiletine is well absorbed after oral administration and is useful by the oral and the intravenous routes. Mexiletine is resistant to first-pass metabolism in the liver, but it does undergo subsequent hepatic metabolism. SA node and AV conduction defects can be worsened by mexiletine, which limits the drug's usefulness in patients with these preexisting problems. Extracardiac adverse reactions include gastrointestinal (nausea, vomiting) and neurologic (tremor, diplopia, dizziness, paresthesias) effects. Hepatitis or agranulocytosis may rarely occur.

Flecainide

A third category of type I antiarrhythmics (class IC) is represented by drugs that are newer to clinical use than the drugs in classes IA and IB. Flecainide (Figure 24-13) belongs to this class (see Table 24-1). Flecainide is indicated for the treatment of disabling supraventricular arrhythmias and sustained life-threatening ventricular arrhythmias unresponsive to other medications.

Pharmacologic effects

Although possessing some similarity to lidocaine, flecainide and related class IC drugs significantly depress conduction velocity by strongly reducing Na^+ conductance during phase 0 of the action potential. This effect is felt throughout the heart but is especially strong in the atrium and His-Purkinje system. It results from the slow association of drug with, and dissociation from, Na^+ channels, especially channels in the open configuration. Recovery from Na^+ channel blockade is protracted.

Flecainide does not selectively reduce phase 0 in diseased tissues. Rather, it inhibits phase 0 more or less uniformly in diseased and healthy tissues and tends to be effective on

reentry mechanisms. Flecainide increases the ERP in atrial and ventricular muscle and widens the QRS complex (as does quinidine). Flecainide also reduces conduction velocity in the AV node but to a lesser degree than in ventricular muscle (see Figure 24-8 and Table 24-2).

Absorption, fate, and excretion

Flecainide is not significantly metabolized on its first pass through the liver and has good bioavailability after oral administration. Approximately 75% of a flecainide dose is eventually metabolized to inactive products. The large range in reported half-lives for the drug stems partly from genetically determined variations in the rate of hepatic metabolism by cytochrome CYP2D6. As discussed in Chapter 4, some individuals lack this enzyme. The resulting potential differences in patient response necessitate careful monitoring of drug effects.

Adverse effects

CNS toxicity is the most common adverse effect. Dizziness, blurred vision, tremor, paresthesia, and headache may occur. Nausea and a metallic taste have been reported for flecainide. The results of the Cardiac Arrhythmia Suppression Trial⁴ indicated that flecainide administration to patients with recent myocardial infarction increased the mortality rate in such patients twofold to threefold compared with placebo-treated patients. An arrhythmogenic effect of these drugs is suspected despite the fact that they suppressed premature ventricular depolarizations in these patients.⁴ The results of the trial have led to cautions concerning the use of flecainide and its use after myocardial infarction. Similar concern exists for the other class IC drugs.

Propafenone

Propafenone is classified as a class IC antiarrhythmic because of its strong tendency to depress the maximum rate of depolarization and conduction velocity. The drug is indicated for life-threatening ventricular arrhythmias and is prescribed for atrial fibrillation and other types of supraventricular arrhythmias. The structure of propafenone is depicted in Figure 24-13.

Pharmacologic effects

Propafenone exerts several actions on the heart. In addition to blocking Na^+ channels, it blocks Ca^{++} channels and exerts β -adrenergic receptor-blocking effects (see Table 24-1). The drug reduces the slope of phase 0, prolongs the PR and QRS intervals, and suppresses ectopic pacemakers (see Table 24-2). Negative inotropic effects are possible but usually occur only with high doses.

Absorption, fate, and excretion

Propafenone is well absorbed orally, but approximately 80% of a given dose is destroyed in the first pass through the liver. The same genetic predisposition for efficient or slow metabolism (by CYP2D6) of the drug exists as for flecainide, and the half-life may be prolonged in patients who are slow metabolizers. At least one major metabolite is pharmacologically active.

Adverse effects

Adverse effects include dizziness, blurred vision, dysgeusia, and gastrointestinal symptoms. CNS toxicity seems to be more likely with slow metabolizers. Asthma may be exacerbated in susceptible individuals. Untoward cardiac signs include SA nodal dysfunction, AV nodal block, and worsening of heart failure. The arrhythmogenic potential of the drug must be considered in light of the problems documented for other class IC agents. Competition for metabolism by CYP2D6 is the basis for interactions involving propafenone and other

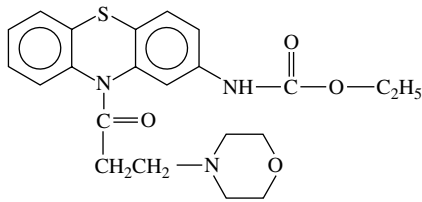

FIGURE 24-14 Structural formula of moricizine.

drugs. Propafenone may increase the anticoagulant effect of warfarin given concurrently.

Moricizine

Moricizine resembles most closely the class IC antiarrhythmics. It is sometimes classified in its own unique category, however. The structure of moricizine is shown in Figure 24-14. It is used in the treatment of life-threatening ventricular arrhythmias.

Moricizine reduces automaticity by altering the threshold voltage. It is effective against ectopic foci without producing significant negative inotropism. It also is effective in reducing afterdepolarizations. These actions bear resemblance to lidocaine. The slope of phase 0 is reduced, with an increase in the PR and QRS intervals reminiscent of quinidine. AV nodal reentry is inhibited. Despite the fact that moricizine is a phenothiazine, it has little psychotropic effect.

Moricizine is well absorbed orally; however, 60% to 70% of the drug is metabolized in the liver before it reaches the systemic circulation. The drug yields multiple metabolites; one is known to have pharmacologic activity. Dizziness, headache, nausea, and vomiting are common side effects of therapy. SA nodal depression, AV nodal block, and other arrhythmogenic effects occur in approximately 4% of patients being treated for ventricular arrhythmias.

β-Adrenergic Receptor–Blocking Drugs

Since the introduction of propranolol in 1968 for clinical use in the United States, a number of β-adrenergic receptor–blocking agents have been approved. (The β-adrenergic antagonists are discussed in Chapters 7, 26, and 28.) Three β-adrenergic blockers—propranolol, metoprolol, and esmolol—are the primary class II antiarrhythmic drugs (see Table 24-1). Sotalol, a fourth drug with ability to block the β-adrenergic receptor, is discussed under class III drugs. Propranolol is reviewed here as the prototypic agent; special features of the other β blockers are also noted.

Pharmacologic effects

Propranolol, the prototypic type II antiarrhythmic, has two types of effects on the heart: indirect effects as a consequence of blockade of β-adrenergic receptors and “membrane-stabilizing” effects similar to those of quinidine. Propranolol decreases automaticity and conduction velocity and increases refractoriness. The drug’s greatest effects are on SA nodal automaticity, AV node refractoriness, and (if it exists) His-Purkinje automaticity (see Figure 24-8 and Table 24-2).

Activation of the sympathetic nervous system leading to β receptor stimulation enhances automaticity by increasing the slope of phase 4 depolarization, speeds conduction velocity, and shortens the ERP (especially in the AV node). By blocking β receptors, propranolol can produce opposite effects proportional to the sympathetic input to the heart at the time of administration. In addition to decreasing automaticity in the SA node (and decreasing the heart rate), propranolol variably reduces automaticity and conduction velocity in the atria,

AV node, His-Purkinje system, and ventricles. Increased refractoriness in the AV node is an especially important manifestation of blockade. The direct actions of propranolol include decreasing the slope of phase 0 and phase 4 depolarization and prolonging the ERP. The β-adrenergic blockers, with the exception of sotalol, do not appreciably affect repolarization.

The major antiarrhythmic indication for propranolol is in the management of supraventricular tachyarrhythmias in which protection of the ventricles (by interfering with AV transmission) is the major clinical objective. Propranolol is also useful in suppressing paroxysmal supraventricular tachycardia and in treating afterdepolarizations and other ventricular arrhythmias in which catecholamine stimulation is involved. Most ventricular arrhythmias respond only to very large doses, however. Because propranolol reduces the ratio of oxygen demand to oxygen supply, arrhythmias caused by myocardial ischemia may also be relieved. Although propranolol is effective in treating cardiac glycoside–induced arrhythmias, phenytoin and lidocaine are more useful, especially if AV conduction is impaired, because propranolol tends to exacerbate the AV block induced by digitalis. β Blockers have been shown to reduce the incidence of heart attack and death in patients with previous myocardial infarction. The mechanism is not established, but it may relate to an antiarrhythmic mechanism.

Absorption, fate, and excretion

Propranolol is readily absorbed after oral administration, but more than two thirds of the drug is destroyed in its first pass through the liver. Peak plasma concentrations are reached in 1 to 2 hours. The rate of metabolism of propranolol, which involves CYP2D6, varies considerably among individuals, so plasma titers may differ markedly with long-term therapy. Propranolol is metabolized by hydroxylation, deamination, and glucuronide conjugation.

Adverse effects

The important adverse effects of propranolol can be explained by its antagonism of β-adrenergic receptors. Heart rate and myocardial contractility are reduced, at least initially, during therapy. Congestive heart failure and AV block are the major severe cardiac side effects; however, after large doses, severe bradycardia or asystole may occur. Sudden withdrawal of the drug in patients prone to angina pectoris may lead to anginal attacks or myocardial infarction. Bronchoconstriction is a predictable side effect and may be significant in susceptible individuals, such as asthmatics. Propranolol inhibits the glycogenolytic and lipolytic actions of endogenous catecholamines released in response to hypoglycemia and complicates therapy of diabetic patients.

β₁-Selective blockers

Acebutolol differs from propranolol in that it is selective for the β₁-adrenergic receptor (cardioselective). Its pharmacologic features are reviewed in Chapter 7. Esmolol is a very short-acting selective β₁-adrenergic receptor blocker that is metabolized by plasma esterases. It is used intravenously for short-term β-adrenergic receptor blockade. The adverse effects of these drugs resemble the adverse effects of propranolol. Despite their selectivity for β₁-adrenergic receptors, metoprolol and esmolol and other β blockers should be avoided if possible in asthmatic patients.

Sotalol

Sotalol, a β-adrenergic–blocking drug, also has properties of and is classified as a class III drug. It increases the ERP in addition to its β-adrenergic–blocking activity. The relative

importance of its β -blocking properties and its class III antiarrhythmic effects has yet to be determined. Sotalol is well absorbed when taken orally, with a bioavailability of nearly 100%. Sotalol is useful in supraventricular arrhythmias such as atrial fibrillation¹² and in certain cases of ventricular tachycardia. It has been shown to be effective in preventing recurrences of ventricular tachyarrhythmias.

Bretylium

Bretylium tosylate is classified as a class III antiarrhythmic because it increases the ERP and delays repolarization without having much effect on conduction velocity. The mechanism involves blockade of K^+ conductance, delaying phase 3 of the action potential. Bretylium was originally developed in the 1950s as an antihypertensive drug but was approved in the United States in 1978 for the treatment of ventricular arrhythmias. The drug has a complex pharmacologic profile, some aspects of which are still incompletely understood.

Pharmacologic effects

Bretylium interferes with sympathetic control of the heart and exerts direct influences on cardiac function. Bretylium is classified as an adrenergic neuron blocker because it produces a prolonged inhibition of norepinephrine release from sympathetic nerve endings. Bretylium also initially stimulates norepinephrine efflux and tends to exert an imipramine-like block of the neuronal uptake of catecholamines. Together, these influences on sympathetic function make the drug's effect in any particular patient difficult to predict, especially in the initial phase of therapy.

The effect of bretylium on supraventricular tissues is largely indirect. After an initial catecholamine release, it decreases sympathetic influences, reducing automaticity in the SA node (see Table 24-1). ERP in the AV node is also increased after the initial stimulation. Although atrial arrhythmias are often not responsive to the drug, the fact that bretylium significantly increases the ERP in the His-Purkinje system and ventricular myocardium supports the finding that the drug is useful in treating ventricular tachyarrhythmias, including its previous use as an adjunct in treating ventricular fibrillation. A reduction in the differences between refractory periods and APDs in diseased and normal ventricular myocardium by the drug contributes further to a lessened likelihood of reentrant arrhythmias.

Absorption, fate, and excretion

Bretylium can be administered orally, intramuscularly, or intravenously. It is, however, unpredictably absorbed from the gastrointestinal tract, as would be expected from its quaternary ammonium structure.

Adverse effects

The side effects of bretylium in most cases can be explained by its adrenergic-blocking actions. Because of its tendency to produce hypotension (to which tolerance may develop), bretylium is reserved for use in ventricular tachyarrhythmias that are not responsive to other therapeutic measures. Nausea and vomiting may occur even with intravenous use, especially when injected rapidly. Parotid gland pain and swelling may occur in 25% of patients receiving long-term oral therapy, but apparently it does not occur with parenteral use. The initial release of catecholamines induced by bretylium may be associated with hypertension or arrhythmias. Other adverse reactions include diplopia, facial flushing, weakness, and nasal congestion. The actions of bretylium on the adrenergic nerve terminals can be blocked by tricyclic antidepressants, which prevent bretylium from gaining access to the nerve terminal.

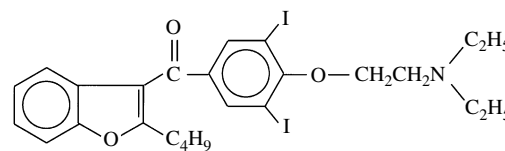

FIGURE 24-15 Structural formula of amiodarone.

Amiodarone

Amiodarone, a benzofuran derivative resembling thyroid hormone (Figure 24-15), was originally introduced in Europe as a coronary vasodilator for the treatment of angina pectoris. It is now widely used for various acute and chronic arrhythmias.

Pharmacologic effects

Amiodarone's major action is to increase the ERP by slowing the rate of repolarization. Blockade of K^+ channels is involved (see Table 24-1). Repolarization is slowed in the His-Purkinje system and in ventricular and atrial myocardium (see Figure 24-8). Although K^+ channel blockade is a major mechanism of action, amiodarone is not as likely to cause torsades de pointes as are drugs whose mechanism of action is largely limited to blocking K^+ channels ("pure" K_r channel blockers). In addition to blocking K^+ channels, amiodarone blocks Na^+ and Ca^{++} channels. Inhibition of these latter channels probably prevents much of the inward depolarizing current that can trigger early afterdepolarizations and torsades de pointes.

Amiodarone decreases automaticity in the SA node and in ectopic pacemakers, but has little effect on automaticity elsewhere in the heart. Conduction velocity is slowed in the AV node by Na^+ and Ca^{++} channel blockade (see Table 24-1), and the ERP in the AV node is lengthened. Conduction velocity in the His-Purkinje system and ventricular muscle is also slowed. The ventricular fibrillation threshold is increased.

Amiodarone has an active metabolite, desethylamiodarone, that contributes to the antiarrhythmic effect. Desethylamiodarone binds to thyroid hormone receptors, inhibiting thyroid hormone-induced gene expression.³ Of the genes normally induced by thyroid hormone, several support the synthesis of certain K^+ channels. This finding is consistent with the fact that amiodarone's effects on K^+ channels are generally delayed compared with its effects on Na^+ and Ca^{++} channels. Long-term therapy with amiodarone is more likely to generate a class III antiarrhythmic effect (K^+ channel block), largely because of reduction in the number of K_r channels. Short-term therapy is more likely to limit effects to Na^+ channels, Ca^{++} channels, and β -adrenergic receptors. The resulting cardiac effects seem to be different from the effects of long-term therapy and avoid many of the adverse effects seen with long-term administration, such as pulmonary fibrosis and hypothyroidism. Amiodarone is a vasodilator, noncompetitively inhibiting the vascular effect of catecholamines.⁹ The cardiac effects of catecholamines are likewise inhibited, and coronary arterial resistance is decreased, resulting in increased coronary blood flow.

Amiodarone is used for various arrhythmias, including ventricular extrasystoles, tachycardia, and fibrillation. It is also efficacious in some atrial arrhythmias, including atrial fibrillation and flutter, in which it may have unique effects on the adverse remodeling changes in the atria, which are thought to be partly responsible for the genesis of atrial fibrillation.^{5,11}

Absorption, fate, and excretion

When administered orally, amiodarone's bioavailability is low (20% to 50%). Amiodarone is also administered intravenously.

A highly lipophilic drug, amiodarone is sequestered in tissues, yielding a volume of distribution of approximately 60 L/kg. It is highly bound to protein in plasma. Because the drug would normally take weeks to reach a steady-state concentration after the initiation of therapy, loading doses are routinely used. Amiodarone is extensively metabolized by the liver; a desethyl derivative, which has antiarrhythmic properties as indicated previously, has been identified. When the drug is withdrawn, the tissue concentrations decrease only gradually as the drug is eliminated. Plasma determinations of amiodarone may not reflect tissue concentrations.

Adverse effects

Sinus arrest may occur if amiodarone is given with β -adrenergic-blocking drugs or other antiarrhythmics, and AV nodal conduction abnormalities may be exacerbated. Because amiodarone has negative inotropic properties, its use may be associated with a decrease in cardiac function. Some preexisting arrhythmias may be worsened by the drug.

Noncardiac adverse reactions are common and occasionally life-threatening. The primary concerns are pulmonary fibrosis and pneumonitis, which may become clinically evident in a significant percentage of patients with long-term use and can be lethal. Amiodarone also commonly causes CNS disturbances (ataxia, dizziness), photosensitivity, and hepatic dysfunction as indicated by an increase of liver enzymes in the blood. The skin may take on a blue-gray hue. Corneal microdeposits occur routinely but usually do not interfere with vision and disappear after withdrawal of the drug. Changes in thyroid function (hyperthyroidism and especially hypothyroidism) have been reported, and these may be related to the aforementioned facts that amiodarone resembles thyroid hormone and influences thyroid hormone actions. Amiodarone can reduce the action of thyroid hormone by binding to the thyroid hormone receptor and blocking its cellular effects. It has also been shown that amiodarone can inhibit the action of thyroid-stimulating hormone, which could also contribute to a hypothyroid effect by amiodarone.⁹ Finally, this drug inhibits the conversion of thyroxine to triiodothyronine in peripheral tissues and causes the buildup of reverse triiodothyronine (see Chapter 34).

Ibutilide and Dofetilide

Ibutilide is classified as a class III drug because it delays repolarization. It blocks Kr channels but, more important, causes the opening of Ca^{++} channels, which promote Na^+ influx through slow channels, extending phase 2 of the action potential.⁶ The drug is administered intravenously for atrial fibrillation and atrial flutter. It can be used to convert these arrhythmias rapidly to normal sinus rhythm. Torsades de pointes is an adverse effect.

Dofetilide is a "pure" class III drug, blocking the Kr channel selectively. It is used for acute conversion of atrial fibrillation and atrial flutter and for short-term maintenance.⁸ Dofetilide is available for intravenous and oral use. Predictably, a characteristic adverse effect is torsades de pointes in response to the prolonged QT interval that is induced by the drug. The structures for ibutilide and dofetilide are shown in Figure 24-16.

Ca^{++} Channel Blockers

Ca^{++} channel blockers, represented by verapamil, diltiazem, and nifedipine, are used for the treatment of certain cardiovascular diseases. Verapamil and diltiazem are prescribed primarily for their antianginal (see Chapter 26) and antiarrhythmic effects. Nifedipine, which has a greater effect on vascular smooth muscle, is a major antihypertensive drug (see Chapter 28). It is not used as an antiarrhythmic drug. In each case, the drugs are selective for potential-dependent Ca^{++} channels

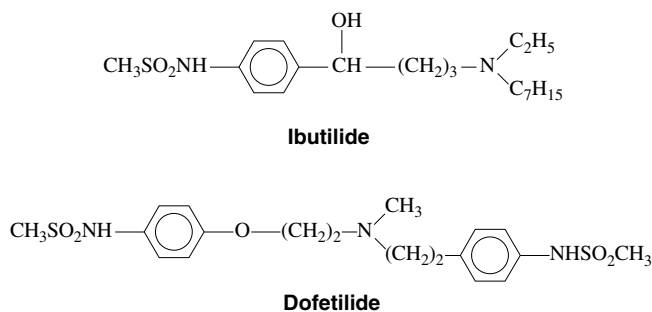

FIGURE 24-16 Structural formulas of ibutilide and dofetilide.

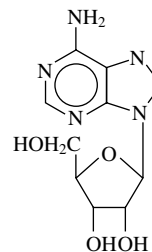

FIGURE 24-17 Structural formula of adenosine.

rather than receptor-operated channels. The potential-dependent Ca^{++} channels are of at least three types: L, N, and T. These channels are distinguished by their electrical properties and anatomic location. The L (long-lasting) channels are selectively inhibited by these drugs. The fact that they are the predominant Ca^{++} channels in the heart and vascular smooth muscle is consistent with the major effects of Ca^{++} channel blockers on these organs. The N (neuronal) and T (transient) channels are not affected by these channel blockers to a major degree, although the T-type channels play a role in phase 2 of action potentials in the heart (see Figure 24-3).

By interfering with the slow inward current in pacemaker cells, these drugs depress the rate of phase 4 depolarization; automaticity in the SA node and the AV node is decreased. The major direct cardiac effect is to reduce conduction velocity and to increase the refractory period of the AV node (see Figure 24-8).¹ Verapamil and diltiazem are useful in treating supraventricular arrhythmias and have been used successfully in terminating attacks of paroxysmal atrial tachycardia unresponsive to vagal stimulation. Verapamil and diltiazem have a negative inotropic effect. This effect is rarely seen with nifedipine because it is a more potent peripheral vasodilator, and reflex cardiac effects tend to overcome any direct actions it has on the heart. Other aspects of the pharmacologic features of the Ca^{++} channel blockers are discussed in Chapters 26 and 28.

Adenosine

The endogenous purine nucleoside adenosine is approved for terminating attacks of paroxysmal supraventricular tachycardia. It does not match the profile of any other antiarrhythmic. The structure of adenosine is shown in Figure 24-17.

Pharmacologic effects

Adenosine stimulates the A_1 adenosine receptor in the heart. This receptor is linked to the G protein G_i , which, when activated, increases K^+ conductance and decreases Ca^{++} channel activity, leading to hyperpolarization.¹ Adenosine also may reduce the release of norepinephrine from nerve endings. The net effect on the heart is to reduce automaticity in the SA node and Purkinje fibers and reduce the AV nodal conduc-

tion rate (see Figure 24-8 and Table 24-2). The drug is useful for short-term treatment of supraventricular tachycardia involving reentry with rapid ventricular rate. Adenosine also dilates coronary vessels and reduces contractility. Selective adenosine receptor agonists offer promise for future drug development.⁵

Adverse effects

Adenosine must be injected intravenously as a bolus because of its extremely short plasma half-life. Adenosine is rapidly transported into tissues, followed by incorporation into purine biosynthetic pathways. Many patients have transient flushing and dyspnea with the drug. Arrhythmias, including heart block and cardiac arrest, may also occur immediately after injection. Because of the drug's rapid uptake, however, therapeutic and adverse responses are normally short-lived.

Digoxin

Digoxin is used in treating certain supraventricular arrhythmias. Its use is discussed in Chapter 24.

Magnesium

Magnesium sulfate is used intravenously to overcome drug-induced torsades de pointes. It may be effective even in the absence of hypomagnesemia.²

Indications for Antiarrhythmic Drugs

Table 24-4 presents the general indications of the various agents discussed in this chapter in treating some of the most commonly encountered arrhythmias. It is not intended to be a comprehensive listing of applications of these drugs. Drugs administered orally are largely used to prevent the recurrence of arrhythmias, whereas drugs administered parenterally are usually given to treat acute disorders.²

Drug Interactions

Antiarrhythmic drugs can participate in a wide variety of drug interactions. Because the margin of safety with these drugs as a group is narrow, clinically significant interactions may develop whenever the activity or plasma concentration of an antiarrhythmic agent is changed. The following discussion

provides an illustrative but not exhaustive list of interactions involving these drugs.

Quinidine may interact with the following drugs to yield the indicated result: with other class I antiarrhythmics and with phenothiazines, additive cardiac effects (quinidine also increases the plasma concentrations of flecainide and propafenone); with digoxin and other digitalis glycosides, increased plasma concentrations of the cardiac glycoside; with rifampin and other hepatic enzyme inducers, decreased plasma quinidine concentrations; with cimetidine and other hepatic enzyme inhibitors, increased quinidine concentrations; with oral anticoagulants, increased likelihood of hemorrhage; with neuromuscular blocking drugs, increased neuromuscular blockade; with systemic antacids that increase urinary pH, reduced urinary excretion of quinidine; and with vasodilators (e.g., nitroglycerin), hypotension. Many of these interactions result from the ability of quinidine to inhibit the activity of CYP2D6.

Quinidine, procainamide, and disopyramide all have antimuscarinic (or antivagal) properties and have additive effects with other antimuscarinic drugs. Drugs that slow AV conduction, such as the β -adrenergic-blocking drugs and amiodarone, can exaggerate the AV conduction effects of drugs with similar actions, possibly leading to bradycardia and heart block. Drugs that have negative inotropic effects (e.g., class IA drugs, Ca^{++} channel blockers, and β blockers) may precipitate heart failure, especially in the presence of other negative inotropic agents. Propranolol and related drugs prevent the tachycardia that normally results from hypoglycemic drugs.

The metabolism of flecainide and propafenone is catalyzed by CYP2D6 in the liver. Drugs that share this same pathway of metabolism increase each other's elimination half-life. Cimetidine and erythromycin can increase the plasma concentrations of flecainide and propafenone. Propranolol and cimetidine reduce lidocaine clearance, whereas induction of hepatic microsomal enzymes by phenobarbital increases it.

Amiodarone increases the effect of warfarin and the concentrations of quinidine, procainamide, and flecainide.¹⁶ There may be more than one mechanism accounting for these interactions. In addition to its effects on metabolism, amiodarone may reduce renal clearance of these drugs by inhibiting the transport

TABLE 24-4

Indications for Representative Antiarrhythmic Drugs

DRUG	INDICATIONS*	
	SUPRAVENTRICULAR	VENTRICULAR
Adenosine	PSVT	
Amiodarone	AF/F, PAC, PSVT	Acute VA, VF, PVTNQ
β Blockers	PSVT, AF/F	PVTNQ
Bretylum		VF
Dofetilide	AF/F	
Flecainide	PAF (prevention), PSVT	VA (prevention of life-threatening)
Ibutilide	AF/F	
Lidocaine		Acute VA, DVA, PVTNQ
Magnesium sulfate		PVTNQ
Procainamide	AF/F	PVTNQ, VA (life-threatening)
Propafenone	AF/F	VT (sustained and life-threatening)
Quinidine	PSVT, AF/F	
Verapamil	AF/F, PSVT (prevention)	

*The suitability of drug versus nondrug therapy for these indications often depends on circumstances. Drug therapy is usually more effective in treating atrial fibrillation of recent origin than if it is long-standing. Maintenance therapy for atrial fibrillation often differs from strategies for converting atrial fibrillation to normal sinus rhythm.

AF/F, Atrial flutter/fibrillation; DVA, digitalis-induced ventricular arrhythmias; PAC, premature atrial contractions; PAF, paroxysmal atrial fibrillation/flutter; PSVT, paroxysmal supraventricular tachycardia; PVTNQ, polymorphic ventricular tachycardia with long QT interval; PVTNQ, polymorphic ventricular tachycardia with normal QT interval; VA, ventricular arrhythmias; VF, prevention of ventricular fibrillation; VT, ventricular tachycardia.

function of P-glycoprotein in the kidney.¹⁶ Verapamil, propafenone, amiodarone, and flecainide (and quinidine) have been reported to increase plasma digoxin concentrations. These interactions may also involve the P-glycoprotein.

IMPLICATIONS FOR DENTISTRY

Patients who are being treated on a long-term basis with antiarrhythmic drugs, if under adequate control, are usually not a management problem for the dentist. Because some antiarrhythmic agents may depress cardiovascular function, the potential for an increased incidence of orthostatic hypotension and hypotensive syncope exists. There is also a greater probability that arrhythmias will develop in a patient with a previous history of arrhythmias who is undergoing stressful treatment. The dentist may wish to consult with the patient's cardiologist regarding the use of epinephrine or other adrenergic vasoconstrictors in patients with a significant arrhythmia history.

As described in Chapter 7, the combination of epinephrine and propranolol may lead to hypertensive reactions. Quinidine, disopyramide, and procainamide, because of their antimuscarinic (or antivagal) activity, interact additively with antimuscarinic antisialagogues. This combination can result in enhancement of antimuscarinic side effects. Quinidine blockade of dealkylation reactions by CYP2D6 may limit the effectiveness of certain oral opioid analgesics, especially codeine, that are converted in the liver to highly active metabolites (e.g., codeine metabolized to morphine). Amiodarone and propafenone also inhibit CYP2D6, which could be the basis for a reduction in analgesic effect of codeine. No interactions with these two drugs and codeine have been reported, however. The additive effect of lidocaine when used as an antiarrhythmic with all local anesthetics is of special importance to the dentist.

The dentist should be aware of the manifestations of adverse drug reactions that occur in the oral cavity. Quinidine has been associated with thrombocytopenia in a few cases. This reaction may lead to oral hemorrhaging and petechiae. Blockade of β -adrenergic receptors is associated with a change in the profile of salivary proteins. The implications of this effect on oral health have not been fully determined. Table 24-5 lists some adverse effects of representative antiarrhythmic drugs.

TABLE 24-5

Unique and Typical Adverse Effects of Representative Antiarrhythmic Drugs

DRUG	ADVERSE EFFECT(S)
Adenosine	Flushing, asthma, dyspnea, SA nodal arrest, AV nodal block
Amiodarone	Pulmonary fibrosis, thyroid abnormalities, skin discoloration, corneal deposits, peripheral neuropathy
Calcium channel blockers	Flushing, AV nodal conduction defects, reduced contractility of the heart, bradycardia
Flecainide	Cardiac risk with recent myocardial infarction
Lidocaine	Convulsions
Procainamide	Mental changes, torsades de pointes, lupus
Propranolol	AV nodal conduction defects, bronchoconstriction in asthmatics, bradycardia
Quinidine	Cinchonism, hypotension, torsades de pointes

AV, Atrioventricular; SA, sinoatrial.

ANTIARRHYTHMIC DRUGS

<i>Nonproprietary (generic) name</i>	<i>Proprietary (trade) name</i>
Adenosine	Adenocard
Amiodarone	Cordarone
Acebutolol	Sectrol
Bretylum	Bretylol
Diltiazem	Cardizem
Disopyramide	Norpace
Dofetilide	Tikosyn
Esmolol	Brevibloc
Flecainide	Tambocor
Ibutilide	Corvert
Lidocaine	Xylocaine
Magnesium sulfate	—
Mexiletine	Mexitil
Moricizine	Ethmozine
Procainamide	Pronestyl, Procanbid
Propafenone	Rythmol
Propranolol	Inderal
Quinidine*	Cardioquin, Quinaglute, Quinidex Extentabs
Sotalol	Betapace
Verapamil	Calan, Isoptin

*Several different salts are available for oral and parenteral administration.

CITED REFERENCES

- Bigger JT, Breithardt G, Brown AM, et al: The Sicilian gambit: a new approach to the classification of antiarrhythmic drugs based on their actions on arrhythmogenic mechanisms. Task Force of the Working Group on Arrhythmias of the European Society of Cardiology, *Circulation* 84:1831-1851, 1991.
- Drugs for cardiac arrhythmias, Treatment guidelines, *Med Lett Drugs Ther* 5:51-58, 2007.
- Drvota V, Blange I, Häggblad J, et al: Desethylamiodarone prolongation of cardiac repolarization is dependent on gene expression: a novel antiarrhythmic mechanism, *J Cardiovasc Pharmacol* 32:654-661, 1998.
- Echt DS, Liebson PR, Mitchell LB, et al: CAST investigators: Mortality and morbidity in patients receiving encainide, flecainide, or placebo. The cardiac arrhythmia suppression trial, *N Engl J Med* 324:781-788, 1991.
- Goldstein RN, Stambler BS: New antiarrhythmic drugs for prevention of atrial fibrillation. *Prog Cardiovasc Dis*, 48:193-208, 2005.
- Lee KS, Lee EW: Ionic mechanism of ibutilide in human atrium: evidence for a drug-induced Na^+ current through a nifedipine inhibited inward channel, *J Pharmacol Exp Ther* 286:9-22, 1998.
- Lombardi F, Terranova P: Pharmacological treatment of atrial fibrillation: mechanisms of action and efficacy of class III drugs, *Curr Med Chem* 13:1635-1653, 2006.
- McClellan KJ, Markham A: Dofetilide: a review of its use in atrial fibrillation and atrial flutter, *Drugs* 58:1043-1059, 1999.
- Pitsiavas V, Smerdely P, Boyages SC: Amiodarone compared with iodine exhibits a potent and persistent inhibitory effect on TSH-stimulated cAMP production in vitro: a possible mechanism to explain amiodarone-induced hypothyroidism, *Eur J Endocrinol* 140:241-249, 1999.
- Roden DM: Drug-induced prolongation of the QT interval, *N Engl J Med* 350:1013-1022, 2004.
- Shinagawa K, Shiroshita-Takeshita A, Schram G, et al: Effects of antiarrhythmic drugs on fibrillation in the remodeled atrium: insights into the mechanism of the superior efficacy of amiodarone, *Circulation* 107:1440-1446, 2003.
- Singh BN, Singh, SN, Reda DJ, et al: for the Sotalol Amiodarone Atrial Fibrillation Efficacy Trial (SAFE-T) investigators: Amioda-

- rone versus sotalol for atrial fibrillation, *N Engl J Med* 352:1861-1872, 2005.
13. Tomargo J, Caballero R, Gómez R, et al: Pharmacology of cardiac potassium channels, *Cardiovasc Res* 62:9-33, 2004.
 14. Vaughan EM, Williams DM: Classification of antidysrhythmic drugs, *Pharmacol Ther [B]* 1:115-138, 1975.
 15. Wenckebach KF, Winterberg H, editors: *Die unregelmässige Herz-tätigkeit*, Leipzig, 1927, W Engelmann.
 16. Yamreudeewong W, DeBisschop M, Martin LG, et al: Potentially significant drug interactions of class III antiarrhythmic drugs, *Drug Saf* 26:421-438, 2003.

GENERAL REFERENCES

- Darbar D, Roden DM: Future of antiarrhythmic drugs, *Curr Opin Cardiol* 21:361-367, 2006
- Fogoros RN: *Antiarrhythmic drugs: a practical guide*, ed 2, Malden, Mass, 2007, Blackwell.
- Kass RS, Clancy CE, editors: Basis and treatment of cardiac arrhythmias. In *Handbook of experimental pharmacology*, Berlin, 2006, Springer.

Drugs Used in Treating Heart Failure

FRANK J. DOWD

Heart failure is characterized by a decreased ability of the heart to pump blood in adequate amounts. In addition to changes in the heart, multiple adaptive mechanisms occur, which provide targets for drug therapy. The severity of heart failure is often rated according to the New York Heart Association (NYHA) classification, ranging from class I, in which signs of heart failure occur only at higher exercise levels, to class IV, in which signs of heart failure occur at rest. In addition to drug therapy, other strategies for treating heart failure include auxiliary mechanical pumps (ventricular assist devices)⁴ and ventricular pacing (resynchronization).

CARDIAC MUSCLE CONTRACTION AND HEART FAILURE

In addition to its role in the action potential, Ca^{++} is intimately involved in the contractile process. The contraction of cardiac muscle is initiated by extracellular Ca^{++} entering the cell with the slow inward current. The immediate source of contractile Ca^{++} in the heart comes largely from intracellular stores, however. Ca^{++} entering the cell during an action potential must first traverse the plasma membrane through voltage-sensitive Ca^{++} channels. This influx of Ca^{++} during the slow inward current triggers the release of much larger amounts of intracellular Ca^{++} from the sarcoplasmic reticulum (SR). The sudden increase in cytoplasmic Ca^{++} stimulates contraction.

Tropomyosin and troponin, which are associated with actin, regulate the interaction between actin and myosin. The binding of Ca^{++} to troponin C initiates a series of conformational changes in troponin and tropomyosin that alter the interaction of tropomyosin and troponin I with actin, favoring the coupling of actin with myosin. Adenosine triphosphate (ATP) is hydrolyzed by myosin-bound adenosine triphosphatase (ATPase) when the actomyosin complex is formed, and chemical energy is converted into mechanical work. The contraction cycle is completed by the active reuptake of Ca^{++} by the SR (and mitochondria) and extrusion from the cell by $\text{Na}^{+}\text{-Ca}^{++}$ exchange.

Drugs such as the β -adrenergic receptor agonists increase cardiac contractility by increasing intracellular cyclic 3',5'-adenosine monophosphate (cAMP), which enhances Ca^{++} influx and accelerates uptake of Ca^{++} by the SR, ultimately making more Ca^{++} available for contraction.¹² The latter effect results from the phosphorylation of phospholamban, a protein associated with the Ca^{++} pump of the SR. The effect of Ca^{++} on troponin may also be enhanced by cAMP.

In heart failure, the heart is unable to maintain the requisite cardiac output. The mechanics underlying this failure

are incompletely understood. The ability of the SR to participate in the trafficking of Ca^{++} seems to be hindered.²¹ The $\text{Na}^{+}\text{-Ca}^{++}$ exchange sites seem to be increased in heart failure, leading to a decrease in intracellular Ca^{++} . There are likely to be multiple biochemical defects in heart failure, however.

According to Starling's law of the heart, cardiac output, or, more precisely, the ventricular stroke volume, increases as ventricular filling pressure increases. Stated simply, the heart pumps whatever is supplied to it by way of venous return, maintaining a near-optimal heart size. As ventricular end-diastolic pressure increases, ventricular stroke work and stroke volume increase. Normal heart function is within well-defined limits and is described by a single curve (Figure 25-1).

When cardiac contractility is reduced in heart failure, three mechanisms are available by which the heart can compensate for the defect: (1) an increase in ventricular end-diastolic pressure, which enhances cardiac output (Frank-Starling preload mechanism); (2) an increase in number of contractile units (hypertrophy); and (3) use of chronotropic and inotropic reserves of the heart through reflex mechanisms (sympathetic activity). If these mechanisms are sufficient to produce normal cardiac output, the heart failure is said to be compensated. In this condition, a new ventricular function curve is generated (see Figure 25-1). For any given ventricular end-diastolic pressure, however, ventricular stroke work, stroke volume, and cardiac output are lower in the failing heart than in the normal heart. Consequently, the heart enlarges to maintain cardiac output, and heart rate increases to help compensate for poor cardiac function.

If the ventricular end-diastolic pressure becomes too elevated (i.e., the heart is working to the far right along the Frank-Starling curve), venous pressures upstream also increase excessively, leading to symptoms of "backward" heart failure. Signs and symptoms include pulmonary congestion and dyspnea (left-sided failure) and systemic venous distention and edema (right-sided failure). If compensatory mechanisms are unable to maintain cardiac output sufficient for the needs of the peripheral tissues, "forward" heart failure ensues. Adverse effects from impaired tissue perfusion include weakness, lassitude, and acute renal failure. In chronic heart failure, aspects of backward and forward failure interact to produce clinical manifestations. Salt and water retention caused by forward failure contributes to the venous hypertension and edema associated with backward failure. Conversely, impaired gas exchange in the congested lungs augments muscle weakness and fatigue associated with reduced cardiac output and delivery of oxygen to skeletal muscle.

Heart failure occurs whenever the workload placed on the heart exceeds the ability of the heart to perform. Heart failure often arises from myocardial infarction or hypertension.

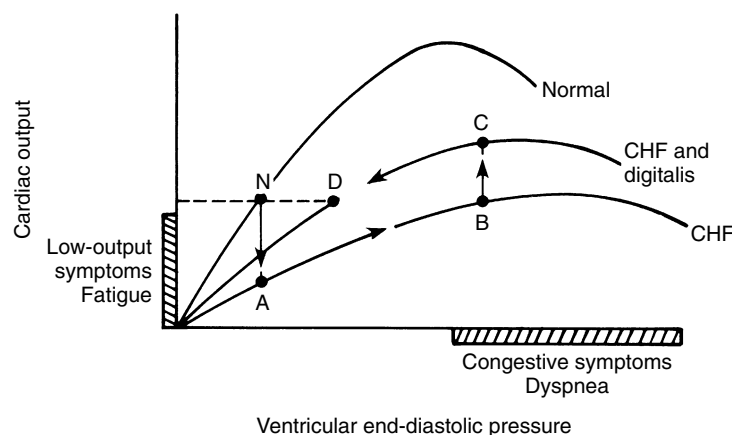

FIGURE 25-1 Operation of the Frank-Starling mechanism in the preload compensation for heart failure. The three curves represent ventricular function curves in the normal state, in congestive heart failure (CHF), and in heart failure after treatment with digoxin. Points N through D indicate, in sequence, normal cardiac status (N), depression of contractility with decompensated heart failure (A), Frank-Starling compensation (B), increase in contractility with digoxin (C), and reduction in use of Frank-Starling preload compensation that digoxin allows (D). Points N, D, and B indicate the same cardiac output on the vertical axis, but each point is at a different end-diastolic pressure on the horizontal axis. The excessive end-diastolic pressures causing congestive symptoms and the lowered levels of cardiac performance resulting in low-output symptoms are shown by the hatched areas. (From Mason DT: Regulation of cardiac performance in clinical heart disease: interactions between contractile state mechanical abnormalities and ventricular compensatory mechanisms, *Am J Cardiol* 32:437-448, 1973.)

Myocardial infarction can lead to heart failure as a result of a reduction in the heart's ability to perform work (pump failure).

An increase in total peripheral vascular resistance, as seen in hypertension or as a reflex reaction in congestive heart failure, can contribute to heart failure because of increased outflow resistance on cardiac contraction. The first reaction of the heart to an increase in outflow resistance is often enlargement, resulting in temporary higher efficiency in cardiac function. This initial reaction is followed, however, by progressive signs of cardiac failure characterized by decreased stroke volume and stroke work, as indicated earlier. Reducing preload and afterload by reducing peripheral resistance is an important strategy in treating heart failure.

Figure 25-2 shows some important adaptive mechanisms that result from heart failure. These changes, including an increase in sympathetic discharge, can compensate for the heart failure. If these and other responses are insufficient, however, the heart failure becomes uncompensated. Adaptive mechanisms also include an increase in production of angiotensin II, leading to remodeling of the heart over time.¹⁰ Remodeling results in cardiac hypertrophy, and several cellular changes, which, although they tend to compensate for heart failure, may hasten the course of the disease. This cardiac remodeling in heart failure has a parallel in hypertension, in which vascular smooth muscle slowly undergoes hypertrophy and hyperplasia.

As a result of the complexity of changes in heart failure, there are numerous processes that can be targeted by drugs: neurohumoral events, vascular dynamics, fluid volume, the sympathetic nervous system, and contractility of the heart.¹⁰ The pharmacologic features of angiotensin-converting enzyme (ACE) inhibitors and other vasodilators, diuretics, β blockers, and catecholamines are discussed elsewhere in this book. They are also discussed in this chapter in relation to the treatment of heart failure. The cardiac glycosides are not extensively discussed elsewhere in the book and so are discussed more fully in this chapter than other drugs used for heart failure.

DRUGS USED IN THE TREATMENT OF CHRONIC HEART FAILURE

Table 25-1 lists the drugs used to treat heart failure and their mechanisms of action. The drugs are often used in combination. Heart failure can be classified as diastolic or systolic failure. In diastolic failure, the heart has inadequate distention and inadequate filling capabilities. Contraction as measured by the ejection function may be normal. This type of heart failure is often seen in patients with hypertension. Systolic heart failure is a deficiency in contractility with a low ejection fraction.

The primary drugs used to treat chronic heart failure are ACE inhibitors, angiotensin II receptor blockers, thiazide and loop diuretics, β -adrenergic receptor blockers, aldosterone antagonists, digoxin, and directly acting vasodilators. For short-term acute treatment, certain catecholamines, nesiritide, other vasodilators, and the phosphodiesterase III inhibitors have special application. Figure 25-3 shows the drugs used in each type of heart failure.^{4,7}

Diuretics

Therapy of mild congestive heart failure has often involved salt restriction and the use of diuretic drugs to reduce tissue edema and blood volume. The resulting reduction in the preload, or diastolic filling pressure, helps decrease wall tension in the heart and lessen myocardial oxygen demand. The vasodilation caused by the thiazide diuretics also aids in reducing the afterload, or the arterial pressure against which the heart has to pump in moving blood. Diuretics also indirectly reduce sympathetic nervous system activity.

Aldosterone Antagonists

The action of spironolactone as a diuretic is caused by its antagonism of aldosterone at the convoluted tubule of the kidney. Antagonism of aldosterone leads to several other effects that are beneficial in patients with heart failure. These are shown in Figure 25-4. K^+ -sparing actions help in preventing hypokalemia. Reducing Mg^{++} loss seems to reduce

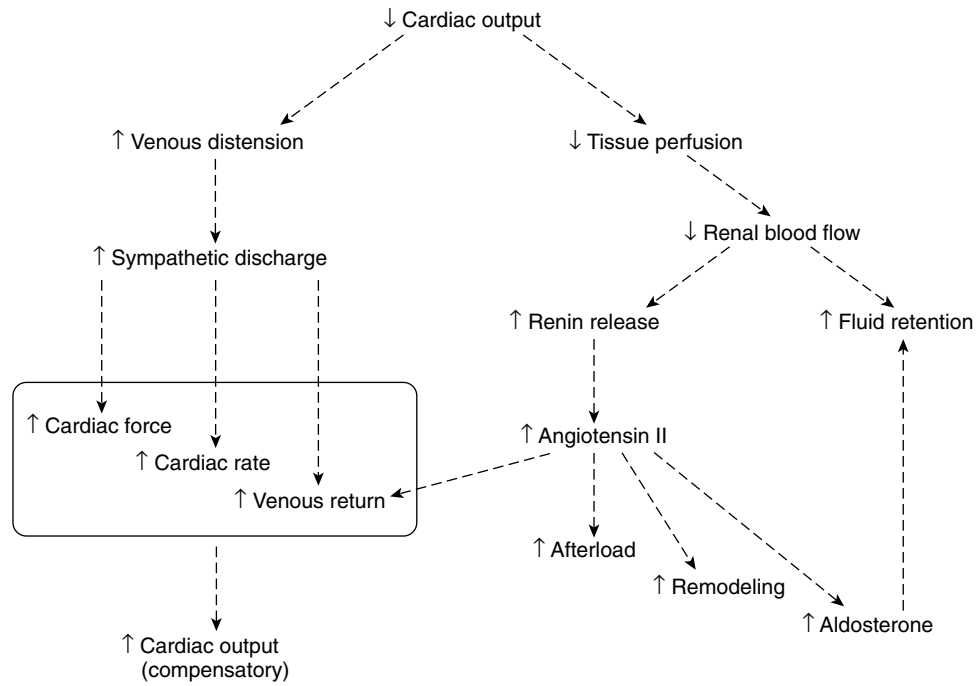

FIGURE 25-2 Adaptive mechanisms in heart failure. A decrease in cardiac output leads to a cascade of events that result in a compensatory increase in cardiac output (box). In addition, activation of the renin-angiotensin system leads to changes that put further burden on the failing heart and promote detrimental and long-term remodeling of the cardiovascular system.

TABLE 25-1

Treatment of Heart Failure

DRUG OR DRUG CLASS	MECHANISM(S)
Long-Term Treatment	
Thiazide and loop diuretics	Reduce fluid volume (reduce preload and afterload)
ACE inhibitors	Reduce effect of angiotensin II, prevent remodeling
Angiotensin II receptor blockers	Reduce effect of angiotensin II, prevent remodeling
β Blockers*	Reduce sympathetic effect, prevent remodeling, prevent arrhythmias
Aldosterone antagonists	Inhibit effect of aldosterone
Digoxin	Direct cardiotoxic effect
Isosorbide dinitrate-hydralazine	Reduce afterload and preload
Short-Term Treatment†	
Dobutamine	Direct cardiotoxic effect
Dopamine	Direct cardiotoxic effect
Nesiritide	Reduces preload and afterload
Phosphodiesterase III inhibitors	Reduce preload and afterload; direct cardiotoxic effect
Nitroglycerin	Reduces preload and afterload
Nitroprusside	Reduces preload and afterload

*Carvedilol is a β blocker that also blocks α₁ adrenoceptors.

†Usually only for a few days.

ACE, Angiotensin-converting enzyme.

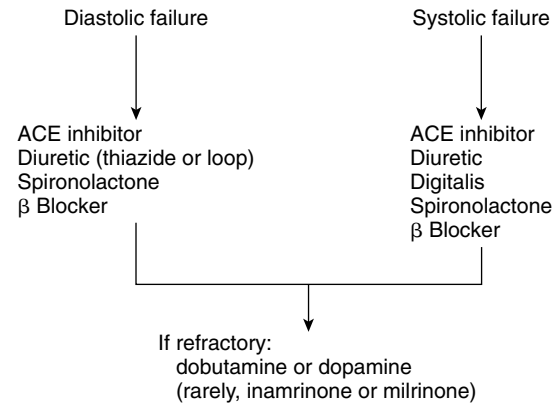

FIGURE 25-3 Heart failure and choice of drug. The choice of digoxin depends on the presence of systolic failure, especially if it occurs with atrial fibrillation. Dobutamine, dopamine, nesiritide, nitroglycerin, nitroprusside, inamrinone, and milrinone are reserved for short-term therapy in refractory cases. ACE, Angiotensin-converting enzyme.

ventricular arrhythmias in patients with heart failure. Because aldosterone can inhibit norepinephrine uptake (uptake 2), spironolactone prevents the enhanced sympathetic activation from aldosterone.¹⁸ Spironolactone also blocks the inhibition of the baroreceptor reflex seen with aldosterone. A consequence of inhibiting the baroreceptor reflex is the lack of parasympathetic nerve response.¹³ The latter response is important in counteracting the adverse effects of sympathetic stimulation, such as arrhythmias and cardiac ischemia. Myocardial fibrosis is also inhibited by spironolactone.

Spironolactone has many salutary effects in heart failure. These beneficial effects also occur when it is used with other

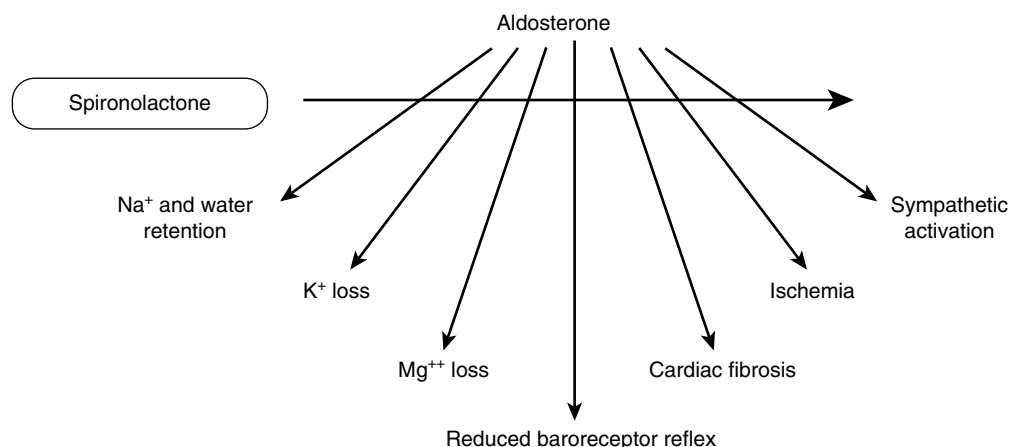

FIGURE 25-4 Effects of spironolactone in treating congestive heart failure. The beneficial effects of spironolactone are the result of inhibiting the several effects of aldosterone at its receptors.

drugs such as ACE inhibitors. Because the reduction of aldosterone release by ACE inhibitors is only partial, an added benefit is gained from the use of an aldosterone antagonist.

Eplerenone is another aldosterone receptor antagonist for the treatment of heart failure. Compared with spironolactone, it has a lower affinity for the androgen receptor and is reported to have a lower incidence of related side effects including gynecomastia.

Angiotensin-Converting Enzyme Inhibitors and Angiotensin II Receptor Blockers

A major effect of ACE inhibitors is to reduce afterload and preload. These drugs improve symptoms in patients with heart failure. In addition, the progressive deterioration of the heart is slowed with ACE inhibitors. ACE inhibitors control remodeling that occurs with chronic heart failure. Remodeling results from growth of the myocardial cell and myocardial fibrosis. This probable cardioprotective effect provides added support for the use of ACE inhibitors in heart failure. Inhibiting the production of angiotensin II or blocking its receptor reduces aldosterone secretion, which reduces Na⁺ and water retention. Reduction of aldosterone release by ACE inhibitors also reduces sympathetic discharge, as described in Chapter 28 (see Figure 25-4).

Evidence also suggests that ACE inhibitors stimulate the proliferation of capillaries in the coronary circulation, increasing blood flow. It is unknown whether this action of ACE inhibitors occurs as a result of the decrease in angiotensin II, an increase in bradykinin, or both. Most likely, the ability of ACE inhibitors to reduce blood pressure in hypertensive patients also contributes to a cardioprotective effect. Early treatment of congestive heart disease with an ACE inhibitor could be a major factor in slowing the progress of the disease and in relieving symptoms. Enalapril is one of the first drugs whose administration was associated with an increased survival time in patients with heart failure.¹⁵ These drugs also are useful in combination with other drugs, including digoxin and diuretics, in treating heart failure.

Angiotensin II antagonists, such as losartan and valsartan, are additional candidates for treating heart failure.^{7,10} They share the benefits of ACE inhibitors, while avoiding such side effects as angioedema and persistent coughing. The pharma-

cologic features of angiotensin II antagonists and ACE inhibitors are discussed in detail in Chapter 28.

β-Adrenergic Receptor Antagonists

The use of β-adrenoceptor blockers to reduce the adverse cardiac effects of heightened sympathetic discharge that occur as heart failure progresses is a strategy used in the long-term treatment of heart failure.²⁰ β Blockers reduce the work of the heart, reduce renin secretion, prevent remodeling of the heart, act as antiarrhythmic drugs, and reduce the downregulation of β₁-adrenergic receptors in heart failure. All of these effects are beneficial in heart failure. Their use is consistent with a neurohumoral component of heart failure. Bisoprolol, betaxolol, and metoprolol are selective β₁-adrenergic receptor blockers that are used in treating heart failure.

Carvedilol is a nonselective β-adrenoceptor blocker and selective α₁-adrenoceptor blocker used in patients with heart failure. β-adrenergic blockade reduces remodeling, whereas α₁-adrenergic blockade reduces preload and afterload. It also has antioxidant properties that result in cell protection against free radicals, in addition to the other effects of β blockers. The relative importance of each mechanism in achieving favorable results in heart failure is unknown.

Directly Acting Vasodilators

Vasodilators such as nitrates and hydralazine reduce the load on the heart, improve tissue perfusion in heart failure, and increase survival rates in these patients. Vasodilators are usually administered in combination with other drugs, such as inotropic agents or ACE inhibitors. Disadvantages of nitrates and hydralazine include the indirect enhancement of sympathetic discharge and activation of the renin-angiotensin pathway. Added interest in vasodilator therapy resulted from evidence supporting the clinical efficacy of two vasodilators in combination: isosorbide dinitrate and hydralazine. The fixed-dose therapy was found to be effective in patients of African descent with class III and class IV heart failure.^{3,17} This drug combination may be particularly effective in this group of patients, who may be less responsive to drugs such as ACE inhibitors. The isosorbide dinitrate-hydralazine combination may also be useful as added therapy in resistant cases or in patients who cannot tolerate other heart failure medications. The pharmacologic characteristics of nitrates and hydralazine are discussed in Chapters 26 and 28, respectively.

DIGOXIN

Digoxin is a cardiac glycoside that is often called *digitalis*, referring to the plant from which it is derived. Digoxin is currently indicated for the treatment of congestive heart failure and the management of atrial flutter and fibrillation.

The first detailed scientific study of digitalis on record was made by Sir William Withering¹⁹ of Shropshire, England, in 1785. In his treatise, "An Account of the Foxglove, and Some of Its Medical Uses; With Practical Remarks on Dropsy, and Other Diseases," Withering detailed clinical uses for the leaf of the *Digitalis purpurea* (purple foxglove) plant and described its effects on the heart. His recognition of the potential usefulness of digitalis plant derivatives was occasioned by their extensive use in local folk medicines. Withering ascribed the beneficial effects of digitalis in treating dropsy to a direct diuretic effect, although he was aware of beneficial effects on the heart as well. He also detailed many toxic effects of the plant.

The history of the use of digitalis since Withering's time has been characterized by a realization of its potential therapeutic benefits on the one hand and its low margin of safety on the other. Advances in digitalis research and clinical use up to the present have contributed greatly to our knowledge of this drug class.

Chemistry and Classification

The term *digitalis* is often used interchangeably with the term *cardiac glycoside*. Both terms refer to many compounds, naturally occurring or semisynthetic, that have similar cardio-tonic effects. Only one such compound, *digoxin*, is commonly used clinically in the United States today. Another agent, digitoxin, is available in Canada and elsewhere. The structure of digoxin is shown in Figure 25-5. The molecule is composed of a steroid ring structure. Other distinguishing molecular characteristics include an α,β -unsaturated lactone ring, and a carbohydrate moiety in glycosidic linkage at C₃. The presence of a sugar in glycosidic linkage accounts for the name *glycoside*. A steroid plus lactone lacking the sugar group is generically called a *genin* or *aglycone*. The genin of digoxin is digoxigenin.

Mechanism of Action

Digoxin has a direct inotropic effect on the heart; it directly increases the force of contraction. The inotropic action of digoxin does not depend on release of endogenous catechol-

amines. Rather, digoxin has a direct action on heart cells. Digoxin is known to be a specific inhibitor of the Na⁺-K⁺ pump, by inhibiting Na⁺,K⁺-activated ATPase (Na⁺,K⁺-ATPase), which is the enzymatic equivalent of the Na⁺-K⁺ pump. The α subunit of Na⁺,K⁺-ATPase is responsible for pumping sodium and potassium and contains the binding site for digoxin (Figure 25-6). Inhibition of Na⁺,K⁺-ATPase leads to a small but significant increase in intracellular Na⁺ near the plasma membrane. This increase in Na⁺, amounting to approximately 2 mmol/L, reduces the rate of Na⁺-Ca⁺⁺ exchange (three Na⁺ exchanged into the cell for one Ca⁺⁺ transported out of the cell) because the increase in Na⁺ reduces the net binding of Ca⁺⁺ to its binding sites on the exchange system. This alteration results in a reduced efflux of Ca⁺⁺ and an increase in Ca⁺⁺ available to the contractile apparatus. In addition, the increase in Ca⁺⁺ stimulates the release of additional Ca⁺⁺ from the SR, further stimulating contraction.

Digoxin may also increase the influx of Ca⁺⁺ through other channels. The added intracellular Ca⁺⁺ increases the amount of Ca⁺⁺ taken up into the SR during diastole. After several contractions, the amount of Ca⁺⁺ released from the SR is also increased. The positive inotropic effect results from the increased Ca⁺⁺ available for contraction during the systolic phase. The inhibition of Na⁺,K⁺-ATPase resulting in increased intracellular Na⁺ and a reduced diastolic membrane potential has important implications for other ion movements and electrical properties of heart cells. Some of these are described subsequently. The relationship between Na⁺,K⁺-ATPase inhibition by digoxin and its inotropic effect is shown in Figure 25-6.

Pharmacologic Effects

The most important actions of the digitalis glycosides are those exerted on the cardiovascular system. Resulting changes in hemodynamics may indirectly influence other systems, yielding beneficial or adverse responses. Some therapeutic effects may be exerted through the nervous system. Direct actions on the central nervous system (CNS), gastrointestinal tract, and cardiovascular system also contribute to the toxic profile of digoxin.

Cardiac effects

Digoxin has two powerful influences on the heart: it increases myocardial contractility, and it alters electrical activity

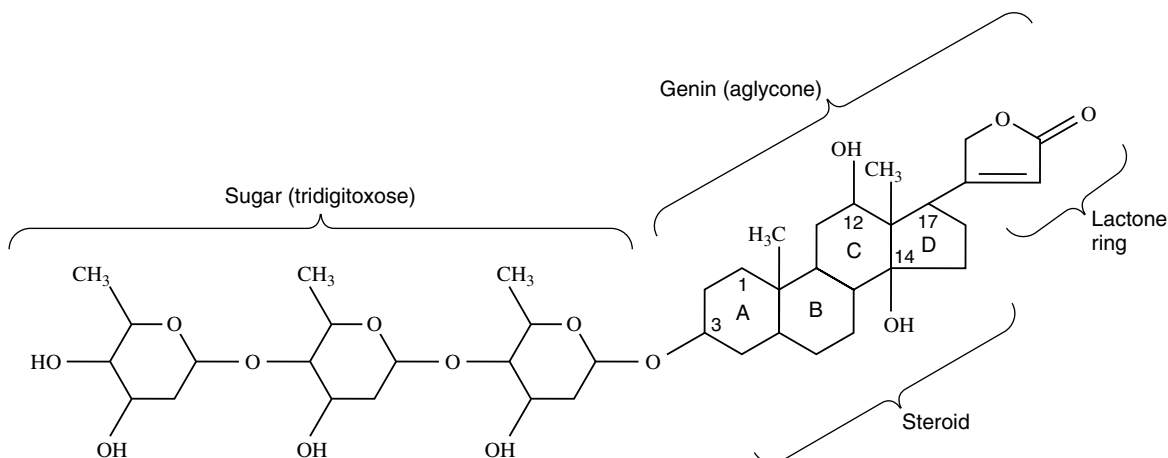

FIGURE 25-5 Structural formula and composition of digoxin.

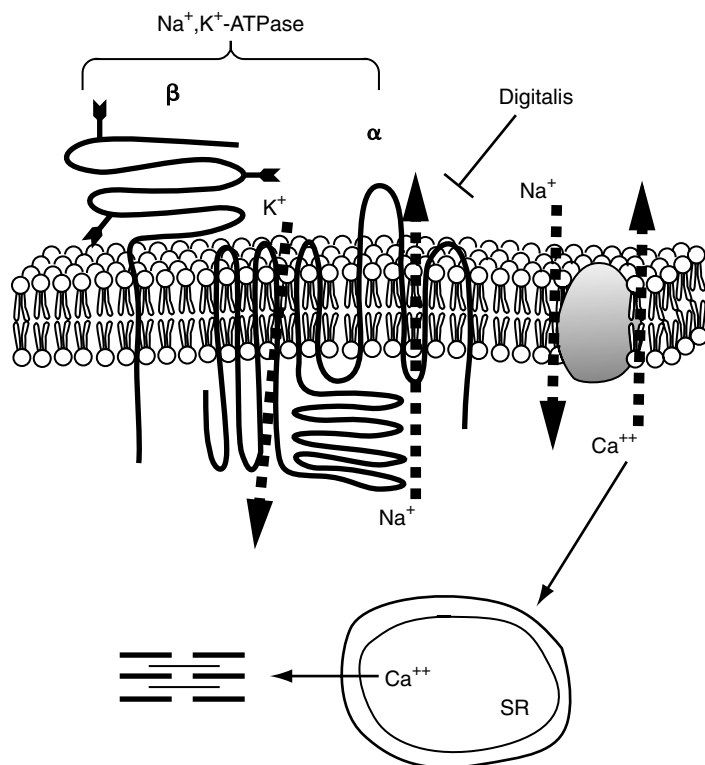

FIGURE 25-6 The role of Na^+, K^+ -ATPase and the Na^+ - Ca^{++} exchange in cardiac contractility and the mechanism of the positive inotropic action of digoxin. Digoxin binds to the extracellular face and transmembrane region of the β subunit (β) of Na^+, K^+ -ATPase, inhibiting Na^+ efflux and K^+ influx. The α subunit (α) of Na^+, K^+ -ATPase is also shown. The increase in intracellular Na^+ results in reduced binding of Ca^{++} to the Na^+ - Ca^{++} exchange system and reduced Ca^{++} efflux. The concentration of intracellular Ca^{++} is increased, and more Ca^{++} is made available to intracellular storage sites, notably the sarcoplasmic reticulum (SR). This leads to enhanced Ca^{++} release to the contractile apparatus and a greater force of contraction.

throughout the heart. A complex interplay of direct actions and autonomically mediated changes contributes to effects clinically observed.^{1,2}

Contractility. The experiments of Cattell and Gold⁵ clearly showed that cardiac glycosides have direct effects on the isolated heart. The drugs increase the force of contraction of the myocardium (positive inotropic effect). Maximum tension developed and rate of tension development are increased, whereas time from onset of contraction to peak contraction is decreased. The duration of the contractile process during systole is abbreviated because of an increase in the rate at which tension is developed. The overall cardiodynamic effect of digoxin on the isolated heart can be summarized as an increased force of contraction caused by an increased rate of force development by the myocardium, resulting in a systolic phase of shorter duration but greater effectiveness.^{5,16}

In vivo, many factors complicate the effects of digoxin on contractility. In the normal intact individual, cardiac glycosides directly increase the force of contraction of the heart, but this effect is more than negated by compensatory autonomic reflexes. Digoxin, in addition to its cardiac effects, constricts peripheral blood vessels by a direct action on vascular smooth muscle. The outcome of such vasoconstriction and the resultant increase in blood pressure is a reduction in myocardial contractile force and cardiac output because of reflex mechanisms. The net effect in normal individuals is that reflex mechanisms cancel out the positive effects of digoxin on heart contractility. Sarcomere shortening with digoxin in the normal heart offsets the increased contractility in vivo.

In patients with failing hearts, a different situation prevails. Vasoconstriction, a physiologic sympathetic response to reduced cardiac output, is significant in peripheral vessels. The renin-angiotensin-aldosterone system is also highly activated in heart failure, and antidiuretic hormone is elevated. In these compromised patients, compensatory mechanisms do not cancel out the cardiac effects of digoxin. Digoxin increases cardiac output, reducing the need for high sympathetic tone

in the blood vessels. Sympathetic tone is consequently decreased in the vasculature when these patients receive digoxin, and vasodilation tends to occur. Digoxin enhances baroreceptor sensitivity and corrects an impaired baroreceptor response in patients with heart failure. The net result is to reduce sympathetic activity. The effect of digoxin in vivo depends on the state of the cardiovascular system at the time of administration.

In compensated and decompensated heart failure, digoxin can improve cardiac function so that a greater cardiac output can be achieved without as much reliance on compensatory mechanisms. Figure 25-1 shows that a new ventricular function curve is generated as a result of digoxin. This curve more closely approximates the normal situation.

Cardiac size and rate of contraction. Congestive heart failure is accompanied by an increase in heart size. As the heart begins to fail, it is unable to eject as much blood per stroke as the normal heart, and the size of the heart increases, compensating for the loss of contractility. The right or left side of the heart, or both, may be affected.

Digoxin, by increasing the force of contraction, reduces the size of the heart. Digoxin enables the heart to pump with greater force at any given filling pressure. This increased force leads to a reduction in diastolic pressure and cardiac distention.¹⁴

In the clinical management of congestive heart failure, the administration of digoxin is most often associated with a reduction in heart rate. This reduction results from a vagal and a direct effect on the heart by digoxin. The cardiac glycosides stimulate the vagus nerve—probably indirectly by an effect on baroreceptors, afferent nerve pathways, and central vagal nuclei—and at therapeutic doses reduce the sympathetic tone of the heart indirectly by improving cardiac function and sensitizing the baroreceptor mechanism. Both effects account for a reduction in heart rate. The effect of digitalis on heart rate during the treatment of certain cardiac arrhythmias is discussed subsequently.

TABLE 25-2

Electrophysiologic Effects of Digoxin

SITE	AUTOMATICITY	DURATION OF EFFECTIVE REFRACTORY PERIOD	EXCITABILITY	CONDUCTION VELOCITY
SA node	↓, ↑A			
Atrial myocardium		↓, ↑A	↑*, ↓T	↑*, ↓T
AV node	↑	↑		↓
Purkinje fibers	↑	↑*, ↓T	↑*, ↓T	↓
Ventricular myocardium		↓	↑*, ↓T	↑*, ↓T

*Lower therapeutic doses only.

↑, Increased; ↓, decreased; ↑, ↓, most important effects.

A, After atropine; AV, atrioventricular; SA, sinoatrial; T, at toxic doses.

Electrophysiology. The effects of digitalis on the electrical properties of the heart can be divided into at least four interrelated categories: automaticity, refractoriness, excitability, and conduction velocity. Because digoxin has vagal and non-vagal effects on the heart and because the areas of the heart affected by the vagus include the sinoatrial (SA) node, the atrial myocardium, and the upper portions of the atrioventricular (AV) node, a discussion of discrete regions of the heart is necessary. The direct effects of digoxin on the electrophysiology of the heart are as follows (Table 25-2): reduced conduction velocity and increased duration of the ERP in the AV node, increased automaticity of subsidiary pacemaker activity in the conductive tissues of the ventricle (e.g., Purkinje fibers), and decreased duration of the ERP of the ventricular myocardium. Cardiac vagal effects of digoxin are limited to effects on the atria, the SA node, and the AV node. They consist of a decrease in the duration of the ERP of the atrial myocardium, a decrease in the automaticity of the SA node, and an increase in the duration of the ERP along with a decrease in the conduction velocity of the AV node.

Electrocardiogram. Therapeutic and toxic effects of digoxin are associated with changes on the electrocardiogram (ECG) that reflect the electrophysiologic effects listed in Table 25-2. They include alterations in the shape of the T wave, the configuration of the ST segment, the lengths of the QT and PR intervals, AV dissociation, and the presence of extrasystoles (Figure 25-7).

At therapeutic doses, changes often occur in the T wave and the ST segment configuration. The T wave may be inverted or distorted, whereas the ST segment may appear “sunken” (lead II of the ECG). These changes are caused by alterations in the sequence of repolarization of various ventricular myocardial cells. Also at therapeutic doses, the PR interval is lengthened by digitalis as a result of decreased conduction velocity in the AV node. The QT interval is shortened because of the shortened ventricular action potential.

Although several cardiac effects of digoxin are observed at toxic doses, two effects are typical. The first is heart block caused by excessive reduction in AV nodal conduction; the second is any of several ventricular arrhythmias caused by ectopic pacemaker activity.

Effects on systemic vasculature

Although digoxin is a vasoconstrictor, vasoconstriction by digoxin is usually not observed in patients with congestive heart failure because sympathetic vascular tone is already elevated. Vasodilation often results from digoxin administration because of the improvement in cardiac function. Nevertheless, caution should be used when administering digoxin

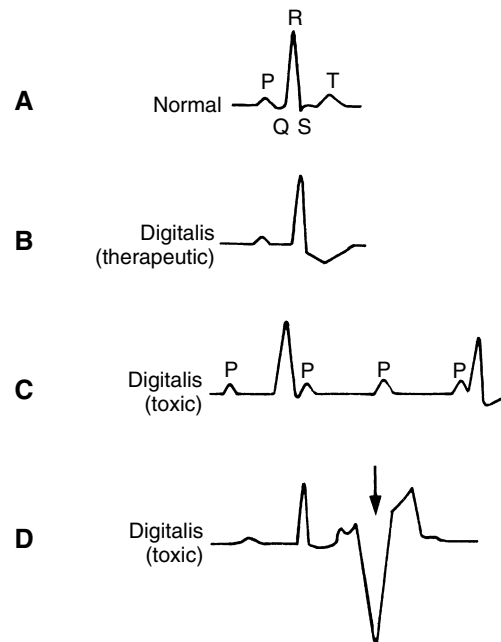

FIGURE 25-7 Some effects of digitalis on the ECG (lead II). **A**, Normal ECG. **B**, Typical changes at therapeutic concentrations include depression of the ST segment and lengthening of the PR interval. **C**, Toxic effect of digoxin on atrioventricular (AV) conduction promotes AV dissociation, such as complete AV block. Notice the lack of relationship between the P waves and QRS complexes. **D**, Toxic effect of digoxin on ventricular impulse generation results in ectopic ventricular beats. An example of an ectopic beat is marked by the arrow.

by the intravenous route because significant vasoconstriction may occur even in a patient with heart failure.

Diuretic effects

At one time, digitalis was thought to act primarily on the kidney because diuresis is such a prominent feature of its use in congestive heart failure. The diuretic effect results primarily from improved cardiac function and a direct effect on afferent nerves in the heart that are involved in the central regulation of blood volume. Together, these actions result in reduced peripheral sympathetic tone and increased blood flow to the kidney. Glomerular filtration is increased, renin secretion in most cases is decreased, and aldosterone secretion is indirectly inhibited. The retention of Na^+ and water is reduced. Digoxin also promotes fluid mobilization and the reduction

TABLE 25-3

Pharmacokinetics of Digoxin

NONPROPRIETARY (GENERIC) NAME	PROPRIETARY (TRADE) NAME	GASTROINTESTINAL ABSORPTION	PEAK DRUG EFFECT*	AVERAGE PLASMA HALF-LIFE	MAIN ROUTE OF ELIMINATION	APPROXIMATE DAILY ADULT ORAL MAINTENANCE DOSE
Digoxin	Lanoxin	60-85% [†]	1-5 hr	36 hr	Kidney excretion	0.125-0.5 mg

*Intravenous administration.

[†]Other marketed formulations may yield different absorption percentages.

of venous pressure, which increases the return of edema fluid to the vascular space and indirectly increases renal excretion. Some of the diuretic effect of digoxin may result from its direct action on the Na⁺-K⁺ pump in the kidney, but this is of secondary importance to the diuresis based on improved cardiovascular dynamics and reduced sympathetic activity.

Miscellaneous effects

Digoxin can cause anorexia, nausea, and vomiting, especially at toxic doses. Excessive salivation often accompanies these effects. Significant neurologic effects of digoxin, usually seen in toxic situations, are discussed later in the chapter. Although digoxin contains a steroid ring structure, it rarely elicits effects associated with steroid hormones. Perhaps the only important endocrine influence is a weak estrogen effect. Digoxin is not an aldosterone receptor antagonist.

Absorption, Fate, and Excretion

Digoxin is usually given by the oral route. Dose schedules are extremely important for digoxin because attaining a therapeutic effect without toxicity requires precise regulation of the amount of drug administered. Digoxin dosages depend on individual patient variations and disease states and concurrent drug therapy. In all cases, patients must be continually monitored, and final judgment on optimal dosages depends on clinical observations.

A comparison of various oral digoxin preparations has shown variability in drug bioavailability, the difference apparently resulting from unequal dissolution rates of the tablets. The highest bioavailability of digoxin has been noted with the use of a solution of digoxin in soft gelatin capsules. Digoxin is excreted by the kidney largely in the active form. The mechanism involves glomerular filtration and tubular secretion and accounts for almost all the elimination of the drug. Because digoxin is largely eliminated in the kidney, patients with kidney hypofunction may require downward dosage adjustments of the drug. The pharmacokinetics of digoxin are summarized in Table 25-3.

Adverse Effects**Signs and symptoms**

Although allergic reactions to digoxin are rare, toxic reactions are not. Withering¹⁹ was well aware of many toxic effects of digitalis when he wrote:

In the year 1775 my opinion was asked concerning a family recipe for the cure of dropsy. I was told that it had long been kept a secret by an old woman in Shropshire who had sometimes made cures after the more regular practitioners had failed. I was informed also that the effects produced were violent vomiting and purging; for the diuretic effects seemed to have been overlooked. This medicine was composed of twenty or more different herbs; but it was not very difficult for one

BOX 25-1*Common Signs and Symptoms of Digoxin Toxicity***Gastrointestinal**

Salivation
Anorexia
Nausea
Vomiting
Diarrhea

Central Nervous System

Headache
Visual disturbances
Fatigue
Drowsiness

Cardiac

AV block
Excessive slowing of the heart
Ventricular extrasystoles
Other arrhythmias

Miscellaneous

Excessive urination

AV, Atrioventricular.

conversant in these subjects to perceive that the active herb could be no other than foxglove.

Digoxin toxicity still represents a significant clinical problem today. The therapeutic index for digoxin is very low. Toxic signs are often seen at roughly twice the minimum effective dose. In practice, adverse reactions usually result from accumulation of the drug or from K⁺ depletion caused by diuretic coadministration, or both. Individual differences in patient response exist and may account for unexpected clinical results; dosages have to be tailored for each patient. Common toxic effects of digoxin are listed in Box 25-1.

Extracardiac toxic effects include anorexia, nausea, diarrhea, and vomiting. Gastrointestinal symptoms may also occur at nontoxic concentrations. The mechanism involves stimulation of the chemoreceptor trigger zone of the medulla. Excessive salivation, headache, fatigue, drowsiness, and abdominal pain often accompany these toxic signs and symptoms. Visual disturbances, such as the appearance of halos and distortions in color perception, can also occur, perhaps because of a direct effect of digoxin on the visual cortex. Objects often appear yellow or green. Giddiness and trigeminal neuralgia are sometimes observed; excessive urination often occurs with digoxin

intoxication. Gynecomastia may occasionally develop in men. This side effect is of little value in determining toxicity, however, because it seldom occurs. The drugs may also suppress follicle-stimulating hormone and lead to vaginal cornification. Such effects are probably caused by an interaction with estrogen receptors.

In approximately half the cases of digoxin toxicity, extracardiac signs of toxicity precede the cardiac signs. A typical pattern would be the development of anorexia, followed in 1 or 2 days by nausea and vomiting and other signs. Nevertheless, the absence of extracardiac signs is no guarantee that cardiac toxicity is not occurring.

Cardiac toxicity is the most serious consequence of digoxin therapy. Although it is difficult to characterize specifically, cardiac toxicity caused by digoxin, two effects stand out as the most typical—AV nodal block and ventricular tachyarrhythmias. Complete AV dissociation can occur at toxic concentrations of digoxin. This effect is an extension of a therapeutic effect of the drug and is mediated by a reduction in AV nodal conduction. Dropped ventricular beats caused by partial heart block are also a sign of toxicity. The effect on AV conduction accounts in great measure for the excessive slowing of the heart seen in some toxic situations. Excessive cardiac slowing may be an important sign of toxicity in many patients.

Digoxin also produces tachyarrhythmias in toxic situations. Increased electrical activity can result in premature beats and extrasystoles of ventricular origin, which may progress to ventricular fibrillation. Tachyarrhythmias may be caused by one of several mechanisms. Some may be caused by increased automaticity of Purkinje fibers, others may be due to a reentry process (see Chapter 24), and still others may be due to delayed afterpotentials whose depolarizations follow quickly on the action potential and in some cases generate a new action potential. Afterdepolarizations are most likely caused by release of intracellular Ca^{++} from overloading of the intracellular Ca^{++} stores. Afterpotentials may also interfere with conduction by reducing the phase 4 resting potential. Other arrhythmias of atrial and of ventricular origin may also occur. Examples of toxic effects on AV conduction and ventricular impulse generation are shown in Figure 25-7.

The arrhythmic effects of digoxin result largely from inhibition of cardiac Na^+, K^+ -ATPase. Vagal effects of digoxin can contribute to certain cardiac effects, such as heart block. In addition, at toxic concentrations, digoxin may exert significant stimulatory effects on the sympathetic nervous system, and these actions may account for some arrhythmias. Enhanced sympathetic activity is most likely caused by inhibition of Na^+, K^+ -ATPase in the CNS and inhibition of active reuptake of norepinephrine at adrenergic nerve endings.

Drug monitoring

Attempts have been made to correlate blood concentrations of cardiac glycosides with signs of toxicity. These attempts create a technical problem because serum digoxin at therapeutic doses is only 0.7 to 1.2 ng/mL, and toxic effects may start to appear at approximately 2.3 ng/mL or lower.

The plasma concentration of cardiac glycosides can be measured by a specific radioimmunoassay. This assay is of limited use, however, in confirming toxic states of patients because of the proximity of toxic and therapeutic plasma titers. Monitoring drug toxicity can best be accomplished by measurement of drug serum concentrations and, more importantly, careful clinical examination. Patient education is a necessary prerequisite for the early detection and prevention of digoxin toxicity.

Treatment of digoxin toxicity

When digoxin toxicity is diagnosed, the drug and any diuretics that may have exacerbated the problem are temporarily dis-

continued. If digoxin must be readministered before signs of toxicity have abated, small doses are given with constant monitoring. Potassium chloride can be administered intravenously in cases of hypokalemia. In general, it is not used if AV conduction is significantly impaired because K^+ can worsen this condition. Atropine can be helpful in controlling AV block, sinus bradycardia, and SA nodal arrest.

Lidocaine may be useful in treating digoxin toxicity. It is given intravenously in these situations. Lidocaine is useful in suppressing ectopic pacemaker activity; however, it has little effect on slowing of AV nodal conduction by digoxin. Phenytoin may also be useful in treating ventricular arrhythmias caused by digoxin.

In severe digoxin toxicity, an antidigoxin drug designated digoxin immune Fab (Digibind) may be administered.¹¹ Digoxin immune Fab consists of antigen-binding fragments derived from sheep antibodies to digoxin. The antidote is given intravenously and inactivates digoxin by forming a complex with the drug. The complex is excreted by the kidney, with an elimination half-life of 15 to 20 hours. With an adequate dose, the reversal of toxicity is rapid. One potential hazard in its use is the induction of hypokalemia if body stores of K^+ are low. Digoxin immune Fab also affects radioimmunoassays for digoxin designed to monitor plasma levels of digoxin. Fab fragments, although less likely than the entire antibody to cause an immune response, are associated with some allergic reactions. Insertion of a cardiac pacemaker may also be helpful in extreme cases.

General Therapeutic Uses of Digoxin

Congestive heart failure

In the United States, the cardiac glycoside used clinically is digoxin, and the term *digitalis* refers in effect to digoxin. The primary use for digoxin is in the treatment of congestive heart failure. The direct effect of digoxin on the myocardium in most cases enables the heart in congestive failure to increase its contractile force and output. Digoxin is most effective in patients with chronic, continuous systolic heart failure,^{1,2} in which the ventricle is enlarged at rest, early ventricular filling is rapid, and the compliance of the heart wall has not been reduced because of a condition such as hypertrophy or amyloid infiltration.

Cardiac arrhythmias

Digoxin is effective in reducing an increased ventricular rate caused by atrial fibrillation. Vagal effects on the AV node account for most of the decrease in conduction. This reduction protects the ventricle from atrial electrical impulses arriving in rapid succession. The dosage can be adjusted to titrate the drug to a given ventricular rate. Occasionally, atrial fibrillation reverts to normal sinus rhythm during therapy; however, this is not the main goal of digoxin therapy, which is to reduce the ventricular rate despite the rapid rate of the atria (rate control). The use of digoxin in treating patients with acute atrial fibrillation has declined because of the use of antiarrhythmics, including β -adrenergic blockers and Ca^{++} channel blockers, and other treatment (see Chapter 24). Digoxin is more appropriately used when systolic heart failure accompanies the atrial fibrillation and where controlling the resting ventricular rate is an added benefit.

CONDITIONS AFFECTING DIGOXIN THERAPY

Electrolyte Concentrations

Because the mechanism of action of digoxin most likely involves an increase in a crucial Ca^{++} "pool" in the heart, high plasma Ca^{++} concentrations can worsen digoxin toxicity.

TABLE 25-4

Effects of Plasma Electrolyte Concentrations on Digoxin Toxicity

NORMAL TOTAL PLASMA CONCENTRATION (mmol/L)	DIGOXIN TOXICITY MORE LIKELY IF PLASMA ELECTROLYTE CONCENTRATION IS:
K ⁺	Decreased
Ca ⁺⁺	Increased
Mg ⁺⁺	Decreased

Mg⁺⁺ inhibits many Ca⁺⁺-induced events; Mg⁺⁺ deficiency can increase susceptibility to digoxin toxicity.

Hypokalemia in particular can predispose a patient to digoxin toxicity. Low plasma K⁺ concentrations allow greater binding of digoxin to Na⁺,K⁺-ATPase and independently alter myocardial membrane properties to increase cardiac automaticity. Together, these factors may account for increased digoxin toxicity at low plasma K⁺ concentrations. (For drugs that reduce plasma K⁺, see the subsequent section on drug interactions.) Loss of intracellular K⁺ also plays an important role in digoxin toxicity. When digoxin is administered, intracellular K⁺ concentrations gradually decrease, reducing the ratio of intracellular to extracellular K⁺. This ratio change and the membrane potential alterations that follow make the heart more sensitive to digoxin toxicity. Reduced intracellular K⁺ may be present without a significant reduction in plasma K⁺ concentrations. The effects of major electrolyte changes on digoxin toxicity are summarized in Table 25-4.

Drug Interactions

Drugs affect digoxin therapy mainly by reducing its absorption, by altering the rate of its metabolism, by changing plasma and intracellular K⁺ concentrations, or by directly influencing the myocardium. Kaolin-pectin and oral antacids reduce the intestinal absorption of digoxin by forming a complex with the drug. Sulfasalazine, neomycin, and metoclopramide have also been reported to reduce the intestinal absorption of digoxin. Cholestyramine is used to bind bile acids in the gastrointestinal tract and reduce plasma concentrations of cholesterol. It is also able to bind certain drugs in the intestine, including digoxin. Digoxin given concurrently by mouth is prevented from being absorbed.

Numerous drugs can predispose a patient to digoxin toxicity by reducing plasma K⁺ concentrations, including amphotericin B, corticosteroids, and, most notably, thiazide and loop diuretics. The clinical problem is a significant one, especially because diuretics are often used with digoxin to treat congestive heart failure or reduce blood pressure. In these situations, the use of K⁺-sparing diuretics or supplementation with oral K⁺ is especially important.

Several reports have indicated a substantial interaction between quinidine and digoxin. The most important clinical results of concurrent therapy are enhanced digoxin toxicity and enhanced quinidine toxicity. Adverse reactions can occur at normal therapeutic dosages. Quinidine increases plasma digoxin concentrations by two mechanisms: first, renal clearance of digoxin is decreased; second, digoxin is displaced from tissue stores as a result of quinidine administration. Because of the interaction with digoxin, concurrent therapy usually requires a reduction in the dose of both drugs, although this interaction varies from patient to patient. Quinine, the levo stereoisomer of quinidine, and amiodarone, verapamil, and diltiazem can also increase plasma digoxin concentrations.

Sympathomimetic amines interact with digoxin because both classes of drugs increase the possibility of ectopic cardiac pacemaker activity. Cardiac arrhythmias are more likely to occur when β -adrenergic receptor agonists are used concurrently with digoxin. β -adrenergic receptor antagonists increase the risk of bradycardia and AV nodal block when given with digoxin, even though β blockers and digoxin are both used to treat heart failure.

Cholinergic and anticholinergic drugs alter responses to digoxin. The cholinergic agents enhance and the anticholinergic drugs antagonize the atrial, SA nodal, and AV nodal effects of digoxin. Succinylcholine, by increasing vagal tone and altering the K⁺ distribution, may acutely increase digoxin toxicity.

Spirolactone reduces digoxin clearance. This reduction in digoxin clearance may necessitate a lower digoxin dose when these drugs are used concurrently. Spirolactone may also interfere with serum digoxin assays.

In approximately 10% of patients, enteric bacteria, especially *Eubacterium lentum*, metabolize a significant portion of ingested digoxin. In these patients, antibiotics, by inhibiting these bacteria, can increase the amount of digoxin absorbed and increase the potential for digoxin toxicity. Erythromycin, other macrolides, and tetracyclines may increase digoxin plasma concentrations. In some cases, the interaction between antibiotics and digoxin has resulted in a twofold increase in serum digoxin concentrations.

DRUGS USED FOR ACUTE THERAPY OF HEART FAILURE**Catecholamines**

Drugs that stimulate β_1 adrenoceptors, such as dobutamine and dopamine, are cardiotoxic. An undesirable chronotropic response may occur, but it is less likely than with other catecholamines, such as epinephrine. Dobutamine and dopamine are used to treat heart failure in the acute setting. Dobutamine is a selective β_1 -adrenergic agonist, which accounts for the positive cardiac inotropic response. A β_2 -adrenergic effect seems to account for its effect of reducing vascular resistance. The effect of dobutamine on α -adrenergic receptors is complex. The negative isomer is an α_1 -adrenergic agonist, whereas the positive isomer is an α_1 -adrenergic antagonist. The combination of both isomers in the clinically available preparation ensures primarily a β_1 -adrenergic effect of the drug. At low doses, dopamine stimulates D₁-dopaminergic receptors selectively. This effect accounts for vasodilation of coronary, renal, and mesenteric blood vessels. At higher doses, dopamine has a greater net effect in stimulating β_1 -adrenergic receptors, leading to an inotropic effect. Finally, at still higher doses, dopamine significantly stimulates α_1 -adrenergic receptors and increases vascular resistance. The choice of catecholamine depends largely on the vascular state of the patient. The pharmacologic features of the catecholamines are discussed in Chapter 6.

Nesiritide

Nesiritide is a human B-type natriuretic peptide that is produced using recombinant DNA methods. The drug binds to and stimulates membrane-bound guanylate cyclase, causing an increase in cyclic 3',5'-guanosine monophosphate (cGMP) in blood vessels.^{6,9} This increase in cGMP leads to relaxation of vascular smooth muscle. The half-life of the drug is about 18 minutes; however, the effect of the drug may last several hours. It is used in the acute management of heart failure.

Inamrinone and Milrinone

Inamrinone and milrinone are bipyridine drugs that have a positive inotropic action on the heart. The bipyridines act by

inhibiting phosphodiesterase III, also termed *cGMP-inhibited phosphodiesterase*. As a result of this inhibition, cardiac concentrations of cAMP are elevated, and a sympathomimetic effect on the heart is achieved. Inamrinone and milrinone also reduce arterial and venous pressures because of the increase in vascular smooth muscle relaxation, which aids in relieving heart failure. The latter effect is the major mechanism operable in heart failure patients.

Inamrinone and milrinone are available for intravenous use. The half-lives of inamrinone and milrinone are approximately 4 to 6 hours (inamrinone) and 3 hours (milrinone). Adverse effects of inamrinone include nausea and vomiting, thrombocytopenia, hepatotoxicity, cardiac arrhythmias, and fever. Milrinone is less likely to cause thrombocytopenia and more likely to cause arrhythmias. The drugs are used clinically for short-term use, especially in cases in which the heart is refractory to other cardiotoxic agents and vascular resistance is elevated. Studies have failed to show long-term benefits, however, and evidence indicates that survival is worsened with long-term administration because of an arrhythmogenic effect of the drugs.

Directly Acting Vasodilators

Nitroprusside and nitroglycerin are sometimes used for acute treatment of heart failure. These drugs are discussed in Chapters 28 (nitroprusside) and 26 (nitroglycerin).

Ca⁺⁺ Sensitizers

Although not yet available in the United States, another strategy in treating heart failure is the use of Ca⁺⁺ sensitizers. These agents increase the sensitivity of the myofilaments to Ca⁺⁺ without overloading the Ca⁺⁺ in the cell or increasing heart rate.⁸ It remains to be seen if these drugs will become useful clinical drugs. Levosimendan is an investigational drug that works by this mechanism.

IMPLICATIONS FOR DENTISTRY

Stress Factors

The practitioner should strive to eliminate needless stress for cardiac patients, especially anxiety or pain associated with dental procedures. Patients being treated for heart failure possess limited cardiac function. These patients are at special risk in stressful situations because stress puts a greater workload on the heart and stimulates the release of endogenous catecholamines. By increasing the likelihood of ectopic pacemaker activity of the heart and possibly by temporarily decreasing plasma K⁺ concentrations, catecholamines increase the risk of digoxin-induced arrhythmias. Fear and apprehension may also increase the likelihood of adverse CNS reactions to digoxin. One practical conclusion is that anti-anxiety therapy or analgesics should be used preemptively if emotional stress or pain is likely.

Drug Interactions

The use of catecholamines in local anesthetic injections for patients taking digoxin is not contraindicated but should be approached with special caution. Proper injection technique to avoid intravascular injection should be followed. Many factors influence the decision to use vasoconstrictors in local anesthetic solutions, including the ability to achieve adequate anesthesia without vasoconstrictors and the volume of anesthetic solution required. The chief danger of sympathomimetic vasoconstrictors for patients taking digoxin is that the combination of drugs increases the risk of cardiac arrhythmias if significant amounts of vasoconstrictor enter the vascular space.

The use of gingival retraction cords impregnated with epinephrine is not recommended in patients taking digoxin. Cardiac disease in general is a contraindication for their use. Considerable amounts of vasoconstrictor may be absorbed systemically from these retraction cords, and the possibility of cardiac arrhythmias developing is significant. If hemostatic retraction cords are to be used in patients who are on digoxin, the cords should be impregnated with an astringent in place of a vasoconstrictor.

The effects of digoxin on the SA node, the atria, and the AV node are mediated primarily by the vagus nerve. Many beneficial effects of digoxin depend on vagal influences, especially in the treatment of atrial fibrillation. Muscarinic and antimuscarinic drugs can influence digoxin therapy. Antisialagogues such as atropine and methantheline should not be used in patients taking digoxin because they tend to reduce the effects of digoxin. Muscarinic receptor agonists such as pilocarpine enhance the effect of digoxin on the SA node, the atria, and the AV node.

Antibiotic therapy may alter the intestinal flora and, in so doing, increase the absorption of digoxin in patients whose gastrointestinal flora metabolizes digoxin. Erythromycin, and presumably other macrolides, has been shown to have this effect. Tetracyclines also seem to interact through this mechanism. When the need arises, concurrent antibiotic therapy, especially with erythromycin (or other macrolide) or a broad-spectrum antibiotic, should be undertaken with sufficient cognizance given to its possible interaction with digoxin. Other dental drug interactions are discussed in chapters in which other drugs addressed in this chapter are discussed in greater detail.

Adverse Effects of Dental Importance

Excessive salivation may be a sign of toxicity owing to digoxin. Adverse effects related to dentistry for other drugs used in the treatment of heart failure are discussed in Chapters 27 and 28.

DRUGS USED IN TREATING HEART FAILURE

<i>Nonproprietary (generic) name</i>	<i>Proprietary (trade) name</i>
Diuretics (see loop and thiazide diuretics*)	
ACE inhibitors	
Benazepril	Lotensin
Captopril	Capoten
Enalapril	Vasotec
Fosinopril	Monopril
Lisinopril	Zestril
Moexipril	Univasc
Perindopril	Aceon
Quinapril	Accupril
Ramipril	Altace
Trandolapril	Mavik
Angiotensin II receptor blockers	
Candesartan	Atacand
Eprosartan	Teveten
Irbesartan	Avapro
Losartan	Cozaar
Olmesartan	Benicar
Telmisartan	Micardis
Valsartan	Diovan

DRUGS USED IN TREATING HEART FAILURE—cont'd

<i>Nonproprietary (generic) name</i>	<i>Proprietary (trade) name</i>
β Blockers	
Bisoprolol	Zebeta
Carvedilol	Coreg
Metoprolol	Lopressor
Aldosterone antagonists	
Eplerenone	Inspira
Spironolactone	Aldactone
Directly acting vasodilators	
Hydralazine + isosorbide dinitrate	BiDil
Cardiac glycosides	
Digoxin	Lanoxin
Drugs for acute treatment	
Dobutamine	Dobutrex
Dopamine	Intropin
Inamrinone	Inocor IV
Milrinone	Primacor
Nesiritide	Natrecor
Nitroglycerin	—
Nitroprusside	Nitropress

*Diuretics are discussed in Chapter 27.
ACE, Angiotensin-converting enzyme.

CITED REFERENCES

- Ahmed A, Rich MW, Fleg JL, et al: Ancillary Digitalis Investigation Group Trial: Effects of digoxin on morbidity and mortality in diastolic heart failure: the ancillary digitalis investigation group trial, *Circulation* 114:397-403, 2006.
- Ahmed A, Rich MW, Love TE, et al: Digoxin and reduction in mortality in hospitalization in heart failure: a comprehensive post hoc analysis of the DIG trial, *Eur Heart J* 27:178-186, 2005.
- BiDil for heart failure. *Med Lett Drug Ther* 47:77-78, 2005.
- Birks EJ, Tansley PD, Hardy J, et al: Left ventricular assist device and drug therapy for the reversal of heart failure, *N Engl J Med* 355:1873-1884, 2006.
- Cattell M, Gold H: The influence of digitalis glucosides on the force of contraction of mammalian cardiac muscle, *J Pharmacol Exp Ther* 62:116-125, 1938.
- Colucci WS, Elkayam U, Horton DP: Nesiritide Study Group: Intravenous nesiritide, a natriuretic peptide, in the treatment of decompensated congestive heart failure, *N Engl J Med* 343:246-253, 2000.

- Drugs for treatment of heart failure, *Treatment Guidelines Med Lett* 4:1-4, 2006.
- Erhardt L: An emerging role for calcium sensitization in the treatment of heart failure, *Expert Opin Invest Drugs* 14:659-670, 2005.
- Feldman DS, Sun B: Practical application of human B-type natriuretic peptide as a therapeutic intervention in the perioperative setting, *Heart Fail Rev* 9:203-208, 2004.
- Jessup M, Brozena S: Medical progress: heart failure, *N Engl J Med* 348:2007-2018, 2003.
- Kelly RA, Smith TV: Antibody therapies for drug overdose. In Austen KF, Burakoff SJ, Rosen FS, et al, editors: *Therapeutic immunology*, Boston, 2001, Blackwell Scientific.
- Lygren B, Tasken K: Compartmentalized cAMP signaling is important in the regulation of Ca(2+) cycling in the heart, *Biochem Soc Trans* 34:489-491, 2006.
- McMurray JJV, O'Meara E: Treatment of heart failure with spironolactone—trial and tribulations, *N Engl J Med* 351:526-528, 2004.
- Mason DT: Regulation of cardiac performance in clinical heart disease: interactions between contractile state mechanical abnormalities and ventricular compensatory mechanisms, *Am J Cardiol* 32:437-448, 1973.
- SOLVD investigators: Effect of enalapril on survival in patients with reduced left ventricular ejection fractions and congestive heart failure, *N Engl J Med* 325:293-302, 1991.
- Sonnenblick EH, Williams JF Jr, Glick G, et al: Studies on digitalis, XV: effects of cardiac glycosides on myocardial force-velocity relations in the nonfailing human heart, *Circulation* 34:532-539, 1966.
- Taylor AL, Ziesche S, Yancy C, et al: African-American Heart Trial Investigators: Combination of isosorbide dinitrate and hydralazine in blacks with heart failure, *N Engl J Med* 351:2049-2057, 2004.
- Thohan V, Torre-Amione G, Koerner MM: Aldosterone antagonism and congestive heart failure: a new look at an old therapy, *Curr Opin Cardiol* 19:301-308, 2004.
- Withering W: *An account of the foxglove, and some of its medical uses; with practical remarks on dropsy, and other diseases*, London, 1785, CGJ and J Robinson (reprinted in *Med Classics* 2:305-443, 1937).
- Xiao R-P, Zhu W, Zheng M, et al: Subtype-specific β-adrenoceptor signaling pathways in the heart and their potential clinical implications, *Trends Pharmacol Sci* 25:358-365, 2004.
- Yano M, Yamamoto T, Ikemoto N, et al: Abnormal ryanodine receptor function in heart failure, *Pharmacol Therap* 107:377-391, 2005.

GENERAL REFERENCES

- Colucci WS, editor: *Atlas of heart failure*, Philadelphia, 2007, Current Medical Group.
- Fonarow GC, guest editor: Neurohumoral modulators in heart failure, *Heart Fail Clin*, vol 1, Philadelphia, 2005, Elsevier.
- Greenberg BH, Barnard DD: *Contemporary diagnosis and management of heart failure*, ed 3, Newtown, PA, 2005, Handbooks in Health Care Co.

Antianginal Drugs

EILEEN L. WATSON AND FRANK J. DOWD

Angina pectoris (from the Latin, literally meaning “pain in the chest”) is usually manifested as severe, transient, retrosternal pain that sometimes radiates to the left arm, back, or jaw. It is frequently accompanied by fear, anxiety, feelings of suffocation, and a sensation of tightening of the chest. There is a wide variation among individuals in the intensity and quality of the pain, and some ischemic episodes may occur without prominent symptoms. The pain and associated changes in the electrocardiogram (e.g., depressed ST segment) result from ischemia (hypoxia) of some area of the myocardium, usually a subendocardial area. The most frequent pathologic cause of angina is epicardial coronary artery atherosclerosis leading to compromised blood flow and reduced oxygen delivery to a region of the myocardium. Angina may also result from vasospasm; the coronary vasoconstriction frequently occurs at an atherosclerotic site on the artery.

As shown in Figure 26-1, the normal response to increased myocardial oxygen demand is satisfied by vasodilation of the small coronary resistance vessels, increased blood flow, and increased oxygen supply. In contrast, in the classic anginal patient with exertional (exercise-induced) episodes, significant sclerosis (>70% narrowing of the luminal diameter) of the large conductance arteries precludes increased vasodilation in response to increased myocardial work because the poststenotic resistance vessels are already dilated, and the resultant demand for oxygen cannot be met. Cardiac determinants of oxygen consumption and factors that can precipitate changes in these determinants are also shown in Figure 26-1.

The intraventricular pressure is important in determining flow in subendocardial regions because of compression of blood vessels in the involved area. Coronary blood flow occurs primarily during diastole, when the intraventricular pressure is least. Increased heart rate decreases the diastolic time more than the systolic and requires increased oxygen supply in concert with the increased rate of metabolism. Alterations of ventricular size also cause concurrent changes in ventricular work and oxygen demand. Finally, the inotropic state of the myocardium is also a factor in determining oxygen consumption. An important control of myocardial contractility is exerted by the sympathetic nervous system through catecholamine release.

It is beyond the scope of this chapter to consider in detail the specific changes in the cardiac determinants of myocardial oxygen consumption caused by each of the factors that may precipitate an anginal attack. It is sufficient to say that any factor that compromises the balance between oxygen demand and oxygen supply may cause an attack of angina. Anginal pain may follow exercise, emotional upset, or exposure to cold or may occur after meals or smoking. Certain individuals have nocturnal attacks of angina, probably because recumbent posture can increase venous return to the heart and cardiac

work. Anginal attacks in susceptible patients may also result from self-medication with various drugs, such as cocaine and cold remedies that contain sympathomimetic agents.

There are three types of angina pectoris: chronic stable angina (classic exertional angina), variant (Prinzmetal's) angina, and unstable angina (also known as *preinfarction angina*, *intermediate coronary syndrome*, *acute coronary insufficiency*, and *accelerated angina*). Chronic stable angina occurs in patients who have fixed atherosclerotic coronary artery disease. Pain in these individuals occurs when the myocardial oxygen requirement reaches a given stable value. Variant angina occurs as a result of coronary artery spasm and a subsequent decrease in coronary blood flow and oxygen supply. These patients usually also exhibit coronary atherosclerosis, although it may be minimal in some. Variant angina is characterized by chest pain occurring at rest and, frequently, during sleep. The third type, unstable angina, refers to a new onset of severe, frequent angina, anginal pain at rest, or a sudden worsening of pain in a patient with previously stable exertional angina.¹⁸ The cause of unstable angina is often sudden platelet aggregation or plaque emboli in coronary vessels. Most of these patients have severe coronary artery disease; coronary spasm may also be involved. Of patients with chest pain, 30% have unstable angina, and it was estimated that 20% of these patients will have a myocardial infarct within a year and most within a month.¹¹ More recent studies suggest that compared with conservative management, early invasive treatment of patients with unstable angina using coronary angiography with or without revascularization reduces mortality and myocardial infarction at 2 and 5 years.¹⁰

Six classes of drugs are used extensively in the treatment of angina pectoris; Figure 26-2 shows the sites of action of β -adrenergic receptor blockers, Ca^{++} channel blockers (CCBs), and nitrates/nitrites. The first class, organic nitrites and nitrates, comprises drugs (e.g., sublingual nitroglycerin) that provide immediate relief from anginal symptoms or provide prophylaxis of an attack and nitrate formulations (e.g., topical nitroglycerin, oral isosorbide dinitrate) that are promoted for long-term protection from anginal episodes.

The second class contains β -adrenergic receptor-blocking agents (β blockers). These drugs are administered on a long-term basis, frequently in conjunction with organic nitrates, to decrease the frequency and severity of anginal attacks.

The third class of drugs useful in the management of angina comprises calcium channel blockers (CCBs). This class includes verapamil, diltiazem, nifedipine, and others. These agents, similar to the β blockers, are used prophylactically in angina therapy.

The fourth class of drugs targets blood-clotting mechanisms and comprises aspirin, other antiplatelet drugs, and anticoagulants. Aspirin is used to treat stable and unstable

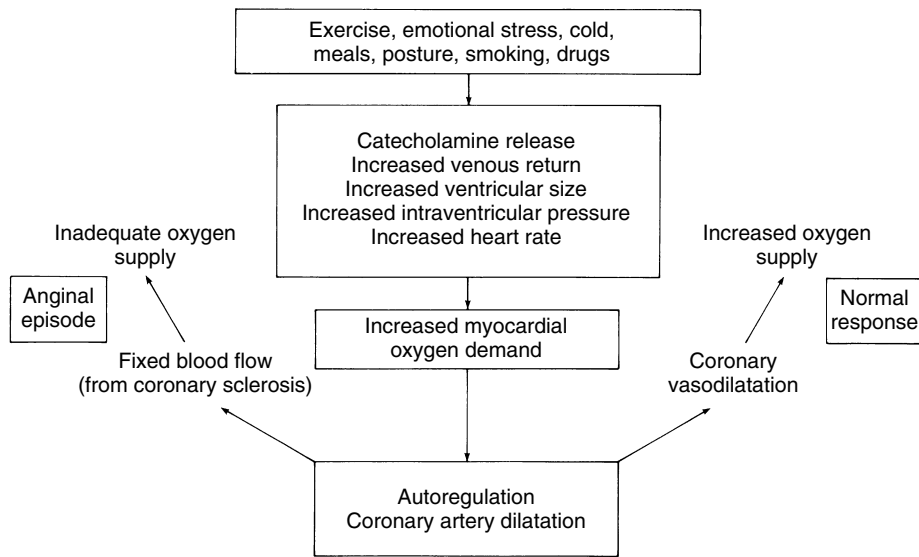

FIGURE 26-1 Pathophysiologic characteristics and precipitating causes of classic angina pectoris.

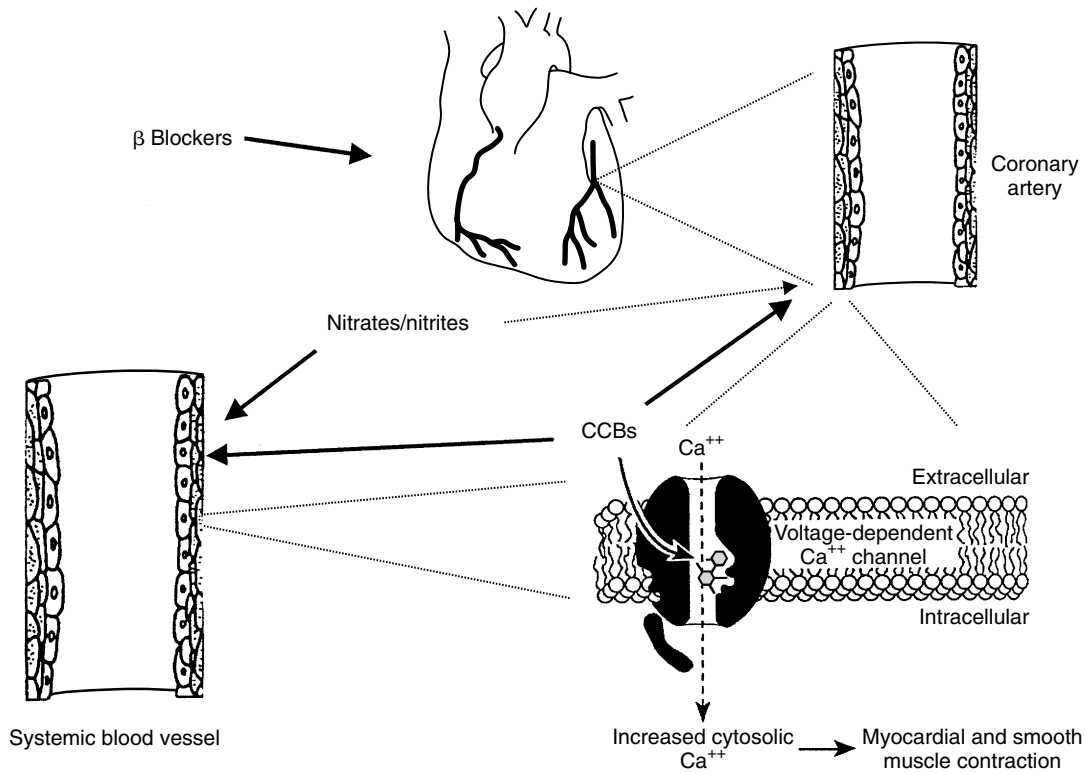

FIGURE 26-2 Sites of action of β -adrenergic receptor blockers, Ca^{++} channel blockers (CCBs), and nitrates/nitrites. β Blockers reduce the rate and contractility of the heart, reducing energy and oxygen demand of the heart. CCBs reduce vasoconstriction in coronary and noncoronary vessels, increasing coronary blood flow and reducing cardiac load. The nitrates/nitrites act primarily on systemic blood vessels to reduce cardiac load. The effect on coronary arteries is less a factor in alleviating classic angina but plays a major role in variant angina. Three anatomic levels are shown: cardiac anatomy, cell layers of the blood vessel walls, and a blood vessel smooth muscle cell membrane showing a Ca^{++} channel and the effect of CCBs in preventing Ca^{++} entry.

angina. The pharmacologic features of aspirin are discussed in detail in Chapter 21. It acts by inhibiting platelet aggregation through irreversible inhibition of cyclooxygenase.

The fifth class is represented by ranolazine, which was approved by the U.S. Food and Drug Administration in 2006

for the treatment of chronic angina in patients who have failed to respond to other angina therapy. The sixth class is represented by trimetazidine, a novel anti-ischemic drug with properties unrelated to changes in myocardial oxygen supply/demand ratio.³ Trimetazidine is considered to be a metabolic

agent that modifies substrate use in chronic heart failure.¹ This drug can lessen oxidation of free fatty acids via inhibition of the enzyme long-chain 3-ketoacyl coenzyme A thiolase, which is crucial in the β -oxidation pathway. Trimetazidine has a favorable side-effect profile and exhibits no notable vasodilator properties at rest or during dynamic exercise.¹⁵ It is not discussed further.

NITRITES AND NITRATES

Amyl nitrite was introduced for use in angina pectoris in 1867, and nitroglycerin (glyceryl trinitrate) was introduced in 1879. Since then, nitroglycerin has remained the drug of choice for the relief of acute symptoms of angina pectoris. Nitroglycerin is administered sublingually as a tablet or aerosol spray and has a quick onset and short duration of action. Various organic nitrates and sustained-release forms of nitroglycerin have been developed in attempts to find a suitable, long-lasting preparation for the control and prevention of anginal pain. Amyl nitrite is used by inhalation for angina pectoris. Its use in the treatment of cyanide poisoning is discussed in Chapter 52.

Chemistry

Nitroglycerin is chemically a simple compound. Figure 26-3 shows its structure and, for comparison, the structures of some of the other organic nitrates marketed for oral, topical, sublingual, buccal, inhalant, or intravenous administration. All nitrites and nitrates with antianginal activity are esters of nitrous or nitric acid. Organic nitrites and nitrates are capable of being metabolized to yield the free radical nitric oxide (NO). Research in this area led to the Nobel Prize for Physiology/Medicine being awarded in 1998 to Robert Furchgott, Louis Ignarro, and Ferid Murad for their discovery of NO as a signaling molecule in the cardiovascular system. Previous studies had identified a vasodilator substance released from endothelial cells and referred to as *endothelium-derived relaxing factor*. Experimental evidence from several laboratories indicates that endothelium-derived relaxing factor is NO.¹² NO is the active intermediate of vasoactive nitrites and nitrates, which are appropriately

referred to collectively as *nitrovasodilators*. (See Figure 8-3 for further information on NO.)

Pharmacologic Effects

The pharmacologic effects of all the members of this class are similar and result from actions of NO released by denitration reactions of the parent drugs in the tissues. It is likely that mitochondrial aldehyde dehydrogenase plays an essential role in the synthesis of NO from nitroglycerin bioactivation, resulting in dilation of blood vessels.⁶ NO has been shown to stimulate the synthesis of cyclic 3',5'-guanosine monophosphate (cGMP) by a direct action on cytosolic guanylyl cyclase or indirectly by being converted to S-nitrosothiols, which stimulate the enzyme (Figure 26-4; see also Figure 8-3). cGMP initiates a cascade of reactions involving cGMP-dependent protein kinases leading to the various cellular responses that relax vascular smooth muscle.

The most important action of nitrovasodilators is the direct relaxation of vascular smooth muscle by the metabolite NO, resulting in vasodilation first in veins at low doses and then in arteries at higher doses. Nitroglycerin has been shown to cause varying degrees of change in coronary flow in normal and diseased mammalian hearts. Its efficacy in the various types of angina is attributed in part to a preferentially increased oxygen supply to ischemic areas, with variable actions on total coronary blood flow. More important, through a reduction in venous tone, there is a reduction in venous pressure, pulmonary arterial pressure, and end-diastolic filling pressure. These actions lead to a decrease in ventricular volume, producing a decrease in intramyocardial tension and a decline in myocardial oxygen demand. Nitrovasodilators tend to cause redistribution of coronary blood flow to the more ischemic areas. As implied earlier, arterial smooth muscle is relaxed by these drugs, although to a lesser degree than venous smooth muscle. The efficacy of nitrates and nitrites in relieving variant angina probably stems from a direct alleviation of coronary artery spasm.

Nitrates and nitrites also relax nonvascular smooth muscle. Bronchial, biliary, and gastrointestinal smooth muscle is relaxed. This action is the basis for the use of nitrates such as isosorbide dinitrate for the treatment of esophageal spasms. The major use of these drugs is based, however, on their cardiovascular actions.

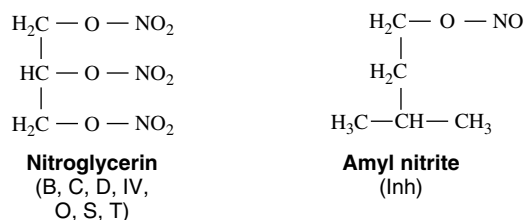
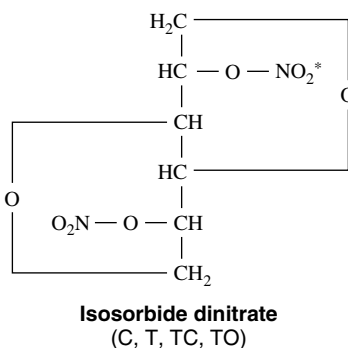

FIGURE 26-3 Structural formulas and methods of administration of selected organic nitrates and amyl nitrite. *B*, Buccal (transmucosal) tablet; *C*, sustained-release capsule or tablet; *D*, transdermal disk; *Inh*, inhalant; *IV*, intravenous injection; *O*, ointment; *S*, lingual spray; *T*, sublingual tablet; *TC*, chewable tablet; *TO*, oral tablet or capsule.



*The nitrate group is replaced by a hydrogen atom in **isosorbide mononitrate** (C, TO).

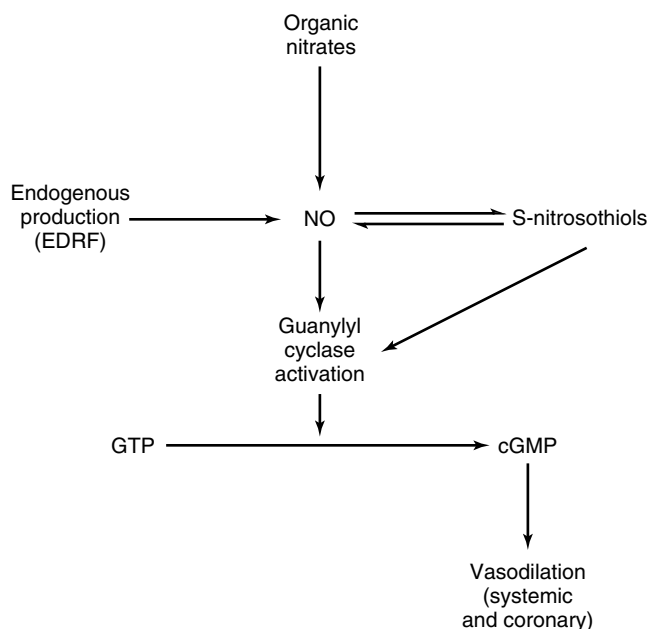

FIGURE 26-4 Major mechanism of action of organic nitrates and nitrites. *EDRF*, Endothelium-derived relaxing factor; *GTP*, guanosine triphosphate.

Absorption, Fate, and Excretion

Nitroglycerin is rapidly absorbed after sublingual administration (onset 1 to 3 minutes, duration 30 to 60 minutes). An advantage of the aerosol spray over the sublingual tablet is the better absorption in patients with dry mucous membranes. Nitroglycerin has a much slower onset when applied topically to the skin in a patch or ointment, but has a comparably longer duration of action. Although organic nitrates administered orally are readily absorbed, they are extensively metabolized during the first pass through the liver.

In addition to undergoing denitration reactions in tissues, nitrates are metabolized in the liver by glutathione–organic nitrate reductase. The products of hepatic biotransformation, including the released nitrite ions, are much less effective than the parent compound; they are subsequently excreted in the urine, at least in part, in the form of glucuronide conjugates. Isosorbide dinitrate is exceptional because its principal metabolite, the mononitrate, is responsible for most of its action and is now available separately for clinical use.

Long-Acting Drugs

Although sublingual nitroglycerin is highly effective for the treatment of acute anginal episodes, its short duration of action makes it unsuitable for long-term prophylaxis. Several nitrates formulated for oral administration have been marketed for many years for the prevention of anginal attacks. The vasodilatory effects of isosorbide dinitrate were discovered in the 1930s, and the drug was introduced in the 1960s as an oral preparation. When administered sublingually, isosorbide dinitrate (see Figure 26-3) was shown to be comparable to nitroglycerin. When administered orally in recommended dosages, this compound offered no protection against exercise-induced angina. Subsequent investigations showed, however, that large doses of isosorbide dinitrate (and nitroglycerin) improve exercise tolerance in patients with angina. There is a concomitantly increased possibility of drug toxicity.

Newer long-acting mononitrates, which are major active metabolites of isosorbide dinitrate, offer the advantage of improved bioavailability because they avoid first-pass hepatic

elimination. Isosorbide-5-mononitrate, which is at least as effective as isosorbide dinitrate, is available as immediate-release tablets and as a sustained-release formulation for once-daily administration. The clinical efficacy of a single dose of isosorbide mononitrate formulated as a 30% immediate-release/70% sustained-release formulation is observed within a few minutes to increase work and exercise capacity.² More recent evidence indicates that nitrates reduce platelet aggregation and adhesion in patients with acute myocardial infarction. This finding suggests a possible added benefit of nitrates.⁹

To avoid the first-pass phenomenon that plagues orally administered nitrates, nitroglycerin has been prepared in several other forms. The first of these, nitroglycerin ointment, is effective prophylactically, but it must be administered every 3 to 4 hours. A further development is the nitroglycerin transdermal system, which comes in the form of an adhesive patch. When applied to the skin, the transdermal patch slowly releases nitroglycerin over a 24-hour period. This system minimizes the potential for toxicity inherent in large-dose oral administration, and it overcomes the inconvenience and frequency of application associated with the ointment. Nitroglycerin is also marketed in a transmucosal preparation. Supplied in a matrix, the drug is made available in a sustained-release fashion when placed between the upper lip and teeth. Swallowing or chewing increases the rate of absorption and could lead to toxicity. The advantages of this preparation are its rapid onset and extended action.

One problem shared by all the long-acting preparations is the development of tolerance. *In vitro* studies suggest that the causes include volume expansion and tissue tolerance resulting partly from enzyme changes. Such tolerance is not observed with the intermittent administration of sublingual nitroglycerin. Intermittent transdermal administration (12 hours on, 12 hours off) has been used to avoid the development of tolerance; however, questions still remain concerning the increased risk of precipitating unstable angina and myocardial infarction during the nontreated periods, especially if they occur during the early morning hours.

Nitrates have a place in the prophylactic treatment of patients with angina pectoris because their efficacy is not in doubt. Some practical problems are associated with their use, however, such as unreliable absorption, short duration of action, treatment-induced headache, development of nitrate tolerance, and a suggested rebound phenomenon observed during intermittent dosing. Patient convenience regarding the treatment schedule should also be considered. Controlled-release formulations that produce sufficiently high nitrate concentrations during part of the day, followed by nitrate-poor rather than nitrate-free intervals, have the potential to prevent tolerance and rebound phenomena and to produce a sufficiently long duration of action with a convenient once-daily regimen. The combination of immediate and sustained-release formulations, used once daily, produces a fast onset of action and a longer period during which nitrate concentrations are sufficient to prevent ischemia during the active part of the day.² During the night, nitrate levels decrease but offer some protection with low risk of tolerance.

Adverse Effects

Almost all side effects of these drugs are direct results of their effects on the cardiovascular system. Headache, due to dilation of meningeal arteries, is the most common untoward response and can be very severe.¹⁶ Tolerance to this effect may develop in some patients before tolerance to other cardiovascular effects occurs. Orthostatic hypotension resulting in reflex tachycardia, cerebral ischemia, weakness, dizziness, flushing, and syncope may follow drug administration. Syncope is likely to occur if the patient is standing and immobile while taking medication or has ingested alcoholic beverage.

ages. Nitrates should not be administered to a patient taking sildenafil (Viagra) because severe, long-lasting hypotension may occur. Significant hypotension may cause anginal pain if coronary blood flow is compromised. Because it dramatically reduces placental blood flow, amyl nitrite is contraindicated for use in pregnant women (pregnancy risk category X; see Table 3-7).

Nitrite ions and high doses of nitrates readily oxidize hemoglobin to methemoglobin; large amounts of methemoglobin can seriously impair the oxygen-carrying capacity of the blood, resulting in anemic hypoxia. Infants are especially sensitive to this effect of nitrates because of their relative inability to reduce methemoglobin back to hemoglobin. Drug rash occasionally may occur, most frequently with topical nitroglycerin.

β-ADRENERGIC RECEPTOR-BLOCKING DRUGS

The history and pharmacology of β-blocking agents are reviewed in depth in Chapter 7. In addition, the use of these compounds in the treatment of cardiac arrhythmias and hypertension is discussed in Chapters 24 and 28. Discussion here is limited to the role that these drugs play in the management of angina pectoris.

Several β blockers are available for use in the treatment of angina pectoris. All these drugs, whether or not they have partial agonist activity, membrane-stabilizing actions, or general or selective β-blocking properties, can increase the pain-free work capacity of patients with angina pectoris. Some of the most frequently used agents for this purpose include propranolol, metoprolol, atenolol, and nadolol. Selection of β blockers depends on other clinical factors. Cardioselective agents are advantageous in patients who have pulmonary disease or peripheral vascular disease. Consideration must be given to the dosage used, however, because all β-blocking drugs have nonselective effects at higher dosages (see Chapter 7).

Pharmacologic Effects

Because exercise and emotional stress are possible precipitating factors in angina (see Figure 26-1), increases in sympathetic nervous system activity can bring on attacks of angina in susceptible individuals. The blockade of adrenergic responses can be beneficial in the treatment of this condition. Effects of β blockers that are helpful in treating angina include decreased heart rate and protection from reflex tachycardia, depressed myocardial contractility, decreased cardiac output, and, in some cases, reduced blood pressure. These effects are more prominent when sympathetic activity is elevated, such as during exercise or emotional stress. Total coronary blood flow may be reduced after β receptor blockade, but this reduction in flow seems to be in well-perfused areas and is not detrimental in classic angina. Drug-induced vasoconstriction (from unopposed α receptor activity) may be problematic, however, in patients with variant angina.

The beneficial effect of β receptor-blocking drugs in angina probably results from their common action: blockade of cardiac β-adrenergic receptors. Although exercise tolerance is improved with β-adrenergic blockade, and changes in heart rate and blood pressure with exercise are blunted, the rate-pressure product (heart rate × systolic arterial pressure) at which pain occurs is decreased. This finding explains why exercise tolerance is increased less than might be expected on the basis of simple single cardiovascular measurements.

Absorption, Fate, and Excretion

The absorption, fate, and excretion of β-adrenergic receptor antagonists are discussed in Chapter 7.

Use in Treatment of Angina

As mentioned previously, most β blockers are effective in treating the various types of angina pectoris. Their use is questionable, however, in the management of variant angina in the absence of other drugs. Long-term administration of β blockers can make the attacks of angina less frequent and individual attacks less severe. Nonetheless, patients receiving long-term treatment with β-blocking agents usually still require nitroglycerin for the treatment of acute anginal attacks. This combined drug therapy with a β-adrenergic antagonist and nitroglycerin or a related drug works well because the drugs have different mechanisms of action. In addition, nitrates and β-adrenergic antagonists may work especially well together in angina because β blockers inhibit the reflex tachycardia caused by nitrates and because nitrates (by causing vasodilation) reduce the preload and afterload of the heart and tend to reduce the impact of a negative inotropic effect from β receptor blockade.

Adverse Effects

As mentioned in Chapter 7, blockade of β receptors may cause bronchoconstriction or prevent the normal response to insulin-produced hypoglycemia in susceptible patients. These problems are less severe with the more selective β₁ blockers, such as metoprolol, which have been used without serious adverse effects in some patients with bronchospastic disease. Drugs such as metoprolol are β₁-selective, not β₁-specific, however, and are capable of eliciting bronchospasm in susceptible patients. Because of the association between β₂-adrenergic receptors and glycogenolysis and gluconeogenesis in the liver, β₁-selective blockers are associated with less risk of hypoglycemic reactions in diabetics than the nonselective β receptor blockers.

A problem encountered with selective and nonselective blockers, because they are related to the inhibition of cardiac β receptors, is that severe myocardial depression and heart failure may occur if initial dosages are too high or if there is concomitant myocardial incompetence (see Chapter 25 for a discussion of the use of β blockers in the treatment of heart failure). For this reason, dosages should be gradually increased until concentrations offering therapeutic effects in the management of angina are reached. The sudden discontinuance of β blockers has been implicated in rebound overstimulation of the heart, worsening of angina, and myocardial infarction.

Ca⁺⁺ CHANNEL BLOCKERS

CCBs are also referred to as *Ca⁺⁺ entry blockers* and less accurately as *Ca⁺⁺ antagonists*. These drugs exert their effect on voltage-dependent Ca⁺⁺ channels in vascular smooth muscle and cardiac muscle (see Figure 26-2). This class of drugs (Figure 26-5) includes verapamil, nifedipine, diltiazem, and several other agents. Many of these compounds have been shown to be effective in the prophylactic treatment of chronic stable exertional angina, variant angina, and unstable angina. They have also proved to be useful in the treatment of other cardiovascular disorders, such as supraventricular tachyarrhythmias and hypertension (see Chapters 24 and 28). Additional indications for certain CCBs include peripheral vascular disease, pulmonary hypertension, hypertrophic cardiomyopathy, and cerebral vasospasm after subarachnoid hemorrhage.

Chemistry and Classification

Verapamil, the first CCB, is a diphenylalkylamine derivative. The only member of its type clinically available, verapamil is closest in pharmacologic profile to diltiazem, a benzothiazepine. The largest category of CCBs consists of dihydropyri-

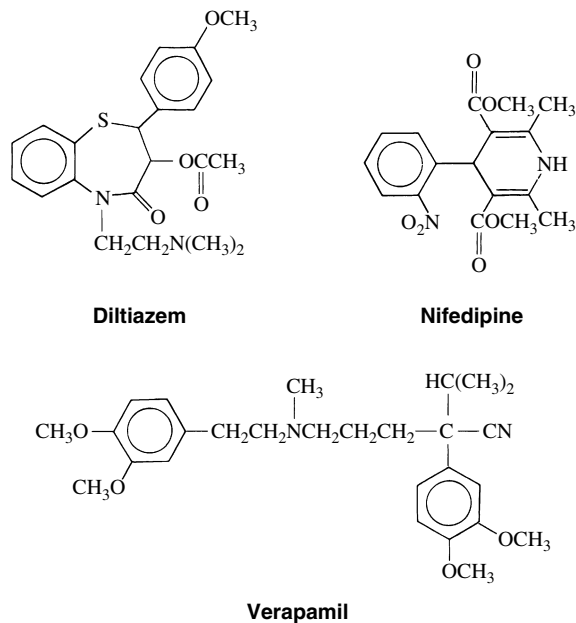

FIGURE 26-5 Structural formulas of some Ca^{++} channel blockers.

BOX 26-1

Cardiovascular Responses to Inhibition of Transmembrane Ca^{++} Influx by Ca^{++} Channel Blockers

Myocardium

Excitation-contraction uncoupling
Prevention of Ca^{++} overload

Specialized Pacemaker and Conducting Tissues

Reduction of automaticity
Damping of ectopic pacemakers
Inhibition of re-entrant pathways

Vasculature

Vasodilation
Protection against Ca^{++} deposition in vessel walls

dines, of which nifedipine is the prototype. Dihydropyridines are characterized by their prominent arterial vasodilatory properties and relative lack of direct cardiac actions.

Pharmacologic Effects

CCBs exert their primary action on Ca^{++} channels that carry the slow inward Ca^{++} current. CCBs differ from local anesthetics, which are primarily fast channel blockers inhibiting the rapid inward influx of Na^+ . Although the primary action of CCBs is on the slow current, they may also act through other mechanisms. Diltiazem, especially at higher doses, has been shown to depress the Na^+ or fast channels.

Some of the diverse effects of CCBs can be explained by the roles that Ca^{++} and slow channels have in different cardiovascular cell types (Box 26-1). In the sinus and atrioventricular (AV) nodes, slow channels are the primary conduit for the generation and propagation of action potentials. They may additionally be involved in regulating sinus node automaticity by altering diastolic depolarization. Ca^{++} channels also govern

conduction velocity in the AV node. The actions of CCBs as antiarrhythmics are discussed in Chapter 24.

CCBs directly and preferentially block voltage-dependent Ca^{++} channels as opposed to receptor-operated channels. By this mechanism, they reduce intracellular Ca^{++} activity and interfere with the replenishment of Ca^{++} stores in vascular smooth muscle. Tonic and phasic muscle contractions are depressed in a dose-dependent manner. The major types of voltage-dependent Ca^{++} channels are designated *L*, *N*, and *T*. Only the *L* (large, long-lasting current) channel is inhibited by CCBs. Verapamil, diltiazem, and the nifedipine-like CCBs apparently bind to different receptor sites on the *L* channel. The degree of binding is influenced by the functional state of the channel (resting, open, or inactivated) in a manner similar to the use dependency described for local anesthetics and Na^+ channels (see Chapter 16). A CCB of one chemical classification can also affect the binding of another, positively or negatively, through allosteric mechanisms.

CCBs induce coronary and peripheral arterial dilation. Their action on coronary vessels is especially prominent in vessels that undergo transient vasospasm in variant angina. The vasodilator action in large measure explains their use as antianginals and antihypertensives.

Although all CCBs directly depress the myocardium and slow conduction velocity in the heart, the overall response in vivo depends on the relative mix of direct and indirect effects of each drug on the cardiovascular system. For verapamil and diltiazem, the direct cardiac effects usually predominate (Table 26-1). Nifedipine and other dihydropyridine CCBs typically elicit prominent vasodilation at doses that do not greatly affect Ca^{++} channels in the heart. Reflex sympathetic activity causes an increase in heart rate and conduction through the AV node and may result in a net positive inotropic effect. Factors that contribute variety to the pharmacologic profile of the different CCBs include the drugs' binding dependence on the frequency of stimulation of the tissue, their binding characteristics to *L* channels in different tissues, and, at least with some agents, their ability to influence other voltage-gated ion channels.

CCBs are important drugs in the treatment of all forms of angina pectoris. They inhibit Ca^{++} flux in cardiac and smooth muscle and are effective in the treatment of stable angina because of their coronary vasodilator effect, negative inotropic and chronotropic effects, enhancement of diastolic relaxation of the left ventricle, and hypotensive effect mediated through peripheral arterial dilation. These effects lead to an increase in coronary blood flow and myocardial perfusion with a decrease in myocardial oxygen demand.

Absorption, Fate, and Excretion

All CCBs are rapidly and almost completely absorbed after oral administration. Bioavailability is reduced, however, by extensive first-pass hepatic metabolism. To extend their duration of action, many CCBs are marketed in sustained-release formulations. Verapamil and diltiazem are converted in part to active metabolites; biotransformation of nifedipine causes complete inactivation. Most CCBs are highly protein bound, especially to plasma albumin. Excretion of the metabolites is primarily by the kidney.

Use in the Treatment of Angina

CCBs as a class have been shown to be effective in the treatment of all types of angina regardless of whether coronary spasm is involved. They seem to be especially effective in preventing coronary vasospasm. In chronic stable exertional angina, CCBs may afford relief of pain through one or more mechanisms: coronary and peripheral vasodilation, attenuation of increased heart rate caused by exercise, or a negative inotropic effect on the heart.

TABLE 26-1

Comparative Pharmacologic Effects of Ca⁺⁺ Channel Blockers

PARAMETER	VERAPAMIL	DILTIAZEM	NIFEDIPINE	NIMODIPINE	BEPRIDIL
Heart rate	↑, ↓	0, ↓	↑	0	↓
Sinoatrial node automaticity	↓↓	↓↓	0, ↓	0, ↓	↓
AV conduction	↓↓↓	↓↓	0	0	↓
Myocardial contractility	↓↓	↓	↓*	0	↓
Cardiac output	↑, ↓	0, ↑	↑↑	0	0
Peripheral vascular resistance	↓↓	↓	↓↓↓↓	↓	↓
Coronary vasodilation	↑↑	↑↑	↑↑↑	↑↑	0
Cerebral vasodilation	↑	↑	↑	↑↑↑	—

*The direct myocardial depression of nifedipine is reversed clinically by the hemodynamic effects of vasodilation.

0, No effect; ↑, slight increase; ↑↑, moderate increase; ↑↑↑, strong increase; ↓, slight decrease; ↓↓, moderate decrease; ↓↓↓, strong decrease. AV, Atrioventricular.

Adverse Effects

The toxicity of CCBs varies with the individual agent; however, some side effects are common to this class of drugs, including dizziness, headache, and nausea and effects related to systemic vasodilation, such as sensation of heat, facial flushing, hypotension, reflex tachycardia (primarily with nifedipine), and peripheral edema. Verapamil is the most likely, and nifedipine-like drugs the least likely, to reduce myocardial contractility. Verapamil and diltiazem usually lead to a net decrease in conduction through the AV node. Myocardial depression and reduction of AV conduction are rarely a problem clinically with these agents, unless predisposing factors exist. Coadministration with a β-adrenergic antagonist may also lead to a deterioration in cardiac performance, especially when verapamil is used in a patient with abnormal AV conduction. Nifedipine and other dihydropyridines, which can reflexly increase AV conduction velocity, are often used to advantage in combination with β receptor blockers because of their complementary actions.

The abrupt vasodilation caused by short-acting CCBs may lead to myocardial ischemia. This is especially the case for dihydropyridines such as nifedipine, which have a greater net effect on blood vessels compared with the myocardium. The peripheral vasodilation can significantly reduce coronary blood flow, causing a condition known as *coronary steal*. An increased incidence of a heart attack and sudden death may result, and short-acting dihydropyridines should not be used for angina therapy. Long-acting agents, including slow-release formulations of nifedipine, are now recommended for the treatment of hypertension. Also for this reason, verapamil and diltiazem are preferred over dihydropyridines for the treatment of angina.

Drug influenced gingival enlargement has been reported during long-term therapy with verapamil, diltiazem, nifedipine, and felodipine. Clinically and histologically, the overgrowth seen with CCBs resembles that previously described for phenytoin (see Chapter 14), but it seems to occur less frequently with CCBs.⁴

RANOLAZINE

Ranolazine is an antianginal agent approved for the treatment of chronic stable angina pectoris for use as combination therapy when angina is not adequately controlled with other antianginal agents.^{7,14}

Chemistry and Pharmacologic Effects

Ranolazine is a piperazine derivative whose mechanism of action is not well understood. It is a cell membrane inhibitor

of the late Na⁺ current and alters glucose and fatty acid metabolism, but it is unknown whether these actions account for its antianginal action.⁷ This drug exerts its antianginal and anti-ischemic effects without reducing heart rate or blood pressure and does not increase the rate-pressure product at maximal exercise levels.⁵ Typically, the drug is used in combination with amlodipine, a β blocker, or nitrates.

Absorption, Fate, and Excretion

Ranolazine is administered twice a day by mouth in an extended-release preparation. It undergoes extensive metabolism, some in the intestine and most in the liver. The metabolites are excreted chiefly in the kidney. The terminal half-life of ranolazine is about 7 hours. Ranolazine tends to increase the plasma levels of digoxin and some other drugs. Ketoconazole, diltiazem, and verapamil increase plasma levels of ranolazine and should not be administered with it.

Adverse Effects

Constipation, nausea, dizziness, and headache are the most common adverse effects. Tinnitus, vertigo, and dry mouth may also occur. Some cardiac disorders have been reported. Ranolazine increases the QT interval of the heart. The drug should be avoided in patients with congenital long QT syndromes, patients with tachycardia, and patients taking other medications that increase the QT interval.

COMBINATION THERAPY

Combination therapy is indicated for a patient who becomes intolerant or continues to have angina with an optimal dosage of a single medication. The rationale for combining a nitrate and a β-adrenergic blocking drug has been previously discussed. If monotherapy fails, nitrates may be used in combination with diltiazem or verapamil, and a β-adrenergic blocking agent may be used with nifedipine. Trimetazidine has also been tested as an antianginal in combination with classic anti-ischemic compounds. In patients treated with nifedipine, the addition of trimetazidine reduced the number and duration of anginal attacks and improved exercise capacity.³ Comparative trials of ranolazine with other antianginal agents and trials examining its effects on long-term morbidity in patients with ischemic heart disease are required to determine the place of the drug in current antianginal therapy. Combinations of antiplatelet drugs may also be useful as discussed subsequently. Although combination therapy may be beneficial, consideration must be given to the potential for a higher incidence of untoward effects.

PREVENTION OF MYOCARDIAL INFARCTION

The use of drugs to prevent myocardial infarction (especially reinfarction) has received considerable attention in recent years. In addition to the drugs already discussed, the following classes of drugs are used for this purpose, especially in patients at risk, such as patients with acute coronary syndrome: antiplatelet drugs, cholesterol-lowering drugs, angiotensin-converting enzyme inhibitors, and anticoagulants. Because β blockers have been consistently shown to be beneficial in reducing sudden death in patients with unstable angina, they are now discussed further in this context.

The primary action of β blockers is to inhibit the effects of sympathetic stimulation on the heart. The result is a reduction in heart rate, arterial blood pressure, and the force of myocardial contraction at rest and during exercise. These changes reduce the overall myocardial oxygen requirement and limit the intensity, extent, and duration of myocardial ischemia. The combination of the antiarrhythmic and anti-ischemic actions of β blockers contributes to a favorable effect on survival rate after myocardial infarction.

Antiplatelet agents are a much more heterogeneous group than β -adrenergic blockers. The traditional antiplatelet drug is aspirin. It is effective in reducing the occurrence of myocardial infarction in patients with ischemic heart disease. Aspirin can reduce the incidence of transient ischemic attacks in patients with cerebrovascular disease.

Dipyridamole is an antiplatelet drug that is used with aspirin to prevent cerebrovascular disease. It is also used with warfarin in prophylaxis against thromboembolism in patients with prosthetic heart valves. It inhibits platelet aggregation and adhesion by increasing platelet cyclic 3',5'-adenosine monophosphate through inhibition of phosphodiesterase. It also decreases adenosine uptake, which results in stimulation of adenosine A_2 receptors on platelets. Dipyridamole is also a coronary vasodilator that exerts little action on peripheral blood vessels. It seems to act primarily on small cardiac arterioles. Dipyridamole does not prevent or alleviate anginal attacks because it does not sufficiently increase blood flow to ischemic areas.

Clopidogrel is a thienopyridine antiplatelet drug that is an aspirin substitute for use in unstable angina and to prevent myocardial infarction and stroke. The drug irreversibly inhibits adenosine diphosphate (ADP) receptors on platelets and prevents aggregation and other effects of ADP on platelets. Clopidogrel is also used in combination with aspirin in acute coronary syndrome and acute myocardial infarction. Ticlopidine is another thienopyridine antiplatelet drug. Ticlopidine may induce life-threatening blood dyscrasias, however, such as thrombocytopenia, neutropenia, and aplastic anemia. For this reason, clopidogrel is generally preferred over ticlopidine.

Abciximab is the Fab fragment of a chimeric human-murine monoclonal antibody that binds to integrin glycoprotein (GP IIb/IIIa) receptors on human platelets. This binding prevents the formation of platelet-platelet bridges resulting from fibrinogen or von Willebrand factor. Abciximab must be given intravenously. This drug reduces the incidence of stroke and death during percutaneous transluminal coronary angioplasty or atherectomy. Bleeding is the most common adverse reaction.¹³ Tirofiban and eptifibatid are two other drugs used clinically that are GP IIb/IIIa inhibitors. All three inhibitors are injected.

Anticoagulants are discussed in Chapter 31. Heparin and low-molecular-weight heparins are used in unstable angina; however, the benefit of warfarin in this setting is not established. Cholesterol-lowering drugs, particularly the statins, are also used to prevent myocardial infarction and coronary artery disease on a long-term basis. This drug class is discussed in Chapter 29. Angiotensin-converting enzyme inhibitors and

angiotensin II receptors blockers have a beneficial role in that they reduce the risk of myocardial infarction and stroke.^{8,17} They are discussed in Chapters 25 and 28.

IMPLICATIONS FOR DENTISTRY

Anginal attacks can be precipitated by physical or emotional stress. Because these situations often arise in the dental operatory, dentists must be aware of the symptoms and treatment of angina. A complete medical history reveals whether a patient is being treated for angina. If so, the dentist should ensure that the patient has medication (e.g., nitroglycerin) available before a procedure is performed. The patient will know when an attack is imminent; for ready access, the patient's medication may be placed on a nearby tray or counter. Also, nitroglycerin or amyl nitrite should be included on the emergency tray. Although nitroglycerin tablets are now stabilized against breakdown, unused tablets should be discarded 6 months after the original bottle has been opened.

The patient should be medicated in a sitting or supine position because standing may lead to hypotension and syncope. In most cases, anginal pain subsides rapidly (2 to 3 minutes), and the patient may have a headache or a stinging sensation under the tongue or both. As a precaution, patients should be treated carefully, be fully informed about the procedure, and, if they feel it necessary, be given prophylactic medication. Preoperative sedation may be helpful and is not contraindicated if significant cardiovascular depression is avoided.

The use of epinephrine in gingival retraction cord is contraindicated in patients with angina pectoris because of the potential for an excessive workload on the heart. Similar considerations dictate prudence with, although not avoidance of, local anesthetics with adrenergic vasoconstrictors. Orthostatic hypotension might be a problem in patients receiving CCBs, but cardiac depression is not usually clinically significant. Sensations of heat or facial flushing may be evident in these patients.

As previously mentioned, gingival inflammation and overgrowth occasionally develop in patients as a result of therapy with CCBs, especially when taken concurrently with other agents that promote gingival enlargement (e.g., phenytoin, cyclosporine). Strict oral hygiene measures, including regular dental prophylaxis, reduce this problem.

DRUGS USED IN THE TREATMENT OF ANGINA PECTORIS

<i>Nonproprietary (generic) name</i>	<i>Proprietary (trade) name</i>
Nitrates and nitrites	
Amyl nitrite	—
Isosorbide dinitrate	Isordil, Sorbitrate, Isochron, Dilatrate SR, ISDN, Isordil Tembids, Isordil Titradose
Isosorbide mononitrate	ISMO, Imdur, Monoket
Nitroglycerin	Nitro-Bid, Nitro-Time, Nitro-Dur, Nitrek, NitroQuick, Nitrocot, Nitrostat, Nitroglyn E-R, Transderm-Nitro
β-Adrenergic blocking drugs	
Atenolol	Tenormin
Betaxolol	Kerlone

Continued

DRUGS USED IN THE TREATMENT OF ANGINA PECTORIS—cont'd

<i>Nonproprietary (generic) name</i>	<i>Proprietary (trade) name</i>
Bisoprolol	Zebeta
Carvedilol	Coreg
Labetalol	Normodyne
Metoprolol	Lopressor, Toprol XL
Nadolol	Corgard
Propranolol	Inderal
Sotalol	Betapace
Timolol	Blocadren
Ca⁺⁺ channel blockers	
Amlodipine	Norvasc
Diltiazem	Cardizem, Dilacor XR
Felodipine	Plendil
Isradipine	DynaCirc
Nicardipine	Cardene
Nifedipine	Adalat, Procardia
Nimodipine	Nimotop
Nisoldipine	Sular
Verapamil	Calan, Isoptin, Verelan
Antiplatelet agents	
Abciximab	ReoPro
Aspirin	—
Clopidogrel	Plavix
Dipyridamole	Persantine
Eptifibatid	Integrilin
Ticlopidine	Ticlid
Tirofiban	Aggrastat
Cholesterol-lowering drugs	
See Chapter 29	
Other drugs	
Trimetazidine*	Vastarel
Fibrinolytics	
See Chapter 31	

*Not available in the United States.

CITED REFERENCES

1. Abozguia K, Clarke K, Lee L, et al: Modification of myocardial substrate use as a therapy for heart failure. *Nat Clin Pract Cardiovasc Med* 3:490-498, 2006.
2. Arthur RM, Mehmehl H: A sustained release formulation of isosorbide-5-mononitrate with a rapid onset of action. *Int J Clin Pract* 53:205-212, 1999.

3. Belardinelli R: Trimetazidine and the contractile response of dysfunctional myocardium in ischaemic cardiomyopathy. *Rev Port Cardiol* 19(Suppl 5):V35-V39, 2000.
4. Butler RT, Kalkwarf KL, Kaldahl WB: Drug-induced gingival hyperplasia: phenytoin, cyclosporine, and nifedipine. *J Am Dent Assoc* 114:56-60, 1987.
5. Chaitman BR: Pharmacological approaches to the symptomatic treatment of chronic stable angina: a historical perspective and future directions. *Can J Cardiol* 21:1031-1034, 2006.
6. Chen Z, Foster MW, Zhang J, et al: An essential role for mitochondrial aldehyde dehydrogenase in nitroglycerin bioactivation. *Proc Natl Acad Sci U S A* 102:12159-12164, 2005.
7. Cheng JWM: Ranolazine for the management of coronary artery disease. *Clin Therap* 28:1996-2007, 2006.
8. Epstein BJ, Gums JG: Angiotensin receptor blockers versus ACE inhibitors: prevention of death and myocardial infarction in high-risk populations. *Ann Pharmacother* 39:470-480, 2005.
9. Gebalska J, Wolk R, Ceremuzynski L: Isosorbide dinitrate inhibits platelet adhesion and aggregation in nonthrombolyzed patients with acute myocardial infarction. *Clin Cardiol* 23:837-841, 2000.
10. Hitzeman N: Early invasive therapy or conservative management for unstable angina or NSTEMI? *Am Fam Physician* 75:47-49, 2007.
11. Mishra B, Jackson G: Unstable angina: a review and practical guide to management. *Int J Clin Pract* 53:530-534, 1999.
12. Murad F: Shattuck lecture. Nitric oxide and cyclic GMP in cell signaling and drug development. *N Engl J Med* 355:2003-2011, 2006.
13. Roe MT, Sapp SK, Lincoff AM: Glycoprotein IIb/IIIa inhibitors in acute coronary syndromes. *Cleve Clin J Med* 67:131-140, 2000.
14. Siddiqui MA, Keam SJ: Ranolazine: a review of its use in chronic stable angina pectoris. *Drugs* 66:693-710, 2006.
15. Szwed H, Sadowski Z, Elikowski W, et al: Combination therapy in stable effort angina using trimetazidine and metoprolol: results of a randomized, double-blind, multicentre study (TRIMPOL II). TRIMetazidine in Poland. *Eur Heart J* 22:2267-2274, 2001.
16. Thadani U, Rodgers T: Side effects of nitrates to treat angina. *Expert Opin Drug Saf* 5:667-674, 2006.
17. Weir MR: Providing end-organ protection with renin-angiotensin system inhibition: the evidence so far. *J Clin Hypertens* 8:99-105, 2006.
18. Yeghiazarians Y, Braunstein JB, Askari A, et al: Unstable angina pectoris. *N Engl J Med* 342:101-114, 2000.

GENERAL REFERENCES

- Atwater BD, Roe MT, Mahaffey KW: Platelet glycoprotein IIb/IIIa receptor antagonists in non-ST segment elevation acute coronary syndromes: a review and guide to patient selection. *Drugs* 65:313-324, 2005.
- Dagenais GR, Pogue J, Fox K, et al: Angiotensin-converting-enzyme inhibitors in stable vascular disease without left ventricular systolic dysfunction or heart failure: a combined analysis of three trials. *Lancet* 368:581-588, 2006.
- Mehta RH, Roe MT, Chen AY, et al: Recent trends in the care of patients with non-ST segment elevation acute coronary syndromes: insights from the CRUSADE initiative. *Arch Intern Med* 166:2027-2034, 2006.

Diuretic Drugs

WILLIAM B. JEFFRIES AND DENNIS W. WOLFF

The kidney serves the vital function of maintaining fluid and electrolyte homeostasis. Through the processes of glomerular filtration and selective tubular reabsorption and secretion, the kidney maintains plasma volume and the plasma concentration of electrolytes, glucose, amino acids, and other substances within tight physiologic limits, while eliminating metabolic waste products and toxins. The kidneys filter approximately 180 L of plasma each day, one fifth of the cardiac output, producing approximately 1.5 L of urine.

The kidney selectively reabsorbs approximately 99% of the filtered load of water and solute. Many of the filtered solutes are reabsorbed by specific transport proteins located on the luminal membrane of the nephron. When inside of a nephron cell, solute movement back into the plasma is often directly or indirectly coupled to the actions of Na^+ - K^+ activated adenosine triphosphatase (Na^+ , K^+ -ATPase) located on the basolateral surfaces of the nephron cells. Transepithelial electrochemical potential differences can also drive the reabsorption of various ions by paracellular pathways.

The reabsorption of water in the kidney is passive, following osmotic gradients created by the movement of solutes along the nephrons to the extent permitted by the water permeability of the various segments of each nephron.¹⁰ Water readily equilibrates across the nephron as solute is reabsorbed from the tubular fluid or in response to the medullary osmotic gradient as it descends toward the tip of the loop of Henle. The ascending portion of the nephron is relatively impermeable to water, however.

The selective reabsorption of solute while trapping water in the lumen in these regions creates the dilute tubular fluid that could ultimately become maximally dilute urine. The solute selectively reabsorbed during the passage of tubular fluid through the ascending loop of Henle creates the medullary osmotic gradient that pulls water from the tubular fluid of the descending loop of Henle and the collecting duct. With the exception of the terminal portions of the collecting duct, where urea is recycled from concentrated urine, relatively little net solute reabsorption occurs in this nephron segment. Instead, this is the portion of the nephron that governs water reabsorption.

Antidiuretic hormone (ADH), also known as *vasopressin*, determines the extent to which this segment is permeable to water.²¹ If ADH is absent, the tubular fluid that reaches the collecting duct becomes, after some solute exchange, the maximally dilute excreted urine. If the collecting duct is responding maximally to ADH, the most concentrated urine that the kidney can generate is excreted; ADH makes collecting duct cells permeable to water, which permits passive water extraction from the tubular fluid as it passes through

the progressively more concentrated osmotic gradient of the medullary interstitium. The more solute that reaches the collecting duct, the greater is the volume of urine for any amount of ADH.

Renal function can become disturbed in many clinical conditions, producing metabolic abnormalities such as edema. There is a therapeutic need for drugs that modulate renal function.

All the drugs discussed in this chapter affect renal function by inhibiting the reabsorptive capacity of the renal nephrons. This action produces an increase in the rate of urine production. Substances that increase the quantity of urine are called *diuretics*. Many substances produce this effect, including caffeine, alcohol, and water itself; however, most clinically useful diuretics produce their effects by inhibiting Na^+ reabsorption by the nephrons.¹⁰ Such drugs are properly called *natriuretics*; even so, in most circumstances, all these drugs are referred to as *diuretics*. All clinically useful diuretics produce their effects by acting at specific segments of the nephron. Common conditions for which diuretics are used include essential hypertension and congestive heart failure.^{5,15,17,18}

CLASSES OF DIURETICS

This discussion of diuretics proceeds up the nephron in a retrograde direction. As shown in Figure 27-1, this order of consideration moves from diuretics with a low maximal effect to diuretics with a high maximal effect. The effects of blockade of Na^+ reabsorption upstream on tubular fluid composition are acted on by downstream mechanisms—mechanisms that act to limit or offset these effects. The effects of the various classes of diuretics on urine volume, urine pH, and urine electrolytes are summarized in Table 27-1.

K^+ -Sparing Diuretics

The pathway by which Na^+ is reabsorbed in the late distal tubule/cortical collecting duct is shown in Figure 27-2. The apical membrane of these cells contains Na^+ channels. The entry of Na^+ through these channels carries a net positive charge along with it (i.e., Na^+ entry is electrogenic), leaving the lumen with a net negative charge. This negative charge in the lumen acts as a driving force for movement in the opposite direction of other cytosolic cations such as K^+ and H^+ by the collecting duct (see Figure 27-2), resulting in Na^+ retention and K^+ excretion. Aldosterone, acting through nuclear receptors in the principal cells of the cortical collecting duct, enhances the conductance of apical Na^+ channels. For a given amount of aldosterone, more Na^+ delivered to this site means

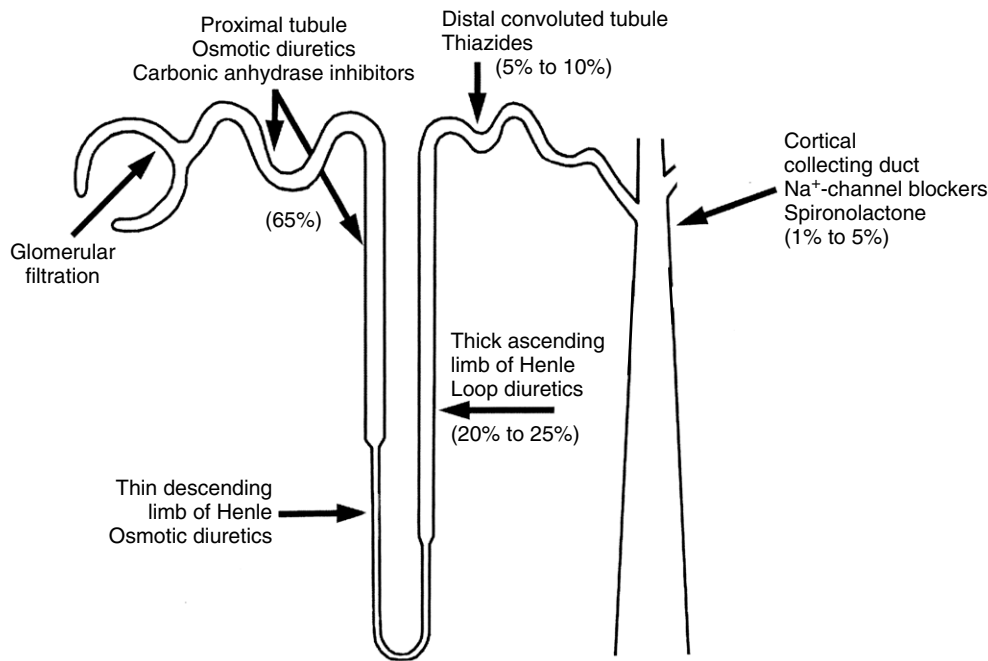

FIGURE 27-1 Sites of action of diuretics along the nephron. The percentages shown illustrate the approximate amount of the filtered load of Na^+ that is reabsorbed by each nephron segment. Each diuretic, with the exception of spironolactone, acts on the tubular lumen to produce its effect.

TABLE 27-1

Summary of Urinary Effects and Mechanisms of Action of Diuretic Drugs

	VOLUME (mL/min)	pH	Na^+	K^+	Cl^-	HCO_3^-	MECHANISM OF ACTION
Control	1	6	50	15	60	1	—
Thiazides (e.g., chlorothiazide)	3	7.4	150	25	150	25	Decreases Na^+ and Cl^- cotransport in distal tubule*
Loop diuretics (e.g., furosemide)	8	6	140	10	155	1	Decreases Na^+ , K^+ , 2Cl^- cotransport in medullary ascending loop of Henle
Amiloride, triamterene	2	7.2	130	5	120	15	Decreases Na^+ reabsorption in late distal tubule and collecting ducts; less K^+ secretion and Na^+-H^+ exchange
Spironolactone	2	7.2	125	5	120	15	Inhibits aldosterone receptor activation; net effects similar to effects of amiloride
Carbonic anhydrase inhibitors (e.g., acetazolamide)	3	8.2	70	60	15	120	Inhibits carbonic anhydrase and H^+ production in proximal tubules; less Na^+ and HCO_3^- reabsorption
Osmotic diuretics (e.g., mannitol)	10	6.5	90	15	110	4	Osmotically retains water in proximal tubule and loop of Henle

Values are average peak diuretic responses in humans with a normal water and electrolyte balance. Electrolyte concentrations are given in mEq/L.

*Thiazide diuretics also variably inhibit carbonic anhydrase.

more Na^+ reabsorption and more K^+ secretion, a coupled process referred to as Na^+/K^+ exchange.³ Because of the Na^+/K^+ exchange at this portion of the nephron, any diuretics acting further upstream to block Na^+ reabsorption and increase distal Na^+ delivery result in enhanced urinary excretion of K^+ .

Pharmacologic effects

K^+ -sparing diuretics are so named because, by blocking Na^+ reabsorption in the cortical collecting duct region of the nephron, they do not produce the hypokalemic effects of the other natriuretic drugs.²⁰ The three drugs of this class—spironolactone, triamterene, and amiloride—are structurally dissimilar (Figure 27-3), but each produces similar effects (mild natriuresis with a decrease in K^+ excretion) because of the blockade of Na^+ reabsorption by this pathway.¹¹ Spiro-

lactone is a 17-spirolactone steroid that is structurally similar to aldosterone and functions as an aldosterone antagonist. Triamterene, a pteridine derivative with structural similarities to folic acid, and amiloride, a pyrazine derivative, exert similar effects by directly blocking the apical membrane Na^+ channels of the principal cells of the collecting duct. By preventing Na^+ entry into these cells, these diuretics reduce the electrogenic driving force for K^+ or H^+ secretion, or both, in this segment. The net effect is a mild diuresis with a K^+ -sparing effect.

The amount of additional Na^+ excretion and K^+ retention is small when drugs of this class are administered alone. When natriuresis from other diuretics is present, the capacity of K^+ -sparing diuretics to inhibit K^+ excretion is significantly increased. This characteristic provides the rationale for com-

binging loop and thiazide diuretics with a K^+ -sparing diuretic to prevent hypokalemia.

Absorption, fate, and excretion

Spironolactone is administered orally and is rapidly absorbed. The onset of action takes 2 to 4 days, however, and full clinical efficacy is not seen for several weeks. Spironolactone is metabolized by the liver and has two active metabolites, canrenone and canrenoate. Canrenone is prescribed as a K^+ -sparing diuretic in Europe.

Amiloride is given orally, despite its poor gastrointestinal absorption. Diuresis begins within 2 hours, and its duration

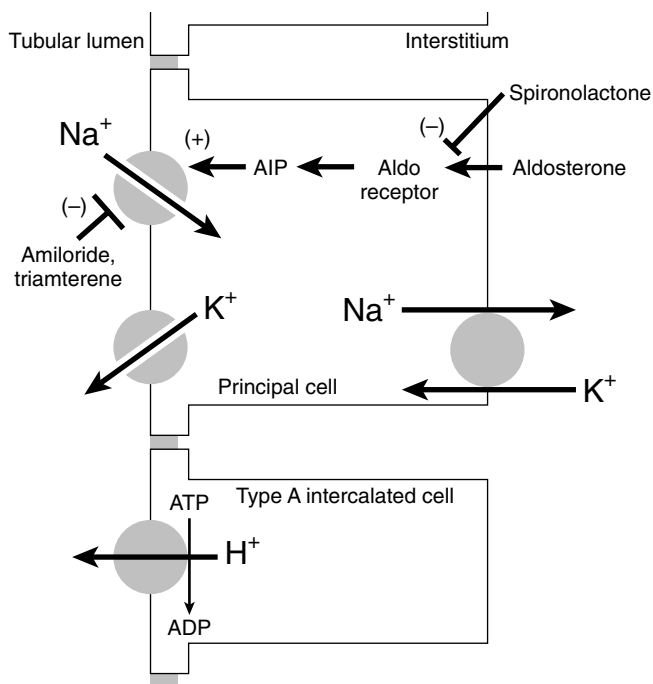

FIGURE 27-2 Actions of K^+ -sparing diuretics in the cortical collecting duct. In this segment, Na^+ is transported passively through channels located on the apical membranes of principal cells. The conductance of this channel is enhanced by an aldosterone-induced protein (AIP). The apical entry of Na^+ (removal of positive charges) creates a negative electrostatic driving force in the tubule lumen that enhances the secretion of K^+ from principal cells and H^+ from type A intercalated cells. Amiloride and triamterene are antagonists of apical membrane Na^+ channels, producing a mild natriuresis and preventing K^+ excretion in this segment. Spironolactone, by antagonizing the action of aldosterone, prevents AIP activation of Na^+ conductance, producing natriuresis with a K^+ -sparing effect. ADP, Adenosine diphosphate; ATP, adenosine triphosphate.

of action is approximately 24 hours. Amiloride does not undergo metabolism and is excreted unchanged in the urine and feces. Triamterene is better absorbed by the gastrointestinal tract and produces a response within 2 hours of administration. Triamterene has a short plasma half-life and is extensively metabolized to products that are excreted in the urine and feces. The duration of diuresis is longer (approximately 14 hours), however, because the hydroxylated metabolites are also active Na^+ channel blockers.

Therapeutic uses

K^+ -sparing diuretics are most often used to prevent hypokalemia caused by thiazide and loop diuretics. Spironolactone, triamterene, and amiloride are each available as combination preparations with thiazide diuretics to facilitate this use. Spironolactone is also sometimes used in the treatment of hyperaldosteronism. More recently, spironolactone has been found to be especially useful in the treatment of congestive heart failure (see Chapter 25). Plasma aldosterone concentration is inappropriately elevated in patients with congestive heart failure, and it contributes to the development of edema, direct hypertrophic effects on the myocardium, and other adverse effects in heart failure. Spironolactone effectively antagonizes these effects and has been shown to reduce the mortality rate of patients with congestive heart failure.

Adverse effects

The primary toxic effect of K^+ -sparing diuretics is hyperkalemia. This effect is most common when these drugs are given alone or concomitantly with other inhibitors of K^+ excretion, such as angiotensin-converting enzyme inhibitors or angiotensin II receptor antagonists. Dietary K^+ supplementation can also precipitate hyperkalemia in patients taking these drugs. Hyperkalemia is infrequent when these drugs are administered in the presence of loop or thiazide diuretics. Spironolactone, because of its steroid structure, can also produce gynecomastia or decreased libido or both in men. Menstrual irregularities have been reported for women. Triamterene and amiloride infrequently cause other effects, such as nausea and vomiting, muscle cramping, and dizziness. Triamterene can sometimes accumulate in the renal pelvis and produce renal stones.

Thiazide Diuretics

Benzothiazide diuretics (commonly referred to as *thiazides*) are derived from 1,2,4-benzothiadiazine-7-sulfonamide 1,1-dioxide (Figure 27-4). Chlorothiazide was originally synthesized in an attempt to produce more potent carbonic anhydrase inhibitors. Investigators soon observed that although chlorothiazide produced prompt diuresis as predicted, it did not do so by increasing the excretion of $NaHCO_3$. Rather, it produced a large increase in the excretion of $NaCl$, suggesting a novel natriuretic and diuretic mechanism: inhibition of Na^+ - Cl^- cotransport in the distal nephron.²² Structural congeners

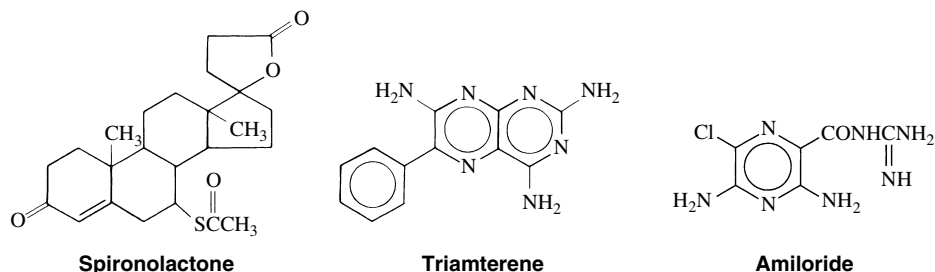

FIGURE 27-3 Structural formulas of K^+ -sparing diuretics.

TABLE 27-2

Thiazide and Thiazide-like Drugs Currently Available in the United States

DRUG	PROPRIETARY (TRADE) NAMES	DAILY DOSE (mg)	HALF-LIFE (hr)	DURATION OF DIURETIC ACTION (hr)
Bendroflumethiazide	Naturetin	2.5-10	8.5	6-12
Chlorothiazide	Diuril	500-1000	1-2	6-12
Chlorthalidone	Hygroton	50-100	35-50	48-72
Hydrochlorothiazide	HydroDIURIL, Microzide, Esidrix, Oretic	12.5-100	5.6-14.8	6-12
Hydroflumethiazide	Saluron	25-100	17	18-24
Indapamide	Lozol	1.25-5	14-18	12-24
Methyclothiazide	Aquatensen, Enduron	2.5-10	NA	>24
Metolazone	Diulo, Zaroxolyn	2.5-10	14	12-24
Polythiazide	Renese	1-4	24	24-48
Quinethazone	Hydromox	50-100	NA	18-24
Trichlormethiazide	Metahydrin, Naqua	2-8	2.5-7.5	<24

Data from *DrugPoints System Online* (formerly USPDI). Drug information for the health care professional, (accessed September 29, 2009) and Lexi-Comp ONLINE (accessed September 29, 2009).
NA, Not available.

TABLE 27-3

Thiazide and K⁺-Sparing Combination Drugs

PROPRIETARY (TRADE) NAME	THIAZIDE	ADDITIONAL DRUG
Moduretic	Hydrochlorothiazide 50 mg	Amiloride 5 mg
Aldactazide, Spiroside	Hydrochlorothiazide 25 mg	Spiroinolactone 25 mg
Aldactazide	Hydrochlorothiazide 50 mg	Spiroinolactone 50 mg
Maxzide	Hydrochlorothiazide 25 mg	Triamterene 37.5 mg
	Hydrochlorothiazide 50 mg	Triamterene 75 mg

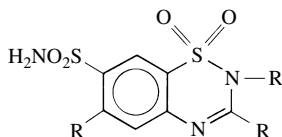

FIGURE 27-4 Structural formula of the parent compound of the thiazide diuretics.

of chlorothiazide, including hydrochlorothiazide, hydroflumethiazide, and methyclothiazide, also share this mechanism. Several other compounds (chlorthalidone, indapamide, metolazone, and quinethazone) that are not structurally related to thiazides also inhibit renal Na⁺-Cl⁻ cotransport and produce natriuresis and diuresis that is indistinguishable from thiazides. For this reason, it is a common convention to refer to all drugs that inhibit renal Na⁺-Cl⁻ cotransport as “thiazides” regardless of their structure.

Table 27-2 lists diuretics of the thiazide class available for prescription in the United States. Hydrochlorothiazide is also available in combination form with K⁺-sparing diuretics (Table 27-3). In addition, there are at least 21 formulations on the market that combine hydrochlorothiazide with another antihypertensive drug.

Pharmacologic effects

Thiazide and thiazide-like diuretics enter the lumen of the nephron by glomerular filtration and through secretion by the organic acid transporters of the proximal tubule. Thiazide diuretics can achieve a luminal concentration that is higher

than their free plasma concentration. Inhibitors of organic acid transport, such as probenecid, can inhibit the action of thiazide diuretics by lowering the luminal concentration. When the drug reaches the distal convoluted tubule, it binds to the Na⁺-Cl⁻ cotransporter (most likely at the Cl⁻ binding site) and inhibits its turnover (Figure 27-5).¹⁷ The result is a reduction in Na⁺-Cl⁻ reabsorption by the distal convoluted tubule and an increase in the amounts of Na⁺-Cl⁻ delivered to the cortical collecting duct.²² Some of the Na⁺ that is delivered to the collecting duct is excreted with an equivalent amount of water, producing natriuresis and diuresis, and some is reabsorbed in the cortical collecting duct as it is exchanged for K⁺ or H⁺; thiazides also produce kaliuresis (increased excretion of K⁺).

In addition to increasing the excretion of Na⁺-Cl⁻ and K⁺, thiazide diuretics increase the reabsorption of filtered Ca⁺⁺. This action distinguishes thiazides from loop diuretics, which promote Ca⁺⁺ excretion. The mechanism for this action is not completely understood, but Ca⁺⁺ reabsorption apparently is increased at the proximal tubule as a result of decreased glomerular filtration (because of reduced plasma volume) and at the distal convoluted tubule as a direct result of Na⁺-Cl⁻ cotransport inhibition. Ca⁺⁺ influx into the distal convoluted cells is governed in part by hormones such as parathyroid hormone, and its efflux is powered by a basolateral Na⁺/Ca⁺⁺ exchanger. Less Na⁺ inside the cell from blockade of apical Na⁺-Cl⁻ cotransport creates a larger gradient for the influx of extracellular Na⁺ through the basolateral Na⁺/Ca⁺⁺ exchanger, resulting in increased Ca⁺⁺ reabsorption. Depending on their structure, some thiazides are also weak inhibitors of carbonic anhydrase; this may result in alkalization of the urine from increased HCO₃⁻ excretion.

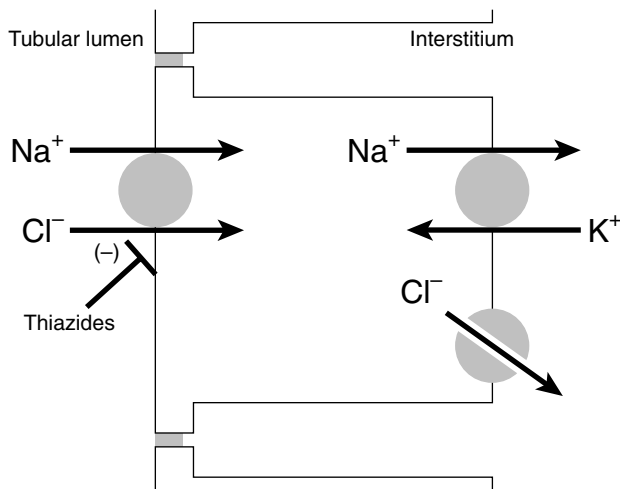

FIGURE 27-5 The action of the thiazide diuretics on the distal convoluted tubule. Na^+ and Cl^- enter the cell from the tubular urine by the electroneutral $\text{Na}^+\text{-Cl}^-$ cotransporter. Intracellular Na^+ is removed by the action of basolateral $\text{Na}^+\text{,K}^+\text{-ATPase}$, and Cl^- exits through basolateral Cl^- channels. Thiazides bind to the Cl^- -binding site of the $\text{Na}^+\text{-Cl}^-$ cotransporter, causing an increase in $\text{Na}^+\text{-Cl}^-$ delivery to more distal tubule segments, increasing $\text{Na}^+\text{-Cl}^-$ excretion.

At the level of the whole organism, long-term administration of a thiazide diuretic produces a reduction in the extracellular fluid volume.² The decrease in blood volume activates the renin-angiotensin system, causing angiotensin II-mediated aldosterone release from the adrenal gland. Aldosterone acts on the cortical collecting duct to increase the conductance of the principal cell Na^+ channels. Blood volume reduction leads to aldosterone-induced increases in the recovery of Na^+ in the cortical collecting duct, which increases the excretion of K^+ in this segment further. Thiazides also lead to a long-term decrease in blood pressure. The mechanism for this effect is controversial. A reduction in blood volume would be expected to decrease arterial blood pressure. Blood volume returns to near-normal values, however, after several weeks of thiazide administration. A direct vascular effect—vasodilation caused by reductions in vascular Na^+ content—has been proposed to explain the continued reduction in total peripheral resistance that persists during thiazide administration.¹⁴

Absorption, fate, and excretion

Absorption of thiazides from the gastrointestinal tract varies with the particular agent. The plasma elimination half-life and duration of diuretic effect for each of the thiazide diuretics are listed in Table 27-2. Plasma protein binding varies considerably among this class of drugs. The parent compounds or metabolites or both are primarily excreted through renal elimination after glomerular filtration and secretion in the proximal tubule.

Therapeutic uses

Thiazide diuretics are primarily used to treat essential hypertension. The Joint National Commission VII and the World Health Organization recommend thiazide diuretics as a first-line treatment for essential hypertension because of their demonstrated efficacy and low cost (see also Chapter 28).^{5,12,15,16} The antihypertensive dosage of thiazide diuretics should normally not exceed the equivalent of 25 mg/day of hydrochlorothiazide because clinical studies have shown that doses greater than this produce equivalent antihypertensive

effects but greater toxicity. Thiazide diuretics can be given as monotherapy for essential hypertension or as an adjunct agent.^{5,8,16,17} Thiazide diuretics enhance the effectiveness of most other antihypertensive agents, especially vasodilators such as hydralazine and minoxidil, which by themselves promote volume expansion. Thiazide diuretics can also mobilize mild edema and are sometimes used for this purpose, but loop diuretics are generally used to treat edema.

Ca^{++} is absorbed from the diet in response to Ca^{++} loss in the urine, and some individuals have higher Ca^{++} turnover than others.⁷ Excessive Ca^{++} excretion promotes the formation of calcium oxalate kidney stones. Thiazide diuretics can be used to lower the concentration of Ca^{++} in the excreted urine, an effect that can prevent the formation of renal stones.

Thiazide diuretics are also sometimes (paradoxically) useful in the treatment of the polyuria of nephrogenic diabetes insipidus. The plasma volume contraction that occurs from thiazide diuretic use leads to a decreased glomerular filtration rate and other compensatory changes that increase $\text{Na}^+\text{-Cl}^-$ and water reabsorption in the proximal nephron. Less delivery of water to the collecting duct in nephrogenic diabetes insipidus means less urine volume.⁶

Adverse effects

Thiazide diuretics are generally safe and effective drugs. Toxicity usually is the result of plasma electrolyte disturbances, which can result in extracellular volume depletion, hyponatremia, and hypokalemia. Most prevalent among these is hypokalemia, which results from the combined effects of volume depletion-induced aldosterone release and increased delivery of Na^+ and Cl^- to the collecting duct. Both of these effects increase reabsorption of Na^+ through apical channels in the cortical collecting duct, which increases the driving force for the secretion of K^+ .

Hypokalemia reduces the resting membrane potential, decreasing the likelihood of action potentials in nerves and muscles. Predictable symptoms occur, such as flaccid muscles; paralytic ileus; confusion and lethargy; and various cardiac arrhythmias such as sinus bradycardia, atrioventricular block, and paroxysmal atrial tachycardia. Hypokalemia also causes hyperglycemia by decreasing insulin production in the pancreatic β cells. Hyperglycemia can occur in nondiabetic patients treated with thiazide diuretics, and glucose control can be destabilized in diabetic patients. Because insulin-dependent glucose uptake promotes cellular uptake of K^+ , this hyperglycemia blunts the full effects of diuretic-induced hypokalemia. Severe, sometimes fatal, hypokalemia could result if insulin is administered under these circumstances. Hypokalemia can be avoided by eating foods rich in K^+ , especially fruits such as bananas, or by taking K^+ supplements. The concomitant use of K^+ -sparing diuretics with thiazide diuretics is an alternative strategy for avoiding hypokalemia, and several combination drugs with hydrochlorothiazide are available for this purpose (see Table 27-3).

Because thiazide diuretics can cause a Na^+ loss in excess of the water loss, they can cause volume depletion and hyponatremia. Hyponatremia causes systemic cellular edema and brain swelling, leading to symptoms such as irritability, depression, and confusion, whereas plasma volume depletion adds symptoms such as postural hypotension, tachycardia, weak pulse, dry mouth, thirst, and oliguria. Other adverse effects of thiazide diuretics include hypercalcemia and hypophosphatemia, simulating hyperparathyroidism. Thiazide diuretics can also precipitate attacks of gout, a potential consequence of hyperuricemia. Urate is freely filtered by the glomerulus, reabsorbed in the proximal tubule, secreted by more downstream portions of the proximal tubule, and later largely reabsorbed again. Urate is poorly soluble, and its concentration is normally close to that at which crystals form.

Thiazide diuretics interfere with urate transport in a manner that promotes urate retention.⁹ This effect combined with thiazide diuretic-induced water loss can increase the plasma urate concentration beyond its solubility limits, leading to the formation of urate crystals that can trigger the inflammatory response known as *gout*. Hyperlipidemia was seen in the past when higher doses of thiazide diuretics (e.g., >25 mg/day of hydrochlorothiazide) were routinely administered to treat hypertension.¹⁷

Allergic reactions are uncommon with thiazide diuretics, but can lead to fever, skin rash, interstitial nephritis, and renal failure. Patients allergic to sulfonamides should not receive thiazide diuretics.

Loop Diuretics

Loop diuretics are so named for their site of action on the thick ascending limb of the loop of Henle (TALH), where they inhibit Na^+ and Cl^- reabsorption (Figure 27-6). Because 20% to 25% of filtered Na^+ is reabsorbed in this segment, the resulting natriuresis can be of a much larger magnitude compared with other diuretics. These drugs are sometimes referred to as high ceiling or high efficacy diuretics. Diuretics that act at segments distal to the TALH have a much smaller maximum effect on Na^+ reabsorption. Loop diuretics are structurally dissimilar (Figure 27-7). Furosemide and bumetanide are sulfonamide derivatives of aminobenzoic acid, torsemide is a pyridine sulfonamide, and ethacrynic acid is an unsaturated ketonic derivative of aryloxyacetic acid.

Pharmacologic effects

Na^+ and Cl^- are reabsorbed in the medullary and cortical TALH by the Na^+ , K^+ , 2Cl^- cotransporter, as described in Figure 27-6.²² Evidence obtained with radiolabeled bumetanide suggests that loop diuretics bind to one of the Cl^- -binding sites on the cotransporter because bumetanide binding is enhanced by Na^+ and K^+ but inhibited by Cl^- . Loop diuretic binding to the Na^+ , K^+ , 2Cl^- cotransporter effectively arrests ion transport, preventing the reabsorption of Na^+ and Cl^- . K^+ reabsorption is also inhibited, which reduces the intraluminal positive electrical potential normally present in the TALH; this reduces the driving force for the paracellular reabsorption of cations in this segment (see Figure 27-6).²² Additional K^+ excretion occurs in the collecting duct in response to increased Na^+ delivery to the collecting duct and increased aldosterone secretion, as described for the thiazide diuretics. The amount of titratable acid secreted by the collecting duct is also enhanced by loop diuretics by the same mechanism. Loop diuretics increase the excretion of Na^+ , K^+ , Ca^{++} , Cl^- , H^+ , and

Mg^{++} . The effect on Ca^{++} is particularly noteworthy because the hypercalciuric effect of loop diuretics is the opposite of the hypocalciuric effect seen with thiazides.

At the level of the whole kidney, inhibition of Na^+ and Cl^- reabsorption in the TALH reduces the medullary interstitial osmotic gradient, which is the driving force for water reabsorption by the adjacent descending loops of Henle and collecting ducts. By blocking NaCl reabsorption in the TALH, a more isotonic tubular fluid is delivered to the collecting duct, impairing the ability of the kidney to excrete a dilute urine. The associated reduction in the interstitial medullary gradient means that less water can be extracted from the tubular fluid, impairing the ability of the kidney to excrete a concentrated urine.¹⁹ The urine excreted in the

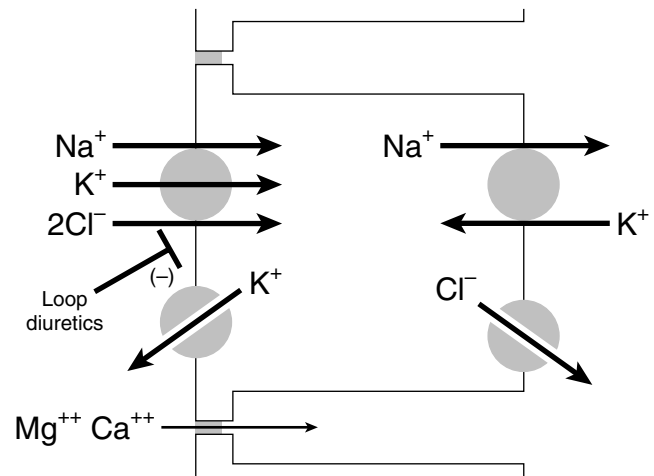

FIGURE 27-6 The action of the loop diuretics on the thick ascending limb of the loop of Henle. Na^+ , K^+ , and Cl^- enter the cell from the tubular urine by the Na^+ , K^+ , 2Cl^- cotransporter. Intracellular Na^+ is removed by the action of basolateral Na^+ , K^+ -ATPase, and Cl^- exits through basolateral Cl^- channels. K^+ is partially recycled as it exits by an apical channel. This action creates a net positive potential in the tubular lumen, which acts as an electrogenic driving force for the paracellular reabsorption of cations such as Na^+ , Mg^{++} , and Ca^{++} . Loop diuretics bind to one of the Cl^- -binding sites of the Na^+ , K^+ , 2Cl^- cotransporter, causing an increase in Na^+ and Cl^- delivery to more distal tubule segments, increasing Na^+ and Cl^- excretion. K^+ recycling is also disrupted, causing an increase in the excretion of Mg^{++} and Ca^{++} .

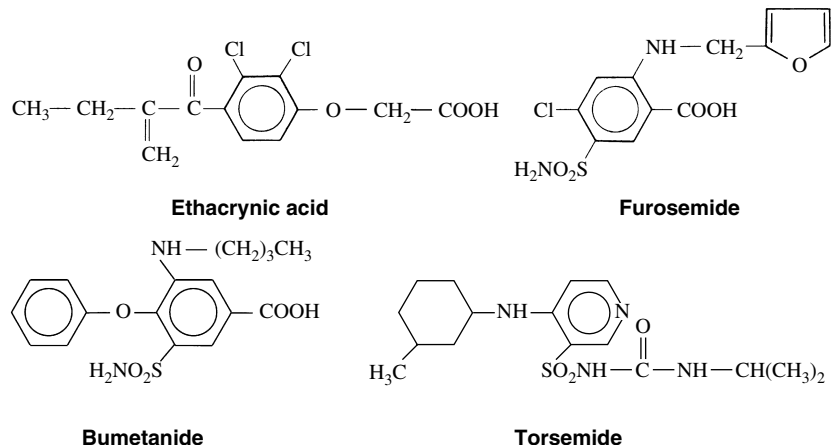

FIGURE 27-7 Structural formulas of loop diuretics.

presence of loop diuretics does not differ much from that of plasma, regardless of ADH levels (i.e., free water clearance is reduced).

At the level of the whole body, loop diuretics reduce the extracellular fluid volume and reduce blood pressure as described for thiazides except that these effects are typically of greater magnitude for loop diuretics. Furosemide also increases venous capacitance, which reduces left ventricular filling pressure. This effect seems to be mediated by prostaglandins and occurs before diuresis. This effect is especially useful with intravenous furosemide to treat acute pulmonary edema.

Absorption, fate, and excretion

Although structurally dissimilar, there is substantial similarity among loop diuretics regarding absorption, fate, and excretion. Furosemide is available in oral and injectable forms, with approximately 65% absorption of the oral form. Diuresis begins within 5 minutes of intravenous administration, with a duration of 2 hours, and begins in approximately 30 minutes after oral or intramuscular administration and lasts 6 to 8 hours. Furosemide is highly protein bound, metabolized by the liver, and excreted in the urine and feces. With normal renal function, it has a half-life of 30 to 70 minutes, but this increases to approximately 9 hours in patients with end-stage renal disease.

Torsemide is available in oral and intravenous forms and is rapidly absorbed after oral administration with 80% to 90% bioavailability. Diuresis begins in 30 to 60 minutes and lasts approximately 6 hours. Torsemide is highly protein bound and is 80% metabolized by the hepatic cytochrome P450 system before excretion in the urine. The half-time for elimination is typically 2 to 4 hours but is increased to 7 to 8 hours by cirrhosis of the liver.

Bumetanide is available in oral and injectable forms. Diuresis begins within 2 to 3 minutes of intravenous administration and 30 to 60 minutes after oral or intramuscular administration and has a duration of approximately 6 hours. Bumetanide is highly protein bound, metabolized by the liver, and excreted in the urine.

Ethacrynic acid is available in oral and intravenous forms. Diuresis begins within 5 minutes of intravenous administration and lasts 2 hours, whereas the onset of the diuretic effect after oral administration requires 30 to 60 minutes and has a duration of approximately 12 hours. Ethacrynic acid is highly protein bound, metabolized by the liver, and excreted in the urine and bile. With normal renal function, ethacrynic acid has a half-life of 2 to 4 hours.

Therapeutic uses

Loop diuretics are predominantly used to treat edema.^{12,18} In cardiac failure, low cardiac output results in poor renal perfusion, which causes volume retention.²³ If cardiac dysfunction is severe, this volume retention results in edema and cardiac dilation, which worsen cardiac failure. Fluid retention in the lungs can also produce grave consequences in heart failure. Loop diuretics reduce plasma volume to cause migration of edema fluid from the tissues back into the circulation, from where it can be excreted. Many primary and secondary kidney diseases are characterized by salt and water retention and hyperkalemia. Thiazide diuretics can be used in some of these patients, but they become ineffective when the glomerular filtration rate decreases to less than 30 mL/min.

Loop diuretics are the primary drugs of choice for volume management in renal failure. Edema can originate from a primary liver disease. Edema in this setting is the result of low plasma oncotic pressure from hypoalbuminemia, ascites formation, low renal perfusion, and increased aldosterone release. Loop diuretics have a place in the management of this complex

syndrome by reducing fluid and electrolyte retention by the kidney. Some patients with liver disease can be resistant to loop diuretics, however, and these drugs can produce dangerous hypovolemia in others. Great care is needed in the use of loop diuretics in the treatment of edema and ascites in liver disease.

Loop diuretics are also the drugs of choice for the treatment of acute pulmonary edema.⁶ In this condition, furosemide is usually administered parenterally, producing a rapid reduction in pulmonary congestion. As stated previously, this response occurs even before the onset of significant natriuresis and seems to be partly caused by a prostaglandin-mediated increase in venous capacitance. This action causes a decrease in left ventricular filling pressure, which relieves the pulmonary edema. Longer term reduction of fluid and electrolyte retention by furosemide maintains the response.

In addition to their use in edema, loop diuretics are useful in the management of other conditions. In refractory hypertension, loop diuretics are used to combat the fluid and electrolyte retention caused by powerful vasodilators such as minoxidil and hydralazine. In such cases, a K⁺-sparing diuretic is also included in the regimen to prevent hypokalemia. Loop diuretics are also used to treat hypercalcemia.⁵ As discussed earlier (see Figure 27-6), loop diuretics decrease Ca⁺ reabsorption in the TALH. In patients with hypercalcemia, furosemide is given intravenously, which produces a prompt reduction in plasma Ca⁺ concentration. To maintain plasma volume and prevent Na⁺ and K⁺ wasting, normal saline must be infused simultaneously at a rate that matches urine flow.

Adverse effects

Similar to thiazide diuretics, toxicity from loop diuretics is usually the result of plasma electrolyte disturbances such as hyponatremia and hypokalemia and extracellular volume depletion. The magnitude of these effects can be greater than the effects produced by thiazides because of the more prominent natriuresis produced by loop diuretics. The hypokalemia produced by loop diuretics occurs by a mechanism similar to that described for thiazide diuretics (increased exchange of K⁺ for Na⁺ in the collecting duct) and can be associated with metabolic alkalosis.⁹ Also similar to thiazide diuretics, hypokalemia is the most prevalent among these electrolyte disturbances and exerts various neuromuscular and metabolic effects. Inasmuch as loop diuretics are routinely used to help regulate plasma volume in patients with congestive heart failure, this is the appropriate place to draw attention to an important drug interaction. Digoxin and other digitalis-like cardiac glycosides are used to increase myocardial contractility in the failing heart. Various toxic effects are associated with the use of cardiac glycosides (see Chapter 25). Digitalis toxicity increases under conditions of hypokalemia. Thiazide and loop diuretics increase the likelihood and severity of digitalis toxicity.⁹

Hyponatremia causes systemic cellular edema and brain swelling, leading to symptoms such as irritability, depression, and confusion. Plasma volume depletion adds symptoms such as postural hypotension, tachycardia, weak pulse, dry mouth, thirst, and oliguria. Similar to thiazide diuretics, disruption of urate excretion or dehydration or both can lead to hyperuricemia and acute gout. Some loop diuretics can cause potentially severe allergic skin reactions similar to thiazide diuretics.

The adverse effects discussed earlier are generally shared with thiazide diuretics. In addition, loop diuretics have some adverse effects that are not shared with thiazide diuretics. Because of their impairment of paracellular reabsorption of Mg⁺⁺ and Ca⁺⁺, loop diuretics can also cause hypomagnesemia

(a risk factor for cardiac arrhythmias and digitalis toxicity) and hypocalcemia (which, in rare instances, can cause tetany). Loop diuretics can cause various gastrointestinal problems, including pancreatitis, jaundice, anorexia, malaise, and abdominal pain. They can elicit thrombocytopenia and, rarely, aplastic anemia or agranulocytosis, and they can cause systemic allergic reactions, such as systemic vasculitis. Finally, loop diuretics affect the central nervous system, with the most important adverse effects being tinnitus and hearing loss, vertigo, and paresthesias. Because of the ototoxic effects of loop diuretics, they should not be administered concurrently with other ototoxic drugs, such as aminoglycosides.

Carbonic Anhydrase Inhibitors

Acetazolamide is the prototype for this class of drugs, which are nonbacteriostatic sulfonamides, and is among the few members of this class that is still marketed as a diuretic. Carbonic anhydrase inhibitors were among the earliest diuretics available, and the search for new members in this family resulted in the discovery of thiazide diuretics.

Pharmacologic effects

Acetazolamide is a potent inhibitor of the enzyme carbonic anhydrase, the enzyme that catalyzes the reversible reaction of carbonic acid to form either water and carbon dioxide or HCO_3^- and H^+ . By blocking this enzyme, reabsorption of HCO_3^- is impaired in the proximal tubule, which leads to increased delivery of Na^+ , K^+ , and HCO_3^- to the distal nephron and ultimately an alkaline diuresis.¹³

Absorption, fate, and excretion

Acetazolamide is readily absorbed from the gastrointestinal tract, with peak concentrations reached in 2 hours. Extended-release capsules are available. Acetazolamide is not metabolized. It is tightly bound to carbonic anhydrase and concentrates in cells with high amounts of this enzyme, such as erythrocytes and the renal cortex. It is excreted unchanged in the urine as a result of active secretion and some passive reabsorption and has a half-life of 2.5 to 6 hours.

Therapeutic uses

Carbonic anhydrase inhibitors can be used to treat the edema of congestive failure but are no longer widely used for this purpose. When used to treat edema, best results are obtained when the drug is skipped every other day or every 2 days, giving the kidneys an opportunity to recover lost HCO_3^- . Carbonic anhydrase inhibitors also suppress aqueous humor formation in the eyes and can be used to reduce interocular pressure in open-angle glaucoma and before surgery in cases of angle-closure glaucoma. Treatment of glaucoma is the therapeutic indication for most carbonic anhydrase inhibitors that are now on the market. For reasons that are not well established, but perhaps because of the tendency toward acidosis with these drugs, carbonic anhydrase inhibitors are also useful for treating epilepsy (especially absence seizures in children). A final use for these drugs is the treatment of altitude sickness when taken before the ascent and, if necessary, to suppress symptoms for a few days afterward.

Adverse effects

Common side effects with carbonic anhydrase inhibitors include a tingling sensation in the extremities, tinnitus, alterations of taste, loss of appetite, nausea, and vomiting. These side effects are especially common early during therapy. The alkaline diuresis caused by carbonic anhydrase inhibitors can also alter the elimination of other drugs; the excretion of weak acids is increased (an effect sometimes harnessed during treatment for drug toxicities), whereas the excretion of weak bases is decreased. In addition, because these drugs are sulfonamide

derivatives, some individuals do have allergic reactions typical of these kinds of drugs. These usually manifest as rashes, but are rarely fatal because of more severe reactions, such as anaphylaxis and Stevens-Johnson syndrome.

Osmotic Diuretics

Mannitol is the prototypic osmotic diuretic, a class of drugs that differs from the drugs previously discussed in two important respects: the amounts needed to exert their effects and the site at which they cause diuresis.

Pharmacologic effects

In contrast to the other drugs, which are administered in small amounts to block transporters, mannitol is administered intravenously in gram quantities (typically 50 to 200 g over a 24-hour period) and functions as an impermeable solute in the extracellular space. By selectively increasing the osmolality of the extracellular space, water is extracted from the intracellular space to equilibrate these osmotic differences. Mannitol is freely filtered at the glomerulus, is poorly reabsorbed (<10%), and is not secreted. Mannitol carries water extracted from cells with it into the urine. In contrast to the other diuretics discussed here, mannitol selectively decreases intracellular volume. (Na^+ and Cl^- excretion is also increased, however.)

Absorption, fate, and excretion

Mannitol must be administered intravenously to exert its diuretic effects. When administered to treat cerebral edema, decreases in intracerebral volume are seen within 15 minutes, and diuresis is evident within 1 to 3 hours. There is little metabolism of mannitol, and it is excreted in the urine with a half-time for elimination of 70 to 100 minutes.

Therapeutic uses

There are three major indications for mannitol administration. The first indication is to increase or maintain urine flow. Maintaining the flow of urine during the oliguric phase of acute renal failure can block the progression of acute renal failure to irreversible chronic renal failure. This effect can also be harnessed to hasten the elimination of toxins from the body that can be trapped in the urine. Second, by extracting intracellular water, mannitol can be administered to decrease brain edema and intracranial pressure. Finally, mannitol is administered preoperatively to reduce intraocular pressure before surgery for glaucoma.

Adverse effects

Adverse effects are common during and after the infusion of mannitol. The redistribution of fluid from the intracellular to the extracellular compartment causes various problems, such as pulmonary congestion, electrolyte imbalances, dryness of the mouth, thirst, blurred vision, convulsions, nausea and vomiting, and fever, along with pain, thrombophlebitis, and infection at the injection site. The cardiovascular status of patients must be carefully assessed before administering mannitol because it can cause severe congestive heart failure.

Antidiuretic Hormone Antagonists

In contrast to natriuretics, this class of drugs primarily prevents water reabsorption, producing a selective increase in free water clearance. Several available drugs produce this effect, such as lithium and the antibiotic demeclocycline, but these drugs are rarely used for this purpose in practice. Conivaptan and an orally active congener, tolvaptan, have been approved more recently for the treatment of acute hyponatremia. Other orally active congeners (lixivaptan, satavaptan) are currently in development.

Pharmacologic effects

Conivaptan is a nonpeptide competitive antagonist of vasopressin V_2 receptors.¹ The drug prevents ADH (vasopressin)-induced insertion of water channels (aquaporins) into the apical membranes of principal cells in the collecting duct. This prevents the absorption of water by the collecting ducts, causing increased water excretion. The increase in free water clearance increases urine volume, decreases urine osmolality, reduces plasma volume, and increases plasma osmolality, primarily because of an increase in Na^+ concentration. These actions make conivaptan particularly suited for the treatment of hyponatremia.

Absorption, fate, and excretion

Conivaptan is available only for intravenous administration. It is extensively bound to plasma proteins with an elimination half-life of approximately 8 hours. Conivaptan is metabolized by cytochrome P450 enzymes in the liver, and it and its metabolites are primarily excreted in the feces.

Therapeutic uses

Conivaptan was originally approved for the treatment of euvolemic hyponatremia in hospitalized patients. In 2007 this approval was extended to patients with hypervolemic hyponatremia.⁴ This drug is useful primarily in the treatment of the syndrome of inappropriate antidiuresis and the hyponatremia of congestive heart failure. Conivaptan can be used only in hospitalized patients because it is administered intravenously.

Adverse effects

Conivaptan is generally well tolerated, with few adverse effects reported. Common adverse effects due to V_2 receptor blockade include thirst, headache, hypokalemia, and vomiting.¹ Conivaptan also blocks vascular vasopressin V_{1A} receptors at therapeutic concentrations, which can lead to vasodilatation and hypotension. Skin reactions at the infusion site are common. Care should be taken not to reverse hypo-

natremia too rapidly because this can lead to osmotic demyelination.⁴ Caution should be exercised in patients with renal impairment, which reduces drug elimination. Drugs that induce cytochrome P450 can reduce the action of conivaptan and vice versa. Conivaptan has been shown to be teratogenic in laboratory animals and should not be used in pregnant women.

IMPLICATIONS FOR DENTISTRY

The major drug interactions of diuretics are summarized in Table 27-4, and some additional concerns related to herbal remedies are presented at the end of this section. Diuretic therapy does not usually influence dental practice. Nonetheless, epinephrine, sedatives, opioid analgesics, adrenocorticosteroids, and nonsteroidal anti-inflammatory drugs (NSAIDs) used in dentistry can interact with patients receiving diuretic agents to cause clinically important adverse effects. Most patients taking diuretics are doing so because of essential hypertension, and the implications of hypertension and its treatment to dental practice are discussed in Chapter 28.¹⁶ Extra caution is especially warranted when dental patients have congestive heart failure, cardiac arrhythmias, and any other conditions in which subtle worsening of hypokalemia could have an adverse effect.

As previously discussed, thiazide and loop diuretics are K^+ -losing diuretics that can cause hypokalemia. Strategies used to compensate for this K^+ loss include increasing the dietary intake of K^+ or prescribing K^+ supplements or a simultaneous K^+ -depleting diuretic. Nonetheless, these patients may still have low plasma K^+ concentrations. Under these circumstances, the epinephrine present in gingival retraction cords and local anesthetic solutions can produce a transient hypokalemia, which increases the propensity of epinephrine to trigger cardiac arrhythmias.

The use of anti-inflammatory dosages of adrenocorticosteroids with even modest mineralocorticoid activity, such as

TABLE 27-4**Drug Interactions of Diuretic Agents**

DIURETIC	INTERACTING DRUG	EFFECT
Thiazides, loop diuretics, K^+ -sparing diuretics	Anticoagulants	Increased concentration of clotting factors from reduction of plasma volume, decreasing anticoagulant effect Natriuresis and hypotensive effect blocked by cyclooxygenase inhibition
	Aspirin, NSAIDs	
	Lithium salts	Decreased Li^+ excretion, leading to increased Li^+ toxicity
	Adrenergic receptor antagonists, α_2 -adrenergic receptor agonists, vasodilators, ACE inhibitors, ARBs	Increased antihypertensive response
Thiazides, loop diuretics	Uricosurics	Enhancement of uric acid reabsorption, reducing efficacy of uricosuric agent
	Oral hypoglycemics, insulin	Hypokalemia-induced hyperglycemia
	Nondepolarizing neuromuscular blockers	Hypokalemia-induced potentiation of paralysis
	Adrenergic receptor agonists	Hypokalemia-induced arrhythmias
	Digoxin	Hypokalemia-induced potentiation of digitalis toxicity
Thiazides	Corticotropin, adrenal steroids	Decreased diuresis, increased hypokalemia
	Cholestyramine, colestipol	Decreased thiazide absorption
Loop diuretics	Aminoglycosides, cisplatin	Ototoxicity
	Clofibrate, warfarin	Competition for binding to plasma proteins by furosemide increases their free concentration
K^+ -sparing diuretics	Cephalosporin antibiotics	Increased renal toxicity
	ACE inhibitors, K^+ supplements, cyclosporine	Hyperkalemia

ACE, Angiotensin-converting enzyme; ARBs, angiotensin II receptor blockers; NSAIDs, nonsteroidal anti-inflammatory drugs.

hydrocortisone, can also promote hypokalemia by exaggerating the hypokalemic effect of thiazide and loop diuretics. In contrast to the rapid-onset transient effects of epinephrine on plasma K⁺ concentrations, the hypokalemic effects of adrenocorticosteroids are slow in onset and slow in termination. They may not be of clinical significance until after the patient has left the dental office. Anything that can cause hypokalemia is of greatest concern in patients with congestive heart failure who are receiving digitalis therapy because hypokalemia is a well-known cause of fatal cardiac arrhythmias in these patients.

In addition, there is an increased likelihood of syncope in dental patients taking diuretics because of a depletion of intravascular volume. Sedative-hypnotics and opioid analgesics are among the drugs that more readily cause orthostatic hypotension in the presence of diuretics.

NSAIDs used for dental pain may antagonize the antihypertensive effect of diuretics. With short-term use, this interaction should not be clinically significant, but it can become relevant if NSAIDs are prescribed to treat chronic dental pain.

Most diuretics are in pregnancy class D, meaning that there is a proven risk of fetal harm. Similarly, breastfeeding is generally contraindicated because most of these drugs enter breast milk.

Because various herbal remedies are touted for their diuretic properties, some patients may be taking diuretic therapy without proper medical supervision, and others may choose to combine the use of herbal remedies with contemporary diuretic pharmacotherapy in the potentially erroneous belief that all diuretics work well together. Herbs used as diuretics include dandelion, horsetail, stone root, cleavers, gravel root, hydrangea, pipsissewa, goldenrod, lovage, and parsley. The mechanism of action for these herbs has generally not been established. Claims that dandelion is a rich source of K⁺ while functioning as a K⁺-depleting diuretic could be of concern, however, if taken by patients who are also taking a K⁺-sparing diuretic. Lastly, the glycyrrhizic acid of "real" (e.g., European) licorice used in candy and for various medicinal purposes has mineralocorticoid properties. Overindulgence in this type of licorice candy has caused hypertension and, if consumed with diuretics, could exacerbate the K⁺-depleting effects of thiazide and loop diuretics or inhibit the activities of spironolactone. The possibility of drug interaction between diuretics and alternative therapies should not be overlooked.

DIURETIC DRUGS

<i>Nonproprietary (generic) name</i>	<i>Proprietary (trade) name</i>
Thiazides and related derivatives	
Bendroflumethiazide	Naturetin
Benzthiazide	Exna
Chlorothiazide	Diuril
Chlorthalidone	Hygroton, Thalitone
Hydrochlorothiazide	Esidrix, HydroDIURIL, Hydro-Par
Hydroflumethiazide	Diucardin, Saluron
Indapamide	Lozol
Methyclothiazide	Aquatensen, Enduron
Metolazone	Zaroxolyn, Mykrox
Polythiazide	Minizide, Renese
Quinethazone	Hydromox
Trichlormethiazide	Diurese, Metahydrin, Naqua

<i>Nonproprietary (generic) name</i>	<i>Proprietary (trade) name</i>
Loop diuretics	
Bumetanide	Bumex
Ethacrynic acid	Edecrin
Furosemide	Lasix
Torsemide	Demadex
K⁺-sparing agents	
Amiloride	Midamor
Eplerenone	Inspira
Spironolactone	Aldactone
Triamterene	Dyrenium
Osmotic nonelectrolytes	
Glycerin (glycerol)	Osmoglyn
Isosorbide	Ismotiv
Mannitol	Osmitol
Carbonic anhydrase inhibitors	
Acetazolamide	Dazamide, Diamox
Brinzolamide	Azopt
Dichlorphenamide	Daranide
Dorzolamide	Trusopt
Methazolamide	Neptazane
Antidiuretic hormone receptor antagonist	
Conivaptan	Vaprisol

CITED REFERENCES

- Cawley M: Hyponatremia: current treatment strategies and the role of vasopressin antagonists. *Ann Pharmacother* 41:840-850, 2007.
- Dustan HR, Tarazi RC, Bravo EL: Diuretic and diet treatment of hypertension. *Arch Intern Med* 133:1007-1013, 1974.
- Edelman IS: The initiation mechanism in the action of aldosterone on sodium transport. *J Steroid Biochem* 3:167-172, 1972.
- Ellison DH, Berl T: The syndrome of inappropriate antidiuresis. *N Engl J Med* 356:2064-2072, 2007.
- Ferdinand KC: Update in pharmacological treatment of hypertension. *Cardiol Clin* 19:279-294, 2001.
- Francisco LL, Ferris TF: The use and abuse of diuretics. *Arch Intern Med* 142:28-32, 1982.
- Friedman PA: Mechanisms of renal calcium transport. *Exp Nephrol* 8:343-350, 2000.
- Gifford RW Jr: Role of diuretics in treatment of essential hypertension. *Am J Cardiol* 58:15A-17A, 1986.
- Greenberg A: Diuretic complications. *Am J Med Sci* 319:10-24, 2000.
- Greger R: Physiology of renal sodium transport. *Am J Med Sci* 319:51-62, 2000.
- Kleyman TR, Sheng S, Kosari F, et al: Mechanism of action of amiloride: a molecular perspective. *Semin Nephrol* 19:524-532, 1999.
- Lee TH, Goldman L: Which drug for hypertension? *Harvard Heart Lett* 3:1-6, 1992.
- Maren TH: Carbonic anhydrase: chemistry, physiology, and inhibition. *Physiol Rev* 47:595-781, 1967.
- Ogilvie RI, Schlieper E: The effect of hydrochlorothiazide on venous reactivity in hypertensive man. *Clin Pharmacol Ther* 11:589-594, 1970.
- Puschett JB: Diuretics and the therapy of hypertension. *Am J Med Sci* 319:1-9, 2000.
- Salvati A, Ghiadoni L: Thiazide diuretics in the treatment of hypertension: an update. *J Am Soc Nephrol* 17(4 Suppl 2):S25-S29, 2006.

17. Ramsey LE: Thiazide diuretics in hypertension. *Clin Exp Hypertens* 21:805-814, 1999.
18. Reyes AJ: Diuretics in the treatment of patients who present heart failure and hypertension. *Hum Hypertens* 16(Suppl 1):S104-S113, 2002.
19. Shankar SS, Brater DC: Loop diuretics: from the Na-K-2Cl transporter to clinical use. *Am J Physiol Renal Physiol* 284:F11-F21, 2003.
20. Stoner LC, Burg MB, Orloff J: Ion transport in cortical collecting tubule: effect of amiloride. *Am J Physiol* 227:453-479, 1974.
21. Strewler GJ, Orloff J: Role of cyclic nucleotides in the transport of water and electrolytes. *Adv Cyclic Nucleotide Res* 8:311-361, 1977.
22. Suki WN, Eknoyan G, Martinex-Maldonado M: Tubular sites and mechanisms of diuretic action. *Annu Rev Pharmacol Toxicol* 13:91-106, 1973.
23. Taylor SH: Diuretic therapy in congestive heart failure. *Cardiol Rev* 8:104-114, 2000.

GENERAL REFERENCES

- Acara MA: Renal pharmacology—diuretics. In Smith CM, Reynard AM, editors: *Textbook of pharmacology*, Philadelphia, 1992, Saunders.
- Better OS, Greger RF, Knauf H, et al: *Diuretics. Handbook of experimental pharmacology*, vol 117, New York, 1995, Springer.
- Brater DC: Pharmacology of diuretics, *Am J Med Sci* 319:38-50, 2000.
- Francisco LL, Ferris TF: The use and abuse of diuretics, *Arch Intern Med* 142:28-32, 1982.
- Hebert SC: Molecular mechanisms, *Semin Nephrol* 19:504-523, 1999.
- Puschett JB: Pharmacological classification and renal actions of diuretics, *Cardiology* 84(Suppl 2): 4-13, 1994.
- Sica DA: Diuretic-related side effects: development and treatment, *J Clin Hypertension (Greenwich)* 6:532-540, 2004.

Antihypertensive Drugs

FRANK J. DOWD AND WILLIAM B. JEFFRIES

About 29% of Americans have hypertension, and it is the leading cause of cardiovascular disease worldwide.¹⁰ Careful examination of the prevalence of hypertension reveals that it is distributed disproportionately among subgroups in the U.S. population. Hypertension increases with advancing age, but its prevalence is much lower in women before menopause than in men of comparable age. There also seems to be a racial component to hypertension³: the prevalence is approximately 23% in whites and Mexican Americans but is 32% in African Americans.

Because of the asymptomatic nature of this disease, approximately one third of affected individuals are unaware of their condition. Isolated systolic hypertension affects more than 15% of all people older than 60 years. Studies suggest that only half of hypertensive patients receive pharmacologic treatment at all, and, of this fraction, only half have adequate control of blood pressure levels. Because the long-term consequences of hypertension (e.g., coronary artery disease, stroke, renal failure) are so devastating to health, screening programs are essential to detect the disease early so that treatment can be instituted before major complications ensue. Education of patients is also essential to ensure compliance with recommended therapy because of the insidious nature of the disease and because unpleasant side effects of the drugs used to treat it may cause the patient to feel better when not receiving medication. An individual is considered hypertensive if his or her systolic or diastolic arterial blood pressure (or both) is elevated above normal (i.e., systolic arterial pressure >140 mm Hg or diastolic arterial pressure >90 mm Hg).²

CLINICAL ASPECTS OF HYPERTENSION

Classification

The severity of hypertension is classified as shown in Table 28-1. Hypertension can arise as a primary disease or as a result of an underlying illness. *Essential hypertension* is a term used to describe the presence of sustained, elevated blood pressure for which no cause is apparent. When this term was coined, it was believed that the elevation of blood pressure was essential to maintain organ perfusion in the affected patient. This idea is no longer widely accepted, but the term is still in use. Essential hypertension remains of unknown etiology and represents 80% to 90% of all cases of hypertension. Although much is known about the cardiovascular changes that occur as a consequence of prolonged elevation of blood pressure, no single pathologic change can be cited as the primary cause. Many theories abound regarding the causes of essential hypertension, some of which are discussed subsequently.

Secondary hypertension results from a known disorder, such as renal, vascular, or parenchymal disease, or from an endocrine disorder such as pheochromocytoma. Treatment of secondary hypertension usually consists of therapy for the underlying disease process. Hypertension may be systolic or diastolic, or both. Until more recently, less emphasis had been placed on the importance of systolic hypertension. More recent evidence indicates, however, its close association with untoward outcomes.²³ Treatment of isolated systolic hypertension in elderly patients with an antihypertensive drug has been shown to reduce mortality rates, especially from stroke.^{14,19} The results are independent of mean arterial pressure. The risk of heart failure is also decreased with reduction in systolic hypertension.¹³ It has been suggested that the incidence of dementia is reduced as systolic pressure is reduced in elderly patients.¹⁶

In metabolic syndrome, hypertension is accompanied by abdominal obesity, hyperlipidemia with atherosclerosis, and hyperglycemia or insulin resistance or both.²² In this syndrome, hypertension is only one target of therapy. Questions that are still being explored are to what extent each sign of the syndrome is related and how.

Regulation of Blood Pressure

Pressure in a hydraulic system is the product of flow through the system and the resistance to such flow. The relationships between mean arterial blood pressure (MAP), cardiac output (CO), and total peripheral resistance (TPR) can be described in the following equation:

$$\text{MAP} = \text{CO} \times \text{TPR}$$

CO is determined by the load presented to the heart (venous return or preload) and the inotropic and chronotropic state of the myocardium. TPR depends on the diameter and compliance (stiffness) of the arterioles. These factors are regulated by the resting vascular smooth muscle tone, intrinsic reactivity of the vasculature, vasoactive substances in the blood, and sympathetic nervous system activity. Another important factor in the governance of blood pressure is the blood volume, which is regulated by the kidneys. The interrelationships among all these factors are illustrated in Figure 28-1.

Blood pressure tends to remain at a constant value, and there are many physiologic control mechanisms to protect the organism from harmful perturbations in blood pressure. Two of the most important regulatory mechanisms are short-term control afforded by the sympathetic nervous system and long-term control, which is a function of the renal system.

Moment-to-moment control of blood pressure largely depends on baroreflexes, in which sympathetic nervous

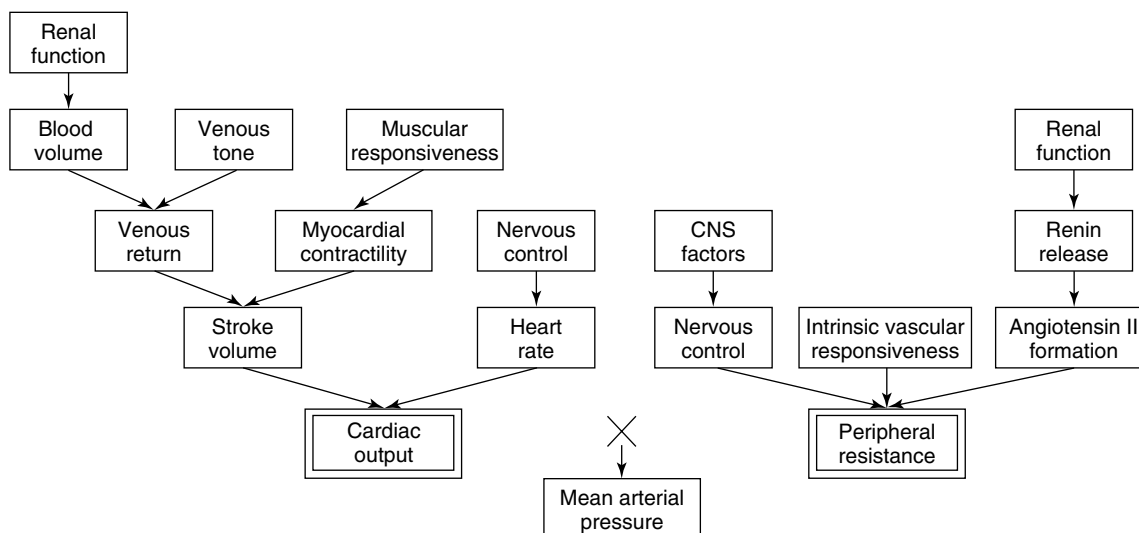

FIGURE 28-1 Factors that govern mean arterial blood pressure. CNS, Central nervous system.

TABLE 28-1

Classification of Severity of Hypertension by Blood Pressure

STAGE	SYSTOLIC (mm Hg)		DIASTOLIC (mm Hg)
Normal	<120	and	<80
Prehypertension	120-139	or	80-89
Stage 1	140-159	or	90-99
Stage 2	>160	or	>100

From the Seventh Report of the Joint National Committee on the prevention, detection, and treatment of high blood pressure, *JAMA* 289:2534-2573, 2003.

Hypertension staging corresponds to the higher of the systolic or diastolic blood pressure values.

system output to the heart, resistance vessels, and capacitance vessels is adjusted in response to feedback from baroreceptors in the carotid sinus and aortic arch. These baroreceptors respond to mechanical stretch (increased pressure) by increasing the firing rate of sensory neurons that innervate blood pressure control areas of the central nervous system (CNS). If blood pressure increases, the resultant increased activity of these sensory neurons inhibits efferent sympathetic nervous system activity, reducing heart rate, vascular tone, and blood pressure. Conversely, if blood pressure suddenly decreases, baroreceptor output is reduced, allowing increased peripheral sympathetic discharge. This reflex is responsible for the maintenance of blood pressure during rapid stresses to cardiovascular homeostasis, as induced by a change in posture.

Long-term stresses on the maintenance of blood pressure (e.g., alterations in water and salt intake) are handled by the kidneys. A change in blood pressure is sensed by the kidneys as a corresponding change in renal perfusion pressure. This disturbance invokes two compensatory mechanisms. First, the tubular reabsorption of Na^+ and water either decreases (in high perfusion pressure) or increases (in low perfusion pressure). This alteration adjusts blood volume and secondarily changes CO to bring blood pressure back to normal. The kidneys also influence resistance vessel tone more directly by releasing renin (activating the renin-angiotensin system) when

BOX 28-1

Risk Factors for Development or Worsening of Essential Hypertension

Unavoidable Risks

Family history
Age
Male sex
African American race
Diabetes

Lifestyle Risks

Na^+ intake
Obesity
Alcohol consumption
Cigarette smoking
Lack of exercise

renal perfusion is diminished. The resultant increase in vasoactive angiotensin peptides increases peripheral vascular resistance by causing vasoconstriction. Angiotensin peptides also promote volume retention by increasing the release of aldosterone and contribute to muscular hypertrophy and other structural changes in the heart and vasculature (collectively referred to as *remodeling*).⁴

The physiologic mechanisms that control blood pressure are important in the treatment of hypertension in two respects. First, each of these mechanisms represents a potential therapeutic target for reducing blood pressure in a hypertensive patient. Second, because these mechanisms are in place to prevent changes in blood pressure, they become activated in an attempt to restore blood pressure to its former (high) level when steps are taken to reduce the hypertension.

Pathophysiologic Characteristics of Essential Hypertension

The physical findings of a patient with essential hypertension usually reveal that CO is normal and TPR is elevated. In a hypertensive patient, the baroreceptor reflexes function normally, but have been “reset” to maintain MAP at a higher than normal value. The reasons for this shift are not yet understood and are the subject of intensive research. It is evident that there is a genetic component to essential hypertension and that certain risk factors lead to a worsening of blood pressure elevation (Box 28-1). In many patients, long-term cardiovascular complications of hypertension can be controlled solely by making appropriate lifestyle changes.

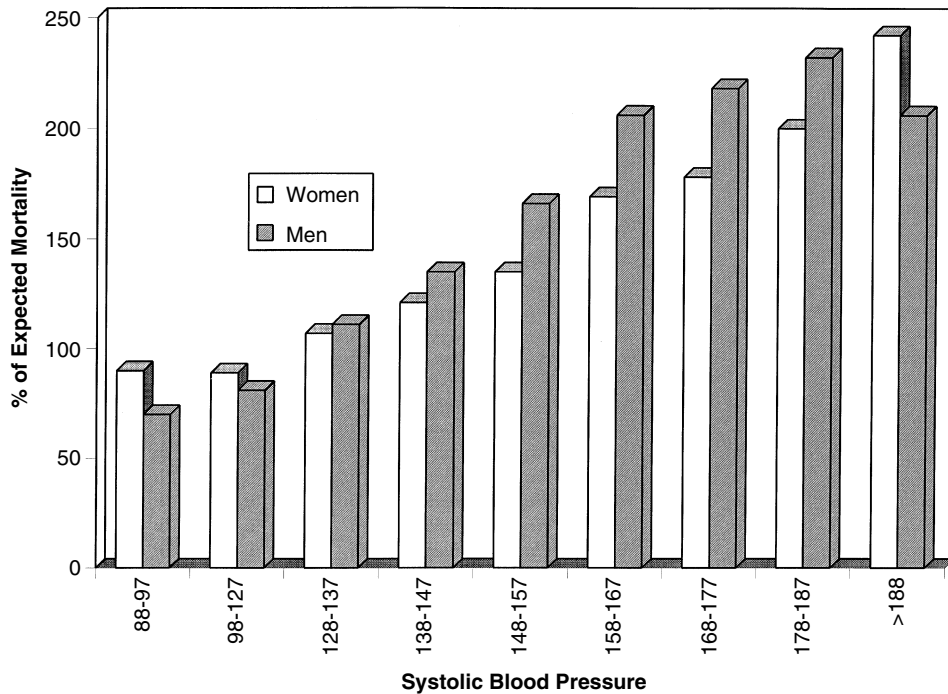

FIGURE 28-2 Expected mortality as a function of systolic blood pressure at all ages without regard to treatment. (Adapted from *The Society of Actuaries and the Association of Life Insurance Medical Directors of America: Blood pressure study 1979*, Boston, 1980, The Society.)

Although the cause of essential hypertension is unknown, it is well established that high blood pressure leads to cardiovascular and renal disease. Elevated blood pressure is directly correlated with overall mortality (Figure 28-2). It is accepted that reducing the blood pressure in hypertensive patients reduces the risk of cardiovascular events including myocardial infarction and stroke, and kidney failure.^{23,26} The damage caused by decades of elevated arterial pressure can be seen in the form of left ventricular hypertrophy, medial thickening of arteries, and nephropathy.^{18,26} These changes contribute to the development of diseases such as congestive heart failure, coronary artery disease, stroke, aneurysm, and renal failure (Box 28-2). Numerous clinical trials have shown a reduction in morbidity and mortality rates after pharmacologic reduction in blood pressure in hypertensive patients.

Diabetic patients are particularly vulnerable to targeted organ damage resulting from hypertension. The current standard of care dictates that antihypertensive therapy be prescribed in diabetics whose blood pressure is in the high-normal range or above (see Table 28-1). Angiotensin-converting enzyme (ACE) inhibitors are most commonly used for this purpose because of their well-documented protective effects in diabetic patients.^{4,21}

General Aims of Antihypertensive Drug Therapy

Treatment of essential hypertension consists of therapy aimed at reducing the blood pressure into the normal range. As shown in Figure 28-1, many factors play a role in the determination of blood pressure, and consequently pharmacologic agents with diverse mechanisms of action can be used singly or in combination to treat essential hypertension. Antihypertensive agents can be categorized according to their mechanism of action and therapeutic use: diuretics, drugs affecting

BOX 28-2

Clinical Disorders Resulting From Hypertension and Atherosclerosis

Hypertension

- Congestive heart failure
- Cerebral hemorrhage or stroke
- Renal failure
- Retinopathy
- Dissecting aneurysm
- Hypertensive crisis

Atherosclerosis

- Coronary artery disease
- Angina pectoris
- Myocardial infarction
- Secondary renovascular hypertension
- Peripheral vascular insufficiency
- Cerebral thrombosis—stroke

angiotensin, Ca⁺⁺ channel blockers (CCBs), drugs affecting sympathetic function, direct-acting vasodilators, and miscellaneous drugs. Because the basic pharmacologic properties of many drugs useful in treating hypertension are discussed elsewhere, only pharmacologic features pertinent to the treatment of hypertension are discussed in detail in this chapter. Figure 28-3 shows the major sites of action of antihypertensive agents.

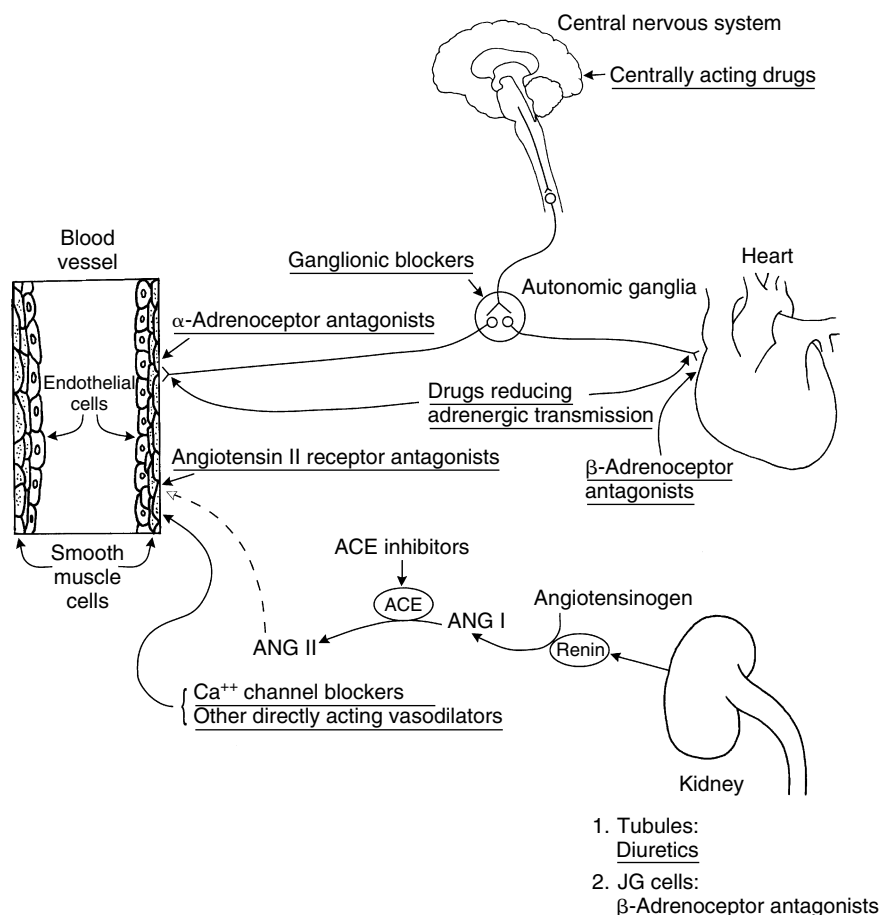

FIGURE 28-3 Sites of action of antihypertensive drugs. The diagram indicates by drug class the targets for antihypertensive action. ACE, Angiotensin-converting enzyme; ANG, angiotensin; JG, juxtaglomerular.

DIURETICS

Thiazide diuretics are currently among the most widely used drugs for the initial management of essential hypertension. K^+ -sparing diuretics are commonly used together with thiazides for their additive effect and to prevent thiazide-induced hypokalemia. Thiazide diuretics may be used alone or in combination with other antihypertensive drugs. Loop diuretics such as furosemide are also useful as adjunctive agents in refractory hypertension.

Diuretics reduce plasma volume by increasing Na^+ and water excretion. Initially, this effect reduces blood pressure by decreasing CO. With time, CO and extracellular fluid volume return toward normal values, but the hypotensive effect persists because of a reduction in peripheral resistance. It is probable that electrolyte changes in vascular smooth muscle account for the vasodilation. For a complete discussion of diuretics used in the treatment of hypertension, see Chapter 27.

DRUGS AFFECTING ANGIOTENSIN

The role played by the renin-angiotensin system in hypertension has received much attention in recent years.^{4,25} Renin catalyzes the conversion of angiotensinogen, a glycoprotein found in the blood, to angiotensin I, a decapeptide with little cardiovascular activity (see Figure 28-3). Angiotensin I is activated by conversion to the octapeptide angiotensin II. This reaction is catalyzed by ACE, otherwise known as *dipeptidyl carboxypeptidase* or *peptidyl dipeptidase*. Under its designation

as *kininase II*, ACE is also the enzyme that inactivates bradykinin.

Angiotensin II is metabolized by aminopeptidase enzymes to yield the less active and shorter lived heptapeptide angiotensin III. Increased renin activity leads to heightened production of angiotensin II and angiotensin III, vasoconstriction of peripheral arterioles, and elevation of blood pressure. Angiotensin peptides stimulate thirst and the secretion of aldosterone and antidiuretic hormone; the resultant increase in extracellular fluid and electrolytes augments the direct pressor effects. Angiotensin II also influences sympathetic nervous system function centrally and peripherally to increase cardiac activity and peripheral vascular resistance.

Patients with essential hypertension can be divided into three groups according to their renin- Na^+ index (i.e., plasma renin activity relative to Na^+ excretion). Approximately 15% of patients have renin concentrations higher than normal, 25% have renin concentrations lower than normal, and the remaining 60% exhibit normal renin titers. Renin titers tend to decrease with age. African American and elderly individuals tend to have a higher incidence of low-renin hypertension.

The percentage of hypertensive patients with normal renin activity may be misleading because renin release is ordinarily depressed as the result of increased blood pressure. Renin release may still be inappropriately high even in the "normal" group. Although angiotensin II may be the main causative agent in high-renin hypertension and may be a factor in the normal-renin hypertension group, other influences are implicated in low-renin hypertension, and these may contribute to normal-renin hypertension as well.

Pharmacologic intervention to reduce blood pressure theoretically can be anywhere along the angiotensin system—

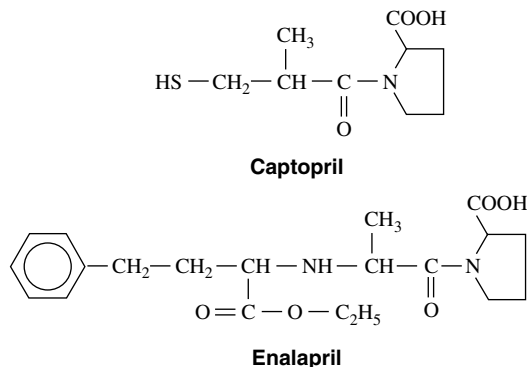

FIGURE 28-4 Structural formulas of two angiotensin-converting enzyme inhibitors.

from the release of renin by the kidney juxtaglomerular cells, to the formation of angiotensin peptides, to the binding of angiotensin II and angiotensin III to receptors in vascular smooth muscle and other effector sites. In the following discussion, attention is limited to drugs whose primary mechanism of action is interference with renin synthesis, renin activity, conversion of angiotensin I to angiotensin II, or action of angiotensin II at its receptor. Other antihypertensive drugs also affect the renin-angiotensin system, however. β -Adrenergic receptor antagonists inhibit renin release by acting at β_1 -adrenergic receptors in the juxtaglomerular apparatus of the kidney. Undesired reflex actions can also occur in which diuretics and direct-acting vasodilators stimulate renin release. Studies indicate that, regardless of the specific drug regimen, treatment of hypertension eventually tends to restore renin to normal levels, whether it was initially high or low.

Angiotensin-Converting Enzyme Inhibitors

ACE inhibitors are among the most commonly used drugs for the treatment of essential hypertension. Captopril, the first drug of this class to be developed, was specifically designed to disrupt the renin-angiotensin pathway. Its structure is shown in Figure 28-4. Captopril differs from other ACE inhibitors because it contains a sulfhydryl group. Enalapril, lisinopril, and most of the other ACE inhibitors have an amino acid substitution. Fosinopril contains a phosphorus linkage.

Pharmacologic effects

Drugs that inhibit ACE block the conversion of angiotensin I to angiotensin II (Figure 28-5; see Figure 28-3).⁴ ACE inhibitors markedly decrease blood concentrations of angiotensin II and induce an immediate decrease in blood pressure. They may also act to maintain the lowered blood pressure by elevating bradykinin (a potent vasodilator) concentrations in the blood (see Figure 28-5). (As previously mentioned, ACE, as kininase II, is responsible for the breakdown of bradykinin.) ACE inhibitors have an antihypertensive effect even in patients without high renin activities. Over the course of several weeks, blood pressure is progressively reduced, mainly through decreased peripheral resistance, with little effect on CO or renal blood flow. Salt and water retention is not induced, and orthostatic hypotension and tachycardia are not problems.

The reduction in angiotensin II concentrations as a result of ACE inhibition leads to a decrease in aldosterone secretion, which results in an increase in Na^+ and water excretion. Correspondingly, there is a net increase in the reabsorption of K^+ in the kidney tubule. Hypokalemia is not an adverse effect of ACE inhibitors. K^+ supplements and K^+ -sparing diuretics should not be used concurrently with ACE inhibitors to avoid hyperkalemia. With long-term ACE inhibitor therapy, deleterious

cardiovascular remodeling may be reduced or even reversed.^{4,5,26} ACE inhibitors are also renoprotective and because of this are useful drugs in patients with chronic renal disease and diabetes. The presence of high normal (or above normal) blood pressure and diabetes is a clear indication for the use of an ACE inhibitor.

Absorption, fate, and excretion

The onset of action of captopril is rapid, and the duration of effect is short, requiring administration two to three times daily. Its elimination half-life is approximately 2 hours. Because food in the gastrointestinal tract significantly reduces the absorption of captopril, the drug should be taken 1 hour before meals. Approximately 40% of captopril is metabolized in the liver, and most of the metabolites and the parent drug are excreted by the kidney.

Lisinopril is less well absorbed than captopril, resulting in peak plasma concentrations after approximately 7 hours. The slow elimination half-life of roughly 12 hours permits single daily dosing of the drug. Lisinopril is excreted unchanged in the urine.

Enalapril (see Figure 28-4) is a prodrug that must be hydrolyzed in the liver to become fully active. Its absorption is not influenced by food, and it has a longer duration of effect than captopril. The active metabolite enalaprilat, with a plasma half-life of 11 hours, provides for the extended action. Enalaprilat is not absorbed from the gastrointestinal tract but is effective after intravenous administration; it has been marketed for such use in patients unable to take drugs orally. Other ACE inhibitors with an esterified carboxyl side chain are also activated (by hydrolysis) in the liver to "prilat" metabolites that avidly bind to ACE and provide durations of effect sufficient for single daily dosing. The other ACE inhibitors are listed at the end of this chapter. They differ primarily in their pharmacokinetic properties.

Adverse effects

The most frequent side effect of the ACE inhibitors is coughing, which occurs in 20% of patients.⁴ Altered or reduced taste sensation is also common, especially with captopril. These adverse effects may disappear after continued use. The significance of reported cases of proteinuria is not established at this time. Other adverse effects that have been documented are skin rash; angioedema of the face, mucous membranes of the mouth, or extremities; and flushing, pallor, and hypotension. Angioedema is a serious condition that demands withdrawal of the drug. Hyperkalemia and neutropenia may rarely occur.

ACE inhibitors may cause renal insufficiency in patients with bilateral renal stenosis. The mechanism is the reduction of renal angiotensin II production, leading to a disproportionate dilation of efferent renal blood vessels compared with afferent vessels. This vascular imbalance results in a significant decline in the glomerular filtration rate. ACE inhibitors can help preserve renal function in diabetic patients.^{4,26} ACE inhibitors have the beneficial effect of reducing proteinuria in patients with some renal diseases.

Although ACE inhibitors are not known to be teratogenic during the first trimester of pregnancy, they can cause significant developmental defects and fetal death later on. After pregnancy has been established, discontinuance or substitution with another antihypertensive agent is mandatory.

Angiotensin Receptor Antagonists

Losartan (as losartan potassium) was the first orally active angiotensin II receptor antagonist to be introduced (Figure 28-6). Other angiotensin II antagonists include candesartan, eprosartan, irbesartan, telmisartan, and valsartan. These non-peptide analogues of angiotensin bind to the angiotensin II receptor and competitively inhibit the action of angiotensin

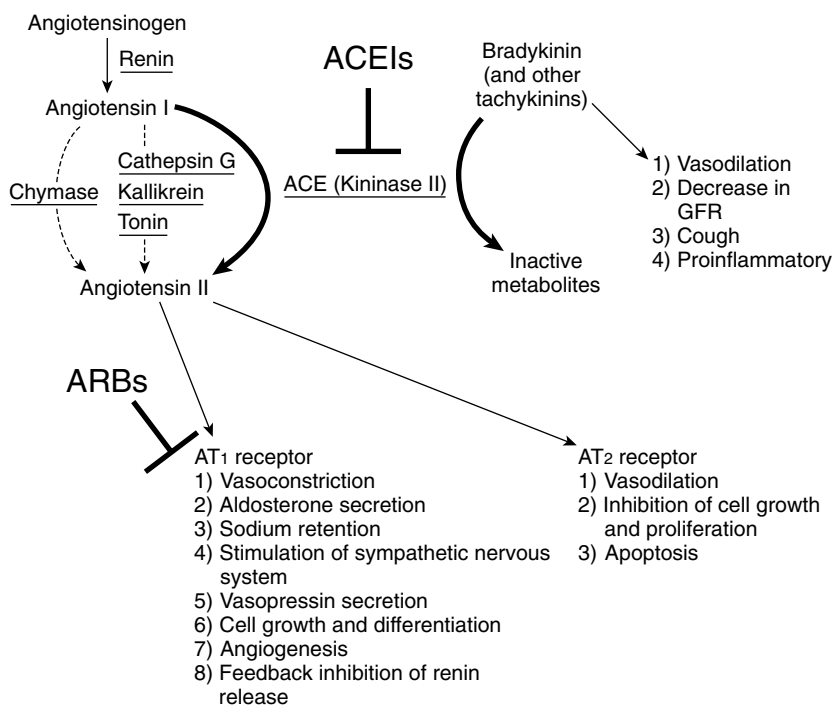

FIGURE 28-5 The role of angiotensin-converting enzyme inhibitors (*ACEIs*) and angiotensin II receptor blockers (*ARBs*) in treating hypertension. *ACEIs* block the major, but not the only, synthetic pathway to angiotensin II. *ACEIs* also increase the concentration of bradykinin and other tachykinins, leading to vasodilation and some undesirable effects. *ARBs* block the effect of angiotensin II by whatever synthetic pathway because they block the AT₁ receptor and the response to AT₁ receptor stimulation. The *ARBs* do not block the AT₂ receptor. This is considered a benefit of *ARBs* because the AT₂ receptor mediates vasodilation, inhibition of growth and proliferation, and apoptosis. Angiotensin-converting enzyme (*ACE*) located in tissues is less affected by *ACEIs*. Enzymes are underlined. *GFR*, Glomerular filtration rate.

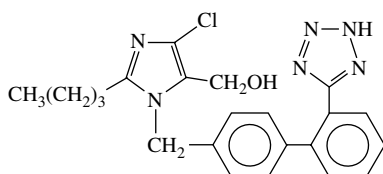

FIGURE 28-6 Structural formula of losartan.

II and angiotensin III.^{4,6} They are selective inhibitors of the AT₁ receptor, the angiotensin receptor subtype that accounts for the major physiologic effects of angiotensin II. The effect is to inhibit the consequences of AT₁ receptor stimulation without affecting potentially beneficial effects mediated by the AT₂ receptor (see Figure 28-5).²³ As is the case with ACE inhibitors, AT₁ receptor blockers reduce the blood pressure and the tissue remodeling seen in hypertension and reduce organ damage resulting from hypertension.^{4,15,26}

Losartan has a half-life of only 1.5 hours, but it is metabolized to an active metabolite with a longer half-life. Valsartan has a plasma half-life of 6 hours; it is excreted in the bile largely in the unchanged form. The half-lives for the other angiotensin II blockers range from 6 hours for eprosartan to 24 hours for telmisartan. The selectivity of angiotensin II antagonists avoids some of the side effects of ACE inhibitors, such as coughing and angioedema, because the bradykinin pathway is not affected by the angiotensin II antagonists (see Figure 28-5). Orally effective angiotensin II receptor antagonists now constitute a major drug group for treating hypertension.⁵

Renin Inhibitors

The renin inhibitor aliskiren has been approved for use in the United States as a once-daily treatment for stage 1 hypertension (see Table 28-1). Aliskiren binds with high specificity to the proteolytically active site of human renin.²¹ Renin is the

rate-limiting step in the renin-angiotensin system, so inhibition of this enzyme provides a logical control point for pharmacologic intervention. Aliskiren reduces circulating concentrations of angiotensin I and angiotensin II, producing a decrease in systolic and diastolic blood pressure, comparable to reductions seen with ACE inhibition or AT receptor antagonism. Early reports on toxicity are favorable. Based on the mechanism of action, expected adverse events include hyperkalemia and hypotension. Aliskiren administration produces hyperreninemia owing to a compensatory increase in renin release. This effect is not clinically significant. Aliskiren does not interfere with ACE-induced catabolism of bradykinin, and it is not expected that cough or angioedema would be produced by this class of drugs (as seen in ACE inhibitors). Similar to other inhibitors of the renin-angiotensin system, aliskiren is contraindicated in patients with bilateral renal artery stenosis and during pregnancy. Aliskiren has a poor bioavailability and is greater than 90% excreted unchanged in the feces, so minimal drug metabolism interactions are expected from this drug.

CA⁺⁺ CHANNEL BLOCKERS

Verapamil, diltiazem, and nifedipine were the first CCBs to be marketed. The pharmacologic features of nifedipine and its dihydropyridine congeners, including amlodipine, felodipine, isradipine, nicardipine, nimodipine, nisoldipine, and nitrendipine, are addressed in this chapter. Other CCBs are discussed in Chapters 24 and 26.

Pharmacologic Effects

All CCBs prevent Ca⁺⁺ influx into smooth and cardiac muscle cells. The potency of these drugs for each of these actions varies, however, producing some important distinctions between the dihydropyridines and verapamil and diltiazem. These latter two drugs inhibit Ca⁺⁺ influx into vascular smooth muscle and the heart with roughly the same potency. The effect of verapamil and diltiazem is to reduce blood pressure by vasodilation and reduced CO. Dihydropyridines such

as nifedipine are much more potent at inhibiting Ca^{++} influx at vascular smooth muscle than in the heart. At clinically relevant plasma concentrations, nifedipine produces a pronounced vasodilation with little direct effect on cardiac function. Reflex tachycardia is a common side effect with dihydropyridines but is almost never seen with verapamil and diltiazem. CCBs are contraindicated in patients with cardiac conduction defects and in heart failure. CCBs are useful drugs for treating low-renin hypertension.

Dihydropyridines enhance the glomerular filtration rate and renal blood flow. Some patients taking dihydropyridines develop pedal edema. This condition does not result from fluid retention but rather from precapillary dilation. Renal Na^+ excretion may be enhanced. The antihypertensive effect and an apparent direct renoprotective effect of these drugs may make them useful in treating chronic renal failure.

Absorption, Fate, and Excretion

The plasma half-lives of most CCBs (diltiazem, isradipine, nifedipine, nifedipine, and verapamil) are 2 to 8 hours. The half-lives of the others are as follows: amlodipine, 30 to 50 hours; felodipine, 10 to 16 hours; nimodipine, 1 to 2 hours; nisoldipine, 7 to 12 hours; and nitrendipine, 10 to 20 hours. Long-term therapy may be associated with some increase in half-lives for some CCBs.

The elimination half-life and duration of action influence the clinical use of these agents. The short time course of nimodipine, along with its relative ability to cross the blood-brain barrier, limits the drug's suitability for the treatment of chronic disease but permits its use to prevent vasospasm subsequent to subarachnoid hemorrhage. Short-acting nifedipine has been associated with an increased cardiovascular mortality rate during long-term use, and it is no longer used for treating hypertension. The drug's short duration of action causes the blood pressure to wax and wane with each dose. A slow-release version of the drug stabilizes blood concentrations and now is the recommended formulation. CCBs with long half-lives and slow-release preparations are recommended for this reason.

Adverse Effects

Toxic reactions and side effects of CCBs are described in Chapter 26.

DRUGS REDUCING SYMPATHETIC FUNCTION

A major homeostatic role of the autonomic nervous system is control of cardiovascular function. Drugs affecting autonomic activity are useful in controlling blood pressure in essential hypertension. This section describes drugs that exert their antihypertensive action on the sympathetic division of the autonomic nervous system. These drugs can conveniently be divided into four groups according to their site of action: (1) α -adrenergic receptor-blocking drugs, (2) β -adrenergic receptor-blocking drugs, (3) drugs altering peripheral adrenergic transmission, and (4) drugs acting on the CNS. (Other drugs that alter adrenergic function, such as monoamine oxidase inhibitors, have been used in treating hypertension, but their use has been superseded in almost all cases by newer agents with fewer adverse effects and greater effectiveness.) Only actions and side effects pertinent to antihypertensive use of agents affecting adrenergic function are described here. For discussion of other uses and actions of these drugs, see Chapter 7.

β -Adrenergic Receptor-Blocking Drugs

The structures of several β -adrenergic receptor-blocking drugs are shown in Figure 28-7. Propranolol, the prototype

for this class of drugs, and its congeners are not only used as antihypertensives, but also are used in many other disorders, including cardiac arrhythmias, angina pectoris, and migraine headache. As indicated in Chapter 7, some of these agents, including propranolol, block β_1 and β_2 receptors, whereas others, such as metoprolol, have a selective effect on β_1 receptors of the heart. Some drugs classified as β -adrenergic blocking drugs are actually partial agonists, and some exert a membrane-stabilizing effect analogous to that of the local anesthetics. Because the local anesthetic action of β -blocking drugs occurs at doses higher than those used clinically, it may not be clinically relevant.

Pharmacologic effects

The various β -adrenergic receptor-blocking drugs are about equally effective in the management of hypertension, regardless of subtype selectivity. They can be used alone or in combination with diuretics and other antihypertensive medications. Although much information is available, the exact mechanisms by which these drugs decrease blood pressure remain equivocal. Their effects have been attributed to the following actions: blockade of β_1 receptors resulting in decreased CO, decreased renin secretion, decreased central sympathetic outflow, blockade of prejunctional β receptors on adrenergic nerve endings, and resetting of baroreceptors.²⁰ Of these mechanisms, the first two are probably the most important for blood pressure control. Some investigators believe that hypertension characterized by high CO or high plasma renin activities represents a specific indication for β receptor antagonist therapy. Partial β receptor agonists produce less bradycardia than β receptor antagonists. Cardioselective β -adrenergic receptor antagonists, having less affinity for bronchial β_2 receptors, are less likely to precipitate asthmatic attacks in susceptible individuals.

Absorption, fate, and excretion

The pharmacokinetics of β -adrenergic receptor-blocking drugs are strongly influenced by lipid solubility, as illustrated by the highly lipophilic propranolol and the poorly lipid-soluble nadolol and atenolol. Propranolol and most β -adrenergic blocking agents are readily absorbed from the gastrointestinal tract, although bioavailability of an administered dose is often restricted to 50% or less by extensive first-pass metabolism in the liver. The bioavailability of nadolol and atenolol is limited to a similar extent because of incomplete absorption. Plasma protein binding, a factor that also tends to correlate with lipid solubility, ranges from 10% (atenolol) to 90% (propranolol).

Metabolism and excretion also vary with the particular β blocker. Propranolol is almost entirely biotransformed in the liver; nadolol and atenolol are essentially excreted unchanged in the urine; agents of more intermediate lipid solubility show a mixture of elimination pathways. Although the plasma half-life of most β -adrenergic receptor antagonists approximates that of propranolol (3 to 5 hours), the slow excretion of nadolol (half-life up to 24 hours) gives the drug an extended duration of action that permits once-daily dosing.

Adverse effects

β -Adrenergic receptor antagonists cause various side effects; tolerance may develop to some but not to others. The side effects to which early tolerance may develop include nausea, vomiting, anorexia, confusion, dizziness, fatigue, sleep disturbances, and depression.

A major toxic effect of β -adrenergic receptor antagonists is the aggravation of an existing defect in myocardial contractility or atrioventricular conduction. Congestive heart failure and bradyarrhythmias may be exacerbated. (β blockers are used in the treatment of heart failure, however, as discussed in Chapter 25.) Blockade of β receptor-mediated vasodilation

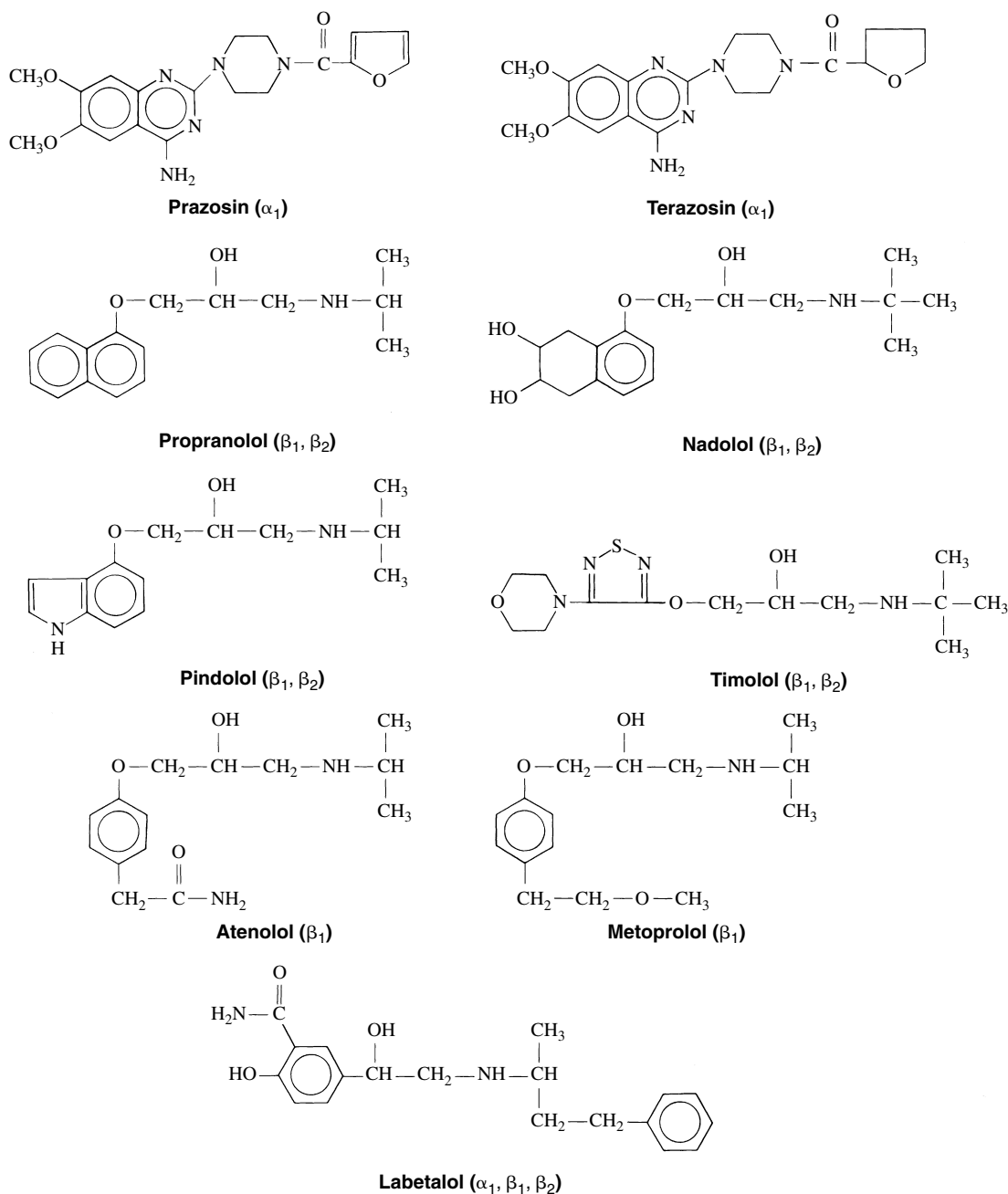

FIGURE 28-7 Structures of some α -adrenergic and β -adrenergic receptor-blocking drugs and their receptor selectivity.

may worsen peripheral arterial insufficiency, intermittent claudication, and Raynaud's phenomenon. Bronchospasm may also be induced in asthmatics, particularly with nonselective β antagonists.

Nonselective β blockers and, to a lesser extent, selective β_1 -adrenergic receptor antagonists, inhibit the ability of endogenous catecholamines to elevate plasma glucose concentrations and should be used with caution in patients prone to hypoglycemia or patients being treated with insulin or sulfonylureas for diabetes. All blockers can reduce the tachycardia resulting from hypoglycemia. They may mask an important sign used to indicate overdosage of hypoglycemic agents.

Abrupt withdrawal of β -adrenergic receptor antagonists in patients with coronary heart disease increases the likelihood of severe ischemic events and may lead to anginal pain, myo-

cardial infarction, or life-threatening arrhythmia. Abrupt withdrawal in hypertensive patients may result in increased blood pressure and heart rate, palpitation, tremors, and sweating. It is important that dosages be gradually decreased when drug treatment with β blockers is terminated.

Salt and water retention, which is a problem with some antihypertensive medications, has not been reported with the β -adrenergic receptor-blocking drugs. Postural hypotension is also not generally encountered.

Selective α_1 -Adrenergic Receptor-Blocking Drugs

Prazosin is the first of a group of selective α_1 -adrenergic receptor-blocking agents used for the treatment of hypertension. Terazosin and doxazosin have a similar action. The chemical structures of these drugs are shown in Figure 28-7,

and their general pharmacologic characteristics are discussed in Chapter 7.

Pharmacologic effects

The hypotensive effect of these drugs is ascribed to vasodilation of arterioles and capacitance veins. The action is a result of blockade of α_1 receptors on vascular smooth muscle. In contrast to older, nonselective α blockers such as phenoxybenzamine, these drugs have a low affinity for α_2 receptors. They can be used in hypertension ranging from mild to severe, alone, with diuretics, or with other antihypertensive drugs.

Nonselective α -adrenergic receptor blockers are used only occasionally in therapy. Their ability to block α_1 and α_2 receptors is useful in treating hypertension resulting from pheochromocytoma. With this disease, α_1 and α_2 receptors play a major role in the hypertensive response to the elevated circulating catecholamine concentrations. Phentolamine is a competitive antagonist, whereas phenoxybenzamine is a noncompetitive antagonist. Tolazoline is another drug that is a competitive antagonist at α_1 and α_2 receptors, with a slight preference for α_2 receptors. It has limited clinical use.

The adverse effects of nonselective α -adrenergic receptor antagonists are more notable than the adverse effects of selective α_1 -adrenergic receptor blockers. Inhibition of prejunctional α_2 receptors accounts for the greater reflex tachycardia seen with nonselective blockers. There is a higher incidence of orthostatic hypotension and fluid retention compared with selective α_1 -adrenergic receptor antagonists.

Absorption, fate, and excretion

Prazosin and terazosin are rapidly absorbed from the gastrointestinal tract and are available only for oral use. Prazosin undergoes more first-pass metabolism than terazosin or doxazosin. Prazosin is bound significantly to plasma α_1 -acid glycoprotein and is excreted principally as glucuronide conjugates, with approximately 90% appearing in the feces and 10% appearing in the urine. The plasma half-life of prazosin (approximately 2 hours) does not correlate with the duration of its hypotensive effect because of tissue binding and the formation of active metabolites, and the drug is administered two to three times daily. Terazosin is eliminated more slowly (half-life of 12 hours), which usually permits once-daily dosing. The half-life of doxazosin is approximately 22 hours. Terazosin and doxazosin are highly bound to plasma proteins and extensively metabolized.

Adverse effects

Prazosin and other α_1 -adrenergic receptor blockers produce less reflex tachycardia than direct vasodilators or nonselective α -adrenergic receptor blockers. Nevertheless, reflex tachycardia may be significant. Syncope from orthostatic hypotension may occur with the initiation of therapy. This heightened response early in therapy has been termed the *first-dose effect*.⁶ Postural hypotension usually abates with continued therapy. These drugs share an array of other side effects, including gastrointestinal upset, palpitation, tinnitus, headache, rash, edema, and urinary incontinence. Inhibition of ejaculation may also occur.

α_1 -Adrenergic and β -Adrenergic Receptor Blockers

Labetalol is a competitive blocker of α_1 , β_1 , and β_2 receptors, with a greater affinity for β receptors. It also exerts some β_2 -agonistic activity and inhibits norepinephrine uptake by the presynaptic nerve terminal. This extensive pharmacologic profile results from the fact that the drug is composed of four different diastereoisomers, each of which has distinct effects. Labetalol has been used singly and in combination with other antihypertensive agents. Used orally and intravenously, labetalol undergoes significant first-pass metabolism in the liver,

accounting for approximately 75% of an oral dose. It has a half-life of approximately 8 hours and is metabolized to the glucuronide conjugate. Labetalol is especially useful in treating pheochromocytoma and hypertensive emergencies. Its adverse effects include gastrointestinal disturbances, dry mouth, fatigue, nervousness, paresthesias, orthostatic hypotension, and bradycardia. Patients with asthma are at risk of bronchospasm.

Carvedilol is the second drug with mixed α_1 -adrenergic and β -adrenergic receptor-blocking activity to be marketed for the treatment of hypertension and heart failure. As with labetalol, several stereoisomers contribute to the drug's complex pharmacologic characteristics. The pharmacokinetic profile is similar to that of labetalol; however, one of the isomers of carvedilol, which contributes roughly half of the drug's α -blocking activity, accumulates up to threefold in patients genetically deficient in cytochrome P4502D6 activity. Carvedilol is available only for oral use.

Drugs That Affect Adrenergic Transmission

Guanethidine, guanadrel, and the rauwolfia alkaloid reserpine exert their primary antihypertensive action on peripheral postganglionic adrenergic nerve endings and are classified as adrenergic neuron-blocking drugs. They are rarely used today for the treatment of hypertension.

Pharmacologic effects

The ultimate effect of reserpine, guanethidine, and guanadrel is depletion of norepinephrine from adrenergic nerve endings, although the mechanism by which depletion occurs with reserpine differs from that of guanethidine and guanadrel. All three drugs must enter the adrenergic nerve ending to exert an antihypertensive effect. Reserpine inhibits the active uptake of catecholamines into the storage vesicles of the nerve terminal. Inhibition of synaptic transmission occurs in concert with the progressive depletion of neurotransmitter. The mechanisms of action of guanethidine are the same as guanadrel. After intravenous injection, guanethidine yields a complex response. Guanethidine may lead to an initial increase in blood pressure caused by the release of catecholamines, which gives way several hours later to extended hypotension associated with inhibition of evoked norepinephrine release. Only the hypotensive effect is usually observed with oral use. The inhibition of norepinephrine release seems to result from a local anesthetic effect on the adrenergic nerve terminal. Competition between norepinephrine and guanethidine for uptake into the nerve terminal and storage in the adrenergic vesicles eventually causes depletion of norepinephrine, but this outcome, although supportive of a decrease in sympathetic activity, is not crucial to the therapeutic effect.

The cardiovascular manifestations that result from these actions and make these agents useful in treating hypertension are decreases in peripheral resistance and CO. Reserpine enters the CNS, and some of its antihypertensive action may be caused by effects at this site. Guanethidine and guanadrel do not readily cross the blood-brain barrier and exert their actions solely on peripheral postganglionic neurons.

Absorption, fate, and excretion

Reserpine is readily absorbed from the gastrointestinal tract, but exhibits a slow onset of antihypertensive effect (3 weeks for maximum effect). Its duration of action is long, probably owing to its strong binding to amine transport sites in storage granules. It is excreted as the parent compound and as various metabolites.

Although available only for oral use, guanethidine is poorly absorbed from the gastrointestinal tract, varying from 3% to 30% among different individuals. Guanethidine and its metabolites are slowly excreted in the urine, and small

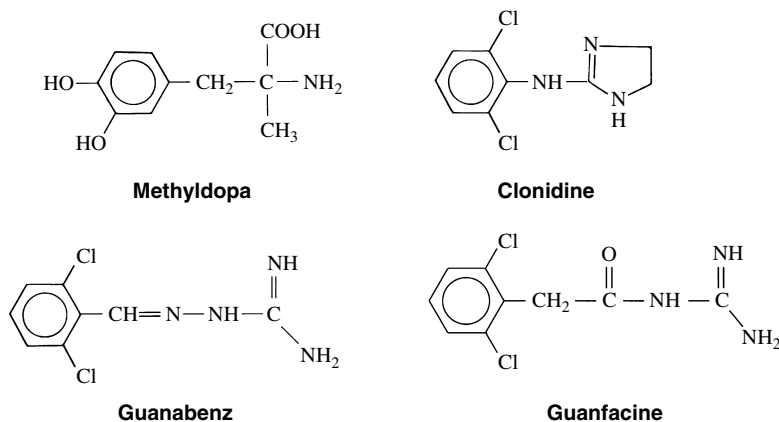

FIGURE 28-8 Structural formulas of centrally acting antihypertensive drugs.

amounts remain in the tissues for prolonged periods (2 weeks). Guanadrel has better absorption, a more rapid onset, and a shorter duration of action than guanethidine.

Adverse effects

The most frequent untoward effects of reserpine are results of actions on either the CNS or the gastrointestinal tract. Sedation is common. Nightmares and emotional depression leading to suicidal tendencies are possible with large doses. Abdominal cramps and diarrhea result because reserpine reduces sympathetic function, resulting in greater parasympathetic effects. Reserpine can also cause nasal congestion. This effect is not serious in adults. Reserpine passes the placental barrier, however, and can cause nasal congestion, cyanosis, drowsiness, and gastrointestinal disturbances in newborns when given before term.

The major troublesome adverse effect of guanethidine is orthostatic hypotension. Other side effects include difficulty in ejaculation, nocturia, intestinal cramps, Na⁺ and water retention, bradycardia, flushing, weakness, depression, and diarrhea. Pharmacologic properties of guanadrel are essentially the same as those of guanethidine, but its use is associated with a lower frequency of diarrhea.

Centrally Acting Antihypertensive Drugs

Methyldopa, clonidine, guanabenz, and guanfacine are drugs that exert their antihypertensive effect by stimulating α_2 receptors in the brainstem. As a result, these drugs reduce sympathetic outflow from the brain. The structures of methyldopa, clonidine, guanabenz, and guanfacine are shown in Figure 28-8. The structural similarity of methyldopa to the catecholamine transmitter norepinephrine is obvious. Clonidine, guanabenz, and guanfacine are not chemically related to norepinephrine but are very similar in structure to the α -adrenergic receptor–blocking drug tolazoline.

Pharmacologic effects

Methyldopa, a prodrug, is biotransformed in the brain to α -methyldopamine and then to α -methylnorepinephrine. The latter metabolite probably stimulates important α_2 -adrenergic receptor sites in the medulla, resulting in inhibition of central sympathetic outflow. In addition, there is evidence that vagal activity to the heart is increased. Clonidine, guanabenz, and guanfacine seem to act directly as central α_2 -adrenergic receptor agonists. With all four drugs, the reduction in central sympathetic outflow and increased vagal activity lead to reduced peripheral vascular resistance and CO. It is uncertain whether presynaptic or postsynaptic medullary α_2 receptors play the predominant role in mediating the antihypertensive response.

Absorption, fate, and excretion

Methyldopa can be given orally or intravenously (as methyldopate hydrochloride). Approximately 25% to 50% of an orally administered dose of methyldopa is absorbed from the gastrointestinal tract. Although methyldopa and its metabolites appear rapidly in the urine, significant concentrations remain in the body for longer periods. It has a long duration of action (up to 24 hours), probably because α -methylnorepinephrine is not metabolized by monoamine oxidase, but is stored in synaptic vesicles in central adrenergic nerve terminals.

Clonidine is available for oral and parenteral use and is well absorbed after oral administration. Peak plasma concentrations are achieved in 3 to 5 hours; its half-life is approximately 10 hours. Approximately 50% is metabolized in the liver. The remaining clonidine and its metabolites are primarily excreted in the urine.

Approximately 75% of an oral dose of guanabenz is absorbed, but hepatic metabolism decreases bioavailability. Peak plasma concentrations appear 2 to 5 hours after administration. The plasma half-life is approximately 6 hours. A large percentage of guanabenz is metabolized in the liver and excreted by the kidney. Guanfacine is rapidly and nearly completely absorbed from the gastrointestinal tract. It has a half-life of 14 to 17 hours. The drug is partly hydroxylated, and parent drug and metabolites are excreted in the urine.

Adverse effects

Untoward effects of methyldopa include drowsiness, depression, nightmares, dry mouth, and nasal stuffiness.²⁴ The drowsiness caused by this drug, although usually transient, may be particularly bothersome. Orthostatic hypotension may occur but is less frequent than with guanethidine because the baroreceptor reflex is not greatly affected by centrally acting drugs. Extrapyramidal reactions, prolactin release, and impotence may also occur. Hepatitis, a lupus-like syndrome, drug fever, and blood dyscrasias are rare adverse manifestations.

The most common side effects of clonidine are dry mouth and sedation.²⁴ The incidence of these effects is high, but some tolerance may develop during long-term therapy. Other side effects include parotid gland pain, nightmares, and insomnia. Constipation and impotence occur in a small percentage of patients treated with clonidine. Other, less frequent adverse effects are allergic reactions and orthostatic hypotension. Rebound hypertension has been observed on abrupt withdrawal of clonidine therapy. The sudden withdrawal of clonidine is also associated with tachycardia, anxiety, and insomnia. When withdrawal is necessary, the dosage should be reduced gradually.

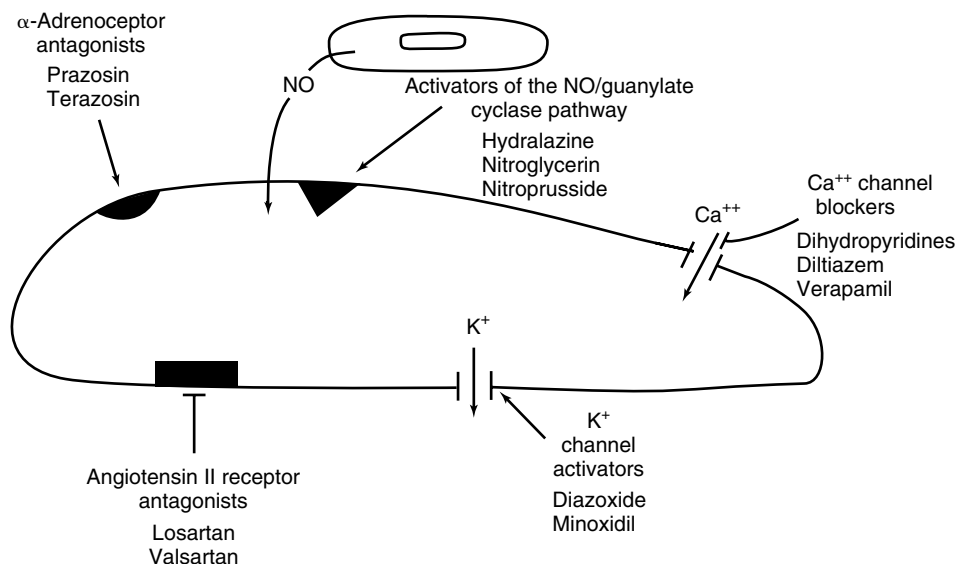

FIGURE 28-9 Sites of action of drugs that relax vascular smooth muscle. Various drug types that act on the vascular smooth muscle cell (*bottom*) are depicted. An endothelial cell (*top*) that releases nitric oxide (NO) is also shown. PDE-5, Phosphodiesterase 5.

Guanabenz has not been found to cause postural hypotension. Adverse side effects, listed in order of decreasing frequency, are drowsiness, dry mouth, dizziness, weakness, and headache. Side effects of guanfacine are mild and dose-related. The side effects include fatigue, dizziness, dry mouth, insomnia, and impotence, but they tend to be less disturbing than with clonidine or guanabenz. Abrupt withdrawal of guanabenz and guanfacine has been associated with rebound hypertension.

Direct-Acting Vasodilators

Hydralazine, minoxidil, diazoxide, nitroprusside, nitroglycerin, and epoprostenol are considered together in this section because they exert their primary antihypertensive effect through a direct action on vascular smooth muscle. Figure 28-9 summarizes the functional relationship between vascular endothelial cells and vascular smooth muscle and depicts the site of action of the direct-acting vasodilators and other drugs that relax vascular smooth muscle by inhibiting membrane-bound proteins involved in contractile responses.

Hydralazine

Hydralazine is one of a series of phthalazine derivatives that have been shown to reduce blood pressure and is the only agent of this series available in the United States. The chemical structure of this compound is shown in Figure 28-10.

Pharmacologic effects. Hydralazine exerts a preferential effect on arterioles compared with veins. The resulting changes are decreased peripheral resistance; decreased blood pressure; and reflexively increased heart rate, stroke volume, and CO. It stimulates guanylyl cyclase in vascular smooth muscle cells, leading to a decrease in muscle tone. The preferential effect on arterioles reduces the incidence of orthostatic hypotension. Reflex inotropic and chronotropic effects that accompany hydralazine vasodilation may cause exacerbation of existing angina pectoris. Hydralazine has no important therapeutic actions on systems other than the cardiovascular system.

Absorption, fate, and excretion. Hydralazine is available for parenteral and oral use. It is readily absorbed from the gastro-

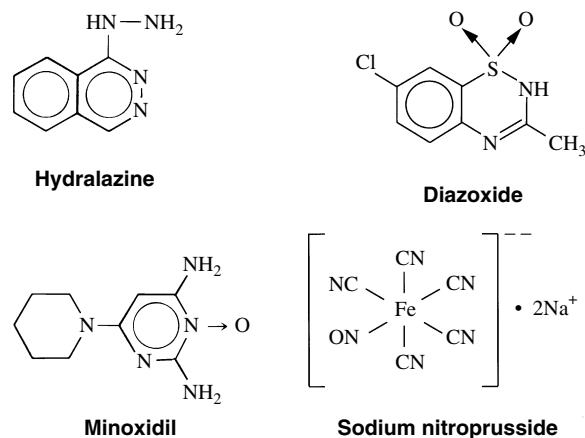

FIGURE 28-10 Structural formulas of some direct-acting vasodilators.

intestinal tract, and peak blood concentrations are reached in 1 hour. The plasma half-life is also approximately 1 hour; however, hydralazine exhibits a high affinity for vascular muscle and is slowly removed from these sites. Only a small percentage of hydralazine is excreted unchanged, with the major portion undergoing acetylation. A dichotomous distribution exists in the rate of metabolism, with half of the population being characterized as fast acetylators.

Adverse effects. A high incidence of side effects is associated with hydralazine therapy. More common untoward effects are palpitation (and angina in susceptible patients), headache, anorexia, nausea, dizziness, and sweating. Less frequently encountered effects include nasal congestion, flushing, tremors, cramps, postural hypotension, and depression. Tolerance to these effects may develop, especially if the initial dosage is gradually increased. Long-term administration of hydralazine in large doses may cause a syndrome resembling lupus erythematosus, particularly in slow acetylators.

Minoxidil

Minoxidil is another antihypertensive drug that acts chiefly through arteriolar vasodilation. The chemical structure of this piperidinopyrimidine is shown in Figure 28-10. Minoxidil is reserved for use in patients refractory to other therapy.

Pharmacologic effects. Minoxidil, similar to other peripheral vasodilators, reduces blood pressure by decreasing TPR. Minoxidil activates K^+ channels, resulting in hyperpolarization, stabilization of the smooth muscle plasma membrane, and reduced contraction. The drug is a prodrug requiring conversion to minoxidil sulfate (a quantitatively minor metabolite) for its vasodilator effect.

The decrease in blood pressure from minoxidil is accompanied by reflex increases in cardiac function, renin secretion, and fluid retention. These potentially adverse responses may be corrected by coadministration of β -adrenergic receptor-blocking agents and diuretics. Minoxidil has no central depressant effects.

Absorption, fate, and excretion. The onset of action of minoxidil after oral administration is rapid, and its hypotensive action is of long duration. This compound is primarily excreted in the urine as the glucuronide conjugate, along with small amounts of the parent compound and hydroxylated derivatives.

Adverse effects. The marked fluid retention caused by minoxidil can lead to congestive heart failure. There are reports of pericardial effusion and cardiac tamponade, sometimes with fatal outcomes. As with other vasodilators, the reflex tachycardia may initiate or intensify angina. Dermatologic reactions and breast tenderness may also occur. Finally, abnormal hair growth, or hypertrichosis, is very common and limits the use of this drug. Topical minoxidil is approved for the treatment of alopecia and baldness, and these indications represent its main therapeutic uses.

Diazoxide

Diazoxide is a nondiuretic thiazide derivative (see Figure 28-10) with direct action as a vasodilator. It reduces blood pressure rapidly, making it useful in hypertensive emergencies and malignant hypertension. Orally, the antihypoglycemic action of diazoxide makes it occasionally useful in the treatment of hypoglycemia caused by insulin.

Pharmacologic effects. Similar to minoxidil, diazoxide acts by opening K^+ channels. Diazoxide has its major effect on arterioles, with much less effect on capacitance vessels. Intravenous administration of the drug routinely leads to tachycardia and increased CO. In contrast to the thiazide diuretics, diazoxide promotes salt and water retention. The opening of K^+ channels accounts for its inhibition of insulin release.

Absorption, fate, and excretion. Diazoxide is restricted to the intravenous route for the treatment of hypertension. In plasma, it is 90% bound to albumin. Its plasma half-life is 20 to 60 hours. Approximately two thirds of the drug is metabolized in the liver. Excretion of metabolites and the parent drug is by the kidney.

Adverse effects. Fluid retention and hyperglycemia can occur, especially if therapy is extended. A diuretic is often required to overcome the fluid retention, and diabetic patients may require added therapy to treat the hyperglycemia. Hyperuricemia, severe hypotension, angina, and cerebral ischemia also may occur.

Sodium nitroprusside

Sodium nitroprusside (see Figure 28-10) is a direct vascular smooth muscle relaxant. Its principal uses are to provide controlled hypotension during surgery and to treat hypertensive emergencies, as described later in this chapter.

Pharmacologic effects. Nitroprusside is a nitrovasodilator. It generates nitric oxide, which activates guanylyl cyclase in vascular smooth muscle.¹¹ The resulting relaxation of smooth muscle accounts for its antihypertensive response. The drug affects veins and arterioles and reduces preload and afterload. Because capacitance and resistance vessels are dilated, cardiac ischemia and angina are not as frequently associated with nitroprusside as with arteriolar vasodilators.

Absorption, fate, and excretion. Nitroprusside works rapidly after intravenous administration. It is not used orally. In addition to producing nitric oxide, it is converted nonenzymatically to cyanide by red blood cells and metabolized further to thiocyanate in the liver and kidney. The half-life of nitroprusside is measured in minutes; thiocyanate may persist with a half-life of approximately 3 days. Thiocyanate is excreted by the kidney.

Adverse effects. Adverse reactions can be classified as acute or chronic. Acute effects include a precipitous decline in blood pressure, with resultant sweating, vomiting, headache, nervousness, and palpitation. Metabolic acidosis, methemoglobinemia, and cardiac arrhythmias have occurred. Cyanide accumulation may occur in some individuals, leading to toxicity. Thiocyanate may accumulate in patients with renal insufficiency. Thiocyanate may cause psychosis, muscle weakness, and hypothyroid symptoms.

Nitroglycerin

Nitroglycerin is described in detail in Chapter 26. When given intravenously, nitroglycerin is an effective treatment for perioperative hypertension and to induce controlled hypotension during surgery. Similar in mechanism of action to nitroprusside, nitroglycerin exerts a relatively greater effect on capacitance vessels. Continuous infusion with careful monitoring of blood pressure is required for proper control of blood pressure.

Prostacyclin

Epoprostenol, better known as prostacyclin, is a naturally occurring vasodilator (see Chapter 21). Prostacyclin is an autacoid that is released from the endothelium and serves to counterbalance the vasoconstrictor and proclotting influences of thromboxane A_2 . It does so by stimulating cell surface prostacyclin (IP) receptors. Epoprostenol is an extremely potent and short-acting (half-life of 6 minutes) vasodilator administered by continuous intravenous infusion to patients with primary pulmonary hypertension refractory to other drugs. The annual costs, including the necessary administration pumps, make this therapy prohibitive for many patients.

Fenoldopam

Fenoldopam is a vasodilator that is used in emergency situations.

Pharmacologic effects. Fenoldopam (Figure 28-11) is an agonist at dopamine D_1 receptors. It stimulates D_1 receptors in blood vessels and results in vasodilation, especially in renal vessels.⁹ As such, it increases renal blood flow and decreases blood pressure.

Absorption, fate, and excretion. Fenoldopam is given by continuous intravenous administration and has an elimination

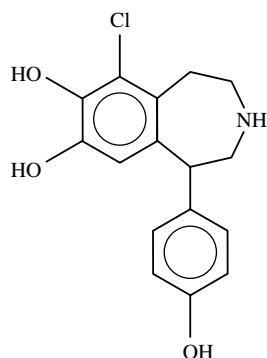

FIGURE 28-11 Structural formula of fenoldopam.

half-life of approximately 5 minutes. Hepatic metabolism by conjugation accounts for the termination of its pharmacologic effects because the metabolites are inactive. Most of the metabolites are excreted by the kidney.

Other Drugs for Treating Hypertension

Endothelin receptor antagonists

Bosentan is a nonselective antagonist at endothelin receptors A and B. Endothelin is a vasoconstrictor peptide released from the endothelial cells of blood vessels. Bosentan is used to treat pulmonary arterial hypertension.

The drug is given orally and its bioavailability is about 50% by this route. Its half-life is about 5 to 6 hours. Adverse effects include headache, dizziness, swelling of the lower extremities, and occasional allergic reactions. Hepatotoxicity has been reported. The drug should not be used in pregnancy.

Darusentan is an investigational drug that is a selective antagonist at the endothelin A receptor. Darusentan, and perhaps other blockers of the endothelin A receptor, seems to be effective in reducing blood pressure in patients who are resistant to other antihypertensive drugs.

Sildenafil

Sildenafil is a drug that is better known by its generic name, Viagra. It has been shown to be effective in improving exercise capacity in patients with pulmonary arterial hypertension.⁷ Sildenafil inhibits phosphodiesterase 5, an enzyme that metabolizes cyclic 3',5'-guanosine monophosphate (cGMP). By increasing cGMP levels in blood vessel smooth muscle cells, it causes relaxation of blood vessels and presumably reduces growth of vascular smooth muscle cells.⁸

MISCELLANEOUS DRUGS

Numerous drugs have limited application in the treatment of hypertension. Some of these agents, such as monoamine oxidase inhibitors and *Veratrum* alkaloids, were previously widely used but have been replaced by more effective or less toxic compounds and are not considered further. Others are restricted to defined roles exclusive of the routine treatment of essential hypertension and are mentioned briefly.

Ganglionic blocking drugs, discussed in Chapter 10, previously were used for the long-term treatment of hypertension. They are rarely prescribed today because of postural hypotension, impotence, and other side effects associated with their use. Trimethaphan infused intravenously is effective in some hypertensive emergencies and to induce a hypotensive state during surgery.

Metyrosine (α -methyltyrosine) is an inhibitor of tyrosine hydroxylase, the rate-limiting enzyme in the formation of norepinephrine and epinephrine. Although not recommended

BOX 28-3

Drugs for Long-term Treatment of Hypertension

Drugs More Commonly Used

Diuretics
 Angiotensin-converting enzyme inhibitors
 Angiotensin II receptor blockers
 Ca^{++} channel blockers
 β -adrenergic receptor blockers
 α_1 -adrenergic receptor blockers

Drugs Less Commonly Used

Aliskiren
 Centrally acting antihypertensive drugs
 Hydralazine
 Minoxidil
 Reserpine
 Guanethidine, guanadrel

for essential hypertension, metyrosine is useful, often in combination with phentolamine, in the pharmacologic amelioration of pheochromocytoma.

TREATMENT OF HYPERTENSION

Treatment of hypertension often includes pharmacologic and nonpharmacologic approaches for optimal control. Although the latter subject is beyond the scope of this discussion, dietary modification to reduce body weight and decrease Na^+ intake causes demonstrable reductions in blood pressure. Na^+ restriction, even within the well-controlled DASH diet, has been shown to reduce blood pressure.¹ The reduction in blood pressure is proportional to the reduction in Na^+ intake.¹⁷ Restriction of fat intake and alcohol ingestion and cessation of smoking are also important considerations in lessening the dangers of cardiovascular diseases associated with hypertension. Optimal pharmacotherapeutic treatment is based on appropriate diagnosis, proper drug and dose selection, and good patient compliance. Inasmuch as essential hypertension in its early states is asymptomatic, compliance depends strongly on the avoidance of side effects and the simplicity of the therapeutic regimen.

Six drug classes are currently the most commonly used antihypertensive drugs: diuretics, ACE inhibitors, angiotensin II receptor blockers, CCBs, β -adrenergic receptor blockers, and α_1 -adrenergic receptor blockers (Box 28-3). Diuretics are considered the most appropriate first choice for most hypertensive patients.² A second drug from one of the other categories, such as a β blocker, is often required for blood pressure control.

Therapy needs to be tailored to the patient. When used alone, ACE inhibitors are usually less effective in African American patients than in white patients, whereas diuretics may be nearly equally useful in both groups. This selectivity of effect correlates with the typically lower contribution of the renin-angiotensin system to hypertension in African Americans and their greater Na^+ sensitivity. Age may also contribute to the response. Certain disease states can also affect the choice of drug. β -Adrenergic receptor blockers are especially useful in patients with a history of migraine headache, angina pectoris, heart failure, or myocardial infarction. β -Adrenergic receptor blockers may be particularly useful in certain cases of blood lipid disorders because they can decrease low-density lipoprotein and increase the high-density lipopro-

tein/total cholesterol ratio. Diabetic patients gain added benefit from treatment with an ACE inhibitor because of the renoprotective effect of the drugs.

For initial therapy of hypertension, a low dose of a thiazide diuretic is recommended. An ACE inhibitor is also considered a logical first choice for many patients.¹² When a single drug is ineffective, combination therapy may be required. Drugs such as the β -adrenergic receptor blockers, ACE inhibitors, or angiotensin II receptor blockers are commonly used with diuretics, sometimes in combination with additional agents. Centrally acting antihypertensives can be combined with CCBs with or without a diuretic. Hydralazine, when used, is combined with a β -adrenergic receptor blocker. The addition of the β blocker prevents tachycardia resulting from hydralazine and enhances the antihypertensive response. In addition to their hypotensive effect, the diuretics reduce fluid retention caused by some antihypertensive drugs.

Severe hypertension almost always requires use of more than one drug. Certain drugs are used only in refractory hypertension. These drugs include guanethidine and minoxidil, each used in combination with a diuretic and other drugs.

Hypertensive Emergencies

In contrast to the gradual increase in blood pressure seen in essential hypertension, a sudden elevation of blood pressure to severely hypertensive levels may sometimes occur. Hypertensive emergencies may arise in the course of any hypertensive disease, including renal hypertension, toxemia of pregnancy,⁹ or pheochromocytoma. These situations, regardless of cause, are life-threatening and require immediate reduction of blood pressure.⁹ Although it is beyond the scope of this discussion to examine in detail the causes of hypertensive emergencies or the pharmacologic management of these conditions, a brief review is provided.

Acute hypertensive episodes can be characterized on the basis of the potential danger to the patient. True emergencies are situations in which greatly elevated blood pressure must be lowered immediately to avoid progression of end-organ damage. Hypertensive urgencies call for control within several hours to reduce patient risk.⁹ Management of a true hypertensive emergency necessitates parenteral therapy and intensive monitoring. Table 28-2 lists the various parenteral drugs indicated for such emergencies and salient facts pertaining to their use. Although rapid control of excessively high blood pressure is sometimes needed to avert necrotizing arteriolitis, hemorrhage, and tissue damage, it is not without risk. A rapid reduction in blood pressure may lead to inadequate tissue perfusion, cerebral ischemia, and angina pectoris. When time permits, as in the treatment of hypertensive urgencies, the use of oral medications (see Table 28-2) provides a safer approach that minimizes the possibility of excessive hypotension and lessens the need for constant monitoring.

Antihypertensive Drug Withdrawal Syndrome

Withdrawal of antihypertensive drug therapy has been associated with several signs and symptoms, depending on the abruptness of the withdrawal, the degree of hypertension, and the drugs involved. The classes of drugs involved in withdrawal reactions include centrally acting agents, β -adrenergic receptor-blocking drugs, neuronal blocking agents, and some vasodilators (e.g., minoxidil, sodium nitroprusside, and nifedipine). Reported responses include rebound hypertension, tachycardia, angina, heart attack, and sudden death.

Recommendations for managing hypertensive patients on drug therapy include encouraging patient compliance and avoiding excessive dosage. To avoid complications, antihypertensive drugs should be withdrawn slowly, and patients should be carefully monitored, especially patients with coronary artery or cerebrovascular disease.

TABLE 28-2

Drugs Used in Acute Hypertension

DRUG	COMMENT
Hypertensive Emergencies (Parenteral)	
Sodium nitroprusside	Often used; requires continuous monitoring
Nitroglycerin	Indicated in patients with ischemic heart disease
Labetalol	Useful in thyrotoxicosis and pheochromocytoma and as a substitute for Na^+ nitroprusside when continuous monitoring is unavailable; contraindicated in patients with systolic heart failure, airway disease, or heart block
Diazoxide	Occasionally used when continuous monitoring is unavailable
Fenoldopam	Has rapid onset and short half-life
Hydralazine	Used in hypertensive states associated with pregnancy
Nifedipine	Short-acting, also used for hypertensive emergencies during pregnancy
Hypertensive Urgencies (Oral Preferred)	
Clonidine	Requires good patient compliance
Captopril	Responses unpredictable
Labetalol	See labetalol above

IMPLICATIONS FOR DENTISTRY

Drug Interactions

Because there are several categories of antihypertensive drugs (each having a different mechanism of action), there are numerous possibilities for drug interactions. Aspirin and other nonsteroidal anti-inflammatory drugs (NSAIDs) antagonize many antihypertensive drugs (see Chapter 21). The antihypertensive effect of ACE inhibitors is reduced by aspirin. In addition, the effect of diuretics is inhibited by NSAIDs. This interaction apparently results from the inhibitory effect of NSAIDs on prostaglandin synthesis. NSAIDs also reduce the antihypertensive effect of β blockers. Although the role of prostaglandins in antihypertensive therapy is unknown, these autacoids are important in maintaining renal blood flow and urine output. Patients should be advised of this drug interaction; in the event that blood pressure control is lost, substitution with acetaminophen with or without opioid supplementation is advised.

In general, the use of vasoconstrictors in local anesthesia is not contraindicated in hypertensive patients, especially in patients whose blood pressure is well controlled. A possible exception to this statement is a patient receiving an adrenergic neuron-blocking or adrenergic neuron-depleting drug, such as guanethidine or reserpine, or a nonselective β -adrenergic receptor-blocking drug such as propranolol. Long-term use of guanethidine-related drugs produces supersensitivity to the actions of exogenously administered catecholamines. Injudicious use of sympathomimetic amine vasoconstrictors in local anesthetic solutions could possibly lead to serious disturbances of blood pressure and cardiac rhythm. Nonselective β -adrenergic receptor blockers prevent the decrease in peripheral vascular resistance normally caused by doses of epinephrine used in local anesthesia. Unopposed α -agonistic action may lead to an acute hypertensive episode. To avoid potential

complications, the blood pressure of a patient on any of these medications should be taken before and 5 minutes after the injection of a small amount of local anesthetic (e.g., 1 mL of 2% lidocaine with 1:100,000 epinephrine). If no significant reaction is observed, dangerous hypertensive responses to additional local anesthetic are unlikely.

The use of epinephrine-impregnated retraction cord is contraindicated in patients with compromised cardiovascular function, including hypertensive patients. Significant amounts of epinephrine can be absorbed, especially if the gingiva is abraded or multiple teeth are involved.

Although not widely used, centrally acting sympatholytics, which have a sedative side effect, are important to the dentist. In dealing with patients taking these drugs, the dentist must proceed cautiously when using antianxiety agents or other drugs that depress the CNS. In combination with anti-hypertensives with sedative side effects, these agents may lead to excessive CNS depression. Use of a smaller dose is advised in the premedication of a patient taking methylodopa, clonidine, guanabenz, guanfacine, or reserpine for hypertension.

Adverse Effects

One adverse effect of significance to the dentist that is associated with antihypertensive medication is orthostatic, or postural, hypotension. After being in a supine position, many patients receiving antihypertensive therapy may be unable to compensate adequately for a sudden change in position. Such patients should be observed carefully at the end of dental appointments. Drugs affecting peripheral adrenergic transmission are most likely to cause orthostatic hypotension, although other drugs may also have this action.

Another adverse effect that has implications in dentistry is inhibition of salivary secretion leading to dry mouth. Xerostomia is especially common in patients medicated with reserpine and centrally acting antihypertensive agents (methylodopa, clonidine, guanabenz, and guanfacine).

Hypertension Detection

The American Heart Association has stressed the need for more effective hypertension detection, and dentists are encouraged to include blood pressure determinations as a part of routine office visits. Studies indicate that many patients identified by dentists as being hypertensive were unaware of their condition. Most of those identified sought medical attention to treat the hypertension.

Screening for hypertension in the dental office is a simple procedure that can be carried out effectively by auxiliary personnel. Because hypertension is a dangerous but asymptomatic disease in its early stages, the dentist's efforts to identify and aid these patients by its detection are worthwhile. The dentist can advise against abrupt withdrawal from antihypertensive medication and inform the patient of the possible hazards of such action.

ANTIHYPERTENSIVE DRUGS

<i>Nonproprietary (generic) name</i>	<i>Proprietary (trade) name</i>
Diuretics See Chapter 27	
Agents affecting adrenergic function	
<i>Transmitter synthesis inhibiting</i>	
Metyrosine	Demser

<i>Nonproprietary (generic) name</i>	<i>Proprietary (trade) name</i>
<i>Neuronal blocking or depleting</i>	
Guanadrel	Hylorel
Guanethidine	Ismelin
Reserpine	—
<i>α-Adrenergic receptor blocking</i>	
Doxazosin	Cardura
Phenoxybenzamine	Dibenzyline
Phentolamine	Regitine
Prazosin	Minipress
Terazosin	Hytrin
Tolazoline*	Priscoline
<i>β-Adrenergic receptor blocking</i>	
Acebutolol	Sectral
Atenolol	Tenormin
Betaxolol	Kerlone
Bisoprolol	Zebeta
Carteolol	Cartrol
Esmolol	Brevibloc
Metoprolol	Lopressor, Toprol XL
Nadolol	Corgard
Penbutolol	Levatol
Pindolol	Visken
Propranolol	Inderal
Timolol	Blocadren
<i>α-Adrenergic and β-adrenergic receptor blocking</i>	
Carvedilol	Coreg
Labetalol	Normodyne, Trandate
<i>Ganglionic blocking</i>	
Mecamylamine	Inversine
Trimethaphan*	Arfonad
<i>Centrally acting</i>	
Clonidine	Catapres
Guanabenz	Wytensin
Guanfacine	Tenex
Methylodopa	Aldomet, Amodopa
Direct vasodilators	
Diazoxide	Hyperstat IV
Hydralazine	Apresoline
Minoxidil	Loniten
Nitroglycerin	Nitro-Bid IV, Tridil
Nitroprusside	Nitropress
Prostacyclin	
Epoprostenol	Flolan
Dopamine D₁ receptor agonist	
Fenoldopam	Corlopan
Endothelin receptor antagonist	
Bosentan	Tracleer
Ca⁺⁺ channel blockers	
Amlodipine	Norvasc
Diltiazem	Cardizem, Dilacor XR
Felodipine	Plendil
Isradipine	DynaCirc
Nicardipine	Cardene
Nifedipine	Adalat, Procardia
Nimodipine	Nimotop

ANTIHYPERTENSIVE DRUGS—cont'd

<i>Nonproprietary (generic) name</i>	<i>Proprietary (trade) name</i>
Nisoldipine	Sular
Verapamil	Calan, Isoptin
Angiotensin-converting enzyme inhibitors	
Benazepril	Lotensin
Captopril	Capoten
Enalapril	Vasotec
Enalaprilat	Vasotec I.V.
Fosinopril	Monopril
Lisinopril	Prinivil, Zestril
Moexipril	Univasc
Perindopril erbumine	Aceon
Quinapril	Accupril
Ramipril	Altace
Trandolapril	Mavik
Angiotensin II receptor blockers	
Candesartan cilexetil	Atacand
Eprosartan	Teveten
Irbesartan	Avapro
Losartan	Cozaar
Olmesartan	Benicar
Telmisartan	Micardis
Valsartan	Diovan
Renin inhibitor	
Aliskiren	Tecturna
Combination products (examples)	
Atenolol, chlorthalidone	Tenoretic
Amlodipine, benazepril	Lotrel
Bendroflumethiazide, nadolol	Corzide
Captopril, hydrochlorothiazide	Capozide
Hydralazine, hydrochlorothiazide	Apresazide
Methyldopa, hydrochlorothiazide	Aldoril
Prazosin, polythiazide	Minizide
Propranolol, hydrochlorothiazide	Inderide
Trandolapril, verapamil	Tarka

CITED REFERENCES

- Appel LJ, Moore TJ, Obarzanek E, et al: A clinical trial of the effects of dietary patterns on blood pressure. *N Engl J Med* 336:1117-1124, 1997.
- Chobanian AV, Bakris GL, Black HR, et al: The seventh report on the joint national committee on prevention, detection, evaluation, and treatment of high blood pressure. The JNC7 Report. *JAMA* 289:2560-2572, 2003.
- Croog SH, Kong BW, Levine S, et al: Hypertensive black men and women: quality of life and effects of antihypertensive medications. The Black Hypertension Quality of Life Multicenter Trial Group. *Arch Intern Med* 150:1733-1741, 1990.

- Dendorfer A, Dominiak P, Schunkert H: ACE inhibitors and angiotensin II receptor antagonist. *Handb Exp Pharmacol* 170:407-442, 2005.
- Dohi Y, Criscione L, Pfeiffer K, et al: Angiotensin blockade or calcium antagonists improve endothelial dysfunction in hypertension: studies in perfused mesenteric resistance arteries. *J Cardiovasc Pharmacol* 24:372-379, 1994.
- Drugs for hypertension. *Med Lett Drugs Ther* 3:39-48, 2005.
- Galie N, Ghofrani HA, Torbicki A, et al: Sildenafil citrate therapy for pulmonary arterial hypertension. *N Engl J Med* 353:2148-2157, 2005.
- Gradman AH, Vivas Y: New drugs for hypertension: what do they offer? *Curr Hypertens Rep* 8:425-432, 2006.
- Haas AR, Marik PE: Current diagnosis and management of hypertensive emergency. *Semin Dial* 19:502-512, 2006.
- Hajjar J, Kotchen JM, Kotchen TA: Hypertension: trends in prevalence, incidence and control. *Annu Rev Public Health* 27:465-490, 2006.
- Ignarro LJ, Lippton H, Edwards JC, et al: Mechanism of vascular smooth muscle relaxation by organic nitrates, nitrites, nitroprusside and nitric oxide: evidence for the involvement of S-nitrosothiols as active intermediates. *J Pharmacol Exp Ther* 218:739-749, 1981.
- Initial therapy of hypertension. *Med Lett Drugs Ther* 46:53-56, 2004.
- Kostis JB, Lawrence-Nelson J, Ranjan R, et al: Association of increased pulse pressure with the development of heart failure in SHEP. Systolic Hypertension in the Elderly (SHEP) Cooperative Research Group. *Am J Hypertens* 14:798-803, 2001.
- Perry HM, Davis BR, Price TR, et al: Effect of treating isolated systolic hypertension on the risk of developing various types and subtypes of stroke. The Systolic Hypertension in the Elderly Program (SHEP). *JAMA* 284:465-471, 2000.
- Preston RA: Renoprotective effects of antihypertensive drugs. *Am J Hypertens* 12:19S-32S, 1999.
- Rigaud AS, Seux ML, Staessen JA, et al: Cerebral complications of hypertension. *J Hum Hypertens* 14:605-616, 2000.
- Sacks FM, Svetkey LP, Vollmer WM, et al: Effects on blood pressure of reduced dietary sodium and the dietary approaches to stop hypertension (DASH) diet. *N Engl J Med* 344:3-10, 2001.
- Safar ME, Smulyan H: Atherosclerosis, arterial stiffness and antihypertensive drug therapy. *Adv Cardiol* 44:331-351, 2007.
- Stokes GS: Treatment of isolated systolic hypertension. *Curr Hypertens Rep* 8:377-383, 2006.
- Taylor AA, Pool JL: Clinical pharmacology of antihypertensive therapy. *Semin Nephrol* 25:215-226, 2005.
- Van Tassel BW, Munger M: Aliskiren for renin inhibition: a new class of antihypertensives. *Ann Pharmacother* 41:456-464, 2007.
- Velarde G, Berk BC: Role of hypertension in the metabolic syndrome: who is affected? *Curr Hypertens Rep* 7:418-426, 2005.
- Wang JG, Staessen JA, Franklin SS, et al: Systolic and diastolic blood pressure lowering as determinants of cardiovascular outcome. *Hypertension* 45:907-913, 2005.
- Weber MA: Clinical pharmacology of centrally acting antihypertensive agents. *J Clin Pharmacol* 29:598-602, 1989.
- Yusuf S, Sleight P, Poque J, et al: Effects of an angiotensin-converting-enzyme inhibitor, ramipril, on cardiovascular events in high-risk patients. The Heart Outcomes Prevention Evaluation Study Investigators. *N Engl J Med* 342:145-153, 2000.
- Zhou X, Frohlich ED: Physiologic evidence of renoprotection by antihypertensive therapy. *Curr Opin Cardiol* 20:290-295, 2005.

GENERAL REFERENCES

- Hollenberg NK: *Atlas of hypertension*, ed 4, Philadelphia, 2003, Current Medicine.
- Johnston GD: *Fundamentals of cardiovascular pharmacology*, New York, 1999, Wiley.
- Lednicer D: *New drug discovery and development*, Hoboken, NJ, 2007, Wiley-Interscience.
- Prisant ML: *Hypertension in the elderly*, Totowa, NJ, 2005, Humana Press.

Lipid-Lowering Drugs

GEORGE A. COOK

The transport of lipids in the blood requires their association with proteins. Fatty acids are transported in association with albumin, and triglycerides derived from dietary fat are transported in large macromolecular, cholesterol-containing particles known as *lipoproteins*. Cholesterol plays an essential role in human life as an important component of cell membranes and a precursor of steroid hormones and bile acids in addition to its role in triglyceride transport. Blood cholesterol levels previously thought to be normal are the cause of premature death, however, from coronary artery disease. Atherosclerosis remains the primary cause of premature death in the United States and in other industrialized countries. The major clinical sequelae of elevated lipoprotein levels, known as *hyperlipidemias* or *hyperlipoproteinemias*, are coronary artery disease, cerebrovascular disease, and peripheral vascular disease. The term *hyperlipemia* (which causes acute pancreatitis) is restricted to elevated plasma triglycerides without elevated cholesterol.

Because the deposition of cholesterol in arteries is a defining feature of atherosclerosis, strategies for its prevention and treatment include methods to reduce plasma cholesterol. Dentists need to understand lipid-lowering drugs as the overall dental patient population of the United States matures, and increasing numbers of patients take these drugs for prevention and therapy of atherosclerosis. Dentists also need to follow the development of the cholesterol synthesis inhibitors because of their implication in the stimulation of bone formation through inhibited isoprenoid synthesis leading to decreased osteoclast activity and increased osteoblast differentiation.^{23,28}

Guidelines on patient cholesterol management are issued periodically by the Adult Treatment Panel of the National Cholesterol Education Program (NCEP).¹⁸ More recent guidelines have included recommendations for improved lifestyle changes, such as increasing exercise and decreasing consumption of saturated fat and cholesterol, which improve cholesterol levels in some patients without drug therapy.

CHOLESTEROL AND ATHEROSCLEROSIS

Atherosclerosis is caused by development of fatty streaks and plaques in large and medium-sized arteries, especially the aorta, coronary arteries, carotid arteries, renal arteries, and arteries of the legs. Plaques develop in the intimal wall of the vessels after deposition of cholesteryl esters derived from certain lipoproteins. The particular clinical manifestation of atherosclerosis depends on the degree to which the lesions have progressed in a particular part of the vasculature. The presence of atheromatous lesions can have several effects on

the circulation to a prescribed area: (1) blood flow may be obstructed by the plaques themselves or by associated thrombi, (2) vascular reactivity and control of blood flow may be lost, and (3) vessels may become weakened and subject to rupture. Observations of initial lesions in young children have shown that this disease begins at an early age and progresses gradually, with clinical symptoms generally appearing much later in life.^{35,43}

Foam cells are a primary characteristic of atheromatous plaques. These cells arise from macrophages that invade the injured arterial endothelium and accumulate large pools of cholesteryl esters from nearby trapped lipoproteins. As with all other cells, macrophages possess a mechanism for converting free cholesterol to cholesteryl esters as a protective mechanism to avoid excessive accumulation of free cholesterol in their membranes. Macrophages also possess scavenger receptors in their plasma membranes that bind chemically modified lipoproteins that arise from free radical-mediated oxidation or glycosylation because of poorly controlled diabetes.

The accumulation of foam cells results in a fatty streak visible to the naked eye. Particularly in vascular areas subject to high mechanical shear stresses and turbulent flow, microscopic tearing and disruption of the local endothelium may expose the underlying tissue, resulting in accelerated lipoprotein accumulation, platelet aggregation, and deposition of fibrin. Eventually, an atherosclerotic plaque forms with a thick fibrous cap covering a necrotic center composed of cellular debris and cholesteryl ester deposits.

Lipoprotein Metabolism

Classification of plasma lipoproteins is based on the density of the complexes, with a lower density indicating higher lipid content (Table 29-1). Chylomicrons are the largest particles and possess the greatest proportion of lipid. The other lipoproteins are very-low-density lipoprotein (VLDL), intermediate-density lipoprotein (IDL), low-density lipoprotein (LDL), high-density lipoprotein (HDL), and lipoprotein(a). Two separate lipoprotein-producing systems or metabolic pathways are responsible for the transport of lipids (Figure 29-1): the *exogenous pathway*, producing chylomicrons in the intestinal mucosa primarily from dietary fat, and the *endogenous pathway*, producing VLDL in the liver with triglycerides from hepatic metabolism of dietary carbohydrates.

A crucial factor in the understanding of physiologic and pathophysiologic aspects of lipoprotein metabolism is the role played by specific *apoproteins*, the proteins associated with lipoprotein particles. Chylomicrons serve to transport dietary lipids to the sites of use and storage. The major protein component of chylomicrons is apoprotein B48, which initially plays an entirely structural role in formation and transport. It

TABLE 29-1

Classification and Characteristics of Major Plasma Lipoproteins

LIPOPROTEIN	MAJOR LIPIDS	MAJOR APOPROTEINS	DENSITY (g/mL)	DIAMETER (nm)
Chylomicrons	Dietary triglycerides	B48, CI, CII, CIII, E	<0.98	80-500
Chylomicron remnants	Dietary cholesteryl esters	B48, E		
VLDLs	Endogenous triglycerides	B100, CII, CIII, E	0.98-1.006	30-80
IDLs	Cholesteryl esters, triglycerides	B100, CII, CIII, E	1.006-1.019	25-35
LDLs	Cholesteryl esters	B100	1.019-1.063	15-25
HDLs	Cholesteryl esters	A1, AII*	1.063-1.210	5-12
Lp(a)	Cholesteryl esters	B100, (a)	1.055-1.085	30

*HDL serves as a reservoir for C and E apoproteins, transferring them to newly synthesized chylomicrons (in exchange for A apoproteins) and VLDL particles and removing them as these particles are depleted of triglyceride.

HDLs, High-density lipoproteins; IDLs, intermediate-density lipoproteins; LDLs, low-density lipoproteins; Lp(a), lipoprotein(a); VLDLs, very-low-density lipoproteins.

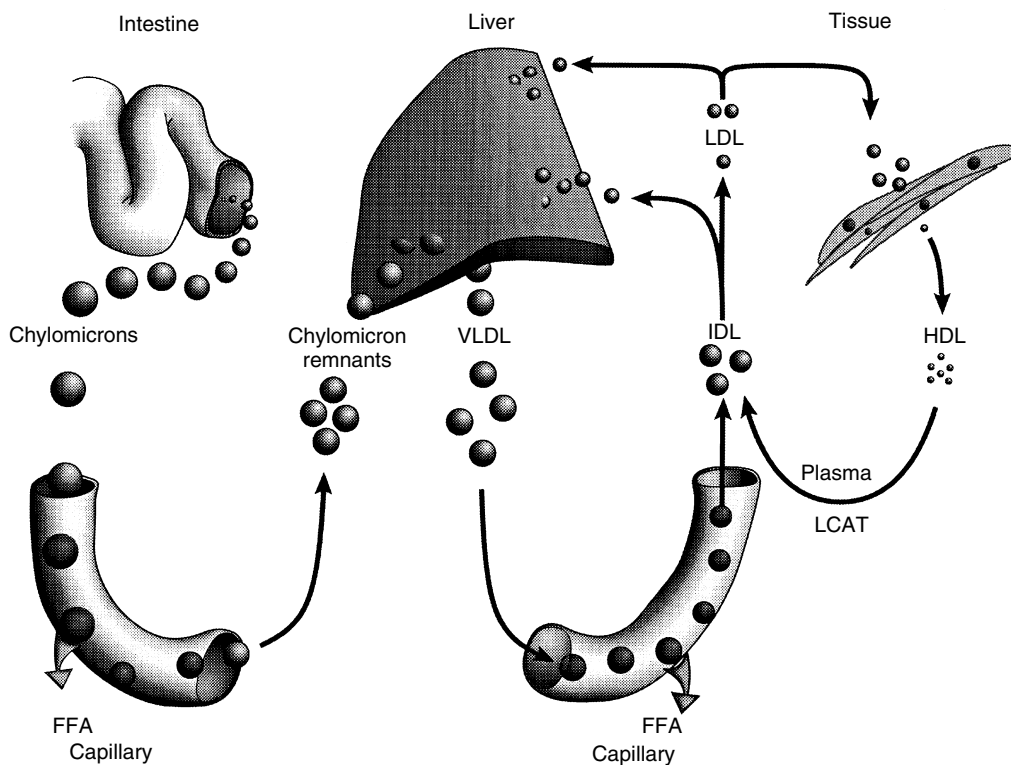

FIGURE 29-1 Pathways of lipid transport. FFA, Free fatty acid; HDL, high-density lipoprotein; IDL, intermediate-density lipoprotein; LCAT, lecithin cholesterol acyltransferase; LDL, low-density lipoprotein; VLDL, very-low-density lipoprotein.

forms the amphipathic coating of the particle along with unesterified cholesterol and phospholipid, which surrounds the hydrophobic core containing triglycerides and cholesteryl esters and allows the particle to remain suspended in an aqueous environment. On reaching the capillary endothelium of muscle and adipose tissue, the chylomicron triglycerides are rapidly degraded to fatty acids, glycerol, and monoglycerides by the enzyme lipoprotein lipase.

Apoprotein CII serves as a stimulus for endothelial lipase activity. The remaining *chylomicron remnants*, depleted of triglycerides and CII but relatively enriched in cholesterol and apoproteins B48 and E, are released back into the circulation. The exogenous pathway terminates in the liver, where the chylomicron remnants are actively taken up by hepatocytes. Apoproteins B48 and E help trigger this receptor-

mediated endocytosis. Within the liver, the remnants are digested, releasing the remaining lipids for further metabolism (Figure 29-2).

The hepatic synthesis and release of VLDL particles initiates the endogenous pathway of lipid transport. VLDL is primarily triglyceride and is subject to attack by lipoprotein lipase on activation by apoprotein CII. The resulting IDL particle, greatly reduced in triglyceride content, has two possible fates: (1) a few particles are released and undergo receptor-mediated endocytosis by the liver and lysosomal degradation, or (2) most particles continue further removal of triglyceride and all apoproteins other than B100 to yield LDL. The cholesterol content of LDL is 50% to 60% by weight and normally accounts for 75% of the total plasma cholesterol. Particles of LDL are subject to apoprotein B100-dependent, LDL

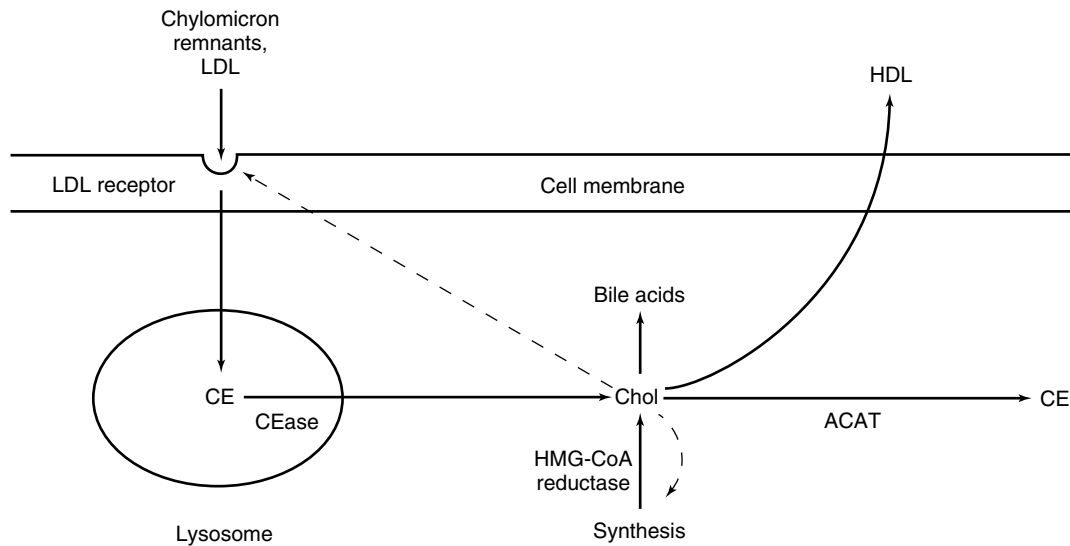

FIGURE 29-2 Cholesterol metabolism and transport. Chylomicron remnants and low-density lipoprotein (*LDL*) particles are actively taken up by hepatocytes through receptor-assisted endocytosis and are metabolized in lysosomes to yield cholesteryl esters (*CE*). Cholesterol-rich *LDL* is similarly transported and metabolized. In addition, reticuloendothelial cells and phagocytic cells of the vascular wall can ingest *LDL* by an *LDL* receptor-independent process. Under the influence of lysosomal acid cholesterol esterase (*CEase*), cholesterol (*Chol*) is made available to the cell. Cholesterol limits its own intracellular concentration by (1) inhibiting *LDL* receptor synthesis, (2) stimulating its own reconversion to *CE* by the enzyme acyl CoA cholesterol acyl transferase (*ACAT*), and (3) downregulating the production of 3-hydroxy-3-methylglutaryl-coenzyme A (*HMG-CoA*) reductase, the rate-limiting enzyme of cholesterol synthesis. The inhibitory actions of cholesterol are indicated by *dashed lines*. Cholesterol may also leave the cell to reenter the bloodstream in association with *HDL*. Cholesterol is converted to bile acids.

receptor-mediated endocytosis by various tissues, most importantly the liver. Excess *IDL* and *LDL*, through scavenger uptake by intimal macrophages, account for the cholesterol accumulation in atheromatous lesions. There is no evidence that chylomicrons are involved in this disease process.

The synthesis of cholesterol, regulated by the initial enzyme of the pathway (3-hydroxy-3-methylglutaryl-coenzyme A [*HMG-CoA*] reductase), is an energetically expensive process because every carbon atom of cholesterol is derived from acetylcoenzyme A, so the maintenance of total body cholesterol is a priority. This is exemplified further by the fact that there is no mechanism in the human body for removal of cholesterol other than conversion to bile acids and fecal excretion. Cholesterol is conserved through *enterohepatic cycling* and *reverse cholesterol transport*, processes that play important roles in energy conservation and sites of action for lipid-lowering drugs.

Enterohepatic cycling includes the following processes³⁶: (1) synthesis of cholesterol and conversion to bile acids by the liver, (2) secretion of biliary cholesterol and bile acids into the small intestine, (3) absorption of bile acids from the terminal ileum, and (4) transfer through the portal system and reuptake by the liver. Reverse cholesterol transport is the process by which *HDL* synthesized by the liver and intestine takes up cholesterol from peripheral cells and transports it back to the liver. *HDL* cholesterol is sometimes referred to as the “good” cholesterol because it represents the amount of cholesterol being removed from most of the body and because higher levels of *HDL* cholesterol are associated with decreased risk of atherosclerosis. *HDL* also assists in the removal of triglycerides from the bloodstream by delivering to chylomicrons and *VLDL* the C and E apoproteins necessary for their processing.

Role of Lipoproteins in Atherosclerosis

The presence of cholesterol as an integral component of arterial plaques has been known for decades, and many studies have been done to determine whether abnormal concentrations of cholesterol are involved in the origin or progress of plaque formation. These studies have shown that plasma cholesterol concentrations are higher in patients with coronary artery disease than in normal patients, and that the relationship between serum cholesterol concentration and risk of premature death from coronary artery disease is continuous and graded.^{38,42} More recent studies of cholesterol reduction therapy in patients with hyperlipidemia have shown that reduction of plasma cholesterol can cause regression of plaque formation and decrease the mortality rate from atherosclerosis.^{18,44}

An increase in plasma *LDL* may be caused either by overproduction of its *VLDL* precursor or, more commonly, by retarded clearance of *LDL* from the blood. The plasma half-life of *LDL* is much longer than the half-lives of *VLDL* and *IDL*. Although *LDL* receptor-dependent uptake predominates normally, only the alternative phagocytic pathway is available in patients with severe familial hypercholesterolemia, who congenitally lack functional *LDL* receptors.⁷ *LDL* contains most cholesterol in the plasma, and it is the lipoprotein group most directly associated with coronary heart disease.^{27,41} High plasma concentrations of *HDL* are inversely related to the risk of coronary heart disease.^{10,41}

Hyperlipidemia may be primary (i.e., genetic in origin) or result from dietary factors; disease states such as diabetes mellitus, hypothyroidism, or uremia; drugs such as alcohol, oral contraceptives, or glucocorticoids; or a combination of causes. A summary of various types of primary hyperlipidemias is provided in Table 29-2.

TABLE 29-2

Primary Hyperlipoproteinemias: Types and Characteristics

TYPE	LIPOPROTEIN ELEVATED*	BIOCHEMICAL DEFECT (INHERITANCE) [†]	INCIDENCE	CLINICAL FINDINGS (AGE OF ONSET)	TREATMENT
Monogenic					
Familial lipoprotein lipase deficiency	Chylomicrons (I, V)	Decreased lipoprotein lipase activity (R)	1:10 ⁶	Eruptive xanthomas, pancreatitis, abdominal pain, hepatosplenomegaly, lipemia retinalis (childhood)	Fat-free diet
Familial apoprotein CII deficiency	Chylomicrons, VLDL (I, V)	Decreased apoprotein CII activity (R)	1:10 ⁶	Pancreatitis, abdominal pain (childhood or adulthood)	Fat-free diet
Familial type 3 hyperlipoproteinemia	Chylomicron remnants, IDL (III)	Dysfunctional apoprotein E plus other defect (R)	1:10 ⁴	Palmar and tuberous xanthomas, premature atherosclerosis (adulthood)	Correction of other defect (e.g., hypothyroidism), gemfibrozil or clofibrate, nicotinic acid
Familial hypercholesterolemia	LDL (IIa, IIb)	Dysfunctional LDL receptor (D)	1:500	Xanthomas, arcus corneae, xanthelasma, early and severe atherosclerosis (childhood or adulthood)	Low cholesterol and saturated fat diet, HMG-CoA reductase inhibitor, bile acid-binding resin
Familial hypertriglyceridemia	VLDL (rarely chylomicrons) (IV, V)	Unknown; probably multiple subtypes (D)	1:500	Obesity, hyperglycemia, hyperinsulinemia, increased incidence of hypertension and atherosclerosis (puberty)	Low saturated fat diet, correct contributing factors, avoidance of alcohol and oral contraceptives, nicotinic acid, gemfibrozil
Multiple lipoprotein-type hyperlipidemia	VLDL, LDL (IIa, IIb, IV)	Unknown; probably multiple subtypes (D)	1:250	Premature atherosclerosis (adulthood)	Low saturated fat diet, correction of contributing factors, avoidance of alcohol and oral contraceptives, lipid-lowering drugs
Lp(a) hyperlipoproteinemia	Lipoprotein(a)	Decreased binding to LDL receptor, decreased fibrinolysis	Not determined; wide variance among ethnic groups	Increased incidence of atherosclerosis (adulthood)	Nicotinic acid
Polygenic					
Polygenic hypercholesterolemia	LDL (IIa, IIb)	Unknown but including normal variation in cholesterol metabolism	1:24	Increased incidence of atherosclerosis (adulthood)	Low cholesterol and saturated fat diet, HMG-CoA reductase inhibitor, bile acid-binding resin

*The electrophoretic pattern, or phenotypic expression, of the lipoproteinemia is indicated in parentheses.

[†]All the monogenic disorders are autosomal.

D, Dominant; HMG-CoA, 3-hydroxy-3-methylglutaryl-coenzyme A; IDL, intermediate-density lipoprotein; LDL, low-density lipoprotein; Lp(a), lipoprotein(a); R, recessive; VLDL, very-low-density lipoprotein.

Risk Factors in Atherosclerosis

In addition to high plasma cholesterol, several risk factors have been identified with an increased incidence of atherosclerosis, including hypertension, cigarette smoking, sedentary habits, obesity, diabetes mellitus, hypothyroidism, male gender, and a family history of atherosclerosis or diabetes. As shown in

Table 29-2, the clinical manifestations of genetic or familial hyperlipoproteinemias are severe. The lipid-lowering agents discussed in this chapter have proved quite useful in treating many of these disorders and even in reversing the progression of atherosclerosis in patients without specific metabolic defects in lipid metabolism.

Treatment Guidelines From the National Cholesterol Education Program

The primary guidelines from NCEP for treatment of patients with hyperlipidemia are to increase exercise, decrease saturated fat and cholesterol in the diet, and lower elevated LDL-cholesterol levels using drugs.¹⁸ Diabetes also predicts a high risk for coronary heart disease, and these patients benefit from treatment with hypolipidemic drugs. Diabetic patients usually have elevated triglycerides and low HDL cholesterol, requiring different types of drug treatment. Diabetic patients who have confirmed coronary heart disease are at even greater risk and need more specific, aggressive treatment to decrease risk of mortality.

There is also a greater awareness today of numerous individuals in the United States who have a condition known as *metabolic syndrome*, which is characterized by abdominal obesity, elevated fasting glucose, low HDL cholesterol, elevated plasma triglycerides, and high blood pressure. These patients benefit from increased exercise, modified diet, and treatment of lipid abnormalities.

THERAPEUTIC AGENTS

Therapy with drugs that reduce plasma cholesterol is used to delay or reverse the progression of atherosclerosis and decrease the mortality and morbidity rates from the associated clinical manifestations of this disease. Strong evidence supports the idea that correction or lowering of plasma lipid concentrations is beneficial in many instances.^{18,41} These drugs are helpful in treating many familial hyperlipidemias, and they are recommended for use in patients with hyperlipidemias of secondary etiology that cannot be corrected by other means. Lipid-lowering drugs are most frequently administered to patients with a history of ischemic heart disease in an attempt to avoid future fatal episodes of myocardial infarction.

The goal of therapy is to reduce lipid levels as much as possible without producing metabolic derangements or adverse drug effects.^{38,42} Altering the diet is generally the initial therapeutic measure, along with correcting any disease state or condition contributing to hyperlipidemia. If nonpharmacologic therapy is insufficient, drug administration should be considered depending on determinants such as age, gender, presence of ischemic vascular disease, and coexistence of other risk factors. Even when pharmacologic antihyperlipidemic treatment is instituted, however, nonpharmacologic management, including reduction of dietary cholesterol and saturated fatty acids, weight reduction, exercise, and smoking cessation, remains the cornerstone of therapy.

The following hypolipidemic agents are considered in this chapter: (1) derivatives of fibric acid, including clofibrate and gemfibrozil; (2) nicotinic acid; (3) the bile acid sequestrants cholestyramine and colestipol; (4) inhibitors of HMG-CoA reductase; (5) cholesterol absorption inhibitors; and (6) other agents. The effects of the major drugs on the various classes of lipoprotein are listed in Table 29-3.

The choice of a drug depends on the lipoprotein profile of the patient, the efficacy of the drug in treating the abnor-

malty, and the ability of the patient to tolerate the agent. Drug therapy to reduce plasma LDL concentrations often begins with an HMG-CoA reductase inhibitor, a bile acid sequestrant, or a combination of the two in reduced dosages. Multiple-drug therapy with agents acting through different mechanisms is common if LDL control is not achieved with a single drug.³¹

Fibric Acid Derivatives

One of the first drugs to be approved for the treatment of hyperlipidemia was clofibrate, a derivative of phenoxisobutyric acid, which is also known as *fibric acid* (Figure 29-3). Gemfibrozil is safer and more effective than clofibrate, and several second-generation fibrates such as fenofibrate are also more effective. These drugs can influence all the lipoproteins, but are most effective in familial type 3 hyperlipoproteinemia and in patients with elevated VLDL concentrations. Fibric acid derivatives act as ligands for the DNA transcription regulator peroxisomal proliferator-activated receptor α (PPAR α),¹⁷ modifying rates of synthesis of specific enzymes. They have been shown to increase significantly the activity of extrahepatic lipoprotein lipase, decrease the hepatic synthesis of fatty acids, and increase hepatic fatty acid oxidation in mitochondria and peroxisomes.

Changes in apoprotein content help increase VLDL catabolism and remnant particle uptake. An inhibition of cholesterol synthesis and an increase in the biliary excretion of cholesterol promote a reduction in LDL in patients without coexisting hypertriglyceridemia. The LDL concentration is often increased, however, by fibrates in patients with elevated amounts of VLDL. Of the more recently developed fibrates, fenofibrate, bezafibrate, and ciprofibrate have been developed in Europe; gemfibrozil and fenofibrate are approved for use in the United States. More recent studies indicate that gemfibrozil is effective in reducing coronary heart disease and stroke by increasing HDL in patients with low HDL and elevated triglycerides.^{39,40} The induction of peroxisome proliferation by fibrates has raised the possibility of increased risk of cancer, but more recent studies with gemfibrozil have indicated no increased risk of death from noncoronary heart disease-related events.⁴⁰ Fibrates also increase blood urea and creatinine, indicating renal dysfunction, but gemfibrozil seems to be devoid of this side effect.⁶

Clofibrate treatment lowers elevated plasma cholesterol and triglyceride concentrations in most patients.^{32,33} It also has been shown to decrease the plasma free fatty acid concentration.³⁰ The major effect on lipoprotein is a reduction in plasma VLDL concentrations. Clofibrate was the most commonly prescribed lipid-lowering drug in the early 1970s. A failure to reduce fatal heart attack and cardiovascular complications, coupled in some studies with a statistical increase in mortality and morbidity rates from other disorders (e.g., cholelithiasis and gastrointestinal carcinoma),¹ has restricted the use of clofibrate to patients with severe hyperlipoproteinemia intolerant of or unresponsive to gemfibrozil. Infrequent side effects of clofibrate therapy are nausea, diarrhea, muscle cramps, and myalgia. Clofibrate may rarely cause chest pain and cardiac arrhythmias. Clofibrate potentiates the effects of coumarin

FIGURE 29-3 Structural formula of the fibric acid derivatives clofibrate and gemfibrozil.

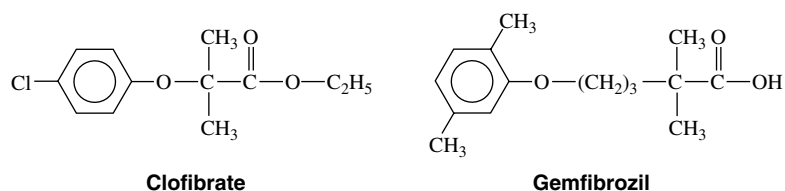

TABLE 29-3

Properties of Lipid-Lowering Drugs

	LIPOPROTEIN CONCENTRATIONS	PLASMA CHOLESTEROL	PLASMA TRIGLYCERIDE	TOXICITY	DRUG INTERACTIONS
Clofibrate	↓ VLDL, ↓ IDL	↓	↓	Nausea, diarrhea, myositis, abnormal liver function tests, skin rash, ventricular ectopy, increased incidence of noncardiac death	Enhanced effect of coumarin anticoagulants
Gemfibrozil	↓ VLDL, ↓ IDL, ↑ HDL	↓	↓	Abdominal pain, epigastric pain, diarrhea, nausea, vomiting, flatulence, rash, headache, dizziness, anemia, eosinophilia, leukopenia	Enhanced effect of coumarin anticoagulants; myopathy with HMG-CoA reductase inhibitors
Nicotinic acid	↓ Chylomicrons, ↓ VLDL, ↓ IDL, ↓ LDL, ↑ HDL	↓	↓	Flushing, pruritus, nausea, diarrhea, glucose intolerance, hyperuricemia, hepatotoxicity	Myopathy, rhabdomyolysis, renal failure with HMG-CoA reductase inhibitors
Cholestyramine, colestipol	↑ VLDL (transient), ↓ LDL	↓	May increase modestly in some patients	Constipation, nausea, abdominal pain, flatulence, biliary tract calcification, steatorrhea, hyperchloremic acidosis	Decreased absorption of thiazides, tetracycline, phenobarbital, thyroxine, digitalis, coumarin anticoagulants
HMG-CoA reductase inhibitors	↓ IDL, ↓ LDL, ↑ HDL	↓	↓	Headache, flatulence, abdominal pain, diarrhea, rash, increased creatine kinase and other enzyme activities, myopathy	Enhanced effect of coumarin anticoagulants; myopathy, rhabdomyolysis, renal failure with nicotinic acid, gemfibrozil, erythromycin, cyclosporine
Ezetimibe	↓ LDL, ↓ HDL	↓	↓	Headache, sinusitis, pharyngitis	Cholestyramine binds ezetimibe and lowers its bioavailability; does not alter bioavailability of digitalis or coumarin anticoagulants

↓, Decrease; ↑, increase.

HDLs, High-density lipoproteins; HMG-CoA, 3-hydroxy-3-methylglutaryl-coenzyme A; IDLs, intermediate-density lipoproteins; LDLs, low-density lipoproteins; VLDLs, very-low-density lipoproteins.

anticoagulants, partly by displacing them from protein-binding sites, but mostly because fibrates interfere with the synthesis of several clotting factors (fibrinogen and factor VII).

Gemfibrozil is chemically distinct from other fibrates because it has a propylene connector between the phenoxy and isobutyrate ends of the molecule. The drug has been shown to decrease the concentrations of blood triglycerides, cholesterol, VLDL, IDL, and sometimes LDL. It also tends to increase HDL concentrations more reliably than clofibrate. In contrast to clofibrate, gemfibrozil has been shown to decrease the incidence of myocardial infarction by 34% over 5 years.¹⁶ Principal side effects of gemfibrozil include abdominal pain, diarrhea, nausea, and vomiting. Less frequent adverse effects are headache, dizziness, anemia, rash, eosinophilia, and leukopenia. Similar to clofibrate, gemfibrozil enhances the action of oral anticoagulants and may cause cholelithiasis. When combined with an HMG-CoA reductase inhibitor, muscle damage leading to rhabdomyolysis and myoglobinuria has been reported.

Fenofibrate is the first of the second-generation fibric acid derivatives to be tested in the United States. Although the

drug has been available in Europe since the early 1980s, it has not been studied in a large prevention trial, as have clofibrate and gemfibrozil. Nevertheless, the basic pharmacologic features of fenofibrate are similar to the features of the previous agents. A potential advantage of the second-generation drugs is their greater ability to reduce LDL concentrations. Side effects include the gastrointestinal disturbances common to all fibrates and the potential for causing cholelithiasis.

Nicotinic Acid

Nicotinic acid, otherwise known as *niacin*, has been recognized since the late 1930s as a member of the vitamin B complex whose deficiency results in the disease pellagra. In 1955, it was reported that doses of nicotinic acid greater than 1 g (i.e., >50 times the recommended daily allowance of niacin as a vitamin) reduce plasma cholesterol concentrations,² subsequently decreasing triglyceride concentrations.⁹ The function of niacin in the body, after conversion to nicotinamide adenine dinucleotide and nicotinamide adenine dinucleotide phosphate, is to act as important enzyme cofactors. The action of niacin as a lipid-lowering drug is not related

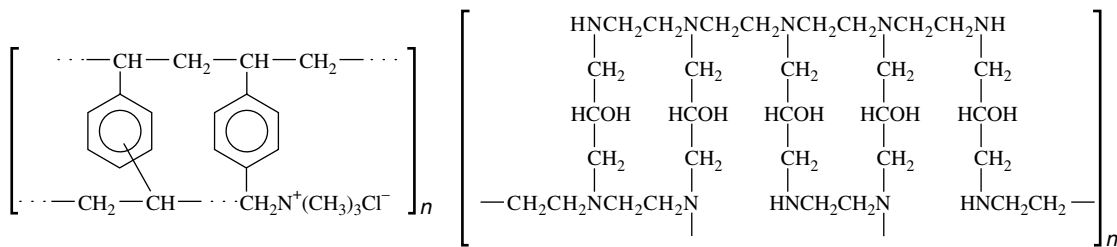

FIGURE 29-4 Structural formula of bile acid sequestrants cholestyramine and colestipol.

to its function as a vitamin. Nicotinamide, interchangeable with nicotinic acid as vitamin B₃, has no effect on plasma lipids and should not be used.

Nicotinic acid is used most often to reduce VLDL and LDL while increasing HDL levels. It has been used alone or in combination with other lipid-lowering drugs. Its mechanism of action seems to involve inhibition of VLDL synthesis through inhibition of adipose tissue lipolysis and inhibition of subsequent delivery of fatty acids to the liver to produce triglycerides for packaging into VLDL particles.¹⁹ Increased clearance of VLDL may also play a role in the mechanism because of elevated lipoprotein lipase activity. Nicotinic acid has the broadest spectrum of activity of the lipid-lowering agents and is potentially useful in most forms of hyperlipidemia.

The major disadvantage of nicotinic acid, which affects 50% or more of the patient population, has been its tendency to produce adverse effects sufficient to impair patient compliance or force cessation of therapy. Common side effects include cutaneous flushing, pruritus, and gastrointestinal distress. An additional side effect in some diabetic patients is increased insulin resistance and hyperglycemia. If treatment is instituted slowly, with a gradually increasing dosage, tolerance to the cutaneous flushing occurs, and therapy can be continued. Aspirin or ibuprofen taken beforehand ameliorates prostaglandin-dependent flushing. Withdrawal of nicotinic acid is most frequently necessitated by gastric disturbances. Other side effects include hyperuricemia, decreased glucose tolerance, and abnormal liver function tests. Extended-release preparations of nicotinic acid marketed in the past few years have made this drug more tolerable to many patients, but do not eliminate flushing in all patients.

Nicotinic acid is absorbed rapidly, usually reaching a peak plasma concentration in less than 1 hour. The short half-life is primarily due to rapid excretion of unmetabolized nicotinic acid by the kidneys; this necessitates frequent administration of the drug, usually three times a day with meals. Because of the frequent lack of tolerance, doses are started at 100 mg three times per day and are gradually increased at 100-mg intervals until a dose of 1 to 1.5 g is reached. The usual therapeutic dose is 2 to 6 g/day. Extended-release preparations are taken once each day, in the evening, and can be started at a higher dose. These preparations have been shown to have less incidence of side effects even in patients with diabetes.

Bile Acid Sequestrants

Bile acid sequestrants are nonabsorbable anion exchange resins that bind bile acids in the intestinal lumen, prevent their reabsorption, and promote their excretion in the feces. Enterohepatic cycling of cholesterol is markedly reduced by this mechanism, which blocks reabsorption of bile acids from the jejunum and ileum, 95% of which are normally reabsorbed, and increases bile acid excretion rate by 10-fold. Bile acids are synthesized in the liver from cholesterol by 7 α -hydroxylase, which is regulated through negative feedback by bile acids. Hepatic cholesterol conversion to bile acids is accelerated, and plasma cholesterol and LDL concentrations

are decreased. LDL concentrations are also reduced by these drugs because of upregulation of LDL receptors and hepatic uptake, whereas the VLDL concentration may be unchanged or increased.²⁶ These resins have no effect in patients with homozygous familial hypercholesterolemia who have no functioning LDL receptors.

Cholestyramine and colestipol are the two clinically available drugs in this category (Figure 29-4). They are very large resins that are insoluble in water. The dry resin is mixed with a liquid such as fruit juice and drunk as a slurry. Cl⁻ is released from the resin as bile acids bind to it, and the released Cl⁻ is absorbed, but the resin itself is not absorbed. Because it is not absorbed, it has a high safety factor and absence of serious side effects, but the annoying gastrointestinal side effects (nausea, vomiting, abdominal distention, and constipation) limit the use of these drugs. An unpleasant taste adds to the problem of patient compliance with these agents. Because cholestyramine and the hydrochloride salt of colestipol clinically exchange Cl⁻ for other anions, hyperchloremic acidosis may develop when large doses are given to small patients. Both resins decrease the absorption and the therapeutic effect of other drugs, such as warfarin, thyroxine, digitalis, propranolol, and thiazides. This interaction can be partially overcome by proper timing of the dosage.

Bile acid-binding resins are used alone or in combination with nicotinic acid and cholesterol synthesis inhibitors. Cholestyramine was used in the Lipid Research Clinics Program Primary Prevention Trial.²⁷ In this trial of almost 4000 healthy men with hypercholesterolemia, there was a 20% decrease in LDL cholesterol with the resin and a 24% reduction in deaths from myocardial infarction.

The newest bile acid sequestrant to be approved for use in the United States is colesevelam hydrochloride, which is available in tablet form. Colesevelam has been found to lower LDL cholesterol as effectively as cholestyramine,¹¹ but has less danger of interaction with other drugs such as warfarin through adsorption.¹² There are also somewhat fewer gastrointestinal side effects, and, because of the tablet form, compliance is greater.

3-Hydroxy-3-Methylglutaryl-Coenzyme A Reductase Inhibitors

The development of drugs that specifically inhibit the biosynthesis of cholesterol has been the most important aspect of hypolipidemic drug development. This class of drugs, called the *statins*, currently includes lovastatin, pravastatin, simvastatin, fluvastatin, cerivastatin, atorvastatin, and rosuvastatin. These agents structurally resemble an intermediate in the HMG-CoA reductase reaction (Figure 29-5) and are potent competitive antagonists of HMG-CoA binding.²⁰ (Lovastatin and simvastatin are actually prodrugs in that they require cleavage of their lactone ring to become active.) Numerous clinical studies have now shown these drugs to be the best tolerated and most effective drugs for lowering LDL cholesterol and for reducing stroke, coronary heart disease, and overall mortality. In addition to lowering LDL cholesterol,

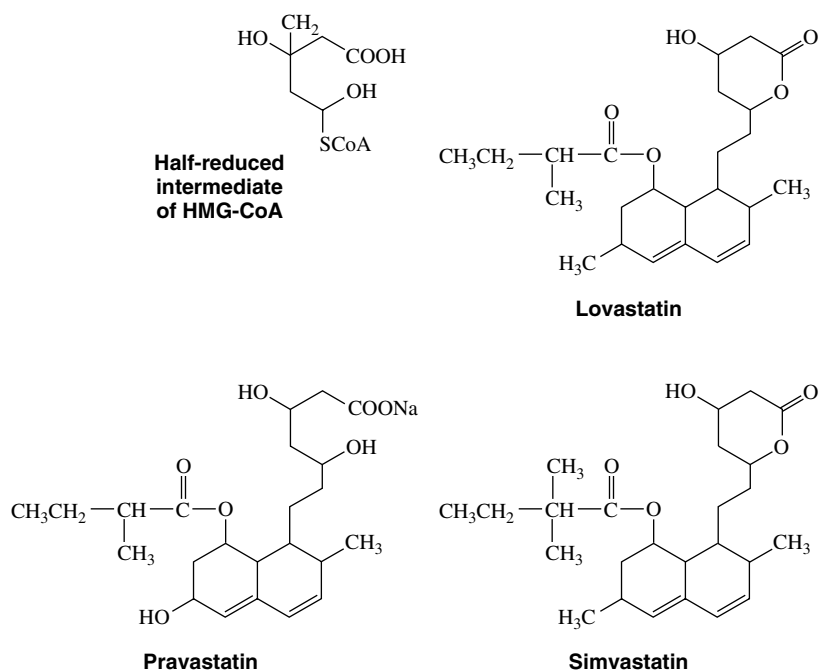

FIGURE 29-5 Structural formula of 3-hydroxy-3-methylglutaryl-coenzyme A (HMG-CoA), half-reduced intermediate, and several HMG-CoA reductase inhibitors.

some studies have shown that statins are useful in reducing triglycerides. Fewer studies have been conducted with patients having low HDL cholesterol, but these have indicated that some statins are effective in elevating HDL cholesterol.

The antihyperlipidemic effect of this class of drugs depends on inhibition of hepatic HMG-CoA reductase, the rate-controlling enzyme in the pathway of cholesterol synthesis. The subsequent depletion of intracellular cholesterol has two effects: (1) sterol inhibition of the transcription of HMG-CoA reductase and HMG-CoA synthetase genes is released, resulting in increased synthesis of these two enzymes, but the continuous presence of the drug keeps cholesterol synthesis inhibited in all tissues, and (2) synthesis of hepatic LDL receptors is stimulated, resulting in increased hepatic uptake of LDL and IDL. The net result of these changes is a reduction in LDL and IDL concentrations, a related decrease in lipoprotein cholesterol and triglyceride concentrations, and a slight increase in HDL concentrations.⁵

HMG-CoA reductase inhibitors are the most commonly prescribed lipid-lowering drugs. They are indicated for the treatment of hypercholesterolemia caused by elevated LDL concentrations in patients who have not responded to dietary or other measures. Statins may also be useful for the reduction of LDL levels in patients with combined hyperlipidemia (hypercholesterolemia and hypertriglyceridemia). They are ineffective in rare patients with familial hypercholesterolemia who are homozygous for the defective LDL receptor gene. More recent studies have suggested that some, but not all, statins may produce beneficial effects beyond decreasing LDL cholesterol, including decreased inflammation resulting from modulation of isoprenylation reactions, stimulation of nitric acid synthesis, decreased C-reactive protein levels, and antioxidant effects.

Adverse effects of HMG-CoA reductase inhibitors include myalgia, blurred vision, constipation, diarrhea, gas, heartburn, stomach pain, dizziness, headache, nausea, skin rash, impotence, and insomnia. The incidence varies among the different agents, with blurred vision more frequent with lovastatin and pravastatin and impotence and insomnia more frequent with lovastatin. HMG-CoA reductase inhibitors increase the anti-

coagulant effect of warfarin. Lovastatin has been linked with severe myopathy (rhabdomyolysis) when administered in combination with erythromycin, cyclosporine, gemfibrozil, or nicotinic acid. Other HMG-CoA reductase inhibitors have also been found to produce rhabdomyolysis in a small percentage of patients, but there is increased risk with higher doses, in elderly patients, or in combination with other drugs. Cerivastatin was removed from the market by its manufacturer because of rhabdomyolysis. It has been suggested that certain statins may cause rhabdomyolysis by inducing autophagy in muscle cells.³ Another side effect of statins that may be important in some patients is the potential for reduction in ubiquinone levels.²⁹ The safety of the statins in pregnant patients or in nursing infants has not been established, so women who are pregnant or nursing should avoid these drugs.^{25,41}

Cholesterol Absorption Inhibitors

The most recent class of lipid-lowering drugs to be developed and approved for use are cholesterol absorption inhibitors.¹³ These agents inhibit cholesterol uptake by the intestinal absorptive epithelium. Dietary cholesterol is normally absorbed in the jejunum from bile acid micelles by enterocytes, in which the cholesterol is immediately converted to cholesteryl esters for assembly of chylomicrons. The uptake of cholesterol is mediated by specific transporters in the brush border of these cells.²¹ The cholesterol absorption inhibitor ezetimibe blocked an elevation in plasma cholesterol in one study in which feeding of high-cholesterol diets increased plasma cholesterol in the control group.⁴⁵ This compound also reduced LDL cholesterol in human trials in a concentration-dependent manner at doses of 1 mg.⁸

In addition to these agents, inhibitors of bile acid uptake by the intestinal epithelium and inhibitors of acyl CoA cholesterol acyltransferase, the enzyme that produces cholesteryl esters, are being developed as lipid-lowering drugs.⁸ The combination of ezetimibe with HMG-CoA reductase inhibitors produces even greater control of hyperlipidemia than is possible with either drug used in monotherapy. An advantage of ezetimibe over bile acid sequestrants is that while inhibiting cholesterol uptake, it does not inhibit uptake of triacylglycer-

ols, bile acids, fatty acids, lipid-soluble drugs, or fat-soluble vitamins by the small intestine.

Other Agents

Some agents with moderate antihyperlipidemic activity may be clinically useful for specific patients. These include the very-long-chain polyunsaturated fatty acids found in fish oil, neomyacin, and β -sitosterol. Others, typified by dextrothroxine, can decrease cholesterol concentrations yet provide no therapeutic benefit to the patient.

Fish oils

Evidence exists to support a role for polyunsaturated fish oils in decreasing plasma lipid concentrations.^{22,37} Specifically, the omega-3 polyunsaturated fatty acids (PUFAs) eicosapentaenoic acid and docosahexaenoic acid have been identified, whether consumed as dietary constituents or as purified supplements. The mechanisms of action of these agents are unclear. Some commercial preparations contain antioxidants, such as vitamin E, in varying concentrations. The actions of the antioxidants and their effect on the action of the fish oils are not defined.

Increasing dietary omega-3 PUFAs has been shown to increase their concentration in platelet phospholipids. This increase allows them to compete with arachidonic acid for cyclooxygenase in the cascade that normally produces prostaglandins, thromboxanes, and prostacyclins.²² The prostaglandins derived from omega-3 PUFAs have biologic effects different from prostaglandins derived from arachidonic acid, and this alteration in prostaglandin synthesis is thought to result in a reduction of platelet aggregation and an increase in bleeding time.^{14,24} Eicosapentaenoic acid in particular may be converted to prostaglandin I₃, which is an antiaggregatory agent.²⁴

Although results vary, some evidence exists to show that fish oils can modestly decrease the levels of plasma cholesterol, triglycerides, and VLDL and modestly increase HDL levels. Patients with severe familial hypertriglyceridemia often have significant improvement on a diet high in fish oil. Before these agents can be recommended for widespread use in hyperlipidemia or to reduce the risk of coronary artery disease, however, long-term studies are needed to establish their safety and efficacy, with special emphasis on contaminants that may be present in some preparations.²³

Thyroid-active substances

Early animal experiments indicated that the dextroisomers of thyroxine and liothyronine (triiodothyronine) decrease plasma lipid levels with no increase in oxygen consumption, an effect that might be useful in treating hyperlipidemias.³⁴ These compounds have been shown to increase the incidence of angina pectoris and death, however, in patients with coronary artery disease.¹⁰ These findings restrict the use of these drugs as lipid-lowering agents and indicate that they should be used with extreme caution, if at all, in patients with heart disease.

Inhibitors of cholesteryl ester transfer protein

Clinical investigations are currently under way to examine the effects of drugs that inhibit cholesteryl ester transfer protein (CETP). CETP is a protein synthesized in the liver that transfers cholesteryl esters from circulating HDL particles to circulating LDL and VLDL particles. In animals and in humans, the inhibition of CETP causes an increase in HDL cholesterol. Phase III trials of one of these drugs has been halted because of significantly higher mortality in a high-risk treatment group, but the adverse effect may be unrelated to the drug's inhibition of CETP, and other drugs in the same class may not have the same adverse effect.^{4,15}

COMBINED-DRUG THERAPY

Lipid-lowering drugs from the different categories are used in combination for three reasons. First, combined-drug therapy may result in a more profound reduction of lipid levels than can be achieved by single-drug therapy. Second, as previously stated, some drugs may elevate certain lipid concentrations; combined therapy with a drug of another category can be used to overcome this unwanted effect. Third, the use of combined-drug therapy may allow smaller doses of the drugs to be used than in single-drug therapy, decreasing potential side effects. Examples of multiple-drug therapies having demonstrable value include the combination of a bile acid sequestrant (cholestyramine or colestipol) with either nicotinic acid or an HMG-CoA reductase inhibitor.⁶ Other drug combinations that have been shown to be useful include a bile acid sequestrant and a fibrate and a resin plus nicotinic acid plus an HMG-CoA reductase inhibitor. Colesevelam plus an HMG-CoA reductase inhibitor may also be a useful combination. The newest combined-drug therapy is the use of a cholesterol absorption inhibitor with an HMG-CoA reductase inhibitor. The combination of ezetimibe and atorvastatin achieved a 50% reduction in LDL cholesterol at low doses (10 mg) of each drug. This result was approximately equal to the effect of 80 mg of atorvastatin alone.

LIPID-LOWERING DRUGS

<i>Nonproprietary (generic) name</i>	<i>Proprietary (trade) name</i>
Atorvastatin	Lipitor
Cholestyramine	Questran
Clofibrate	Atromid-S
Colesevelam	WelChol
Colestipol	Colestid
Ezetimibe	Zetia, Vytorin (combination with simvastatin)
Fenofibrate	Tricor, Lofibra
Fish oils (n-3 PUFAs)	Max-EPA, Promega, Sea-omega, Super EPA
Fluvastatin	Lescol
Gemfibrozil	Lopid
Lovastatin	Altoprev, Mevacor, Advicor (combination with niacin)
Nicotinic acid (niacin)	Niacor, Niaspan, Niacin SR, Slo-Niacin
Pravastatin	Pravachol
Rosuvastatin	Crestor
Simvastatin	Zocor

PUFAs, Polyunsaturated fatty acids.

CITED REFERENCES

1. A co-operative trial in the primary prevention of ischaemic heart disease using clofibrate. Report from the Committee of Principal Investigators. *Br Heart J* 40:1069-1118, 1978.
2. Altschul R, Hoffer A, Stephen JD: Influence of nicotinic acid on serum cholesterol in man. *Arch Biochem Biophys* 54:558-559, 1955.

3. Araki M, Motojima K: Hydrophobic statins induce autophagy in cultured human rhabdomyosarcoma cells. *Biochem Biophys Res Commun* 367:462-467, 2008.
4. Barter PJ, Caulfield M, Eriksson M, et al: ILLUMINATE Investigators: Effects of torcetrapib in patients at high risk for coronary events. *N Engl J Med* 357:2109-2122, 2007.
5. Bilheimer DW, Grundy SM, Brown MS, et al: Mevinolin and colestipol stimulate receptor-mediated clearance of low density lipoprotein from plasma in familial hypercholesterolemia heterozygotes. *Proc Natl Acad Sci U S A* 80:4124-4128, 1983.
6. Broeders N, Knoop C, Antoine M, et al: Fibrate-induced increase in blood urea and creatine: is gemfibrozil the only innocuous agent? *Nephrol Dial Transplant* 15:1993-1999, 2000.
7. Brown MS, Goldstein JL: Lipoprotein receptors in the liver: control signals for plasma cholesterol traffic. *J Clin Invest* 72:743-747, 1983.
8. Brown WV: Novel approaches to lipid lowering: what is on the horizon? *Am J Cardiol* 87(Suppl):23B-27B, 2001.
9. Carlson LA, Orö L, Adostman J: Effect of nicotinic acid on plasma lipids in patients with hyperlipoproteinemia during the first week of treatment. *J Atheroscler Res* 8:667-677, 1968.
10. Castelli WP, Garrison RJ, Wilson PW, et al: Incidence of coronary heart disease and lipoprotein cholesterol levels. The Framingham study. *JAMA* 256:2835-2838, 1986.
11. Davidson MH, Dillon MA, Gordon B, et al: Colesevelam hydrochloride (Cholestage): a new, potent bile acid sequestrant associated with a low incidence of gastrointestinal side effects. *Arch Intern Med* 159:1893-1900, 1999.
12. Donovan JM, Stypinski D, Stiles MR, et al: Drug interactions with colesevelam hydrochloride, a novel, potent lipid-lowering agent. *Cardiovasc Drugs Ther* 14:681-690, 2000.
13. Dujovne CA, Bays H, Davidson MH, et al: Reduction of LDL cholesterol in patients with primary hypercholesterolemia by SCH 48461: results of a multicenter dose-ranging study. *J Clin Pharmacol* 41:70-78, 2001.
14. Dyerberg J, Bang HO: A hypothesis on the development of acute myocardial infarction in Greenlanders. *Scand J Clin Lab Invest* 42(Suppl 161):7-13, 1982.
15. El Harchaoui K, van der Steeg WA, Stroes ES, et al: The role of CETP inhibition in dyslipidemia. *Curr Atheroscler Rep* 9:125-133, 2007.
16. Frick MH, Elo A, Haapa K, et al: Helsinki Heart Study: primary-prevention trial with gemfibrozil in middle-aged men with dyslipidemia: safety of treatment, changes in risk factors, and incidence of coronary heart disease. *N Engl J Med* 317:1237-1245, 1987.
17. Fruchart JC, Staels B, Duriez P: The role of fibric acids in atherosclerosis. *Curr Atheroscler Rep* 3:83-92, 2001.
18. Grundy SM, Cleeman JI, Merz CN, et al: Implications of recent clinical trials for the National Cholesterol Education Program Adult Treatment Panel III guidelines. *Circulation* 110:227-239, 2004.
19. Grundy SM, Mok HY, Zech L, et al: Influence of nicotinic acid on metabolism of cholesterol and triglycerides in man. *J Lipid Res* 22:24-36, 1981.
20. Gullestad L, Oie E, Ueland T, et al: The role of statins in heart failure. *Fundam Clin Pharmacol* 21(Suppl 2):35-40, 2007.
21. Hernandez M, Montenegro J, Steiner M, et al: Intestinal absorption of cholesterol is mediated by a saturable, inhibitable transporter. *Biochem Biophys Acta* 1486:232-242, 2000.
22. Herold PM, Kinsella JE: Fish oil consumption and decreased risk of cardiovascular disease: a comparison of findings from animal and human feeding trials. *Am J Clin Nutr* 43:566-598, 1986.
23. Hughes A, Rogers MJ, Idris AI, et al: A comparison between the effects of hydrophobic and hydrophilic statins on osteoclast function in vitro and ovariectomy-induced bone loss in vivo. *Calcif Tissue Int* 81:403-413, 2007.
24. Jorgensen KA, Dyerberg J: Platelets and atherosclerosis. *Adv Nutr Res* 5:57-75, 1983.
25. Kazmin A, Garcia-Bournissen F, Koren G: Risks of statin use during pregnancy: a systematic review. *J Obstet Gynaecol Can* 29:906-908, 2007.
26. Levy RI, Frederickson DS, Shulman R, et al: Dietary and drug treatment of primary hyperlipoproteinemia. *Ann Intern Med* 77:267-294, 1972.
27. Lipid Research Clinics Program: The Lipid Research Clinics Coronary Primary Prevention Trial Results. I. Reduction in incidence of coronary heart disease. *JAMA* 251:351-364, 1984.
28. Ma B, Clarke SA, Brooks RA, et al: The effect of simvastatin on bone formation and ceramic resorption in a peri-implant defect model. *Acta Biomater* 4:149-155, 2008.
29. Mabuchi H, Haba T, Tatami R, et al: Effects of an inhibitor of 3-hydroxy-3-methylglutaryl-coenzyme A reductase on serum lipoproteins and ubiquinone-10 levels in patients with familial hypercholesterolemia. *N Engl J Med* 305:478-482, 1981.
30. Macmillan DC, Oliver MF, Simpson JD, et al: Effect of ethylchlorophenoxyisobutyrate on weight, plasma volume, total body water, and free fatty acids. *Lancet* 2:924-926, 1965.
31. Oberman A, Kreisberg RA, Henkin Y: *Principles and management of lipid disorders: a primary care approach*, Baltimore, 1992, Williams & Wilkins.
32. Oliver MF: Current therapeutics. CXC. "Atromid-S" and "Atromid." *Practitioner* 192:424-430, 1964.
33. Oliver MF: Further observations on the effects of Atromid and of ethyl chlorophenoxyisobutyrate on serum lipid levels. *J Atheroscler Res* 3:427-444, 1963.
34. Oliver MF, Boyd GS: Reduction of serum-cholesterol by dextrothyroxine in men with coronary heart disease. *Lancet* 1:783-785, 1961.
35. Oster KA: Evaluation of serum cholesterol reduction and xanthine oxidase inhibition in the treatment of atherosclerosis. *Recent Adv Stud Cardiac Structure Metab* 3:73-80, 1973.
36. Packard CJ, Shepherd J: The hepatobiliary axis and lipoprotein metabolism: effects of bile acid sequestrants and ileal bypass surgery. *J Lipid Res* 23:1081-1098, 1982.
37. Phillipson BE, Rothrock DW, Connor WE, et al: Reduction of plasma lipids, lipoproteins, and apoproteins by dietary fish oils in patients with hypertriglyceridemia. *N Engl J Med* 312:1210-1216, 1985.
38. Report of the National Cholesterol Education Program Expert Panel on Detection, Evaluation, and Treatment of High Blood Cholesterol in Adults. The expert panel. *Arch Intern Med* 148:36-69, 1988.
39. Robins SJ, Collins D, Wittes JT, et al: Relation of gemfibrozil treatment and lipid levels with major coronary events: VA-HIT: a randomized controlled trial. *JAMA* 285:1585-1591, 2001.
40. Rubins HB, Robins SJ, Collins D, et al: Gemfibrozil for the secondary prevention of coronary heart disease in men with low levels of high-density lipoprotein cholesterol. Veterans Affairs High-Density Lipoprotein Cholesterol Intervention Trial Study Group. *N Engl J Med* 341:410-418, 1999.
41. Scandinavian Simvastatin Survival Study Group: Randomised trial of cholesterol lowering in 4444 patients with coronary heart disease: the Scandinavian Simvastatin Survival Study (4S). *Lancet* 344:1383-1389, 1994.
42. Stamler J, Wentworth D, Neaton JD: Is relationship between serum cholesterol and risk of premature death from coronary heart disease continuous and graded? Findings in 356,222 primary screenees of the Multiple Risk Factor Intervention Trial (MRFIT). *JAMA* 256:2823-2828, 1986.
43. Stein EA: Lipids, lipoproteins, and apolipoproteins. In Tietz NW, editor: *Textbook of clinical chemistry*, Philadelphia, 1986, Saunders.
44. Superko HR, Krauss RM: Coronary artery disease regression: convincing evidence for the benefit of aggressive lipoprotein management. *Circulation* 90:1056-1069, 1994.
45. VanHeek M, Compton DS, Davis HR: The cholesterol absorption inhibitor, ezetimibe, decreases diet-induced hypercholesterolemia in monkeys. *Eur J Pharmacol* 415:79-84, 2001.

GENERAL REFERENCES

- Mahley RW, Bersot TP: Drug therapy for hypercholesterolemia and dyslipidemia. In Brunton LL, Lazo JS, Parker KL, editors: *Goodman & Gilman's the pharmacological basis of therapeutics*, ed 11, New York, 2006, McGraw-Hill.
- Malloy MJ, Kane JP: Agents used in hyperlipidemia. In Katzung BG, editor: *Basic and clinical pharmacology*, ed 10, New York, 2007, McGraw-Hill.

O'Regan C, Wu P, Arora P, et al: Statin therapy in stroke prevention: a meta-analysis involving 121,000 patients, *Am J Med* 121:24-33, 2008.

Paoletti R, Bolego C, Cignarella A: Lipid and non-lipid effects of statins, *Handb Exp Pharmacol* 170:365-388, 2005.

Schwartz GG: Lipid management after acute coronary syndrome, *Curr Opin Lipidol* 18:626-632, 2007.

Tenenbaum A, Fisman EZ, Motro M, et al: Atherogenic dyslipidemia in metabolic syndrome and type 2 diabetes: therapeutic options beyond statins, *Cardiovasc Diabetol* 5:20, 2006.

Third Report of the National Cholesterol Education Program (NCEP) Expert Panel on Detection, Evaluation and Treatment of High Blood Cholesterol in Adults (Adult Treatment Panel III) Final Report, *Circulation* 106:3143-3421, 2002.

USP dispensing information (USPDI). *Drug information for the health care professional*, vol 1, ed 24, Greenwich Village, CO, 2004, Thomson MICROMEDEX.

Antianemic and Hematopoietic Stimulating Drugs

BARTON S. JOHNSON

Hematopoiesis is the intricate system of growth and differentiation of immature pluripotent/multipotent stem cells into all the formed elements of the blood (Figure 30-1). These stem cells, derived embryologically in the liver and later from bone marrow,³³ divide early in development into either myeloid or lymphoid precursors. The myeloid precursors differentiate into the erythrocytes, megakaryocytes (which give rise to thrombocytes [platelets]), neutrophils, and monocytes. The lymphoid precursors give rise to the T-cell and B-cell lymphocytes, natural killer cells, and all their respective subtypes. The derivation of eosinophils and basophils lies in the myeloid stem line, but appears to be downstream of the common myeloid precursors.²⁶ Hematopoietically active bone marrow retains essentially the same mass throughout life, and although cell-producing bone marrow is found in practically all bones through adolescence, it becomes restricted to the vertebrae, sternum, ribs, pelvis, scapulae, parts of the skull, and epiphyseal ends of the long bones after approximately age 20 years.

Hematopoiesis is a dynamic, continuous process because mature cells of the blood have a limited life span in periods of sickness and health. Because of its complexity, ubiquity, and high rate of activity, the hematopoietic system is often the first organ system to show evidence of underlying systemic disease. This chapter discusses the pharmacologic interventions currently available to correct perturbations in marrow function. Conditions such as anemia, thrombocytopenia, neutropenia, and volume depletion and novel approaches to medical care that involve the hematopoietic system are discussed in detail.

ANEMIA

Anemia comprises a multifactorial group of illnesses with a wide range of underlying causes. As a result, *anemia* is a generic term indicating only that the concentration of hemoglobin in whole blood is less than normal. Anemia is not a disease, but a sign of underlying disease. When discussing anemia, it is important to diagnose the nature and the cause of the anemia. There are three general categories of diseases that cause anemia: (1) diseases that cause blood loss, (2) diseases that disturb red blood cell production, and (3) diseases that increase endogenous destruction of red blood cells.

Blood loss can occur either acutely, as in hemorrhage from trauma or surgery, or chronically, as with excessive menstrual bleeding or the occult bleeding of esophageal varices or gastric/duodenal ulcers. Disturbed red blood cell production is associated with nutritional deficiencies, disorders that suppress erythrocyte production (such as in aplastic anemia

and with some antiretroviral therapy), and myelophthistic (marrow-displacing) diseases. Finally, anemia can be caused by increased destruction of the red blood cells, such as in sickle cell disease, thalassemia, hemolytic immune reactions, and genetic disorders such as glucose-6-phosphate dehydrogenase deficiency.

When a patient is suspected to have a type of anemia, the first tests to consider are a simple hematocrit and erythrocyte count. These two tests tell whether the production-to-loss ratio of red blood cells is normal. The hematocrit is defined as the ratio of red blood cells to the total blood volume. It is expressed as a percentage and is determined by comparing the packed cell volume (which is composed largely of erythrocytes) to the total volume of centrifuged whole blood. Normal values for women are 36% to 45%, and normal values for men are 38% to 50%. In an anemic patient, the hematocrit level is reduced, often into the 20s and in severe cases into the teens or lower. Conversely, the hematocrit increases (referred to as *polycythemia vera* if moderate and *erythroleukemia* if severe) in patients with poor pulmonary function, in patients with some chronic cardiac conditions, in patients with certain marrow tumors, and in patients living at high altitudes. In acute hemorrhage, because plasma and red blood cells are lost together, the hematocrit does not initially reflect the loss until the body or exogenous medical intervention has had the opportunity to replenish the lost plasma volume. In these cases, there may be no indication of a problem until several hours later.

The erythrocyte (reticulocyte) count is a simple determination of the absolute number of cells (in millions) per microliter. Normal values for women are 3.8 to 5 million/ μL , and normal values for men are 4.4 to 5.6 million/ μL .

After anemia has been detected, it can be characterized by evaluating the hemoglobin in the erythrocytes. Normal amounts of hemoglobin per unit volume of blood (assayed on peripheral blood draw) are 15.2 ± 2.2 g/dL for men and 13.7 ± 2.1 g/dL for women. Hemoglobin is the oxygen-carrying component of red blood cells. It comprises three components: iron, porphyrin rings, and globin chains. Alterations in any one of these three components can be a cause for a clinical anemia. In normal hemoglobin, iron in the ferrous form (Fe^{++}) is chelated into the middle of the porphyrin chemical ring to yield heme, the nonprotein component of hemoglobin (Figure 30-2).

The globin chains constitute the main protein constituents of hemoglobin. There are four forms of globin chains: α (141 amino acids), β (146 amino acids), δ , and γ (δ and γ are variants of β). Approximately 97% of normal hemoglobin (hemoglobin A) consists of two α and two β chains ($\alpha_2\beta_2$); 1% to 2% consists of the $\alpha_2\delta_2$ combination (hemoglobin A₂). The

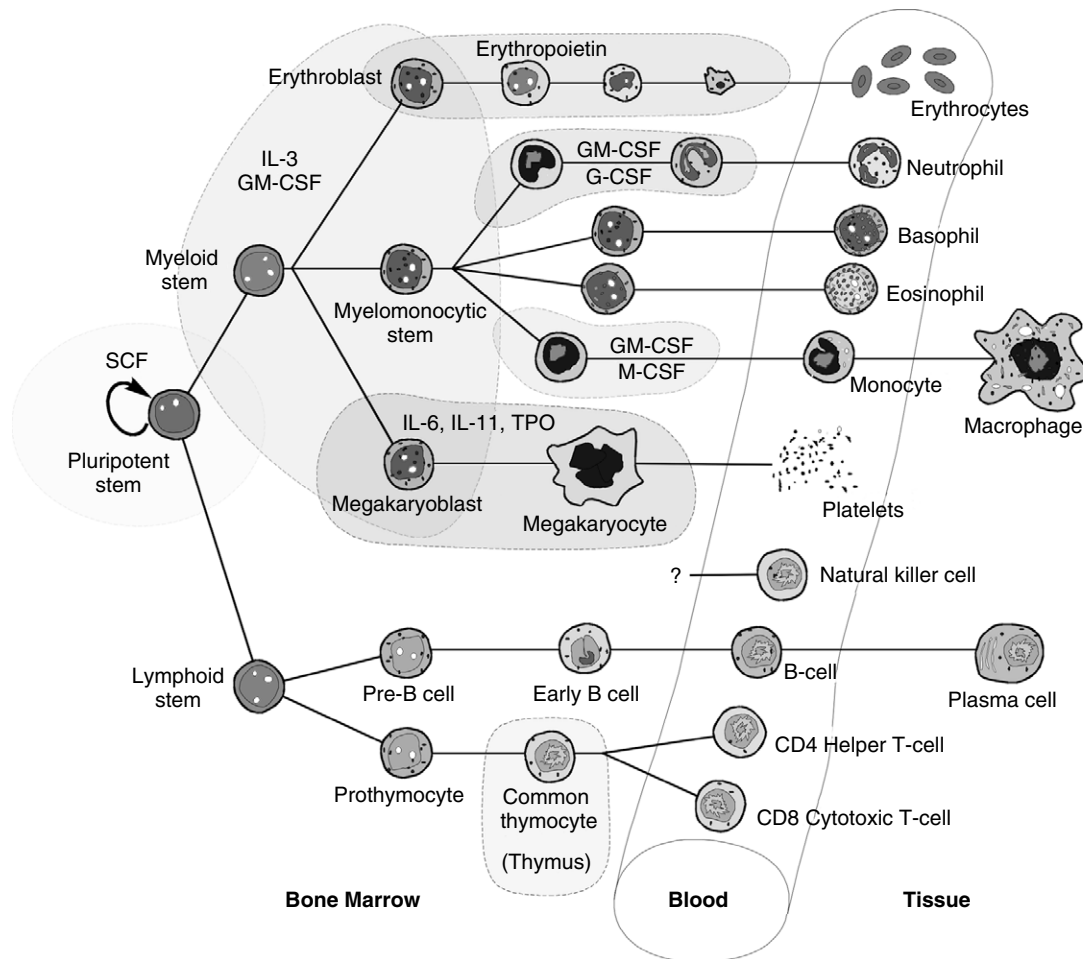

FIGURE 30-1 Overview of hematopoiesis. G-CSF, Granulocyte colony-stimulating factor; GM-CSF, granulocyte-macrophage colony-stimulating factor; IL-3, IL-6, IL-11, interleukin-3, interleukin-6, interleukin-11; M-CSF, monocyte/macrophage colony-stimulating factor; SCF, stem cell factor; TPO, thrombopoietin.

$\alpha_2\gamma_2$ tetramer forms hemoglobin F, or fetal hemoglobin. Hemoglobin F is the major form during gestation and until approximately 6 months of age. In adults, hemoglobin F makes up less than 1% of normal hemoglobin. One heme ring is accommodated within each of the four structural folds of the tetramer, allowing each molecule of hemoglobin to bind four oxygen molecules.

Hemoglobin accounts for approximately 95% of the dry weight of mature erythrocytes. Any significant changes in hemoglobin are often directly reflected in the way the erythrocytes look or behave grossly. Classically, laboratory analyses for anemia have reviewed erythrocyte size, shape, and color intensity. The size is determined by the mean corpuscular volume (MCV). The *normocytic*, or normal size, range is 80 to 100 fL/cell. Cells that are too small are termed *microcytic*, whereas cells that are too large are termed *macrocytic*. The shape of the red blood cells is also important in diagnosing the cause of anemia. Box 30-1 lists terms that describe various shapes found on a peripheral blood smear. The color intensity of the cell is reflected in the mean corpuscular hemoglobin (normally 26 to 34 pg/cell) and the mean corpuscular hemoglobin concentration (normally 31 to 36 g/dL). These two parameters, along with MCV, collectively referred to as the *red blood cell indices*, are extremely helpful in delineating the causes of a particular anemia.

The various kinds of anemia are classified by their typical effect on the erythrocytes (Table 30-1). When anemia results

from a loss of blood (intrinsically from hemolysis or extrinsically from hemorrhage) or because of a decrease in production of normal erythrocytes, the cells are still normal, just fewer in quantity. These anemias are *normocytic* and *normochromic*. When anemia is caused by a decrease in the production of properly formed hemoglobin, the cells tend to be smaller (because hemoglobin comprises such a high percentage of erythrocyte content) and paler in color. These forms of anemia are known as *microcytic* and *hypochromic* and are usually the result of defective or inadequate iron absorption. Forms of anemia that cause the red blood cells to mature incompletely and retain some DNA content result in larger cells; these are known as *macrocytic* or *megaloblastic* anemia. They generally occur as a result of a deficiency in vitamin B₁₂, folic acid, or both nutrients. In these forms of anemia, the cells may also have a darker or *hyperchromic* color.

Iron and Iron Deficiency Anemia

Nutrition and physiologic characteristics

Iron deficiency anemia is the most common cause of anemia worldwide and may occur for many reasons: inadequate nutrition in relation to rate of growth (qualitative or quantitative); defective absorption, transport, or storage (e.g., congenital transferrinemia or inability to release iron from transferrin to the red blood cells and their precursors); or blood loss from hemorrhage (most commonly gastrointestinal), menstruation, or blood donation. In the United States, iron deficiency

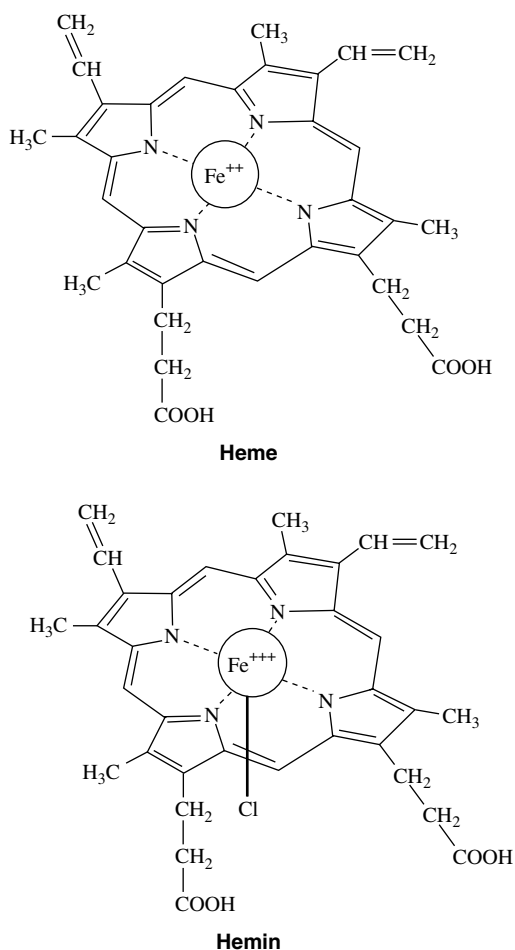

FIGURE 30-2 Structural formulas of heme and hemin.

BOX 30-1*Descriptive Terms of Red Blood Cell Morphologic Characteristics*

TERM	DESCRIPTION
Poikilocytosis	Irregular erythrocyte shape
Anisocytosis	Irregular erythrocyte size
Polychromasia	Change in amount of hemoglobin
Sickling	Sickle cell disease and trait
Targeting	“Bull’s-eye” look to the erythrocytes caused by hemoglobin C and liver disease
Leptocytes	Hemoglobin in the border with pigmentation in the center; found in thalassemia, obstructive jaundice, any hypochromic anemia, hemoglobinopathy, and after splenectomy
Spherocytes	Round erythrocytes (not biconcave), caused by hereditary spherocytosis or by immune or microangiopathic hemolysis
Schistocytes	Fragments of erythrocytes; found in hemolytic transfusion reactions, microangiopathic hemolysis, and other severe anemias
Acanthocytes	Distorted (“thorny”) erythrocytes with protoplasmic projections; seen in severe liver disease and with high titers of bile, fats, or toxins
Howell-Jolly bodies	Smooth, round remnants of nuclear chromatin; seen in megaloblastic and hemolytic anemias and after splenectomy
Nucleated erythrocytes	Found in severe bone marrow stress (e.g., hemorrhage, hemolysis), marrow replacement by tumor, extramedullary hematopoiesis

TABLE 30-1*Classification of Anemia by Cause and Presentation*

	MICROCYTIC	MACROCYTIC	NORMOCYTIC
Decreased Production	Iron deficiency Thalassemia Anemia of chronic disease	Megaloblastic: vitamin B ₁₂ deficiency, folate deficiency Nonmegaloblastic: myelodysplasia, chemotherapy, hepatitis	Aplastic anemia Bone marrow infiltration Carcinoma Lymphoma
Increased Destruction			Intrinsic hemolysis Extrinsic hemolysis
Blood Loss			Acute hemorrhage Chronic hemorrhage

anemia is found in 7% of infants, 4% to 5% of children, and 9% to 16% of menstruating women.⁵ Only 2% to 3% of men have iron deficiency anemia, and women taking oral contraceptives tend to have lower rates because progestins reduce menstrual blood loss. Children 6 months to 2 years old are particularly vulnerable because of their high growth rate coupled with weaning off breast milk and onto cow’s milk.

Cow’s milk is low in absorbable iron and may irritate the intestines. Pregnancy may precipitate iron deficiency anemia by rapidly increasing the blood volume, sometimes requiring two to five times the normal intake of iron. According to a World Health Organization technical report,¹⁷ women who have sufficient iron reserves to support the increase in hemoglobin production during pregnancy and who breastfeed their

FIGURE 30-3 Absorption, excretion, and storage of iron within the body of a 70-kg man. The amounts of iron absorbed, excreted, and stored in the three major compartments are expressed in milligrams. Note the balance between daily absorption and excretion.

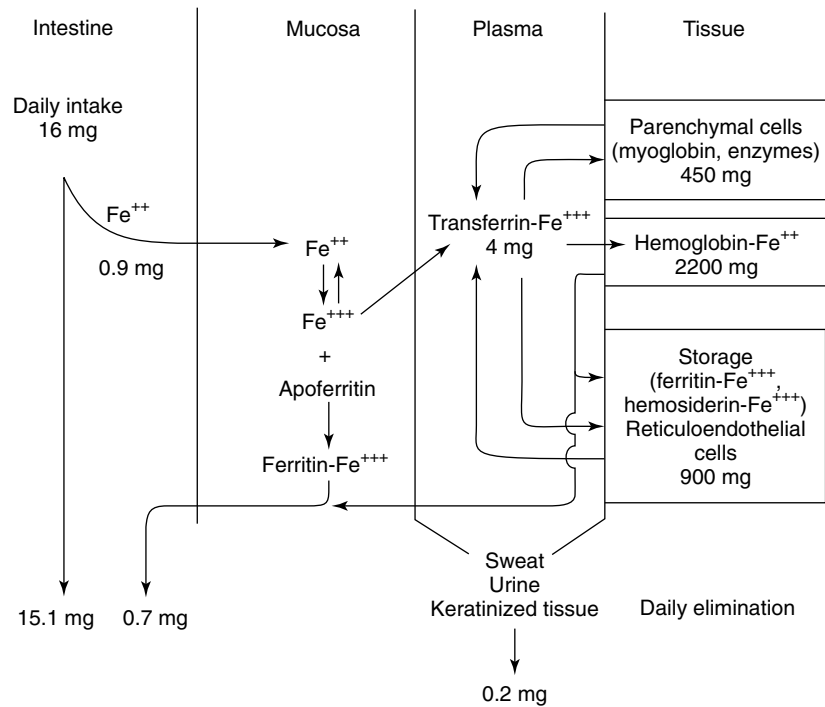

infants are generally capable of meeting their iron needs by diet alone, although supplementation is still recommended. In a nonpregnant, normal, healthy individual, iron reserves and recycling are so effective that even extreme reduction of iron intake may be insufficient to cause severe anemia.¹²

Men average 3.8 g total iron (50 mg/kg) and women average 2.3 g (35 to 42 mg/kg). Approximately 60% to 80% of the iron in the body is incorporated into hemoglobin (Figure 30-3). Anemia is the primary presenting sign of iron deficiency. Approximately 10% to 25% is sequestered in reticuloendothelial cells in the storage forms ferritin and hemosiderin (described later), and another 10% to 15% is associated in parenchymal cells with myoglobin. Less than 1% is used in various enzymes, most notably the cytochromes, and trace amounts are linked to the plasma transport protein transferrin. The amount of stored iron varies with intake and demand, averaging 400 mg in women and 1000 mg in men.

The average American ingests 10 to 20 mg of iron per day. Iron is obtained through the diet, most commonly by heme or iron complexed to various organic compounds. Foods considered high in iron (>0.5% by weight) are liver, heart, oysters, egg yolks, and yeast. Other meats and green vegetables have less iron. Absorption of iron from dietary sources is ordinarily 10% efficient or less, but it increases when iron stores are depleted. Therapeutic iron, generally in the form of inorganic salts or complexes, has an even poorer absorption profile than dietary iron because the Fe^{++} must be liberated from the salt before it can be absorbed across the intestinal mucosa.

Iron absorption occurs along the entire length of the intestine, but maximum absorption occurs in the duodenum and proximal jejunum because iron is absorbed primarily as Fe^{++} , and an acid medium favors the breakdown of salts to the ionic form. In the lower portions of the gastrointestinal tract there is a trend toward increasing alkalinity, which favors the formation of less soluble iron salts and complexes. Iron ingested as heme iron is absorbed five to seven times more efficiently than Fe^{++} salts. Iron absorption is hindered by coffee, tea, phosphates, and antacids, particularly calcium carbonate and aluminum or magnesium hydroxide. Absorption of nonheme iron is facilitated by vitamin C. How ethanol interacts with

iron is not well elucidated, but approximately 50% of alcoholics exhibit some iron depletion or anemia.

Iron is absorbed by active transport across the intestinal mucosa, where it is converted intracellularly to ferric iron (Fe^{+++}). Depending on the body's acute need for iron, Fe^{+++} is either bound to transferrin or converted to ferritin or hemosiderin for storage in the intestinal mucosa. Transferrin is a transport glycoprotein electrophoretically migrating with the β globulins; it specifically binds two molecules of Fe^{+++} . It enters the plasma and carries Fe^{+++} to the bone marrow and developing erythroblasts. The erythroblasts present membrane transferrin receptors that bind diferric transferrin and then internalize the complex by endocytosis. Inside the cell, the transferrin receptor, transferrin, and Fe^{+++} are broken apart, with the iron being used in hemoglobin synthesis and the transferrin and transferrin receptor being carried back intact to the surface for recycling. The typical developing erythroblast can process 25,000 to 50,000 transferrin molecules per minute.

A test for transferrin is total iron-binding capacity (TIBC). In a normal adult, approximately 20% to 50% of transferrin is replete with Fe^{+++} . In an iron-deficient individual, transferrin saturation may decrease to 15% or less. The capacity to bind iron is considerably greater, and the TIBC value increases. Normal values are 250 to 450 $\mu\text{g}/\text{dL}$.

If the body is not in acute need of iron, most of the ingested iron is stored as ferritin. Twenty-four apoferritin monomers bind together to form a hollow spherical shell 130Å in diameter and fenestrated with small pores through which 4000 Fe^{++} atoms can enter. When inside, the Fe^{++} is oxidized to Fe^{+++} and stored in the form of hydrous ferric oxide phosphate. Ferritin, the resulting apoferritin-iron complex, is a very effective storage mechanism, allowing the binding and release of iron to occur rapidly and efficiently. Mature ferritin is found in virtually all cells of the body and in plasma. Although the amount in plasma is small, it reflects the total ferritin stores in the body and is measured to diagnose iron deficiency anemia. Normal values for serum ferritin are 16 to 300 mg/mL in men and 4 to 160 mg/mL in women.

The other minor storage component of iron is hemosiderin. It is found in the monocyte/macrophage system of the marrow and in the Kupffer cells of the liver. Hemosiderin is an insoluble compound that seems to be aggregated ferritin cores partially or completely stripped of the apoferritin protein shell. In pathologic conditions (hemosiderosis), it can be found in large quantities in most tissues of the body.

The concentration of iron in the plasma at any one time represents a balance between the absorption rate, storage capacity, rate of hemoglobin formation, and rate of iron excretion. Iron is remarkably well conserved in the body; less than 0.1% is excreted on a daily basis, or approximately 0.5 to 1 mg/day. The major pathway of iron excretion is through the feces by exfoliation of gastrointestinal cells and their intracellular stores of ferritin when the mucosal cells are replaced by new epithelium. Iron is also lost in considerably smaller amounts by excretion through urine, exfoliation of dermal cells, and perspiration. Menstruation causes the amount of lost iron roughly to double to 2 mg/day. Uncommon sources of iron loss include excessive blood loss or excessive destruction of erythrocytes. Hemorrhage depletes heme iron, whereas excessive turnover of erythrocytes releases it back into the circulation, where it can be recycled. A normal individual can lose a quarter to a third of the erythrocyte mass through hemorrhage without need for iron therapy. Because iron is so well conserved in the body and most people have large reserves, chronically insufficient intake of iron is almost always the cause of iron deficiency anemia.

Pathophysiologic characteristics

Iron deficiency is manifested as signs and symptoms of anemia (pale color, fatigue, tachycardia, tachypnea on exertion). Severe cases, which are rare in first-world nations, may show progressive skin and mucosal changes, such as angular cheilosis and brittle fingernails and toenails. Splenomegaly may be present if hemolysis is occurring. The classic intraoral finding is a red-appearing, sore, smooth tongue caused by atrophy of the dorsal filiform papillae. In very severe cases, Plummer-Vinson syndrome may occur, which is iron deficiency anemia coupled with the formation of esophageal webs and resultant dysphagia. This syndrome is also associated with pharyngeal or esophageal squamous cell carcinoma. Many iron-deficient patients develop pica, an unusual craving for specific foods or unnatural food items (e.g., ice cubes, soil, paint chips) that may or may not contain iron.

The laboratory findings of iron deficiency anemia reflect the severity of the loss. In the first stage, there is a normocytic anemia without changes in erythropoiesis. The ferritin stores are depleting, so the serum ferritin values decrease while the TIBC increases. As anemia progresses and the stores are depleted, the erythrocytes become affected, resulting in a decrease in the MCV, mean corpuscular hemoglobin, erythrocyte count, hemoglobin, and hematocrit.

Iron therapy

The intuitive treatment of any disease state that is accompanied by extreme fatigue, weakness, and loss of color includes increased dietary intake, and the ancient Greeks, Hindus, and other early peoples turned to iron in many forms simply because it represented "strength." Although Sydenham is generally credited with the first rational use of iron (iron filings in wine) for treating anemia in 1681, it was not known that iron was actually present in blood until 30 years later, when Lemery and Geoffroy demonstrated its presence. Shortly thereafter, Menghini, an Italian physician, showed that foods with iron actually increase blood iron, but it was not until approximately 1830 that a pill containing iron (ferrous sulfate and potassium carbonate, 1:1) was introduced into medicine

by Blaud,³ an event that marked the beginning of modern treatment of iron deficiency anemia.

Iron therapy is indicated in iron deficiency anemia; it is contraindicated in anemia of any other cause. Iron is available in the form of Fe⁺⁺ salts (sulfate, gluconate, and fumarate), which are reasonably well absorbed, and a Fe⁺⁺⁺-containing compound (iron polysaccharide), which is not as well absorbed. The most commonly used Fe⁺⁺ preparation, and the agent of choice for uncomplicated iron deficiency anemia, is ferrous sulfate. It is normally given in doses (325 mg three times a day) much larger than should theoretically be needed because of its limited absorption ($\leq 15\%$). The response to oral iron preparations is usually evident in 5 to 10 days and is first manifested by an increase in reticulocytes. Adverse effects associated with orally administered iron are gastrointestinal symptoms, chiefly nausea and vomiting, because of direct irritation of the stomach. The patient has black stools as a result of therapy, which may obscure the diagnosis of melena. The drug is unquestionably best absorbed when taken between meals, but gastrointestinal distress is reduced if the medication is taken with meals and if the dose is started at a lower level and slowly increased with time. In general, the hematocrit returns halfway to normal in approximately 3 weeks and is fully corrected in roughly 8 weeks. To replenish iron stores, a course of therapy of 3 to 6 months is generally required.

Although parenteral iron preparations are available, they are not generally used because of the simplicity of oral medication and the much greater risk of serious side effects and higher expense. Iron should be administered parenterally only if the oral preparations are inadequately absorbed or poorly tolerated, such as in patients with enteritis or colitis, or if it is absolutely necessary to replace a serious iron deficit quickly. The classic parenteral form is iron dextran, a sterile colloidal solution of ferric hydroxide and low-molecular-weight dextran, which is administered by intramuscular or intravenous injection. Adverse reactions include pain and straining at the site of injection (intramuscular), urticaria, fever, arthralgia, lymphadenopathy, nausea, and vomiting. Rarely, severe or fatal anaphylactic reactions have occurred after the use of this preparation. Another parenteral form, iron sucrose, is a polynuclear ferric hydroxide sucrose complex. It is believed that the antigenic potential of iron dextran lies in the Fe⁺⁺ and dextran polysaccharides and that this preparation is less allergenic. Iron sucrose is commonly used in patients undergoing renal dialysis who are receiving erythropoietin (EPO) therapy.

Acute iron poisoning is uncommon, but can occur, particularly because many iron formulations are brightly colored and attractive to children. Ingestion of large doses of iron causes the transferrin to become saturated, and free iron enters the blood in excess. Unbound iron is toxic and has caused severe gastrointestinal disturbances and may lead to circulatory collapse. Chelating agents have been used in the treatment of acute iron toxicity; deferoxamine, a potent and specific iron-chelating compound, is capable of removing iron from ferritin and transferrin but not from hemoglobin. It is, however, no substitute for more immediate measures, such as inducing vomiting, gastric lavage, and fluid administration, that should be carried out in the event of iron poisoning.

Perhaps the most important consideration for the dental professional is the finding that people who are taking oral iron supplements may have altered absorption profiles of other drugs. The quinolone class of antibiotics, tetracyclines, and thyroid replacement hormones all form complexes with iron and result in significantly poorer (36% less) absorption profiles. Simply having the patient stagger the iron and the interacting competing medication by 2 or more hours is usually sufficient to avoid this difficulty.

OTHER MINERALS AND HEMATOPOIESIS

Copper deficiency, although extremely rare in humans, has been reported as the cause of anemia in patients undergoing intestinal bypass surgery. Copper is required for the operation of several copper-containing enzymes (e.g., cytochrome oxidase and monoamine oxidase) and may be essential for iron absorption. Too much zinc in the diet can result in copper deficiency.

Cobalt is not essential for hematopoiesis except in the form of vitamin B₁₂, as described later in this chapter. Elemental cobalt can stimulate red blood cell formation, however, to the point of polycythemia in humans. This effect is thought to be derived from the release of EPO by the kidneys. The toxic effects of cobalt limit its clinical application.

Lithium salts, used in the treatment of manic-depressive illness, frequently induce a selective leukocytosis involving neutrophils, eosinophils, and monocytes and may increase platelet formation. This effect is a true increase in blood cell proliferation, and lithium has been used in aplastic anemia, specific leukemias, and thrombocytopenia, albeit with limited success.

PORPHYRIA

Although iron deficiency anemia is the most commonly encountered form of anemia, it is not the only disorder in which insufficient functional heme is produced. The porphyrias, a cluster of disorders that involve decreased or disordered production of the porphyrin ring, can be associated with anemia depending on the variety and severity of the presentation of the diseases. Heme is a major component of hemoglobin, but it is also crucial to several enzyme systems, most notably the large family of cytochrome P450 enzymes involved in steroid synthesis and drug metabolism.

Porphyrin is produced in an eight-step process that occurs in the mitochondria and in the cytosol. The two principal cell types involved are the developing erythroblasts and reticulocytes of the bone marrow (mature erythrocytes lack mitochondria and are unable to synthesize porphyrin) and the liver hepatocytes. As a result, two general classifications of porphyria exist—erythropoietic and hepatic—that are divided further into nine varieties (Table 30-2), each corresponding to a particular enzyme deficiency in the synthetic pathway of porphyrin. These deficiencies may be genetic in nature or caused by medications.

Acute exacerbations usually occur when there is a significant demand for heme synthesis that cannot be met by the

limited enzyme function. This deficiency in heme inhibits the negative feedback cycle on δ -aminolevulinic acid synthase, causing induction of this rate-limiting enzyme. Because the heme synthesis pathway is damaged, induction instead leads to the excessive production in the liver of the porphyrin precursors δ -aminolevulinic acid and porphobilinogen, which build up and cause the acute symptoms. This accumulation of protoporphyrin precursors results in neurologic disorders, photocutaneous disturbances, or both.

Probably the most common genetic form of porphyria is acute intermittent porphyria. Its mode of transmission is autosomally dominant and results from a partial enzymatic deficiency (<50% of normal) in the third step of porphyrin synthesis. Because synthetic activity is diminished but not lost, most patients remain asymptomatic throughout normal life. Acute exacerbations, which give rise to the name, have highly variable symptoms that last from days to months. The most common presentation is neurologic, including mental changes; seizures; and acute sensory neuropathies such as abdominal pain, chest and back pain, and limb pain. The severity of the pain can be great enough to mimic other acute disorders and result in unnecessary surgical intervention such as laparotomy. Motor neuropathies, especially in the cranial nerves, are often seen. Occasionally, motor paralysis of the respiratory diaphragm has resulted in death. Gastrointestinal disturbances—primarily nausea, vomiting, and diarrhea—are common.

Several events can precipitate an attack. Physiologic stressors, such as surgery, excessive alcohol intake, illnesses, and infections, may induce hepatic heme oxygenase, which breaks down heme. Endocrine changes, such as may occur around a woman's menses, or synthetic estrogens and progestins may also induce an attack. More than 1000 medications have been categorized with regard to their porphyrinogenicity,³² of which a few reactions are well documented and many are still anecdotal. What is accepted is that endocrine properties of the drug, affinity for cytochrome P450, hepatic load, and capacity to modulate nuclear receptors affecting gene transcription (particularly 5-aminolevulinic acid synthase [ALAS1]) all play a role in how porphyrinogenic a drug might be.

Several medications commonly used in dentistry and medicine (Box 30-2) are steroid-based or metabolized by, and induce the synthesis of, the cytochrome P450 enzyme system, which leads to increased accumulation of porphyrin precursors.²² The response of any individual to any of these medications can be highly variable; the proposed unsafe medications should be discussed with the physician on a case-by-case basis. In susceptible porphyric patients, which also includes individuals with hereditary coproporphyrin and variegate porphyria, dose reductions or avoidance of specific medications

TABLE 30-2

Classification of Porphyrias

PORPHYRIA	SITE OF EXPRESSION	PRINCIPAL CLINICAL FEATURE
Acute intermittent porphyria	Liver	Neurologic
δ -Aminolevulinic acid dehydratase deficiency porphyria (rare)	Liver	Neurologic
Hereditary coproporphyrin	Liver	Neurologic, photosensitivity
Porphyria cutanea tarda	Liver	Photosensitivity
Variegate porphyria	Liver	Neurologic, photosensitivity
Hepatoerythropoietic porphyria	Liver, bone marrow	Photosensitivity
Congenital erythropoietic porphyria	Bone marrow	Photosensitivity
Erythropoietic protoporphyria	Bone marrow	Photosensitivity
X-linked sideroblastic anemia	Bone marrow	Hemolytic anemia

BOX 30-2

Drugs Considered Safe or Unsafe for Use in Patients with Acute Intermittent Porphyria, Variegate Porphyria, and Hereditary Coproporphyria

SAFE	POSSIBLY UNSAFE
Acetaminophen	Alcohol
Amitriptyline	Alkylating agents
Aspirin	Barbiturates (severe)
Atropine	Carbamazepine
Chloral hydrate	Chlordiazepoxide
Clorazepate	Chlorpropamide
Diazepam	Chloroquine
Digoxin	Clonidine
Diphenhydramine	Dapsone
Glucocorticoids	Ergots
Guanethidine	Erythromycin
Hyoscine	Estrogens, synthetic
Ibuprofen	Food additives
Imipramine	Glutethimide
Insulin	Griseofulvin
Labetalol	Hydralazine
Lithium	Ketamine
Naproxen	Meprobamate
Nitrofurantoin	Methyl dopa
Opioid analgesics	Metoclopramide
Penicillamine	Nortriptyline
Penicillin and derivatives	Pentazocine
Phenothiazines	Phenytoin
Procaine	Progestins
Propranolol	Pyrazinamide
Selective serotonin reuptake inhibitors	Rifampin
Streptomycin	Spiro lactone
Succinylcholine	Succinimides
Tetracycline	Sulfonamides (severe)
Thiouracil	Theophylline
Vitamins B and C	Tolazamide
	Tolbutamide
	Valproic acid

may be necessary. Thunell and colleagues³² have proposed a standardized method to determine a drug's probable porphyrogenicity, and an Internet database is available at <http://www.drugs-porphyrin.org>. Poor nutritional intake has also been associated with acute attacks.

Porphyria cutanea tarda is the most common porphyria and is representative of the erythropoietic porphyrias. Symptoms commonly include photosensitivity, which results from sequestration of protoporphyrins in the skin and subsequent deposition of iron in the integument. Porphyrin and its precursors undergo photoactivation at 400 nm in the presence of oxygen, causing cellular destruction by release of oxygen free radicals. In skin exposed to light, the porphyrins become photoexcited, and clinically evident cellular damage occurs. Porphyrin-laden erythrocytes also undergo phototoxicity when circulating through light-penetrated tissues. The damage may be sufficient to result in hemolytic anemia.

Management of acute intermittent porphyria has been primarily aimed at avoiding exacerbating conditions. Adequate caloric intake, prompt diagnosis and treatment of infections (including odontogenic and other orofacial infections), and care in not taking medications known to trigger attacks

are strategies the patient can use to minimize the risk of developing a crisis. In patients who have photoreactive porphyria, avoidance of sunlight, wearing clothing to cover the skin, and generous use of sunscreen lotion are helpful. If an acute attack occurs that is not amenable to glucose infusion, a medication of choice is lyophilized hemin with sodium carbonate. Hemin is ferric heme that has a Cl^- on one of the two available coordination sites for Fe^{+++} (see Figure 30-2). On mixing with sterile water, hemin is converted in the resulting alkaline solution to hematin by replacement of the Cl^- with an OH^- group. Hematin serves as an enzymatic inhibitor of porphyrin synthesis by decreasing the concentration of the precursors porphobilinogen and δ -aminolevulinic acid. The reconstituted drug is unstable, however, and has been frequently associated with thrombophlebitis and increased coagulopathy. Palliative use of opioid analgesics is also often indicated during porphyric exacerbations.

THALASSEMIA

In addition to problems affecting iron and porphyrin, several disorders of the third component of hemoglobin—the globin chains—can lead to clinical anemia. Grouped together, these disorders are called the *thalassemias*. As discussed previously, normal hemoglobin A is composed of two α -globin and two β -globin chains. When there is a genetic defect in the production of the α chains, the patient has α -thalassemia. Similarly, a defect in the β chains results in β -thalassemia. Sickle cell anemia, although normally addressed as a separate entity, is a variant of β -thalassemia. Thalassemias generally result in a decreased production of their respective protein chains. As a result, hemoglobin synthesis is impaired, and a non-iron-deficient, hypochromic, microcytic anemia ensues.

There are two pairs of genes encoding the α -globin chains, both located on chromosome 16. When all four α -globin genes are defective, the fetus develops hydrops fetalis, a condition incompatible with life. If there is a defective mutation in one of the four genes, the individual is clinically normal but is called a *silent carrier*. If two genes are affected, the patient has *α -thalassemia minor*. The hematocrit is mildly depressed (32% to 40%), and there is a marked decrease in erythrocyte size (MCV 60 to 75 fL). All iron parameters are normal. If three genes are affected, the patient is diagnosed with *α -thalassemia intermedia*, also known as *hemoglobin H disease*. Hemoglobin H is composed of tetramers of β -globin (β_4), resulting from a relative excess of β -globin chains compared with the α chains. Hemoglobin H has a high affinity for oxygen and binds it too tightly for efficient tissue delivery. It is unstable, being prone to denaturation by oxidative medications (e.g., sulfonamides) and infectious conditions. The hematocrit in hemoglobin H disease is markedly depressed (22% to 32%), and the anemia is hypochromic and microcytic in nature (MCV 60 to 70 fL). Clinical signs of the disease include pallor and splenomegaly.

β -Thalassemias exhibit a similar variability in severity based on which mutations in the genome are present. Most β -thalassemias result from point mutations in the gene, which create premature stop codons or cause difficulties with RNA transcription. As a result, the affected β chain may be either reduced (β^+) or absent (β^0). Because the δ or γ forms of hemoglobin can substitute for the β form, β -thalassemias typically have decreased ratios of hemoglobin A ($\alpha_2\beta_2$) and increased ratios of hemoglobin A₂ ($\alpha_2\delta_2$) and hemoglobin F ($\alpha_2\gamma_2$). The total amount of useful hemoglobin is usually severely depressed, however, decreasing oxygen transport capability. Further clinical disease occurs because of a relative excess of α -globin chains, which precipitate and cause damage to the developing erythrocytes and the circulating peripheral

erythrocytes. The intramedullary destruction of reticulocytes triggers a hyperplastic response by the bone marrow, resulting in increased marrow spaces and subsequent pathologic fractures and osteopenia. Peripherally, the destruction of the red blood cells may lead to a potentially life-threatening hemolytic anemia, splenomegaly, hepatomegaly, and hyperbilirubinemia.

The correct diagnosis of thalassemia is crucial to proper treatment. Mild forms of the disease need no treatment. More severe forms typically require transfusion support and folate supplementation. Iron therapy should be avoided because there is often hemosiderosis/iron overload owing to insufficient complete hemoglobin production. Patients requiring chronic transfusions are particularly susceptible to iron overload. In these cases, deferoxamine can be used to chelate iron and suppress the progression of hemosiderosis. Splenectomy may be required if severe hemolysis is occurring. Finally, allogeneic bone marrow transplantation may be required to correct the defect in severe cases.

Sickle Cell Anemia

Sickle cell anemia is technically a variant of β -thalassemia. A point mutation in the number 6 position of the β -globin chain causes a valine to be substituted for glutamic acid. As an autosomal recessive disorder, *sickle cell anemia* occurs when both alleles are positive for the sickle variant. *Sickle cell trait* occurs in the heterozygous state, where partial penetrance ($\alpha_2\beta^s\beta$) can occur. The abnormal β chain is designated β^s , and the resulting tetramer of $\alpha_2\beta^s_2$ is known as *hemoglobin S*. The significance of hemoglobin S is that in the severely deoxygenated state the globin tetramers are capable of coalescing into long, straight, spiral polymers that act as deforming filaments within the red blood cell. The cell loses its typical biconcave disk shape and its inherent pliability that is so important for moving through the microvasculature. These deformed and hardened erythrocytes are much more prone to automembrane damage and hemolysis. Simultaneously, the sickled shape makes them likely to cause microvascular occlusion and endothelial vascular damage.

Sickle cell anemia generally first manifests in the homozygous patient by age 6 months, when hemoglobin F is downregulated and hemoglobin S becomes the dominant form of hemoglobin in the erythrocyte. Many patients with homozygous disease can have normal lives as long as they avoid situations in which moderate-severe hypoxic stress can develop. Acute crises of sickling occur when the globin tetramers are deoxygenated for a sufficient time to allow polymerization into the deforming filamentous form. Small infections, such as odontogenic infections, may or may not cause an acute crisis. Although acidosis can develop, unless the red blood cells are severely hypoxic, they reoxygenate at the lungs before developing significant polymers and distorted cells. If the hypoxic stress is great, such as with more severe infection acute sickling occurs. The episodes are extremely painful, often lasting several hours to days. Treatment for the acute crisis is aimed at hydration, oxygenation, and resolution of the underlying precipitating factor. Many patients require opioid analgesics to help them through a crisis.

A patient with sickle cell anemia who is prone to repeated acute crises experiences various chronic complications from the disease. The erythrocytes containing hemoglobin S have a shortened life span compared with the erythrocytes containing hemoglobin A, and episodes of sickling accelerate their demise, resulting in a chronic hemolytic-type anemia. The anemia predisposes the patient to diminished oxygen transport capability (furthering the likelihood of a sickling crisis), and the breakdown by-products of the erythrocytes can produce clinical jaundice, hepatomegaly, and splenomegaly. At the same time, chronic and repeated microvascular occlu-

sive episodes can cause renal infarction, stroke, retinopathy, cardiomyopathy, and hepatic damage from occlusive ischemic necrosis. Many patients develop significant microvascular damage in the spleen because of its slow, tortuous microcirculation. In some cases, the spleen ultimately undergoes reactive fibrosis and becomes a small, scarred, essentially nonfunctional organ (autosplenectomy). In severe cases of sickle cell anemia, death can occur from multisystem organ failure.

Two strategies have been used in the long-term management of sickle cell anemia: bone marrow transplantation and pharmacotherapy. In one controlled study, definitive cure was shown in 36 (86%) of 42 cases by bone marrow transplantation from an antigen-matched sibling, with 5 of the 6 failures cured by subsequent engraftment.¹⁴ Bone marrow transplantation replaces the pluripotent stem cells of the marrow with cells of a person without the genotype, erasing the genetic defect. Although bone marrow transplantation is significantly more predictable than in years past, there is still a significant (>10%) mortality rate associated with the procedure, and the implications of chronic graft-versus-host disease must be weighed. This approach is generally reserved for severe cases that exhibit recurrent sickle crises.

Although still experimental, pharmacologic therapy has shown at least partial success in β -thalassemia and sickle cell anemia. This approach is based on the premise that any measure that increases the quantity of β -like globin molecules in erythrocytes is beneficial.²¹ Several antineoplastic agents—cytarabine, hydroxyurea, 5-azacytidine, interferon- γ , butyrate, and EPO with or without hydroxyurea—have been used to stimulate the formation of hemoglobin F. Hemoglobin F transports oxygen as effectively as hemoglobin A, and it circumvents the genetic abnormalities associated with defective β -globin synthesis. In addition, hemoglobin F suppresses the polymerization of hemoglobin S, helping further to reduce the effects of the disease. Although not a cure, this therapy has been recommended by the National Institutes of Health for adult patients, as long as they are closely monitored hematologically, to reduce the pain and organ damage of sickle cell anemia.¹

VITAMIN B₁₂, FOLIC ACID, AND MEGALOBlastic ANEMIA

Deficiency Syndromes

Vitamin B₁₂ and folic acid are two nutritional supplements that are crucial to normal DNA synthesis. When one or both of these are deficient, all rapidly dividing cells throughout the body, but especially cells of the bone marrow and gastrointestinal epithelium, begin to have difficulties with proliferation and differentiation caused by inhibition of mitosis and cytokinesis. Primarily, DNA synthesis is impaired; the resulting cells have large RNA-to-DNA ratios, increased cytoplasmic compartments, and unusual immature nuclear forms. In hematopoiesis, the deficiency causes the cells to assume a characteristic macrocytic and often oval or irregular shape that resembles the less mature blast forms—hence the term *megaloblastic anemia*. Protein synthesis is also adversely affected, resulting in substandard cell membranes and shortened life spans, causing the anemia to have a hemolytic component as well.

Although the diagnosis of megaloblastic anemia is most commonly made because of the characteristic changes in erythrocytes, all hematopoietic cell types are affected, which in rare cases can result in pancytopenia. The myeloid-derived cells released into the bloodstream may include macro-ovalocytes, hypersegmented polymorphonuclear leukocytes, and oversized platelets. Depending on which cell types

are adversely affected, there may be not only clinical fatigue caused by erythropoietic depression, but also leukopenia and thrombocytopenia, with an increased potential of infection (particularly in the urinary tract) and hemorrhage.

Although folic acid and vitamin B₁₂ have similar effects on the developing erythrocytes, the overall clinical presentations of their respective deficiency states differ greatly. The similarity comes from the sharing of a common biochemical pathway. The major difference is that neurologic manifestations often occur with vitamin B₁₂ deficiency but not with folic acid deficiency. Folate deficiency alone is characterized by pallor, anemia, fatigue, and glossitis. Vitamin B₁₂ deficiency results in the same signs and symptoms as folate deficiency but also causes inadequate myelin synthesis and epithelial replacement in the gastrointestinal tract. Symptoms of vitamin B₁₂ deficiency include gastrointestinal disturbances, weight loss, hepatomegaly, splenomegaly, and prominent neurologic disturbances related to inadequate myelin formation and maintenance. Paresthesias involving the peripheral nerves are the most common presenting symptoms. There is also decreased vibration and positional sense. Reflexes may be altered, and motor disturbances, including weakness and loss of sphincter tone, may occur. As the disease progresses, the posterior columns are affected, resulting in difficulty with balance.

In advanced cases, cerebral dysfunction may lead to memory loss, confusion, or dementia and other neuropsychiatric changes. It is crucial to diagnose correctly and treat a vitamin B₁₂ deficiency early because most of these neurologic findings can be reversed in the early stages. Patients with more advanced cases have permanent neurologic damage. On occasion, neurologic changes occur without hematopoietic alterations.

Although any interruption in DNA synthesis, maturation, or division of marrow stem cells can give rise to a megaloblastic anemia, virtually all cases seen clinically result from vitamin B₁₂ or folic acid deficiency. The cause may be insufficient dietary intake, decreased absorption, decreased utilization, or increased destruction of either or both of these two essential nutrients. Other, rarer causes include chemical agents that interfere with purine metabolism (e.g., chemotherapeutic drugs) and an intestinal parasite, the fish tapeworm (*Diphyllobothrium latum*), which competes successfully with the host for available vitamin B₁₂.

One particular form of vitamin B₁₂ deficiency is *pernicious anemia*. Historically, some anemic patients did not respond to iron supplementation, and their disease was characterized as pernicious, meaning fatal. Although Addison and others described pernicious anemia in the early 1800s, it was not until 1926 that Minot and Murphy²⁵ showed the value of raw liver in treating the disease. Castle⁴ showed in 1927 that a carrier glycoprotein secreted into the intestinal lumen by the gastroparietal cells plays a crucial role in reversing the lethal course of pernicious anemia. This finding led to the isolation of vitamin B₁₂.

Vitamin B₁₂

Nutrition and physiologic characteristics

Vitamin B₁₂ is a generic term for cyanocobalamin and hydroxocobalamin, two stable forms of cobalamin. Cobalamins are unique because they are the only cobalt-containing organic compounds known to occur in nature, and they represent the only known biologic example of a metal-carbon bond. The cobalamins are composed of a nearly planar macrocyclic corrin ring (similar to porphyrin) covalently linked to a trivalent cobalt atom by four coordination bonds in a manner similar to iron binding in heme (Figure 30-4).²⁴ The nucleotide 5,6-dimethylbenzimidazole is bound perpendicularly

below this ring structure to the corrin ring and the cobalt atom, whereas various R groups above the ring are bound solely to the cobalt atom. Four forms of the cobalamins have significant biochemical activity in vivo. Cyanocobalamin has a cyanide moiety as its R group; hydroxocobalamin has a hydroxyl. Hydroxocobalamin is converted endogenously to either deoxyadenosylcobalamin (5'-deoxyadenosyl R group) or methylcobalamin (methyl R group), the major form of cobalamin in plasma.

The cobalamins are essential cofactors in three human enzymatic processes. Deoxyadenosylcobalamin activates methylmalonyl coenzyme A (CoA) mutase, a mitochondrial enzyme that converts potentially toxic methylmalonyl CoA to the easily metabolized succinyl CoA. Methylmalonyl CoA is produced in the catabolism of propionate, which is formed during the breakdown of valine and isoleucine. In vitamin B₁₂ deficiency, it is believed that accumulation of methylmalonyl CoA results in aberrant fatty acid synthesis and metabolism, causing nonphysiologic fatty acids to be incorporated into cell membranes of the central nervous system, leading to the neurologic symptoms already described.²

In a separate enzymatic pathway, methylcobalamin serves as a cofactor for methionine synthase, a cytoplasmic methyltransferase that converts homocysteine and 5-methyltetrahydrofolate to methionine and tetrahydrofolate. As discussed later, tetrahydrofolate is the precursor to many folate cofactors, several of which are crucial to DNA synthesis. When vitamin B₁₂ is deficient, 5-methyltetrahydrofolate (derived from dietary folate) accumulates, and tetrahydrofolate (the metabolically useful product) declines, leading to megaloblastic anemia. Because of the common factor of folic acid, pharmacologic vitamin B₁₂ can sometimes ameliorate a folic acid deficiency and vice versa. As stated previously, folic acid alone cannot correct the induced neurologic changes associated with decreased vitamin B₁₂ activity. A deficiency of methionine, an essential amino acid whose daily utilization is approximately twice the normal dietary intake, may contribute to the degenerative nervous system changes that can occur in pernicious anemia.

The third vitamin B₁₂-dependent enzyme is leucine 2,3-aminomutase, which permits the interconversion of leucine and β-leucine. It is unknown at this time how interruption of this pathway may contribute to human disease.

The sole natural and commercial source of cobalamin is synthesis by microorganisms. Many animals can use vitamin B₁₂ produced by their own enteric bacteria, but because microbial synthesis in humans is limited to the large intestine, a site too distal for effective absorption, humans must derive their vitamin B₁₂ exogenously. Foods rich in vitamin B₁₂ include shellfish, such as oysters and clams (>10 μg/100 g tissue), and mammalian organ meats (liver, kidney, and heart). The average daily diet contains 5 to 30 μg of vitamin B₁₂, of which 20% to 30% is absorbed. Daily intake of 1 to 3 μg does little more than compensate for daily loss, but normally more than 1000 times this amount (up to 4 mg) is stored in the liver.

Vitamin B₁₂ is quite lipophobic and depends heavily on transfer mechanisms to be absorbed from the gastrointestinal tract. Cobalamin transport is mediated by several different proteins. When first ingested, the cobalamin liberated from food interacts with *R proteins* in the stomach. These proteins bind tightly to cobalamin and protect it from acidic degradation, but they do not have any ability to transport the cobalamin across the enteric mucosa. As the R protein-cobalamin complex moves into the duodenum and the pH increases, pancreatic proteases degrade the R protein from around the cobalamin. The cobalamin is next adsorbed onto *intrinsic factor*, a glycoprotein secreted by the stomach parietal cells

FIGURE 30-4 Hemelike corrin ring structure of deoxyadenosylcobalamin, one of the active coenzyme forms of vitamin B₁₂. Current therapeutic agents cyanocobalamin and hydroxocobalamin have CN or OH substituted for the 5'-deoxyadenosyl moiety at the bond indicated by the arrow. Methylcobalamin (CH₃ substituted) and deoxyadenosylcobalamin are active coenzyme forms. (Adapted from McGilvery RW, Goldstein GW: *Biochemistry: a functional approach*, ed 3, Philadelphia, 1983, Saunders.)

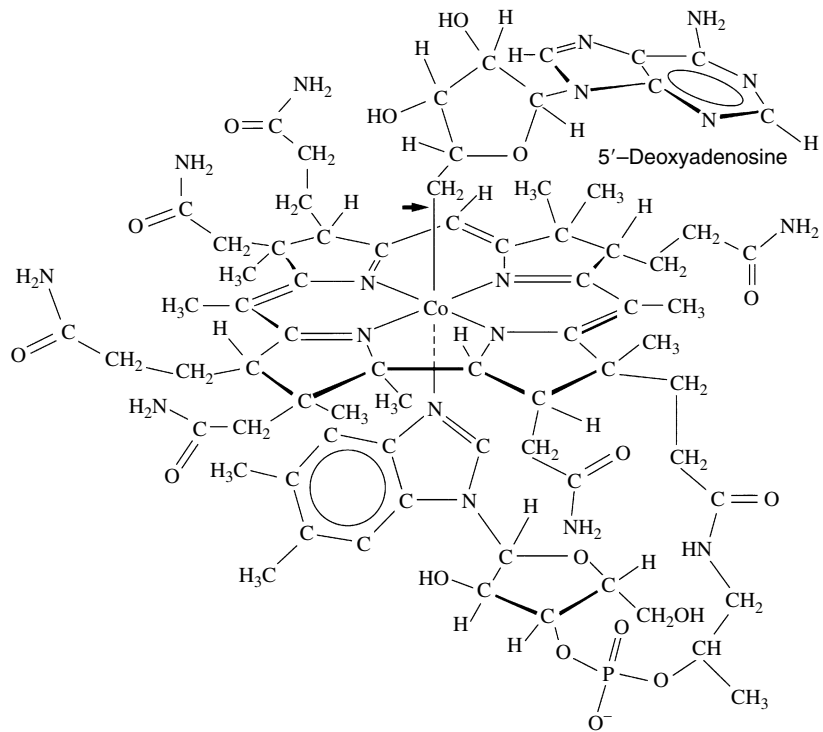

that has specific cobalamin-binding properties. The intrinsic factor-cobalamin complex is carried to the ileum, where highly specific receptors on cells of the ileal microvilli transport it across the cell membrane. In the enterocytes, the intrinsic factor is broken down, liberating the cobalamin. A plasma polypeptide, *transcobalamin II*, binds the cobalamin to carry the vitamin into the portal bloodstream.

Receptors for this protein-cobalamin complex are ubiquitous, but are especially rich in the liver. If the vitamin is needed in the tissues, it is taken up by the respective cells by endocytosis. If there is surplus, the cobalamin is moved to the hepatocytes for storage. Inside the cell, the cobalamin is freed by lysosomal enzymes, and the transcobalamin II is recycled back for reuse.

Transcobalamin II is the active transport protein, yet most of the circulating cobalamin is bound to two other transcobalamins—I and III—with transcobalamin I being the principal binding protein. Both proteins are also known to exist in saliva, bile, milk, and other fluids. It is unknown if transcobalamin I functions as a storage reserve of vitamin B₁₂ or if it is involved in the excretion of nonuseful corrinoid moieties. Dietary foodstuffs do have other corrin-containing compounds, and it has been theorized that transcobalamin I binds all corrin compounds, not just vitamin B₁₂. The bound complexes are excreted into the intestine by the bile. In the intestine, vitamin B₁₂ is reabsorbed with the assistance of intrinsic factor, whereas the other corrin compounds are excreted in the feces.

The enterohepatic cycling of cobalamin emphasizes the striking ability of the body to retain cobalamin. Normal hepatocyte turnover releases 3 to 4 μg of cobalamin into the bile each day, but the vitamin is essentially quickly rebound by intrinsic factor in the small intestine and reabsorbed. Very little new vitamin B₁₂ is required in the diet each day. As long as the ability of the body to transport cobalamin across the intestinal wall and reabsorb the bile-secreted cobalamin is intact, a diet completely devoid of vitamin B₁₂ may not produce clinical symptoms for many years.

Pathophysiologic characteristics

Vitamin B₁₂ deficiency can be difficult to diagnose. Typically, the MCV of the erythrocytes is markedly increased (usually 110 to 140 fL). If there is a concurrent iron deficiency anemia, the combination of microcytic and macrocytic anemias may result in relatively normal-sized cells. Other times, the cells are normocytic for obscure reasons. The peripheral blood smear is abnormal, showing anisocytosis and poikilocytosis, along with the characteristic macro-ovalocytes. Multilobulated neutrophils are typical. Hemolytic changes, resulting in increased plasma bilirubin, lactate dehydrogenase, iron, and saturated transferrin, may also be found. Serum vitamin B₁₂ concentrations, normally 150 to 350 pg/mL, are less than 100 pg/mL. Currently, interest has focused on measuring homocysteine and methylmalonic acid concentrations as good indicators of vitamin B₁₂ deficiency, especially because a rise in homocysteine has been shown to be a significant risk factor for cardiovascular disease.¹⁹

It is rare to see an individual with dietary vitamin B₁₂ insufficiency, especially in first-world nations. Only vegans, the strictest of vegetarians who eat no animal products whatsoever (including dairy products), may show dietary insufficiency. Even then, small amounts of vitamin B₁₂ may be available in the diet from microorganisms of legumes or exogenous application of cobalamins to grain and cereal products. As previously mentioned, dietary deficiency may take decades to become clinically evident.

A more common difficulty is with malabsorption of dietary cobalamin. In these patients, the transport proteins are defective, so that not only is the primary absorptive capacity decreased or lost, but also the ability of the body to recycle enterohepatic cobalamin is impaired. These patients have a much more rapid onset of symptoms, usually 3 to 6 years. Three basic causes exist: (1) inadequate production of intrinsic factor in the stomach; (2) altered ileal ability to absorb the intrinsic factor-cobalamin complex; and (3) pancreatic disease, in which transfer of the cobalamin from the R proteins to intrinsic factor is interrupted.

Pernicious anemia is a hereditary autoimmune disease in which antibodies develop against intrinsic factor. Although the disorder is hereditary, the patient is usually middle-aged or older with age-related chronic atrophic gastritis. The antibodies (IgG or IgM) may bind to intrinsic factor and prevent cobalamin binding, or they may bind to the intrinsic factor-cobalamin complex to prevent the complex from binding to the ileal receptors. In the classic form, other problems such as IgA deficiency, polyglandular endocrine insufficiency, and predisposition to gastric carcinoma, are also found. Additional causes of decreased gastric secretion resulting in a condition similar to pernicious anemia include severe nonautoimmune gastritis, atrophic gastritis, and surgical resection. Surgical gastrectomy results in loss of intrinsic factor, usually in proportion to the amount of stomach removed. Total or near-total gastrectomy causes vitamin B₁₂ deficiency and requires supplemental therapy.

Ileal problems may also lead to vitamin B₁₂ deficiency. Luminal stasis may allow significant enteric bacterial overgrowth, leading to blind loop syndrome; the vitamin is "stolen" by the bacteria and is unavailable to the host. Other conditions such as surgical resection, carcinoma, Crohn's disease, and other inflammatory bowel disorders may similarly induce a vitamin B₁₂ deficiency. Because vitamin B₁₂ deficiency results in decreased DNA synthesis of rapidly dividing cells, the enterocytes themselves begin to experience inhibition of mitosis and cytokinesis as the availability of cobalamin declines. As the disease progresses, it becomes increasingly self-perpetuating because the enterocytes become defective and further lose their ability to absorb cobalamin. Pancreatic disease decreases the absorption of vitamin B₁₂ by impairing the secretion of bicarbonate and pancreatic proteases necessary to degrade the R protein-cobalamin complex in the small intestine.

Finally, certain drugs such as *p*-aminosalicylic acid can reduce cobalamin absorption. Megadoses of vitamin C may cause vitamin B₁₂ to be converted to nonuseful analogues, some of which may harbor anti-vitamin B₁₂ activity.¹² Long-term exposure to nitrous oxide has been shown in pigs and humans to result in megaloblastic anemia by inhibiting methionine synthase activity. The nitrous oxide irreversibly oxidizes the exposed cobalt atom after the methylcobalamin cofactor of methionine synthase has transferred its methyl group to homocysteine. In so doing, nitrous oxide permanently inactivates the enzyme.

Therapeutic use

Various preparations are used for vitamin B₁₂ therapy, most commonly cyanocobalamin and hydroxocobalamin. Both are given by intramuscular or deep subcutaneous injection. Hydroxocobalamin is more highly protein-bound and remains in circulation longer, but the more popular form is cyanocobalamin because hydroxocobalamin has been associated with the development of antibodies to the transcobalamin II-vitamin B₁₂ complex. Neither cyanocobalamin nor hydroxocobalamin should be given intravenously.

Oral cobalamin is a relatively ineffective and expensive therapy because it relies on the same protein transport systems that have usually gone awry. In very high doses, sufficient vitamin B₁₂ can be passively absorbed across the intestinal wall to correct some deficiencies. Although oral vitamin B₁₂ is often formulated with intrinsic factor concentrate or liver extract to aid in the absorption process, these are not recommended over preparations of cobalamin only. The oral route is generally reserved for patients who cannot tolerate intramuscular injections.

Initial treatment of pernicious anemia involves twice-weekly intramuscular injections of vitamin B₁₂ for several months. Such treatment brings about a rapid change in the

bone marrow from megaloblastic to normoblastic erythropoiesis (usually in 2 to 3 days), with improving relief of glossitis, neuritis, and spinal cord degeneration in several months. As the blood picture improves, the interval between doses can be increased to 2 or 3 weeks. Because the hepatic stores are so great after they are replenished, the patient can eventually be put on maintenance therapy involving an injection every 1 or 2 months, but it must be continued for life. Neurologic damage that is not reversed after 12 to 18 months of therapy must be considered permanent.

Large doses of cobalamin are promptly excreted in the urine and to a lesser extent in the feces. There have been no reports of toxic effects from cyanocobalamin or hydroxocobalamin other than occasional allergic responses to impurities in the preparations. There is no evidence that large doses of cyanocobalamin result in cyanide poisoning.

Folic Acid

Nutrition and physiologic characteristics

In the course of an attempt to isolate vitamin B₁₂ to treat another form of macrocytic anemia peculiar to Hindu women, a different hematopoietic factor, folic acid (folacin or pteroylglutamic acid), was recognized and isolated.³⁶ Because the hematologic picture produced by vitamin B₁₂ deficiency is almost indistinguishable from that of folic acid deficiency, it is not surprising that the paths of discovery of these two essential antianemic factors were so entwined.

Although not usually referred to as such, folic acid fits the definition of a vitamin. It occurs widely in nature as polyglutamate conjugates, but is an essential nutrient in microgram quantities for humans. Folic acid itself is formed from glutamic acid, *p*-aminobenzoic acid, and pterin, as is shown in Figure 30-5. Fresh green vegetables (e.g., asparagus, broccoli, spinach, lettuce) are an excellent source of folic acid. Fruits such as bananas, lemons, and melons have high amounts, and liver, kidney, yeast, and mushrooms are also abundant in folate conjugates. Prolonged cooking destroys folic acid, especially when the conjugates are in dilute aqueous solution.

Absorption occurs primarily in the proximal jejunum, and it depends on specific mucosal membrane carboxypeptidases (conjugates) that hydrolyze the dietary polyglutamates to yield folic acid. In the mucosa, folic acid is reduced by dihydrofolate reductase and methylated to 5-methyltetrahydrofolate before entering the bloodstream. When in tissues, the compound is demethylated by vitamin B₁₂-dependent methionine synthase. The product, tetrahydrofolate, is conjugated with 1-carbon moieties to yield several active coenzyme forms that are essential for purine and thymidylate synthesis. Tetrahydrofolate is also involved in the conversion reactions of several amino acids. Figure 30-6 illustrates the major metabolic pathways and interactions of folate and vitamin B₁₂.

The minimum daily folate requirement for humans is approximately 50 µg, but because of incomplete absorption and special requirements for lactating women and certain other individuals, a daily intake of 400 µg of free folate is recommended. Folate is stored to some extent in cells as polyglutamates, primarily as the pentaglutamate, and is recycled through the enterohepatic pathway similarly to cobalamin. The resorptive process is far less efficient than with vitamin B₁₂, however, and deficient intake may manifest as megaloblastic anemia within a month.

Pathophysiologic characteristics

Folic acid deficiency has the same hematologic profile as cobalamin deficiency. As previously mentioned, folic acid deficiency causes a megaloblastic anemia essentially without neurologic manifestations. In patients who are folate-deficient, serum folate concentrations are less than 3 ng/mL, and erythrocyte folate is less than 150 ng/mL.

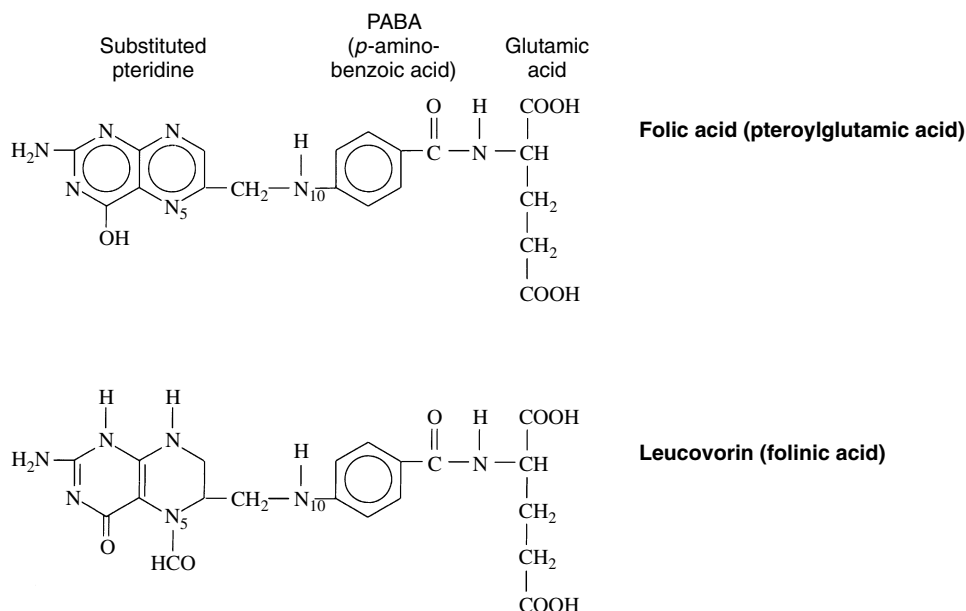

FIGURE 30-5 Structural formulas of folic acid and leucovorin.

Despite the fact that folates are abundant in many foods, deficiency still occurs from many different causes. Various malabsorption syndromes disturb the absorption of folic acid by the intestines. Phenytoin and other antiepileptic drugs, oral contraceptives, and antimalarial drugs may cause folate deficiency by inhibiting folate conjugates in the intestinal wall. The antimetabolites methotrexate and trimethoprim inhibit dihydrofolate reductase and lead to a megaloblastic anemia with prolonged use.

Elderly individuals and individuals of low socioeconomic status may have an inadequate intake of folate simply from poor nutrition. Overcooking of folate-containing foods, if consistently performed, can lead to folate deficiency. Pregnancy greatly increases the maternal requirement for folate, and a marginal diet can become inadequate to meet the growing demands of the fetus. Maternal folate deficiency, especially before conception, has been implicated in fetal neural tube defects such as spina bifida. Chronic debilitating disease, such as cancer and myeloproliferative disorders, may predispose a patient to folic acid deficiency. Alcoholism and other hepatic diseases are definitely correlated with folate deficiency caused by generally poor nutritional status, malabsorption difficulties across the intestinal wall, and depleted liver stores.

Folate therapy

Folate deficiency can often be treated with simple dietary supplements, such as an additional piece of fresh fruit daily. The vitamin is available in oral tablet form, is included in most multivitamin preparations, and is supplied for injection in the form of sodium folate or the calcium salt of folinic acid (citrovorum factor) under the nonproprietary name of leucovorin (see Figure 30-5). Leucovorin has been used to counteract the effects of folic acid antagonists (e.g., the dihydrofolate reductase inhibitors methotrexate and trimethoprim) used in cancer or malaria chemotherapy. A study showed that even simple use of folic acid or folinic acid greatly improved the side effects of methotrexate therapy in patients with rheumatoid arthritis, allowing better tolerance of the chemotherapeutic agent.³⁴ The response to oral folic acid therapy is rapid, and an improvement in the hematologic picture is seen 5 to 10 days after beginning daily administration of folic acid.

Adverse effects directly attributable to folic acid have not been reported.

HEMATOPOIETIC GROWTH FACTORS

Perhaps the most exciting advance in the pharmacologic management of anemia and related disorders has been the introduction of hematopoietic growth factors to the therapeutic armamentarium. Numerous diseases and iatrogenic disorders can cause all or part of a patient's hematopoietic system to produce insufficient cells; the result is usually a pancytopenia with different degrees of individual cell line depression. Examples of causative conditions include the many varieties of leukemia, myeloproliferative disorders, lymphomas, aplastic anemia, and end-stage renal disease; therapies such as cytotoxic chemotherapy, ionizing radiation, stem cell transplants, and bone marrow transplantation also are causes. Other causes include side effects of medications such as the sulfonamides, phenytoin, zidovudine, and carbamazepine. In the past, the only recourse was to transfuse the patient with whole blood or appropriate replacement components of blood. In severe instances, a bone marrow transplant may have been necessary. Although not a panacea, the introduction of several hematopoietic growth factors has greatly reduced the need for transfusion therapy in many patients with various forms of hematopoietic depression. All these products are derived from their respective human genes that have been subcloned into mammalian, bacterial, or yeast expression systems so that large quantities can be obtained.

Erythropoietin/Darbepoetin

Background and physiologic characteristics

EPO was the first growth factor to be identified and successfully cloned into a recombinant vector. The gene is located on chromosome 7q11-22, and the final endogenous protein is a 165-amino acid glycoprotein with a molecular weight of 30,400 Da. Native EPO is formed primarily in the kidneys and, to a smaller degree, in the liver.⁸ It is the major humoral regulator of red blood cell production and does not seem to have any effect on other cell lineages.

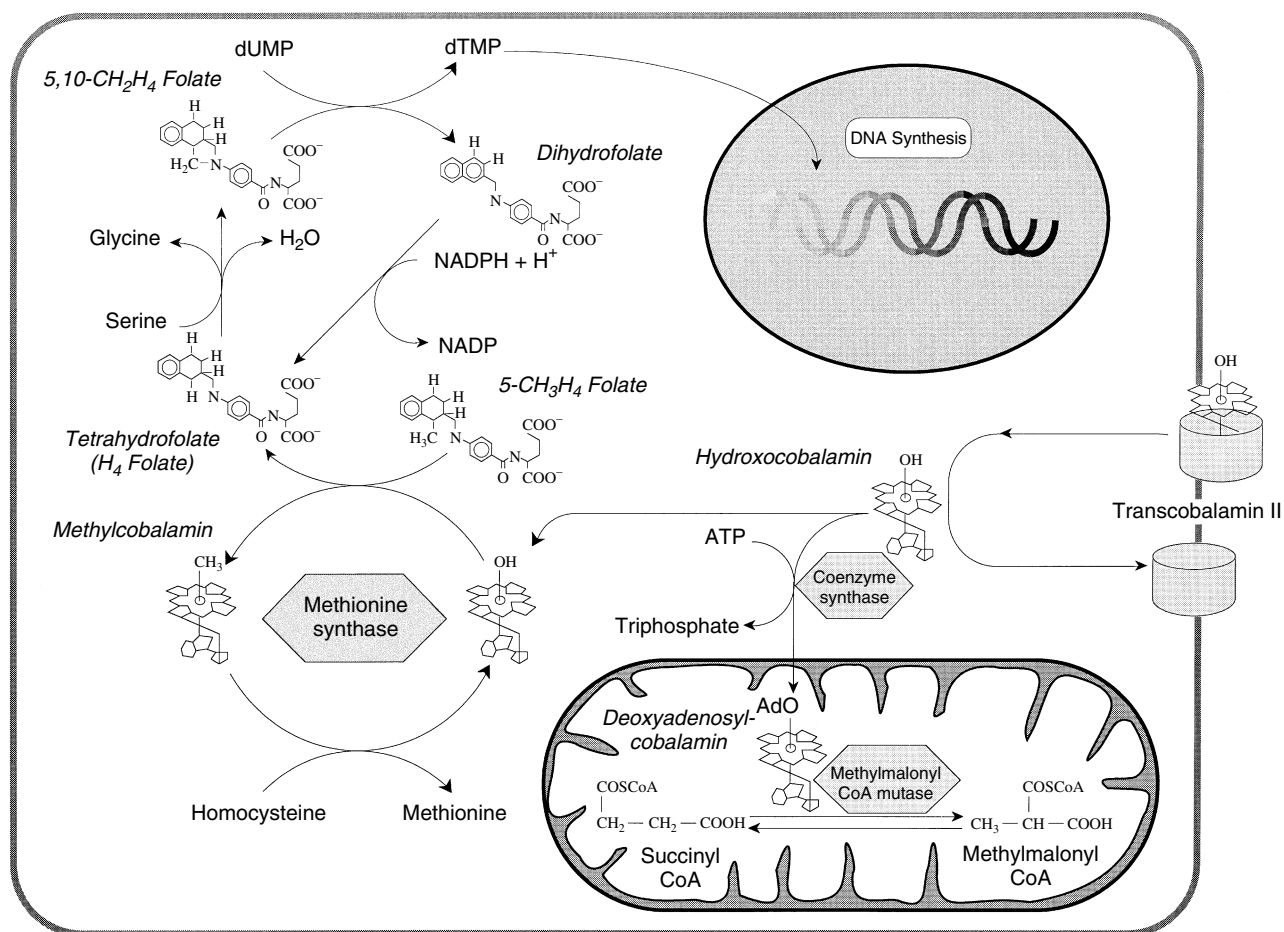

FIGURE 30-6 Major pathways of folate and vitamin B₁₂ metabolism. Dietary folates are converted to 5-methyltetrahydrofolate (5-CH₃H₄ folate). Demethylation by the enzyme methionine synthase yields tetrahydrofolate, an acceptor of single-carbon units in the metabolism of histidine (not shown) and serine. The folate products of these reactions provide carbon units for the synthesis of purines and, as shown for 5,10-methylenetetrahydrofolate (5,10-CH₂H₄ folate), the conversion of deoxyuridylylate (dUMP) to thymidylate (dTMP). Vitamin B₁₂, carried to the cell by transcobalamin II in the form of hydroxocobalamin, is converted to methylcobalamin and deoxyadenosylcobalamin, necessary cofactors for methionine synthase and methylmalonyl CoA mutase. AdO, Deoxyadenosyl moiety; NADP, nicotinamide adenine dinucleotide phosphate; NADPH, reduced nicotinamide adenine dinucleotide phosphate.

EPO expression is regulated in the kidney in response to the local oxygen tension by signaling mechanisms that are not well understood but are suspected to involve a membrane-bound, oxygen-sensitive heme protein.¹¹ The newly formed EPO moves to the bone marrow, where it attaches to EPO receptors on the cell membranes of myeloid stem cells, causing the cells in the presence of other regulatory factors to differentiate into erythroblasts and ultimately into erythrocytes. When committed to the erythrocytic line, these cells become dependent on continued EPO for their survival. If EPO is removed, the cells die within one or two cell cycles. As a result, it has been postulated that EPO may be an apoptosis inhibitor rather than a differentiation stimulator. Bone marrow sensitivity to EPO depends on the availability of iron; various inflammatory mediators suppress EPO secretion and stem cell stimulation.

Pathophysiologic characteristics

In disease states, EPO synthesis may be disrupted (as in end-stage renal disease), the protein may be prematurely cleared (as in the anemia associated with rheumatoid arthritis), or the target stem cells may not be responsive to it (as in some myeloproliferative disorders). In all cases of depressed synthe-

sis or accelerated catabolism, the plasma EPO is low. If the problem is decreased tissue responsiveness, plasma EPO levels may be increased 100 times above normal.

Therapeutic use

Two forms of pharmacologic EPO are currently available. The recombinant form of the endogenous glycoprotein known as *epoetin alfa* has been available for several years and has been well tolerated. It generally requires intravenous or subcutaneous dosing three times a week. A newer form, darbepoetin alfa, has been approved for use and requires dosing only once a week. Darbepoetin contains five N-linked oligosaccharide chains instead of only three such chains in epoetin. Its pharmacologic profile is similar to that of epoetin alfa.

Both forms of EPO are currently approved for use in the anemia of chronic renal failure and cancer chemotherapy. Epoetin alfa has also been extensively studied for use in numerous other conditions that result in anemia or pancytopenia for which there is insufficient production of EPO in relation to the metabolic needs of the patient. One study showed that the use of EPO with supplemental iron significantly improved the health status of patients with congestive

heart failure and anemia. Treated patients experienced relative improvements in serum creatinine and left ventricular ejection fraction, resulting in better renal function and a reduced need for diuretics. The authors concluded that correction of anemia markedly enhanced cardiac function in these patients.³¹

Epoetin alfa has the most consistent effect when plasma EPO is low, but exogenous EPO has also been successful in treating some conditions in which endogenous titers are already high, and the target stem cells seem to be resistant to the effects of the protein. Epoetin alfa is also used in the treatment of chronic anemia associated with acquired immunodeficiency syndrome, but results have been inconsistent. On the positive side, epoetin alfa can often stabilize a patient's hematopoietic profile enough to resume zidovudine therapy. Zidovudine depresses the bone marrow, complicating the anemia to the point at which it may be necessary to discontinue the medication.

Epoetin alfa is sometimes used to prepare patients for autologous blood donation before nonemergency surgery. In these instances, the patient is phlebotomized normally and put on a course of epoetin alfa for a few weeks before surgery. Just before the surgery, patients can be phlebotomized again to maximize the available yield of autologous blood. Epoetin alfa has also been used in patients who require blood products but do not allow transfusions for religious reasons. Epoetin alfa solutions contain human albumin, a blood product. For this reason, these patients may still refuse the therapy unless the diluent can be changed.

Epoetin alfa can be given intravenously and is well absorbed, but the subcutaneous route is preferred because of a greater persistence of each dose in the plasma. (Epoetin alfa has a half-life of 6 to 9 hours after intravenous injection, but 24 to 30 hours after subcutaneous administration.) Less medication needs to be given, resulting in lower cost and fewer adverse effects. Contraindications for its use include uncontrolled hypertension and allergy to albumin or mammalian cell-derived products. Adverse reactions include aggravation of existing hypertension, seizures, headache, and nausea. Failure of epoetin alfa most commonly results from the development of a significant iron deficiency caused by the increased production of hemoglobin. For this reason, close monitoring of the iron stores (TIBC, iron, ferritin) should be performed routinely, with iron supplementation given as necessary. The rate of hematocrit increase should not exceed 4% per week to avoid depleting the iron stores. Clinically significant results are usually seen in 2 to 6 weeks.

Myeloid Growth Factors

Background and physiologic characteristics

Several additional growth factors are currently approved for use by the U.S. Food and Drug Administration. Granulocyte colony-stimulating factor (G-CSF) and granulocyte-macrophage colony-stimulating factor (GM-CSF), are crucial to the early and intermediate development of the myeloid line of hematopoiesis. G-CSF is a lineage-specific growth factor for the neutrophil line, whereas GM-CSF is a stimulator for granulocytes and monocytes (with some erythrocyte and megakaryocyte effect as well; see Figure 30-1). In addition to increasing the numbers of neutrophils, both also activate the neutrophils and monocytes/macrophages in the tissues. Their names are derived from their ability to stimulate colony formation of hematopoietic stem cells when grown in semisolid media.

Recombinant human G-CSF, assigned the nonproprietary name of *filgrastim*, is synthesized in an *Escherichia coli* bacterial expression system. It is a 175-amino acid polypeptide. A pegylated derivative known as *pegfilgrastim* is produced by covalently linking a large polyethylene glycol moiety to the active polypeptide.

G-CSF binds to cell surface receptors present on the granulocytes and stimulates them to proliferate and mature. The more differentiated cells are known to have two to three times more G-CSF receptors on their surface, which seems to correlate with increased functional activity in the presence of the drug. Exactly how the G-CSF upregulates transcription in the nucleus is currently unknown, but part of the therapeutic benefit of this medication is from enhanced neutrophilic activity and increased numbers.

The commercially available form of GM-CSF is a 127-amino acid glycopeptide with a leucine substitution at position 23; *sargramostim* is the nonproprietary name. Similar to G-CSF, GM-CSF stimulates terminal proliferation and differentiation of the granulocyte lineage. In contrast to G-CSF, it also stimulates the monocytic lineage. As with G-CSF, the mechanism by which the intracellular changes occur is unknown. It does seem, however, to require interleukin-3 (IL-3) stimulation to obtain a maximal differentiative response.¹⁶

Four additional growth factors have been cloned, purified, and made available for investigational laboratory and clinical use. They are stem cell factor (SCF), monocyte/macrophage-colony-stimulating factor (M-CSF), thrombopoietin (TPO), and IL-3. These four, coupled with G-CSF and GM-CSF, round out the six "classic" known hematopoietic stimulating agents.

SCF has been assigned the nonproprietary name of *ancestim*. As the name implies, SCF is crucial for the survival and proliferation of the early pluripotent/multipotent and myeloid/lymphoid stem cells. The immature stem cells produce and "autostimulate" themselves with their own SCF production to maintain a sufficient population of pluripotent/multipotent cells to keep the marrow supplied with adequate precursors for the various differentiation pathways. SCF alone does not push the stem cells toward maturation but maintains their immaturity. When coupled with other growth factors, SCF acts synergistically to "bump" the cells into a committed pathway, where most of these early intermediates begin to lose their need for this particular factor. As the cells continue to move toward maturation, SCF is no longer necessary.

M-CSF, as the name implies, promotes the growth and differentiation of monocyte progenitor cells, but only at high concentrations. More important, however, may be its ability to activate monocyte/macrophage cytotoxicity, as shown by its ability to increase the survival of patients with invasive fungal infections.²⁸ It remains to be seen how M-CSF may significantly differ in function from GM-CSF.

TPO has been tested in two forms. The first is a full-length, 332-amino acid recombinant human glycoprotein molecule known as *rhTPO*. The other is a pegylated truncated 163-amino acid form of the protein in which the receptor-binding N-terminal domain is intact. It is known as *pegylated megakaryocyte growth and development factor* (PEG-MGDF). TPO stimulates the megakaryocytic lineage, which results in increased platelet production by 10-fold. The medication so far has been used in cancer chemotherapy patients to hasten platelet recovery after thrombocytopenic nadirs are reached. The full-length and truncated versions seem to work equally well, but PEG-MGDF has caused neutralizing antibodies to develop in some patients.

IL-3 is encoded by a gene located near the gene for GM-CSF. Endogenous supply is essentially from activated T cells, mast cells, and natural killer cells.¹⁰ IL-3 is a multilineage, broader-acting hematopoietic growth factor important in initiating early and intermediate stages of hematopoietic differentiation. It seems to be a crucial early trigger for the shift from pluripotent/multipotent stem cells down any of the myeloid differentiation pathways. IL-3 mediates its effects by the retinoic acid (vitamin A) receptors.¹⁶ When "nudged" this

way, the cells show irreversible commitment and go on to become one of the myeloid stems that later differentiate into the granulocytic, erythroid, monocytic, or megakaryocytic lineages. IL-3 by itself has little differentiative activity, but it does seem to be involved in the crucial first step to bring stem cells out of the pluripotent/multipotent stage. As the cells mature, they become less dependent on its actions.

Interleukin-11 (IL-11), in the recombinant form of oprelvekin, is the first growth factor to gain approval for the management of thrombocytopenia. IL-11 is produced by fibroblasts and stromal cells in bone marrow. It binds to a specific receptor but acts with other growth factors to simulate the growth of myeloid and lymphoid cell lines. The primary therapeutic benefit is a significant decrease in the need for platelet transfusions in patients receiving chemotherapy for nonmyeloid cancers.

Pathophysiologic characteristics

Any of the diseases or therapeutic interventions that adversely affect the hematopoietic system may cause leukopenia, thrombocytopenia, or pancytopenia. Congenital or acquired bone marrow failure states, hematopoietic neoplasms, cancer chemotherapy, and total body ionizing radiation therapy are the most common causes for hematopoietic disruption.

Therapeutic use

Stimulating or accelerating the recovery of the bone marrow (especially the neutrophils) after disease or medical therapy is the primary indication for the myeloid growth factors G-CSF and GM-CSF. Similarly, TPO is being used to hasten the recovery of platelet counts in patients with thrombocytopenia. When so used, the window of immunosuppression and hemorrhagic vulnerability of leukopenic and thrombocytopenic patients has been significantly shortened, greatly improving chances for survival, while decreasing morbidity.

Filgrastim administered intravenously or subcutaneously is generally well tolerated, with the most common side effect being bone pain that clears on discontinuance of the medication. Rare serious reactions include anaphylaxis and splenic rupture. Pegfilgrastim is administered subcutaneously as a single dose after chemotherapy.

Sargramostim is administered intravenously. At normal doses, it does not significantly alter the megakaryocyte (and thrombocyte) or erythrocyte lineages. It does have significantly more severe side effects, however, especially at higher doses. The most common are fever, malaise, arthralgia, myalgia, and increased vascular permeability, which can lead to pleural and pericardial effusions.

SCF generally is given in conjunction with filgrastim and sargramostim. Its use is still limited; side effects associated with its administration include fever, chills, rash, myalgia, injection site irritation, and edema. In high doses, it can produce mast cell activation with associated symptoms.³⁵ IL-3 is usually given subcutaneously in daily doses in conjunction with GM-CSF and has been well tolerated.

Oprelvekin is injected daily for 3 weeks after a course of chemotherapy is completed. The therapeutic goal is to reach a platelet count of 50,000/ μL . Impaired renal excretion of Na^+ may lead to fluid retention, hypokalemia, pulmonary edema, and atrial arrhythmias.

RED BLOOD CELL SUBSTITUTES AND PLASMA EXTENDERS

In recent years, considerable research has been focused on developing products that could substitute for blood on a temporary basis.⁹ As the population ages and increases, and as surgeries become more sophisticated and therapies (e.g., for

cancer) affect marrow function, more blood products are required for these procedures. Some patients have rare blood types that are simply unavailable at their hospital in significant quantities. In major trauma, large amounts of blood (≥ 20 U) might be required emergently, and careful screening, typing, and crossing is time-consuming. In times of war or natural disaster, urgent blood requirements can easily outstrip supplies. Testing blood for disease transmission risk is becoming increasingly complex (and costly) and remains problematic with some viruses; as a result, it is often not done in third-world nations. Finally, adherents of some religious groups do not accept blood product transfusions from another person.

As a result of these issues, several different products have been developed to serve as artificial blood capable of binding oxygen and supporting gaseous exchange in the lungs and peripheral tissues. Although *artificial blood* is technically a misnomer because these compounds do not have any of the cellular, immunologic, hemostatic, or hormonal constituents of whole blood, they do have the potential advantage that they could be manufactured in great quantities without the worry of viral contamination. Many of these compounds can be stored for long periods and can be administered in the field, and they serve as an emergency bridge to keep the patient alive until better solutions can be found. A less ambitious goal is to use artificial colloids to help maintain the normal volume and oncotic pressure of blood after acute hemorrhage. These products can be divided into hemoglobin preparations and plasma extenders.

Hemoglobin

The first approach to oxygen-transport compounds was to prepare solutions of hemoglobin tetramers ($\alpha_2\beta_2$). The rationale was to purify hemoglobin molecules to avoid the antigenic determinants (ABO) found in the erythrocyte membrane, while inactivating any viruses that may be present. It rapidly became clear, however, that after hemoglobin is removed from the erythrocyte, its properties change significantly.²⁹ Free tetrameric hemoglobin has a significantly higher affinity for oxygen (i.e., a leftward shift in the oxyhemoglobin desaturation curve) because of the lack of 2,3-diphosphoglycerate found in the erythrocyte, which allosterically reduces the affinity of hemoglobin for oxygen. In addition, the injected free hemoglobin rapidly dissociates into a dimeric or monomeric form that is cleared from the plasma by the kidneys, often with renal damage if sufficient dimers exist. Finally, the oncotic effect of the free hemoglobin molecules in the plasma greatly limits the amount that can be given safely. As a result, several modified hemoglobin products have been investigated in an attempt to circumvent these problems.²⁹

The first modification was to polymerize the hemoglobin by cross-linking the α or β chains into polyhemoglobin. In this form, the normal hemoglobin tetramers are intramolecularly stabilized, preventing breakdown into dimers, while they are intermolecularly linked to other tetramers to form polymers, usually with three to six tetramers each. These approaches resulted in significantly larger molecules that were much more difficult to clear, giving significantly higher half-lives (30 hours). The hemoglobin was also modified to have a lower oxygen affinity by pyridoxylation of the β -globin chain. These modified hemoglobin solutions were shown to support life after near-complete transfusion in baboons and sheep.³⁰ In human clinical trials, the results were not as promising. Severe side effects, including renal failure and dyspnea, caused some trials to be discontinued. In the acidic ascending loop of Henle, the hemoglobin molecules precipitated, causing renal damage.

Further research indicated that most of the problems with polyhemoglobin preparations were caused by a significant per-

centage of intramolecularly cross-linked single tetramers existing among the polytetramers.⁶ Removal of these single units gave much better results. Two formulations have been developed that essentially eliminate the single tetramers: glutaraldehyde cross-linked human pyridoxylated polyhemoglobin and *o*-raffinose cross-linked human polyhemoglobin. (Concern exists over the possible transmission of bovine spongiform encephalitis, or “mad cow” disease; however, the manufacturer obtains its hemoglobin from a single controlled herd, which is carefully screened for prions.^{6,23}) These later generation polyhemoglobin products are promising in phase III trials. They are well tolerated, provide better plasma oxygenation in the microvasculature than erythrocytes, and are able to be stored for more than a year with good results.⁶

In a completely different approach, recombinant human hemoglobin ($\alpha_2\alpha_2$) tetramers have been synthesized in *E. coli*.¹³ These tetramers effectively prevent breakdown to the dimer form and have a modified 2,3-diphosphoglycerate pocket yielding a more favorable oxygen dissociation curve. In clinical trials this product has shown significant vasoactivity because it scavenges free nitric oxide, a potent vasodilator. Normal ($\alpha_2\beta_2$) hemoglobin releases nitric oxide from its cysteine residues whenever it gives off oxygen, which causes capillary vasodilation and facilitates oxygenation. These recombinant tetramers apparently have nitric oxide-binding sites and end up causing the opposite effect. A second-generation recombinant human hemoglobin is being developed in an attempt to modify the nitric oxide-binding site on the molecule to reduce the hypertensive effect.⁶

Another approach has been to conjugate the individual hemoglobin tetramers to macromolecules such as polyethylene glycol, dextran, or polyoxyethylene derivatives.^{17,29} Some products have been well tolerated in early clinical trials, but it remains to be seen how they will fare when more data are gathered. These formulations have also been tested in patients undergoing radiotherapy for cancer as a means to oxygenate hypoxic tumor tissue and increase its radiosensitivity.

Finally, much research is aimed at encapsulation methods to create an artificial red blood cell.¹⁸ Free hemoglobin has a short half-life of about 24 hours and has to be ultrapure to avoid adverse reactions, problems that could be minimized by encapsulation. One way to encapsulate hemoglobin is with the use of liposomes, but to date many liposomal products have been phagocytized by the reticuloendothelial system. Polyactide membrane nanocapsules (about 150 nm in diameter) may be a potential solution to this problem. Polyactide is broken down into carbon and water, circumventing the need for lipid structures. Consideration is being given to include superoxide dismutase, catalase, carbonic anhydrase, and other enzymes with the nanocapsules to prevent the accumulation of methemoglobin.¹⁸

Synthetic Plasma Extenders

In applications in which support of oxygenation is not as crucial but blood volume needs supplementation to avoid hypotension, artificial colloids have been developed to serve as plasma extenders. These preparations help maintain the normal oncotic pressure of blood and can reduce, but not eliminate, the need for blood transfusion. There is no true substitute for lost whole blood except whole blood, but within fairly wide limits of total hemoglobin various colloidal solutions can be substituted to sustain an acceptable blood pressure. Whole plasma is the most effective replacement; however, individual units of plasma pose a risk of viral infection equal to that of individual units of whole blood. Suitable alternatives are 5% plasma protein solution (pooled plasma heated to 60° C for 10 hours to minimize the risk of cross-infection) and 5% human albumin. The former preparation may cause hypotension, and both are expensive and

unacceptable to certain religious groups because of their human origins.

Theoretically, the development of a synthetic substitute to fulfill the oncotic functions of plasma proteins would be an ideal approach. To be of more value than isotonic saline solution as an oncotic substitute, a substance must be relatively inert, nontoxic, and nonallergenic and have a molecular size and weight greater than those that can be easily filtered across the glomerulus. Of the many materials that have been tested, the most suitable have proved to be polysaccharide derivatives—dextran and hetastarch.²⁷

Dextran

A branched polysaccharide, dextran is produced by certain bacteria and consists of 200,000 glucose molecules interconnected by glucosidic linkages to produce a molecular weight of approximately 4×10^7 Da. Controlled hydrolysis of this material can yield a wide range of molecules that are then fractionated according to size. Available dextrans for injection include two forms: high-molecular-weight dextran, a 6% solution of dextran with a mean molecular weight of approximately 70,000 or 75,000 Da depending on manufacturer, and low-molecular-weight dextran, having a weight of approximately 40,000 Da. The main advantage of the smaller material, which can escape more readily across the glomerular membranes, is the fact that it seems to improve microcirculation by reducing the rouleaux formation and red blood cell sludging that usually accompanies hemorrhagic and other forms of shock.

Dextran can interfere with blood typing, which must precede dextran injection, and it impairs platelet function, resulting in an iatrogenic form of von Willebrand's disease. Fibrin formation is also impaired. The major disadvantage of dextrans is their antigenic potential. Enteric bacteria produce dextran, and a small percentage of the population has antibodies for dextran in the blood. When dextran is used as a plasma extender, a massive dose is usually given that overwhelms the immune response (immunologic paralysis), and anaphylactic risk is as low as or lower than the risk of blood transfusion. This risk can be reduced further by prophylactic administration of dextran 1, a monovalent hapten that binds to immunoglobulins without triggering an allergic response.

Hetastarch

Hetastarch is a hydroxyethylated derivative of amylopectin, with a mean molecular weight of 450,000 Da and a range of 10,000 to 1 million Da. The lower weight molecules (<50,000 Da) are excreted by glomerular filtration (33% within 24 hours); remaining molecules are metabolized slowly over 2 to 3 weeks to smaller products by plasma α -amylase activity.¹⁵ The volume expansion produced by this agent lasts approximately 24 to 36 hours. Hematologically, there seems to be no obvious advantage of hetastarch over dextran; however, hetastarch is said to have a low incidence of anaphylaxis and may have less of an effect on blood clotting. Besides being effective as a volume expander, hetastarch has been found to be useful in leukapheresis (harvesting of granulocytes for patient use) and as a priming fluid for extracorporeal pumps used in coronary surgery.

IMPLICATIONS FOR DENTISTRY

The dentist is often in a unique position as the first health professional to observe manifestations of anemia in a patient. Because the oral signs frequently precede a decrease in hemoglobin below the normal range, the dentist may be able to diagnose the disease before it has caused symptoms warranting medical attention. Because anemia is a sign of an underlying

ing hematopoietic disorder, the blood cells are frequently the earliest biologic indicators of diseases such as cancer, malnutrition, or conditions of drug toxicity. The response may take the form of granulocytopenia, hemolytic or aplastic anemia, or thrombocytopenia with associated immunosuppression and defective hemostasis leading to spontaneous hemorrhage, internal bleeding, and purpura.

Patients with these difficulties may have oral mucositis, intraoral or circumoral viral outbreaks, fungal infections, and serious bacterial infections of odontogenic origin. The dentist should recognize these signs, understand the gravity of the situation, and attempt to ensure that the patient receives proper medical evaluation. Anemic conditions can run the gamut from easily corrected nutritional deficiency states to life-threatening disorders, and the sooner the patient is diagnosed, the better the chances are for correcting the underlying problem.

Patients who are undergoing therapy for these same diseases and taking many of the medications described in this chapter are increasingly encountered in dental practice. The dentist who knows how these medications function and why they are being given is better able to identify the presence or history of a particular disease and to make appropriate decisions about how to manage the patient's overall care.

As a final concern, dental professionals should know about the relationship between chronic nitrous oxide inhalation and pernicious anemia. Megaloblastic responses to nitrous oxide were first recognized in 1956 when the gas was used for sedation of patients with tetanus.²⁰ More recently, individuals habituated to inhaling nitrous oxide have been found to develop neuropathies similar to those seen with vitamin B₁₂ deficiency.⁷ It is now recognized that nitrous oxide readily interacts with the cobalt atom in cobalamin, which is oxidized and rendered inactive as a cofactor for methionine synthase. The potential implications for health care workers chronically exposed to nitrous oxide and for patients receiving nitrous oxide therapeutically are discussed in Chapters 17 and 18.

ANTI-ANEMIC DRUGS

<i>Nonproprietary (generic) name</i>	<i>Proprietary (trade) name</i>
Iron preparations	
Ferrous fumarate	Femiron, Feostat, Ferretts, Ferro-Sequels, Hemocyte, Iron, Nephro-Fer
Ferrous gluconate	Fergon
Ferrous sulfate	Feosol, Fer-Gen-Sol, Fer-In-Sol, Fer-Iron, Feratab, Slow FE
Iron dextran	DexFerrum, INFED
Iron sucrose	Venofer
Iron polysaccharide	Ferrex 150, Niferex, Nu-Iron 150, Poly-Iron 150, ProFe
Iron-chelating agent	
Deferoxamine	Desferal
Hematopoietic factors	
Darbepoetin alfa	Aranesp
Epoetin alfa	Epogen, Procrit
Filgrastim (G-CSF)	Neupogen
Oprelvekin	Neumega

<i>Nonproprietary (generic) name</i>	<i>Proprietary (trade) name</i>
Pegfilgrastim	Neulasta
Plerixafor	Mozobil
Sargramostim (GM-CSF)	Leukine
Vitamin B₁₂ preparations	
Cyanocobalamin	CaloMist, Nascobal, Twelve Resin-K
Hydroxocobalamin	Cyanokit
Folic acid preparations	
Folate sodium	Folvite
Folic acid	—
Leucovorin (folinic acid)	—
Heme derivative	
Hemin	Panhematin
Plasma volume extenders	
Dextran	Gentran, LMD
Hetastarch	Hespan, Hextend, Voluven
Human albumin	Albumarc, Albuminar, AlubuRx, Albutein, Buminat, Flexbumin, Plasbumin
Plasbumin	
Plasma protein fraction	Plasmanate

G-CSF, Granulocyte colony-stimulating factor; GM-CSF, granulocyte-macrophage colony-stimulating factor.

CITED REFERENCES

- Atweh G, Loukopoulos D: Pharmacologic induction of fetal hemoglobin in sickle cell disease and β -thalassemia. *Semin Hematol* 38:367-373, 2001.
- Babior BM: The megaloblastic anemias. In Beutler E, Lichtman MA, Coller BS, et al, editors: *Williams hematology*, ed 6, New York, 2001, McGraw-Hill.
- Blaud P: Sur les maladies chlorotiques, et sur un mode de traitement spécifiques dans ces affections. *Rev Med Française Etrangère* 45:341-367, 1832.
- Castle WB: Observations on the etiologic relationship of achylia gastrica to pernicious anemia, I: effect of administration to patients with pernicious anemia of contents of normal human stomach recovered after ingestion of beef muscle. *Am J Med Sci* 178:748-764, 1929.
- Centers for Disease Control and Prevention: Iron deficiency—United States, 1999-2000. *MMWR Morb Mortal Wkly Rep* 51:897-899, 2002.
- Chang T: Red blood cell substitutes. *Baillieres Clin Haematol* 13:651-667, 2000.
- Deacon R, Lumb MJ, Perry J: Vitamin B₁₂, folate and nitrous oxide. *Med Lab Sci* 39:171-178, 1982.
- Dessypris EN, Krantz SB: Erythropoietin: regulation of erythropoiesis and clinical use. *Adv Pharmacol* 21:127-147, 1990.
- Dietz NM, Joyner MJ, Warner MA: Blood substitutes: fluids, drugs, or miracle solutions? *Anesth Analg* 82:390-405, 1996.
- Ganser A: Clinical results with recombinant human interleukin-3. *Cancer Invest* 11:212-218, 1993.
- Goldberg MA, Dunning SP, Bunn HF: Regulation of the erythropoietic gene: evidence that the oxygen sensor is a heme protein. *Science* 242:1412-1415, 1988.
- Herbert V, Drivas G, Foscaldi R, et al: Multivitamin/mineral food supplements containing vitamin B₁₂ may also contain analogues of vitamin B₁₂. *N Engl J Med* 307:255-256, 1982.

13. Hoffman SJ, Looker DL, Roehrich JM, et al: Expression of fully functional tetrameric human hemoglobin in *Escherichia coli*. *Proc Natl Acad Sci U S A* 87:8521-8525, 1990.
14. Hoppe C, Walters M: Bone marrow transplantation in sickle cell anemia. *Curr Opin Oncol* 13:85-90, 2001.
15. Hulse JD, Yacobi A: Hetastarch: an overview of the colloid and its metabolism. *Drug Intell Clin Pharm* 17:334-341, 1983.
16. Johnson B, Mueller L, Si J, et al: The cytokines IL-3 and GM-CSF regulate the transcriptional activity of retinoic acid receptors in different in vitro models of myeloid differentiation. *Blood* 99:746-753, 2002.
17. Kahn RA, Allen RW, Baldassare J: Alternate sources and substitutes for therapeutic blood components. *Blood* 66:1-12, 1985.
18. Kawaguchi AT, Fukumoto D, Haida M, et al: Liposome-encapsulated hemoglobin reduces the size of cerebral infarction in the rat: evaluation with photochemically induced thrombosis of the middle cerebral artery. *Stroke* 38:1626-1632, 2007.
19. Klee G: Cobalamin and folate evaluation: measurement of methylmalonic acid and homocysteine vs vitamin B₁₂ and folate. *Clin Chem* 46:1277-1283, 2000.
20. Lassen HCA, Henriksen E, Neukirch F, et al: Treatment of tetanus: severe bone-marrow depression after prolonged nitrous-oxide anaesthesia. *Lancet* 1:527-530, 1956.
21. Ley TJ, Nienhuis AW: Induction of hemoglobin F synthesis in patients with thalassemia. *Annu Rev Med* 36:485-498, 1985.
22. Linker CA: Blood. In McPhee SJ, Papadakis MA, editors: *Current medical diagnosis and treatment*, ed 48, New York, 2009, McGraw-Hill.
23. Lowe KC: Perfluorinated blood substitutes and artificial oxygen carriers. *Blood Rev* 13:171-184, 1999.
24. McGilvey RW, Goldstein GW: *Biochemistry, a functional approach*, ed 3, Philadelphia, 1983, Saunders.
25. Minot GR, Murphy WP: Treatment of pernicious anemia by a special diet. *JAMA* 87:470-476, 1926.
26. Mori Y, Iwasaki H, Kohno K, et al: Identification of the human eosinophil lineage-committed progenitor: revision of phenotypic definition of the human common myeloid progenitor. *J Exp Med* 206:183-193, 2008.
27. Mudge GH, Weiner IM: Agents affecting volume and composition of body fluids. In Hardman JG, Limbird LE, Gilman AG, editors: *Goodman & Gilman's the pharmacological basis of therapeutics*, ed 10, New York, 2001, McGraw-Hill.
28. Nemunaitis J, Shannon-Dorcy K, Appelbaum FR, et al: Long-term follow-up of patients with invasive fungal disease who received adjunctive therapy with recombinant human macrophage colony-stimulating factor. *Blood* 82:1422-1427, 1993.
29. Ogden JE, Parry ES: The development of hemoglobin solutions as red cell substitutes. *Int Anesthesiol Clin* 33:115-129, 1995.
30. Rabinovici R, Neville LF, Rudolph AS, et al: Hemoglobin-based oxygen-carrying resuscitation fluids. *Crit Care Med* 23:801-804, 1995.
31. Silverberg DS, Wexler D, Sheps D, et al: The effect of correction of mild anemia in severe, resistant congestive heart failure using subcutaneous erythropoietin and intravenous iron: a randomized controlled study. *J Am Coll Cardiol* 37:1775-1780, 2001.
32. Thunell S, Pomp E, Brun A: Guide to drug porphyrinogenicity prediction and drug prescription in the acute porphyrias. *Br J Clin Pharm* 64:668-679, 2007.
33. Till JE, McCulloch EA: Hemopoietic stem cell differentiation. *Biochim Biophys Acta* 605:431-459, 1980.
34. van Ede AE, Laan RF, Rood MJ, et al: Effect of folic or folinic acid supplementation on the toxicity and efficacy of methotrexate in rheumatoid arthritis: a forty-eight week, multicenter, randomized, double-blind, placebo-controlled study. *Arthritis Rheum* 44:1515-1524, 2001.
35. Vose JM, Armitage JO: Clinical applications of hematopoietic growth factors. *J Clin Oncol* 13:1023-1035, 1995.
36. Wills L, Clutterbuck PW, Evans BDF: A new factor in the production and cure of macrocytic anaemias and its relation to other haemopoietic principles curative in pernicious anaemia. *Biochem J* 31:2136-2147, 1937.

GENERAL REFERENCES

- Handin RI, Lux SE, Stossel TP, editors: *Blood: principles and practice of hematology*, ed 2, Philadelphia, 2002, Lippincott Williams Wilkins.
- Hillman RS, Ault KA, Rinder H: *Hematology in clinical practice*, ed 4, New York, 2005, McGraw-Hill.
- Lichtman MA, Beutler E, Kipps TJ, et al, editors: *Williams hematology*, ed 7, New York, 2005, McGraw-Hill.
- McPhee SJ, Papadakis MA, editors: *Current medical diagnosis and treatment*, ed 48, New York, 2009, McGraw-Hill.

Procoagulant, Anticoagulant, and Thrombolytic Drugs

BARTON S. JOHNSON

The practice of dentistry frequently involves procedures that cause bleeding, and the dentist is often confronted with the need to achieve and maintain hemostasis. The dental practitioner must be familiar with the physiologic processes of hemostasis and the myriad conditions that cause abnormalities of these processes. Complicating matters, modern medicine has developed several therapies for systemic disease that use medications that purposefully alter normal hemostasis. When appropriate, the dentist needs to eliminate or make alterations in the dosage of these compounds before surgery. Only with a clear understanding of the complex process of hemostasis and the various drugs that affect it can the clinician manage patients with inherited or acquired bleeding disabilities safely.

HEMOSTASIS

Large or intermediate arteries and veins are generally not severed intentionally without prior ligation, but it is common during the extraction of teeth and other oral surgical procedures to sever small arteriolar, venous, and capillary vessels. Extensive blood loss may occur if hemostasis is delayed. The formation of a patent clot requires four distinct yet interdependent steps: (1) vessel constriction; (2) platelet adhesion, activation, and aggregation; (3) cross-linking of fibrin by the coagulation cascade; and (4) limitation of the blood clot to the area of damage only. Later, a fifth step becomes necessary: the controlled breakdown of the clot so that repair and remodeling can occur.

Vascular Constriction

In laboratory animals, transection of small arteries and arterioles has revealed several patterns of hemorrhagic flow. In general, after a sudden surge of blood, there is a moderate-severe reduction in flow, apparently caused by contraction of vascular smooth muscle initiated directly by the trauma. This initial hemostasis is independent of blood coagulation and platelet agglutination because it occurs in heparinized animals. It is maintained only for a short period (5 to 20 minutes). The vessel wall is lined with endothelial cells that constitutively secrete nitric oxide and prostacyclin, both of which are potent smooth muscle relaxing agents. Nitric oxide and prostacyclin diffuse to the vascular smooth muscle surrounding the endothelial cells, effect relaxation, and maintain luminal patency. On injury, this secretion is disrupted, and the now unopposed muscle layer reflexively and rapidly constricts, greatly narrowing the lumen. The effect is short-lived; after a few minutes the constriction wanes, and the muscle layers begin to relax again. This brief period of constriction provides a healthy

individual sufficient time, for the platelets and coagulation cascade to seal the injured site.

Platelet Adhesion, Activation, and Aggregation *Adhesion*

The next major event is the adhesion of platelets at the severed edges of the vessel. In normal untraumatized blood vessels, platelets show little tendency to adhere to the endothelium, partly because prostacyclin, again elaborated by the endothelial cells, induces cyclic adenosine 3',5'-monophosphate (cAMP) synthesis in platelets and inhibits platelet adhesion. Endothelium-derived relaxing factor—now believed by most investigators to be largely or entirely nitric oxide—also normally secreted by the endothelial cells, is another natural inhibitor of platelet adhesion. Injury to the intima, even if the vessel wall remains intact, leads, however, to exposure of subendothelial extracellular matrix proteins such as collagen, fibronectin, von Willebrand factor (vWF), thrombospondin, and laminin.

The presence of these proteins, particularly vWF, stimulates a “catch and grab” response in the platelets, causing them to leave the laminar flow of the blood and adhere to the injured area. Platelets have a high density of surface receptors that respond to these proteins, and they undergo an extremely rapid localization to the site of injury, beginning the formation of a thrombus. Two main receptors are involved in adhesion: the glycoprotein (GP) Ia/IIa heterodimer, which binds to collagen directly but weakly, and the GP Ib/IX/V heterotrimer, which binds with high shear strength to connective tissue vWF associated with the collagen surface (Figure 31-1).¹ The GP Ib/IX/V–vWF linkage is more of a “tethering” of the platelet to the substrate; later, the adhesion is firmed up by GP IIb/IIIa activation. If vessels without a muscular sheath are severed, the immediate hemostatic action of platelet aggregation is especially important. The true significance of platelets in hemostasis is most evident in the management of patients with thrombocytopenia.

Activation

Activation of platelets is a crucial step in forming a proper thrombus. Activation can occur from various agonists, some of which are strong and some of which are weak. Examples include thrombin, adenosine diphosphate (ADP), thromboxane A₂ (TXA₂), 5-hydroxytryptamine (serotonin), epinephrine, vasopressin, fibrinogen, immune complexes, plasmin, and platelet-activating factor. Most plasma-derived agonists exert their effect by numerous G protein-linked membrane receptors. The strongest agonist for platelet activation is binding of vWF to the GP Ib/IX/V heterotrimeric receptors.¹⁴ When one of these receptors is bound by its specific agonist,

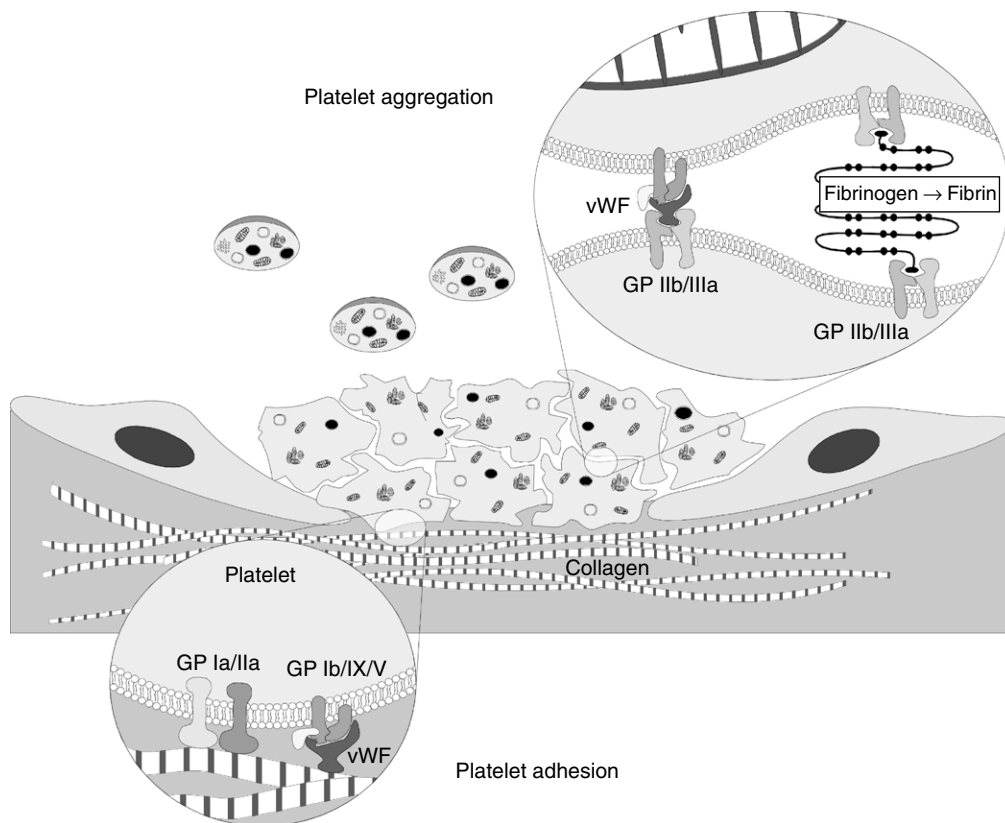

FIGURE 31-1 Platelet adhesion and aggregation. Exposed collagen at the site of injury stimulates initial weak platelet adhesion by the glycoprotein (GP) Ia/IIa receptors. Stronger adhesion follows by the GP Ib/IX/V/vWF complex. Platelet activation is triggered, which leads to initial aggregation by the GP IIb/IIIa receptors binding the GP Ib/IX/V complex. This low-shear bond is later supplanted by a pair of GP IIb/IIIa receptors interacting with fibrinogen to create high-strength mature fibrin “ropes” interconnecting the two, then cross-linking to others. *vWF*, von Willebrand factor.

an intraplatelet protein cascade begins that ultimately causes activation of Ca^{++} transporters and movement of Ca^{++} from stores in the platelet's dense tubular system to the general intracellular matrix.²⁶ The intracellular increase in Ca^{++} causes several other changes.

Platelets in the resting state have internal cytoskeletal actin that provides them with a smooth shape; as Ca^{++} increases, the actin is initially fragmented into smaller subunits, transforming the normal discoid shape of the platelet to a spherical conformation. These smaller actin subunits are rapidly reassembled into very-long-chain actin monomers, which cause the platelet to sprout filopods. The filopods are important in ultimate clot retraction. Meanwhile, as the filopods are developing, the increasing intracellular Ca^{++} concentrations act on cytoplasmic vesicles known as α and dense (or δ) granules (Figure 31-2), prompting them to rise to the cell surface and degranulate. The dense granules release ADP, adenosine triphosphate (ATP), the vasoconstrictor 5-hydroxytryptamine, Ca^{++} , and inorganic pyrophosphate.¹⁸ The α granules contain numerous proteins involved in coagulation, adhesion, cellular mitogenicity, protease inhibition, and other functions (Box 31-1). Major proteins released include fibrinogen, coagulation factors, vWF, fibronectin, high-molecular-weight kininogen, plasminogen, plasminogen activator inhibitor-1 (PAI-1), platelet-derived growth factor, additional GP IIb/IIIa, and thrombospondin.¹⁸

Release of the dense granule ADP into the extracellular milieu has an autocatalytic effect on the platelet from which it came and also stimulates nearby platelets. The ADP binds to its own purinergic receptors, most notably P2Y_1 and P2Y_{12} .

BOX 31-1

Contents of Platelet α Granules

α_2 -Antiplasmin	Multimerin
α_2 -Macroglobulin	P-selectin
Albumin	Plasminogen activator inhibitor 1
β -Thromboglobulin	Platelet factor
CD63	Platelet-derived growth factor
C1-inhibitor	Protein S
Endothelial cell growth factor	Thrombospondin
Epidermal growth factor	Tissue factor pathway inhibitor
Factors V, XI, XIII	Transforming growth factor- β
Fibrinogen	Vascular endothelial growth factor
Fibronectin	Vitronectin
GMP 33	von Willebrand factor
High-molecular-weight kininogen	
IgA, IgG, IgM	
Interleukin-1B	

Activation of both of these receptors is required for maximal aggregation of the platelets to one another. P2Y_1 stimulation acts to mobilize Ca^{++} further (an autocatalytic effect), which leads to further shape change and transient aggregation. P2Y_{12} activation causes inhibition of adenylyl cyclase (blocking conversion of ATP to cAMP), potentiation of secretion by the α

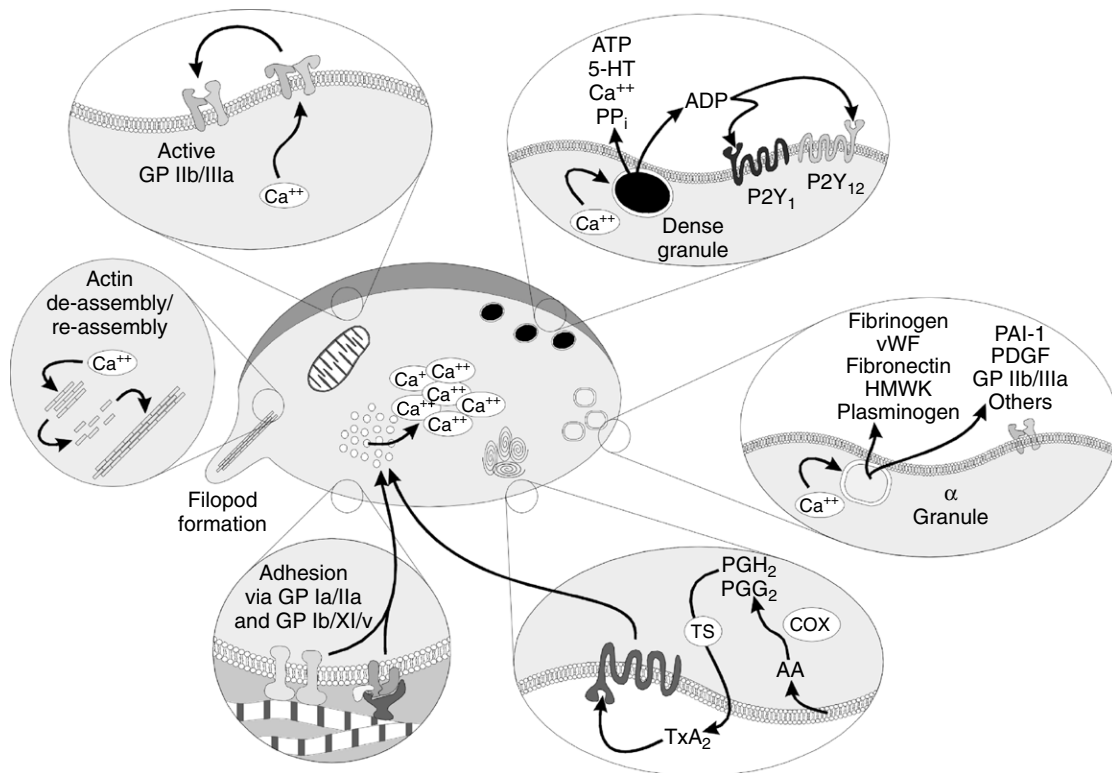

FIGURE 31-2 Platelet activation. *Lower left, moving clockwise,* Contact with the compromised vessel wall by platelet membrane GPs Ia/IIa and Ib/XI/V, stabilized by von Willebrand factor (*vWF*), causes the platelets to become activated and begin moving Ca^{++} out of their tubular stores. The increased intracellular Ca^{++} causes actin to break down and reassemble in long chains, resulting in filopod formation. The increase in Ca^{++} causes conversion of the GP IIb/IIIa from its inactive form to the active form. The dense granules move to the surface and release many activating substances, one of which is adenosine diphosphate (*ADP*). *ADP* stimulates purinergic receptors P2Y_1 and P2Y_{12} , both of which accelerate the activation process. The increase in Ca^{++} also causes a degranulation, resulting in the release of many substances important for further aggregation. Finally, platelet membrane phospholipids yield arachidonic acid (*AA*), which is converted by cyclooxygenase (*COX*) to prostaglandins G_2 (PGG_2) and H_2 (PGH_2). Thromboxane synthase (*TS*) converts these to thromboxane A_2 (TXA_2), which, acting on a G protein-linked receptor, is a potent catalyst of platelet aggregation by accelerating further release of stored platelet Ca^{++} . *5-HT*, 5-Hydroxytryptamine; *HMWK*, high-molecular-weight kininogen; *PAI-1*, plasminogen activator inhibitor-1; *PDGF*, platelet-derived growth factor; *PPi*, pyrophosphate.

and dense granules, and sustained aggregation. *ADP* also binds the transmembrane protein P2X_1 , an ion channel receptor linked to influx of extracellular Ca^{++} into the platelet.

Aggregation

As the activated platelets interact with one another, they begin to aggregate. Aggregation is initiated by the Ca^{++} -mediated conformational activation of GP IIb/IIIa, a heterodimeric transmembrane protein. GP IIb/IIIa is a protein receptor complex unique to platelets and is expressed at extraordinarily high density on the surface of the platelets—some 80,000 to 100,000 per platelet—at an average distance of only 20 nm from one another. Another 20,000 to 40,000 units are stored in the α granules and are released onto the surface or within the local plasma milieu during degranulation. In the circulating, platelet, the resting GP IIb/IIIa receptor has little affinity for its ligands (primarily fibrinogen), so intravascular thrombus formation is minimized. On activation the GP undergoes a conformational change, however, which imparts high affinity for its ligands. Several proteins have the specific amino acid sequence necessary for binding to the GP IIb/IIIa receptor, including fibrinogen, fibronectin, vitronectin, and *vWF*.

As the α and dense granule contents are released extracellularly, nearby platelets become activated. The ligand proteins bind to the surface-associated GP IIb/IIIa of these adjacent platelets, forming bridges. At low shear rates, fibronectin and fibrinogen (stabilized by thrombospondin, another GP from the α granules) serve as the main adhesive proteins, whereas *vWF* is necessary for proper adhesion in areas of high shear. Microvascular video imaging studies show that thrombus formation initially is inefficient. Platelets bind quickly, but a significant percentage of them break free and float away. As a result, thrombus formation is much slower than would be the case if all the platelets that physically aggregate remained bound.¹

Several other events occur simultaneously with activation and aggregation, but the two most important are generation of TXA_2 and platelet-assisted generation of thrombin. Both of these agents accelerate the platelet-activation response. TXA_2 is generated when platelet phospholipases are activated during platelet aggregation, which release arachidonic acid from glycerophospholipids of the platelet membrane. Arachidonic acid is a substrate for cyclooxygenase (*COX*), yielding the prostaglandin endoperoxides PGH_2 and PGG_2 . These

prostaglandins are modified by thromboxane synthase to produce TXA₂, which acts at its own protein-linked receptor.

Perhaps the most remarkable effect of platelet activation is the procoagulant activity the platelets impart. In the normally resting platelet, the plasma membrane has negatively charged phospholipids, including phosphatidylserine, sequestered almost exclusively on the inner surface by processes that are not fully understood. When activating ligands bind to the platelet, the resultant increase in intracellular Ca⁺⁺ causes a membrane enzyme termed *scramblase* to evert the phosphatidylserine to the outer surface, while simultaneously prompting the membrane to form small evaginated microvesicles. Factors Va and VIIIa (discussed subsequently) bind to the phosphatidylserine moieties and recruit factors Xa and IXa. The interaction of these complexes in toto accelerates the conversion of prothrombin to thrombin by a factor of 2.4 × 10⁶. In addition, the binding of activated coagulation factors to the platelets seems to protect the factors from plasma inhibitors, while directing the bulk of the coagulation cascade to the site of injury. The α granules contain factors V and IX; factor V is apparently complexed with multimerin, a carrier protein (see Box 31-1).

As the thrombin is generated, it activates other platelets by stimulating G protein-linked receptors. The thrombin receptors seem to be unique “suicide” receptors, requiring proteolytic cleavage to transmit an activating signal. Thrombin is a serine protease, and it acts on the receptors by cleaving the protein at a serine residue near the amino terminus. The new amino terminus acts as a “tethered ligand” to double back and stimulate the transmembrane protein to activate—hence this receptor has been named a *protease-activated receptor (PAR)*. There are four such thrombin receptors, PAR-1 through PAR-4; only PAR-1 and PAR-4 are expressed by human platelets.²³ Thrombin-induced activation seems to upregulate GP IIb/IIIa activation while downregulating GP Ib/IX/V activity. The platelets apparently are converted from a mainly adhesive role to an aggregate role when thrombin is present.

Two other important activities of platelets warrant mention. First, the α granules contain P-selectin, a membrane protein that helps recruit and tether neutrophils and monocytes into the local area. This activity is believed to be crucial for generating a local inflammatory response at the site of injury, while promoting yet limiting thrombosis.³⁵ Second, platelets are also essential in clot retraction, an event that facilitates wound healing by bringing the severed ends of small blood vessels into closer apposition. Clot retraction, or syneresis, occurs when the filopodia expressed by platelets during activation attach to fibrin strands and contract. A number of actin-binding proteins are present in platelets.⁴ On activation, phosphorylated myosin monomers polymerize into filaments next to the long-chain actin filaments, which slide past one another to generate a contractile force in the presence of ATP.

Coagulation Cascade

Although it is possible to separate the numerous events of hemostasis (e.g., platelet aggregation, formation of fibrin, retraction of the blood clot), the whole process occurs synergistically. Many of the factors involved are enzymatic cofactors, and most of the reaction occurs on cell and platelet membranes (Figure 31-3). Many refinements in the understanding of blood coagulation have come about through study of “experiments of nature,” in which discrete defects of the clotting process have been identified in patients with bleeding diatheses, as illustrated by the factors and deficiency states listed in Table 31-1.

Initiation of coagulation after injury is a complex process involving an initial pathway of thrombin generation, which

autocatalyzes a subsequent burst of additional thrombin generation sufficient to convert fibrinogen to fibrin (see Figure 31-3). Before the process is described, a brief review of the crucial factors and cofactors and how they function is warranted.

Vitamin K–dependent clotting factors

Synthesized in the liver, the vitamin K–dependent clotting factors comprise factors II (prothrombin), VII, IX, and X, and protein C. These five proteins are serine proteases and have similar structural elements (including a serine residue at their catalytic site). Molecular genetic evidence suggests they all are derived from a common ancestral precursor gene. They all have a preprotein leader that is cleaved away post-translationally, leaving an amino-terminal γ-carboxyglutamic acid (Gla) domain with 9 to 12 Gla residues. This sequence is followed by a hydrophobic domain and finally the serine protease domain, in which the carboxy-terminal region becomes activated by cleavage of key arginine residues.

The amino terminus Gla domain is crucial for the lipid binding of these proteases to their substrate membranes. In the presence of seven Ca⁺⁺ ions intercalated within the three-dimensional structure of the Gla domain, the protein undergoes a conformational change that places its hydrophilic domain at one end of the three-dimensional protein structure, with the hydrophobic moieties facing outward. This arrangement is crucial because it allows the protein to settle into the lipid membrane and exert its effects locally rather than systemically in the vasculature. Before these events can occur, however, the Gla residues must be formed post-translationally by carboxylation of their precursor glutamate residues by a specific γ-glutamyl carboxylase that requires the uncleaved preprotein leader sequence of amino acids to bind to the protein. This carboxylase enzyme requires oxygen, carbon dioxide, and vitamin K to function (see Figure 31-8). For every glutamate residue carboxylated, one molecule of reduced vitamin K is converted to its epoxide form. A separate enzyme, vitamin K epoxide reductase, converts the vitamin K back to the reduced form. This reductase is the target of the warfarin-like anticoagulants and is discussed in greater detail later.

Each of the clotting factors mentioned is a protease with activity directed at substrate arginyl residues. Activated factors VII, IX, and X have specific cofactors associated with them—tissue factor (TF) with VIIa (*a* for activated), VIIIa with IXa, and Va with Xa. The cofactors bind the protease and its substrate in approximation to each other and modify the enzyme factor allosterically to have greater activity in the presence of substrate.

Enzymatic cofactors

TF is a unique protein normally constitutively expressed on the cell surfaces of many extravascular cell types. In contrast to the other coagulation cofactors, it is a transmembrane protein homologous to the receptors for interleukin-10 and interferons α, β, and γ. It seems to have procoagulant and signal transduction functions. It can be induced to become expressed on the cell surfaces of intravascular monocytes and endothelial cells in response to some bacterial products and inflammatory cytokines, perhaps as part of the body's immunologic defense system. P-selectin, secreted by platelet α granules, can also induce TF expression in monocytes adhering to activated platelets.

When injury occurs and the vasculature gains exposure to cells with TF on their surface, circulating factor VII rapidly binds to TF and undergoes proteolytic cleavage to factor VIIa by mechanisms that are not well understood. The TF/VIIa complex serves two crucial functions: it cleaves factor X to Xa and factor IX to IXa, both of which have distinct and separate activities. Newly formed factor Xa

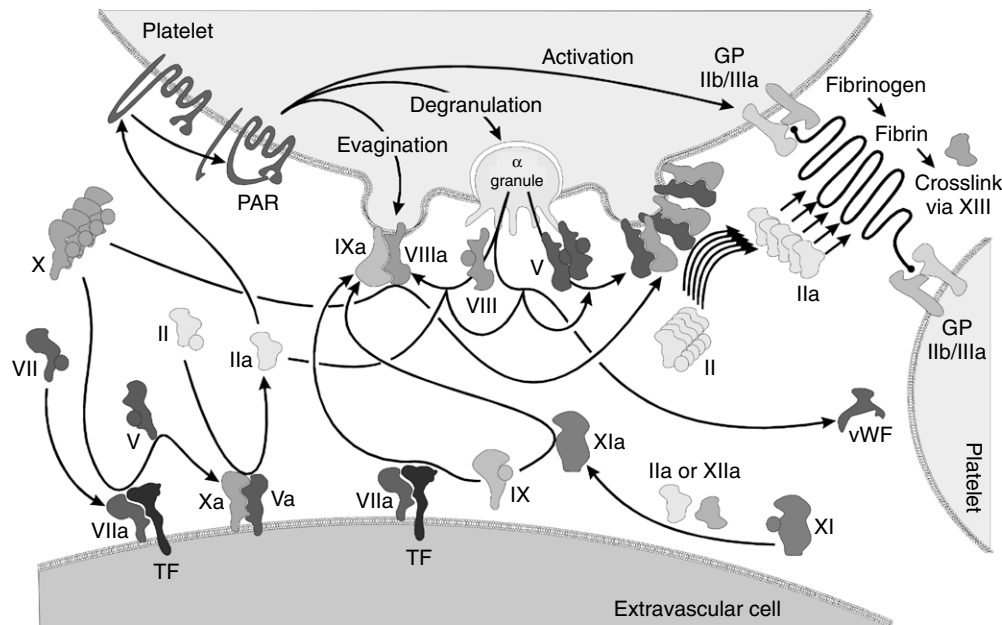

FIGURE 31-3 Blood coagulation cascade. Tissue factor (*TF*) (factor III) on cell membranes of exposed subendothelial matrix cells combines with circulating factor VIIa (activated by Ca^{++}) to form an activating complex for factor X and factor IX. Factor Xa, locally bound to the membrane by factor Va, converts prothrombin (factor II) to thrombin (factor IIa). Meanwhile, converted factor IXa diffuses to adjacent platelets, where it is bound to the platelet membrane by factor VIIIa. The complex acts to accelerate factor Xa conversion, leading to additional factor Va binding and ultimately vastly increased thrombin formation. Fibrin, after it is formed from fibrinogen by the proteolytic action of thrombin, is cross-linked and stabilized by factor XIIIa. Thrombin, a serine protease, accelerates the entire cascade by catalyzing cleavage of factor XI to factor XIa, stimulating platelets to activate by the transmembrane protease-activated receptor (*PAR*), and stimulates conversion of factor XIII to factor XIIIa (not shown). *GP*, Glycoprotein; *vWF*, von Willebrand factor.

TABLE 31-1**Blood Clotting Factors**

INTERNATIONAL NUMBER OR TERM*	PLASMA FACTOR AND ALTERNATIVE NAMES [†]	CAUSE OR DESCRIPTION OF DEFICIENCY
I	Fibrinogen	Liver disease
II	Prothrombin	Liver disease or vitamin K deficiency
III	TF, thromboplastin	Deficiency of TF probably does not occur
IV	Ca^{++}	Never deficient without tetany
V	Proaccelerin	Parahemophilia, rare
VII	Proconvertin	Liver disease or vitamin K deficiency
VIII	Antihemophilic globulin, AHF A	Hemophilia A, 80% of hemophiliacs
IX	Christmas factor, AHF B	Hemophilia B (Christmas disease), depressed with vitamin K deficiency
X	Stuart-Prower factor	Liver disease or vitamin K deficiency
XI	Plasma thromboplastin antecedent, AHF C	Factor XI hemophilia (hemophilia C)
XII	Hageman factor	Generally no clinical symptoms but may have thromboses, rare
XIII	Fibrin-stabilizing factor, Laki-Lorand factor, fibrinase	Delayed bleeding, defective healing, rare
PF3	Platelet factor 3	Thrombocytopenia
—	Protein C	Liver disease or vitamin K deficiency
—	Protein S	Liver disease or vitamin K deficiency
—	Protein M	Liver disease or vitamin K deficiency
vWF	von Willebrand factor	vWD types I, IIa, IIb, IIc, III
Pre-K	Prekallikrein, Fletcher factor	
HMWK	High-molecular-weight kininogen	

*Roman numerals were assigned in 1958 by the International Committee on Blood Clotting Factors. Factor VI, originally assigned to prothrombin converting principle (prothrombinase), has since been abandoned.

[†]Most sources currently use factor numbers.

AHF, Antihemophilic factor; TF, tissue factor.

rapidly binds to circulating factor V and activates it to Va. The factor Xa/Va complex settles into the adjacent cellular membrane (using the hydrophobic Gla domain), where it acts on circulating prothrombin to generate a very small amount of thrombin. This tiny amount of thrombin is insufficient to cleave fibrinogen significantly but instead serves four crucial functions that set up the area for a much larger burst of thrombin formation: (1) nearby platelets are activated by their PAR receptors, which causes degranulation; (2) additional factor V liberated from the platelet α granules is activated (thrombin activates factor V much more efficiently than does factor Xa); (3) factor VIII is activated and dissociated from vWF; and (4) factor XI is activated. Factor Xa exerts its effect locally; any factor Xa that escapes the TF/VIIa complex area is rapidly destroyed by tissue factor pathway inhibitor (TFPI) or antithrombin III (ATIII), both of which are discussed later.

In contrast to the factor Xa/Va complex, activation of factor IXa by TF/VIIa results in an enzyme that is not restricted to the nearby cell surface because it is not inhibited by TFPI and is only slowly affected by ATIII. As a result, factor IXa diffuses through the plasma over to nearby activated platelets. As previously discussed, activated platelets rapidly place factors Va and VIIIa on their cell surfaces. The diffusing factor IXa binds tightly to the factor VIIIa cofactor, and this IXa/VIIIa complex efficiently activates additional factor X to Xa. As before, factor Xa then binds to adjacent factor Va, and this time a much larger burst of prothrombin conversion to thrombin occurs. This much larger amount of thrombin formation is sufficient to begin cleaving fibrinogen and start clot formation and continue to perform the activating functions listed previously.

Fibrinogen and factor XIII

The final phase of blood clotting consists of the thrombin-mediated proteolytic cleavage of fibrinogen to fibrin. Fibrinogen consists of a mirror image dimer in which each monomer is composed of three intertwined and disulfide bond-linked polypeptide chains. In the dimer, the amino terminus of all six polypeptides meet in the middle of the linear molecule to form the N-terminal disulfide knot, or *E domain*. The carboxy termini of the three polypeptides at each opposite end form a globular protein cluster known as the *D domain*. Between the E and D domains, the polypeptide chains form a helical structure.

Thrombin binds to the central E domain and cleaves off peptides from the knot to expose binding sites in the E domain that match the corresponding D domains of two neighboring fibrinogen molecules. The monomers begin to form a staggered "ladder" protofibril. As the monomers continue to associate, branch points occur that allow the fibrin meshwork to become more like a net and thicken. The initial clot is unstable, being held together primarily by hydrogen bonds. With time, however, the fibrin strands become cross-linked with covalent bonds by the action of a transglutaminase, fibrin-stabilizing factor XIII. This factor cross-links proteins between the γ -carbon of glutamine in one fibrin strand and the ϵ -amino group of lysine in the other.

Entrapped in this coagulum are red and white blood cells and intact platelets; the latter promote clot retraction as previously described. These events are followed by the inflammatory processes of organization and wound healing, which require, among other things, an effective proteolytic (fibrinolytic) mechanism described later in this chapter.

Other coagulation cascade proteins

It has long been known that patients with factor XI deficiency do not have severe bleeding profiles. Activated by thrombin, factor XIa cleaves factor IX to IXa. It is thought that this

factor boosts the levels of factor IXa, but is not crucial to its function. Factor XII, prekallikrein, and high-molecular-weight kininogen all have been implicated in the activation of platelets when exposed to a negatively charged surface such as glass or kaolin. It is believed that these proteins work together to yield factor XIIa, which activates factor XI to XIa and ultimately factor IX to IXa. This method of "surface activation" is used to initiate the activated partial thromboplastin time (aPTT) test to determine how well the factor IXa system is functioning.

Regulation of Coagulation

When discussing hemostatic mechanisms, consideration should be given to the natural inhibitors of blood clotting. As important as the procoagulant process is, it is equally important to ensure that inappropriate clotting does not occur. The intent of the clotting system is to seal a site of vascular compromise; powerful antithrombotic mechanisms must come into play to ensure that clotting remains limited to the injured area. Several mechanisms of antithrombosis have been elucidated; they are discussed in detail subsequently and summarized in Figure 31-4. At the heart of the matter is how to control the extremely efficient clotting cascade after it is initiated.

Strict control of the coagulation cascade is mediated by several proteins that act as natural anticoagulants, all of which rely on the first traces of thrombin from the nearby wound site to activate them. In general, the theory is simple: bind or degrade any activated procoagulant proteins if they escape the site of injury. At the same time, the site of injury must be protected from invasion or inclusion of these same inhibitory proteins.

Because thrombin is the major procoagulant protein, it makes sense that inactivation of it is a high priority. An elegant mechanism exists that, instead of destroying thrombin, uses thrombin to catalyze an important set of anticoagulant proteins, the protein C/protein S system. In the microcirculation, where there is a high cell surface-to-volume ratio, the protein C/protein S system predominates. Vascular endothelial cells normally express thrombomodulin on their membranes. Thrombomodulin is a transmembrane cofactor protein with no known enzymatic activity. It binds the thrombin that escapes from the surface of nearby platelets but is not carried off in the vascular flow.

Thrombomodulin, as the name implies, alters the conformation of the thrombin and effectively removes its ability to cleave fibrinogen, activate platelets, and activate factors V and VIII. Instead, the new conformation of thrombin imparts a 2000 times greater affinity for activation of the vitamin K-dependent protein C.¹² Activated protein C (aPC) has considerable homologous characteristics with the other vitamin K-dependent factors, complete with a Gla domain, hydrophobic domain, and active serine protease domain. The cofactor for aPC is protein S, a membrane-bound protein that has no inherent activity. When aPC is bound, the complex efficiently cleaves and destroys any factors Va and VIIIa that might have been liberated from the platelet surfaces, however, slowing coagulation and protecting the normal individual against random intravascular coagulation.

Another protein, ATIII, is a serine protease inhibitor ("serpin") found in the plasma. It inhibits clotting by covalently binding 1:1 to the active sites of thrombin and certain other serine proteases (factors IXa, Xa, and XIIa). This reaction is normally slow but is accelerated 1000-fold in the presence of heparan sulfate, a proteoglycan synthesized on the surfaces by endothelial cells. (A similar effect is achieved therapeutically by administration of the closely related agent heparin sulfate.) Although ATIII binds to these factors only without destroying them, reactivation by unbinding

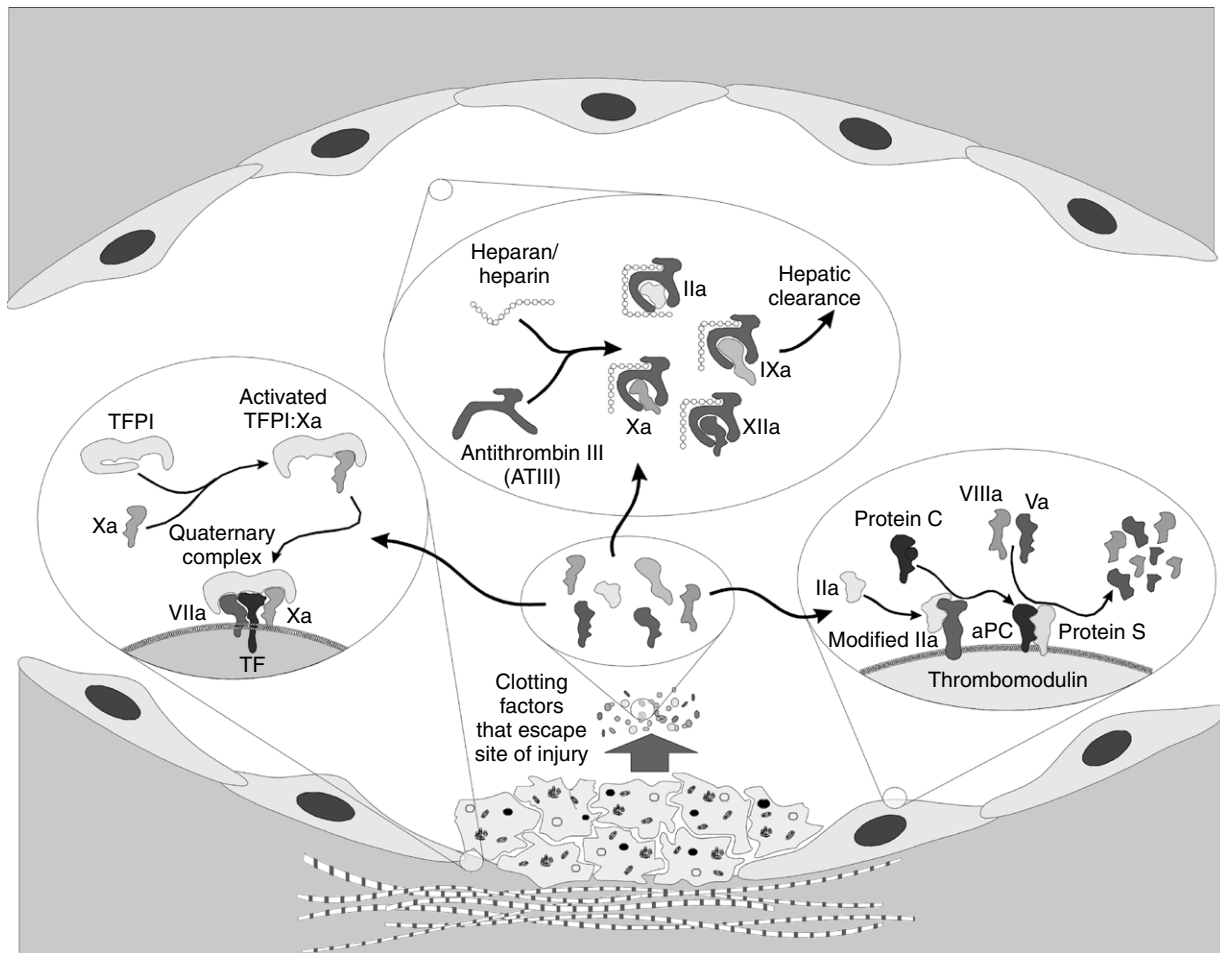

FIGURE 31-4 The clotting inhibition system: examples of proteins that help limit fibrin formation to the site of the vascular injury by inactivating clotting factors. Antithrombin III (*ATIII*) undergoes conformational change in the presence of heparin/heparan, which allows it to bind and sequester factors IIa (thrombin), IXa, Xa, and XIIa. It is later cleared in the liver. When trace amounts of thrombin bind to thrombomodulin on intact endothelial cell membranes, the thrombin-thrombomodulin dimer undergoes a conformational change that allows it to activate protein C, which is bound to the membrane by protein S to form a protease complex specific for factors Va and VIIIa. Loss of these two factors disrupts the coagulation cascade sufficiently to prevent disseminated intravascular coagulation. A final inhibitor, tissue factor pathway inhibitor (*TFPI*), is first activated by factor Xa and then binds to the tissue factor (*TF*)/VIIa complex to interrupt conversion of additional factor X. *aPC*, Activated protein C.

probably does not occur physiologically. The ATIII-protease complexes are cleared in the liver. It is believed that ATIII is responsible for complexing with proteases that escape into the circulation.

Finally, as mentioned earlier, TFPI is a protease inhibitor found in low concentrations in the plasma, mostly bound to circulating lipoproteins or to endothelial cell membrane heparans. It is capable of inactivating factor Xa and the TF/VIIa complex; it must first bind factor Xa before it can bind to the TF/VIIa complex. TFPI seems to be the major inhibitor of free-floating factor Xa, and it may be responsible for shifting the activation of factor IX from the TF/VIIa complex to thrombin-activated factor XI. The inhibitor is found in high concentrations in patients with hemophilia A and B, presumably because fewer substrates are available for TFPI binding. This finding offers one explanation for why hemophiliacs bleed despite normal concentrations of TF, factor VIIa, and factor Xa at the site of injury. TFPI is synthesized in liver and endothelial cells.

PROCOAGULANT AGENTS

In medical and dental practice it is essential to take appropriate precautions to avoid serious hemorrhage. This admonition is particularly true for patients with hemophilia, patients with hematopoietic disease, and patients receiving therapies known to affect hemostasis. Precautions, which may include the administration of clotting factors or hospitalization or both, are prudent in these cases. In contrast, normal patients usually require no more than temporary hemostatic assistance (e.g., pressure packs, hemostatic forceps, ligation, or other locally active measures) to facilitate normal hemostasis and allow clotting to occur. Table 31-2 outlines various methods for controlling bleeding.

Local Measures

A perplexing hemostatic problem may arise from continued, slow oozing of blood from small arterioles, veins, and capillaries. These vessels cannot be ligated, and measures such as

TABLE 31-2

Methods of Controlling Bleeding

DESIRED RESULT	PHYSIOLOGIC METHODS	PHYSICAL METHODS	CHEMICAL AGENTS
Hemostasis	Vasoconstriction, platelet plugs, clot retraction	Pressure, electrocautery, cooling, sutures	Epinephrine, astringents-styptics*
Clotting	Procoagulants: thrombin, platelets, other clotting factors	Physical matrixes: gelatin, cellulose, collagen	Topical thrombin, fibrin sealant, antifibrinolytics

*Chemicals that denature protein include aluminum, zinc, iron, and silver salts; alcohol; tannic acid; and cellulosic acid.

pressure packs and intrasocket preparations, vasoconstrictor agents, and procoagulants must be used. Styptics or astringents, extensively used in the past, are no longer viewed as rational procedures for routine hemostasis in most applications; however, some astringents are commonly used during gingival retraction to aid in controlling the tissue for impressions.

Bleeding caused by dentoalveolar surgery is most often controlled by applying direct pressure with sterile cotton gauze. If this treatment is inadequate, the clinician must localize the source of bleeding as originating either within the soft tissues or within the bony structures. Soft tissue bleeding may be controlled by hemostats, ligation, electrocautery, or application of microfibrillar collagen or collagen sheets (on broad bleeding surfaces). Microfibrillar collagen, made from purified bovine skin collagen, is used topically to arrest certain hemorrhagic conditions that do not respond to conventional methods of hemostasis. Collagen accelerates the aggregation of platelets and may have limited effectiveness in patients with platelet disorders or hemophilia.

Intrasocket Preparations

Bleeding from bony structures, especially from extraction sockets, can be controlled by various means. If initial attempts to achieve hemostasis with sterile cotton gauze and pressure do not succeed, a gelatin sponge, denatured cellulose sponge, or collagen plug may be inserted within the bony crypt.

Gelatin sponges are intended to be a matrix in which platelets and red blood cells can be trapped. In so doing, the sponges facilitate platelet disruption and can absorb 40 to 50 times their own weight in blood, both of which aid in coagulation. They typically resorb in 4 to 6 weeks. Because they are made of gelatin, they must be applied dry; when moistened, they become difficult to handle. For this reason, many practitioners prefer to use either denatured cellulose preparations or collagen sponge.

Denatured cellulose sponge or gauze serves as a physical plug and a chemical hemostatic. The apparent coagulation-promoting action stems from the release of cellulosic acid, which denatures hemoglobin, and these breakdown products help plug the site of injury. Cellulosic acid, similar to tannic acid, inactivates thrombin; the use of cellulose sponge in conjunction with this procoagulant is ineffective. Two forms of cellulose sponge, oxidized cellulose and oxidized regenerated cellulose, are available. Both these materials cause delayed healing, particularly oxidized cellulose, which notably interferes with bone regeneration and epithelialization. Although regenerated cellulose is said to have less inhibitory action, neither dressing should be left permanently in the wound if it can be removed.

The collagen plug, similar to microfibrillar collagen, serves to accelerate the aggregation of platelets and form a physical barrier. Because it also is usually made from bovine collagen sources, occasional foreign body responses can occur. Overall,

the collagen plug generally activates platelets more completely and is the preferred intrasocket product.

Topically Applied Clotting Factors

The most physiologic hemostatic aids are the blood clotting factors themselves. Assuming an otherwise normal clotting system, topical thrombin is often used clinically. It must remain topically applied; if given intravenously, thrombin causes extensive thrombosis and possibly death. Topically applied thrombin (particularly in conjunction with a compatible matrix such as gelatin sponge) operates as a hemostatic, particularly if the patient has a coagulation deficiency or is receiving oral anticoagulants, because all that is required for clotting is a normal supply of platelets, fibrinogen, and factor XIII in the plasma. If blood flows too freely, temporary physical hemostasis must be attained before topical thrombin can be of practical value. The use of thrombin is not without problems. Currently available thrombin, especially the bovine products, may be relatively crude preparations that still contain plasmin, a fibrinolytic agent (discussed subsequently). Antibodies may also be generated to the bovine thrombin or bovine factor V; the latter can cross-react with human factor V and lead to an acquired inhibition and bleeding.

Fibrin sealant, also sometimes referred to as *fibrin glue*, is one of the more promising hemostatic aids to appear in recent years.⁵ With this agent, the concept of the application of topical thrombin is taken one step further. Bovine or human thrombin and calcium chloride are mixed in one of two syringes; purified human fibrinogen with factor XIII, aprotinin, and other plasma proteins (fibronectin and plasminogen) are in the second syringe. The two solutions are mixed in a single delivery barrel, where the thrombin cleaves the fibrinogen to fibrin monomers. Initially, they are gelled by hydrogen bond formation, but in 3 to 5 minutes the factor XIII in the presence of Ca^{++} initiates cross-linking and increases the tensile strength of the clot.⁵ As the clot solidifies, the sealant becomes milky white.

The rate of fibrin clot formation depends on the concentration of the thrombin; 4 IU/mL produces a clot in approximately 1 minute, whereas 500 IU/mL requires only a few seconds. The strength of the clot depends on the concentration of the fibrinogen. If used in an area where the clot is likely to break down too soon, or in patients with compromised hemostasis, a protease inhibitor such as aprotinin can be added to delay fibrinolysis. Aprotinin functions by inhibiting plasmin, which is generally carried along with the thrombin. The term *glue* arises from the fact that in many medical applications this material has been literally used to adhere tissues together naturally.

Fibrin sealant is commercially available in the United States. The protein fractions are lyophilized and require careful reconstitution at 37° C under sterile conditions; proper mixing of the materials requires approximately 30 minutes to perform. As a result, the emergent use of this material is

difficult; typically, it is used more in planned surgeries in patients with known bleeding disorders. It is also an expensive medication; 1 mL of the material costs several hundred dollars. Fibrin sealant works well, however, in stopping the microbleeding and oozing that often accompany dental procedures.²⁷

Astringents and Styptics

The terms *astringents* and *styptics* are interchangeable, referring to different concentrations of the same drugs. Many chemicals have vasoconstrictive or protein-denaturing ability, but relatively few are appropriate for dentistry. The suitable preparations are primarily salts of several metals, particularly zinc, silver, iron, and aluminum. Aluminum and iron salts are quite acidic (pH 1.3 to 3.1) and irritating.³⁶ Iron causes annoying, although temporary, surface staining of the enamel, whereas silver stains may be permanent.

Currently, astringents are generally used in dentistry only to aid hemostasis while retracting gingival tissue. Other applications, such as controlling bleeding after surgery, are not looked on as favorably as in the past, when 20% ferric subsulfate (Monsel's solution) and 8% zinc chloride were among the most popular agents used. Aluminum and iron salts function by denaturing blood and tissue proteins, which agglutinate and form plugs that occlude the capillary orifices. In a rabbit mandible model, when ferric sulfate salts were left in an osseous wound, there was an intense foreign body reaction and delayed healing in many of the experimental sites compared with the control sites.²⁴ When the salts were irrigated, and the coagulum was curetted away, this response was markedly diminished with no persistent inflammation or delay of osseous repair.

It is imperative that if these compounds are used in dentistry, they are used briefly and with copious irrigation and debridement to remove the breakdown products. They should not be applied to areas of exposed osseous material so as to avoid inflammation or complications of retarded healing such as the distressful dry socket. Tannic acid (0.5% to 1%) is an effective astringent; it also precipitates proteins, including thrombin, but is often incompatible with other drugs and metal salts used therapeutically. Finally, the use of an astringent in a patient with even a mild bleeding tendency may provide temporary hemostasis, but subsequently lead to a larger area of delayed oozing after the chemically affected tissue sloughs.

Vasoconstrictors

Temporary hemostasis may be obtained with adrenergic vasoconstrictor agents, generally epinephrine. Such vasoconstrictors should be applied topically or just under the mucosa only for restricted local effects and for very short periods to avoid prolonged ischemia and tissue necrosis. Because some of the drug is absorbed systemically, particularly in inflamed and abraded tissue, cardiovascular responses may occur. Epinephrine solutions and dry cotton pellets impregnated with racemic epinephrine are available for topical application, but other methods to control bleeding are generally preferred.

Systemic Measures

Patients with acquired or genetic bleeding disorders usually have deficiencies in platelet number, platelet function, or faulty or missing clotting factors. Bleeding may develop several hours after trauma or surgery. Uncontrolled bleeding does not generally appear with superficial abrasions, but hemarthrosis and hemorrhage are common with deeper injuries. Thrombocytopenia is frequently drug-induced or associated with other myelogenous diseases; hemophilia disorders are generally inherited. With proper evaluation and supportive

therapy (Table 31-3), extensive surgery can usually be accomplished without serious incident.

Platelet disorders

Patients with a platelet count of less than 50,000/mm³ are at risk for surgical or other trauma, but generally do not exhibit spontaneous hemorrhage until the count becomes less than 20,000/mm³. Platelet transfusion should be reserved for acute situations because alloimmunization to injected platelets can occur. One unit of platelet concentrate (equal to the platelets derived from 1 U of whole blood) increases the platelet count in adults from 4000/mm³ to 10,000/mm³. Platelet recovery is low in patients with hypersplenism and may be undetectable in patients with immune thrombocytopenia. Idiopathic forms may benefit from corticosteroid administration, splenectomy, use of immunosuppressive agents, or (acutely) high doses of intravenous immunoglobulin. Drug-induced disease generally is alleviated by withdrawal of the offending drug. In the case of aspirin or a thienopyridine such as clopidogrel prescribed deliberately to alter platelet function, the relative risks of hemorrhage versus thromboembolism must be considered in relation to the planned procedure.

Hemophilia

All forms of hemophilia are genetically based disorders of coagulation. They may range in severity from mild to moderate to severe; this designation greatly affects what dental interventions can occur. The most common forms of hemophilia result from deficiencies in factors VIII and IX (hemophilia A and B). Although the transmission of hemophilia A or B is hereditary and X-linked, nearly half of all cases arise spontaneously as new mutations.³² Any child or adult with newly discovered hemophilia should have counseling with the family as provided by hemophilia treatment centers. Bleeding disorders (especially of the mild variety) are often first discovered after dental procedures, such as extractions or periodontal surgery.

Hemophilia A occurs when there is a deficiency in circulating factor VIII activity. Factor VIII accelerates blood coagulation by serving as a cofactor in the platelet membrane in the enzymatic activation of factor X by the factor IXa/VIIIa complex (see Figure 31-3). In the inactive state, factor VIII is an asymmetric protein molecule. The normal amount of factor VIII antigen averages 100 U/dL (range 50 to 180 U/dL). Mild hemophilia occurs when the patient's blood has 5% to 30% of normal factor VIII activity. Moderate disease is defined as showing 1% to 4% factor VIII, and severe hemophilia shows less than 1% factor VIII. Individuals with more than 40% normal factor VIII antigen clot normally.

The gene for factor VIII resides on the long arm of the X chromosome (Xq28),³² resulting in an X-linked pattern of inheritance. In severe factor VIII hemophilia, gene inversions account for 45% of mutations, whereas other patients have point mutations that often cause a premature stop codon to be inserted, resulting in incomplete mRNA transcription. In general, only males with a faulty factor VIII gene on their only X chromosome show phenotypic expression of severe disease, at a rate of 1 in 10,000. Females who carry an affected X chromosome typically do not show phenotypic disease because the unaffected factor VIII gene on the other X chromosome provides sufficient protein to allow normal clotting. Expression of the normal gene may become depressed during development, however, if key progenitor cells favor the chromosome with the defective gene. The result is that some carrier females are phenotypically mild (or, rarely, moderate) hemophilics, with factor VIII concentrations 15% to 25% of normal. Referred to as *symptomatic carriers*, their bleeding tendency is often not discovered until they encounter a significant insult, such as extraction of teeth, orthognathic

TABLE 31-3

Procoagulant Preparations Used in the Management of Bleeding Disorders

NONPROPRIETARY (GENERIC) NAME	PROPRIETARY (TRADE) NAMES	CONTENT	THERAPEUTIC USE
Factor VIII Products			
Antihemophilic factor, plasma derived	Humate-P	250, 500, and 1000 IU/vial; contains albumin vWF and small amounts of other proteins	Hemophilia A, vWD
Antihemophilic factor, plasma derived, purified	Alphanate, Hemofil M, Koate DVI, Monarc-M, Monoclate-P	250, 500, 1000, and 1500 IU/vial; contains albumin	Hemophilia A
Antihemophilic factor, recombinant	Bioclate, Helixate, FS, Recombinate	250, 500, and 1000 IU/vial; contains albumin and trace amounts of animal protein	Hemophilia A; patients without HIV or viral hepatitis
Antihemophilic factor, recombinant, albumin-free	Advate, Kogenate FS, ReFacto, Xyntha		
Factor IX Products			
Factor IX complex	Bebulin VH, Profilnine SD, Proplex T	500, 1000, and 1500 IU/vial; also contains significant amounts of factors II, VII, and X	Hemophilia B
Factor IX human complex, purified	AlphaNine SD, Mononine	500, 1000, and 1500 IU/vial; contains small amounts of factors II, VII, and X	Hemophilia B
Factor IX, recombinant	BeneFIX	250, 500, and 1000 IU/vial	Hemophilia B; patients without HIV or viral hepatitis
Factor VIIa Product			
Factor VIIa, recombinant	NovoSeven RT	1, 2, and 5 mg/vial	Hemophilia A or B; patients with inhibitors for factors VIII or IX
Mixed Factor Products			
Anti-inhibitor coagulant complex (factor VIII inhibitor bypassing activity)	Autoplex T, FEIBA VH	≥80 IU/bag; contains other clotting factors; prepared from single donors	Hemophilia A, vWD, hypofibrinogenemia, DIC, Kasabach-Merritt syndrome
Antihemophilic factor, cryoprecipitated	—	≥80 IU/bag; contains other clotting factors; prepared from single donors	Hemophilia A, vWD, hypofibrinogenemia, DIC, Kasabach-Merritt syndrome

Unless otherwise noted, all products are derived from human plasma or, in the case of recombinant products, based on human genes. DIC, Disseminated intravascular coagulopathy; HIV, human immunodeficiency virus; vWD, von Willebrand's disease; vWF, von Willebrand factor.

surgery, or extensive periodontal surgery. For this reason, female relatives of hemophilics should have interviews, and possibly blood tests, to determine their carrier status and their factor VIII activity.

Hemophilia B was discovered when it was noted that combining plasma from different hemophilics sometimes allowed normal clotting; it was deduced that the second sample corrected the defect in the first. It was later determined that deficiencies in factor IX were responsible for approximately one fifth of the forms of hemophilia. Older literature refers to factor IX deficiency as *Christmas disease*, named after the surname of the first family studied with this variant of hemophilia.

Similar to hemophilia A, the gene for factor IX is on the X chromosome (Xq27.3)²² and shows the same familial pattern of expression: affected males and carrier females. Because this gene is considerably smaller than the factor VIII gene (34 kDa versus 186 kDa), most of the genetic variations have been identified in kindreds. Similar to factor VIII deficiency, partial or whole gene deletions or insertions lead to severe hemophilia B, as do nonsense point and some missense mutations. Also similar to hemophilia A, there are mild,

moderate, and severe forms of the disease, and female symptomatic carriers occur. Hemophilia A and B are clinically indistinguishable.

von Willebrand's disease

Originally described by von Willebrand in 1926, von Willebrand's disease (vWD) is an autosomal dominant hemorrhagic disorder resulting from a quantitative or qualitative deficiency of the vWF GP. Males and females are affected equally; the defect is in an autosomal dominant gene located on chromosome 12.¹⁵ vWD may be the most common inherited bleeding disorder, with many cases remaining undiagnosed.

The vWF GP is produced in vascular endothelial cells and megakaryocytes and is stored intracellularly in the α granules of platelets and circulated in the plasma as multimeric polymers. The high-molecular-weight multimers are necessary for normal biologic activity, presumably because of their greater number of ligand-binding domains. vWF has three important functions. The first is to form a tight but noncovalent complex with factor VIII protein (in a ratio of approximately 1 factor VIII to 100 vWF), stabilizing factor VIII and slowing its

clearance from the circulation. Second, vWF promotes normal, high-shear platelet adhesion to the subendothelium on injury and exposure of subendothelial matrix proteins. The latter function is mediated by the GP Ib/IX/V tetramer found on the platelets, and the vWF involved is bound to the subendothelial matrix proteins. Third, vWF is one of the proteins that binds to the multiple platelet membrane GP IIb/IIIa receptors, along with fibrinogen, to help stabilize the aggregating platelets.

As an aside, ristocetin, one of the first antistaphylococcal antibiotics, was found to cause thrombocytopenia in many patients because of binding to the platelet membrane, which enhanced the binding of vWF, resulting in platelet aggregation, thrombus formation, and depletion thrombocytopenia. Although the antibiotic was removed from clinical use as a result, it is now used in an assay for vWD. By mixing ristocetin, washed platelets, and plasma from the affected patient, an inverse correlation occurs between the amount of functional vWF present in the plasma (originally called *ristocetin cofactor*) and the amount of ristocetin necessary to induce platelet aggregation. When the ristocetin cofactor assay is compared with tests that show the amount of vWF protein present in the plasma, diagnosis of the type of vWD can be made.

The hematologic disorder in vWD can manifest as either structural or quantitative changes in vWF. Three basic types of disease exist. Type 1 vWD is associated with a mild quantitative defect in the amount of vWF produced. Titers of vWF antigen (total vWF protein) and ristocetin cofactor activity (functional vWF protein) are comparable. This is the most common type (80%) and is most often manifested by mucocutaneous bleeding. Type 2 vWD is a defect in the amount of high-molecular-weight multimers present in the plasma, causing a marked decrease in platelet adhesion, but little change in total vWF antigen. There is a high ratio of antigen to ristocetin cofactor activity. Type 3 vWD is characterized by severe bleeding disorders from an essential lack of any vWF, with concomitantly low concentrations of factor VIII and decreased platelet adhesion. This third type is rare, mostly occurring in homozygous or compound heterozygous offspring of parents with mild or asymptomatic variants of vWD.

Treatment

Treatment of either variety of hemophilia or vWD requires the restoration of the appropriate factor so that factor complex IXa/VIIIa activity is sufficient. For the treatment of hemophilia A, various factor VIII replacement products are available (see Table 31-3).³² Because the half-life of factor VIII is 8 to 12 hours, the patient must be reinfused with at least half the original dose at approximately 12-hour intervals to prevent late bleeding from surgical wounds.

Until more recently, the only way to obtain factor VIII was by pooled human blood products. Initially, the most common method was to use cryoprecipitate. Cryoprecipitate is the cold-insoluble (precipitated) protein fraction derived when fresh frozen plasma is thawed at 4° C. It is primarily composed of factor VIII, fibrinogen, and vWF. Classically, it was one of the mainstays of factor VIII hemophilia treatment, but has virtually disappeared from this use with the development of methods to manufacture recombinant factor VIII. Similar to plasma, cryoprecipitate is not virally inactivated. The most common current use of cryoprecipitate is as a source of fibrinogen for the treatment of disseminated intravascular coagulopathy.³ Cryoprecipitate is still occasionally used for the treatment of vWD, particularly if it is obtained from a single donor after desmopressin stimulation, but this use is waning.

Modern plasma-derived factor VIII products have greatly reduced the risk of viral transmission by donor screening and viral inactivation protocols. Two methods are currently being

used to inactivate viruses—heat and solvent detergent. All viruses that have lipid envelopes are readily destroyed, including human immunodeficiency virus (HIV), hepatitis B virus, and hepatitis C virus. Viruses that do not have lipid envelopes, such as the B19 parvovirus and hepatitis A virus, can still be transmitted in the solvent detergent or heat-inactivated products. A vaccination for hepatitis A is now available, and patients with hemophilia or vWD are encouraged to receive it early in life.

Some manufacturers additionally purify their factor VIII protein products from the pooled factor VIII proteins on affinity columns, increasing the specific activity of the preparation and decreasing further the risk of viral transmission. Those products are more expensive. One of the factor VIII products, Humate-P, is purified with a process that retains a considerable amount of vWF. Although still occasionally used for factor VIII hemophiliacs, this product has become the favored way to treat bleeds or potential bleeds in patients with moderate-severe vWD and is used mostly for this reason. It has the advantage that it can be manufactured on a large scale, lyophilized for stability and storage, and reconstituted when necessary. It is considered very safe from viral contamination.

Most factor VIII hemophiliacs are now receiving recombinant factor VIII products, particularly if they are HIV and hepatitis virus negative. These proteins are derived from stable transfection of the human factor VIII cDNA into Chinese hamster ovary (CHO) or baby hamster kidney (BHK) cells, with resultant transcription and protein production. The first-generation products required human albumin to be added to provide stabilization through the purification process; the second-generation and third-generation products are now being made albumin-free. The distinction is important because the albumin adds a small risk for viral contamination. The new products are considered virus-free, have high specific activities, and have been successful in transiently correcting the bleeding disorder. The main difficulty is that in a patient with severe hemophilia with essentially no endogenous protein, the use of this “foreign antigen” product may cause the development of anti-factor VIII antibodies, known in hematology as *inhibitors* and discussed in greater detail subsequently. In most patients who develop them, the inhibitors are low titer and controllable with low-dose daily infusions of factor VIII protein to build immune tolerance over time.

Another approach to the treatment of mild hemophilia A and type 1 vWD was introduced when it was discovered that desmopressin, the synthetic 1-desamino-8-D-arginine analogue of vasopressin (antidiuretic hormone), could prevent bleeding in many of these patients. This medication causes endogenous factor VIII, vWF, and plasminogen activator to be released from storage sites on the vascular endothelium. In many patients with mild hemophilia or type 1 vWD, the protein structures are normal, but concentrations are low. With desmopressin, transient increases of two to three times the patient's baseline concentrations can be achieved, which may be sufficient to allow adequate hemostasis during minor surgery. For hemophiliacs who use single donors (usually a parent or sibling) as their sole source of factor product to decrease the risk of viral transmission, desmopressin can be given to the donor before donation to double or triple the amount of factor VIII recovered.

The advantage of desmopressin over vasopressin is that it retains the factor VIII-releasing activity but lacks the vasoconstrictor action of vasopressin. Most importantly, desmopressin is devoid of the risk of viral transmission inherent in the blood-derived products. Desmopressin is subject to peptic hydrolysis and is injected or insufflated intranasally. Mild facial flushing is normal during the infusion, with headache, nausea, and lightheadedness as common side effects. Because of its anti-

uretic properties, water intake must be restricted for 12 hours to avoid volume overload. (The drug is also used in lower doses as an aid for children with bed-wetting difficulties.)

Historically, factor IX concentrates have been difficult to purify. The most common factor IX preparations are known as *factor IX complex* because, although they have high amounts of factor IX protein, they also contain factors II and X and some factor VII (see Table 31-3).³¹ Because of the presence of the excessive extra clotting factors (some partially activated), disseminated intravascular coagulopathy is occasionally a problem, so in some preparations heparin has been added to reduce thrombin generation during storage. These concentrates are still in use simply because of cost considerations. Similar to factor VIII concentrates, they are subjected to various forms of viral inactivation to reduce the transmission of HIV, hepatitis B, and hepatitis C.

A recombinant factor IX preparation was licensed in 1997. Similar to all recombinant products, it is essentially virus-free. It is produced in CHO cells. A major difficulty in developing this product is the extensive post-translational modifications the natural protein undergoes. Eleven disulfide bonds, 1 β -hydroxylation, 1 sulfation, 1 phosphorylation, and 12 γ -carboxylations all must occur to activate the protein. The recombinant product has several differences from the native protein: only approximately 60% is fully carboxylated, 15% gets sulfated, and only 1% is phosphorylated. As a result, the protein is not as efficacious as the natural factor, so patients typically require an average of 1.5 times more protein than the highly purified plasma-derived protein to get sufficient increases in plasma factor IX. The cost is also substantially higher on a per-unit basis.³³

One aspect of blood product replacement therapy that is often overlooked is cost. On average, a patient with severe hemophilia A uses \$10,000 to \$90,000 worth of factor per year depending on the type of product used and the dose required. Younger hemophiliacs, to avoid potential viral exposure, generally use the recombinant products.

As a hope for the future, correction of hemophilia by gene transfer is actively being pursued. Gene therapy is in its infancy, but hemophilia is considered one of the more ideal targets for early trials because the active proteins are found in the bloodstream and can be made in just about any tissue as long as they can be released to the blood. It will be interesting to see which hemophilia gene transfer succeeds first. The factor VIII gene is larger and more difficult to transfer, but the resultant protein undergoes much less post-translational modification than occurs with factor IX.

Inhibitors

A confounding problem in treating hemophiliacs is the development of antibody inhibitors against the deficient factor.²⁵ Approximately 10% of patients with severe hemophilia A express a high titer of inhibitor, usually within the first few years of being treated with factor VIII concentrates. Multiple approaches must be used to protect these patients against bleeding crises. The most crucial task is to determine whether the patient carries low-titer or high-titer antibodies. Patients with low-titer antibodies can often be given excessive amounts of factor replacement, depleting the inhibitor antibody sufficiently to allow the remaining factor to promote hemostasis. Although low-titer inhibitors may persist for years, they do not show the typical alloantibody boost response after exposure to human factor VIII concentrates. Care must be exercised in using this method for elective procedures because there is the risk that in some patients the additional factor challenge will boost the titer from a low-titer to a high-titer inhibitor, making future crisis intervention more difficult.

In patients who have high-titer inhibitors, preventing or reducing hemorrhage risk is crucial. Daily infusion of high-

dose, medium-dose, or low-dose factor replacement to induce immune tolerance has been shown to be successful. Concomitant administration of immunosuppressant medications may depress antibody formation further. This approach is much more effective with autoantibody inhibitors than with alloimmune responses. A short course of daily intravenous infusion of IgG has sometimes reduced titers as well. After immune tolerance is achieved, most patients require continued low-dose prophylactic factor infusions at least weekly.

In an acute hemorrhagic situation, or in an emergent dental crisis, porcine factor VIII is sometimes useful. Although not readily available in the United States, a recombinant version is being developed. The protein is fully functional in humans, but inhibitor antibodies directed against the human form tend not to be strongly cross-reactive. Side effects include fever, chills, headache, vomiting, and rarely anaphylaxis. Continued use can result in development of species-specific antibody or, occasionally, immune tolerance to the human antigen.

When hemophiliacs with high-titer inhibitors require coagulation support, but factor VIII replacement therapy cannot be used, two products may be effective. Factor VIIa is a recombinant protein derived in BHK cells transfected with factor VII cDNA and has no risk of transmission of human pathogenic viruses. During processing, it spontaneously activates to factor VIIa. The protein as a therapeutic agent functions similar to its endogenous counterpart: by combining with TF present at all sites of injury to stimulate conversion of factors IX and X to their respective activated analogues. Because TF is found only at the site of injury, disseminated coagulation has not been a problem. Also, factor VIIa is not rapidly inactivated by ATIII, giving it a sufficient half-life to allow hemostasis. It has a much shorter half-life (only 2 to 3 hours) than either factor VIII or factor IX and requires high doses every 2 hours in the dental setting. The drug has the limitation that its mechanism is to achieve sufficient thrombin formation via the part of the coagulation cascade that is intended for only small amounts of thrombin generation. It seems to work well for initial hemostasis, but there have been difficulties with breakthrough bleeding 48 hours or so after surgery (unpublished data). The use of topical fibrin sealant in conjunction with this product seems to be a wise choice. The current cost of this medication is several thousand dollars per dose.

The other medication that can be used is a procoagulant complex known as FEIBA VH (factor eight inhibitor bypassing activity). The VH form is a vapor-heated concentrate of plasma-derived factors II, VII, IX, and X (the vitamin K-dependent clotting factors) in their inactive and active forms. How this medication corrects the bleeding disorder is unknown, but it is believed the extra factors II and X complex with endogenous factor V and reconstruct the common pathway, eliminating the need for factor VIII. The main difficulty with this medication is that the extra clotting factors can overshoot and cause thrombosis elsewhere in the body. Which product, FEIBA versus factor VIIa, works best in any given patient is unpredictable. Some patients clearly do better with one over the other, but the reason for this is elusive.

AGENTS THAT PROMOTE OR INHIBIT FIBRINOLYSIS

Fibrinolytics

Achieving hemostasis is a crucial aspect of the coagulation system, and limiting its spread is another; remodeling or breaking down clots when they are no longer necessary is a third crucial facet of vascular repair. As healing occurs, it is necessary to remove part or all of the fibrin that has been

deposited so that normal blood flow can be restored to the affected tissue. This process is mediated by the protease plasmin (Figure 31-5). When fibrin is initially deposited, thrombin stimulates adjacent endothelial cells to release tissue plasminogen activator (t-PA) and urokinase plasminogen activator (u-PA).

A serine protease with a fibrin-binding domain, t-PA must adhere to the fibrin molecules to function. This binding occurs on lysine residues of the fibrin. When adhered, t-PA binds plasminogen (also at a lysine residue) and cleaves the plasminogen to liberate plasmin, another serine protease. Plasmin has the ability to bind directly to fibrin. u-PA acts independently of fibrin and instead activates plasminogen to plasmin

in the circulation. Plasmin associated with t-PA lyses the fibrin, releasing fibrin degradation products, and degrades factors V and VIII, inhibiting further clotting. t-PA can associate with circulating plasminogen, but does not effectively activate it unless both become bound to the fibrin, which is an important consideration in the therapeutic use of this compound.⁹

As expected, strict control mechanisms for plasmin activity exist. Without such control, circulating plasmin would cause systemic fibrinolysis and oozing of previously clotted sites. Three proteins are intimately involved. The first, α_2 -antiplasmin (α_2 -AP), is a serpin (serine protease inhibitor) that is synthesized in the liver and is efficient at neutralizing

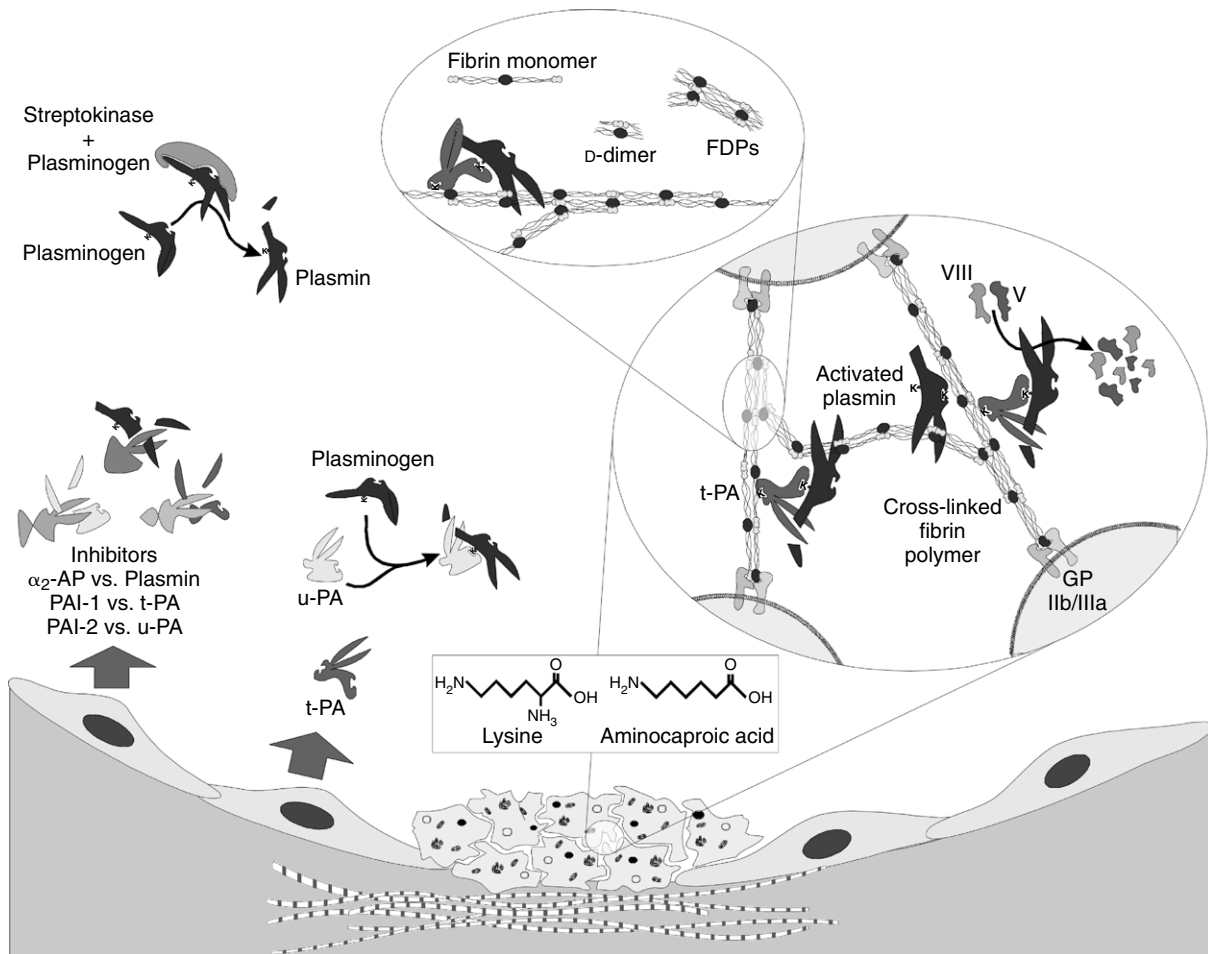

FIGURE 31-5 Fibrinolysis. Thrombin formation causes adjacent endothelial cells to release tissue plasminogen activator (t-PA) and urokinase plasminogen activator (u-PA). t-PA adheres to lysine residues on the fibrin molecules and adsorbs plasminogen onto it, also by lysine binding. The proteolytic action of t-PA converts the plasminogen to plasmin at the wound site, whereas u-PA converts it in the free circulation. Plasmin acts to degrade factors V and VIII and proteolytically cleave the fibrin. Various fibrin degradation products (FDPs) are liberated, including the d-dimer formed from two fibrin molecule “ends” linked to one fibrin molecule “middle.” Aminocaproic acid interferes with plasminogen conversion by occupying lysine-binding sites on t-PA and plasminogen, resulting in antifibrinolysis. The endothelial cells also release several inhibitors: plasminogen activator inhibitor-1 (PAI-1), which destroys any free circulating t-PA, and plasminogen activator inhibitor-2 (PAI-2), which inhibits u-PA. Both serve to limit the plasminogen activation primarily to the clot site. Another protein, circulating α_2 -antiplasmin (α_2 -AP), neutralizes any free plasmin in the bloodstream, also restricting activity of plasmin to the wound site. Exogenous t-PA functions similarly to endogenous t-PA. Streptokinase combines with plasminogen to create a complex that cleaves other plasminogen molecules to free circulating plasmin. As a result, systemic fibrinolysis is more common with this medication. Not shown is streptokinase formulated with exogenous acylated plasminogen, which spontaneously deacylates on mixing with the plasma to form the same streptokinase-plasminogen complex. GP, Glycoprotein.

any free plasmin circulating in the blood. Conversely, binding of the plasmin to fibrin (independently or by t-PA) protects it from attack by α_2 -AP, which appropriately restricts the activity of plasmin to the wound site. The second control protein, PAI-1, is a serpin synthesized by the endothelial cells in response to thrombin stimulation, with specificity for t-PA as its substrate. PAI-1 is in molar excess in the plasma compared with t-PA, effectively inhibiting systemic conversion of plasminogen to plasmin by t-PA, unless (as with α_2 -AP and plasmin) the t-PA can "hide" from it by binding to fibrin. The third control protein is PAI-2, which functions similar to PAI-1, only with specificity for u-PA. The liver also functions to clear the bloodstream of any free active plasmin, further helping to prevent systemic fibrinolysis.

Therapeutic measures designed to induce or facilitate fibrinolysis are available for use in relieving certain types of thromboses, most notably in the event of acute myocardial infarction. These agents may also be valuable in patients with life-threatening pulmonary emboli, infarctive stroke, or deep venous thrombosis. All these agents function by activating the conversion of plasminogen to plasmin with subsequent natural fibrinolysis. One of the medications used is the natural activator, u-PA. The parent compound is cleaved twice, first to high-molecular-weight u-PA and second to low-molecular-weight u-PA. As with the endogenous form, low-molecular-weight u-PA loses its fibrin-binding domain, causing it to be ineffective at activating circulating plasminogen to plasmin. In pharmacologic doses, this activity results in systemic fibrinolysis.

t-PA is produced by recombinant DNA techniques. It is marketed under the nonproprietary name of alteplase. Because t-PA is naturally more fibrin specific than are preparations containing streptokinase or u-PA, it is the first thrombolytic agent recommended by the American Heart Association in the management of myocardial thrombosis.¹⁹ At pharmacologic doses, it imparts some circulating plasminogen conversion, however. A deletion mutation variant of t-PA is available by the nonproprietary name of reteplase. It is similar in activity and side effects to t-PA.

Streptokinase, an exotoxin from certain β -hemolytic streptococci, also serves as an activator of plasminogen. It is different from t-PA and u-PA because it is not an enzyme and does not proteolytically cleave plasminogen to plasmin. Instead, it binds noncovalently to plasminogen and confers plasmin-like proteolytic activity on the plasminogen-streptokinase complex. The complex cleaves other molecules of plasminogen, liberating active plasmin. Because streptokinase is an exogenous protein originating in bacteria, there is a higher incidence of adverse and allergic reactions with this medication. Similar to u-PA, streptokinase is efficient at converting circulating plasminogen to plasmin, causing systemic fibrinolysis. It has been shown, however, that there is no greater mortality rate with this product than with t-PA when used for the treatment of acute myocardial infarction.¹⁹

A similar medication, anistreplase (anisoylated streptokinase plasminogen activator complex), is a combination of streptokinase with an acylated plasminogen, forming an inactive complex that spontaneously deacylates in plasma. The deacylated form is the same as the streptokinase-plasminogen complex previously discussed. Anistreplase has the advantage that it does not seem to be inhibited by endogenous serpins because of the acylated plasminogen protein, but its disadvantage is that it still causes systemic fibrinolysis.

The many available plasminogen activators have made effective treatment possible in reducing ischemic myocardial necrosis if given within 30 to 60 minutes after the onset of chest pain.¹⁹ There is a 47% success rate in thrombolysis if the products are given 1 hour from onset of symptoms. Results are poor if given after a 3- to 6-hour delay.

Antifibrinolytics

In some circumstances it is advantageous to limit fibrinolytic activity (e.g., after surgery in a hemophilic who may be prone to breakthrough bleeding as the wound heals). The drug used for this purpose is aminocaproic acid (sometimes referred to as ϵ -aminocaproic acid), which competitively inhibits plasminogen and plasminogen activators from binding to fibrin. Aminocaproic acid is a lysine analogue that binds to plasminogen and plasmin, masking their ability to adhere to fibrin. The usual dose of aminocaproic acid is 50 mg/kg every 6 hours for 10 days. In its tablet form (500 mg) this dosage requires the average adult patient to take approximately seven tablets every 6 hours. As a result, compliance can be difficult. A concentrated syrup form exists for pediatric use (250 mg/mL), and experience indicates that adult patients generally are more compliant with taking the liquid form of the medication, especially after oral surgical procedures.

Side effects of this medication include unwanted thrombosis in patients who are prone to deep venous thrombosis and cardiovascular disease. Careful consideration and consultation with the physician is important before using this medication in such patients.

ANTICOAGULANTS

Although dentists are unlikely ever to prescribe an anticoagulant agent, it is essential that they be aware of any hemostatic deficiency in the patient, whether pathologic or therapeutic in origin. Anticoagulants are being used with ever-increasing frequency by physicians, and dentists commonly encounter patients who are taking these medications. There are now three classes of anticoagulants in clinical use: direct-acting agents, which are capable of acting *in vitro* and *in vivo*; indirect-acting agents, which interfere with the synthesis of coagulation system proteins; and platelet inhibitors, of which three subclasses exist: COX inhibitors, GP IIb/IIIa antagonists, and ADP receptor antagonists. Dentists should be familiar with the pharmacologic features of each class and understand if, how, and, more important, when their effects should be modified.

Direct-Acting Anticoagulants: Heparins

First extracted by McLean in 1916, heparin is a powerful, systemically effective direct-acting anticoagulant. Heparin is a linear mucopolysaccharide primarily composed of repeating units of D-glucosamine in 1,4 glucosidic linkage with D-glucuronic and L-iduronic acids. These disaccharide residues, which are partially esterified ($\leq 40\%$) with sulfuric acid, make heparin the strongest organic acid normally occurring in the body. About 10 to 15 of these chains, each with 200 to 300 monosaccharide units, are attached to a core protein to give the final proteoglycan as the storage form of heparin in mast cells. Because the polysaccharide chains differ in length, and the sulfation reactions vary, endogenous heparin is a heterogeneous mixture of molecules, with molecular weights ranging from 4000 to 40,000, none of which has been completely characterized. Commercial preparations are made primarily from recombinant DNA techniques. Figure 31-6 depicts 1 of 40 to 50 repetitive sequences found in commercial preparations, a pentasaccharide segment of heparin that is believed to include an essential binding site for anticoagulant activity.

Heparin is produced endogenously in mast cells, where it is stored in a large macromolecular form complexed with histamine. Heparin and histamine are released together, providing a physiologic example of a fixed-drug combination, the significance of which is not yet fully understood. Many investigators have attempted to explain the *in vivo* maintenance of blood fluidity by the presence of heparin in plasma.

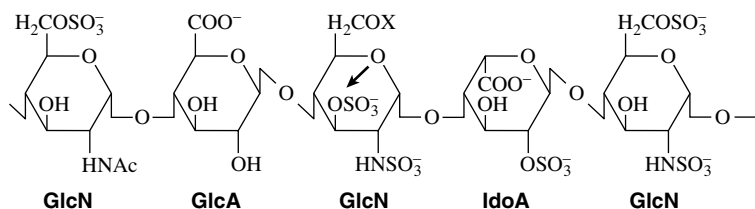

FIGURE 31-6 Pentasaccharide sequence of heparin. This sequence, unique in its high affinity for antithrombin III (binding site indicated by *arrow*), also reflects the general structure of heparin: repeating units of sulfate-substituted glucosamine (*GlcN*), glucuronic acid (*GlcA*), and iduronic acid (*IdoA*) residues. *Ac*, Acetyl group; *X*, H or SO_3^- .

Historically, such attempts have been frustrated by methodologic limitations and by the strong tendency of heparin to bind with proteins. An important feature of heparin's activities, and one that is obscured by a narrow focus on plasma heparin concentrations, is the fact that the vascular epithelium can concentrate heparin against a gradient of 100:1. It has been proposed that adsorbed heparin-like mucopolysaccharides (termed *heparans*) are major contributors to the normally strong electronegative charge maintained by the vascular epithelium. This property is made use of in the manufacture of prosthetic devices such as heart valves, in which ionizable heparin is incorporated into the surface plastic to inhibit thrombus generation.

Mechanism of action

Heparin interferes with blood coagulation in several ways. Heparin functions by binding tightly to the plasma protease inhibitor ATIII, causing a conformational change in the inhibitor that exposes its active site and accelerates its activity 1000-fold. ATIII is a "suicide" serine protease inhibitor that covalently binds to several serine proteases (factors IXa, Xa, and XIIa), resulting in the permanent inactivation of the protease and the ATIII protein. As a result, factor Xa-mediated conversion of prothrombin to thrombin does not occur, and because thrombin is unavailable, factors V, VIII, and XIII are also not activated. In the form of a true catalyst, heparin is not destroyed in this process. The heparin-ATIII complex dissociates on binding of a protease to ATIII, releasing intact heparin for renewed binding to another ATIII molecule.

At higher concentrations, the heparin-ATIII complex binds to and inactivates thrombin itself (also a serine protease), inhibiting its proteolytic action on fibrinogen. This occurs when the heparin-ATIII dimer forms a ternary complex with thrombin by the heparin binding to one site on the thrombin protein and ATIII binding the active site on the other side. These two sites are a significant distance from one another, and only the higher molecular weight moieties of heparin are capable of producing the effect. Molecules of less than 18 monosaccharides are incapable of reaching far enough across the protein to allow ATIII to bind and inhibit thrombin.

The effects of heparin on platelets are likewise complex. In part, because thrombin is not formed or is rendered inactive, platelet activation is usually reduced. More troubling, heparin may also sometimes induce independently of other aggregating agents a transient, anomalous platelet aggregation and significant thrombocytopenia in 1% to 5% of patients. Two varieties of heparin-induced thrombocytopenia (HIT) exist: a relatively benign nonimmune process and an immune-mediated process. The latter, known as type II, can be fatal in 30% of cases. It is believed that complexing of the heparin to platelet factor 4 results in antibody formation and subsequent activation of platelets. In this syndrome, the difficulty is not with bleeding, but with runaway thrombosis. As the platelets activate, they form thrombi, which account for much of the clinical presentation. As the platelets are used up, thrombocytopenia and bleeding occur. Patients with a history

of HIT are far more likely to have a repeat problem, as would be expected with immunologic phenomena.¹⁷

Heparin also exhibits an ability to promote lipid clearance from the bloodstream. In this capacity it releases and stabilizes lipoprotein lipase, which hydrolyzes the triglycerides of chylomicrons and very-low-density lipoproteins to free fatty acids, which can be rapidly absorbed by tissue cells. This effect occurs at low physiologic blood concentrations, and it has been shown that all heparin molecules are capable of activating lipoprotein lipase. Because the anticoagulant property of heparin and its antilipemic action depend on the presence of ATIII in the plasma, heparin cannot act as an anticoagulant in a system composed of isolated clotting factors alone, and it cannot function as a lipemia-clearing agent in the absence of cofactor.

Low-molecular-weight heparins

Much research activity has focused on the use of low-molecular-weight heparin (LMWH) fractions for the prevention of thrombosis.¹³ Unfractionated heparin consists of heterogeneous combinations of various-sized sulfated mucopolysaccharides. Because only high-molecular-weight heparins (heparins with ≥ 18 specific saccharide sequences) can bind thrombin and inactivate it, attention has turned to LMWHs. They are poor inhibitors of thrombin, but they retain the ability to catalyze ATIII to inhibit other serine proteases, most notably factor Xa. As a result, they have at least some advantage in that they exert antithrombotic activity without completely destroying the coagulant activity thrombin imparts on factors V, VIII, XII, and XIII. A problem with LMWHs is that they all are prepared by fractionating heparin, and different methods impart different ratios of anticoagulant and antithrombotic activity. Enoxaparin and dalteparin currently are the most commonly used medications in this class; the one selected by the physician depends on the degree of anticoagulation desired for the patient.

A synthetic pentasaccharide, fondaparinux, similar to LMWHs, has been marketed. This medication is a selective factor Xa inhibitor, and studies have shown that it is more effective than enoxaparin in preventing deep venous thrombosis after hip and knee surgery.¹¹ More specific products are likely to be developed that mimic the basic actions of heparin.

Absorption, fate, and excretion

All available forms of heparin must be administered parenterally because they are highly charged and rapidly hydrolyzed in the gastrointestinal tract. Unfractionated heparin is usually infused intravenously but may be given by deep subcutaneous or fat depot injection. It should not be injected intramuscularly because of the risk of deep muscle hematoma. Heparin has a dose-dependent biologic half-life of 1 to 5 hours when given intravenously, and it is removed primarily by the liver. Two distinct advantages of LMWHs are that they are generally administered subcutaneously, and their effects are prolonged compared with unfractionated heparin because they are less readily neutralized by platelet factor 4 (platelet antiheparin), which permits once-daily or

twice-daily dosing. LMWHs cause more release of t-PA and have less lipoprotein lipase-activating capacity than the unfractionated drug.

Heparin activity is best monitored by the partial thromboplastin time or the aPTT, both of which measure drug effects on the intrinsic pathway and are sensitive to low doses of heparin. The partial thromboplastin time is much less sensitive (and often completely normal) to LMWHs. Standardized doses of LMWHs achieve a more consistent anticoagulant effect, reducing the need for monitoring. The prothrombin time (PT), routinely used to monitor oral (indirect-acting) anticoagulants, is also of little value because it does not respond to inhibition of the thrombin-catalyzed part of the coagulation cascade, and heparin is diluted out in the procedure.

Antidotes

The action of heparin can be readily terminated by intravenous injection of one of several highly positively charged compounds, including protamine sulfate, toluidine blue dye, or hexadimethrine bromide. Only protamine is currently recommended for this purpose, however. Protamine is a highly basic compound that combines with heparin as an ion pair to form a stable complex that can no longer bind to ATIII. Because protamine may itself have anticoagulant (antithromboplastic) effects, only enough drug should be given to neutralize the heparin (approximately 1 mg protamine/100 U unfractionated heparin). The drug should be given slowly intravenously (5 mg/min) to avoid depression of the myocardium and vascular smooth muscle. Anticoagulant rebound is often seen after protamine administration because of more rapid clearance of protamine compared with heparin.

Other Direct-Acting Anticoagulants

Direct thrombin inhibitors

It has long been known that leeches secrete a potent anticoagulant in their saliva. In many centers, medicinal leeches (*Hirudo medicinalis*) are still used to help patients combat venous thromboembolic events. The active component has been isolated and identified as hirudin, a 65-amino acid polypeptide chain that is a specific direct thrombin inhibitor. It works by stoichiometrically binding to thrombin at two sites, the fibrinogen-binding site and the active protease site. It is the most powerful naturally occurring anticoagulant known.

Hirudin has many advantages over heparin. As a direct thrombin inhibitor, it is able to inhibit clot-bound thrombin that the heparin-ATIII complex cannot reach. As would be expected with a direct inhibitor, it also has caused more severe bleeds. A recombinant analogue, lepirudin, has been approved for the treatment of thrombosis associated with HIT. Because 50% of patients develop IgG antibodies against the hirudins, aPTT must be monitored closely.

Perhaps the most widely used direct thrombin inhibitor is bivalirudin, a semisynthetic analogue of hirudin consisting of 20 amino acids. It competes for the fibrinogen-binding site and the proteolytic site, effectively stopping all cleavage of fibrinogen to fibrin. Bivalirudin differs from hirudin in that it produces only transient inactivation of the thrombin protease site because the thrombin itself slowly acts on the bivalirudin to cleave it, and when cleaved it "falls off" the thrombin molecule, allowing fibrinogen to bind. This net effect means that it has a relatively short clinical half-life of 1 to 2 hours, but that is advantageous because it can be infused to prevent thrombosis before cardiac surgery and turned off shortly before the case to allow full clotting to occur in a predictable fashion. Bivalirudin was shown more recently to prevent blood clots better than heparin in patients undergoing angioplasty.²⁸ The drug is primarily cleared via intravascular

proteolysis and renal elimination in the urine; it has a significantly longer clinical half-life in patients with moderate-severe renal failure.

Several low-molecular-weight thrombin inhibitors have been developed. They bind to the active protease site of thrombin and inhibit its action. Argatroban is the only currently approved medication in this class. Argatroban has been associated with an increased mortality rate when treating patients with HIT type II.

Miscellaneous agents

Danaparoid functions similarly to heparin, but it is composed of a mixture of glycosaminoglycans, including heparan sulfate, dermatan sulfate, and chondroitin sulfate. It works primarily by binding with ATIII to diminish factor Xa activity and has been used to treat HIT type II.

Aprotinin is a broad-spectrum protease inhibitor. It selectively blocks the activation of the major thrombin receptor PAR-1. As discussed earlier, this platelet receptor is activated by thrombin cleaving a portion away, allowing the "new" N-terminus to autostimulate signal transduction. Aprotinin blocks this proteolytic cleavage, inhibiting the receptor from thrombin activation. It does not stop ADP-induced, collagen-induced, or epinephrine-induced activation of platelets because the receptors for those ligands do not require proteolytic cleavage, and it does not fully inhibit clot formation. The medication is often used during cardiopulmonary bypass surgery because it helps protect platelets from forming thrombi under the influence of thrombin liberated from platelets while in the bypass circuit.²³

Indirect-Acting Anticoagulants: Coumarin-Indanediones

Discovery of the prothrombin-depressant action of spoiled sweet clover by Roderick in 1929 led to the isolation and synthesis of dicumarol (bishydroxycoumarin) by Campbell and Link in the 1940s. These advances introduced a new era of relatively inexpensive, self-administered oral anticoagulant therapy. Since then, several other coumarin compounds have been introduced, as have drugs of a related group, the indanediones. Because there is little qualitative difference in the action of any of these agents, they are referred to here as a single group, the coumarin-indanediones. Indanediones are generally more toxic, however.

Mechanism of action

Indirect anticoagulants act by competitively inhibiting vitamin K epoxide reductase, an enzyme essential for the synthesis of many coagulation factors by the liver. (The structural similarity between these drugs and vitamin K is shown in Figure 31-7.) Vitamin K serves as a cofactor with oxygen and carbon dioxide in the γ -carboxylation of glutamic acid residues of several proteins, including the clotting factors II, VII, IX, and X and proteins C and S. The carboxylglutamic acid moieties formed are able to chelate Ca^{++} , which promotes conformational change and eversion of hydrophobic domains, allowing the factors to settle into the platelet or endothelial cell membrane and bind cofactors. Vitamin K is oxidized in the carboxylation process and must be reduced enzymatically to regain cofactor activity. Coumarin-indanediones inhibit this reduction (Figure 31-8).

The most sensitive indicator of vitamin K deficiency, or of dicumarol anticoagulation, is the depression of factor VII. Prothrombin (factor II) is the most resistant of the factors affected. This apparent ordering of sensitivity is a reflection of the plasma half-lives of the clotting factors. Factor VII is initially depressed because its half-life is only 4 to 8 hours. Prothrombin, with a half-life of 2 to 3 days, is the last to be diminished.

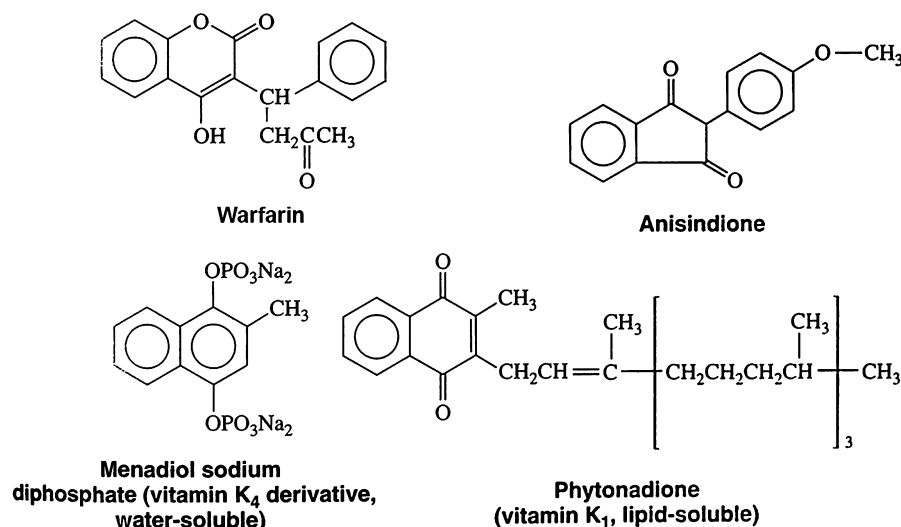

FIGURE 31-7 Structural formulas of several indirect-acting anticoagulants and analogues of vitamin K.

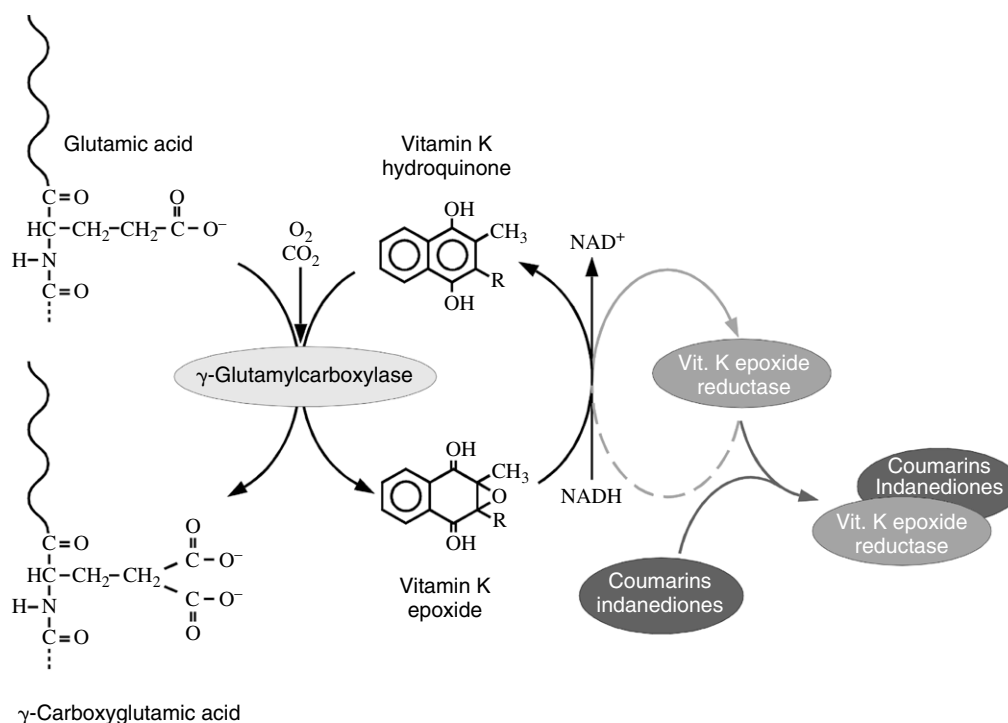

FIGURE 31-8 Inhibition of synthesis of vitamin K–dependent clotting factors by coumarin-indanedione anticoagulants. In the final post-translational modification of prothrombin (factor II), factor VII, factor IX, factor X, protein C, and protein S, vitamin K is oxidized to the epoxide in the process of carboxylating glutamic acid residues on the amino end of each protein. The resultant γ -carboxyglutamic acid groups serve to chelate Ca^{++} ions and conformationally change to expose a hydrophobic domain that settles into phospholipid membranes, anchoring the factors for normal hemostasis. The indirect-acting anticoagulants prevent the restoration of vitamin K by competitively inhibiting vitamin K epoxide reductase, the enzyme responsible for reducing vitamin K epoxide by nicotinamide adenine dinucleotide (NADH). R, Hydrocarbon side chain of vitamin K.

Because of the close relationship between hypovitaminosis K and spontaneous hemorrhaging in patients and animals receiving coumarin-indanedione drugs, it is generally assumed that there is a direct causal relationship between coagulation impairment and hemorrhage. This has never been proved,

however, and there is reason to doubt that the incoagulability of blood per se is sufficient to cause spontaneously leaky vessels. Vitamin K may have physiologic functions not yet fully realized, including an important role in carboxylation of bone proteins necessary for Ca^{++} binding.

Adverse effects

Indirect anticoagulants notably produce adverse reactions in the presence of certain drugs and medical conditions. These effects most often arise from interference with vitamin K absorption or metabolism, competition for the drug-binding sites of proteins, or competition for or activation of the hepatic microsomal enzymes responsible for biotransformation. The most important toxic effect of coumarin-indanediones is hemorrhage.

Any change in the absorption or availability of vitamin K from the intestine affects the balance between the anticoagulant and vitamin K in the liver and is reflected in the PT. A decrease in vitamin K uptake may result from a disease such as sprue (biliary stasis with concomitant loss of fat-emulsifying bile salts) or from the use of mineral oil as a laxative. In patients with marginal amounts of vitamin K in the diet, it can reflect the depressed bacterial synthesis of vitamin K in the intestine resulting from administration of a wide range of antimicrobial agents. A great deal of attention has been directed in recent years to the effects of oral contraceptive agents on the blood coagulation mechanism. In this regard, oral estrogen, such as that used in contraceptive preparations, greatly increases vitamin K₁ absorption in experimental animals.²¹

Coumarin compounds are highly protein-bound in the plasma (warfarin approximately 99%). This association creates a tremendous reserve of drug in the bloodstream, a very small displacement of which could easily double the concentration of active free drug. Many unrelated compounds that are highly protein-bound theoretically may compete for this protein binding by coumarins and potentiate their action. Examples of drugs reported to compete successfully with indirect anticoagulants for albumin binding sites are some anti-inflammatory drugs; the antiepileptic agent phenytoin; and clofibrate, a drug capable of lowering blood cholesterol. It has been suggested that part of the salicylate potentiation of dicumarol may also result from this kind of mechanism.

Only trace amounts (approximately 1%) of coumarin-type anticoagulants are excreted unchanged; hepatic biotransformation serves as the principal route of elimination. Warfarin is a racemic mixture of an R-enantiomer and S-enantiomer. The R-enantiomer, a weak anticoagulant, is metabolized primarily by CYP1A2, with CYP2C19 and CYP3A4 providing minor pathways. The S-enantiomer, a potent anticoagulant, is metabolized by CYP2C9. Medications that either inhibit or induce these various hepatic microsomal enzymes may affect the patient's response to warfarin. Certain agents, particularly rifampin, phenytoin, and the barbiturates (including phenobarbital, which is only partially metabolized), are capable of hepatic microsomal enzyme induction, which tends to decrease plasma concentrations of coumarin compounds. Microsomal enzyme induction may also occur with chloral hydrate, ethanol, and other drugs. In some instances, a reverse sensitization may be shown in which coumarin compounds potentiate these and other drugs by inhibiting their metabolism through competition for microsomal enzymes or, more important, are potentiated, leading to overaccumulation of anticoagulant and generalized hemorrhaging. Drug-warfarin interactions are listed in Box 31-2.

Many other drug interactions regarding oral anticoagulant agents do not involve vitamin K absorption, carrier protein displacement, or biotransformation. Aspirin, ibuprofen, and clopidogrel are representative drugs that inhibit platelet function. When administered concurrently with warfarin, their combined influences on the coagulation cascade may result in uncontrolled bleeding. Finally, there are many still unexplained interactions, such as the lethal hemorrhagic

effects of adrenocorticotropin, reserpine, and various stress situations.

Antidotes

Except in situations in which an emergency demands the replacement of whole blood or plasma, the usual antidote for coumarin-indanedione toxicity is vitamin K administered parenterally in high concentrations. Because coumarin-indanediones inhibit recycling of vitamin K, simple administration of more "fresh" vitamin K obviates the need for recycling the epoxide form immediately. This therapy depends on the temporal synthesis of clotting factors, and significant shortening of PT cannot be expected to occur for several hours. Of the two major congeners, vitamin K₁ (naturally occurring, lipid-soluble phytonadione) and vitamin K₄ (as water-soluble menadiol salts), the more efficient drug is vitamin K₁. Natural vitamin K₁ is not water-soluble, but it is now available in solubilized form (with a polyoxyethylated fatty acid derivative), reducing the hazard of injecting an emulsion intravenously and the added delay of oral administration. Subcutaneous or intramuscular administration provides obvious improvement in coagulation in 1 to 3 hours, but normal hemostasis may not be achieved for 24 hours.

Similarly, minor correction in an anticoagulated PT is seen if patients ingest significant amounts of vitamin K via their diet. Liver, broccoli, Brussels sprouts, spinach, Swiss chard, collards, and other green leafy vegetables that are high in vitamin K can add enough vitamin K to shift the patient's anticoagulation profile in a few hours after ingestion. This technique is often used by anticoagulation clinics to "fine-tune" a patient before dental surgery if they are close to, but not quite under, their target PT international normalized ratio (INR).

Anticoagulants: General Pharmacologic Characteristics and Therapeutic Uses

The principal pharmacologic actions of direct-acting and indirect-acting anticoagulants interfere with some step in the blood coagulation process. Beyond this, neither direct-acting nor indirect-acting anticoagulants have outstanding effects on the cardiovascular, respiratory, or other systems except in the case of coumarin-type agents through competition with other drugs for protein binding sites and drug-metabolizing enzymes.

There are many indications in medicine for the use of anticoagulants, including myocardial infarction, cerebrovascular thrombosis, pulmonary embolism, venous thrombosis, rheumatic heart disease, mechanical cardiac valves, and renal dialysis. Cardiovascular compromise, such as that seen in atrial fibrillation or congestive heart failure, causes decreased flow of blood and presents a greater risk for thrombosis in areas of stasis. Atherosclerotic plaques, especially in hypertensive patients, are risks for intimal tears, with resultant thrombus formation. Heparin and oral anticoagulants are useful in the prevention and treatment of these disorders. Heparin, although it is costly and requires parenteral administration, acts immediately and is more effective than coumarin-indanediones in arterial thrombosis. Oral anticoagulants, most commonly warfarin, provide a less expensive, more easily administered, and more readily controlled form of sustained therapy. It has become commonplace to see patients treated with anticoagulants for long periods for these various reasons, and anticoagulation clinics are a staple in most medical centers. The dentist must be able to manage such patients appropriately without causing undue harm either from excessive bleeding or from increased thrombosis risk.

BOX 31-2

*Drug-Drug Interactions Involving Coumarin-Indanedione Derivatives***Drugs That May Increase Response of Coumarin-Indanedione Derivatives**

Acetaminophen	Diflunisal	Ketoprofen	Streptokinase
Alcohol (acute intoxication)	Disulfiram*	Lovastatin	Sulfinpyrazone
Allopurinol	Erythromycin	Meclofenamate	Sulfonamides
Aminosalicylic acid	Ethacrynic acid	Mefenamic acid	Sulindac
Amiodarone*	Fenofibrate	Methylthiouracil	Tamoxifen
Anabolic steroids	Fenoprofen	Metronidazole*	Tetracyclines
Azithromycin	Fluoroquinolones	Miconazole	Thiazides
Capecitabine	Fluoxetine	Nalidixic acid	Thyroid drugs
Cefixime	Flutamide	Neomycin (oral)	Tramadol
Celecoxib	Fluvastatin	Pentoxifylline	Tricyclic antidepressants
Chloral hydrate	Fluvoxamine	Phenylbutazone*	Urokinase (u-PA)*
Chloramphenicol	Gemfibrozil	Propafenone	Vitamin E
Cimetidine	Glucagon	Propoxyphene	Zafirlukast
Clofibrate	Ibuprofen	Propylthiouracil	Zileuton
Co-trimoxazole	Indomethacin	Quinidine	
Danazol	Influenza virus vaccine	Salicylates*	
Diazoxide	Isoniazid	Sertraline	

Dietary or Herbal Supplements That May Increase Response to Coumarin-Indanedione Derivatives

Agrimony	Bromelains	<i>Ginkgo biloba</i>	Poplar
Alfalfa	Buchu	Ginseng (<i>Panax</i>)	Prickly ash (northern)
Aloe gel	Capsicum	Horse chestnut	Quassia
Angelica (dong quai)	Cassia	Horseradish	Red clover
Aniseed	Celery	Inositol nicotinate	Senega
Arnica	Chamomile (German/Roman)	Licorice	Sweet clover
Asafetida	Clove	Meadowsweet	Sweet woodruff
Aspen	Dandelion	Nettle	Tamarind
Black cohosh	Fenugreek	Onion	Tonka beans
Black haw	Feverfew	Parsley	Wild carrot
Bladderwrack (<i>Fucus</i>)	Garlic	Passion flower	Wild lettuce
Bogbean	German sarsaparilla	Pau d'arco	Willow
Boldo	Ginger	Policosanol	Wintergreen

Drugs That May Decrease Response to Coumarin-Indanedione Derivatives

Alcohol (chronic alcoholism)*	Corticosteroids	Methaqualone	Spironolactone
Aminoglutethimide	Corticotropin	Nafcillin	Trazodone
Atorvastatin	Ethchlorvynol	Oral contraceptives containing estrogens*	Sucralfate
Barbiturates*	Glutethimide	Raloxifene	Vitamin K
Carbamazepine	Griseofulvin	Rifampin	
Clozapine	Mercaptopurine		

Dietary or Herbal Supplements That May Decrease Response to Coumarin-Indanedione Derivatives

Agrimony	Goldenseal	St. John's wort
Coenzyme Q10 (ubidecarenone)	Mistletoe	Yarrow

From *American Hospital Formulary Service Drug Information*, Bethesda, MD, 2002, American Society of Health-System Pharmacists.

*Concurrent use should be avoided if possible.

PLATELET INHIBITORS

As is discussed in Chapter 21, drugs that interfere with platelet function are increasingly being recommended for prophylaxis of arterial and venous thrombosis. In recent years, many different agents have been developed and marketed successfully. These agents can be divided into three essential groups: COX inhibitors, ADP receptor inhibitors, and GP IIb/IIIa inhibitors. Each has unique characteristics in managing thrombosis, and the dentist is likely to find patients with one or more of these medications in their drug profiles.

Cyclooxygenase Inhibitors

Aspirin (acetylsalicylic acid) is the prototypic and most commonly recognized COX inhibitor. Inexpensive and readily available, it is prescribed in doses of 81 to 325 mg/day to reduce the risk of myocardial infarction, particularly in men with a history of unstable angina, or in any patient at risk for myocardial infarction or ischemic stroke or both. The antihemostatic effect of aspirin is ascribed to irreversible acetylation of COX-1 isozyme. (The COX-2 isozyme is also inhibited, but is involved in inflammatory and pain pathways; aspirin is a more potent inhibitor of COX-1 than

COX-2, which explains its ability to impart antithrombotic activity at much lower doses than pain control requires.) COX-1 is required to synthesize platelet TXA₂ from arachidonic acid. Disruption of this pathway results in decreased platelet ADP release and aggregation. Because platelets are incapable of synthesizing new COX, the inhibition by aspirin lasts for the life of the platelet. The seemingly fortuitous effect on TXA₂ may be offset theoretically by a similar inhibition of prostacyclin synthesis in the vascular endothelium, which could facilitate thrombotic activity. The nonreversible nature of this inhibition and the relative insensitivity of COX-2–dependent prostacyclin synthesis to aspirin remove this concern, however.

When aspirin therapy is used in combination with thrombolytic therapy after acute myocardial infarction, there are significant reductions in mortality rate and in the incidence of major complications.²⁹ Ibuprofen has been shown to prevent the platelet inhibition of aspirin. In one study, aspirin was given either 2 hours before or 2 hours after acetaminophen, ibuprofen, or diclofenac. When ibuprofen was given before the aspirin, a 54% decrease in the TXB₂ (a stable metabolite of TXA₂) effect was seen. In all other arms of the study, no change was noted.⁸

Adenosine Diphosphate Receptor Inhibitors

As described earlier, ADP binds to its own receptor proteins P2Y₁ and P2Y₁₂, which results in maximal aggregation of the platelets to one another. The thienopyridine compounds ticlopidine and clopidogrel are two medications currently available that irreversibly inhibit the P2Y₁₂ receptor by what is believed to be a covalent bond to the receptor. Ticlopidine is more toxic and infrequently administered, leaving clopidogrel as the clear favorite in this drug class. Both are inactive until metabolized in the liver to their active forms. Because they bind only to the P2Y₁₂ receptor, the P2Y₁-mediated ADP effects still occur. This results in the platelets still undergoing shape change and transient aggregation, but sustained aggregation and potentiation of granule secretion are inhibited. Clinically, patients are likely to have sustained bleeding as a result of the action of these drugs. No reversal agents are available. Because the inhibition lasts the lifetime of the platelet, stopping antiplatelet therapy for 3 to 7 days before invasive surgery may be necessary to synthesize sufficient unaffected platelets.¹⁵

A new thienopyridine drug, prasugrel, is undergoing final approval by the U.S. Food and Drug Administration, but has been delayed several times from entering the market. It is pharmacologically similar to clopidogrel. Another drug, cangrelor, is a nonthienopyridine drug that inhibits the P2Y₁₂ receptor in a similar manner to the thienopyridines but has a much shorter half-life. It would theoretically have a unique position in hospital environments when more precise control over platelet aggregation is desired.

Glycoprotein IIb/IIIa Receptor Inhibitors

Activation of GP IIb/IIIa receptors is a crucial near-final step in platelet aggregation, and platelets genetically deficient in these receptors (i.e., Glanzmann thrombasthenia) display a much more profound inhibition to aggregation than platelets altered by the limited effects of aspirin or thienopyridines. As a result, attention has been focused on developing agents that can antagonize the GP IIb/IIIa receptors. The first agent, abciximab, is a mouse-human chimeric monoclonal antibody protein. The highly variable region of the antibody is from the mouse and is directed against the human GP IIb/IIIa protein complex. The Fc region is human, however, so as to not engender an immunogenic response. The medication has also been shown to bind to the vitronectin receptor on the endothelial cells, contribut-

ing further to its antithrombotic activity. No allergic or anaphylactic reactions have been reported, but the medication can result in severe thrombocytopenia.

Molecular analysis of the GP IIb/IIIa receptors indicates that they recognize a specific arginine-glycine-aspartic acid (RGD) sequence found in many of the adhesive molecules to which they bind (e.g., vWF). As a result, peptide analogues have been developed to bind at this RGD sequence and compete for the active sites. (Similarly, the venom of several species of viper contains peptides with similar RGD homologous features; these peptides are referred to as *disintegrins* and are known to bind to the GP IIb/IIIa receptors in an antagonistic fashion.³⁰) Cyclic peptides bind better than linear ones, and one that is currently available is the peptide eptifibatid. Rather than an RGD sequence, it has a lysine-glycine-aspartic acid (KGD) sequence that imparts improved specificity for the GP IIb/IIIa receptor.

Finally, various nonpeptide agents that can compete for binding with the GP IIb/IIIa receptor have been developed. Similar to eptifibatid, they have structure and charge characteristics that mimic the RGD sequence and compete for the receptor's docking. Not being peptides, they have the advantage that they might be engineered to be orally acting. Currently, tirofiban (a tyrosine derivative) and lamifiban have been approved. In addition, lotrafiban is currently undergoing evaluation.

Herbal and Dietary Supplements

There is great academic interest in the surging herbal and dietary supplement use in current society and whether these agents may have pharmacologic action. Many of these agents have been implicated in directly modifying the coagulation status of patients or indirectly interacting with Western medications to increase or decrease their pharmacokinetic profiles (see Box 31-2). Chapter 56 discusses in detail the current knowledge about many of these compounds. As more data become available, it will be necessary for the dentist to be knowledgeable about what these medications might do in a patient who requires dentoalveolar or other oral surgery.

IMPLICATIONS FOR DENTISTRY

Anticoagulants

There are no accepted indications for the use of anticoagulants in the practice of dentistry. Many patients requiring dental treatment receive some form of medical anticoagulation therapy, however, for the reasons previously cited. These patients present three kinds of problems to the dentist: (1) their therapeutic regimen may result in excessive bleeding after oral or periodontal surgery, unless there is appropriate prior modification; (2) modification of their therapeutic regimen in preparation for surgery may predispose them to thromboembolic events; and (3) they may present a real danger of drug interaction between their anticoagulants and agents commonly used in dental practice, such as some analgesics, antibiotics, and sedatives. It is essential for the dentist to have a complete and thorough knowledge of the patient's drug history and what options are available when treating patients in whom anticoagulant therapy is involved.

Any intended oral surgical therapy in anticoagulated patients requires preliminary planning and consultation with the patient's physician or anticoagulation clinic. Coumarin-indanone anticoagulants are monitored by the PT, which is now expressed in INR units. The PT test is performed by adding a source of TF and Ca⁺⁺ to a patient's citrated blood sample and measuring the time necessary to coagulate the

sample. Previously, this value has been expressed in seconds or as a ratio of the patient's value to a laboratory-specific control. Because various laboratories use TF from different sources (human, rabbit, recombinant), there have been wide variations in the reported values and the resulting amount of anticoagulation. In an effort to normalize the activity of the various forms of TF, a formula has been developed that accounts for the inherent sensitivities of TF and individual laboratory methods. The resultant ratio, the INR, can be compared with any other INR value with high accuracy.² The test should not be called "the INR" because the assay is the PT, with the results reported as an INR. Other tests, such as aPTT, are likely to have INR units attached to them soon.

Because the PT INR is derived from an exponential formula, small changes in anticoagulation result in large changes in the PT INR value as the anticoagulation progresses. It is generally agreed that for coumarin-indanediones a PT INR value of 2.0 to 3.0 is considered ideal for most medical conditions. Prosthetic heart valves and other instances in which more anticoagulation is required generally have a target value of 2.5 to 3.5. Although there are no official recommendations from the American Dental Association on the topic of PT INR and dental treatment, one report recommends that a PT INR of 4.0 be used as the upper limit for simple oral surgical procedures and that a maximum of 3.0 be targeted for procedures likely to result in significant blood loss, such as multiple extractions with alveoloplasty.⁷ The authors state, and others have agreed,^{7,10,20,22} that it is unusual to have significant clinical bleeding when the PT INR is less than 3.0.

If a patient is anticoagulated to a high PT INR value, the dentist should consult with the physician about the possibility of reducing the anticoagulation to an acceptable PT INR, as shown in Figure 31-9. A unilateral request by a dentist for a

patient to discontinue or decrease coumarin without consulting the physician is at best poor medical practice because medicolegally, even if the coumarin is ultimately decreased, the physician is the appropriate individual to alter and follow the dosages perioperatively. This adjustment may take several days to a week to accomplish. Current medical practice often places the responsibility of the anticoagulation management with an anticoagulation clinic that tracks the PT INR on a consistent basis, and such a clinic is a reliable resource to help guide the dentist and patient in making therapeutic decisions. Some patients have erratic responses to the coumarin class of anticoagulants, with unpredictable highs and lows in the PT INR despite the best efforts of the medical team to stabilize it. In these patients, the prudent dentist obtains a PT INR on the day of surgery and is prepared to reschedule the appointment if the value is too high to be safe. In the emergent patient, reversal with vitamin K and use of local hemostatic measures (collagen plugs, suturing, topical thrombin, fibrin sealant) may be indicated; in severe cases, the administration of fresh frozen plasma may be necessary.

If the anticoagulant is intravenous heparin, the drug may be withheld by the physician for 1 to 6 hours. This time interval is dose-dependent. If the heparin is to be restarted after surgery, typically waiting at least 1 hour is advisable to allow time for the clot to form fully. The use of local hemostatic agents may be considered for further hemorrhage control; in rare cases, protamine infusion may be necessary. Note that subcutaneous "maintenance" heparin absorbs into the bloodstream at such a slow rate that it can be effectively ignored in terms of dental bleeding issues.

Patients who are taking a LMWH such as enoxaparin present a dilemma. Because LMWHs stimulate ATIII to be active against factor Xa but are not very effective against thrombin (factor IIa), the PT and aPTT in these patients are usually normal. A special factor Xa assay (costly and not

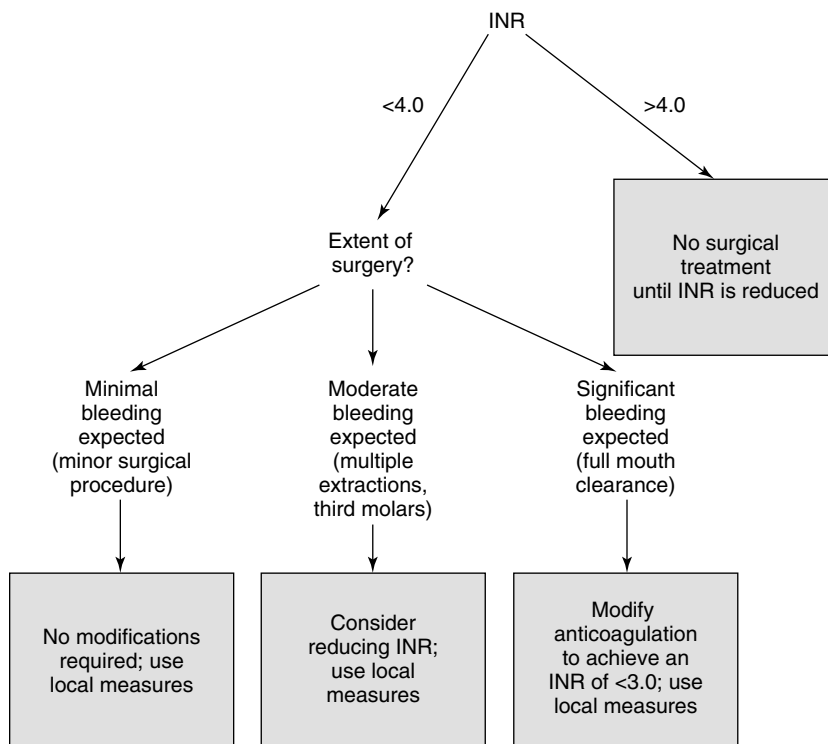

FIGURE 31-9 Flow chart for determining the appropriateness of dental therapy based on the prothrombin time. INR, International normalized ratio. (From Beirne OR, Koehler JR: Surgical management of patients on warfarin sodium, *J Oral Maxillofac Surg* 54:1115-1118, 1996.)

always available in every medical center) is used to monitor these medications when needed. The question arises as to what a dentist should do when patients are using these agents on a daily basis. Data are limited; one author suggests that the LMWH should be discontinued for 12 hours before the surgical event.³⁴ It can be argued, however, that for simple surgical procedures (e.g., dentoalveolar surgery, periodontal surgery), if there is sufficient thrombin generation to maintain the aPTT at a normal value, perhaps no adjustment to the regimen needs to be made. Anecdotal evidence supports this latter concept. Until proper research data become available, it is advisable to discuss each situation with the physician and arrive at a consensus decision.

Several studies have shown that postoperative bleeding after minor oral surgery, including tooth extraction, is not significantly affected by long-term aspirin therapy.⁶ Although such studies are not currently available with respect to thienopyridines such as clopidogrel—either taken alone or with aspirin—an advisory report regarding patients with coronary artery stents states “there is little or no indication to interrupt antiplatelet drugs for dental procedures.”¹⁶ This conclusion is based on a paucity of reported bleeding problems after dental procedures, easy access to the affected tissues, and the high effectiveness of local measures in controlling oral bleeding. Should unusual circumstances dictate the need to restore platelet function to normal before treatment, withholding antiplatelet drugs for 3 to 7 days may be necessary because of the irreversible nature of the antiplatelet actions of aspirin and clopidogrel. The patient’s physician should be involved in any plan to limit antiplatelet therapy. Local measures coupled with platelet transfusion as required may be necessary if the clinical situation is emergent or too risky to have the patient off these medications for several days.

Hemophilics

Managing a patient with hemophilia and other coagulopathies has become significantly easier in recent years, but many issues require careful consideration before proceeding. Patients who were previously believed to be unable to undergo operative procedures are now being treated routinely in many hospitals and dental offices. The most difficult problem a hemophilic faces is not the threat of exsanguination from a small laceration, but rather the problems encountered from a massive muscle bleed or chronic joint disease resulting from hemarthroses. In dentistry, there are many procedures that potentially can cause significant bleeding in a hemophilic. Surgical procedures must be planned so that replacement factor can be given preoperatively and postoperatively.

An important issue involves prediction of where an uncontrolled hematoma might develop in the head and neck region. Any potential space that might support the movement of blood through fascial planes toward crucial structures (e.g., the airway or major blood vessels) needs to be considered for “vented” wound management. In these areas, suturing to a tight, primary closure is contraindicated to allow any accumulation of blood to drain preferentially into the oral cavity and be identified rather than fill crucial spaces. Conversely, whenever the wound site is sufficiently removed from worrisome dissection paths (e.g., an anterior frenectomy), closure can be sutured tightly to help control localized bleeding. For similar reasons, the dentist must take care that inferior alveolar or posterior superior alveolar nerve block injections of local anesthetic are adequately covered by factor replacement to reduce the risk of hemorrhage into muscle or one of the parapharyngeal areas or both. The use

of a commercial intraosseous anesthetic delivery system is indicated for patients in whom block anesthesia is contraindicated. Profound anesthesia usually can be easily obtained with minimal hemorrhage risk when these systems are used in hemophilics.

Associated disorders that commonly occur with hemophilics also may affect the delivery of dental care. Hemophilics often have joint disorders resulting from hemarthrosis. Any spontaneous or trauma-induced bleeding into the synovial space of a joint may cause permanent damage if inflammatory by-products, produced as the blood breaks down, damage the surrounding cartilaginous and bony structures. Knees, ankles, and elbows are most commonly affected, and many hemophilics have permanent limitation of motion in their joints by the time they reach adulthood. Joint replacement surgery is common in patients with severe hemophilia. As a result, mobility in and out of the operatory and positioning in the chair itself may be compromised.

Because of the historic necessity of transfusing hemophilics with pooled human blood products before recombinant factor replacements were available or the products were treated with heat or solvent detergent to inactivate viruses, many hemophilic patients were infected with HIV, hepatitis B virus, and hepatitis C virus. Seroconversion to HIV began around 1979 and accelerated rapidly until the mid-1980s. Many of these patients have since died. Screening donors began in the 1970s for hepatitis B, in 1985 for HIV, and in 1990 for hepatitis C. This screening has significantly reduced, but not eliminated, the viral risk. Noninfected hemophilics (primarily children and teens) are now being given recombinant factor replacements, whereas infected hemophilics more often select pooled human-derived, virally inactivated products. In uninfected patients for whom no recombinant factor replacement is available, and especially in families with vWD that is not responsive to desmopressin, the use of single-donor cryoprecipitate (usually a family member) for all necessary transfusions has proved effective in reducing the risk for viral transmission.

When surgical procedures are required in hemophilics, it is imperative that the dentist work closely with a hematologist well versed in the care of these patients. The dentist should describe the nature of the proposed surgery, the expected amount of bleeding, and the normal postoperative course after the procedure. In this way, the hemophilia treatment center can best plan how much and which kinds of factor replacement (or other pharmacologic intervention, such as desmopressin) are most appropriate. Depending on the training, location (office versus hospital), and experience of the treating dentist, the blood product or factor replacement may be given in the dental office, the medical office, or perhaps at home by the patient. Most of the products have an in vivo half-life of several hours, allowing the patient to receive the product at another site and go to the dental office for treatment with no reduction in hemostatic ability.

The normal healing mechanism of a wound site involves breakdown and re-establishment of newer fibrin matrices as the tissue heals. In a patient with a coagulopathy, the normal breakdown of fibrin can result in a rebleeding episode a few days later. Stabilization of the clot with an antifibrinolytic medication such as aminocaproic acid helps reduce the incidence of bleeding episodes for several days postoperatively. In many cases, the use of aminocaproic acid can greatly reduce or eliminate the need for additional blood or factor replacement. Adjunctive measures, such as the use of local hemostatic agents (microfibrillar collagen, suturing, or fibrin sealant), may also be helpful.

AGENTS THAT AFFECT COAGULATION AND HEMOSTASIS

<i>Nonproprietary (generic) name</i>	<i>Proprietary (trade) name</i>
Astringents-styptics	
Aluminum chloride	Hemodent
Tannic acid	In tea bags
Vasoconstrictor	
Epinephrine	Adrenalin
Topical procoagulants	
Absorbable gelatin film	Gelfilm
Absorbable gelatin powder	Gelfoam
Absorbable gelatin sponge	Gelfoam, Surgifoam
Absorbable gelatin sponge with thrombin (human)	Gelfoam Plus
Carboxymethylcellulose	In Orabase
Fibrin sealant (human)	Artiss, Tisseel
Gelatin matrix with thrombin (human)	FloSeal
Microfibrillar collagen	Avitene
Oxidized cellulose	Oxycel
Oxidized regenerated cellulose	Surgicel
Thrombin (bovine)	Thrombin-JMI
Thrombin (recombinant)	RECOTHROM
Systemic procoagulants	See Table 31-3
Fibrinolytics	
Alteplase (t-PA)	Activase
Anistreplase*	Eminase
Fibrinolytin, human*	In Elase
Retepase	Retavase
Streptokinase	Streptase
Tenecteplase	TNKase
Urokinase (u-PA)	Abbokinase
Fibrinolysis inhibitors	
Aminocaproic acid	Amicar
Aprotinin	Trasylo
Tranexamic acid*	Cyklokapron
Direct-acting anticoagulants	
<i>Unfractionated heparin, heparinoids</i>	
Danaparoid*	Orgaran
Heparin [†]	—
<i>Low-molecular-weight heparins</i>	
Ardeparin	Normiflo
Dalteparin	Fragmin
Enoxaparin	Lovenox
Fondaparinux	Arixtra
Tinzaparin	Innohep
<i>Direct thrombin inhibitors</i>	
Argatroban	Novastan
Bivalirudin	Angiomax
Hirudin	<i>Hirudo medicinalis</i> [‡]
Lepirudin	Refludan
Indirect-acting anticoagulants	
Anisindione*	Miradon

<i>Nonproprietary (generic) name</i>	<i>Proprietary (trade) name</i>
Dicumarol* (bishydroxycoumarin)	—
Phenindione*	Hedulin
Warfarin	Coumadin, Jantoven
Antidotes for anticoagulants	
Menadiol* (vitamin K ₄)	Synkayvite
Menadione (vitamin K ₃)	—
Phytonadione (vitamin K ₁)	Mephyton
Protamine sulfate	—
Platelet inhibitors	
Abciximab	ReoPro
Aspirin	—
Clopidogrel	Plavix
Cangrelor*	—
Dipyridamole	Persantine
Eptifibatide	Integrilin
Ticlopidine	Ticlid
Tirofiban	Aggrastat

*Not currently available in the United States.

†Available in calcium and sodium salts.

‡Organism of origin.

CITED REFERENCES

- Andrews RK, Berndt MC: Platelet adhesion: a game of catch and release. *J Clin Invest* 118:3009-3011, 2008.
- Beirne OR, Koehler JR: Surgical management of patients on warfarin sodium. *J Oral Maxillofac Surg* 54:1115-1118, 1996.
- Bick RL: Disseminated intravascular coagulation and related syndromes: a clinical review. *Semin Thromb Hemost* 14:299-338, 1988.
- Blockmans D, Deckmyn H, Vermeylen J: Platelet activation. *Blood Rev* 9:143-156, 1995.
- Brennan M: Fibrin glue. *Blood Rev* 5:240-244, 1991.
- Brennan MT, Valerin MA, Noll JL, et al: Aspirin use and post-operative bleeding from dental extractions. *J Dent Res* 87:740-744, 2008.
- Campbell J, Alvarado F, Murray RA: Anticoagulation and minor oral surgery: should the anticoagulation regimen be altered? *J Oral Maxillofac Surg* 58:131-135, 2000.
- Catella-Lawson F, Reilly MD, Kapoor SC, et al: Cyclooxygenase inhibitors and the antiplatelet effects of aspirin. *N Engl J Med* 345:1809-1817, 2001.
- Collen D, Topol EJ, Tiefenbrunn AJ, et al: Coronary thrombolysis with recombinant human tissue-type plasminogen activator: a prospective, randomized, placebo-controlled trial. *Circulation* 70:1012-1017, 1984.
- Devani P, Lavery KM, Howell CJ: Dental extractions in patients on warfarin: is alteration of anticoagulant regime necessary? *Br J Oral Maxillofac Surg* 36:107-111, 1998.
- Eriksson B, Bauer KA, Lassen MR, et al: Fondaparinux compared with enoxaparin for the prevention of venous thromboembolism after hip-fracture surgery. *N Engl J Med* 345:1298-1304, 2001.
- Esmon CT: The regulation of natural anticoagulant pathways. *Science* 235:1348-1352, 1987.
- Frydman A: Low-molecular-weight heparins: an overview of their pharmacodynamics, pharmacokinetics, and metabolism in humans. *Haemostasis* 26(Suppl 2):24-38, 1996.
- Gachet C: ADP receptors of platelets and their inhibition. *Thromb Haemost* 86:222-232, 2001.
- Ginsburg D, Bowie EJW: Molecular genetics of von Willebrand disease. *Blood* 79:2507-2519, 1992.
- Grines CL, Bonow RO, Casey DE Jr: Prevention of premature discontinuation of dual antiplatelet therapy in patients with coronary artery stents: a science advisory from the American Heart

- Association, American College of Cardiology, Society for Cardiovascular Angiography and Interventions, American College of Surgeons, and American Dental Association, with representation from the American College of Physicians. *J Am Dent Assoc* 138:652-655, 2007.
17. Hammeke M: Heparin-induced thrombocytopenia type II: criteria for diagnosis and options for treatment. *University of Washington Drug Therapy Topics* 31:11-16, 2002.
 18. Harrison P, Cramer EM: Platelet α -granules. *Blood Rev* 7:52-62, 1993.
 19. Hazinski MF, Cummins RO, Field JM, editors: *2008 handbook of emergency cardiac care for healthcare providers*, Dallas, 2008, American Heart Association.
 20. Jeske AH, Suchko GD: Lack of a scientific basis for routine discontinuation of oral anticoagulation therapy before dental treatment. *J Am Dent Assoc* 143:1492-1497, 2003.
 21. Jolly DW, Craig C, Nelson TE Jr: Estrogen and prothrombin synthesis: effect of estrogen on absorption of vitamin K1. *Am J Physiol* 232:H12-H17, 1977.
 22. Kearon C, Hirsch J: Management of anticoagulation before and after elective surgery. *N Engl J Med* 336:1506-1511, 1997.
 23. Landis RC, Haskard DO, Taylor KM: New anti-inflammatory and platelet-preserving effects of aprotinin. *Ann Thorac Surg* 72:S1808-S1813, 2001.
 24. Lemon RR, Steele PJ, Jeansonne BG: Ferric sulfate hemostasis: effect on osseous wound healing, I: left in situ for maximum exposure. *J Endod* 19:170-173, 1993.
 25. Macik BG: Treatment of factor VIII inhibitors: products and strategies. *Semin Thromb Hemost* 19:13-24, 1993.
 26. Parise LV, Smyth SS, Shet AS, et al: Platelet morphology, biochemistry, and function. In Lichtman MA, Beutler E, Kipps TJ, et al, editors: *Williams hematology*, ed 7, New York, 2006, McGraw-Hill.
 27. Rakocz M, Mazar A, Varon D, et al: Dental extractions in patients with bleeding disorders: the use of fibrin glue. *Oral Surg Oral Med Oral Pathol* 75:280-282, 1993.
 28. Ramana RK, Lewis BE: Percutaneous coronary intervention in patients with acute coronary syndrome: focus on bivalirudin. *Vasc Health Risk Manag* 4:493-505, 2008.
 29. Ranjadayalan K, Umachandran V, Timmis AD: Clinical impact of introducing thrombolytic and aspirin therapy into the management policy of a coronary care unit. *Am J Med* 92:233-238, 1992.
 30. Smith JB, Theakston RD, Coelho AL, et al: Characterization of a monomeric disintegrin, ocellatusin, present in the venom of the Nigerian carpet viper. *Echis ocellatus*, *FEBS Lett* 512:111-115, 2002.
 31. Thompson AR: Factor IX concentrates for clinical use. *Semin Thromb Hemost* 19:25-36, 1993.
 32. Thompson AR: Molecular biology of the hemophilias. *Prog Hemost Thromb* 10:175-214, 1991.
 33. Thompson AR: Recombinant factor IX for the treatment of hemophilia B. *Semin Hematol* 35(suppl 2):1-3, 1998.
 34. Todd D, Roman A: Outpatient use of low-molecular weight heparin in an anticoagulated patient requiring oral surgery: case report. *J Oral Maxillofac Surg* 59:1090-1092, 2001.
 35. Wohner N: Role of cellular elements in thrombus formation and dissolution. *Cardiovasc Hematol Agents Med Chem* 6:224-228, 2008.
 36. Woody RD, Miller A, Staffanou RS: Review of the pH of hemostatic agents used in tissue displacement. *J Prosthet Dent* 70:191-192, 1993.

GENERAL REFERENCES

- AHFS drug information 2009*, Bethesda, MD, 2009, American Society of Health-System Pharmacists.
- Hillman RS, Ault KA, Rinder H: *Hematology in clinical practice*, ed 4, New York, 2005, McGraw-Hill.
- Lichtman MA, Beutler E, Kipps TJ, et al, editors: *Williams hematology*, ed 7, New York, 2006, McGraw-Hill.
- Majerus PW, Tollefesen DM: Blood coagulation and anticoagulant, thrombolytic, and antiplatelet drugs. In Brunton LL, Lazo JS, Parker KL, editors: *Goodman & Gillman's the pharmacological basis of therapeutics*, ed 11, New York, 2006, McGraw-Hill.
- McPhee SJ, Papadakis MA, editors: *Current medical diagnosis and treatment 2009*, ed 48, Stamford, CT, 2009, Lange Medical Books/McGraw-Hill.

Drugs Acting on the Respiratory System

KAREN S. GREGSON, BRUNO KREINER, AND JEFFREY D. BENNETT

Worldwide interest and concern continue to increase as a result of the escalating morbidity of inflammatory lung disease. According to the Centers for Disease Control and Prevention, the prevalence of asthma among U.S. children increased from 3.8% in 1980 to 5.8% in 2003.²⁷ Globally, it is estimated that 300 million people have asthma.³² The World Health Organization in the Global Burden of Disease Study ranked chronic obstructive pulmonary disease (COPD) as the 12th leading contributor to the burden of disease in 1990; by 2020, it is estimated that COPD will be ranked 5th.⁴⁵ COPD is currently the fourth leading cause of death in the United States.⁵⁵

In response to the alarming increase in inflammatory lung disease, a global network of physicians and scientists founded the Global Initiative for Asthma (GINA) in 1989. In 1998, the Global Initiative for Chronic Obstructive Lung Disease (GOLD) was founded. The goals of both assemblies are to increase awareness of asthma and COPD as global health problems, present guidelines for the diagnosis and treatment of disease, and stimulate research in each area. Asthma is defined by GINA as a chronic inflammatory disorder of the airways associated with airway hyperresponsiveness, with episodes of wheezing, breathlessness, chest tightness, and coughing and with a widespread, variable, and often reversible airflow limitation. The severity of disease is measured with spirometry as mild, moderate, or severe and defined by the percentage decrease of forced expiratory volume in 1 second (FEV₁) after a methacholine or histamine challenge.

COPD is defined by GOLD as a progressive airflow-limiting disease that is irreversible with a component of abnormal inflammatory responsiveness to noxious stimuli. Some significant extrapulmonary effects are also seen in many individuals with COPD. Classification of severity of COPD is measured with spirometry. The degree by which FEV₁ differs from predicted indicates mild, moderate, or severe disease. Treatment guidelines are based on measurements of severity of disease.

Many of the drugs recommended by the aforementioned assemblies are discussed in this chapter, including corticosteroids, bronchodilators, and leukotriene modifiers. The information presented here is intended to give the dentist an overview of why and how the drugs are used and how they may influence the choice of dental treatment or drug therapy for a patient with inflammatory lung disease.

PATHOPHYSIOLOGY OF ASTHMA

Asthma is a chronic inflammatory disease of the airways associated with acute symptoms, exacerbations, and airway remodeling.¹⁴ The acute symptoms, bronchospasm and

wheezing, can be reversed by bronchodilators. Exacerbations and airway remodeling are caused by chronic inflammation. Exacerbations can be controlled with anti-inflammatory drugs. There is no defined treatment for airway remodeling. Airway obstruction follows an acute bronchoconstrictor response to the spasmogenic stimulus, peaking within 10 to 20 minutes.¹⁵ This early-phase reaction is characterized by the release of IgE and the activation of cells bearing allergen-specific IgE receptors, especially airway mast cells. The activated cells produce proinflammatory mediators such as histamine, eicosanoids, and reactive oxygen species (ROS).

Proinflammatory mediators induce contraction of airway smooth muscle, mucus secretion, and vasodilation. Airflow obstruction is caused by inflammatory mediators that induce microvascular leakage and exudation of plasma into the airways. Plasma protein leakage induces a thickened, engorged, and edematous airway wall and a narrowing of the airway lumen. The late-phase reaction occurs 6 to 9 hours after the early-phase reaction and is characterized by recruitment and activation of eosinophils, CD4⁺ cells, basophils, neutrophils, and macrophages. Adhesive interactions occur among the various cell types. T cells are recruited 24 hours after the early-phase reaction and are thought to play a role in the chronic phase of the response and the enhancement of non-specific bronchial hyperresponsiveness.

The chronic inflammation seen in the airways in patients with asthma is a complex process in which the whole mucosal immune system seems to be involved. Cell survival in airway tissues plays a role in chronic inflammation. The tissue load in inflammatory sites is controlled by apoptosis. In asthma, the persistence of inflammation is thought to be an alteration of the regulation of apoptosis. Characteristics of chronic inflammation include epithelial cell shedding and activation and the presence of mixed inflammatory infiltrates, lymphocytes, and many other cell types. There is also an increase of inflammatory mediators, including endothelins and nitric oxide. The end result of chronic inflammation is remodeling of the airways.

Activation of epithelial cells may be important in the regulation of airway remodeling and fibrosis because these cells release fibrogenic growth factors. The airway structural changes include thickening of the airway wall, increased muscle mass, and proliferation of mucous glands. Some clinical consequences of airway remodeling are increased resistance to airflow, bronchial contraction and bronchial hyperresponsiveness, production of mucous and exudate, and increased surface tension favoring airway closure. Although drug therapy does not reverse the effects of airway remodeling, it does decrease the chronic inflammation that plays an important role in this serious complication of asthma.

PATHOPHYSIOLOGY OF CHRONIC OBSTRUCTIVE PULMONARY DISEASE

COPD is a progressive condition characterized by irreversible airflow limitation.⁴¹ The major etiologic factor is cigarette smoking. Cigarette smoke is a complex mixture of approximately 4700 compounds, including high concentrations of free radicals and other oxidants. Inflammation of the lungs as a reaction to cigarette smoke is characteristic of the disease and is thought to produce lung injury. Symptoms of COPD include chronic cough with sputum production and breathlessness on exertion. There is also a systemic component to the disease involving various organs, including skeletal muscle, the central nervous system (CNS), and the cardiovascular system. Systemic inflammation intensifies with progression of COPD and has been linked to cardiovascular events, muscle wasting, and colon cancer.

Chronic bronchitis, emphysema, and small airway disease are present in variable degrees in patients with COPD. Chronic bronchitis is an innate immune response to the inhaled toxic particles in cigarette smoke. Emphysema is defined as enlargement of the distal airspaces beyond the terminal bronchioles caused by destruction of the airway walls. Airway obstruction in the smaller conducting airways is caused by inflammatory mucus exudates.

The presence of CD8⁺ lymphocytes and CD4⁺ cells suggests chronic immunostimulation of the airway epithelium. Neutrophils and macrophages are found in the sputum, lung parenchyma, and bronchoalveolar lavage fluid from patients with COPD. Each cell type is activated by cigarette smoke. Activation causes the release of ROS and proteases by neutrophils. Macrophage activation induces the synthesis and secretion of inflammatory mediators, such as tumor necrosis factor- α , interleukin-8, monocyte chemoattractant peptide-1, and leukotriene B₄ (LTB₄). Inflammation in the lungs may be intensified further by an imbalance between histone acetylation and deacetylation. Oxidants are believed to interact with histone deacetylase. Nitrosylation of tyrosine residues in histone deacetylase decreases enzymatic activity and leads to enhancement of inflammatory gene expression through chromatin remodeling.

DRUGS USED TO TREAT ASTHMA

Corticosteroids

Mechanism of action

Corticosteroids diffuse readily across plasma membranes to enter cells where they encounter the glucocorticoid receptor, a cytosolic protein. When the steroid binds the receptor, the receptor undergoes a conformational change.⁸ Chaperone proteins dissociate from the receptor, and nuclear receptor localization regions on the receptor are exposed. The receptor-steroid complex dimerizes and is transported to the nucleus, where it binds to DNA in promoter sequences termed *glucocorticoid response elements* (GREs). Repression of genes activated by inflammatory diseases is the predominate effect of corticosteroids. These genes encode cytokines; chemokines; adhesion molecules; and inflammatory enzymes, proteins, and receptors. Repression of these genes by corticosteroids occurs at concentrations easily achieved clinical practice. There are no recognizable GRE sites within these genes, however. This response seems to be a result of corticosteroid effects on chromatin remodeling.⁶

Chronic inflammation involves activation of the proinflammatory transcription cofactors nuclear factor- κ B (NF- κ B) and activating protein-1 (AP-1). NF- κ B and AP-1 bind to large coactivator molecules, such as cyclic adenosine 3',5'-monophosphate (cAMP) response element-binding protein,

which possess intrinsic histone acetyltransferase activity. Acetylation of core histones on specific lysine residues reduces their charge and changes the electrostatic attraction between the histone protein and DNA; this allows the histone-DNA complex to undergo a conformational change from the closed structure to the activated open form. DNA unwinds and is accessible to RNA polymerases, which initiate transcription of inflammatory genes. Histone deacetylases (HDACs) act as corepressors along with other proteins, such as nuclear receptor corepressor, to silence gene expression. Deacetylation of histone proteins on lysine residues returns the DNA to the closed basal state, countering the activity of the histone acetyltransferases.¹

Corticosteroids have multiple effects on chromatin remodeling proteins. Anti-inflammatory genes are activated by selective acetylation of histone H₄ by coactivator molecules, such as steroid receptor coactivator-1 (SRC-1) and glucocorticoid receptor interacting protein-1 (GRIP-1). Corticosteroids also repress gene activity by reversal of histone acetylation of proinflammatory sequences; this can occur in two pathways. First, activated glucocorticoid receptor can bind directly to cAMP response element-binding protein and other coactivators and inhibit their histone acetyltransferase activity. Second, and more important, activated glucocorticoid receptor can recruit HDACs to the transcriptional complex, which results in deacetylation of histones associated with inflammatory gene expression.²

Given the effects that corticosteroids have on chromatin remodeling pathways, it is now apparent why low doses are effective in the treatment of asthma. The pathophysiology of asthma involves the increased expression of multiple inflammatory genes activated by the proinflammatory transcription factors AP-1 and NF- κ B. In bronchial biopsy specimens from patients with asthma, there is an increase of histone acetyltransferase and a small decrease of HDAC activity compared with airways of patients without asthma, indicating an increase of inflammatory gene expression.

Steroids can also reduce chronic inflammation by transactivation.⁸ Transactivation requires higher concentrations of steroids, however, than those concentrations required for chromatin remodeling. Transactivation involves the monomeric glucocorticoid receptor complex, which can interact directly with AP-1 and NF- κ B through protein-protein interactions. This interaction decreases their transcription factor-mediated proinflammatory actions. Corticosteroids also increase the expression of two proteins that affect these inflammatory signal transduction pathways: glucocorticoid-induced leucine zipper protein (GILZ) and mitogen-activated protein kinase phosphatase-1 (MKP-1). GILZ inhibits AP-1 and NF- κ B. MKP-1 inhibits p38 mitogen-activated protein kinase, which is activated by AP-1.

Pharmacologic effects

The pharmacologic effects of steroids on inflammatory lung diseases indicate that they are very effective at controlling symptoms of the disease, but they do not cure the disease. When the steroid dose is reduced, or the steroid is discontinued, the symptoms eventually return. In asthma, corticosteroids reduce airway inflammation and hyperresponsiveness, improve lung function, and decrease the incidence and severity of acute asthma exacerbations. Treatment of COPD with corticosteroids is controversial.⁴² Experimental data indicate that the inflammatory processes in COPD may be resistant to the effects of corticosteroids because of oxidation and nitrosylation of proteins involved in chromatin remodeling by the oxidants found in cigarette smoke. Clinical data show inhaled corticosteroids improve the health of patients with COPD, however.⁵⁰ The pharmacologic effects seen with corticosteroids in COPD are largely the same as those

seen with asthma, but they also reduce systemic inflammation and reduce the rate of decline of health in patients with COPD.

Efficacy and safety

The optimal route of administration of corticosteroids for inflammatory lung disease is inhalation. Inhalation delivers the drug directly to the lungs. The corticosteroid acts locally, which minimizes the systemic adverse effects encountered with oral or parenteral administration. Receptor-binding affinity is the only pharmacodynamic parameter that differs among the corticosteroids that are available for inhalation.²⁴ High binding affinity can be considered a desirable trait providing for better efficacy in the lung. High binding affinity can also be detrimental because it can lead to increased systemic adverse effects.

The differences between the inhaled products depend on factors such as formulation, pulmonary and systemic bioavailability, and excretion.²³ Characteristics that enhance the efficacy of inhaled corticosteroids include small particle size and long pulmonary residence time. Solution aerosols formulated with hydrofluoroalkane, such as ciclesonide and beclomethasone dipropionate, have a small mass median aerodynamic diameter (MMAD) <2 μm . A small MMAD can have effects on efficacy because the smallest airways have an internal perimeter $\leq 2 \mu\text{m}$. MMAD can also have an impact on local adverse effects because larger particles are more likely to be deposited in the oropharyngeal cavity.

Pulmonary residence time depends on two factors, lipophilicity and lipid conjugation. Lipophilic side chains on the D-ring of the steroid portion of the drug (see Figure 35-2) slow the dissolution in aqueous bronchial fluid. Lipophilic groups also aid the passage of the drug through the phospholipid bilayer of cell membranes to reach the receptors in the cell. Lipid conjugation to fatty acids in the pulmonary cells occurs via a reversible ester bond. Esterification provides a slow-release reservoir of the corticosteroid, prolonging residence time. This prolonged residence time allows a once-a-day dosing schedule for budesonide and ciclesonide.

Adverse effects

The most common adverse effects of inhaled corticosteroids are oropharyngeal candidiasis and dysphonia.³⁶ Although they can be easily managed, these localized adverse effects diminish compliance leading to uncontrolled disease and reduced quality of life. Less common adverse effects of inhaled corticosteroids are systemic in nature, including adrenal suppression, bone loss, skin thinning, metabolic changes, behavioral abnormalities, weight gain, and decreased linear growth in children. The concentration of the corticosteroid in the blood is a combination of the portion that is swallowed and the portion that is delivered to and absorbed from the lungs.

The safety of inhaled corticosteroids depends on factors such as activation in the lungs, low oral bioavailability, high protein binding, and rapid systemic clearance. Although most corticosteroids are inhaled in their pharmacologically active form, beclomethasone dipropionate undergoes activation in the human lung.³⁰ Beclomethasone dipropionate is metabolized to beclomethasone 17-monopropionate, which has a relative receptor affinity about 30 times greater than the parent compound. Metabolism in human plasma is quite different from metabolism in human lung. Human lung metabolism involves a simple hydrolysis reaction to the active form. Metabolism in human plasma involves hydrolysis, transesterification, and loss of hydrogen chloride. Metabolism in human plasma results in beclomethasone 21-monopropionate, which has no binding affinity for the glucocorticoid receptor. This differential metabolism in lung and plasma leads to fewer systemic effects of beclomethasone.

Ciclesonide is metabolized to desisobutyl-ciclesonide by esterases located in human lung. This metabolite has a relative receptor binding affinity 120 times that of ciclesonide. Metabolism of ciclesonide in the oropharynx region is very low, resulting in low amounts of active drug entering the systemic circulation by swallowing. Activation in the lung can improve the safety profile of an inhaled corticosteroid. The degree of protein binding can also affect the safety of an inhaled corticosteroid. Protein binding to albumin in the blood controls the systemic unbound concentrations and limits adverse effects.

β_2 -Adrenergic Receptor Agonists

β_2 -adrenergic receptor agonists are structurally modified catecholamines. The useful structural modifications result in increased β_2 receptor selectivity, enhanced oral activity, and an extended duration of action after inhalation.¹² Susceptibility to degradation by catechol-O-methyltransferase (COMT) and reuptake mechanisms in neurons are decreased by structural modifications. There are two types of β_2 adrenergic receptor agonists. The short-acting drugs have bronchodilatory effects that last 4 to 6 hours and are exemplified by albuterol. The long-acting drugs have bronchodilatory effects that last 12 hours and bronchoprotective effects lasting 6 to 12 hours.

Short-acting and long-acting drugs were designed along the same structure-activity principles. Albuterol and salmeterol have a nearly identical active moiety, (Figure 32-1). Salmeterol has an extended aliphatic side chain, however, which was designed to anchor the drug in or near the receptor. There are currently two long-acting β_2 agonists on the market: salmeterol and formoterol.³ Formoterol is a formanilide-substituted phenylethanolamine. Formoterol has a higher intrinsic efficacy and a faster onset of action than salmeterol.

Two theories have been proposed to explain the increased duration of action of salmeterol and formoterol. Using site-directed mutagenesis of the β_2 receptor, Green and coworkers³⁴ proposed that the aliphatic side chain of salmeterol binds in a second locus of the receptor that is separate from the active site, termed the *exosite*. These investigators used β receptor antagonists to determine activity kinetics. An exosite would explain how activity is so quickly restored after washout with the β receptor antagonist. In the second theory, termed the *diffusion microkinetic theory*, which applies to salmeterol and formoterol, the high membrane partition affinity of the two drugs creates a microdepot of the drug near the receptor.³ The exact nature of the sustained duration of action is likely to relate to aspects of the clinical pharmacology and tolerability of salmeterol and formoterol.

Mechanism of action

The β_2 -adrenergic receptor is a member of the seven-transmembrane receptor superfamily of G protein-coupled receptors.² The ligand-binding pocket open to the extracellular space is formed when the seven α helices of the receptor cluster together in a ring. When a receptor is moved to its active state by binding of ligand, its associated G protein dissociates into a G_α subunit and a β/γ dimer. As illustrated in Figure 5-7, the G_{α_s} subunit activates adenylyl cyclase, which increases the concentration of cAMP in the cell. cAMP activates protein kinase A. Protein kinase A phosphorylates protein substrates that control Ca^{++} availability in the cell. With decreased Ca^{++} availability, the myosin light chain is ineffective in sustaining active tone in airway smooth muscle. The tissue relaxes passively.

The mechanism previously described is the traditional cAMP/cAMP-dependent protein kinase A cascade. Studies

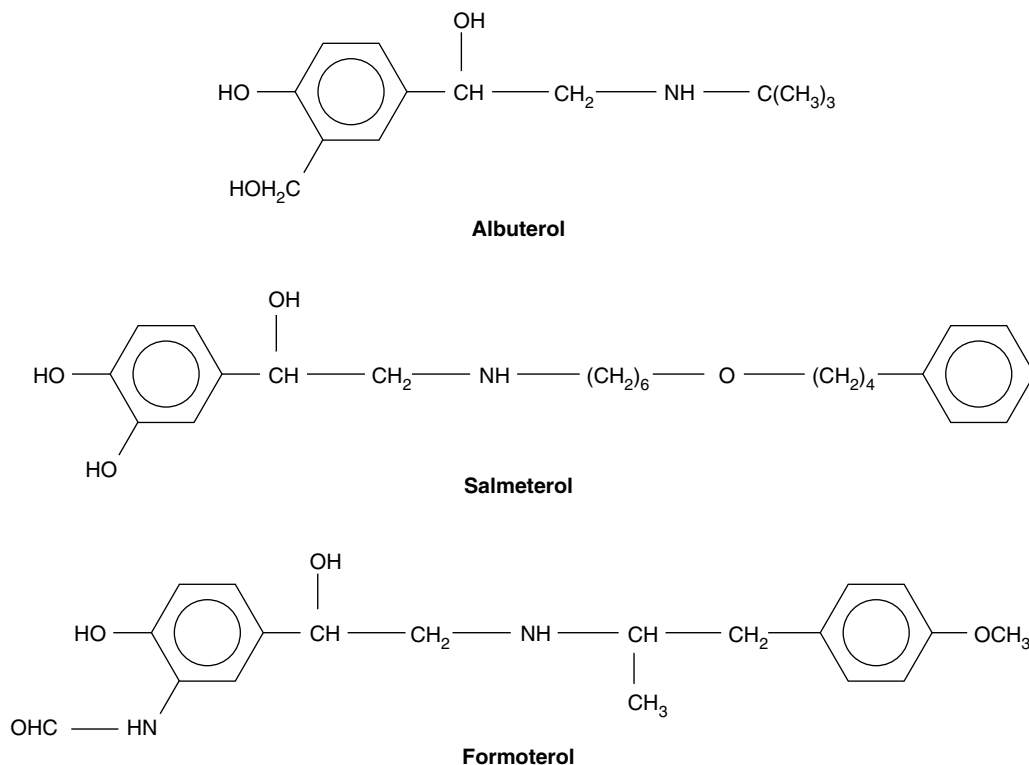

FIGURE 32-1 Structural formulas of several β_2 -adrenergic receptor agonists.

since the 1990s suggest that there are other mechanisms involved with β -adrenergic signaling in the airways.³¹ In addition to G_{os} , the β_2 -adrenergic receptor can also couple to G_{oi} and inhibit adenylyl cyclase. β_2 Receptors are found on pro-inflammatory and immune cells, including mast cells, macrophages, neutrophils, lymphocytes, eosinophils, epithelial and endothelial cells, and types 1 and 2 alveolar cells. Inhibition of adenylyl cyclase may be involved in decreasing the reactivity of these proinflammatory cells.

Membrane hyperpolarization is another significant effect of β_2 agonists. Activation of K^+ channels by β_2 -adrenergic receptor agonists in the plasma membrane decreases electrical excitation. This decrease in electrical excitation inhibits extracellular Ca^{++} from entering the cell and decreases the available Ca^{++} for smooth muscle contraction. The effect of β_2 agonists on K^+ channels is thought to occur by direct coupling of the big-conductance K^+ channel and the G_{os} subunit of the receptor.

Pharmacologic effects

Bronchodilation is not the sole pharmacologic effect of β_2 receptor activation. Other effects include reduction of inflammatory cytokine production, suppression of plasma exudation secondary to receptor presence on postcapillary venules, regulation of fluid balance in alveolar epithelial cells, and reduction of cholinergic neurotransmission. In asthma and COPD, β_2 -adrenergic agonists not only cause bronchodilation but also offer bronchoprotection, or reduced responsiveness, to noxious stimuli.

Adverse effects

The most serious adverse effect of β_2 agonist use is an increase in sensitivity of the smooth muscle in the lungs to noxious stimuli. Paradoxically, an increased incidence of asthma exacerbations and morbidity and mortality is seen after long-term use of β_2 agonists⁴⁴; this is attributable to the loss of broncho-

protection and bronchodilation effects of the drugs. This effect is called *tolerance*, a state of refractoriness that occurs after prolonged exposure to an agonist. The mechanistic basis for tolerance involving β -adrenergic receptors is currently unclear. Factors that can contribute to tolerance include receptor downregulation, due to receptor internalization, and receptor desensitization (see Figure 1-12) which can be due in part to receptor uncoupling from adenylyl cyclase.¹⁵ It is not the use of intermittent short-acting β_2 agonists, such as albuterol, that leads to tolerance, but rather the continued use of long-acting β_2 agonists.

The U.S. Food and Drug Administration (FDA) has required manufacturers of long-acting β_2 agonists to place a "black box" warning on the physician information for salmeterol and formoterol. Data for the advisory labeling came from the Salmeterol Multi-Center Asthma Research Trial (SMART),¹⁸ which examined the safety of salmeterol when added to usual asthma therapy. Study subjects who were on salmeterol showed a small but significant increase in asthma-related death compared with subjects receiving placebo.

Upregulation of phosphodiesterase-4, the enzyme responsible for degradation of cAMP, is also thought to play a role in the loss of effect of β_2 agonists. This hypothesis led to the development of phosphodiesterase-4 inhibitors, roflumilast and cilomilast. Currently available in Europe, phosphodiesterase-4 inhibitors seem to improve FEV₁ in COPD patients.

With the exception of levalbuterol, all β_2 agonists are racemic mixtures of R-enantiomers and S-enantiomers.³⁹ Although the R-enantiomer of albuterol, levalbuterol, is 100 times more potent at the receptor, the S-enantiomer of albuterol is metabolized much more slowly and is retained in the lung. Preclinical data indicate that S-albuterol is associated with proinflammatory activity that can lead to bronchial hyperresponsiveness. These activities include an increase in intracellular Ca^{++} , an increase in inflammatory stimuli, an increase in eosinophil activation and recruitment, and an increase in mucin

production. These proinflammatory activities have led to speculation that the S-enantiomer of salmeterol is responsible for the loss of effect seen with long-term use of this drug. Formoterol has two chiral centers, and there is evidence to suggest that S-formoterol accumulates in bronchial tissue relative to the R-enantiomer because of different rates of metabolism. Many new long-acting β_2 agonists in clinical development are pure active enantiomers.

Clinical trial retrospective analyses of genetic polymorphisms of the β_2 receptor in individual patients seem to suggest that individuals who are homozygous for arginine at position 16 on the β_2 receptor (about 15% of the population) show greater rates of asthma exacerbations than patients who have glycine at this position, or patients who are heterozygous. It is unclear what role the arginine substitution at position 16 on the β_2 receptor plays in the mechanism of β_2 agonists. More data are needed to determine if genotype is another factor contributing to receptor desensitization.

Specific agents

Albuterol. Albuterol, the most commonly prescribed β_2 -adrenergic bronchodilator, is available in tablet form, as a sustained-release tablet, and as a metered-dose pressurized aerosol. Pulmonary β_2 specificity is greater with aerosol delivery than it is with an oral dose.⁴⁰ Adverse reactions to albuterol are similar to adverse reactions of other β_2 -adrenergic receptor agonists.

Levalbuterol. The R-enantiomer of albuterol, levalbuterol is available currently on the in form of a metered-dose inhaler and as an inhalation solution for nebulizers. As mentioned previously, the potential advantage of levalbuterol over the racemic form of the drug is that S-albuterol may have some bronchoconstrictive activity mediated through nonadrenergic mechanisms. The bronchoconstrictive action is not observed in humans acutely after single doses of albuterol compared with levalbuterol, but the much slower metabolism of the S-enantiomer causes it to predominate over time with repeated doses. This selective build-up may explain the paradoxical bronchoconstrictive responses that occasionally occur with albuterol (and with other racemic β_2 agonists). Additional studies will be required to access accurately the relative merits of levalbuterol versus albuterol in the clinical setting.

Salmeterol. Salmeterol is a long-acting, highly selective β_2 -adrenergic agent structurally related to albuterol. Compared with albuterol, salmeterol has greater β_2 receptor selectivity, but decreased intrinsic efficacy. The receptor selectivity and the intrinsic efficacy differences of the drug minimize cardiac side effects. Salmeterol provides bronchodilation usually lasting at least 12 hours. Salmeterol is slow in onset (approximately 10 minutes), and maximal bronchodilation takes hours. It is not indicated for the symptomatic relief of acute asthma. Side effects, such as tachycardia, tremor, hypokalemia, and hyperglycemia, are minimal at standard doses.

Incorporating a long-acting β_2 agonist into the therapeutic regimen has several advantages. Clinical trials have shown salmeterol to be more efficacious than albuterol in (1) reducing variation in diurnal peak expiratory flow rates; (2) decreasing nocturnal symptoms, asthma exacerbations, and the need for rescue medications; and (3) increasing overall lung function.^{20,49} The combination of salmeterol with an inhaled corticosteroid has been shown to be beneficial. Several studies have indicated that the administration of salmeterol with a lower dose of corticosteroid results in improved pulmonary function compared with a larger dose of corticosteroid administered alone.^{29,61} In addition to the improved physiologic response, the administration of salmeterol decreases the potential of systemic effects of corticosteroids.

Metaproterenol. Metaproterenol is a derivative of the non-selective β -adrenergic blocker isoproterenol in which the hydroxyl group is moved from C₄ to C₅ of the benzene nucleus in the molecule. This structural change produces a predominantly β_2 -stimulant action. It also protects metaproterenol from enzymatic degradation by COMT, prolonging the drug's duration of action.

An effective clinical response is obtained after inhalation or oral administration of metaproterenol. As with all the β_2 -selective sympathomimetic drugs, however, selectivity of action is less apparent when the drug is given orally. Inhalation produces a peak effect in 30 to 60 minutes, and there is sustained improvement in pulmonary function tests for 5 hours. Tachycardia and tremor are two common side effects, but the incidence and severity of cardiac reactions are less than with isoproterenol.

Terbutaline. Terbutaline, a congener of metaproterenol, is of clinical interest because of its long duration of action (3 to 6 hours), its availability in an injectable form, and a side-effect profile equivalent to metaproterenol.⁴ For patients with spontaneous asthma, terbutaline is reported to provide greater protection against bronchoconstriction than an equivalent dose of metaproterenol. Terbutaline from the aerosol metered-dose inhaler stimulates bronchial β_2 receptors more selectively than oral or parenteral forms of the drug. Tolerance to the aerosol does not seem to develop with continued use over several months. The most common side effect of therapeutic doses is a slight tremor, which may be particularly noticeable in elderly patients. Other side effects, typically seen with nonselective β blockers, are infrequent. Terbutaline is the only drug used as a bronchodilator that has good safety data supporting its use during pregnancy.

Interaction between corticosteroids and β_2 -adrenergic receptor agonists

Corticosteroids and β_2 agonists have different mechanisms of action and in the treatment of patients with asthma and COPD. Coadministration of the two classes of drugs results in a synergistic effect as each drug enhances the activity of the other.^{28,46} In addition, corticosteroids can protect against receptor desensitization.⁵⁴ The β_2 receptor gene contains several GRE sites in the promoter region, enabling corticosteroids to increase the rate of transcription of β_2 receptors. This effect can offset one of the mechanisms for tolerance—receptor downregulation seen in long-term use of β_2 agonists. The efficiency of coupling is increased between the β_2 receptor and G_{as} after administration of corticosteroids with the resulting increase in the concentration of cAMP in the cell.

Long-acting β_2 -adrenergic receptor agonists can promote the translocation of the corticosteroid receptor to the nucleus with no corticosteroid present.³⁴ When a corticosteroid is added, the translocation of the receptor is accelerated, and the rate of GRE-dependent expression of corticosteroid-inducible genes is enhanced. An increase in smooth muscle bulk is a pathologic feature of asthma that leads to bronchial hyperplasia and bronchial hyperactivity. Coadministration of β_2 agonists and corticosteroids induces p21, a kinase inhibitor that restrains smooth muscle hyperplasia.⁵³

Other Adrenergic Receptor Agonists

Epinephrine

Epinephrine may be administered by oral inhalations from a nebulizer or metered-dose inhaler. The inhaler is generally favored because it is effective, less expensive, and more portable. The therapeutic effect is weak and transient compared with longer acting β_2 agonists immune to metabolism by COMT. Signs of overdose include nervousness, restlessness, sleeplessness, bronchial irritation, and tachycardia. Inhalation

of recommended dosages may minimize reactions other than bronchodilation. Patients frequently have palpitation and tremors, however, which increase with increased use. The occurrence of these signs and symptoms usually limits the use of this drug because patients tend not to tolerate these effects.

Parenteral epinephrine is reserved for acute episodes of asthma requiring immediate relief when inhaled β_2 -selective agonists have proved ineffective or could not be effectively administered. In such cases, 0.2 to 0.5 mg may be injected subcutaneously or intramuscularly to produce bronchodilation. Because epinephrine produces α -adrenergic and β -adrenergic receptor stimulation, it can also improve respiration by relieving congestion of the bronchial mucosa.

Ephedrine

Ephedrine stimulates α -adrenergic and β -adrenergic receptors by a direct action and through the release of endogenous catecholamines. Its pharmacologic effects are similar to the effects of epinephrine. Ephedrine was previously widely used in treating mild-moderate asthma because of its oral efficacy and longer duration of action. It is not as effective as epinephrine in severe attack because its bronchodilator action is weaker. Ephedrine may be administered at bedtime to prevent nocturnal wheezing. The tendency of ephedrine to produce tolerance when taken for long periods has limited its use in chronic asthma.

Ephedrine is marketed as a single-entity drug and as a component in fixed-dose combination products. It was often combined with theophylline, sedatives, or expectorants. Until the FDA banned its sale, ephedrine was widely used in the form of ephedra and related herb products.

The adverse reactions are similar to those of epinephrine. In addition, there may be CNS stimulation, the most common signs of which are nervousness, excitability, and insomnia. There is little reason to recommend ephedrine over the more recently developed β_2 -selective bronchodilators.

Isoproterenol

Isoproterenol is the prototypic nonselective β -adrenergic receptor agonist. It acts on β_1 receptors to increase the rate and force of cardiac contractions and on β_2 receptors located in the smooth muscle of the bronchi, blood vessels, and other locations. Oral inhalation is still used to treat asthmatic attacks, but has been largely superseded by the more selective β_2 agonists. Isoproterenol has a rapid onset but a short duration of action. Excessive administration of the drug can produce adverse effects, such as nervousness, headaches, and severe arrhythmias (including ventricular fibrillation), and tolerance and refractoriness.

Theophylline

Mechanism of action

Theophylline is a naturally occurring plant alkaloid (a methylxanthine) related to caffeine and theobromine.¹⁰ Theophylline causes an increase in the concentration of cAMP in the cell through inhibition of phosphodiesterase-3 and phosphodiesterase-4. As with the β_2 agonists, an increase in cAMP concentration leads ultimately to a decrease in available Ca^{++} in the cell and smooth muscle relaxation. In addition to bronchodilation, theophylline has anti-inflammatory effects, which are exerted through action on HDACs. The exact mechanism of action of theophylline on HDACs is not completely understood. This action differs from that of the corticosteroids in that the steroids recruit HDACs to the active transcription site with no direct effect on HDAC activation. There is evidence to suggest that the action of theophylline on HDACs is more direct.³⁸ In immunoprecipitation studies, theophylline, HDACs, and several other nuclear proteins are copre-

TABLE 32-1

Anti-inflammatory Effects of Theophylline

TARGET	EFFECT
In Vitro	
Mast cells	Decreased mediator release
Macrophages	Decreased release of reactive oxygen species
Monocytes	Decreased cytokine release
Eosinophils	Decreased basic protein release, decreased release of reactive oxygen species
T lymphocytes	Decreased proliferation, decreased cytokine release
Neutrophils	Decreased release of reactive oxygen species
In Vivo	
Experimental animals	Decreased late response to allergen, decreased plasma exudation (guinea pigs), decreased airway responsiveness to allergen and platelet-activating factor (guinea pigs, sheep), decreased airway inflammation after endotoxin and allergen (guinea pigs, rats)
Asthmatic patients	Inhibition of late response to allergen, increased CD8 ⁺ cells in peripheral blood, decreased T lymphocytes in airways

From Barnes PJ, Pauwels RA: Theophylline in the management of asthma: time for reappraisal?, *Eur Respir J* 7:583, 1994.

cipitated with antibodies to HDAC.² This mechanism suggests that theophylline and corticosteroids may have synergistic effects on inflammatory processes. In vitro, theophylline and dexamethasone increase the repression of inflammatory cytokine release in macrophages and epithelial cells to a greater extent than either drug alone.

Pharmacologic effects

Theophylline has been used since the early 1920s for its bronchodilatory effects. Anti-inflammatory effects of theophylline include inhibition of the late response to allergen, reduced infiltration of eosinophils and CD4⁺ lymphocytes into the airways, and a decrease in the concentration of interleukin-8 and neutrophil chemotactic responses.⁹ In vitro, theophylline inhibits mediator release from mast cells, inhibits ROS release from macrophages and eosinophils, and inhibits cytokine release from monocytes and T lymphocytes (Table 32-1).

Adverse effects

Theophylline has a narrow therapeutic window with therapeutic plasma concentrations of 10 to 20 mg/L.⁵¹ At concentrations >20 mg/L, serious effects, such as ventricular arrhythmias, seizures, and death, can occur. These serious adverse effects may be preceded by headache, abdominal discomfort, increased acid secretion, gastroesophageal reflux, diuresis, repetitive vomiting, and restlessness. Proper dosing of theophylline depends on many patient factors, including smoking history, cardiac disease, and hepatic disease. Serum concentration monitoring is often necessary because of the narrow therapeutic window.

Theophylline is not effective when administered by inhalation. Theophylline is administered orally. Theophylline is metabolized by the cytochrome P450 isoenzyme CYP1A2. Many drug interactions with theophylline involve the inhibition or induction of the enzyme that metabolizes theophylline (Box 32-1). Inhibition of CYP1A2 would increase theophylline plasma concentrations, possibly causing toxicity. Induction would decrease theophylline plasma concentrations, rendering them subtherapeutic. The clinical use of theophyl-

BOX 32-1*Drug Interactions with Theophylline***May Decrease Effect at Adenosine Receptors**

Adenosine
Diazepam
Flurazepam
Lorazepam
Midazolam

May Decrease Theophylline Clearance

Alcohol
Allopurinol
Cimetidine
Ciprofloxacin
Clarithromycin
Disulfiram
Erythromycin
Estrogen
Fluvoxamine
Interferon alfa-2a
Methotrexate
Mexiletine
Pentoxifylline
Propafenone
Propranolol
Thiabendazole
Ticlopidine
Troleandomycin
Verapamil

May Increase Theophylline Clearance

Aminoglutethimide
Carbamazepine
Phenobarbital
Phenytoin
Rifampin
Sulfinpyrazone

line has declined because of the potential for toxicity, difficulty in dosing, and numerous drug interactions.

Anticholinergics

Muscarinic acetylcholine receptors are physiologically important, but medications directed to these receptors are not commonly used because of the difficulty in targeting a specific organ or tissue. The advantage of targeting the respiratory system is in the route of administration, inhalation. The mechanism of action of anticholinergic drugs in respiratory disease is competitive antagonism of acetylcholine at M_3 muscarinic receptors in the smooth muscle cells of the lungs.³⁵ The result is bronchodilation.

There are currently two anticholinergic bronchodilators on the market, ipratropium and tiotropium.²⁵ These agents are synthetic quaternary ammonium congeners of atropine, and they are poorly absorbed into the bloodstream when given by inhalation. The differences in the two drugs are in their pharmacokinetics. The dissociation half-life of ipratropium from human M_3 muscarinic receptors is approximately 20 minutes. The dissociation half-life of tiotropium at M_3 muscarinic receptors is approximately 35 hours. Ipratropium is marketed in a combination inhaler with albuterol, which is indicated for use in patients with COPD. It is used four times a day. Tiotropium is also used in patients with COPD, but because of its long half-life it can be administered once a day.

Adverse effects for both drugs include mild dry mouth, altered taste, and coughing after administration.

Leukotriene Modifiers

Cysteinyl leukotrienes (cysLTs) are a class of lipid molecules that produce smooth muscle contraction and mucus secretion, induce allergic inflammatory cells, modulate cytokine production, influence neural transmission, and alter structure in the airway.⁴⁸ Administration of cysLTs to experimental animals and humans produces symptoms that resemble allergic reactions and asthma.

The cysLTs are produced in mast cells, eosinophils, and macrophages from arachidonic acid. Arachidonic acid is cleaved from membrane phospholipids and metabolized through the 5-lipoxygenase pathway. Arachidonic acid is oxidized to LTA_4 , which on conjugation to glutathione is converted to LTC_4 . LTC_4 is transported to the extracellular space and cleaved to LTD_4 and LTE_4 . LTC_4 , LTD_4 , and LTE_4 all contain a cysteine residue and are collectively called cysLTs. Previously known as the slow-reacting substance of anaphylaxis, they stimulate airway smooth muscle by interacting with cysLT receptor type 1. It has been shown that they play a role in the inflammatory responses seen in asthma. LTA_4 can also be converted to LTB_4 by epoxide hydrolase in neutrophils and other inflammatory cells. LTB_4 is a neutrophil and eosinophil chemoattractant.

Bronchoalveolar lavage fluid shows an increase in cysLTs in asthmatic subjects after administration of allergen. The increases in cysLTs are not reduced by treatment with inhaled corticosteroids. Increases in cysLTs in the bronchi are not limited to noxious stimuli. Drying of the airway and exercise can also stimulate cysLT production. The cysLTs also interact with inflammatory pathways. Release of cysLTs from mast cells is seen in response to IgE ligation. Hyperosmolarity in exercise-induced asthma and cyclooxygenase-1 (COX-1) inhibition in nonsteroidal anti-inflammatory drug (NSAID)-intolerant asthma also cause release of cysLTs. cysLTs also promote the generation of chemokines and cytokines from airway smooth muscle, increase the expression of histamine receptors, amplify the effects of tachykinins in the airway, and have a role in the structural changes in the airway seen in asthma. Two classes of drugs are used to decrease the effects of the leukotriene pathway in asthma: leukotriene formation inhibitors and leukotriene receptor antagonists.²²

Zileuton, an N-hydroxyurea derivative, chelates the iron in the active site of 5-lipoxygenase, blocking the redox potential of the enzyme.¹⁹ Zileuton is able not only to block the formation of the cysLTs, but also that of LTB_4 . Zileuton is not used as extensively as leukotriene receptor antagonists probably because of its short half-life and potential liver toxicity. Zileuton is orally bioavailable, with a half-life of 2 hours, and must be administered three to four times a day. This frequent administration can cause problems with patient compliance, and only an extended release form of the drug is still in use. Zileuton is contraindicated in liver disease, and liver enzymes must be monitored during therapy.

Montelukast and zafirlukast are selective antagonists for the cell surface cysLT 1 receptor.²² They reduce airway hyperresponsiveness, eosinophils, and exhaled nitric oxide. They are orally active and are administered once daily and are generally well tolerated. Elevated concentrations of cysLTs are found in chronic asthma with concomitant allergic rhinitis, exercise-induced asthma, and aspirin-sensitive asthma. It has been suggested that leukotriene antagonists may have a specific role in these conditions.

Cromolyn

Cromolyn is a nonbronchodilating, nonsteroidal drug used for prophylactic treatment of asthma. It is a synthetic deriv-

ative of khellin, the agent in extracts of the *Ammi visnoga* plant that produces smooth muscle relaxation. It is administered by inhalation. Although the mechanism of action is not fully understood, it is known that cromolyn inhibits the release of mediators from mast cells and other inflammatory cells, probably by inhibiting the inflow of Ca^{++} into the mast cells.^{16,58} The drug inhibits early and late asthmatic responses and is effective in the long-term treatment of chronic asthma. Other biologic effects, including inhibition of afferent pulmonary nerve fiber receptors that contribute to reflex bronchoconstriction, may also be relevant to its therapeutic action.

Clinically, cromolyn is ineffective in the treatment of acute attacks of asthma, including status asthmaticus. It functions exclusively as a prophylactic agent in the management of chronic symptoms. Maximum benefit is obtained only after 4 weeks of treatment. Cromolyn has also been shown to be useful as a premedication before a challenge-like exercise, where the drug, similarly to steroids and leukotriene inhibitors, reduces airway hyperactivity. Long-term and short-term studies have documented clinical improvement in patients taking cromolyn, with a low incidence of adverse effects. Cromolyn is one of the least toxic medications used for asthma. Most adverse reactions have been mild and have consisted mainly of wheezing, coughing, and dryness of the throat. There have been rare reports, however, of eosinophilia with pulmonary infiltration, pulmonary granulomatosis, and the development of subacute and acute allergic reactions. In general, cromolyn therapy is stopped in any patient who shows a reaction other than a transitory irritative response.

During cromolyn treatment, patients are maintained on regular medication, such as oral bronchodilators. In cromolyn-treated patients receiving corticosteroids, there have been reports of a decreased corticosteroid requirement, which permits many patients to convert from a daily steroid schedule to an alternate-day program or to discontinue steroids completely. A decreased requirement for sympathomimetic and xanthine bronchodilators has also been noted. This medication-sparing effect is one of the major advantages of cromolyn therapy. Cromolyn is generally available in a metered dose aerosol unit and in a nebulizer solution. The availability of liquid cromolyn has been beneficial to many asthmatics, especially young children.

Nedocromil

Nedocromil is a novel and potent anti-inflammatory drug with many properties and effects similar to cromolyn.¹⁷ It inhibits the immediate bronchoconstrictor response to allergen challenge, probably as a result of preventing the release of mast cell mediators. It also inhibits the late-phase asthmatic response. Nedocromil, similar to cromolyn, is essentially free from systemic toxicity. Both drugs are highly ionized (>99%) at physiologic pH, and their inability to penetrate cells, coupled with the lack of an extracellular route of metabolism, results in their being excreted unchanged in the urine (approximately 80%) and feces (approximately 20%). Clinical experience has shown that nedocromil is well tolerated by most patients, but a bitter taste and, less frequently, headache and nausea have been reported.

Ketotifen

Ketotifen, an oral agent with cromolyn-like activity, has been tested in the management of mild-moderate bronchial asthma and allergic disorders.³³ It has strong antihistaminic (H_1) actions and powerful antianaphylactic properties. Inhibition of the release or activity of proinflammatory mediators may contribute to the prophylactic effect of ketotifen. Some evidence suggests that ketotifen also interferes

with Ca^{++} flux. It does not seem to affect smooth muscle contraction.

In asthmatic patients, the clinical benefit of ketotifen is usually detectable only after 6 to 12 weeks of treatment. The delayed onset has not been satisfactorily explained. Comparative clinical trials have shown that the oral administration of ketotifen and the inhalation of cromolyn have a similar prophylactic efficacy. As with cromolyn, an important benefit of ketotifen treatment is that dosages of bronchodilators and corticosteroids can be reduced during therapy.

The major side effect of ketotifen is sedation, which is experienced by 10% to 15% of patients during the first week of treatment. Drowsiness diminishes with time. The drug is well tolerated, and the oral route of administration promotes patient compliance. Currently, ketotifen is approved for topical use in the treatment of allergic conjunctivitis.

Methotrexate

Methotrexate is a well-known immunosuppressive chemotherapeutic drug used for the treatment of various diseases. Methotrexate inhibits the enzyme dihydrofolate reductase, preventing folate-dependent nucleic acid synthesis. The drug is used as an adjuvant for the treatment of severe glucocorticoid-dependent asthma. The low doses used do not significantly inhibit nucleic acid synthesis, but they have an anti-inflammatory action. There is often a decrease in white blood cell count, and the patient should be monitored to detect this change. The rationale for methotrexate in the treatment of asthma came from the observation that corticosteroid doses can be reduced when combination therapy with methotrexate is prescribed. Some studies have found a reduction of steroid dosages by 25%, but others have been unable to show this effect.⁴³ Because methotrexate produces no direct effect on pulmonary function, it is added to the treatment of asthma patients only for its steroid-sparing effect in patient unresponsive to steroids or taking high doses with severe side effects. The objective is to reach the lowest possible oral steroid dose. Low doses of methotrexate are not free of side effects. Liver toxicity, pneumonitis, and *Pneumocystis carinii* pneumonia have been observed.⁶⁰ There is also a small possibility for delayed malignancy.

Omalizumab

IgE is produced by B cells after sensitization to an allergen. IgE plays a central role in the pathophysiology of allergic responses in patients with asthma.²¹ Epidemiologic studies suggest that 60% to 80% of patients with asthma have rhinitis, and 20% to 40% of patients with rhinitis have asthma. Although the plasma concentration of IgE is low, it is highly active because of the large number of high-affinity receptors on mast cells and basophils. The binding of allergen to IgE on these cells initiates the inflammatory cascade that results in the release of many mediators, including histamine, leukotrienes, and platelet-activating factor. The release of these mediators results in airway obstruction by smooth muscle contraction, vascular leakage, and secretion of mucus.

Omalizumab is a humanized murine monoclonal anti-IgE antibody directed against an epitope on the fragment of IgE that binds to the high-affinity and low-affinity receptor regions.⁴⁷ This activity prevents free IgE from interacting with receptors on cellular targets. The antibody binds only to free IgE, not receptor-bound IgE. The antibody does not cause receptor cross-linking and cell degranulation, which leads to anaphylaxis. The antibody causes a 99% reduction of free IgE. Omalizumab also downregulates receptor expression on basophils. The reduction in free IgE and IgE receptors results in inhibition of IgE-mediated inflammation.

The most frequent adverse reactions to omalizumab include nasopharyngitis, upper respiratory tract infection,

TABLE 32-2

Levels of Asthma Control

CHARACTERISTIC	CONTROLLED (ALL OF THE FOLLOWING)	PARTLY CONTROLLED (ANY MEASURE PRESENT IN ANY WEEK)	UNCONTROLLED*
Daytime symptoms	None (≤ 2 /wk)	> 2 /wk	≥ 3 features of partly controlled asthma
Limitations of activities	None	Any	present in any week
Nocturnal symptoms/awakenings	None	Any	
Need for reliever/rescue treatment	None (≤ 2 /wk)	> 2 /wk	
Lung function (PEF or FEV ₁)	Normal	$< 80\%$ predicted based on personal best (if known)	

Adapted from Global Initiative for Asthma expert panel: *Global strategy for asthma management and prevention*, Medical Communications Resources, 2009 update. Available at <http://www.ginasthma.org>. Accessed January 16, 2010.

*Any exacerbation indicates that the asthma is uncontrolled.

FEV₁, Forced expiratory volume in 1 second; PEF, peak expiratory flow.

TABLE 32-3

Steps in Drug Therapy for Controlling Asthma

STEP 1	STEP 2	STEP 3	STEP 4	STEP 5
Rapidly acting β_2 agonist as needed	Add one of the following to Step 1: Low-dose ICS* Leukotriene modifier	Add one of the following to Step 1: Low-dose ICS plus long-acting β_2 agonist* Medium- or high-dose ICS Low-dose ICS plus leukotriene modifier Low-dose ICS plus sustained-release theophylline	Add one or more of the following to Step 3: Medium- or high-dose ICS plus long-acting β_2 agonist* Leukotriene modifier Sustained-release theophylline	Add one of the following to Step 4: Oral glucocorticoid Anti-IgE treatment

Adapted from Global Initiative for Asthma expert panel: *Global strategy for asthma management and prevention*, Medical Communications Resources, 2009 update. Available at <http://www.ginasthma.org>. Accessed January 16, 2010.

*Preferred option in each step.

ICS, Inhaled corticosteroid.

headache, and sinusitis. About 0.1% of patients experience urticaria, bronchospasm, hypotension, syncope, angioedema of the throat or tongue, and other symptoms of anaphylaxis. The onset of anaphylaxis can occur 2 to 24 hours after the administration of omalizumab. In 2007 the FDA required the manufacturer of omalizumab to place a boxed warning on the packaging to alert physicians of the possibility of anaphylactic reaction in patients after administration of omalizumab.

PHARMACOTHERAPY FOR ASTHMA

GINA defines controlled asthma as two or fewer daytime symptoms in 1 week, no limitations of activities, no nocturnal symptoms, the need for reliever treatment two or fewer times in 1 week, normal lung function as measured by FEV₁, and no exacerbations (Table 32-2). Although this definition of controlled asthma seems idealized, studies have shown that it is achievable. The Gaining Optimal Asthma control (GOAL) study enrolled 3421 patients in a 1-year prospective trial that compared the efficacy of two therapies.¹¹ The therapies compared were an increasing dose of fluticasone alone or combined with salmeterol to achieve asthma control as defined in the GINA guidelines. Most of the patients (80%) were able to achieve asthma control as defined by the guidelines with the combination therapy.

Asthma treatment is progressive in steps and is based on the severity of the disease.⁷ Step 1 is the use, as-needed, of a rapidly acting β_2 agonist. If the patient has exacerbations, step 2 involves the addition of either a low-dose inhaled cortico-

steroid or a leukotriene modifier drug. If the asthma is not controlled at step 2, one more therapy is indicated based on the therapy choice in step 2. The choice in step 3 includes a long-acting inhaled β_2 agonist or a medium-dose or high-dose inhaled corticosteroid, or if a low-dose inhaled corticosteroid was used in step 2, a leukotriene modifier or sustained-release theophylline is recommended. Step 4 involves the addition of a drug or drugs not already in use, such as the addition of a leukotriene modifier or sustained-release theophylline or an increase in the dose of the inhaled corticosteroid. Step 5 is the addition of either the lowest dose of an oral corticosteroid or anti-IgE treatment (Table 32-3).

Regardless of the severity of asthma, other therapeutic measures may also be used. The prompt administration of antibiotics is indicated for respiratory infections of nonviral origin. Sedatives may be used to minimize emotional stress; expectorants may aid in the removal of secretions. Finally, avoidance of tobacco and environmental irritants or allergens may help prevent episodes of asthma. Table 32-4 lists properties of common drugs used in asthma.

ASPIRIN-INDUCED ASTHMA

The incidence of aspirin-induced asthma among adult patients with asthma is estimated oral provocation testing to be 21%.⁵⁷ Aspirin hypersensitivity is underreported probably because of either lack of routine aspirin challenge or lack of recognition by patients of a mild NSAID-induced reaction. Aspirin-induced asthma is more frequent in women than in men. It

TABLE 32-4

Properties of Common Drugs for Asthma

DRUG CLASS	REPRESENTATIVE NONPROPRIETARY NAME (PROPRIETARY NAME)	MECHANISM OF ACTION	THERAPEUTIC EFFECTS	ADVERSE EFFECTS
Selective β_2 -adrenergic agonists	Short-acting: Albuterol (Proventil HFA) Long-acting: Salmeterol (Serevent Diskus)	Stimulation of β_2 receptors in the lung	Bronchodilation	Tachycardia, tremor, potential for overuse Airway hyperresponsiveness
Antimuscarinic agents	Ipratropium (Atrovent)	Blockade of M_3 receptors	Bronchodilation, decreased secretions	Tachycardia, xerostomia
Methylxanthines	Theophylline (Theo-24)	Phosphodiesterase inhibition, adenosine receptor blockade	Bronchodilation, anti-inflammatory effects	Nausea and vomiting, arrhythmias, tachycardia
Inhaled glucocorticoids	Fluticasone (Flovent HFA)	Modulation of gene expression	Reduced airway inflammation, prophylactic control	Oropharyngeal candidiasis
Leukotriene synthesis inhibitors	Zileuton (Zyflo CR)	Inhibition of 5-lipoxygenase	Decreased inflammation	Hepatotoxicity
Leukotriene antagonists	Montelukast (Singulair)	Blockade of cys-LT1 receptor	Decreased inflammation	Slight increase in gastrointestinal symptoms
Khellin derivative	Cromolyn (Intal)	Unknown	Inhibition of mast cell degranulation	Sneezing, burning

usually begins in adulthood, at an average age of 30 years. Rhinorrhea and nasal congestion are the first symptoms, with complications of nasal polyposis developing in response to chronic inflammation. Approximately 80% of patients with aspirin-induced asthma have sinusitis. This syndrome is characterized by asthma, nasal polyps, aspirin reactions, and chronic hyperplastic eosinophilic sinusitis.

The prostaglandin PGE_2 plays a role in aspirin-induced asthma.⁵⁶ PGE_2 is proinflammatory in many diseases, but in the lung it protects against bronchoconstriction during aspirin challenge. This prostaglandin exerts its activity through the binding of the prostanoid receptor EP_3 . This receptor is expressed on bronchial epithelia and mast cells. Through the EP_3 receptor, PGE_2 inhibits synthesis of cysLTs, inhibits release of mediators from mast cells, and diminishes inflammatory cell influx. PGE_2 is synthesized by COX-1 and COX-2 in the lung. In the lungs of individuals with aspirin-induced asthma, the expression of COX-2 is diminished. When COX-1 is inhibited by aspirin or NSAIDs, the concentration of the protective prostaglandin PGE_2 is decreased. COX-2 biosynthesis of PGE_2 is insufficient to compensate.

Another biochemical difference between patients with asthma who are aspirin-tolerant and those who are not is the expression of 5-lipoxygenase. In aspirin-intolerant patients, 5-lipoxygenase is upregulated, and the synthesis of cysLTs is increased. Aspirin-intolerant patients also express more cysLT receptors on nasal inflammatory cells. Although treatment of asthma in aspirin-intolerant patients is essentially the same as treatment in aspirin-tolerant patients, leukotriene modifiers, either inhibitors or antagonists, have been reported to be effective in long-term therapy in individuals with aspirin hypersensitivity.

PHARMACOTHERAPY FOR CHRONIC OBSTRUCTIVE PULMONARY DISEASE

Recognizing that there is no cure for COPD, the goals of therapy are to prevent disease progression, relieve symptoms,

improve health status, prevent exacerbations, reduce morbidity, and minimize adverse effects from treatment.²⁶ Anticholinergics and β_2 -adrenergic receptor agonists cause bronchodilation through different mechanisms. There is a long history of therapy with a combination of these two drug classes. Combination therapy also allows for smaller doses to be administered and minimizes adverse effects from treatment. The American Thoracic Society, the European Respiratory Society, and GOLD recommend that as COPD symptoms progress, the patient should receive treatment with one or more long-acting bronchodilators. If the patient has repeated exacerbations, an inhaled corticosteroid should be added as regular therapy.⁵⁹ Drug therapy is combined with smoking cessation and pulmonary rehabilitation exercises. As the disease progresses, the patient requires supplemental oxygen therapy.

IMPLICATIONS FOR DENTISTRY

To provide the most effective and safest dental care for a patient with respiratory disease, the dentist must be aware of the patient's history, medication usage, and how the medical problem is being managed. Factors that are important in the patient interview include past history of sudden severe exacerbations, previous intubation, previous admission to an intensive care unit, two or more hospitalizations or three or more emergency department visits in the past year, comorbidity from cardiovascular disease, frequency of use of a rapidly acting β_2 -adrenergic receptor agonist inhaler, and current use of steroids or recent withdrawal from corticosteroids.³⁷ The use of two or more canisters per month of a rapid-acting β_2 agonist inhaler is an indication that the respiratory disease is not well controlled.

The dentist must also be aware that patient factors, such as dementia, psychiatric disease, or psychosocial problems, can have an impact on the perception of airflow obstruction. Low socioeconomic status, urban residence, and illicit drug use also put the patient at risk for exacerbation of asthma or COPD. Inhaled steroids can contribute to slower healing in

the oral cavity and make the patient more susceptible to oral fungal infections. The patient should be asked to bring all medications for the respiratory condition to the dental appointment.

Another consideration is how the patient reacts to dental appointments. Many individuals become apprehensive and anxious about impending visits to the dental office. Emotional factors play an active role in precipitating or exacerbating respiratory symptoms. Dental materials that contain powder or the powder in latex gloves can increase the patient's airway obstruction if the particles are inhaled. Some patients may be unable to tolerate a horizontal position in the dental chair for a long time.

Analgesic therapy for a patient with asthma must be chosen with care. Aspirin should be avoided if there is a question of patient intolerance or nasal polyps because asthmatic episodes can be precipitated in some patients in minutes to hours after ingestion of these drugs. Patients with asthma who are unable to tolerate aspirin may also react adversely to other NSAIDs. The analgesic of choice for patients with asthma and aspirin allergy is acetaminophen. Large doses of morphine can produce bronchial obstruction by causing histamine release from mast cells. Opioids also decrease the respiratory drive, which is a dangerous liability to a patient whose airway resistance may be greater than normal.

The hypoxic state seen in patients with COPD can cause oral complications such as difficulty in healing after surgery and difficulty in fighting infection. Difficulty in breathing often forces patients to breathe through the mouth, which can cause xerostomia and the oral problems associated with a dry mouth. Also, many medications commonly used in COPD can inhibit salivation, such as β -agonist inhalers. Patients with advanced emphysema might use portable oxygen with a nasal cannula.

Long-term exposure to cigarettes places a patient with COPD at a greater risk for oral cancer. The dentist can encourage the patient to stop smoking. In 2003, the American Dental Association provided guidelines to assist the dentist in approaching patients who want to stop smoking.

It is important for the dentist and dental practice employees to be prepared for emergency exacerbations that may occur during a dental appointment. The National Asthma Education and Prevention Program of the National Heart, Lung and Blood Institute has written guidelines for such situations.¹³ The dentist should encourage patients with respiratory disease to bring their inhalers to all dental appointments. Initial recommended treatment for acute exacerbations is the administration of a short-acting β_2 agonist (2 to 4 puffs) by a metered dose inhaler at 20-minute intervals. After initial treatment, the response should be assessed as good, incomplete, or poor. If the response is incomplete or poor, patients might require further treatment in the emergency department. Additional therapy may include an oral corticosteroid and inhaled anticholinergic inhaled short-acting β_2 agonist. For severe episodes, administration of subcutaneous epinephrine, 0.2 to 0.5 mg, may be required.

DRUGS FOR MILD RESPIRATORY ILLNESSES

Numerous drugs are used to provide symptomatic relief of some uncomfortable symptoms of respiratory infection or mild allergies with respiratory symptoms. These include bronchodilators, antitussives, nasal decongestants, intranasal steroids, expectorants, and mucolytic agents.

Antitussives

Coughing is a protective reflex that clears the respiratory tract of accumulated secretions or noxious substances. A produc-

tive cough, with the elimination of excessive secretions, is beneficial, but nonproductive cough may impair rest and increase discomfort. An ideal antitussive agent should decrease the frequency and intensity of coughing but still allow adequate elimination of excessive secretions from the respiratory tract.

Opioid analgesics

In addition to their analgesic effect, most opioids suppress cough. Because of their side effects and addiction liability, more potent drugs, such as morphine and hydromorphone, are not commonly used as antitussives.

Codeine is the most useful opioid for cough suppression, by acting centrally on the medullary cough center. At therapeutic doses and for short-term use, its addiction potential is minimal, and depressed ventilation is infrequent. Overdosage can result in respiratory depression, convulsions, hypotension, and tachycardia.

Hydrocodone, similar to codeine, acts centrally on the medullary cough center. Hydrocodone apparently is three times more potent in antitussive activity than codeine. It also has a greater abuse potential. At therapeutic doses, the most common side effects include nausea, constipation, and dizziness. Long-term use should be accompanied by a plan for supporting bowel function. Lactulose may be prescribed to minimize constipation.

Other drugs for cough

Other drugs that act centrally on the medullary cough center include benzonatate, dextromethorphan, and noscaphine. These agents generally produce fewer adverse reactions than the traditional opioid drugs.

Benzonatate is an antitussive structurally related to tetracaine. Although the primary action of benzonatate is apparently depression of the central cough mechanism, it may also act by inhibiting the stretch receptors of the respiratory mucosa. The most common adverse reactions include nausea, constipation, headache, drowsiness, and vertigo. Nasal congestion and numbness of the tongue, mouth, and pharynx have been noted if the capsules are chewed before swallowing.

Dextromethorphan, the methyl ester of the dextroisomer of the opioid levorphanol, seems to be the most popular cough suppressant. In one clinical study, the antitussive effects of 60 mg of dextromethorphan did not differ significantly from the antitussive effects of 30 mg of codeine phosphate.⁵ In over-the-counter mixtures, dextromethorphan is often used in combination with other agents, such as bronchodilators, antihistamines, and expectorants. It has no addiction liability or analgesic properties. Side effects are minimal at recommended doses.

Noscaphine is one of the isoquinoline series of opium alkaloids. It has no analgesic activity or abuse potential but is an effective antitussive with few adverse reactions. At high doses, nausea, headache, and drowsiness have been reported. Noscaphine is occasionally included in multientity over-the-counter preparations.

Nasal Decongestants

The most commonly used nasal decongestants are adrenergic agents. These drugs act by stimulating excitatory α -adrenergic receptors of vascular smooth muscles, constricting the dilated arterioles within the nasal mucosa. This constriction reduces blood flow in the edematous area and opens obstructed nasal passages.

Most of these drugs are used topically. Topical application may cause temporary stinging, burning, or drying of the mucosa. Rebound congestion occurs after the use of many of these agents, often causing misuse of the drugs. Prolonged topical use may be irritating enough to induce a chronic swell-

ing of the nasal mucosa; discontinuing the drug remedies this situation.

Phenylephrine, a selective α_1 -adrenergic receptor agonist, is a widely used decongestant. It is less potent than the catecholamines but its duration of action is longer. Pseudoephedrine is a closely related drug.

Ephedrine and epinephrine are effective decongestants, but they are seldom used in this capacity. Ephedrine can produce swelling of the nasal mucosa, tachyphylaxis, CNS stimulation, palpitation, and transient hypertension. Epinephrine frequently produces rebound nasal congestion and the typical symptoms of CNS and cardiovascular stimulation, such as anxiety, palpitation, restlessness, dizziness, and headache. The adverse reactions produced by either drug disappear rapidly after the medication is discontinued.

Propylhexedrine is administered by nasal inhalation. Although local burning and stinging may occasionally occur, it has few adverse effects when used clinically. It can even be used for patients in whom the pressor effect of ephedrine is to be avoided.

Oxymetazoline is an effective decongestant with a long duration of action. It is a selective α_2 -adrenergic receptor agonist. (Nasal vessels contain numerous α_2 -adrenergic receptors.) It is available as a solution and as a spray. The adverse reactions associated with its use are mild and include stinging or drying of the nasal mucosa, headache, palpitation, and insomnia. Rebound nasal congestion may occur with use. Similar drugs include naphazoline, tetrahydrozoline, and xylometazoline.

Intranasal Steroids

Adrenal corticosteroids administered by nasal spray are effective for the relief of seasonal and perennial rhinitis. In this use, these drugs share many of the characteristics of steroids given by inhalation for the management of asthma. Drugs that are used for both purposes include beclomethasone, flunisolide, triamcinolone, budesonide, and fluticasone. Therapeutic benefits normally begin after several days of continuous use (one to three times per day, depending on the drug) but may be delayed for 3 weeks.

When intranasal steroids are used appropriately, systemic effects are minimal. Local candidiasis of the mouth and pharynx has occasionally been reported. Rinsing the mouth after use helps prevent such occurrences.

Expectorants and Mucolytics

Agents administered to stimulate the flow of respiratory tract secretions are termed *expectorants*. Mucolytic agents are used to reduce the viscosity of respiratory tract secretions. Both drug groups enhance the movement of secretions upward and outward by ciliary movement and coughing.

Expectorants are believed to act by stimulating receptors in the gastric mucosa, initiating reflex secretion of respiratory tract fluid. This action is assumed to increase the volume and decrease the viscosity of the secretions. There is little clinical evidence supporting the efficacy of these agents.

Potassium iodide is an example of a drug used traditionally as an expectorant and for which there is little proof of effectiveness. It is readily absorbed and produces untoward reactions on prolonged use. Iodism, characterized by skin rash, fever, parotitis, and lacrimal gland enlargement, can be produced. Thyroid enlargement or decreased thyroid function can also occur. Sensitivity reactions can develop, and anaphylaxis has occasionally been reported.

Ammonium chloride is another example of a drug used traditionally to stimulate the flow of respiratory secretions. It is used most frequently in multientity mixtures. It is readily absorbed and can produce metabolic acidosis if large doses are administered.

Guaifenesin (glyceryl guaiacolate) is available as an ingredient in various tablets and syrups. In clinical evaluations when compared with a matching vehicle, guaifenesin reportedly increased sputum volume; facilitated removal of sputum; and reduced cough frequency, cough intensity, and chest discomfort.⁵² Nausea and gastrointestinal upset may occasionally occur, but no serious adverse effects are associated with guaifenesin.

DRUGS ACTING ON THE RESPIRATORY SYSTEM

<i>Nonproprietary (generic) name</i>	<i>Proprietary (trade) name</i>
Emergency drugs	
Aromatic ammonia spirit	Aromatic Ammonia Aspirols
Doxapram	Dopram
Oxygen	—
Corticosteroids (inhalation or intranasal or both)	
Beclomethasone	Beclovent, Beconase AQ, QVAR
Budesonide	Pulmicort, Rhinocort
Dexamethasone	Decadron
Flunisolide	AeroBid, Nasalide
Fluticasone	Flonase, Flovent, in Advair
Mometasone	Nasonex
Triamcinolone	Nasacort AQ
Adrenergic bronchodilators	
Albuterol	Proventil HFA, Ventolin HFA
Bitolterol*	Tornalate
Ephedrine	—
Epinephrine	Nephron, Primatene Mist
Ethylnorepinephrine	Bronkephrine
Formoterol	Foradil
Isoetharine	—
Isoproterenol	Isuprel
Levalbuterol	Xopenex
Metaproterenol	Alupent
Pirbuterol	Maxair
Procaterol*	Pro-Air
Salmeterol	Serevent, in Advair
Terbutaline	Brethine
Xanthines	
Aminophylline (theophylline ethylenediamine)	Phyllocontin, Truphylline
Oxtriphylline	Brondecon, Choleldyl
Theophylline	Elixophyllin, Slo-Phyllin
Theophylline, extended-release	Slo-Phyllin Gyrocaps, Theo-Dur
Agents limited to prophylaxis or long-term treatment of asthma	
Cromolyn	Intal, Nasalcrom
Ketotifen*	Zaditen

DRUGS ACTING ON THE RESPIRATORY SYSTEM—cont'd

<i>Nonproprietary (generic) name</i>	<i>Proprietary (trade) name</i>
Montelukast	Singulair
Nedocromil	Tilade
Zafirlukast	Accolate
Zileuton	Zyflo CR
Anticholinergic bronchodilators	
Atropine	Day-Dose Atropine Sulfate
Ipratropium	Atrovent
Antitussives	
Benzonate	Tessalon Perles
Caramiphen	In Rescaps-D S.R.
Codeine	—
Dextromethorphan	Pertussin, Vicks Formula 44
Diphenhydramine	Bydramine, Diphen Cough
Hydrocodone	In Hycodan
Hydromorphone	In Dilaudid Cough Syrup
Noscapine	—
Nasal decongestants	
Ephedrine	Pretz-D, Vicks Vatronol
Epinephrine	Adrenalin Chloride
Naphazoline	Privine
Oxymetazoline	Afrin, Dristan Long Acting
Phenylephrine	Alconefrin, Neo-Synephrine
Phenylpropanolamine*	Propagest
Propylhexedrine	Benzedrex
Pseudoephedrine	Novafed, Sudafed
Tetrahydrozoline	Tyzine
Xylometazoline	Otrivin
Expectorants and mucolytics	
Acetylcysteine	Mucomyst, Mucosil
Ammonium chloride	In Efricon Expectorant Liquid
Guaifenesin	In Halotussin, in Robitussin
Iodinated glycerol	Iophen NR, Organidin NR
Potassium iodide	Pima
Syrup of ipecac	—
Terpin hydrate	—

CITED REFERENCES

- Adcock IM, Ito K, Barnes PJ: Histone deacetylation: an important mechanism in inflammatory lung diseases. *COPD* 2:445-455, 2005.
- Anderson GP: Current issues with β_2 -adrenoceptor agonists: pharmacology and molecular and cellular mechanisms. *Clin Rev Allergy Immunol* 31:119-130, 2006.
- Anderson GP, Lindén A, Rabe KF: Why are long-acting beta-adrenoceptor agonists long-acting? *Eur Respir J* 7:569-578, 1994.
- Arner B: A comparative clinical trial of different subcutaneous doses of terbutaline and orciprenaline in bronchial asthma. *Acta Med Scand Suppl* 512:45-48, 1970.
- Aylward M, Maddock J, Davies DE, et al: Dextromethorphan and codeine: comparison of plasma kinetics and antitussive effects. *Eur J Respir Dis* 65:283-291, 1984.
- Barnes PJ: Corticosteroids: the drugs to beat. *Eur J Pharmacol* 533:2-14, 2006.
- Barnes PJ: Current therapy for asthma. In Hansel TT, Barnes PJ, editors: *New drugs for asthma, allergy and COPD*, vol 31, Basel, 2001, Karger.
- Barnes PJ: How corticosteroids control inflammation: Quintiles Prize Lecture 2005. *Br J Pharmacol* 148:245-254, 2006.
- Barnes PJ: Theophylline in chronic obstructive pulmonary disease: new horizons. *Proc Am Thorac Soc* 2:334-339, 2005.
- Barnes PJ: Theophylline: new perspectives for an old drug. *Am J Respir Crit Care Med* 167:813-818, 2003.
- Bateman ED, Boushey HA, Bousquet J, et al: Can guideline-defined asthma control be achieved? The Gaining Optimal Asthma Control study. *Am J Respir Crit Care Med* 170:836-844, 2004.
- Bhatnagar P, Guleria R, Kukreti R: Pharmacogenomics of β_2 -agonist: key focus on signaling pathways. *Pharmacogenomics* 7:919-933, 2006.
- Blake K: Review of guidelines and the literature in the treatment of acute bronchospasm in asthma. *Pharmacotherapy* 26:148S-155S, 2006.
- Bousquet J, Jeffery PK, Busse WW, et al: Asthma: from bronchoconstriction to airways inflammation and remodeling. *Am J Respir Crit Care Med* 161:1720-1745, 2000.
- Broadley KJ: β -Adrenoceptor responses of the airways: for better or worse? *Eur J Pharmacol* 533:15-27, 2006.
- Chesnutt M, Kazarys S: Asthma therapy in the nineties: focus on inflammation. *Hosp Form* 27:166-187, 1992.
- Church M, Polosa R, Rimmer S: Cromolyn sodium and nedocromil sodium: mast cell stabilizers, neuromodulators, or anti-inflammatory drugs? In Kaliner MA, Barnes PJ, Persson CGA, editors: *Asthma: its pathology and treatment. Lung biology in health and disease*, vol 49, New York, 1991, Marcel Dekker.
- Currie GP, Lee DK, Lipworth BJ: Long-acting β_2 -agonists in asthma: not so SMART? *Drug Saf* 29:647-656, 2006.
- Currie GP, McLaughlin K: The expanding role of leukotriene receptor antagonists in chronic asthma. *Ann Allergy Asthma Immunol* 97:731-741, 2006.
- D'Alonzo GE, Nathan RA, Henochoicz S, et al: Salmeterol xinafoate as maintenance therapy compared with albuterol in patients with asthma. *JAMA* 271:1412-1416, 1994.
- D'Amato G: Role of anti-IgE monoclonal antibody (omalizumab) in the treatment of bronchial asthma and allergic respiratory diseases. *Eur J Pharmacol* 533:302-307, 2006.
- Dahlen SE: Treatment of asthma with antileukotrienes: first line or last resort therapy? *Eur J Pharmacol* 533:40-56, 2006.
- Derendorf H: Pharmacokinetic and pharmacodynamic properties of inhaled corticosteroids in relation to efficacy and safety. *Respir Med* 91(Suppl A):22-28, 1997.
- Derendorf H, Nave R, Drollmann A, et al: Relevance of pharmacokinetics and pharmacodynamics of inhaled corticosteroids to asthma. *Eur Respir J* 28:1042-1050, 2006.
- Disse B, Speck GA, Rominger KL, et al: Tiotropium (Spiriva): mechanistical considerations and clinical profile in obstructive lung disease. *Life Sci* 64:457-464, 1999.
- Donohue JF: Combination therapy for chronic obstructive pulmonary disease: clinical aspects. *Proc Am Thorac Soc* 2:272-281, 2005.
- Eder W, Ege MJ, von Mutius E: The asthma epidemic. *N Engl J Med* 355:2226-2235, 2006.
- Ernst P, McIvor A, Ducharme FM, et al: Safety and effectiveness of long-acting inhaled β -agonist bronchodilators when taken with inhaled corticosteroid. *Ann Intern Med* 145:692-694, 2006.
- Faurischou P, Steffensen I, Jacques L: Effect of addition of inhaled salmeterol to the treatment of moderate-to-severe asthmatics uncontrolled on high-dose inhaled steroids. European Respiratory Study Group. *Eur Respir J* 9:1885-1890, 1996.

30. Foe K, Brown KF, Seale JP: Comparative kinetics of metabolism of beclomethasone propionate esters in human lung homogenates and plasma. *J Pharm Sci* 89:1143-1150, 2000.
31. Giembycz MA, Newton R: Beyond the dogma: novel β_2 -adrenoceptor signalling in the airways. *Eur Respir J* 27:1286-1306, 2006.
32. Global Initiative for Asthma expert panel: *Global strategy for asthma management and prevention*, Medical Communications Resources, 2009 update. Available at <http://www.ginasthma.org>. Accessed January 16, 2010.
33. Grant SM, Goa KL, Fitton A, et al: Ketotifen: a review of its pharmacodynamic and pharmacokinetic properties, and therapeutic use in asthma and allergic disorders. *Drugs* 40:412-448, 1990.
34. Green SA, Spasoff AP, Coleman RA, et al: Sustained activation of a G protein-coupled receptor via "anchored" agonist binding: molecular localization of the salmeterol exosite within the β_2 -adrenergic receptor. *J Biol Chem* 271:24029-24035, 1996.
35. Gross NJ: Anticholinergic agents in asthma and COPD. *Eur J Pharmacol* 533:36-39, 2006.
36. Hanania NA, Chapman KR, Kesten S: Adverse effects of inhaled corticosteroids. *Am J Med* 98:196-208, 1995.
37. Hupp W: Dental management of patients with obstructive pulmonary diseases. In Hupp J, editor: *Medical conditions and their impact on dental care*, New York, 2006, Elsevier.
38. Ito K, Lim S, Caramori G, et al: A molecular mechanism of action of theophylline: induction of histone deacetylase activity to decrease inflammatory gene expression. *Proc Natl Acad Sci U S A* 99:8921-8926, 2002.
39. Kelly HW: Risk versus benefit considerations for the β_2 -agonists. *Pharmacotherapy* 26:164S-174S, 2006.
40. Louie S, Yoneda KY, Kenyon NJ: Treatment of asthma in adults. In Gershwin ME, Albertson TE, editors: *Bronchial asthma: principles of diagnosis and treatment*, ed 4, Totowa, NJ, 2001, Humana.
41. MacNee W: Pathogenesis of chronic obstructive pulmonary disease. *Proc Am Thorac Soc* 2:258-266, 2005.
42. Man SF, Sin DD: Inhaled corticosteroids in chronic obstructive pulmonary disease: is there a clinical benefit? *Drugs* 65:579-591, 2005.
43. Marin MG: Low-dose methotrexate spares steroid usage in steroid-dependent asthmatic patients: a meta-analysis. *Chest* 112:29-33, 1997.
44. McGraw DW, Almoosa KF, Paul RJ, et al: Antithetic regulation by β -adrenergic receptors of Gq receptor signaling via phospholipase C underlies the airway β -agonist paradox. *J Clin Invest* 112:619-626, 2003.
45. Murray CJ, Lopez AD: Evidence-based health policy—lessons from the Global Burden of Disease Study. *Science* 274:740-743, 1996.
46. Naedele-Risha R, Dorinsky P, Craig TJ: Dual components of optimal asthma therapy: scientific and clinical rationale for the use of long-acting β -agonists with inhaled corticosteroids. *J Am Osteopath Assoc* 101:526-533, 2001.
47. Nowak D: Management of asthma with anti-immunoglobulin E: a review of clinical trials of omalizumab. *Respir Med* 100:1907-1917, 2006.
48. Ogawa Y, Calhoun WJ: The role of leukotrienes in airway inflammation. *J Allergy Clin Immunol* 118:789-798; quiz 799-800, 2006.
49. Pearlman DS, Chervinsky P, LaForce C, et al: A comparison of salmeterol with albuterol in the treatment of mild-to-moderate asthma. *N Engl J Med* 327:1420-1425, 1992.
50. Rahman I, Adcock IM: Oxidative stress and redox regulation of lung inflammation in COPD. *Eur Respir J* 28:219-242, 2006.
51. Reilly K, Salluzzo R: Theophylline toxicity. *Resid Staff Physician* 37:55-57, 1991.
52. Robinson RE, Cummings WR, Deffenbaugh EB: Effectiveness of guaifenesin as an expectorant: a cooperative double blind study. *Curr Ther Res* 22:284-296, 1977.
53. Roth M, Johnson PRA, Rüdiger JJ, et al: Interaction between glucocorticoids and β_2 agonists on bronchial airway smooth muscle cells through synchronised cellular signalling. *Lancet* 360:1293-1299, 2002.
54. Sin DD, Man SF: Corticosteroids and adrenoceptor agonists: the compliments for combination therapy in chronic airways diseases. *Eur J Pharmacol* 533:28-35, 2006.
55. Sin DD, Man SF: Pharmacotherapy for mortality reduction in chronic obstructive pulmonary disease. *Proc Am Thorac Soc* 3:624-629, 2006.
56. Stevenson DD, Szczeklik A: Clinical and pathologic perspectives on aspirin sensitivity and asthma. *J Allergy Clin Immunol* 118:773-786, 2006.
57. Szczeklik A, Sanak M: The broken balance in aspirin hypersensitivity. *Eur J Pharmacol* 533:145-155, 2006.
58. Thompson N: Non-steroidal prophylactic agents: mode of action and place in management. In Clark TJ, Godfrey S, Lee T, editors: *Asthma*, London, 2000, Arnold.
59. van Schayck CP, Reid J: Effective management of COPD in primary care—the role of long-acting beta agonist/inhaled corticosteroid combination therapy. *Prim Care Respir J* 15:143-151, 2006.
60. Wenzel SE: New approaches to anti-inflammatory therapy for asthma. *Am J Med* 104:287-300, 1998.
61. Woolcock A, Lundback B, Ringdal N, et al: Comparison of addition of salmeterol to inhaled steroids with doubling of the dose of inhaled steroids. *Am J Respir Crit Care Med* 153:1481-1488, 1996.

GENERAL REFERENCES

- Adcock IM, Caramori G, Chung KF: New targets for drug development in asthma, *Lancet* 372:1073-1087, 2008.
- Mahmoudi M, editor: *Allergy and asthma: practical diagnosis and management*, New York, 2008, McGraw Hill Medical.

Drugs Acting on the Gastrointestinal Tract

DAVID H. SHAW

Drugs that exert an effect on the gastrointestinal tract are among the most frequently used drugs. Digestive diseases are estimated to affect 60 to 70 million people in the United States each year with an annual direct cost of more than \$85 billion.²³ There is a high likelihood that a patient coming into the dental office may be on a regimen of one or more of these agents. Included in this group of drugs are anticholinergics, antihistamines, antacids, proton pump inhibitors (PPIs), antiemetics, laxatives, antidiarrheal or antispasmodic drugs, and gastrointestinal stimulants. Some of these drugs are available over-the-counter (OTC) without prescription and may be used at the discretion of the patient.

Dentists are likely to prescribe these some of these drugs to modify salivary gland function or reduce nausea and vomiting. Knowledge that the patient is taking these drugs helps the dental provider to understand the patient's medical situation better, guides treatment decisions such as chair position, and may influence the choice of a dental therapeutic agent. A gastrointestinal disturbance arising during the course of dental treatment may be attributable to, or managed by, one of these agents.

Many of the drugs discussed here are described in detail in other parts of the book. This chapter focuses on drugs used exclusively for their effect on the gastrointestinal tract and drugs with a wider spectrum of activity that have application to gastrointestinal disorders. Drugs that act on the gastrointestinal tract and are commonly used in dentistry to modify salivary gland activity or to reduce drug-induced nausea and vomiting are listed in Table 33-1.

GASTRIC HYPERACIDITY, GASTROESOPHAGEAL REFLUX DISEASE, AND PEPTIC ULCER DISEASE

Acid-peptic conditions such as heartburn (pyrosis), dyspepsia (indigestion), gastroesophageal reflux, and peptic ulcer disease (PUD) (gastric and duodenal) are often treated with drugs that either reduce intragastric acidity or promote gastrointestinal mucosal defense. In all these conditions, patient discomfort primarily results from the caustic effects of the gastric acid on the esophagus or from overcoming the gastrointestinal mucosal defense system or both. In the United States, heartburn has been reported to occur at least once a month by 44% of adults, at least weekly by 14%, and at least daily by 7%.¹² *Heartburn* is a common term to describe a burning sensation that usually arises from the lower chest area (substernal) and moves upward toward the neck. It most commonly occurs within 2 hours after eating or when lying down or bending over. The symptoms are caused by the abnormal reflux of gastric contents or vapors retrograde into the esophagus. Heartburn that

is frequent and persistent is the most common symptom of gastroesophageal reflux disease (GERD). GERD is one of the most prevalent digestive diseases among adults in the United States with more than 19 million cases annually.²⁵ Symptoms arising from GERD, such as heartburn, are among the most common reasons for visits to primary care physicians.

PUD is a common malady affecting 10% to 15% of the population at some time in life. In a given year, nearly 15 million people in the United States have PUD.²³ Although PUD is a painful condition that can seriously affect the quality of life, it is rarely fatal. Economically it is a major illness, with annual direct costs in the United States of greater than \$3 billion, not including dollars lost in decreased wages and work productivity.²⁵ Peptic ulcers are characterized by spontaneous healing and recurrence. The primary complication is hemorrhage, which may be life-threatening if undetected or ignored. Perforation of the gastrointestinal wall, which occurs much less frequently, accounts for most of the more than 4000 deaths from this disease each year in the United States.¹⁰

Throughout most of the twentieth century, therapy for PUD was directed at suppression of acid secretion or neutralization of secreted acid. This approach was based on the erroneous assumption that ulcers develop only because of increased gastric acid secretion. The primary causes of PUD are now known to be related to mucosal exposure to gastric acid and pepsin with a very strong association with *Helicobacter pylori* infection or the breakdown of normal mucosal defenses from the use of nonsteroidal anti-inflammatory drugs (NSAIDs).¹⁰ *H. pylori* infects more than half of the U.S. population older than 50 years and accounts for 80% of all stomach ulcers and greater than 90% of all duodenal ulcers.³ Because only a relatively small percentage of *H. pylori*-infected patients develop PUD in their lifetime, other factors must play a role in the development of this disease. Although *H. pylori* is found in saliva, the relationship between its presence in the mouth and infection in the stomach is unknown. The oral cavity may be a permanent reservoir for *H. pylori*, and a person-to-person route is the most probable mode of transmission.²⁶

DRUGS USED TO REDUCE GASTRIC ACID AND TREAT PEPTIC ULCER DISEASE

Proton Pump Inhibitors

PPIs are drugs that irreversibly inhibit H⁺/K⁺-activated adenosine triphosphatase (H⁺,K⁺-ATPase, commonly called the *proton pump*) in the gastric parietal cell (Figure 33-1), the final common pathway for acid secretion. PPIs have become the drug class of choice for treating acid-related gastrointestinal diseases such as PUD and GERD. PPIs are among the most

FIGURE 33-1 The physiologic control of H^+ secretion by the gastric parietal cell, with the site of action of the major antisecretory drugs. Included is an endocrine cell that secretes histamine (enterochromaffin-like [ECL] cell) and an acid-secreting parietal cell.

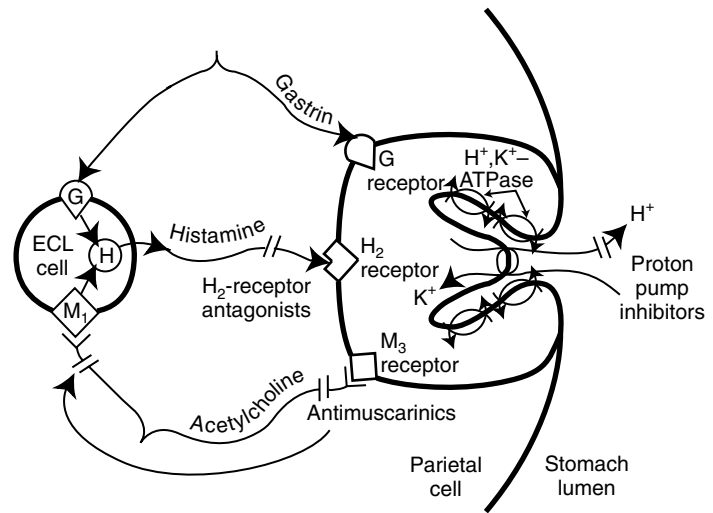

TABLE 33-1

Drugs Useful in Dentistry That Affect the Gastrointestinal Tract

THERAPEUTIC USE	DRUG	DOSE (mg)*
Sialagogue	Pilocarpine hydrochloride (Salagen)	5 [†]
	Cevimeline hydrochloride (Evoxac)	30 [†]
Antisialagogue	Atropine sulfate (Sal-Tropine)	0.3-1.2
	Scopolamine hydrobromide (Scopace)	0.4-0.8
	Glycopyrrolate (Robinul)	1-2
	Propantheline bromide	7.5-30
Antiemetic	Dimenhydrinate (Dramamine)	50-100
	Meclizine hydrochloride (Antivert)	25-50
	Promethazine hydrochloride (Phenergan)	25

*Adult, oral route.

[†]Discussed in Chapter 8.

widely selling drugs because of their outstanding efficacy and safety. Currently, five members of the PPI class are available by prescription in the United States: esomeprazole, lansoprazole, omeprazole, pantoprazole, and rabeprazole (Table 33-2). Omeprazole is available OTC. When taken orally, all five agents effectively reduce basal and stimulated acid secretion considerably. They are longer lasting and substantially more potent than histamine H_2 -receptor antagonists in the short-term treatment of PUD and GERD and relief of heartburn.

PPIs are administered as inactive prodrugs that accumulate selectively in the acid environment of the secretory canaliculus of the gastric parietal cell. The PPI is rapidly protonated and converted to the active form of the drug. Because PPIs bind covalently to active proton pumps, synthesis of new pumps or activation of resting pumps is required to restore activity. This irreversible inhibition of the pump explains why the duration of action of this class extends beyond the elimi-

nation half-life of 0.5 to 2 hours (see Table 33-2). PPIs are best taken on an empty stomach (food can decrease bioavailability up to 50%) once daily 1 hour before a meal so that the peak serum concentration coincides with the maximum activation of the proton pumps.

The most common adverse effects reported with PPIs are headache, diarrhea, and nausea, but the frequency is only slightly greater than placebo. Long-term use of PPIs may cause a slight increase in serum gastrin. This information led to concerns regarding gastrin-induced neoplasms that have been reported in animal models. PPIs have been available for more than 20 years and, to date, none have been associated with an increased risk of gastric cancers in patients receiving long-term therapy. Of more recent concern are reports that PPIs, particularly at high doses, are associated with an increased risk of hip fracture by interfering with Ca^{++} absorption through induction of hypochlorhydria³¹ and with an increased risk to develop community-acquired *Clostridium difficile*-associated disease (CDAD).²²

All PPIs increase gastric pH and may alter the absorption of drugs that are weak bases or acids or formulated as pH-dependent, controlled-release products. Absorption of aspirin, digoxin, and midazolam may be increased, and ketoconazole absorption may be decreased when administered with a PPI. The clinical significance of the alterations is unclear. PPIs can also alter the hepatic metabolism of other medications. All PPIs are metabolized to varying degrees by hepatic P450 cytochromes, including CYP2C19 and CYP3A4, and may interfere with the medications metabolized by these same enzymes. Omeprazole has been shown to progressively inhibit CYP2C19 activity with repeated administration and may inhibit the metabolism of diazepam, warfarin (Coumadin), and phenytoin.²⁴ Despite these concerns, few clinically significant drug interactions have been reported given the enormous popularity of PPIs.

H_2 Receptor Antihistamines

Histamine is one of the primary mediators of gastric acid secretion, along with acetylcholine and gastrin. The final common pathway is through the proton pump (see Figure 33-1). As discussed in Chapter 22, H_2 receptors are located on the membranes of acid-secreting parietal cells of the stomach. H_2 receptor antihistamines (commonly called *H₂ blockers*) are reversible, competitive antagonists of histamine at the H_2 receptors. The duration and the degree of acid suppression are dose-dependent. These are highly selective agents in that they do not affect the H_1 receptors and are not

TABLE 33-2

Comparison of Proton Pump Inhibitors

DRUG	BIOAVAILABILITY (%)	PEAK PLASMA TIME (hr)	ELIMINATION HALF-LIFE (hr)	ORAL DOSE INTERVAL (hr)
Esomeprazole (Nexium)	>50	1.5	1.7	24
Lansoprazole (Prevacid)	>80	1.7	1.5	24
Omeprazole (Prilosec)	35	0.5-3.5	0.5-1	24
Pantoprazole (Protonix)	>77	2.4	1	24
Rabeprazole (Aciphex)	52	2-5	1-2	24

TABLE 33-3

Comparison of H₂ Antihistamines

DRUG	BIOAVAILABILITY (%)	PEAK PLASMA TIME (hr)	ELIMINATION HALF-LIFE (hr)	ORAL DOSE INTERVAL (hr)*
Cimetidine (Tagamet)	60-70	0.75-1.5	2	6-24
Famotidine (Pepcid)	40-45	1-3	3	12-24
Nizatidine (Axid)	>90	0.5-3	1.5	12-24
Ranitidine (Zantac)	50-60	1-3	2.5	12-24

*For treatment of duodenal or gastric ulcer.

anticholinergic. Cimetidine, the first of these drugs to be used widely, revolutionized the treatment of duodenal ulcers. With the recognition of the role of *H. pylori* in PUD and the introduction of PPIs, the use of H₂ antagonists has markedly declined.

A usual single dose of any of the H₂ antagonists currently available for prescription or nonprescription use in the United States, including cimetidine, famotidine, nizatidine, and ranitidine (Table 33-3), inhibits 60% to 70% of total 24-hour acid secretion. These agents are particularly effective in inhibiting nocturnal acid secretion, which is stimulated more by histamine. Food-induced gastric acid secretion is stimulated more by gastrin and acetylcholine and is less inhibited by the H₂ blockers.

H₂ antagonists, in addition to their antisecretory actions, also accelerate ulcer healing by the induction of endogenous prostanoid synthesis. Patients with untreated duodenal ulcers have significantly lower gastric prostanoid synthesis than occurs in normal subjects, and patients on long-term NSAID therapy show almost complete inhibition of prostanoid synthesis by gastric mucosa. These findings suggest that decreased endogenous prostanoid synthesis may contribute to the pathogenesis of mucosal damage.

H₂ blockers are commonly administered orally. The antisecretory activity usually begins within 1 hour of administration and persists for 6 to 12 hours. They have an oral bioavailability of 40% to greater than 90%, achieve peak plasma concentrations in 0.5 to 3 hours, and are eliminated with a terminal half-life of 1.5 to 3 hours (see Table 33-3). The drugs undergo partial metabolism in the liver; the remainder of the parent drug is eliminated unchanged by the kidney. The duration of effectiveness varies with the drug, dose, and medical condition being treated, ranging from 4 hours for a low dose of cimetidine for hypersecretory disorders to 24 hours for all these agents when used to treat duodenal and gastric ulcers.

Comparative studies of H₂ blockers show that the four drugs in this class are essentially equal in clinical effectiveness regarding ulcer treatment even though they express varying potencies in their ability to block pentagastrin-stimulated gastric acid secretion in the research laboratory. Cimetidine

seems unique among H₂ blockers in exerting biologic effects that are unrelated to gastric H₂ occupancy. Cimetidine therapy, particularly when prolonged and at high doses, can cause antiandrogenic effects. These reversible effects result from the ability of cimetidine to compete with dihydrotestosterone at androgen-binding sites and to inhibit the CYP metabolism of estradiol.¹³ Men treated with high doses of cimetidine for long periods may experience impotence and development of gynecomastia, whereas women may develop galactorrhea. Substitution of ranitidine for cimetidine reverses these effects; no antiandrogenic effects have been reported after therapeutic doses of famotidine or nizatidine.

Of importance to the dentist is the ability of cimetidine to decrease the hepatic oxidative biotransformation of many other drugs, including lidocaine and diazepam. Cimetidine and ranitidine are ligands for multiple CYP enzymes (see Table 2-3), with cimetidine exhibiting a much higher affinity and inhibiting hepatic microsomal enzyme activity to a much greater extent. The clinical use of ranitidine, famotidine, and nizatidine does not seem to have a significant effect on the metabolism and elimination of other drugs.

The widespread use of cimetidine has revealed various central nervous system (CNS) manifestations (e.g., headache, lethargy, confusion, forgetfulness), especially in elderly patients. Impaired renal function in an older patient may contribute to these reactions. Similar effects have been reported for ranitidine and famotidine but seem to be less common.

Antibiotics

The evidence that PUD (and gastritis and possibly gastric adenocarcinoma) is directly linked to infection by the gram-negative organism *H. pylori* is now well established. Cultures taken from biopsy material are positive for *H. pylori* in approximately 95% of duodenal ulcer specimens and 75% of biopsy specimens taken from gastric ulcers compared with a roughly 25% incidence in asymptomatic control subjects.⁵

These findings have led to the routine use of antibiotic therapy for the eradication of gastric and duodenal ulcers. Significant reductions in clinical symptoms and histologic evidence of ulcers have been achieved. The current cornerstone

of therapy for *H. pylori*-associated peptic ulcers involves a triple regimen of a PPI (e.g., lansoprazole) with dual antibiotics clarithromycin and amoxicillin. This treatment regimen results in eradication of the organism in greater than 80% of patients,⁹ although the success rate has been declining because of increasing clarithromycin resistance.⁶ PPIs not only add antisecretory properties, but may also enhance healing through direct anti-*H. pylori* properties. Other therapeutic approaches include adding bismuth subsalicylate to the regimen (quadruple therapy) or substituting a different antibiotic such as levofloxacin or metronidazole.⁹ For patients with NSAID-induced PUD, rapid healing is often initiated with the use of a PPI and discontinuation of the NSAID. Future studies are required to determine the exact interaction between bacterial infection and other prognostic factors (e.g., smoking, alcohol, NSAIDs) implicated in ulcer formation.

Gastric Antacids

Gastric antacids are weak bases that buffer or neutralize gastric hydrochloric acid (HCl) to form a salt and water and reduce gastric acidity. They are useful in the treatment of PUD, heartburn, GERD, and dyspepsia caused by overeating or eating certain foods. Through acid neutralization, antacids also secondarily reduce the proteolytic activity of pepsin, which is completely inactivated at a pH greater than 4. Overuse of antacids is discouraged because excessive neutralization may stimulate acid rebound; this response may be of little clinical significance because the added acid load likely is compensated by the buffers in the antacid. All antacids may affect the absorption of other medications by directly binding to the drug or increasing the intragastric pH, altering the drug's dissolution/solubility. In particular, antacids should not be given within 2 hours of a dose of a tetracycline or fluoroquinolone antibiotic.

Antacids may also enhance ulcer healing independent of their acid-neutralizing property by enhancing the gastric mucosal defense mechanisms. They may stimulate prostaglandin production or bind unidentified substances that may be injurious to the mucosa, or both. Prostaglandins are known to inhibit gastric acid secretion and exert cytoprotective properties. Taken together, the overall effect of antacid therapy is far more complex than simple acid neutralization.

Antacids have a rapid onset of action that depends on how fast the product dissolves in gastric acid. In general, antacid suspensions dissolve more easily than tablets or powders for a faster response. The duration of action of an antacid in the stomach is influenced by the gastric emptying time, which is slowed by food in the stomach and patient variability in gastric secretory capacity. In general, antacids taken on an empty stomach have a duration of action of approximately 30 minutes, whereas antacids taken after a full meal may neutralize acid for 3 hours. Four primary compounds are currently used, alone or in combination, in antacid products: sodium bicarbonate, Mg⁺⁺ salts, aluminum salts, and calcium carbonate. Following is a discussion of these commonly used antacid preparations:

Sodium bicarbonate

Sodium bicarbonate is widely available in the form of baking soda and combination products. It reacts almost instantaneously to neutralize HCl to produce CO₂ and NaCl. The formation of CO₂ results in belching and gastric distention. Sodium bicarbonate is referred to as a "systemic" antacid because the unreacted fraction is readily absorbed into the general circulation and may alter systemic pH. The potential for Na⁺ overload and systemic alkalosis limits its use to short-term relief of indigestion. Na⁺ overload resulting from repeated use of large doses may contribute to fluid retention, edema, hypertension, congestive heart failure, and renal failure.

Sodium bicarbonate is contraindicated in patients on a low-salt diet.

Mg⁺⁺ salts

Several Mg⁺⁺ salts (carbonate, hydroxide, oxide, trisilicate) have antacid properties. Magnesium hydroxide (milk of magnesia) is used most often and has a more rapid onset of action and high neutralizing capacity. It reacts slowly with HCl to form MgCl₂ and water. No CO₂ is generated. The risk of Mg⁺⁺ overload is low and significant only in patients with impaired renal function. A disadvantage is its laxative effect, and few ulcer patients can tolerate it as the sole antacid for any length of time.

Magnesium trisilicate is much weaker than magnesium hydroxide, and substantially more of the drug is required for the same degree of neutralization. Its onset of action is slow, and it reacts with gastric acid to form silicon dioxide in the stomach. Silicate kidney stones have been reported after its prolonged use. It is generally used in combination with other antacids, such as aluminum hydroxide, calcium carbonate, and magnesium carbonate.

Aluminum salts

Aluminum may be administered in several salt forms (aminoacetate, carbonate, hydroxide, phosphate), but aluminum hydroxide gel is the most potent buffer and most frequently used. Aluminum hydroxide dissolves slowly, is poorly absorbed, and reacts with HCl to form AlCl₃ and water. As with the Mg⁺⁺ salts, no CO₂ is generated. Liquid formulations provide a more rapid response than solid forms. Other than occasional nausea and vomiting, toxicity is rare. The formation of insoluble salts limits its absorption. Patients with impaired renal function who take aluminum antacids long-term may not clear the Al⁺⁺⁺ resulting in hyperalbuminemia and accumulation of Al⁺⁺⁺ in other tissues. The most common side effect is constipation, which may lead to intestinal obstruction. The constipating effect of aluminum-containing antacids is dose-related and can be managed with stool softeners or laxatives or minimized when the drug is taken with magnesium hydroxide. Because Al⁺⁺⁺ can combine with phosphate in the gut to form insoluble aluminum phosphate, which is then excreted in the feces, prolonged use of large doses of aluminum hydroxide may result in phosphate depletion, particularly when phosphate intake is low. Anorexia, malaise, and muscle weakness are characteristic of phosphate depletion.

Calcium carbonate

Calcium carbonate produces a potent and prolonged neutralization of HCl forming CO₂ and CaCl₂. Approximately 90% of the ingested Ca⁺⁺ forms insoluble salts in the gut and is excreted in the feces. The remaining Ca⁺⁺ is absorbed into the systemic circulation. Extensive use of Ca⁺⁺-containing antacids may cause or exacerbate hypercalcemia, which is characterized by neurologic symptoms and reduced renal function. This effect is rare in healthy patients with normal renal function. Ca⁺⁺-containing antacids are associated with acid rebound and increased serum gastrin concentrations. These effects have not been shown to delay ulcer healing and may be caused by a direct effect of Ca⁺⁺ on the gastric mucosa.²⁵ Calcium carbonate has a chalky taste and may produce constipation, which reduces its desirability as an antacid. Because some Ca⁺⁺ is absorbed, Ca⁺⁺-containing antacids may be marketed as a source of dietary Ca⁺⁺.

Alginic Acid

Alginic acid is not an antacid, but because of its unique mechanism of action it is added to various antacid preparations to increase their effectiveness in the treatment and relief

of the symptoms of GERD. In the presence of saliva, alginic acid reacts with sodium bicarbonate to form sodium alginate. Gastric acid causes this alginate to precipitate, forming a foaming, viscous gel that floats on the surface of the gastric contents. This provides a relatively pH-neutral barrier during episodes of acid reflux and enhances the efficacy of drugs used to treat GERD. These effects are considered to be of questionable value to the U.S. Food and Drug Administration (FDA). Alginic acid products are not indicated for the treatment of PUD.

Simethicone

Simethicone is a defoaming agent used to relieve gas discomfort in the stomach and intestine. It does not have antacid properties, but may be included in antacid products. Its action is to reduce the surface tension of gas bubbles in the gastrointestinal tract, which allows the gas bubbles to break up and coalesce, facilitating the elimination of the gas by belching or passing through the rectum. The FDA considers simethicone to be safe and effective as an antilflatulent agent.

Sucralfate

Sucralfate, a complex of aluminum hydroxide and sulfated sucrose, is a cytoprotective agent that provides a physical barrier over the surface of a gastric ulcer and enhances the gastric mucosal protective system. It is employed in clinical practice to treat several gastrointestinal diseases, including PUD, GERD, and dyspepsia. After oral administration the drug disperses in the stomach and, in the presence of acid, forms a viscous suspension that binds with high affinity at the ulcer site. An adherent, physical cytoprotective barrier is produced that covers the ulcer and protects it from further attack by damaging agents such as acid, pepsin, and bile salts.

Although sucralfate has multiple actions, it possesses no meaningful antacid properties. A key element in the acute gastroprotective actions of sucralfate is its ability to maintain mucosal vascular integrity and blood flow. It enhances bicarbonate and mucus secretion, increases mucosal hydrophobicity, and induces an increase in mucosal concentration of prostaglandin—all factors considered important in tissue healing. An increase in local fibroblast growth factors and possibly other growth factors has also been proposed to explain the powerful ulcer-healing actions of sucralfate, which occur independently of a decreased gastric acid concentration in the stomach and duodenum.⁷

Because it is minimally absorbed from the gastrointestinal tract, sucralfate is considered a remarkably safe agent. For this reason, sucralfate is a first-choice therapy in the management of acid-related diseases during pregnancy.⁸ It requires an acid pH to be activated and so should not be administered concomitantly with antacids, H₂ antagonists, or PPIs. The most common side effect is constipation (15%). Other reactions include dry mouth, nausea, vomiting, headache, and rashes.

Sucralfate may reduce the absorption of many other drugs, including the fluoroquinolone and tetracycline antibiotics. The use of a topical sucralfate suspension has also been advocated in the prevention or treatment of stomatitis caused by chemotherapy or radiation, despite studies that showed no substantial benefits from this drug in inhibiting radiation-induced esophagitis.²¹

Antimuscarinic Drugs

The use of antimuscarinic drugs (muscarinic receptor antagonists) for the treatment of PUD declined dramatically after the introduction of the H₂ blocker cimetidine. As discussed in Chapter 9, antimuscarinic agents (e.g., atropine) are not selective inhibitors of gastric acid secretion, and therapeutic benefits for the treatment of gastrointestinal disease accrue

only at doses that cause sufficient side effects to impair patient compliance. Antimuscarinic drugs with a higher relative affinity for gastric M₁ muscarinic receptors have been developed, however. Pirenzepine and telenzepine, selective M₁-receptor antagonists, are currently available in other countries for the treatment of PUD, but they are still investigational in the United States. Pirenzepine and telenzepine block gastric acid secretion more selectively because the M₁ receptor is not the major muscarinic receptor in most smooth muscle, cardiac muscle, or salivary glands. In those tissues, M₂ and M₃ muscarinic receptors predominate. Pirenzepine and telenzepine have a low incidence of side effects because of their selective inhibition of gastric acid secretion; this may make them a valuable addition to current agents used in the treatment of PUD.

Prostaglandins

Misoprostol, a synthetic prostaglandin E₁ analogue, is the best studied of the prostaglandin derivatives. Although the prostaglandins are crucial in creating the alkaline mucus layer that provides cytoprotective effects on the gastroduodenal mucosa, the ulcer-healing effect of misoprostol and other prostaglandin analogues seems to be caused mainly by the inhibition of acid secretion.¹³ These agents interact with a basolateral receptor of the parietal cell that causes the inhibition of adenylyl cyclase. This inhibition results in reduced production of cyclic adenosine 3',5'-monophosphate, the major second messenger for histamine-induced acid secretion. Misoprostol is approved for prevention of NSAID-induced ulcers in high-risk patients, although PPIs may be as effective and better tolerated. The most common side effects are abdominal pain (7% to 20%) and diarrhea (13% to 40%); both are dose-related. Misoprostol stimulates contraction of the uterus, which contraindicates its use during pregnancy or in women of childbearing potential. This property makes it effective, however, in women undergoing elective termination of pregnancy by facilitating expulsion of the uterine contents.

Implications for Dentistry

The diagnosis of GERD may be a very important finding when considering if a patient should be reclined in the dental chair. Although it is safe to place most GERD patients supine, some with severe GERD need to be kept at a 45-degree angle for their visit. Asking patients how they sleep can help elucidate what should be done. Similarly, if general anesthesia is being considered in a patient with GERD, a rapid-induction sequence with cricothyroid pressure may be indicated.

A patient history of a gastric or duodenal ulcer provides important information for the dentist because this can influence the choice of a therapeutic agent or time of drug administration. The use of aspirin as an analgesic is contraindicated because of its irritating effect on gastric mucosa; this is particularly true for elderly patients. All NSAIDs share the ulcerogenic property of the salicylates, with the risk of developing NSAID-induced peptic ulcer disease. The risk is affected with increased drug dosage and duration of use. Acetaminophen may be used as an alternative analgesic because it produces minimal damage to gastric mucosa compared with aspirin and other NSAIDs. For acute dental pain in high-risk patients, the cyclooxygenase-2-selective inhibitor celecoxib may also be used. It is efficacious and significantly less ulcerogenic than either aspirin or ibuprofen (see Chapter 21).

As previously mentioned, PPIs may cause sufficient inhibition of gastric acid secretion to reduce the absorption of drugs in which gastric pH influences bioavailability (e.g., ketoconazole, ampicillin). The clinical significance of this interaction has yet to be determined. Likewise, the theoretic risk of

increasing the response to diazepam when coadministered with PPIs, especially omeprazole, has shown little clinical significance to date.

Systemic corticosteroids, as used after oral surgical procedures, are potentially ulcerogenic. Even topical steroids used in the management of oral lesions should be avoided in patients with an ulcer because of the possibility that absorption through the mucosa would occur. The choice of a preoperative or postoperative sedative is particularly important for ulcer patients. Chloral hydrate is quite irritating, and gastrointestinal side effects such as nausea and vomiting can occur. Diazepam is appropriate for selected patients because, in addition to producing sedation, it can suppress the nocturnal secretion of gastric acid. Absorption of orally administered diazepam is increased by the use of aluminum hydroxide, whereas Mg^{++} salts retard its absorption. For a patient being treated with cimetidine or omeprazole, a prudent choice might be lorazepam or oxazepam; these are antianxiety drugs not dependent on hepatic oxidative biotransformation. They are eliminated in the urine as glucuronide conjugates, the formation of which is not impaired by either drug.

Treatment with cimetidine for a day or more may cause much higher plasma concentrations of diazepam taken on a regular basis, a more pronounced sedative effect, and slowed elimination of the drug. The significance of such cimetidine-induced drug interactions is likely to depend on the patient, however. The manifestations of the diazepam-cimetidine interaction may be clinically insignificant in young adults, but the interaction could be important in elderly patients or in patients on multiple medications. If a course of diazepam therapy is prescribed for a dental patient on cimetidine, dosage reduction should be considered.

As previously mentioned, cimetidine inhibits the hepatic metabolism of lidocaine and presumably other amide local anesthetics. This interaction is of little practical concern in view of the low dosages of lidocaine typically required for intraoral anesthesia and the extrahepatic metabolism in the vascular endothelial lining.

Aluminum hydroxide gels, Ca^{++} and Mg^{++} antacids, and sodium bicarbonate impair the absorption of tetracyclines and fluoroquinolones. This action is shared by milk and milk products and seems to result from chelation and an increased gastric pH. Sucralfate can also reduce the absorption of several drugs, including tetracycline, when administered concomitantly. A reasonable general approach for prescribing these vulnerable drugs to a dental patient receiving antacid or sucralfate therapy, or both, would be to separate the administration of each drug by several hours. This approach results in a negligible effect on absorption of the antibiotic.

ANTISIALAGOGUES

The short-term control of salivary flow is often helpful in dental procedures (e.g., occlusal adjustment and impression taking), but is not an approved indication for antisialagogues. A dramatic reduction of the secretory function of the salivary glands can be achieved by blockade of acetylcholine at muscarinic receptor sites. The pharmacologic characteristics of the antimuscarinic drugs are presented in detail in Chapter 9, but in summary, these drugs block the action of acetylcholine on the muscarinic receptor sites of effector cells innervated by postganglionic parasympathetic cholinergic nerves. They are used in dentistry to control excessive salivation and as a preanesthetic medication. In medicine, they are used as antispasmodics. The recommended oral doses for blocking excessive salivation are low and free of side effects (see Table 33-1).³⁰

The prototypic drugs for this class are the belladonna alkaloids atropine and scopolamine. Many patients experience unpleasant side effects such as difficulty in swallowing because of excessive dryness in the mouth and throat and a reduction in sweating. Scopolamine in particular may impair psychomotor activity and is not the drug of choice to reduce salivary secretion in the typical dental setting. The decision to use an antisialagogue depends partly on the patient's medical history. Atropine is contraindicated in patients with prostatic hypertrophy or narrow-angle glaucoma, and the topical use of atropine is absolutely contraindicated in all forms of glaucoma. Atropine should be administered with caution in patients with cardiovascular disease because it can increase the pulse rate and cardiac workload. It may also antagonize the vagal effects of digitalis. Toxic effects are common, particularly in children, who have increased susceptibility to heat prostration from inhibition of sweating.

The synthetic anticholinergic drugs propantheline and glycopyrrolate have also been used in dental procedures to control excessive salivation. Because they are quaternary amines, they are ionized at body pH and are unable to cross the blood-brain barrier. The resultant freedom from CNS effects constitutes a distinct advantage over atropine and scopolamine. Both drugs are also less well absorbed, however, and propantheline is less selective in controlling salivation. Precautions for their use in dentistry are similar to the precautions for atropine and scopolamine.

EMETICS AND ADSORBENTS

Emetics such as syrup of ipecac have been used in emergent cases of poisoning because they induce forceful emptying of the stomach. The efficacy of emesis in the management of acute poisoning episodes declines when treatment is initiated more than 1 hour after ingestion of a toxic substance. The amount of substance removed from the stomach is inversely related to the duration of time from ingestion to emesis. For these reasons, the American Academy of Pediatrics and the American Academy of Clinical Toxicology no longer support the use of ipecac to treat accidental poisonings in the home.¹ Instead, the administration of activated charcoal as an adsorbent is preferred because it has been shown to reduce the bioavailability of ingested substances effectively. Routine use of activated charcoal for poison management in the home cannot yet be recommended, however, because its efficacy and safety have not been clearly shown.² In all cases in which poisoning is suspected, consultation with the local poison control center should be the first action taken for information needed to determine the appropriate treatment approach.

Despite the previous discussion, if an emetic is recommended, syrup of ipecac is available OTC. Syrup of ipecac is a mixture of plant alkaloids (principally emetine) that act centrally on the medullary chemoreceptor trigger zone (CTZ) and locally by irritation of the stomach and duodenum. Vomiting occurs 15 to 30 minutes after oral administration. Because emesis may not occur if the stomach is empty, the drug should be followed by a drink of water. Adverse reactions to ipecac syrup include diarrhea, lethargy, and prolonged vomiting; such responses are rare if the recommended dose is not exceeded.¹ The oral dose is 15 mL in children 1 to 12 years old and 15 to 30 mL in adolescents and adults.

Apomorphine, a potent dopamine receptor agonist derived chemically from morphine, has been used as an emetic in a supervised medical setting. Because excessive dosages may cause significant respiratory depression, apomorphine is now considered too dangerous for this use and is employed infrequently as an emetic.

ANTIEMETICS

Numerous drugs are available that have shown antiemetic action (see Table 33-1). Nausea and vomiting are complex processes that are not yet fully elucidated. The brainstem vomiting center, located in the lateral medullary reticular formation, apparently coordinates the associated motor activities after input from the CTZ, cerebral cortex, gastrointestinal tract, and vestibular apparatus. The identification of the neurotransmitters and their receptors within these sites has provided a likely target for the disruption of the emetic process. Cancer chemotherapeutic agents and other chemical stimuli activate the CTZ, an area rich in dopamine D₂ receptors, serotonin 5-HT₃ receptors, and neurokinin 1 and opioid receptors. Motion sickness results from muscarinic and histamine H₁ receptor-mediated response from vestibulocochlear disturbances via cranial nerve VIII. Drugs or drug classes useful as antiemetics include antipsychotics (phenothiazines and butyrophenones), metoclopramide, H₁ antihistamines, anticholinergics, serotonin 5-HT₃ antagonists, neurokinin antagonists, cannabinoids, and corticosteroids.

The pharmacologic features of antipsychotics are discussed in Chapter 12. The phenothiazines and butyrophenones are central dopamine antagonists and inhibit stimulation of the CTZ. Inhibition of muscarinic receptors may also play a role in this activity. Most antipsychotics are not effective for motion sickness, but they are often used successfully for the nausea of pregnancy, postoperative emesis, or vomiting induced by radiation or cancer chemotherapy. Among the most commonly used agents are promethazine, prochlorperazine, and droperidol. Trimethobenzamide, a substituted benzamide, also inhibits the CTZ through dopamine-receptor blockade and has the same range of action as antipsychotic antiemetic agents.

Nausea and vomiting, sometimes very marked, are almost universal sequelae of cancer chemotherapy. The protracted bouts of severe drug-induced vomiting, which may be only slightly relieved by standard antiemetic therapy, have led to the inability of some patients to complete courses of potentially curative treatment. Chemotherapy-induced nausea and vomiting were found to respond to high doses of the dopaminergic D₂ receptor antagonist metoclopramide. Approximately 40% to 60% of cancer patients treated with cisplatin (a highly emetogenic drug) responded to the antiemetic effect of metoclopramide in well-controlled clinical trials. Metoclopramide acts peripherally and centrally. Peripherally, it stimulates the release of acetylcholine and sensitizes smooth muscle to acetylcholine. Centrally, it blocks D₂ receptors in the CTZ. In addition, metoclopramide inhibits 5-HT₃ receptors, which may be more responsible for its antiemetic effect. High-dose metoclopramide, similar to other dopamine antagonists, may cause extrapyramidal symptoms and sedation, particularly in young and elderly patients. Prolonged use has been associated with tardive dyskinesia. Droperidol, an anti-D₂ dopamine receptor neuroleptic, is an antiemetic used in anesthesia for the prophylactic management of postoperative nausea and vomiting.

As pointed out in Chapter 22, certain H₁ histamine antagonists are effective antiemetics. All possess significant anticholinergic actions that contribute to their antiemetic efficacy. Diphenhydramine, dimenhydrinate, meclizine, and cyclizine are especially useful in treating the nausea and vomiting associated with motion sickness, pregnancy, and the postoperative state. These drugs should not be used during pregnancy, however, unless absolutely necessary. The antihistamines are not of significant value in relieving nausea associated with the administration of cytotoxic drugs. Promethazine, a phenothiazine antihistamine without significant dopamine-blocking activity, is effective in vertigo and motion sickness. Its sedative

action is advantageous in the treatment of postoperative nausea and vomiting. Nonsedating H₁ antihistamines such as loratadine are ineffective against motion sickness because they penetrate poorly into the CNS.

The anticholinergic scopolamine is effective in the prevention and treatment of motion sickness, but its oral use is limited by its sedative and antimuscarinic actions. A transdermal sustained-release preparation of scopolamine, when applied to the postauricular area for several hours before need, effectively prevents motion sickness for 72 hours with minimal side effects.

The recognition that 5-HT₃ receptor blockade by high-dose metoclopramide provides antiemetic activity led to the development of ondansetron. It is a potent, highly selective competitive 5-HT₃ antagonist. 5-HT₃ receptors are found in the gastrointestinal tract and the CNS. Ondansetron is more effective than high-dose metoclopramide in the first 24 hours after chemotherapy, and there is evidence that it maintains efficacy for at least the following 4 days. It is generally well tolerated, although during clinical trials, constipation, abdominal discomfort, headache, sedation, dry mouth, blurred vision, and anxiety were noted in some patients. Extrapyramidal effects have not been reported. At this time, the relative efficacy and safety of ondansetron and its congeners granisetron and dolasetron have made them drugs of first choice for the management of chemically induced nausea.

Cannabinoids are indicated when conventional antiemetics fail to relieve the nausea and vomiting associated with cancer chemotherapy. Dronabinol, or Δ-9-tetrahydrocannabinol, is the main psychoactive constituent in marijuana (see Chapter 51). Investigation of its use as an antiemetic was undertaken after anecdotal reports that marijuana smokers had less nausea and vomiting in association with cytotoxic agents than other patients. Dronabinol given orally has been shown to be significantly better than placebo and comparable to metoclopramide in reducing chemotherapy-induced vomiting in selected patients. The use of dronabinol is limited by its tendency to produce acute, and often intolerable, mental disturbances, particularly in older patients who are unaccustomed to marijuana-like side effects.

Corticosteroids, such as dexamethasone and methylprednisolone, have been reported to be effective for cancer chemotherapy-induced nausea and vomiting. The mechanism of this effect is unknown, but it may be related to a reduced synthesis of prostaglandins; prostaglandin E has been shown to induce nausea and vomiting (see Chapter 21). Sedative-hypnotics such as the benzodiazepines may also help prevent anticipated nausea and vomiting associated with chemotherapy; lorazepam is most commonly used.

Aprepitant is a highly selective neurokinin 1 receptor antagonist employed in combination with 5-HT₃ antagonists and corticosteroids for the prevention of chemotherapy-induced nausea and vomiting. Adding aprepitant greatly improves antiemetic outcomes. This drug is metabolized by CYP enzymes (CYP3A4), and its use may influence the metabolism of other drugs sharing this pathway.

Just as combinations of antineoplastic drugs with different modes of action are used in cancer chemotherapy (see Chapter 42), combinations of different antiemetic drugs are being used to treat the nausea and vomiting associated with the use of antineoplastics. Combinations of antiemetics are often more effective than single-agent therapy because of multiple sites of emetic action by antineoplastic agents and the potential for additive or even synergistic effects of several antiemetics with different mechanisms of action.

Droperidol, metoclopramide, dexamethasone, and 5-HT₃ blockers are useful as antiemetics when used prophylactically to reduce the incidence of postoperative nausea and vomiting. In a comparison of the first three antiemetics, the choice was

not a significant predictor of postoperative nausea and vomiting. The choice of antiemetic drug given for prophylaxis had little effect on clinical outcome or patient satisfaction.¹¹ Ondansetron and granisetron are now widely used when there is expectation of postoperative nausea and vomiting.

Alternative treatments, including acupuncture, hypnosis, ginger, and pyridoxine (vitamin B₆), have shown efficacy in several conditions with nausea and vomiting.^{18,19,29} Widespread acceptance of these alternative therapies awaits confirmation of efficacy from additional studies.

LAXATIVES

Constipation is a common gastrointestinal complaint, affecting more than 65 million Americans.¹⁵ Laxatives are used to relieve acute and chronic constipation, treat anorectal disorders (hemorrhoids), and prepare the bowel for examination (colonoscopy). Constipation occurs in all age groups, but is especially common in pregnant women and elderly individuals. Most cases are self-limiting or are self-treated with diet. Laxatives are well-known, highly advertised, and the most overused OTC drugs having a therapeutic effect on the gastrointestinal tract. Traditionally, these drugs have been generally classified as stimulants/irritants, saline and osmotic cathartics, bulk-forming agents, stool softeners, and lubricants (Figure 33-2). Although that taxonomy is used in this chapter, these categories are arbitrary and not reflective of either the pathophysiologic principles or the multiplicity of effects generated by laxatives.

Stimulants

Numerous laxatives belong to the stimulant category. As a group, these drugs are thought to act as a local irritant of the intestinal mucosa that increases propulsive activity. The exact mechanism is not completely understood, but they may increase motility by a selective action on the intramural nerve plexus of intestinal smooth muscle. All the stimulant laxatives increase mucosal permeability, resulting in movement of fluid and electrolytes into the intestinal lumen.

Castor oil is obtained from the seeds of *Ricinus communis* and is hydrolyzed in the small intestine by pancreatic lipase to glycerol and ricinoleic acid, an unsaturated hydroxy fatty acid. Castor oil evokes the secretion of water and electrolytes in the colon and small intestine and increases small bowel

peristaltic activity to produce a very prompt cathartic effect in 2 to 6 hours. It is of historic interest but rarely used today.

Phenolphthalein was a widely used stimulant OTC laxative until the FDA banned its use because of reports of its association with carcinogenic tumors in laboratory rats. Bisacodyl is structurally related to phenolphthalein and has similar pharmacologic actions. After oral administration, approximately 5% of a therapeutic dose is absorbed from the digestive tract with no apparent systemic effects. The laxative effect is obtained in 6 to 8 hours, but can be accelerated by administration in suppository form. The major toxicity is diarrhea with overdosage.

Some of the most extensively used stimulant laxatives are in the anthraquinone group, which includes senna and cascara sagrada. These preparations contain emodin (or anthracene) alkaloids in an inactive glycoside form. The glycosides are hydrolyzed within the colon by the action of bacteria to liberate the active principle. A small percentage of the active form may be absorbed and excreted in the bile and other body fluids. The laxative action is limited primarily to the colon and is produced in 6 to 8 hours. Cascara sagrada is considered to be milder than senna. In general, adverse reactions to these agents relate to excessive catharsis and may include severe abdominal pain.

Stool Softeners and Lubricants

Docusate sodium (dioctyl sodium sulfosuccinate) and docusate calcium (dioctyl calcium sulfosuccinate) act like detergents and are used to soften the stool when it is desirable to lessen the discomfort or the strain of defecation. These drugs are anionic surfactants that produce their effect by reducing the surface tension and allowing intestinal fluids and fatty substances to penetrate the fecal mass. They usually require 1 to 3 days to exert their full effect if used alone, but they may be combined with other laxatives in OTC preparations. These agents are not believed to interfere with the absorption of nutrients from the intestinal tract, and they are not appreciably absorbed. Docusate is frequently recommended for elderly patients because it is associated with so few side effects. Diarrhea and mild abdominal cramps are the only adverse effects reported.

Mineral oil (liquid petrolatum) may be considered with the surface-active agents because it also softens the stool. Mineral oil acts as a lubricant and coats the intestinal contents, preventing the absorption of fecal water. It produces a cathartic action in 6 to 8 hours after oral administration and 5 to 15 minutes if given rectally. Its use is attended by several potential hazards not associated with the other agents. Prolonged oral use or administration with meals can reduce the absorption of the fat-soluble vitamins (A, D, E, and K). Lipid pneumonia can result from the accidental aspiration of the oil. Mineral oil is absorbed to a limited extent from the intestinal tract; its use with a wetting agent (docusate), which could increase its absorption, is contraindicated. Significant absorption of mineral oil may occur if used repeatedly. The seepage of oil through the anal sphincter may occur and produce pruritus ani or other perianal conditions.

Saline and Osmotic Cathartics

Saline cathartics are salt solutions containing one or more ions that are poorly absorbed from the gastrointestinal tract. Available preparations include Mg⁺⁺ salts (hydroxide, sulfate, or citrate), sodium phosphate (monobasic or dibasic), and sodium bisphosphate. The salt solutions osmotically increase the water content of feces and fluid volume in the intestinal lumen; this increases the intraluminal pressure, which exerts a mechanical force to stimulate peristalsis. It has also been postulated that Mg⁺⁺ salts increase colonic motility by causing the release of cholecystokinin. Oral administration of these

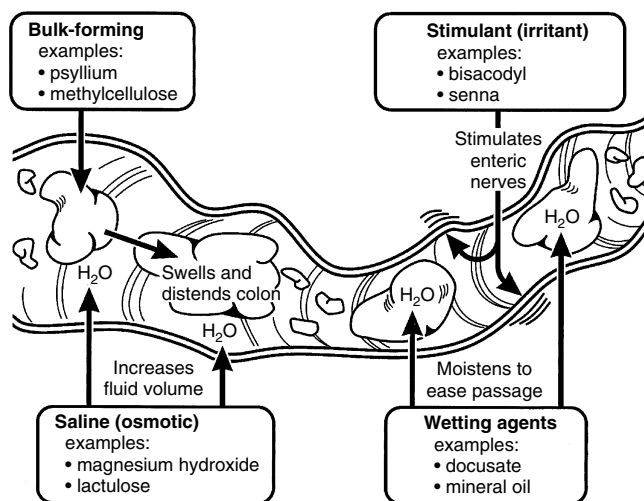

FIGURE 33-2 The site of action of the major categories of laxatives.

agents generally results in the production of a fluid to semi-fluid stool within 30 minutes to 3 hours. If given rectally, laxation occurs in 2 to 5 minutes.

Some absorption of saline cathartics does occur, and consequently systemic effects may be noted. For this reason, Na⁺ salts are contraindicated in patients on a low-salt diet and in patients with edema or congestive heart failure. Mg⁺⁺ and K⁺ salts are contraindicated in patients with impaired renal function. Magnesium sulfate (Epsom salt), which is an effective and frequently used cathartic, may cause serious loss of body water with repeated use. Milk of magnesia, a suspension of magnesium hydroxide, is a widely used OTC preparation. Abdominal cramps and dehydration are reported adverse reactions from saline laxatives.

Several preparations, notably glycerin, lactulose, and polyethylene glycol (PEG), contain large poorly absorbable or nonabsorbable molecules that produce an osmotic effect resulting in distention and catharsis. Glycerin is used in suppository form to promote defecation. It osmotically dehydrates exposed rectal tissue; the resultant irritation promotes evacuation of the lower bowel within 30 minutes. Lactulose is a semisynthetic disaccharide. In the large intestine, lactulose is metabolized by enteric bacteria to various acids and carbon dioxide. The acidification and increased osmolarity of the bowel contents cause fecal softening and a more normal bowel movement. Two days may be required for a therapeutic effect to occur. Lactulose is also used in patients with liver failure who have developed too much ammonia in their bodies. Lactulose is given orally and rectally to scavenge ammonia ions from the gut lumen and inhibit their absorption. As expected, a side effect is loose stools.

Although PEG acts osmotically to retain water in the gut to produce laxation, it is not metabolized by bowel flora and is not significantly absorbed. In contrast to lactulose, PEG does not produce significant cramps or flatus. These osmotic agents are often the mainstay of therapy for individuals with chronic constipation.

Bulk-Forming Agents

Bulk-forming agents include synthetic fibers (polycarbophil) and natural plant products (psyllium and methylcellulose). They possess the property of absorbing water and expanding, increasing the bulk of the intestinal contents. The elevated luminal pressure stimulates reflex peristalsis, and the increased water content softens the stool. These agents are not absorbed and do not interfere with the absorption of nutrients from the gastrointestinal tract. Several days of medication may be required to achieve the full therapeutic benefit, although the usual onset of action is 12 to 24 hours. Some patients prefer to add foods such as bran or dried fruit (e.g., prunes and figs) to their diet that exert the same effect rather than use a bulk-forming laxative. These laxatives have the advantage of having few systemic effects and are unlikely to produce laxative abuse. Cellulose agents may physically bind with other drugs if administered concurrently (e.g., salicylates, warfarin, digitalis glycosides) and hinder their absorption. Patients should not take a calcium polycarbophil laxative within 2 hours of taking tetracycline for the same reason.

Laxatives with psyllium come in a powdered mixture containing approximately 50% powdered psyllium seeds and 50% dextrose or sucrose. Sugar-free products are also available. Psyllium seeds are rich in a hemicellulose that forms a gelatinous mass with water. The refined hydrophilic colloid from the seeds is the most widely used form of this agent. Methylcellulose is indigestible and not absorbed systemically. Bloating and flatus have been reported after the use of psyllium products because of bacterial digestion of the plant fibers within the colon.

ANTIDIARRHEAL AGENTS

One out of every six illnesses of adults and children involves the digestive system, and diarrhea is one of the most common complaints. Diarrhea occurs when not enough water is removed from the stool during transit, making the stool loose and poorly formed. Commonly used antidiarrheal agents act in one of two ways. They either soak up excess water or decrease intestinal motility, which provides the body more time to absorb the luminal water. Antidiarrheal agents may be used to treat acute diarrhea, although they should be discontinued if the diarrhea worsens despite therapy. They may also be used to control chronic diarrhea associated with conditions such as irritable bowel syndrome (IBS) or inflammatory bowel disease. The following agents have been determined by the FDA to be safe and effective in the treatment of acute nonspecific diarrhea.⁴

Kaolin

Kaolin is a hydrated aluminum silicate with a crystalline structure that allows for a large surface area that adsorbs many times its weight in water. Its use in the treatment of diarrhea is based on its purported ability to absorb fluid, bacteria, toxins, and various noxious materials in the gastrointestinal tract, decreasing stool liquidity and frequency. In the colon, it may act as an adsorbent or protectant, but the adsorption is not selective, and it should not be used in children younger than 12 years without physician approval. If taken together, kaolin may adsorb other medications and reduce their systemic absorption. Few controlled clinical studies showing the efficacy of kaolin have been published, and no major product containing kaolin as the sole active ingredient is presently available in the United States.⁴

Bismuth Subsalicylate

Bismuth subsalicylate (Pepto-Bismol) is a commonly used OTC agent in the treatment of various gastrointestinal symptoms and diseases, including dyspepsia and acute diarrhea, and in the prevention of traveler's diarrhea. It is the only OTC bismuth compound available in the United States and is estimated to be used by most American households. It is a crystal complex of bismuth and salicylate suspended in a mixture of magnesium aluminum silicate clay. In the stomach, the bismuth subsalicylate reacts with the hydrochloric acid to form bismuth oxychloride and salicylic acid. The salicylate is readily absorbed into the body, whereas the bismuth passes unaltered and unabsorbed into the feces. Caution is advised if patients are taking aspirin or other salicylate-containing drugs concurrently because toxic levels of salicylate may be reached. Bismuth subsalicylate products are not recommended for patients younger than 12 years because of a lack of studies to prove efficacy in young children.

Bismuth is thought to produce its therapeutic actions in part by stimulating prostaglandin, mucus formation, and bicarbonate secretion. It also has direct antimicrobial effects and may bind to enterotoxins, which accounts for its use in the prevention of traveler's diarrhea. In addition, bismuth has been used in the home treatment of gastric ulcers because of its ability to coat the ulcer and other gastric erosions, shielding them from the stomach acid and pepsin. In the treatment of acute diarrhea, the salicylate moiety is thought to inhibit intestinal prostaglandin and Cl⁻ secretion, leading to a reduction in stool frequency and liquidity. Bismuth subsalicylate has an excellent safety record, and side effects are minor. Bismuth may cause blackening of the stool or harmless black staining of the tongue, which is thought to be caused by the formation of bismuth sulfide from the reaction between the drug and the bacterial sulfides in the gastrointestinal tract. As noted previously, salicylate-induced adverse reactions may

occur after the administration of bismuth subsalicylate (see Chapter 21).

Opioid Preparations

Opioids are effective and prompt-acting antidiarrheal agents. As discussed in Chapter 20, opioids enhance tone in the anal sphincter and in segments of the longitudinal muscle of the gastrointestinal tract, while inhibiting propulsive contraction of circular and longitudinal muscle. Opioids cause a marked slowing of fluid movement through the jejunum, but produce a minimal effect on the movement of fluid through the ileum or colon. By increasing the contact time of luminal fluid with mucosal cells, therapeutic doses of an opioid increase net intestinal absorption of water and electrolytes, reducing stool volume. Commonly used opioid diarrheals include diphenoxylate and loperamide, which act primarily via peripheral μ -opioid receptors (see Chapter 20).

Diphenoxylate

Diphenoxylate, a Drug Enforcement Administration (DEA) Schedule V (C-V) prescription drug, is a congener of meperidine and was originally synthesized during the search for compounds similar to the opioid analgesics in actions on the gastrointestinal tract but devoid of their CNS effects. The efficacy of diphenoxylate was found to be approximately equal to that of camphorated tincture of opium in patients with diarrhea of various causes. Because diphenoxylate is structurally related to meperidine, there was concern about its abuse potential, but in the several decades of experience with it, diphenoxylate has emerged as having an addiction liability comparable to that of codeine, which is diminished further by the incorporation of atropine (as in Lomotil) and by the low water solubility of diphenoxylate salts, both of which prevent inappropriate parenteral administration.

Various minor side effects have been reported, including abdominal cramps, nausea, weakness, drowsiness, xerostomia, gingival swelling, partial intestinal obstruction, and urinary retention. In patients with inflammatory bowel disease, diphenoxylate has caused toxic megacolon, and it has caused hepatic coma in patients with severe liver disease. Toxic doses have produced respiratory depression and unconsciousness, which can be effectively reversed by the opioid antagonists. Although clinical studies have indicated only minimal, if any, drug interactions during diphenoxylate therapy, the drug may potentially augment the actions of barbiturates, alcohol, opioids, and antianxiety and antipsychotic drugs.

Difenoxin, the principal active metabolite of diphenoxylate, is a DEA Schedule IV (C-IV) prescription antidiarrheal drug that is effective at one fifth the dosage of diphenoxylate. Atropine is added to the formulation to discourage deliberate misuse of the drug.

Loperamide

Loperamide, a long-acting derivative of haloperidol and diphenoxylate, is the most selective antidiarrheal opioid currently available for clinical use because it has a distribution within the body different from other opioids. Although drugs such as meperidine penetrate the blood-brain barrier and interact with CNS opioid receptors to modify intestinal motor function, only small concentrations of loperamide reach the brain. Its antidiarrheal effect is thought to result mainly from interactions with intestinal μ -opioid receptors. When loperamide is administered orally at therapeutic doses, the effect on the gastrointestinal tract is not accompanied by any significant CNS opioid effect. Large amounts of the drug become concentrated in target tissues along the gastrointestinal tract. One hour after oral administration, 85% of the drug is distributed to the gastrointestinal tract, 5% is distributed to the liver, and less than 0.04% is distributed to the brain.

Loperamide exerts its antidiarrheal effect by altering motor function in the intestine, which results in increased capacitance of the intestine and slowing of intestinal motility; this permits greater absorption of electrolytes and water through the intestine. This action is analogous to that of morphine and codeine. The stimulation of μ -opioid receptors also decreases gastrointestinal secretions, which contributes further to its antidiarrheal effects. Despite differences in distribution and other pharmacologic properties, the action of the traditional opioid antidiarrheal drugs and loperamide seems to be the same inhibition of propulsion through the intestine.

Adverse effects of loperamide occur infrequently but include abdominal pain and distention, constipation, nausea and vomiting, dry mouth, and drowsiness or dizziness. Allergic reactions, including skin rash, have been reported. In contrast to diphenoxylate and difenoxin, loperamide is available OTC. After years of extensive use, there has been no evidence of drug abuse or physical dependence. It is a safe and effective antidiarrheal agent.

Agents Used for the Prevention and Treatment of Traveler's Diarrhea

Nearly 50% of travelers from the United States acquire a diarrheal illness while visiting developing countries.¹⁶ Worldwide, approximately 20 million episodes of diarrhea occur annually in people traveling from industrial regions to developing countries.¹⁴ The most common infecting organism is enterotoxigenic *Escherichia coli*, which is primarily acquired through fecal contamination of food (e.g., raw vegetables) and water, including ice. The ingested bacteria produce enterotoxins that cause the sudden onset of loose stools, commonly referred to as traveler's diarrhea. This is usually a self-limiting illness lasting only several days. Less common pathogens that may cause this disorder include *Shigella*, *Campylobacter*, *Giardia*, and nontyphoid *Salmonella*.

Several approaches to the prevention of traveler's diarrhea have been evaluated. Because of the potential for drug resistance and adverse reactions, the Centers for Disease Control and Prevention does not recommend prescription of drugs prophylactically; instead, they recommend the traveler begin treatment promptly only when symptoms occur. When prophylaxis is used, once-daily dosing with a fluoroquinolone antibiotic (see Chapter 39) is the recommended treatment of choice. Antibiotics recommended from this group include ciprofloxacin (500 mg), levofloxacin (500 mg), ofloxacin (300 mg), and norfloxacin (400 mg). Rifaximin is a nonabsorbed antibiotic approved for prevention and treatment of traveler's diarrhea caused by noninvasive strains of *E. coli* because the action of this drug is limited to the gut.²⁸ Azithromycin has been recommended for treatment of traveler's diarrhea in countries where antibiotic resistance is prevalent.

Bismuth subsalicylate has also been shown to be particularly active against mild-moderate traveler's diarrhea, although it is considered less effective than antibiotics. A regimen of 520 mg (2 fluid oz [60 mL] of the liquid suspension or two 260-mg tablets) taken four times a day is effective for the prevention of traveler's diarrhea.³² If started after the onset of diarrhea, it diminishes the number of loose bowel movements and relieves abdominal cramps. The preparation is well tolerated, and constipation is not a problem. As described previously, the mechanisms of action of bismuth subsalicylate are complex and incompletely understood. Bismuth subsalicylate possesses an antibacterial effect, but this may not be its major action. Salicylate is absorbed, but its exact role is undetermined. Patients on anticoagulants should seek medical advice before using this medication because they may get an additional antiplatelet effect from the salicylate. Travelers taking doxycycline for malaria prophylaxis should not take bismuth

subsalicylate because it interferes with the absorption of the doxycycline.

An effective treatment for traveler's diarrhea in most parts of the world consists of loperamide (4 mg loading dose, then 2 mg orally after each loose stool, to a maximum of 16 mg/day) plus a single dose of a fluoroquinolone antibiotic. This regimen usually relieves symptoms within 24 hours. If diarrhea persists after 1 day of therapy, treatment should be continued for 1 or 2 more days. The antimicrobial combination product trimethoprim-sulfamethoxazole has also been used successfully in the past, but resistance to it has become common in many areas, and its use is no longer recommended.³²

In countries where traveler's diarrhea is prevalent, what one ingests or avoids ingesting may be as important as chemoprophylaxis in reducing the risk. Common sense is an important preventive measure. Helpful maxims to keep in mind include "boil it, cook it, peel it, or forget it" and the "rule of P's": food is safe if it is peelable, packaged, purified, or piping hot.²⁰

GASTROINTESTINAL STIMULANTS

Drugs that stimulate smooth muscle of the gastrointestinal and urinary tracts are used in the treatment of nonobstructive urinary retention, paralytic ileus, gastrointestinal atony, and postoperative abdominal distention. Cholinomimetic agents such as bethanechol are effective in these situations by promoting gastrointestinal motility (see Chapter 8). Bethanechol is a useful agent because it is resistant to metabolism by cholinesterase enzymes, its actions are essentially stimulatory to the muscarinic M₃ receptors, and its effects on the gastrointestinal tract are much more pronounced than its effects on the cardiovascular system. Previously used for the treatment of GERD and gastroparesis, it is now seldom used because of the introduction of less toxic agents. The side effects of bethanechol are those typical of other cholinergic drugs, but serious adverse reactions are rare with therapeutic doses. This drug is contraindicated in patients with obstructive ileus, obstructive urinary retention, peptic ulcer, bronchial asthma, hyperthyroidism, or serious cardiac disease.

Gastroparesis (gastric stasis) is a clinical syndrome characterized by delayed gastric emptying that leads to debilitation. It is most commonly seen in patients with diabetes mellitus and is characterized by intractable nausea, vomiting, early satiety, abdominal pain, and bloating.¹⁷ Therapeutic success is often elusive. The use of a prokinetic agent is the best option for acute exacerbations and long-term maintenance therapy. Metoclopramide, the dopamine D₂ receptor antagonist cited earlier for its antiemetic action, and the macrolide antibiotic erythromycin both have prokinetic actions that are commonly used in the management of gastroparesis. Erythromycin acts as a motilin receptor agonist to stimulate gastrointestinal activity (see Chapter 39). Metoclopramide, possessing cholinomimetic and dopamine antagonist properties, is also useful in this syndrome because the drug stimulates the motility of the upper gastrointestinal tract. Metoclopramide augments esophageal peristalsis, gastric antral contractions, and the rate of intestinal transit. In addition, metoclopramide increases the resting pressure of the lower esophageal sphincter but reduces the resting pressure of the pyloric sphincter. It does not stimulate gastric, biliary, or pancreatic secretions and has little effect on colonic motor activity.

Oral administration of metoclopramide is indicated for relief of symptoms associated with diabetic gastroparesis. The usual duration of therapy is 2 to 8 weeks, depending on the response. An injectable form of metoclopramide is also

approved for use in facilitating intubation of the small intestine and the passage of barium into the intestine for radiographic procedures. Of particular concern to the dentist is that the use of opioids or anticholinergic drugs antagonizes the gastrointestinal effects of metoclopramide.

IRRITABLE BOWEL SYNDROME

IBS is the most common disorder diagnosed by gastroenterologists and one of the most common gastrointestinal conditions encountered by family practice physicians. It is characterized by abdominal pain and discomfort in association with altered bowel habits (diarrhea, constipation, or both). IBS is reported to affect 5% to 11% of the population worldwide.²⁷ Pharmacologic treatment of IBS differs from patient to patient and is directed at relieving abdominal discomfort and improving bowel function. Antidiarrheal agents, especially loperamide, are helpful for patients with predominant diarrhea. Increasing dietary fiber is often helpful for IBS patients presenting with constipation. Increasing dietary fiber (e.g., psyllium) may increase gas production and exacerbate abdominal discomfort, however. For that reason, an osmotic cathartic agent such as milk of magnesia is commonly used to soften stools and increase stool frequency.

Anticholinergic drugs such as dicyclomine, inhibitors of muscarinic cholinergic receptors in the enteric plexus and on smooth muscle, previously were commonly used to provide relief of abdominal discomfort through antispasmodic actions. These drugs are now infrequently used because of the significant anticholinergic effects they produce (e.g., xerostomia, urinary retention). Newer therapeutic modalities for IBS include serotonin 5-HT₃ receptor antagonists (alosetron) and serotonin 5-HT₄ receptor agonists (tegaserod).

ADVERSE REACTIONS OF THE GASTROINTESTINAL SYSTEM TO DRUGS

The gastrointestinal tract must be considered a target for the adverse side effects of many drug groups, some important to dentistry. Opioid analgesics may produce constipation, nausea, and vomiting. Aspirin-containing analgesic compounds are associated with gastric distress, fecal blood loss, and ulceration. All nonselective cyclooxygenase-inhibiting NSAIDs share the gastric irritation and ulcerogenic action of aspirin. The sedative-hypnotic alcohol chloral hydrate may be prescribed by the dentist for children or elderly patients. A major complaint against its use is the gastric irritation it produces.

Antibiotic agents are often associated with gastrointestinal distress, especially diarrhea. Antibiotics, especially agents with a broad spectrum of activity, affect the bacteria that normally exist in the large intestine. As a consequence, antibiotic-associated diarrhea develops. Typically, this diarrhea is caused from an overgrowth of *C. difficile* (*C. difficile*-associated diarrhea). Most antibiotics can cause *C. difficile*-associated diarrhea, but it is most commonly associated with clindamycin, amoxicillin, and the cephalosporins. Many drugs not directly related to dentistry cause a wide spectrum of gastrointestinal effects, including adverse effects on the oral cavity. Taste disturbances, especially in elderly patients, are often drug-induced. Xerostomia can be produced from numerous drug classes, including anticholinergics, antispasmodics, psychotropic agents, antihistamines, drugs for parkinsonism, and anti-hyperlipidemics. Drugs may also induce various oral lesions (e.g., erythema multiforme) in all age groups. Gingival hyperplasia is a well-known side effect from phenytoin, Ca⁺⁺ channel blocker, and cyclosporine therapy.

**DRUGS ACTING ON THE
GASTROINTESTINAL TRACT**

<i>Nonproprietary (generic) name</i>	<i>Proprietary (trade) name (selected)</i>
Antacids	
Algenic acid, sodium bicarbonate, magnesium carbonate	Gaviscon
Aluminum carbonate gel	Basaljel
Aluminum hydroxide gel	Amphojel
Calcium carbonate	Tums, Alka-Mints
Magaldrate (aluminum magnesium hydroxide sulfate)	Riopan
Magnesium hydroxide	Milk of Magnesia
Magnesium hydroxide/aluminum hydroxide	Maalox, Gelusil, Mylanta
Magnesium oxide	Mag-Ox 400, Uro-Mag
Sodium bicarbonate	Bell/ans
Sodium bicarbonate/aspirin	Alka-Seltzer
Sodium citrate	Citra pH
H₂ antagonists	
Cimetidine	Tagamet, Tagamet HB
Famotidine	Pepcid, Pepcid AC
Nizatidine	Axid, Axid AR
Ranitidine	Zantac, Zantac 75
H. pylori agents (combination packages)	
Bismuth subsalicylate, metronidazole, tetracycline	Helidac
Lansoprazole, amoxicillin, clarithromycin	Prevpac
Prostaglandin analogue	
Misoprostol	Cytotec
Proton pump inhibitors	
Esomeprazole	Nexium
Lansoprazole	Prevacid
Omeprazole	Prilosec, Prilosec OTC
Pantoprazole	Protonix
Rabeprazole	Aciphex
Ulcer-adherent complex	
Sucralfate	Carafate
Antisialagogue*	
See Tables 9-5 and 33-1	
Emetic	
Ipecac syrup	Ipecac
Antiemetics[†]	
Alosetron	Lotronex
Buclizine	Bucladin-S Softabs
Chlorpromazine	Thorazine
Cyclizine	Marezine
Dimenhydrinate	Dramamine
Diphenhydramine	Benadryl
Dolasetron	Anzemet
Dronabinol	Marinol
Granisetron	Kytril

<i>Nonproprietary (generic) name</i>	<i>Proprietary (trade) name (selected)</i>
Meclizine	Bonine, Antivent
Metoclopramide	Reglan
Ondansetron	Zofran
Perphenazine	Trilafon
Phosphorated carbohydrate solution	Emetrol
Prochlorperazine	Compazine
Promethazine	Phenergan
Scopolamine, oral	Scopace
Scopolamine, transdermal	Transderm-Scop
Thiethylperazine	Torecan
Triflupromazine	Vesprin
Trimethobenzamide	Tigan
Laxatives	
Bisacodyl	Dulcolax
Cascara sagrada	Cascara Sagrada
Castor oil	Purge
Docusate calcium	Surfak Liquigels
Docusate sodium	Colace
Docusate/casanthranol	Peri-Colace
Glycerin, liquid	Fleet BabyLax
Glycerin, suppositories	Sani-Supp
Lactulose	Chronulac
Magnesium hydroxide	Milk of Magnesia
Magnesium sulfate	Epsom Salt
Methylcellulose	Citrucel
Mineral oil	Milkinol
Polycarbophil	FiberCon
Polyethylene glycol–electrolyte solution	CoLyte
Polyethylene glycol	MiraLax
Psyllium	Metamucil, Fiberall
Sennosides	Ex-Lax, Senokot
Antidiarrheal agents	
Antibiotics	See Chapter 39
Attapulgit	Diasorb
Bismuth subsalicylate	Pepto-Bismol
Difenoxin with atropine	Motofen
Diphenoxylate with atropine	Lomotil
Loperamide	Imodium
Opium tincture, camphorated	Paregoric
Gastrointestinal stimulants	
Erythromycin	See Chapter 39
Dexpanthenol	Ilopan
Metoclopramide	Reglan
Antispasmodics	
Loperamide	Imodium
Anticholinergics	See Chapter 9

*See Table 33-1 and Chapter 9.

†See also Table 33-1.

CITED REFERENCES

1. American Academy of Clinical Toxicology, European Association of Poisons Centres and Clinical Toxicologists Position Paper: Ipecac syrup. *J Toxicol Clin Toxicol* 42:133-143, 2004.

2. American Academy of Pediatrics Committee on Injury, Violence, and Poison Prevention Policy Statement: poison treatment in the home. *Pediatrics* 112:1182-1185, 2003.
3. Anderson J, Gonzalez J: *H. pylori* infection: review of the guideline for diagnosis and treatment. *Geriatrics* 55:44-49, 2000.
4. Antidiarrheal drug products for over-the-counter human use: final monograph. *Fed Reg* 68:18869-18882, 2003.
5. Befrits R, Granstrom M, Rylander M, et al: *Helicobacter pylori* in 205 consecutive endoscopy patients. *Scand J Infect Dis* 25:185-191, 1993.
6. Bytzer P, Morain C: Treatment of *Helicobacter pylori*. *Helicobacter* 10(Suppl 1):40-46, 2005.
7. Candelli M, Carloni E, Armuzzi A, et al: Role of sucralfate in gastrointestinal diseases. *Panminerva Med* 42:55-59, 2000.
8. Charan M, Katz PO: Gastroesophageal reflux disease in pregnancy. *Curr Treat Options Gastroenterol* 4:73-81, 2001.
9. Chey W, Wong BCY: American College of Gastroenterology guideline on the management of *Helicobacter pylori* infection. *Am J Gastroenterol* 102:1-18, 2007.
10. Crawford JM, Kumar V: The oral cavity and the gastrointestinal tract. In Kumar V, Cotran RS, Robbins SL, editors: *Basic pathology*, ed 7, Philadelphia, 2003, Saunders.
11. Darkow T, Gora-Harper M, Goulson DT, et al: Impact of antiemetic selection on postoperative nausea and vomiting and patient satisfaction. *Pharmacotherapy* 21:540-548, 2001.
12. Dekel R, Morse C, Fass R: The role of proton pump inhibitors in gastro-oesophageal reflux disease. *Drugs* 64:277-295, 2004.
13. Del Valle J, Cohen H, Laine L, et al: Acid-peptic disorders. In Yamada T, Alpers DH, Laine L, et al, editors: *Textbook of gastroenterology*, ed 4, Philadelphia, 2003, Lippincott Williams & Wilkins.
14. DuPont HL: Travelers' diarrhea: antimicrobial therapy and chemoprevention. *Nat Clin Pract Gastroenterol Hepatol* 2:191-198, 2005.
15. Higgins PDR, Johanson JF: Epidemiology of constipation in North America: a systematic review. *Am J Gastroenterol* 99:750-759, 2004.
16. Hill DR: Occurrence and self-treatment of diarrhea in a large cohort of Americans traveling to developing countries. *Am J Trop Med Hyg* 62:585-589, 2000.
17. Hoogerwerf WA, Pashricha PJ, Kalloo AN, et al: Pain: the overlooked symptom in gastroparesis. *Am J Gastroenterol* 94:1029-1033, 1999.
18. Jewell D, Young G: Interventions for nausea and vomiting in early pregnancy. *Cochrane Database Syst Rev* (4):CD000145, 2003.
19. Lee A, Done ML: Stimulation of the wrist acupuncture point P6 for preventing postoperative nausea and vomiting. *Cochrane Database Syst Rev* (3):CD003281, 2004.
20. Liu LX: Travel medicine, part II: malaria, traveler's diarrhea, and other problems. *Infect Med* 10:24-28, 1993.
21. McGinnis WL, Loprinzi CL, Buskirk SJ, et al: Placebo-controlled trial of sucralfate for inhibiting radiation-induced esophagitis. *J Clin Oncol* 15:1239-1243, 1997.
22. Moyer P: Therapies for reducing gastric acid linked to increased risk of *Clostridium difficile*. *JAMA* 294:2989-2995, 2005.
23. National Digestive Diseases Information Clearinghouse (NDDIC). Available at: <http://digestive.niddk.nih.gov/statistics/statistics.htm>. Accessed January 19, 2010.
24. Robinson M, Horn J: Clinical pharmacology of proton pump inhibitors: what the practising physician needs to know. *Drugs* 63:2739-2754, 2003.
25. Sandler RS, Everhart JE, Donowitz M, et al: The burden of selected digestive diseases in the United States. *Am J Gastroenterol* 12:1500-1511, 2002.
26. Song Q, Spahr A, Schmid RM, et al: *Helicobacter pylori* in the oral cavity: high prevalence and great DNA diversity. *Dig Dis Sci* 45:2162-2167, 2000.
27. Spiller R, Aziz Q, Creed F, et al: Guidelines on the irritable bowel syndrome: mechanisms and practical management. *Gut* 56:1770-1798, 2007.
28. Steffen R, Sack DA, Riopel L, et al: Therapy of travelers' diarrhea with rifaximin on various continents. *Am J Gastroenterol* 98:1073-1078, 2003.
29. Vutyavanich T, Kraissarin T, Ruangsri R: Ginger for nausea and vomiting in pregnancy: randomized, double-masked, placebo-controlled trial. *Obstet Gynecol* 97:577-582, 2001.
30. Yagiela JA: Agents affecting salivation. In Ciancio SG, editor: *ADA/PDR guide to dental therapeutics*, ed 4, Chicago, 2006, American Dental Association.
31. Yang YX, Lewis JD, Epstein S, et al: Long-term proton pump inhibitor therapy and risk of hip fracture. *JAMA* 296:2497-2953, 2006.
32. Yates J: Traveler's diarrhea. *Am Family Physician* 71:2095-2100, 2005.

GENERAL REFERENCES

- American College of Gastroenterology Chronic Constipation Task Force: An evidence-based approach to the management of chronic constipation in North America, *Am J Gastroenterol* 100:S1-S4, 2005.
- Brandt LJ, Prather CM, Quigley EMM: Systematic review on the management of chronic constipation in North America, *Am J Gastroenterol* 100:S5-S22, 2005.
- Camilleri M: Management of the irritable bowel syndrome, *Gastroenterology* 120:652-668, 2001.
- Ramkumar D, Rao SSC: Efficacy and safety of traditional medical therapies for chronic constipation: systematic review, *Am J Gastroenterol* 100:936-971, 2005.
- Rendi-Wagner P, Kollaritsch H: Drug prophylaxis for travelers' diarrhea, *Clin Infect Dis* 34:628-633, 2003.
- Scorza K, Williams A, Phillips JD: Evaluation of nausea and vomiting, *Am Family Physician* 76:76-84, 2007.
- Yamada T, Alpers D, Kaplowitz L, editors: *Textbook of Gastroenterology*, vols 1 and 2, Philadelphia, 2003, Lippincott Williams & Wilkins.

Pituitary, Thyroid, and Parathyroid Pharmacology

GAIL T. GALASKO

HYPOTHALAMIC AND PITUITARY HORMONES

The pituitary gland consists of an anterior lobe (adenohypophysis) and a posterior lobe (neurohypophysis). It is connected to the hypothalamus, which lies above it, by the stalk that contains neurosecretory fibers and capillaries. The hypophyseal portal system drains the hypothalamus and perfuses the anterior pituitary. Numerous releasing factors or regulating hormones that are produced by the hypothalamus are carried to the anterior pituitary by this portal system. These hypothalamic releasing factors stimulate the anterior pituitary to produce and secrete numerous tropic hormones, which stimulate target glands to produce hormones. The hypothalamic releasing factors, anterior pituitary hormones produced, target glands, and target gland hormones are presented in Table 34-1. Pituitary hormone secretion is regulated by negative feedback. For anterior pituitary hormones, secretion of releasing factors from the hypothalamus is decreased when the concentration of target gland hormones is high and increased when it is low.

POSTERIOR PITUITARY HORMONES

The posterior lobe of the pituitary secretes two homologous peptide hormones, vasopressin and oxytocin. These hormones are synthesized in the hypothalamus and transported via the neurosecretory fibers of the stalk to the posterior pituitary, where they are stored and released. Both of these hormones are nonapeptides, and their structures are similar.

Vasopressin

Vasopressin (antidiuretic hormone [ADH]) acts on the kidney to increase water reabsorption. It increases total peripheral resistance and has an important role in the long-term control of blood pressure. Vasopressin also has a vasoconstrictor action that plays a role in the short-term regulation of arterial pressure. There are two subtypes of vasopressin receptors. V_1 receptors, which are $G_{q/11}$ protein-linked, produce their action by stimulation of phospholipase C and formation of inositol triphosphate. This is the pathway responsible for the vasoconstrictor action of vasopressin. V_2 receptors, which are G_s protein-linked, cause stimulation of adenylyl cyclase and increase cyclic adenosine 3',5'-monophosphate (cAMP) formation. Stimulation of V_2 receptors by vasopressin leads to its antidiuretic effect. Lack of ADH leads to diabetes insipidus, resulting in polyuria and polydipsia.

Pharmacokinetics

Vasopressin may be given intravenously, intramuscularly, or intranasally. Because the drug is rapidly metabolized

in the liver and kidney, the half-life is approximately 20 minutes.

Therapeutic uses

Vasopressin and desmopressin acetate, a long-acting synthetic analogue that acts predominantly at V_2 receptors, are used to treat diabetes insipidus. The receptors mediating this effect are located on the cells of the collecting duct in the kidney. Vasopressin is also used to control bleeding in certain conditions (e.g., colonic diverticular bleeding). Vasopressin stimulates the release of von Willebrand factor and clotting factor VIII and is used to treat deficiencies of these factors in certain types of hemophilia. Desmopressin is also used to decrease nocturnal enuresis. Felypressin, a synthetic analogue of vasopressin, is a vasoconstrictor that is used outside the United States with local anesthetics as an alternative to epinephrine.

Oxytocin

Oxytocin receptors are $G_{q/11}$ protein-linked receptors that, when stimulated, lead to an increase in intracellular Ca^{++} and muscle contraction. Oxytocin causes contraction of uterine smooth muscle and may play a role in the initiation of labor. Oxytocin also stimulates milk ejection in lactating mothers by stimulating myoepithelial cells around the alveoli of the mammary glands. Recent data suggests that oxytocin is a neuropeptide involved in a wide array of social behaviors in diverse species. Maternal bonding, social decision making, and processing of social stimuli and social memory are enhanced by increased levels of oxytocin.

Pharmacokinetics

Oxytocin has a circulating half-life of 5 minutes. It is not bound to plasma protein and is metabolized in the liver and kidneys.

Therapeutic uses

Oxytocin is used intravenously for stimulation of labor and to induce postpartum lactation in cases of breast engorgement. Investigations are underway for its use in therapeutic interventions in a variety of conditions, especially those characterized by anxiety and aberrations in social function, such as autism.¹²

ANTERIOR PITUITARY HORMONES

Growth Hormone

Growth hormone (GH), also known as somatotropin, is the most abundant of the anterior pituitary hormones. The principal form of GH is a 191-amino acid single-peptide chain with two sulfhydryl bridges. GH for pharmacologic use is

TABLE 34-1

Hypothalamic Stimulatory Releasing Factors, Corresponding Anterior Pituitary Tropic Hormones, Target Glands, and Target Gland Hormones

HYPOTHALAMIC HORMONE	PITUITARY HORMONE	TARGET ORGAN	HORMONE PRODUCED
Corticotropin-releasing hormone	Adrenocorticotropin	Adrenal cortex	Glucocorticosteroids, mineralocorticosteroids, androgens
GH-releasing hormone	GH (somatotropin)	Liver, bone, other tissues	IGFs
Gonadotropin-releasing hormone	Follicle-stimulating hormone, luteinizing hormone	Gonads	Estrogen, progesterone, testosterone
Thyrotropin-releasing hormone	Thyroid-stimulating hormone	Thyroid	T ₄ , T ₃

GH, Growth hormone; IGFs, insulin-like growth factors; T₃, triiodothyronine; T₄, thyroxine.

produced by recombinant DNA techniques and contains the 191-amino acid sequence of somatotropin, recombinant human GH, or 192 amino acids consisting of somatotropin plus an extra methionine at the amino terminal end. These preparations are equipotent.

Actions

GH has direct and indirect effects. Its action is through cell surface receptors (JAK/STAT family). The direct actions of GH include lipolysis in fat cells and stimulation of hepatic glucose output. These effects are opposite to those of insulin. The anabolic and growth-promoting effects of GH are indirect and are mediated by insulin-like growth factor type I (IGF-I). IGF-I stimulates chondrogenesis and skeletal and soft tissue growth. IGF-I increases mitogenesis, increasing cell number rather than cell size. GH-releasing hormone from the hypothalamus stimulates GH release. Somatostatin from the hypothalamus inhibits GH release and release of gastrointestinal secretions.

In contrast to the direct effects of GH, the effects mediated by IGF-I are insulin-like. IGF-I acts through cell membrane receptors that resemble those of insulin. Insulin at high doses may act at IGF-I receptors and vice versa (see Chapter 36). In pharmacologic doses, GH causes an initial insulin-like effect followed by an effect antagonistic to that of insulin.

Pharmacokinetics

Circulating endogenous GH has a half-life of 20 to 25 minutes, although slow-release forms are available allowing injections once or twice a month. Human GH can be given subcutaneously, with peak plasma levels reached in 2 to 4 hours. Metabolism occurs in the liver and the kidney.

Therapeutic uses

GH (somatrem, somatotropin) is used in the treatment of growth failure in children (pituitary dwarfism), wasting in acquired immunodeficiency syndrome (AIDS), and somatotropin deficiency syndrome. Short-term treatment of GH-deficient adults results in increased lean body mass, decreased fat mass, increased exercise tolerance, and improved psychological well-being. It is sometimes abused by athletes⁶ or used for its antiaging effect. GH is a potent anabolic agent and may have a role in clinical management of burn injuries. The GH-releasing hormone analogue sermorelin is used to treat GH deficiency in children who have growth retardation and diagnostically to determine the GH-releasing capacity of the pituitary. Octreotide, a somatostatin analogue that inhibits GH release, is approved for use in treating symptoms of vasoactive intestinal tumors, metastatic carcinoid tumors, and acromegaly. Other uses include AIDS-associated diarrhea and esophageal varices. Pegvisomant, a competitive antagonist of GH, is used to treat acromegaly.

TABLE 34-2

Hypothalamic Inhibitory Releasing Factors, Anterior Pituitary Hormones Inhibited, and Target Glands

HYPOTHALAMIC HORMONE	PITUITARY HORMONE INHIBITED	TARGET ORGAN
Dopamine	Prolactin	Breast
Somatostatin	Growth hormone	Liver, bone, other

Adverse effects

GH may induce relative insulin resistance. It has been documented to cause diabetes in AIDS patients¹⁶ and decreased insulin sensitivity that is dose-dependent, with a possible increase in type 2 diabetes in children.⁵ It may cause scoliosis in children. Arthralgia, especially in the hands and wrist, may occur. Patients may have headaches, especially in the first few months of therapy, and should be carefully observed (monitored) because of the possibility of intracranial hypertension.

Prolactin

Prolactin is an anterior pituitary hormone that is similar in structure to GH. Prolactin increases the growth of the secretory epithelium in the breast and stimulates the production of milk. Although prolactin is not used clinically, the secretion of prolactin can be altered by certain drugs. Because dopamine inhibits prolactin release (Table 34-2), drugs that affect dopamine levels or dopamine receptors in the pituitary affect prolactin release. Bromocriptine and cabergoline are dopamine-receptor agonists that are used to inhibit prolactin release and reduce the size of pituitary prolactin-releasing tumors.

Thyrotropin (Thyroid-Stimulating Hormone)

Thyrotropin (thyroid-stimulating hormone [TSH]) is a glycoprotein hormone consisting of two subunits (α and β). Secretion is pulsatile and follows a circadian rhythm, with levels of TSH being highest during sleep at night. TSH secretion is controlled by thyrotropin-releasing hormone (TRH), which is inhibited by thyroid hormone negative feedback. Because TRH is stimulated by cold and decreased by severe stress, TSH is also affected by these conditions. TSH stimulates the thyroid to synthesize thyroglobulin and the thyroid hormones thyroxine (T₄) and triiodothyronine (T₃). An increase in the amount of free thyroid hormone in the circulation results in decreased TSH gene transcription and decreased TSH secretion.

The TSH receptor is G protein-coupled. The effects of TSH are mediated by stimulation of adenylyl cyclase and increased cAMP (G_s -adenylyl cyclase-cAMP) in the thyroid cell. TSH also causes activation of phospholipase C (G_q -PLC). TSH is used for diagnostic purposes and to stimulate iodine (^{131}I) uptake in some patients with thyroid cancer (see later).

THYROID HORMONES

The active principles of the thyroid gland are iodine-containing amino acid derivatives of thyronine. They are formed from iodinated tyrosine residues. The structures are shown in Figure 34-1.

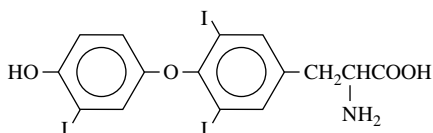

Triiodothyronine (T_3)

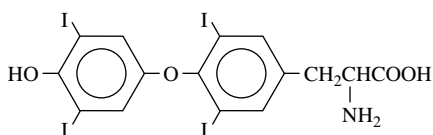

Thyroxine (T_4)

FIGURE 34-1 Structure of thyroid hormones.

Synthesis of Thyroid Hormones

The synthesis of thyroid hormones is shown schematically in Figure 34-2. The first step is uptake of iodide by the thyroid gland. This step may be inhibited by ions of similar size and charge such as perchlorate. Iodide uptake is followed by oxidation of iodide to hypoiodite and iodination of tyrosyl groups within the thyroglobulin molecule may be monoiodinated to monoiodotyrosine (MIT) or diiodinated to form diiodotyrosine (DIT). This step is catalyzed by thyroperoxidase and is rapid. Iodotyrosyl residues are coupled to form iodothyronyl residues within thyroglobulin. This may be either MIT plus DIT to form T_3 or DIT plus DIT to form T_4 . The ratio of T_4 to T_3 formed is approximately 4:1. The coupling of iodotyrosyl groups is also catalyzed by peroxidase enzyme. Thyroid hormones are released by proteolysis of thyroglobulin. Most of the hormone released is T_4 , which is converted to T_3 in peripheral tissues by iodothyronine deiodinases. T_3 is about four times more potent than T_4 .

Control of Thyroid Hormone Secretion

The effect of TSH on the thyroid gland is to stimulate the synthesis and secretion of thyroid hormones T_4 and T_3 (see previous discussion). In addition to TSH, the iodine concentration in the blood plays an important role in regulating the uptake of iodide and formation of thyroid hormones in the thyroid gland. Iodination and thyroid hormone release can be inhibited by larger doses of iodides.

The hypothalamic-pituitary-thyroid axis is stimulated by cold and decreased in severe stress. It is under negative feedback control of the thyroid hormones, which act on the hypothalamus to decrease TRH synthesis and secretion, and on the pituitary to block the action of TRH.

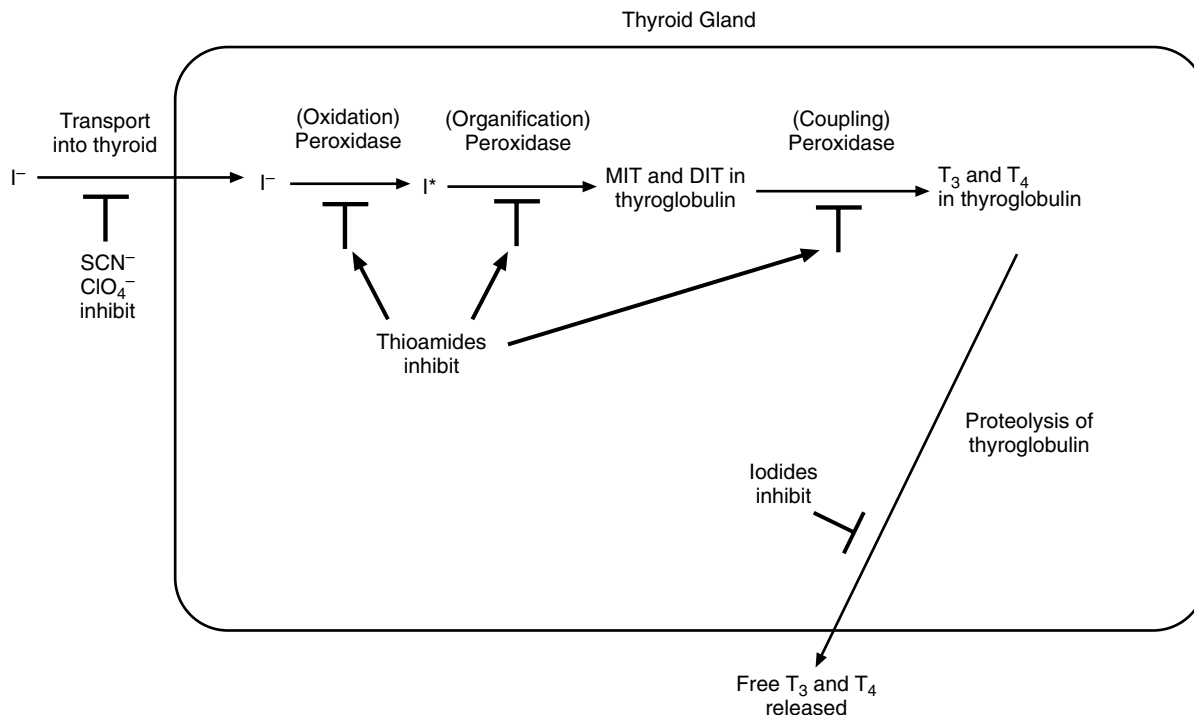

*= Iodine in hypoiodate form

FIGURE 34-2 Synthesis of thyroid hormones and sites of action of various antithyroid drugs. *DIT*, Diiodotyrosine; *MIT*, monoiodotyrosine; T_3 , triiodothyronine; T_4 , thyroxine.

Actions of Thyroid Hormones

Thyroid hormones act by diffusing across the cell membrane and binding to intracellular receptors in target tissues. T_4 is converted to T_3 inside the cell. T_3 has greater affinity than T_4 for the receptors. The action of thyroid hormones leads to an increase in transcription, resulting in synthesis of proteins that produce many of the actions of thyroid hormones. Thyroid hormones are crucial in normal development and metabolism. They have a critical effect on growth, partly by direct action and partly by potentiating GH. Thyroid hormones are important for a normal response to parathyroid hormone (PTH) and calcitonin. They are crucial for nervous and skeletal tissues. Thyroid deficiency during development causes cretinism, characterized by mental retardation and dwarfism.

In addition, thyroid hormones are regulators of metabolism in most tissues. They increase basal metabolic rate and resting respiratory rate. Thyroid hormones stimulate the heart, resulting in the heart beating more rapidly and with greater force and an increase in cardiac output. Energy use in skeletal muscle, liver, and kidney is also markedly stimulated. T_3 sensitizes the heart to the effects of circulating endogenous catecholamines by a direct effect on Ca^{++} channels,⁸ and thyroid hormones cause an increase in myocardial β -adrenergic receptors.¹⁷

Pharmacokinetics

The thyroid hormones are highly protein-bound; the major plasma-binding protein is thyroxine-binding globulin. They are also bound by thyroxine-binding prealbumin and albumin. The half-life of T_4 is normally 6 to 7 days; this is shortened to 3 to 4 days in hyperthyroidism. T_3 binds more loosely to plasma proteins and has a half-life of approximately 2 days.

THYROID DISORDERS

Worldwide, the most common cause of thyroid disorders is iodine deficiency. In the United States, the leading cause of hypothyroidism is Hashimoto's thyroiditis, an autoimmune disease. Graves' disease (diffuse toxic goiter), also an autoimmune disorder, is the most common cause of hyperthyroidism in the United States.

Hypothyroidism

Thyroid deficiency during development causes cretinism, which is characterized by gross retardation of growth and mental deficiency. In an adult, thyroid deficiency results in hypothyroidism and, in more severe cases, myxedema. Hypothyroidism is a common endocrine disorder affecting 1.4% to 2% of women and 0.1% to 0.2% of men. The prevalence of overt and subclinical hypothyroidism is significantly greater in women than in men and increases dramatically in women after age 40 years, affecting 5% to 10% of women older than 50 years.² Subclinical hypothyroidism is common, especially among older women.¹⁵ It has been suggested that this condition may be associated with an increased mortality rate, particularly from cardiovascular disease and a subtle decrease in myocardial contractility.¹¹ Subclinical hypothyroidism is associated with a small increase in low-density lipoprotein cholesterol and a decrease in high-density lipoprotein cholesterol, changes that increase risk of atherosclerosis and coronary artery disease.¹⁰ Cognitive impairment occurs in hypothyroidism, and attention, motor speed, memory, and visual spatial organization all are significantly impaired.⁴ In addition, hypothyroidism is an important risk factor for carpal tunnel syndrome.¹⁴

Signs and Symptoms of Hypothyroidism

Typical symptoms of hypothyroidism include lethargy; fatigue; loss of energy and ambition; slowing of intellectual

and motor activity; decreased appetite; increased weight; and skin that is dry, cold, and coarse. Hair loss, including loss of the outer third of eyebrows, occurs. Hypothyroid patients have cold intolerance, bradycardia, hypotension, and increased capillary fragility. They also show an exaggerated response to central nervous system depressants such as sedatives and narcotic analgesics.

Replacement Therapy

Animal products include desiccated thyroid, which is composed of animal thyroid glands. Numerous preparations of levothyroxine sodium (T_4) are available. Liothyronine sodium (T_3) and liotrix, a mixture of T_4 and T_3 in a 4:1 ratio, are also available. Synthetic T_4 has a uniform content and a long half-life and is the preferred and most widely used thyroid replacement medication. Because of its greater potential for cardiotoxicity and its shorter half-life, the use of T_3 is controversial and much less frequent. Nevertheless, for some patients, the combination of T_3 and T_4 is better than T_4 alone.³ Animal experiments have shown that in rats, only replacement of T_3 and T_4 ensures euthyroidism in all tissues.

The thyroid hormones are well absorbed after oral administration. Absorption of T_4 may be decreased, however, by food, Ca^{++} preparations, and aluminum-containing antacids. Absorption of T_4 is best if it is taken on an empty stomach in the morning. Absorption of T_3 , which is almost completely absorbed, is not affected by food.

Levothyroxine has a half-life of approximately 7 days. It takes about 1 month to reach steady state. The half-life of liothyronine is shorter (<2 days), as is its duration of action.

Hyperthyroidism

Hyperthyroidism may be caused by Graves' disease (diffuse toxic goiter), an autoimmune disorder, or toxic nodular goiter. Graves' disease is the most common cause of hyperthyroidism in the United States. In hyperthyroidism (thyrotoxicosis), there is an excess of thyroid hormones, resulting in a high metabolic rate, increased heart rate and contractility, and increased sensitivity to catecholamines. Other signs and symptoms include increased appetite but decreased weight, weakened skeletal muscles or muscle wasting, increased body temperature, sensitivity to heat, nervousness, and tremor. Exophthalmus may be present in Graves' disease.

Hyperthyroidism may be treated surgically or pharmacologically. The most common treatments are described subsequently.

DRUGS USED IN THE TREATMENT OF HYPERTHYROIDISM

The major drugs used to inhibit production of thyroid hormones are radioactive iodine (^{131}I), thioamides, and iodide.

Radioactive Iodine

The ^{131}I isotope has a half-life of 8 days and emits γ radiation and β particles. Given orally, it is concentrated in the thyroid, where the β particles destroy the gland. Symptoms of hyperthyroidism begin to improve in a few days to a few weeks, but 2 to 3 months are often required for a complete effect.

^{131}I is selective for the thyroid gland. Advantages of the use of ^{131}I include the comparative low cost because surgery is not required and the fact that no deaths have been reported resulting from this treatment. The disadvantage of this treat-

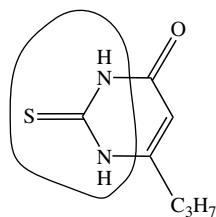

Propylthiouracil

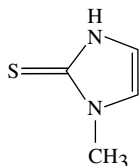

Methimazole

FIGURE 34-3 Chemical structure of propylthiouracil and methimazole. The thiocarbamide group is circled in propylthiouracil.

ment is that hypothyroidism frequently occurs as a delayed effect. It is now believed, however, that hypothyroidism may represent the end stage of hyperthyroidism rather than overtreatment with ^{131}I . ^{131}I should be avoided in children and pregnant patients. Uptake of low-dose ^{131}I may be used as a test of thyroid function.

Thioamides

Propylthiouracil and methimazole are the most important antithyroid drugs used in the United States within the thioamides (Figure 34-3). These drugs are related to thiourea and contain a thiocarbamide group that is essential for their antithyroid activity.

Mechanism of action

Thioamides inhibit thyroid peroxidase, decreasing iodide oxidation, iodination of tyrosines, and coupling of iodotyrosyl and iodothyronyl residues (see Figure 34-2). As a result, less thyroid hormone is synthesized. Propylthiouracil also inhibits the peripheral conversion of T_4 to T_3 .

Pharmacokinetics

Thioamides are given orally. Methimazole is distributed throughout body water and has a plasma half-life of 6 to 15 hours. An average dose produces more than 90% inhibition of thyroid incorporation of iodide within 12 hours, but the clinical response takes weeks to manifest because of the long half-life of T_4 and because there may be stores of hormone in the thyroid that need to be depleted. The actions of propylthiouracil may be seen more quickly because of the inhibition of peripheral conversion of T_4 to T_3 .

Adverse effects

Adverse effects include occasional, reversible, yet rapidly developing agranulocytosis; rashes; pain; stiffness in joints; paresthesias; and loss or depigmentation of hair.

Therapeutic uses

Thioamides are used to control hyperthyroidism in anticipation of spontaneous remission, before surgery, or together with ^{131}I to hasten recovery from hyperthyroidism.

Ionic Inhibitors

Ionic inhibitors interfere with the concentration of iodide by the thyroid gland. They are monovalent anions that resemble iodide. Examples include thiocyanate and perchlorate. Their effects may be overcome by large doses of iodides. Thiocyanate, which is not used therapeutically, may be formed during the digestion of certain foods such as cabbage and has an antithyroid effect.

Iodide

Iodide is the oldest remedy for thyroid disorders. Iodine/iodides are required for thyroid hormone synthesis (see Figure 34-2); however, high concentrations of iodide limit its own transport. In addition, high concentrations of iodide inhibit synthesis of iodotyrosines and iodothyronines (organification) and inhibit thyroid hormone release. These effects, which depend on intracellular concentrations of iodide, are transient. High plasma iodide concentrations also inhibit release of thyroid hormones. Iodide has been used preoperatively in preparation for thyroidectomy because it makes the gland less vascular. Iodide is also used together with antithyroid drugs and propranolol to treat thyrotoxic crisis.

Hypersensitivity to iodides is the major adverse effect. Iodism, which is chronic iodine toxicity, has many adverse effects, including unpleasant taste, burning in the mouth and throat, soreness of teeth and gingiva, and increased salivation. Symptoms similar to those of a head cold commonly occur, as do skin eruptions, gastric irritation, and diarrhea. Inflammation of the larynx, tonsils, and lungs and enlargement of the parotid and submandibular glands may occur. Iodide concentrates in salivary glands.

IMPLICATIONS FOR DENTISTRY

Subclinical hypothyroidism and hyperthyroidism are common, well-defined conditions that often progress to overt disease. The clinical presentation of thyroid disorders is often subtle in older adults and may be confused with normal aging.

Hypothyroidism

Hypothyroidism is five to six times more common than hyperthyroidism. Hypothyroidism affects 7 to 10 times as many women as men, and the incidence of the disease increases sharply with age in women after age 40 years, affecting 5% to 10% of women older than 50 years.^{2,15} Subclinical states may contribute to hyperlipidemia, cardiac dysfunction, and osteoporosis.¹⁵

The dentist may be in a position to detect signs and symptoms of subclinical thyroid disease and refer the patient for medical evaluation and treatment; this is very important in hypothyroidism, in which signs and symptoms are subtle and similar to those of depression (Box 34-1). As a result, the disease may not be diagnosed. Subclinical hypothyroidism in younger individuals may manifest as delayed eruption of teeth, malocclusion, and skeletal growth retardation. Other oral manifestations of hypothyroidism include tongue enlargement and scalloping. Hypothyroid patients have increased capillary fragility and show an exaggerated response to central nervous system depressants such as sedatives and opioids.

Clinical hypothyroidism or myxedema may be recognized by a patient's dull expression; puffy eyelids; alopecia of the outer third of the eyebrows; dry, rough skin; dry, brittle, coarse hair; increased size of the tongue; slowing of physical and mental activity; anemia; constipation; and increased sensitivity to cold. In patients with myxedema, stressful situations such as surgery, trauma, or infections may precipitate myx-

BOX 34-1**Common Signs of Hypothyroidism and Depression**

Depressed mood
 Decreased interests
 Weight gain
 Disturbed sleep
 Muscle weakness/slow speech
 Disturbed concentration and cognition
 Feelings or guilt or inadequacy/inability to cope

edematous coma. Myxedematous coma is very rare and occurs predominantly in elderly women and has a greater than 50% mortality rate.¹

Hyperthyroidism

Thyrotoxicosis is characterized by warm, moist skin; a rosy complexion; weight loss; fine, friable hair; and nail softening. Profuse sweating is common in these patients. Achlorhydria may occur, and approximately 3% of individuals affected develop pernicious anemia. Hyperthyroid individuals are nervous, emotionally labile, and always moving. They display tremor of the hands and tongue and muscle weakness. In thyrotoxicosis there is increased bone loss. In these patients there is also increased stroke volume and heart rate and palpitations. Supraventricular arrhythmias may occur. Graves' ophthalmopathy may be recognized by eyelid retraction, proptosis, and a bright-eyed stare. Patients who are hyperthyroid are highly sensitive to epinephrine. Propranolol alleviates adrenergic symptoms such as sweating, tremor, and tachycardia.

Oral complications of thyrotoxicosis include osteoporosis of the alveolar bone. Dental caries and periodontal disease appear more frequently. In children, teeth and jaws develop more rapidly, and there is early loss of deciduous teeth and early eruption of permanent teeth. Changes in the gingiva resulting from hyperthyroidism may lead to ill-fitting dentures.

HORMONES OF Ca⁺⁺ HOMEOSTASIS**Parathyroid Hormone**

The parathyroid glands (there are usually four) are embedded within the posterior surface of the thyroid. The principal cells secrete PTH, which is formed by proteolysis of a larger precursor. PTH is a single-chain polypeptide containing 84 amino acids and has a molecular weight of approximately 9500 Da. Loss of the first two amino acids eliminates most biologic activity.

Regulation of secretion

The principal factor in control of PTH secretion is plasma Ca⁺⁺ concentration. High plasma Ca⁺⁺ concentration decreases PTH secretion; low Ca⁺⁺ concentration stimulates it. Ca⁺⁺ regulates PTH secretion by a G protein-coupled, cell surface Ca⁺⁺-sensing receptor. Phosphate regulates PTH secretion indirectly by forming complexes with Ca⁺⁺. Increases in phosphate concentration reduce Ca⁺⁺ levels and increase PTH secretion. Calcitriol (1,25-dihydroxyvitamin D₃) directly inhibits PTH secretion by affecting gene transcription.

Pharmacologic effects

PTH regulates Ca⁺⁺ and phosphate, causing an increase in plasma Ca⁺⁺ and a decrease in plasma phosphate concentra-

tions. The primary function of PTH is to maintain a constant extracellular Ca⁺⁺ concentration.

The most important target tissues for PTH are bone and kidney. In bone, PTH increases Ca⁺⁺ and phosphate release by increasing bone resorption. It acts on the osteoblast to induce RANK ligand (RANKL), which stimulates osteoclast activity, resulting in increased bone turnover. Bone formation and bone resorption are enhanced by PTH. With constant dosing, PTH increases bone resorption. When PTH is given intermittently at low doses, it stimulates cortical and trabecular bone growth.¹³ Teriparatide (recombinant human PTH1-34) has been approved for the treatment of osteoporosis. In the kidney, PTH increases reabsorption of Ca⁺⁺ and Mg⁺⁺ and decreases reabsorption of phosphate. PTH also increases conversion of vitamin D to its active form, 1,25-dihydroxyvitamin D₃ (calcitriol), which is secreted into the circulation and acts in the gastrointestinal tract to increase the absorption of Ca⁺⁺.

Pharmacokinetics

PTH has a half-life of minutes, with clearance occurring mostly in the liver and kidney.

Calcitonin

Calcitonin is secreted by the parafollicular cells of the thyroid gland. Calcitonin is synthesized as a prohormone and processed to the hormone. There is considerable species variation in calcitonin. Human calcitonin is a single-chain peptide composed of 32 amino acids and has a molecular weight of 3600 Da. A disulfide bridge between positions 1 and 7 is essential for biologic activity.

Control of secretion

Elevated extracellular Ca⁺⁺ concentration is the most important stimulator of calcitonin secretion. Calcitonin release is also stimulated by gastrointestinal tract hormones, including cholecystokinin and gastrin.

Actions

Calcitonin acts on G protein-linked cell surface receptors located on target tissues. It reduces plasma Ca⁺⁺ and phosphate concentrations mainly by acting on bone to inhibit osteoclast activity and bone resorption. Calcitonin also acts on the kidney to increase urinary excretion of Ca⁺⁺ and phosphate.

Therapeutic uses

Calcitonin is used in the treatment of Paget's disease, in which there is excessive, disorganized bone remodeling, and in some patients with osteoporosis. Salmon calcitonin, which is more potent and has a longer half-life than mammalian calcitonin, is typically used in therapy. It is given by injection or nasal spray.

Adverse effects

Nausea and gastrointestinal tract effects are the most common adverse effects. Rash with itching and swelling may also occur.

Vitamin D

Vitamin D is the name given to two related substances, cholecalciferol (vitamin D₃) and ergocalciferol (vitamin D₂). Both substances are active in humans and are able to prevent or cure rickets. Cholecalciferol is formed in the skin from 7-dehydrocholesterol by the action of ultraviolet irradiation; ergocalciferol comes from plants. Vitamin D is also found in dietary products.

The major action of vitamin D is control of Ca⁺⁺ homeostasis. Vitamin D facilitates absorption of Ca⁺⁺ and phosphate from the small intestine, interacts with PTH to enhance

TABLE 34-3

Effects of Parathyroid Hormone and Vitamin D on Bone, Gastrointestinal Tract, and Kidney

ORGAN	PARATHYROID HORMONE	VITAMIN D
Bone	Low doses increase bone formation; high doses increase bone resorption	Secalcifediol may increase bone formation; calcitriol increases bone resorption
Gastrointestinal tract	Increases Ca ⁺⁺ and phosphate absorption (by increased calcitriol production)	Calcitriol increases Ca ⁺⁺ and phosphate absorption
Kidney	Decreases Ca ⁺⁺ , increases phosphate excretion	Decreases Ca ⁺⁺ and phosphate excretion
Overall effect	Increases plasma Ca ⁺⁺ , decreases plasma phosphate	Increases plasma Ca ⁺⁺ and plasma phosphate

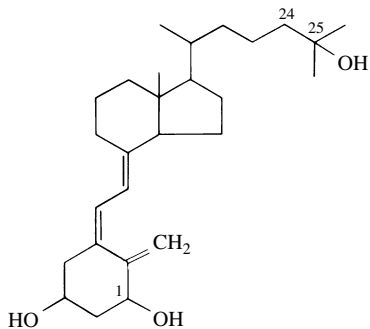

FIGURE 34-4 Structural formula of the primary active form of vitamin D: 1,25-dihydroxycholecalciferol (calcitriol).

mobilization of Ca⁺⁺ and phosphate from bone, and decreases excretion of Ca⁺⁺ and phosphate by the kidney. In addition, vitamin D has effects on bone remodeling. More recent studies suggest that vitamin D may have several other actions, including anti-inflammatory properties (downregulation of tumor necrosis factor- α , interleukin-6, interleukin-1, and interleukin-8). Vitamin D is used to treat secondary hypoparathyroidism.

The net effect of vitamin D is to increase serum Ca⁺⁺ and serum phosphate. This is different from the net effect of PTH, which is to increase serum Ca⁺⁺ and reduce serum phosphate. The effects of PTH and vitamin D are shown in Table 34-3.

Vitamin D is a prohormone that is a precursor to numerous biologically active metabolites. Cholecalciferol is biotransformed to 25-hydroxycholecalciferol (calcifediol) in the liver and converted further to 1,25-dihydroxyvitamin D₃ (calcitriol) and 24,25-dihydroxyvitamin D₃ (secalcifediol) in the kidney.

Calcitriol is biologically the most active metabolite of vitamin D (Figure 34-4).²⁰ It stimulates Ca⁺⁺ and phosphate absorption from the gastrointestinal tract. Calcitriol is required for bone mineralization, although it directly stimulates bone

resorption.⁷ In the kidney, it slightly increases Ca⁺⁺ and phosphate reabsorption. Receptors for calcitriol are found in various tissues, including bone, gut, and kidney. These are intracellular receptors, as are typical of other steroid hormone receptors. Calcitriol binding to its receptors leads to a selective increase in transcription and production of proteins such as Ca⁺⁺-binding proteins in the gastrointestinal tract. Calcitriol may also act directly on the membrane to alter Ca⁺⁺ flux. In addition to its classic effects (discussed earlier), calcitriol has many other actions, including regulation of PTH secretion, cytokine production, and proliferation and differentiation of numerous cells. Secalcifediol stimulates bone formation and is essential for fracture healing.

Calcifediol (25-hydroxycholecalciferol) is more potent than calcitriol in stimulating renal reabsorption of Ca⁺⁺ and phosphate. Calcifediol may be the major metabolite involved in the regulation of Ca⁺⁺ flux and contractility in muscle.

High levels of Ca⁺⁺ and phosphate reduce the amount of 1,25-dihydroxyvitamin D₃ produced by the kidney and decrease the amount of 24,25-dihydroxyvitamin D₃. Calcitriol directly inhibits PTH secretion by a direct action on PTH gene transcription.

Vitamin D is usually given orally. After absorption, vitamin D and its metabolites circulate in plasma bound to vitamin D-binding protein, which is an α globulin. Vitamin D (cholecalciferol) has a plasma half-life of 19 to 25 hours but is stored in fat for prolonged periods. The major circulating form is calcifediol, which has a half-life of 19 days. The half-life of calcitriol is 3 to 5 days.

Calcifediol and calcitriol are available for clinical use as vitamin D. In addition, doxercalciferol and paricalcitol have been approved for treatment of secondary hyperparathyroidism in patients with renal failure.

Bisphosphonates

Bisphosphonates are analogues of pyrophosphate (Figures 34-5 through 34-8). There are three distinct classes: non-nitrogen-containing bisphosphonates (etidronate, clodronate, tiludronate), linear nitrogen-containing bisphosphonates (pamidronate, alendronate, ibandronate), and ringed nitrogen-containing bisphosphonates (risedronate, zoledronic acid). Non-nitrogen drugs are very low potency, linear nitrogen drugs are moderate potency, and ringed nitrogen drugs are high potency.

The major action of bisphosphonates is inhibition of osteoclast-mediated bone resorption. Because osteoblasts require cytokines released from osteoclasts to differentiate them from their precursors, osteoblastic bone formation is coupled to osteoclastic bone resorption. By inhibiting the osteoclasts, a secondary, indirect decrease in bone formation occurs. This process is believed to be responsible for delaying healing and creating bisphosphonate osteonecrosis of the jaw.

The mechanisms of action of bisphosphonates are not completely understood. It is believed that bisphosphonates are incorporated into bone matrix and taken into the osteoclast during resorption, incapacitating it. Non-nitrogen-containing drugs apparently replace the distal phosphate in adenosine 5'-triphosphate (ATP), rendering it useless for energy production. Nitrogen-containing bisphosphonates have been shown to inhibit farnesyl diphosphate synthase, a crucial enzyme in the cholesterol biosynthesis pathway and in the isoprenylation of several regulatory proteins, including GTPases, Ras, Rac, Rho, and Cdc. The latter proteins play a rate-limiting role in the activity of the osteoclast.¹⁸

Pharmacokinetics

It is crucial to understand that there is a vast clinical difference between how orally administered bisphosphonates work versus intravenously administered preparations. Oral bisphos-

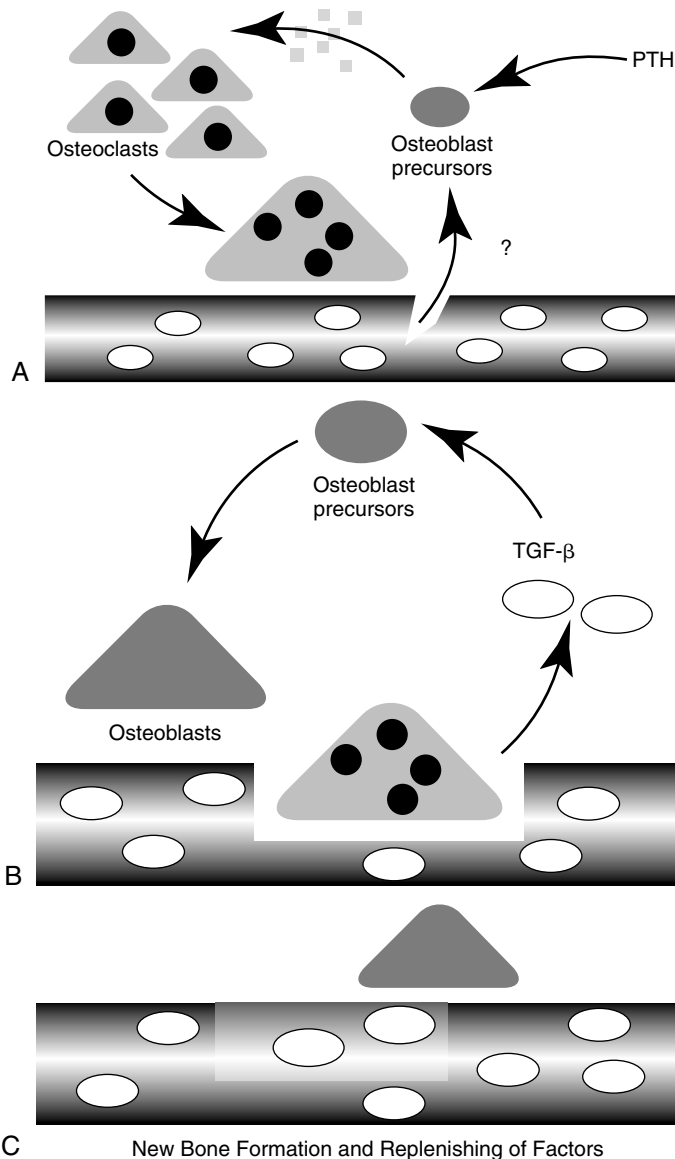

FIGURE 34-5 Normal physiologic bone processes. **A**, Microfractures that occur in bone release chemical mediators (as yet still unknown) that stimulate osteoblastic precursors to release cytokines (RANK ligand is among them). Parathyroid hormone (*PTH*) provides a similar stimulus. The cytokines trigger osteoclasts to coalesce into activated multinucleated cells. **B**, Activated osteoclasts break down the bone surrounding the microfracture. In so doing, they liberate transforming growth factor- β (*TGF- β*) and other cytokine factors housed in the structural bony matrix. *TGF- β* stimulates the osteoblast precursors to differentiate terminally into mature osteoblasts. **C**, Mature osteoblasts set down new bone matrix and replenish the intramatrix supply of growth factors. (Adapted from Green JR: Bisphosphonates: preclinical review, *Oncologist* 9[Suppl 4]:3-13, 2004.)

phosphonates are poorly absorbed after administration, with only about 2% of the drug taken into the bloodstream. Food significantly decreases absorption. These drugs should be taken only with water, after an overnight fast, and 2 hours before breakfast. Bioavailability is reduced if coffee or orange juice is taken concurrently with these drugs. The lack of a sizable absorption profile is considered to be one of the major reasons why the risk of osteonecrosis of the jaw is very low with orally

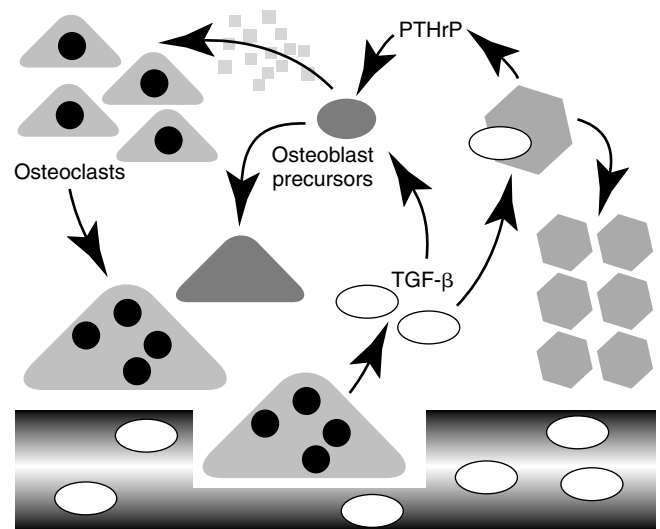

FIGURE 34-6 Cancer disruption theory. Metastatic cancer cells (illustrated as *hexagons*) are believed to disrupt the normal physiologic process in several ways. First, they “rob” the system of transforming growth factor- β (*TGF- β*) and use this growth factor to stimulate their own proliferation, giving rise to additional cancer cells. Second, they release parathyroid hormone-related peptide (*PTHrP*), a similar peptide that can stimulate the osteoblastic precursors to release additional cytokines capable of activating the osteoclasts. Conceptually, with less *TGF- β* available to differentiate the osteoblasts and more cytokines available to activate the osteoclasts, the osteoclast numbers outweigh the osteoblasts, causing lytic lesions to occur in the bone. This process, coupled with the additional cancer cells, gives rise to metastatic lesions in bone and a state of hypercalcemia. (Adapted from Green JR: Bisphosphonates: preclinical review, *Oncologist* 9[Suppl 4]:3-13, 2004.)

administered drugs, even if they are from the higher potency classes (e.g., alendronate and risedronate). The intravenously administered drugs, pamidronate and zoledronic acid, are estimated to have about 40% of their dose available to the bone after liver conjugation and renal elimination. The risk for osteonecrosis becomes much higher with the intravenous forms of these drugs, and in particular with zoledronic acid because of its particularly high potency. Orally administered drugs include alendronate, etidronate, ibandronate, risedronate, and tiludronate.

Bisphosphonates, in contrast to pyrophosphate, are not metabolized and are excreted unchanged in the urine. Plasma levels decrease by more than 95% within 6 hours, but the terminal half-life may exceed 10 years because they are slowly released from the skeleton, to which they bind.

Therapeutic uses

Bisphosphonates are used to treat diseases in which there is rapid bone turnover or excessive osteolytic activity.¹⁹ They are used to treat osteoporosis, Paget’s disease, and malignant bone disease. In the treatment of osteoporosis, alendronate and risedronate have been shown to decrease the incidence of fractures significantly and improve bone mineral density.^{9,21} These two drugs do not have the effect of decreasing bone formation that is seen with etidronate.

In cancer, particularly breast cancer, inhibition of osteolysis has proved to be effective therapy for decreasing metastases to the jaws and malignancy-associated hypercalcemia and for adjunctive therapy in delaying or preventing cancer-related skeletal pain. Therapy reduces the incidence of fractures and

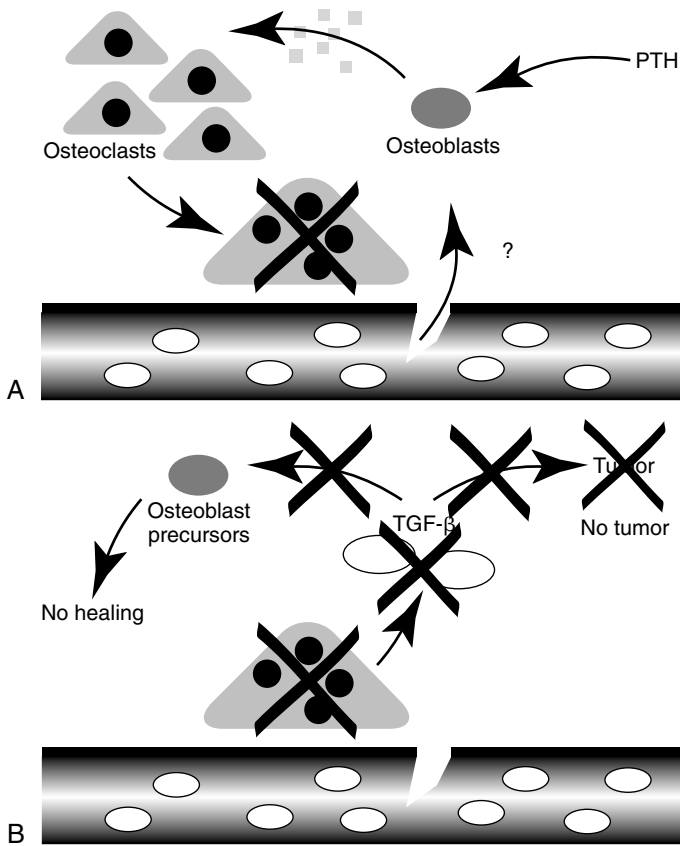

FIGURE 34-7 Effects of bisphosphonate drugs. Bisphosphonates are incorporated into the bony matrix by resembling pyrophosphate. Some bisphosphonates can stay bound and active for months to years. **A**, Bisphosphonates, through at least two different methods, act to disrupt the function of or induce apoptosis in osteoclasts (or both), rendering them partially or completely unable to break down the bone. *PTH*, parathyroid hormone. **B**, Without bony breakdown, transforming growth factor- β (*TGF- β*) is not released from the matrix, which not only limits tumor formation and hypercalcemia, but also reduces the ability of the bone to heal. This effect is presumed to be incomplete because not all osteoclasts are impeded. There is also an unanswered question of why this process seems to occur in the mandible to a greater degree than other bones of the body. (Adapted from Green JR: Bisphosphonates: preclinical review, *Oncologist* 9[Suppl 4]:3-13, 2004.)

may reduce the need for radiation therapy. In Paget's disease, bisphosphonates reduce the rapid bone turnover rate and slow disease progression.¹¹

Adverse effects

The most common adverse effects of bisphosphonates are gastrointestinal tract disturbances. Esophagitis can occur with oral preparations. To prevent esophagitis, oral preparations are given with liberal amounts of water and with the patient in an upright position. Proton pump inhibitors (see Chapter 33) can also be used. The use of an intravenous form of bisphosphonate such as zoledronic acid is another alternative. Bisphosphonates may cause musculoskeletal pain. Bisphosphonates have been shown to cause osteonecrosis, especially in the mandible and, to a much lesser extent, the maxilla. There is little evidence that these agents cause significant lesions elsewhere in the body. Although osteonecrosis occurs infrequently, it is most common in patients receiving intrave-

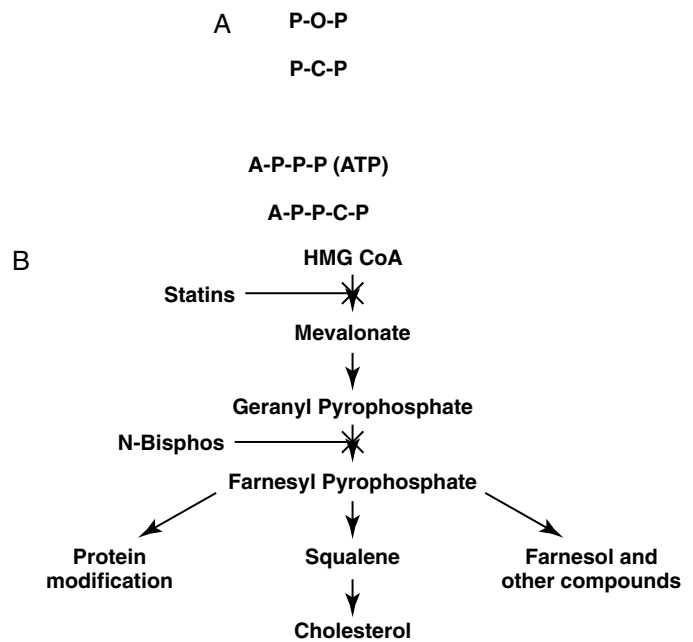

FIGURE 34-8 Pathways by which bisphosphonates seem to function. **A**, Bisphosphonates have a phosphate-carbon-phosphate structure that mimics the phosphate-oxygen-phosphate structure of pyrophosphate. In the non-nitrogen class of bisphosphonates (e.g., etidronate, clodronate, tiludronate), the osteoclastic inhibitory effect seems to result from integrating the bisphosphonate into adenosine 5'-triphosphate (*ATP*), yielding a derivative (*A-P-P-C-P*) incapable of intracellular energy transfer by disrupting mitochondrial *ATP*/adenosine 5'-diphosphate translocase. **B**, In the nitrogen-containing bisphosphonates (*N-Bisphos*) (e.g., alendronate, pamidronate, risedronate, zoledronic acid), the mechanism seems to be interruption of a crucial rate-limiting step in the formation of farnesyl. Ras protein requires farnesylation to be activated. Without Ras activation, cytochrome *c* is released from the mitochondria, which causes caspase-3 activation, an apoptotic signaler. Statin drugs also interrupt this pathway but not as effectively because of their limited systemic uptake. The caspase-mediated apoptotic effect seems to be stronger than the *ATP* analogue effect provided by the non-nitrogen class of bisphosphonates. (Adapted from Green JR: Bisphosphonates: preclinical review, *Oncologist* 9[Suppl 4]:3-13, 2004.)

nous bisphosphonate therapy. The risk of developing osteonecrosis in patients taking oral bisphosphonates is estimated to be about 1 per 100,000 person-years' exposure. For patients who are receiving intravenous bisphosphonate therapy for malignant neoplasms, it is recommended that the dentist avoid extractions unless critically necessary.

HYPOTHALAMIC, PITUITARY, THYROID, AND PARATHYROID DRUGS

<i>Nonproprietary (generic) name</i>	<i>Proprietary (trade) name</i>
Hypothalamic and pituitary drugs*	
Conivaptan	Vaprisol
Desmopressin	DDAVP, Stimate
Mecasermin (recombinant IGF-I)	Increlex
Octreotide	Sandostatin

Continued

HYPOTHALAMIC, PITUITARY, THYROID, AND PARATHYROID DRUGS—cont'd

<i>Nonproprietary (generic) name</i>	<i>Proprietary (trade) name</i>
Oxytocin	Pitocin, Syntocinon
Pegvisomant	Somavert
Sermorelin	Geref
Somatrem	Protropin
Somatropin	Genotropin, Humatrope, Nutropin, Nutropin AQ, Norditropin, Saizen, Serostim, Tev-Tropin
Vasopressin	Pitressin

Drugs used to inhibit prolactin release

Bromocriptine	Parlodel
Cabergoline	Dostinex

Thyroid hormone and TSH preparations

Levothyroxine	Levolet, Levo-T, Levothroid, Levoxyl, Novothyrox, Synthroid, Unithroid
Liothyronine	Cytomel, Triostat
Liotrix	Thyrolar
Thyroid desiccated	Armour Thyroid, Thyroid, Strong, Thyrar, S-P-T
Thyrotropin (recombinant human TSH)	Thyrogen

Antithyroid agents

Iodide (¹³¹ I) sodium	Iodotope, Sodium iodide ¹³¹ I Therapeutic
Methimazole	Tapazole
Potassium iodide	Lugol's solution, Pima, SSKI, iOSAT
Propylthiouracil	PTU

Drugs affecting Ca⁺⁺ metabolism*Bisphosphonates*

Alendronate	Fosamax
Etidronate	Didronel
Pamidronate	Aredia
Risedronate	Actonel
Tiludronate	Skelid
Ibandronate	Boniva
Zoledronic acid	Zometa

Ca⁺⁺ salts

Calcium acetate	Phos-Ex, PhosLo
Calcium carbonate	Cal-Sup, Os-Cal, Tums
Calcium chloride	—
Calcium citrate	Citracal
Calcium glubionate	Neo-Calglucon
Calcium gluceptate	—
Calcium gluconate	—
Calcium lactate	—
Tricalcium phosphate	Posture

Vitamin D analogues

Calcifediol	Calderol
Calcitriol	Calcijex, Rocaltrol
Cholecalciferol	Delta-D

<i>Nonproprietary (generic) name</i>	<i>Proprietary (trade) name</i>
--------------------------------------	---------------------------------

Dihydroxyachysterol	DHT, Hytakerol
Doxercalciferol	Hectorol
Ergocalciferol	Calciferol, Drisdol
Paricalcitol	Zemplar
<i>Other drugs</i>	
Calcitonin (salmon)	Calcimar, Miacalcin, Salmonine

*Gonadotropins are discussed in Chapter 37.

IGF-I, Insulin-like growth factor type I; *TSH*, thyroid-stimulating hormone.

CITED REFERENCES

- Bailes BK: Hypothyroidism in elderly patients. *AORN J* 69:1026-1030, 1999.
- Bonar BD, McColgan B, Smith DF, et al: Hypothyroidism and aging: the Rosses' survey. *Thyroid* 10:821-827, 2000.
- Bunevicius R, Kazanavicius G, Zalinkevicius R, et al: Effects of thyroxine as compared with thyroxine plus triiodothyronine in patients with hypothyroidism. *N Engl J Med* 340:424-429, 1999.
- Capet C, Jego A, Denis P, et al: Is cognitive change related to hypothyroidism reversible with replacement therapy? *Rev Med Intern* 21:672-678, 2000.
- Clayton PE, Cowell CT: Safety issues in children and adolescents during growth hormone therapy—a review. *Growth Horm IGF Res* 10:306-317, 2000.
- De Palo EF, Gatti R, Lancerin F, et al: Correlations of growth hormone (GH) and insulin-like growth factor I (IGF-I): effects of exercise and abuse by athletes. *Clin Chim Acta* 305:1-17, 2001.
- Gardiner EM, Baldock PA, Thomas GP, et al: Increased formation and decreased resorption of bone in mice with elevated vitamin D receptor in mature cells of the osteoblastic lineage. *FASEB J* 14:1908-1916, 2000.
- Gotzsche LB: L-Triiodothyronine acutely increases Ca²⁺ uptake in the isolated, perfused rat heart: changes in L-type Ca²⁺ channels and β-receptors during short- and long-term hyper- and hypothyroidism. *Eur J Endocrinol* 130:171-179, 1994.
- Harris ST, Watts NB, Genant HK, et al: Effects of risedronate treatment on vertebral and nonvertebral fractures in women with postmenopausal osteoporosis: a randomized controlled trial. Vertebral Efficacy with Risedronate Therapy (VERT) Study Group. *JAMA* 282:1344-1352, 1999.
- Kahaly GJ: Cardiovascular and atherogenic aspects of subclinical hypothyroidism. *Thyroid* 10:665-679, 2000.
- Lourwood DL: The pharmacology and therapeutic utility of bisphosphonates. *Pharmacotherapy* 18:779-789, 1998.
- Macdonald K, Macdonald TM: The peptide that binds: a systemic review of oxytocin and its presocial effects in human. *Harv Rev Psychiatry* 18(1):1-21, 2010.
- Morley P, Whitfield JE, Willick GE: Parathyroid hormone: an anabolic treatment for osteoporosis. *Curr Pharm Des* 7:671-687, 2001.
- Palumbo CF, Szabo RM, Olmsted SL: The effects of hypothyroidism and thyroid replacement on the development of carpal tunnel syndrome. *J Hand Surg [Am]* 25:734-739, 2000.
- Samuels MH: Subclinical thyroid disease in the elderly. *Thyroid* 8:803-813, 1998.
- Schauster AC, Geletko SM, Mikolich DJ: Diabetes mellitus associated with recombinant human growth hormone for HIV wasting syndrome. *Pharmacotherapy* 20:1129-1134, 2000.
- Seppet EK, Kaasik A, Minajeva A, et al: Mechanisms of thyroid hormone control over sensitivity and maximal contractile responsiveness to β-adrenergic agonists in atria. *Mol Cell Biochem* 184:419-426, 1998.
- Reszka AA, Rodan GA: Nitrogen-containing bisphosphonate mechanism of action. *Mini Rev Med Chem* 4:711-719, 2004.
- Theriault RL, Hortobagyi GN: The evolving role of bisphosphonates. *Semin Oncol* 28:284-290, 2001.

20. van Leeuwen JP, van den Bemd GJ, van Driel M, et al: 24,25-Dihydroxyvitamin D₃ and bone metabolism. *Steroids* 66:375-380, 2001.
21. Watts NB: Treatment of osteoporosis with bisphosphonates. *Rheum Dis Clin North Am* 27:197-214, 2001.

GENERAL REFERENCES

- Bikle DD: What is new in vitamin D: 2006-2007, *Curr Opin Rheumatol* 19:383-388, 2007.
- Bilezikian JP, Meng X, Shi Y, et al: Primary hyperparathyroidism in women: a tale of two cities—New York and Beijing, *Int J Fertil Womens Med* 45:158-165, 2000.
- Bindels AJ, Westendorp RG, Frolich, M, et al: The prevalence of subclinical hypothyroidism at different total plasma cholesterol levels in middle aged men and women: a need for case-finding? *Clin Endocrinol* 50:217-220, 1999.
- Bjoro T, Holmen J, Kruger O, et al: Prevalence of thyroid disease, thyroid dysfunction and thyroid peroxidase antibodies in a large, unselected population. The Health Study of Nord-Trondelag, *Eur J Endocrinol* 143:639-647, 2000.
- Brownlie BE, Rae AM, Walshe JW, et al: Psychoses associated with thyrotoxicosis—"thyrotoxic psychosis." A report of 18 cases, with statistical analysis of incidence, *Eur J Endocrinol* 142:438-444, 2000.
- Carter-Su C, King AP, Argetsinger LS, et al: Signaling pathway of GH, *Endocr J* 43(Suppl):S65-S70, 1996.
- Christakos S, Dhawan P, Shen Q, et al: New insights into the mechanisms involved in the pleiotropic actions of 1,25 dihydroxy vitamin D₃, *Ann N Y Acad Sci* 1068:194-203, 2006.
- Cohen MM: Merging the old skeletal biology with the new, II: molecular aspects of bone formation and bone growth, *J Craniofac Genet Dev Biol* 20:94-106, 2000.
- Duggal J, Singh S, Barsano CP, et al: Cardiovascular risk with sub-clinical hyperthyroidism and hypothyroidism: pathophysiology and management, *J Cardiometab Syndr* 2:198-206, 2007.
- Franklyn JA: Thyroid disease and its treatment: short- and long-term consequences, *J R Coll Physicians Lond* 33:564-567, 1999.
- Hellgren G, Albertsson-Wikland K, Billig H, et al: Growth hormone receptor interaction with Jak proteins differs between tissues, *J Interferon Cytokine Res* 21:75-83, 2001.
- Hunter I, Greene SA, MacDonald TM, et al: Prevalence and aetiology of hypothyroidism in the young, *Arch Dis Child* 83:207-210, 2000.
- Kroll MH: Parathyroid hormone temporal effects on bone formation and resorption, *Bull Math Biol* 62:163-188, 2000.
- Lal SO, Wolf SE, Herndon DN: Growth hormone, burns and tissue healing, *Growth Horm IGF Res* 10(Suppl B):S39-S43, 2000.
- Marx RE, Sawatari Y, Fortin M, et al: Bisphosphonate-induced exposed bone (osteonecrosis/osteopetrosis) of the jaws: risk factors, recognition, prevention and treatment, *J Oral Maxillofac Surg* 63:1567-1575, 2005.
- McCarthy TL, Ji C, Centrella M: Links among growth factors, hormones, and nuclear factors with essential roles in bone formation, *Crit Rev Oral Biol Med* 11:409-422, 2000.
- Murray RD, Shalet SM: Growth hormone: current and future therapeutic applications, *Expert Opin Pharmacother* 1:975-990, 2000.
- Rack SK, Makela EH: Hypothyroidism and depression: a therapeutic challenge, *Ann Pharmacother* 34:1142-1145, 2000.
- Rosen CJ: Growth hormone and aging, *Endocrine* 12:197-201, 2000.
- Skripitz R, Andreassen TT, Aspenberg P: Strong effect of PTH (1-34) on regenerating bone: a time sequence study in rats, *Acta Orthop Scand* 71:619-624, 2000.
- Vallejo-Bolanos E, Espana-Lopez AJ, Munoz-Hoys A, et al: The relationship between bone age, chronological age and dental age in children with isolated growth hormone deficiency, *Int J Paediatr Dent* 9:201-206, 1999.
- Weigel RJ: Nonoperative management of hyperparathyroidism: present and future, *Curr Opin Oncol* 13:33-38, 2001.
- Wimalawansa SJ: Prevention and treatment of osteoporosis: efficacy of combination of hormone replacement therapy with other anti-resorptive agents, *J Clin Densitom* 3:187-201, 2000.
- Yonemura K, Suzuki H, Fujigaki Y, et al: New insights on the pathogenesis of hypercalcemia in primary hyperparathyroidism, *Am J Med Sci* 320:334-336, 2000.

Adrenal Corticosteroids

CLARENCE L. TRUMMEL

The adrenal gland is the source of a diverse group of hormones essential to metabolic control, regulation of water and electrolyte balance, and modulation of the body's response to stress. The medullary portion of the gland secretes epinephrine and norepinephrine on sympathetic stimulation. These hormones and their physiologic effects and pharmacologic actions have been previously discussed (see Chapters 5 and 6). The adrenal cortex produces numerous substances derived from cholesterol and collectively known as *corticosteroids*. Certain corticosteroids and their synthetic analogues are used in medicine for replacement in adrenal insufficiency. They are used even more widely for an array of nonadrenal diseases, primarily for their notable ability to suppress the acute or chronic inflammation that accompanies injury and many diseases. When corticosteroids are administered in hyperphysiologic doses over long periods, as they often are in chronic inflammatory disorders, severe and even lethal toxicity can result. To understand the therapeutic applications and limitations of this group of drugs properly, the physiologic role of corticosteroids must be reviewed.

GENERAL PHYSIOLOGIC AND PHARMACOLOGIC ACTIONS

Using cholesterol as a substrate, the adrenal cortex synthesizes and secretes two types of steroid hormones—the 19-carbon androgens and the 21-carbon corticosteroids (Figure 35-1). The latter group can be considered derivatives of pregnane (Figure 35-2). The corticosteroids can be classified further on the basis of their major actions. Some of these compounds, such as **hydrocortisone** (the nonproprietary name for the natural hormone cortisol), **have greater effects** on carbohydrate metabolism, as measured by liver glycogen deposition, and are termed **glucocorticoids**. They also possess potent anti-inflammatory actions and are used therapeutically for this purpose. Other compounds, represented by aldosterone, are most active in enhancing Na^+ retention and are referred to as **mineralocorticoids**. These corticosteroids do not have anti-inflammatory effects (Table 35-1). The structures of hydrocortisone and aldosterone are shown in Figure 35-2.

Production of corticosteroids and androgen is highly compartmentalized in the adrenal cortex (Figure 35-3). The mineralocorticoid aldosterone is produced by the outer layer cells (*zona glomerulosa*), cortisol and other glucocorticoids are produced by the middle layer (*zona fasciculata*), and the androgens are produced by the inner layer (*zona reticularis*) adjacent to the medulla. The corticosteroids are not stored to any extent in the adrenal gland but are continuously synthesized and secreted. The total daily production of the major gluco-

corticoid, cortisol, is normally 20 to 25 mg. There is a strong diurnal variation in this process; plasma concentrations of cortisol are severalfold higher at 8 A.M. than at 4 P.M.

Production of all corticosteroids except aldosterone is directly regulated by the blood concentration of adrenocorticotrophic hormone (ACTH) secreted by the anterior pituitary (adenohypophysis). Circulating corticosteroids act on the hypothalamus and adenohypophysis to suppress the release of ACTH, completing the control loop linking the pituitary and the adrenal cortex (Figure 35-4). By this negative feedback mechanism, the administration of large doses of corticosteroids can prevent the tropic influence of ACTH on the adrenal cortex, completely suppressing the adrenal production of corticosteroids. Aldosterone secretion is controlled primarily by a direct effect of angiotensin II on the adrenal cortex. Hyponatremia and hyperkalemia also favor the release of aldosterone. ACTH has only a minor stimulatory effect on the release of aldosterone.

Corticosteroids play diverse and complex roles in the body economy of mammalian organisms. They are involved in carbohydrate, protein, lipid, and purine metabolism; electrolyte and water balance; the functions of the cardiovascular, nervous, and immune-inflammatory systems; and the functions of the kidneys, skeletal muscle, bone, and most other organs and tissues. The hormones of the adrenal cortex play a major role in the ability of animals to withstand stressful events. Without the adrenal cortex, life is possible only when food and large amounts of salt and water are regularly ingested, a constant ambient temperature prevails, and infection and other perturbing events are absent.

Most of the diverse actions of corticosteroids seem to be achieved by regulating gene expression. As described in Chapter 32, **glucocorticoids enter target cells and bind to cytosolic receptors**. These receptors exist in a complex with several proteins, including heat shock protein and an immunophilin. Binding by the hormone or a synthetic analogue alters the conformation of the receptor, freeing it from the associated proteins. **The hormone-receptor complex migrates to the nucleus and binds to the glucocorticoid-responsive elements on DNA of affected genes**. The DNA-binding domain on the receptor is distinct from the drug-binding domain. Gene expression is regulated either negatively or positively to render the characteristic and complex glucocorticoid signature for modification of protein synthesis.¹⁴ The mechanism of action of mineralocorticoids has been less well studied, but it seems to be similarly based on regulation of transcription in renal and other target cells.

Consistent with the mechanism described, the major effects of corticosteroids are not manifested for several hours. Other, less apparent effects are more immediate, however.

Rights were not granted to include this figure in electronic media.
Please refer to the printed publication.

FIGURE 35-1 Major steps in the synthesis of adrenocortical steroid hormones. All three groups have cholesterol as a common precursor. Cholesterol is derived from several sources, including circulating cholesterol and cholesteryl esters, endogenous stores of cholesteryl esters, and de novo synthesis by the gland. Some of the intermediate steps are not shown. (For a detailed review of corticosteroid synthesis, see Schimmer BP, Parker, KL: Adrenocorticotropic hormone; adrenocortical steroids and their synthetic analogs; inhibitors of the synthesis and actions of adrenocortical hormones. In Brunton LL, Lazo JS, Parker KL, editors: *Goodman & Gilman's the pharmacological basis of therapeutics*, ed 11, New York, 2006, McGraw-Hill.)

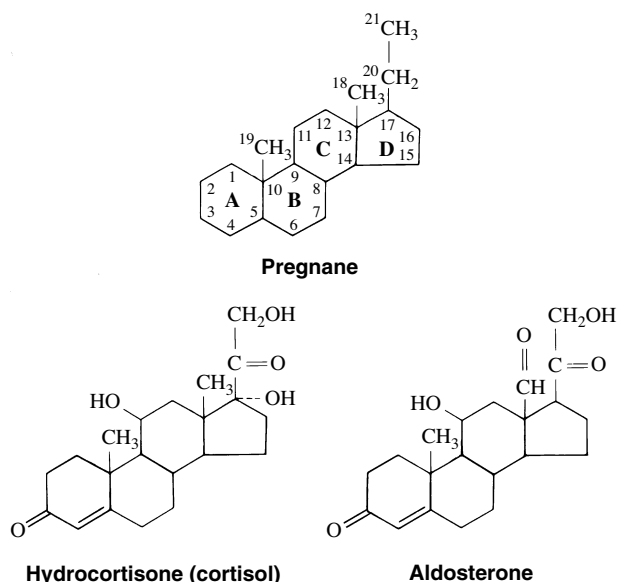

FIGURE 35-2 Structural formulas of pregnane, the basic corticosteroid nucleus, and hydrocortisone (cortisol) and aldosterone, the prototypic glucocorticoid (hydrocortisone) and mineralocorticoid (aldosterone).

These likely occur through other receptor mechanisms involving the plasma membrane of target cells.⁷

The pharmacologic effects of glucocorticoids are largely exaggerations of the physiologic functions of the endogenous corticosteroids. These effects simulate the pathologic features of Cushing's syndrome, a metabolic disorder resulting from an excess of corticosteroids, primarily cortisol. A review of these features and their pathophysiologic basis is helpful in understanding the pharmacologic and toxic actions of glucocorticoids.¹⁵

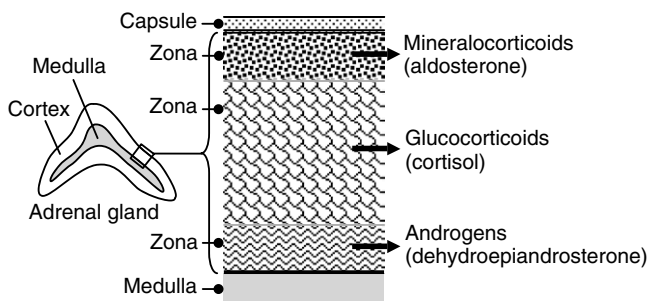

FIGURE 35-3 Schematic representation of the adrenal cortex and its major hormones. The cortex consists of three histologically and functionally distinct cellular compartments: *zona glomerulosa*, *zona fasciculata*, and *zona reticularis*. Biosynthesis of the mineralocorticoids (primarily aldosterone), glucocorticoids (primarily cortisol), and androgens occurs in these compartments.

TABLE 35-1

**Potencies of Commonly Used Corticosteroids
(Relative to Hydrocortisone)**

	LIVER GLYCOGEN DEPOSITION*	Na ⁺ RETENTION
11-Desoxycorticosterone	0	100
Aldosterone	0.1	3000
Cortisone	0.8	0.8
Hydrocortisone	1	1
Prednisolone	4	0.8
Triamcinolone	5	0
Fludrocortisone	10	3000
Dexamethasone	25	0
Betamethasone	25	0

*Generally paralleled by anti-inflammatory activity.

Carbohydrate and Protein Metabolism

Through several actions, glucocorticoids exert prominent anti-insulin effects. Glucocorticoids decrease the peripheral use of glucose by decreasing the cellular uptake of glucose. In the liver, glucocorticoids specifically stimulate glucose synthesis from amino acids (gluconeogenesis)⁸; concurrently, they mobilize amino acids by inhibiting protein synthesis in muscle, connective tissues, and skin (antianabolic effect). These actions are reflected in the parallel increases in blood glucose, liver glycogen, and urinary nitrogen excretion seen after the administration of glucocorticoids. As a consequence of these actions, prolonged high titers of glucocorticoids cause clinical manifestations of protein wasting: retardation of linear growth in children, wasting of the skin and increased capillary fragility resulting in ecchymoses, loss of muscle tissue leading to weakness (which may be extreme), and osteoporosis associated with enhanced bone resorption.

Lipid Metabolism

The effects of glucocorticoids on lipid metabolism antagonize the actions of insulin further. Glucocorticoids inhibit fatty acid synthesis and exert a permissive action on fatty acid mobilization from adipose tissue by lipolytic hormones. Long-term administration of large doses of glucocorticoids causes redistribution of fat from peripheral stores to more central locations on the back, shoulders, abdomen, and face; the result is termed *centripetal obesity*. Cutaneous striae form on

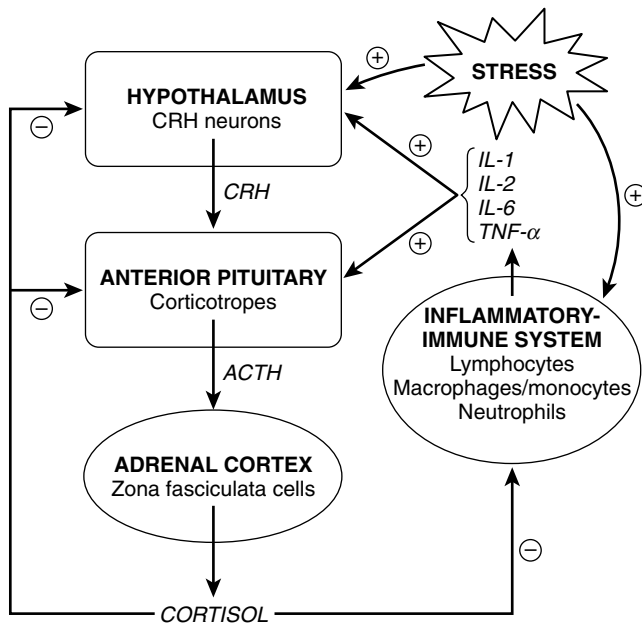

FIGURE 35-4 Hypothalamic-pituitary-adrenal axis and its relationship to stress and the inflammatory-immune system. Cortisol exerts a negative feedback control on the secretion of corticotropin-releasing hormone (CRH) and adrenocorticotropic hormone (ACTH). Physiologic or psychological stress increases cortisol secretion directly through neural mechanisms or by activation of the inflammatory-immune system and production of cytokines, including interleukin-1 (IL-1), interleukin-2 (IL-2), interleukin-6 (IL-6), and tumor necrosis factor- α (TNF- α).

areas of the trunk where the skin is stretched by the accumulation of fat.

Electrolyte and Water Balance

Excesses or deficiencies of corticosteroid hormones are associated with severe disturbances in electrolyte and fluid balance. These disturbances result from the following actions of corticosteroids on the kidney: stimulation of reabsorption of Na^+ from the tubular fluid and increased urinary excretion of K^+ and H^+ ions. Excessive concentrations of corticosteroids lead to Na^+ retention, hypokalemia, alkalosis, and expanded extracellular fluid volume. These changes are manifested clinically by edema and hypertension; they may lead to left ventricular hypertrophy and predispose the patient to congestive heart failure and stroke. In corticosteroid deficiency (Addison's disease), essentially the opposite occurs (loss of Na^+ , hyperkalemia, reduced extracellular fluid volume, and generalized cellular hydration) and, if severe, may lead quickly to death.

Anti-inflammatory Properties

Glucocorticoids are potent inhibitors of the inflammatory response. This anti-inflammatory activity is independent of the initiating stimulus and occurs at multiple points throughout the process (see Figure 35-4). The actions of glucocorticoids are due to many effects resulting from glucocorticoids binding to glucocorticoid receptors. The activated receptors bind to glucocorticoid response elements in the DNA, resulting in gene expression. In addition, activated glucocorticoid receptors can bind directly to transcription factors resulting in inhibition of inflammatory gene expression. Several resulting actions are especially prominent.

Glucocorticoids, by their action on gene expression, induce the production of numerous proteins with anti-inflammatory

action, including annexin-1 (formerly lipocortin-1). Annexin-1 is a multifunctional protein that inhibits phospholipase A_2 as one of its actions. The resulting decrease in the production of arachidonic acid leads to a reduction in the synthesis of prostaglandins and leukotrienes, important mediators of inflammation. (See Chapter 21 on nonsteroidal anti-inflammatory drugs [NSAIDs].) This effect is particularly important in macrophages, monocytes, endothelial cells, and fibroblasts. Glucocorticoids also suppress the synthesis of cyclooxygenase. The net result of these two actions is an inhibition of neutrophil, eosinophil, and monocyte chemotaxis (from inhibition of leukotriene B_4 synthesis), inhibition of capillary permeability and bronchoconstriction (from decreased leukotrienes C_4 and D_4 and the prostaglandin $\text{PGF}_{2\alpha}$), and inhibition of the vascular and inflammatory responses to the prostaglandins PGI_2 and PGE_2 .

In addition, glucocorticoids inhibit the production of eosinophils, basophils, monocytes, and lymphocytes; the synthesis of various cytokines (interleukins and tumor necrosis factor- α) in macrophages, lymphocytes, monocytes, and endothelial cells; and the release of histamine. Glucocorticoids inhibit the synthesis of adhesion molecules in endothelial cells; this impairs the attachment of inflammatory cells and hinders their recruitment to sites of inflammation.

Immune Responses

Glucocorticoids are widely used to suppress undesirable immune reactions such as graft rejection. The mechanism for this effect is complex but involves glucocorticoid inhibition of T-lymphocyte activation and proliferation. Production of plasma cells is also inhibited. These effects on T and B lymphocytes seem to be largely caused by the reduced production of cytokines, as described previously. Glucocorticoids impair the ability of inflammatory cells to migrate into sites of immunologic or inflammatory reactions. Phagocytosis and subsequent digestion (processing) of antigen by macrophages, events necessary for the development of some immune responses, are inhibited. Finally, glucocorticoids suppress antibody production.

ABSORPTION, FATE, AND EXCRETION

All the natural and synthetic corticosteroids except desoxycorticosterone are well absorbed from the gastrointestinal tract. Significant amounts of these drugs may also be absorbed from sites of local application, such as the skin, mucous membranes, and eye. In normal circumstances, more than 90% of circulating corticosteroids are bound to plasma proteins, principally an α -globulin (corticosteroid-binding globulin, also known as transcortin), which has a high affinity but low capacity for these compounds, and albumin, which has the opposite characteristics.

Hydrocortisone is rapidly degraded in the liver by reduction, conjugated with glucuronic acid, and excreted in the urine. Most other corticosteroids are similarly metabolized, although at different rates. The plasma half-life of hydrocortisone is approximately 1.5 hours. Synthetic analogues of hydrocortisone generally have longer half-lives; the potent long-acting compound dexamethasone has a plasma half-life of approximately 4 hours and a tissue half-life of approximately 2 days. Because the corticosteroids act by modifying gene expression, the time course of effect bears little correspondence to the plasma concentration.

The major metabolic products of corticosteroid metabolism found in the urine, 17-hydroxycorticosteroids and 17-ketosteroids, were formerly measured by clinical laboratories to assess adrenal-pituitary function. This method has been

largely supplanted by direct measurement of plasma cortisol concentrations by radioimmunoassay.

GENERAL THERAPEUTIC USES

Glucocorticoids are used clinically in two ways. The first and most intuitive is replacement therapy. Insufficient production of corticosteroids can result from a defect in the adrenal cortex, anterior pituitary, or hypothalamus; these defects may be congenital or acquired. Depending on the degree of insufficiency, the outcome may be either acute or chronic. Acute adrenal insufficiency (adrenal crisis) is a life-threatening emergency characterized by extreme weakness, gastrointestinal symptoms, dehydration, and hypotension. It frequently follows abrupt cessation of long-term high-dose therapy with glucocorticoids and stems from a drug-induced suppression of adrenal-pituitary function (which may require 2 years for full recovery). The features of chronic adrenal insufficiency (Addison's disease) are similar to, but milder than, features of acute adrenal insufficiency. Treatment of adrenal insufficiency, regardless of the cause, requires replacement with appropriate corticosteroids.

In addition to replacement therapy, glucocorticoids are used on a purely empiric basis in many conditions (Box 35-1). These conditions, although varied, are generally characterized by chronic inflammatory and immune phenomena and are associated with tissue destruction and functional impairment. For this reason it is widely assumed that the salutary effects of glucocorticoid therapy in these diseases are related to suppression of inflammation and immune reactions. In none of these conditions do the corticosteroids have specific actions on the basic disease process, despite their ability in some cases to produce dramatic improvement and remission of signs and symptoms. The destructive aspects of the primary disease may continue unchecked; in rheumatoid arthritis, glucocorticoids can effectively relieve the distressing inflammation and pain, but deterioration of affected joints progresses.¹⁰ The use of corticosteroids in other than replacement therapy must be considered palliative.

Because of their lack of specificity and their considerable potential for causing harm, the long-term use of corticosteroids to treat inflammatory disorders should be viewed with caution. Before corticosteroids are considered, less toxic agents and nonpharmaceutical measures should be used to the maximum extent possible. This approach is well illustrated in rheumatoid arthritis. Systemic corticosteroids should seldom be necessary in this disease and should not be used as the initial agent. Most patients improve considerably with NSAID therapy in large, regular doses combined with application of heat and appropriate physical therapy. This program may be supplemented by other drugs, such as methotrexate. Patients in whom these drugs are ineffective or intolerable are candidates for corticosteroid therapy, but corticosteroids should be used in the smallest possible dosage for the shortest time as adjuncts to other measures.

The use of glucocorticoids in the treatment of asthma involves several strategies to minimize systemic toxicity. Depending on the severity of an acute asthmatic attack, intravenous or oral administration can be used, with doses tapering off as the condition subsides.⁴ Inhaled steroids are preferred for long-term therapy because they minimize systemic uptake.²

When corticosteroids are used on a long-term basis, they are often administered on alternate days to minimize suppression of the pituitary-adrenal axis. Giving a glucocorticoid every other day between 6 and 9 A.M. mimics the normal diurnal pattern of corticosteroid secretion. Such a regimen seems to lessen suppression of the adrenal cortex and permits increased endogenous corticosteroid production in response

BOX 35-1

Conditions Treated with Corticosteroids

- Adrenal insufficiency (acute or chronic, primary or caused by anterior pituitary insufficiency)
- Cerebral edema and increased intracranial pressure (brain tumors, meningitis, trauma, cerebrovascular accidents)
- Collagen vascular diseases
 - Lupus erythematosus
 - Polymyositis
 - Polyarteritis nodosa
 - Chronic granulomatous disorders (sarcoidosis and others)
 - Temporal (giant cell) arteritis
 - Mixed connective tissue disease syndrome*
- Dermatologic conditions
 - Psoriasis
 - Dermatitis (atopic, allergic, irritant)
 - Pemphigus
 - Lichen planus
- Gastrointestinal diseases
 - Ulcerative colitis
 - Crohn's disease
 - Celiac disease
- Hematologic diseases
 - Malignancies (acute and chronic lymphocytic leukemia, lymphoma, multiple myeloma)
 - Hemolytic anemia (autoimmune or drug-induced)
 - Idiopathic thrombocytopenic purpura
- Hepatic diseases
 - Chronic active hepatitis
 - Alcoholic hepatitis (severe forms with hepatic encephalopathy)
 - Hypercalcemia (sarcoid, malignancies, vitamin D intoxication)
- Multiple sclerosis (acute episodes)
- Nephrotic syndrome
- Ocular diseases with inflammatory or allergic components
- Pulmonary disorders
 - Asthma
 - Chronic bronchitis (acute episodes)
 - Aspiration pneumonia
- Rheumatic diseases and joint ailments
 - Rheumatic arthritis
 - Rheumatic carditis
 - Osteoarthritis (intra-articular administration)
 - Bursitis (intracapsular administration)
- Shock
- Solid tumors (breast)
- Tissue grafts and organ transplants

*Must be differentiated from scleroderma, which is usually not altered by corticosteroids.

to stress. Alternate-day therapy may not adequately control symptoms in some cases, especially in patients with rheumatoid arthritis and ulcerative colitis. Glucocorticoid therapy for 1 week usually does not cause significant suppression of pituitary or adrenal function.

THERAPEUTIC USES IN DENTISTRY

Glucocorticoids have limited applications in dentistry. As in medicine, they are used largely to reduce the signs and symptoms of unwanted inflammatory reactions. These potential uses fall into the following general categories: oral

ulcerations, pulpal hypersensitivity, temporomandibular joint pain, postoperative sequelae, and anaphylaxis and other allergic reactions.

Oral Ulcerations

A wide variety of ulcerative lesions of the oral mucosa are frequently treated by the topical application of glucocorticoids. Relief of symptoms and abbreviation of the clinical course are usually obtained, regardless of the cause of the ulceration. Applicable conditions are denture-induced and other traumatic ulcers, recurrent ulcerative (aphthous) stomatitis, erosive lichen planus, erythema multiforme, pemphigus, desquamative gingivitis and stomatitis, geographic tongue, and angular stomatitis (cheilitis).^{12,13} Despite their usual salutary effects on signs and symptoms, glucocorticoids do not alter the underlying pathogenesis of chronic ulcerative lesions of the oral mucosa. Although severe disorders with dermatologic and mucosal manifestations, such as pemphigus, are usually treated with systemic glucocorticoids, further improvement of associated oral ulceration may be obtained by topical application of glucocorticoids. Despite the fact that herpetic ulcers may respond favorably, the use of glucocorticoids to treat this condition is contraindicated because suppression of the host response may allow dissemination of the herpesvirus. It is important for the clinician to make a careful diagnosis of oral ulcers before instituting glucocorticoid therapy.

The benefit of glucocorticoids applied topically is greatest when the period of contact with the tissue is maximal. Retention at the site of application is difficult in the oral cavity. A partial solution is to apply the drug in a paste that adheres to the mucosa and resists dissolution and displacement. One such vehicle is carboxymethylcellulose in a base of polyethylene resin and mineral oil (Orabase); it is available with or without a glucocorticoid. Symptomatic relief of many oral ulcers, particularly ulcers likely to be limited in duration, may be obtained with the adhesive paste alone.

Pulpal Hypersensitivity

Hypersensitivity of the dental pulp can result from various conditions that induce an inflammatory response in the pulp, including operative trauma, invasion of the pulp by bacteria or their products, and exposure of dentin to the oral environment. Glucocorticoids have been variously applied directly or indirectly to the pulp to reduce pain. Although success has been claimed, the value of this therapy in the management of pulpal inflammation has not been established, and it cannot be recommended.

Temporomandibular Joint Disorders

Pain originating in the temporomandibular joint may have many possible causes, including trauma, bruxism, anatomic anomalies, rheumatoid arthritis, and psychophysiologic disorders. Treatment of such conditions should be conservative and based on careful diagnosis. NSAIDs, anti-anxiety muscle relaxant drugs, carbamazepine, and tricyclic antidepressants have proved useful for short-term pharmacotherapy. Nondrug approaches include rest, heat, gentle stretching, bite-plane appliances, and occlusal adjustments. In refractory cases of temporomandibular joint pain or when acute pain is initially so severe that it precludes a course of conservative therapy, intra-articular injection of a glucocorticoid such as prednisolone or dexamethasone may be beneficial. Relief of symptoms may be full or partial, permanent or temporary (especially if the underlying cause of the disorder is not corrected). Although deterioration of the articular surfaces of the joint has been claimed to result from intra-articular injection of corticosteroid, the weight of available evidence does not support such an association. Nevertheless, the best responses

to intra-articular injection seem to occur in patients free of radiographic changes in the joint.

Postoperative Sequelae

Glucocorticoids are often used to lessen postoperative complications, mainly reduction of edema and trismus, after dental surgical procedures.⁵ Although the risk of adverse effects from a short, intensive perioperative course of glucocorticoids is slight, it is uncertain whether the modest benefits typically obtained justify such "prophylactic" use. What is certain, however, is that careful surgical technique is of primary importance in the reduction of uncomfortable postoperative sequelae.

Anaphylaxis and Other Allergic Reactions

The immunosuppressant and anti-inflammatory effects of glucocorticoids may be used to treat the manifestations of various allergic reactions, such as urticaria, contact dermatitis, angio-neurotic edema, allergic rhinitis and conjunctivitis, insect bites, drug reactions, and serum sickness. Because histamine is an important mediator in most of these conditions, H₁ antihistamines are major drugs in the treatment of milder reactions involving histamine release (e.g., urticaria). Systemic glucocorticoids are useful in more severe responses. In anaphylaxis, although epinephrine is the drug of choice, large doses of glucocorticoids may be beneficial in reducing bronchospasm and laryngeal edema. In this situation, glucocorticoids also act to increase the cardiac and vascular effects of catecholamines. In addition, because the maximal effects of glucocorticoids are delayed for several hours after administration, the prolonged duration of action of glucocorticoids can afford added benefit. The glucocorticoids are not the primary drugs in treating the life-threatening cardiovascular failure of anaphylaxis; they add a supplemental benefit after the administration of epinephrine.

ADVERSE EFFECTS

Although glucocorticoids are valuable agents in some situations, they have considerable potential to cause greater harm than good. Actualization of this potential depends on, among other factors, the intensity and duration of therapy. A single large dose or a short course of moderate doses of hydrocortisone causes few adverse effects. If more than 20 to 30 mg of hydrocortisone (or its equivalent) is given daily for more than a week, however, some manifestations of glucocorticoid toxicity are likely to appear. In general, these manifestations are predictable from a knowledge of the pathologic features of endogenous Cushing's disease.

Major adverse effects of glucocorticoid therapy are listed in Box 35-2 and are summarized in the following paragraphs. The frequency and severity of adverse effects correlate with the dose and duration of therapy, the age and condition of the patient, and the disease being treated.

Hyperglycemia and Glycosuria

A diabetic-like state stems from the anti-insulin action of glucocorticoids. It is usually mild and controllable with diet, insulin, or both. In diabetics, the requirement for insulin or oral hypoglycemic agents is increased.

Myopathy

Large doses of glucocorticoids, especially the more potent fluorinated synthetic compounds, cause muscle wasting, manifested chiefly as weakness of the musculature of the limbs. Significant reduction of muscle mass in the extremities can occur. Recovery may be incomplete after cessation of therapy.

BOX 35-2**Major Adverse Effects of Glucocorticoid Therapy**

Neurologic	Insomnia, agitation, mania, withdrawal syndrome
Infectious	Increased infections, opportunistic infections
Vascular	Hypertension, increased atherosclerotic disease risk
Skin and mucosa	Atrophy
Skeletal	Reduced Ca ⁺⁺ absorption, osteoporosis, avascular osteonecrosis, impaired growth
Muscular	Myopathy, wasting
Metabolic	Glucose intolerance, obesity, hyperlipidemia
Reproductive	Hypogonadism
Gastrointestinal	Peptic ulcer
Ocular	Cataracts

Osteoporosis and Osteonecrosis

Osteoporosis is a common sequela of long-term glucocorticoid therapy and can lead to compression fractures of the vertebrae and to an increased susceptibility to traumatic fractures.¹ In postmenopausal women and other individuals prone to develop osteoporosis, this complication may be especially serious. Several mechanisms are responsible. Glucocorticoids reduce Ca⁺⁺ absorption from the intestine and increase renal excretion of Ca⁺⁺. Resorption of bone occurs through an increase in parathyroid hormone release and a direct inhibitory effect of glucocorticoids on osteoblasts. Aseptic osteonecrosis may involve the large joints, especially the head of the femur. The condition is often progressive, necessitating joint replacement. Studies indicate that concurrent treatment with bisphosphonates such as alendronate can reduce bone wasting in patients on long-term glucocorticoid therapy.¹¹

Suppression of Growth

In children and adolescents, glucocorticoids can inhibit skeletal growth and maturation.

Negative Nitrogen Balance

A net nitrogen loss results from the imbalance between protein synthesis and degradation. It reflects the antianabolic effects of glucocorticoids in cutaneous and musculoskeletal tissues.

Peptic Ulcer

There is an increased incidence of gastric ulcers in patients treated with glucocorticoids, especially patients with rheumatoid arthritis. Because such patients are often concurrently taking aspirin or other NSAIDs, it is difficult to implicate glucocorticoids only in the pathogenesis of these ulcers.⁹ Nonetheless, when they occur, ulcers associated with glucocorticoid therapy have a high incidence of complications, such as hemorrhage and perforation. The mechanism is likely related to the decreased synthesis of PGI₂ and PGE₂, which provide protection for the gastric mucosa.

Ocular Effects

Increased intraocular pressure, which may produce irreversible damage, and posterior subcapsular cataracts can result from either topical or systemic administration of glucocorticoids. Children and patients with diabetes are particularly susceptible to untoward ocular effects.

Central Nervous System Effects

Psychological disturbances can occur during glucocorticoid therapy. These reactions are reversible and range in severity from mild (euphoria, insomnia, or nervousness) to pronounced (manic-depressive or schizophrenic psychosis).

Edema and Hypokalemia

Although water retention with hypokalemia is a potentially serious complication of glucocorticoid therapy, the incidence and severity can be greatly minimized by dietary Na⁺ restriction and by the use of a synthetic glucocorticoid essentially devoid of mineralocorticoid activity.

Altered Distribution of Body Fat

Long-term treatment with glucocorticoids often causes changes in the distribution of body fat deposits, leading to the classic cushingoid appearance. The most characteristic of these changes are a round ("moon") face, accumulation of fat in the back of the neck ("buffalo hump") and supraclavicular region, and increased abdominal fat. The obese trunk may markedly contrast with the thin, wasted extremities. The enhanced lipolysis seen with glucocorticoids leads to these changes; however, the reason for the redistribution is unknown.

Increased Susceptibility to Infection

Because of the effect on inflammation and the immune system, the body's reaction to infectious agents is depressed by glucocorticoids. Fungal, bacterial, and viral pathogens that would otherwise cause localized or no infection may become widely disseminated with serious or fatal consequences. Latent tuberculosis may be reactivated after the initiation of glucocorticoid therapy.

Suppression of Pituitary-Adrenal Function

Prolonged administration of glucocorticoids (greater than physiologic amounts for >1 week) results in suppression of ACTH and, consequently, suppression of adrenal corticosteroid production; the degree of suppression is dose-related. Abrupt withdrawal or significant reduction of glucocorticoid dosage can precipitate acute adrenal insufficiency. Acute exacerbation of the disease being treated may occur during withdrawal. Cessation or reduction of glucocorticoid therapy must be done slowly and with great caution to permit the recovery of normal pituitary and adrenal function.

Various physiologic stressors, such as acute illness, trauma, pain, anxiety, infection, blood loss, surgery, and general anesthesia, elicit a rapid increase in circulating concentrations of hydrocortisone and other glucocorticoids. This increase is crucial to the success of the body's response to these stresses. In subjects with adrenal suppression resulting from disease or induced by long-term glucocorticoid therapy, any needed surge of glucocorticoid output is impaired. This impairment can quickly lead to a condition known as *acute adrenal insufficiency*, or *adrenal crisis*. The risk of this condition is a function of the degree of adrenal suppression and the demand for increased glucocorticoid production. The onset of adrenal crisis is often signaled by any or all of the following: severe nausea, vomiting, and diarrhea, leading to dehydration; chills and fever; sudden penetrating pain in the lower back, abdomen, and legs; profound muscle weakness; extreme lethargy; hypoglycemia; hypotension and tachycardia; and tachypnea. These symptoms may be followed by confusion, psychotic manifestations, loss of consciousness, convulsions, cardiovascular and respiratory collapse, and death. Adrenal crisis is a medical emergency, and appropriate and timely intervention is essential. Treatment consists of intravenous glucocorticoids; correction of fluid, electrolyte, and glucose deficits; and vasopressors and other supportive measures as needed.

Miscellaneous Effects

Acne, thinning of the skin and mucosa, hirsutism, weight gain, intestinal perforation, pancreatitis, hyperlipidemia, hypertension, hepatomegaly, and poor wound healing may occur during long-term glucocorticoid therapy.

IMPLICATIONS FOR DENTISTRY

Patients treated with large doses of glucocorticoids for long periods present special problems in dentistry. As noted previously, such patients are likely to have a decreased resistance to infection and a poor wound healing response. Actual or potential sources of infection in the oral cavity, such as carious teeth and inflamed tissues, should be promptly treated. If surgical procedures are necessary, they should be as conservative, atraumatic, and aseptic as possible. Preoperative antimicrobial prophylaxis may be indicated in some cases.

A second consideration in patients treated with glucocorticoids is suppression of pituitary-adrenal function. The degree of adrenal suppression depends on the length of treatment, the frequency and manner of administration, and the glucocorticoid preparation used (glucocorticoid potency of individual agents may vary >25-fold; see Table 35-1). As described earlier, an individual with intact adrenal function responds to a stressful situation, such as anxiety, an acute infection, or a surgical procedure, with an increased release of ACTH and production of cortisol. Patients with suppressed adrenal function are unable to increase cortisol production. In assessing the degree of suppression, a good guideline is to assume that any patient who has received 30 mg of hydrocortisone or its equivalent for 4 or more weeks or 80 mg of hydrocortisone for more than 2 weeks has some degree of adrenal suppression. It is a time-honored but unproven notion that these patients may develop signs and symptoms of adrenal insufficiency during stressful dental situations (surgery or acute infection). It is often suggested that the dose of glucocorticoids be increased during and immediately after treatment in such patients to compensate for the lack of endogenous hormone production. The recommended dose is typically at least double or triple the patient's maintenance dose, depending on the degree of suppression of adrenal function and the severity of the stressful event. When the period of stress is over, the dose is gradually reduced over several days to the maintenance level.

A careful review of the literature suggests that patients with glucocorticoid-induced adrenal suppression are at little risk of acute adrenal insufficiency as a result of routine dental treatment, including simple extractions and minor periodontal or endodontic surgery.⁶ Given this, it is likely quite safe for such patients to forego perioperative glucocorticoid supplementation ("steroid cover"). Patients should be scheduled for an appointment in the morning when circulating cortisol concentrations are the highest and instructed to take their usual dose of corticosteroid within 2 hours of the procedure. Measures to reduce anxiety are also appropriate.

More invasive surgical procedures, such as removal of impacted teeth, bone resection, or quadrant periodontal surgery; lengthy procedures (>1 hour); procedures that may cause considerable blood loss; and any procedure done under general anesthesia constitute more stressful episodes, and may require essentially complete corticosteroid replacement in a patient with adrenal suppression. One commonly accepted approach is to give 100 mg of cortisone acetate intramuscularly approximately 8 hours before the procedure. Sufficient hydrocortisone or its equivalent is given intravenously during the procedure so that the total dose on the day of the opera-

tion is 300 mg of hydrocortisone or its equivalent. If the postoperative course is uneventful, corticosteroid dosage is tapered over a 2- to 3-day period (e.g., 300 mg of hydrocortisone on the day of the procedure, 150 mg the following day, 75 mg on the next day, and the usual maintenance dose on the third postoperative day).³ A low-dose alternative is to infuse 25 mg of hydrocortisone during the induction of anesthesia, followed by a continuous infusion of 100 mg during the next 24 hours.

Because recovery of glucocorticoid-induced adrenal suppression may be slow, dental patients formerly treated for prolonged periods with glucocorticoids and assumed to have adrenal suppression by the above-mentioned criteria may need to receive glucocorticoids during stressful situations for 1 year after cessation of glucocorticoid therapy. Consultation with the patient's physician is essential for the optimal management of a patient who is receiving or has received long-term glucocorticoid therapy.

PREPARATIONS

Numerous glucocorticoids are available in various forms for local, oral, and parenteral administration. These include the natural hormone hydrocortisone and synthetic compounds prepared by modifying the chemical structures of hydrocortisone and other natural hormones; three of these are shown in Figure 35-5. Relative to hydrocortisone, the synthetic compounds are, in varying degrees, longer acting and more potent. These differences are the basis for classifying glucocorticoids as short-acting (<12 hours), intermediate-acting (12 to 36 hours), and long-acting (>36 hours) (Box 35-3). Representatives of these three categories are hydrocortisone, prednisolone, and dexamethasone. Intermediate-acting and long-acting compounds also have a greater ratio of glucocorticoid to mineralocorticoid activity. Consequently, these agents are preferred for long-term use in the treatment of chronic inflammatory disorders because they cause less disturbance of electrolyte and fluid balance than hydrocortisone.

In the clinical management of inflammatory or allergic disorders, the dosage of glucocorticoids varies widely accord-

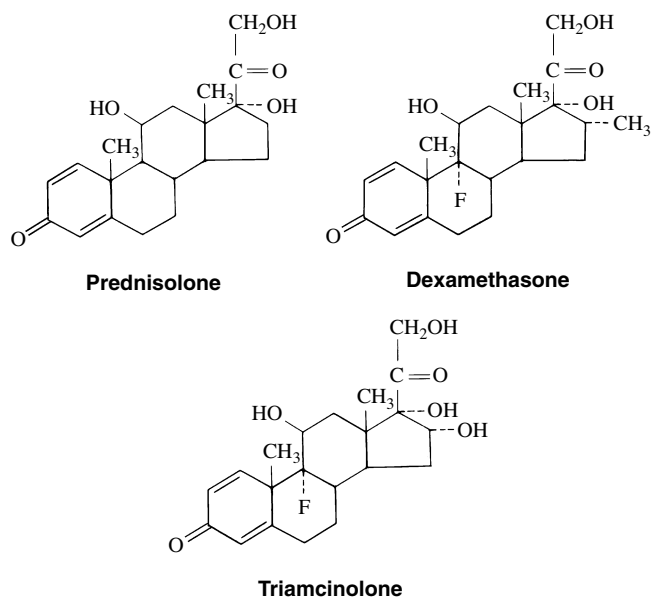

FIGURE 35-5 Structural formulas of three synthetic glucocorticoids.

TABLE 35-2

Commonly Used Corticosteroid Preparations

NONPROPRIETARY (GENERIC) NAME	PROPRIETARY (TRADE) NAME	RELATIVE POTENCY	USUAL ADULT DOSE	ROUTE OF ADMINISTRATION	PREPARATIONS
Hydrocortisone	Hydrocortone	1	20-240 mg/day	Oral	Tablets: 5, 10, and 20 mg
Hydrocortisone acetate	Orabase HCA	1	2-3 times daily	Topical	Paste: 0.5%, containing gelatin, pectin, and sodium carboxymethylcellulose in a polyethylene and mineral oil base Suspension: 25 and 50 mg/mL
Hydrocortisone sodium succinate	Hydrocortone acetate	1	5-50 mg	Intra-articular	Suspension: 25 and 50 mg/mL
Hydrocortisone sodium succinate	Solu-Cortef	1	100-500 mg/day	Intravenous or intramuscular	Powder: 100, 250, 500, and 1000 mg
Prednisone	Deltasone, Orasone	4	5-60 mg/day	Oral	Tablets: 1, 2.5, 5, 10, 20, 25, and 50 mg
Prednisolone	Delta-Cortef	4	5-60 mg/day	Oral	Tablets: 5 mg
Prednisolone acetate	Econopred	4	1-2 drops	Ophthalmic	Suspension: 0.12% and 1%
Triamcinolone acetonide	Kenalog in Orabase	5	2-3 times daily	Topical	Paste: 0.1%, with gelatin, pectin, and sodium carboxymethylcellulose in a polyethylene and mineral oil base Suspension: 25 and 40 mg/mL
Triamcinolone diacetate	Aristocort	5	5-40 mg every 1-8 wk	Intra-articular	Suspension: 25 and 40 mg/mL
Dexamethasone	Decadron	25	0.75-9 mg/day	Oral	Tablets: 0.25, 0.5, 0.75, 1, 1.5, 2, 4, and 6 mg
Dexamethasone acetate	Decadron-LA	25	1-5 mg*	Intra-articular	Suspension: 8 and 16 mg/mL
Betamethasone	Celestone	25	0.6-7.2 mg/day	Oral	Tablets: 0.6 mg

*Dose recommended for the temporomandibular joint.

BOX 35-3

Biologic Half-Lives* of Commonly Used Corticosteroids

8-12 hr (short-acting)	Cortisone Hydrocortisone
18-36 hr (intermediate-acting)	Methylprednisolone Prednisolone Prednisone Triamcinolone
36-72 hr (long-acting)	Betamethasone Dexamethasone Paramethasone

*Biologic half-life of corticosteroid is defined as the period of suppression of the hypothalamus-pituitary-adrenal axis.

ing to such factors as the nature, severity, and probable duration of the condition being treated and the patient's response. In acute or life-threatening situations, a glucocorticoid should be given in sufficient doses to control the disorder quickly; treatment should be discontinued as soon as possible. In the long-term management of chronic diseases such as rheumatoid arthritis, alternate-day therapy with the minimum dosage that achieves an acceptable reduction of symptoms is the regimen of choice. Table 35-2 lists some of the many different preparations currently available, some of the dosage forms, and a range of doses for a given route of administration.

GLUCOCORTICOIDS

Nonproprietary (generic) name	Proprietary (trade) name
Beclomethasone	Beclovent, Vanceril
Betamethasone	Celestone
Cortisone	Cortone
Dexamethasone	Decadron, Dexone, Hexadrol
Fludrocortisone	Florinef
Flunisolide	AeroBid
Hydrocortisone (cortisol)	Cortef, Hydrocortone, Solu-Cortef
Methylprednisolone	Depo-Medrol, Medrol, Solu-Medrol
Prednisolone	Delta-Cortef, Predalone, Pediapred
Prednisone	Deltasone, Orasone
Triamcinolone	Aristocort, Kenacort, Kenalog

CITED REFERENCES

- Adachi JD, Bensen WG, Hodsman AB: Corticosteroid-induced osteoporosis. *Semin Arthritis Rheum* 22:375-384, 1993.
- Barnes PJ: Inhaled glucocorticoids for asthma. *N Engl J Med* 332:868-875, 1995.
- Blonde LRR, Tullman MJ, Redding SW: Endocrinologic disease. In Tullman MJ, Redding SW, editors: *Systemic disease in dental treatment*, New York, 1982, Appleton-Century-Crofts.
- Goldstein RA, Paul WE, Metcalfe DD, et al: Asthma. *Ann Intern Med* 121:698-708, 1994.

5. Mico-Llorens JM, Satorres-Nieto M, Gargallo-Albiol J: Efficacy of methylprednisolone in controlling complications after impacted lower third molar surgical extraction. *Eur J Clin Pharmacol* 62:693-698, 2006.
6. Miller CS, Little JW, Falace DA: Supplemental corticosteroids for dental patients with adrenal insufficiency: reconsideration of the problem. *J Am Dent Assoc* 132:1570-1579, 2001.
7. Norman AW, Mizwicki MT, Norman DP: Steroid hormone rapid actions, membrane receptors, and a conformational ensemble model. *Nat Rev Drug Discov* 3:27-41, 2004.
8. Pilkis SJ, Granner DK: Molecular physiology of the regulation of hepatic gluconeogenesis and glycolysis. *Annu Rev Physiol* 54:885-902, 1992.
9. Piper JM, Ray WA, Daugherty JR, et al: Corticosteroid use and peptic ulcer disease: role of nonsteroidal anti-inflammatory drugs. *Ann Intern Med* 114:735-740, 1991.
10. Ramos-Remus C, Sibley J, Russell AS: Steroids in rheumatoid arthritis: the honeymoon revisited. *J Rheumatol* 19:667-670, 1992.
11. Saag KG, Emkey R, Schnitzer TJ, et al: Alendronate for the prevention and treatment of glucocorticoid-induced osteoporosis. Glucocorticoid-Induced Osteoporosis Intervention Study Group. *N Engl J Med* 339:292-299, 1998.
12. Sciubba JJ: Oral mucosal diseases in the office setting, part I: aphthous stomatitis and herpes simplex infections. *Gen Dent* 55:347-354, 2007.
13. Sciubba JJ: Oral mucosal diseases in the office setting, part II: lichen planus, pemphigus vulgaris and mucosal pemphigoid. *Gen Dent* 55:464-476, 2007.
14. Webster JC, Cidlowski JA: Mechanism of glucocorticoid-receptor mediated repression of gene expression. *Trends Endocrinol Metab* 10:396-402, 1999.
15. Williams GH, Dluhy RG: Disorders of the adrenal cortex. In Fauci AS, Braunwald E, Isselbacher KJ, et al, editors: *Harrison's principles of internal medicine*, ed 15, New York, 2008, McGraw-Hill, pp 2227-2269.

GENERAL REFERENCE

- Schimmer BP, Parker KL: Adrenocorticotrophic hormone; adrenocortical steroids and their synthetic analogs; inhibitors of the synthesis and actions of adrenocortical hormones. In Brunton LL, Lazo JS, Parker KL, editors: *Goodman & Gilman's the pharmacological basis of therapeutics*, ed 11, New York, 2006, McGraw-Hill.

Insulin, Oral Hypoglycemics, and Glucagon

GAIL T. GALASKO

INSULIN AND THE ENDOCRINE PANCREAS

The pancreas has exocrine and endocrine functions. The exocrine system comprises the acinar cells, which secrete digestive enzymes. The islets of Langerhans, which make up the endocrine system, contain four types of cells, each of which synthesizes and secretes different polypeptide hormones (Table 36-1). Insulin is produced by the β cells, which constitute most (60% to 80%) of the islet and form its central core. The β cell is the primary glucose sensor for the islet.

Insulin is a polypeptide containing 51 amino acids. It has a molecular weight of approximately 5800 Da. It is composed of two chains (called the *A and B chains*) that are joined by two disulfide bridges. Insulin is formed by proteolysis of a large, single-chain precursor, proinsulin. In proinsulin, shown in Figure 36-1, the A and B chains are joined by a connecting (C) peptide. Proinsulin is converted to insulin when the C peptide is removed; this occurs within the secretory granules of the pancreatic β cell. Approximately equimolar amounts of insulin and C peptide are stored in the granules and released by exocytosis when the β cell is stimulated. C peptide has no known biologic function, but it can serve as an index of insulin secretion. Units of insulin, originally defined by activity, are now defined on the basis of weight. There are approximately 28 U/mg of insulin.

Insulin is a member of a family of related peptides known as *insulin-like growth factors (IGFs)*. IGF-I and IGF-II have molecular weights of approximately 7500 Da and structures that are homologous to proinsulin. The receptors for insulin and IGF-I are closely related. Insulin can bind to the receptor for IGF-I with low affinity and vice versa. The growth-promoting actions of insulin seem to be mediated, at least in part, through the IGF-I receptor. In contrast to insulin, IGFs are produced in many tissues, where they are more important in regulating growth than in regulating metabolism. IGFs mediate the anabolic and growth-promoting effects of growth hormone. IGF-I and IGF-II were originally known as *nonsuppressible insulin-like activity (NSILA)* because of their ability to produce insulin-like effects in bioassays that were not suppressed by the addition of excess anti-insulin antibodies.

Regulation of Insulin Secretion

The pancreas secretes insulin into the portal vein. Insulin secretion is a tightly regulated process designed to provide stable concentrations of glucose in the blood during fasting and feeding. Regulation of plasma glucose is achieved by the coordinated interplay of various nutrients, gastrointestinal hormones, pancreatic hormones, and autonomic neurotrans-

mitters. A basal secretion of insulin is present during fasting periods.¹⁵ There is a subsequent rapid increase in insulin secretion after ingestion of a meal. Glucose is the principal stimulus to insulin secretion in humans. It is more effective in provoking insulin secretion when taken orally than when administered intravenously.⁵

Actions of Insulin

The classic action of insulin is to decrease the blood glucose concentration. Insulin does this by affecting glucose use and glucose production. Liver, muscle, and fat are the important target tissues for regulation of glucose homeostasis by insulin, but insulin exerts potent regulatory effects on other cell types as well. Insulin stimulates glucose transport into muscle and fat by promoting translocation of the intracellular transporter, glucose transporter 4 (Glut 4), to the cell surface (Figure 36-2).¹⁴ Insulin does not stimulate glucose uptake into the liver, but it inhibits hepatic glucose production. Insulin inhibits catabolic processes, such as breakdown of glycogen, fat, and protein. Glycogenolysis and gluconeogenesis are inhibited. Insulin receptors are found on virtually all cells. Activation of the insulin receptor leads to a cascade of phosphorylation or dephosphorylation reactions, or both. As a result, insulin affects the activities of various enzymes involved in intracellular use and storage of glucose, amino acids, and fatty acids. Glycolysis (use) and glycogen synthesis (storage) are promoted. The effects of insulin are summarized in Table 36-2.

In addition to the short-term metabolic effects, insulin has other, longer term actions. It affects synthesis of key enzymes and is believed to have important growth-regulating effects in vivo. Insulin regulates gene transcription,¹³ affecting protein synthesis; increases cell proliferation and differentiation; and decreases apoptosis.

Pharmacokinetics

Insulin is biotransformed in various tissues, including the liver, kidney, and skeletal muscle. Almost half of the insulin secreted by the pancreas is destroyed by the liver before it reaches the general circulation. Metabolism of insulin results in the production of inactive peptides. The half-life of exogenous insulin in plasma is approximately 8 minutes in nondiabetic subjects and diabetic subjects with no complications.

Insulin Receptor Interactions

The insulin receptor in mammalian cells is a large transmembrane glycoprotein. It is composed of two α subunits and two β subunits linked by disulfide bonds to form a β - α - α - β heterotetramer. Binding of hormone to the α subunits of

the insulin receptor leads to the rapid intramolecular auto-phosphorylation of tyrosine residues in the β subunits. A series of events is initiated that culminates in a cascade of phosphorylation or dephosphorylation reactions. This activity is shown schematically in Figure 36-2.

Insulin Signaling

There is evidence that insulin acts by synthesis of second messengers that enter the cell to mediate some of the hormone's actions on intracellular enzymes (e.g., phosphorylation, dephosphorylation). These mediators are of the inositolphosphoglycan (IPG) class.⁸ IPGs represent a family of second messengers or mediators that are increasingly being implicated as having an important role in signal transduction, not only for insulin, but also for other hormones and growth factors. They are discussed later in this chapter.

TABLE 36-1

Pancreatic Islet Secretions

CELL TYPE	HORMONE SECRETED
α (A) cell	Glucagon
β (B) cell	Insulin, amylin (islet amyloid polypeptide)
δ (D) cell	Somatostatin
F (PP) cell	Pancreatic polypeptide
G cell	Gastrin

DIABETES MELLITUS

Diabetes mellitus is a group of syndromes characterized by hyperglycemia. Virtually all forms of diabetes mellitus are due to either a decrease in the circulating concentration of insulin (insulin deficiency) or a decrease in the response of peripheral

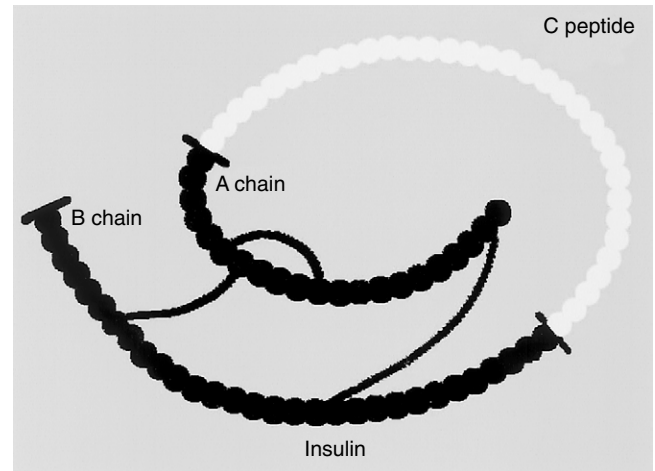
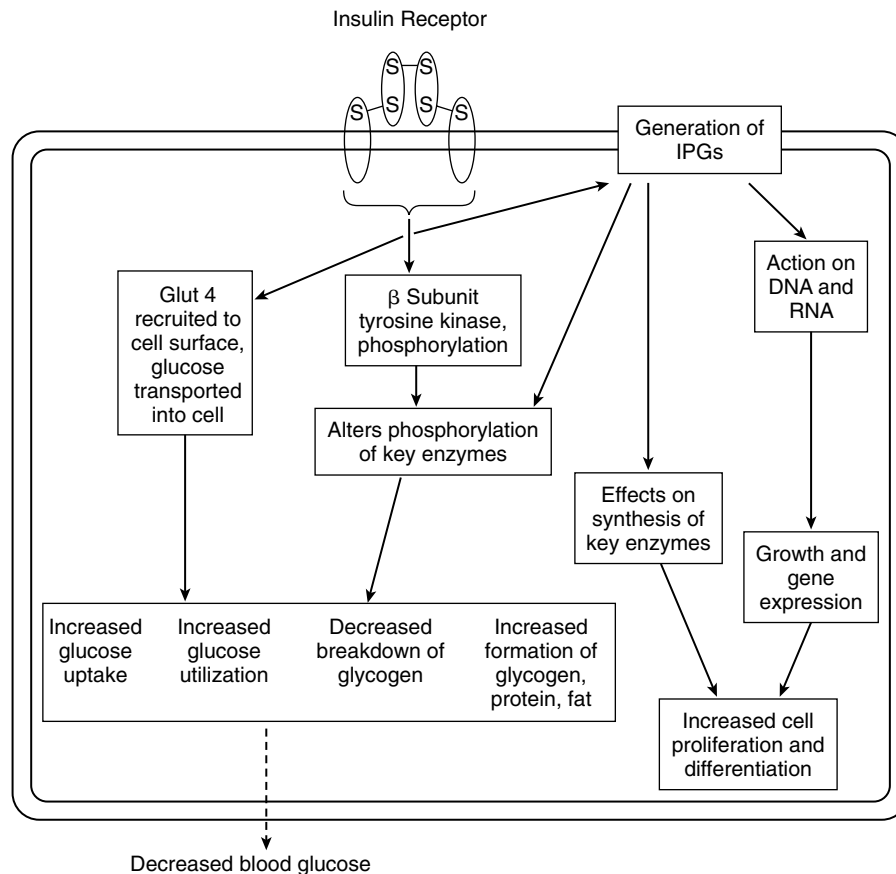

FIGURE 36-1 Structure of proinsulin. When the connecting (C) peptide is removed, insulin is formed. The A and B chains of insulin are shown in black; C peptide is white.



*Inositolphosphoglycans (IPGs) are released on the outside of the cell and then transported back into the cell.

FIGURE 36-2 Insulin signaling pathways. *Glut 4*, Glucose transporter 4.

TABLE 36-2

Metabolic Actions of Insulin

TYPE OF METABOLISM	ACTION OF INSULIN	MAJOR TARGET TISSUE*
Carbohydrate	Increases glucose transport	Muscle, fat
	Increases glycogen synthesis	Liver, muscle
	Decreases gluconeogenesis	Liver
	Increases glycolysis	Liver, muscle
Fat	Increases glucose oxidation	Fat
	Increases lipogenesis	Liver, fat
	Decreases lipolysis	Liver, fat
Protein	Increases synthesis of triglycerides	Fat
	Decreases protein breakdown	Liver
	Increases protein synthesis	Muscle, various
	Increases amino acid uptake	Muscle, various

*Insulin exerts potent regulatory effects on other cell types in addition to liver, muscle, and fat, the classically important target tissues for glucose regulation.

tissues to insulin (insulin resistance). The disease has two major forms. Currently, the preferred nomenclature is *type 1* and *type 2 diabetes mellitus*. Older names include *juvenile-onset* or *insulin-dependent diabetes mellitus* for type 1 and *maturity-onset* or *non-insulin-dependent diabetes mellitus* for type 2.

Evidence indicates that the incidence of type 1 and type 2 diabetes mellitus is increasing worldwide. In 1999, the prevalence was predicted to double by 2010.⁷ Type 2 diabetes is becoming increasingly common and is an emerging problem in children and adolescents, particularly minorities.³ In the United States, the annual number of newly diagnosed diabetes cases tripled during 1980-2005. Major risk factors for type 2 diabetes are obesity and physical inactivity. The incidence of type 1 diabetes is reported to be increasing by approximately 3% per year.¹⁶

Type 1 Diabetes Mellitus

There is considerable evidence that type 1 diabetes is an autoimmune disease of the pancreatic β cell, resulting in degeneration. In type 1 diabetes, there is an absolute lack of insulin. Genetic predisposition and environmental components are involved, with the incidence in homozygous twins being approximately 50%.¹⁷ Approximately 5% to 10% of diabetics have type 1 diabetes.

Type 2 Diabetes Mellitus

Approximately 90% to 95% of diabetics have type 2 diabetes mellitus. In type 2 diabetes, target cells are relatively insensitive to insulin.⁶ This is known as *peripheral resistance to insulin*. Impaired glucose metabolism in muscle and liver are key features of type 2 diabetes. Genetic predisposition is important in type 2 diabetes; there is greater than 95% concordance in identical twins.¹⁷ In addition, most type 2 diabetics are obese. Type 2 diabetics have impaired glucose taste detection,¹¹ which may reflect a generalized defect in glucose sensitivity, including the glucose-sensing pancreatic β cells.

Glycosylation of Hemoglobin

Nonenzymatic glycosylation of proteins can occur as a result of elevated blood glucose concentrations. Hemoglobin is glycosylated on its amino terminal valine residue to form the glycosyl valine adduct, termed *hemoglobin A_{1c}* (*HbA_{1c}*). Because the half-life of HbA_{1c} is the same as that of red blood cells, the concentration of HbA_{1c} in the circulation can be

used to assess the severity of the glycemic state over an extended period (4 to 12 weeks) before sampling.

Insulin Therapy

Insulin is the mainstay for treatment of virtually all type 1 and many type 2 diabetic patients. When necessary, insulin may be administered intravenously or intramuscularly. Long-term treatment generally relies on subcutaneous injection of the hormone, however.

Subcutaneous administration of insulin differs from physiologic secretion of insulin in two major ways. First, the kinetics of absorption are relatively slow and do not mimic the normal rapid increase and decrease of insulin secretion in response to ingestion of nutrients. Second, the injected insulin diffuses into the peripheral circulation instead of being released into the portal circulation. Any preferential effect of secreted insulin on hepatic metabolic processes is lost.

Insulin preparations

Insulin occurs in the pancreas complexed with zinc and is extracted in the form of zinc insulin, which is not water-soluble at neutral pH. This form can be converted to the Na⁺ salt, which is water-soluble at neutral pH. Available preparations include human insulins and insulin analogues. Human insulins, so called because they have the same structure as normal human insulin, are made by genetic engineering (recombinant DNA). In ultrashort-acting insulin analogues (insulin aspart, glulisine, and lispro), amino acids are substituted, or reversed. Long-acting insulin analogues (insulin detemir and glargine) have groups added. Insulin analogues have been developed to alter the kinetics.

Insulin preparations are classified according to their duration of action into rapid-acting (ultrashort-acting and short-acting), intermediate-acting, and long-acting preparations. Insulin products available in the United States are listed in Table 36-3.

Rapid-acting (ultrashort-acting and short-acting) insulin preparations. Ultrashort-acting insulin preparations—insulin aspart (NovoLog), insulin glulisine (Apidra), and insulin lispro (Humalog)—all are insulin analogues. They may be used with a pump.* Regular insulins (Humulin R and Novolin R) are short-acting preparations. They are soluble, have a rapid onset, and are dispensed as clear solutions at neutral pH.

Intermediate-acting and long-acting insulin preparations. Insulin analogues—insulin glargine (Lantus) and insulin detemir (Levemir)—are soluble, long-acting insulin preparations. Their duration of action is longer and their time-action profile is flatter (peakless) than NPH (neutral protamine Hagedorn) insulin preparations. They cause less hypoglycemia at night.

Other intermediate-acting and long-acting insulin preparations contain particles and are cloudy suspensions at neutral pH. The larger the particles, the more slowly they dissolve, and the longer the duration of action of the preparation. NPH insulin is a protamine zinc suspension of insulin, at neutral pH, developed in Hagedorn's laboratory. Isophane insulin is NPH insulin in which there is no excess of either protamine or insulin. For therapeutic purposes, dosages and concentrations of insulin are expressed in units. Most commercial preparations of insulin are supplied in solution at a concentration of 100 U/mL (approximately 3.7 mg/mL).

*Insulin lispro, more than the others, may precipitate in pump infusion systems, resulting in unexplained hyperglycemia in patients on continuous subcutaneous insulin infusion therapy.

TABLE 36-3

Insulin Preparations

PREPARATION	ONSET	PEAK	DURATION
Rapid—Ultrashort-Acting			
Insulin aspart (NovoLog)	5-15 min	1-2.5 hr	≤5 hr
Insulin glulisine (Apidra)	5-15 min	0.5-1.5 hr	2-5 hr
Insulin lispro (Humalog)	5-15 min	0.5-1.5 hr	2-5 hr
Rapid—Short-Acting			
Humulin R	30-60 min	2-4 hr	≤16 hr
Novolin R	30 min	2.5-5 hr	8 hr
Intermediate-Acting			
Humulin N	1-2 hr	4-12 hr	≤24 hr
Novolin N	1-2 hr	4-12 hr	24 hr
Premixed (% NPH/% Regular)			
Humulin 70/30	30-60 min	2-4 hr	≤24 hr
Humulin 50/50	30-60 min	2-4 hr	≤24 hr
Novolin 70/30	30 min	2.5-5 hr	24 hr
Premixed			
Humalog Mix (75% insulin lispro protamine/25% insulin lispro)	10-30 min	1-6 hr	≤24 hr
NovoLog Mix 70/30 (70% insulin aspart protamine/30% insulin aspart)	10-20 min	1-4 hr	15-18 hr
Long-Acting			
Insulin detemir (Levemir)	50-120 min	No peak	≤24 hr
Insulin glargine (Lantus)	1-2 hr	No peak	24 hr

Kinetics of insulin preparations vary with site of injection.
N, NPH; R, regular.

Pharmacokinetics

Insulin is given by injection, usually subcutaneously. Absorption of insulin after subcutaneous administration is affected by the site of injection, the subcutaneous blood flow, the volume and concentration of the injected insulin, and the presence of circulating insulin antibodies. Insulin absorption is usually most rapid from the abdominal wall, followed by the arm, buttock, and thigh. Increased subcutaneous blood flow (brought about by massage, hot baths, and exercise) increases the rate of absorption. Soluble insulins may also be given intravenously. The onset of action of insulin after intravenous injection is very fast, but the duration of action is short.

Adverse effects

Hypoglycemia is the most common adverse reaction to insulin. Hypoglycemia may result from an inappropriately large dose, a mismatch between the time of peak delivery of insulin and food intake, increased sensitivity to insulin (e.g., adrenal insufficiency), or increased insulin-independent glucose uptake (exercise). The more vigorous the attempt to achieve euglycemia, the more frequent the episodes of hypoglycemia. The most frequent symptoms of hypoglycemia include sweating, tachycardia, tremor, blurred vision, weakness, hunger, confusion, and altered behavior. Loss of consciousness may follow. Hypoglycemia may be confused with inebriation by onlookers.

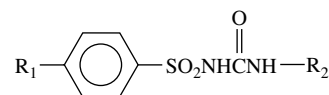

General structure of sulfonylureas

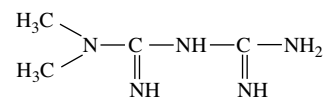

Metformin

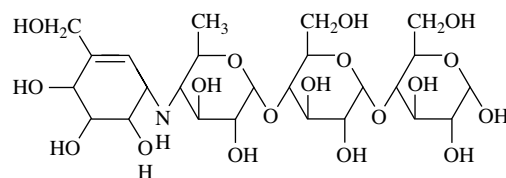

Acarbose

FIGURE 36-3 Chemical structures of the sulfonylureas, metformin and acarbose.

With long-standing type 1 diabetes, the mechanisms for counteracting hypoglycemia may be blunted or absent in many patients, putting them at higher risk of developing hypoglycemia. Mild-moderate hypoglycemia may be treated by ingestion of sugar or honey. When hypoglycemia is severe, it should be treated with intravenous glucose or an injection of glucagon.

ORAL ANTIHYPERGLYCEMIC AGENTS**Sulfonylureas**

Sulfonylureas are sulfonamide derivatives (Figure 36-3). They are traditionally divided into two groups or generations of agents. Second-generation sulfonylureas are considerably more potent than the earlier drugs. Table 36-4 lists sulfonylureas available in the United States.

Mechanism of action

Sulfonylureas are effective only in patients with functioning pancreatic β cells. These drugs stimulate release of insulin by blocking adenosine 5'-triphosphate (ATP)-dependent K^+ current in pancreatic β cells. The effects of sulfonylureas are initiated by their binding to and blocking an ATP-sensitive K^+ channel. Glimepiride has been shown to have an additional effect: it increases the sensitivity of peripheral tissues to insulin.⁹ This may be true for the other sulfonylureas (especially second-generation drugs) as well.² The predominant effect is on insulin secretion.

Pharmacokinetics

Sulfonylureas are well absorbed after oral administration. Glipizide absorption is delayed by food. All sulfonylureas are highly bound to plasma protein (90% to 99%). Plasma protein binding is least for chlorpropamide and greatest for glyburide. Sulfonylureas are metabolized in the liver and excreted in the urine.

The half-life and extent of metabolism vary considerably among first-generation sulfonylureas. Metabolism of chlorpropamide is incomplete, and approximately 20% of the drug is excreted unchanged, which can be a problem for patients with impaired renal function.

TABLE 36-4

Sulfonylureas Available in the United States

NONPROPRIETARY (GENERIC) NAME	PROPRIETARY (TRADE) NAME	ONSET (hr)	SERUM HALF-LIFE (hr)	DURATION OF ACTION (hr)
First-Generation				
Acetohexamide	Dymelor	1	6-8	12-24
Chlorpropamide	Diabinese	1	36	24-60
Tolazamide	Tolinase	4-6	7	12-24
Tolbutamide	Orinase	1	4.5-6.5	6-12
Second-Generation				
Glimepiride	Amaryl	2-3	9	10-24
Glipizide (glydiazinamide)	Glucotrol, Glucotrol XL	1-3	2-4	10-24
Glyburide (glibenclamide)	DiaBeta, Micronase, Glynase PresTabs	1-4*	4-10	10-24

*Micronized forms have a faster onset of action.

Therapeutic uses

Sulfonylureas are used to control hyperglycemia in type 2 diabetics who cannot achieve appropriate control with changes in diet and exercise alone.

Adverse effects

Adverse effects are infrequent, occurring in approximately 4% of patients taking first-generation drugs and perhaps slightly less often in patients receiving second-generation agents. The most important adverse effect is hypoglycemia, which, if severe, can lead to coma. Hypoglycemia is a particular problem in elderly patients with impaired hepatic or renal function who are taking longer acting sulfonylureas.

Sulfonylureas have a sulfonamide structure, which is the basis for cross-sensitivity with antibacterial sulfonamide drugs. Hypersensitivity reactions occur with some regularity. Other adverse effects of sulfonylureas include nausea and vomiting, occasional hematologic reactions (especially leukopenia and thrombocytopenia, and hemolytic anemia in susceptible patients), cholestatic jaundice, and dermatologic effects. Sulfonylureas are teratogenic in animals (large doses). Patients taking sulfonylureas tend to gain weight, which is a problem in type 2 diabetics, who tend to be obese.

Sulfonylureas have a disulfiram-like effect. In patients who take alcohol concurrently, sulfonylureas may decrease aldehyde dehydrogenase, causing acetaldehyde accumulation (see Chapter 43). As a result, the patient may have flushing, headache, nausea, vomiting, sweating, and hypotension shortly after alcohol ingestion. This reaction is not as likely to occur with a single occasional drink.

Drug interactions

As shown in Box 36-1, numerous drugs interact with sulfonylureas by enhancing or decreasing their effect on blood glucose concentration.

Contraindications

Contraindications to the use of sulfonylureas include hypersensitivity to sulfonylureas and drugs that have similar structures (see earlier) and pregnancy. Caution should be exercised in cases of reduced renal or hepatic function. Patients with ketoacidosis should receive insulin, not an oral antihyperglycemic agent.

Meglitinides

Meglitinides that are approved for use in the United States are repaglinide and nateglinide. The structure of repaglinide

BOX 36-1

*Sulfonylurea Drug Interactions***Drugs That Increase the Effect of Sulfonylureas**

Antihistamines (H₂ antagonists)
 Azole antifungals
 Clofibrate
 Mg⁺⁺ salts
 Methyldopa
 Monoamine oxidase inhibitors
 Oral anticoagulants
 Salicylates
 Sulfonamides
 Tricyclic antidepressants
 β-Adrenergic receptor blockers

Drugs That Decrease the Effect of Sulfonylureas

Ca⁺⁺ salts
 Corticosteroids
 Diazoxide
 Estrogens
 Phenothiazines
 Sympathomimetics
 Thiazide diuretics
 Thyroid hormones

is shown in Figure 36-4. These drugs are effective only in patients with functioning pancreatic β cells. Similar to sulfonylureas, they stimulate release of insulin by blocking ATP-dependent K⁺ channels in pancreatic β cells. They may be used alone or in combination with metformin (see later) and may be given to patients who are allergic to sulfonamides.

Pharmacokinetics

Repaglinide and nateglinide are rapidly absorbed after oral administration. They are metabolized primarily by the liver. Repaglinide peak plasma levels occur within 1 hour, and the plasma half-life is 1 hour. It is recommended that this drug be taken just before each meal. Nateglinide is most effective if taken 1 to 10 minutes before a meal. These drugs offer the advantage of rapid and short-term control over blood glucose.

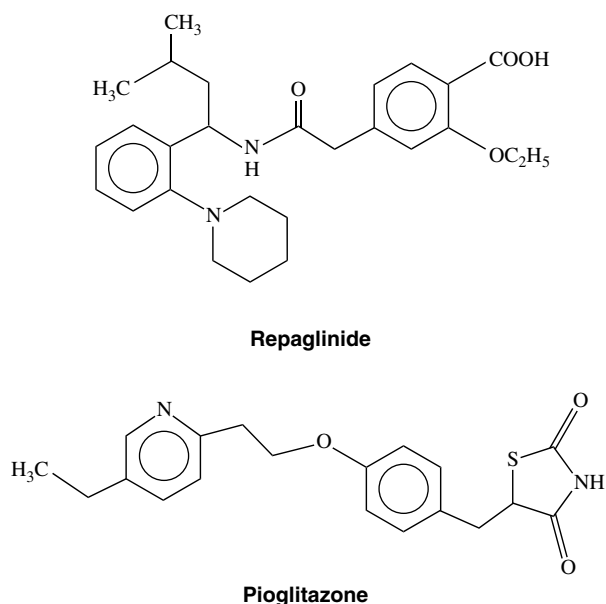

FIGURE 36-4 Chemical structure of repaglinide and pioglitazone.

Adverse effects

Hypoglycemia is the major adverse effect of repaglinide and is most likely to occur if a meal is delayed or skipped or in patients with hepatic insufficiency.

Drug interactions

Ketoconazole, miconazole, and erythromycin decrease biotransformation and potentiate the effect of repaglinide. Non-steroidal anti-inflammatory drugs, salicylates, sulfonamides, and other highly protein-bound drugs may potentiate the hypoglycemic effects of repaglinide.

Biguanides

Metformin is currently the only biguanide approved for use in the United States (see Figure 36-3). Phenformin and buformin, two other biguanides, are widely used in Europe and elsewhere.⁴ Phenformin was withdrawn from the United States in 1977 because of its ability to cause lactic acidosis.

Mechanism of action

The mechanism of action of biguanides differs from that of sulfonylureas or meglitinides. Biguanides decrease blood glucose concentrations by several different actions. They decrease hepatic gluconeogenesis, improve tissue sensitivity to insulin, increase peripheral glucose uptake and use, and decrease intestinal absorption of glucose. Biguanides do not cause hypoglycemia. In addition, patients do not gain weight, in contrast to patients taking sulfonylureas. The action of biguanides does not depend on functioning pancreatic β cells, and they are often used in combination with sulfonylureas and other hypoglycemic agents such as thiazolidinediones.

Pharmacokinetics

Approximately 50% to 60% of an oral dose of metformin is absorbed after oral administration. Food decreases the extent of absorption and delays it slightly. Protein binding is minimal, and metformin is excreted unchanged in the urine by tubular secretion. Approximately 90% is excreted within 24 hours. It has a plasma half-life of approximately 6 hours.

Adverse effects

Gastrointestinal tract symptoms, such as nausea, anorexia, vomiting, diarrhea, flatulence, and cramps, are common adverse effects of metformin (biguanides). These effects are dose-dependent and may be transient. In some patients they are severe enough to make the drug intolerable. Metformin may cause a decrease in vitamin B₁₂ levels, possibly by decreasing absorption from the vitamin B₁₂ intrinsic factor complex. Lactic acidosis is a rare but serious complication of biguanides. When it occurs, it is fatal in roughly 50% of patients.

Contraindications

Biguanides are contraindicated in patients with renal disease, hepatic disease, or conditions predisposing to tissue anoxia (including cardiopulmonary dysfunction) because of concern regarding lactic acidosis.

Thiazolidinediones

Thiazolidinediones currently available are pioglitazone and rosiglitazone. The structure of pioglitazone is shown in Figure 36-4.

Mechanism of action

Thiazolidinediones act by increasing insulin sensitivity in tissues. They are agonists at the nuclear peroxisome proliferator-activated receptor- γ (PPAR γ). They depend on the presence of insulin for their activity. Thiazolidinediones decrease hepatic gluconeogenesis and increase insulin-dependent glucose uptake in muscle and fat.¹⁰ They act synergistically with sulfonylureas and metformin.

Pharmacokinetics

Thiazolidinediones are taken orally, once a day, with or without food. The maximal effect is not seen for 6 to 12 weeks. They are metabolized by the cytochrome P450 oxidative enzyme system.

Adverse effects

Thiazolidinediones now carry a “black box” warning of congestive heart failure and myocardial ischemia. There is also weight gain and a risk of edema, osteoporosis, and fractures.¹⁸ Hepatotoxicity is also a possible adverse effect.

Drug interactions

Concurrent administration of pioglitazone with oral contraceptives containing ethinyl estradiol and norethindrone results in decreased plasma concentrations of the contraceptive and can result in loss of contraceptive effect. Ketoconazole has been shown to inhibit pioglitazone metabolism in vitro.

Incretin-Related Drugs

Incretin-related drugs include exenatide and sitagliptin. Vildagliptin is in clinical trials. Although exenatide is not given orally, these drugs are generally classified with oral antihyperglycemic agents.

It has long been known that oral glucose produces greater release of insulin than intravenous glucose. Two hormones, secreted from the gastrointestinal tract, have been shown to stimulate insulin secretion. They are known as *incretins*. The two compounds are glucagon-like peptide 1 (GLP-1), and glucose-dependent insulinotropic polypeptide (GIP). Their secretion is increased by food and elevated glucose levels. GLP-1 has been shown to augment glucose-dependent insulin secretion. It also reduces glucagon secretion, slows gastric emptying, and decreases appetite. GLP-1 is rapidly inactivated by dipeptidyl peptidase 4 (DPP-4). Exenatide is an agonist at GLP-1 receptors, but it is resistant to DPP-4. It is given by injection twice daily. There are reports of rare cases of hemorrhagic or necrotizing pancreatitis with exenatide.

Sitagliptin inhibits GPP-4, decreasing the biotransformation of GLP-1. It is given orally.

Analogue of Amylin

Pramlintide is an analogue of amylin that is approved in the United States. Amylin is a peptide containing 37 amino acids. It is produced by pancreatic β cells and cosecreted with insulin. Amylin has a role in the maintenance of glucose homeostasis. It decreases glucagon secretion, slows gastric emptying by a vagally mediated mechanism, and decreases appetite centrally. Pramlintide is an analogue of amylin and has an action similar to amylin. It is used in patients who are being treated with insulin (type 1 and type 2 diabetics). It is given by injection at mealtimes.

MISCELLANEOUS DRUGS USED IN THE TREATMENT OF DIABETIC PATIENTS

α -Glucosidase Inhibitors

Acarbose and miglitol are α -glucosidase inhibitors approved for use in the United States. The structure of acarbose is shown in Figure 36-3. α -glucosidases facilitate digestion of complex starches, oligosaccharides, and disaccharides into monosaccharides, allowing them to be absorbed from the small intestine. α -glucosidase inhibitors are competitive, reversible inhibitors of intestinal α -glucosidases. Acarbose also inhibits α -amylase. α -glucosidase inhibitors delay absorption of most carbohydrates. This delayed absorption limits the postprandial increase in glucose. They do not directly affect insulin secretion.

Pharmacokinetics

α -Glucosidase inhibitors are taken at the beginning of meals. Absorption of acarbose is poor. It is metabolized in the gastrointestinal tract, principally by intestinal bacteria. Miglitol is absorbed after oral administration.

Adverse effects

Adverse effects include flatulence, diarrhea, and abdominal pain from the presence of undigested carbohydrates in the lower gastrointestinal tract. These effects tend to decrease with continued use. When given alone, α -glucosidase inhibitors do not cause hypoglycemia. Hypoglycemia may occur, however, with concurrent sulfonylurea therapy. Hypoglycemia should be treated with glucose, not sucrose, because breakdown of sucrose may be inhibited. Miglitol has minor lactase inhibitory activity, but should not induce lactose intolerance.

Drug interactions

Miglitol decreases plasma concentrations of several drugs, including glyburide and metformin.

Contraindications

Contraindications to α -glucosidase inhibitors include hypersensitivity to these agents, inflammatory bowel disease, and intestinal obstruction.

Inositolphosphoglycans

Evidence suggests that interaction of insulin with its receptor leads to the release of low-molecular-weight IPGs, which enter the cell and act as mediators of insulin action. IPG mediators have been shown to reproduce various short-term effects of insulin (see Figure 36-2). Two families of IPG insulin mediators have been isolated. Myo-inositol is a major component of one; chiro-inositol is a major component of the other. Studies have shown the presence of hypochiro-inositoluria in type 2 diabetics. In addition, there is decreased chiro-

inositol content and decreased chiro-inositol mediator activity in type 2 diabetics.¹ There is evidence that chiro-inositol decreases elevated blood glucose concentrations in diabetic monkeys and rats. Studies have also shown that pinitol, which is 3-O-methyl chiro-inositol, decreases hyperglycemia in a diabetic murine model and in humans with diabetes.

Angiotensin-Converting Enzyme Inhibitors

Angiotensin-converting enzyme inhibitors and angiotensin II receptor blockers have been shown to delay the onset and reduce significantly the progression of diabetic nephropathy. They are given to diabetics to decrease the incidence of these complications of the disease.¹²

GLUCAGON

Glucagon is synthesized in the α cells of the pancreatic islets. It is a 29-amino acid peptide with a molecular weight of approximately 3500 Da. Similar to insulin, it is formed from a larger precursor molecule by proteolytic cleavage. Glucagon binds to specific G_s protein-linked receptors in the liver, causing an increase in adenylyl cyclase activity and production of cyclic adenosine 3',5'-monophosphate. This ultimately results in an increase in glycogen phosphorylase activity and a decrease in glycogen synthase. Glucagon increases blood glucose concentration by decreasing glycogen synthesis, stimulating breakdown of stored glycogen, and increasing gluconeogenesis in the liver. It does not affect skeletal muscle glycogen, presumably because of a lack of receptors in skeletal muscle. Glucagon has potent inotropic and chronotropic effects on the heart. These are similar to effects resulting from β -adrenergic receptor stimulation.

Pharmacokinetics

Glucagon is rapidly degraded in the plasma, liver, and kidney. Its half-life is 3 to 6 minutes.

Therapeutic Uses

Glucagon may be used in the emergency treatment of severe hypoglycemic reactions (sufficient to cause unconsciousness). It is given parenterally. Glucagon is also used to reverse the cardiac effects of toxic amounts of β -adrenergic receptor blockers.

Adverse Effects

Adverse effects include nausea (usually transient) and vomiting. Glucagon may cause transient tachycardia and hypertension.

IMPLICATIONS FOR DENTISTRY

There are approximately 23.6 million diabetics (approximately 7.8% of the population) in the United States. About a quarter of diabetics are unaware that they have the disease. In the United States, the annual number of newly diagnosed diabetes cases tripled during 1980-2005.

Type 2 diabetes is becoming increasingly common and is an emerging problem in children and adolescents, particularly minorities. Major risk factors for type 2 diabetes are obesity and physical inactivity. Dentists can expect to have an increasing number of diabetic patients, many of whom are unaware of their condition.

Diabetes mellitus is a complex, chronic disease that is characterized by hyperglycemia. It is an incurable disease, and the need for lifelong compliance is a problem for many patients. Complications of the disease include neuropathy, microangiopathy, and macrovascular disease. Diabetic neu-

ropathy may cause numbness, tingling, or a deep burning pain. Neuropathy may manifest as oral paresthesias and burning mouth. Diabetics are more susceptible to infection and have an impaired ability to deal with infection. They also have delayed wound healing. In addition, infection, stress (emotional or physical), and surgical procedures commonly disturb the control of diabetes.

Numerous oral complications may occur in diabetes, including xerostomia; infection; poor healing of wounds or lesions; and an increased incidence and severity of caries, candidiasis, gingivitis, periodontal disease, and periapical abscesses. Diabetics often have progressive periodontal disease and may have multiple periodontal abscesses. Diabetics may have burning mouth syndrome or loss of sensation. Type 2 diabetics have impaired sweet taste detection (glucose and sucrose).

Because of the antihyperglycemic drugs or irregular eating habits or both, patients may become hypoglycemic. Signs and symptoms of mild hypoglycemia include hunger, weakness, tachycardia, pallor, and sweating. Tachycardia may be masked by β -adrenergic receptor blockers. β Blockers, especially nonselective ones, also tend to worsen hypoglycemia. Signs of moderate hypoglycemia include incoherence, uncooperativeness, belligerence, lack of judgment, and poor orientation. If hypoglycemia is severe, the patient may become unconscious.

Diabetics are more susceptible to infection and may need antimicrobial therapy more often. Morning appointments are usually best for diabetic patients because that minimizes the chance of stress-induced hypoglycemia. A source of sugar should be readily available. Patients taking α -glucosidase inhibitors need glucose, not sucrose, because breakdown of sucrose may be inhibited by these drugs.

ANTIHYPERTENSIVE AND HYPERGLYCEMIC AGENTS

<i>Nonproprietary (generic) name</i>	<i>Proprietary (trade) name</i>
Antihyperglycemic agents	
Acarbose	Precose
Acetohexamide	Dymelor
Chlorpropamide	Diabinese
Exenatide	Byetta
Glimepiride	Amaryl
Glipizide	Glucotrol, Glucotrol XL
Glyburide	Micronase, DiaBeta, Glynase PresTabs
Insulin	See Table 36-3
Metformin	Glucophage, Riomet
Miglitol	Glyset
Nateglinide	Starlix
Pioglitazone	Actos
Pramlintide	Symlin
Repaglinide	Prandin
Rosiglitazone	Avandia
Sitagliptin	Januvia
Tolazamide	Tolinase
Tolbutamide	Orinase
Combined preparations	
Glipizide + metformin	Metaglip
Glyburide + metformin	Glucovance
Pioglitazone + glimepiride	Duetact
Rosiglitazone + glimepiride	Avandaryl

<i>Nonproprietary (generic) name</i>	<i>Proprietary (trade) name</i>
Rosiglitazone + metformin	Avandamet
Sitagliptin + metformin	Janumet
Hyperglycemic agents	
Glucagon	—
Glucose	Insta-Glucose

CITED REFERENCES

- Asplin I, Galasko G, Larner J: Chiro-inositol deficiency and insulin resistance: a comparison of the chiro-inositol- and the myo-inositol-containing insulin mediators isolated from urine, hemodialysate, and muscle of control and type II diabetic subjects. *Proc Natl Acad Sci U S A* 90:5924-5928, 1993.
- Beck-Nielsen H, Hother-Nielsen O, Pedersen O: Mechanism of action of sulfonylureas with special reference to the extrapancreatic effect: an overview. *Diabetic Med* 5:613-620, 1988.
- Dabelea D, Pettitt DJ, Jones KL, et al: Type 2 diabetes mellitus in minority children and adolescents: an emerging problem. *Endocrinol Metab Clin North Am* 28:709-729, 1999.
- DeFronzo RA, Goodman AM: Efficacy of metformin in patients with non-insulin-dependent diabetes mellitus. The Multicenter Metformin Study Group. *N Engl J Med* 333:541-549, 1995.
- Ganda OP, Soeldner JS, Gleason RE, et al: Metabolic effects of glucose, mannose, galactose, and fructose in man. *J Clin Endocrinol Metab* 49:616-622, 1979.
- Groop LC: Insulin resistance: the fundamental trigger of type 2 diabetes. *Diabetes Obes Metab* 1(Suppl 1):S1-S7, 1999.
- Heine RJ: Diabetes in the next century: challenges and opportunities. *Neth J Med* 55:265-270, 1999.
- Huang LC, Fonteles MC, Houston DB, et al: Chiroinositol deficiency and insulin resistance, III: acute glycolytic and hypoglycemic effects of two inositol phosphoglycan insulin mediators in normal and streptozotocin-diabetic rats in vivo. *Endocrinology* 132:652-657, 1993.
- Kawamori R, Morishima T, Kubota M, et al: Influence of oral sulfonylurea agents on hepatic glucose uptake. *Diabetes Res Clin Pract* 28:S109-S113, 1995.
- Lawrence JM, Reckless JP: Pioglitazone. *Int J Clin Pract* 54:614-618, 2000.
- Lawson WB, Zeidler A, Rubenstein A: Taste detection and preferences in diabetics and their relatives. *Psychosom Med* 41:219-227, 1979.
- Lewis EJ, Hunsicker LG, Bain RP, et al: The effect of angiotensin-converting-enzyme inhibition on diabetic nephropathy. The Collaborative Study Group. *N Engl J Med* 329:1456-1462, 1993.
- O'Brien RM, Granner DK: Regulation of gene expression by insulin. *Physiol Rev* 76:1109-1161, 1996.
- Olson AL, Pessin JE: Structure, function, and regulation of the mammalian facilitative glucose transporter gene family. *Annu Rev Nutr* 16:235-256, 1996.
- O'Meara NM, Sturis J, Blackman JD, et al: Analytical problems in detecting rapid insulin secretory pulses in normal humans. *Am J Physiol* 264:E231-E238, 1993.
- Onkamo P, Vaananen S, Karvonen M, et al: Worldwide increase in incidence of type I diabetes—the analysis of the data in published incidence trends. *Diabetologia* 42:1395-1403, 1999.
- Pyke DA: Diabetes: the genetic connections. *Diabetologia* 17:333-343, 1979.
- Schwartz AV, Sellmeyer DE: Effect of thiazolidinediones on skeletal health in women with type 2 diabetes. *Expert Opin Drug Saf* 7:69-78, 2008.

GENERAL REFERENCES

- Aguilar-Bryan L, Nichols CG, Wechsler SW, et al: Cloning of the beta cell high-affinity sulfonylurea receptor: a regulator of insulin secretion. *Science* 268:423-426, 1995.

- Bailey CJ: Biguanides and NIDDM, *Diabetes Care* 15:755-772, 1992.
- Banting FG, Best CH, Collip JB, et al: Pancreatic extracts in the treatment of diabetes mellitus, *Can Med Assoc J* 12:141-146, 1922.
- Bates SH, Jones RB, Bailey CJ: Insulin-like effect of pinitol, *Br J Pharmacol* 130:1944-1948, 2000.
- Bolen S, Feldman L, Vassy J, et al: Systematic review: Comparative effectiveness and safety of oral medications for type 2 diabetes mellitus, *Ann Intern Med* 147:386-399, 2007.
- Cohick WS, Clemmons DR: The insulin-like growth factors, *Ann Rev Physiol* 55:131-153, 1993.
- Drugs for type 2 diabetes, *Med Lett Drugs Ther* 6:47-54, 2008.
- Duronio V, Jacobs S: Comparison of insulin and IGF-1 receptors. In Kahn CR, Harrison LC, editors: *Insulin receptors, part B. Clinical assessment, biological responses and comparison to the IGF-1 receptor*, New York, 1988, Alan R Liss.
- Fujimoto WY, Bergstrom RW, Boyko EJ, et al: Preventing diabetes—applying pathophysiological and epidemiological evidence, *Br J Nutr* 84:173-176, 2000.
- Hirsch IB: Insulin analogues, *N Engl J Med* 352:174-183, 2005.
- Kim JJ, Kim JC, Kang MJ, et al: Effects of pinitol isolated from soybeans on glycaemic control and cardiovascular risk factors in Korean patients with type II diabetes mellitus: a randomized controlled study, *Eur J Clin Nutr* 59:456-458, 2005.
- Kilgour E, Larner J, Romero G: The generation of inositolglycan mediators from rat liver plasma membranes: the role of guanine nucleotide binding proteins, *Biochem Biophys Res Comm* 186:1151-1157, 1992.
- Larner J: Four questions times two: a dialogue on the mechanism of insulin action dedicated to Earl W. Sutherland, *Metabolism* 24:249-255, 1975.
- Leibiger IB, Leibiger B, Berggren P-O: Insulin signaling in the pancreatic β -cell, *Ann Rev Nutr* 28:233-251, 2008.
- McGuinness OP: Defective glucose homeostasis during infection, *Ann Rev Nutr* 25:9-35, 2005.
- Martikkala V, Sundvall J: Prevention of type 2 diabetes mellitus by changes in lifestyle among subjects with impaired glucose tolerance, *N Engl J Med* 344:1343-1350, 2001.
- Mertes G: Safety and efficacy of acarbose in the treatment of type 2 diabetes: data from a 5-year surveillance study, *Diabetes Res Clin Pract* 52:193-204, 2001.
- Nathan DM: Prevention of long-term complications of non-insulin-dependent diabetes mellitus, *Clin Invest Med* 18:332-339, 1995.
- Panten U, Burgfeld J, Goerke F, et al: Control of insulin secretion by sulfonylureas, meglitinide and diazoxide in relation to their binding to the sulfonylurea receptor in pancreatic islets, *Biochem Pharmacol* 38:1217-1229, 1989.
- Partanen J, Niskanen L, Lehtinen J, et al: Natural history of peripheral neuropathy in patients with non-insulin-dependent diabetes mellitus, *N Engl J Med* 333:89-94, 1995.
- Philipson LH, Steiner DF: Pas de deux or more: the sulfonylurea receptor and K^+ channels, *Science* 268:372-373, 1995.
- Pratley RE, Foley JE, Dunning BE: Rapid acting insulinotropic agents: restoration of early insulin secretion as a physiologic approach to improve glucose control, *Curr Pharm Des* 7:1375-1397, 2001.
- Scheen AJ: Non-insulin-dependent diabetes mellitus in the elderly, *Baillieres Clin Endocrinol Metab* 11:389-406, 1997.
- Sels JP, Huijberts MS, Wolffenbuttel BH: Miglitol, a new alpha-glucosidase inhibitor, *Expert Opin Pharmacother* 1:149-156, 1999.
- Stumvoll M, Nurjan N, Perriello G, et al: Metabolic effects of metformin in non-insulin-dependent diabetes mellitus, *N Engl J Med* 333:550-554, 1995.
- Tchobroutsky G, Charitanski D, Blouquit Y, et al: Diabetic control in 102 insulin-treated out-patients, *Diabetologia* 18:447-452, 1980.
- Van den Brande JL: A personal view on the early history of the insulin-like growth factors, *Horm Res* 51:149-175, 1999.
- Visscher TL, Seidell JC: The public health impact of obesity, *Annu Rev Public Health* 22:355-375, 2001.
- Yalow RS, Berson SA: Immunoassay of endogenous plasma insulin in man, *J Clin Invest* 39:1157-1175, 1960.

Steroid Hormones of Reproduction and Sexual Development*

ANGELO J. MARIOTTI

The central focus of endocrinology is on specific regulatory molecules (i.e., hormones) that govern reproduction; growth and development; maintenance of the internal environment; and energy production, usage, and storage. As a result of these global demands within the organism, the actions of hormones are complex and diverse in nature. A single hormone may elicit a different outcome in various tissues, or a variety of hormones may be required to produce a single, particular effect in a group of tissues. Estrogens can function independently to stimulate growth of the breast (promotion of fat accumulation, connective tissue development, and ductal growth) yet must work in concert with other hormones (prolactin, progesterone, placental lactogen, glucocorticoids, thyroxine, and oxytocin) to regulate lactation. Despite the complex and diverse nature of hormones, it is possible to categorize these compounds into two classes depending on their chemical structure: the peptide/amino acid derivative hormones and the steroid hormones.

Steroid hormones are derivatives of cholesterol and consist of a combination of three rings of six carbon atoms each (phenanthrene) and one ring of five carbon atoms (cyclopentane) to form a complex hydrogenated cyclopentanoperhydrophenanthrene ring system (Figure 37-1). Steroid hormones can be divided further into three principal sets: corticosteroid hormones (glucocorticoids and mineralocorticoids), Ca⁺⁺-regulating steroid hormones (vitamin D and its metabolites), and gonadal or sex steroid hormones (estrogens, androgens, and progestins).

The past 50 years have dramatically improved our perceptions concerning the actions of sex steroid hormones in health and disease. Although there is no doubt of the importance of sex steroid hormones in reproductive endocrinology, evidence has accrued that gonadal hormones have a much broader role in human tissues. Androgens, estrogens, and progestins are now believed to be directly or indirectly involved in the regulation of various diverse tissues, such as the brain, heart, kidney, skin, liver, and tissues of the oral cavity. Reports of the effects of sex steroid hormones in the periodontium, a unique structure composed of two fibrous (gingiva and periodontal ligament) and two mineralized (cementum and alveolar bone) tissues, have been noted for more than a century. The effect of sex steroid hormones on each periodontal tissue has heightened interest in defining the specific relationships among androgens, estrogens, and progestins and their role in normal function and disease in the periodontium.

*The author recognizes Dr. William Warner for his past contributions to this chapter.

Since the identification of gonadal hormones in the early twentieth century, the use of these agents has exploded. Today, steroidal and nonsteroidal compounds with properties of sex steroid hormones are extensively used in the prophylaxis or treatment of disease and for birth control. Although dentists do not typically prescribe these agents, their ubiquitous presence in the population requires a careful understanding of the actions and interactions of sex steroids with other pharmacologic agents and how they affect structures in the oral cavity.

STRUCTURE AND FUNCTION

Androgens

Androgens (Figure 37-2) are derived from a 19-carbon tetracyclic hydrocarbon nucleus known as *androstane*. One of the most potent androgenic hormones, testosterone, is synthesized by the Leydig cells of the testes, the thecal cells of the ovary, and the adrenal cortex. In men, testosterone is the principal plasma androgen and is reduced to dihydrotestosterone, the mediator of most actions of the hormone.³² The irreversible metabolic conversion of testosterone to dihydrotestosterone occurs only in tissues that contain the enzyme 5 α -reductase.⁵¹ Testosterone (but not dihydrotestosterone) can also be aromatized to estradiol by numerous extragonadal tissues (primarily adipose tissue and skeletal muscle), a common route of estrogen production in men. In women, the major plasma androgen is androstenedione (androst-4-ene-3,17-dione), which can be secreted into the bloodstream or converted into either testosterone or estradiol by the ovary.

When secreted into the bloodstream, most androgens are transported to their sites of action by a liver-secreted carrier protein termed *sex hormone-binding globulin* (44% bound) and serum albumins and other proteins (54% bound).⁷ Secreted plasma androgens are also metabolized to physiologically weak or inactive molecules consisting of either 17-ketosteroids or polar compounds (diols, triols, and conjugates) for excretion by the kidney or liver.²⁰

Androgens may be administered orally, topically, or through intramuscular injections (Table 37-1). Testosterone is generally not administered enterally because extensive first-pass hepatic metabolism rapidly reduces plasma concentrations. The bioavailability of androgens is increased by intramuscular injections in an oil vehicle, by transdermal application, or by alkylation at C17, which significantly decreases hepatic metabolism and makes oral administration therapeutically possible.

The biologic activities of androgens are manifested in virtually every tissue of the body. Important functions of andro-

gens include (1) male sexual differentiation of wolffian ducts, external genitalia, and brain in utero; (2) development of adult male phenotype, including growth and maintenance of male sex accessory organs and anabolic actions on skeletal muscle, bone, and hair; (3) facilitation of human sexual behavior; and (4) regulation of specific metabolic processes in the liver, kidney, and salivary glands.³²

Estrogens

Estrogens (Figure 37-3)—estrone, estradiol, and estriol—are characterized by an aromatic A ring, a hydroxyl group at C3, and either hydroxyl groups (C16 and C17) or a ketone group (C17) on the D ring. Estradiol is the most potent estrogen

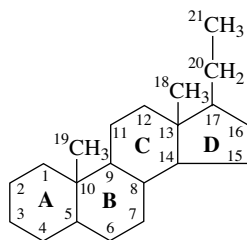

FIGURE 37-1 Ring structure for pregnane and numbering system for steroids. Progesterone contains 21 carbons. Androgens, estrogens, and some progestins lack carbons 20 and 21. Estradiol and synthetic estrogenic steroids have an aromatic ring A and lack carbon 19.

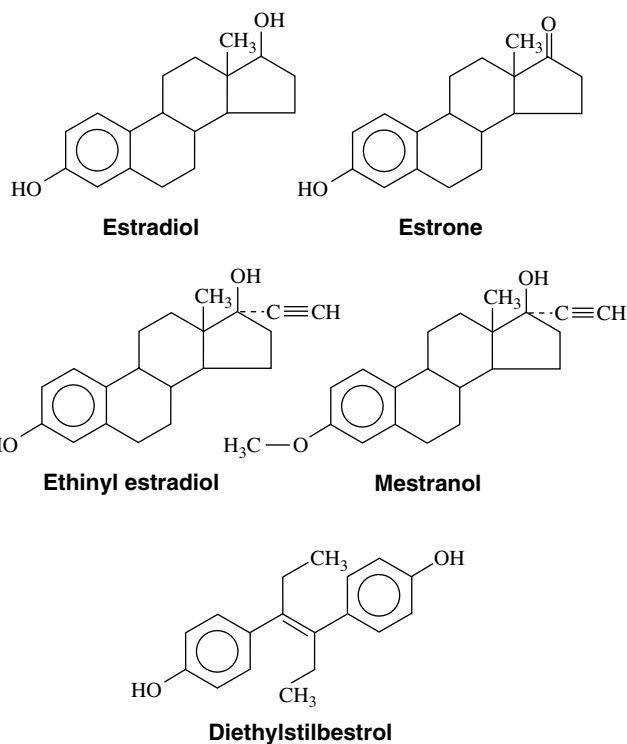

FIGURE 37-3 Structural formulas of estradiol and other estrogens.

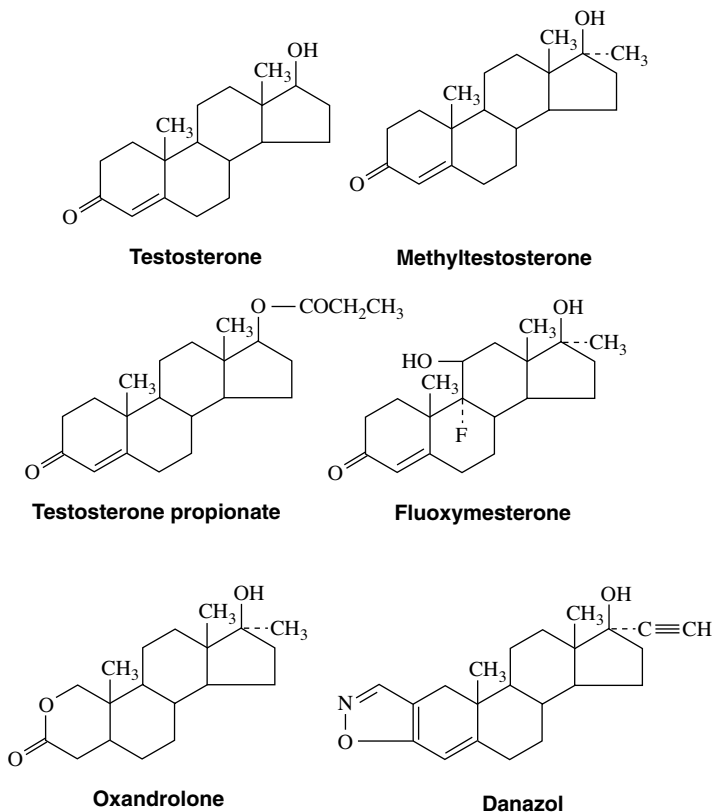

FIGURE 37-2 Structural formulas of testosterone and other androgens.

TABLE 37-1

Anabolic-Androgenic Drugs

NONPROPRIETARY (GENERIC) NAME	PROPRIETARY (TRADE) NAME	INDICATIONS	DOSE	MISCELLANEOUS
Danazol	Danocrine	Endometriosis, fibrocystic breast disease, hereditary angioedema	Oral, 800 mg/day	Suppresses pituitary-ovarian axis; weak androgen
Fluoxymesterone	Halotestin	Delayed puberty in boys, hypogonadism, breast cancer	Oral, 10-40 mg/day depending on indication	Methylated androgens are more likely to cause jaundice
Methyltestosterone	Android, Testred, Virilon	Delayed puberty in boys, hypogonadism, breast cancer	Oral, 5-200 mg/day depending on indication	Methylated androgens are more likely to cause jaundice
Oxandrolone	Oxandrin	Catabolic or tissue-depleting processes	Oral, 2.5-20 mg/day depending on indication	Methylated androgens are more likely to cause jaundice
Testosterone propionate	Testex	Lichen sclerosus, microphallus	Injected or topical (ointment)	Ester forms of testosterone increase its duration of action

TABLE 37-2

Estrogenic Drugs

NONPROPRIETARY (GENERIC) NAME	PROPRIETARY (TRADE) NAME	INDICATIONS	DOSE	MISCELLANEOUS
Diethylstilbestrol	Stilphostrol	Prostatic carcinoma	Oral, 1 mg/day	Not available in U.S., available in Canada
Ethinyl estradiol	Estinyl	Prostatic carcinoma; menopausal vasomotor symptoms; estrogen deficiency from surgery, ovarian failure, or hypogonadism; contraception	Oral, 0.02-0.15 mg/day depending on indication	Used in combination with progestins in oral contraceptives
Conjugated estrogens	Premarin	Menopausal symptoms, prevention of postmenopausal bone loss, atrophic vaginitis, hypoestrogenism	Oral, 0.3-1.25 mg/day (more in certain circumstances); intravenous or intramuscular (for hormone imbalance), up to 50 mg/day; vaginal cream, 0.5-2 g/day	

and is secreted by the ovary, testes, placenta, and peripheral tissues. Estrone is also secreted by the ovary; however, the principal source in women and men is through extragonadal conversion of androstenedione in peripheral tissues.⁴³ In premenopausal women, the most abundant physiologic estrogen is estradiol; in men and postmenopausal women, the most abundant estrogen in the plasma is estrone.⁵⁴ Similar to other lipid-soluble hormones, estrogens are transported in the blood principally bound to carrier proteins; estradiol in the plasma is bound by either albumin (60%) or sex hormone-binding globulin (38%), leaving only 2% of the hormone free.⁵³ Estradiol and estrone are metabolized principally to estriol, which is the major estrogen detected in the urine.

Estrogens may be administered orally, topically, or through intramuscular injections (Table 37-2). Although estradiol is available for enteral administration, it is generally not used in this manner because concentrations in the bloodstream remain low because of extensive hepatic metabolism.¹⁰ The half-life of estrogenic compounds can be increased by synthetic substitutions on the C or D ring (see Figure 37-3). The half-life of estradiol is a few minutes, whereas the half-life of ethinyl

estradiol (ethinyl substitution at the C17 position) may be more than 13 hours. Nonsteroidal compounds may also have estrogenic activity; examples of such compounds include diethylstilbestrol, flavones, isoflavones, and certain pesticides (e.g., p,p'-DDT) and plasticizers (e.g., bisphenol A).

The biologic activities of estrogens in women include (1) development, growth, and maintenance of secondary sex characteristics; (2) uterine growth; (3) pulsatile release of luteinizing hormone from the pituitary; (4) thickening of the vaginal mucosa; and (5) ductal development in the breast. In men, the physiologic significance of estrogens is largely unknown, but may be involved in the regulation of plasma androgen and estrogen levels and sexual behavior.

Progestins

Progestins (Figure 37-4), or steroids that have progestational activity, are derived from a 21-carbon saturated steroid hydrocarbon known as *pregnane*. The principal progestational hormone secreted into the bloodstream is progesterone, which is synthesized and secreted by the corpus luteum, placenta, and adrenal cortex. As with androgens, most progesterone is

TABLE 37-3

Progestins

NONPROPRIETARY (GENERIC) NAME	PROPRIETARY (TRADE) NAME	INDICATIONS	DOSE	MISCELLANEOUS
Medroxyprogesterone acetate	Provera, Depo-Provera	Dysfunctional uterine bleeding, endometrial carcinoma, contraception	Oral and injectable (IM), 5-20 mg/day orally or 150 mg IM for 3 mo to 400 mg IM per month depending on indication	
Norethindrone	Aygestin, Micronor, Nor-QD	Dysfunctional uterine bleeding, endometriosis, contraception	Oral, variable depending on indication	For contraception, 0.35 mg/day
Norgestrel	Ovrette	Contraception	Oral, 0.075 mg/day	

IM, Intramuscular.

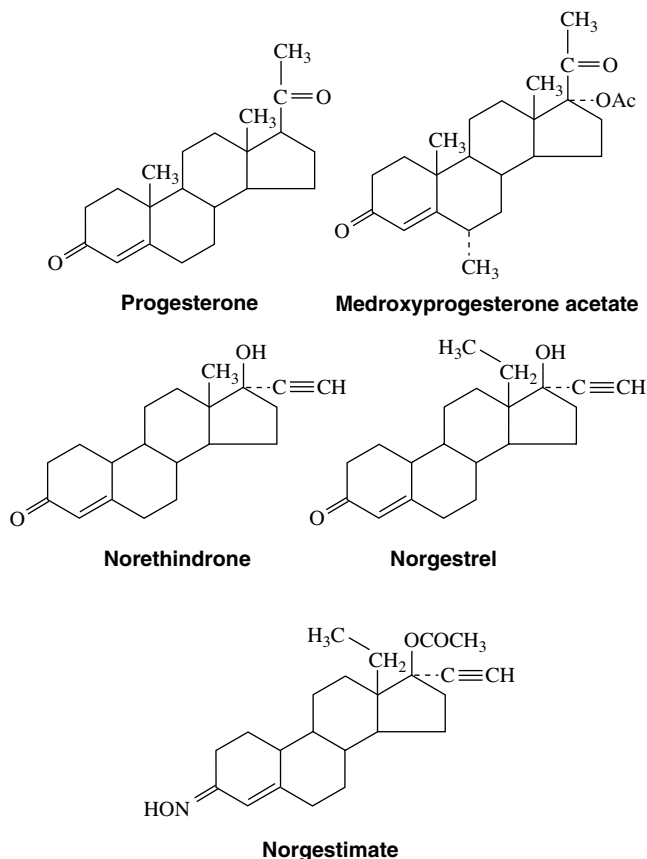

FIGURE 37-4 Structural formulas of progesterone and progestins.

transported in the bloodstream by plasma proteins; however, progesterone in humans is primarily nonspecifically bound to globulin and albumin proteins. The fate of plasma progesterone depends on hepatic, extrahepatic, and extra-adrenal metabolism. 5- α -Dihydroprogesterone and deoxycorticosterone are the most probable active progesterone metabolites. Metabolic inactivation of progesterone to pregnanediol is accomplished by the liver.

Progestins may be administered orally, topically, or through intramuscular injections (Table 37-3). Progesterone is available for enteral administration; however, it is generally not administered in this manner because concentrations in the bloodstream remain low because of extensive first-pass hepatic metabolism. The bioavailability of progestins can be increased

by intramuscular injections in oil, by vaginal suppositories, or by ethinyl or other substitution at C17, which significantly decreases hepatic metabolism.

The biologic activities of progestins are principally observed during the luteal phase of the menstrual cycle and pregnancy. Progesterone is necessary for glandular endometrial development before nidation, the development of mammary lobules and alveoli, and the maintenance of pregnancy (i.e., endometrial gland function, decreased excitability of myometrium, and possible effects on the immune system to decrease rejection of the developing fetus). Progesterone also decreases hepatic secretion of very-low-density lipoprotein and high-density lipoprotein, diminishes insulin action, stimulates the hypothalamic respiratory center, elevates basal core body temperature at ovulation, and enhances sodium excretion by the kidneys.

MECHANISM OF ACTION

In the bloodstream, sex steroid hormones exist in extremely low concentrations (in the femtomolar to nanomolar range), yet are capable of regulating differentiation and growth in selected tissues distant from the site of secretion. The actions of sex steroid hormones become even more intriguing when one considers that the distinct biologic effects of these hormones depend on nominal differences between relatively small (molecular weight approximately 300 Da) molecules. Testosterone, which is capable of powerful virilizing effects, differs from estradiol by only one carbon atom and four hydrogen atoms. (Estradiol is aromatic, as are the other estrogens.) These differences in molecular structure of steroid hormones change biologic activity. Specificity of hormone response also depends on the presence of intracellular proteins or receptors, which specifically recognize and selectively bind the hormone and act in concert with the hormone ligand to regulate gene expression.

The current hypothesis of sex steroid hormone action² begins with the absorption of the hormones into the bloodstream, where they circulate, principally bound (approximately 98%) to plasma proteins. In the circulation, the unbound or free hormone can enter the cell by diffusion and bind to receptors. These large intracellular protein receptors are located in the nucleus of the cell. When the steroid hormone is bound to the receptor, it transforms the receptor to an active configuration, and the activated receptor-steroid hormone complex binds with high affinity to specific nuclear sites (e.g., discrete DNA sequences, nuclear matrix, nonhistone proteins, nuclear membrane). When the receptor-hormone complex is bound to nuclear regulatory elements, a coactivator is usually recruited to the promoter region

to allow gene activation and transcription of messenger RNA. After the nuclear interaction, the receptor-hormone complex dissociates, leaving an unoccupied receptor and the steroid hormone. The dissociated receptor is thought to be in an inactive configuration that requires conversion to a form that can bind the steroid again, and the steroid hormone is metabolized and eliminated from the cell.

Although the regulation of gene transcription by hormone-receptor complexes in the nucleus seems to be the major biologic action of sex steroid hormones, these molecules also have other behaviors that are distinct from actions at nuclear receptors. Androgens, estrogens, and progestins have membrane effects and can influence the production of second messenger systems, which can affect neural transmission, the transport of Ca^{++} ions into cells, and the intracellular concentration of polyamines.²⁸

Steroid Hormone Receptor Structure

The receptors for steroid hormones are able to initiate a wide assortment of responses yet are very similar to one another, not only in their mechanism of action, but also in their structure.^{9,22} In general, steroid hormone receptors consist of asymmetric protein subunits with long (10:101) axial ratios. These subunits, which form either dimers or tetramers at low ionic strengths, range in weight from 80 to 100 kDa. As a class of regulatory proteins, the different steroid hormone receptors have a high degree of homology. Each protein can be divided into six sections, designated as regions A through F.³²

The A/B regions located at the N-terminal are exceedingly variable in size (50 to >500 amino acids) and have negligible amino acid similarities between different receptors. The C region, located between the N-terminus and C-terminus, is a remarkably conserved area that contains the DNA-binding domain. The hydrophilic D region is not conserved in length or sequence but may serve as a hinge between the hormone-binding and DNA-binding domains. The E/F regions located at the C-terminal are similar in size (250 to 300 amino acids), have moderate amino acid homology among the different steroid receptor proteins, and contain the hormone-binding domain. Areas in the N-terminal and the C-terminal are responsible for the transcriptional activation of the DNA.^{13,23}

From these six regions, two important binding domains are present for sex steroid hormone receptors. In one binding

domain, the functional activation of the receptor depends on a distinct, high-affinity binding site for a specific hormone. This steroid hormone-binding domain is a large hydrophobic region located near the C-terminal. The other receptor-binding domain recognizes specific sites on DNA. This DNA-binding domain of the steroid receptor is a highly conserved area that contains a tetrahedral arrangement of four cysteine residues around a zinc ion to form a zinc finger-like structure.³⁰ On activation of the receptor, the receptor-steroid complex binds to a specific site on the DNA that is referred to as a *steroid responsive element*. Steroid responsive elements are unique for each receptor but have common nucleotide characteristics.

THERAPEUTIC USES

Androgens

The least controversial and principal indication for androgen therapy is for the treatment of testosterone deficiency in adolescent boys and men. Transdermal testosterone preparations have been used to mimic normal serum levels for testosterone-deficient boys to develop normal genitalia and secondary sex characteristics and for the normal virilization of hypogonadal men. Other, less common and more controversial applications for androgens include uses for male senescence, female hypogonadism, enhancement of athletic performance, male contraception, catabolic and wasting states, angioneurotic edema, and blood dyscrasias.

Estrogens

The two principal reasons for the prescription of estrogens are for the prevention of conception and to reduce the sequelae associated with declining hormone levels after menopause. Oral contraceptives are among the most widely used medications in the world and most often are a combination of estrogens and progestins (Table 37-4). Combination oral contraceptives principally affect conception by suppressing the surge of luteinizing hormone, which consequently prevents ovulation (Figure 37-5).²⁴ The estrogen component of combination oral contraceptives usually contains either ethinyl estradiol or mestranol. In these preparations, the estrogen content ranges from 20 to 50 μg ; pills containing less than 35 μg are usually considered low-dose contraceptives.

TABLE 37-4

Examples of Contraceptive Agents

PROPRIETARY (TRADE) NAME	ESTROGEN	PROGESTIN
Ovcon-35 (monophasic), Ortho-Novum 10/11 (biphasic), Necon 7/7/7 (triphasic), Loestrin 24 Fe* (monophasic)	Ethinyl estradiol	Norethindrone
Norinyl 1/50 (monophasic), Ortho-Novum 1/50 (monophasic)	Mestranol	Norethindrone
Ortho-Cyclen (monophasic), Ortho Tri-Cyclen (triphasic)	Ethinyl estradiol	Norgestimate
Lo/Ovral (monophasic), Cryselle (monophasic)	Ethinyl estradiol	Norgestrel
Yaz* (monophasic), Yasmin (monophasic)	Ethinyl estradiol	Drospirenone
Seasonale (84-day therapy, extended cycle), Seasonique (84-day therapy, extended cycle)	Ethinyl estradiol	Levonorgestrel
Lybrel [†]	Ethinyl estradiol	Levonorgestrel
Micronor [†]	—	Norethindrone
Depo-Provera	—	Medroxyprogesterone acetate
Implanon (implant)	—	Etonogestrel
Ortho Evra (transdermal)	Ethinyl estradiol	Norelgestromin
NuvaRing (transvaginal)	Ethinyl estradiol	Etonogestrel
Plan B (emergency) [‡]	—	Levonorgestrel
Preven (emergency) [‡]	Ethinyl estradiol	Levonorgestrel

*24-day formulation followed by 4 days of inert tablets.

[†]Continuous therapy, without a placebo or pill-free period.

[‡]Emergency, postcoital preparation.

FIGURE 37-5 Hormonal changes during the normal menstrual cycle. The gonadotropins follicle-stimulating hormone (FSH), and luteinizing hormone (LH) are measured in mU/mL; the sex steroids estradiol and progesterone are plotted in units (1 unit = 100 pg/mL of estradiol and 2 ng/mL of progesterone). Combination oral contraceptives prevent ovulation by inhibiting LH (and FSH) secretion, resulting in no LH peak at mid-cycle.

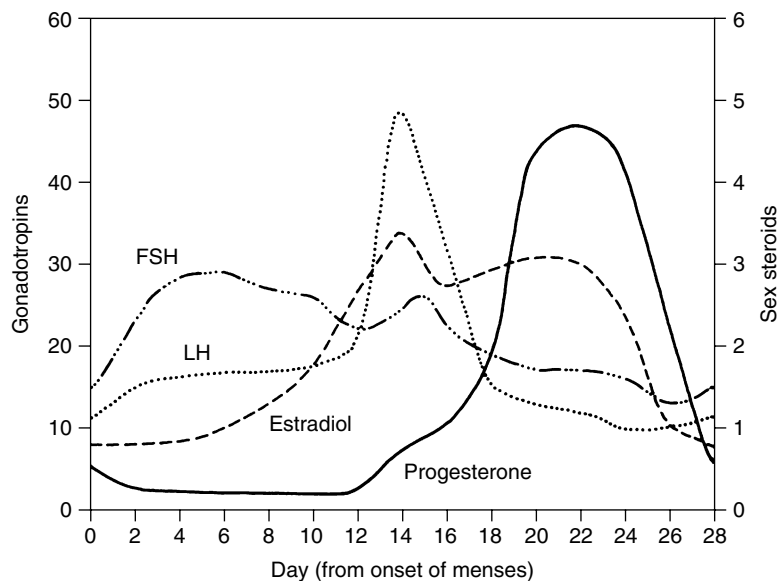

Combination oral contraceptives include monophasic, biphasic, or triphasic preparations. Monophasic preparations maintain a fixed dose of estrogen and progesterone over a 21-day period; biphasic contraceptives maintain a fixed dose of estrogen but increase the progestin dose over a 21-day period; and triphasic preparations may have varying amounts of estrogen and progestin for 21 days. In each case the 21-day treatment regimen is followed by 7 days of placebo or no drug. Biphasic and triphasic oral contraceptives were designed to approximate more closely the ratios of estrogen and progesterone during the menstrual cycle. The progestin in the oral contraceptive also protects the endometrium of the uterus against the proliferative action of the estrogen. The inclusion of a progestin reduces the risk of endometrial cancer. A modification of these regimens is 24 days of drug treatment (monophasic) followed by 4 days of placebo.

More recently, extended-cycle and continuous contraceptive dosing were introduced. A combination of ethinyl estradiol and a progestin, usually levonorgestrel, is administered. Extended-cycle preparations (Seasonale and Seasonique) involve 84 days of drug treatment followed by placebo for 7 days or 7 pill-free days (see Table 37-4). An advantage with extended-cycle preparations is that menses occurs only four times a year in most cases. Continuous dosing involves no drug-free period; in this case, one adverse effect that has been reported is breakthrough bleeding. Contraceptives may also be administered transdermally or vaginally (see Table 37-4). An advantage to these routes of administration is the ability to reduce liver exposure to the hormones. Estrogens, by their effects on the liver, increase certain blood clotting factors and renin substrate, which increases the risk for thromboembolism and hypertension.

Another major use of estrogen has been in postmenopausal women for the prevention of osteoporosis-related fractures to vertebral or long bones. Osteoporosis is characterized by reduced bone mass and microarchitectural deterioration of cortical and trabecular bone and is a major public health problem among elderly women. In the United States, one in three postmenopausal women is affected by osteoporosis; by age 90 years, one in two women and one in six men are likely to sustain an osteoporosis-related fracture. Of affected elderly individuals, 12% to 20% die of fracture-related complications, making osteoporosis the twelfth leading cause of death in the United States.³⁴ It has been estimated that more than \$19

billion was required to treat the 2 million Americans who had an osteoporosis-related fracture and its sequelae. It is estimated that the costs of managing osteoporosis will increase to approximately \$25.3 billion by 2025.³³ As the elderly population continues to increase, so will the incidence of osteoporosis and its complications.^{14,17,34}

To reduce the incidence of osteoporosis, and if estrogen receptor agonists are indicated, treatment with a traditional estrogen or raloxifene (see later) in combination with exercise and an appropriate diet should begin before there is significant bone loss (Table 37-5). Estrogens can prevent further bone loss but cannot restore lost bone; the benefits of estrogen replacement therapy require continuous use of the drug. Estrogen replacement therapy has also been shown to be effective in the treatment of vasomotor symptoms associated with menopause (e.g., hot flashes, paresthesia, hyperhidrosis) and postmenopausal urogenital atrophy. Orally or locally administered estrogens can prevent the symptoms (e.g., pruritus vulvae, urinary incontinence, dysuria, dyspareunia) associated with a thinning epithelial lining of the vagina or bladder. As in oral contraceptives, the addition of a progestin in postmenopausal therapy protects against endometrial cancer.

In addition to the use of estrogens for postmenopausal women, estrogen treatment has been successful in adolescents when ovaries do not develop and puberty is absent.¹ Treatment with estrogen can promote normal growth of genital structures and breasts and assist in bone growth.

Progestins

Similar to estrogens, progestins can be used alone or in combination with estrogen for contraception and are used in combination for hormone replacement in postmenopausal women (see Table 37-5). The dose of the progestin component for combination oral contraceptives has greater variability because of differences in the potency of the progestin used. In most preparations, the progestin content ranges from 0.1 to 1 mg. Progestins commonly used in oral contraceptives include norethindrone and levonorgestrel. A unique progestin, drospirenone, is presently used in two oral contraceptive preparations (see Table 37-5). Drospirenone is also an antiandrogen and an antimineralocorticoid drug. Drospirenone has been shown to reduce blood pressure, hirsutism, acne, and premenstrual tension, which makes oral contraceptives with this progestin advantageous to many patients. It should not be used with

TABLE 37-5

Comparison of Drugs Used to Treat Postmenopausal Osteoporosis

PREPARATIONS AND COMPONENTS	PROPRIETARY NAME(S)	COMMENTS
Oral Combinations		
Estradiol/norgestimate	Prefest	Traditional estrogens protect bone and reduce hot flashes, but increase the risk of thromboembolism and breast cancer. The progestin component protects against endometrial cancer
Estradiol/norethindrone	Femhrt, Activella	
Conjugated equine estrogens/ medroxyprogesterone	Prempro, Premphase	
Estradiol/drospirenone	Angeliq	Drospirenone reduces blood pressure but increases the risk of hyperkalemia in patients with renal insufficiency or patients taking other drugs that can increase plasma K ⁺
SERM		
Raloxifene	Evista	Protects bone, reduces risk of breast cancer, very little effect on the uterus, but increases the risk of thromboembolism and does not prevent hot flashes
Transdermal		
Estradiol	Alora, Climara, Divigel, Elistrin, Estraderm, Evamist (spray), Menostar, Vivelle	Transdermal administration reduces liver effects of estradiol
Estradiol/norethindrone	Combi-Patch	
Estradiol/levonorgestrel	Climara Pro	

SERM, Selective estrogen receptor modulator.

other drugs that tend to increase plasma potassium concentrations or in patients with renal insufficiency because hyperkalemia may result.

Progestin-only contraceptives are also available and can be administered daily by oral administration. Long-acting (3 months to 3 years) preparations of progestin-only contraceptives are also available as subdermal implants (etonorgestrel) or through intramuscular injection (medroxyprogesterone acetate). Progestins can also be used for uterine bleeding disorders, infertility (luteal-phase support), and premature labor and as a diagnostic test for estrogen secretion and endometrial responsiveness.

ADVERSE EFFECTS

Androgens

In men, major untoward effects of pharmacologic doses of androgens include bladder irritation, breast soreness, gynecomastia, and priapism. In women, amenorrhea or oligomenorrhea and virilism (e.g., acne, decreased breast size, hirsutism, enlarged genitalia, male-pattern baldness, hoarseness, deepening of voice) can occur. For prepubertal children, virilism is a common untoward reaction of androgens, and stunting of linear growth is possible because of the premature closure of the epiphyses by androgens. Rarely in men and women, hepatic necrosis and hepatocellular tumors may develop in individuals who use 17 α -alkylated androgens for a long duration or at high doses.⁵

Estrogens and Progestins

Major concerns about untoward effects associated with estrogens have involved thromboembolic disorders, neoplasms, and hypertension. The use of estrogen-only preparations can

significantly increase endometrial cancer⁴² in postmenopausal women, but the risk declines if low doses of estrogen are combined with a progestin.³⁸ The association between estrogens, progestins, and breast cancer is more controversial. Analysis of epidemiologic studies has suggested that breast cancer increases by approximately 25% in women who use combination oral contraceptives.¹⁸ In older premenopausal women, the risk for breast cancer with oral contraceptive use increases probably as a result of other increasing health hazards.¹⁸ The incidence of breast cancer 10 years after discontinuation of oral contraceptives is not different from the incidence in women who have never used these agents.¹⁸

Other untoward consequences associated with estrogen therapy include an increased risk of thromboembolic disorders¹⁵ and stroke. Finally, estrogen therapy has also been implicated in increasing rates of gallbladder disease, nausea, vomiting, breast tenderness, edema, migraine, and endometriosis. More recent evidence indicates a small but significant cardiovascular risk with at least one type of postmenopausal hormone replacement therapy, and this has led to more restricted recommendations regarding such therapy.⁵² Despite the benefits of hormone replacement therapy, the risks of such therapy may outweigh the benefits.⁵² Risks include cardiovascular disease, breast cancer, and dementia, which for many women outweigh the reduction in bone loss and relief of postmenopausal symptoms. These findings are likely to change treatment strategies in many postmenopausal women. Options include other drugs to reduce osteoporosis and a reduction in the dose of sex hormones used in this age group.

Oral Contraceptives and the Periodontium

Numerous clinical studies from the late 1960s through the early 1980s have recorded gingival changes that develop as a result of the use of oral contraceptive agents. Several case

reports described gingival enlargement induced by oral contraceptives in otherwise healthy women with no history of gingival hyperplasia.^{16,26} In all cases, the gingival enlargement was reversed when oral contraceptive use was discontinued or the dosage was reduced. Other clinical studies have shown that oral contraceptives have the ability to induce gingival diseases^{8,35} that could ultimately lead to periodontal attachment loss.¹⁹ Since the 1970s it has become evident that many of the side effects elicited by oral contraceptives are dose-dependent. This realization led to the development of current, low-dose oral contraceptive formulations. In a prospective, longitudinal, clinical study, women using low-dose oral contraceptives were found to be at no greater risk of gingival disease than women who were not using these drugs.³⁹ Data from a cross-sectional study of the National Health and Nutrition Examination Survey (NHANES) I and NHANES III have not shown an association between current low-dose oral contraceptives and increased levels of gingival disease.⁴⁷ These studies support the premise that current low-dose oral contraceptives have little or no effect on the gingival inflammatory status of women using these drugs.

DRUG INTERACTIONS

Androgens

The effects of anticoagulants, antidiabetic drugs, insulin, and cyclosporine all are increased with androgens. Hepatotoxic medications pose a greater risk with androgenic agents. The dentist should use caution when prescribing corticosteroids because concomitant use of androgens and corticosteroids can increase edema and exacerbate existing cardiac or hepatic disease.

Estrogens

Estrogens may increase the effect of corticosteroids. Rifampin, barbiturates, carbamazepine, phenytoin, and topiramate all tend to decrease the effects of estrogens because the former drugs induce liver metabolism of estrogens. The administration of corticosteroids may need to be adjusted in patients taking estrogens because estrogen can increase the therapeutic and toxic effects of corticosteroids.

Progestins

Hepatic enzyme-inducing medications (see earlier) decrease the effect of progestins.

Oral Contraceptives and Antibiotics

Numerous anecdotal observations have suggested that antibiotics, such as rifampin, penicillins, tetracyclines, and metronidazole, may reduce oral contraceptive efficacy. The mechanism for this change is clear for rifampin, which induces enzymes in the liver that metabolize steroids. For the other antibiotics, it has been suggested that antibiotics may increase urinary and fecal excretion of oral contraceptives, decrease enterohepatic circulation or intestinal absorption of oral contraceptives, or antagonize either estrogen or progesterone receptors.⁴⁰ Changes in intestinal flora leading to enhanced fecal excretion have been proposed as mechanisms. A reduction in bacteria that elaborate β -glucuronidase could result in a reduced regeneration of metabolized estrogens in the gut.

Currently, there is no large, prospective clinical trial to determine whether a significant interaction between antibiotics (except rifampin) and oral contraceptives exists. The American Medical Association Council on Scientific Affairs has reviewed the available literature and suggested that women face a significant risk of oral contraceptive failure when concomitantly using rifampin; other antibiotics pose a small risk for reducing the efficacy of oral contraceptives.⁶ In

all cases, the administration of antibiotics to patients using oral contraceptives should involve discussion of the possible interaction between the drugs, counsel about nonhormonal methods of controlling pregnancy, and the design of treatment regimens that are medically appropriate yet take into consideration personal concerns.

HORMONE ANTAGONISTS AND PARTIAL AGONISTS

Androgens

Agents that block the effect of androgens (Figure 37-6) can be categorized into three principal groups: inhibitors of testosterone synthesis, androgen receptor antagonists, and 5α -reductase inhibitors (Table 37-6). In addition, analogues of gonadotropin-releasing hormone are used occasionally to treat breast and prostate cancer and are usually given with an inhibitor of estrogen or androgen synthesis. Ketoconazole, an antifungal drug, has been shown to block testosterone synthesis, but because of its inhibition of cortisol and its hepatotoxicity, the intentional use of this drug to inhibit androgen synthesis is not indicated. Spironolactone and cyproterone acetate are weak androgen receptor antagonists that can be used to treat hirsutism. Flutamide, bicalutamide, and nilutamide are androgen receptor blockers and are used to treat prostate cancer. Finasteride is an inhibitor of the type 2 isozyme of 5α -reductase. Dutasteride is an inhibitor of type 1 and type 2 isozymes of 5α -reductase. 5α -Reductase inhibitors have been developed for the treatment of benign prostatic hypertrophy. In addition, finasteride is used to treat androgenetic alopecia.

Estrogens

Agents that modulate estrogen activity (Figure 37-7) can be categorized into three principal groups: selective estrogen receptor modulators (SERMs), pure estrogen receptor antagonists, and estrogen synthesis inhibitors (see Table 37-6). SERMs are also referred to as *partial estrogen receptor agonists*.

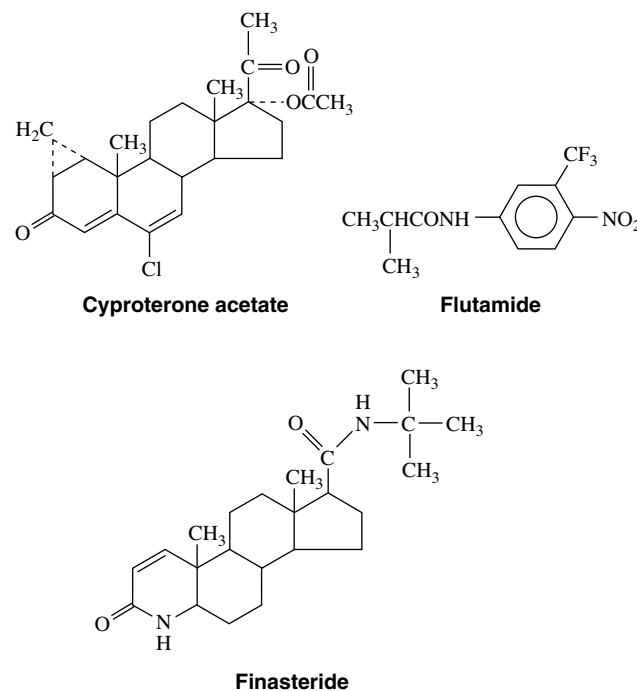

FIGURE 37-6 Structural formulas of two antiandrogens and finasteride.

TABLE 37-6

Examples of Hormone Antagonists

NONPROPRIETARY (GENERIC) NAME	PROPRIETARY (TRADE) NAME	CLASSIFICATION	INDICATION
Anastrozole	Arimidex	Aromatase inhibitor	Early and advanced breast carcinoma
Clomiphene	Clomid, Serophene	SERM	Induction of ovulation
Exemestane	Aromasin	Aromatase inhibitor	Early and advanced breast carcinoma
Flutamide	Eulexin	Androgen receptor antagonist	Prostatic carcinoma
Finasteride	Propecia, Proscar	Type II 5 α -reductase inhibitor	Benign prostatic hypertrophy, androgenetic alopecia
Mifepristone	Mifeprex	Progesterone receptor antagonist	Early pregnancy termination
Tamoxifen	Nolvadex	SERM	Adjunctive and preventive treatment of breast cancer
Toremifene	Fareston	SERM	Adjunctive treatment of breast cancer
Raloxifene	Evista	SERM	Postmenopausal osteoporosis prevention

SERM, Selective estrogen receptor modulator (also referred to as *partial estrogen receptor agonist*).

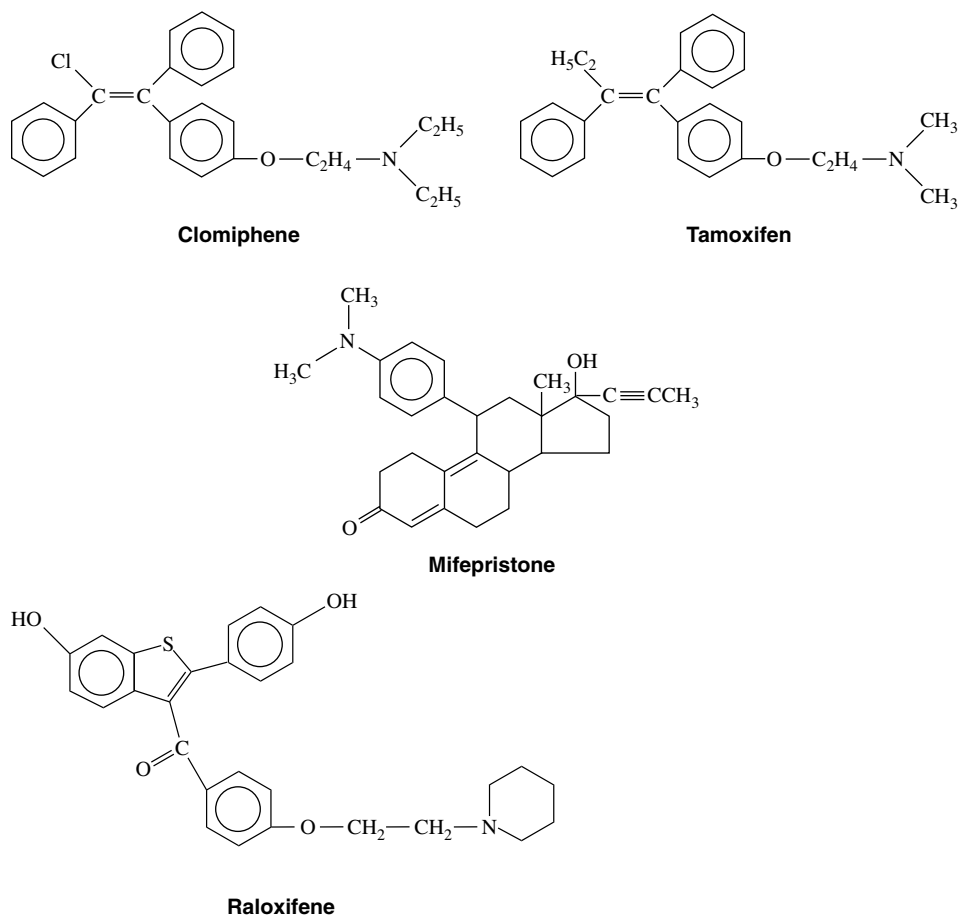

FIGURE 37-7 Chemical structures of partial estrogen receptor agonists and the antiprogesterin mifepristone.

The pharmacologic goal of SERMs is to provide agonist activity in tissues where estrogen action is desired and antagonist or no activity in tissues where estrogen activity may be harmful. The selective modulation of estrogenic activity in tissues is possible because of the location of two distinct estrogen receptors (α and β forms) with variable tissue distribution and variable drug affinity to these estrogen receptor forms.³⁷ The partial agonistic activity of these drugs accounts for some degree of selectivity.

Raloxifene has been approved for the prevention and treatment of osteoporosis. The drug is a partial agonist at estrogen receptors and in effect stimulates estrogen receptors in bone, but inhibits estrogen receptors in the breast and many other tissues. Tamoxifen and toremifene are examples of

drugs that are often referred to as *antiestrogens* even though they are partial agonists. They also display tissue selectivity, as does raloxifene (Table 37-7). Tamoxifen has been approved for the adjunctive treatment of breast neoplasms and as a prophylactic agent for women who are at high risk for breast cancer. Toremifene is used for the treatment of metastatic, estrogen receptor–positive breast cancer in postmenopausal women. In contrast to raloxifene, tamoxifen, and toremifene, clomiphene shows little, if any, tissue selectivity. It has been shown to act as an estrogen antagonist (actually a partial agonist) in all tissues studied. Clomiphene has been approved to promote ovulation in women.

The term *SERM* is usually applied to raloxifene, whereas *SERM* is less often applied to tamoxifen, toremifene, and

TABLE 37-7

Comparison of Representative Selective Estrogen Receptor Modulators (SERMs)

ESTROGEN RECEPTOR SITE	SERM		
	RALOXIFENE	TAMOXIFEN	TOREMIFENE
Breast	-	-	-
Uterus	0, -	+	+
Bone	+	-, +*	0
Hypothalamus	-	-	-

*Tamoxifen may increase or decrease bone density depending on clinical conditions.

-, Inhibits estrogen receptors; +, stimulates estrogen receptors.

especially clomiphene because these three drugs are used for their ability to block estrogen receptors. Fulvestrant is a pure estrogen receptor antagonist. It is used to treat breast cancer. Therapeutic estrogen synthesis inhibitors involve blocking the activity of aromatase, the enzyme responsible for the conversion of testosterone to estradiol. Aromatase inhibitors (e.g., exemestane, anastrozole) have been used for the adjunctive treatment of breast cancer patients who have been unresponsive to tamoxifen.

Progestins

Agents that block the effect of progesterone (see Figure 37-7) are primarily potent, competitive antagonists of the progesterone receptor (see Table 37-6). Progesterone receptor antagonists, such as mifepristone, can be used as contraceptives and abortifacients and for treatment of endometriosis, leiomyomas, breast cancer, and meningiomas.⁴ In the United States, mifepristone is primarily used for the termination of early pregnancy (defined as ≤ 49 days).

IMPLICATIONS FOR DENTISTRY

The homeostasis of the periodontium is a complex, multifactorial relationship that involves, at least in part, the endocrine system. The assertion that hormone-sensitive periodontal tissues exist relies on several salient observations, including the retention and metabolic conversion of sex steroid hormones in the periodontium and the presence of steroid hormone receptors in periodontal tissues.²⁸ These biologic findings correlated with clinical observations confirm an increased prevalence of gingival diseases with fluctuating sex steroid hormone levels, even when oral hygiene remained unchanged. The dramatic increase in steroid hormone levels during puberty has been accompanied by an increase in gingival inflammation in circumpubertal individuals of both sexes. During pregnancy, the prevalence and severity of gingival disease have been reported to be elevated until parturition, which is further evidence of the relationship between sex steroid hormones and the periodontium.^{3,25} A cross-sectional study examined 121 pregnant and 61 postpartum women for changes in gingival inflammation and found the prevalence and severity of the gingival inflammation were significantly higher in the pregnant versus the postpartum patients, even though plaque scores remained the same between the two groups.⁴⁴ Gingival probing depths are larger,^{25,31} bleeding on probing or toothbrushing is increased,^{3,31} and gingival crevicular fluid is elevated in pregnant women. Finally, women who are pregnant also exhibit a significant prevalence (0.5% to 0.8%) of localized gingival enlargements.^{25,31} These pregnancy-induced gingival overgrowths are reversed after parturition.

In contrast to pregnancy, when hormone levels are significantly elevated, during menopause ovarian function is declining, and there is a reduction in the production and secretion of sex steroid hormones. During this period, the question has arisen whether osteoporosis can affect the periodontal attachment apparatus. Although theories for the pathogenesis of osteoporosis are diverse, it is known that estrogen deficiency is an important factor in bone loss.⁴⁶ In addition, positive correlations between estrogens and bone density have been shown.⁴⁶ Considering these findings, it is not surprising that bone mass from edentulous mandibles has been shown to differ by age and sex. Several cross-sectional studies have shown decreased bone mass and density²¹ and reduced bone mineral content⁴⁹ in edentulous mandibles of postmenopausal women. Various studies have attempted to provide insight into the relationship of osteoporosis to periodontitis, but the results of these studies have been equivocal.*

In addition to the intentional prescription of estrogens, new compounds that have estrogenic activity are being released into the environment. Many environmental estrogens do not bind tightly to estrogen receptors and are poorly absorbed from the gastrointestinal tract, yet the constant exposure, bioaccumulation in adipose tissue, and persistence in the environment have heightened consideration of these chemicals as possible toxic agents in humans. Currently, the prescribed use of Bis-GMA-based resins for restoration of the dentition has increased the concern of dentists about the safety of what were previously considered inert materials.⁴⁵ On the basis of existing research, certain impurities may be present in some Bis-GMA-based resins, and release of impurities from such restorations is potentially estrogenic.⁴⁵ Under extreme conditions, these impurities are capable of inducing weak estrogenic effects on target tissues. The amounts of bisphenol A that may be present as an impurity or produced as a degradation product from dental restorations, including sealants, are quite small and far below the doses needed to affect the reproductive tract.²⁹

The specific relationship of sex steroid hormones to periodontal endocrinopathies remains an enigma; however, the most reasonable explanations of hormone action in the periodontium have focused on hormone effects on microbial organisms, the vasculature, the immune system, and specific cells in the periodontium.²⁸ When one considers the primary functions of sex steroid hormones, the periodontium would seem to be an odd target; however, given the influence of sex steroid hormones on periodontium, the health and lifestyles of women may be significantly affected.

PEPTIDE HORMONES

Human menopausal gonadotropins (menotropins) that contain follicle-stimulating hormone and luteinizing hormone, urofollitropin, and chorionic gonadotropin are used as fertility drugs in women and in men with hypogonadism and cryptorchidism. These drugs, derived from the urine of postmenopausal (menotropins, urofollitropin) and pregnant (chorionic gonadotropin) women, are injected intramuscularly. Short-acting gonadotropin-releasing hormone analogues such as gonadorelin, given in a pulsatile manner, are used to increase fertility in women and to treat cryptorchidism in men. Long-acting gonadotropin-releasing hormone analogues such as leuprolide are used to treat precocious puberty, prostate cancer, endometriosis, and estrogen-dependent tumors in women. (The long-acting nonpulsatile administration of the drugs inhibits release of the gonadotropins.) The gonadotropin-releasing hormone analogues are given intravenously, subcutaneously, and by nasal spray.

*References 11, 12, 27, 36, 41, 48, 50.

HORMONES OF REPRODUCTION AND RELATED DRUGS

<i>Nonproprietary (generic) name</i>	<i>Proprietary (trade) name</i>
Estrogens	
Chlorotrianisene	Tace
Conjugated estrogens	Premarin
Diethylstilbestrol*	Stilphostrol
Dienestrol	Ortho Dienestrol
Esterified estrogens	Menest
Estradiol	Estrace, Estraderm
Estrogenic substance	Gravigen Aqueous
Estropipate	Ogen
Ethinyl estradiol	Estinyl, in many oral contraceptives
Mestranol	In some oral contraceptives
Quinestrol	Estrovis
Progestins	
Hydroxyprogesterone	Hylutin
Levonorgestrel	Norplant
Medroxyprogesterone	Provera
Megestrol	Megace
Norethindrone	Aygestin
Norgestrel	Ovrette
Progesterone	—
Oral contraceptives	See Table 37-4
Postmenopausal steroid hormones	See Table 37-5
Anabolic-androgenic drugs	
Danazol	Danocrine
Ethylestrenol	Maxibolin
Fluoxymesterone	Halotestin
Methandrostenolone	Dianabol
Methyltestosterone	Testred
Nandrolone	Durabolin
Oxandrolone	Oxandrin
Oxymetholone	Anadrol-50
Stanozolol	Winstrol
Testosterone	Striant, Androgeal
Testolactone	Teslac
Gonadotropins	
Choriogonadotropin alfa	Ovidrel
Chorionic gonadotropin	Pregnyl, Novarel
Follitropin alfa (FSH)	Gonal-f
Follitropin beta (FSH)	Follistim
Menotropins	Menopur
Urofollitropin (FSH)	Bravelle
GnRH analogues	
Buserelin*	Suprefact
Gonadorelin	Factrel
Goserelin	Zoladex
Histrelin	Supprelin
Leuprolide	Lupron
Nafarelin	Synarel
Antagonists at GnRH receptors	
Cetrorelix	Cetrotide

<i>Nonproprietary (generic) name</i>	<i>Proprietary (trade) name</i>
Ganirelix	Antagon
Estrogen receptor partial agonists	
Clomiphene	Clomid
Raloxifene	Evista
Tamoxifen	Nolvadex
Toremifene	Fareston
Pure estrogen receptor antagonist	
Fulvestrant	Faslodex
Antiprogestin	
Mifepristone (RU-486)	Mifeprex
Androgen receptor antagonists	
Bicalutamide	Casodex
Cyproterone*	Androcur
Nilutamide	Nilandron
Flutamide	Eulexin
5α-Reductase inhibitors	
Dutasteride	Avodart, Duagen
Finasteride	Propecia, Proscar
Aromatase inhibitors	
Anastrozole	Arimidex
Exemestane	Aromasin
Letrozole	Femara

*Not currently available in the United States.

FSH, Follicle-stimulating hormone; GnRH, gonadotropin-releasing hormone.

CITED REFERENCES

- Alonso LC, Rosenfield RL: Oestrogens and puberty. *Best Pract Res Clin Endocrinol Metab* 16:13-30, 2002.
- Amanatullah DF, Zafonte BT, Pestell RG: The cell cycle in steroid hormone regulated proliferation and differentiation. *Minerva Endocrinol* 27:7-20, 2002.
- Arafat AH: Periodontal status during pregnancy. *J Periodontol* 45:641-643, 1974.
- Cadepond F, Ulmann A, Baulieu EE: RU486 (mifepristone): mechanisms of action and clinical uses. *Annu Rev Med* 48:129-156, 1997.
- Cobasso A: Peliosis hepatis in a young adult bodybuilder. *Med Sci Sports Exerc* 26:2-4, 1994.
- Dickinson BD, Altman RD, Nielsen NH, et al: Drug interactions between oral contraceptives and antibiotics. *Obstet Gynecol* 98:853-860, 2001.
- Dunn JF, Nisula BC, Rodbard D: Transport of steroid hormones: binding of 21 endogenous steroids to both testosterone-binding globulin and corticosteroid-binding globulin in human plasma. *J Clin Endocrinol Metab* 53:58-68, 1981.
- El-Ashiry GM, El-Kafrawy AH, Nasr MF, et al: Comparative study of the influence of pregnancy and oral contraceptives on the gingivae. *Oral Surg Oral Med Oral Pathol* 30:472-475, 1970.
- Evans RM: The steroid and thyroid hormone receptor superfamily. *Science* 24:889-895, 1988.
- Fotherby K: Bioavailability of orally administered sex steroids used in oral contraception and hormone replacement therapy. *Contraception* 54:59-69, 1996.
- Grodstein F, Colditz GA, Stampfer MJ: Hormone use and tooth loss: a prospective study. *J Am Dent Assoc* 127:370-377, 1996.

12. Groen J, Menczel J, Shapero S: Chronic destructive periodontal disease in patients with presenile osteoporosis. *J Periodontol* 33:1-23, 1968.
13. Gronemeyer H, Turcotte B, Quirin-Stricker C, et al: The chicken progesterone receptor: sequence, expression and functional analysis. *Embo J* 6:3985-3994, 1987.
14. Hildebolt CF: Osteoporosis and oral bone loss. *Dentomaxillofac Radiol* 26:3-15, 1997.
15. Jick H, Derby LE, Myers MW, et al: Risk of hospital admission for idiopathic venous thromboembolism among users of postmenopausal oestrogens. *Lancet* 348:981-983, 1996.
16. Kaufman AV: An oral contraceptive as an etiologic factor in producing hyperplastic gingivitis and a neoplasm of the pregnancy tumor type. *Oral Surg Oral Med Oral Pathol* 28:666-670, 1969.
17. Kelsey JL: Osteoporosis: prevalence and incidence. In *Consensus development conference summary*, Bethesda, MD, 1984, National Institutes of Health.
18. Key TJ, Verkasalo PK, Banks E: Epidemiology of breast cancer. *Lancet Oncol* 2:133-140, 2001.
19. Knight GM, Wade B: The effects of hormonal contraceptives on the human periodontium. *J Periodont Res* 9:18-22, 1974.
20. Kochakian CD, Arimasa N: The metabolism in vitro of anabolic-androgenic steroids in mammalian tissues. In Kochakian CD, editor: *Anabolic-androgenic steroids*, New York, 1976, Springer-Verlag.
21. Kribbs PJ: Comparison of mandibular bone in normal and osteoporotic women. *J Prosthet Dent* 63:218-222, 1990.
22. Krust A, Green S, Argos P, et al: The chicken oestrogen receptor sequence: homology with v-erbA and the human oestrogen and glucocorticoid receptors. *Embo J* 5:891-897, 1986.
23. Kumar V, Green S, Stack G, et al: Functional domains of the human estrogen receptor. *Cell* 51:941-951, 1987.
24. Lobo RA, Stanczyk FZ: New knowledge in the physiology of hormonal contraceptives. *Am J Obstet Gynecol* 170:1499-1507, 1994.
25. Loe H, Silness J: Periodontal disease in pregnancy, I: prevalence and severity. *Acta Odontol Scand* 21:533-551, 1963.
26. Lynn BD: "The pill" as an etiologic agent in hypertrophic gingivitis. *Oral Surg Oral Med Oral Pathol* 24:333-334, 1967.
27. Manson J: Bone morphology and bone loss in periodontal disease. *J Clin Periodontol* 3:14-22, 1976.
28. Mariotti A: Sex steroid hormones and cell dynamics in the periodontium. *Crit Rev Oral Biol Med* 5:27-53, 1994.
29. Mariotti A, Söderholm KJ, Johnson S: The in vivo effects of Bis-GMA on murine uterine weight, nucleic acids and collagen. *Eur J Oral Sci* 106:1022-1027, 1998.
30. Miller J, McLachlan AD, Klug A: Repetitive zinc-binding domains in the protein transcription factor IIIA from *Xenopus oocytes*. *Embo J* 4:1609-1614, 1985.
31. Miyazaki H, Yamashita Y, Shirahama R, et al: Periodontal condition of pregnant women assessed by CPITN. *J Clin Periodontol* 18:751-754, 1991.
32. Mooradian AD, Morley JE, Korenman SG: Biological actions of androgens. *Endocr Rev* 8:1-28, 1987.
33. National Osteoporosis Foundation. Available at: <http://www.nof.org/osteoporosis/diseasesfacts.htm>. Accessed February 1, 2009.
34. Owen RA, Melton LF, Gallagher FC, et al: The national cost of acute care of hip fractures associated with osteoporosis. *Clin Orthop* 150:172-176, 1980.
35. Pankhurst CL, Waite IW, Hichs KA, et al: The influence of oral contraceptive therapy on the periodontium—duration of drug therapy. *J Periodontol* 52:617-620, 1981.
36. Payne JB, Reinhardt RA, Nummikoski PV, et al: Longitudinal alveolar bone loss in postmenopausal osteoporotic/osteopenic women. *Osteoporos Int* 10:34-40, 1999.
37. Pettersson K, Gustafsson J-A: Role of estrogen receptor beta in estrogen action. *Annu Rev Physiol* 63:165-192, 2001.
38. Pike MC, Peters RK, Cozen W, et al: Estrogen-progestin replacement therapy and endometrial cancer. *J Natl Cancer Inst* 89:1110-1116, 1997.
39. Preshaw PM, Knutsen M, Mariotti A: Experimental gingivitis in women using oral contraceptives. *J Dent Res* 80:2011-2015, 2001.
40. Rasmussen JE: The effect of antibiotics on the efficacy of oral contraceptives. *Arch Dermatol* 125:1562-1564, 1989.
41. Ronderos M, Jacobs DR, Himes FH, et al: Associations of periodontal disease with femoral bone mineral density and estrogen replacement therapy: cross-sectional evaluation of US adults from NHANES III. *J Clin Periodontol* 27:778-786, 2000.
42. Shapiro S, Kelly FP, Rosenberg L, et al: Risk of localized and widespread endometrial cancer in relation to recent and discontinued use of conjugated estrogens. *N Engl J Med* 313:969-972, 1985.
43. Siiteri PK, MacDonald PC: Role of extraglandular estrogen in human endocrinology. In Greep RO, Astwood EB, Geiger SR, editors: *Endocrinology, vol II: female reproductive system. Handbook of physiology*, Washington, DC, 1973, American Physiology Society.
44. Silness J, Loe H: Periodontal disease in pregnancy, II: correlation between oral hygiene and periodontal condition. *Acta Odontol Scand* 22:121-135, 1963.
45. Söderholm KJ, Mariotti A: Bis-GMA-based resins in dentistry: are they safe? *J Am Dent Assoc* 130:201-209, 1999.
46. Steinberg KK, Freni-Titulaer LW, Depuey EG, et al: Sex steroids and bone density in premenopausal and perimenopausal women. *J Clin Endocrinol Metab* 69:533-539, 1989.
47. Taichman LS, Eklund SA: Oral contraceptives and periodontal diseases: rethinking the association based upon analysis of National Health and Nutrition Examination Survey data. *J Periodontol* 76:1374-1385, 2005.
48. Tezal M, Wactawski-Wende F, Grossi SG, et al: The relationship between bone mineral density and periodontitis in postmenopausal women. *J Periodontol* 71:1492-1498, 2000.
49. Von Wöwern N: Bone mineral content of mandibles: normal reference values—rate of age-related bone loss. *Calcif Tissue Int* 43:193-198, 1988.
50. Weyant RJ, Perlstein ME, Churak AP, et al: The association between osteopenia and periodontal attachment loss in older women. *J Periodontol* 70:982-991, 1999.
51. Wilson JD: Metabolism of testicular androgens. In Greep RO, Astwood EB, Geiger SR, editors: *Endocrinology, vol V: male reproductive system. Handbook of physiology*, Washington, DC, 1975, American Physiology Society.
52. Writing Group for the Women's Health Initiative Investigators: Risks and benefits of estrogen plus progesterone in healthy postmenopausal women: principal results from the Women's Health Initiative randomized controlled trial. *JAMA* 288:321-333, 2002.
53. Wu CH, Motohashi T, Abdel-Rahman HA, et al: Free and protein-bound plasma estradiol-17 during the menstrual cycle. *J Clin Endocrinol Metab* 43:436-445, 1976.
54. Yen SS: The biology of menopause. *J Reprod Med* 18:287-296, 1977.

GENERAL REFERENCES

- Casey PM, Pruthi S: The latest contraceptive options: what you must know. *J Fam Pract* 57:797-805, 2008.
- Chabbert-Buffet N, Ouzounian S, Kairis AP, et al: Contraceptive applications of progesterone receptor modulators. *Eur J Contracept Reprod Health Care* 13:222-230, 2008.
- Cohen MB, Rokhlin OW: Mechanisms of prostate cancer cell survival after inhibition of AR expression. *J Cell Biochem* 106:363-371, 2009.
- Hayashi S, Yamaguchi Y: Estrogen signaling pathway and hormonal therapy. *Breast Cancer* 15:256-261, 2008.
- Mariotti A: Sex steroid hormones and cell dynamics in the periodontium. *Crit Rev Oral Biol Med* 5:27-53, 1994.
- Practice Committee of American Society for Reproductive Medicine in collaboration with Society for Male Reproduction and Urology: Androgen deficiency in the aging male. *Fertil Steril* 90(Suppl 5):S83-S87, 2008.
- Summers A: Interaction of antibiotics and oral contraceptives. *Emerg Nurse* 16:20-21, 2008.

Principles of Antibiotic Therapy*

THOMAS J. PALLASCH

INFECTIOUS DISEASE PAST AND PRESENT

In 1967 the U.S. Surgeon General declared, “The time has come to close the book on infectious diseases.” In 1993, 17 million people died of infectious diseases throughout the world, with 11.4 million deaths (mostly of children) caused by bacterial diarrhea and pneumonia. In the same year, 15.6 million died of cardiovascular disease and cancer combined.⁶⁹ The four primary disease killers caused by infection are the same as in 1900: diarrhea, pneumonia, tuberculosis, and malaria.¹⁹ One third of the world population has tuberculosis, and Africa accounts for 90% of the 300 to 500 million new cases of malaria annually, with 1.5 to 2.7 million deaths per year. In World War II, 55 million people were killed; by 2010, 65 million will have died of acquired immunodeficiency syndrome (AIDS).

The Surgeon General was echoing the prevailing wisdom of the 1960s era of optimism regarding antibiotics. In the late 1950s the medical community became alarmed at the extent and rapidity of *Staphylococcus aureus* resistance to the penicillins, erythromycin, and tetracyclines and the discovery that bacteria could transfer the genes for antibiotic resistance among themselves. In the early 1960s, a plethora of new antibiotics became available: cephalosporins, β -lactamase-resistant penicillins, lincosamides, and new aminoglycosides. The belief that humankind would always stay several steps ahead of the microbes because they could not possibly match human intelligence was widely accepted. Assumptions are the genesis of most disasters, and, as one of “Murphy’s laws” states, “Optimism indicates that the situation is not clearly understood.”

The U.S. Centers for Disease Control and Prevention estimates that 65,000 to 90,000 deaths annually in U.S. hospitals result from nosocomial (hospital-acquired) infections. This figure may be a significant underestimate and the number may be closer to 200,000 to 300,000 because infectious disease deaths may be misclassified as cardiac arrest or respiratory or renal failure instead of their underlying microbial causes. In 1977, 100,000 gram-negative nosocomial bacteremic deaths were estimated annually in the United States⁵⁷; bloodstream infections (septicemia and bacteremia) alone, among all nosocomial infections, may now be the eighth leading cause of death in the United States.^{114,115}

Hospitals are currently plagued by vancomycin-resistant enterococci, vancomycin-resistant or glycopeptide-intermediate-resistant *S. aureus*, coagulase-negative staphylococci (CoNS),

and other microorganisms resistant to multiple antibiotics, particularly *Streptococcus pneumoniae* and extended β -lactamase-producing enteric bacilli. The community is now beset by methicillin-resistant *S. aureus* (MRSA), which was previously thought to be a problem only in hospitals; penicillin-resistant and macrolide-resistant *S. pneumoniae* and viridans group streptococci (VGS); β -lactamase-producing *Haemophilus influenzae* and *Moraxella catarrhalis*; and widespread fluoroquinolone resistance. The oral cavity is home to β -lactam-resistant VGS and β -lactamase-producing *Prevotella* and *Porphyromonas*.

Mechanisms for resistance to antibiotics have likely always existed in some form to allow microbes to ensure their survival against competing microorganisms and find a niche in their environment to survive and thrive. Our current problems are of human origin, however—we disturbed the delicate microbial ecology for our own benefit, never realizing how formidable microbial retaliation would be. We are approaching the loss of one of our greatest gifts.

The importance of two medical discoveries that have essentially doubled the human life span in first-world countries since the 1850s—anesthesia and the control of infectious diseases—cannot be overestimated. Without the ability to operate internally within the human body free of excruciating pain, the gains of medical and dental surgery would be void. In the United States in 1776, the average life span was less than 40 years of age. In England in 1853, infectious disease was responsible for 37% of all deaths. At the beginning of the twentieth century in the United States, the infant mortality rate was 100 per 1000; now it is less than 10 per 1000.⁶⁹ A child in 1900 had a 10% chance of death between ages 1 and 4 years from pneumonia or diarrhea.⁶⁹ Many adults, infants, and children died of typhus, typhoid, diphtheria, whooping cough, yellow fever, malaria, influenza, measles, smallpox, and streptococcal and staphylococcal infections.

Even before the advent of the modern germ theory of disease in the 1870s, many individuals surmised that filth had a substantial bearing on disease. The “sanitary movement” began in Great Britain in the 1850s and the United States in the 1870s with improvement in wages, housing, education, and personal hygiene. Civil engineers cleaned the streets, water, and air, and cities removed refuse and their attendant rodent vectors of disease. Waste disposal, clean water, and hand hygiene by public health engineering have reduced the transmission of 35 to 40 infectious diseases.³¹

The modern era of infectious disease began with the first visualization of microbes by Anton van Leeuwenhoek in 1683, the “animicules” of dental plaque scraped from his upper gingiva and killed with salt (the first periodontal chemotherapy).⁴⁷ In 1776, Edward Jenner administered the first

*The author recognizes Dr. Edward Montgomery for his past contributions to this chapter.

smallpox vaccination. In 1848, Ignaz Semmelweiss introduced clean surgical operating technique (“gentlemen, wash your hands”). In 1854, John Snow showed the link between cholera and drinking water.⁴⁷

In the 1860s, Louis Pasteur first used the word *germ* for living entities that produced disease, and Joseph Lister used carbolic acid to disinfect wounds. In the 1870s, Robert Koch proved the bacterial causation of anthrax and tuberculosis, and in the 1880s, Pasteur developed anthrax and rabies vaccines. In 1891, Paul Ehrlich showed that antibodies were responsible for immunity. In 1897, Ivanowski and Beiternick discovered viruses. The mosquito vector for yellow fever was shown in 1900, *Treponema pallidum* was found to be the cause of syphilis in 1905, human immunodeficiency virus (HIV) was identified in 1983, *Helicobacter pylori* was discovered as a cause of peptic ulcer in 1984, and the West Nile virus was identified in 1999.⁴⁷

In the early 1900s, Paul Ehrlich used the term *magic bullet* for his predicted chemical that would affect only microbial cells and have no effect on mammalian cells. He later used fuchsin and mercury (Salvarsan) to treat syphilis. In 1928, Alexander Fleming serendipitously discovered that a mold, *Penicillium chrysogenum*, lysed staphylococci; this was later developed to its full potential by the isolation of penicillin from *Penicillium notatum* by Florey and colleagues at Oxford in the late 1930s and early 1940s. The first use of penicillin was in 1941 on an English police constable with streptococcal and staphylococcal skin abscesses. In the United States, penicillin was first used in 1942 on Anne Miller, who had streptococcal toxemia of pregnancy. All of these firsts have possibly overshadowed arguably the greatest of all medical advances: the demonstration in 1935 by Gerhard Domagk that sulfanilamide could be safely used systemically to treat infectious disease. The “dreaded disease of summer” (poliomyelitis) declined from 57,879 cases in the United States in 1953 to 72 cases in 1965 with the advent of the polio vaccine.⁷¹ By 1977, smallpox was eradicated from the world as a contagious disease. During 1900–1997, the American life span increased by 60% to a median age of 76.¹⁹

In the developing world, a different story has unfolded. In 1998, the World Health Organization determined that infectious disease caused 25% (13 million) of the 54 million deaths in the world that year, with pneumonia (3.5 million), AIDS (2.3 million), diarrhea (2.2 million), tuberculosis (1.5 million), malaria (1.1 million), and measles (1 million) the top killers.¹⁹ The incidence of emerging infections (defined by the Institute of Medicine as new, re-emerging, or drug-resistant infections whose incidence has increased in the last 2 decades or whose incidence threatens to increase) has increased.¹⁹ Now included in this category are legionnaires disease, toxic shock syndrome, respiratory syncytial virus, Lyme disease, Nipah virus, *Hantavirus*, hemorrhagic viral diseases (dengue, Ebola, Marburg), *Escherichia coli* O157:H7, malaria, yellow fever, cholera, and multidrug-resistant tuberculosis. All of these infections and more are potentially transmitted by 500,000 world refugees and 1.6 billion annual airline passengers, 500 million of which cross borders each year.⁶⁹

All of the media attention to these potential pathogens has led to a second “germ panic” with the revival of the focal infection theory of disease,⁷³ which alleges that many or most current diseases are caused by various microbes, including cardiovascular disease; various forms of emotional disorders such as obsessive-compulsive disorder, Tourette’s syndrome, autism, and schizophrenia; preterm births; chronic fatigue syndrome; and multiple sclerosis. The first germ panic of 1900–1940 was fostered by the focal infection theory as espoused by Hunter and colleagues, in which a localized infection in one area of the body could move and occur elsewhere in the body and cause various pathologic conditions,

such as arthritis, neuritis, myalgia, osteomyelitis, endocarditis, brain abscess, skin abscess, pneumonia, anemia, indigestion, gastritis, pancreatitis, colitis, diabetes, emphysema, goiter, thyroiditis, Hodgkin’s disease, “obscure fever,” nervous diseases, headache, mental apathy, and mental incompetence.⁷³ All of these were disorders for which medicine at the time (and many currently) had no explanations and no answers.

These foci of infection were conveniently located in areas of the body readily accessible to surgery (particularly in the wealthy): teeth, tonsils, and the facial sinuses, leading to an excessive number of dental extractions, tonsillectomies, and other surgeries in the first half of the twentieth century.^{42,73,117,118} The resurrection of the foci of infection concept today is based on limited scientific evidence and questionable studies that lack attention to sound epidemiologic methods.

Very rarely, microbes leave the oral cavity and metastasize to other areas of the body to initiate a nonspecific inflammatory infectious process manifested as liver, splenic, or brain abscesses or bacterial endocarditis. These microorganisms are almost always VGS and almost never pathogens associated with periodontal disease. That these metastatic infections are so rare is truly remarkable and speaks well for our immune defense mechanisms, particularly in the oral cavity and blood, and the reticence of microorganisms to leave their ecologic niches for foreign environments. Currently, little evidence suggests that the oral cavity is the source of significant systemic disease.^{72,73}

PATTERNS OF ANTIBIOTIC USE AND MISUSE

Antibiotics are the most widely abused prescribed drugs on the basis of inappropriate indications, dosages, and duration of use. Approximately half of all antibiotics used in hospitals are given to patients without signs or symptoms of infection, in many cases to “prevent” infections and to ensure that “everything was done” to avoid later criticism. Antibiotics are often used as “drugs of fear”⁴⁵ to cover for potential errors of omission or commission and prevent a claim of negligence. The abuse of negligence (tort) law has been a major contributing factor to the massive overuse of antibiotics and the attendant mortality rate associated with highly antibiotic-resistant microorganisms.

In hospitals, one third of antibiotics are used empirically, one third for prophylaxis, and one third with appropriate culture and sensitivity tests.⁶⁹ Because hospitals save money by not using culture and sensitivity tests, the demand has been for broader spectrum antibiotics, which has created a vicious cycle by disturbing the hospital microbial ecology further and fostering even greater microbial resistance.⁹⁸

Outpatient antibiotic use is characterized by the “80:80 rule”: 80% of all antibiotics are used in the community, and 80% are used for respiratory infections—most of which are viral in cause and not amenable to antibiotic therapy.⁶⁹ Of the 50% of people with acute respiratory illness who seek medical treatment, 50% to 80% may receive an antibiotic, but pneumonia (the only respiratory tract disorder requiring an antibiotic) may account for only 2% of these cases.

The prescribing of antibiotics can vary 15-fold among physicians. Physicians who tend to prescribe many drugs also prescribe many antibiotics. Antibiotic prescriptions are a quick way to end an office visit and reduce return visits.⁹⁰

Dentists prescribe 7% to 11% of all common antibiotics (β -lactams, macrolides, tetracycline, metronidazole, clindamycin), and abuse of such antibiotics can be substantial.¹⁸ In England, 33% to 87% of various antibiotics were judged to be inappropriately prescribed by dentists according to the Dental Practitioners Formulary.⁷⁴ Experts in England are in agreement that antibiotics are used too long for the

management of orofacial infections and that shorter durations are more appropriate and reduce the selection of drug-resistant microbes.⁵⁶

In a survey of 505 Canadian dentists, the average length of antibiotic therapy was 6.92 days (range 1 to 21 days), and 17.5% did not use the 1997 American Heart Association (AHA) guidelines for endocarditis prophylaxis.²⁷ Two thirds of the dentists used antibiotic prophylaxis for patients with rheumatic fever without rheumatic heart disease; 25%, for patients with HIV/AIDS; 70%, for prosthetic joints; and two thirds, for restorative dentistry not associated with significant bleeding even though not advocated by the AHA.

AHA prophylaxis for patients with cardiac valve prostheses was not used by 20% of dental specialists. The study concluded that antibiotics are underused for symptomatic infections, overused for surgical prophylaxis, and commonly used at suboptimal dosing with prolonged dosing schedules and often not according to antibiotic prophylaxis guidelines.²⁷

In a survey of antibiotic use by 1606 members of the American Association of Endodontists, 12.5% used antibiotics as an analgesic for post-treatment pain; 37.3%, as antibiotic prophylaxis after surgery; 44.8%, after incision and drainage without systemic involvement or patient immunosuppression; and 12% to 54%, for situations in which they are not effective, such as the following: (1) irreversible pulpitis with moderate-severe symptoms with or without apical periodontitis; (2) asymptomatic necrotic pulps with chronic apical periodontitis but no swelling; (3) necrotic pulps with acute apical periodontitis, no swelling, and moderate-severe symptoms; and (4) asymptomatic necrotic pulps with chronic periapical periodontitis with or without a sinus tract.¹¹⁹ The authors concluded that not much had changed in the past 25 years.

Inappropriate antibiotic use in dentistry includes the following situations: (1) antibiotic therapy initiated after surgery to prevent an infection unlikely to occur and not documented effective for this purpose by clinical trials; (2) failure to use prophylactic antibiotics according to the principles established for such use; (3) use of antibiotics as analgesics in endodontics; (4) overuse in situations in which patients are not at risk for metastatic infections; (5) treatment of chronic periodontitis almost totally amenable to mechanical therapy; (6) administration of antibiotics instead of mechanical therapy for periodontitis; (7) long-term administration in the management of periodontal diseases; (8) antibiotic therapy instead of incision and drainage; (9) administration of antibiotics to avoid claims of negligence; and (10) administration in improper situations, dosage, and duration of therapy.⁶⁹

ANTIBIOTIC MECHANISMS OF ACTION

To appreciate how microbes defend themselves against chemicals in their environment, one must first determine how antimicrobial agents kill microbes or prevent their replication. Antibiotics are chemicals most often, but not always, derived from microorganisms (commonly yeasts and fungi) that are intended in nature to perform as part of the system that maintains the ecologic balance in the microbial world. This system is composed of various entities, including bacteriophages (bacterial viruses); cationic peptides; antibiotics; and the quorum-sensing system that conveys chemical messages to microbes regarding metabolic activities, surface adhesion, colony formation, virulence, and the presence of chemicals intended to do harm. Virtually all clinically useful antibiotics are derived from naturally occurring entities, with only three synthetically produced: sulfonamides, fluoroquinolones, and oxazolidinones.

Antimicrobials affect the viability of microorganisms by five known processes: (1) inhibition of cell wall synthesis, (2) alteration of cell membrane integrity, (3) inhibition of ribosomal protein synthesis, (4) suppression of deoxyribonucleic acid (DNA) synthesis, and (5) inhibition of folic acid synthesis (Table 38-1, Figure 38-1). Microbial cell wall synthesis inhibition and membrane effects are extracytoplasmic, and inhibition of nucleic acid, protein, and folic acid synthesis is intracytoplasmic. Drugs that affect bacterial cell wall or membrane integrity and DNA synthesis are usually, but not always, bactericidal (inducing cell death), and protein and folic acid synthesis inhibitors are usually bacteriostatic (preventing cell growth or replication).

Whether an antimicrobial agent is bactericidal (cidal) or bacteriostatic (static) can also depend on its concentration at the infected site and the particular offending organism because some static drugs become cidal at high concentrations. The previous preference for cidal drugs over static antibiotics (cidal drugs allegedly do not rely on host defenses) has become less distinct because of the appreciation of the long post-antibiotic effects (continued antibiotic activity when the drug blood levels have declined) of bacteriostatic drugs.

Cell Wall Synthesis Inhibitors

The principal cell wall inhibitors are β -lactam antibiotics and glycopeptides. Bacterial cell walls are rigid and composed of alternating peptidoglycan (murein) units of N-acetyl-D-glucosamine and N-acetylmuramic acid (NAM). These are cross-linked via short peptides by amide linkages to a D-alanyl group on NAM. Various bacterial enzymes (transglycosylases, transpeptidases, carboxypeptidases, endopeptidases), termed *penicillin-sensitive enzymes* or *penicillin-binding proteins (PBPs)*, catalyze the formation of the rigid cell wall by incorporating new peptidoglycan into existing peptidoglycan by attaching a free amino group on the NAM-pentapeptide to a terminus opened by displacement of D-alanine. β -Lactam antibiotics competitively inhibit this final transpeptidation reaction to prevent three-dimensional rigid cell wall formation. The internal osmotic pressure of the bacterium causes lysis of the bacterial cell because the wall is no longer an effective barrier.

In addition, in some organisms, the β -lactams inhibit the inhibitor (derepression) of an endogenous bacterial autolysin (N-acetyl-muramyl-L-alanine amidase), which, when activated, causes the lysis of the bacterial cell wall, initiating bacterial suicide. Microbes that lose this autolysin system can become tolerant to antibiotics, with the antibiotic becoming bacteriostatic instead of bactericidal. Glycopeptides inhibit gram-positive bacterial cell wall synthesis by complexing with the D-alanyl-D-alanine portion of the muramyl peptide precursors to inhibit the action of transglycosylase and transpeptidase at a stage just before that of the β -lactams.

Alteration in Cell Membrane Integrity

Polymyxin B disrupts the integrity of the cell membrane by displacing Ca^{++} and Mg^{++} from membrane lipid phosphate groups. Cationic antimicrobial peptides are part of humans' natural skin and mucosal defense system and act by disrupting cell wall or membrane integrity by an effect on the gram-negative lipopolysaccharide component that literally puts holes in the wall or membrane.

Inhibition of Ribosomal Protein Synthesis

The macrolides bind to the P site of the 50S ribosomal subunit to inhibit RNA-dependent protein synthesis by inhibiting peptidyl transferase or by increasing the dissociation of peptidyl tRNA from the ribosome. Clindamycin similarly attaches to the same 50S subunit and can compete with the macrolides for this site. Cross-resistance between these two disparate antibiotics is common. Tetracyclines attach to the 30S

TABLE 38-1

Mechanisms of Action of Common Antibiotics

Rights were not granted to include this table in electronic media.
Please refer to the printed publication.

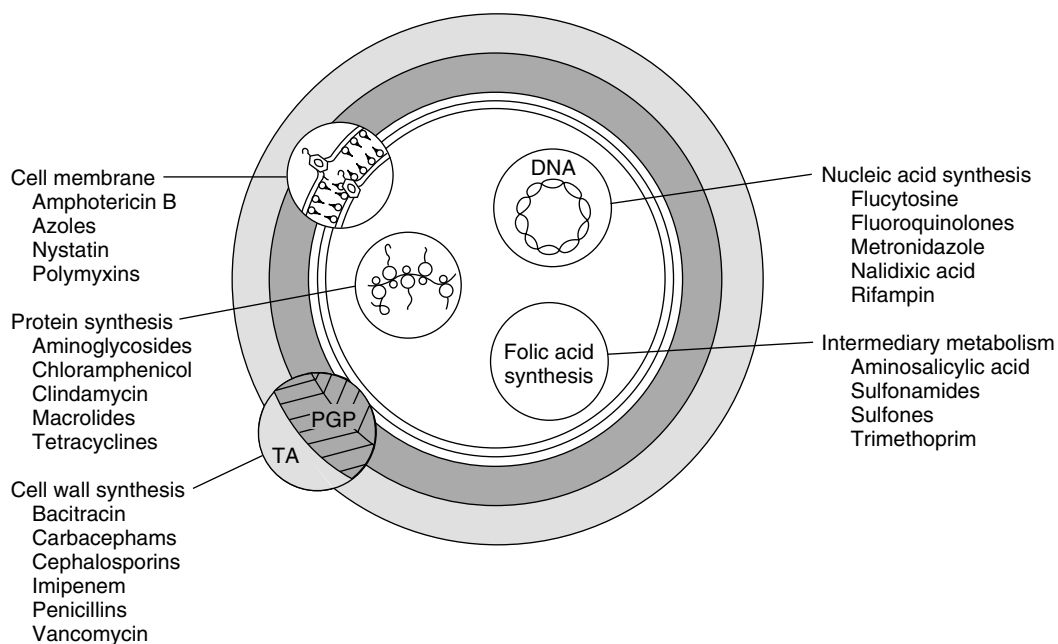

FIGURE 38-1 Site and mechanism of action of antimicrobial agents. *PGP*, Peptidoglycan; *TA*, teichoic acid.

ribosomal subunit to block ribosomal protein synthesis by inhibiting the binding of tRNA to mRNA on the ribosome. Aminoglycosides attach to the 30S subunit to inhibit ribosomal protein synthesis, but may also induce the formation of abnormal bactericidal proteins. Streptogramins (quinupristin-dalfopristin) bind to two different sites on the 50S subunit of the 70S ribosome to prevent newly synthesized peptide chains from extruding from the ribosome. The oxazolidinone, linezolid, attaches to the 50S ribosome near the interface with the 30S subunit to prevent the initiation complex required for bacterial translation.

Inhibition of Nucleic Acid Synthesis

The 5' nitro group of metronidazole is reduced in sensitive obligate anaerobes by nitro reductase to cell toxic nitro, nitroso, and hydroxylamine compounds that damage DNA or inhibit its synthesis. Fluoroquinolones inhibit topoisomerase IV and DNA gyrase that control the supercoiling of DNA and DNA replication, recombination, and repair. Fluoroquinolones may also induce the SOS response, which constitutes a repair system of DNA (the bacterial response to DNA damage) that normally functions to inhibit cell division to prevent the replication of damaged DNA. When the SOS repair system is affected by fluoroquinolones, unbalanced growth, vacuoles, filamentation, and cell lysis occur.

Inhibition of Folic Acid Synthesis

Sulfonamides and trimethoprim are antimetabolites that inhibit sequential steps in the bacterial synthesis of folic acid essential for one-carbon transfers in nucleic acid synthesis. Mammalian cells do not synthesize folic acid but acquire it from the environment. Sulfonamides are structural analogues of *p*-aminobenzoic acid (PABA) and block the conversion of PABA to dihydrofolic acid by inhibiting tetrahydroptericoic acid synthetase, which has greater affinity for sulfonamides than PABA. Trimethoprim blocks the next step in folic acid synthesis by inhibiting dihydrofolate reductase, which catalyzes the conversion of dihydrofolic acid to tetrahydrofolic acid.

MICROBIAL RESISTANCE TO ANTIBIOTICS

Microbial resistance to antibiotics has become a major factor in determining when and which antibiotic is used and dosages and length of administration. It also has spurred renewed interest in antibiotic pharmacokinetics and pharmacodynamics.

Procedures designed to reduce antibiotic-resistant pathogenic microorganisms have been developed, including education of health care providers and the general public, improved handwashing techniques, better hospital infection control, isolation of patients with highly resistant bacteria, control of antibiotic use in hospitals through formularies and pharmacist oversight, and the removal of antibiotics for growth promotion in agricultural animals. Many of these programs have had little effect to date.

All microbial resistance is local; the patterns and extent of this resistance are determined by the use of antibiotics in a particular community. What is true in Florida may not be true in Los Angeles or in Paris, London, Rome, or New Delhi. If tetracyclines are used widely in the community for acne or Lyme disease, a high resistance level to the drug is likely to be present in that locale. If not, the microbial resistance level is likely to be low. If an antibiotic or its analogue has been used widely in agriculture, this may strongly influence resistance patterns—to the point of rendering a new antibiotic far less useful. In Taiwan, virginiamycin (a streptogramin) has been used for more than 2 decades as a growth promoter in

food animals. When quinupristin-dalfopristin, a new streptogramin, was tested on human bacterial isolates before its clinical introduction, more than 50% of some pathogens were already resistant to the drug. Antibiotics are truly societal drugs that cumulatively affect the individual receiving the drug and many others as well.⁵⁰

Microorganisms have developed seven known mechanisms to evade the bactericidal or bacteriostatic actions of antimicrobials, as follows: (1) enzymatic inactivation, (2) modification/protection of the target site, (3) limited access of antibiotic (altered cell membrane permeability), (4) active drug efflux, (5) failure to activate the antibiotic, (6) use of alternative growth requirements, and (7) overproduction of target sites (Table 38-2).^{69,88}

Enzymatic inactivation is one of the more common methods and is typified by β -lactamase hydrolysis of penicillins and cephalosporins and acetyltransferases that inactivate

TABLE 38-2

Antibiotic Resistance Mechanisms

Rights were not granted to include this table in electronic media. Please refer to the printed publication.

chloramphenicol, aminoglycosides, and tetracyclines. Altered target sites include ribosomal point mutations for tetracyclines, macrolides, and clindamycin; altered DNA gyrase and topoisomerase for fluoroquinolones; and modified PBPs for VGS and pneumococci. Most microorganisms have developed ways to alter their cell wall or membrane permeability to limit access of the antibiotic to its receptor by deleting outer membrane proteins or closing membrane pore channels. Altering antibiotic access to the cell interior usually does not confer a high level of resistance on the organism and must be combined with another mechanism for significant resistance potential. Several hundred efflux proteins are available that extrude waste products from the microbial cell but that now have been adapted over time to eliminate antibiotics specifically from the cell interior virtually as fast as they can enter. Enterococci can evade destruction by developing alternative metabolic growth requirements (auxotrophs). Sulfonamide resistance may occur from the overproduction of PABA, and some enteric organisms evade β -lactam antibiotics by overproducing β -lactamase (hyper- β -lactamase producers).

Antibiotic tolerance occurs when the antibiotic no longer kills the microorganism, but merely inhibits its growth or multiplication. Tolerant microorganisms start to grow after the antibiotic is removed, whereas resistant microorganisms multiply in the presence of the antibiotic. Tolerance is usually caused by the loss of autolysin activity through a failure to create or mobilize the autolytic enzymes. Vancomycin tolerance in *S. pneumoniae* is unique; a mutation in the sensor-response system controls the bactericidal autolysin activity.

Most experts agree that the major factor in the development and maintenance of antibiotic resistance in microbes is their ability to eliminate sensitive microorganisms and allow resistant ones to multiply and dominate. Although this selection process is crucial, other factors also contribute. Lengthy antibiotic regimens are commonly advocated to kill all the resistant strains or prevent stepped resistance (the development of resistance by a sequence of mutations occurring over several generations of microbial multiplication). Theoretically, if the antibiotic is given long enough, all these mutants are exposed to the antibiotic and killed at cell division. This is the rationale for taking the entire prescribed antibiotic rather than stopping the antibiotic when the patient is well. This concept is false for three reasons: (1) microbial mutations rarely occur during antibiotic treatment; (2) stepped resistance occurs even with prolonged antibiotic use⁴; and (3) most antibiotic resistance is gained by the transfer of genetic material between microbes, which is greatly enhanced by low-dose, prolonged antibiotic therapy.⁵⁰ Combination antibiotic therapy against the stepped resistance seen with *Mycobacterium tuberculosis* is unique for this organism, but should not be extrapolated to all microbes. Also, a directive to “take all the antibiotic” assumes that the prescriber knows the exact duration of the infection, which is impossible.

Microbial resistance is most likely to occur when subtherapeutic antibiotic doses are used—doses that do not kill or inhibit the microorganism, but rather allow it to perceive the chemical as a threat to its survival and to react by mutation to resistance, acquisition, or transfer of resistance genes/virulence factors or induction (expression) of latent resistance genes.^{32,50} The gastrointestinal tract is a massive reservoir for resistance genes readily transferred within and between enteric microbial species,⁹³ a process greatly enhanced by antibiotics that readily induce the expression or transfer of resistance genes, such as tetracyclines, imipenem, cefoxitin, and clavulanic acid.⁸²

Bacteria-carrying resistance genes may have a reduction in “fitness” (a biologic cost) that results in slower growth rates,

loss of virulence, and an increased biologic burden (synthesis of nucleic acids). Studies indicate, however, that many bacteria can adapt to this new genetic burden or even require resistance genes for survival. If this situation becomes common, removal of the antibiotic from the environment would have little effect on reducing resistance in the hospital or community, a point that may already have been reached with some microbes.

SPECIFIC RESISTANCE MECHANISMS

β -Lactamases

The most important acquired mechanism for β -lactam resistance, particularly in gram-negative microorganisms, is the production of various β -lactamases that hydrolyze the β -lactam ring to form a linear metabolite incapable of binding to PBPs. In 1984, 19 plasmid-mediated β -lactamases were known; the number now has increased to more than 340 chromosomally and plasmid-mediated β -lactamases—70 of the TEM-1 and TEM-2 and 20 of the SHV-1 types alone.¹¹

β -Lactamases have been variously classified by Richmond-Sykes (I to V), Ambler (A to D), and Bush (1 to 4).¹¹ β -Lactamase enzymes can be chromosomally mediated or easily transferred by transposable elements. Many are of the TEM type (from a patient named Temoniera in Greece, in whom a β -lactamase was isolated in the early 1960s) or the SHV type (sulfhydryl variable).¹¹ The most pressing difficulties with β -lactamases are their widespread dissemination throughout the microbial environment, ability to move between widely disparate organisms, tendency to inhibit new antibiotic agents rapidly, and increasing resistance to β -lactamase inhibitors (clavulanic acid, sulbactam, and tazobactam). β -Lactamases have been observed in numerous gram-positive and gram-negative pathogens. The cohabitation of staphylococci and enterococci on human skin in hospitals has likely led to the incorporation of β -lactamase genes into enterococci after the latter organisms had successfully avoided this transfer for billions of years.

Point mutations have appeared more recently in TEM and SHV β -lactamases, resulting in extended-spectrum β -lactamases in *Klebsiella pneumoniae* that hydrolyze the latest cephalosporins (cefotaxime, ceftazidime, cefepime) and aztreonam. Certain enteric microorganisms (*Escherichia coli*, *Citrobacter freundii*, *K. pneumoniae*, *Proteus mirabilis*) can produce massive amounts of TEM-1 β -lactamase (hyper- β -lactamase producers) that can overwhelm β -lactamase inhibitors. Metallo- β -lactamases possess the broadest spectrum of inhibitory activity and hydrolyze all β -lactam antibiotics except monobactams (aztreonam) and are not inhibited by any of the β -lactamase inhibitors currently available.

The first plasmid encoded β -lactamases with the ability to hydrolyze cephalosporins were termed the *extended-spectrum β -lactamases (ESBLs)*.¹³ These ESBLs microbes were also resistant to aminoglycosides, tetracyclines, and trimethoprim/sulfonamides.¹³ ESBLs cause resistance to third-generation cephalosporins (cefotaxime, ceftriaxone, ceftazidime) and monobactams (aztreonam) but are sensitive to cefamycins (cefoxitin, cefotetan) and carbapenems (imipenem, meropenem, ertapenem). These ESBLs are horizontally transmitted by mobile genetic elements from food, animals, or family members and induce greater mortality than enteric bacilli without these ESBLs.⁷⁷

Multidrug Antibiotic Efflux Pumps

A mechanism by which bacteria move an antibiotic out of the cell as soon as it enters was first detected in *E. coli* by Levy in 1978; the first gene (*qacA*) encoding a multidrug efflux protein was subsequently detected in an isolate of *S. aureus*.⁶⁹

Currently, more than 50 such systems have been described, and these cytoplasmic membrane transport proteins (multi-drug efflux pumps) have likely evolved to protect the cell from foreign chemical invasion and allow its secretion of cell metabolic products.¹¹⁰ Efflux pumps operate in *E. coli*, *Pseudomonas aeruginosa*, staphylococci, *Streptococcus pyogenes* and *S. pneumoniae*, *Bacillus subtilis*, *Pasteurella multocida*, *Neisseria gonorrhoeae*, mycobacteria, and enterococci.¹¹⁰ For tetracyclines, these efflux pumps are the major mechanism for resistance and are becoming increasingly so for the fluoroquinolones.¹¹⁰ Efflux pumps are classified into five main groups: (1) the major facilitator family; (2) the small/staphylococcal multidrug resistance family; (3) the resistance, modulation, and cell division family; (4) the adenosine 5'-triphosphate binding cassette superfamily; and (5) the multidrug and toxic compound extrusion family.¹¹⁰

These chromosomal and plasmid-mediated efflux transporter proteins may be quite specific for antibiotics and metabolic product substrates and are regulated by numerous genes and gene products. Repressors are also present and are highly regulated to prevent the accidental overproduction of efflux pumps. Tetracyclines derepress this system, leading to an overproduction of efflux proteins and increasing resistance to themselves and any other antibiotics carried by these proteins.⁸¹

Transposable Elements

Microorganisms possess three mechanisms for genetic variation: (1) local nucleotide changes in the genome, (2) rearrangement of genomic sequences, and (3) horizontal acquisition of DNA from other microorganisms. Such genetic alterations have allowed for their evolution and survival for 3.5 billion years. The rearrangement of genes and particularly the acquisition of new genetic information are commonplace and are now the major mechanism controlling microbial resistance to antibiotics.

In the 1950s, McClintock described genetic controlling elements that did not follow the Mendelian Laws of Genetics and acquired an independent existence (selfish genes, jumping genes). In the early 1970s, Hedges and Jacob first used the term *transposon* for a mobile genetic element conveying resistance to ampicillin. Microbes acquire new genetic information by three mechanisms—transformation, transduction, and conjugation—and use numerous transposable elements, such as bacteriophages, transposons, integrons, and plasmids.

During transformation, bacteria acquire “naked” DNA from their environment to incorporate into their genome. Such genetic transformations are uncommon and require unique circumstances involving genes, binding, uptake, and integration. At least 50 bacteria are sufficiently competent to acquire environmental genes from their fellow microbes, plants, yeasts, and animals. VGS and *S. pneumoniae* have the DNA recognition sites and a quorum-sensing peptide (competence-stimulating peptide) that allows for the acquisition of each other's genes when released into the environment on their death. Because they coinhabit the oropharynx, and penicillin resistance occurs in a stepwise manner with gradual amino acid mutations in at least four PBPs for high penicillin resistance, this resistance likely evolved over many years and indicates that transformation is a slow but ultimately efficient mechanism for genetic change.

Transduction is the movement of DNA from one bacterium to another by a bacteriophage (bacterial virus) intermediary. Conjugation is the self-transfer of genetic information by plasmids or transposons to other microorganisms, generally by physical contact with a sex pilus in gram-negative organisms and stimulated by various pheromones (small peptides). Mobile elements commonly require site-specific combination sites but not DNA segment identity, allowing for broad DNA

movement. Mobile elements of various types include bacteriophages, transposons, plasmids, integrons, and shufflons.

Transposons are DNA segments that cannot self-replicate, but can self-transfer between plasmids, bacteriophages, and chromosomes. Transposons can recruit as many genes as required for their purpose, and the mechanisms that control this process are essentially unknown. That we know so little about a system with so much potential for genetic change is worrisome. Between 30% and 40% of the human genome is composed of transposable element sequences or gene sequences directly derived from them.²³

Plasmids may be conjugative (self-transmissible) or non-conjugative (unable to effect their own transfer) and may be narrow range (replication in only one or a few hosts) or broad range (replication in many hosts). Too great a concentration of plasmids in one microorganism is usually intolerable because of the high energy costs to maintain it; plasmids have an autoregulatory system (iterons) that allows them to determine their own rate of replication.

Plasmids may also be constitutive (ongoing formation) or inductive (formed only when stimulated or induced by a foreign chemical). Plasmids carry resistance genes and virulence genes or pathogenicity islands that carry all the components necessary to damage the host directly or initiate host responses, such as inflammation, that harm the host. Plasmids are common in oral and gastrointestinal *Bacteroides*, *Porphyromonas*, and *Prevotella* isolates.

Researchers previously hoped that resistance genes and their transporters would pose such a fitness problem for bacteria (requiring so much energy) that bacteria no longer exposed to the antibiotic would lose their resistance genes. Such genes may become so important for bacterial functions, however, that they become permanent. The tetracycline efflux pumps can become necessary for bacterial survival by functioning in Na⁺-K⁺ exchange across the bacterial membrane.⁶ The problem is compounded when the resistance gene for a particular antibiotic becomes part of an integron-containing multiple antibiotic resistance gene array. Eliminating the one antibiotic does nothing; all the antibiotics must be eliminated from the environment for the integron to be lost.

Integrons

Antibiotic resistance has been enhanced further by the discovery of the integron, a genetic element that captures and disseminates genes by site-specific integration of DNA (gene cassettes) that can mediate resistance, virulence, and biochemical functions.⁷⁹ Integrons have three distinct genes encoding for an integrase enzyme, a recombination site, and a promoter element.⁷⁹ Integrons resemble bundled products with a computer operating system; they package resistance determinants to allow for widespread gene dissemination.

Each gene is a cassette, and five genes may commonly be present in one integron.⁷⁹ Superintegrons have been isolated in *Vibrio cholerae* that contain hundreds of gene cassettes that encode many bacterial functions beyond those of resistance and virulence. Gene cassettes have been identified for all antibiotics except fluoroquinolones, and they exist for quaternary ammonium compounds. Integrons cannot promote self-transfer because they lack transporter genes, but they are commonly associated with transposons and conjugative plasmids.

Horizontal Gene Transfer

Horizontal gene transfer (HGT), also known as *lateral gene transfer*, has been a major impetus for the exceptional diversity and survival of the microbial world. Ancient integrons, bacteriophages, plasmids, transposons, and now insertion sequence common regions have changed the otherwise clonal mode of prokaryotic life⁹⁵ and allowed for gene capture and

dissemination from the global gene pool.⁸ These mobile bacterial elements move from one bacterial cell to another via transduction and conjugation as circular, usually double-stranded DNA and often via a sex pilus as an extension from the donor to the recipient cell. Technically, a third form of DNA transfer is via transformation whereby “naked” DNA from disrupted cells is taken up from the extracellular fluid by certain “competent” cells.

These mobile genetic elements include plasmids, transposons, bacteriophages, integrons, and insertion sequence common regions that move from bacterial cell to bacterial cell or, when translocated, from various DNA sites within the bacterial cell.⁸ These DNA elements carry genes for antibiotic resistance, heavy metal toxins, and virulence determinants and can induce or repair DNA damage.⁸

HGT encompasses two processes that move genetic material from one bacterium to another to enable unique phenotypic characteristics or to translocate genes from one location (plasmids) to another (chromosomes).⁵⁹ The combination of integrons, transposons, and insertion elements results in antimicrobial resistance islands.⁵⁹ Insertion sequences are mobile genetic elements that promote and translocate genes and are inserted into transposons to mobilize DNA resistance genes for β -lactamase of the CTX-M type.⁵⁹

HGT facilitates genome rearrangement, deletions, and insertions to allow adaptation to changing environments and is induced by antimicrobials, metals, and organic contaminants (environmental stress).⁷ This facilitation of gene transfer occurs in four steps: (1) packaging of nucleic acids for transfer via excision and circularization of the transposons, (2) transfer of the DNA via contact with the recipient cell (conjugation), (3) entrance into the cell and integration with host chromosomal DNA, and (4) transfer of chromosomal DNA or the replicating elements into the daughter cells and subsequent generations.⁷

RESISTANCE IN MAJOR MICROBIAL PATHOGENS

Streptococcus pneumoniae

Microbial resistance to antibiotics in *S. pneumoniae* is most serious because the organism is responsible for 3000 cases of meningitis, 50,000 cases of bacteremia, 500,000 cases of pneumonia, and 2 million cases of otitis media in the United States annually and 3 to 5 million deaths annually worldwide.⁶⁹ Resistance to sulfonamides was first detected in 1943 and to penicillin in the late 1960s in Australia and New Guinea. The mechanism of penicillin resistance is a single point mutation in PBP2x or PBP2b, with an altered PBP2a requiring mutation also in pBP2x (the organism has six PBPs).

High penicillin resistance (usually a plasma concentration of ≥ 2 $\mu\text{g/mL}$) is seen in 14% of U.S., 6.8% of Canadian, 10.4% of European, and 17.8% of Asian-Pacific isolates.³⁸ Resistance of the pneumococcus to penicillin can vary significantly with geographic area: 38.8% in Tennessee, 15.3% in Maryland, 65.3% in Japan, 60.8% in Vietnam, 15.6% to 48.2% in Latin America, and 79.7% in Korea.⁶⁹

Tolerance to vancomycin has been detected in an isolate responsible for meningitis and high-level resistance to quinupristin-dalfopristin and cefotaxime. Tetracycline resistance in *S. pneumoniae* is currently low but is increasing, which may pose a significant problem because doxycycline has become an important drug for community and nosocomial-acquired pneumonia caused by *S. pneumoniae*, *Mycoplasma pneumoniae*, *Legionella pneumophila*, and *Chlamydia pneumoniae*.

Methicillin-Resistant Staphylococci

In a 1999 review of more than 10,000 bloodstream infections at 49 U.S. hospitals, *S. aureus* accounted for 16% and CoNS

for 32% of all isolates, with most of the CoNS being methicillin-resistant.⁶⁹ Some isolates are susceptible only to vancomycin; others are susceptible to linezolid and quinupristin-dalfopristin; and still others are susceptible to older agents such as macrolides, tetracyclines, aminoglycosides, rifampin, clindamycin, sulfonamides, and fluoroquinolones. The mechanism of methicillin resistance is an altered PBP2 (PBP2a or PBP2') conferred through a *mecA* gene that results in a much lower binding affinity of methicillin for PBP2a. This mode of resistance requires the cooperation of PBP2 and PBP2a sites and two enzymes, one natural and one environmentally acquired.

The first MRSA isolate was detected in the United Kingdom in 1961, and MRSA remained rare in the United States until 1976. MRSA spread throughout the hospital by nasal secretions, hands, clothing, bedding, air currents, fomites, and skin boils (furuncles). The anterior nares is the prime carrier site of *S. aureus* in humans, with 80% of people either persistent or intermittent carriers and possibly 25% of healthy individuals colonized with CoNS. High concentrations of staphylococci are also found in the throat, axilla, and perineum (groin and upper thighs).

Enterococci

Of the 17 species of enterococci found in the human oral cavity and gastrointestinal and genitourinary tracts, *Enterococcus faecalis* accounts for 90% of human infections, and *E. faecium* accounts for approximately 10%.⁶⁹ Enterococcal infections are classic examples of a relatively harmless commensal organism becoming a serious pathogen by the acquisition of multiple resistance genes.

Enterococci are intrinsically resistant to cephalosporins and have varying degrees of resistance to aminoglycosides, macrolides, tetracyclines, and clindamycin. Vancomycin resistance, particularly in *E. faecium*, has been of major concern since the late 1980s. Enterococci cause 800,000 nosocomial infections annually in the United States, with more than 50% caused by vancomycin-resistant *E. faecium*; resistance is more than 90% in *E. faecium* bacteremias. Currently, 17% of enterococcal strains in the United States are resistant to vancomycin.⁵²

Vancomycin-resistant enterococcus (VRE) infections, particularly of the bloodstream type, are becoming extremely difficult to treat. Doxycycline has been enlisted more recently in the treatment of VRE.⁵² Enterococcal resistance is complicated further by the observations that (1) streptococci, staphylococci, and enterococci often share the same resistance genes; (2) β -lactamase in enterococci is identical to that in staphylococci, indicating sharing of genetic information; (3) enterococci can transfer resistance genes, particularly for vancomycin to staphylococci and other organisms, in vitro and in animal models; (4) staphylococci and enterococci coinhabit the skin; and (5) the possibility exists that vancomycin resistance may one day appear in many VGS.⁶⁹

Helicobacter pylori

Chronic gastritis, peptic ulcer, and gastric cancer have been linked to *H. pylori*. Depending on the geographic area and the prevalence of antibiotic use, alarming reports have appeared of resistance to all antibiotic agents used in its management, including metronidazole, clarithromycin, tetracycline, and amoxicillin. Resistance to metronidazole acquired by a decreased ability to reduce its nitro group ranges from 10% to 50% in developed countries and up to 100% in developing countries, where it is widely used to treat parasitic diseases. Resistance to amoxicillin ranges from 0% in The Netherlands to 18% in Mexico to 72% in Shanghai, China. Resistance to clarithromycin ranges from 1.7% in The Netherlands to 10% to 12% in the United States to 24% in Mexico.

Tetracycline has been added more recently to antibiotic regimens, and resistance rates are 0% in The Netherlands, 5.3% in Korea, and 58.8% in Shanghai, China, with the disturbing possibility that tetracycline-resistant *H. pylori* may exhibit cross-resistance with metronidazole. Metronidazole resistance in *H. pylori* may decrease the effectiveness of therapy by 37.7%, and clarithromycin resistance may decrease the effectiveness of therapy by 55%.²⁵ The widespread use of systemic metronidazole and tetracycline is difficult to justify in the management of a relatively trivial, mechanically responsive disease such as periodontitis when such a practice may promote resistance in a microbial pathogen responsible for very serious diseases such as peptic ulcer and gastric cancer.

Human Immunodeficiency Virus

The current therapy for HIV infection entails highly active antiretroviral therapy (HAART) (see Chapter 40) with a combination of drugs that interfere with several steps in viral replication, including reverse transcriptase inhibitors, protease inhibitors, and the new integrase inhibitors that prevent HIV from integrating into the genome of the host cell. Difficulties have arisen with this therapeutic approach because the virus provides for reservoirs of replication-competent HIV in resting CD4 T lymphocytes throughout many years of intensive HAART. It is estimated that more than 60 years of HAART may be necessary to eradicate the virus from these reservoirs.⁶⁹ More than 50% of HIV-infected individuals in the United States receiving HAART are resistant to one or more of the drugs, and 78% of individuals with measurable viral loads are resistant to at least one drug, encompassing about 100,000 people in the United States.⁹⁹ From 1994-2000, 14% of new HIV cases had one or more HIV mutations associated with antiretroviral drug resistance; in 2000, it was 27%. Approximately 25% of newly infected, therapy-naïve individuals carry at least one key HIV drug-resistant mutant.⁷⁸

SPECIFIC ANTIMICROBIAL AGENT RESISTANCE

Vancomycin

The long-feared arrival of vancomycin resistance in MRSA was realized in El Salvador, Japan, France, and the United States during 1996-1999.⁶⁹ Because the glycopeptides (vancomycin, teicoplanin) are the only consistently effective agents against MRSA, the appearance of such resistance has the potential for microbiologic disaster, as 50% of nosocomial *S. aureus* and 80% of CoNS are methicillin resistant. Some of these strains are at least for now susceptible to streptogramins, tetracyclines, sulfamethoxazole/trimethoprim, chloramphenicol, and fluoroquinolones. More recently, streptogramin resistance has been reported in glycopeptide-intermediate *S. aureus*. Vancomycin tolerance is now found in *S. pneumoniae*, group G streptococci, *Streptococcus bovis*, *Streptococcus mitis*, *Staphylococcus epidermidis*, and *Staphylococcus haemolyticus*. Possibly 2% to 3% of all *S. pneumoniae* strains are tolerant to vancomycin.⁶⁵ In 1994, 61% of all surveyed hospitals reported VRE compared with 23% in 1992.⁶⁹ The mortality rate for bloodstream infections with VRE is 36% versus 16% for vancomycin-sensitive enterococci. Five genes (*vanA*, *vanB*, *vanC*, *vanD*, *vanE*) modulate vancomycin resistance with spread by all transposable elements.

One mechanism of vancomycin resistance is caused by an altered peptidoglycan terminus of D-ala-D-lac rather than the usual D-ala-D-ala, which results in reduced vancomycin binding and failure to prevent rigid cell wall synthesis.¹⁴ Resistance in vancomycin-intermediate *S. aureus* may be caused by the production of abnormal mucopeptides (false binding sites) in the cell wall that bind vancomycin and prevent its access to the peptidoglycan receptor or increase peptidoglycan

within the cell wall to produce thickened cell walls.¹⁵ The mechanism for vancomycin tolerance in *S. pneumoniae* is unique in that a mutation in the sensor-response system controlling autolysin activity is necessary to kill bacteria.⁶⁹ This sensor system is also required for the bactericidal activity of β -lactams, fluoroquinolones, and aminoglycosides.

Macrolides

Within 1 year of its introduction in 1952, erythromycin resistance was detected in the United States, Japan, and Europe; after 6 months of use at Boston City Hospital, virtually all staphylococci were resistant to the drug. The current global resistance rate for erythromycin is approaching epidemic proportions. In the United States, resistance in *S. pneumoniae* and *S. pyogenes* has reached 40% to 60% in some areas. In Taiwan, where the macrolides are over-the-counter drugs, resistance rates are among the highest in the world: 80% for MRSA, 30% for methicillin-sensitive *S. aureus*, 58% for *S. pneumoniae*, and 42% for *S. pyogenes*. In a 1995-1999 Centers for Disease Control and Prevention study of 15,481 invasive isolates of *S. pneumoniae*, macrolide use increased 13% in adults and 320% in children younger than 5 years, and macrolide resistance increased from 10.6% of isolates in 1995 to 20.4% in 1999.⁶⁹

In 66 VGS isolates from the blood of neutropenic cancer patients, 68.8% of the isolates highly resistant to penicillin were also resistant to erythromycin, as were 43.6% of the *S. mitis* isolates.⁶⁹ Of much concern is the ability of VGS to confer the *mefA* resistance gene (M phenotype) to *S. pneumoniae* and *S. pyogenes* because 50% to 60% of the VGS in the pharynx possess the M phenotype. VGS may provide a reservoir for erythromycin resistance genes available for transfer to various other streptococci.

The principal mechanism for resistance to the macrolides is by an *erm* (erythromycin-resistant methylase) gene encoding an enzyme that catalyzes the demethylation of the 2058 residue of bacterial 23S ribosomal RNA, resulting in decreased macrolide binding to its ribosomal receptor site (a ribosomal protection mechanism).⁶⁹ The *erm* genes are constitutive and inducible with induction on exposure to the 14-membered and 15-membered, but not the 16-membered macrolides. Approximately 21 *erm* genes have been identified.⁸⁴ The *erm* genes are often associated with other antibiotic resistance genes, particularly genes for tetracycline (*tetQ*, *tetM*), making it possible to select for resistance to both drugs while using only one.

Macrolide resistance genes are also commonly combined with resistance genes for lincosamides (clindamycin) and streptogramins (quinupristin-dalfopristin) in the MLS_B aggregate. Because resistance has now been detected in new ketolide analogues of macrolides, a new designation has arisen of MLKS resistance (macrolide, lincosamide, ketolide, streptogramin). Other macrolide resistance mechanisms include active efflux encoded by *mefA* and *mefE* genes for 14-membered and 15-membered macrolides and esterification by phosphorylation or glycosylation to inactivate the macrolides.⁸⁴

Fluoroquinolones

Resistance to fluoroquinolones was detected early after their introduction and was easily predictable because it required only a single point mutation, and its precursor, nalidixic acid, showed rapid development of resistance. Little attention was paid to this potential for serious difficulties with this group of antibiotics. One of the major factors in the epidemic increase in potentially fatal *Clostridium difficile*-associated diarrhea (CDAD) was the massive overuse of fluoroquinolone antibiotics in hospitals resulting in a mutation in the regulating protein in *C. difficile* that controls the production of toxins A and B.

Resistance to fluoroquinolones is chromosomally mediated by three mechanisms: (1) target alteration by point mutations for DNA gyrase (serine 83 and aspartate 87 of *gyrA*) and topoisomerase IV (serine 79 and aspartate 83 of *parC*), (2) active efflux pumps, and (3) reduction in permeability from loss of outer membrane protein F (OmpF). No bacterial enzyme capable of metabolizing fluoroquinolones has yet been detected, and the significance of a transferable resistance plasmid in *K. pneumoniae* is unknown. Microorganisms displaying efflux mechanisms include VGS, staphylococci, enterococci, *S. pneumoniae*, Enterobacteriaceae, *P. aeruginosa*, *Campylobacter jejunum*, *Bacteroides fragilis*, and *N. gonorrhoeae*.

Clinical microbial resistance to fluoroquinolones has become widespread, necessitating the development of newer agents that are only marginally better than the older agents and still susceptible to the same resistance mechanisms. Resistance in *N. gonorrhoeae* increased in Japan from 6.6% in 1993-1994 to 24.4% in 1997-1998.⁶⁹ A single 500-mg antibiotic prophylaxis dose of ciprofloxacin increased the percentage of resistant *E. coli* in the colon from 3% to 12%.¹¹²

Tetracyclines

Microbial resistance to tetracyclines is widespread, inducible, transposable, and sometimes permanent because the genes for tetracycline resistance are commonly associated with other antibiotic resistance genes on transposons, bacteriophages, and plasmids. None of these resistance genes may be lost until all antibiotics whose resistance genes are carried on the transposable element are eliminated from the environment, or, conversely, tetracycline may select for all antibiotic resistance genes carried on the element. Because tetracyclines have been rediscovered as effective therapy for nosocomial VRE and MRSA and community-acquired *S. pneumoniae* and *H. pylori*, the unwarranted use of tetracycline poses potentially serious clinical difficulties.

Three mechanisms exist for tetracycline resistance: drug efflux pumps, ribosomal protection, and enzymatic inactivation.¹⁷ At least 29 different tetracycline resistance genes (*tet*) have been characterized, with at least 19 for specific and nonspecific efflux pumps, 8 for ribosomal protection, and the *tetX* gene for enzymatic activation.¹⁷ Resistance determinants encoding at least one of these mechanisms are likely in most genera of bacteria.

The major mechanism for tetracycline resistance is drug efflux and *tet* efflux genes, which encode at least 300 different active efflux proteins¹⁷ and in gram-negative bacteria are widely distributed and associated with large conjugative plasmids that carry resistance genes for other antibiotics, heavy metals, bacterial toxins, and virulence factors. Any chemical that selects for one of these genes can select for them all. Nine genes encode for cytoplasmic ribosomal proteins that bind to the ribosome to alter its configuration and prevent tetracycline from attaching to its receptor.¹⁷ Enzymatic inactivation is encoded by a *tetX* gene currently present only in *Bacteroides*. Mutation in the *tetA* and *tetB* genes promotes efflux resistance in the new glycolcyclines.

Since the 1970s, resistance to tetracyclines has become common in Enterobacteriaceae, staphylococci, streptococci, *Bacteroides*, *H. influenzae*, and *P. aeruginosa*, ranging from 25% to 97% of all isolates.¹⁷ Considering the close association of tetracycline resistance genes with transposable elements, this is not surprising. Thirty-nine genera of gram-negative bacteria and 23 genera of gram-positive organisms have acquired tetracycline resistance with an ongoing process of new gene discovery. Oral VGS have acquired *tetM*, *tetO*, *tetL*, and *tetK* genes, as have *S. pneumoniae* and *S. pyogenes*.

Not only is tetracycline almost exclusively associated with multiple drug resistance, it may also induce bacterial expres-

sion of resistance genes. The drug also downregulates a repressor gene that controls efflux mechanisms. Only nanomolar amounts of tetracycline are necessary to derepress this efflux control system. After that, regardless of the concentration, tetracycline can stimulate its own microbial cell efflux and that of other intracellular chemicals.

Subinhibitory levels of tetracycline that are allegedly insufficient to prevent microbial growth or stimulate resistance as used in agriculture and some therapeutic regimens increase antibiotic resistance in streptococci and staphylococci.⁶⁹ Tetracycline promotes gene transfer by stimulating the frequency of bacterial conjugation, and colonic *E. coli* may express tetracycline and other resistance genes only when the drug is present.⁶⁴ Resistance gene (*tetQ*) transfer in the colon is widespread and occurs readily by conjugative transfer with more than 95% of DNA sequence homology with *ermF* and *ermG* genes for erythromycin.⁹³

With standard tetracycline doses, within 24 hours, more than 95% of coliform bacteria in the gastrointestinal tract show resistance to tetracycline that lasts as long as the drug is present and for at least 4 to 6 months or longer in some cases after tetracycline is discontinued.⁷⁶ Family members of individuals taking tetracyclines for acne may have a 1000 times greater chance of multidrug-resistant bacteria than those whose members do not take tetracycline.⁵⁸

It was long assumed that the massive resistance to tetracyclines observed from the 1960s to the 1980s would always remain and that the drugs were essentially useless against most major pathogens, particularly nosocomial pathogens. To the contrary, more recent clinical studies document a very low level of tetracycline resistance (1.3% in some studies) in common outpatient pathogens: *S. pneumoniae*, *H. influenzae*, *C. pneumoniae*, *Chlamydia trachomatis*, *M. pneumoniae*, *Mycoplasma hominis*, and *Ureaplasma urealyticum*. Tetracyclines have now become accepted, if not primary, antibiotics against community-acquired *S. pneumoniae*, and many are lifesaving against VRE and MRSA.⁶⁹

The advocates of long-term low doses of doxycycline for periodontitis maintain that such doses produce a maximum blood level of $0.79 \pm 0.285 \mu\text{g/mL}$ and that such blood/tissue levels do not adversely affect oral bacteria or increase levels of resistance.¹⁰⁶ Limited data are presented regarding resistance in other body areas (colon, skin). Ample evidence suggests that such blood levels of tetracyclines, particularly doxycycline, are therapeutic and even lifesaving at 0.06 to $0.25 \mu\text{g/mL}$ or less, many times below the $0.79 \pm 0.285 \mu\text{g/mL}$ or less seen with a dosage of 20 mg twice/day.⁶⁹ A choice must be made between long-term therapy with tetracycline for whatever benefit, if any, it may have in periodontitis and the possibility of losing these drugs again by resistance development for serious and sometimes life-threatening diseases.

Heavy Metal Resistance

Microbial resistance to the heavy metals (e.g., silver, mercury, lead) is widespread in nature among various microorganisms. The most widely studied has been mercury resistance systemically and in the oral cavity. Not only do microorganisms develop genetic resistance mechanisms to the toxic effects of heavy metals (mercury damages thiol-containing enzymes), but these genes are also associated with antibiotic-resistance genes (penicillin, aminoglycosides, tetracyclines, chloramphenicol) in transposable elements and induce the transfer of resistance genes among microorganisms.¹¹⁷

Controversy has arisen regarding the potential effect of dental amalgam mercury on the resistance patterns of oral and fecal bacteria (silver has not been studied). Monkeys given 12 to 16 occlusal amalgams at one time showed that shortly after placement, mercury-resistant bacteria increased in the oral cavity and feces and were associated with resistance to several

antibiotics (ampicillin, tetracycline, aminoglycosides).¹¹⁷ Clinical studies in three separate populations (subjects in whom all amalgams had been removed, subjects never having had an amalgam, and subjects with a varying number of amalgams) showed no differences in the minimal inhibitory concentrations (MICs) of oral and fecal microorganisms in their resistance patterns to tetracycline, chlorhexidine, cefuroxime, penicillin, and mercury chloride.^{48,66}

The animal studies placed a large number of amalgams at one time with no data on their mercury content or the occlusal volume of the restoration and studied the resistance patterns for a maximum of 12 weeks, at which time the fecal mercury level had decreased so as not to present any selective advantage to resistance.¹⁰³ If the mercury resistance genes are transient and are later lost, the effect of mercury on the oral and fecal bacteria would likely be insignificant. Conversely, if the metal resistance genes become permanent residents of the oral or fecal flora, associate as part of a multidrug-resistant transposable element, or significantly induce resistance gene transfer among bacteria, a significant problem could exist. At least one study documents such gene transfer¹¹⁷; further study is warranted. Currently, no compelling evidence indicates that dental amalgam possesses any significant long-term adverse effect on microbial resistance patterns in the oral or fecal flora.

New vaccines are on the horizon against staphylococci, enterococci, and VGS. New antibiotics will be developed, but progress in developing new classes of drugs is limited. Meanwhile, the public, agribusiness, and health practitioners must use antimicrobial agents with much wisdom and circumspection. In the words of Norman Simmons: “We screwed up, and we ought to say so and apologize. Doctors were handed the wonderful gift of antibiotics but are destroying them through indiscriminate use. We know what to do, we should use them less.”⁹⁷

FACTORS INFLUENCING ANTIMICROBIAL THERAPY

The goal of microbial culture and sensitivity testing is to predict the outcome of treatment for an infection managed with an antibiotic agent. Identification of the microorganism allows for the ideal choice of antimicrobial agent. Empiric antibiotic therapy remains satisfactory for infections in which the microbial cause is likely to be routinely predictable or unlikely to be associated with drug-resistant strains, but empiric therapy may not be satisfactory for nonpredictable infections.⁴¹

The mere recovery of an organism from an infection does not indicate that it is involved in disease causation.⁶³ Orofacial infections are characterized by a rapid onset, prompt resolution with the elimination of the source, and a multiplicity of potential pathogens. Orofacial infections differ substantially from infections elsewhere in the body, where the onset is typically slow with protracted resolution and commonly monomicrobial in causation with rarely an opportunity to perform incision and drainage. Orofacial infections, if treated properly and caused by antibiotic-sensitive organisms, are commonly in remission before the culture tests are available. Because of their polymicrobial cause, determining the etiologic pathogens is difficult to impossible.

The issue of whether microbial culture and sensitivity tests are required or even desirable for the management of orofacial infections has been debated.^{33,113} Because of the clinical features of orofacial infections (rapid onset and resolution, polymicrobial nature, well-established pathogens), routine culture and sensitivity tests are unlikely to be necessary, much less useful, unless the infection is very serious or fails to respond to diligent intervention. Polymicrobial infections defy the detection of the precise offending pathogens.

The breakpoints for minimal inhibitory concentrations (MIC) determinations are established in the United States by the National Committee for Clinical Laboratory Standards (NCCLS) but can vary widely throughout the United States and the rest of the world. One locale may use 0.1 µg/mL for penicillin resistance, whereas another may use 1 µg/mL. These breakpoints should reflect the reasonable blood level of the antibiotic that can be achieved by conventional and practical doses. Sometimes breakpoints are used that, although approved by the NCCLS, cannot be attained in the body except by unusual dosing. The use of such breakpoints can imply lack of resistance when for all clinical purposes the organism is resistant. The NCCLS recommendations are currently under criticism for just such difficulties. As stated by Jacobs and colleagues³⁹: “Many of the NCCLS breakpoints are actually higher than the peak concentrations of the agent in serum and tissue, so that clinically achievable concentrations can never reach, let alone exceed, the concentrations needed to inhibit organisms for which the MICs are at or close to the susceptibility breakpoint value.”

ANTIBIOTIC PHARMACOKINETICS AND PHARMACODYNAMICS

Despite being used clinically for more than 60 years, antibiotic unit doses, dosing intervals, and duration of therapy are not generally established for most infections.^{44,80} Because antibiotics produced such remarkable cures not previously encountered and were essentially nontoxic drugs, clinicians would often forgo clinical trials and merely administer the drug until the patient got well or died. Very few clinical studies were ever performed on dosage, with one of the only being the 10-day therapy for the treatment of streptococcal sore throat, which was then extrapolated to most infections—10 days for all infections regardless of cause and locale. This was another case of an assumption determining therapy without any scientific basis.

Many dosing guidelines are empiric and should not be relied on blindly^{7,108}; substantial resistance is encountered to changing package insert dosages even in the light of new data and understanding of antibiotic pharmacokinetics and pharmacodynamics.³⁵ The formula approach does not take into account mechanisms of action or postantibiotic effects, host-microbe interactions, or whether the antibiotic effect is concentration-dependent or time-dependent. It does not incorporate clinical data on microorganism virulence, anatomic location of the infection, whether incision and drainage can be established, microbial resistance, the physical signs and symptoms of the patient, and the status of the host defense mechanisms.

Formulas are a poor way to treat multifactorial infections unique to each patient because antibiotic therapy is not an exact science. Suspicion lingers that because of the common practice of inadequate antibiotic dosing, many patients get well by themselves with the antibiotic contributing little to their recovery. A clear understanding of current concepts of antibiotic pharmacokinetics (dose, absorption, distribution, metabolism, excretion) and pharmacodynamics (serum concentrations, dosing, host-microbe interaction, postantibiotic effects) is essential to achieving optimal efficacy and reducing microbial resistance.

PRINCIPLES OF ANTIBIOTIC DOSING

The goal of antibiotic therapy is to aid the body's defenses to clear the tissues of the microbial pathogens by achieving antibiotic levels in the infected area equal to or greater than the

MIC.⁴⁹ To accomplish this, the organism must be susceptible, and the drug concentration must be sufficient at the infected site until the next dose. Local factors that interfere with antibiotic activity must be minimized, with all efforts being made to eliminate the organism physically (incision and drainage). Host defenses need to be adequate to eradicate the pathogen and associated metabolic products (toxins) eventually.⁴⁹

Minimal Inhibitory Concentration

The MIC is the **lowest antibiotic concentration that prevents growth of microorganisms after an 18- to 24-hour incubation period** with a standard organism inoculation of 10^4 to 10^5 cfu/mL. The minimal bactericidal concentration, which is rarely used as a clinical measure, is the lowest concentration of the antibiotic that causes the complete destruction of the organism or permits survival of less than 0.1% of the inoculum. Because the concentration of the antibiotic cannot be measured at the site of the infection, the serum antibiotic concentration and the MIC serve as surrogate markers attempting to quantify antibiotic activity.¹⁰

Although useful, the MIC has certain inherent difficulties. The MIC is a point in time only and tells nothing about the true antibiotic activity at the locus of the infection (antibiotic pharmacodynamics). The concentration of organisms (inoculum size) at the site of the infection is commonly 10^8 to 10^{10} cfu/mL, many times greater than that used to determine the MIC in the laboratory. The growth of microorganisms *in vitro* is exponential, whereas growth *in vivo* can be very slow to none.⁴⁹ The laboratory MIC determination is also subject to considerable variables, including temperature, inoculum size, pH, and growth medium, which may substantially differ from those occurring in the patient.

The MIC can be useful, however, in determining certain guides to antibiotic dosing: (1) the ratio of the peak drug concentration in the serum to the MIC (peak/MIC ratio), (2) the duration of time the serum drug concentration exceeds the MIC (time above the MIC), and (3) the ratio of the 24-hour area under the curve (AUC) to the MIC (AUC₂₄/MIC ratio).⁴⁹ The AUC is the measure of the drug exposure to the bacteria over time. The time above the MIC is very important in the efficacy of time-dependent β -lactam antibiotics, linezolid, and, to some extent, macrolides and clindamycin. The ratio of the 24-hour AUC to the MIC is important for concentration-dependent aminoglycosides and fluoroquinolones. A general rule of thumb is that the concentration of the antibiotic in the blood should exceed the MIC by a factor of two to eight times to offset the tissue barriers that restrict access to the infected site.⁶³ Substantial differences exist in interpretation of MICs when used to direct clinical antibiotic choices and dosing, particularly in the interpretation of antibiotic resistance studies. The clinically useful breakpoint (i.e., the threshold above which the bacterium is unlikely to respond to the specified MIC of the antimicrobial agent) depends on the amount of antibiotic that can readily be achieved in the blood of the patient.⁴⁰

All of these guidelines apply only if the offending microorganism can be cultured and the MICs can be determined. Such determinations are not commonly performed in outpatient medicine, are not performed as often as they should in hospitals, and are virtually never performed in dentistry. These principles are useful, however, and have led to the concepts of concentration-dependent versus time-dependent antibiotics.

Concentration-Dependent Versus Time-Dependent Antibiotics

Depending on their mechanism of action, some antibiotics are much more effective if very high blood (and presumably tissue) concentrations are reached periodically (peak and

trough effects, concentration-dependent), and others are more effective if the blood levels are maintained above the MIC for as long a time as possible (time-dependent). The antibacterial activity of aminoglycosides, metronidazole, and fluoroquinolones depends on high drug concentrations at the infected site because the killing rate is proportional to the drug concentration.⁴⁹ Conversely, some antibiotics, such as β -lactams and vancomycin, are less dependent for their activity on tissue concentrations and are much more effective with a long time of exposure of the microorganism to the antibiotic (time-dependent killing).

Because these agents require organisms in the process of cell division for their activity, antibiotics with slow time-dependent killing should ideally be continually present in the infected area because bacteria divide at different times and at different rates. Bacterial cell walls can be inhibited only while being formed; hence, β -lactams have no effect on cells with fully formed cell walls. The goal of dosing with cell wall inhibitors is to maximize the time of exposure to active drug levels and maintain the blood and tissue concentrations above the organism's MIC for as long as possible.⁴⁹ For pragmatic purposes, the blood/tissue concentrations of β -lactams should exceed the organism MIC for at least 60% to 70% of the dosing interval for pathogens with a short or no postantibiotic effect and 40% to 50% of the dosing interval for pathogens with long postantibiotic effects.²⁰

Increasing the dosage of β -lactams to gain tissue concentrations more than four to five times the MIC does not result in increased killing and may end in a paradoxical or "Eagle" effect, in which very high β -lactam concentrations produce reduced rates of microbial killing.^{67,70} It may be theoretically possible to have too high a dose of an antibiotic, but little or no evidence suggests that this paradoxical effect contributes to antibiotic failures.

Time-dependent killing with current package insert dose regimens is easy to achieve with β -lactams with long half-lives, such as amoxicillin, but difficult with penicillin V, cephalexin, or cephadrine, which have short half-lives of about 45 minutes or less. If the peak blood level of these agents is achieved 1 hour after oral administration, and the standard formulas for half-lives and blood levels are at work (50% of the drug left at one half-life, 25% at two half-lives, 12.5% at three half-lives), at 4 hours from the original dosing, less than 12.5% of the peak blood level of the short half-life β -lactam remains. Unless the organism is very sensitive to the β -lactam (something that is unknown without culture and sensitivity tests), this concentration is unlikely to be above the MIC, leading to at least a 2-hour time period below the MIC because the package insert dosing interval for these agents is typically 6 hours. This considerable time period below the MIC allows for more rapid regrowth of the organism and increased risk of the emergence of resistant strains, both of which are associated with therapeutic failure. These dosing intervals merit serious reassessment.

Postantibiotic Effects

The concepts of time-dependent or concentration-dependent killing primarily involve bactericidal antibiotics that inhibit either nucleic acid or cell wall synthesis. For bacteriostatic antibiotics (macrolides, clindamycin, tetracyclines) that act by ribosomal protein synthesis inhibition and possess long post-antibiotic effects (PAEs), such critical blood and tissue concentrations are considerably less imperative. A PAE is the persistent suppression of microbial growth after short-term exposure to an antimicrobial agent.

The concept of the PAE is gaining increasing interest as an important corollary to concentration-dependent versus time-dependent dosing. The antibiotic concentration may be well below the MIC, or the drug may even no longer be

present, yet suppression of bacterial replication persists, and the organism may be more susceptible to phagocytosis and the postantibiotic leukocyte effect (greater susceptibility of microorganisms to white blood cells after exposure to antibiotics). Humoral and cellular immune processes undergo altered morphologic characteristics and lose their adhesive properties, which may be important in the antibiotic prevention of bacterial endocarditis. The PAE may also render bacteria less susceptible to cell wall inhibitors, but allow for longer dosing intervals for bacteriostatic agents.

Virtually all antibiotics have demonstrable PAEs, but the duration is most significant with intracellular bacteriostatic agents and least with β -lactams. Various factors influence the PAE, including the particular organism, inoculum size, growth medium, organism growth phase, antibiotic mechanism of action, antibiotic concentration, and exposure time to the antibiotic. β -Lactams have a short PAE (1 to 3 hours) in gram-positive organisms and no PAE in gram-negative organisms. Under ideal circumstances, antibiotics that suppress ribosomal protein synthesis may have 5- to 10-hour PAEs, whereas fluoroquinolones and aminoglycosides possess intermediate PAEs of 2 to 4 hours.²⁹

The exact mechanism for PAEs is unknown but is related to the time necessary to recover from sublethal structural and metabolic alterations that prevent resumption of bacterial regrowth (replication).²⁹ The precise clinical benefits of PAEs are difficult to determine but likely allow for less concern about rigid dosing intervals for bacteriostatic agents and undermine the old clinical adage that bactericidal antibiotics are always superior to bacteriostatic agents.

Microbial Persistence and Regrowth

The next antibiotic dose must be given before significant microbial regrowth can recur.⁴⁹ Microbial regrowth is not related to resistance but rather to the subpopulation of organisms that is not inhibited or killed during a given dosing interval (the residual bacteria at the end of each dosing cycle), which can re-establish themselves and continue growth. The size of the residual population is related to the initial population size (inoculum size), bactericidal activity, organism MIC, postantibiotic effects, antibiotic pharmacokinetics, and the doubling time of the organism.⁴⁹ The doubling time of VGS in bacterial endocarditis and *S. pneumoniae* in pneumonia can be every 20 minutes, whereas the doubling time for *Treponema pallidum* in syphilis may be 36 hours. Any rapidly expanding or spreading infection implies a very rapid microbial doubling time and a necessity to reduce the residual population available for regrowth to as low a number as possible.

Dosing and Resistance

The antibiotic concentration in the tissues should ideally exceed the MIC by a factor of 8 to 10 times to reduce or prevent the emergence of a resistant subpopulation.⁴⁹ The likelihood for the emergence of resistant strains during antibiotic therapy increases with greater spontaneous mutations, reduced host ability to eliminate the mutants, and, most important, the concentration of the antibiotic at the site of infection (the greater the concentration, the less likely the emergence of resistance; the lower the concentration, the greater the risk of resistance emergence).⁴⁹

The less time the pathogen is exposed to sub-MIC doses, the less the chance of resistance mutations.⁸⁹ The ability of the resistant subpopulation to develop and overgrow decreases exponentially with greater antibiotic concentrations.¹⁰⁷

Antibiotic Loading Doses

Because most acute orofacial infections begin and peak rapidly, high antibiotic blood levels must be achieved quickly;

this is best and often only achieved with oral loading doses (two to four times the maintenance dose).^{67,70,116} An antibiotic loading dose should be used whenever the half-life of the antibiotic is longer than 3 hours or a delay of 12 hours or longer to achieve therapeutic blood levels is unacceptable. If an antibiotic loading dose is not used, approximately four maintenance doses spaced at the recommended intervals are required to achieve a steady-state blood level of the antibiotic. Most antibiotics useful in orofacial infections have half-lives of less than 3 hours, but the acute nature of orofacial infections necessitates therapeutic blood levels earlier than 12 hours. With antibiotics with exceptional bioavailability, such as amoxicillin, a loading dose is not as crucial as with penicillin V or cephalexin, which are not as rapidly or as well absorbed.

Duration of Antibiotic Dosing

There is a natural but irrational tendency to treat infections for longer than necessary when shorter durations would be just as effective and decrease the overall selection pressure or microbial resistance.^{22,56} Determining the optimal duration of antibiotic treatment is usually difficult because bacterial kinetics and effects of drugs are not precisely known. Although some bacteria may occasionally mutate to resistance in a stepwise fashion, and the presence of the antibiotic and high or prolonged doses might stop these mutants from attaining complete resistance, the reality of today is that virtually all resistance occurs by transposable element gene transfer promoted by the use of antibiotics, particularly at low doses and for long durations.^{50,69}

Antibiotics should be used aggressively and for as short a time as is compatible with patient remission of disease.^{67,70} With infectious diseases that do not rebound (return at cessation of the antibiotic), the proper duration of the antibiotic is determined by the time required for the patient's host defenses to gain control of the infection. The ideal antibiotic duration is the shortest time that prevents clinical and microbiologic relapse. The only practical guide to effectiveness of antibiotic therapy and the duration of therapy is clinical improvement of the patient as judged by remission of the infection. Antibiotic success is best determined by clinical improvement.

The following four misconceptions are the major reasons for the unnecessary prolonged use of antibiotics: (1) prolonged antibiotic therapy destroys resistant bacteria, (2) prolonged antibiotic therapy is necessary to prevent oral rebound infections, (3) antibiotic dosages and duration of therapy can be extrapolated from one infection to another, and (4) the antibiotic prescriber knows how long the infection will last.

Certain infections (fungal, urinary tract, respiratory) tend to recur when the antibiotic is terminated because the organisms may not be eliminated but only suppressed. Orofacial infections rarely, if ever, rebound, particularly if the source of the infection is eradicated. Often in medicine the temptation has been to extrapolate from one infection to another regarding dosage and duration of therapy. Many regimens have been based on the 10-day therapy against group A β -hemolytic streptococcal sore throat with little thought that such therapy might not apply to infections in the rest of the body.

Even experts get caught up in the adage to finish the course of the antibiotic and "make sure you take it all." In many cases, this advice is based on a fallacious assumption—that the prescriber knows beforehand just how long the particular infection will last. This foreknowledge is unlikely considering the number of variables involved in any given infectious process. The dentist should prescribe a reasonable amount of antibiotic (commonly for 3 to 5 days) with an initial loading dose (probably unnecessary with amoxicillin) and then re-evaluate the patient shortly into the infection (in 1 or 2 days) and monitor the patient's progress until he or she

is well. Prescription refills are designed for additional antibiotic administration if necessary. The antibiotic is terminated when, in the dentist's best clinical judgment, the patient's host defenses have gained control of the infection, and it is well on its way to or at termination.

Incision and Drainage

The reduction in the inoculum size of the infecting organism is paramount in the management of infections. As stated by Cunha and Ortega,²¹ "Most patients who develop abscesses and are being treated with antibiotics cannot hope to be cured by antibiotics alone. . . . Surgical drainage remains the cornerstone of the therapeutic approach in the patient with abscesses."

With some clinical infections (pericoronitis, indurated cellulitis), the infection is too diffuse or has no nidus that would respond to incision and drainage. With most orofacial infections, incision and drainage is imperative because (1) antibiotics do not diffuse well into infected areas; (2) some antibiotics are inactive at abscesses because of acidic pH and other reasons; (3) abscess microorganisms may not be dividing or may be at a very low metabolic state, negating the effects of antibiotics, particularly β -lactam cell wall inhibitors; and (4) high levels of antibiotic inhibitors (β -lactamases or other enzymes) may be present to inactivate the antibiotic.^{67,70}

Antibiotic Dosing Variables

Additional pharmacokinetic factors determining antibiotic efficacy include diffusion to the site of the infection, lipid solubility, plasma protein binding, inoculum effect, surface area/volume ratio, pregnancy, age, and renal and hepatic function. The ease with which antibiotics penetrate to the site of infection follows the same path as other drugs and is guided by the pK_a , tissue pH, and lipid and water solubility. Lipophilic antibiotics, such as tetracyclines, macrolides, and fluoroquinolones, pass through tissue barriers better than hydrophilic β -lactams. Tetracyclines and macrolides are highly concentrated within cells, making them effective against intracellular pathogens and providing for a drug depot within macrophages. β -Lactams, vancomycin, and aminoglycosides are principally confined to the extracellular fluid. Diffusion through the capillary endothelium is easy for rifampin, metronidazole, and chloramphenicol; difficult for β -lactams and aminoglycosides; and intermediate for tetracyclines, fluoroquinolones, and trimethoprim.

Only an antibiotic not bound to plasma protein is free to diffuse through capillary walls and other barriers to its site of action. The degree of plasma protein binding can vary from 80% to 96% for oral anti-staphylococcal penicillins, clindamycin, and doxycycline; 50% to 80% for penicillin V, penicillin G, erythromycin, and tetracycline; and less than 25% for amoxicillin, ciprofloxacin, cephalexin, metronidazole, and aminoglycosides. Protein binding may increase with infection, inflammation, malignancy, and diabetes and decrease with cirrhosis, burns, and malnutrition. The clinical significance of antibiotic protein binding is currently debated, but, all things being equal, drugs with lower protein binding may be preferable.

The inoculum effect (loss of antibiotic efficacy against dense microbial populations) may significantly affect antibiotic activity and the ability of the drug to penetrate to the core of the infection. A large mass of bacteria results in a decreased growth rate, less phagocytic activity, increased β -lactamase activity, more glycocalyx production, and reduced pH. The deleterious effect of inoculum size can be eliminated by early and vigorous antibiotic therapy combined with mechanical removal of the microorganisms (incision and drainage, scaling, and root planing). Antibiotics penetrate poorly into dense biomasses.

The antibiotic concentration at the site of the infection also depends on the ratio of the surface area of the vascular bed to the volume of the tissue compartment to be supplied.⁸⁵ With a high vascular bed/volume ratio (high vascularity and low infection volume), as is found in areas of inflammation and minimal purulence, the antibiotic concentration (except for β -lactams) may be similar to that of blood; in areas of low vascular bed/volume ratio (low vascularity and high infection volume), the antibiotic concentration may be much lower than serum. Incision and drainage can create a high vascularity, low infection volume situation that promotes better antibiotic penetration.

In pregnancy, all tetracyclines are contraindicated because of their tooth-staining effects and hepatotoxicity. The estolate form of erythromycin is contraindicated because it has a greater tendency to induce cholestatic hepatitis, including during pregnancy. Metronidazole and fluoroquinolones affect DNA synthesis and have been studied for any teratogenic, mutagenic, or carcinogenic effects. None seem to exist, but metronidazole carries a warning that its use should be avoided if possible in the first trimester of pregnancy. Similar caution should be exercised for fluoroquinolones.

Few data exist on the effect of hepatic disease on antibiotic pharmacokinetics, but impaired renal function or renal failure can have significant effects on antibiotic blood levels. As a rule in renal dysfunction, the dosage interval is increased for concentration-dependent antibiotics, and the dose is decreased for time-dependent antibiotics.^{28,35} In renal dysfunction, dosage modification is required for many antibiotics. Clindamycin, dicloxacillin, azithromycin, and doxycycline do not require dosage adjustment in renal dysfunction.^{35,51} The central nervous system effects of fluoroquinolones, the toxic effects of aminoglycosides, the platelet aggregation resulting from some penicillins, and the deafness associated with macrolides may be seriously increased with renal insufficiency.⁵¹

The following modifications should be used for antibiotics used in dentistry in patients with renal failure: amoxicillin, increase dose interval to 8 to 12 hours with moderate failure and to 24 hours with severe failure; ciprofloxacin, reduce dosage by 25% to 50%; cephalexin, increase dose interval to 8 to 12 hours; cefaclor, decrease dosage by 50%; cephadrine, decrease dosage by 50% with moderate failure and 75% with severe failure; metronidazole, decrease dosage by 25% with severe failure; clarithromycin, decrease dosage by 25% to 50%; and erythromycin, decrease dosage by 25% to 50%.⁵¹

Drug pharmacokinetics in neonates (first month of life) and infants (1 month to 2 years) may differ substantially from children (2 to 13 years) and adults.^{67,70} Infants and neonates have a significantly greater percentage of body weight compared with body water, leading to a greater volume of distribution and increased serum half-lives. Other factors in neonates and infants versus children and adults are reduced gastric emptying and acidity, plasma protein binding, and reduced glomerular filtration rate. Renal function may be assumed to be totally functional by age 1 year.¹²

Elderly patients must also be considered substantially different from younger adults because of normal aging processes, underlying illness, and reduced host defenses predisposing to more serious infections^{67,70} and altered pharmacokinetics. Altered pharmacokinetics in the elderly include reduced total body water and lean body mass (more body fat) and reduced cardiac output, gastric acid, gastric emptying time, and renal function. Age may have little effect on most antibiotic pharmacokinetics, but renal insufficiency must always be a concern. Elderly patients also tend to be noncompliant about taking medication because of impaired memory, hearing, and vision; fear of drug interactions; perceived ineffectiveness of antibiotics; or the desire to save the medication for "the next time" because of the high cost of drugs.

COMBINATION ANTIBIOTIC THERAPY

Some established but limited situations may require combining antibiotics. The use of more than one antibiotic agent to treat an infection is often controversial because the efficacy of such therapy is likely to be microorganism-specific and may promote the emergence of resistant organisms, as many antibiotic resistance genes are now carried on multiple gene transposable elements. A common empiric reason for combined antibiotic therapy is to broaden the antibacterial spectrum when confronted with a probable polymicrobial infection of unknown origin.⁹ Other proposed benefits include a reduction of dose for each agent (rarely done clinically), antibiotic synergism, and a decrease in adverse drug reactions. In most cases, unless documented by certain laboratory tests (fractional inhibitory concentration, checkerboard or time-killing curve methods) or proven empiric data, the disadvantages of combination antibiotic therapy commonly outweigh the advantages; the more drugs are present, the greater the likelihood of adverse reactions, antibiotic antagonism, increased financial costs, greater microbial resistance, greater environmental spread of resistance genes, and increased risk of superinfections (appearance of a new infection when treating a primary one).^{67,70}

Antibiotic synergism is the combined effect of two or more antibiotics that is greater than the effectiveness of the antibiotics individually. Antibiotic combinations that have been documented to be synergistic are (1) cell wall inhibitors and aminoglycosides, (2) β -lactams with β -lactamase inhibitors, (3) β -lactams that act on different PBPs, (4) streptogramin combinations, and (5) sulfonamides and trimethoprim.^{4,67,70} Other combinations that may be synergistic include doxycycline and aminoglycosides for brucellosis; amoxicillin, tetracycline, macrolides, and metronidazole for *H. pylori*; vancomycin, rifampin, and aminoglycosides for MRSA; penicillin and clindamycin for group A streptococci; and fluoroquinolones and macrolides for *L. pneumophila*. A special case exists in the treatment of active tuberculosis, in which the use of combination antibiotic therapy is required, not because of a synergistic effect of antibiotics, but because of the necessity of reducing the growth of strains of *M. tuberculosis* resistant to a single or multiple drugs.

Antibiotic antagonism (a decrease in the efficacy of two or more antibiotic agents in combination) is not well documented clinically. Some examples of antagonism include penicillin and macrolides in the treatment of *S. pneumoniae*, β -lactam induction of β -lactamase production in enteric bacilli, and macrolide and lincosamide combination against *S. aureus* leading to induction of MLS_B resistance.³

ANTIBIOTIC FAILURES

The inability of antibiotic therapy to control and eliminate an infection can be the result of many factors (Box 38-1), which primarily involve microbial resistance, poor antibiotic pharmacokinetics, faulty dosing, and inadequate host response to the infection.^{67,70} Antibiotic failures are marked by persistent fever, lack of clinical improvement, and clinical deterioration of the patient.²¹

A common factor in antibiotic failures is patient non-compliance with the prescribed antibiotic regimen. The most common reason for antibiotic failure in orofacial infections is a lack of or inadequate incision and drainage. A typical initial reaction to an apparent antibiotic failure is to add an additional antibiotic in the assumption that the current antibiotic has an inadequate spectrum of activity against the pathogen, when the most likely reason is poor antibiotic penetration to the infected site.²¹ The specter of

BOX 38-1

Common Reasons* for Antibiotic Failure

Rights were not granted to include this box in electronic media. Please refer to the printed publication.

increased microbial resistance in the oral cavity is expected to play a greater role in antibiotic failures with an anticipated increased spread of oral infections to the orbit and submandibular regions.

HOST-MICROBE-ANTIBIOTIC INTERACTIONS

Host Defenses

Except in immunocompromised patients, antibiotics do not cure patients; patients cure patients. The innate immune system of humans provides a wide variety of defense mechanisms to recognize the microbial pathogen, activate effector mechanisms to isolate and destroy the invader, and eliminate its waste products eventually. Antibiotics gain time for this system, initially overwhelmed by the invasion and rapid multiplication of the organism, to re-establish its control of defense against microbial pathogens.

Microorganisms attempting to gain access to the interior of their host first encounter the physical barriers of the skin and mucosa along with skin-associated lymphoid tissue, dendritic (antigen-processing) cells, defensins, cathelicidins and associated cationic antimicrobial peptides, and secreted IgA that increases mucosal stickiness.⁸⁸ If these barriers are breached, specific and nonspecific defenses assert their protective effects.

Antibiotics and Immune Function

The assumption that antibiotics act synergistically with the immune system against microbial pathogens seems reasonable, but this is not always the case. Antibiotics may assist by PAE and postantibiotic leukocyte effect activities and by altering microbial adherence and virulence. Conversely, antibiotics, most notably tetracyclines, may reduce macrophage and polymorphonuclear cell chemotaxis, decrease phagocytic activity, and reduce the oxidative burst. Some antimicrobials may reduce inflammation (macrolides), whereas most are capable of releasing microbial toxins (endotoxins) on microbial cell death. In general, most cell wall inhibitors have no effect on the immune system, whereas fluoroquinolones, imipenem, and some cephalosporins may enhance the immune response.⁴⁶ The data on macrolides are presently equivocal, and tetracyclines, rifampin, sulfamethoxazole/trimethoprim,

aminoglycosides, and chloramphenicol may impair immune function. The clinical significance of these interactions is currently unknown, but does imply that host-microbe-antibiotic interactions are complex.

Microbial Virulence

The virulence (pathogenicity) of a microorganism depends on the following necessary traits: the ability to colonize, penetrate, grow, inhibit, or avoid host defenses and induce host damage.⁹⁶ Microbial virulence is highly regulated by population density, growth phases, osmolality, pH, iron/ion concentrations, temperature, adhesin expression,²⁴ and “quorum sensing”—the ability of microbes to convey the information for all these factors to each other to maintain optimal existence and occasionally attack their hosts.

The genes for virulence are contained in pathogenicity “islands” that are distinct genetic elements encoding virulence factors for pathogenic bacteria acquired by horizontal gene transfer and fully capable of enclosure in integrons for transfer to other bacteria. These pathogenicity islands contain the genes for adherence factors (adhesins, fimbriae), toxins (hemolysins, enterotoxins), iron uptake systems, apoptosis, and mobile elements (transposons, integrons, insertion sequence elements).³⁶

ANTIBIOTIC ADVERSE REACTIONS

This section discusses adverse drug reactions, some of which are unique to antibiotics; others are not exclusive to antimicrobials, but are clinically more significant than the common adverse reactions seen with most drugs.

Antibiotic Teratology

Few studies have been published regarding the ability of antibiotics to cause birth defects. Most antibiotics are in the U.S. Food and Drug Administration (FDA) class B or C categories (see Table 3-7), indicating little, if any, risk. Several studies have followed the long-term use of metronidazole and found its use in pregnancy does not seem to be associated with any increased rate of birth defects, preterm delivery, or low birth weight. Studies on aminoglycosides, cephalosporins, and oxacillin have likewise shown no teratogenic effects.

Antibiotic-Induced Mania

Acute mania has been described in association with clinical antibiotic therapy. Worldwide, 103 cases have been reported, making such reactions rare but disconcerting. The prime causative agents are clarithromycin followed by the fluoroquinolones and isoniazid.² Other antibiotics less commonly implicated are metronidazole, erythromycin, sulfamethoxazole/trimethoprim, and amoxicillin.² All but two of these reactions were reversible with antibiotic discontinuance and are likely to be due to the antibiotic, although some occurred in patients taking other medications that could cause mania. The mechanism may be related to altered γ -aminobutyric acid (GABA) activity in the brain because fluoroquinolones and isoniazid are GABA antagonists.²

Long QT Interval Syndrome

Long QT interval syndrome is a cardiac disorder caused by ion channel abnormalities that prolong the time interval between the beginning of the QRS complex and the end of the T wave on the electrocardiogram (see Chapter 24). Long QT interval syndrome may be either congenital or acquired, with the congenital mutations in the genes controlling the cardiac K⁺ channels. The acquired form is caused by metabolic disorders or certain drugs. Metabolic disorders include reduced blood K⁺, Ca⁺⁺, and Mg⁺⁺, and diseases include heart failure,

myocardial ischemia, mitral valve prolapse, and liver and renal disorders. Antibiotics that have been implicated in the cause of torsades de pointes include fluoroquinolones (gatifloxacin, levofloxacin, moxifloxacin, sparfloxacin), macrolides (erythromycin, clarithromycin), and clindamycin.¹⁰⁵

The FDA Adverse Event Reporting System has analyzed 202 cases of macrolide-induced or fluoroquinolone-induced torsades de pointes and found that 77% were caused by macrolides and 23% by fluoroquinolones; 89% to 95% were in older patients; 9% to 13% were fatal; the mean time to the adverse event was 4 to 5 days; and 42% to 62% had cardiac disease, 7% to 11% had renal disease, and 17% had low blood K⁺ or Mg⁺⁺ levels.⁹² The risk rate has been estimated to be 1 per 1 million exposures to ciprofloxacin, 3 per 1 million exposures to clarithromycin, and 14.5 per 1 million exposures to sparfloxacin.

Antibiotics and Oral Contraceptives

In response to a few case reports, in the 1980s the FDA issued a warning that antibiotics may interfere with the action of oral contraceptives, potentially resulting in unwanted pregnancies. The proposed mechanisms of reduced contraceptive blood concentrations leading to decreased efficacy include (1) increased urinary/fecal excretion from antibiotic-induced diarrhea, (2) increased microsomal liver metabolism, (3) receptor displacement, (4) reduced gastrointestinal absorption, and (5) reduced enterohepatic circulation. The antibiotic rifampin stimulates the liver metabolism of the oral contraceptives, reducing blood levels. No other experimental data or controlled clinical studies have documented the interference of any other antibiotics with the activity of oral contraceptives.

The most likely theoretic mechanisms are the gastrointestinal reduction in free estrogen or a reduction in enterohepatic circulation. Several studies document no effect of antibiotics on the blood levels of ethinyl estradiol, norethindrone, and progesterone in patients taking doxycycline (100 mg/day for 7 days),⁶² tetracycline (500 mg every 6 hours for 10 days),⁶¹ and ciprofloxacin (500 mg three times per day for 7 days).⁵⁴ No effort has been made to determine whether the failure rate of oral contraceptives in women taking antibiotics is greater than the normal failure rate of oral contraceptives in women not taking antibiotics. No official authoritative body has ever examined this alleged drug interaction to investigate the evidence and make a recommendation. The initial FDA response has never been updated.

From a purely scientific point of view, no reason exists to believe that any antibiotics except rifampin interfere with the action of oral contraceptives. From a medicolegal point of view, the dentist may wish to advise a patient taking oral contraceptives and receiving antibiotics to use an additional contraceptive method or practice abstinence during the time the antibiotic is present and for several days after its termination to allow for complete antibiotic excretion (usually five times the half-life of the drug). The oral contraceptive should never be stopped during antibiotic therapy because it is the most effective means of contraception with the exception of abstinence.

Antibiotic-Induced Agranulocytosis

Various antibiotics have been implicated as rare causative agents in reduced blood neutrophil counts with accompanying signs and symptoms of fever and septicemia or septic shock. The median onset of agranulocytosis is 12 to 14 days after beginning antibiotic therapy. The mortality rate in the literature from all drug-induced agranulocytosis is 6% to 20%, with antibiotics possibly causing 20% of the cases. The most commonly involved antibiotics are sulfonamides and β -lactams, followed by aminoglycosides and macrolides.

Antibiotic-Induced Photosensitivity, Photoallergy, and Phototoxicity

Antibiotics (along with phenothiazine antipsychotics) are among the most common drugs inducing skin reactions on exposure to sunlight. Photosensitivity may occur in one of two forms: (1) phototoxicity, in which chemicals (drugs) are deposited in the skin, absorb ultraviolet light, and transfer the energy to local tissue, resulting in inflammatory responses, or (2) photoallergy, in which sunlight causes a hapten to become a complete antigen in the skin, eliciting an immediate or a delayed allergic reaction. The signs and symptoms (erythema, urticaria, eczema, lichenoid dermatitis, bullous lesions) may be the same, but the mechanisms are different (photoallergy may need a sensitizing dose unless the drug is continually taken for ≥ 5 to 10 days). The most common antibiotics that induce photosensitivity are sulfonamides, tetracyclines, and fluoroquinolones. Photosensitivity is managed by discontinuing the drug, avoiding sunlight, and wearing protective clothing.

Antibiotic Effects on Body Flora and Superinfection

The question of whether human exposure to antibiotic doses at the low concentrations seen in agriculture and aquaculture, as therapy for inflammatory or other diseases, or in the food and water supply alters body flora or promotes emergence of resistant microbes or the transfer of resistance genes is of crucial importance to public health. Some data from veterinary studies indicate that daily doses of tetracycline at 15 mg per 60 kg/day of animal body weight or 2 mg/day of oxytetracycline may have no effect on gastrointestinal carbohydrate or fat metabolism and do not cause any increase in antibiotic-resistant enteric bacilli; however, 20 mg of oxytetracycline twice a day can promote such resistance.¹⁰⁴ Several studies have been unable to document the transfer of resistance genes from animals to farmers or shared resistance plasmids between farm animals and farmers. At times when resistance is not detected, the chosen breakpoint for such a determination was extremely high (e.g., 32 $\mu\text{g}/\text{mL}$ for vancomycin), which is not comparable to concentrations achieved with human doses.

On balance, the evidence is substantial that antimicrobial agents at any dose or concentration for virtually any length of time do select for resistance and promote the acquisition and transfer of drug-resistant genes.⁶⁹ Many of these species exhibit extraordinary resistance patterns: 50% to 100% of *Salmonella*, staphylococci, and enteric bacilli are resistant to tetracycline, and 32% to 47% are resistant to β -lactams, with 49.7% exhibiting polyantibiotic resistance; 30% of *S. aureus* is resistant to ciprofloxacin and 47% to tetracycline; 72% of *Campylobacter* in humans and 99% in chickens and pigs are resistant to ciprofloxacin; and *E. coli* exhibits 70% to 94% resistance to amoxicillin, and 62% to 98% resistance to tetracycline.^{1,30,55,86,111} If the very low (nanogram/nanomolar) concentrations of antibiotics found in the food chain and used in nature to control bacterial ecologic niches induce such resistance patterns, the assumption (until proven otherwise) must be that subtherapeutic dosages in humans would do the same. Subtherapeutic is not synonymous with biologically or pharmacologically inactive. If microbes employ nanogram amounts of antibiotics to control their own microbial ecology (kill fellow microorganisms, promote resistance gene expression and transfer), it is difficult to believe that micrograms would not do the same in humans.

Of possibly greater importance is the ability of antibiotics to induce microbial resistance or promote the transfer of resistance genes from one species to another. The mere presence of a β -lactam antibiotic produces a 100-fold to 1000-fold increase in induction of β -lactamase in microorganisms producing extended-spectrum β -lactamases.⁵³ *E. coli* carries resistance genes that are not expressed until tetracycline is

present.⁶⁹ Concentrations of tetracyclines at 0.1 to 1 $\mu\text{g}/\text{mL}$ per gram in meat cause the dissemination of resistance genes in the human gastrointestinal tract,³⁴ and 1 $\mu\text{g}/\text{mL}$ of tetracycline in drinking water results in a 10-fold increase in the transfer of conjugative plasmids from *E. faecalis* to *Listeria monocytogenes*.²⁶

In oral plaque biofilm, tetracycline resistance genes can be transferred from *B. subtilis* to streptococci, illustrating that nonoral bacteria have the potential to transfer genes to opportunistic oral microorganisms.⁸³ The presence of tetracycline increases the conjugative transfer of Tn916 by a factor of 19 to 119 times in matings between *B. subtilis* and *Bacillus thuringiensis* and 15 times between *E. faecalis* and *B. thuringiensis*⁹⁴ and *B. subtilis*.¹⁰⁹ The self-transfer of *Bacteroides* conjugative transposons can be increased 100-fold to 1000-fold by the presence of low levels of tetracycline (1 $\mu\text{g}/\text{mL}$)^{101,102} because of the transcription of a three-gene operon near the middle of a transfer element.⁸⁷

Oral streptococci can harbor tetracycline resistance genes in dental plaque and disseminate such genes by mobile elements to other microflora: *E. faecalis*, *Veillonella*, and other streptococci.⁸³ Salyers and colleagues⁸⁷ stated that “the fact that tetracycline acts as an inducer of transfer gene expression illustrates how the use of an antibiotic could accelerate the spread of antibiotic resistance genes not only by selecting for their acquisition but also by stimulating their transfer.”

A significant and unappreciated adverse effect of antibiotics is the potential to decrease colonization resistance of indigenous anaerobic flora in the digestive tract and other anatomic areas (skin, oral mucosa). The role of colonization resistance is to limit the concentration of potentially pathogenic flora of either an exogenous or endogenous nature in a given body part. Removal of indigenous flora by antibiotics can promote growth of microorganisms not sensitive to the drug (superinfection). Many superinfections result from a reduction in the endogenous microorganisms important for colonization resistance, with the most notable example being antibiotic-induced diarrhea and colitis.

Antibiotic-Induced Diarrhea and Pseudomembranous Colitis

Adverse colonic effects of antibiotics range from simple diarrhea (antibiotic-associated diarrhea) to mucosal inflammatory diarrhea/colitis (antibiotic-associated colitis), with or without associated *C. difficile* (*C. difficile*-associated colitis [CDAC]), to potentially fatal pseudomembranous colitis (PMC). Of the 25 million people affected by serious diarrhea annually in the United States, approximately 10% of these cases are the result of antibiotics, particularly broad-spectrum agents.⁶⁸ Most of these cases of antibiotic-associated diarrhea are not clinically significant and respond to drug discontinuance and rehydration if necessary.

Nevertheless, a significant portion of cases are a manifestation of “benign” colitis or the far more menacing PMC caused by toxins from *C. difficile*. Approximately 3 million cases of CDAD or CDAC may occur annually in the United States, primarily in hospitalized patients.⁶⁸ The outpatient toll of CDAD or CDAC is approximately 20,000 cases per year, with a range of 7.7 to 20 cases per 100,000 patient-years worldwide.

PMC was first described in 1893 as “diphtheric colitis” and before the introduction of antibiotics was ascribed to staphylococci, heavy metal intoxication, sepsis, surgical shock, and uremia. Antibiotic-associated PMC was described in the 1950s with the advent of penicillins, tetracyclines, and chloramphenicol. In 1977, the association of PMC with a toxin from *C. difficile* was discovered, and the relationship between the organism and antibiotic-associated diarrhea and PMC was established in 1978.⁶⁸

Virtually all cases of CDAD, CDAC, and PMC are associated with antibiotics, with 92% of patients exposed to the antibiotic within 2 weeks of onset of the diarrhea and 100% within 8 weeks, of which 87% were nosocomially acquired.⁶⁸ Any antibiotic is capable of inducing diarrhea, colitis, or PMC but the most common agent involved is amoxicillin, followed by third-generation cephalosporins and clindamycin. When the colonic flora are disturbed by antibiotics or disease, the colonization resistance of the gastrointestinal tract is reduced by the suppression of natural antagonists of *C. difficile* such as *Bacteroides*, *Lactobacillus*, pseudomonads, staphylococci, streptococci, peptostreptococci, enterococci, and *E. coli*. It is no accident that these antibiotics are involved because their antibacterial spectrum includes these microbial antagonists of *C. difficile*. Antibiotic-associated colitis and CDAC are classic superinfections.

C. difficile is a spore-forming, gram-positive obligate anaerobic bacillus commonly acquired by cross-infection by oral ingestion and widely found in rivers, seas, lakes, swimming pool water, soil, domestic animals, and raw vegetables. *C. difficile* is cultured in 19% of patients with antibiotic-associated diarrhea without colitis, 60% of patients with antibiotic-associated colitis without PMC, and 95% with PMC.⁶⁸

CDAC is caused by cytotoxins (A and B) that gain access to the intestinal mucosa to alter Rho proteins (guanosine 5'-triphosphate-binding proteins) to disrupt the F-actin structures and cause cell rounding and eventual intestinal cell death.⁶⁸ The initial diarrhea may appear 1 to 10 days or 6 to 10 weeks after initiating the antibiotic therapy. The incubation period after exposure to or acquisition of *C. difficile* may be less than 1 week, with a median time of diarrhea onset of 2 days.

As the disease progresses, the signs and symptoms include fever; diarrhea with abdominal tenderness; profuse green, watery, foul-smelling, bloody diarrhea with abdominal distention; and fecal and blood leukocytosis. The onset of PMC is heralded by high fever; marked abdominal tenderness; dehydration; and the initiation of 2 to 20 mm in diameter, raised, adherent yellow plaques interspersed between relatively normal colonic mucosa. From patchy epithelial necrosis, these plaques may proceed to ulcerations overlaid by a pseudomembrane consisting of fibrin, mucus, leukocytes, and cellular debris. In fulminant colitis, the colonic muscle tone may be lost, resulting in toxic colonic dilation (toxic megacolon), paralytic ileus, or colonic perforation with peritonitis. CDAD is diagnosed by the presence of diarrhea and one of the following: (1) a pseudomembrane on colonoscopy, (2) positive cytotoxin stool assay for toxin B, (3) a stool assay for toxins A and B, or (4) a positive stool culture for *C. difficile*.⁶⁸

In 15% to 25% of CDAD cases the diarrhea resolves with antibiotic discontinuance only. The antibiotic of choice for unresolved CDAC or PMC is metronidazole (250 mg orally four times per day or 500 mg three times per day) for 10 days.⁶⁸ Vancomycin (125 mg orally four times per day for 10 days) is now reserved only for cases that do not respond to metronidazole or in severely ill patients because of concerns about selection of vancomycin-resistant organisms in the hospital. Other therapies that have been attempted are bacitracin; fusidic acid; teicoplanin; vancomycin plus rifampin; vancomycin in tapering doses; and the re-establishment of the colonic flora with the probiotics *Lactobacilli*, nonenterotoxigenic *C. difficile*, and *Saccharomyces boulardii*.

Resolution of CDAD occurs in an average of 2 to 4 days with metronidazole and 2.6 to 4.2 days with vancomycin.⁶⁸ The hospital stay for patients acquiring antibiotic-associated diarrhea may be extended to 18 to 21 days. Studies on the mortality rates associated with nosocomial CDAD are

virtually nonexistent, but several have reported a 3% to 17% death rate. The mortality rate associated with community-acquired CDAC or PMC is very low.^{37,100}

The range for relapse and recurrence rates of CDAD is 4.8% to 66%, with an average of 20% seeming reasonable.⁶⁸ Relapse may be caused by the incomplete eradication of *C. difficile* and recurrence or the acquisition of a new organism. Most individuals with recurrence or relapse respond to the same initial metronidazole or vancomycin regimen, but refractory CDAD can occasionally become persistent and elude long-term cure for years. Risk factors for recurrence include acquisition during the spring, female sex, diarrhea that resolves but then recurs within 2 weeks after the antibiotic treatment is terminated, and, most important, receiving antibiotics again within 2 months of the initial recurrent CDAD.

The fear of inducing a potentially fatal case of PMC has led to a reluctance to use clindamycin because early and faulty preliminary data reported a 10% association of PMC with the drug.⁶⁸ More recent data indicate that incidence of antibiotic-associated diarrhea and CDAC associated with clindamycin in community use of the drug is very low. The overall risk rate for community-acquired *C. difficile*-associated PMC from retrospective data may be 1 per 10,000 antibiotic prescriptions, and the risk of hospitalization may be 0.5 to 1 per 100,000 patient-years.³⁷ In a study of 376,590 antibiotic prescriptions given to more than 280,000 patients over a 4-year period, four cases of acute antibiotic-associated colitis were detected.¹⁰⁰ The incidence rate was calculated to be 1.6 per 100,000 persons exposed to ampicillin, 2.9 per 100,000 persons exposed to dicloxacillin, and 2.6 per 100,000 persons exposed to tetracycline with no antibiotic-associated diarrhea seen in the 1509 patients receiving oral or topical clindamycin.

In another retrospective study, 51 cases of CDAD were detected in 662,500 person-years (7.7 per 100,000 person-years).³⁷ All patients recovered, and only six were hospitalized. The overall risk rate for community-acquired CDAD in this study was less than 1 per 10,000 antibiotic prescriptions, and the risk of hospitalization was 0.5 to 1 per 100,000 patient-years.³⁷ The risk for hospitalization from community-acquired, antibiotic-induced diarrhea or colitis seems to be very low.^{37,100}

On the basis of the preceding epidemiologic data, it seems that the fears of significant PMC associated with the outpatient use of clindamycin are unfounded. Statistically, PMC is more likely to occur with amoxicillin than clindamycin. Clinicians should refrain from unnecessary antibiotic therapy in patients within the first 2 months after the elimination of CDAD. Any elective dental procedure requiring antibiotic treatment or prophylaxis would best be postponed for this 2-month period. If antibiotic therapy is required, the use of antibiotics far less commonly associated with CDAD (penicillin V, macrolides) is appropriate.

NEW ANTIMICROBIAL APPROACHES

Since 1998, only linezolid and daptomycin have been introduced with novel new antibiotic mechanisms of action, and only caspofungin and voriconazole have been presented as new antifungal agents.⁶⁰ Pharmaceutical companies see new antibiotic development as problematic for economic, regulatory, and scientific reasons.⁶⁰ As a result, 10 of the 15 largest drug companies have reduced or eliminated antibiotic research since 1999.⁴³ The costs of development may be prohibitive for venture capital companies because the time from drug discovery to marketing can be 14 years.^{43,75}

The scientific difficulty with developing new antibiotics is that all the easy targets in bacteria have already been

discovered with possibly only a few remaining. From 1996-2004, greater than 125 antibacterial screens for 60 different antibiotic targets by 34 different companies have yielded no credible antibiotic candidates.⁷⁵ The current pattern of formulating “new” antibiotics that are merely derivatives of existing antibiotics will not solve the problems of microbial resistance. Entirely new approaches to unique mechanisms of antibiotic action attacking heretofore unknown microbial metabolic processes require a much better basic understanding of microbial life and considerable risk-taking on the part of the pharmaceutical industry.

Some of the following approaches currently under study include (1) inhibiting species-specific enzymes; (2) using bacteriophages; (3) using natural cationic peptide antibiotics; (4) inhibiting glycosyltransferases that control bacterial membrane lipopolysaccharide synthesis; (5) using antisense RNA inhibitors; (6) sequestering the iron necessary for microbial survival; (7) sequencing the bacterial genome to identify unique antibiotic targets; (8) improving the immune system’s ability to recognize and destroy microbial pathogens; (9) developing highly specific narrow-spectrum antibiotics to target specific microbes identified by real-time polymerase chain reaction; (10) developing chemicals that inhibit microbial surface adhesion; and (11) interfering with microbial quorum sensing so that bacteria misread signals for virulence, adherence, and growth.

Peptide antibiotics and cationic antimicrobial peptides are natural antibiotics that function as a component of all immune systems of living species. Some 500 cationic antimicrobial peptides have been isolated, with some living species possessing 30 or more entities. Nonribosomally synthesized peptides include gramicidins, polymyxins, bacitracins, and glycopeptides; ribosomally synthesized peptides include defensins, cathelicidins, cecropins, and magainins.

Peptide antibiotics function to kill all invading microorganisms (bacteria, viruses, parasites, fungi), elicit the inflammatory response and IgG production, recruit neutrophils and T cells, increase phagocytosis and chemotaxis, and participate in apoptosis.⁹¹ Cationic antimicrobial peptides are located in epithelial cells, neutrophils, and macrophages and on the epithelial surfaces of the skin, mucosa (including the oral cavity), lungs, kidneys, and gastrointestinal tract. Cationic antimicrobial peptides may act on the microbial membrane to disrupt its permeability.

The use of cationic antimicrobial peptides as antibiotic agents is hampered by their destruction in gastric acid; however, they may function as topical agents because they seem to be essentially nontoxic and nonallergenic. Cationic antimicrobial peptides have been used experimentally in the management of oral mucositis and to sterilize catheter sites.

An intriguing approach to the control of pathogenic bacteria is the possibility of interfering with their ability to communicate with each other. Quorum sensing is the process by which microbes exchange signaling chemicals (autoinducers) that allow the bacterial population to coordinate gene expression for virulence, symbiosis, conjugation, sporulation, mobility, apoptosis, antibiotic production, and biofilm development.¹⁶ Quorum sensing is related to the size of the colony, where a single autoinducer from a single microbe is incapable of inducing change, but when the colony reaches a critical density (quorum), a threshold of autoinduction is reached, and gene expression begins.

The autoinducers can be specific to each bacterial species and usually consist of acetylated homoserine lactones in gram-negative and oligopeptides in gram-positive bacteria. A boron-containing sensor, AI-Z, has been identified as a possible universal signal for interspecies communication.¹⁶ Quorum sensing may explain how microorganisms can build geometrically perfect colonies without ever seeing them. Interference

with these signals for virulence or adhesiveness may prove to be of significant benefit to humans.

Some of these new approaches pose difficulties. Bacteriophages are bacterial viruses that are specific for a single bacterium and require precise identification of the pathogen to be effective. Cationic peptides are a vital part of our natural defense to microbial pathogens and have protected us for millions of years, but are unstable in the gastrointestinal tract and may be effective only topically. If resistance were to occur to these peptides when used as therapeutic agents, a “Satan bug” might be created that is unaffected by our most basic defense mechanism.¹⁰ Just such resistance has been detected in *Porphyromonas gingivalis*, which secretes a peptide that destroys cationic peptides.¹²⁰ Widespread resistance of this type would be catastrophic. Soil microorganisms serve as potential reservoirs for new antibiotic agents, but to date only 1% have been identified, and these organisms seem to be very difficult to grow in the laboratory.

CITED REFERENCES

1. Aarestrup FM, Agerso LY, Ahrens P, et al: Antimicrobial susceptibility and presence of resistance genes in staphylococci from poultry. *Vet Microbiol* 74:353-364, 2000.
2. Abouesh A, Stone C, Hobbs WR: Antimicrobial-induced mania (antibiomania): a review of spontaneous reports. *J Clin Psychopharmacol* 22:71-81, 2002.
3. Acar JF: Antibiotic synergy and antagonism. *Med Clin North Am* 84:1391-1406, 2000.
4. Ahmad M, Urban C, Mariano N, et al: Clinical characteristics and molecular epidemiology associated with imipenem-resistant *Klebsiella pneumoniae*. *Clin Infect Dis* 29:352-355, 1999.
5. Ambrose PG Jr, Owens RC, Grasela D: Antimicrobial pharmacodynamics. *Med Clin North Am* 84:1431-1446, 2000.
6. Barbosa TM, Levy SB: The impact of antibiotic use on resistance development and persistence. *Drug Resist Update* 3:303-311, 2000.
7. Barkay T, Smets BF: Horizontal gene flow in microbial communities. *Nat Rev Microbiol* 3:675-687, 2005.
8. Bennett PM: Plasmid encoded antibiotic resistance: acquisition and transfer of antibiotic resistance genes in bacteria. *Br J Pharmacol* 153:S347-S357, 2008.
9. Bouza E, Munoz P: Monotherapy versus combination therapy for bacterial infections. *Med Clin North Am* 84:1357-1389, 2000.
10. Breithaupt H: The new antibiotics: can novel antibacterial treatments combat the rising tide of drug resistant infections? *Nat Biotechnol* 17:1165-1169, 1999.
11. Bush K: New β -lactamases in gram-negative bacteria: diversity and impact on the selection of antimicrobial therapy. *Clin Infect Dis* 32:1085-1089, 2001.
12. Butler DR, Kuhn RJ, Chandler MH: Pharmacokinetics of anti-infective agents in paediatric patients. *Clin Pharmacokinet* 26:374-395, 1994.
13. Canton R, Coque TM: The CTX-M beta-lactamase pandemic. *Curr Opin Microbiol* 9:466-475, 2006.
14. Cetinkaya Y, Falk P, Mayhall CG: Vancomycin-resistant enterococci. *Clin Microbiol Rev* 13:686-707, 2000.
15. Chadwick PR, Wooster SL: Glycopeptide resistance in *Staphylococcus aureus*. *J Infect* 40:211-217, 2000.
16. Chen X, Schauder S, Potier N, et al: Structural identification of a quorum-sensing signal containing boron. *Nature* 415:545-549, 2002.
17. Chopra I, Roberts M: Tetracycline antibiotics: mode of action, applications, molecular biology, and epidemiology of bacterial resistance. *Microbiol Mol Biol Rev* 65:232-260, 2001.
18. Cleveland JL, Kohn WC: Antimicrobial resistance and dental care: a CDC perspective. *Dent Abstr* 43:108-110, 1998.
19. Cohen ML: Changing patterns of infectious disease. *Nature* 406:762-767, 2000.
20. Craig WA: Pharmacokinetic/pharmacodynamic parameters: rationale for antimicrobial dosing in mice and men. *Clin Infect Dis* 26:1-10, 1998.

21. Cunha BA, Ortega AM: Antibiotic failures. *Med Clin North Am* 79:663-672, 1995.
22. Cunney RJ, Smith EG: The impact of laboratory reporting practice on antibiotic utilization. *J Int Antimicrob Agents* 14:13-19, 2000.
23. Deragon JM, Capy P: Impact of transposable elements on the human genome. *Ann Med* 32:264-273, 2000.
24. Donnenberg MS: Pathogenic strategies of enteric bacteria. *Nature* 406:768-774, 2000.
25. Dore MP, Leandro G, Realdi G, et al: Effect of pretreatment antibiotic resistance to metronidazole and clarithromycin on outcome of *Helicobacter pylori* therapy: a meta-analytical approach. *Dig Dis Sci* 45:68-76, 2000.
26. Doucet-Populaire F, Trieu-Cuot P, Dosbaa I, et al: Inducible transfer of conjugative transposons Tn/1545 from *Enterococcus faecalis* to *Listeria monocytogenes* in the digestive tracts of gnotobiotic mice. *Antimicrob Agents Chemother* 35:185-187, 1991.
27. Epstein JB, Chong S, Le ND: A survey of antibiotic use in dentistry. *J Am Dent Assoc* 131:1600-1609, 2000.
28. Estes L: Review of pharmacokinetics and pharmacodynamics of antimicrobial agents. *Mayo Clin Proc* 73:1114-1122, 1998.
29. Fuursted K: Postantibiotic effects in vitro. *APMIS Suppl* 90:1-23, 1999.
30. Gebreyes WA, Davies PR, Morrow WEM, et al: Antimicrobial resistance of *Salmonella* isolates from swine. *J Clin Microbiol* 38:4633-4636, 2000.
31. Greene VW: Personal hygiene and life expectancy improvements since 1850: historic and epidemiologic associations. *Am J Infect Control* 29:203-206, 2001.
32. Guillemot D, Carbon C, Balkau B, et al: Low dosage and long treatment duration of β -lactam: risk factors for carriage of penicillin-resistant *Streptococcus pneumoniae*. *JAMA* 279:365-370, 1998.
33. Heimdahl A: Culturing the exudate of an odontogenic infection: a useful procedure? [letter]. *Oral Surg Oral Med Oral Pathol Oral Radiol Endod* 90:2-4, 2000.
34. Heimdahl A, Nord CE: Influence of doxycycline on the normal human flora and colonization of the oral cavity and colon. *Scand J Infect Dis* 15:293-302, 1983.
35. Henry NK, Hoecker JL, Rhodes KH: Antimicrobial therapy for infants and children: guidelines for the inpatient and outpatient practice of pediatric infectious diseases. *Mayo Clin Proc* 75:86-97, 2000.
36. Hentschel U, Hacker J: Pathogenicity islands: the tip of the iceberg. *Microbes Infect* 3:545-548, 2001.
37. Hirschhorn LR, Trnka Y, Onderdonk A, et al: Epidemiology of community-acquired *Clostridium difficile*-associated diarrhea. *J Clin Infect Dis* 169:127-133, 1994.
38. Hoban DJ, Doern GV, Fluit AC, et al: Worldwide prevalence of antimicrobial resistance in *Streptococcus pneumoniae*, *Haemophilus influenzae*, and *Moraxella catarrhalis* in the SENTRY Antimicrobial Surveillance Program, 1997-1999. *Clin Infect Dis* 32(Suppl 2):S81-S93, 2001.
39. Jacobs MR, Applebaum PC, Zhanel GG, et al: Authors reply: assumed versus approved breakpoints. *Antimicrob Agents Chemother* 44:3243-3245, 2000.
40. Jorgensen JH: Who defines resistance? The clinical and economic impact of antimicrobial susceptibility testing breaking points. *Semin Pediatr Infect Dis* 15:105-108, 2004.
41. Jorgensen JH, Ferraro ML: Antimicrobial susceptibility testing: general principles and contemporary practices. *Clin Infect Dis* 26:973-980, 1998.
42. Kopeloff N: *Why infections?* London, 1926, Alfred A Knopf.
43. Kresse K, Belsy MJ, Rovini H: The antibacterial drugs market. *Nat Rev Drug Discov* 6:19-20, 2007.
44. Kunin CM: Dosage schedules of antimicrobial agents: a historical review. *Rev Infect Dis* 3:4-11, 1981.
45. Kunin CM: Editorial response: antibiotic Armageddon. *Clin Infect Dis* 25:240-241, 1997.
46. Labro M-T: Interference of antibacterial agents with phagocyte functions: immunomodulation or "immuno-fairy tales"? *Clin Microbiol Rev* 13:615-650, 2000.
47. Lederberg J: Infectious history. *Science* 288:287-293, 2000.
48. Leisteuvuo J, Järvinen H, Österblad M, et al: Resistance to mercury and antimicrobial agents in *Streptococcus mutans* isolates from human subjects in relation to exposure to dental amalgam fillings. *Antimicrob Agents Chemother* 44:456-457, 2000.
49. Levison ME: Pharmacodynamics of antibacterial drugs. *Infect Dis Clin North Am* 14:281-291, 2000.
50. Levy SB: *The antibiotic paradox*, New York, 1992, Plenum Press.
51. Livornese LL Jr, Slavin D, Benz RL, et al: Use of antibacterial agents in renal failure. *Infect Dis Clin North Am* 14:371-390, 2000.
52. Low DE, Keller N, Barth A, et al: Clinical prevalence, antimicrobial susceptibility, and geographic resistance patterns to enterococci: results from the SENTRY Antimicrobial Surveillance Program, 1997-1999. *Clin Infect Dis* 32(Suppl 2):S133-S145, 2001.
53. Low DE, Kellner JD, Wright GD: Superbugs: how they evolve and minimize the cost of resistance. *Infect Dis Rep* 1:464-469, 1999.
54. Maggiolo F, Puricelli G, Dottorini M, et al: The effect of ciprofloxacin on oral contraceptive steroid treatments. *Drug Exp Clin Res* 17:451-454, 1991.
55. Manie T, Khan S, Brozel VS, et al: Antimicrobial resistance of bacteria isolated from slaughtered and retail chickens in South Africa. *Lett Appl Microbiol* 26:253-258, 1998.
56. Martin MV, Longman LP, Hill JB, et al: Acute dentoalveolar infections: an investigation of the duration of antibiotic therapy. *Br Dent J* 183:135-137, 1997.
57. McCabe RM, Kreger DE, Johns M: Type-specific and cross-reactive antibodies in gram-negative bacteremia. *N Engl J Med* 287:261-267, 1977.
58. Miller YW, Eady EA, Lacey RW, et al: Sequential antibiotic therapy for acne promotes the carriage of resistant staphylococci on the skin of contacts. *J Antimicrob Chemother* 38:829-837, 1996.
59. Miriagov V, Carattoli A, Fanning S: Antimicrobial resistance islands: resistance gene clusters in *Salmonella* chromosomes and plasmids. *Microbiol Infection* 8:1923-1930, 2006.
60. Monaghan RL, Barrett JF: Antibacterial drug discovery—then, now and the genomic future. *Biochem Pharmacol* 71:901-909, 2006.
61. Murphy AA, Zachur HA, Charache P, et al: The effect of tetracycline on levels of oral contraceptives. *Am J Obstet Gynecol* 164:28-33, 1991.
62. Neely JL, Abate M, Swinker M, et al: The effect of doxycycline on serum levels of ethinyl estradiol, norethindrone, and endogenous progesterone. *Obstet Gynecol* 77:416-420, 1991.
63. Neu HC: Current practices in antimicrobial dosing. *Rev Infect Dis* 3:12-18, 1981.
64. Nguyen TN, Phan QG, Duong LP, et al: Effects of carriage and expression of the Tn10 tetracycline resistance operon on the fitness of *Escherichia coli* K12. *Molec Biol Evol* 6:213-225, 1989.
65. Novak R, Henriques B, Charpentier E, et al: Emergence of vancomycin tolerance in *Streptococcus pneumoniae*. *Nature* 399:590-593, 1999.
66. Osterblad M, Leisteuvuo J, Leisteuvuo T, et al: Antimicrobial and mercury resistance in aerobic gram-negative bacilli in fecal flora among persons with and without dental amalgam fillings. *Antimicrob Agents Chemother* 39:2499-2502, 1995.
67. Pallasch TJ: How to use antibiotics effectively. *J Calif Dent Assoc* 21:46-50, 1993.
68. Pallasch TJ: *Clostridium difficile*-associated diarrhea and colitis. *J Calif Dent Assoc* 27:405-413, 1999.
69. Pallasch TJ: Global antibiotic resistance and its impact on the dental community. *J Calif Dent Assoc* 28:215-233, 2000.
70. Pallasch TJ: Pharmacokinetic principles of antimicrobial therapy. *Perio* 2000 10:5-11, 1996.
71. Pallasch TJ, Gill CJ: Microbial resistance to antibiotics. *J Calif Dent Assoc* 14:25-27, 1986.
72. Pallasch TJ, Slots J: Oral microorganisms and cardiovascular disease. *J Calif Dent Assoc* 28:204-214, 2000.
73. Pallasch TJ, Wahl MJ: Focal infection: new age or ancient history? *Endod Topics* 4:32-45, 2003.
74. Palmer NO, Martin MV, Pealing R, et al: An analysis of antibiotic prescriptions from general dentist practitioners in England. *J Antimicrob Chemother* 46:1033-1035, 2000.
75. Payne DJ, Gwynn MN, Holmes DJ, et al: Drugs for bad bugs: confronting the challenge of antibacterial discovery. *Nat Rev Drug Discov* 6:29-40, 2007.

76. Petrocheilou V, Richmond MH, Bennett PM: The persistence of R-plasmid-carrying *E. coli* in a married couple, one of whom was receiving antibiotics. *Contrib Microbiol Immunol* 6:178-188, 1979.
77. Pfaller MA, Segreti J: Overview of the epidemiological profile and laboratory detection of extended-spectrum beta-lactamases. *Clin Infect Dis* 42:S153-S163, 2006.
78. Phillips A: Will the drugs still work? Transmission of resistant HIV. *Nat Med* 7:993-994, 2001.
79. Ploy MC, Lambert T, Couty J-P, et al: Integrins: an antibiotic resistance gene capture and expression system. *Clin Chem Lab Med* 38:483-487, 2000.
80. Polk R: Optimal use of modern antibiotics: emerging trends. *Clin Infect Dis* 29:264-274, 1999.
81. Putman M, vanVeen HW, Konings WN: Molecular properties of bacterial multidrug transporters. *Microbiol Mol Biol Rev* 64:672-693, 2000.
82. Rice LB, Bonomo RA: The red menace: emerging issues in antimicrobial resistance in gram-negative bacilli. *Curr Infect Dis Rep* 1:338-346, 1999.
83. Roberts AP, Pratten J, Wilson M, et al: Transfer of a conjugative transposon, Tn 5397 in a model oral biofilm. *FEMS Microbiol Lett* 177:63-66, 1999.
84. Roberts MC, Sutcliffe J, Courvalin P, et al: Nomenclature for macrolide and macrolide-lincosamide-streptogramin B resistance determinants. *Antimicrob Agents Chemother* 43:2823-2830, 1999.
85. Ryan DM, Cars O, Hoffstedt B: The use of antibiotic serum levels to predict concentrations in tissues. *Scand J Infect Dis* 18:381-388, 1986.
86. Saenz Y, Zarazaga M, Lantero M, et al: Antibiotic resistance in *Campylobacter* strains isolated from animals, foods, and humans in Spain in 1997-1998. *Antimicrob Agents Chemother* 44:267-271, 2000.
87. Salyers AA, Shoemaker NB, Li LY: In the driver's seat: the *Bacteroides* conjugative transposons and the elements they mobilize. *J Bacteriol* 177:5727-5731, 1995.
88. Salyers AA, Whitt DD: *Bacterial pathogenesis: a molecular approach*, ed 2, Washington, DC, 2002, ASM Press.
89. Schrag SJ, Beall B, Dowell SF: Limiting the spread of resistant pneumococci: biological and epidemiologic evidence for the effectiveness of alternative interventions. *Clin Microbiol Rev* 13:588-601, 2000.
90. Scott G: Prevention and control of infections in intensive care. *Intensive Care Med* 26(Suppl 1):S22-S25, 2000.
91. Scott MG, Hancock RE: Cationic antimicrobial peptides and their multifunctional role in the immune system. *Crit Rev Immunol* 20:407-431, 2000.
92. Shaffer D, Singer S, Korvick J: *Macrolide and fluoroquinolone associated torsades de pointes: review of the FDA Adverse Event Reporting System*, 41st Annual ICAAC Meeting, A-635, Chicago, December 2000.
93. Shoemaker NB, Vlamakis H, Hayes K, et al: Evidence for extensive resistance gene transfer among *Bacteroides* spp. and among *Bacteroides* and other genera in the human colon. *Appl Environ Microbiol* 67:561-568, 2001.
94. Showsh SA, Andrews RE Jr: Tetracycline enhances Tn916-mediated conjugal transfer. *Plasmid* 28:213-214, 1992.
95. Smets BF, Barkay T: Horizontal gene transfer: perspectives at a crossroads of scientific disciplines. *Nat Rev Microbiol* 3:675-687, 2005.
96. Smith H: Host factors that influence the behavior of bacteria pathogens in vivo. *Int J Med Microbiol* 290:207-213, 2000.
97. Smith R: Action on antimicrobial resistance: not easy but Europe can do it. *BMJ* 317:764, 1998.
98. Spratt BG: Antibiotic resistance: counting the cost. *Curr Biol* 6:1219-1221, 1996.
99. Stephenson J: "Sobering" levels of drug-resistant HIV found. *JAMA* 287:704-705, 2002.
100. Stergachis A, Perera DR, Schnell MM, et al: Antibiotic-associated colitis. *West J Med* 140:217-219, 1984.
101. Stevens AM, Sanders JM, Shoemaker NB, et al: Genes involved in production of plasmidlike forms by a *Bacteroides* conjugal chromosomal element share amino acid homology with two-component regulatory systems. *J Bacteriol* 174:2935-2942, 1992.
102. Stevens AM, Shoemaker NB, Li LY, et al: Tetracycline regulation of genes on *Bacteroides* conjugative transposons. *J Bacteriol* 175:6134-6141, 1993.
103. Summers AO, Wireman J, Vimy MJ, et al: Mercury released from dental "silver" fillings provokes an increase in mercury- and antibiotic-resistant bacteria in oral and intestinal floras of primates. *Antimicrob Agents Chemother* 37:825-834, 1993.
104. Tancrede C, Barakat R: Ecological impact of low doses of oxytetracycline on human intestinal microflora. *J Vet Med* 42:35-39, 1989.
105. Tatro DS: Drug-induced prolongation of the QT interval and torsades de pointes. *Drug Facts and Comparison News* Sept:67-70, 2001.
106. Thomas J, Walker C, Bradshaw M: Long-term use of subantimicrobial dose doxycycline does not lead to changes in antimicrobial susceptibility. *J Periodontol* 71:1472-1483, 2000.
107. Thomas JK, Forrest A, Bhavnani SM, et al: Pharmacodynamic evaluation of factors associated with the development of bacterial resistance in acutely ill patients during therapy. *Antimicrob Agents Chemother* 42:521-527, 1998.
108. Thompson RL, Wright AJ: General principles of antimicrobial therapy. *Mayo Clin Proc* 73:995-1006, 1998.
109. Torres OR, Korman RZ, Zahler SA, et al: The conjugative transposon Tn925: enhancement of conjugal transfer by tetracycline in *Enterococcus faecalis* and mobilization of chromosomal genes in *Bacillus subtilis* and *E. faecalis*. *Mol Gen Genet* 225:395-400, 1991.
110. Van Bambeke F, Balzi E, Tulkens PM: Antibiotic efflux pumps. *Biochem Pharmacol* 60:457-470, 2000.
111. van den Bogaard AE, London N, Stobberingh EE: Antimicrobial resistance in pig faecal samples from The Netherlands (five abattoirs) and Sweden. *J Antimicrob Chemother* 45:663-671, 2000.
112. Wagenlehner F, Stower-Hoffman J, Schneider-Brachert W, et al: Influence of a prophylactic single dose of ciprofloxacin on the level of resistance of *Escherichia coli* to fluoroquinolones in urology. *Int J Antimicrob Agents* 15:207-211, 2000.
113. Walton RE: Culturing the exudate of an odontogenic infection: a useful procedure? [editorial]. *Oral Surg Oral Med Oral Pathol Oral Radiol Endod* 88:525, 1999.
114. Wenzel RP, Edmond MB: The impact of hospital-acquired bloodstream infections. *Emerg Infect Dis* 7:174-177, 2001.
115. White MC: Mortality associated with nosocomial infections: analysis of multiple cause-of-death data. *J Clin Epidemiol* 46:95-100, 1993.
116. Wilkowske CJ: General principles of antimicrobial therapy. *Mayo Clin Proc* 66:931-941, 1991.
117. Wireman J, Liebert CA, Smith T, et al: Association of mercury resistance with antibiotic resistance in gram-negative fecal bacteria of primates. *Appl Environ Microbiol* 63:4494-4503, 1997.
118. Woods AC: Focal infection. *Am J Ophthalmol* 25:1423-1444, 1942.
119. Yingling NM, Byrne BE, Hartwell GR: Antibiotic use by members of the American Association of Endodontists in the year 2000: report of a national survey. *J Endod* 28:396-404, 2002.
120. Zasloff M: Antimicrobial peptides of multicellular organisms. *Nature* 415:389-395, 2002.

GENERAL REFERENCES

-
- Duncan MJ: Oral microbiology and genomics, *Periodontol* 2000 38:63-71, 2005.
- Haffajee AD, Socransky SS: Introduction to microbial aspects of periodontal biofilm communities, development and treatment, *Periodontol* 2000 42:7-12, 2006.
- Kolenbrander PE, Palmer RJ Jr, Rickard AH, et al: Bacterial interactions and successions during plaque development, *Periodontol* 2000 42:47-79, 2006.
- Socransky SS, Haffajee AD: Periodontal microbial ecology, *Periodontol* 2000 38:135-187, 2005.
- Taubman MA, Nash DA: The scientific and public-health imperative for a vaccine against dental caries, *Nat Rev Immunol* 6:555-563, 2006.

Antibacterial and Antibiotic Drugs*

THOMAS J. PALLASCH

OROFACIAL INFECTIONS

Infectious diseases are commonly and mistakenly managed as if they all were essentially the same, when the opposite is true because few diseases are associated with more variables than infectious diseases. Each infectious disease process is uniquely dependent on its anatomic location, etiologic microorganism and virulence patterns, accessibility to surgical drainage, signs and symptoms, and, most important, the host response to the process. Pneumonia differs from otitis media, which differs from urinary tract infection, which differs from infective endocarditis.

Orofacial infections are unique and do not mimic infections in other anatomic locations. They can be chronic (e.g., periodontitis), chronic-subacute with acute exacerbations (e.g., pericoronitis, periodontal abscesses), or intensely acute (e.g., necrotizing ulcerative gingivitis, periapical abscesses, or cellulitis with or without extension into the orbital or sub-mandibular spaces). Acute orofacial infections commonly arise rapidly and may spread easily into fascial planes because of their streptococcal component; they are often rapidly terminated by incision and drainage along with antibiotic therapy if appropriate and necessary. The accessibility of orofacial infections to mechanical incision and drainage procedures is often not shared by other bodily infections except infections of surgical sites and prosthetic devices.

As with other infectious diseases, various orofacial infections share a commonality among their etiologic microbial pathogens. Otitis media and sinusitis are almost always associated with *Streptococcus pneumoniae*, *Moraxella catarrhalis*, or *Haemophilus influenzae*, whereas orofacial infections commonly are associated with viridans group streptococci (VGS), *Prevotella*, *Porphyromonas*, *Fusobacterium*, *Peptostreptococcus*, *Eubacterium*, *Veillonella*, and *Actinomyces*. Otitis media or sinusitis is usually associated with only one of its three pathogens, whereas orofacial infections are polymicrobial in nature with two to eight or more microbial species involved. This situation makes determining the precise etiologic microbe virtually impossible—if only one is the cause. In orofacial infections, it is essentially impossible to determine which are the principal pathogens and which are only commensals.

Many infections are monomicrobial in etiology and are caused by microorganisms that, by their nature, are primary pathogens capable of producing disease in the absence of

other factors. Orofacial pathogens are rarely, if ever, primary pathogens, but rather are usually opportunists that cause disease when local or systemic variables change—such as trauma, necrosis, tissue oxidation, microbial acquisition of virulence or resistance genes, loss of microbial antagonists from antibiotic therapy, and, probably most often, a reduction or loss of host immune defense mechanisms. A thorough knowledge of the commonalities and vagaries of oral microbial pathogens is as important as the effective use of antibiotic agents in the successful management of orofacial infections.

Oral Microbial Pathogens and Associated Oral Infections

Acute orofacial infections

Table 39-1 presents quantifiable data from 12 clinical studies from 1976-1996 on the microbiology of acute orofacial infections. The average number of isolates per case was 3.6, with a maximum of 12. The data in Table 39-1 indicate that acute orofacial infections are polymicrobial, dominated by anaerobes, and often contaminated by various microorganisms, particularly from the pharynx, sinuses, and gastrointestinal tract.

Substantial commonality exists in the microbial cause of acute orofacial cellulitis, pulp infections, periodontal abscesses, periimplantitis, pericoronitis, acute necrotizing gingivitis, osteomyelitis, and their serious extensions (e.g., Ludwig's angina, mediastinal infections). These entities differ primarily in quantitative rather than qualitative microbiologic characteristics. Rapidly spreading infections often have a VGS component because streptococci possess various "spreading factors" (e.g., hyaluronidase, streptokinase, streptodornase) that promote rapid movement by fascial planes. Staphylococci rarely move except in blood, whereas gram-negative oral anaerobes may move in tissue but rarely in blood to cause metastatic infections elsewhere; streptococci move easily in blood and tissue.

Metastatic infections from *Porphyromonas gingivalis*, *Prevotella intermedia*, and *Prevotella nigrescens* and other anaerobic periodontal pathogens apparently are very rare,^{68,83} whereas respiratory tract infections may commonly precede pericoronitis. Staphylococci isolated from facial cellulitis are most likely contaminants because these organisms are not a normal component of the subgingival flora residing primarily on oral mucosal surfaces. They can be a major factor in the cause of oral mucositis. Anterior nares carriage of *Staphylococcus aureus* occurs permanently in 20% and intermittently in 60% of the population.⁵³ Subgingival staphylococci may appear because of selection by local or systemic antibiotic therapy.²³ Retropharyngeal abscesses seem to have the same microbial cause as facial cellulitis.

*The author recognizes Dr. Edward Montgomery for his past contributions to this chapter.

TABLE 39-1

Microorganisms Associated with Acute Orofacial Abscesses Based on 2339 Isolates in 12 Studies from 1976-1996

MICROORGANISM	NO. OF ISOLATES	PERCENT OF TOTAL
Aerobes/Facultative		
VGS	470	20.1
<i>Staphylococcus aureus</i> / <i>Staphylococcus epidermidis</i>	136	5.8
β-Hemolytic streptococci	68	2.9
TOTAL	674	28.8
Anaerobes		
<i>Prevotella</i> / <i>Porphyromonas</i> *	641	27.4
<i>Peptostreptococcus</i>	388	16.6
<i>Fusobacterium</i>	181	7.7
<i>Eubacterium</i>	87	3.7
<i>Veillonella</i>	58	2.5
<i>Actinomyces</i>	47	2
TOTAL	1402	9.8

Each of the following species is less than 1% of total but together constitute 11.3% of all isolates: *Acinetobacter*; *Aggregatibacter actinomycetemcomitans*; *Arachnia*; *Citrobacter*; *Corynebacterium*; *Eikenella corrodens*; *Clostridium*; *Enterobacter*; *Escherichia coli*; group A, B, C, D, and G streptococci; *Haemophilus influenzae*; *Klebsiella pneumoniae*; *Lactobacillus*; *Neisseria*; *Propionibacterium acnes*; *Serratia*; and spirochetes (most likely contaminants).

*Most studies list as *Bacteroides*.

VGS, Viridans group streptococci.

Pulpal and periapical pathogens

It may be artificial to separate acute orofacial infections from the microbiologic features of pulpal and periapical lesions because acute facial cellulitis is most often a sequela to dentition-derived infections. Yet this separation is often made in the literature, and at times it is difficult to determine precisely what type of infection is being studied, making a review of both of these entities necessary.

Numerous studies have attempted to determine the significance and quantity of microbial pathogens responsible for pulpal and periapical infections. Some studies maintain that certain microorganisms work synergistically to initiate orofacial infections, whereas others have concluded that each pulpal infection has its own distinct flora. More recent studies have isolated a high prevalence of black-pigmented anaerobes (e.g., *P. nigrescens*, *P. intermedia*, *P. gingivalis*, and *Porphyromonas endodontalis*); however, this may reflect better anaerobic isolation technique, rather than a shift in pathogenic flora. The percent of obligate anaerobes isolated varies with the particular study from 21% to 80%, possibly reflecting the skill in taking the culture. These infections are polymicrobial, with the number of species isolated varying from 1 to 33, with 5 to 7 species commonly reported as an average. Achieving a general consensus of the major pathogenic microorganisms responsible for pulpal/periapical infections is hampered by methodologic difficulties, including small sample sizes, lack of randomization or use of consecutive case series, varying expertise in culturing, presence or absence of dental caries or periodontal disease, and bacterial contamination of cultures. The major exception is VGS, which is prominent in periodontal health and acute orofacial infections.

Commonly isolated microorganisms associated with pulpal/periapical lesions seem to be VGS, other streptococci (β-hemolytic, β-hemolytic, group D), *Fusobacterium*, *Peptostreptococcus micros*, *Lactobacilli*, *Actinomyces*, *Porphyromonas*, *Prevotella*, *Veillonella*, *Eubacterium*, and *Bacteroides forsythus*. Other microorganisms found less commonly or rarely include *Propionibacterium acnes*, *Candida albicans*, *Enterococcus*, staphylococci, *Pseudomonas aeruginosa*, *Enterobacter aerogenes*, *Serratia marcescens*, *Eikenella corrodens*, *S. pneumoniae*,

Corynebacterium, *Capnocytophaga*, *Selenomonas*, and *Wolliella* (Box 39-1). A significant portion of these may be contaminants.

Periodontal abscesses

An acute periodontal abscess is characterized as a lesion of periodontal breakdown located within the gingival wall of the periodontal pocket and manifested as a localized accumulation of purulence.⁴⁰ An acute periodontal abscess may result from an exacerbation of local periodontitis pathology, after periodontal debridement procedures, or from the lodgment of a foreign object in the periodontal pocket (e.g., popcorn husks, dental floss, calculus).⁴⁰ The microbial cause of a periodontal abscess is similar to that of adult periodontitis, and the flora is commonly indistinguishable from the microflora of the subgingival plaque in adult periodontitis.⁴⁰ The predominant microflora are *P. gingivalis* (55% to 100% of isolates), *P. intermedia* (25% to 100% of isolates), *Fusobacterium nucleatum* (44% to 65% of isolates), *Aggregatibacter actinomycetemcomitans* (25% of isolates), *Campylobacter rectum* (80% of isolates), *Prevotella melaninogenica* (22% of isolates), and *Treponema denticola* (71% of isolates)⁴⁰; other organisms include *P. micros* and *B. forsythus*.⁴⁰ It has been estimated that 74% may be anaerobes and 67% may be gram-negative rods, with streptococci significant only at the base of the abscess.⁷³

The principal and sometimes only therapy of periodontal abscess is incision and drainage through the external tissue and compression of the soft tissue wall.⁴⁰ Curettage or root planing is not usually required unless a reasonable chance exists to eliminate the periodontal pocket.⁴⁰ The abscess tends to become fistulous readily and rarely results in metastasis or acute orofacial cellulitis, possibly because VGS have been replaced by periodontal pathogens that do not spread by fascial planes as do streptococci. On fistulization, the lesion is self-limiting, as opposed to dentoalveolar abscesses of pulpal origin, which may readily end in cellulitis.

Periodontal abscess often can be treated simply with incision and drainage without antibiotics because it is rarely associated with fever, malaise, lymphadenopathy, and other signs of systemic involvement; periodontal abscess may necessitate

BOX 39-1

Microorganisms Isolated from Pulpal/Periapical Infections

Aerobic/Facultative**Gram-Positive Cocci**Staphylococci
VGS***Gram-Positive Bacilli**Lactobacillus
Corynebacterium
Eikenella corrodens***Anaerobic****Gram-Positive Cocci**

Peptostreptococcus micros*

Gram-Negative Cocci

Veillonella*

Gram-Positive BacilliActinomyces*
Bifidobacterium
Eubacterium
Clostridium
Propionibacterium**Gram-Negative Bacilli**Bacteroides
Fusobacterium*
Porphyromonas*
Prevotella***Treponemes***Treponema denticola
Treponema macrodentium
Treponema oralis
Treponema pectinovorum
Treponema socranskii
Treponema vincentii*Major oral pathogens.
VGS, Viridans group streptococci.

antibiotic therapy only if the signs and symptoms of systemic involvement or cellulitis are present, or incision and drainage cannot be performed.^{40,60,80} This is in contrast to antibiotic therapy of pulpal/periapical infection, which should be more aggressive because there is a much greater tendency to spread into the fascial planes. If antibiotic therapy of a periodontal abscess is indicated, the situation is classic for short-term, high-dose therapy, as opposed to commonly longer therapy for dentoalveolar abscess.^{60,81} Periodontal pathogens rarely, if ever, metastasize to the heart or other organs and tissues.^{82,83}

Acute necrotizing ulcerative gingivitis

The microbiology of acute necrotizing ulcerative gingivitis (trench mouth, Vincent's infection) is characterized primarily by *Treponema*, *Fusobacterium*, *Selenomonas*, and *P. intermedia* and secondarily by *Veillonella*, *Neisseria*, *Capnocytophaga*, *E. corrodens*, *Bacteroides*, *Actinomyces*, and gram-positive cocci.⁶⁵

Pericoronitis

The microbial flora of pericoronitis are a complex mixture of organisms resembling that of periodontitis and gingivitis,⁵⁸

often with a high concentration of VGS. Common microorganisms found in 40% or more of samples include *Stomatococcus*, *Rothia dentocariosa*, *Actinomyces naeslundii*, *Actinomyces israelii*, *Prevotella*, *Neisseria*, *Haemophilus*, *P. micros*, *Capnocytophaga*, *Corynebacterium*, *Bifidobacteria*, and treponemes.⁵⁸ Other, less common isolates include coagulase-negative staphylococci (CoNS), lactobacilli, *Veillonella*, *Fusobacterium*, and *Porphyromonas*.⁵⁸

Periimplantitis

The microbial causes of chronic periodontitis, refractory periodontitis, and periimplantitis (an inflammatory process of the tissues surrounding an osseointegrated implant resulting in loss of supporting bone) are remarkably similar, differing primarily in the quantitative and not qualitative isolation of the predominant species: *B. forsythus*, *F. nucleatum*, *P. gingivalis*, *P. intermedia*, *P. nigrescens*, *C. rectum*, and treponemes (spirochetes).⁶² Healthy dentulous or implant periodontium usually exhibits fewer of the above-mentioned organisms and is dominated by VGS, *Actinomyces*, *Veillonella*, *E. corrodens*, and *Capnocytophaga*.⁵⁷

Periimplantitis results from a shift in periodontal flora with facultative anaerobic streptococci (VGS) and nonmotile rods replaced by gram-negative anaerobic bacilli and spirochetes, similar to what occurs in periodontitis.^{57,62} The issue of whether implant success is compromised in patients with periodontitis (treated or untreated) is controversial, but it seems reasonable to postulate that the gingival sulcus in patients with periodontitis is a reservoir for periodontal microbial pathogens.⁸⁴ Host resistance and factors that reduce immunity (stress) are as likely a complicating factor in periimplantitis as they are in aggressive periodontitis.

Osteomyelitis

Osteomyelitis is an infectious inflammatory process resulting in bone destruction. There are several clinical descriptions of osteomyelitis as follows: (1) secondary to a contiguous infection, (2) secondary to vascular deficiency and diabetic foot infection, (3) in association with an infected prosthesis (e.g., dental implant, prosthetic joint), (4) hematogenous, (5) chronic, and (6) acute.^{21,59} Osteomyelitis, resulting from local spread from a contiguous contaminated or infectious source, commonly follows trauma, bone surgery, or joint replacement. Approximately 15% of diabetics develop foot pathology requiring amputation with contributing factors of bone and soft tissue ischemia and peripheral motor, sensory, and autonomic neuropathy. The amount of osteomyelitis associated with various bone implants is increasing; this includes dental implants.^{21,59} Spread of bacteria to bone via the hematogenous route is particularly common in prepubertal children and immunocompromised elderly patients. Chronic osteomyelitis is a long-standing infection of months to years in duration characterized by persistent microorganism, low-grade inflammation, sequestrum formation, and fistulous tracts. Acute osteomyelitis evolves over a few days or weeks.

The treatment of osteomyelitis usually involves antibiotic therapy and surgery. Because of the multiplicity of etiologic organisms, it seems imperative to get a culture and sensitivity test as soon as possible to initiate the most appropriate antibiotic therapy.⁴⁵ The disease may have a polymicrobial etiology with an average of 3.9 microbes per culture. The microbial cause of oral osteomyelitis varies to some extent with the anatomic site. The most common microorganisms in orofacial osteomyelitis include streptococci, lactobacilli, *Eubacterium*, *Klebsiella pneumoniae*, *S. aureus*, *Acinetobacter baumannii*, and *P. aeruginosa*.²¹

Deep neck space infections

Deep neck space infections arise most commonly from upper airway infections (47.5% to 53.2%) and odontogenic infections (28.8% to 30.5%).^{10,46} The spaces involved include the sublingual, submylohyoid (submental, submandibular), lateral pharyngeal (parapharyngeal, peripharyngeal, pterygopharyngeal, retropharyngeal), and masseter spaces (masseter, pterygometopar, parotid, peritonsillar).⁸⁷ These infections include Lemierre's syndrome (suppurative thrombophlebitis of the internal jugular vein from septic emboli) and Ludwig's angina. Deep neck infections seem to be more common in patients with diabetes mellitus⁴⁷ and patients with low socioeconomic status and with poor oral hygiene.³

The microbiology of deep neck space infections is primarily that of commensal microorganisms that for some reason travel quickly through the fascial planes, which likely have acquired virulence genes they do not normally possess. These organisms include VGS, *S. aureus*, *Peptostreptococcus*, *K. pneumoniae*, and oral anaerobes (*Porphyromonas*, *Prevotella*, and *Fusobacterium* species).⁹

There are no data to support pretreatment or postsurgical antibiotic prophylaxis to prevent deep neck space infections (see Chapter 49). For unknown reasons, these normally commensal and harmless bacteria become very aggressive and spread rapidly to the submandibular regions. These infections are often polymicrobial, making antibiotic treatment alone very difficult, and most must be treated by incision and drainage.

Ludwig's angina

As first described by Ludwig in 1836, Ludwig's angina is characterized by a massive bilateral edema of the mouth floor with pathognomonic elevation of the tongue against the palate and posterior pharyngeal wall along with glottic edema, resulting in potentially life-threatening airway obstruction—hence the vernacular terms *morbus strangulatoris*, *angina maligne*, and *garotillo* (“hangman's noose”). Ludwig's angina involves the connective tissues, fascia, and muscle and spreads by fascial planes through the submandibular, sublingual, and submental spaces and potentially on to the pharynx, retropharyngeal region, and mediastinum.⁷⁷ Approximately 70% to 80% of cases are of odontogenic origin, with 99% exhibiting bilateral swelling in the neck; 95%, an elevated tongue; 89%, fever; and 51%, trismus.⁷⁷ In 71 patients in whom cultures were obtained, 35% of species were VGS, 28% were “other” streptococci, 14% were staphylococci, and 27% were *Porphyromonas* and *Prevotella* and other anaerobes, with a few isolates of *P. aeruginosa*, *K. pneumoniae*, *H. influenzae*, *S. pneumoniae*, and *Escherichia coli*.⁷⁰ The heavy preponderance of streptococci emphasizes the ability of these organisms to move through tissue rapidly.

Mediastinal infections

Rarely, oral microorganisms may traverse anatomic pathways to locate in the mediastinum. The microbial flora is typically diverse, with the single predominant organisms being VGS, followed by *Porphyromonas*, *Prevotella*, *Fusobacterium*, and staphylococci. Rare isolates included *E. coli*, *P. aeruginosa*, *Clostridium perfringens*, *Enterobacter*, *Enterococcus*, *H. influenzae*, *K. pneumoniae*, and *Proteus vulgaris*.

Necrotizing fasciitis

Necrotizing fasciitis is a rare but often fatal infection involving the superficial fascial layers of the neck, extremities, abdomen, and perineum.³⁶ It was first described by Hippocrates and has also been known as *streptococcal*, *hospital*, or *galloping gangrene*. Most recently, the lay press has labeled it the “flesh-eating disease.” The term *necrotizing fasciitis* was first employed in 1952.³⁶

The most common cause of head and neck necrotizing fasciitis is dental infection (odontogenic origin) with 9% of all cases located in the head and neck region.³⁸ In a review of 125 literature cases, it was found that (1) the male/female ratio was 3:1; (2) the origin of the infection was 66 in the mandible, 11 in the maxilla, and 48 nondelineated; (3) periapical infection was the most common cause; and (4) 70 of 125 patients had systemic complications (e.g., alcoholism, hypertension, liver cirrhosis, acquired immunodeficiency syndrome [AIDS], intravenous drug abuse, and renal insufficiency). Despite aggressive therapy, the mortality rate was 19.2%.¹⁰³ In other scenarios, death may occur within hours, and the mortality rate may be 50%.

Cervicofacial actinomycosis

The most common organisms causing actinomycosis are *A. israelii*, *A. naeslundii*, *Actinomyces odontolyticus*, and *Actinomyces viscosus*. Cervicofacial actinomycosis commonly appears in one of two distinct patterns: (1) a chronic, slowly progressive mass evolving into multiple abscesses and fistulas or (2) an acute fluctuant suppurative pyogenic mass. Involved sites in the head and neck include the tongue, larynx, hypopharynx, mandible, cheek, scalp, paranasal sinuses, palate, and parotid gland. The characteristic sulfur granule is a small colony of intertwined actinomycetes filaments grossly resembling a granule of sulfur. It is likely also to be associated with *A. actinomycetemcomitans*, *E. corrodens*, *Fusobacterium* species, *S. aureus*, streptococci, and enterococci. *Actinomyces* species are usually susceptible to penicillin G or penicillin V and may require surgical removal.

Microbial Resistance in Orofacial Pathogens

The data on the antibiotic sensitivity of orofacial pathogens are very limited, vary with the community's exposure to antibiotics, and depend crucially on what mean minimal inhibitory concentration (MIC) is selected as the “breakpoint” for resistance (the higher the chosen MIC, the lower the number of organisms labeled “resistant”). The breakpoint is the MIC at which microbes are said to be resistant if they are not killed or inhibited in growth.

Although data on microbial resistance patterns in orofacial pathogens are limited, the data are adequate to determine that difficulties exist. Until more recently, it was, and may still be, the impression in dentistry that the oral cavity somehow has remained relatively unscathed by the antibiotic resistance epidemic that has plagued other human microbial ecologic systems. It is now apparent that no such immunity exists and that oral pathogenic microbes may exhibit substantial antibiotic resistance that can compromise treatment.

In the 1950s and 1960s it was apparent that oral streptococci and *S. pneumoniae* (pneumococcus) coinhabit the oropharynx (but not the oral cavity) and had the potential for gene transfer between species. Later it became apparent that VGS and pneumococci possessed identical β -lactam resistance mechanisms: an altered penicillin binding protein-2b that greatly decreased the affinity of penicillin for its receptor. The genes for this resistance spread from oral streptococci to oropharyngeal *S. pneumoniae* with devastating effects on the management of one of the world's worst microbial killers.

In the 1970s, viridans and anaerobic streptococci were universally sensitive to the β -lactams, with 90% to 99% also sensitive to erythromycin and clindamycin. In 1983, a high rate of penicillin resistance in VGS was detected in South Africa in the oral flora of children with a similar high penicillin resistance in pneumococci.³⁵ Currently, β -lactamase enzymes are common in oral microorganisms, and VGS (*Streptococcus*

milleri, *Streptococcus mutans*, *Streptococcus salivarius*, *Streptococcus sanguis*, *Streptococcus mitis* groups) with altered penicillin binding proteins (PBPs) are increasingly resistant to β -lactams and macrolides.

In children treated for otitis media and exposed to repeated antibiotics who had samples taken of their supragingival plaque, 60% of *S. sanguis* isolates were resistant to at least one antibiotic; 26%, to at least two antibiotics; 32%, to amoxicillin; 24%, to penicillin V; and 20%, to amoxicillin and penicillin V.³¹ In 139 cultures of VGS isolated from mixed orofacial infections, 23% were resistant to penicillin G; 45%, to erythromycin; 46%, to clindamycin; and 44%, to levofloxacin; 100% were sensitive to minocycline.⁵⁵ Reports of 23% to 81% resistance rates of VGS to ampicillin and amoxicillin in hospitalized patients and patients in the community are common, depending on the breakpoint chosen for resistance.

In a cohort of Japanese children at high risk for bacterial endocarditis, 31.7% of VGS exhibited resistance at MICs of 4 to 16 $\mu\text{g/mL}$.⁷⁴ Children treated with long-term penicillin for the prevention of rheumatic fever were found to have resistance rates of 78% to 81%. The problem is compounded further because many oral streptococci are resistant to multiple antibiotics with reduced sensitivities to cephalosporins, macrolides, and clindamycin,⁵⁵ as shown by a Taiwan study reporting a 20% to 50% resistance rate to clindamycin and 30% to 70% resistance to tetracycline in penicillin-resistant *Streptococcus oralis*.⁹⁹

In the United States, 40% to 50% of sampled VGS are resistant at MICs greater than or equal to 0.25 $\mu\text{g/mL}$,⁴⁹ whereas in a study of 43 U.S. medical centers from 1993-1994, 352 VGS blood cultures exhibited a resistance rate of 13.4% at MICs greater than or equal to 4 $\mu\text{g/mL}$ (high resistance) and 42.9% at MICs of 0.25 to 2 $\mu\text{g/mL}$ (intermediate resistance).²⁸ Intermediate resistance commonly escalates to high resistance over time.

Of considerable concern is the high β -lactam resistance rate in VGS in patients with neutropenia associated with hematologic malignancies and patients at risk for infective endocarditis. Approximately 18% to 21% of bacteremias experienced by immunocompromised patients may be caused by VGS, particularly *S. mitis* with a 3.2% to 40% resistance rate to penicillin G and cephadrine,⁸⁶ with some at MICs of 0.25 to 4 $\mu\text{g/mL}$ for penicillin and 2 to 32 $\mu\text{g/mL}$ for cephadrine.

Approximately 25 studies have detected β -lactamase production in *Prevotella* and *Porphyromonas* species associated with periodontitis or acute orofacial infections. The prevalence of β -lactamase in these clinical isolates ranges from 11% to 100% depending on study year and type of organisms, but most studies document a 30% to 50% median/mean prevalence of β -lactamase in pigmented and nonpigmented gram-negative anaerobes in the oral cavity. Commonly, these organisms presently remain susceptible to β -lactam/ β -lactamase inhibitor combinations, metronidazole, and azithromycin.

β -Lactamase production is also present in oral *Veillonella*, *Fusobacterium*, *Capnocytophaga*, *P. aeruginosa*, and *B. forsythus*. Lengthy or repeated antibiotic exposure increases the presence of β -lactamase in oral *Prevotella*, *Porphyromonas*, and *Fusobacterium*.^{41,76} Resistance genes may be shared between family members.⁵⁴

Resistance to fluoroquinolones in VGS is increasing, and the resistance factors can be transferred between VGS, *Streptococcus constellatus*, and *S. pneumoniae*, providing for efflux mechanisms or point mutations in topoisomerase IV or DNA gyrase. Methicillin-resistant *S. aureus* (MRSA) may be present in the oral cavity of children for 5 or more years.⁹⁷

In a study of gingival crevicular fluid microorganisms found in periodontitis patients and their sensitivities to seven

antibiotics at two different time periods (1980-1985 and 1991-1995), the resistance rates increased by 172% to tetracycline, 193% to doxycycline, 133% to penicillin G, 238% to amoxicillin, 116% to erythromycin, and 108% to clindamycin.¹⁰⁷ VGS showed variable sensitivities: 85% to 100% to penicillin G, 75% to 100% to amoxicillin, 46% to 100% to clindamycin, and 34% to 74% to tetracyclines.

Veillonella species were 83% to 100% sensitive to tetracyclines, 89% sensitive to penicillin G, 67% sensitive to amoxicillin, 86% sensitive to erythromycin, and 94% sensitive to clindamycin. *P. micros* was 67% to 82% susceptible to tetracycline and amoxicillin, 82% susceptible to erythromycin, 95% susceptible to penicillin G, and 91% susceptible to clindamycin. The breakpoint MICs used for resistance determination in this study were high in some cases: 4 $\mu\text{g/mL}$ for various tetracyclines and 2 $\mu\text{g/mL}$ for penicillins, erythromycin, and clindamycin. Many studies use lower breakpoints, which would likely have shown an even higher percentage of resistance strains.

The resistance patterns for orofacial pathogens depends on many variables, including frequency and duration of exposure to antibiotics from health care providers and the environment, age, family member exposure to antimicrobials, patterns of antibiotic use in geographic locales, and the particular MICs chosen as breakpoints for resistance. Breakpoints that are too high underestimate levels of microbial resistance, and breakpoints that are too low overestimate it. The proper breakpoint is the MIC commonly attained in humans by reasonable doses.

The oral cavity is as much a part of the microbial world of antibiotic resistance as any other portion of the body and is subject to the same forces that ensure microbial survival elsewhere. The more we look for microbial resistance in the oral environment, the more we are likely to find. It is probable that antibiotic failures in the management of orofacial infections will continue to increase, resulting in more severe orofacial infections and a greater dependence on vigorous incision and drainage and sophisticated antibiotic therapy, unless wise and judicious use of antimicrobials becomes the universal rule.

ANTIBACTERIAL ANTIMICROBIAL DRUGS

Antibacterial drugs are primarily classified according to their chemical class and mechanism of action.⁵ They also can be distinguished based on spectrum and adverse effects. In addition to these aspects of antimicrobial drugs, the therapeutic uses, including dental applications, of each class of drugs are discussed.

β -Lactam Antibiotics

Penicillin has been said to have "brought more curative power to a barefoot, itinerant care provider in the deepest reaches of Africa than the collective powers of all the physicians in New York City."⁶⁹ Yet with the seemingly infinite ability of humans to push a system until it breaks, we now have a multiplicity of microorganisms that were initially exquisitely sensitive to the antimicrobial effects of penicillins but that are now highly resistant to their killing power. β -Lactam antibiotics remain the most widely used antibiotics in the world, however, because of their broad spectrum of activity and relative lack of toxicity despite a relatively high incidence of allergy.

β -Lactams are composed of five different groups of antibiotics, with the β -lactam nucleus as the common feature: penicillins, cephalosporins, carbapenems, monobactams, and carbacephems. Penicillins and cephalosporins are the most important with carbapenems (imipenem, meropenem, ertapenem), monobactams (aztreonam), and carbacephems (lor-

acarbef) reserved for serious infections such as nosocomial (hospital-acquired) infections. β -Lactams as a group have the widest spectrum of antimicrobial activity, but range from an extremely narrow spectrum (e.g., β -lactamase-resistant penicillins) to a very wide spectrum (e.g., imipenem and some cephalosporins).

Penicillins

Penicillin is a generic term for a group of antibiotics that share the β -lactam ring nucleus, similar adverse drug reactions, and similar mechanism of action, but differ in their antibacterial spectrum, pharmacokinetics, and resistance to β -lactamase enzymes.

Chemistry and classification. Penicillin is a cyclic dipeptide consisting of two amino acids (D-valine, L-lysine), a particular

molecular configuration unknown in higher life forms (Figure 39-1). The synthesis in 1958 of the basic structure of penicillins (6-aminopenicillanic acid) allowed for its manipulation by the addition of various side chains to the β -lactam and thiazolidine rings. Different salts (Na^+ , K^+ , procaine, benzathine) were also created for pharmacokinetic purposes. On the basis of these modifications, penicillins can be divided into four groups: penicillin G and its congeners, β -lactamase-resistant (stable) penicillins, extended-spectrum penicillins, and extended-spectrum penicillins with β -lactamase inhibitors (Table 39-2).

Acid-stable penicillins are resistant to breakdown in stomach acid, indicating their usefulness as oral drugs. Penicillin V, amoxicillin, and cloxacillin are examples. Other examples of orally useful drugs are listed in Table 39-2. Penicillinase-resistant penicillins are resistant to some β -lactamases.

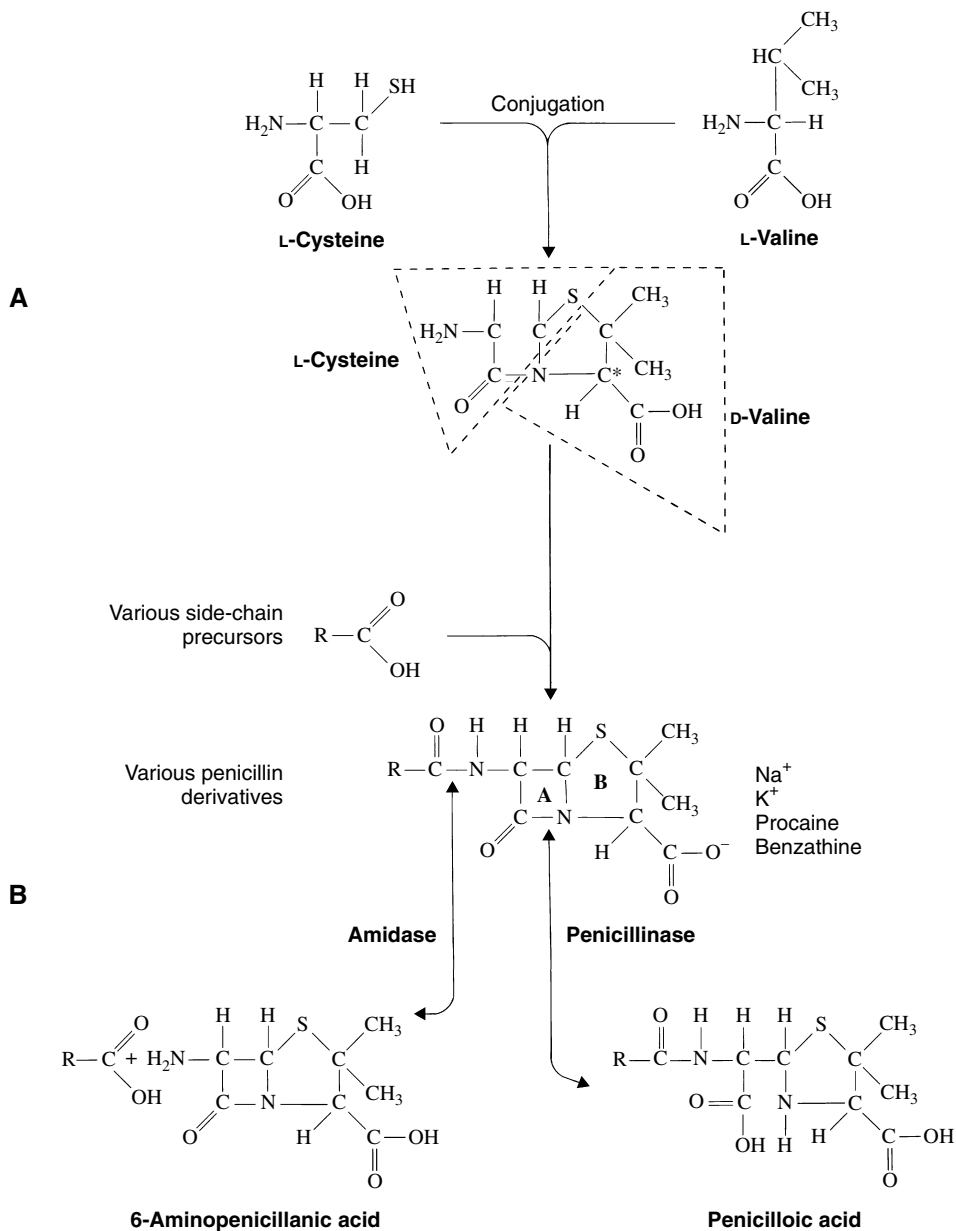
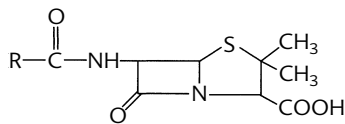

FIGURE 39-1 Biosynthesis and hydrolysis of penicillins (isomeric conversion of L-valine and D-valine during conjugation). A, β -Lactam ring. B, Thiazolidine ring.

TABLE 39-2

Structures and Characteristics of Penicillin Derivatives



NONPROPRIETARY NAME	R SIDE CHAIN	PROPRIETARY NAME(S)	ROUTE OF ADMINISTRATION
Penicillin G and Congeners			
Penicillin G		Pfizerpen	IM, IV, oral*
Penicillin V		PenVee-k, Veetids	Oral
Benzathine penicillin G	Same as penicillin G	Bicillin L-A, Permapen	IM
Procaine penicillin G	Same as penicillin G	Wycillin	IM
Procaine + benzathine penicillin G	Same as penicillin G	Bicillin C-R	IM
β-Lactamase-Resistant Penicillins			
Methicillin [†]		Staphcillin	IM, IV
Nafcillin		Unipen, Nafcil	Oral, IM, IV
Oxacillin		Bactocill	Oral, IM, IV
Cloxacillin		Cloxapen	Oral
Dicloxacillin		Dynapen, Dycill	Oral
Extended-Spectrum Penicillins			
<i>Aminopenicillins</i>			
Ampicillin		Omnipen, Principen	Oral, IM, IV
Bacampicillin	1-Ethoxycarbonyl-oxyethyl ester of ampicillin	Sectrobid	Oral
Amoxicillin		Amoxil, Trimox	Oral
<i>Carboxypenicillins</i>			
Carbenicillin indanyl		Geocillin	Oral

TABLE 39-2

Structures and Characteristics of Penicillin Derivatives—cont'd

NONPROPRIETARY NAME	R SIDE CHAIN	PROPRIETARY NAME(S)	ROUTE OF ADMINISTRATION
Ticarillin		Ticar	IM, IV
Ureidopenicillins			
Mezlocillin		Mezlin	IM, IV
Piperacillin		Pipracil	IM, IV
Extended-Spectrum Penicillins Plus β-Lactamase Inhibitors			
Amoxicillin plus clavulanate		Augmentin	Oral
Ampicillin plus sulbactam		Unasyn	IM, IV
Piperacillin plus tazobactam		Zosyn	IV
Ticarillin plus clavulanate		Timentin	IV

*Poorly absorbed by the oral route.

[†]Discontinued in the United States.

IM, Intramuscular; IV, intravenous.

Bacteria, particularly staphylococci, develop resistance to penicillins chiefly through the elaboration of β -lactamase enzymes (penicillinases) that inactivate the penicillins by cleavage of the 6-aminopenicillanic acid nucleus to yield penicilloic acid derivatives. The production of staphylococcal penicillinase is encoded in a plasmid and may be transferred to other bacteria. Methicillin was the first semisynthetic derivative to be introduced that was stable in the presence of β -lactamase. Subsequently, nafcillin and three isoxazolyl derivatives (oxacillin, cloxacillin, and dicloxacillin) were marketed. The structural formulas for these semisynthetic derivatives are shown in Table 39-2.

Extended-spectrum penicillins are represented by two groups of penicillin derivatives. One group includes ampicillin, the first extended-spectrum penicillin to be introduced; amoxicillin, a close congener of ampicillin; and bacampicillin, a drug that is rapidly hydrolyzed in vivo to yield ampicillin (which accounts for its pharmacologic and toxicologic effects). The second group contains carbenicillin, the first penicillin to exhibit activity against *Pseudomonas* and indole-positive *Proteus* species, and ticarillin, mezlocillin, and piperacillin, drugs with improved activity against *P. aeruginosa*.⁷⁵ The

molecular structures of these agents are depicted in Table 39-2. Carbenicillin for injection is no longer available in the United States, but carbenicillin indanyl, the oral form, is still used.

Mechanism of action and antibacterial spectrum. Early in the discovery of penicillin, it was noted that the drug acted only on rapidly dividing organisms, and it was later determined that bacterial cell wall precursors (the Park nucleotides) accumulated in sensitive bacteria exposed to the penicillins. Penicillin was determined to be a structural analogue of D-alanine; the final step in the formation of the bacterial rigid cell wall was a transpeptidation reaction involving the enzymatic removal of a terminal D-alanine to allow for the formation of the completed peptidoglycan cell wall. β -Lactams are competitive inhibitors of various enzymes (transpeptidases, carboxypeptidases), collectively termed *penicillin-sensitive enzymes*, or more commonly PBPs. β -Lactams promote the formation of cell wall-deficient microorganisms of different shapes (oval, oblong, spherical) depending on the particular PBP affected, which cannot maintain their internal osmotic pressure and eventually burst. The mechanism of action of β -lactams is a

BOX 39-2**Penicillins as Drugs of Choice or Alternative Agents (Penicillin G, Penicillin V, Ampicillin, or Amoxicillin Unless Otherwise Indicated)**

*Acinetobacter**
Actinomyces israelii
Bacillus anthracis
*Bacteroides**
*Campylobacter fetus**
Capnocytophaga canimorsus
*Citrobacter freundii**
Clostridium perfringens
Clostridium tetani
Eikenella corrodens
*Enterobacter**
Erysipelothrix rhusiopathiae
Fusobacterium nucleatum
 Group A, B, C, and G streptococci
Listeria monocytogenes
Neisseria meningitidis
Pasteurella multocida
Peptostreptococcus micros
*Serratia marcescens**
Proteus mirabilis
Spirillum minus
Streptobacillus moniliformis
Staphylococcus aureus/*Staphylococcus epidermidis*†
Streptococcus bovis
Treponema pallidum
 VGS

From Choice of antibacterial drugs, *Med Lett Drugs Ther* 5:33-50, 2007; *Facts and comparisons*, St Louis, 2008, Facts and Comparisons; Wright AJ: The penicillins, *Mayo Clin Proc* 74:290-307, 1999.

*Imipenem/meropenem.

†β-Lactamase-resistant penicillins if methicillin susceptible.

VGS, Viridans group streptococci

BOX 39-3**Disease Entities for Which Penicillin G, Penicillin V, and Amoxicillin Are of Major Use**

Abscesses, including orodental
 Bacteremia (gram-positive)
 Endocarditis
 Gas gangrene
 Mastoiditis
 Meningitis
 Orodental infections
 Osteomyelitis
 Pericarditis
 Periodontal infections
 Pharyngitis
 Pneumonia
 Rat-bite fever
 Scarlet fever
 Suppurative arthritis
 Syphilis
 Vincent's stomatitis
 Weil's disease
 Wound infections

These diseases are caused by various gram-positive cocci and bacilli and some gram-negative organisms, spirochetes, and anaerobic microorganisms. Susceptibility testing may be essential for some to determine therapeutic mean inhibitory concentrations.

classic example of Ehrlich's goal of the "magic bullet," or more specifically a chemical that inhibits a cellular activity present only in bacteria (a rigid cell wall) and not found in mammalian cells.

In some bacterial species, β-lactams have an additional mechanism of action as they activate an enzyme, muramyl synthetase, responsible for the separation of daughter cells after cell division. Activation of this enzyme in the absence of cell division produces lysis of the cell wall (autolysis) and literally bacterial suicide.

Considering these mechanisms, it is apparent why consistently high blood levels of β-lactams are required for optimal success (not all bacteria divide at the same time) and why penicillins do not kill rapidly (it takes time for enzyme inhibition and eventual microorganism rupture). This realization that β-lactams kill slowly has raised questions about the mechanism of action in endocarditis prophylaxis: whether they act only (or at all) by microbial killing or rather by cell wall alteration to retard attachment of the bacteria to damaged cardiac valves.

Penicillin G and penicillin V are narrow-spectrum antibiotics, showing activity against mostly gram-positive cocci and gram-positive bacilli and gram-negative cocci. Other penicillins have an extended spectrum and greater activity against some gram-negative bacilli.

Penicillins as agents of choice in treating specific organisms are listed in Box 39-2 (primarily according to the *Medical Letter of Drugs and Therapeutics*).^{18,33,110} Amoxicillin and penicillin V are drugs of choice against VGS, *Peptostreptococcus*, *E. corrodens*, *F. nucleatum*, *A. israelii*, *Clostridium tetani*, *C. perfringens*, *Leptotrichia buccalis*, *Neisseria*, and non-β-lactamase-producing *Prevotella* and *Porphyromonas*.^{18,33,110} Amoxicillin plus clavulanate is additionally effective against *K. pneumoniae*, *Enterobacter*, *M. catarrhalis*, *Bacteroides fragilis*, non-methicillin-resistant and β-lactamase-producing staphylococci, and β-lactamase-producing *Prevotella* and *Porphyromonas*.³³

Amoxicillin and penicillin V are the initial drugs of choice in orofacial infections in nonallergic patients but are ineffective against streptococci (VGS) with altered PBP. The clinical impact of antibiotic failures against these resistant streptococci and gram-negative β-lactamase-producing oral anaerobes is likely to be significant but has yet to be determined by clinical studies. On the basis of the antimicrobial spectrum of penicillin G and V and other clinical characteristics, the drugs are useful in the treatment of numerous diseases (Box 39-3).

Bacterial resistance. Bacteria evade the killing effects of β-lactams by three mechanisms: reduced drug binding to PBPs (altered target sites), hydrolysis by β-lactamase enzymes (enzymatic inactivation), or development of tolerance by the loss of the autolysis mechanism (penicillin becomes bacteriostatic instead of bactericidal). In most species, the principal mechanism is β-lactamase production.

Absorption, fate, and excretion. Table 39-3 lists important pharmacokinetic properties of oral penicillins.^{13,72} Penicillin G (benzylpenicillin) is rarely used orally because of its poor gastric absorption rate. If it is prescribed orally, it should be given at doses four to five times greater than drugs used parenterally. Penicillin V and amoxicillin are well absorbed orally, with amoxicillin considerably superior in its half-life and peak serum concentrations. Better oral absorption argues for the use of amoxicillin over penicillin V, but both drugs are effective in microorganism-sensitive orofacial infections and are equally inactive against VGS with altered PBPs.

Procaine penicillin G and benzathine penicillin G are repository forms prepared for intramuscular injection with

TABLE 39-3

Pharmacokinetics of Various Oral Penicillins

PENICILLIN	ORAL ABSORPTION (%)	HALF-LIFE (hr)	PEAK SERUM LEVELS ($\mu\text{g}/\text{mL}$)	PROTEIN BINDING	FOOD AFFECTS ABSORPTION (ACID LABILE)
Penicillin G	20	0.5	2	45-68	Yes
Penicillin V	60-73	0.5	4	75-89	No
Amoxicillin	75-90	0.7-1.4	7.5	17-20	No
Dicloxacillin	35-76	0.3-0.9	15	95-97	Yes
Amoxicillin-clavulanate	75-90	0.7-1.4	7.5	17-20	No

From Cars O: Efficacy of beta-lactam antibiotics: integration of pharmacokinetics and pharmacodynamics, *Diag Microbiol Infect Dis* 27:29-33, 1997; Neu HC: Penicillins. In Mandell GL, Douglas RG Jr, Bennett JE, editors: *Principles and practice of infectious diseases*, ed 5, New York, 1990, Churchill Livingstone.

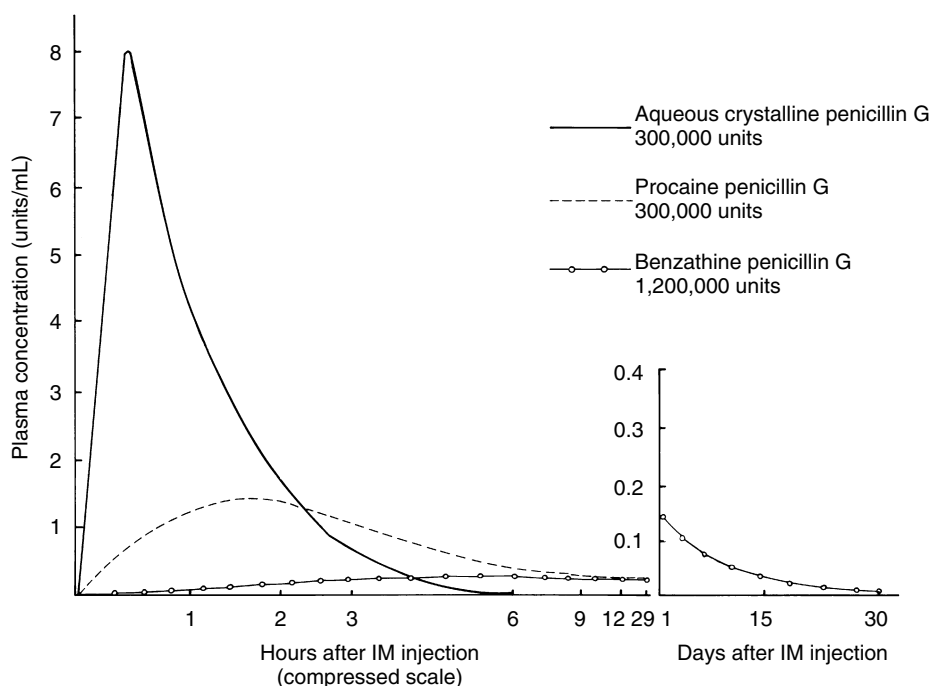

FIGURE 39-2 Comparative plasma concentrations of penicillin G obtained from soluble versus repository intramuscular (IM) dosage forms.

slow release from the injection site (Figure 39-2). The free non-protein-bound serum concentrations of penicillins are 0.9 $\mu\text{g}/\text{mL}$ for penicillin G, 0.8 $\mu\text{g}/\text{mL}$ for penicillin V, 0.45 $\mu\text{g}/\text{mL}$ for dicloxacillin, and 6.2 $\mu\text{g}/\text{mL}$ for amoxicillin.¹³ The route of excretion is primarily by the kidneys, with limited liver metabolism.¹³

β -Lactam antibiotics produce time-dependent killing of bacteria, and frequent dosing is required to maintain relatively constant blood levels with as little fluctuation as possible.¹⁰¹ The killing power of β -lactams is maximum at three to four times the MIC of susceptible microorganisms.¹⁰¹ The prime determinant of the efficacy of β -lactams is the length of time the concentration of the drug in the infected area is greater than the MIC of the infecting organism.¹⁰¹

To be maximally effective, the serum and tissue concentrations of β -lactams should be greater than the MIC for 50% to 70% of the dosing interval.²² The current package insert recommends dosing intervals of 6 hours for penicillin V and first-generation oral cephalosporins. Some drugs have very short half-lives (30 to 45 minutes),³³ and consequently 6-hour dosing intervals may result in very low serum levels

in the last 2 or 3 hours. Continuous intravenous penicillin is receiving greater attention as a way to circumvent this problem.

β -Lactamase inhibitors. Currently, three agents are available to bind irreversibly to the catalytic site of susceptible β -lactamases to prevent hydrolysis of β -lactam antibiotics: clavulanic acid, sulbactam, and tazobactam. Clavulanic acid is derived from *Streptomyces clavuligerus*, sulbactam is a semisynthetic penicilloic acid sulfone, and tazobactam is chemically related to sulbactam.¹¹ All β -lactamase inhibitors have the same mechanism of action, which is to bind to the active site of β -lactamases, where they are converted to an inactive product by β -lactamase ("suicide inhibition").¹¹ Only clavulanic acid is orally absorbed. Clavulanic acid is combined with amoxicillin, sulbactam with ampicillin, and tazobactam with piperacillin.

β -Lactamase inhibitors are generally effective against plasmid-mediated β -lactamases found in methicillin-sensitive *S. aureus* (MSSA), *H. influenzae*, *Haemophilus ducreyi*, *E. coli*, *K. pneumoniae*, *Proteus mirabilis*, *Listeria*, *Neisseria gonor-*

rhoae, all anaerobes, and some Enterobacteriaceae. They are generally ineffective against chromosomally mediated β -lactamases found in *Enterobacter*, *P. aeruginosa*, *Morganella morganii*, *S. marcescens*, and organisms producing inducible extended-spectrum β -lactamases.

The sole therapeutic use of β -lactamase inhibitors is to prevent the hydrolysis of penicillins in the management of β -lactamase-producing microorganisms responsible for otitis media and sinusitis (*S. pneumoniae*, *H. influenzae*, *M. catarrhalis*), nosocomial pneumonia (MSSA or *K. pneumoniae*), intra-abdominal abscesses from β -lactamase-producing anaerobes and other microorganisms, and some upper respiratory tract infections. β -lactam/ β -lactamase inhibitor combinations offer no advantage against non- β -lactamase-producing microorganisms and are ineffective against MRSA; many CoNS and enterococci; and the inducible β -lactamases produced by *P. aeruginosa*, *S. marcescens*, *Enterobacter cloacae*, *Citrobacter freundii*, and *M. morganii*.¹¹ These β -lactam/ β -lactamase inhibitor combinations can often be useful as alternative antibiotics against *Bacteroides*, *M. catarrhalis*, *E. coli*, *K. pneumoniae*, indole-positive *Proteus*, *Providencia rettgeri*, *Providencia stuartii*, *E. corrodens*, *Pasteurella multocida*, and *Pseudomonas pseudomallei* (see Box 39-2).¹⁸

Therapeutic uses in dentistry. Because the oral route is the safest, most convenient, and least expensive mode of

drug administration, it is favored in the treatment of dental patients. Currently, penicillin V is the most frequently prescribed antibiotic for chemotherapy of infections of dental origin, but amoxicillin has significantly superior pharmacokinetics. Parenteral penicillin G is largely reserved for severe infections in patients or situations in which the oral route is compromised (as in malabsorption syndrome and vomiting).

In some instances, penicillins G and V and amoxicillin are unsuitable for treating oral infections. Some dental infections are caused by β -lactamase (penicillinase)-producing organisms, and in such cases the appropriate antibiotic is a penicillinase-resistant penicillin derivative, erythromycin, or clindamycin. Patients who have been receiving extended prophylactic therapy with penicillin for the prevention of rheumatic fever generally require another antibiotic if they acquire an infection or require endocarditis prophylaxis. Certain periodontal infections are associated with gram-positive and gram-negative aerobic and anaerobic microorganisms, for which an antimicrobial agent with a more extended antibacterial spectrum, such as amoxicillin or more commonly a β -lactam/ β -lactamase agent combined with metronidazole, may be the agent of choice. Table 39-4 summarizes antimicrobial therapy based on pathogens; it emphasizes the importance of penicillin V and amoxicillin.

TABLE 39-4

Drugs Used to Treat Infections Caused by Specific Microorganisms

MICROORGANISM	DRUG OF FIRST CHOICE	ALTERNATIVE DRUGS*
Gram-Positive Cocci		
<i>Staphylococcus</i> species		
Methicillin-sensitive	Penicillinase-resistant penicillin (e.g., cloxacillin)	First-generation cephalosporin, vancomycin, clindamycin, imipenem, meropenem, fluoroquinolone, linezolid, daptomycin
Methicillin-resistant	Vancomycin with or without gentamicin or rifampin	Quinupristin-dalfopristin, linezolid, fluoroquinolone, doxycycline, trimethoprim-sulfamethoxazole, tigecycline, daptomycin
<i>Streptococcus pyogenes</i>	Penicillin G or V	Cephalosporin, erythromycin, vancomycin, clindamycin, clarithromycin, azithromycin, linezolid, daptomycin
<i>Streptococcus viridans</i> group		
Oral infections	Penicillin G or V	Erythromycin, clindamycin, cephalosporin
Bacteremia or endocarditis	Penicillin G with or without gentamicin	Ceftriaxone, vancomycin
<i>Streptococcus</i> , anaerobic (<i>Peptostreptococcus</i>)	Penicillin G or V	Cephalosporin, clindamycin, vancomycin
<i>Streptococcus pneumoniae</i>	Penicillin G or V, amoxicillin	Cephalosporin, trimethoprim-sulfamethoxazole, erythromycin, clindamycin, clarithromycin, azithromycin, levofloxacin, gemifloxacin, moxifloxacin, meropenem, imipenem, ertapenem
<i>Enterococcus</i> species	Ampicillin, amoxicillin, penicillin G with gentamicin	Vancomycin with gentamicin, or linezolid, quinupristin-dalfopristin
Gram-Negative Cocci		
<i>Neisseria gonorrhoeae</i>	Ceftriaxone	Cefotaxime, cefixime, penicillin G
<i>Neisseria meningitidis</i>	Penicillin G	Cefotaxime, ceftizoxime, ceftriaxone, chloramphenicol, fluoroquinolone, sulfonamide
<i>Moraxella (Branhamella) catarrhalis</i>	Fluoroquinolone, cefuroxime	Trimethoprim-sulfamethoxazole, amoxicillin-clavulanate, erythromycin, clarithromycin, azithromycin, doxycycline, cefotaxime, ceftizoxime, ceftriaxone
Gram-Positive Bacilli		
<i>Bacillus anthracis</i>	Ciprofloxacin, tetracycline	Penicillin G, erythromycin, amoxicillin, imipenem, clindamycin, levofloxacin
<i>Clostridium difficile</i>	Metronidazole	Vancomycin
<i>Clostridium perfringens</i>	Penicillin G, clindamycin	Imipenem, meropenem, ertapenem, metronidazole, chloramphenicol
<i>Clostridium tetani</i>	Metronidazole	Penicillin G, doxycycline
<i>Corynebacterium diphtheriae</i>	Macrolide	Penicillin G

TABLE 39-4

Drugs Used to Treat Infections Caused by Specific Microorganisms—cont'd

MICROORGANISM	DRUG OF FIRST CHOICE	ALTERNATIVE DRUGS*
<i>Corynebacterium</i> species (diphtheroids)	Vancomycin or penicillin G with gentamicin	Erythromycin
Gram-Negative Bacilli		
<i>Bacteroides</i> , oropharyngeal strains	Penicillin G	Cefotetan, ceftioxin, clindamycin, metronidazole, ampicillin-sulbactam, amoxicillin-clavulanate
<i>Capnocytophaga canimorsus</i>	Penicillin G or V	Cefotaxime, ceftriaxone, ceftizoxime, clindamycin, ciprofloxacin, imipenem, meropenem, vancomycin, fluoroquinolone
<i>Eikenella corrodens</i>	Ampicillin, amoxicillin-clavulanate	Erythromycin, ceftriaxone, doxycycline, clarithromycin, azithromycin
<i>Escherichia coli</i>	Cefotaxime, ceftizoxime, ceftriaxone, ceftazidime, cefepime	Ciprofloxacin, ampicillin with or without gentamicin, tobramycin or amikacin, aztreonam, extended-spectrum penicillin with penicillinase inhibitor, trimethoprim-sulfamethoxazole, imipenem, meropenem, ertapenem, fluoroquinolone, tigecycline
<i>Fusobacterium</i> species	Penicillin G, penicillin V, metronidazole	Clindamycin, ceftioxin, erythromycin
<i>Haemophilus influenzae</i>	Cefotaxime, ceftriaxone, trimethoprim-sulfamethoxazole	Ampicillin or amoxicillin with or without penicillinase inhibitor, cefaclor, cefuroxime, fluoroquinolone, clarithromycin, azithromycin
<i>Klebsiella pneumoniae</i>	Cefotaxime, ceftriaxone, ceftazidime, cefepime	Aminoglycoside, aztreonam, fluoroquinolone, imipenem, meropenem, ertapenem, mezlocillin, extended-spectrum penicillin with penicillinase inhibitor, piperacillin, tigecycline, trimethoprim-sulfamethoxazole
<i>Legionella pneumophila</i>	Azithromycin or ciprofloxacin or other fluoroquinolone with or without rifampin	Trimethoprim-sulfamethoxazole, erythromycin, doxycycline, with or without rifampin
<i>Leptotrichia buccalis</i>	Penicillin G, penicillin V	Clindamycin, doxycycline, erythromycin
<i>Proteus mirabilis</i>	Ampicillin	Aminoglycoside, cephalosporin, fluoroquinolone, ticarcillin/clavulanate, piperacillin/tazobactam, aztreonam, imipenem, meropenem, ertapenem
<i>Pseudomonas aeruginosa</i>	Ticarcillin/clavulanate, piperacillin/tazobactam with or without aminoglycoside, ciprofloxacin	Aztreonam, ceftazidime, cefepime or imipenem with aminoglycoside, doripenem
<i>Salmonella typhi</i>	Ceftriaxone, ciprofloxacin, or levofloxacin	Amoxicillin, ampicillin, trimethoprim-sulfamethoxazole, chloramphenicol
<i>Shigella</i>	Fluoroquinolone	Trimethoprim-sulfamethoxazole, ampicillin, azithromycin, ceftriaxone
Other Microorganisms		
<i>Mycobacterium tuberculosis</i>	Isoniazid with rifampin (or rifabutin or rifapentine) and pyrazinamide with or without ethambutol	Ethambutol, streptomycin, amikacin, ciprofloxacin, ofloxacin, capreomycin, kanamycin, ethionamide, aminosalicylic acid, cycloserine (in combinations)
<i>Actinomyces israelii</i>	Penicillin G	Doxycycline, erythromycin, clindamycin
<i>Nocardia asteroides</i>	Trimethoprim-sulfamethoxazole	Minocycline, sulfisoxazole, amikacin, imipenem, meropenem, ceftriaxone, linezolid, cycloserine
<i>Treponema pallidum</i>	Penicillin G	Ceftriaxone, doxycycline
<i>Chlamydia psittaci</i>	Doxycycline	Chloramphenicol
<i>Rickettsiae</i>	Doxycycline	Fluoroquinolone, chloramphenicol, rifampin
<i>Candida albicans</i>		
Oral lesions	Nystatin, clotrimazole, fluconazole	Itraconazole
Systemic infections	Fluconazole, itraconazole	Amphotericin B with or without flucytosine
Viruses†		
Herpes simplex		
Orolabial	Penciclovir	
Keratitis	Acyclovir	Trifluridine, foscarnet
Genital infection	Acyclovir	Valacyclovir, famciclovir
Encephalitis	Acyclovir	
Human immunodeficiency virus	Zidovudine with another nucleoside analogue, plus a protease inhibitor†	Zidovudine with another nucleoside analogue, plus nevirapine, with or without fusion inhibitor
Influenza A	Rimantadine	Amantadine, zanamivir, oseltamivir

*Listing does not include all alternative drugs.

†See Chapter 40.

Adverse effects. The adverse effects of penicillins are allergic and nonallergic in nature.

PENICILLIN ALLERGY. Allergic reactions to penicillins are common while allergic fatalities are far less common. Allergy to penicillins ranges from 0.7% to 8% in various studies, with a 0.7% to 4% chance of an allergic reaction (average of 2%) during any given course of penicillin therapy.^{49,50} Most allergic manifestations are maculopapular or urticarial skin reactions.

Penicillin may be the most common cause of anaphylactic death in the United States, accounting for 75% of all cases and 400 to 800 annual deaths. These numbers may be low estimates, however. Penicillin-induced anaphylaxis is most common in adults 20 to 49 years old.^{49,50} Estimates of severe penicillin anaphylaxis range from 0.004% to 0.015% of individuals exposed and, from the point of view of number of exposures, possibly 1 in 1200 to 1 in 2500 penicillin exposures. The fatality rate from penicillin anaphylaxis by all routes of administration may be 1 in 60,000 patient courses (16 per 1 million),^{79,81} but data regarding penicillin allergy are limited.

Eventually, 1% to 10% of the general population exposed to therapeutic penicillin have an allergic reaction, with a higher positive history with increased age. Retrospective studies suggest that the incidence of allergy varies with the route of administration—oral (0.3%), intravenous (2.5%), and intramuscular (5%); the lower incidence by the oral route has been questioned because of limited data.^{79,80} With higher oral doses (3.5 g of amoxicillin), the allergy rate may approach that of intramuscular penicillin, indicating that the dose and the route may be a determining factor in penicillin allergy. Fatal anaphylactic reactions after oral penicillin are well documented.^{79,81}

It is probable that an acute penicillin allergic reaction is less common in children and elderly patients, but fatal reactions may be more likely in elderly patients because of their compromised cardiopulmonary function. Whether certain individuals are predisposed to penicillin allergy remains unsettled. Risk factors for penicillin allergies include multiple allergies to other drugs, particularly other antibiotics (“multiple allergy syndrome”), or atopic disease (asthma, allergic rhinitis, nasal polyps). Several studies indicate a higher rate of penicillin allergy in individuals with a history of other drug allergies, whereas other studies indicate no such increased risk.^{79,81} It is possible that individuals with multiple drug allergies or atopy may have more severe penicillin allergic reactions. Allergy to the procaine component of procaine penicillin G has been detected.

In individuals with a positive history of penicillin allergy, 15% to 40% exhibit allergy on re-exposure to penicillin, and individuals with a positive history of penicillin allergy have a four to six times greater likelihood of a subsequent reaction than individuals with a negative history.^{79,81} Some patients may retain penicillin-specific IgE antibodies indefinitely, whereas most lose them over time. The serum half-life of penicillin IgE antibodies ranges from 10 to more than 1000 days; the risk of recurrent penicillin allergy is higher in individuals with antibodies with long half-lives or repeated penicillin exposures. Few data are available regarding whether the 60% to 85% not exhibiting allergy on re-exposure reacquire the IgE antibodies to penicillin and then have an allergic reaction to the drug on the next (third) exposure by resensitization. In a study of patients with a positive history of penicillin allergy (25 with urticaria/angioedema, 19 with anaphylaxis, 19 with pruritic skin rash) and a negative skin test for penicillin allergy, none had an allergic reaction to three successive 10-day courses of penicillin.⁹¹ The average length of time from the penicillin allergic reaction to rechallenge was 25 years

(range 5 to 50 years), indicating that patients commonly lose their antibodies to penicillin. This study provides no information, however, on patients with a more recent history of penicillin allergy.

Because variable IgE antibody levels to penicillin are common, skin testing for penicillin allergy becomes problematic. The incidence of positive skin tests in individuals with a history of penicillin allergy ranges from 4% to 91% depending on the accuracy of the patient history, the haptens in the test solution, and the time elapsed between the allergic reaction and the skin test.^{68,70} It is possible that penicillin skin tests may be reliable only for 72 hours after the test is performed.^{79,81}

Penicillin skin testing can be considerably valuable in determining who might have a severe anaphylactic reaction. Approximately 95% of penicillin-allergic individuals form the penicilloyl-protein conjugate (the major antigenic determinant), and approximately 5% form the 6-aminopenicillanic acid and benzyl-penamaldic acid minor antigenic determinants (Figure 39-3).^{79,81} Penicillin skin tests with the major and minor antigenic determinants eliciting a negative skin test virtually eliminate the risk for a serious IgE-mediated reaction. A positive skin reaction to the minor determinant mixture indicates a high risk for anaphylaxis.

Penicillins are primarily associated with IgE-mediated (Gell and Coombs type I) allergic reactions, but may also induce cytotoxic (type II) or immune complex (type III) reactions. Type I signs and symptoms include skin erythema, itch, angioedema, urticaria, wheezing, hypotension, and bronchospasm resulting from mast cell/basophil release of histamine along with other tissue allergic mediators. Type II reactions are caused by circulating IgM or IgG antibodies that attach to blood cells and induce blood dyscrasias, including hemolytic anemia, leukopenia, thrombocytopenia, and aplastic anemia. Type III reactions result from the deposition of soluble immune complexes on blood vessels and basement membranes resulting in serum sickness, vasculitis, and glomerulonephritis.

Allergic reactions to penicillins can also be classified according to their time of onset. Immediate IgE reactions begin within seconds to 1 hour after drug exposure and are the most life-threatening (it is an allergy truism that the more rapid the onset of the allergic reaction, the more serious the consequences). Accelerated reactions begin 1 to 72 hours after antigen exposure and usually manifest as urticaria or angioedema. Late reactions occur after 72 hours and are characterized by type II and type IV (eczema-like) Gell and Coombs reactions. Of all fatal anaphylactic reactions, 96% occur within the first 60 minutes after penicillin exposure.^{79,81}

Other adverse reactions to penicillins are likely to be autoimmune in origin and have an obscure etiology, including maculopapular rashes, eosinophilia, Stevens-Johnson syndrome, and exfoliative dermatitis. A maculopapular rash is seen in 2% to 3% of patients late in penicillin therapy.

MULTIPLE ANTIBIOTIC ALLERGY SYNDROME. Most practitioners have encountered at least one patient with a history of allergy to multiple antibiotics (and probably other drugs as well). Whether such an antibiotic allergy syndrome exists is still undetermined, but may constitute 1% to 4% of all patients who have taken multiple antibiotics.⁶⁶ Serious adverse drug reactions such as anaphylaxis with antibiotics are rare except for the β -lactams.⁸⁸

Some difficulties with the health history are that (1) patients may confuse any adverse drug reaction with “allergy,” (2) rarely are any of these “allergies” confirmed by skin testing, and (3) often the patient’s history is nebulous.⁶⁶ The management of such patients requires a detailed medical history, including (1) when during the treatment the reaction

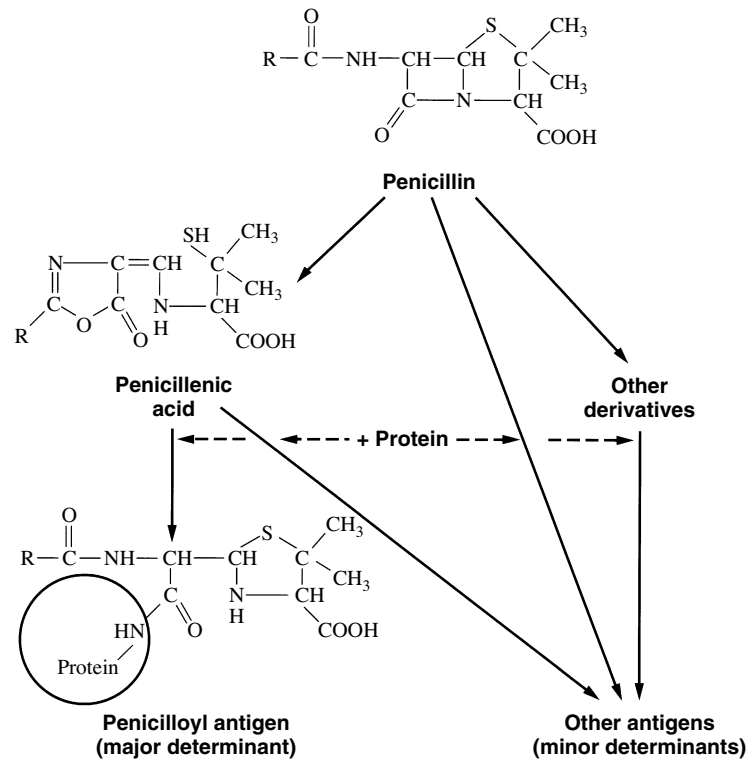

FIGURE 39-3 Antigenic determinants of penicillin allergy.

occurred, (2) what infectious disease was being treated, (3) what doses of antibiotics were taken and for how long, and, most important, (4) what were the signs and symptoms. The primary concern is to determine the signs and symptoms of an acute IgE-mediated allergic reaction—rash, angioedema, bronchospasm, and syncope—along with the time between drug ingestion or administration and onset of symptoms. If the onset of signs and symptoms occurred within 1 hour of ingestion or administration, it was likely an immediate allergic reaction. After taking a thorough history, a possible skin test (reliable only for β -lactams) is indicated and a specific management plan. Comorbid conditions that may increase the incidence of allergy in general are atopic disease (asthma, eczema), chronic urticaria, nonsteroidal anti-inflammatory drug (NSAID) intolerance, immunosuppression, human immunodeficiency virus (HIV) positivity, and a history of multiple antibiotic use.⁶⁶

NONALLERGIC ADVERSE EFFECTS. Ticarcillin, mezlocillin, and piperacillin may cause abnormal coagulation times; abnormal liver function tests may occur with β -lactamase-resistant penicillins, and Na^+ overload may be seen with antipseudomonal penicillins. Large intravenous doses of penicillins may induce hyperexcitability, seizures, and hallucinations. Amoxicillin is the most common cause of antibiotic-induced diarrhea/colitis because of its spectrum and widespread use. Penicillins are U.S. Food and Drug Administration (FDA) pregnancy category B drugs.

Approximately 5% to 10% of individuals receiving ampicillin or amoxicillin may have a mild pruritic rash, usually beginning on the trunk and extending to the face, extremities, and extensor portions of the knees and elbows. This nonallergic “ampicillin/amoxicillin rash” is not associated with antibody formation and is of unknown cause. It does not seem to increase the risk of true penicillin allergy. The rash may begin 24 hours to 28 days after the drug is begun and may last 90

minutes to 7 days. The incidence of ampicillin/amoxicillin rash is 95% to 100% in individuals with cytomegalovirus infection/mononucleosis and 22% in individuals given ampicillin and allopurinol.

Rare and reversible disorders reportedly associated with penicillins include acute pancreatitis, neutropenia, aseptic meningitis, hepatotoxicity, and increased prothrombin time/international normalized ratio (INR) in patients taking oral anticoagulants either through impaired platelet function or altered gastrointestinal microbial flora. Untoward bleeding may also occur in patients not taking coumarin anticoagulants and is dose-dependent, with a maximum effect 3 to 7 days after penicillin is begun, with a return to a normal bleeding time in 72 to 96 hours; this bleeding has been reported after a dental extraction.⁸ The mechanism is likely due to an altered adenosine 5'-diphosphate-mediated platelet aggregation response and is seen most commonly in patients with underlying chronic illnesses associated with hypoalbuminemia and uremia.

Drug interactions. Oral penicillins (penicillin G, penicillin V, amoxicillin) may be antagonized by bacteriostatic antibiotics (tetracycline, erythromycin, clindamycin). NSAIDs and probenecid may increase the serum half-lives of penicillins by decreasing their renal excretion. Individuals taking β -adrenergic blocking drugs may have a diminished or nonexistent response to a β -adrenergic receptor agonist given for the treatment of penicillin-induced anaphylactic bronchospasm.

Contraindications. Penicillins are generally contraindicated in individuals allergic to the drugs, but it is well documented that some individuals with a previous allergic history may subsequently tolerate penicillins without allergic manifestations. The best policy is to refrain if possible from penicillin administration to anyone with a positive history. Penicillins may be contraindicated in some individuals taking coumarin

TABLE 39-5

Recommended Doses of Some Antibiotics

ANTIBIOTIC	DOSE
β-Lactams	
Penicillin V	Adult: 250-500 mg every 6 hr; child (<12 yr old): 250-500 mg every 6 hr
Amoxicillin	Adult: 250-500 mg every 8 hr; child (<20 kg): 20-40 mg/kg in 8-hr divided doses or 6.7-13.3 mg/kg every 8 hr
Amoxicillin-clavulanate	Adult: 250-500 mg every 8 hr; child: 25-40 mg/kg/day in 8-hr divided doses or 6.6-13.3 mg/kg every 8 hr
Dicloxacillin	Adult: 125-500 mg every 6 hr; child (<20 kg): 50-100 mg/kg/day in 6-hr divided doses or 3.125-6.25 every 6 hr
Cephalexin	Adult: 125-1000 mg every 6 hr; child: 25-100 mg/kg/day in 4 divided doses
Cephadrine	Adult: 250-1000 mg every 6 hr; child: 25-100 mg/kg/day in 2 or 4 divided daily doses
Cefaclor	Adult: 250-500 mg every 8 hr; child: 20-40 mg/kg/day in divided doses every 8 hr
Macrolides	
Erythromycin	Adult: 250-500 mg (stearate, base, or estolate salts) or 400 mg ethylsuccinate salt every 6 hr; child: 30-50 mg/kg per day in divided doses every 6 hr
Azithromycin	Adult: 500 mg every 12 hr; child: 5-12 mg/kg/day
Clarithromycin	Adult: 250-500 mg every 12 hr; child: 7.5 mg/kg twice daily up to 500 mg twice daily
Miscellaneous Antibiotics	
Clindamycin	Adult: 150-450 mg every 6 hr; child: 8-20 mg/kg/day in 3 or 4 equal doses
Metronidazole	Adult: 250-750 mg every 8 hr, not to exceed 4 g in 24 hr
Ciprofloxacin	Adult: 250-500 mg every 12 hr; child: 25 mg/kg/day divided every 12 hr
Doxycycline	Adult: 200 mg on day 1 (100 mg every 12 hr) then 100 mg daily; child (≥8 yr old): 4.4 mg/kg in 2 divided doses on day 1 then 2.2 mg/kg daily
Linezolid	Adult: 375-625 mg every 12 hr

From Amsden GW: Tables of antimicrobial agent pharmacology. In Mandell GL, Bennett JE, Dolin R, editors: *Mandell, Douglas and Bennett's principles and practice of infectious diseases*, Philadelphia, 2000, Churchill Livingstone; *Facts and comparisons*, St Louis, 2002, Facts and Comparisons; Neu HC: Penicillins. In Mandell GL, Douglas RG, Jr, Bennett JE, editors: *Principles and practice of infectious diseases*, ed 5, New York, 1990, Churchill Livingstone; Pallasch TJ: Antibiotics for acute orofacial infections, *J Calif Dent Assoc* 21:34-44, 1993; Wright AJ: The penicillins, *Mayo Clin Proc* 74:290-307, 1999.

anticoagulants because untoward bleeding may occur, but this seems to be highly unpredictable and rare in occurrence.

Dosage. The standard package insert doses for amoxicillin are given in Table 39-5. Amoxicillin has excellent and rapid oral absorption, yields high blood levels, and has a longer half-life than penicillin V. Based on pharmacokinetic studies, the package insert intervals of 6 hours for β-lactams with a short half-life (penicillin V, cephalexin, cephadrine) seem inappropriate, and 4-hour dosing intervals would provide more constant blood and tissue levels for these time-dependent antibiotics. As with all acute infections, a loading dose of two to four times the maintenance dose is appropriate, with the possible exception of amoxicillin because of its superior pharmacokinetics.

Cephalosporins

The isolation of the fungus *Cephalosporinium acremonium* (now *Acremonium chrysogenum*) in 1948 by Brotzu from the harbor sewage of Sardinia and the subsequent isolation of the active nucleus of cephalosporin C (7-amino-cephalosporinic acid) by Florey and Abraham at Oxford University contributed in large measure to a golden age in antimicrobial chemotherapy. The massive use and misuse of cephalosporins because of their broad antibacterial spectra combined with low toxicity and allergenicity have resulted in widespread microbial resistance to these agents.

Chemistry and classification. Cephalosporins are closely related to penicillins, with a six-membered dihydrothiazine ring replacing the five-membered thiazolidine ring of penicillin (Figure 39-4). Both contain the β-lactam ring, as do the monobactams and carbapenems discussed later. Side chain modification of the 7-APA nucleus has led to differences in antibacterial spectrum, pharmacokinetics, susceptibility to

various β-lactamases, affinity for different PBPs, and occasionally adverse reactions.

Cephalosporins are most commonly classified according to their “generations”: first generation (introduced in the 1960s), second generation (introduced in the 1970s), third generation (introduced in the 1980s), and fourth generation (cefepime introduced in 1997) (Box 39-4).^{7,33,50,67} Ceftidoren is a third-generation agent introduced in 2001. It is useful to examine cephalosporins according to their antibacterial spectrum and therapeutic uses (Table 39-6).³³

Cephalosporins evolved from early agents primarily active against gram-positive microorganisms (first generation) to agents with a greater gram-negative spectrum (second generation) to agents with greater activity against various nosocomial pathogens, including *P. aeruginosa*, *B. fragilis*, and organisms producing extended-spectrum and ampicillin C (ampC) β-lactamases. The demand for wider spectrum cephalosporins to avoid having to isolate the organism via culture and sensitivity tests (and save money) has been a major factor in microbial resistance to these agents. Technically, second-generation agents include true cephalosporins and cephamycins (cefoxitin, cefotetan, cefmetazole), which are derived from *Streptomyces* rather than *Cephalosporinium*.

Mechanism of action and antibacterial spectrum. Cephalosporins possess a mechanism of action identical to penicillins: inhibition of bacterial cell wall peptidoglycan synthesis by inhibition of penicillin-sensitive enzymes (transpeptidases, carboxypeptidases) that are responsible for the final three-dimensional structure of the rigid bacterial cell wall. Each bacterial species may have different PBPs, and the affinity of cephalosporins for these PBPs can vary greatly.⁵⁰ Most cephalosporins bind to PBP1 and PBP3 of gram-negative organisms,⁷ and depending on which PBPs are inhibited, the resulting bacterial cells may take different shapes—oval, round, or fila-

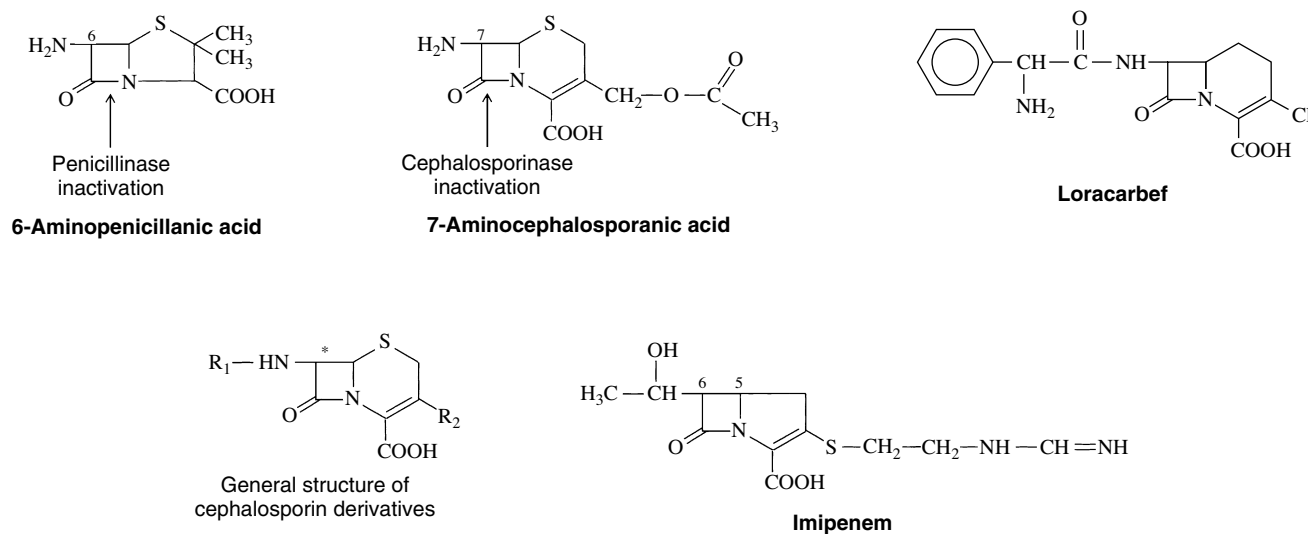

FIGURE 39-4 Comparison of basic nuclei of penicillins and cephalosporins. *A methoxy group is added to the 7 carbon in cephamycins. Included for comparison are the structures of imipenem, a carbapenem antibiotic, and loracarbef, a carbacephem.

BOX 39-4

Classification of Cephalosporins by Generations and Classification of Other β -Lactam Antibiotics

Cephalosporins

First Generation

Cefadroxil (Duricef)*

Cefazolin (Ancef, Kefzol, Zolicef)[†]

Cephalexin (Biocef, Keflex, Keftab)*

Cephalothin (Keflin)[†]

Cephapirin (Cefadyl)[†]

Cephadrine (Velosef)[†]

Second Generation

Cefaclor (Ceclor)*

Cefamandole (Mandol)[†]

Cefonicid (Monocid)[†]

Cefotetan (Cefotan)[†]

Cefoxitin (Mefoxin)[†]

Cefprozil (Cefzil)*

Cefuroxime (Ceftin, Kefurox, Zinacef)[‡]

Loracarbef (Lorabid)*

Third Generation

Cefdinir (Omnicef)*

Cefixime (Suprax)*

Cefoperazone (Cefobid)[†]

Cefotaxime (Claforan)[†]

Cefpodoxime (Vantin)*

Ceftazidime (Ceptaz, Fortaz, Tazicef, Tazidime)[†]

Ceftibuten (Cedax)*

Cefditoren (Spectracef)*

Ceftizoxime (Cefizox)[†]

Ceftriaxone (Rocephin)[†]

Fourth Generation

Cefepime (Maxipime)[†]

Other β -Lactam Antibiotics

Carbapenems

Imipenem (with cilastatin in Primaxin)[†]

Meropenem (Meronem)[†]

Ertapenem (Invanz)[†]

Doripenem (Doribax)[†]

Monobactams

Aztreonam (Azactam)[†]

Adapted from Asbel LE, Levison ME: Cephalosporins, carbapenems, and monobactams, *Infect Dis Clin N Am* 14:435–447, 2000; *Facts and comparisons*, St Louis, 2002, Facts and Comparisons; Karchmer AW: Cephalosporins. In Mandell GL, Bennett JF, Dolin R, editors: *Principles and practice of infectious diseases*, ed 5, New York, 2000, Churchill Livingstone; Marshall WF, Blair JE: The cephalosporins, *Mayo Clin Proc* 74:187-195, 1999.

*Oral.

[†]Parenteral.

[‡]Oral and parenteral.

mentous.⁷ The antibacterial spectrum, susceptible microorganisms, and drugs of choice or alternative indications are listed in Table 39-6.^{7,18,50,67}

First-generation agents are intended for gram-positive aerobes, facultative cocci, and MSSA. Cefazolin is commonly used as single-dose antibiotic prophylaxis for clean-clean hospital surgery. Second-generation drugs have variable antistaphylococcal activity, a greater gram-negative spectrum, and

some activity against anaerobes (e.g., cefotetan, cefoxitin). Third-generation agents are most active against gram-negative organisms and penicillin-resistant *S. pneumoniae*, with a subset effective against *P. aeruginosa*. Cefoperazone, ceftazidime, and cefsulodin have good antipseudomonal activity. Fourth-generation drugs have a wider antibacterial spectrum and good activity against *Pseudomonas*, penicillin-resistant *S. pneumoniae*, VGS, multidrug-resistant *S. pneumoniae* and *Enterococcus*.

TABLE 39-6

Classification of Cephalosporins According to Disease and Antibacterial Spectrum

	ANTIBACTERIAL SPECTRUM	THERAPEUTICS USES	AGENTS
Group 1	<i>Staphylococcus aureus</i> <i>Streptococcus pneumoniae</i> / <i>Streptococcus pyogenes</i> <i>Haemophilus influenzae</i> <i>Escherichia coli</i> <i>Klebsiella pneumoniae</i> <i>Proteus mirabilis</i> <i>Moraxella catarrhalis</i> <i>Neisseria gonorrhoeae</i> VGS	Skin and skin structures Urinary tract infections Respiratory tract infections Bone (<i>S. aureus</i>) Septicemia Tonsillitis Pharyngitis	Cefazolin Cephapirin Cefdinir Ceftibuten Cefprozil Loracarbef Cephradine Cefadroxil Cephalexin Cefpodoxime
Group 2	<i>S. aureus</i> <i>S. pneumoniae</i> / <i>S. pyogenes</i> <i>E. coli</i> <i>H. influenzae</i> <i>P. mirabilis</i> / <i>Proteus vulgaris</i> Enterobacteriaceae <i>K. pneumoniae</i> <i>Bacteroides fragilis</i> <i>Clostridium perfringens</i> <i>Moraxella catarrhalis</i> <i>Streptococcus agalactiae</i> (group B streptococcus) <i>Neisseria meningitidis</i> <i>Peptostreptococcus</i>	Skin and skin structures Urinary tract infections Lower respiratory tract infections Acute otitis media Sexually transmitted diseases Sinusitis Chronic bronchitis Community-acquired pneumonia Mild-moderate abdominal infections Meningitis	Cefmetazole Cefoxitin Cefuroxime Cefonicid Ceftriaxone Cefixime Cefdinir Cefoperazone
Group 3	<i>S. pneumoniae</i> <i>H. influenzae</i> <i>S. aureus</i> <i>K. pneumoniae</i> <i>E. coli</i> <i>P. mirabilis</i> Enterobacteriaceae <i>B. fragilis</i> <i>Streptococcus agalactiae</i> <i>Clostridium</i> <i>Neisseria gonorrhoeae</i> CoNS <i>Fusobacterium nucleatum</i> <i>Peptostreptococcus</i> <i>P. aeruginosa</i>	Lower respiratory tract infections Skin infections Urinary tract infections Sexually transmitted diseases Septicemia Bone and joint infections Pelvic inflammatory disease Intra-abdominal infections Peritonitis	Cefotaxime Ceftriaxone Cefotetan Ceftazidime Cefamandole Cefditoren Cefoperazone Ceftazidime or cefoperazone (for <i>P. aeruginosa</i> , cefoperazone or ceftazidime)
Group 4	<i>S. pyogenes</i> <i>S. aureus</i> <i>K. pneumoniae</i> <i>P. aeruginosa</i> Enterobacteriaceae <i>B. fragilis</i>	Pneumonia Moderate-severe skin and abdominal infections Prophylaxis for febrile neutropenia	Cefepime

From Asbel LE, Levison ME: Cephalosporins, carbapenems, and monobactams, *Infect Dis Clin North Am* 14:435-447, 2000; Choice of antibacterial drugs, *Med Lett Drugs Ther* 43:69-78, 2001; *Facts and comparisons*, St Louis, 2002, Facts and Comparisons; Karchmer AW: Cephalosporins. In Mandell GL, Bennett JF, Dolin R, editors: *Principles and practice of infectious diseases*, ed 5, New York, 2000, Churchill Livingstone; Marshall WF, Blair JE: The cephalosporins, *Mayo Clin Proc* 74:187-195, 1999.

CoNS, Coagulase-negative staphylococci; VGS, viridans group streptococci.

coccus, MRSA, and hyper- β -lactamase-producing organisms. Fourth-generation agents include cefclidin, cefpirone, cefclidin, cefoselis, cefpirime, and ceftuprenan.⁷

Bacterial resistance. The major mechanism of resistance to cephalosporins is the microbial elaboration of various

β -lactamases (cephalosporinases). First-generation agents are very sensitive to β -lactamase hydrolysis, with the second to fourth generations more resistant to β -lactamases. Moderate stability is shown by cefonicid, loracarbef, cefdinir, and cefixime; moderate-high stability, by cefoxitin, cefuroxime, ceftriaxone, cefotaxime, ceftizoxime, cefmetazole, and cefotetan;

and high stability, by cefoperazone, cefpodoxime, and ceftazidime.^{7,33,50,67} The current concern is the microbial production of extended-spectrum β -lactamases derived from point mutations on TEM-1, TEM-2, and SHV-1 β -lactamases (see Chapter 38) that result in high-level resistance to ceftazidime, aztreonam (a monobactam), and third-generation cephalosporins in highly pathogenic nosocomial *E. coli*, *K. pneumoniae*, and *E. cloacae*.⁵⁰

Absorption, fate, and excretion. Oral cephalosporins are generally well absorbed, with all except cefadroxil and cefprozil having their absorption delayed, but not reduced, by food.³³ Cephalosporins are hydrophilic and widely distributed in extracellular fluid, but do not enter the cells of the immune system (macrophages, polymorphonuclear leukocytes), as do lipophilic macrolides, tetracyclines, and lincosamides. Only cefuroxime of the first-generation and second-generation agents penetrates into the cerebrospinal fluid. Plasma protein binding ranges from 10% for ceftibuten to 80% to 90% for cefazolin, cefoxitin, and cefoperazone. Plasma protein binding is 10% for cephalixin, 25% for cefaclor, and 8% to 17% for cephradine. The serum half-lives of some oral cephalosporins are 50 to 80 minutes for cephalixin, 48 to 80 minutes for cephradine, and 35 to 54 minutes for cefaclor.³³ In patients with end-stage renal disease, these half-lives may increase to 19 to 22 hours for cephalixin, 8 to 15 hours for cephradine, and 2 to 3 hours for cefaclor.

General therapeutic uses. Cephalosporins have wide applications in the treatment of infections. Tables 39-4 and 39-6 indicate their clinical importance as antimicrobial drugs. The utility of these drugs depends on the generation. First-generation drugs are used to treat infections caused by staphylococci and streptococci. They also are useful in surgical and endocarditis prophylaxis. Some gram-negative bacilli, such as *P. mirabilis* and *K. pneumoniae*, may be sensitive. Second-generation drugs have limited use, although a subset of this group represented by cefoxitin has good activity against many gram-negative anaerobes.

Third-generation drugs have become prominent in the treatment of serious gram-negative coccal and bacillary infections. They are very useful in treating meningitis, pneumonia, gonorrhea, and sepsis from sensitive organisms. Cephalosporins are often given with aminoglycosides for gram-negative bacilli infections. There are significant individual differences between members of the third-generation drugs, and not all indications apply to each member. Fourth-generation cephalosporins are resistant to many β -lactamases and are effective in treating some gram-negative bacilli that produce β -lactamases.

Therapeutic uses in dentistry. Cephalosporins have good activity against many orofacial pathogens, but limited activity against oral anaerobes. These β -lactam antibiotics are also time-dependent agents without significant post-antibiotic effects, and the serum and tissue concentrations of cephalosporins should remain greater than the organism's MIC for at least 60% of the dosing interval to retard organism regrowth as much as possible.²² At the current package dosing intervals of 6 hours for oral cephalosporins with a short half-life (e.g., cephalixin, cephradine, cefaclor), these serum levels are not likely to be attained. At three half-lives after ingestion (approximately 4 hours), only 12.5% of the β -lactam remains in the blood or tissue and may well be less than the organism's MIC. Brief peak blood concentrations followed by a significant period below the organism's MIC are not ideal for time-dependent antibiotics and allow for recovery of the pathogen from inhibition of β -lactam cell wall formation.²⁰ Shortening the dosing interval to 4 hours for these agents may resolve this pharmacokinetic difficulty.

Adverse effects. Serious adverse reactions associated with cephalosporins are rare, with the major concern being the potential for cross-allergy with penicillins. Unusual adverse reactions include transient increases in liver enzymes, nephrotoxicity, reversible neutropenia, eosinophilia and thrombocytopenia, aseptic meningitis, and disulfiram-like reactions associated with cephalosporins with the methylthiotetrazole side chain (e.g., cefotetan, cefoperazone, cefamandole). Pseudomembranous colitis is rare with first-generation and second-generation agents, but is more common with third-generation cephalosporins, possibly because of their anti-*Bacteroides* activity (*Bacteroides* and antagonistic *C. difficile* in the colon). Some cephalosporins (e.g., cefoperazone, cefotetan, cefmetazole, cefmenoxime) may induce hypoprothrombinemia by reduced synthesis of vitamin K-dependent clotting factors.

The inherent allergic potential of cephalosporins along with their cross-allergenicity with penicillins is of major concern. Cutaneous allergic reactions to cephalosporins (rash, pruritus, urticaria) are commonly reported to occur in 1% to 3% of patients. Serum sickness or a morbilliform rash may be seen in children receiving cefaclor. Stevens-Johnson syndrome and toxic dermal necrolysis have been reported.³³ In 6573 patients receiving cephalosporins,⁷³ 1.1% exhibited an allergic reaction.²⁴

Anaphylactic reactions to cephalosporins seem to be rare, with an incidence ranging from 0.0001% to 0.1% of individuals exposed.⁵¹ In 9388 patients without a history of penicillin allergy given cephalosporins, two anaphylactic reactions were reported (0.2%).⁵¹ In a retrospective study of 350,000 adverse drug reactions, six fatal cases of cephalosporin-induced anaphylaxis were reported, with three of the six cases in patients with a history of penicillin allergy.⁸⁵

The issue of cross-sensitivity between the cephalosporins and penicillins has never been satisfactorily resolved. Estimates range from 1.1% (the same as the allergy incidence to cephalosporins in the general population) to 18% in the earliest studies.^{79,81} Penicillin-allergic individuals may have a four-fold greater risk of allergy to cephalosporins than individuals not allergic to penicillins; however, penicillin-allergic individuals have a three to four times greater risk of allergy to any drug. No skin test is available to detect cephalosporin allergy, and experience with desensitization is limited and not standardized.

It is generally agreed that it is reasonably safe to give cephalosporins to patients with a history of a mild skin reaction to penicillins or a positive penicilloyl-polylysine (major determinant mixture) skin test.^{79,81} Cephalosporins are generally contraindicated in patients with a positive penicillin skin test to the minor determinant mixture or a history of local or systemic penicillin anaphylaxis (severe urticaria, bronchospasm, hypotension, exfoliative dermatitis), unless cephalosporins are mandated in the management of a life-threatening infection, and anaphylaxis antidotal therapy is readily available.

Drug interactions. Antacids decrease the plasma concentrations of cefaclor, cefdinir, and cefpodoxime; H₂ histamine receptor antagonists reduce the plasma concentrations of cefpodoxime and cefuroxime, and iron supplements reduce the gastric absorption of cefdinir.³³ Food decreases the oral absorption of cefuroxime and cefpodoxime. Cefmetazole, cefoperazone, and cefotetan may induce a disulfiram reaction with ethanol and hypoprothrombinemia. Nephrotoxicity may be seen with the combination of cephalosporins with aminoglycosides or loop diuretics. Cephalosporins may produce a false-positive reaction for urine glucose with Benedict's solution, and cephradine may produce a false-positive reaction for urinary proteins with tests using sulfosalicylic acid.³³

Contraindications. Cephalosporins are contraindicated in patients allergic to these drugs and in individuals with a history of severe penicillin reactions or a positive skin test reaction to the penicillin minor determinant mixture.

Other β -lactam antibiotics

Carbapenems. Carbapenems are derivatives of thienamycin (from *Streptomyces cattleya*) and differ from penicillins by the replacement of the sulfur by a methylene group in the five-membered ring of the β -lactams (see Figure 39-4). Currently, four carbapenems are available for parenteral use in the United States: imipenem, meropenem, ertapenem, and doripenem. Imipenem is combined with cilastatin to reduce the hydrolysis of imipenem by a renal peptidase.

Carbapenems have a very wide antibacterial spectrum, have a high specificity for PBP2 of gram-positive and gram-negative microorganisms (resulting in ovoid organisms), and are not hydrolyzed by most β -lactamases.³⁹ Carbapenems are drugs of choice for the management of infections caused by *Campylobacter fetus*, *C. freundii*, *Enterobacter*, *Acinetobacter*, *S. marcescens*, and *Rhodococcus equi* and alternative drugs against MSSA, penicillin-resistant or non-penicillin-resistant *S. pneumoniae*, *Bacillus subtilis*, *Bacillus cereus*, *C. perfringens*, *Bacteroides*, *E. coli*, *K. pneumoniae*, *P. mirabilis*, indole-positive *Proteus*, *P. stuartii*, *Capnocytophaga canimorsus*, *H. influenzae*, and *P. aeruginosa*.¹⁸

Microorganisms that are generally resistant to carbapenems include *Enterococcus faecium*, *Pseudomonas cepacia*, *Stenotrophomonas maltophilia*, *Flavobacterium*, JK *Corynebacterium*, MRSA, and methicillin-resistant CoNS. Organisms with varying resistance include *P. aeruginosa*, *S. marcescens*, penicillin-resistant *S. pneumoniae*, *K. pneumoniae*, and vancomycin-resistant enterococci. Metallo- β -lactamases derived from *K. pneumoniae*, *P. cepacia*, and *S. maltophilia* readily metabolize the carbapenems and induce the production of cephalosporinases, which significantly increase microbial resistance to third-generation cephalosporins.⁷ Microbial resistance to carbapenems is via the loss of an outer membrane protein retarding cell wall penetration of the drugs, altered PBPs in *E. faecium* and MRSA, and hydrolysis by metallo- β -lactamases and other β -lactamases.³⁹

Carbapenems are classified as FDA pregnancy category B or C drugs, are cross-allergenic with other β -lactams, may increase the level of serum liver transaminases, may induce pseudomembranous colitis, and are associated with a 3% to 4% incidence of skin rash. Imipenem, meropenem, and ertapenem are associated with increased central nervous system (CNS) toxicity and seizures. Doripenem has a lower risk of CNS toxicity.

Monobactams. Aztreonam is a monocyclic β -lactam (monobactam) lacking the thiazolidine ring of penicillin (Figure 39-5).^{7,39} It is available only parenterally. It does not bind to the PBPs of gram-positive or anaerobic microorganisms; its spectrum is limited to aerobic gram-negative species (binding to PBP3 to produce filamentous organisms), primarily Entero-

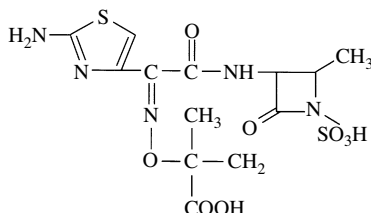

FIGURE 39-5 Structural formula of aztreonam.

bacteriaceae, *K. pneumoniae*, *P. mirabilis*, *C. freundii*, *Yersinia enterocolitica*, *P. multocida*, *Salmonella*, *Shigella*, *Providencia*, *Neisseria*, *Haemophilus*, and *P. aeruginosa*. Aztreonam can be combined with clindamycin, metronidazole, and vancomycin and can be used with aminoglycosides (which have a similar antibacterial spectrum) in the management of infections caused by *E. coli*, *K. pneumoniae*, *P. mirabilis*, *P. stuartii*, *S. marcescens*, and *P. aeruginosa*. Aztreonam is metabolized by β -lactamases elaborated by *K. pneumoniae* and *P. aeruginosa*. Aztreonam is not the initial drug of choice for any infection.¹⁸

Aztreonam is an FDA pregnancy category B drug and lacks cross-allergenicity with β -lactams. Aztreonam induces β -lactamase production and may be synergistic with the renal toxicity and ototoxicity of aminoglycosides.

Macrolide and Ketolide Antibiotics

Chemistry and classification

Macrolide antibiotics are characterized by large 14-membered, 15-membered, or 16-membered lactone rings. Box 39-5 details the macrolides available in the United States. Erythromycin, as derived from *Streptomyces erythreus*, was introduced in 1952, and azithromycin and clarithromycin were introduced in 1991 and 1992. Azithromycin is a 15-membered macrolide with an added nitrogen and N-methylation (making it technically an azalide), whereas clarithromycin is formed by the alkylation of a hydroxyl group of erythromycin (a 14-membered ring) (Figure 39-6). Troleanomycin is a synthetic derivative of oleandomycin, dirithromycin is a prodrug yielding erythromycylamine in the intestine, and telithromycin is a derivative of erythromycin A and a 14-membered macrolide with a 3-keto group substitution.³³

Mechanism of action and antibacterial spectrum

The mechanism of action of macrolides is to bind reversibly to the P site of the 50S ribosomal subunit and inhibit RNA-dependent protein synthesis by stimulating the dissociation of peptidyl transfer RNA (tRNA) from the ribosome.^{20,33} Box 39-6 lists the infections for which macrolides are drugs of choice or alternative agents.^{33,89} In general, macrolides have similar activity against gram-positive aerobic/facultative staphylococci and streptococci, gram-negative anaerobes (*M. catarrhalis*, *Bordetella pertussis*, *Legionella pneumophila*), and *Mycoplasma pneumoniae*, but differing activity against other

BOX 39-5

Macrolide Preparations Available in the United States

NONPROPRIETARY (GENERIC) NAME	PROPRIETARY (TRADE) NAME
Erythromycin base (film-coated)	Erythromycin Filmtabs
Erythromycin (enteric-coated)	E-Base, E-Mycin, Ery-Tab, Eryc
Erythromycin stearate	Erythrocin Stearate
Erythromycin ethylsuccinate	E.E.S., EryPed
Erythromycin estolate	Ilosone
Erythromycin lactobionate	—
Erythromycin gluceptate	Ilotycin Gluceptate
Clarithromycin	Biaxin
Azithromycin	Zithromax
Dirithromycin	Dynabac
Troleandomycin	TAO

From *Facts and comparisons*, St Louis, 2008, Facts and Comparisons.

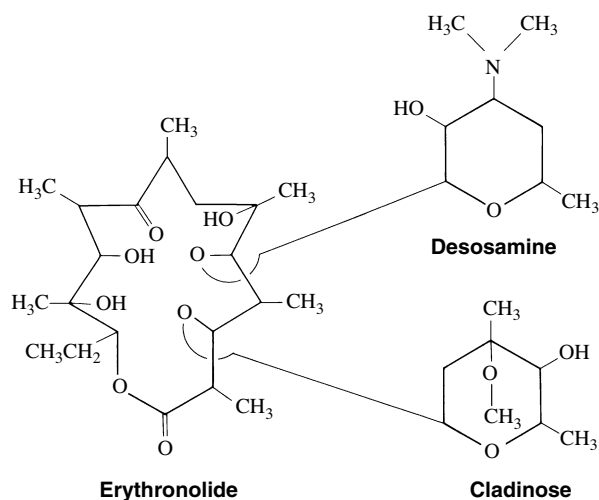

FIGURE 39-6 Structural formula of erythromycin.

BOX 39-6

Macrolides as Agents of Choice or Alternative Drugs

DRUGS OF CHOICE	ALTERNATIVE AGENTS
<i>Bartonella henselae</i>	<i>Actinomyces israelii</i>
<i>Bartonella quintana</i>	<i>Bacillus anthracis</i>
<i>Bordetella pertussis</i>	<i>Borrelia burgdorferi</i>
<i>Campylobacter jejuni</i>	<i>Capnocytophaga canimorsus</i>
<i>Chlamydia trachomatis</i> (Chlamydia)	<i>Chlamydia pneumoniae</i> (Chlamydia)
<i>Corynebacterium diphtheriae</i>	<i>Corynebacterium jeikeium</i>
<i>Haemophilus ducreyi</i>	<i>Eikenella corrodens</i>
<i>Legionella pneumophila</i>	<i>Erysipelothrix rhusiopathiae</i>
<i>Mycobacterium avium</i>	<i>Helicobacter pylori</i>
<i>Mycoplasma pneumoniae</i>	<i>Leptotrichia buccalis</i>
<i>Ureaplasma urealyticum</i>	<i>Mycobacterium kansasii</i>
	<i>Mycobacterium leprae</i>
	<i>Mycobacterium marinum</i>
	<i>Streptococcus pneumoniae</i>
	<i>Streptococcus pyogenes</i>

From Choice of antibacterial drugs, *Med Lett Drugs Ther* 5:33-50, 2007; *Facts and comparisons*, St Louis, 2008, Facts and Comparisons.

microorganisms. *The Medical Letter*¹⁸ lists erythromycin as a drug of choice against *Corynebacterium diphtheriae*, *Bartonella henselae*, *Bartonella quintana*; azithromycin as a drug of choice against *H. ducreyi*, *L. pneumophila*, and *Ureaplasma urealyticum*; clarithromycin as a drug of choice against *Mycobacterium fortuitum*/*Mycobacterium chelonae* complex; erythromycin or azithromycin as a drug of choice against *Campylobacter jejuni*; azithromycin or clarithromycin as a drug of choice against *Mycobacterium avium*; and erythromycin, azithromycin, and clarithromycin as equally effective drugs of choice against *Chlamydia pneumoniae*, *Chlamydia trachomatis* (depending on the disorder), *M. pneumoniae*, and *B. pertussis*.

Erythromycin is an alternative drug against *Bacillus anthracis*, *Corynebacterium JK* group, *Erysipelothrix rhusiopathiae*, *E. corrodens*, *H. ducreyi*, *L. buccalis*, *A. israelii*, and *R. equi*; azithromycin is recommended against *Shigella*, *B. hense-*

lae, and *B. quintana*; clarithromycin is recommended against *Mycobacterium kansasii*, *Mycobacterium marinum*, and *Mycobacterium leprae*; clarithromycin or azithromycin is recommended against *B. pertussis* and upper respiratory infections, *U. urealyticum*, and *Borrelia burgdorferi*; and erythromycin, azithromycin, and clarithromycin are recommended as equally effective against *Streptococcus pyogenes*, *S. pneumoniae*, and *M. catarrhalis*.

Microorganisms generally resistant to macrolides include *H. influenzae*, *Peptostreptococcus*, *A. actinomycetemcomitans*, *Pasteurella*, *Fusobacterium*, *Mycobacterium tuberculosis*, MRSA, and Enterobacteriaceae. Marginally affected organisms include *Prevotella* and *Porphyromonas*.⁴

Bacterial resistance

The major mechanism for microbial resistance is demethylation of the 2058 residue of the gene coding for the 23S ribosomal RNA peptidyl transferase region, resulting in reduced macrolide binding (ribosomal protection).²⁰ The *erm* (erythromycin-resistant methylase) gene responsible for the ribosomal protection is often associated with tetracycline resistance genes and is frequently combined with the resistance genes for lincosamides (clindamycin) and streptogramins (quinupristin-dalfopristin) to form the macrolide-lincosamide-streptogramin B (MLS_B) aggregate, which confers resistance to all three antibiotic groups simultaneously. Other macrolide resistance mechanisms include active efflux genes encoding for transport efflux proteins and an esterification gene that codes for inactivation of the macrolides by phosphorylation and glycosylation.²⁰

Absorption, fate, and excretion

Despite minor structural modifications, macrolides have distinct pharmacokinetic properties.³³ Erythromycin and azithromycin are available for oral and intravenous use, whereas the remaining agents are used only orally. Bioavailability ranges from 10% for dirithromycin to 40% to 50% for azithromycin, clarithromycin, and erythromycin. Food in the stomach may increase or have no effect on the absorption of erythromycin, but the remaining macrolides should be taken 1 hour before or 2 hours after a meal except for estolate and ethylsuccinate salts of erythromycin, which may be taken without regard to meals.

Erythromycin base is poorly resistant to gastric acid and is prepared with enteric coating or as various salts (stearate), esters (ethylsuccinate), or salts of esters (estolate), which protect against gastric acid degradation. Macrolides are best absorbed in the small intestine and when given orally in standard doses generally produce adequate tissue MIC concentrations of 0.5 µg/mL for azithromycin, 1 to 3 µg/mL for clarithromycin, and 0.3 to 2 µg/mL for erythromycin.³³ Erythromycin may have a variable absorption rate resulting in tissue concentrations ranging from 0.3 to 2 µg/mL. The time to maximum blood concentrations of a single dose is 2.2 hours for azithromycin, 2 to 3 hours for clarithromycin, and 1.6 hours for erythromycin. Impaired renal function may reduce the excretion of the macrolides, with the elimination half-life of erythromycin increasing from 1.6 hours to 5 to 6 hours in anuric patients. Clarithromycin and erythromycin are primarily eliminated in the urine, and azithromycin is primarily eliminated in the bile, although erythromycin may also undergo significant biliary excretion. The average serum half-lives are 68 hours for azithromycin, 3 to 7 hours for clarithromycin, and 1.6 hours for erythromycin.

A remarkable property of macrolides and highly fat-soluble tetracyclines and clindamycin is selective uptake by phagocytic cells and fibroblasts, which function as repository drug depots and as a drug delivery system to areas of inflammation and infection. These cells concentrate the macrolides

and then transport them to areas of tissue pathology where they are released for their anti-infective and anti-inflammatory properties. The tissue concentrations of azithromycin may reach 100 to 1000 times that of blood and persist long after blood levels have declined because of their significant postantibiotic effects.⁶³ The tissue concentration of azithromycin may exceed the microorganism's MIC for 2 to 10 days, and the elimination half-life in abscesses may be 4 days.

General therapeutic uses

Macrolides are often indicated for treating community-acquired bacterial pneumonia because of their action against numerous causative organisms. Microbial resistance is becoming increasingly common, however. They are useful against various chlamydial infections and numerous gram-positive coccal infections. They are also active against *Corynebacterium*. The 14-membered macrolides possess anti-inflammatory effects distinct from their antimicrobial actions by decreasing proinflammatory cytokine release from phagocytes, which may prove useful in management of rheumatoid arthritis, cystic fibrosis, asthma, and chronic sinusitis. General therapeutic uses are listed in Table 39-4 and Box 39-6.

Therapeutic uses in dentistry

Erythromycin has a long and successful history of use against acute orofacial infections, particularly in β -lactam-allergic patients. Its spectrum of activity is good to excellent against gram-positive aerobic/facultative cocci (streptococci, some staphylococci). Its spectrum is not generally favorable against gram-negative anaerobes associated with orofacial infections, including *Prevotella*, *Porphyromonas*, *Fusobacterium*, and *Veillonella*. Azithromycin has been observed to be effective against oral spirochetes and pigmented anaerobes.⁹⁰ In the management of acute periapical abscesses, azithromycin, 500 mg/day for 3 days, has shown comparable efficacy to amoxicillin/clavulanic acid, 625 mg three times daily for 5 to 10 days.¹ Macrolides are also useful for endocarditis prophylaxis.

Clarithromycin is most active against gram-positive anaerobes (*Actinomyces*, *Propionibacterium*, *Lactobacillus*), whereas erythromycin is more active than azithromycin for these organisms. Azithromycin has the best activity against gram-negative anaerobes (*Fusobacterium*, *Prevotella*, *Porphyromonas*, *Wolinella*, *Selenomonas*, and *A. actinomycetemcomitans*). Azithromycin may be more active against streptococci and staphylococci than erythromycin and clarithromycin and has much less propensity for drug interactions. Prolonged use of erythromycin and possibly other macrolides may lead to superinfection with gram-negative enteric bacilli.

Adverse effects

Serious toxicity with macrolides is rare but occasionally significant. The most important adverse effects include epigastric pain, ototoxicity (deafness), ventricular arrhythmias (torsades de pointes), acute pancreatitis, mania, cholestatic hepatitis, hypersensitivity syndrome, and certain drug interactions.

Cholestatic hepatitis is much more common with the estolate form of erythromycin than with other forms of erythromycin or other macrolides. This reaction can be misdiagnosed as viral hepatitis. Symptoms usually appear after approximately 10 days of erythromycin use, disappear 2 to 4 weeks after drug discontinuance with no residual effects, and readily reappear with drug readministration. This reaction is less common in children.

The most common serious adverse reaction associated with macrolides, particularly erythromycin, is potentially severe epigastric pain resulting from stimulation of the gastric smooth muscle motilin receptor.¹⁴ Motilin is a regulatory peptide of the gastrointestinal tract that stimulates enzyme

secretions by the stomach and pancreas and induces strong phasic contractions of the stomach. The most significant agonists of the motilin receptor are the 14-membered macrolides (erythromycin); azithromycin and clarithromycin are lesser stimulants.

Approximately 30 cases have been reported of macrolide-induced hearing loss, with at least 2 cases judged to be irreversible. Most seem to be associated with erythromycin doses exceeding 4 g/day or from accumulation of lesser doses in patients with impaired renal or hepatic function. In patients with renal impairment, the dose of erythromycin should be no greater than 1.5 g/day. Ototoxicity is particularly common in patients with HIV/AIDS because of the use of macrolides as prophylaxis for *M. avium* infections. All macrolides induce ototoxicity, possibly by an effect on the auditory nerve pathways, and tinnitus has been observed even with therapeutic doses of azithromycin.

Long QT syndrome is characterized by delayed ventricular repolarization that triggers ventricular tachyarrhythmias, most notably torsades de pointes, resulting in syncope, seizures, or sudden death. Long QT syndrome may be either congenital or acquired, and the list of drugs, diseases, and metabolic disorders inducing torsades de pointes is long and impressive (see Chapter 24).

At least four cases of acute pancreatitis associated with erythromycin have been reported, and several cases of mania have been associated with clarithromycin in patients with and without HIV/AIDS. Stevens-Johnson syndrome (erythema multiforme) may occur with erythromycin along with a hypersensitivity syndrome associated with azithromycin and clarithromycin consisting of fever, rash, hepatitis, interstitial nephritis, oliguria, and xerostomia. Azithromycin and erythromycin are classified as FDA pregnancy category B drugs, and clarithromycin, dirithromycin, and troleanomycin are classified as FDA pregnancy category C drugs.³³

Drug interactions

Macrolides are associated with many drug interactions (Table 39-7).⁹⁸ Erythromycin and clarithromycin—either through their inhibition of the liver microsomal enzyme drug-metabolizing system or through their effect on gastrointestinal microbial flora—increase serum levels of fluconazole, ranitidine, alfentanil, benzodiazepines, tacrolimus, theophylline, vinblastine, bromocriptine, buspirone, carbamazepine, cyclosporine, digoxin, disopyramide, ergot alkaloids, felodipine, oral anticoagulants, methylprednisolone, and omeprazole.³³ Azithromycin and dirithromycin do not affect the liver microsomes. Macrolide blood levels may be increased by fluconazole, H₂-receptor antagonists, and omeprazole and decreased by theophylline. Antacids reduce the rate, but not the total amount, of macrolide absorption, and the combination of macrolides and oral contraceptives may result in cholestasis. Bacteriostatic macrolides may interfere with the bactericidal effect of cell wall inhibitors. Concomitant administration with fluoroquinolones, pimozide, or cisapride may lead to torsades de pointes.

After only 3 days of administration, macrolides may seriously reduce cardiac glycoside metabolism in the gastrointestinal tract by *Eubacterium lentum*, resulting in digitalis toxicity because the microorganism may metabolize 30% to 40% of the drug.¹⁰⁰ Macrolides may potentiate the anticoagulant effect of oral anticoagulants. Concomitant use of macrolides may increase the myopathy and rhabdomyolysis seen with the "statin" anticholesterol agents.³³

Contraindications

Macrolides are contraindicated in patients with allergy to the drugs in patients with a history of previous allergic cholestatic hepatitis. Macrolides are also contraindicated in combinations

TABLE 39-7

Drug Interactions Associated with Macrolides

MACROLIDE	INTERACTING DRUG(S)	ADVERSE REACTION
E	Grepafloxacin, sparfloxacin	Torsades de pointes
All	Warfarin	Bleeding
All	Cyclosporines	Nephrotoxicity and neurotoxicity
All	Theophylline	Decreased macrolide blood levels, increased theophylline toxicity
All	Benzodiazepines	Increased CNS depression
C, E	Carbamazepine	Carbamazepine toxicity
C, E	Digitalis	Digitalis toxicity
E, T	Methylprednisolone	Increased steroid effects
C, E, T	Buspirone	Increased CNS depression
C, E, T	Tacrolimus	Renal toxicity
C, E, T	Rifampin	Reduced macrolide activity
C, E, T	Ergot alkaloids	Peripheral ischemia
C, E, T	Pimozide	Torsades de pointes
C, E, T	Cisapride	Cardiotoxicity

From *Facts and comparisons*, St Louis, 2008, Facts and Comparisons; Tatro DS: *Drug interaction facts*, St Louis, 2008, Facts and Comparisons, Wolters Kluwer. Drug interaction is potentially severe or life-threatening and its occurrence has been suspected, established, or probable in well-controlled studies. "All" includes E, C, and T and azithromycin and dirithromycin.
E, Erythromycin; C, clarithromycin; CNS, central nervous system; T, troleandomycin.

with other drugs that may induce torsades de pointes. The maximum daily dose should be 4 g in adults with normal renal function and 1.5 g per day in patients with impaired renal function.

Ketolides

Ketolides (e.g., telithromycin) are derivatives of erythromycin specifically designed for activity against bacteria responsible for community-acquired respiratory tract infections. Telithromycin is a 14-membered macrolide with a 3-keto group substitution.¹¹² The oral bioavailability of telithromycin is approximately 55%, with maximum serum concentrations of 1.9 µg/mL at 1 to 3 hours. The elimination half-life is 13.4 hours; the drug has a long post-antibiotic effect and is highly concentrated in white blood cells and pulmonary tissue. It is primarily metabolized in the liver. Telithromycin inhibits bacterial protein synthesis by binding to the 50S ribosomal subunit to inhibit translation at the peptidyl transferase site. The drug also inhibits formation of the bacterial 50S and 30S ribosomal subunits.

Telithromycin is active against a wide spectrum of respiratory pathogens, including *S. pneumoniae*, *H. influenzae*, *M. catarrhalis*, *C. pneumoniae*, *M. pneumoniae*, *L. pneumophila*, group A and B streptococci (*S. pyogenes* and *Streptococcus agalactiae*), *Enterococcus*, *Clostridium*, *Neisseria*, *H. pylori*, MRSA, and MSSA.¹¹² It is also active against some anaerobes, including *Porphyromonas*, *Prevotella*, *E. corrodens*, and some *Bacteroides* species. Telithromycin may be effective against *S. pneumoniae* with *mefE* and *ermB* resistance genes and gram-positive cocci with MLS_B resistance.

Staphylococcus epidermidis is intrinsically resistant to telithromycin, and *S. pneumoniae* and *S. pyogenes* isolates have appeared in Germany, Mexico, and Canada with very high telithromycin resistance (>100 µg/mL) because of the *ermB* and L4 mutations. In Central and Eastern Europe, *S. pyogenes* presently has a 1.5% resistance rate to telithromycin and 12.3% resistance rate to erythromycin. Telithromycin may select for staphylococci and *B. fragilis* in the gastrointestinal tract.

The most frequent adverse reactions associated with telithromycin are diarrhea (12% to 20%), nausea (2% to 12%), dizziness (2% to 5%), and headache (2.5% to 5%). Telithro-

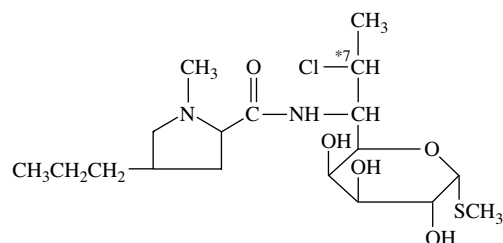

FIGURE 39-7 Structural formula of clindamycin. Substitution of the chlorine atom on the 7 carbon with a hydroxyl group yields lincomycin.

mycin is an inhibitor of the liver microsomal enzyme cytochrome P450 system and would be expected to increase blood levels of many drugs.¹¹² Similar to macrolides, telithromycin may prolong the QT interval. It is classified as an FDA pregnancy category B drug.

Telithromycin has no place in the management of acute or chronic orofacial infections unless dictated by sensitivity testing. It should be reserved for highly and multiply resistant microbial pathogens, particularly of the respiratory tract.

Lincosamides

Clindamycin and lincomycin are the only lincosamide antibiotics (Figure 39-7). Lincomycin was isolated from *Streptomyces lincolnensis* in 1962, and clindamycin (7-chloro-7-deoxy-lincomycin) was introduced in 1966. Clindamycin is used almost exclusively because of its greater efficacy and superior pharmacokinetics.

Mechanism of action and antibacterial spectrum

The receptor site for lincosamides is identical to that of macrolides, chloramphenicol, and streptogramins—the 23S subunit of the 50S bacterial ribosome, resulting in bacteriostatic inhibition of microbial protein synthesis. Clindamycin has significant activity against many gram-positive and gram-negative anaerobic and facultative/aerobic microorganisms, including *Bacteroides*, *Prevotella*, *Porphyromonas*, *Veillonella*,

Peptostreptococcus, microaerophilic streptococci, *Actinomyces*, *Eubacterium*, *Clostridium* (except *C. difficile*), and *Propionibacterium*. Gram-positive organisms generally susceptible to clindamycin include *S. pneumoniae*; VGS; *Corynebacterium*; group A, B, C, and G streptococci; and *Streptococcus bovis*, with variable susceptibility in staphylococci.^{33,34} Also susceptible are *L. buccalis*, *B. cereus*, *B. subtilis*, *C. canimorsus*, and some β -lactamase-producing staphylococci. Microorganisms with intrinsic resistance to lincosamides include *Enterococcus*, Enterobacteriaceae, *H. influenzae*, *N. meningitidis*, *M. pneumoniae*, and most MRSA, with increasing resistance in *S. pneumoniae* and *S. pyogenes* and 12% to 20% resistance rates in *Prevotella*, *Porphyromonas*, *Fusobacterium*, and *Peptostreptococcus* in the hospital setting.

Bacterial resistance

Resistance to clindamycin occurs by three mechanisms: (1) alteration of 23S ribosomal RNA of the 50S ribosomal subunit by adenine methylation (ribosomal protection), (2) an altered single 50S ribosomal protein at the receptor site (receptor alteration), or (3) inactivation in some staphylococcal strains by a nucleotidyl transferase (drug inactivation). Adenine methylation is plasmid mediated and confers MLS_B resistance. The M phenotype macrolide resistance in *S. pneumoniae* does not confer resistance to clindamycin. If erythromycin resistance in staphylococci is inducible and not constitutive, the microorganisms are resistant only to the 14-membered and 15-membered macrolides and remain sensitive to lincosamides, streptogramins, and 16-membered macrolides. Constitutive resistance in staphylococci of the MLS_B type confers resistance to all these antibiotics simultaneously.

Absorption, fate, and excretion

Clindamycin is well absorbed orally with a 90% bioavailability not appreciably reduced by food. The time to oral peak serum levels is 45 to 60 minutes, with mean peak serum levels of 2.5 $\mu\text{g/mL}$ and an elimination half-life of 2.4 to 3 hours.³³ With renal failure the elimination half-life increases to 6 hours, with a doubling of the serum level. The drug penetrates well into bone, but not cerebrospinal fluid; is metabolized primarily in the liver (>90%); and is highly concentrated in the bile, where it may alter colonic flora for 2 weeks after it is discontinued. In a manner similar to macrolides, clindamycin is concentrated preferentially in polymorphonuclear cells, alveolar macrophages, and abscess tissue.

General therapeutic uses

Clindamycin is used in the treatment of certain infections caused by susceptible strains of streptococci, staphylococci, pneumococci, or anaerobes such as *Bacteroides*. Clindamycin may be indicated in the treatment of refractory bone infections. Clindamycin is also useful in treating certain conditions involving anaerobes, such as infections of the female genital tract, pelvic infections, and abdominal penetrating wounds. It can also be used in combination for *Pneumocystis carinii* and for toxoplasmosis.

Therapeutic uses in dentistry

Although amoxicillin and penicillin V remain drugs of choice for acute orofacial infections, a resurgence in clindamycin use may be appropriate as the oral microbial resistance to β -lactams continues to increase. It is anticipated that oral microbial resistance to clindamycin will also increase proportionately along with the specter of MLS_B resistance shared with macrolides and streptogramins.

Adverse effects

Minor adverse reactions associated with clindamycin include nausea and vomiting, abdominal pain, esophagitis, glossitis,

stomatitis, allergy, reversible increase in serum transaminase levels, reversible myelosuppression, metallic taste, maculopapular rash (3% to 10%), and diarrhea (2% to 20%, average of 8%).³³ High intravenous doses of clindamycin may result in a neuromuscular blockade similar to that of aminoglycosides, tetracyclines, and polymyxin B.

The major concern with clindamycin has been its purported propensity to cause antibiotic-induced diarrhea and colitis, most notably pseudomembranous colitis, based on early reports of incidences reaching 10%. It is now apparent that the association of clindamycin with these colonic disorders in outpatient use is much less than previously reported, although nonetheless real (see Chapter 38).

In a large retrospective study, the overall risk for community-acquired *C. difficile*-associated pseudomembranous colitis was determined to be 1 per 10,000 antibiotic prescriptions, with a risk rate for hospitalization of 0.5 to 1 per 100,000 patient-years.⁴² In a study of 376,590 antibiotic prescriptions given to more than 280,000 patients over a 4-year period, 4 cases of acute antibiotic-induced colitis were detected.⁹⁴ The incidence rate was calculated to be 1.6 in 100,000 individuals exposed to ampicillin, 2.9 in 100,000 individuals exposed to dicloxacillin, and 2.6 in 100,000 individuals exposed to tetracycline, with no cases in patients receiving clindamycin.⁹⁴

Although antibiotic-associated diarrhea is common in the outpatient environment and readily managed by drug discontinuance, serious antibiotic-induced colitis and potentially lethal pseudomembranous colitis seem to be rare. Such forms of colitis are more likely to occur with amoxicillin than clindamycin simply based on the much greater use of the former antibiotic, but this might change if clindamycin is used more often clinically.

Care should be taken with patients who have recently recovered from *C. difficile*-associated diarrhea or colitis for 2 months after the cessation of the disease. Any elective dental procedure requiring antibiotic therapy or prophylaxis is best postponed for this 2-month period. If antibiotic therapy is required, antibiotics far less associated with antibiotic-induced diarrhea (e.g., penicillin V, macrolides) are appropriate.

Drug interactions

Clindamycin acts synergistically with nondepolarizing (curare-like) neuromuscular blocking drugs in blocking neurotransmission at skeletal muscle. Oral absorption of clindamycin is slowed by kaolin-pectin antidiarrheal drugs.³³

Contraindications

Clindamycin is contraindicated in patients allergic to the drug and in combination with curare-like neuromuscular blocking drugs. All antibiotics should be avoided if possible for 2 months after antibiotic-induced colitis.

Metronidazole

Metronidazole (Figure 39-8) is a synthetic nitroimidazole patterned after a naturally occurring antiparasitic substance that was isolated from a *Streptomyces* species in 1955. The drug was introduced into medicine in 1959 and was quickly found to possess strong trichomonocidal activity. Since then, metronidazole has become the drug of choice for various protozoal

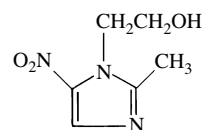

FIGURE 39-8 Structural formula of metronidazole.

infections. A chance observation that the symptoms of acute necrotizing ulcerative gingivitis were relieved in a woman receiving metronidazole for the treatment of vaginal trichomoniasis stimulated research on the drug's antibacterial effects, culminating in its approval in 1981 for the treatment of anaerobic bacterial infections. Its extensive use in treating parasitic diseases worldwide has led to significant resistance to the drug where parasites are a major problem. It was soon discovered that the drug possessed exceptional activity against obligate anaerobic and microaerophilic microorganisms, including microorganisms involved in acute orofacial infections, periodontitis, and acute necrotizing ulcerative gingivitis.

Mechanism of action and antibacterial spectrum

The antimicrobial activity of metronidazole requires entry into the cell and reduction of its nitro group to produce metabolites that damage DNA, eventually inducing cell death. Metronidazole is active only against bacteria that are obligate anaerobes. It is a concentration-dependent, rather than time-dependent antibiotic. Because metronidazole metabolites interfere with nucleic acid synthesis, concerns have been raised regarding its potential for mutagenicity, carcinogenicity, and teratogenicity.

Metronidazole penetrates all bacterial cells equally well. In sensitive anaerobes, the nitro moiety of the drug is enzymatically reduced, however, and this metabolite is the active form of the drug. Metronidazole is almost always bactericidal. The drug reacts with bacterial DNA, causing inhibition of DNA replication, fragmentation of existing DNA, and, in low doses, mutation of the bacterial genome.

Bacterial resistance

Microbial resistance to metronidazole is limited probably because of its limited clinical use except in developing countries, where it is widely used to manage parasitic diseases. A notable exception to this generalization is the high level of resistance in *H. pylori* in developed countries. Resistance to metronidazole is chromosomally mediated and plasmid-mediated by a reduction in activity or expression of several genes (*rdxA*, *nimA*, *nimB*) that control nitroreductase activity, which reduces the concentration of active metronidazole metabolites within the microbial cell.

Limited resistance is seen in *Trichomonas vaginalis*, *Bacteroides*, *Gardnerella vaginalis*, *C. fetus*, *L. buccalis*, and *Treponema pallidum*. High-level metronidazole resistance in *T. vaginalis* has been detected in 1 of 2000 to 1 of 3000 cases. During 1994-1997 in five U.S. medical centers, the sensitivity rate to metronidazole was 85% to 100% in *Prevotella*, 80.9% to 96.7% in *Peptostreptococcus*, and 93.3% to 100% in *Fusobacterium*, with a decline in sensitivity in *Fusobacterium* and *Peptostreptococcus* from 100% to 93.3% and 100% to 95%.³² Subinhibitory concentrations of metronidazole may increase resistance rates in various periodontal pathogens, including *Fusobacterium*, *Prevotella*, *Porphyromonas*, and *Peptostreptococcus*.⁵⁶ *Bacteroides* strains resistant to metronidazole also acquire enhanced virulence properties.²⁷

The most striking resistance to metronidazole has occurred in *H. pylori*, the etiologic agent in some cases of peptic ulcer and gastric cancer. The resistance rates range from 10% to 50% in developed countries and 100% in developing countries, where the drug is used for parasitic diseases. *H. pylori* resistance may significantly reduce the efficacy of other agents used along with metronidazole (e.g., omeprazole, bismuth, tetracycline, clarithromycin) and increase macrolide resistance in *H. pylori*.

Absorption, fate, and excretion

Metronidazole is almost completely absorbed from the gastrointestinal tract (oral bioavailability approaches 100%) so

that serum levels are essentially the same whether the drug is administered orally or intravenously.³³ Food may delay peak serum levels of metronidazole but not the total amount absorbed. Metronidazole attains a peak blood level orally in 1 to 2 hours, has a wide volume of distribution, has excellent CNS penetration, has an elimination half-life of 8 hours, and is biotransformed into five metabolic products, all of which have antianaerobic activity. The pharmacokinetics of metronidazole are the same in pregnant and nonpregnant women, its metabolism is reduced in the presence of severe hepatic dysfunction, and its pharmacokinetics are not significantly altered with renal impairment.³³

General therapeutic uses

The principal medical indications for metronidazole are anaerobic abdominal and CNS infections, bacterial vaginosis, protozoan and *H. pylori* infections, and the management of *C. difficile*-associated diarrhea and colitis.¹⁸ Metronidazole is very active against obligate anaerobes (e.g., *Bacteroides*, *Porphyromonas*, *Prevotella*, *Fusobacterium*, *Peptostreptococcus*, *Clostridium*), many of which are associated with periodontitis, and various human parasites (e.g., *T. vaginalis*, *G. vaginalis*, *Entamoeba histolytica*, *Balantidium coli*). Metronidazole has variable activity against *Mycobacterium hominis*, *C. fetus*, *T. pallidum*, *H. pylori*, and *C. canimorsus*. *A. actinomycetemcomitans*, *E. corrodens*, *Actinomyces*, and *Propionibacterium* are commonly resistant to metronidazole. The combination of metronidazole with amoxicillin may significantly enhance its activity against *A. actinomycetemcomitans*, apparently by increasing cellular uptake of metronidazole.¹⁰⁵

Three studies have used antibiotics (e.g., metronidazole, clindamycin) during pregnancy in an attempt to prevent preterm delivery in women with bacterial vaginosis, and all have been unsuccessful.^{12,52,106} These results may weaken the potential association between periodontal disease and preterm birth because metronidazole is active against periodontal pathogens and pathogens associated with bacterial vaginosis.

Therapeutic uses in dentistry

Metronidazole is highly effective against gram-negative anaerobic pathogens responsible for acute orofacial infections and chronic periodontitis. Combination of metronidazole with a β -lactam antibiotic for oral infections may be indicated for serious acute orofacial infections and in the management of aggressive periodontitis.

Metronidazole is a concentration-dependent, not time-dependent, antibiotic, a fact that is not reflected in the current package insert dosing regimen for the drug. The promiscuous use of metronidazole for classic chronic periodontitis is a misuse of the drug and may contribute to the increasing resistance of metronidazole seen with parasites, *H. pylori*, and other microorganisms.

Adverse effects

Minor adverse reactions associated with metronidazole include reversible neutropenia, metallic taste, dark or red-brown urine, skin rash, urethral or vaginal burning sensation, gynecomastia, and nausea and vomiting. Rare major adverse reactions include pancreatitis; pseudomembranous colitis; peripheral neuropathy; disulfiram reaction when combined with ethanol; and CNS toxicity consisting of seizures, encephalopathy, cerebellar dysfunction, paresthesias, mental confusion, and depression. These neurologic reactions generally occur only with high prolonged cumulative doses.

Because metronidazole affects DNA synthesis, numerous studies have addressed its potential to cause birth defects. Its use in pregnancy does not seem to be associated with any congenital abnormalities, preterm delivery, or low birth weight in newborns, and the drug has an FDA pregnancy

category B classification. There also is no increase in cancer in women who take metronidazole during pregnancy, making it very unlikely that the drug is carcinogenic.⁹²

Drug interactions

Barbiturates may reduce the efficacy of metronidazole, and cimetidine may reduce its liver metabolism. The concurrent use of metronidazole and ethanol may result in acute psychosis and the disulfiram reaction (flushing, tachycardia, nausea and vomiting), although for most individuals the risk is minor.³³ Metronidazole may increase lithium blood levels, decrease the body clearance of phenytoin,³³ and significantly increase blood warfarin levels by decreasing its liver metabolism.

Tetracyclines and Glycylcyclines

Tetracyclines are a group of broad-spectrum, bacteriostatic antibiotics that have been extensively used in the treatment of numerous and varied infections. Their widespread use, and often misuse, has resulted in the appearance of many bacterial strains that are resistant to these drugs, which has curtailed their clinical usefulness. Paradoxically, the clinical use of tetracyclines has had a recent resurgence of interest with the growing realization that the drugs may be lifesaving in the treatment of serious nosocomial infections from highly and multiply antibiotic-resistant methicillin-resistant staphylococci and vancomycin-resistant enterococci. This renewed effectiveness of tetracyclines may be related to the almost complete lack of use of the drugs in hospitals for several decades, possibly leading to the loss of tetracycline resistance genes in this environment. Because of the advent of widespread resistance of *H. pylori* to metronidazole and macrolides, tetracyclines have gained importance in the treatment and prevention of peptic ulcers and gastric cancer and have emerged as a prophylactic agent in the prevention of multi-drug-resistant malaria and the management of community-acquired pneumonia, particularly in penicillin-resistant and macrolide-resistant strains.

Tetracyclines comprise a group of antibiotics with a similar antibacterial spectrum but differing pharmacokinetic properties created by various chemical substitutions on the hydronaphthacene four-ringed nucleus. The first tetracycline was marketed in 1948 as chlortetracycline isolated from *Streptomyces aureofaciens*. Along with oxytetracycline, tetracycline, and demeclocycline, these four drugs constitute the first-generation tetracyclines. Second-generation agents introduced from 1965-1972 include minocycline, methacycline, and doxycycline.¹⁹ Glycylcyclines are third-generation agents. The first microorganism clinically detected to be resistant to tetracyclines was a *Shigella dysenteriae* strain in 1953.

Chemistry

The structure of tetracycline is shown in Figure 39-9. As is implied by the name ("tetra," four; "cycline," ring), all the tetracyclines are derivatives of a four-ringed nucleus and differ structurally only with regard to the chemical moieties attached at the 2, 5, 6, and 7 positions of the nucleus. Various deriva-

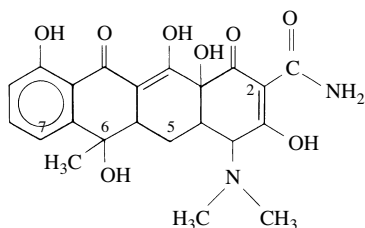

FIGURE 39-9 Structural formula of tetracycline.

tives exhibit different pharmacologic properties, such as differences in absorption, protein binding, metabolism, excretion, and degree of activity against susceptible microorganisms.

Mechanism of action and antibacterial spectrum

Tetracyclines inhibit bacterial protein synthesis by preventing the association of aminoacyl-tRNA with the bacterial ribosome.¹⁹ The drugs must transverse the gram-negative microbial outer membrane via OmpF and OmpC porin channels or through the gram-positive cell wall in its electronegative hydrophobic form and attach to a single high-affinity binding site on the ribosomal 30S subunit and protein 7 on the 16S rRNA base.¹⁹

Important therapeutic uses of tetracyclines are listed in Box 39-7. Tetracyclines are drugs of choice against *H. pylori*, *Chlamydia*, *Rickettsia*, *Ehrlichia*, *B. anthracis*, and *Vibrio cholerae*. The list of indications for which tetracyclines serve as alternative drugs is impressive,^{18,33} including treatment of nosocomial infections from life-threatening staphylococci and enterococci, treatment of community-acquired pneumonia caused by highly antibiotic-resistant pathogens, and chemoprevention of chloroquine/mefloquine-resistant malaria.²

It is imperative with tetracyclines, as with all antibiotics, that a determination be made of the risk/benefit ratio associated with their use. The severity of the disease and likely response to the drugs are key considerations.

Bacterial resistance

Microbial resistance to tetracyclines is widespread, transposable, inducible, and commonly permanent because their resistance genes are almost always combined in transposable elements with the genes for resistance to other antibiotics (multidrug resistance gene cassettes). Of the three mechanisms for tetracycline resistance (drug efflux, ribosomal protection, and enzymatic inactivation), drug efflux is the most important, with at least 300 different active efflux proteins capable of extruding tetracycline from the bacterial cell.^{19,93}

Tetracyclines are one of the most active chemical inducers of microbial resistance gene expression and downregulate a

BOX 39-7

Tetracyclines as Drugs of Choice

Brucella
*Borrelia burgdorferi**
Borrelia recurrentis
Chlamydophila (Chlamydia) pneumoniae
Chlamydophila (Chlamydia) psittaci
Chlamydia trachomatis
*Ehrlichia chaffeensis**
*Ehrlichia ewingii**
Mycobacterium marinum†
Mycoplasma pneumoniae
Pseudomonas mallei
*Rickettsiae**
Vibrio cholerae
Vibrio vulnificus
Yersinia pestis

From Choice of antibacterial drugs, *Med Lett Drugs Ther* 5:33-50, 2007; Chopra I, Roberts M: Tetracycline antibiotics: mode of action, applications, molecular biology, and epidemiology of bacterial resistance, *Microbiol Mol Biol Rev* 65:232-260, 2001; Standiford HC: Tetracyclines and chloramphenicol. In Mandell GL, Bennett JE, Dolin R, editors: *Mandell, Douglas, and Bennett's principles and practice of infectious diseases*, ed 5, Philadelphia, 2000, Churchill Livingstone.

*Specifically doxycycline.

†Specifically minocycline.

repressor gene that controls efflux activity for not only tetracyclines, but also possibly other antibiotics. Only nanomolar amounts of tetracycline are necessary to de-repress this system and greatly increase antibiotic efflux from bacterial cells.¹⁹ Tetracyclines also promote the mobility of resistance determinants (transfer of resistance genes between bacteria) by stimulating the frequency of bacterial conjugation.⁹⁵ Considering these extraordinary properties of tetracyclines to induce and promote microbial resistance not only to themselves, but also other antibiotics, it would seem prudent to restrict their use to serious medical infections and restrict their use for most cases of periodontitis, where they may have limited or even undocumented value.

Absorption, fate, and excretion

Tetracyclines are adequately but variably absorbed from the gastrointestinal tract with significant differences in bioavailability, as follows: chlortetracycline, 30%; demeclocycline, tetracycline, and oxytetracycline, 60% to 80%; and minocycline or doxycycline, 95% to 100%.³³ Dairy products, Ca⁺⁺, Mg⁺⁺ and aluminum compounds, and Na⁺ bicarbonate significantly impair tetracycline absorption either by chelation or by altered gastric pH.³³ Their serum protein binding ranges from 20% to 40% for oxytetracycline to 80% to 95% for doxycycline, and the percent excreted unchanged in the urine ranges from 70% for oxytetracycline to 30% to 42% for doxycycline and 12% to 16% for minocycline.³³ With renal impairment, only doxycycline and minocycline do not have increased half-lives and can be administered with reasonable safety. Other tetracyclines may accumulate in conditions of renal impairment, resulting in high blood levels and possible liver necrosis and death.

Tetracyclines are metabolized in the liver to a varying degree depending on the individual drug and are highly concentrated in the bile at levels three to five times higher than serum.¹¹¹ More recent tetracyclines are more lipid-soluble with greater tissue distribution than earlier tetracyclines. Enterohepatic circulation and incomplete absorption may lead to high drug concentrations in the feces, particularly with older agents.³³ Doxycycline may be found to some degree in the feces as an inactive form, and it is as yet unknown if this metabolic product is as capable of inducing resistance gene expression or transfer as the parent compound. The serum half-lives of the various agents are 12 to 16 hours for oxytetracycline, tetracycline, and demeclocycline; 14 to 16 hours for methacycline; 11 to 18 hours for minocycline; and 15 to 25 hours for doxycycline.³³ Peak serum concentrations of 3 to 5 µg/mL are reached in 2 hours after the usual therapeutic doses.¹¹¹ Box 39-8 lists tetracycline preparations that are available in the United States.

BOX 39-8

Commercially Available Tetracycline Preparations

NONPROPRIETARY (GENERIC) NAME	PROPRIETARY (TRADE) NAME
Tetracycline hydrochloride	Tetralen, Panmycin, Sumycin, Tetracyn, Tetracap
Oxytetracycline hydrochloride	Terramycin
Demeclocycline hydrochloride	Declomycin
Doxycycline hyclate	Vibramycin, Doxy Caps
Minocycline hydrochloride	Minocin, Vectrin, Dynacin

General therapeutic uses

Important indications for tetracyclines are listed in Table 39-4 and Box 39-7. These lists of pathogenic microorganisms and associated diseases make it difficult to rationalize the widespread use of tetracyclines in the management of periodontitis when it is amenable to mechanical therapy. The degree of benefit of the use of tetracyclines in periodontal disease has to be weighed against the risk of developing resistant strains of microorganisms, resistance gene transfer, and induction of latent resistance genes. A careful consideration of the risk/benefit ratio is appropriate when tetracyclines are employed systemically for the management of periodontitis, particularly if the benefit is marginal at best. Acne can be a serious psychological disease in adolescents sensitive to the scorn of their peers, and long-term tetracycline use is reasonable based on risk/benefit analysis, but this does not apply to periodontitis.

Tetracyclines are major drugs in treating rickettsial diseases, *Mycoplasma*, *Chlamydia*, *H. pylori*, and *Borrelia*. (*B. burgdorferi* is the causative agent of Lyme disease.) Many other bacteria nominally within their range of activity should not be treated, at least initially, with a tetracycline because of the numerous resistant strains.

Tetracyclines have been used in the treatment of acne using oral and topical preparations. Tetracyclines are concentrated in the skin and are effective against *P. acnes* and may have an antiseborrheic action to reduce skin lipids. Because tetracyclines are deposited in bone, they can be used to measure the rate of bone growth. Other indications include plague, tularemia, cholera, brucellosis, and certain protozoal infections.

Therapeutic uses in dentistry

The use of tetracyclines in the management of acute orofacial infections is widely considered inappropriate because of their bacteriostatic activity and extensive microbial resistance, but with the advent of oral microbial pathogens increasingly resistant to β-lactams, macrolides, and clindamycin, this concept may have to be reconsidered. Systemic tetracyclines in the management of chronic periodontitis must be carefully evaluated for risk/benefit ratio considering their limited efficacy (questionable clinical efficacy and limited data on long-term efficacy), and propensity to induce microbial resistance gene expression and stimulation of drug efflux mechanisms, and common association with multiple resistance genes to other antibiotics in transposable elements. Tetracyclines are effective in the management of localized aggressive periodontitis and its associated organism, *A. actinomycetemcomitans*. Tetracyclines also seem to inhibit inflammatory matrix metalloproteinase activity. Tetracyclines may also be used subgingivally.

Adverse effects

Numerous adverse drug reactions are associated with tetracyclines. Tetracyclines may induce photosensitivity; nephrogenic diabetes insipidus (demeclocycline); blood dyscrasias; liver dysfunction (high doses and especially during pregnancy); pseudotumor cerebri and bulging fontanelles (adults and infants); *C. albicans* overgrowth; gastrointestinal difficulties (nausea, vomiting, diarrhea, pancreatitis); and various allergic manifestations, including urticaria, serum sickness, angioneurotic edema, and anaphylaxis.³³

Minocycline in conventional doses is associated with skin, nail, and hair pigmentation and a systemic lupus erythematosus-like syndrome, mainly in adolescents taking the drug for acne. This syndrome is usually reversible but may require corticosteroid therapy; however, the absolute risk seems to be low (52.8 per 100,000 uses). Sixteen cases of autoimmune hepatitis have been described.

Minocycline is the only tetracycline that induces vestibular toxicity (ataxia, loss of balance), possibly because of its high concentration in the lipid-rich cells of the inner ear. Tetracyclines in general are one of the few groups of drugs that are toxic if ingested beyond their expiration date, inducing a Fanconi-like syndrome (azotemia, kidney damage). Tetracycline-induced acute interstitial nephritis may result in acute renal failure. Hepatotoxicity is rare except at high doses and is most likely to occur during pregnancy, leading to an absolute contraindication to the drugs in pregnancy.

The chelation properties of tetracyclines are responsible for their deposition in calcifying teeth, bone, and cartilage, and these drugs have been used as vital stains to determine bone growth. Tetracycline staining is not permanent in tissues that are remodeled (bone, cartilage), but is permanent in tissues that are not remodeled (teeth). Tetracyclines should not be used in children younger than 8 years unless other antibiotics are unlikely to be effective or are contraindicated.³³ Tetracyclines most likely to stain the dentition severely are tetracycline and demeclocycline with oxytetracycline, chlorotetracycline, and doxycycline (the least likely), but the magnitude of the staining may depend more on dose and duration than the drug itself. Deposition of tetracyclines in bone and teeth eliminates their antimicrobial activity. Because of the deleterious staining effects on the teeth, tetracyclines are classified by the FDA as pregnancy category D drugs. Tetracyclines should not be used in pregnancy because of staining of teeth and potential hepatotoxicity.

Drug interactions

Tetracyclines and all other antimicrobial ribosomal protein synthesis inhibitors may reduce the efficacy of antibiotic cell wall inhibitors, which rely on cell wall division for their action. Polyvalent cations (aluminum, Ca⁺, zinc, iron, magnesium, bismuth) may decrease gastric tetracycline absorption by chelation. Na⁺ bicarbonate alters the gastric pH and reduces absorption of tetracyclines.

Tetracyclines may reduce insulin requirements and may alter lithium blood levels.³³ Serum blood levels of digoxin may be increased in 10% of patients, and serum levels of tetracyclines may be reduced from increased hepatic metabolism induced by barbiturates, carbamazepine, and hydantoins.³³ The addition of tetracyclines to coumarin anticoagulants (e.g., warfarin) may greatly increase the latter's effect on the INR and lead to serious bleeding episodes. The effect is partially due to the inhibitory effect of tetracyclines on the intestinal flora that produce vitamin K (see Chapter 31).

Contraindications

Tetracyclines are contraindicated in children younger than 8 years, in cases of allergy, during pregnancy, during lactation, and in individuals with sulfite sensitivity.

Glycylcyclines

Glycylcyclines are synthetic derivatives of minocycline that may be effective against some tetracycline-resistant bacteria and *S. pneumoniae* resistant to macrolides and penicillin where the *S. pneumoniae* possesses a lower MIC for the macrolides and penicillins than for tetracycline, minocycline, and doxycycline.⁴³ The resistance gene for glycylcyclines is carried on the same transposon as the resistance genes for the macrolides and tetracycline, making the use of glycylcyclines potentially limited. Tigilcycline is a glycylcycline presently undergoing clinical trials.

Fluoroquinolones

Fluoroquinolones were introduced in the 1980s and are C6 fluorine derivatives of nalidixic acid, which is a by-product of chloroquine (Figure 39-10). Nalidixic acid (a quinolone) was

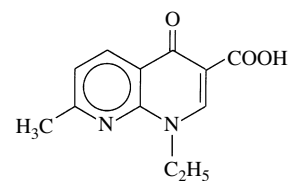

Nalidixic acid

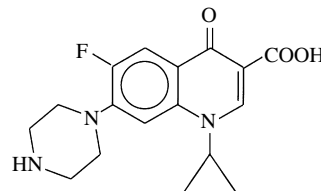

Ciprofloxacin

FIGURE 39-10 Structural formulas of nalidixic acid, a quinolone antibiotic, and ciprofloxacin, a fluoroquinolone derivative.

BOX 39-9

Generational Classification of Major Fluoroquinolones/Quinolones

First Generation*

Cinoxacin (Cinobac)
Nalidixic acid (NegGram)

Second Generation

Ciprofloxacin (Cipro)
Lomefloxacin (Maxaquin)
Levofloxacin (Levaquin)
Norfloxacin (Noroxin)
Ofloxacin (Floxin)

Third Generation

Moxifloxacin (Avelox)
Sparfloxacin (Zagam)

Fourth Generation

Clinafloxacin
Gemifloxacin (Factive)

Adapted from Andriole VT: The future of the quinolones, *Drugs* 58(Suppl 2):1-5, 1999; Naber KG, Adam D: Classification of fluoroquinolones, *Int J Antimicrob Agents* 10:255-257, 1998; Walker RC: The fluoroquinolones, *Mayo Clin Proc* 74:1030-1037, 1999.

*Quinolones.

discovered in the 1960s and is still available but has the undesirable properties of CNS stimulation, rapid development of microbial resistance, poor pharmacokinetics, and chondrotoxicity (damage to cartilage). The terms *fluoroquinolone* and *quinolone* are often used interchangeably; however, this is technically incorrect because nalidixic acid, oxolinic acid, and cinoxacin are the only true quinolones (devoid of the fluorine substitution).

Fluoroquinolones and quinolones are currently classified similar to cephalosporins into first, second, third, and fourth generations depending on the time of their introduction into medicine and to a lesser extent their antibacterial spectrum (Boxes 39-9 and 39-10).^{6,71,108} The first fluoroquinolone (norfloxacin) was synthesized in 1978 as a 6-fluorinated

BOX 39-10

*Classification of Fluoroquinolones Based on Antibacterial Spectrum***Group I (Urinary Tract Infections)**

Norfloxacin (Noroxin)

Group II (Broad Spectrum)Ciprofloxacin (Cipro)
Levofloxacin (Levaquin)
Lomefloxacin Maxaquin)
Ofloxacin (Floxin)**Group III (Greater Gram-Positive Activity)**Gemifloxacin (Factive)
Sparfloxacin (Zagam)**Group IV (Greater Gram-Positive/Antianaerobic Activity)**

Moxifloxacin (Avelox)

Adapted from Naber KG, Adam D: Classification of fluoroquinolones, *Int J Antimicrob Agents* 10:255-257, 1998.

derivative of nalidixic acid with a piperazine ring at position 7. Ciprofloxacin was synthesized in 1981 and marketed in 1986. Newer fluoroquinolones have improved activity against *S. pneumoniae*, *S. aureus*, gram-positive cocci, anaerobes, *P. aeruginosa*, and various other organisms (see Table 39-4).^{6,18,108} Potential new agents include 2-pyridones and desfluoroquinolones.

Mechanism of action and antibacterial spectrum

DNA gyrase and topoisomerases are enzymes involved in the crucial processes of DNA replication, transcription, and recombination. DNA gyrase has two subunits (A and B) regulated by two genes (*gyrA* and *gyrB*), with topoisomerase IV encoded by *parC* and *parE* genes. Both enzymes are responsible for supercoiling DNA, forming double-stranded DNA, and maintaining DNA in its physiologically stable and biologically active state. Topoisomerase IV nicks double-stranded DNA and seals the nicked DNA, whereas DNA gyrase guides the passage of the DNA through the interior of the enzyme complex. Both enzymes are responsible for supercoiling DNA, allowing for its fit into the bacterial cell. Fluoroquinolones stabilize the enzyme complex after strand breakage and before resealing, preventing DNA supercoiling.

Fluoroquinolones are broad-spectrum antibiotics that were initially greeted with great enthusiasm because they were orally effective against some of the most pathogenic nosocomial microorganisms: *S. aureus*, *P. aeruginosa*, and *S. pneumoniae*. As with all orally effective antibiotics, fluoroquinolones were used widely throughout the community, often in infections for which older agents were still effective. This overuse has led to widespread resistance to these agents and ultimately a race to produce new fluoroquinolones, which are only marginally better in many cases.

Fluoroquinolones are most active against aerobic bacilli and cocci, including Enterobacteriaceae, *H. influenzae*, *N. gonorrhoeae*, *Neisseria meningitidis*, *M. catarrhalis*, and *P. aeruginosa*. Fluoroquinolones can be classified according to their antibacterial spectrum with considerable overlap (see Box 39-10).⁷¹ *The Medical Letter* lists fluoroquinolones as drugs of choice in the management of infections caused by penicillin-resistant *S. pneumoniae*, *N. gonorrhoeae*, *B. anthracis*, *Salmonella typhi*, other *Salmonella* species, *Shigella*, *B. henselae*, *L.*

BOX 39-11

*Fluoroquinolones as Drugs of Choice or Alternative Agents for Various Infections***DRUGS OF CHOICE****ALTERNATIVE AGENTS**

<i>Bacillus anthracis</i>	<i>Acinetobacter</i>
<i>Campylobacter jejuni</i>	<i>Aeromonas</i>
<i>Legionella pneumophila</i>	<i>Calymmatobacterium granulomatis</i>
Penicillin-resistant <i>Streptococcus pneumoniae</i>	<i>Capnocytophaga canimorsus</i>
<i>Pseudomonas aeruginosa</i> (urinary tract)	<i>Chlamyphila (Chlamydia) pneumoniae</i>
<i>Salmonella typhi</i> and other <i>Salmonella</i>	<i>Chlamyphila (Chlamydia) trachomatis</i>
<i>Shigella</i>	<i>Citrobacter freundii</i>
<i>Moraxella catarrhalis</i>	<i>Enterobacter</i>
	<i>Enterococcus</i> (urinary tract)
	<i>Erysipelothrix rhusiopathiae</i>
	<i>Escherichia coli</i>
	<i>Haemophilus ducreyi</i>
	<i>Haemophilus influenzae</i> (respiratory tract)
	<i>Klebsiella pneumoniae</i>
	MRSA
	<i>Mycoplasma pneumoniae</i>
	<i>Mycobacterium tuberculosis</i>
	<i>Neisseria meningitidis</i>
	<i>Proteus</i> (indole-positive)
	<i>Proteus mirabilis</i>
	<i>P. aeruginosa</i> (non—urinary tract)
	<i>Rickettsiae</i>
	<i>Serratia marcescens</i>
	<i>Stenotrophomonas maltophilia</i>
	<i>Vibrio cholerae</i>

From Choice of antibacterial drugs, *Med Lett Drugs Ther* 5:33-50, 2007. MRSA, Methicillin-resistant *Staphylococcus aureus*.

pneumophila, *P. aeruginosa* (urinary tract infection), and *R. equi* and as an alternative drug for myriad infections (Box 39-11; see Table 39-4).¹⁸

The in vitro MICs for sensitive microorganisms range from 0.008 to 1 µg/mL; the maximum serum concentrations range from 1.1 to 5.7 µg/mL.³³ MSSA may have MICs of 0.06 to 0.25 µg/mL, but MRSA and ciprofloxacin-resistant *S. aureus* have MICs of 1 to 4 µg/mL and 8 to 18 µg/mL for some fluoroquinolones.

The MICs for fluoroquinolones against VGS range from 0.12 to 8 µg/mL, whereas MICs for various fluoroquinolones against oral anaerobic pathogens are 0.25 to 128 µg/mL. Moxifloxacin, gatifloxacin, and trovafloxacin have the best activity against anaerobes, but the effect is highly variable depending on the species.

Bacterial resistance

Three mechanisms account for microbial resistance to fluoroquinolones: mutations in DNA gyrase and topoisomerase IV, drug efflux pumps, and reduction in microbial outer membrane permeability.^{6,108} The target alterations are accom-

plished by simple point mutations in DNA gyrase (*gyrA*) and topoisomerase IV (*parC*). Significant and sometimes extensive resistance has been detected in *N. gonorrhoeae*, *Salmonella*, *Shigella*, *E. coli*, *C. jejuni*, and many gram-negative anaerobes. Microorganisms displaying efflux mechanisms include VGS, *Enterococcus*, *S. pneumoniae*, Enterobacteriaceae, *P. aeruginosa*, and *B. fragilis*.

Absorption, fate, and excretion

Fluoroquinolones are well absorbed orally with a 70% and 90% bioavailability for ciprofloxacin and levofloxacin.³³ Food generally delays the peak concentration of ciprofloxacin and levofloxacin, but has no effect on gatifloxacin and moxifloxacin. The percent excreted by the kidneys ranges from 27% to 73%, and protein binding ranges from 15% to 35%.³³ Fluoroquinolone half-lives vary—approximately 4 hours for ciprofloxacin and norfloxacin; 7 to 8 hours for gatifloxacin, lomefloxacin, and sparfloxacin; and 9 to 12 hours for moxifloxacin and trovafloxacin.³³ Pharmacokinetic improvements have included longer half-lives to allow for once-daily dosing and greater volumes of distribution for better tissue penetration. The post-antibiotic effects of fluoroquinolones vary from 1 to 4 hours.

General therapeutic uses

Fluoroquinolones are used to treat urinary tract infections and bacterial diarrhea (e.g., traveler's diarrhea²) because of their activity against many of the causative organisms (see Table 39-4). Because fluoroquinolones vary in their pharmacokinetics and in their spectra, some, but not all, fluoroquinolones are employed for upper and lower respiratory tract infections, *P. aeruginosa* infections, genital diseases caused by gonococci and *Chlamydia*, legionnaires disease, and tuberculosis.

Therapeutic uses in dentistry

Fluoroquinolones are not indicated for any acute orofacial infections unless dictated by culture and sensitivity tests. Drugs with better antimicrobial spectra are readily available. The drugs possess concentration-dependent killing not reflected in their package insert doses, and they are not predictably synergistic with β -lactams and aminoglycosides (may be additive or indifferent). Ciprofloxacin may be useful for the management of aggressive periodontitis associated with Enterobacteriaceae as dictated by culture and sensitivity tests.

Adverse effects

The major adverse effects associated with fluoroquinolones occur in the gastrointestinal tract, CNS, skin, and cartilage.³³ Less common systems involved are the cardiovascular, hepatic, and renal systems. The incidence of each adverse effect may vary among the different drugs because of chemical substitutions on the quinolone nucleus.

Gastrointestinal adverse reactions include nausea and vomiting, dyspepsia and heartburn, and abdominal pain.³³ The heavy use of fluoroquinolones has been associated with pseudomembranous colitis and diarrhea owing to overgrowth of *C. difficile*.⁷⁸ These antibiotics have become a major risk factor in this disease associated with a more virulent strain of *C. difficile*.¹¹³ CNS effects include mild neuropathy (headache, dizziness, malaise, restlessness, bad dreams) possibly caused by central γ -aminobutyric acid inhibition or activity at the *N*-methyl-D-aspartate receptor. Dermatologic toxicity includes rash, pruritus, exfoliative dermatitis, Stevens-Johnson syndrome, and phototoxicity likely caused by dose-related ultraviolet light activation of reactive oxygen from the fluoroquinolones in the skin. Anaphylactic and anaphylactoid reactions occur at a rate of 0.46 to 1.23 per 100,000 drug

exposures, with an onset of 3 to 30 minutes after drug administration.

Chondrotoxicity includes arthralgia, joint swelling, tendinitis, and tendon rupture (primarily the Achilles tendon). In a more recent study of 42 cases of tendinitis and tendon rupture, most subjects took normal doses with a median 6 days (range 1 to 510 days) until the onset of signs and symptoms (pain, edema, dysfunction, erythema, warmth), with 93% occurring within 30 days of the onset of drug intake.¹⁰⁴ These disorders were more likely to occur in men; patients with a median age of 68 years; and patients with concomitant corticosteroid therapy, diabetes mellitus, renal failure, other musculoskeletal disorders, or involvement in sports activity.¹⁰⁴ The tendinitis usually resolved with drug discontinuance. In animals given fluoroquinolones, changes have occurred in all immature joint cartilage (epiphyseal growth plate), possibly by chelation of the Mg^{++} ion.³³ These agents are not approved for children younger than 18 years except for ciprofloxacin.¹⁰⁴

Other possible adverse effects include induction of a prolonged QT interval (torsades de pointes), transient increase in liver enzymes, neutropenia, serum sickness, allergic vasculitis, and renal crystalluria. Because these antibiotics affect DNA, they have been investigated as possible teratogens. At extremely high in vitro doses of 100 to 750 $\mu\text{g}/\text{mL}$ for 24 hours, fluoroquinolones have induced genotoxicity in the chromosomal aberration test; however, a clinical study of 200 women exposed to ciprofloxacin and norfloxacin during gestation showed no increase in fetal malformations or musculoskeletal defects.⁶⁴

Anecdotal reports in Europe have claimed an association between fluoroquinolones and suicidal behavior, but a study of individuals receiving the drugs for 31 to 180 days could detect no increase in suicidal behavior.⁴⁸ Two cases of possible exacerbation of myasthenia gravis have been reported.

Drug interactions

An important drug interaction with fluoroquinolones is the potential increase in CNS toxicity with the concomitant use of NSAIDs and methylxanthines.³³ The combination of sparfloxacin, gatifloxacin, and moxifloxacin with tricyclic antidepressants, erythromycin, phenothiazines, and antiarrhythmic agents (quinidine, procainamide, disopyramide) may increase the risk of torsades de pointes.³³ Fluoroquinolones may reduce the liver clearance of warfarin and procainamide and increase the toxicity of cyclosporine.³³ Cimetidine may increase fluoroquinolone blood levels, and antacids and sucralfate may reduce gastric absorption of fluoroquinolones. Fluoroquinolones may induce urine false-positive findings for opioid drugs by immunoassay techniques.

Contraindications

Ciprofloxacin should be used with caution during pregnancy and in children. For children younger than 18 years, other fluoroquinolones are contraindicated.³³ Phototoxicity may occur on skin areas exposed to sunlight, and sunscreens are not always effective.³³

Aminoglycosides

The era of the aminoglycosides began in 1943 with the isolation of streptomycin by Waksman and the subsequent development of kanamycin (1957), gentamicin (1963), tobramycin (1968), amikacin (1972), and netilmicin (1975). Aminoglycosides are amino sugars bound by glycosidic bridges to a hexose nucleus.

Chemistry

Streptomycin is produced by *Streptomyces griseus*. Other aminoglycosides are elaborated by various species of *Streptomyces*

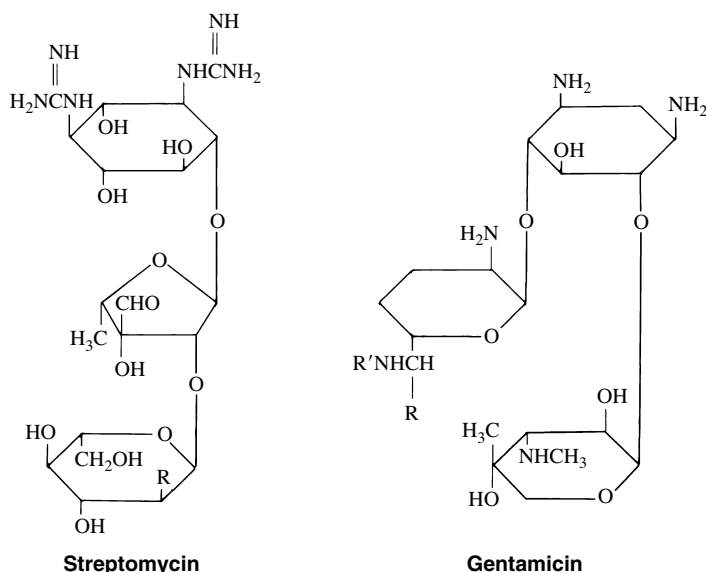

FIGURE 39-11 Structural formulas of streptomycin and gentamicin. R for streptomycin is CH_3NH . Commercial preparations of gentamicin contain three closely related gentamicins: C_1 ($\text{R} = \text{CH}_3$, $\text{R}' = \text{CH}_3$), C_{1a} ($\text{R} = \text{H}$, $\text{R}' = \text{H}$), and C_2 ($\text{R} = \text{CH}_3$, $\text{R}' = \text{H}$).

and *Micromonospora* or, in the case of amikacin and netilmicin, are semisynthetic derivatives of naturally occurring aminoglycosides. As the name implies, these agents consist of a highly polar amino base attached by glycosidic linkage to one or more sugars. Streptomycin is composed of three elements: streptidine (the amino base) and the two sugar moieties streptose and N-methyl-glucosamine (Figure 39-11).

Mechanism of action and antibacterial spectrum

Aminoglycosides bind irreversibly to the 30S ribosome to interfere with the reading of the microbial genetic code and to inhibit protein synthesis. Aminoglycosides are generally bactericidal, and their efficacy in several cases can be greatly enhanced by the concomitant use of cell wall-inhibiting β -lactams and glycopeptides.

The activity of aminoglycosides is primarily directed toward gram-negative bacilli and mycobacteria. The spectrum includes Enterobacteriaceae and *P. aeruginosa*. There are some differences among aminoglycosides regarding their efficacy toward specific microorganisms: amikacin for gentamicin-resistant gram-negative bacilli, gentamicin and doxycycline for brucellosis, gentamicin and penicillins for *Campylobacter* infective endocarditis, tobramycin for *Acinetobacter* and *P. aeruginosa*, and streptomycin for tularemia and plague. Most Enterobacteriaceae remain sensitive to aminoglycosides. Significant resistance has occurred in enterococci.²⁹ Gentamicin is the most commonly used aminoglycoside, often acting synergistically with ampicillin, penicillin G, ceftriaxone, vancomycin, and rifampin.²⁹ Some original indications for aminoglycosides have been supplanted by safer extended-spectrum β -lactams and fluoroquinolones.²⁹

Bacterial resistance

Three resistance mechanisms presently exist for aminoglycosides: ribosomal mutations (less affinity for the 30S ribosome), reduced intracellular transport (primarily in staphylococci and pseudomonads), and, most commonly, plasmid-mediated aminoglycoside-modifying enzymes (acetyltransferases, adenyltransferases, and phosphotransferases).

Absorption, fate, and excretion

Aminoglycosides are poorly absorbed orally and do not penetrate well into the CNS, bronchial secretions, or certain microbial cells (e.g., *Rickettsia*, *Chlamydia*) but are effective intracellularly in the treatment of tuberculosis, plague, brucel-

losis, and tularemia. Aminoglycosides are classic concentration-dependent antibiotics commonly administered in high parenteral doses repeated after the blood levels have decreased to a low concentration (peak and trough dosing). Single daily dosing is becoming more common, taking advantage of the long post-antibiotic effect of aminoglycosides, a reduction in cost, and lessening of renal toxicity. The normal elimination half-life of aminoglycosides is 2 to 3 hours, which can be extended to 24 to 100 hours in end-stage renal disease.³³ Aminoglycosides are excreted primarily by glomerular filtration.

General therapeutic uses

Parenteral aminoglycosides currently available include amikacin, gentamicin, kanamycin, netilmicin, streptomycin, and tobramycin. Kanamycin and neomycin are available for oral use for gastrointestinal infections. Aminoglycosides are primarily indicated for infections caused by gram-negative aerobic bacteria, including *P. aeruginosa*, *Serratia*, *Klebsiella*, *Enterobacter*, and *Proteus*. Aminoglycosides are often combined with a penicillin or cephalosporin for various infections (see Table 39-4). Their use in tuberculosis is described later.

Therapeutic uses in dentistry

Aminoglycosides have no uses in orofacial infections unless dictated by culture and sensitivity tests.

Adverse effects

The major adverse effects of aminoglycosides are renal toxicity and auditory and vestibular ototoxicity.²⁹ Nephrotoxicity is caused by inhibition of an intracellular lysosomal phospholipase in the renal proximal tubules, resulting in aminoglycoside accumulation and subsequent reduced glomerular filtration, reduced water and Na^+ transport, reduced mitochondrial respiration, and reduced renal protein synthesis resulting in renal necrosis.²⁹ The incidence of some degree of nephrotoxicity can be 10% to 20%.

A primary target for toxicity of aminoglycosides is the hair cells of the inner ear where the initial loss of the outer hair cells eventually damages the inner ear cochlear hair cells (type II).²⁹ Further damage may occur to the cochlear sensory epithelium and the spiral ganglion cells required for cochlear implants. Vestibular (type I) hair cell damage occurs at the apex of the macula and often earlier than the cochlear hair cell damage.³⁷ Initial signs and symptoms are hearing loss at the higher frequencies, which increases with dose, duration,

and noise exposure.³⁷ The incidence of cochlear damage may be 15%. Other adverse reactions associated with aminoglycosides include neuromuscular blockade of the curare type, rare blood dyscrasias, headache, dizziness, and urticarial and peripheral neuropathy.

Drug interactions

The nephrotoxicity of aminoglycosides is increased by vancomycin, cephalosporins, and methoxyflurane. Loop diuretics increase auditory toxicity.

Vancomycin

Vancomycin is the most important glycopeptide antibiotic, originally isolated from *Streptomyces orientalis* in Borneo in 1956 and introduced into medicine in 1958. Other glycopeptides include teicoplanin and daptomycin. Glycopeptides are seven-membered peptide chains with two sugars, vancosamine and glucose. Vancomycin is poorly absorbed from the gastrointestinal tract and causes severe pain when given intramuscularly. It is administered intravenously to treat systemic infections or orally to treat pseudomembranous colitis. Its elimination half-life is 6 hours, and it has a post-antibiotic effect of 1.5 to 3 hours.

Mechanism of action and antibacterial spectrum

Vancomycin inhibits gram-positive bacterial cell wall synthesis by complexing with the D-alanyl-D-alanine portion of the peptide precursor units to inhibit the transglycosylase reaction in peptidoglycan synthesis.¹⁰⁹ This inhibition is at the second stage of bacterial cell wall synthesis before the action of the penicillins at the third stage. Vancomycin may also affect cytoplasmic membrane permeability and RNA synthesis and, as with the β -lactams, requires active cell replication. Because of its large molecular size, vancomycin cannot traverse the outer cell membrane of gram-negative bacteria.

The activity of vancomycin is almost exclusively against aerobic and anaerobic gram-positive species, including staphylococci, streptococci (*S. pneumoniae*, VGS, β -hemolytic streptococci), *Corynebacterium*, *Peptostreptococcus*, *Enterococcus*, nutritionally variant streptococci (*Abiotrophia*), *Bacillus*, *Listeria*, and *Clostridium*.¹⁰⁹ Occasionally, *N. gonorrhoeae* is susceptible. Vancomycin is a drug of choice against MRSA, methicillin-resistant CoNS, *Corynebacterium jeikeium*, and multiple antibiotic-resistant *S. pneumoniae*. It may also be indicated for serious enterococcal infections and in patients who cannot tolerate β -lactams. *The Medical Letter* lists vancomycin as a drug of choice for MRSA, penicillin-resistant *S. pneumoniae*, MSSA, *S. epidermidis*, *B. cereus*, *B. subtilis*, *Corynebacterium* JK group, and *R. equi* and as an alternative drug for enterococcal endocarditis, VGS, group A and B streptococci, *S. bovis*, *Peptostreptococcus*, and *C. difficile*.¹⁸

Bacterial resistance

Vancomycin resistance is caused by an altered peptidoglycan terminus (D-ala-D-lac instead of the usual D-ala-D-ala), resulting in reduced vancomycin binding and failure to prevent cell wall synthesis.¹⁵ Resistance in vancomycin-intermediate *S. aureus* and glycopeptide-intermediate *S. aureus* may be due to the production of abnormal peptides ("false binding sites") in the cell wall that bind vancomycin and prevent its attachment to its receptor or possibly to an increase of peptidoglycan resulting in thickened cell walls.¹⁶ A form of resistance is seen in *S. pneumoniae* by a unique mutation in the sensor response system that controls autolysin activity necessary to kill certain bacteria.⁷⁵

General therapeutic uses

Vancomycin is used for serious gram-positive infections caused by such organisms as methicillin-resistant staphylo-

cocci and *S. pneumoniae*. It is also useful for non-vancomycin-resistant enterococcal infections. It is effective in treating enterocolitis caused by *C. difficile*; however, metronidazole should be used for this situation if possible because of the significant risk of promoting vancomycin enterococcal resistance. Vancomycin may also be useful in treating multiple antibiotic-resistant VGS infections.

Therapeutic uses in dentistry

Glycopeptides have no uses in the management of acute or chronic orofacial infections unless dictated by laboratory culture and sensitivity tests.

Adverse effects

Major adverse drug reactions associated with vancomycin include transient or permanent ototoxicity, hypotension, reversible neutropenia, renal toxicity, skin rash, and red man (red neck) syndrome. The auditory toxicity of vancomycin is rare if the peak blood levels are maintained less than 40 to 50 $\mu\text{g/mL}$ but can be exacerbated by the combination with aminoglycosides. Red man syndrome results from the direct histamine release from mast cells manifesting as pruritus; erythematous rash of the head, neck, face, and upper torso; and hypotension mimicking anaphylactic shock.¹⁰⁹ This glycopeptide-induced anaphylactoid reaction may occur with the first drug exposure, is tachyphylactic in nature, and can be reduced significantly by the slow infusion of vancomycin over a 1-hour period and premedication with antihistamine drugs.¹⁰⁹ To reduce the development of resistant bacteria, vancomycin use is contraindicated or discouraged for routine surgical prophylaxis.

Drug interactions

Vancomycin-induced nephrotoxicity or ototoxicity is increased with the concomitant use of aminoglycosides and neuromuscular blockade with curare-like agents.

Streptogramins

Quinupristin-dalfopristin, a 30/70 mixture of streptogramins A and B, is approved for intravenous use in the United States.

Mechanism of action and antibacterial spectrum

Quinupristin and dalfopristin bind sequentially to different sites of the 50S subunit of the 70S ribosome to prevent newly synthesized peptide chains from extruding from the ribosome, resulting in cell death. Quinupristin-dalfopristin is used to treat life-threatening vancomycin-resistant *E. faecium* (*Enterococcus faecalis* is resistant) and skin or skin structure infections from *S. aureus* and *S. pyogenes*. The drug is additionally approved in the United Kingdom for nosocomial pneumonia. In vitro, the drug combination is active against *E. faecium*, MRSA, MSSA, methicillin-resistant CoNS, methicillin-sensitive CoNS, penicillin-sensitive and penicillin-resistant *S. pneumoniae*, *N. meningitidis*, *M. catarrhalis*, *L. pneumophila*, *M. pneumoniae*, and *C. perfringens*. Its spectrum closely resembles that of vancomycin and linezolid.

Bacterial resistance

Microbial resistance occurs by three mechanisms: decreased ribosomal binding by methylation of an adenine residue, drug efflux, and enzymatic inactivation. This resistance belongs to the MLS_B type, potentially conferring cross-resistance to all these antibiotics. The streptogramin group also contains virginiamycin and pristinamycin, which have been used for years in some countries as animal growth promoters, resulting in microbial resistance in humans even before the drugs were clinically employed. Currently, intermediate resistance has

been detected in *S. aureus* and *E. faecium*, with vancomycin and streptogramin resistance genes detected on the same plasmid. *E. faecium* resistance may occur during drug use, and quinupristin-dalfopristin selects for superinfection with *E. faecalis*.

General therapeutic uses

Quinupristin-dalfopristin should be reserved for life-threatening and multiple antibiotic-resistant infections from *E. faecium*, staphylococci, and some streptococci encountered primarily in the hospital.

Adverse effects

Adverse effects associated with streptogramins include possible severe arthralgias and myalgias, elevation in conjugated serum bilirubin, and significant inhibition of the liver microsomal CYP3A4 drug metabolizing system.

Drug interactions

Streptogramins decrease the liver metabolism of Ca⁺⁺ channel blockers, immunosuppressant drugs, corticosteroids, several anticancer agents, 3-hydroxy-3-methylglutaryl coenzyme A reductase inhibitors (statins), HIV protease inhibitors, quinine, non-sedating antihistamines, sildenafil, opioids, and benzodiazepines.

Oxazolidinones

Oxazolidinones (eperezolid, linezolid) were synthesized in 1987, and linezolid was approved for use in the United States in 2000. Linezolid is the first totally synthetic new antibiotic released in approximately 40 years.

Mechanism of action and antibacterial spectrum

Linezolid has a unique mechanism of action by binding to the 50S ribosome subunit near the interface with the 30S subunit to prevent the initiation complex required for bacterial translation.^{17,25,26} This unique mechanism may possibly limit cross-resistance with other antibiotics.²⁶ Linezolid is approved in the United States for the management of vancomycin-resistant *E. faecium*; nosocomial and community-acquired pneumonia from *S. aureus* and penicillin-sensitive *S. pneumoniae*; and complicated skin and skin structure infections from MRSA, MSSA, methicillin-resistant CoNS, *S. pyogenes*, and *S. agalactiae*.³³

Linezolid has exhibited in vivo and in vitro bacteriostatic activity against penicillin-resistant VGS, β -hemolytic streptococci, *Bacillus*, *Listeria*, *Corynebacterium*, *M. catarrhalis*, *P. multocida*, *B. fragilis*, and antibiotic-resistant mycobacteria.²⁵ Linezolid has little useful clinical activity against Enterobacteriaceae, *Acinetobacter*, *P. aeruginosa*, and most gram-negative species, with some activity against mycobacteria and chlamydiae.

Bacterial resistance

Microbial resistance to linezolid has been detected in isolated cultures of vancomycin-resistant enterococci, *E. coli*, and laboratory strains of *S. aureus*. More recent reports of clinical isolates of *E. faecium* and *S. aureus* resistant to linezolid are disconcerting because the drug has been available only for a short time. The mechanism of resistance seems to be a 62,576T mutation in the gene encoding the central loop domain of 23S rRNA.²⁶

Absorption, fate, and excretion

Linezolid, with a near 100% oral bioavailability, produces peak blood levels at 1 to 2 hours and can be administered parenterally as well. It has an elimination half-life of 4.4 to 5.5 hours and a post-antibiotic effect of 0.6 to 1.4 hours.³³

General therapeutic uses

Linezolid is currently highly effective against three of the five most important nosocomial pathogens—*S. aureus*, *S. pneumoniae*, and *Enterococcus*—and should be reserved for highly resistant and multiple antibiotic-resistant microorganisms. The ability of *S. aureus* to mutate to resistance after only a few months of exposure to the drug is disconcerting. Linezolid has no use in orofacial infections.

Adverse effects

Approximately 2% to 3% of patients receiving linezolid experience nausea and vomiting, diarrhea, headache, tongue discoloration, taste alteration, fungal superinfections, or very rarely pseudomembranous colitis.³³ The most serious adverse reaction is myelosuppression (anemia, leukopenia, pancytopenia, thrombocytopenia), which may occur in an average of 2.4% of patients. Linezolid requires weekly blood monitoring tests. The safety of the drug has not been established beyond 28 days of use. It is classified as an FDA pregnancy category C drug.

Drug interactions

Linezolid is a weak monoamine oxidase inhibitor and should be used with caution with drugs that release catecholamines and foods containing tyramine. Linezolid may precipitate serotonin syndrome (confusion, agitation, seizures, hypertension, tachycardia, sweating, myoclonus, muscle rigidity, trismus, death),³³ but the clinical significance of this drug effect is as yet unknown.

Sulfonamides

The era of effective and safe systemic antibiotic therapy began in 1932 with the discovery by Domagk that a dye (prontosil) protected laboratory animals from streptococcal infections. Domagk determined that the active antibacterial portion of prontosil was sulfanilamide, which was subsequently first used in the United States in 1935. Trimethoprim was introduced in 1968 as a synergistic agent with sulfonamides, and the combination of sulfamethoxazole and trimethoprim is the most commonly used sulfonamide preparation today. The discovery of prontosil by Domagk ranks with the discovery of the anesthetic properties of nitrous oxide by Wells, the work on penicillin by the Oxford group, and the discovery by Jenner of vaccinations as among the greatest of all medical discoveries.

Chemistry

All the sulfonamides are derivatives of *p*-aminobenzenesulfonamide (Figure 39-12). For antibacterial activity, the sulfur must be attached directly to the benzene ring, and the *p*-amino group (N₄) must be a primary amine in vivo. Substitutions on the amino group (N₁) of the sulfonamide moiety confer differences in rates of absorption and excretion of these drugs and, to some degree, in variations of antibacterial activity. Sulfonamides are weak acids with limited water solubility, particularly in solutions of low pH. This property may present problems for the excretion of these drugs in acidic urine.

Mechanism of action and antibacterial spectrum

Sulfonamides and trimethoprim interfere with the microbial synthesis of folic acid necessary for life in some microorganisms. Mammals acquire folic acid from their diet. Sulfonamides competitively inhibit the incorporation of para-aminobenzoic acid (PABA) into tetrahydropterotic acid because the sulfas have a greater affinity for tetrahydropterotate synthetase than PABA (Figure 39-13). Trimethoprim inhibits bacterial dihydrofolate reductase with 50,000 to 100,000 times greater affinity for the bacterial than the human enzyme; this blocks the conversion of dihydrofolic acid to

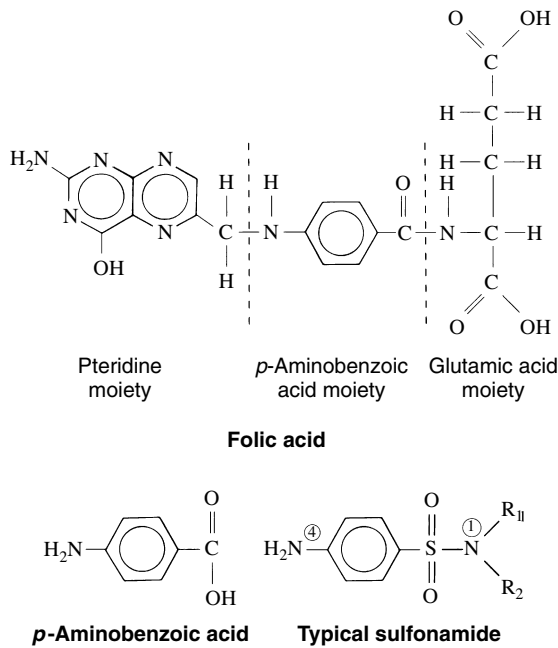

FIGURE 39-12 Structural formulas of folic acid, a sulfonamide, and *p*-aminobenzoic acid.

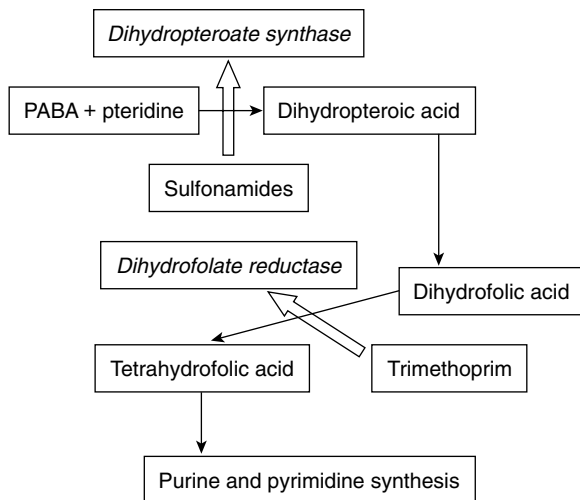

FIGURE 39-13 Sites of inhibition of folic acid synthesis by sulfonamides and trimethoprim. Note the effect of the two drugs on this common pathway and the effect on purine and pyrimidine synthesis. PABA, *p*-Aminobenzoic acid.

tetrahydrofolic acid, resulting in the reduced synthesis of folic acid, purines, and DNA. Sulfonamides and trimethoprim inhibit successive steps in the synthesis of folic acid and eventually bacterial nucleotides and DNA.

Sulfonamides and trimethoprim are intended primarily for respiratory, urinary, and gastrointestinal infections.¹⁸ *The Medical Letter* lists this combination as drugs of choice for *Y. enterocolitica*, *Aeromonas*, *Burkholderia cepacia*, *S. maltophilia*, *Nocardia*, and generally for bronchitis and upper respiratory tract infections and alternative drugs for some Enterobacteriaceae, *M. catarrhalis*, MRSA, *S. pneumoniae*, *Listeria monocytogenes*, *B. henselae*, *Brucella*, *L. pneumophila*, *V. cholerae*, *Yersinia pestis*, *M. marinum*, and *P. pseudomallei*.¹⁸ Species that have intrinsic resistance or that can become highly resis-

tant include enterococci, *B. anthracis*, various Enterobacteriaceae, *P. aeruginosa*, *S. pneumoniae*, and *C. diphtheriae*.

Bacterial resistance

Transferable microbial resistance to sulfonamides and trimethoprim occurs by three principal mechanisms: increased cell permeability barriers and efflux proteins, decreased sensitivity or alterations in target enzymes (dihydropteroate synthase and dihydrofolate reductase), and the acquisition of new target enzymes. Trimethoprim-sulfamethoxazole resistance in *S. pneumoniae* occurs via a single amino acid substitution in dihydrofolate reductase. Chromosomal resistance by mutations in the dihydropteroate synthetase gene occurs in *E. coli*, staphylococci, *P. carinii*, *Campylobacter*, *S. pneumoniae*, *S. pyogenes*, and *N. meningitidis*.

Despite a determined effort to reduce sulfonamide use drastically in the United Kingdom, the resistance rate in *E. coli* not only did not decline but actually increased.³⁰ As is now common, the resistance genes for trimethoprim-sulfamethoxazole are carried on transposable elements along with the resistance genes for other antibiotics, possibly necessitating the removal of all from the environment before resistance declines.

Absorption, fate, and excretion

Sulfonamides are classified as short-acting, medium-acting, or long-acting. Short-acting to medium-acting agents include sulfisoxazole, sulfamethoxazole, sulfamethizole, and sulfadiazine. Sulfadoxine is a long-acting agent with an elimination half-life 100 to 230 hours. (It is used in combination with pyrimethamine to treat malaria caused by *Plasmodium falciparum*.) Various other sulfonamide preparations include preparations used topically for burns (silver sulfadiazine, mafenide), vaginal preparations, ophthalmic preparations (sulfacetamide), and drugs for the management of ulcerative colitis (salicylazosulfapyridine or sulfasalazine) given orally for local gastrointestinal effects. Oral sulfonamides are 70% to 100% bioavailable (except for sulfasalazine) with a large volume of distribution and ready penetration into the CNS. The drugs are metabolized by acetylation and conjugation in the liver and excreted by glomerular filtration.

General therapeutic uses

The primary clinical uses of a sulfonamide alone or trimethoprim-sulfamethoxazole are acute bronchitis, community-acquired pneumonia, *L. pneumophila* and *P. carinii* pneumonia, uncomplicated urinary tract infections, male genitourinary tract infections, traveler's diarrhea from enterotoxigenic *E. coli*, *Shigella*, *Nocardia asteroides*, toxoplasmosis, malaria (sulfadoxine in combination with pyrimethamine), *N. meningitidis* prophylaxis, trachoma, chancroid, rheumatic fever, and Wegener's granulomatosis. Some sulfonamides are also used in special cases such as in burns and in certain cases of ophthalmic, gastrointestinal, and skin disorders (Table 39-8). There are no indications for sulfonamides and trimethoprim in the management of orofacial infections.

Adverse effects

Approximately 8% of individuals receiving sulfonamides and trimethoprim have some form of adverse reaction, such as nausea and vomiting, blood dyscrasias, and crystalluria (less soluble preparations, such as sulfadiazine, precipitate in the urine), with 3% to 5% experiencing allergy in any of its forms from skin rash and pruritus to major skin eruptions (Stevens-Johnson syndrome, epidermal necrolysis, exfoliative dermatitis, photosensitivity) to anaphylaxis.³³ Stevens-Johnson syndrome is much more likely to occur with long-acting sulfonamides. Of patients with AIDS, 70% have some form of skin rash and fever from sulfonamides and trimethoprim.

TABLE 39-8

Classification, by Use, of Selected Sulfonamide and Trimethoprim Preparations

USE	NONPROPRIETARY (GENERIC) NAME	PROPRIETARY (TRADE) NAME
Systemic infections	Sulfadiazine	—
	Sulfamethoxazole*	Gantanol
	Sulfisoxazole*	Gantrisin
	Erythromycin-sulfisoxazole	Eryzole, Pediazole
	Trimethoprim*	Proloprim, Trimpex
	Trimethoprim-sulfamethoxazole*	Bactrim, Cotrim, Septra, Sulfatrim
Urinary tract infections	Sulfamethizole	Thiosulfil Forte
Dermatitis herpetiformis	Sulfapyridine	—
Local use in gastrointestinal tract	Sulfasalazine	Azulfidine
Ophthalmic use	Sulfacetamide sodium	Bleph-10, Sodium Sulamyd
Acne	Sulfacetamide sodium	Plexion
Topical use, burns	Mafenide	Sulfamylon
	Silver sulfadiazine	Silvadene

*These drugs are also used in the treatment of urinary tract infections.

†Also used in the treatment of *Pneumocystis jiroveci* (formerly *Pneumocystis carinii*) pneumonia in AIDS patients.

Drug interactions

Trimethoprim-sulfamethoxazole increases the clinical activity of oral anticoagulants, thiopental, methotrexate, hydantoins, sulfonylureas, and tolbutamide and decreases the activity of cyclosporine.³³ Sulfonamides are displaced from plasma protein by aspirin, other NSAIDs, and probenecid. PABA (present in some health foods) competes against the effect of sulfonamides.

Contraindications

Contraindications for the use of sulfonamides include allergy to sulfonamides and other related drugs, such as sulfonylureas and thiazide, loop, and carbonic anhydrase inhibitor diuretics. Health foods and possibly sunscreens containing PABA are contraindicated because PABA competes against the sulfonamide.

Chloramphenicol

Chloramphenicol (Chloromycetin) is a broad-spectrum antibiotic isolated in 1949 from *Streptomyces venezuelae*. It is bacteriostatic because of its inhibition of bacterial protein synthesis by reversible binding to the peptidyl transferase component of the 50S ribosomal subunit. Chloramphenicol is unique among naturally occurring antibiotics because it contains a nitrobenzene group, which is attached to a propanediol moiety linked to a dichloroacetamide side chain. Its structure is illustrated in Figure 39-14. Resistance occurs by plasmid-mediated and chromosomally mediated chloramphenicol acetyltransferase, which metabolizes chloramphenicol to an inactive form.

Chloramphenicol may be active against a wide range of microorganisms including gram-positive and gram-negative bacteria, spirochetes, *Rickettsia*, *Mycoplasma*, and *Chlamydia*. Common pathogens sensitive to chloramphenicol include *S. typhi*, other *Salmonella* species, *S. pneumoniae*, *H. influenzae*, and *N. meningitidis*. Enterococci are variably resistant, and MRSA, methicillin-resistant CoNS, and *P. aeruginosa* are completely resistant. Because of its propensity to induce bone marrow depression and aplasia, chloramphenicol is not the current drug of choice for any infection, but is an alternative drug for gastrointestinal *Bacteroides*, *C. perfringens*, *P. mirabilis*, *Brucella*, *S. typhi*, other *Salmonella* species, *Francisella tularensis*, *Fusobacterium*, *H. influenzae*, *Pseudomonas mallei*, *P. pseudomallei*, *Y. pestis*, *Chlamydia psittaci*, various *Ehrlichia*,

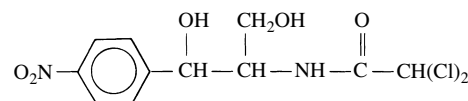

FIGURE 39-14 Structural formula of chloramphenicol.

Vibrio vulnificus, and rickettsial diseases (Rocky Mountain spotted fever, tick-bite fever, Q fever, and typhus).³³

The most significant adverse reactions associated with chloramphenicol are reversible and irreversible bone marrow depression seen with topical, oral, and parenteral use.⁹³ The reversible type is dose-related (>4 g/day) and possibly caused by inhibition of mitochondrial protein synthesis resulting in anemia, leukopenia, or thrombocytopenia. “Idiosyncratic” bone marrow aplasia is not dose-related; may begin weeks or months after the drug is stopped; and is manifested by an often fatal aplastic anemia, the incidence of which seem to be 1 in 24,500 to 1 in 40,800 patients receiving chloramphenicol by any route of administration. This incidence is 13 times greater than the spontaneous random occurrence of aplastic anemia in the general population. Topical use is associated with a risk of 3 cases in 440,000 uses. The cause of this idiosyncratic aplastic anemia is unknown, but it may be due to a genetically determined liver metabolite.

The “gray baby syndrome” associated with chloramphenicol is caused by toxicity resulting from the inability of the immature liver of neonates to detoxify the drug by conjugation.⁹³ The signs and symptoms include abdominal distress, cyanosis, vomiting, circulatory collapse, and possibly death. There are no indications for chloramphenicol in the management of orofacial infections. The drug is rarely used because of its major adverse effects.

Bacteriophages

Bacteriophages are bacterial viruses that invade bacterial cells and can induce cell lysis by disrupting microbial metabolism.⁹⁶ Bacteriophages literally punch holes in microbial cell membranes and are among the most ubiquitous entities on earth, found in or on salt and fresh water, soil, plants, animals, and humans. Bacteriophages are composed of either RNA or DNA with a protein coat, have either a spherical or a rod shape, and contain fewer than 10 to several hundred genes.⁶¹ Bacte-

riophages thrive when horizontal transfer of genetic material between microorganisms is common.⁶¹ Bacteriophages came into clinical use in World Wars I and II almost exclusively in Germany, Russia (Georgia), and Eastern Europe (Poland), with claims of 75% to 100% cures of various infections from staphylococci, pseudomonads, *Shigella*, *Salmonella*, *E. coli*, and *K. pneumoniae*.⁸³

The difficulties with bacteriophage therapy are lack of clinical proof of efficacy with controlled clinical studies, the potential for autoantibodies developed against bacteriophages that may decrease their efficacy, microbial resistance development, and unknown activity against intracellular pathogens. The merits of bacteriophage therapy include high, but not absolute, specificity for a single pathogenic organism, greatly reducing the risk for superinfections and resistance development; apparent safety, although this has not been studied in clinical trials; and ease of chemical manipulation to affect newly emerging pathogens.⁹⁶

Microbial cells can mutate to resist bacteriophages or not even recognize these entities.⁶¹ As with cationic peptides, if microorganisms develop resistance mechanisms to bacteriophages, humans will have lost another essential host defense mechanism. Proper use of bacteriophages requires very specific identification of the microbial pathogen because they are specific for each individual microbial species, making them of limited or no value in the treatment of polymicrobial disease such as pneumonia and orofacial infections.

Topical Antibiotics

Bacitracin

Bacitracin is a polypeptide antibiotic derived from *B. subtilis* that functions to block cell wall formation by interfering with the dephosphorylation of the lipid compound that carries peptidoglycans to the growing microbial cell wall.¹⁰² The antibacterial spectrum of bacitracin is gram positive and includes staphylococci, streptococci, *Corynebacterium*, and *Clostridium*, with rare resistance seen in staphylococci. Bacitracin is too toxic to be used parenterally, whereas allergic contact dermatitis has been reported occasionally. Bacitracin is commonly combined with neomycin and polymyxin B in over-the-counter topical antibiotic preparations, but evidence for efficacy is limited.¹⁰²

Neomycin

Neomycin is an aminoglycoside derived from *Streptomyces fradiae* and binds to the 30S ribosomal subunit to inactivate bacterial DNA polymerase and cause misreading of the genetic code to produce lethal proteins. Neomycin has a wide antibacterial spectrum against gram-positive and gram-negative bacteria, but is poorly effective against streptococci and *P. aeruginosa*.¹⁰² It is useful as a topical antibiotic and in the management of hepatic coma by reducing nitrogen-producing bacteria in the gastrointestinal tract.¹⁰²

Polymyxin B

Polymyxin B was isolated from *Bacillus polymyxa* and functions as a cationic detergent to disrupt the microbial cell membrane, causing a leak in cell constituents. Its spectrum is gram negative, and it is particularly useful against *P. aeruginosa*. The drug is not used parenterally because it commonly induces paresthesias, ataxia, and slurred speech.

Mupirocin

Mupirocin has a unique chemical structure composed of a short fatty acid chain linked to monic acid; it inhibits bacterial RNA and protein synthesis by binding to isoleucyl-tRNA synthetase to prevent incorporation of isoleucine into the cell wall protein chain.¹⁰² The antimicrobial spectrum for mupirocin includes staphylococci (MRSA, MSSA,

methicillin-resistant CoNS), *P. aeruginosa*, streptococci, fungi, anaerobes, and Enterobacteriaceae.¹⁰² Irreversible resistance has been detected in *S. aureus* and CoNS either by altering the binding sites on isoleucyl-tRNA transferase or by a plasmid resistance gene, *mvpA*, which creates a modified isoleucyl tRNA synthetase.¹⁰² Organisms that are inherently resistant include enterococci, *Corynebacterium*, and *P. acnes*. The primary use of mupirocin is as a topical application for skin infections, such as impetigo, folliculitis, burns, and leg ulcers.¹⁰² Mupirocin is also used to reduce or eliminate nasal carriage of staphylococci, particularly MRSA.¹⁰² Its widespread use is associated with an 11% to 63% reinfection rate from resistance development or reinfection from other body areas.¹⁰²

Retapamulin

Retapamulin belongs to a more recently developed group of drugs called the *pleuromutilins*. The drug inhibits protein synthesis by binding to the 50S ribosomal subunit. Retapamulin inhibits *S. pyogenes* and *S. aureus*, even if methicillin-resistant. It also has activity against some gram-negative bacteria and many anaerobes. It is used to treat impetigo.

Urinary Antiseptics

Nitrofurantoin

Nitrofurantoin is prepared in various suspension forms and, as with all urinary antiseptics, has limited bioavailability, low volumes of distribution, and high urinary excretion rates. Its mechanism of action is unknown but may involve inhibition of cell wall formation or DNA synthesis after its enzymatic activation in the bacterial cell.⁴⁴ Its antibacterial spectrum includes *E. coli*, *Citrobacter*, *Staphylococcus saprophyticus*, *E. faecalis*, group B streptococci, *K. pneumoniae*, and *Enterobacter*, with inherent resistance in *Proteus*, *Providencia*, *Morganella*, *Serratia*, *Acinetobacter*, and *P. aeruginosa*.^{33,44} Adverse drug reactions include severe gastrointestinal upset (nausea and vomiting, anorexia, cramping), hepatitis, pneumonitis, peripheral neuropathy, and bone marrow depression.^{33,111} Pulmonary pneumonitis may be acute, subacute, or chronic with an incidence for the acute form of 1 in 100,000 users.⁴⁴ Hemolytic anemia may occur in individuals deficient in glucose-6-phosphate dehydrogenase. Nitrofurantoin and the other agents mentioned subsequently are indicated for uncomplicated urinary tract infections and cystitis.

Fosfomycin

Fosfomycin is a broad-spectrum bactericidal drug that is converted in the blood to free acid fosfomycin. Its mechanism of action is to inactivate enolpyruvyl transferase responsible for the condensation of uridine diphosphate-N-acetylglucosamine with *p*-enolpyruvate, one of the initial steps in microbial cell wall synthesis.³³ The antimicrobial spectrum for fosfomycin includes *E. coli*, *E. faecalis*, *Citrobacter*, *Enterobacter*, *K. pneumoniae*, *P. mirabilis*, and *S. marcescens*. Adverse reactions are mild and include diarrhea, vaginitis, rash, and headache. Use of fosfomycin use is commonly restricted to only a single dose because of rapid microbial resistance.³³

Methenamine

The hydrolysis of methenamine results in the liberation of ammonia and formaldehyde as its active ingredient. The mechanism of action of methenamine is to denature proteins and amino acids.⁴⁴ Methenamine has a broad spectrum of activity against *E. coli*, staphylococci, and enterococci, with significant resistance in *E. aerogenes*, *P. vulgaris*, and *P. aeruginosa*.³³ Adverse reactions include pruritus, urticaria, nausea and vomiting, cramping, headache, dizziness, proteinuria, hematuria, and precipitation of urate crystals in the urine.³³

Nalidixic acid

Because of its high microbial resistance rates and CNS toxicity, the quinolone nalidixic acid is presently relegated to the management of urinary tract infections from gram-negative microorganisms, including *K. pneumoniae*, *E. coli*, *P. mirabilis*, *P. vulgaris*, and *Providencia*. *P. aeruginosa* is resistant to nalidixic acid. Its mechanism of action is the same as the fluoroquinolones. More specifically, it causes the inhibition of DNA gyrase and topoisomerase IV. The major adverse effects are CNS toxicity (dizziness, weakness, headache, papilledema, and rare seizures and psychosis), blood dyscrasias, photosensitivity, and hemolytic anemia in glucose-6-phosphate dehydrogenase-deficient individuals.

Drugs Used to Treat Tuberculosis

Successful treatment of tuberculosis caused by *M. tuberculosis* became possible only with the advent of chemotherapeutic agents. Multidrug-resistant strains of *M. tuberculosis* have arisen, especially among patients with HIV/AIDS. Because of the rapid development of antimicrobial resistance in strains of *M. tuberculosis*, a combination of agents is always employed for treatment. The primary antituberculosis drugs are isoniazid, rifampin, pyrazinamide, ethambutol, and streptomycin. For recurrent infections or cases that exhibit microbial resistance, secondary drugs are available, including ethionamide, cycloserine, amikacin, kanamycin, capreomycin, ciprofloxacin, ofloxacin, and aminosalicylic acid. These agents are generally less active and often more toxic than the primary drugs.

Typical therapy consists of isoniazid, rifampin, and pyrazinamide for 2 months followed by isoniazid and rifampin for 4 months or, alternatively, isoniazid and rifampin for 9 months.¹⁸ Until the results of sensitivity tests dictate the regimen, tuberculosis therapy should begin with four drugs—isoniazid, rifampin, pyrazinamide, and ethambutol or streptomycin—for 2 months, followed by 4 months of isoniazid and rifampin.¹⁸ Other options are available in multidrug-resistant tuberculosis. The pharmacologic features of isoniazid, rifampin, pyrazinamide, and ethambutol are described here. Streptomycin, an aminoglycoside antibiotic, has been previously discussed.

Isoniazid

Isoniazid, the name of which derives from its chemical designation of isonicotinic acid hydrazide, is the most important drug for the treatment and prophylaxis of tuberculosis. Its spectrum of activity is limited, however, to *M. tuberculosis* and one species of atypical mycobacteria, *M. kansasii*.

Isoniazid inhibits the synthesis of mycolic acids, unique and necessary components of the cell wall of mycobacteria. The drug is bactericidal to actively growing tubercle bacilli but not to dormant organisms. Resistance to isoniazid occurs by spontaneous mutation of the bacterial chromosome (at a rate of 1 in 106 divisions), resulting in the failure of the bacterium to take up the drug, possibly as a result of an alteration in mycolic acid synthesis. Most established infections can be expected to harbor at least several resistant bacteria. There is no cross-resistance between isoniazid and other antituberculosis drugs except ethionamide.

Isoniazid is well absorbed after either oral or parenteral administration, but the oral route is preferred for reasons of convenience and maximum therapeutic effect. The drug is well distributed into all body fluids, including the caseous material of the tubercle-infected foci. Isoniazid is mainly metabolized in the liver and excreted in the urine as metabolites. Genetic differences in the rate of biotransformation are seen, but these seem to have little effect on therapeutic efficacy. The plasma half-life is prolonged in patients with hepatic dysfunction.

One important adverse reaction with isoniazid is peripheral neuritis caused by an isoniazid-induced increase in the

excretion of pyridoxine. This adverse effect is more common in slow acetylators. This reaction and other symptoms of pyridoxine deficiency can be prevented by prophylactic administration of vitamin B₆ (15 to 50 mg daily). Other adverse effects include allergic reactions (fever, rashes, hepatitis), fatal hepatic necrosis (rarely), xerostomia, epigastric distress, hematologic reactions, and convulsions in seizure-prone patients (although administration of isoniazid to patients taking phenytoin has not been problematic except for the potential of pharmacokinetic effects on phenytoin metabolism). A nonallergic hepatitis of some severity has also been reported, and subsequent studies have shown that the incidence of hepatic damage increases with age and in individuals who regularly drink alcohol.

Isoniazid is effective prophylaxis against tuberculosis and approved for single-drug therapy for prophylaxis. It is also the most important drug used in tuberculosis therapy for reasons of effectiveness, expense, convenience of administration, and relative safety.

Rifampin

Rifampin is a semisynthetic derivative of one of the rifamycins, a group of macrocyclic antibiotics produced by *Streptomyces mediterranei*. Rifampin is effective against numerous gram-positive and gram-negative bacteria in addition to *M. tuberculosis* and most other species of *Mycobacterium*. Its mechanism of action involves inhibition of DNA-dependent RNA polymerase. Mammalian RNA polymerase does not bind the drug, and RNA synthesis in host cells is unaffected. Resistance can develop rapidly to rifampin, frequently in a single step, by alteration of the target enzyme.

Rifampin is generally well absorbed from the gastrointestinal tract after oral administration. The drug is distributed throughout the body and imparts an orange-red color to the urine, saliva, sweat, tears, sputum, and feces. It is secreted in the bile and undergoes enterohepatic recirculation, prolonging its half-life. Elimination occurs by hepatic deacetylation and excretion in the urine and feces.

Rifampin may be useful in prophylaxis of tuberculosis in contacts of patients infected with isoniazid-resistant organisms. The drug has proven effective in certain diseases refractory to conventional therapy, such as rifampin in combination as an option in treating resistant *S. pneumoniae* and methicillin-resistant staphylococci.

The incidence of adverse reactions to rifampin is low (4%), and the most common is liver toxicity. Gastrointestinal disturbances, suppression of T-lymphocyte function, neurologic disorders, and various allergic reactions, including soreness of the mouth and tongue, have been reported. Decreased effectiveness of oral anticoagulants, oral contraceptives, estrogens, and glucocorticoids has occurred with concomitant administration of rifampin because rifampin induces liver microsomal enzymes. If the drug is used sporadically, a flulike syndrome (possibly immune related) may develop, sometimes leading to renal failure, hepatorenal syndrome, hemolysis, and thrombocytopenia. The drug should be taken according to a prescribed regimen. Because rifampin can cause a reddish orange color in body fluids, staining of soft contact lenses may occur.

Rifabutin

Rifabutin is chemically similar to rifampin and acts by a similar mechanism. Rifabutin is not as potent an inducer of cytochrome P450 enzymes as rifampin and offers the advantage of not interacting with other drugs to the extent that rifampin does. It is useful in treating patients who have HIV/AIDS because it has less interaction with protease inhibitors and non-nucleoside reverse transcriptase inhibitors. Adverse effects include uveitis and neutropenia but are otherwise similar to those of rifampin.

Rifapentine

Rifapentine is a long-acting rifampin-type drug that has a similar mechanism of action and similar adverse effects. It can be used twice weekly for initial treatment and once weekly during the long-term phase of treatment.

Pyrazinamide

Pyrazinamide is the pyrazine analogue of nicotinamide. It had widespread use in the 1960s but proved to be hepatotoxic in the doses used and was relegated to secondary status after the development of isoniazid and rifampin. More recently, pyrazinamide in reduced dosage has re-emerged as the third most important antituberculosis agent.

Pyrazinamide is active against various mycobacteria, including *M. tuberculosis*. It seems to function as a prodrug, relying on amidase enzymes in the mycobacteria to convert it to the active pyrazinoic acid form. Resistance to the drug in *M. tuberculosis* infection is associated with the loss of pyrazinamidase activity. The mechanism of action of pyrazinamide is inhibition of mycolic acid synthesis, most likely by inhibiting fatty acid synthase I.

Pyrazinamide is well absorbed after oral administration and is distributed throughout the body. It is metabolized primarily in the liver and excreted largely in the urine. Although pyrazinoic acid is an intermediate metabolite, it may be inactive against intracellular mycobacteria because it is not taken up intracellularly.

Pyrazinamide is administered with other antituberculosis drugs to decrease the duration of therapy required to effect a cure of uncomplicated tuberculosis. Hepatotoxicity is the most common adverse effect, but this has been less evident with the lower dosages currently used. Other toxic effects associated with current regimens are relatively benign or infrequent. Gastrointestinal disturbances, arthralgias, fever, and rash have been noted. Pyrazinamide may cause hyperuricemia, and the drug represents a risk in patients with gout.

Ethambutol

Ethambutol is a synthetic agent that inhibits arabinosyl transferases, which are important in cell wall synthesis of sensitive mycobacteria. It is active against almost all strains of *M. tuberculosis* and *M. kansasii*. Other *Mycobacterium* species show variable sensitivity, and other bacteria are not affected by the drug. Ethambutol is tuberculostatic, and resistance develops, although slowly, if it is used alone.

Ethambutol is given orally because of good absorption from the gastrointestinal tract. Distribution into various body compartments is adequate. The major route of excretion of ethambutol is by renal tubular secretion and glomerular filtration, with the drug appearing in the urine mostly as unchanged drug and as two metabolites. Dosage adjustment is required in the presence of renal impairment.

Adverse reactions to ethambutol are infrequent, the most notable being optic neuritis, with symptoms of decreased visual acuity and loss of the ability to perceive the color green. Other adverse effects include gastrointestinal upset; peripheral neuritis; allergic reactions, usually appearing as skin rashes or drug fever; and increased retention of uric acid.

Second-line drugs

A number of second-line drugs are used to treat tuberculosis. These are useful in cases of resistance to first-line drugs and include streptomycin, ethionamide, capreomycin, kanamycin, amikacin, aminosalicylic acid, cycloserine, and select members of the fluoroquinolone group of drugs.

Drugs Used to Treat Leprosy

Although leprosy is rarely seen in the United States, the World Health Organization estimates that 12 million cases

exist throughout the world. Leprosy is a bacterial disease caused by the tubercle bacillus *M. leprae*. Five clinical types of leprosy are recognized, ranging from the skin lesion of tuberculoid leprosy to the neuropathies and spontaneous amputations occurring in disseminated lepromatous disease. Patients may be infectious or noninfectious, depending on the type, duration, and effectiveness of therapy. In general, this disease can be treated successfully with drugs. Treatment may be 2 to 4 years or extend throughout the patient's life, depending on the severity and type of disease.

Dapsone is the major drug used in the treatment of leprosy. It belongs to a group of drugs called *sulfones*, which are chemical relatives of sulfonamides. Dapsone is bacteriostatic against *M. leprae*, with a mechanism of action similar to that of sulfonamides. Dapsone is used orally. Other drugs, normally used in combination with dapsone, are rifampin and clofazimine. Clarithromycin, minocycline, and ofloxacin may also be beneficial.

ANTIBACTERIAL ANTIBIOTICS*

<i>Nonproprietary (generic) name</i>	<i>Proprietary (trade) name</i>
Aminoglycosides	
Amikacin	Amikin
Gentamicin	Garamycin, Jenamicin
Kanamycin	Kantrex
Neomycin	Mycifradin
Netilmicin	Netromycin
Paromomycin	Humatin
Streptomycin	—
Tobramycin	Nebcin
Antituberculosis drugs (not included elsewhere in this list)	
Aminosalicylate sodium	Tubasal
Capreomycin	Capastat Sulfate
Cycloserine	Seromycin
Ethambutol	Myambutol
Ethionamide	Trecator-SC
Isoniazid	Nydravid
Pyrazinamide	—
Rifabutin	Mycobutin
Rifampin	Rifadin, Rimactane
Rifapentine	Priftin
Topical antibiotics	
Bacitracin	Baciguent
Mupirocin	Bactroban
Neomycin	Myciguent
Polymyxin B	Aerosporin
Retapamulin	Altabax
Bacitracin with neomycin and polymyxin B	Neosporin
Miscellaneous agents	
Chloramphenicol	Chloromycetin
Clofazimine	Lamprene
Colistimethate	Coly-Mycin M
Colistin	In Coly-Mycin S
Dapsone	—
Daptomycin	Cubicin

ANTIBACTERIAL ANTIBIOTICS*—cont'd

Nonproprietary (generic) name	Proprietary (trade) name
Fosfomycin	Monurol
Lincomycin	Lincocin
Linezolid	Zyvox
Methenamine	Hiprex, Mandelamine, Urex
Metronidazole	Flagyl
Nitrofurantoin	Furadantin, Macrochantin
Quinupristin-dalfopristin	Synercid
Spectinomycin	Trobicin
Telithromycin	Ketek
Tigecycline	Tygacil
Troleandomycin	TAO
Vancomycin	Vancocin

*Agents not shown here are listed in various tables throughout this chapter.

CITED REFERENCES

- Adriaenssen CF: Comparison of the efficacy, safety and tolerability of azithromycin and co-amoxiclav in the treatment of acute periapical abscesses. *J Int Med Res* 26:257-265, 1998.
- Advice for travelers. *Med Lett Drugs Ther* 44:33-38, 2002.
- Agarwal AK, Sethia A, Sethi D, et al: Risk of socioeconomic factors on deep neck abscesses: a prospective study of 120 patients. *Br J Oral Maxillofacial Surg* 45:553-555, 2007.
- Alvarez-Elcoro S, Enzler MJ: The macrolides: erythromycin, clarithromycin, and azithromycin. *Mayo Clin Proc* 74:613-634, 1999.
- Amsden GW: Tables of antimicrobial agent pharmacology. In Mandell GL, Bennett JE, Dolin R, editors: *Mandell, Douglas and Bennett's principles and practice of infectious diseases*, ed 5, Philadelphia, 2000, Churchill Livingstone.
- Andriole VT: The future of the quinolones. *Drugs* 58(Suppl 2):1-5, 1999.
- Asbel LE, Levison ME: Cephalosporins, carbapenems, and monobactams. *Infect Dis Clin North Am* 14:435-447, 2000.
- Bandrowsky T, Vorono AA, Borris TJ, et al: Amoxicillin-related postextraction bleeding in an anticoagulated patient with tranexamic acid rinses. *Oral Surg Oral Med Oral Pathol Oral Radiol Endod* 82:610-612, 1996.
- Brook I: Microbiology and management of deep facial infections and Lemierre syndrome. *ORL J Otorhinolaryngol Relat Spec* 65:117-120, 2003.
- Buscolo-Rizzo P, Marchiori C, Montolli F, et al: Deep neck infections: a constant challenge. *ORL J Otorhinolaryngol Relat Spec* 68:259-265, 2006.
- Bush LM, Johnson CC: Ureidopenicillins and beta-lactam/beta-lactamase inhibitor combinations. *Infect Dis Clin North Am* 14:409-433, 2000.
- Carey JC, Klebanoff MA, Hauth JC, et al: Metronidazole to prevent preterm delivery in pregnant women with asymptomatic bacterial vaginosis. *N Engl J Med* 342:534-540, 2000.
- Cars O: Efficacy of beta-lactam antibiotics: integration of pharmacokinetics and pharmacodynamics. *Diagn Microbiol Infect Dis* 27:29-33, 1997.
- Catnach SM, Fairclough PD: Erythromycin and the gut. *Gut* 33:397-401, 1992.
- Cetinkaya Y, Falk P, Mayhall CG: Vancomycin-resistant enterococci. *Clin Microbiol Rev* 13:686-707, 2000.
- Chadwick PR, Wooster SL: Glycopeptide resistance in *Staphylococcus aureus*. *J Infect* 40:211-217, 2000.
- Champney WS, Miller M: Linezolid is a specific inhibitor of 50S ribosomal subunit formation in *Staphylococcus aureus* cells. *Curr Microbiol* 44:350-356, 2002.
- Choice of antibacterial drugs. *Med Lett Drugs Ther* 5: 33-50, 2007.
- Chopra I, Roberts M: Tetracycline antibiotics: mode of action, applications, molecular biology, and epidemiology of bacterial resistance. *Microbiol Mol Biol Rev* 65:232-260, 2001.
- Chu DTW: Recent developments in macrolides and ketolides. *Curr Opin Microbiol* 2:467-474, 1999.
- Coviello V, Stevens MR: Contemporary concepts in the treatment of chronic osteomyelitis. *Oral Maxillofac Surg Clin North Am* 19:523-534, 2007.
- Craig WA, Ebert SC: Killing and regrowth of bacteria in vitro: a review. *Scand J Infect Dis* 22(Suppl 1):63-70, 1990.
- Dahlen G, Wikstrom M: Occurrence of enteric rods, staphylococci and *Candida* in subgingival samples. *Oral Microbiol Immunol* 10:42-46, 1995.
- Dash CH: Penicillin allergy and the cephalosporins. *J Antimicrob Chemother* 1(Suppl 3):107-118, 1975.
- Diekema DJ, Jones RN: Oxazolidinones: a review. *Drugs* 59:7-16, 2000.
- Diekema DJ, Jones RN: Oxazolidinone antibiotics. *Lancet* 358:1975-1982, 2001.
- Diniz CG, Cara DC, Nicoli JR, et al: Effect of metronidazole on the pathogenicity of resistant *Bacteroides* strains in gnotobiotic mice. *Antimicrob Agents Chemother* 44:2419-2423, 2000.
- Doern GV, Ferraro MJ, Brueggeman AB, et al: Emergence of high rate of antimicrobial resistance among viridans group streptococci in the United States. *Antimicrob Agents Chemother* 40:891-894, 1996.
- Edson RS, Terrell CL: The aminoglycosides. *Mayo Clin Proc* 74:519-528, 1999.
- Enne VI, Livermore DM, Stephens P, et al: Persistence of sulphonamide resistance in *Escherichia coli* in the UK despite national prescribing restriction. *Lancet* 357:1325-1328, 2001.
- Erickson PR, Herzberg MC: Emergence of antibiotic resistant *Streptococcus sanguis* in dental plaque of children after frequent antibiotic therapy. *Pediatr Dent* 21:181-185, 1999.
- Erwin ME, Fix AM, Jones RN: Three independent yearly analyses of the spectrum and potency of metronidazole: a multicenter study of 1,108 contemporary anaerobic clinical isolates. *Diagn Microbiol Infect Dis* 39:129-132, 2001.
- Facts and comparisons*, St Louis, 2008, Facts and Comparisons.
- Falagas ME, Gorbach SL: Clindamycin and metronidazole. *Med Clin North Am* 79:845-867, 1995.
- Farber BF, Eliopoulos GM, Ward JI, et al: Multiply resistant viridans streptococci: susceptibility to β -lactam antibiotics and comparison of penicillin-binding protein patterns. *Antimicrob Agents Chemother* 24:702-705, 1983.
- Fontes RA, Ogilvie CM, Miclau T: Necrotizing: soft-tissue infections. *J Am Acad Orthop Surg* 8:151-158, 2000.
- Forge A, Schacht J: Aminoglycoside antibiotics. *Audiol Neurootol* 5:3-22, 2000.
- Headley AJ: Necrotizing soft tissue infections: a primary care review. *Am Family Physician* 68:323-329, 2003.
- Hellinger WC, Brewer NS: Carbapenems and monobactams: imipenem, meropenem, and aztreonam. *Mayo Clin Proc* 74:420-434, 1999.
- Herrera D, Roldan S, Sanz M: The periodontal abscess: a review. *J Clin Periodontol* 27:377-386, 2000.
- Herrera D, van Winkelhoff AJ, Delleimijn-Kippuw N, et al: β -lactamase producing bacteria in the subgingival microflora of adult patients with periodontitis: a comparison between Spain and The Netherlands. *J Clin Periodontol* 27:520-525, 2000.
- Hirschhorn LR, Trnka Y, Onderdonk A, et al: Epidemiology of community-acquired *Clostridium difficile*-associated diarrhea. *J Infect Dis* 169:127-133, 1994.
- Hoellman DB, Pankuch GA, Jacobs MR, et al: Antipneumococcal activities of GAR-936 (a new glycolcycline) compared to those of nine other agents against penicillin-susceptible and -resistant pneumococci. *Antimicrob Agents Chemother* 44:1085-1088, 2000.
- Hooper DC: Urinary tract agents: nitrofurantoin and methenamine. In Mandell GL, Bennett JE, Dolin R, editors: *Mandell, Douglas and Bennett's principles and practice of infectious diseases*, ed 5, Philadelphia, 2000, Churchill Livingstone.
- Hudson JW: Osteomyelitis of the jaws: a 50-year perspective. *J Oral Maxillofac Surg* 51:1294-1301, 1993.
- Huang T-T, Liu T-C, Chen P-R, et al: Deep neck infection: analysis of 185 cases. *Head Neck* 26:854-860, 2004.

47. Huang T-T, Tseng F-Y, Liu T-C, et al: Deep neck infection in diabetic patients: comparison of clinical picture and outcomes with non-diabetic patients. *Otolaryngol Head Neck Surg* 132:943-947, 2005.
48. Jick SS, Vasilakis C, Martinez C, et al: A study of the relation of exposure to quinolones and suicidal behavior. *Br J Clin Pharmacol* 45:77-81, 1998.
49. Jones RN, Wilson WR: Epidemiology, laboratory detection, and therapy of penicillin-resistant streptococcal infections. *Diag Microbiol Infect Dis* 31:453-459, 1998.
50. Karchmer AW: Cephalosporins. In Mandell GL, Bennett JF, Dolin R, editors: *Mandell, Douglas and Bennett's principles and practice of infectious diseases*, ed 5, Philadelphia, 2000, Churchill Livingstone.
51. Kelkar PS, Li JT: Cephalosporin allergy. *N Engl J Med* 345:804-809, 2001.
52. Klebanoff MA, Carey JC, Hauth JC, et al: Failure of metronidazole to prevent preterm delivery among pregnant women with asymptomatic *Trichomonas vaginalis* infection. *N Engl J Med* 345:487-493, 2001.
53. Kluytmans J, van Belkum A, Verbrugh H: Nasal carriage of *Staphylococcus aureus*: epidemiology, underlying mechanisms, and associated risks. *Clin Microbiol Rev* 10:505-520, 1997.
54. Kononen F, Saarela M, Kanervo A, et al: β -lactamase production and penicillin susceptibility among different ribotypes of *Prevotella melaninogenica* simultaneously colonizing the oral cavity. *Clin Infect Dis* 20(Suppl 2):S364-S366, 1995.
55. Kuriyama T, Karasawa T, Nakagawa K, et al: Bacteriologic features and antimicrobial susceptibility in isolates from orofacial odontogenic infections. *Oral Surg Oral Med Oral Pathol Oral Radiol Endod* 90:600-608, 2000.
56. Larsen T, Fiehn N-E: Development of resistance to metronidazole and minocycline in vitro. *J Clin Periodontol* 24:254-259, 1997.
57. Lee KH, Maiden MF, Tanner AC, et al: Microbiota of successful osseointegrated dental implants. *J Periodontol* 70:131-138, 1999.
58. Leung WK, Theilade E, Comfort MB, et al: Microbiology of the pericoronal pouch in mandibular third molar pericoronitis. *Oral Microbiol Immunol* 8:306-312, 1993.
59. Lew DP, Waldvogel FA: Osteomyelitis. *Lancet* 364:369-379, 2004.
60. Lewis MA, MacFarlane TW: Short-course high dosage amoxicillin in the treatment of acute dentoalveolar abscess. *Br Dent J* 162:175, 1987.
61. Lindqvist BH: Bacteriophage and gene transfer. *APMIS* 106(Suppl 84):15-18, 1998.
62. Listgarten MA, Lai C-H: Comparative microbiological characteristics of failing implants and periodontally diseased teeth. *J Periodontol* 70:431-437, 1999.
63. Lode H, Borner K, Koeppe P, et al: Azithromycin—a review of key chemical, pharmacokinetic and microbiological features. *J Antimicrob Chemother* 37:1-8, 1996.
64. Loebstein R, Addis A, Ho E, et al: Pregnancy outcome following gestational exposure to fluoroquinolones: a multicenter prospective controlled study. *Antimicrob Agents Chemother* 42:1336-1339, 1998.
65. Loesche WJ, Syed SA, Laughon BE, et al: The bacteriology of acute necrotizing ulcerative gingivitis. *J Periodontol* 53:223-230, 1982.
66. Macy E: Multiple antibiotic allergy syndrome. *Immunol Allergy Clin North Am* 24:533-543, 2004.
67. Marshall WF, Blair JE: The cephalosporins. *Mayo Clin Proc* 74:187-195, 1999.
68. Matto J, Asikainen S, Vaisanen M-L, et al: Role of *Porphyromonas gingivalis*, *Prevotella intermedia*, and *Prevotella nigrescens* in extraoral and some odontogenic infections. *Clin Infect Dis* 25(Suppl 2):S194-S198, 1997.
69. McDermott W, Rogers DE: Social ramifications of control of microbial diseases. *Johns Hopkins Med J* 151:302-312, 1982.
70. Moreland LW, Corey J, McKenzie R: Ludwig's angina: report of a case and review of the literature. *Arch Intern Med* 148:461-466, 1988.
71. Naber KG, Adam D: Classification of fluoroquinolones. *Int J Antimicrob Agents* 10:255-257, 1998.
72. Neu HC: Penicillins. In Mandell GL, Douglas RG Jr, Bennett JE, editors: *Principles and practice of infectious diseases*, ed 3, New York, 1990, Churchill Livingstone.
73. Newman MG, Sims TN: The predominant cultivable microbiota of the periodontal abscess. *J Periodontol* 50:350-354, 1979.
74. Nishi J, Yoshinaga M, Nomura Y: Prevalence of penicillin-resistant viridans streptococci in the oral flora of Japanese children at risk for endocarditis. *Circulation* 99:1274-1275, 1999.
75. Novak R, Henriques B, Charpentier E, et al: Emergence of vancomycin tolerance in *Streptococcus pneumoniae*. *Nature* 399:590-593, 1999.
76. Nyfors S, Kononen T, Takal A, et al: β -lactamase production by oral anaerobic gram-negative species in infants in relation to previous antimicrobial therapy. *Antimicrob Agents Chemother* 43:1591-1594, 1999.
77. Owens BM, Schuman NJ: Ludwig's angina. *Gen Dent* 42:84-87, 1994.
78. Owens RC Jr, Donsky CJ, Gaynes RF, et al: Antimicrobial-associated risk factors for *Clostridium difficile* infection. *Clin Infect Dis* 46:S19-S31, 2008.
79. Pallasch TJ: Antibiotics for acute orofacial infections. *J Calif Dent Assoc* 21:34-44, 1993.
80. Pallasch TJ: Pharmacokinetic principles of antimicrobial therapy. *Periodontol* 10:5-11, 1996.
81. Pallasch TJ: Principles of pharmacotherapy: III. Drug allergy. *Anesth Prog* 35:178-189, 1988.
82. Pallasch TJ, Slots J: Antibiotic prophylaxis and the medically compromised patient. *Periodontol* 10:107-138, 1996.
83. Pallasch TJ, Wahl MJ: Focal infection: new age of ancient history? *Endod Topics* 4:32-45, 2003.
84. Papaioannou W, Quirynen M, Nys M, et al: The effect of periodontal parameters on the subgingival microbiota around implants. *Clin Oral Implant Res* 6:197-204, 1995.
85. Pumphrey RS, Davis S: Under-reporting of antibiotic anaphylaxis may put patients at risk [letter]. *Lancet* 353:1157-1158, 1999.
86. Reinert RR, von Eiff C, Kresken M, et al: Nationwide German multicenter study on the prevalence of antibiotic resistance in streptococcal blood isolates from neutropenic patients and comparative in vitro activities of quinupristin/dalfopristin and eight other antimicrobials. *J Clin Microbiol* 39:1928-1931, 2001.
87. Reynolds SC, Chow AW: Life-threatening infections of the peripharyngeal and deep fascial spaces of head and neck. *Infect Dis Clin North Am* 21:557-576, 2007.
88. Robinson JL, Hameed T, Carr S: Practical aspects of choosing an antibiotic for patients with a reported allergy to an antibiotic. *Clin Infect Dis* 35:26-31, 2002.
89. Schlossberg D: Azithromycin and clarithromycin. *Med Clin North Am* 79:803-815, 1995.
90. Sefton AM, Maskell JP, Beighton D, et al: Azithromycin in the treatment of periodontal disease: effect on microbial flora. *J Clin Periodontol* 23:998-1003, 1996.
91. Solensky R, Earl HS, Gruchalla RS: Lack of penicillin resensitization in patients with a history of penicillin allergy after receiving repeated penicillin courses. *Arch Intern Med* 162:822-826, 2002.
92. Sorensen HT, Larsen H, Jensen ES, et al: Safety of metronidazole during pregnancy: a cohort study of risk of congenital abnormalities, preterm delivery, and low birth weight in 124 women. *J Antimicrob Chemother* 44:854-856, 1999.
93. Standiford HC: Tetracyclines and chloramphenicol. In Mandell GL, Bennett JE, Dolin R, editors: *Mandell, Douglas and Bennett's principles and practice of infectious diseases*, ed 5, Philadelphia, 2000, Churchill Livingstone.
94. Stergachis A, Perera DR, Schnell MM, et al: Antibiotic-associated colitis. *West J Med* 140:217-219, 1984.
95. Stevens AM, Shoemaker NB, Li LY, et al: Tetracycline regulation of genes on *Bacteroides* conjugative transposons. *J Bacteriol* 175:6134-6141, 1993.
96. Sulakvelidze A, Alavidze Z, Morris JG Jr: Bacteriophage therapy. *Antimicrob Agents Chemother* 45:649-659, 2001.
97. Suzuki J, Komatsuzawa H, Sugai M, et al: A long-term survey of methicillin-resistant *Staphylococcus aureus* in the oral cavity of children. *Microbiol Immunol* 41:681-686, 1997.
98. Tatro DS: *Drug interaction facts*, St Louis, 2001, Facts and Comparisons, Wolters Kluwer.

99. Teng L-J, Hsueh P-R, Chen Y-C, et al: Antimicrobial susceptibility of viridans group streptococci in Taiwan with an emphasis on the high rates of resistance to penicillin and macrolides in *Streptococcus oralis*. *J Antimicrob Chemother* 41:621-627, 1998.
100. Thalhammer F, Hollenstein UM, Locker GJ, et al: Azithromycin-related toxic effects of digitoxin. *Br J Clin Pharmacol* 45:91-92, 1998.
101. Trunidge JD: The pharmacodynamics of β -lactams. *Clin Infect Dis* 27:10-22, 1998.
102. Tunkel AR: Topical antibiotics. In Mandell GL, Bennett JF, Dolin R, editors: *Mandell, Douglas and Bennett's principles and practice of infectious diseases*, ed 5, Philadelphia, 2000, Churchill Livingstone.
103. Umeda M, Minamikawa T, Komatsubara H, et al: Necrotizing fasciitis caused by dental infection: a retrospective analysis of 9 cases and a review of the literature. *Oral Surg Oral Med Oral Path Oral Radiol Endod* 95:283-290, 2003.
104. van der Linden PD, van Puijenbroek EP, Feenstra J, et al: Tendon disorders attributed to fluoroquinolones: a study of 42 spontaneous reports in the period 1988 to 1998. *Arthritis Rheum Care Res* 45:235-239, 2001.
105. Van Winkelhoff AJ, Tjihof CJ, De Graaff J: Microbiological and clinical results of metronidazole plus amoxicillin therapy in *Actinobacillus actinomycetemcomitans*-associated periodontitis. *J Periodontol* 63:52-57, 1992.
106. Vermeulen GM, Bruinse HW: Prophylactic administration of clindamycin 2% vaginal cream to reduce the incidence of spontaneous preterm birth in women with an increased recurrence risk: a randomised placebo-controlled double-blind trial. *Br J Obstet Gynaecol* 106:652-657, 1999.
107. Walker CB: The acquisition of antibiotic resistance in the periodontal microflora. *Periodontol* 2000 10:79-88, 1996.
108. Walker RC: The fluoroquinolones. *Mayo Clin Proc* 74:1030-1037, 1999.
109. Wilhelm MP, Estes L: Symposium on antimicrobial agents, part XII: vancomycin. *Mayo Clin Proc* 74:928-935, 1999.
110. Wright AJ: The penicillins. *Mayo Clin Proc* 74:290-307, 1999.
111. Yao JDC, Moellering RC Jr: Antibacterial agents. In Murray PR, Baron EJ, Pfaller MA, et al, editors: *Manual of clinical microbiology*, ed 7, Washington, DC, 1999, American Society for Microbiology Press.
112. Yassin HM, Dever LL: Telithromycin: a new ketolide antimicrobial for treatment of respiratory tract infections. *Expert Opin Invest Drugs* 10:353-367, 2001.
113. Zilberberg MD, Shore AF, Kollef MH: Increase in adult *Clostridium difficile*-related hospitalizations and case-fatality rate, United States, 2000-2005. *Emerg Infect Dis* 14:929-931, 2008.

Antifungal and Antiviral Agents

NO-HEE PARK AND MO K. KANG

Although the management of systemic fungal and viral diseases lies within the realm of medicine, the dentist is called on to treat localized and superficial lesions in and around the oral cavity. This chapter discusses drugs that are useful in the management of such localized lesions and drugs whose use may indicate that a patient has a potentially communicable disease, a defective immune response, or both.

ANTIFUNGAL AGENTS

Fungal diseases may take the form of superficial infestations involving the skin or mucous membranes or systemic (deep) infections involving various internal organs. Superficial mycoses are generally managed with topical drugs. Topical agents discussed in this chapter are agents with activity against mucocutaneous infections caused by *Candida albicans*, the fungus most commonly observed in oral lesions. Often these infections are benign, as in denture stomatitis, but they may indicate a serious medical condition, such as immunodeficiency.

Systemic fungal infections are subdivided into two groups according to the status of the patient and the type of infecting organism. Opportunistic mycoses occur in debilitated and immunocompromised patients, such as patients with acquired immunodeficiency syndrome (AIDS), leukemia, or lymphoma, and in patients who are receiving immunosuppressive agents or broad-spectrum antibiotics. Fungi involved include *Candida*, *Aspergillus*, and *Cryptococcus* species and various *Phycomycetes*. They are particularly dangerous and carry a high mortality rate.⁵⁹ Endemic mycoses are caused by various pathogens distributed unevenly throughout the world and have a low incidence in temperate climates. Examples of endemic mycoses that occur in the United States include blastomycosis, histoplasmosis, coccidioidomycosis, and sporotrichosis.

A number of antifungal agents have been developed (Table 40-1). Two polyene antibiotics are amphotericin B, an important drug for many deep mycoses,¹ and nystatin, an agent useful in the treatment of oral candidiasis. A third polyene, natamycin, is limited to ophthalmologic use. Miconazole, ketoconazole, and clotrimazole are representative imidazole antifungals. First introduced in 1981, ketoconazole was a major advance in systemic antifungal therapy. Clotrimazole has become a widely used topical agent. Itraconazole and fluconazole are triazole derivatives. Voriconazole and posaconazole are newer additions to the broad-spectrum triazoles that are valuable for severe fungal infections in immunocompromised patients. A new class of antifungals known as *echinocandins* comprises caspofungin, micafungin, and anidulafungin;

these agents exhibit fungicidal activities against many fungal isolates.

Other antifungal drugs include flucytosine, tolnaftate, and griseofulvin. Flucytosine is a pyrimidine analogue used infrequently as a single agent but commonly used with amphotericin B for severe fungal infections. Tolnaftate is a thiocarbamate used as a topical agent for dermatophytosis. Griseofulvin is also effective against dermatophytosis and has a unique mechanism of action in binding to keratin in human skin and to microtubules of dermatophytes, inhibiting the fungal cell mitosis.

Polyene Antifungal Drugs

Polyene antifungal drugs consist primarily of amphotericin B and nystatin, which are among the earliest antifungal drugs that became available for clinical uses. These drugs show a wide spectrum of antifungal activity against common superficial and deep fungal infections, such as candidiasis, aspergillosis, zygomycosis, and cryptococcosis.²⁴ The primary mode of their antifungal activity results from binding to ergosterol, a component of the cell membrane of sensitive fungi.⁴⁹ This binding forms channels in the cell membrane, altering its permeability and causing leakage of Na⁺, K⁺, and H⁺ ions. Polyenes also bind to a lesser extent to cholesterol of mammalian plasma membrane, which accounts for most of the toxicity associated with the systemic use of amphotericin B. In addition, amphotericin B may stimulate the function of host macrophages, and this immunomodulation is mediated by the oxidized form of amphotericin B.¹⁵ Finally, amphotericin B increases the ability of *C. albicans* to induce the synthesis of tumor necrosis factor- α .⁸⁸ Resistance to polyenes is associated with a replacement of ergosterol with other sterols in the fungal plasma membrane. A parallel decline in virulence generally occurs, however, and resistance has not been a problem clinically except for rare instances involving *Candida* species other than *C. albicans*.

Amphotericin B

Amphotericin B is an antifungal agent obtained from *Streptomyces nodosus*, an actinomyces found in the soil. It is a member of the polyene family of antibiotics, so called because their structure contains a large lactone (macrolide) ring with numerous conjugated double bonds (Figure 40-1). The polar hydroxylated portion and the nonpolar hydrocarbon sequence lend an amphiphilic character to the molecule. Polyenes are unstable in solution because of the unsaturated chromophore region, which is easily photo-oxidized. Amphotericin B exerts either fungistatic or fungicidal activity depending on the concentration of the drug, the pH, and the fungus involved. Peak activity occurs at a pH between 6.0 and 7.5. Amphotericin B

TABLE 40-1

Mechanisms of Action and Clinical Uses of Some Antifungal Agents

ANTIFUNGAL AGENT	MECHANISM OF ACTION	CLINICAL USES
Amphotericin B	Binding to ergosterol of fungal membrane	<i>Topical:</i> superficial candidiasis; <i>intravenous:</i> severe, progressive systemic fungal infection*
Nystatin	Binding to ergosterol of fungal membrane	<i>Topical:</i> oral candidiasis
Clotrimazole	Inhibition of ergosterol synthesis	<i>Topical:</i> oral candidiasis, superficial fungal infections [†]
Fluconazole	Inhibition of ergosterol synthesis	<i>Oral and intravenous:</i> systemic and localized candidiasis, cryptococcal meningitis, systemic blastomycosis, coccidioidomycosis, and histoplasmosis
Itraconazole	Inhibition of ergosterol synthesis	<i>Oral:</i> systemic fungal infections,* dermatophyte infections and sporotrichosis
Miconazole	Inhibition of ergosterol synthesis	<i>Topical:</i> cutaneous candidiasis and vulvovaginitis, superficial fungal infections [†]
Flucytosine	Inhibition of nucleic acid synthesis	<i>Oral:</i> systemic candidiasis and cryptococcosis
Griseofulvin	Disruption of mitotic spindle	<i>Oral:</i> dermatophyte infections of skin, hair, and nails
Caspofungin	Inhibition of fungal cell wall synthesis	<i>Intravenous:</i> severe, invasive aspergillosis, esophageal candidiasis, candidemia
Micafungin	Inhibition of fungal cell wall synthesis	<i>Intravenous:</i> prophylactic antifungal therapy in neutropenic HSCT patients, esophageal candidiasis, candidemia
Anidulafungin	Inhibition of fungal cell wall synthesis	<i>Intravenous:</i> esophageal candidiasis, candidemia
Terbinafine	Inhibition of ergosterol synthesis	<i>Oral and topical:</i> dermatophyte infections of skin, hair, and nails, and sporotrichosis

*Systemic fungal infections include aspergillosis, blastomycosis, candidiasis, chromomycosis, cryptococcosis, coccidioidomycosis, histoplasmosis, paracoccidioidomycosis, phycosporidiosis, and sporotrichosis. Indications for specific drugs vary.

[†]Superficial fungal infections caused by pathogenic dermatophytes, yeasts, and *Malassezia furfur*.

HSCT, Hematopoietic stem cell transplantation.

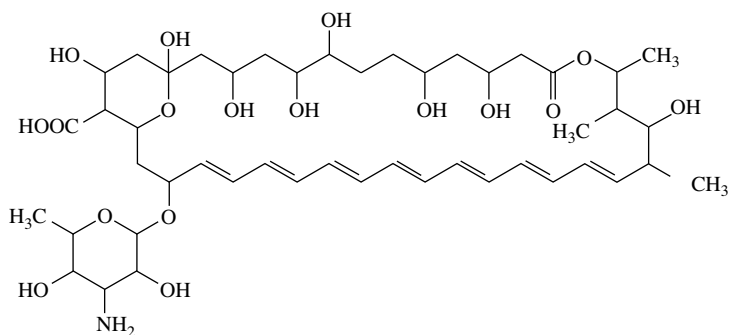

Amphotericin B

Nystatin A₁

FIGURE 40-1 Structural formulas of polyene antifungal agents. Nystatin A₁ is one of three compounds found in the commercial nystatin preparation.

has a broad spectrum of antifungal activity and is effective against *Candida* species, *Histoplasma capsulatum*, *Cryptococcus neoformans*, and *Coccidioides immitis*.

Amphotericin B is not absorbed from the skin or mucous membranes and is poorly and inconsistently absorbed from the gastrointestinal tract. Because of its insolubility in an

aqueous medium, the drug is reconstituted in a solution of the bile salt deoxycholate immediately before use. For systemic infections, amphotericin B is administered by slow intravenous infusion (over 2 to 6 hours each day). The drug is bound in plasma to various lipoproteins and in tissues to cholesterol-containing membranes. More recent studies

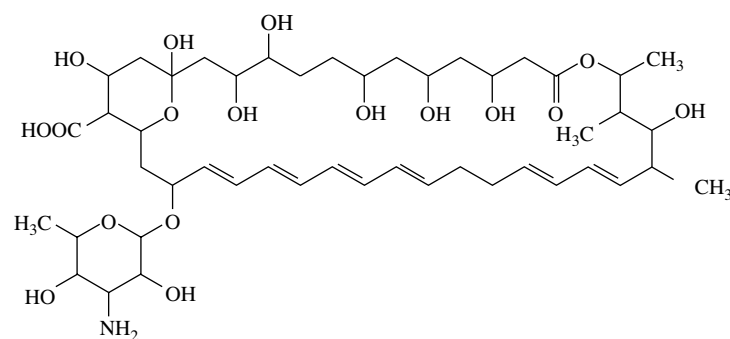
showed that amphotericin B lipid complex or liposomal amphotericin B preparations could be used for systemic infections, particularly in premature infants and other immunocompromised patients.⁵⁰ Amphotericin B can also be prepared in colloidal dispersion with sodium cholesteryl sulfate in a 1:1 discoidal complex. Colloidal amphotericin B showed reduced peak plasma levels, prolonged residence time, and reduced renal toxicity and hepatotoxicity compared with conventional amphotericin B preparations.⁴¹

The exact metabolic pathway of amphotericin B is unknown, but most of the drug is biotransformed and slowly excreted by the kidney over the next 2 months. The plasma concentration of amphotericin B is unaffected by renal disease; no dosage adjustment needs to be made in patients with compromised renal function. Amphotericin B applied topically as a 3% cream, ointment, or lotion is useful in the treatment of superficial *Candida* infections. Because *C. albicans* infection can readily occur in patients receiving broad-spectrum antibiotics, these agents are sometimes administered with amphotericin B or nystatin. The efficacy of fixed-ratio combinations has not been proven, however, and does not reflect sound therapy.

The only adverse effects accompanying the topical application or oral administration of amphotericin B are local irritation and mild gastrointestinal disturbances. As an intravenous agent, however, amphotericin B is the most toxic antibiotic in current use. Intravenous amphotericin B causes many side effects, including hypotension, delirium, fever, nausea, vomiting, abdominal pain, anorexia, headache, and thrombophlebitis. Hypochromic, normocytic anemia is induced by amphotericin B, and leukopenia and thrombocytopenia occur rarely. Allergic reactions of all types have been reported, including anaphylaxis. All patients receiving intravenous amphotericin B show some degree of nephrotoxicity, which may lead to discontinuation of therapy. Permanent damage of the kidneys does not occur, however, in patients receiving a cumulative dosage of less than 4 g during a normal therapeutic interval of several weeks. Great caution should be exercised when amphotericin B is used with other nephrotoxic drugs. Because amphotericin B can cause hypokalemia, it can increase digitalis toxicity. The toxic effects of cyclosporine may also be increased.

Nystatin

Nystatin is a polyene antibiotic obtained from *Streptomyces noursei*. Its structure is similar to the structure of amphotericin B (see Figure 40-1). Nystatin is relatively insoluble in water and unstable except as a dry powder.

Nystatin has a spectrum of activity slightly narrower than that of amphotericin B, but is nevertheless active against many species of *Candida*; *Histoplasma*; *Cryptococcus*; *Blastomyces*; and the dermatophytes *Epidermophyton*, *Trichophyton*, and *Microsporium*. Similar to amphotericin B, nystatin is either fungistatic or fungicidal depending on the concentration of the drug present, the pH of the surrounding medium, and the nature of the infecting organism. The mechanism of action of nystatin is also similar to that of amphotericin B. In vitro, some species of *Candida*, such as *Candida tropicalis*, can develop resistance to nystatin, but resistance is rarely observed clinically.

Nystatin is not appreciably absorbed from the skin, mucous membranes, or gastrointestinal tract. After oral administration, the bulk of the administered dose appears unchanged in the feces. Because of unacceptable systemic toxicity, nystatin is never given parenterally. A newer form of nystatin encapsulated in liposomes showed reduced systemic cytotoxicity, however, making it an active systemic antifungal agent.³⁸ Also, liposomal nystatin has been suggested to target *Candida* species that are resistant to amphotericin B.¹⁰

Nystatin is used primarily to treat candidal infections of the mucosa, skin, intestinal tract, and vagina. Although the efficacy of oral nystatin for enteric candidiasis has been questioned, topical nystatin remains a drug of choice for the treatment of candidal infections of the oral cavity (oral moniliasis, thrush, denture stomatitis). It has also been used prophylactically in immunocompromised patients.⁶⁴ To treat oral candidiasis, 2 to 3 mL of a suspension containing 100,000 U/mL of nystatin is placed in the mouth, swished, and held for at least 5 minutes before swallowing. This regimen is repeated every 6 hours for at least 10 days or for 48 hours after remission of symptoms. Alternatively, 1 to 2 lozenges (200,000 U per each) may be used four to five times per day. For denture stomatitis, nystatin ointment (100,000 U/g) can be applied topically every 6 hours to the tissue surface of the denture.

Nystatin is well tolerated. Only mild and transient gastrointestinal disturbances, such as nausea, vomiting, and diarrhea, have occurred after oral ingestion. The major complaint associated with nystatin is its bitter, foul taste.

Imidazole and Triazole Antifungal Drugs

Imidazoles and triazoles (together called *azoles*) are synthetic compounds that belong to the azole class of antifungal drugs. The antifungal spectrum of azole antifungal drugs is broad, including yeasts, dermatophytes, and various species of *Histoplasma*, *Coccidioides*, *Paracoccidioides*, *Cladosporium*, *Phialophora*, *Blastomyces*, and *Aspergillus*. Although the mode of action is not fully established, it is known that azoles inhibit an enzyme involved in the synthesis of fungal ergosterol. More specifically, one of the nitrogen atoms of the azole ring binds to the heme moiety of the fungal cytochrome P450 enzyme lanosterol 14- α -demethylase, inhibiting the conversion of lanosterol to ergosterol.²⁵ The addition of ergosterol fails to reverse the antifungal effect in vitro, however, and other mechanisms must be invoked to explain the activity of these compounds against several protozoa and bacteria in which ergosterol is not an important membrane constituent. The addition of 14- α -methyl sterols such as lanosterol, whose concentrations increase as a result of azole therapy, may disrupt cell membranes even in the presence of ergosterol.

Other antifungal actions ascribed to ketoconazole and similar drugs, perhaps related to the changes caused by lanosterol, include inhibition of purine transport, interference with mitochondrial respiration, and alteration of the composition of nonsterol membrane lipids. Acquired resistance to imidazoles has not been a significant problem clinically; however, it can develop in *C. albicans*.⁸² Refractory mucosal candidiasis in immunocompromised patients has been ascribed to the *Candida* species with cross-resistance to clotrimazole and other azole compounds.⁶⁵

Ketoconazole

Ketoconazole (Figure 40-2) is rarely used because of its toxicity and the availability of other azoles. Ketoconazole was the first oral antifungal agent to be approved for the treatment of deep systemic mycoses. It is well absorbed from the gastrointestinal tract, provided that the stomach content is acidic. Drugs that increase gastric pH, such as antacids and H₂ anti-histamines, markedly reduce its absorption.⁵⁴ It should be reserved for cases refractory to other therapy.^{11,66,80}

The drug should be used cautiously because severe hepatotoxicity occurs in approximately 0.01% of individuals. Ketoconazole markedly inhibits the synthesis of testosterone and estradiol, which may lead to gynecostasia and menstrual irregularities. Alterations of adrenal steroid synthesis may also occur. Ketoconazole inhibits the metabolism of cyclosporine, phenytoin, sulfonyleureas, warfarin, and several other drugs. Isoniazid increases the metabolism of ketoconazole.

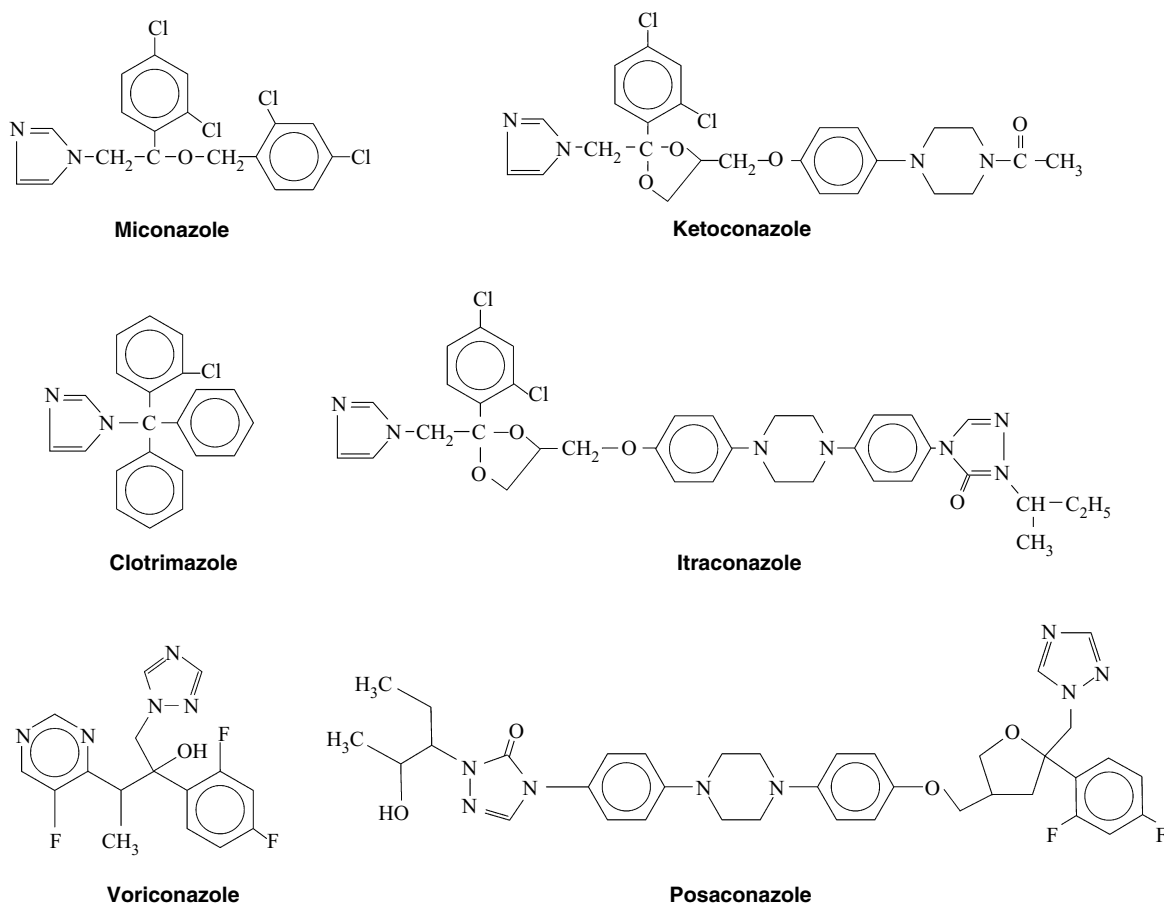

FIGURE 40-2 Structural formulas of several imidazole and triazole antifungal agents.

Miconazole

Miconazole (see Figure 40-2) was the first imidazole antifungal drug to be approved for topical and parenteral use. It is no longer used systemically. Cutaneous candidiasis and vulvovaginitis caused by *C. albicans* respond rapidly and reliably to 2% miconazole nitrate cream. Oral candidiasis is also effectively treated; however, a specific formulation for intraoral use is unavailable. Other topical uses of miconazole are treatment of cutaneous dermatophyte infections caused by *Epidermophyton*, *Microsporum*, and *Trichophyton*. Untoward effects after topical administration of miconazole are rare, but burning, skin maceration, itching, and redness can develop.

Clotrimazole

Clotrimazole is an imidazole antifungal drug used for various mucosal and cutaneous infections. The antifungal spectrum and mechanism of action are similar to other azoles. Clotrimazole is restricted to topical use. A preparation specifically suited for intraoral application is marketed.

For treatment of oral candidiasis, clotrimazole is available as a 10-mg troche. Slow dissolution in the mouth results in the binding of clotrimazole to the oral mucosa, from which it is gradually released to maintain at least fungistatic concentrations for several hours. The swallowed drug is variably but poorly absorbed. It is metabolized in the liver and eliminated in the feces along with the unabsorbed drug.

One troche dissolved in the mouth five times a day for 2 weeks is the standard regimen for oropharyngeal candidiasis. Patient compliance is believed to be enhanced by the more pleasant taste of clotrimazole compared with nystatin. Clotrimazole also seems to be useful for the topical treatment

of oral candidiasis in patients with AIDS.^{80,88,89} For cutaneous candidiasis and dermatophytoses, a 1% cream or lotion is equivalent to topical miconazole.

Irritation associated with topical clotrimazole, although unlikely, is qualitatively similar to the irritation described in association with miconazole. Occasionally, minor gastrointestinal upset may follow oral ingestion of the drug.

Itraconazole

Itraconazole is a water-insoluble triazole compound that shows a broader spectrum of antifungal activity and a faster clinical effect compared with some other azoles. Similar to ketoconazole, itraconazole is well absorbed from the gastrointestinal tract when it is given with meals. It is highly bound to plasma proteins (>99%) and has a long half-life (approximately 20 hours after a single dose, ≤60 hours at steady state). Although the concentrations of itraconazole in saliva and cerebrospinal fluid are negligible, tissue concentrations are two to five times higher than that of plasma. The drug is mostly metabolized in the liver and partially eliminated in the bile.

When given in therapeutic doses, itraconazole exerts effective antifungal activity against paracoccidioidomycosis, blastomycosis, aspergillosis, histoplasmosis, sporotrichosis, candidiasis, and various dermatophytoses. Previous studies show that itraconazole is effective for suppressive therapy and primary treatment of histoplasmosis in patients seropositive for human immunodeficiency virus (HIV).^{55,83} Drug interactions are qualitatively similar to those noted for ketoconazole, but occur less frequently. Itraconazole and related triazoles are more specific for fungal 14- α -demethylase, however, and

do not affect mammalian steroid metabolism as greatly.²³ Adverse effects include rashes, hepatotoxicity, hypokalemia, hypertension, and heart failure in susceptible patients.

Fluconazole

Fluconazole is a water-insoluble, fluorine-substituted bistrizazole with effective antifungal activity in immunocompetent and immunocompromised patients. Fluconazole is significantly less potent as an inhibitor of mammalian steroid synthesis, indicating more specific antifungal actions than ketoconazole. It is well absorbed from the gastrointestinal tract (the drug is also available for intravenous injection), weakly bound to plasma proteins (12%), and well distributed throughout the body. Peak plasma concentrations are reached within 2 hours after oral administration; concentrations in the cerebrospinal fluid are generally more than 50% of the corresponding plasma values. Fluconazole has a long plasma half-life of 20 to 50 hours in adults and approximately 17 hours in children. Fluconazole is excreted largely unchanged in the kidney.

Fluconazole is active in suppressive therapy and primary treatment of cryptococcal meningitis, which may occur in patients with AIDS.⁴⁶ It is effective in the treatment of mucosal candidiasis, including oropharyngeal and esophageal candidiasis.¹¹ Weekly use of fluconazole was suggested to have prophylactic value against mucosal candidiasis in HIV-seropositive patients.⁷¹ It is also used in the primary treatment of coccidioid meningitis and treatment of blastomycosis and histoplasmosis. In one study, fluconazole was found to be more effective against oral candidiasis than nystatin in immunocompromised children.³⁷ It may also be effective in candidiasis resistant to polyenes and imidazoles.⁵⁷

Nausea, vomiting, gastric pain, headache, and rashes are the most common adverse effects. Increases in serum transaminases have been reported in less than 5% of individuals receiving fluconazole. Seizures, anaphylaxis, and exfoliative dermatitis occur rarely. The drug interactions generally resemble those of itraconazole, but to a lesser degree. Gastric pH has little effect on the oral absorption of fluconazole (antacids and H₂ antihistamines do not interact).

Other imidazoles and triazoles

Terconazole, a member of the triazole antifungal drugs, is supplied in a vaginal suppository for vaginal candidiasis. Butoconazole and tioconazole are imidazoles that are also used topically for vulvovaginitis. Oxiconazole and sulconazole are used topically for infections caused by dermatophytes. Econazole is another imidazole derivative that is used topically for the treatment of dermatophyte and *Candida* infections.

Voriconazole and posaconazole have been developed more recently and represent a new generation of triazole antifungals with enhanced pharmacologic properties. These drugs show broad-spectrum fungicidal activity against molds and fungistatic activity against *Candida* and other yeasts.⁴⁸ Voriconazole is a derivative of fluconazole exhibiting increased antifungal activity and specificity. It is the drug of choice for the treatment of invasive aspergillosis caused by *Aspergillus terreus*, which is increasingly observed as a pathogen in immunocompromised patients.⁷⁴ Voriconazole is also effective against dimorphic fungi (*Histoplasma*, *Coccidioides*, and *Blastomyces* species), yeasts (*Candida krusei*, *Candida glabrata*, *C. neoformans*, and *Tricosporon asahii*), and pathogenic molds (*Fusarium* and *Scedosporium* species).⁴⁰ Adverse side effects of voriconazole include erythematous rash, visual disturbances, hepatotoxicity, and headache.⁴⁷ Voriconazole is considered a safer alternative to other antifungals such as amphotericin B for patients at risk of renal dysfunction or receiving concurrent administration of nephrotoxic drugs.⁸¹

Posaconazole is a newer addition to the antifungal triazoles that structurally resembles itraconazole (see Figure

40-2). The antifungal spectrum of posaconazole is similar to that of voriconazole except that its potential therapeutic efficacy has also been shown against Zygomycetes (e.g., *Rhizopus*, *Absidia*, and *Mucor* species).²⁷ Voriconazole and posaconazole are effective against a wide variety of *Candida* species. In particular, voriconazole administration led to a higher success rate against *C. tropicalis* compared with amphotericin B and fluconazole.⁵² Posaconazole was found to be as effective as fluconazole for the treatment of oropharyngeal candidiasis in patients infected with HIV and led to fewer incidences of clinical relapse.⁷⁹ Posaconazole may have extensive uses in dentistry in the future.

Echinocandin Antifungal Drugs

Echinocandins are a new class of antifungal drugs approved recently by the U.S. Food and Drug Administration (FDA) (Figure 40-3). Their unique mechanism of drug action involves noncompetitive inhibition of synthesis of 1,3- β -D-glucan linkages in fungal cell walls.¹⁴ The 1,3- β -D-glucan linkages are crucial for fungal cell wall synthesis and maintaining the osmotic balance. Echinocandins currently available for clinical uses include caspofungin, micafungin, and anidulafungin. Echinocandins are especially useful for treating candidal esophagitis and candidemia and *Aspergillus* infections, for empiric treatments of febrile neutropenia, and for antifungal prophylaxis in hematopoietic stem cell transplant (HSCT) recipients.⁶⁰ Caspofungin is also approved for treatment of invasive aspergillosis in patients who are refractory to other antifungal drugs. No echinocandins are approved for pediatric patients.

Caspofungin

Caspofungin (see Figure 40-3) is derived from the fermented by-product of *Glarea lozoyensis*. It is the first echinocandin approved by the FDA for clinical use. It is an echinocandin with antifungal activity against a wide variety of fungal pathogens, including *Candida*,⁸ *Pneumocystis*, *Aspergillus*, and *Histoplasma* species. Caspofungin disrupts the formation of the fungal cell wall by inhibiting the enzyme 1,3- β -D-glucan synthase, which is necessary for β (1,3)-D-glucan polymerization in filamentous fungi. Because this mechanism of action differs from those of amphotericin B and the azole compounds, combination therapy using caspofungin with other antifungal agents has been suggested and has yielded synergistic effects against cryptococcal species.³⁰ Caspofungin showed higher therapeutic efficacy against candidal infections compared with amphotericin B in immunocompromised patients.^{15,44}

Caspofungin is of particular importance in patients with life-threatening systemic fungal infection who cannot tolerate amphotericin B or azole therapy; it is generally well tolerated when administered parenterally. The manufacturer recommends intravenous infusion of 70 mg of caspofungin acetate for the first day, followed by 50 mg/day thereafter. Common adverse effects resemble histamine-mediated symptoms, such as rash, facial swelling, pruritus, or sensation of warmth. One case of anaphylaxis was also reported with the initial administration of the drug.

Micafungin

Micafungin is a synthetic derivative of lipopeptides isolated from *Coleophoma empetri*. It is approved for therapeutic use against esophageal candidiasis and for chemoprophylaxis against candidiasis in neutropenic patients undergoing HSCT.⁶⁰ Fluconazole has been the primary drug of choice for chemoprophylaxis against candidiasis and aspergillosis in HSCT patients. A comparative phase III clinical trial of antifungal prophylactic efficacy showed superior results, however, with micafungin compared with fluconazole.⁷⁷ Among 889 adult and pediatric patients enrolled for HSCT, 50 mg of

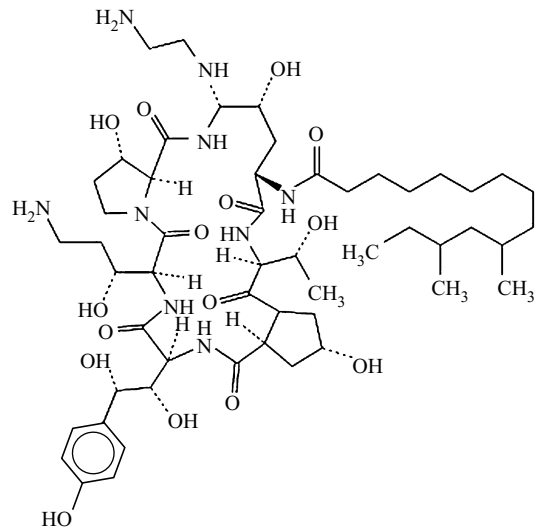

caspofungin

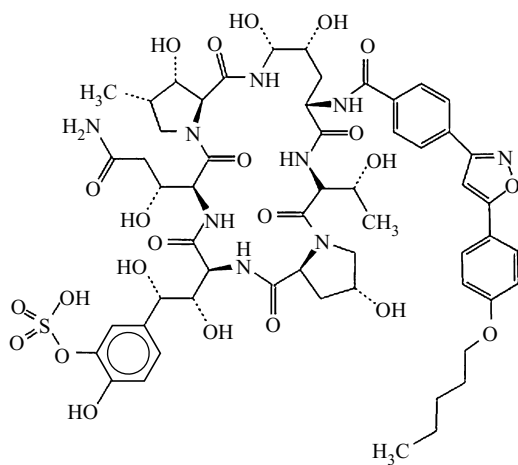

micafungin

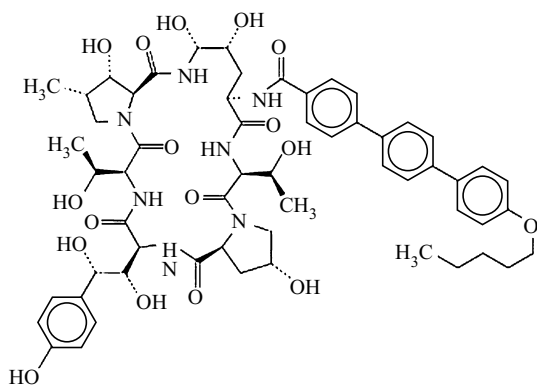

anidulafungin

FIGURE 40-3 Structural formula of echinocandin antifungals.

miconazole administered daily to patients yielded an 80% success rate versus 73.5% in patients who received 400 mg daily dose of fluconazole. Also, the patients receiving micafungin prophylaxis reported fewer side effects and fewer incidences of discontinued therapy compared with patients receiving fluconazole prophylaxis.

Micafungin was found to be as effective as fluconazole against esophageal candidiasis with a similar spectrum of adverse effects in HIV patients.²⁹ A more recent study also showed a comparable level of therapeutic efficacy of micafungin against candidemia and invasive candidiasis as liposomal amphotericin B when both drugs were delivered as an intravenous infusion.⁵³ Compared with amphotericin B, micafungin treatment led to significantly fewer adverse effects, such as hypokalemia, rigors, back pain, infusion-related reactions, and nephrotoxicity. Micafungin is considered a well-tolerated addition to the antifungal armamentarium. Micafungin is given at a daily infusion dose of 150 mg for esophageal candidiasis and 50 mg for antifungal prophylaxis.

Anidulafungin

Anidulafungin is derived from *Aspergillus nidulans*. It is the newest addition to echinocandin antifungals approved for esophageal candidiasis, candidemia, and invasive candidiasis. Anidulafungin showed potent and broad antifungal activity against *Candida* and *Aspergillus* species, including species resistant to fluconazole.⁶⁷ Compared with azole antifungals, anidulafungin was more effective in vitro against *C. albicans*, *C. tropicalis*, *C. glabrata*, and *C. krusei*, but not *Candida famata* and *Candida parapsilosis*.⁹ Anidulafungin was also more effective than caspofungin against *Aspergillus*.⁶⁸ Large-scale clinical trials confirmed the therapeutic efficacy of anidulafungin against invasive candidiasis compared with fluconazole.⁶⁹ Anidulafungin is given by intravenous infusion as a 100-mg daily maintenance dose for invasive candidiasis and 50-mg daily dose for esophageal candidiasis. A loading dose is also recommended for the first day of treatment.

Other Antifungal Drugs

In addition to the aforementioned antifungal drugs, several other antifungal drugs with different and unique mechanisms of action are discussed next: flucytosine, thiocarbamates (tolnaftate and tolnaftate), allylamines (naftifine and terbinafine), and griseofulvin. Flucytosine is used in combination therapy for severe systemic mycosis. Thiocarbamates, allylamines, and griseofulvin are primarily indicated for dermatophytosis as topical or systemic agents.

Flucytosine

Flucytosine, a fluorinated analogue of cytosine (5-fluorocytosine) (Figure 40-4), is a synthetic antimycotic agent orally effective in the treatment of systemic fungal infections, in particular infections caused by yeasts. Flucytosine has a limited antifungal spectrum compared with amphotericin B and is mainly effective against *Candida* and *Cryptococcus*. It is also active against some species of *Cladosporium*

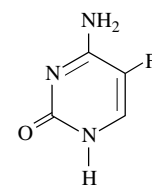

Flucytosine

FIGURE 40-4 Structural formula of flucytosine.

and *Phialophora*, the latter being etiologic agents for chromoblastomycosis.

Flucytosine is taken up into sensitive fungal cells by cytosine permease, where it is converted to 5-fluorouracil by cytosine deaminase. The 5-fluorouracil is metabolized further to yield 5-fluorodeoxyuridine monophosphate, a competitive inhibitor of thymidylate synthetase. The formation of thymidine monophosphate from deoxyuridine monophosphate is blocked, and the synthesis of DNA is impaired; 5-fluorouridine triphosphate is also formed in fungal cells, leading to the synthesis of defective RNA. Selective toxicity against fungi is achieved with flucytosine because mammalian cells do not readily take up the drug or convert it to 5-fluorouracil.

Flucytosine is indicated for the treatment of systemic candidiasis and cryptococcosis; however, resistance to flucytosine frequently develops during therapy of these infections. Mechanisms of resistance include decreased flucytosine uptake by fungal cells (altered permease) and decreased synthesis of active nucleotide metabolites (decreased deaminase and other enzyme activities). Flucytosine is normally used in combination with amphotericin B, which seems to increase fungal uptake of flucytosine and to result in synergistic effects against certain fungal diseases. Perhaps more important, coadministration permits reduction in the dose of amphotericin B.

Flucytosine is well absorbed from the gastrointestinal tract, and the peak plasma concentration is attained within 1 to 2 hours after oral administration. The drug is widely distributed throughout the body; it attains a concentration in cerebrospinal fluid approximately 65% to 90% that of the plasma. Flucytosine has a half-life of 3 to 6 hours and is excreted unchanged in the urine.

The major toxicity of flucytosine is depression of the bone marrow, resulting in anemia, leukopenia, and thrombocytopenia. This effect is dose-related and is reversible. Because flucytosine is excreted mainly through the kidneys, it is advisable to measure the plasma concentration of the drug periodically, especially because it is normally given with the highly nephrotoxic amphotericin B. An elevation of hepatic enzymes in plasma and hepatomegaly occurs in approximately 5% of patients receiving flucytosine. Lastly, flucytosine may cause nausea, vomiting, diarrhea, and (rarely) severe enterocolitis. These toxic effects may result from the formation and release of 5-fluorouracil by fungi and intestinal microbes.

Tolnaftate and allylamine antifungal drugs

Tolnaftate is a thiocarbamate that is commonly used as a topical antifungal agent against mild-moderate superficial fungal infection in skin and toenails, such as tinea pedis, tinea cruris, tinea corporis, tinea manuum, and tinea versicolor. Susceptible dermatophytes include *Malassezia furfur*, *Epidermophyton floccosum*, *Trichophyton mentagrophytes*, *Trichophyton tonsurans*, and *Microsporum canis*. However, tolinaftate is generally ineffective against yeasts, however, such as *C. albicans*.¹² Adverse effects associated with the topical use of tolinaftate are generally mild and could involve allergic contact dermatitis. Possible teratogenic effects of tolinaftate spray use during pregnancy have been suggested²⁶ and need further investigation for conclusive results.

The mechanism of action of tolinaftate involves noncompetitive inhibition of fungal squalene epoxidase, which is a membrane-bound enzyme necessary for conversion of acetate to sterols and biosynthesis of ergosterol. This mechanism of drug action is shared by another class of antifungals known as *allylamines*, which include naftifine and terbinafine. Terbinafine is effective against dermatophytes (*Microsporum*, *Trichophyton*, and *Epidermophyton* species) and molds (*Aspergillus*

and *Scopulariopsis* species).³⁹ Terbinafine is highly lipophilic and keratophilic and accumulates in the stratum corneum of skin and nails. Similar to thiocarbamate antifungals, allylamine agents are used effectively for dermatophytosis of skin and nails. The adverse effects of terbinafine include mild and transient forms of gastrointestinal symptoms, rash, urticaria, pruritus, and neutropenia, but the drug is generally well tolerated. Terbinafine is used orally and topically, whereas naftifine is used only topically.

Griseofulvin

Griseofulvin was first isolated from *Penicillium griseofulvum dierckx* in 1939, but its antifungal activity was unknown until 1946. It exerts a fungistatic effect against *Microsporum*, *Epidermophyton*, and *Trichophyton* species that infect skin, hair, and nails. Griseofulvin interacts with polymerized microtubules, causing the disruption of the mitotic spindle and eventually fungal mitosis.

Griseofulvin is variably absorbed from the gastrointestinal tract; micronization of the primary drug particles (see Chapter 2) and ingestion with a fatty meal improve bioavailability. Although most of the absorbed drug is inactivated in the liver by dealkylation, the plasma half-life is fairly long (approximately 20 hours), and griseofulvin readily reaches the skin, hair, and nails, where it binds avidly to newly synthesized keratin and inhibits fungal invasion through surface keratin. Serious side effects are uncommon, but griseofulvin may induce nausea, vomiting, diarrhea, fatigue, headache, and mental confusion. The drug may also cause hematologic and dermatologic reactions. As an inducer of cytochrome P450 enzymes, griseofulvin is contraindicated in patients with acute intermittent porphyria and may participate in many drug interactions, potentially decreasing the effectiveness of drugs such as warfarin and oral contraceptives. Its use has waned as a result of marketing of newer drugs for treating superficial fungal infections.

Treatment of Oral Candidiasis

Candidiasis is the most common type of oral fungal infection. Regardless of which drug is used, therapy for 2 weeks is required, and more extended treatment may be necessary. Clotrimazole, in the form of oral troches, is highly effective in most cases. On swallowing, clotrimazole can cause an increase in plasma concentrations of hepatic enzymes, which and may rarely lead to hepatitis. If patients have liver disease or are at greater risk of liver toxicity (e.g., alcoholics), nystatin oral pastilles or rinses are preferred. For more extensive disease or difficult cases, such as patients with AIDS, systemic antifungal therapy may be indicated.^{64,89}

Oral fluconazole (100 to 200 mg/day) is a major systemic drug useful for oral candidiasis. The risk of causing liver abnormalities is less with fluconazole than the outmoded ketoconazole.²³ If the infection is resistant to fluconazole, oral itraconazole (200 mg/day) is another alternative.³¹ Posaconazole can be administered orally at 400 mg twice daily for oral candidiasis resistant to itraconazole or fluconazole. The use of caspofungin, 50 mg intravenously, is an option in more advanced cases, as are micafungin and anidulafungin. In extreme cases, intravenous amphotericin B may be considered.³¹ The toxicity of this drug must be carefully weighed, and consultation with a specialist in infectious disease is essential. Surgery may be helpful to remove a condensed lesion after medical therapy. The occurrence of oral candidiasis with lichen planus is common. In these cases, a topical antifungal drug may be applied with a topical corticosteroid. It has been suggested that clotrimazole be given with a topical steroid in patients with oral lichen planus for prophylaxis against candidiasis.⁸⁹ Chlorhexidine oral rinses may also be useful in treating oral candidiasis.

ANTIVIRAL AGENTS

Advances in the pharmacologic control of viral infections have lagged behind achievements in the chemotherapy of other microbial diseases. The reason for this delay, which also applies to the therapeutic management of neoplastic disorders (see Chapter 42), has been the difficulty in attaining an antiviral agent with an adequate degree of selective toxicity. When the First Conference on Antiviral Agents, sponsored by the New York Academy of Sciences, was held in 1965, there were no more than a half-dozen scientists in the United States who believed that safe and effective antiviral agents could be identified. Because the replication of viruses was known to use metabolic machinery essential for the function of normal cells, it seemed to be nearly impossible to find antiviral agents that would inhibit viral growth without killing the host.

Since the First Conference on Antiviral Agents many molecular events unique to viral replication have been identified and exploited in the development of selective antiviral agents. Potential points of attack include virus-encoded enzymes and other proteins that appear during viral replication and are different from corresponding cellular enzymes in noninfected cells. Endogenous mediators of antiviral immunity are another potential source of antiviral compounds. Although the issue of selective toxicity of antiviral agents still remains a major challenge, there is now considerable optimism for the future of viral therapeutics, and many safe and effective antiviral agents have been introduced.

The FDA has approved more than 40 antiviral agents for clinical use. These drugs are reviewed in Table 40-2 and include (1) amantadine and rimantadine for prophylaxis and treatment of influenza A infections and oseltamivir and zanamivir for prophylaxis and treatment of influenza A and B infections; (2) idoxuridine, vidarabine, and trifluridine for treatment of ocular herpetic diseases; (3) acyclovir, valacyclovir, famciclovir, penciclovir, ganciclovir, and foscarnet for treatment of various systemic and localized herpes group infections; (4) ribavirin, a broad-spectrum agent for treatment of respiratory syncytial viral bronchitis and pneumonia; (5) interferons for the treatment of human papillomavirus and chronic hepatitis infections; and (6) three classes of antiviral agents for the control of HIV infection (two groups belong to the reverse transcriptase inhibitors).

Anti-Influenza Virus Agents

Replicative cycles of influenza virus, a representative RNA virus, have been extensively studied during the past two decades. After penetrating into the cytoplasm of cells through endocytosis, the M2 protein virus allows an influx of hydrogen ion into the virion interior, resulting in uncoating of virion. This uncoating process induces the release of the ribonucleoprotein (RNP) complex into the cytoplasm. Then viral RNAs (vRNAs) enter nuclei of cells and begin to make more progeny vRNAs expressing structural and nonstructural proteins of the virus. These vRNAs and proteins are assembled to be virions, which are eventually released from the infected cells. Several antiviral drugs were developed to disrupt this replicative cycle and have been used for the treatment and prophylaxis of influenza caused by influenza virus type A or B. Amantadine and rimantadine inhibit the function of M2 protein and in doing so prevent the uncoating process of the virus. Oseltamivir and zanamivir are known to inhibit the activity of viral neuraminidase, resulting in blockade of the release of progeny virus from the infected cells.

Amantadine and rimantadine

Amantadine and rimantadine are synthetic tricyclic amines (Figure 40-5). In 1966, amantadine became the first antiviral agent to be licensed for general use in the United States.

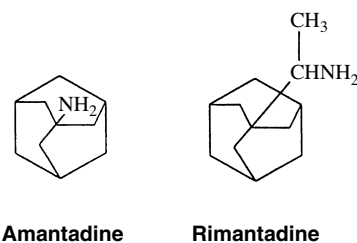

FIGURE 40-5 Structural formulas of amantadine and rimantadine.

Rimantadine is a close structural analogue of amantadine in which the amino moiety is replaced with an α -aminoethyl group. It also shares a similar pharmacologic profile.

Amantadine inhibits the replication of influenza A virus, influenza C virus, Sendai virus, and pseudorabies virus. No inhibition is observed, however, with influenza B virus, parainfluenza virus types 1 through 3, mumps virus, and Newcastle disease virus. Different strains of influenza A virus display sensitivities to amantadine that vary by 100-fold.⁵¹

Although the mechanism by which amantadine inhibits virus replication has not been fully determined, it has been suggested that amantadine inhibits or delays the uncoating process that precedes primary transcription. Specifically, it blocks the action of the M2 viral protein that facilitates dissociation of the ribonucleoprotein complex preceding replication and the conformational changes in viral hemagglutinin that follow translation. Amantadine has no effect on the virus-specific, RNA-dependent RNA polymerase activity of influenza A virus.

Amantadine hydrochloride is a water-soluble compound and is rapidly absorbed from the gastrointestinal tract. Peak plasma concentrations are reached within 2 to 4 hours; the pulmonary concentration is approximately two thirds that of the plasma. Amantadine is excreted in the urine with an elimination half-life of approximately 15 hours.

Amantadine is available in capsules or syrup and is administered orally for the prevention of influenza A virus infection. Amantadine prophylaxis reduces infection rates by at least 50% and illness rates by at least 60%. The effectiveness of amantadine after the onset of influenza symptoms is not as convincing as its effectiveness with prophylactic use. More recently, an aerosol mist of amantadine has been used for the treatment of influenza virus. Although such use significantly reduces certain respiratory symptoms of influenza, no effect is observed on fever, other constitutional symptoms, or pulmonary function measurements.

Dose-dependent side effects of amantadine are observed in 3% to 30% of patients, including nervousness, drowsiness, difficulty in concentration, insomnia, and depression. Symptoms usually appear within 48 hours after the initiation of drug use and disappear quickly after drug administration is terminated. The ability of amantadine to affect central nervous system (CNS) dopaminergic transmission (see Chapter 15) is largely responsible for the CNS disturbances. During the 2005-2006 influenza season, influenza A virus acquired resistance against amantadine and rimantadine. These agents are not presently recommended for prophylaxis or treatment of influenza. Amantadine and rimantadine have shown moderate activity against some strains of avian influenza virus, but not against most of the H5N1 subtype strains that have caused the outbreaks in Asia.

Oseltamivir and zanamivir

Oseltamivir and zanamivir are neuraminidase inhibitors effective against symptoms related to infection with influenza A

TABLE 40-2

Antiviral Spectrum, Mechanisms of Action, and Clinical Uses of Some Antiviral Agents

AGENT	ANTIVIRAL SPECTRUM	MECHANISM OF ACTION	CLINICAL USES
Anti-Influenza Virus Agents			
Amantadine, rimantadine	Influenza A virus	Blockade of uncoating process	Prophylaxis of influenza A infection
Oseltamivir, zanamivir	Influenza A and B virus	Inhibition of viral neuraminidase activity	Prophylaxis and treatment of influenza A and B virus infection
Influenza vaccine	Influenza A and B	Production of antibody	Prophylaxis of influenza A and B virus infection
Antiherpesvirus Agents			
Idoxuridine	HSV	Inhibition of DNA synthesis	Topical use for herpetic keratitis and keratoconjunctivitis
Vidarabine	HSV	Inhibition of DNA synthesis	Topical use for herpetic keratitis and keratoconjunctivitis; treatment of herpes encephalitis
Trifluridine	HSV	Inhibition of DNA synthesis	Topical use for herpetic keratitis and keratouveitis
Acyclovir, valacyclovir	HSV and VZV	Inhibition of DNA synthesis	Treatment of primary and recurrent herpes genitalis, herpetic encephalitis, mucocutaneous herpetic infections in immunocompromised patients, neonatal herpetic infection, VZV infection, and CMV prophylaxis
Famciclovir	HSV and VZV	Inhibition of DNA synthesis	Oral use for VZV infection and recurrent herpes infections
Penciclovir	HSV	Inhibition of DNA synthesis	Topical use for recurrent herpes labialis
Foscarnet	HSV, VZV, and CMV	Inhibition of DNA synthesis	Treatment of CMV retinitis and acyclovir-resistant HSV and VZV infections
Ganciclovir	CMV	Inhibition of DNA synthesis	Treatment of CMV retinitis and prevention of CMV colitis and esophagitis
Cidofovir	CMV and HSV	Inhibition of DNA synthesis	Treatment of CMV keratitis and HSV lesions
Fomivirsen	CMV	Inhibition of viral mRNA function	CMV retinitis in AIDS patients
Anti-Viral Hepatitis Agents			
Interferon alfa and alfa-2b	HCV and HPV	Stimulation of synthesis of antiviral proteins	Treatment of HBV and HCV and refractory genital warts
Anti-Respiratory Syncytial Virus Agent			
Ribavirin	RSV	Inhibition of mRNA synthesis and purine synthesis	Treatment of RSV pneumonia and bronchitis
Anti-HIV Agents			
Reverse transcriptase inhibitors*	HIV	Inhibition of viral DNA synthesis	Treatment of HIV infection and AIDS
Protease inhibitors [†]	HIV	Blockade of HIV protease	Treatment of HIV infection and AIDS
Fusion inhibitor—enfuvirtide	HIV	Blocks fusion of viral envelope with host plasma membrane	Treatment of HIV infection and AIDS
Papillomavirus Vaccine			
Human papillomavirus quadrivalent vaccine, recombinant	HPV	Production of antibody against HPV	Prevention of diseases (e.g., genital warts; precancerous cervical, vaginal, or vulval lesions; and cervical cancer) associated with HPV infection

*Includes nucleoside (e.g., zidovudine, 2',3'-dideoxyinosine, didanosine, stavudine, and lamivudine) and non-nucleoside (e.g., nevirapine and efavirenz) inhibitors.

[†]Includes such drugs as saquinavir, indinavir, ritonavir, indinavir, nelfinavir, and amprenavir.

AIDS, Acquired immunodeficiency syndrome; *CMV*, cytomegalovirus; *HBV*, hepatitis B virus; *HCV*, hepatitis C virus; *HIV*, human immunodeficiency virus; *HPV*, human papillomavirus; *HSV*, herpes simplex virus; *RSV*, respiratory syncytial virus; *VZV*, varicella-zoster virus.

or B. Taken orally, oseltamivir can reduce the severity and duration of the symptoms caused by influenza viruses and can decrease the incidence of upper respiratory complications. Zanamivir can be orally inhaled and is used for treatment of acute uncomplicated influenza A or B infection. These drugs are effective when taken within 48 hours after the onset of symptoms. The earlier they are started, however, the more effective they are. Oseltamivir or zanamivir taken once or twice daily for prophylaxis seems to be effective against influenza-related illnesses. Viral resistance can occur, but viral resistance to oseltamivir and zanamivir has rarely been reported in immunocompetent individuals. Common side effects include nausea and vomiting with oseltamivir and nasal discomfort and bronchospasm with zanamivir.

Because oseltamivir and zanamivir reduce the clinical efficacy of live attenuated intranasal influenza vaccines, such as FluMist, they should be stopped at least 48 hours before and should not be started for 2 weeks after the use of such vaccines.^{5,16} Both these drugs are effective against subtype strains of avian influenza virus and can be used for prophylaxis and early treatment of H5N1 infection.

Influenza vaccine

The most effective way to prevent infection from influenza A and B is annual immunization. There are two types of influenza vaccine in the United States: trivalent inactivated vaccine and live attenuated intranasal vaccine. In general, the vaccines are recommended for pregnant women, individuals older than 50 years, individuals older than 5 years with chronic medical conditions, caregivers of children younger than 6 years, and health care workers.⁴

Approximately 2 weeks after immunization, antibodies against influenza virus reach protective levels and persist for 6 months.⁶² The immunization can cause soreness at the injection site; other side effects are uncommon. One study showed, however, that a significant proportion of patients receiving the live attenuated vaccine shed vaccine-strain viruses, but the peak titer was below the infectious dose.⁷⁵

Antiherpetic Agents

Many different herpesviruses cause diseases in humans. Among them, herpes simplex virus (HSV), herpes zoster virus (HZV), and cytomegalovirus (CMV) are major herpesviruses that cause various infections. These are DNA viruses. The viral replication and reproduction in cells are very well known as depicted in Figure 40-6. Most anti-HSV agents inhibit viral DNA replication. HSV causes diseases in the orofacial area, eyes, skin, genital organs, and brain, resulting in primary herpes stomatitis, recurrent herpes labialis, herpes keratitis, cutaneous herpetic infections, herpes genitalis, and herpetic encephalitis. Primary infection with varicella-zoster virus (VZV) causes varicella (chickenpox), which may induce zoster (shingles) in individuals older than 60 years. CMV infection can cause retinitis in 20% to 25% of patients with AIDS and may cause CMV colitis and esophagitis in AIDS patients.

With the exception of foscarnet and vaccines, drugs effective against herpesviruses are purine or pyrimidine analogues that are converted to active nucleotides by cellular or virus-specific enzymes. Drugs that are activated by virus-encoded enzymes and inhibit a specific molecular event in viral replication, such as acyclovir, valacyclovir, and penciclovir, are the most selective agents currently available.

Anti-herpes simplex virus agents

Idoxuridine. Idoxuridine was synthesized in 1959 as part of an anticancer program and was soon found to possess antiviral activity against HSV. Idoxuridine is a thymidine analogue with an iodine atom replacing the methyl group on the carbon

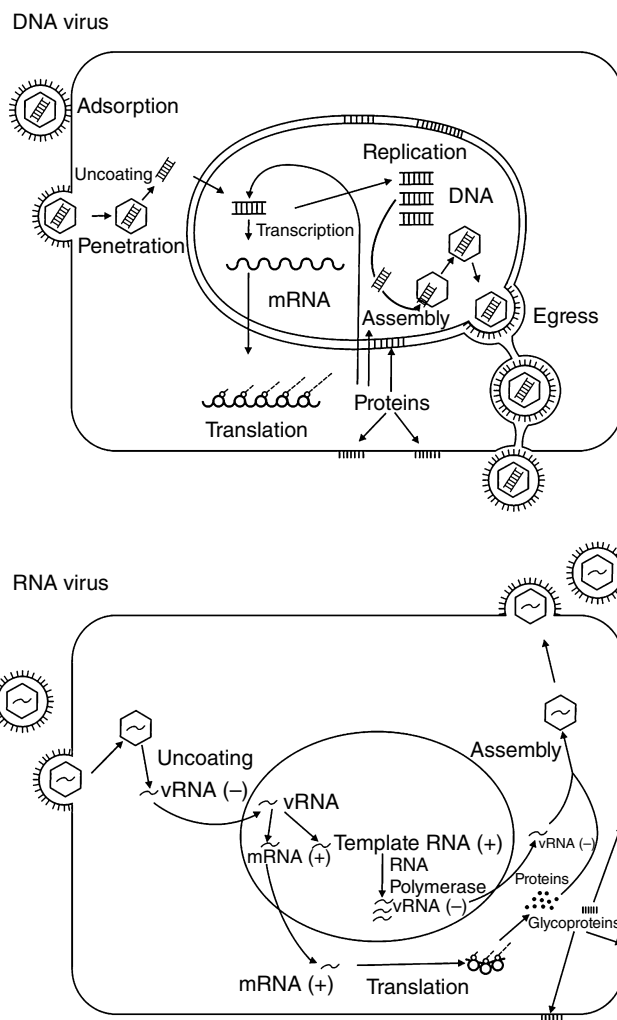

FIGURE 40-6 Viral replication and reproduction of DNA and RNA viruses. *mRNA*, Messenger RNA; *vRNA*, viral RNA.

5 atom (Figure 40-7). Because iodine has almost the same radius as the methyl moiety, idoxuridine is readily phosphorylated to idoxuridine monophosphate by thymidine kinase. Idoxuridine monophosphate is metabolized further to the triphosphate form and is incorporated into viral and cellular DNA. Several enzymes involved in the biosynthesis of DNA, such as thymidine kinase, thymidylate kinase, and DNA polymerase, are inhibited by idoxuridine and its phosphorylated forms. The antiviral effect of idoxuridine is most likely related, however, to the adverse biologic consequences of incorporating idoxuridine into the DNA of normal uninfected cells: chromosomal breakage and altered synthesis of viral proteins. The incorporation of idoxuridine into the DNA of normal uninfected cells is similarly responsible for the drug's toxicity.

Idoxuridine in vitro shows antiviral activity against various DNA-dependent viruses, but the clinical use of idoxuridine solution and ointment is limited to the treatment of keratitis caused by HSV and vaccinia virus (the latter without specific FDA approval). Viral resistance commonly develops during therapy; idoxuridine is rapidly inactivated by deaminase or nucleotidase enzymes.

Topical application of idoxuridine to the conjunctiva can cause local irritation, contact dermatitis, punctate keratopathy (which may be more closely associated with the disease process than the drug), corneal clouding, photophobia, and lacrimation. In addition to these undesirable effects, idoxuri-

PURINES

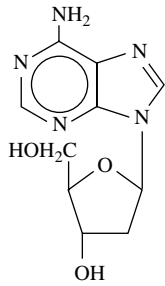

Deoxyadenosine

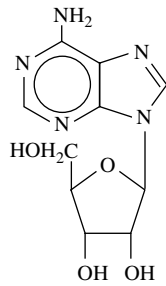

Vidarabine

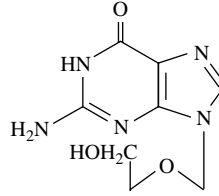

Acyclovir

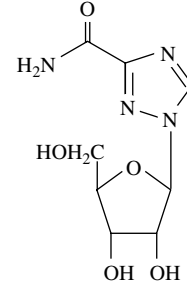

Ribavirin

PYRIMIDINES

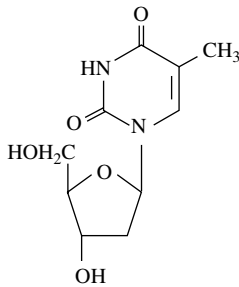

Thymidine

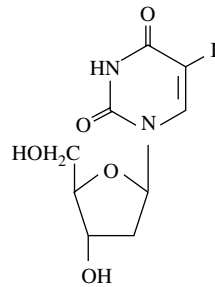

Idoxuridine

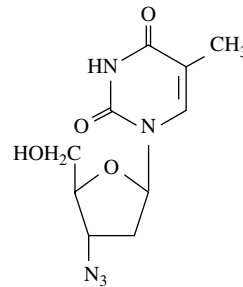

Zalcitabine

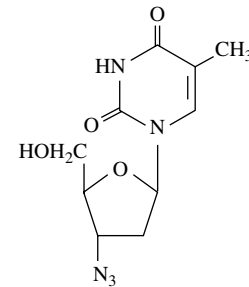

Zidovudine

FIGURE 40-7 Structural formulas of deoxyadenosine, thymidine, and several nucleoside antiviral drugs.

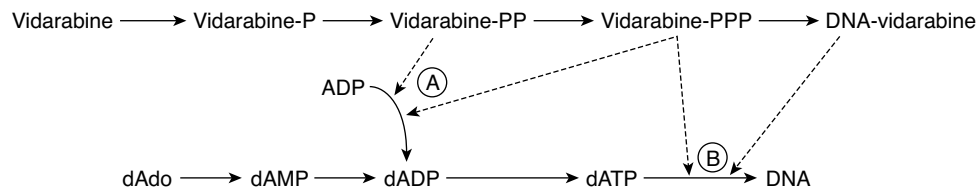

FIGURE 40-8 Mechanisms of action of vidarabine. *Top*, Sequential phosphorylation of vidarabine by cellular enzymes and its incorporation into viral DNA. *Bottom*, Conversion of deoxyadenosine (*dAdo*) to deoxyadenosine monophosphate (*dAMP*), diphosphate (*dADP*), and triphosphate (*dATP*) and the synthesis of normal viral DNA. *A*, Vidarabine diphosphates (*-PP*) and triphosphates (*-PPP*) inhibit ribonucleotide reductase-dependent production of *dADP*. *B*, Vidarabine triphosphate and vidarabine incorporated into DNA block further DNA synthesis by inhibiting the activity of DNA polymerases and terminal deoxynucleotidyl transferase.

dine causes chromosomal damage in cell culture and has disturbed embryonic development in animals after topical administration to the eye.

Vidarabine. Vidarabine (adenosine arabinoside) is an analogue of adenosine originally synthesized but subsequently found in cultures of *Streptomyces antibioticus*. In vidarabine, the *D*-ribose moiety is replaced with arabinose (see Figure 40-7). Vidarabine exhibits a spectrum of antiviral activity in vitro against many DNA viruses (e.g., herpesvirus group and poxviruses) and some oncogenic RNA viruses (oncornaviruses). Studies indicate that the biologic activity of vidarabine can be attributed to phosphorylated derivatives, as shown in Figure 40-8, which inhibit viral DNA polymerases. The percentage of phosphorylated vidarabine is limited after intrave-

nous infusion, however, and most of the drug is rapidly metabolized (the average plasma half-life is 3.5 hours) by adenosine deaminase to arabinosyl hypoxanthine, which is 60 times less potent than vidarabine. Because of the compound's low water solubility and poor gastrointestinal absorption, vidarabine must be administered by prolonged intravenous infusion of dilute solutions.

Topical treatment with vidarabine ointment is useful for keratitis caused by HSV and is the drug's main use.⁸⁵ It seems to be superior to idoxuridine in that it is at least as effective and is less allergenic, less irritating to the eye, and less likely to encounter viral resistance. Intravenous infusion of vidarabine is effective for the treatment of herpes encephalitis and useful for the control of VZV infections in immunocompromised patients; however, acyclovir has essentially replaced

vidarabine for these uses. Topical application of vidarabine for recurrent herpes labialis and herpes genitalis has been reported to have no significant therapeutic effect.

Major toxic effects of vidarabine are mostly associated with the phosphorylated derivatives and their effects on DNA synthesis. Adverse responses to parenteral vidarabine include gastrointestinal disturbance (nausea, vomiting, diarrhea), CNS manifestations (dizziness, confusion, ataxia), and hematologic disorders (hyperbilirubinemia, leukopenia). As with other drugs affecting DNA synthesis, vidarabine is potentially teratogenic and carcinogenic. The side effects of topical application are similar to the side effects described for idoxuridine.

Trifluridine. Trifluridine (trifluorothymidine) is a derivative of idoxuridine in which the iodine atom is replaced with a trifluoromethyl group. Trifluridine exhibits antiviral activity against numerous DNA viruses, including HSV, vaccinia, and adenoviruses. The advantages of trifluridine over idoxuridine are its 10-fold greater potency against herpetic keratitis and 10-fold greater solubility in aqueous solution. More recent studies also suggest that trifluridine is often effective in patients who have previously not responded to idoxuridine or vidarabine.

The mechanism of antiviral action of trifluridine has primarily been studied regarding its effects against vaccinia virus. Trifluridine is phosphorylated to trifluridine monophosphate, diphosphate, and triphosphate by viral or cellular thymidine kinase and thymidylate kinase. Trifluridine triphosphate is preferentially incorporated into viral DNA and produces effects similar to those of idoxuridine. Major cytotoxic reactions are more closely associated with the inhibition of cellular thymidine synthetase by trifluridine monophosphate.⁴³

Trifluridine, marketed as a 1% ophthalmic solution, is the drug of choice for superficial herpes keratitis. Toxic reactions to trifluridine are infrequent and generally mild, consisting of a burning sensation on instillation and palpebral edema. Allergic reactions are rare. Trifluridine is potentially mutagenic and carcinogenic; however, the risk from conjunctival application is minute.

Acyclovir and valacyclovir. Acyclovir is a product of research revolving around the synthesis of compounds designed to mimic substrates for adenosine deaminase, an enzyme essential to nucleic acid metabolism. (Although acyclovir proved not to act through inhibition of this enzyme, experimental drugs have been devised that do.) Acyclovir is an analogue of guanosine, or deoxyguanosine, in which two carbon atoms are missing from the ribose constituent (see Figure 40-7). Acyclovir is effective against herpesviruses such as HSV, VZV, and CMV. As an antiherpetic agent, acyclovir is 160 times as potent as vidarabine and 10 times as potent as idoxuridine.

Valacyclovir is the L-valyl ester of acyclovir. A prodrug, valacyclovir is rapidly absorbed after oral ingestion and converted to acyclovir during its first pass through the intestine and liver. The pharmacologic actions and effects of valacyclovir and acyclovir are essentially identical.

The mechanisms of antiviral action of acyclovir are well known (Figure 40-9). The nucleoside analogue is phosphorylated to form acyclovir monophosphate by herpesvirus-encoded thymidine kinase and phosphorylated further by other enzymes to acyclovir diphosphate and triphosphate. Acyclovir triphosphate acts to inhibit viral DNA polymerase and to terminate elongation of the viral DNA chain as spurious nucleotide is incorporated into DNA. In the noninfected host cell, phosphorylation of acyclovir occurs to a limited extent. Acyclovir triphosphate inhibits HSV DNA polymerase 10 to 30 times more effectively than it does mammalian cell DNA polymerase.³³

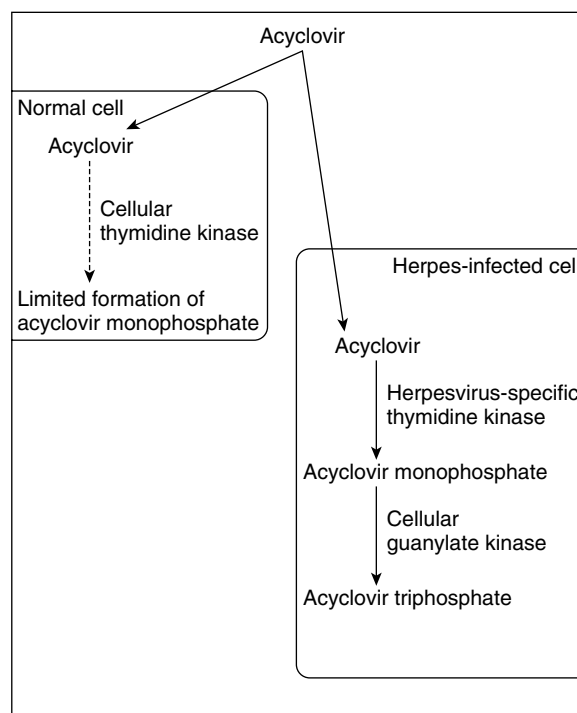

FIGURE 40-9 Selective phosphorylation of acyclovir by herpesvirus-specific thymidine kinase and subsequent phosphorylation to acyclovir triphosphate by cellular guanylate kinase. The preferential phosphorylation of acyclovir in herpesvirus-infected cells and selective inhibition of viral DNA polymerase by acyclovir triphosphate provide for the drug's selectivity; inhibition of the growth of uninfected cells can require a 3000-fold greater concentration of drug than inhibition of viral multiplication.

The bioavailability of acyclovir after oral administration is only approximately 20%. Peak plasma concentrations, which occur 2 hours after ingestion, are sufficient only for prophylaxis and treatment of highly susceptible infections such as genital herpes. Intravenous infusion can produce the much higher blood titers required for more resistant infections. The plasma half-life of acyclovir ranges from 2 to 5 hours in normal individuals but is approximately 20 hours in patients with renal failure. Acyclovir is mostly eliminated through glomerular filtration and tubular secretion, with 90% of the excreted dose recovered as the parent molecule.

The FDA has approved the use of acyclovir ointment for treatment of primary herpes genitalis and for treatment of initial and recurrent mucocutaneous herpetic lesions that are not life-threatening in immunocompromised patients. Although physicians and dentists have used topical acyclovir for symptomatic relief of recurrent herpes labialis in patients with normal immune systems, there is little evidence of this practice providing real benefits.⁷³ Oral acyclovir is used for the prevention of recurrent herpes genitalis and treatment of primary and recurrent herpes genitalis and VZV infections. Oral therapy has also been shown to be effective in preventing reactivation of HSV in immunosuppressed patients.⁶ Parenteral acyclovir has proved to be effective in the treatment of chronic and recurrent mucocutaneous HSV infections in immunocompromised patients, VZV infections (chickenpox and shingles), and herpes encephalitis.^{28,84,87,88} Valacyclovir is currently indicated for treatment of VZV infections and recurrent genital herpes.

Because acyclovir is in extensive clinical use, reports concerning the facile emergence of acyclovir-resistant HSV

mutants have received much attention.^{21,36} The specific mechanisms of viral resistance against acyclovir include (1) loss of viral thymidine kinase activity, (2) elaboration of a viral thymidine kinase with altered substrate specificity, and (3) expression of altered DNA polymerase activity. The first two mechanisms account for most resistant strains isolated in the laboratory; however, virulence is decreased by alterations in thymidine kinase activity. Full infectivity seems to be retained by mutant strains with DNA polymerase resistant to acyclovir binding.

No serious toxicity has been reported with topical or oral acyclovir therapy. The most frequent side effects during 3 to 6 months of oral use are headache, diarrhea, nausea and vomiting, arthralgias, and vertigo. Intravenous injection of acyclovir can induce local phlebitis, nausea and vomiting, diaphoresis, rash, and hypotension. Serious adverse effects, such as nephrotoxicity or encephalopathy, occasionally occur after intravenous administration of acyclovir.

Penciclovir. Penciclovir is a guanine nucleoside analogue structurally related to acyclovir. It is less potent than acyclovir as an inhibitor of DNA polymerase, but the triphosphate form attains much higher concentrations than those of acyclovir and persists intracellularly for a longer time (half-life 7 to 20 hours). The spectrum of action is similar to acyclovir. Herpesviruses that are resistant to acyclovir because of reduced thymidine kinase activity are also resistant to penciclovir. For recurrent herpes labialis, 1% penciclovir cream is available as a topical agent. It can be topically applied to recurrent herpetic lesions every 2 hours while awake for 4 days. Clinical trials involving additional uses of penciclovir are under way.⁸⁶

Foscarnet. Foscarnet is a phosphonoformate analogue of pyrophosphate. It is strongly active against HSV, CMV, other herpesviruses, and HIV-1. The drug inhibits herpetic DNA polymerase activity by blocking the pyrophosphate binding site on the enzyme. It inhibits the synthesis of DNA complementary to HIV-1 RNA by similarly suppressing the activity of reverse transcriptase. Foscarnet is approximately 100 times more selective for herpesvirus DNA polymerase than for mammalian DNA polymerase.

Foscarnet has been approved by the FDA for the treatment of acyclovir-resistant HSV infections in AIDS patients and CMV retinitis in immunocompromised patients.³¹ The drug is also effective clinically against acyclovir-resistant VZV infection and against HIV-1 infection. The drug is highly ionized and must be given by slow (1 hour minimum) intravenous infusion every 8 hours.

Foscarnet has two major problems: renal toxicity and electrolyte disturbances. Nephrotoxicity occurs to some degree in most patients receiving foscarnet. Renal impairment is often reversible, but nephritis and necrosis may lead to permanent loss of renal function. Foscarnet binds divalent cations and causes a dose-dependent hypocalcemia, with possible paresthesias, muscle spasms, tetany, and seizures. Hypomagnesemia and disturbances in phosphate concentrations also occur. Malaise, nausea and vomiting, fatigue, headache, genital ulcers, CNS disturbances, anemia, leukopenia, and liver dysfunction are additional manifestations of foscarnet toxicity.

Docosanol. Docosanol is a long-chain saturated alcohol and has been approved by the FDA for over-the-counter treatment of herpes labialis. In vitro, it prevents infection by lipid-enveloped viruses by inhibiting fusion between the viral envelope and the plasma membrane of the host cells. In clinical trials, docosanol, available in 10% cream, allowed for faster healing from recurrent herpes labialis compared with placebo when docosanol was placed topically at the first sign of recurrence.

Anticytomegalovirus agents

Many drugs have been approved by the FDA for the control of CMV infections, including ganciclovir, valganciclovir, foscarnet, cidofovir, and Fomivirsen.

Ganciclovir and valganciclovir. Ganciclovir (9-[1,3-dihydroxy-2-propoxymethyl]-guanine) is a hydroxymethylated analogue of acyclovir. Valganciclovir is a prodrug of ganciclovir. Similar to acyclovir, ganciclovir is phosphorylated to the monophosphate form by herpesvirus-specific thymidine kinase and phosphorylated further to the triphosphate form.^{20,72} Ganciclovir triphosphate inhibits viral DNA polymerase. The agent is more potent than acyclovir against HSV, CMV, and VZV, but the cytotoxicity of ganciclovir is also much greater.

Systemic ganciclovir is indicated for the treatment of life-threatening and sight-threatening CMV infections, especially CMV retinitis in immunocompromised patients.⁵⁸ Ganciclovir is also effective for the treatment of some acyclovir-resistant HSV (DNA polymerase mutant) infections. The drug can cause aspermatogenesis in animals and is potentially carcinogenic and teratogenic. The most common serious side effects of ganciclovir are granulocytopenia and thrombocytopenia, and these toxicities are not always reversible after the cessation of drug administration.

Because of its poor oral bioavailability (<10%), ganciclovir is administered intravenously for treatment of active disease; oral administration may be used to prevent relapse after the infection has been suppressed. More recent studies showed that valganciclovir exhibited greater than 10-fold oral bioavailability compared with ganciclovir, making it possible to replace intravenous ganciclovir with this drug.⁷⁰ The plasma half-life of ganciclovir is approximately 3 hours, with renal excretion of unchanged drug as the primary method of elimination.

Cidofovir. Cidofovir is an analogue of cytidine that gets converted to cidofovir diphosphate, resulting in the inhibition of DNA polymerase. The diphosphate form of the drug persists in the cell. This permits infrequent dosing intervals. Cidofovir is poorly absorbed orally and is given topically or intravenously. It is used to treat CMV retinitis and HSV mucocutaneous lesions.

Formivirsen. Formivirsen is a phosphothioate antisense oligonucleotide. It binds to specific viral RNA and inhibits viral protein synthesis. It is used topically to treat CMV retinitis in AIDS patients.

Anti-varicella-zoster virus agents

Acyclovir, valacyclovir, famciclovir, and foscarnet are available for the control of VZV infections.

Famciclovir. Famciclovir is an ester prodrug that is converted to penciclovir during its passage from the gut to the systemic circulation. The spectrum of action is similar to acyclovir; herpesviruses that are resistant to acyclovir because of reduced thymidine kinase activity are also resistant to penciclovir. Famciclovir is currently approved for the treatment of acute, localized VZV and HSV infections.

Herpes zoster vaccine. The FDA more recently approved a live attenuated varicella-zoster vaccine (Zostavax) for prevention of herpes zoster (shingles) in individuals older than 60 years. VZV persists in a latent form in sensory ganglia after primary infection. The latent VZV can be reactivated and induce varicella. In the United States, more than 90% of adults have had varicella and are at risk of the development of herpes zoster, and more than 1 million new cases of herpes

zoster are reported in the United States each year. The vaccine enhances VZV-specific cell-mediated immunity, which inhibits the reactivation of latent VZV.⁵⁶ The vaccine reduces the severity and duration of discomfort and pain caused by herpes zoster by 61%.⁶³

Anti-respiratory syncytial virus agents

Ribavirin. Ribavirin is a synthetic triazole nucleoside analogue of guanosine with a broad spectrum of antiviral activity (including DNA viruses and RNA viruses). Ribavirin exerts multiple actions. It directly inhibits guanine deaminase, and its metabolite, ribavirin 5'-phosphate, inhibits inosine monophosphate dehydrogenase and the formation of guanosine 5'-triphosphate. The triphosphate form of ribavirin, which is the predominant form intracellularly, interferes with viral messenger RNA transcriptase activity.

Although ribavirin has a broad antiviral spectrum *in vitro*, its approval in the United States is presently limited to use as an aerosol for the treatment of respiratory syncytial virus bronchitis and pneumonia in children and use in combination with interferon alfa-2a for certain adult patients with hepatitis C. Ribavirin administered by aerosolization to hospitalized infants and young children with respiratory syncytial virus infections produces significant reductions in fever and severity of systemic illness. It holds promise as an aerosol and oral medication for treatment of influenza, measles, acute and chronic hepatitis, Lassa fever, and various RNA viral infections not commonly seen in the United States.³²

The pharmacokinetics of ribavirin are complex. Systemic absorption occurs after inhalation, and plasma concentrations increase with long-term therapy. Ribavirin has a terminal half-life of 18 to 36 hours; however, the triphosphate derivative in red blood cells persists for several months after cessation of therapy.

Various serious toxic reactions have been attributed to use of ribavirin, particularly in severely ill patients. Respiration may be worsened after inhalation, especially if the patient has preexisting chronic obstructive pulmonary disease. Anemia, hypotension, and cardiac arrest are possible side effects. Because ribavirin is a nucleoside analogue and nonselective

antiviral agent, it is potentially mutagenic, carcinogenic, and teratogenic.

Palivizumab. Palivizumab is a monoclonal antibody directed against the A antigen site of RSV. It is used in high-risk infants and children. The adverse effects of palivizumab include gastrointestinal symptoms, rash, and respiratory tract infections.

Anti-Viral Hepatitis Agents

Human interferons

Interferons are glycoproteins secreted by virus-infected cells that promote the establishment of an antiviral state in uninfected cells. In addition to their antiviral activity, interferons regulate cellular functions dealing with cell proliferation and immunologic responses. Although all tissues seem to be capable of synthesizing interferons, cells that are derived from the hematopoietic system (e.g., lymphocytes and macrophages) may be the most significant in contributing to the total interferon synthesis of the body. All DNA and RNA viruses—single or double-stranded, enveloped or not, with or without virion-associated polymerase, and replicating in the cytoplasm or in the nucleus—are sensitive to interferons to a greater or lesser degree.

Interferons can be classified according to three major groups: α , β , and γ . These are produced by induction of synthesis in human leukocytes, fibroblasts, or lymphoblastoid cells and, in larger amounts, by recombinant DNA techniques in bacteria. The mechanisms of action of interferons are complex; two important responses to interferon are reviewed in Figure 40-10. After binding to specific plasma-membrane receptors and being taken up by infected cells, interferon induces the synthesis of two enzymes: an oligonucleotide polymerase that synthesizes from adenosine 5'-triphosphate a series of oligonucleotides containing 2',5'-phosphodiester bonds and a protein kinase that phosphorylates and inactivates eukaryotic initiation factor. Oligonucleotides stimulate cellular endonucleases to cleave viral messenger RNA, whereas the inactivated eukaryotic initiation factor no longer supports protein synthesis.^{35,45} Additional antiviral effects may result

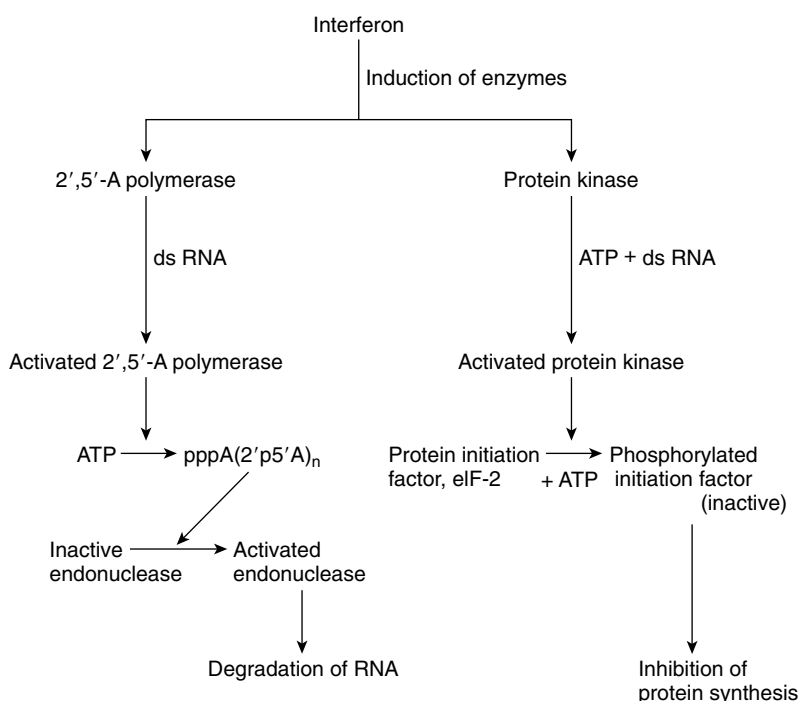

FIGURE 40-10 Mechanisms of action of interferon. After incorporation into the cell, interferon induces the synthesis of two enzymes, an oligonucleotide polymerase (2',5'-A polymerase) and a protein kinase, which in the presence of double-stranded RNA (*ds RNA*) lead to a cascade of reactions that inhibit viral replication. *ATP*, Adenosine 5'-triphosphate; *ds*, double strand.

from activation of macrophages and natural killer cells and modulation of cell surface proteins to facilitate immune recognition.

For prophylaxis of viral infection or for early treatment, interferons may have certain advantages over more narrow-spectrum antiviral agents. In other circumstances, a specific antiviral agent may be preferable to interferons on the grounds of convenience of administration, a quicker onset of antiviral action, or a lack of side effects. Interferons can cause increases in pulse rate and temperature; decreases in white blood cell counts; and headache, somnolence, and malaise. Interferons are currently undergoing clinical trials for various viral diseases, including AIDS. Interferon alfa-2b and mixed interferon- α preparations are currently approved for use against chronic hepatitis B and C infections, condylomata acuminata (anogenital warts) caused by human papillomavirus infection, multiple sclerosis, and Kaposi's sarcoma in patients with HIV infection. The approved uses of interferons in the treatment of cancer are reviewed in Chapter 42. Interferon beta-1a and interferon beta-1b have been approved for the management of multiple sclerosis, and interferon gamma-1b has been approved for chronic granulomatous disease.

Hepatitis B virus DNA polymerase inhibitors

Lamivudine inhibits reverse transcriptase (discussed subsequently in the section on anti-HIV drugs). As a result of its action, it inhibits HBV DNA polymerase. The drug is a cytosine analogue and is used orally. Entecavir is a guanosine analogue that inhibits HBV DNA polymerase. The drug is well absorbed when taken orally; however, it should be taken on an empty stomach. Adverse effects are usually mild and include headache and dizziness. Some animal studies indicate a potential for carcinogenesis. Adefovir dipivoxil is an adenine nucleotide analogue prodrug that inhibits HBV DNA polymerase. At the lower doses used to treat HBV, it is generally well tolerated. Adverse effects include gastrointestinal symptoms and nephrotoxicity.

Anti-Human Immunodeficiency Virus Agents

Since AIDS was first characterized in the early 1980s and attributed to HIV, a retrovirus, tremendous efforts have been made to develop effective therapies against the disease. Although numerous anti-AIDS drugs have been tested, many have proved to be of dubious worth. Four groups of drugs—nucleoside reverse transcriptase inhibitors, non-nucleoside reverse transcriptase inhibitors, HIV protease inhibitors, and fusion inhibitors—are now available for clinical use. Because of the rapidity with which some of these drugs have been developed and approved for marketing, research is ongoing regarding the therapeutic uses and toxic profiles of these agents. An especially promising development from these studies has been the dramatic therapeutic benefits obtained with multiple-drug therapy. Adverse effects of nucleoside reverse transcriptase inhibitors include lactic acidosis, headaches, gastrointestinal disorders such as nausea and vomiting, and hepatomegaly. Adverse effects of other anti-HIV drugs are discussed subsequently.

Reverse transcriptase inhibitors

Zidovudine. Zidovudine (azidothymidine) was the first antiviral agent to be sufficiently safe and effective to receive FDA approval for treatment of AIDS. Zidovudine is a thymidine analogue in which the 3'-hydroxyl group is replaced by an azido group ($-N_3$) (see Figure 40-7). Zidovudine is phosphorylated by cellular enzymes to zidovudine triphosphate, which is incorporated into viral complementary DNA (cDNA) by the reverse transcription of HIV RNA. The 3' substitution of zidovudine prevents further 5'-3'-phosphodiester linkages and terminates chain elongation. HIV-1 reverse transcriptase

is approximately 100 times more susceptible to inhibition by zidovudine than DNA polymerase of mammalian cells. Zidovudine not only seems to block replication of the virus, but also promotes regeneration of CD4⁺ lymphocytes. The agent also delays progression of AIDS in HIV-infected individuals with CD4⁺ lymphocyte counts less than 500 cells/mm³ and in individuals with no symptoms or early symptoms of AIDS-related illness.

Zidovudine provides palliative treatment only; it does not cure AIDS and cannot eliminate HIV from the body. As a preventive measure, however, zidovudine significantly reduces the incidence of neonatal infection when an HIV-infected mother begins taking the drug orally after 14 weeks of gestation and continues until birth (at which time intravenous zidovudine is administered). The efficacy of zidovudine for postexposure prophylaxis is controversial. A case-controlled study indicated that zidovudine reduced the risk of HIV infection in exposed health care workers by 79%.¹⁹ Preliminary guidelines at this time recommend the basic 4-week regimen of two drugs (zidovudine and lamivudine or didanosine and stavudine) for most HIV exposures.⁷⁶ For HIV exposures that pose an increased risk for transmission, an expanded regimen that includes the addition of a third drug is recommended.

Many HIV strains resistant to zidovudine have been isolated from clinical specimens. Although HIV strains from individuals not receiving zidovudine are very susceptible to zidovudine, the sensitivity of HIV from patients receiving zidovudine for 6 months is significantly decreased. Zidovudine-resistant strains are susceptible to other anti-HIV agents such as didanosine, zalcitabine, and foscarnet *in vitro*.

Zidovudine is given orally on a rigid 4-hour schedule. The drug is rapidly absorbed, quickly metabolized in the liver, and excreted in the urine. The mean elimination half-life is approximately 1 hour. Intracellular zidovudine triphosphate persists for several hours. Common side effects are nausea, headache, and bone marrow depression.³¹ Occasionally, transfusion may be required to correct granulocytopenia and anemia. Other side effects of zidovudine include asthenia, dizziness, insomnia, malaise, and myalgia. Long-term use of this drug is infrequently associated with a toxic myopathy. Although zidovudine can induce cell transformation *in vitro* and tumors in animals, the teratogenic potential in humans is unknown.

Didanosine. Didanosine (dideoxyinosine) is active against HIV, including zidovudine-resistant strains, and was approved for human use in 1991. Similar to zidovudine, didanosine, when converted to the triphosphate form, inhibits the activity of reverse transcriptase and by so doing blocks the synthesis of HIV cDNA. Oral didanosine increases the number of CD4⁺ lymphocytes, decreases viral antigen titers, and decreases symptoms of AIDS-related illness. Cross-resistance between didanosine and zidovudine has not been reported so far. Major side effects include peripheral neuropathy and potentially fatal pancreatitis.

Didanosine is well absorbed at neutral pH and should be taken on an empty stomach. The chewable didanosine tablet contains an antacid to neutralize the pH of the stomach. It should not be taken with medications that require an acidic pH for absorption, such as itraconazole and quinolone antibiotics. Although the drug is quickly eliminated in the urine (elimination half-life of approximately 1 hour), persistence of intracellular didanosine triphosphate permits twice-daily dosing.

Didanosine was originally reserved for patients with advanced HIV infection who were intolerant to zidovudine or showed clinical or immunologic deterioration. It is now commonly used in combination with zidovudine and a protease

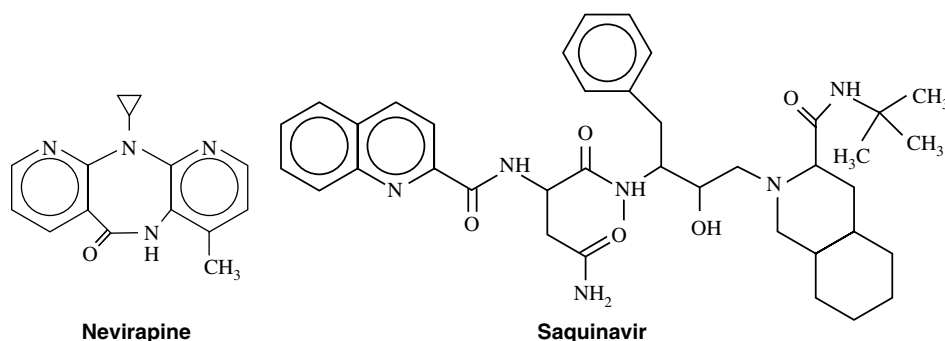

FIGURE 40-11 Structural formulas of nevirapine and saquinavir.

ase inhibitor. Resistance to didanosine is progressive, with resistant strains appearing in most patients after 6 months of monotherapy.

Zalcitabine. Zalcitabine is the 2'-3'-dideoxy analogue of cytidine. Its mechanism of action and pharmacologic profile are similar to zidovudine. Zalcitabine was initially approved for the control of HIV infection in 1992, but it is inferior to zidovudine for monotherapy when used as the initial treatment modality. Zalcitabine shows therapeutic efficacy in patients who are resistant to zidovudine and is comparable to didanosine in patients intolerant to zidovudine.^{2,3} Cross-resistance is common between didanosine and zalcitabine. The drug is often administered in combination with zidovudine and a protease inhibitor.

Stavudine. Stavudine, approved in 1994, is the 2'-3'-dideoxy analogue of thymidine. Its mechanism of action and clinical pharmacologic features are similar to those of the previously discussed antiretroviral agents. Studies have shown that stavudine therapy increases the number of CD4⁺ cells in patients who did not respond to zidovudine therapy. Occasionally, development of resistance to stavudine also confers resistance to zidovudine and didanosine. As with other antiretrovirals, stavudine is used in combination drug therapy.

Abacavir. Abacavir is a nucleoside analogue reverse transcriptase inhibitor that is useful in combination for treating HIV infections. It was approved for clinical use in 1998. Abacavir can cause adverse effects common to other nucleoside reverse transcriptase inhibitors and has been associated with fatal hypersensitivity reactions.

Lamivudine and emtricitabine. Lamivudine is another nucleoside analogue introduced into clinical practice in 1995. It is the (–) enantiomer of 2'-deoxy-3'-thiacytidine. Conversion intracellularly to the triphosphate form inhibits chain elongation of the viral cDNA by inhibiting reverse transcriptase. Poorly effective as monotherapy, lamivudine is approved for the control of infection in combination with zidovudine. Clinical studies indicate that the combination synergistically inhibits HIV replication and strongly enhances CD4⁺ cell counts.²³ As with other retroviral agents, the persistence of lamivudine triphosphate intracellularly effectively counteracts the rapid elimination of the parent drug. Side effects of lamivudine are generally mild and include nausea and headache. Emtricitabine is a fluoro derivative of lamivudine. It has a longer half-life than lamivudine and is given once a day. Its adverse effects are similar to lamivudine.

Trizivir is a single-tablet combination regimen of lamivudine, zidovudine, and abacavir for treatment of HIV. Trizivir should be used only for patients whose treatment regimens would otherwise include all three of the nucleoside analogues. It is not recommended for patients weighing less than 40 kg because it is a fixed-dose tablet. Because Trizivir combines three drugs in a single tablet, it may help patients with com-

pliance. The most notable side effect of Trizivir is associated with the hypersensitivity reaction to abacavir, which has been observed in 5% of HIV patients.

Nevirapine, efavirenz, delavirdine, and etravirine. Nevirapine, a dipyrroloquinone (Figure 40-11), is the first non-nucleoside inhibitor of reverse transcriptase. The drug requires no activation; it binds directly to reverse transcriptase of HIV-1 and noncompetitively inhibits cDNA synthesis. Rapid development of drug resistance is the major limitation of this compound, which should never be used as monotherapy.

In contrast to nucleoside analogues, nevirapine is lipid-soluble, very well absorbed, and extensively metabolized by cytochrome P450 (CYP3A family). The elimination half-life decreases from 2 days to 1 day as nevirapine induces its own metabolism. The drug also induces the breakdown of estrogens and HIV protease inhibitors (described later). Nevirapine may cause rash, diarrhea, and drug fever.

Other non-nucleoside inhibitors of reverse transcriptase are efavirenz, delavirdine, and etravirine. These drugs are used to treat HIV-1 infections. Gastrointestinal symptoms can occur with these drugs. Rash, including Stevens-Johnson syndrome, may occur with delavirdine and less commonly with etravirine; CNS adverse effects and mild skin rash are common with efavirenz.

Protease inhibitors

HIV protease is a viral enzyme responsible for the cleavage of the Gag and Gag-Pol polyproteins into the enzymes and structural proteins that are required for the final assembly of new infectious virions.¹³ In patients with advanced HIV infection, use of a protease inhibitor in combination therapy with other classes of antiretroviral agents significantly improved the survival of patients. After sustained exposure to antiviral agents, viral isolates may develop resistance to one class of drugs and remain susceptible to others. It is preferred to use new protease inhibitors combined with other drugs when drug resistance has occurred. All protease inhibitors exhibit similar side effects after prolonged exposure. Most commonly, patients may experience hyperglycemia, increased aminotransferase activity, and gastrointestinal dysfunction.¹⁸ Fat redistribution and hyperlipidemia have also been noted.

Saquinavir. Saquinavir (see Figure 40-11) was the first drug approved by the FDA to inhibit HIV protease. Saquinavir has shown selective and potent anti-HIV activity; however, saquinavir monotherapy rapidly induces viral resistance. Similar to combination therapy involving nucleoside and non-nucleoside antiretrovirals, the use of protease inhibitors in conjunction with nucleoside analogues has shown improved clinical efficacy over single drugs or two-drug combinations. The combination of saquinavir, zidovudine, and zalcitabine greatly reduced the viral load without causing any increased toxicity compared with two-drug therapy.²² The side effects of saquinavir include gastrointestinal disturbances such as nausea and vomiting. Because saquinavir is metabolized by

and is an inhibitor of hepatic CYP3A isoenzymes, interactions are possible with other drugs that rely on the same P450 enzymes for inactivation. Saquinavir may accumulate in patients taking drugs that inhibit CYP3A, and saquinavir may inhibit the metabolism of drugs such as verapamil and triazolam. Drugs that induce CYP3A enzymes, such as rifampin and nevirapine, may reduce the effectiveness of saquinavir.

Indinavir and ritonavir. Indinavir and ritonavir are HIV protease inhibitors. They were released for use in 1996 by the FDA under a special program for drugs with promising anti-HIV activity (as have several other drugs discussed in this chapter).¹⁷ The triple-drug combination of ritonavir and two nucleoside analogues significantly increased the number of CD4⁺ lymphocytes and reduced the mortality rate of patients with advanced AIDS,³⁴ and the combination of indinavir with zidovudine and lamivudine resulted in sustained undetectable viral titers for 1 year in more than 80% of patients receiving the therapy. A more recent study evaluated the therapeutic efficacy of combination therapy with indinavir for pediatric patients seropositive for HIV-1.⁷⁸ The initial 2-year therapy showed HIV-1 RNA load below the detectable limit and increase in CD4⁺ cell counts to 94% of the age-matched normal value in most treated patients.

Major side effects of indinavir include hyperbilirubinemia and nephrolithiasis. Because 3% of patients receiving indinavir develop kidney stones, drinking at least 48 oz of water per day is recommended. Ritonavir induces gastrointestinal disturbances, altered taste, and perioral paresthesia. Potential drug interactions for both drugs are similar to interactions mentioned for saquinavir.

Nelfinavir and lopinavir. Nelfinavir is probably the most commonly used protease inhibitor because of its relatively low toxicity. Its side effects include hyperglycemia, abnormal fat distribution, and diarrhea, often controllable with loperamide. Lopinavir shows high potency *in vitro*, especially when given in combination with ritonavir. The combination of lopinavir and ritonavir causes mild gastrointestinal side effects and headache.

Amprenavir and fosamprenavir. Amprenavir can be used for HIV-infected adults and children older than 4 years. Amprenavir is available in large capsules (150 mg and 50 mg) and in oral solution (15 mg/mL). Amprenavir capsules contain vitamin E. The vitamin E facilitates drug absorption. Each 150-mg capsule contains 109 IU of vitamin E, which exceeds the recommended daily allowance, so patients taking amprenavir should not take additional vitamin E supplements. In a 24-week study, combination therapy with amprenavir, zidovudine, and lamivudine reduced the viral load to less than 500 copies/mL.⁶¹ The side effects of amprenavir include nausea, vomiting, diarrhea, oral and perioral paresthesias, and rash. Similar to other protease inhibitors, altered body fat distribution, hyperglycemia, and increased aminotransferase activity have been reported with amprenavir. Fosamprenavir is a prodrug of amprenavir that has the advantage of being better absorbed, which reduces the required daily dose.

Darunavir, tipranavir, and atazanavir. Darunavir is a protease inhibitor and effective against many HIV strains resistant to other protease inhibitors. This drug should be given with ritonavir, which increases the bioavailability of darunavir by 14 times. Side effects of this drug are similar to other protease inhibitors and include diarrhea, nausea, headache, and increased aminotransferase activity. Darunavir may also worsen diabetes.⁷

Tipranavir is similar to darunavir in that ritonavir increases its plasma levels. The drug can cause gastrointestinal symptoms

and rash. More serious adverse effects include liver toxicity and intracranial hemorrhage.

Atazanavir is a protease inhibitor whose plasma half-life is increased by ritonavir. The drug should not be taken with drugs that increase stomach pH. Adverse effects include gastrointestinal symptoms, rash, and peripheral neuropathy. There are several drug-drug interactions involving atazanavir.

Fusion inhibitor

Enfuvirtide. Enfuvirtide is a fusion inhibitor that is effective against HIV. Enfuvirtide binds to a viral envelope glycoprotein (gp),⁴¹ which prevents the fusion between the viral envelope with the host plasma membrane. It is given by the subcutaneous route. Adverse effects include eosinophilia.

Other anti-human immunodeficiency virus agents

Once-daily combination tablet for human immunodeficiency virus. The drug Atripla is the combination of efavirenz, a non-nucleoside reverse transcriptase inhibitor (600 mg); emtricitabine, a nucleoside reverse transcriptase inhibitor (200 mg); and tenofovir, a nucleoside reverse transcriptase inhibitor (300 mg). This is the first once-daily, single-tablet combination for HIV. Side effects are similar to the side effects of the individual drugs taken separately, including rash, dizziness, headache, insomnia, dreams, and inability to concentrate. It is also contraindicated in pregnant women because of its teratogenicity.⁴²

Human immunodeficiency virus vaccine

More recently, a vaccine (AIDSVax) was introduced for the prevention of HIV infection; this vaccine is HIV glycoprotein 120-like protein, which induces HIV glycoprotein 120 antibody formation in humans. It has shown modest success in Asians and blacks, but failed to show clinical efficacy in whites. The reason for the difference in vaccine efficacy in various ethnic groups remains to be investigated.

ANTIVIRAL THERAPY IN THE ORAL CAVITY

HSV causes various oral mucosal lesions, including herpetic gingivostomatitis, recurrent intraoral herpes simplex, herpes labialis, and the life-threatening eczema herpeticum. Herpetic gingivostomatitis can also manifest in weakened hosts as aphthoid of Pospischill-Feyrter, characterized by rapid expansion of the lesion to the throat and perioral skin. Most HSV-associated viral lesions are routinely treated by oral acyclovir, with intravenous administration in some severe cases.

Acyclovir is best used as soon as symptoms begin to appear. The intravenous dosage is based on body weight and the type of the lesion. In general, 5 to 10 mg/kg of body weight is administered intravenously for 1 hour and repeated every 8 hours for 5 to 10 days. Long-term suppressive acyclovir therapy is recommended for patients with eczema herpeticum at 200 to 400 mg orally two to three times per day. In addition, supportive therapies for herpetic lesions include antipyretic analgesics, antibacterial antibiotics, and antifungals that help control secondary infections.

Topical 1% penciclovir cream is the drug of choice for the control of recurrent herpes labialis, and it may be applied to the lesion every 2 hours while awake for 4 days. It reduces the uncomfortableness of the infection and can shorten the period of lesions by 1 to 2 days.

HSV infection can develop into a more severe and generalized form in AIDS patients. Recurrent herpetic lesions become chronic in these patients, and HSV strains resistant to acyclovir could arise, in which case other antiherpetic agents, such as ganciclovir and foscarnet, may be effective. In AIDS patients, numerous concomitant oral lesions of different

viral origins are common. Human papillomavirus infection is almost always noted in these patients, resulting in variants of papillomas, condylomata, and focal epithelial hyperplasia in the oral cavity. Also, CMV is associated with aphthae-like ulcerations in the oral mucosa. Oral hairy leukoplakia is an early sign of HIV infection, presumably caused by Epstein-Barr virus in immunocompromised patients. Treatment of oral hairy leukoplakia is reserved for symptomatic patients and usually involves topical application of a solution of podophyllin resin 25% and oral acyclovir 800 mg five times daily. Valacyclovir (1000 mg) and famciclovir (500 mg), given orally three times a day, can be used as alternatives. Systemic antiretroviral therapy is also provided as described earlier. Oral hairy leukoplakia disappears after drug therapy but normally recurs when the medication is discontinued.

ANTIFUNGAL AND ANTIVIRAL AGENTS

<i>Nonproprietary (generic) name</i>	<i>Proprietary (trade) name</i>
Antifungal agents	
Amphotericin B	Abelcet, Amphotec, Fungizone
Anidulafungin	Eraxis
Butenafine	Mentax
Butoconazole	Femstat
Caspofungin	Cancidas
Ciclopirox	Loprox
Clioquinol	Vioform
Clotrimazole	Lotrimin, Mycelex
Econazole	Spectazole
Fluconazole	Diflucan
Flucytosine	Ancobon
Gentian violet	—
Griseofulvin	Fulvicin, Grifulvin V, Grisactin
Haloprogin	Halotex
Itraconazole	Sporanox
Ketoconazole	Nizoral
Miconazole	Micatin, Monistat-Derm, Monistat i.v.
Micafungin	Mycamine
Naftifine	Naftin
Natamycin	Natacyn
Nystatin	Mycostatin, Nilstat, Nystex
Oxiconazole	Oxistat
Posaconazole	Noxafil
Sulconazole	Exelderm
Terbinafine	Lamisil
Terconazole	Terazol
Tioconazole	Vagistat-1
Tolnaftate	Aftate, Tinactin
Triacetin	In Fungoid
Undecylenic acid (and derivatives)	Crex, Desenex, Fungoid AF
Voriconazole	Vfend
Antiviral agents	
Abacavir	Ziagen
Abacavir, zidovudine, and lamivudine (combination)	Trizivir
Acyclovir	Zovirax

<i>Nonproprietary (generic) name</i>	<i>Proprietary (trade) name</i>
Adefovir dipivoxil	Hepsera
Amantadine	Symmetrel
Amprenavir	Agenerase
Atazanavir	Reyataz
Cidofovir	Vistide
Darunavir	Prezista
Delavirdine	Rescriptor
Didanosine	Videx
Docosanol	Abreva
Efavirenz	Sustiva
Emtricitabine	Emtriva, in Truvada
Enfuvirtide	Fuzeon
Entecavir	Baraclude
Etravirine	Intelence
Famciclovir	Famvir
Fomivirsen	Vitravene
Fosamprenavir	Lexiva
Foscarnet	Foscavir
Ganciclovir	Cytovene
Herpes zoster vaccine	Zostavax
Human papillomavirus quadrivalent vaccine, recombinant	Gardasil
Idoxuridine	Herplex
Imiquimod	Aldara
Indinavir	Crixivan
Interferon alfa-2a	Referon-A
Interferon alfa-2b	Intron A
Interferon alfa-n3	Alferon
Lamivudine	Epivir
Lopinavir	Kaletra
Nelfinavir	Viracept
Nevirapine	Viramune
Once-daily combination tablet for HIV	Atripla
Oseltamivir	Tamiflu
Palivizumab	Synagis
Penciclovir	Denavir
Ribavirin	Virazole
Rimantadine	Flumadine
Ritonavir	Norvir
Saquinavir	Invirase, Fortovase
Stavudine	Zerit
Tenofovir disoproxil fumarate	Viread
Tipranavir	Aptivus
Trifluridine	Viroptic
Valacyclovir	Valtrex
Valganciclovir	Cymeval, Valcyte
Vidarabine	Vira-A
Zalcitabine	Hivid
Zanamivir	Relenza
Zidovudine	Retrovir

CITED REFERENCES

1. Abernathy RS: Treatment of systemic mycoses. *Medicine (Baltimore)* 52:385-394, 1973.
2. Abrams DI, Goldman AI, Launer C, et al: A comparative trial of didanosine or zalcitabine after treatment with zidovudine in

- patients with human immunodeficiency virus infection. *N Engl J Med* 330:657-662, 1994.
3. Adkins JC, Peters DH, Faulds D: Zalcitabine: an update of its pharmacodynamic and pharmacokinetic properties and clinical efficacy in the management of HIV infection. *Drugs* 53:1054-1080, 1997.
 4. Advisory Committee on Immunization Practices: Prevention and control of influenza: recommendations of the Advisory Committee on Immunization Practices (ACIP). *MMWR Recomm Rep* 55(RR10):1, 2005.
 5. Advisory Committee on Immunization Practices; Smith NM, Bresse JS, et al: Prevention and control of influenza: recommendations of the Advisory Committee on Immunization Practices (ACIP). *MMWR Recomm Rep* 55(RR-10):1-41, 2006.
 6. Aoki FY: Management of genital herpes in HIV-infected patients. *Herpes* 8:41-45, 2001.
 7. Arasteh K, Clumeck N, Pozniak A, et al: TMC/ritonavir substitution for protease inhibitor(s) in a non-suppressive antiretroviral regimen: a 14-day proof-of-principle trial. *AIDS* 19:943-947, 2005.
 8. Arathoon EG, Gotuzzo E, Noriega LM, et al: Randomized, double-blind, multicenter study of caspofungin versus amphotericin B for treatment of oropharyngeal and esophageal candidiasis. *Antimicrob Agents Chemother* 46:451-457, 2002.
 9. Arevalo MP, Carrillo-Munoz AJ, Salgado J, et al: Antifungal activity of the echinocandin anidulafungin (VER002, LY-303366) against yeast pathogens: a comparative study with M27-A microdilution method. *J Antimicrob Chemother* 51:163-166, 2003.
 10. Arikan S, Rex JH: Nystatin LF (Aronex/Abbott). *Curr Opin Investig Drugs* 2:488-495, 2001.
 11. Barchiesi F, Giacometti A, Arzeni D, et al: Fluconazole and ketoconazole in the treatment of oral and esophageal candidiasis in AIDS patients. *J Chemother* 4:381-386, 1992.
 12. Barrett-Bee KJ, Lane AC, Turner RW: The mode of antifungal action of tolnaftate. *J Med Vet Mycol* 24:155-160, 1986.
 13. Bartlett JG: Protease inhibitors for HIV infection. *Ann Intern Med* 124:1086-1088, 1996.
 14. Bouffard FA, Zambias RA, Dropinski JF, et al: Synthesis and antifungal activity of novel cationic pneumocandin Bo derivatives. *J Med Chem* 37:222-225, 1994.
 15. Brajtborg J, Powderly WG, Kobayashi GS, et al: Amphotericin B: current understanding of mechanisms of action. *Antimicrob Agents Chemother* 34:183-188, 1990.
 16. Bright RA, Shay DK, Shu B, et al: Amantadine resistance among influenza viruses isolated early during the 2005-2006 influenza season in the United States. *JAMA* 295:891-894, 2006.
 17. Carpenter CC, Cooper DA, Fischl MA, et al: Antiretroviral therapy in adults: updated recommendations of the International AIDS Society-USA panel. *JAMA* 283:381-390, 2000.
 18. Carr A, Morey A, Mallon P, et al: Fatal portal hypertension, liver failure, and mitochondrial dysfunction after HIV-1 nucleoside analogue-induced hepatitis and lactic acidemia. *Lancet* 357:1412-1414, 2001.
 19. Case-control study of HIV seroconversion in health-care workers after percutaneous exposure to HIV-infected blood-France, United Kingdom, and United States, January 1988-August 1994. *MMWR Morb Mortal Wkly Rep* 44:929-933, 1995.
 20. Chun Y-S, Park N-H: Effect of ganciclovir [9-(1,3-dihydroxy-2-propoxymethyl)-guanine] on viral DNA and protein synthesis in cells infected with herpes simplex virus. *Antimicrob Agents Chemother* 31:349-351, 1987.
 21. Coen DM, Schaffer PA: Two distinct loci confer resistance to acyclo-guanosine in herpes simplex virus type 1. *Proc Natl Acad Sci U S A* 77:2265-2269, 1980.
 22. Collier AC, Coombs RW, Schoenfeld DA, et al: Treatment of human immunodeficiency virus infection with saquinavir, zidovudine, and zalcitabine. AIDS Clinical Trials Group. *N Engl J Med* 334:1011-1107, 1996.
 23. Como JA, Dismukes WE: Oral azole drugs as systemic antifungal therapy. *N Engl J Med* 330:263-272, 1994.
 24. Cornely OA, Vehreschild J, Ullmann AJ: Is there a role for polyenes in treating invasive mycoses? *Curr Opin Infect Dis* 19:565-570, 2006.
 25. Cupp-Vickery JR, Garcia C, Hofacre A: Ketoconazole-induced conformational changes in the active site of cytochrome P450eryF. *J Mol Biol* 311:101-110, 2001.
 26. Czeizel AE, Kazy Z, Puho E: Tolnaftate spray treatment during pregnancy. *Reprod Toxicol* 18:443-444, 2004.
 27. Dannaoui E, Meletiadis J, Mouton JW, et al: In vitro susceptibilities of zygomycetes to conventional and new antifungals. *J Antimicrob Chemother* 51:45-52, 2003.
 28. De Clercq E: Antivirals for the treatment of herpesvirus infections. *J Antimicrob Chemother* 32(Suppl A):121-132, 1993.
 29. De Wet N, Llanos-Cuentas A, Suleiman J, et al: A randomized, double-blind, parallel-group, dose-response study of micafungin compared with fluconazole for the treatment of esophageal candidiasis in HIV-positive patients. *Clin Infect Dis* 39:842-849, 2004.
 30. Del Poeta M, Cruz MC, Cardenas ME, et al: Synergistic antifungal activities of baflomycin A1, fluconazole, and the pneumocandin MK-0991/caspofungin acetate (L-743,873) with calcineurin inhibitors FK506 and L-685,818 against *Cryptococcus neoformans*. *Antimicrob Agents Chemother* 44:739-746, 2000.
 31. Drugs for HIV infections. *Med Lett Drugs Ther Handbook* 16:88-97, 2002.
 32. Drugs for non-HIV viral infections. *Med Lett Drugs Ther* 44:9-16, 2002.
 33. Elion GB: Mechanism of action and selectivity of acyclovir (Acyclovir Symposium). *Am J Med* 73(1A):7-13, 1982.
 34. Eron JJ, Benoit SL, Jemsek J, et al: Treatment with lamivudine, zidovudine, or both in HIV-positive patients with 200 to 500 CD4+ cells per cubic millimeter. *N Engl J Med* 333:1662-1669, 1995.
 35. Farrell PJ, Sen GC, Dubois MF, et al: Interferon action: two distinct pathways for inhibition of protein synthesis by double-stranded RNA. *Proc Natl Acad Sci U S A* 75:5893-5897, 1978.
 36. Field HJ, Larder BA, Darby G: Isolation and characterization of acyclovir-resistant strains of herpes simplex virus (Acyclovir Symposium). *Am J Med* 73(1A):369-371, 1982.
 37. Flynn PM, Cunningham CK, Kerkering T, et al: Oropharyngeal candidiasis in immunocompromised children: a randomized, multicenter study of orally administered fluconazole suspension versus nystatin. The Multicenter Fluconazole Study Group. *J Pediatr* 127:322-328, 1995.
 38. Gigolashvili T: Update on antifungal therapy. *Cancer Pract* 7:157-159, 1999.
 39. Goudard M, Buffard Y, Ferrari H, et al: In vitro spectrum of action of new antifungal derivative of naftifine: terbinafine (SF86-327). *Pathol Biol* 34:680-683, 1986.
 40. Groll AH, Lehrnbecher T: New antifungal drugs and the pediatric cancer patient: current status of clinical development. *Klin Padiatr* 217:158-168, 2005.
 41. Guo LS: Amphotericin B colloidal dispersion: an improved antifungal therapy. *Adv Drug Deliv Rev* 47:149-163, 2001.
 42. Hammer SM, Saag MS, Schcheter M, et al: Treatment for adult HIV infection: 2006 recommendations of the international AIDS Society-USA Panel. *JAMA* 296:827-843, 2006.
 43. Heidelberger C, King DH: Trifluorothymidine. *Pharmacol Ther* 6:427-442, 1979.
 44. Hoang A: Caspofungin acetate: an antifungal agent. *Am J Health Syst Pharm* 58:1206-1214, 2001.
 45. Hovanessian AG, Brown RE, Kerr IM: Synthesis of low molecular weight inhibitor of protein synthesis with enzyme from interferon-treated cells. *Nature* 268:537-540, 1977.
 46. Irizarry L: Cryptococcal meningitis. *Curr Treat Options Neurol* 3:413-426, 2001.
 47. Jain LR, Denning DW: The efficacy and tolerability of voriconazole in the treatment of chronic cavitary pulmonary aspergillosis. *J Infect* 52:e133-e137, 2006.
 48. Kauffman CA: Clinical efficacy of new antifungal agents. *Curr Opin Microbiol* 9:483-488, 2006.
 49. Kerridge D: Mode of action of clinically important antifungal drugs. *Adv Microb Physiol* 27:1-72, 1986.
 50. Knoppert DC, Salama HE, Lee DS: Eradication of severe neonatal systemic candidiasis with amphotericin B lipid complex. *Ann Pharmacother* 35:1032-1036, 2001.
 51. Koff WC, Knight V: Effect of rimantadine on influenza virus replication. *Proc Soc Exp Biol Med* 160:246-253, 1979.
 52. Kullberg BJ, Sobel JD, Ruhnke M, et al: Voriconazole versus a regimen of amphotericin B followed by fluconazole for candidaemia in non-neutropenic patients: a randomized non-inferiority trial. *Lancet* 366:1435-1442, 2005.

53. Kuse ER, Chetchotisakd P, da Cunha CA, et al: Micafungin versus liposomal amphotericin B for candidaemia and invasive candidosis: a phase III randomised double-blind trial. *Lancet* 369:1519-1527, 2007.
54. Lake-Bakaar G, Tom W, Lake-Bakaar D, et al: Gastropathy and ketoconazole malabsorption in the acquired immunodeficiency syndrome (AIDS). *Ann Intern Med* 109:471-473, 1988.
55. Laochumroonvorapong P, Diconstanzo DP, Wu H, et al: Disseminated histoplasmosis presenting as pyoderma gangrenosum-like lesions in a patient with acquired immunodeficiency syndrome. *Int J Dermatol* 40:518-521, 2001.
56. Levin MJ, Barber D, Goldblatt E, et al: Use of a live attenuated varicella vaccine to boost varicella-specific immune responses in seropositive people 55 years of age and older: duration of booster effect. *J Infect Dis* 178:S109-S112, 1998.
57. Lucatorto FM, Franken C, Hardy WD, et al: Treatment of refractory oral candidiasis with fluconazole: a case report. *Oral Surg Oral Med Oral Pathol* 71:42-44, 1991.
58. Martin DF, Sierra-Madero J, Walmsley S, et al: A controlled trial of valganciclovir as induction therapy for cytomegalovirus retinitis. *N Engl J Med* 346:1119-1126, 2002.
59. Medoff G, Dismukes WE, Pappagianis D, et al: Evaluation of new antifungal drugs for the treatment of systemic fungal infections. *Clin Infect Dis* 15(Suppl 1):S274-S281, 1992.
60. Morrison VA: Echinocandin antifungals: review and update. *Expert Rev Anti Infect Ther* 4:325-342, 2006.
61. Murphy RL, Sommadossi JP, Lamson M, et al: Antiviral effect and pharmacokinetic interaction between nevirapine and indinavir in persons infected with human immunodeficiency virus type 1. *J Infect Dis* 179:1116-1123, 1999.
62. Nicholson KG, Wood JM, Zambon M: Influenza. *Lancet* 362:1733-1745, 2003.
63. Oxman MN, Levine MJ, Johnston GR, et al: A vaccine to prevent herpes zoster and postherpetic neuralgia in older adults. *N Engl J Med* 352:2271-2284, 2005.
64. Patton LL, Bonito AJ, Shugars DA: A systematic review of the effectiveness of antifungal drugs for the prevention and treatment of oropharyngeal candidiasis in HIV-positive patients. *Oral Surg Oral Med Oral Pathol Oral Radiol Endod* 92:170-179, 2001.
65. Pelletier R, Peter J, Antin C, et al: Emergence of resistance of *Candida albicans* to clotrimazole in human immunodeficiency virus-infected children: in vitro and clinical correlations. *J Clin Microbiol* 38:1563-1568, 2000.
66. Petersen EA, Ailing DW, Kirkpatrick CH: Treatment of chronic mucocutaneous candidiasis with ketoconazole: a controlled clinical trial. *Ann Intern Med* 93:791-795, 1980.
67. Pfaller MA, Boyken L, Hollis RJ, et al: In vitro activities of anidulafungin against more than 2,500 clinical isolates of *Candida* spp, including 315 isolates resistant to fluconazole. *J Clin Microbiol* 43:5425-5427, 2005.
68. Pfaller MA, Marco F, Messer SA, et al: In vitro activity of two echinocandin derivatives, LY202255 and MK-0991 (L-473,792) against clinical isolates of *Aspergillus*, *Fusarium*, *Rhizopus*, and other filamentous fungi. *Diagn Microbiol Infect Dis* 30:251-255, 1998.
69. Reboli AC, Rotstein C, Pappas PG, et al: Anidulafungin versus fluconazole for invasive candidiasis. *N Engl J Med* 356:2472-2482, 2007.
70. Reusser P: Oral valganciclovir: a new option for treatment of cytomegalovirus infection and disease in immunocompromised hosts. *Expert Opin Investig Drugs* 10:1745-1753, 2001.
71. Schuman P, Capps L, Peng G, et al: Weekly fluconazole for the prevention of mucosal candidiasis in women with HIV infection: a randomized, double-blind, placebo-controlled trial. *Ann Intern Med* 126:689-696, 1997.
72. Smee DF, Martin JC, Verheyden JP, et al: Anti-herpesvirus activity of the acyclic nucleoside 9-(1,3-dihydroxy-2-propoxymethyl) guanine. *Antimicrob Agents Chemother* 23:676-682, 1983.
73. Spruance SL, Crumpacker CS: Topical 5 percent acyclovir in polyethylene glycol for herpes simplex labialis: antiviral effect without clinical benefit (Acyclovir Symposium). *Am J Med* 73(1A):315-319, 1982.
74. Steinbach WJ, Benjamin DK, Jr, Kontoyiannis DP, et al: Infections due to *Aspergillus terreus*: a multicenter retrospective analysis of 83 cases. *Clin Infect Dis* 39:192-198, 2004.
75. Talbot TR, Crocker DD, Peters J, et al: Duration of virus shedding after trivalent intranasal live attenuated influenza vaccination in adults. *Infect Control Hosp Epidemiol* 26:494-500, 2005.
76. U.S. Public Health Service: Updated U.S. Public Health Service guidelines for the management of occupational exposures to HBV, HCV, and HIV and recommendations for postexposure prophylaxis. *MMWR Morb Mortal Wkly Rep* 50(RR-11):1-52, 2001.
77. van Burik JA, Ratanatharathorn V, Stepan DE, et al: Micafungin versus fluconazole for prophylaxis against invasive fungal infections during neutropenia in patients undergoing hematopoietic stem cell transplantation. *Clin Infect Dis* 39:1407-1416, 2004.
78. van Rossum AMC, Geelen SPM, Hartwig NG, et al: Results of 2 years of treatment with protease-inhibitor containing antiretroviral therapy in dutch children infected with human immunodeficiency virus type 1. *Clin Infect Dis* 34:1008-1016, 2002.
79. Vazquez JA, Sliest DJ, Nieto L, et al: A multicenter randomized trial evaluating posaconazole versus fluconazole for the treatment of oropharyngeal candidiasis in subjects with HIV/AIDS. *Clin Infect Dis* 42:1179-1186, 2006.
80. Vazquez JA: Therapeutic options for the management of oropharyngeal and esophageal candidiasis in HIV/AIDS patients. *HIV Clin Trials* 1:47-59, 2000.
81. Walsh TJ, Pappas P, Winston DJ, et al: Voriconazole compared with liposomal amphotericin B for empirical antifungal therapy in patients with neutropenia and persistent fever. *N Engl J Med* 346:225-234, 2002.
82. Warnock DW, Johnson EM, Richardson MD, et al: Modified response to ketoconazole of *Candida albicans* from a treatment failure. *Lancet* 1:642-643, 1983.
83. Wheat J, Hafner R, Korzun AH, et al: AIDS Clinical Trial Group. Itraconazole treatment of disseminated histoplasmosis in patients with the acquired immunodeficiency syndrome. *Am J Med* 98:336-342, 1995.
84. Whitley RJ; NIAID Collaborative Antiviral Study Group: Interim summary of mortality in herpes simplex encephalitis and neonatal herpes simplex virus infections: vidarabine versus acyclovir. *J Antimicrob Chemother* 12(Suppl B):105-112, 1983.
85. Wilhelmus KR: The treatment of herpes simplex virus epithelial keratitis. *Trans Am Ophthalmol Soc* 98:505-532, 2000.
86. Woo SB, Challacombe SJ: Management of recurrent oral herpes simplex infection. *Oral Surg Oral Med Oral Pathol Oral Radiol Endod* 103(S12):1-18, 2007.
87. Wutzler P: Antiviral therapy of herpes simplex and varicella-zoster virus infections. *Intervirology* 40:343-356, 1997.
88. Yamaguchi H, Abe S, Tokuda Y: Immunomodulating activity of antifungal drugs. *Ann N Y Acad Sci* 685:447-457, 1993.
89. Zegarelli DJ: Fungal infections of the oral cavity. *Otolaryngol Clin North Am* 26:1069-1089, 1993.

GENERAL REFERENCES

- Antifungal drugs, *Med Lett Drugs Ther* 6:1-8, 2008.
- Brown TJ, Vander-Straten M, Tyring SK: Antiviral agents, *Dermatol Clin* 19:23-34, 2001.
- Deck DH, Guglielmo BJ: Pharmacological advances in the treatment of invasive candidiasis, *Expert Rev Anti Infect Ther* 4:137-149, 2006.
- Goldschmidt RH, Moy A: Antiretroviral drug treatment for HIV/AIDS, *Am Fam Physician* 54:574-580, 1996.
- Hofmann WP, Soriano V, Zeuzem S: Antiviral combination therapy for treatment of chronic hepatitis B, hepatitis C, and human immunodeficiency virus infection, *Handb Exp Pharmacol* 189:321-346, 2009.
- Lewis RE, Kontoyiannis DP: Rationale for combination antifungal therapy, *Pharmacotherapy* 21:149S-164S, 2001.

Immunotherapy

JOHN A. YAGIELA AND ANAHID JEWETT*

Immunopharmacology is the study of the interaction between drugs and the immune system. Immunotherapy is the application of clinical strategies to modulate the activities of certain components of the immune system in order to improve immune function and to prevent or treat disease. This chapter reviews the immune system with regard to the pathways used toward adaptive, specific immunity that are or can be targeted for immunotherapy and discusses immunotherapeutic strategies that are of clinical importance today or show promise for the future. The pharmacologic manipulation of innate immune mechanisms involved in inflammation is covered in Chapters 21 and 35.

OVERVIEW OF SPECIFIC IMMUNITY

Components of the Immune System

Research in immunology has progressed rapidly over the last three decades. Spanning this period, major technologic feats (e.g., the development of hybridomas for the production of monoclonal antibodies) and major strides in our understanding of the immune system (including elucidation of cytokines and intracellular signaling) have resulted in significant advances in immunotherapeutics. Today immunopharmacologists use these new insights to pinpoint therapeutic targets among (1) a constellation of cytokines and other factors that influence cellular growth, differentiation, and function and (2) myriad receptors responsive to these mediators, specific antigens, or ligands found on other cells.

Cells

The immune system is composed of two major arms, innate immunity and adaptive immunity. These two components of the immune system differ in the types of effectors, their specificity for antigens, speed of action, and induction of memory. Innate immune cells are the primary initiators of the immune response and support functional activation of adaptive immune effectors. They differ from the adaptive immune effectors by their lack of antigen specificity and their fast acting capabilities. Unlike the adaptive immune effectors, the innate immune effectors do not generate memory. The main effectors of innate immune system are granulocytes, macrophages, and natural killer (NK) cells, whereas T and B lymphocytes are the main effectors of adaptive immunity.

All the effectors of the immune system are derived from the bone marrow. Pluripotent hematopoietic stem cells in bone marrow give rise to either myeloid progenitor cells or lymphoid progenitor cells (Figure 41-1). Myeloid progenitor cells are the precursors of red blood cells, platelets, granulo-

cytes (polymorphonuclear leukocytes [PMNs]: neutrophils, eosinophils, and basophils), monocyte-macrophages, dendritic cells (DCs), and mast cells. Lymphoid progenitor cells give rise to the T, B, and NK cells. Lymphocytes are generated and mature in the bone marrow and thymus, which are considered to be the primary or central lymphoid organs. From there, they travel to reside in secondary or peripheral lymphoid organs, such as lymph nodes, spleen, mucosa-associated lymphoid tissues (MALT), gut-associated lymphoid tissues (GALT), and bronchus-associated lymphoid tissues (BALT).

The various cell types exit the bone marrow at different levels of maturation, circulate through the bloodstream, and may take up residence in specific tissues. Certain cells involved in the body's defense system provide rapid responses, whereas others support slower, adaptive responses. Neutrophils and NK cells exit the bone marrow in a relatively mature state and require very little time to become activated. In contrast, monocytes, dendritic cells, and most lymphoid cells leave the bone marrow in a relatively immature state and complete their maturation at some other tissue site, where they can be activated to respond to local cues.

Lymphocytes circulate between blood and lymphatics continuously. Lymphocytes that have not encountered antigen are called naïve lymphocytes; those that have encountered antigen and have become mature are effector lymphocytes. Activation of antigen-presenting cells (APCs)—monocytes, B cells and dendritic cells—is the necessary first step for the induction of adaptive immunity. In adaptive immunity, lymphocytes activated by antigens give rise to clones of antigen-specific cells, which are then selected either positively or negatively. Clonal selection is the central principle of adaptive immunity. The four basic postulates of clonal selection are that (1) each lymphocyte bears a single type of receptor with a unique specificity to self and nonself; (2) lymphocytes expressing receptors for specificity for self-antigens are deleted at an early stage and therefore are absent from the pool of mature lymphocytes; (3) interaction between a foreign antigen and the receptor capable of binding to it leads to lymphocyte activation; and (4) the differentiated effector cells derived from an activated lymphocyte will bear receptors of identical specificity to those of the parental cells. In adaptive immunity, unique antigen receptors are generated by gene rearrangement, and signals received through antigen receptors determine the development and survival of lymphocytes. Binding of antigen activates lymphocytes, resulting in the generation of effector cells and the establishment of immunologic memory.

T cells exit the bone marrow as CD3-CD4-CD8–null cells according to the cluster of differentiation (CD) classification of leukocyte antigens before entering the thymus. In young individuals, the thymus contains large numbers of developing T-cell precursors embedded in a network of epithelia known

*The authors wish to recognize Dr. Kenneth T. Miyasaki for his past contributions to this chapter.

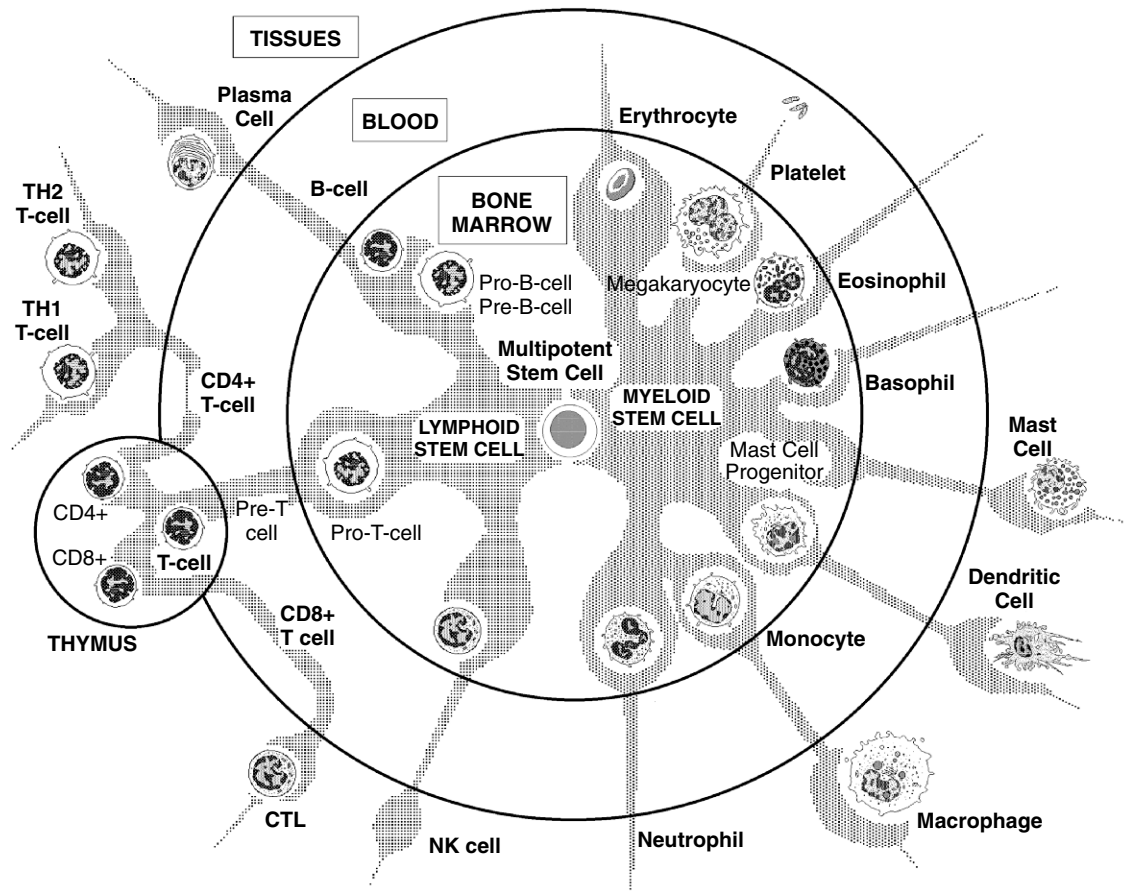

FIGURE 41-1 Lineage and location of blood cells and other cells involved in the immune response. Differentiative and proliferative events are indicated by shading. Not shown are the regulatory T cell and the T helper cell TH17. *Pre-T cell*, precursor T cell.

as the thymic stroma, which provides a supportive environment for the developing T cells. T-cell precursors proliferate extensively in the thymus, but most eventually are eliminated there. The thymus of a young adult mouse contains $1-2 \times 10^8$ thymocytes. Although 50 million new cells are generated each day, only 2 million of these cells survive to leave the thymus. The developmental pathway of T cells in the thymus is the following. Early on, CD3-CD4-CD8-null cells develop into CD3+pT α CD4+CD8+ (triple-positive) thymocytes. About 95% of triple-positive thymocytes will be eliminated by apoptosis, and the remaining 5% will exit thymus as either CD3+CD4+ or CD3+CD8+ double-positive T cells.

Once T cells have completed their developmental stages in the thymus, they enter the bloodstream and then are carried to the secondary lymphoid tissues, such as the lymph nodes or spleen. If they encounter their specific antigen, they will become activated, proliferate, and differentiate to armed effector T cells. Otherwise, they will continue to travel back and forth from the blood to the secondary lymphoid tissues. Meanwhile, these naïve T cells will receive survival signals from self-peptide-self-MHC complexes.

Immature dendritic cells also travel from the tissues to secondary lymphoid tissues where they mature to activate T cells. The first encounter of a naïve T cell with the antigen on a mature dendritic cell is called *priming*, to distinguish it from the response of an armed effector T cell to antigen.

The sampling of different peptide-MHC complexes by naïve T cells on dendritic cells is important for the specific encounter of antigen-specific T cells, since only 0.0001% to 0.01% of T cells are specific for any particular antigen. Once they encounter the antigen they cease migration, proliferate,

and differentiate to effector T cells. This process may take several days. At the end of that time, they leave the lymphoid tissues and re-enter the bloodstream to migrate to the site of the infection.

CD4+ T cells differentiate further outside the thymus into four distinct subsets. T helper (TH)1 cells primarily secrete interleukin (IL)-2 and interferon (IFN)- γ and activate monocytes and B cells, whereas TH2 cells primarily secrete IL-4, IL-5, IL-6, and IL-10 and activate B cells. TH17 cells secrete IL-17 and activate neutrophil responses to extracellular bacteria; T regulatory (Treg) cells function to suppress T cell responses.

TH1 cells upon activation produce IL-2 and IL-2 receptors, both of which are important in the induction of cell proliferation. The IL-2 receptor is composed of three different chains; α , β , and γ chains. Resting T cells express the β and γ chains, which together form the intermediate affinity IL-2 receptor and can respond to high concentrations of IL-2. The high affinity IL-2 receptor is formed when all three chains associate; it responds to low concentrations of IL-2 in activated T cells.

CD8+ T cells differentiate into cytotoxic cells. CD8+ cytotoxic T cells kill virally infected cells or tumor-target cells via two different mechanisms, namely apoptosis and necrosis. Apoptosis is distinguished from necrosis by the intact plasma membrane at the initial stages of programming for cell death, nuclear membrane blebbing, and DNA fragmentation.

Receptors and other cell-surface proteins

Cells involved in specific immunity express various surface glycoproteins to help coordinate their functions and interac-

tions. These glycoproteins include adhesion molecules, cytokine receptors, and receptors that bind and respond to specific antigens and to co-receptors and costimulatory receptors expressed on other cells.

Clonally distributed antigen-specific receptors. As mentioned above, T cells and B cells possess receptors that specifically recognize the antigen and are distributed in a clonal manner. These receptors, both members of the immunoglobulin superfamily, are the T cell receptor (TCR) mentioned previously and the B-cell antigen receptor (BCR). Secreted forms of the BCR constitute the immunoglobulins found in plasma, extracellular fluid, and secretions. The BCR and TCR recognize short oligomeric sequences of a molecule and exhibit primary sequence specificity. In addition, the BCR (but not the TCR), which is designed to react with unprocessed antigen, may recognize secondary, tertiary, and quaternary structural features. The diversity of the TCR/BCR repertoire is generated by four main mechanisms: (1) somatic recombination, in which variable regions of the receptor chains, which are encoded in several pieces called *gene segments*, are assembled in the developing lymphocytes by somatic DNA recombination (a process known as *gene rearrangement*); (2) pairing of heavy and light chains of the BCR, or α and β chains of the TCR; (3) junctional diversity; and (4) somatic hypermutation. In both BCRs and TCRs the diversity is significantly increased by the addition and subtraction of nucleotides at the junction between the gene segments. Because the total number of nucleotides added by junctional diversity is random, the added nucleotides may disrupt the reading frame of the coding sequences, causing frameshifts that will lead to a non-functional protein. This outcome is called nonproductive rearrangement. Since two out of three rearrangements are nonproductive, many B cell progenitors never succeed in producing BCRs and never mature (into plasma cells and memory cells). Junctional diversity is achieved only at the expense of considerable cellular waste.

Rearranged genes in B cells (but not T cells) are further diversified by somatic hypermutation. Somatic hypermutation is the process of introducing point mutations into the variable region of the rearranged heavy and light chain genes at a very high rate. Somatic hypermutation occurs only when the B cells respond to the antigen along with the signals from activated T cells. Mutations that are deleterious and cannot bind antigen will remove the B cells (*negative selection*). Those that are positive will select for B cells with an even more improved antigen binding capacity (*affinity maturation*) causing the clonal expansion of these B cells.

Nonclonally distributed antigen-binding receptors. Most cells possess receptors that bind and present antigen specifically, but are not clonally distributed. These receptors are members of the immunoglobulin superfamily and include two classes of proteins encoded within the major histocompatibility gene complex (MHC) named MHC I and MHC II. T cells recognize self- and non-self-antigens as peptide fragments bound to MHC antigens. The MHC I and MHC II molecules recognize peptides derived from proteins that have been processed internally. MHC I proteins deliver peptides originating from cytosolic compartments, whereas MHC II proteins deliver peptides from vesicular compartments. The MHC I and II molecules do not discriminate the entire primary structure of the peptide, but instead recognize two (or more) "anchor" positions in the peptide separated by a short sequence of amino acids of virtually any composition or sequence. Peptide fragments presented through MHC I activate CD8+ T cells to kill; peptide fragments presented by MHC II activate the function of CD4+ T cells to aid B cells and macrophages to become activated.

Polygenic and polymorphic properties of the MHC make it difficult for pathogens to evade immune responses. Polygenic refers to the fact that the MHC contains several different MHC I and II genes; polymorphic indicates there are multiple variants of each gene.

The MHC is located on chromosome 6 in humans. There are three class I genes in humans named *HLA-A*, *HLA-B*, and *HLA-C* (classical MHC I genes). There are also three pairs of class II genes named *HLA-DR*, *HLA-DP*, and *HLA-DQ*. The *HLA-DR* cluster contains an extra β chain gene, where its product can pair with the *DR α* chain, giving rise to four types of MHC II proteins. Expression of MHC II genes is induced by IFN- γ via the production of a transcriptional activator known as *MHC class II transactivator* (CIITA). The absence of CIITA causes severe immunodeficiency.

MHC restriction refers to the recognition of the antigen by the T cells in the context of self-MHC. Thus a non-self-MHC I presenting the same peptide would not be recognized and would not activate T cells. Non-self-MHC molecules are recognized by 1% to 10% of T cells, an event termed *alloreactivity*. In alloreactivity, recognition of either the peptide antigen (peptide-dominant binding) or the foreign MHC molecule irrespective of the peptide with which it is complexed (MHC-dominant binding) leads to T-cell activation.

Other genes that map to the MHC locus include components of the complement cascade, such as C2, C4, and factor B, and cytokines including tumor necrosis factor (TNF)- α . These genes are referred to as *MHC class III genes*. In addition to highly polymorphic MHC I and II genes, there are many genes encoding MHC I-like molecules that show little polymorphism termed *MHC class Ib*. Some MHC Ib genes (e.g., the MIC gene family) are induced during cellular stress and regulate NK function.

Most individuals are heterozygous at each MHC locus. MHC polymorphism affects T-cell recognition of antigen by influencing both the peptide binding and the contact between the TCR and MHC molecule.

Mediators

Numerous water-soluble proteins affect or create specific immune reactions. Two principal groups of interest in immunotherapy are the cytokines and humoral antibodies.

Cytokines. Cytokines are produced by a wide variety of cells. They play crucial roles in stimulating the production of blood cells of all types and in regulating the differentiation, activation, and suppression of cells involved in specific immunity. Some cytokines are referred to as *interleukins*; cytokines also include interferons, and colony-stimulating factors. Cytokines have local and distant effects and activate cells in an autocrine (causing a self-response) and paracrine (affecting other cells) fashion.

An important feature of cytokine action is that multiple cytokines often work in concert to foster a particular change in cellular activity. The proliferation and differentiation of effector T cells important in cell-mediated immunity (CMI) depend on the interplay of TH1 cytokines such as IL-2, IL-12, and IFN- γ . Activation of B cells for humoral immunity is based on the release of several interleukins (IL-4, IL-5, IL-10, and IL-13) by TH2 cells. TH1 cytokines are important in stimulating B-cell differentiation leading to the production of immunoglobulins IgG1, IgG2, and IgG3. TH2 cytokines stimulate IgE and IgG4 production. The actions of selected cytokines are summarized in Table 41-1.

Humoral antibodies. Antibodies synthesized and released by plasma cells directly mediate humoral immunity. As shown in Figure 41-2, the basic immunoglobulin structure consists of two heavy chains and two light chains covalently linked by

TABLE 41-1

Selected Cytokines and Their Functional Relationships

CYTOKINE	SECRETED BY	FUNCTIONS
Lymphoid Hematopoiesis		
IL-7	SC	Lymphopoietin-1 Growth of pro-B and pre-B cells Growth of CD4 ⁺ and CD8 ⁺ T cells
T-Cell–Stimulating Factors		
IL-1 (α and β)	APC, B, Ep, En	Upregulation of IL-2 receptors on T cells Fever (endogenous pyrogen) Bone resorption (OAF)
IFN- α	B, Ma	Death of virus-infected cells Isotype switching Upregulation of MHC class II Ag
IFN- β	Fb, Ep	Same as for IFN- α
IFN- γ	T	Same as for IFN- α Upregulation of IL-2 receptors
IL-2	T	T-cell proliferation and formation of cytotoxic T lymphocytes
IL-10	T, B	T-cell proliferation Inhibition of cytokine synthesis by TH1 cells Cofactor for mast cell growth Increased B-cell expression of MHC class II molecules
B-Cell–Stimulating Factors		
IL-4	T	Activation of resting B cells Isotype switching (IgG1 and IgE)
IL-5	T	B-cell proliferation Isotype switching (IgA, IgM)
IL-6	T, M, Fb	Eosinophil differentiation factor B-cell proliferation
IL-13	CD4 ⁺ T	Death of virus-infected cells Monocytes assume dendritic features Stimulation of B-cell differentiation
Tumor Killers and Cell-Mediated Immunity		
TNF- α	Ma	Death of tumor cells Related to IFN- γ and TNF- β Promotion of healing Angiogenesis
TNF- β	T	Death of tumor cells (lymphotoxin)
IL-12	Ma	Stimulation of TH1 cells and CMI Inhibition of TH2 cells and IgE production
Myeloid Factors		
IL-3	L, My	Multiple granulocytic cell type CSF
IL-8	Ma, En	Neutrophil (and lymphocyte) chemotaxis Granulocyte differentiation cofactor
IL-9	T	Erythroid cell precursor growth Mast cell growth
IL-11	SC	Megakaryocyte growth and differentiation
GM-CSF	L, My	Granulocyte/monocyte CSF
M-CSF	L, My	Monocyte CSF
G-CSF	L, My	Granulocyte/erythroid cell CSF
Erythropoietin	RC	Erythroid growth and differentiation

This summary table is not intended to provide a complete listing of all the biologic functions of the cytokines, but rather to point out the relationships among them.

Ag, Antigen; APC, antigen-presenting cell; B, B cell; CMI, cell-mediated immunity; CSF, colony-stimulating factor; En, endothelial cell; Ep, epithelial cell; Fb, fibroblast; G, granulocyte; L, lymphoid cell; M, monocyte; Ma, macrophage; My, myeloid cell; OAF, osteoclast-activating factor; RC, renal cortex; SC, stromal cell; T, T cell; TNF, tumor necrosis factor.

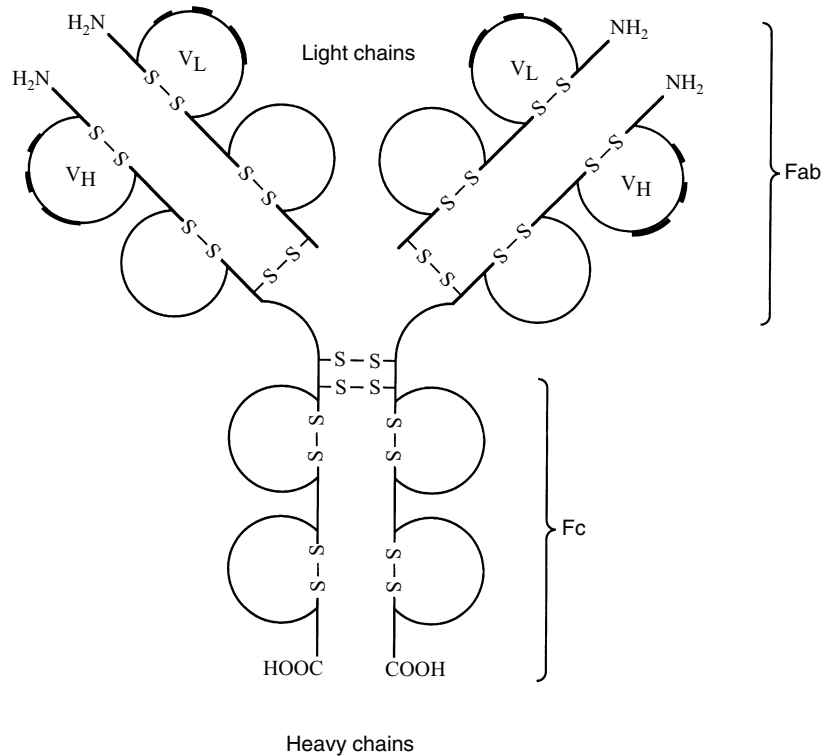

FIGURE 41-2 Diagram of an IgG antibody, including disulfide linkages. The “crystallization fragment” (*Fc*) of the molecule, formed by portions of the two heavy chains, contains the binding sites for specific cells and for complement; each remaining “antibody fragment” (*Fab*), which consists of one light chain and the remaining portion of one heavy chain, includes the variable regions (*VL* and *VH*) that participate in antibody binding. The hypervariable sequences of the variable regions are shown as thickened segments.

interchain disulfide bonds. Both chains consist of two or more domains, each defined by a single intrachain disulfide bond. The heavy chain is composed of three or four constant domains and one variable domain. The light chain incorporates one constant and one variable domain. The relatively flexible hinge regions found in certain immunoglobulins are believed to be remnants of primordial constant domains. Terminal sequences on the amino end of each chain make up the variable regions of the molecule. Within each variable region are hypervariable sequences that are responsible for specific antigen binding. There are two types of light chains, λ and κ . The ratio of λ and κ chains differs in various species, being 1:20 in mice and 1:2 in humans. Sometimes the ratio of λ to κ is used to identify multiple myeloma.

The class of an antibody is determined by its heavy chain. There are five heavy chains or isotypes: IgM, IgG, IgD, IgA, and IgE. IgG is the most abundant subtype and has several subclasses: IgG1, IgG2 (IgG2a and IgG2b), IgG3; and IgG4. The amino terminal region in the variable domain (v domain) of the heavy and light chains (*V_H* and *V_L*) binds to antigen, whereas constant domain (C domain) of the heavy and light chains (*C_H*, *C_L*) makes up the constant regions.

These domains form the Fc region of the molecule (Fc is the “crystallizable fragment” of a polyclonal immunoglobulin). The Fc region dictates the specific binding of each isotype to different Fc receptors on phagocytes, mast cells, and other cells involved in inflammatory reactions. The Fc region also dictates complement activation by IgG and IgM.

There are three discrete regions in the *V_H* and *V_L* domains of the antibodies named HV1 (hypervariable 1), HV2, and HV3 (HV3 is the most variable site of each domain). These are separated by structural framework regions (FRs), namely FR1, FR2, FR3, and FR4. The six hypervariable regions in each arm of the antibody that form the antigen binding site when brought together are complementary to the antigen, thus they are called *complementarity determining regions* or CDRs. There are three CDRs, CDR1, CDR2 and CDR3. Antigen molecules contact antibody over a broad area of its surface and binds

noncovalently through electrostatic forces, hydrogen bonds, van der Waals forces, and hydrophobic interactions.

Transmembrane and secreted forms of Igs are generated through alternative splicing of heavy chain domains. There are two polyadenylated sites that dictate the generation of transmembrane or secreted forms of Igs. All B cells initially express IgM in its transmembrane form, but upon contact with antigen they generate the secreted forms and undergo isotype switching to generate other antibodies.

Sequence differences between Ig heavy chains cause the various isotypes to differ in the number and location of their disulfide bonds, the number of attached oligosaccharide moieties, the number of C domains, and the length of the hinge region.

IgM, which is co-expressed with IgD on the surface of cells, predominates in neonates and during initial, or primary, immune responses to antigenic challenges. IgG, IgA, and IgE are important in responses to antigens on secondary exposure. Because of an extended half-life (approximately 21 days), IgG constitutes approximately 75% of circulating immunoglobulins. IgG is the principal opsonic antibody important for phagocytosis; it plays a central role in immune responses against submucosal antigens. Fc receptors for IgG are found on neutrophils, monocytes, and dendritic cells.

On a daily basis, approximately three times more IgA is produced than all other immunoglobulins combined. IgA has two subclasses, IgA1 and IgA2. The IgA2 isotype is found in most mucous secretions and constitutes about 40% of total salivary IgA. It is important in mucosal immunity and caries immunology. Both IgA and IgM are bound by the polymeric immunoglobulin receptor (pIgR), which is not within the Fc receptor family. Found on the basolateral surface of ductal epithelial and intestinal epithelial cells, the pIgR enables the two immunoglobulins to be transported by transcytosis across the epithelium and into secretions. IgA is important in specific immunity against supramucosal antigens and in anti-inflammatory reactions below the mucosa. Although circulatory IgA production (mostly IgA1) is equal to that of IgG,

it has a shorter half-life (approximately 7 days) than IgG and a lower plasma concentration.

IgE is evolutionarily related to IgG in that both their ancestries can be traced back to IgY, the predominate inflammatory immunoglobulin found in nonmammalian vertebrates. IgE is bound with extremely high affinity by Fc receptors found on mast cells and basophils; it promotes immediate inflammation (which is important in initiating acute and chronic inflammation). IgE is also bound by low-affinity receptors present on eosinophils and enables these cells to exert anthelmintic and antiparasitic effects. IgE production is tightly controlled.

The role of IgD is less clear; it is not a secondary response antibody because it can be co-expressed with IgM on a single B cell. IgD and IgM mRNA is produced as a single transcript. Post-transcriptional modifications dictate whether IgM or IgD will be translated. IgD is believed to prevent the induction of B-cell tolerance, which can occur in B cells expressing IgM alone. Fc receptors for IgD have been found on T cells.

Each plasma cell produces a unique antibody because of the clonal distribution of the BCR. Initially, the differentiation of B cells to plasma cells results in the production of IgM antibodies. If antigen has also been presented to CD4+ T cells by B cells, the T cells can guide B-cell differentiation along the memory pathway as opposed to the plasma cell differentiation pathway. In the memory pathway, the isotype may change. Secondary antigen exposure can elicit IgA, IgG, or IgE production. This process of isotype switching promotes a more appropriate interplay of antibodies with complement and with myeloid immune cells (e.g., neutrophils, monocytes, mast cells, and eosinophils).

Initiation, Progression, and Termination of Specific Immune Responses

The immune system is normally engaged in the homeostatic regulation of host-derived antigens. Once an antigen receptor is formed it has to be rigorously tested against self peptides. Given the incredible number of receptors formed it is important that those lymphocytes which reach maturity are likely to be useful in recognizing foreign antigens. In general, developing lymphocytes whose receptors interact weakly with self-antigens, or bind antigen in a particular fashion, receive a survival signal. In contrast, lymphocytes with strongly self-reactive receptors must be deleted to prevent auto-immunity through negative selection. The fate of lymphocytes in the absence of any signal is death. In addition, the immune system participates in its more widely appreciated inflammatory function known as the *immune response*.

Immune responses are the measurable alterations in immune system activity after an antigenic perturbation. They are usually initiated by an immediate inflammatory reaction resulting from the activation of soluble factors (e.g., complement) found within the extracellular fluid or mediators released by resident leukocytes, especially the mast cell. The immediate inflammatory response signals postcapillary venule endothelial cells to recruit the appropriate acute-phase or chronic-phase leukocytes from the blood. Initially recruited are cells that do not need to progress through proliferation or differentiation to exert an effect, such as neutrophils. Neutrophils are the predominant cell in acute inflammation. Acute inflammation may be followed by slower, chronic inflammation involving less mature cells capable of adaptive cellular differentiation (with or without proliferation). The proliferation and differentiation of clones of cells that recognize the antigen specifically constitute the specific immune response.

Specific immune responses involve a series of events (Figure 41-3), each of which offers a potential site for immunotherapeutic intervention. Included in this series are antigen processing and presentation, T-cell selection, lymphocyte differentiation, effector function, and termination. These events

occur in response to changes in the concentrations of antigens intracellularly and extracellularly.

Antigen processing

Antigen processing is the partial degradation of polymeric antigens into oligomeric units (especially the degradation of a protein into small peptides), which are subsequently bound by MHC I or II molecules. Various hydrophobic peptides and glycolipids can be bound by CD1 antigens, which are related to the MHC I and II molecules.

Intracellular antigens. Processing of intracellular antigens generated within the endoplasmic reticulum or cytosol occurs continuously in all cells. Proteins in the cells become degraded and are replaced by newly synthesized proteins. Degradation of protein occurs in a large, multi-subunit protease-like structure called the *proteasome*. Peptides can further be trimmed in the endoplasmic reticulum (ER) by the help of aminopeptidases. Some proteasomes accept proteins for degradation only if they are tagged by small polypeptides called *ubiquitin*. The peptides generated in the cytosol are transported into the ER where they are bound by nascent MHC I molecules.

Viruses and certain types of bacteria are degraded in the cytosol or in the nuclear compartments before they are presented in the context of MHC I. Structurally, MHC I consists of two polypeptide chains, α and β . The α chain is the larger of the two and has three domains, $\alpha 1$, $\alpha 2$ and $\alpha 3$. The smaller, nonpolymorphic β chain, termed β_2 *microglobulin*, is noncovalently attached to the $\alpha 3$ domain. Only the α chain spans the membrane. The $\alpha 1$ and $\alpha 2$ domains form the cleft that binds to the peptide fragment and are highly polymorphic. Peptides that bind to MHC I molecules are transported from the cytosol to the ER. The peptide-binding site of MHC I is formed in the lumen of the ER and is never exposed to the cytosol. Expression of MHC I on the surface of the cells is unstable unless it is bound to peptide. Mutations at a site where peptides bind to the MHC I protein cause significant decreases in the expression of MHC I on the surface of the cells. Mutations in transporters associated with antigen processing (TAPs) may also not allow for the transport of the peptides from the cytosol to the lumen of the ER.

Newly synthesized MHC I α chains bind to a chaperone protein called *calnexin*, which retains MHC I in a partly folded structure in the ER. When β_2 microglobulin binds the α chain the complex dissociates from calnexin and then binds to another chaperone, *calreticulin*. A third protein, tapasin, forms a bridge between MHC I molecules and TAP, allowing the transport of the suitable peptide from the cytosol. Most of the chaperon proteins play a role in selecting peptides with higher binding affinity.

Viruses have evolved several means of evading recognition by preventing the appearance of peptide:MHC I complexes at the cell surface. For example, the herpes simplex virus prevents the transport of viral peptides into the ER by producing proteins that bind and inhibit TAP, whereas adenoviruses produce a protein that binds MHC I molecules and retains them in the ER. Cytomegaloviruses accelerate retrograde translocation of MHC I back into the cytosol, where they are degraded.

Extracellular antigens. The majority of pathogenic bacteria and some eukaryotic parasites replicate in the endosomes and lysosomes that form the vesicular system. Pathogens such as *Leishmania* and *Mycobacteria* are picked up by macrophages through endocytosis. The resultant endocytic vesicles gradually become acidified and finally fuse with lysosomes, forming phagolysosomes. These organelles contain acid proteases that become activated at low pH, resulting in degradation of the protein antigen. Among acid proteases are the cysteine proteases cathepsin B, D, S, and L. Cathepsin L is the most active of the family. Disulfide bonds also need to be cleaved for

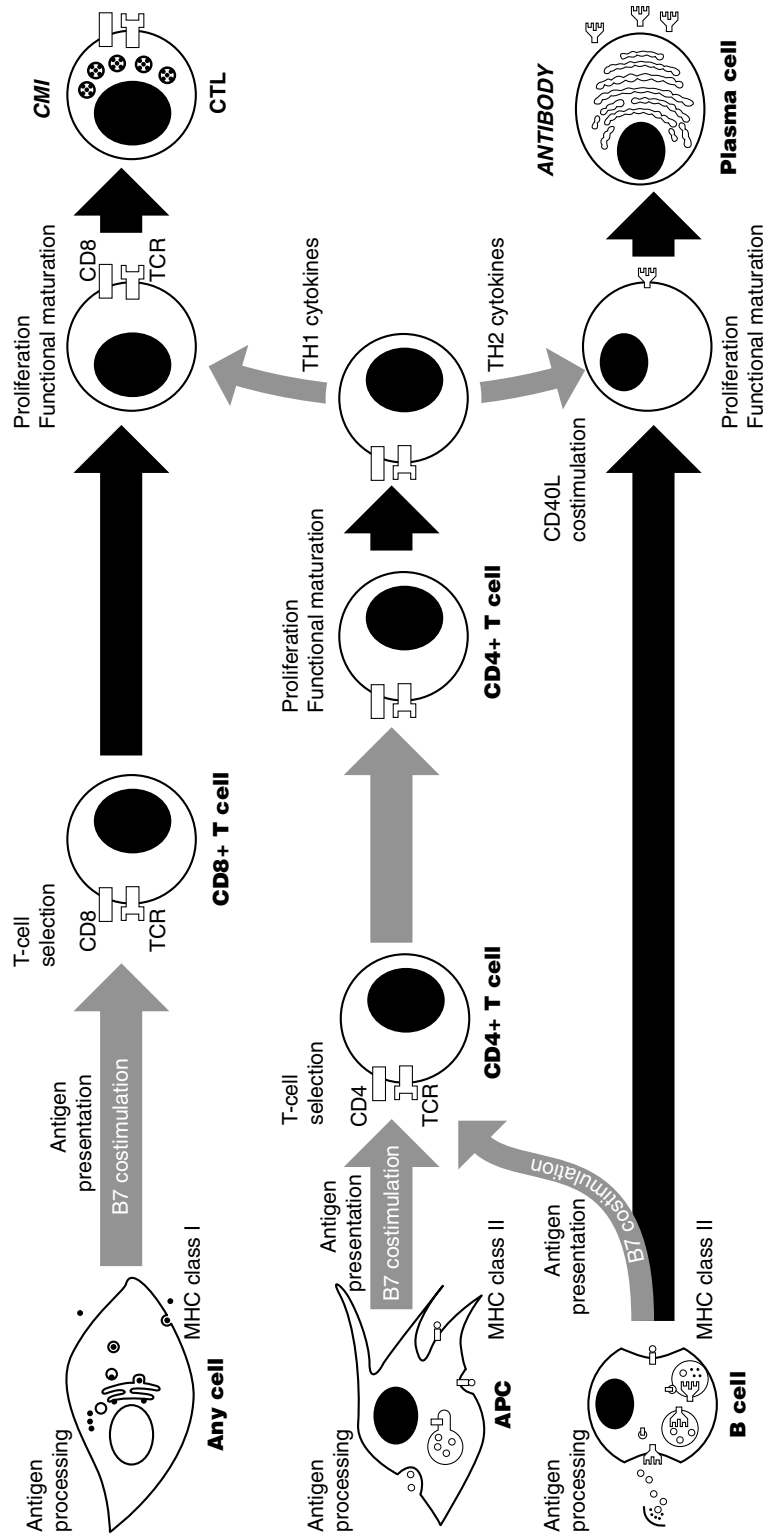

FIGURE 41-3 Overview of specific immune responses. For simplicity, the IL-2 receptor and the TH17 and Treg helper cells are not shown. APC, Antigen-presenting cell; CMI, cell-mediated immunity; CTL, cytotoxic T lymphocyte.

peptide processing. Degraded peptides from pathogens are then presented in the context of MHC II molecules to T cells.

Each MHC II protein comprises two noncovalently bound chains, α and β , both of which span the membrane. There are two α domains, $\alpha 1$ and $\alpha 2$, and two β domains, $\beta 1$ and $\beta 2$. The $\alpha 1$ and $\beta 1$ domains are very polymorphic and form the peptide-binding locus. The folding of $\alpha 1$ and $\beta 1$ is more open than the $\alpha 2$ and $\beta 2$ domain of MHC I, thus the ends of the peptide fragments are exposed.

Binding of nonspecific peptides to MHC II is prevented by the association of MHC II in the ER with a third polypeptide termed the *invariant chain*. The invariant chain, by forming a trimer with MHC II, covers the antigen-binding groove. Invariant chains also target MHC II to low-pH endosomal compartments where peptide loading can occur. The invariant chain is then cleaved by acid proteases, such as Cathepsin S, to generate a truncated form. The subsequent cleavage releases the MHC II molecule leaving a fragment called CLIP bound to the MHC II.

Most MHC II molecules are brought to the cell surface in vesicles, which at some point fuse with incoming endosomes where they encounter and bind peptides derived from self- or non-self-proteins. HLA-DM assists in the process by stabilizing MHC II molecules, which would otherwise aggregate. It also catalyzes the removal of CLIP and the loading of the peptide into the groove of the MHC II. HLA-DM, closely related to the MHC II molecule, does not bind to the peptide because its groove is closed. HLA-DM also removes weakly bound peptides, allowing for the binding of high affinity peptides. Peptides bound to MHC can remain several days in case the APC does not encounter the target; therefore, increased binding affinity of the peptide to the groove is important.

A second atypical MHC II molecule, called HLA-DO is produced in thymic epithelial cells and B cells. Unlike HLA-DM, which aids in releasing CLIP and binding peptide, HLA-DO inhibits HLA-DM function and subsequently inhibits antigen loading. The activating capacity of HLA-DM is higher than the inhibiting capacity of HLA-DO because secreted IFN- γ can upregulate HLA-DM but not HLA-DO.

T-cell activation

T-cell recognition, activation, and effector function depend on cell-cell contact mediated by cell adhesion molecules. T cells enter the lymph nodes through binding to specialized postcapillary swellings called *high endothelial venules*. The main classes of adhesion molecules involved in lymphocyte interaction are the selectins, integrins, members of the Ig superfamily, and mucin-like molecules. Selectins are important for leukocyte homing to particular tissues and can be expressed either on leukocytes (L selectin) or on endothelial cells (P and E selectins). Selectins are cell-surface molecules with a common core structure, but different lectin-like domains in their extracellular portions. The lectin domain binds to particular sugar groups on a carbohydrate backbone. L selectin binds to the carbohydrate moiety of mucin-like molecules called vascular addressins, which are expressed in the surface of endothelial cells. The interaction between L selectin and vascular addressins is responsible for the specific homing of naïve T cells to lymphoid tissues, whereas the integrins and the Ig superfamily are involved in their crossing through the endothelial barrier.

Just as binding of neutrophils to endothelial cells is guided by chemokines, migration of naïve T cells into lymphoid tissues is directed by similar molecules, such as secondary lymphoid tissue chemokine. This interaction increases both the affinity and surface expression of integrins on the T cell membranes, which arrests the cells and causes them to move through the endothelial layer to enter the lymphoid parenchyma. The integrin LFA-1, for example, is expressed on all

T cells. It binds to Ig superfamily adhesion molecules, such as ICAM-1 and ICAM-2, which are expressed on endothelium and APCs. Binding to LFA-1 allows the leukocytes to migrate through the blood vessel wall in lymph nodes and be able to sample antigen on the surface of APCs. ICAM-3, another adhesion molecule, is expressed only on leukocytes and binds to its partner (DC-sign) on dendritic cells. The binding of CD58 (LFA3) on APCs to CD2 on T cells is yet another example of adhesion molecule interactions.

The initial association of T cells with APCs is mediated by the interplay of multiple adhesion molecules. Binding of LFA-1, ICAM-3 and CD2 on T cells to ICAM-1, ICAM-2, DC-sign and CD-58 on APCs provides enough redundancy that if one pairing is missing the T cells can still bind and recognize the specific antigen on the APCs. The transient binding to APCs allows the T cells to sample a large number of MHC:peptide sequences on APCs, and if it recognizes the antigen, signaling through the TCR will significantly increase the affinity of LFA-1 for ICAM-1.

Both signals for specific antigen and costimulatory molecules are required for the clonal expansion of T cells. In the absence of costimulatory signals, activation of T cells through antigen receptor will lead to anergy or unresponsiveness. Anergic cells are deleted by cell death. The most highly characterized costimulatory molecules are structurally related glycoproteins belonging to the B7 family. The best known are B7.1 (CD80) and B7.2 (CD86). They bind to the CD28 receptor on the surface of naïve T cells and costimulate in the presence of antigen receptor. Once a naïve T cell is activated, it up-regulates CD40 ligand, which binds to the CD40 receptor on APCs and further activates both the T cells and the APCs. Activated T cells will then upregulate cytotoxic T-lymphocyte-associated antigen-4 (CTLA-4 or CD152), which is similar in structure to CD28 and limits further activation by binding to B7 family costimulatory molecules. This way activation and proliferation of T cells are regulated.

Resident dendritic cells such as Langerhans cells are able to pick up antigen by phagocytosis or macropinocytosis. They can travel and take the antigen to the secondary lymphoid tissues where they lose the capability to phagocytize but gain the ability to present antigen to T and B cells. Both dendritic cells and B cells can bind soluble antigens and present them as peptide: MHC II complexes to T cells. B cells do not express costimulatory molecules constitutively; they need to be activated by bacteria to express B7.1 and B7.2.

The actual recognition of antigen by the TCR is a low-affinity reaction. This characteristic enables many TCRs of a given T cell to interact with the few specific antigens presented by the antigen-presenting cell. Multiple interactions are important because T-cell activation depends on the number of TCRs that interact with antigen over time.⁴² The factors that influence T-cell activation include the number of antigen molecules presented by the antigen-presenting cell, the affinity of the TCR for the antigen, and the number of TCRs. If the interaction with peptide antigen by TCRs is sufficient, the TCRs cluster on the T-cell surface and downregulate (the TCRs are probably internalized). With costimulation, downregulation of approximately 4250 TCRs leads to T-cell activation.

In early stages of exposure to antigen, costimulatory signals permit T cells to become receptive to differentiative signals, allowing them to proliferate or mature in function. These signals also block apoptosis. At later stages, the same signals can permit T cells to differentiate terminally, even to the point of death.

Differentiation

After antigen recognition by TCR and BCR, intracellular signaling events allow the T cell to differentiate into functionally mature cells (Figure 41-4). Much present-day immunother-

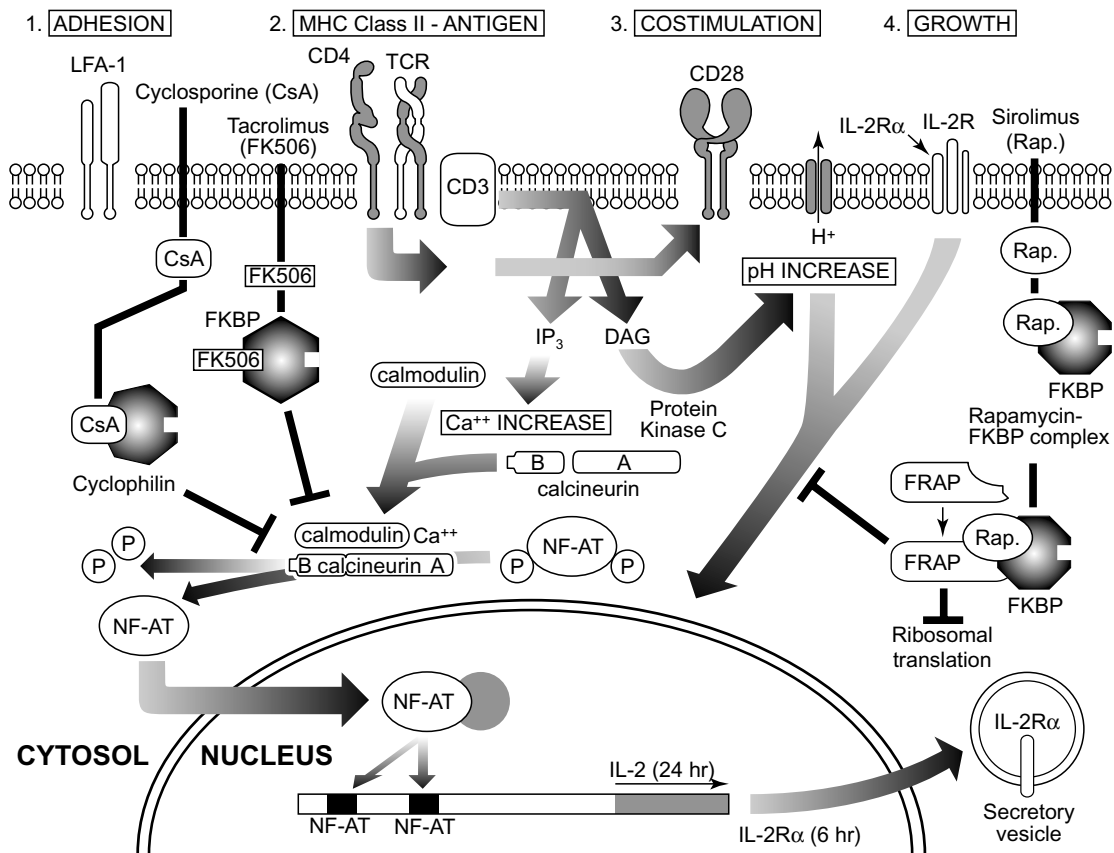

FIGURE 41-4 Intracellular mediators of T-cell differentiation and its inhibition by immunosuppressant drugs. The Map kinase pathway is not shown. CsA, Cyclosporine; DAG, diacylglycerol; Rap., sirolimus.

apy is aimed at this stage of the specific immune response. Binding of antigen to its receptor leads to the clustering of antigen receptor on lymphocytes, which is the first step in signal transduction. Clustering of antigen receptor leads to activation of intracellular signaling molecules. Protein tyrosine kinases are enzymes that affect the function of other proteins by adding a phosphate group to certain tyrosine residues. Specific growth factors such as c-kit have cytoplasmic domains that contain intrinsic tyrosine kinase activity. T- and B-cell signaling is different from c-kit signaling since the TCR and BCR do not have intrinsic kinase domains; rather they rely on the interaction with other tyrosine kinases known as receptor-associated tyrosine kinases.

There are specialized areas within the membrane lipid bilayer that contain high quantities of sphingolipids and cholesterol. These areas are called *lipid rafts*. Signaling molecules associate with lipid rafts. Disruption of the lipid rafts inhibits T- and B-cell signaling.

Signaling through T and B cells is governed by a complex array of intracellular signaling elements, which can phosphorylate and activate other elements to transduce the signal from the receptor. The receptor-associated protein kinases are localized in the inner surface of the cell membrane and cannot activate their cytosolic targets efficiently unless they themselves are activated. Their activation and subsequent phosphorylation of tyrosines on receptor-associated chains recruits other protein tyrosine kinases, which then transduce the signal. The Src family kinases involved in T and B cell receptor signaling provide an example of this kind of signaling element.

The variant chains of the lymphocyte antigen receptor are associated with invariant accessory chains that mediate the signaling function of the receptor. The BCR is associated with Ig α and Ig β invariant chains. The TCR is associated with multiple invariant accessory chains (ϵ , γ , δ , and ζ). Accessory

chains have a structure termed the *immunotyrosine activation motif* (ITAM), which enables them to signal when the BCR or TCR is bound to the antigen. ITAMs are phosphorylated by src family receptor-associated tyrosine kinases, which gives them the ability to bind to the members of a second family of tyrosine kinases (Syk in B cells and Zap 70 in T cells). The enzyme activity of each src family kinase is regulated by the phosphorylation status of its kinase domain and its carboxy terminal region, each having a regulatory tyrosine residue. Phosphorylation of tyrosine in the kinase domain activates the enzyme, whereas phosphorylation at the carboxy terminal tyrosine is inhibitory. Src family kinases are kept inactive by a tyrosine kinase called CSK (c-terminal src kinase), which phosphorylates the inhibitory domain. Since the function of CSK is constitutive in resting cells, src-family proteins remain quiescent until antigen recognition, which then activates a protein tyrosine phosphatase (CD45 that removes the phosphate block from the inhibitory tyrosine and permits activation of the src-family kinases.

Antigen receptor signaling is enhanced by coreceptors that bind to the same ligand. B cell co-receptors are formed by a complex of CD19, CD21, and CD81 proteins. Src family kinases phosphorylate the ITAMs on Ig α and Ig β , and these subsequently recruit Syk to Ig β . Trans-phosphorylation of each kinase by the other occurs, and the activated kinases in turn activate phospholipase C- γ (PLC- γ), guanine exchange factors (GEFs), and Tec kinases.

Similar to BCRs, clustering of TCRs and the co-receptors activates CD45, which removes a phosphate from Src family kinases (e.g., Lck) and activates their function, resulting in the phosphorylation of ITAMs. After phosphorylation, ZAP-70 is able to bind and become activated by Lck, which will initiate a signaling cascade leading to the activation of PLC- γ , GEF, and Tec kinases.

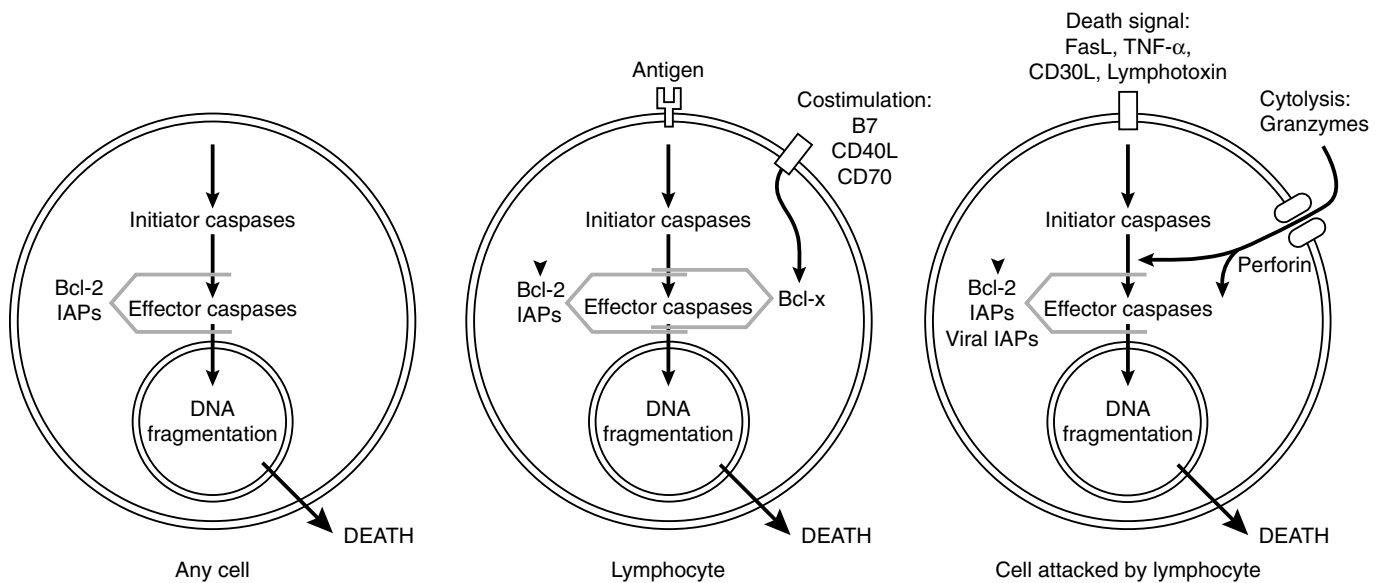

FIGURE 41-5 Apoptosis and lymphocyte-induced cytolysis. Apoptosis, indicated by the sequence of arrows, involves the activation of initiator caspases (e.g., caspase 8), which promotes proteolytic activation of other effector caspases involved in apoptosis. Environmental cues help prevent programmed cellular death by invoking the blocking action (shaded lines) of Bcl-2 or specific inhibitor of apoptosis proteins (IAPs) or both. Similar molecules (e.g., Bcl-x) inhibit apoptosis in lymphocytes co-stimulated by members of the tumor necrosis factor family (B7, CD40L, and CD70) and in virally infected cells. Cytotoxic lymphocytes destroy targeted cells either by (1) signaling for apoptosis to occur or (2) releasing perforins and granzymes that activate proteolysis directly. *FasL*, Fas ligand.

PLC- γ is known to cleave membrane phosphatidylinositol biphosphate (PIP₂), yielding diacylglycerol (DAG) and inositol triphosphate (IP₃). DAG activates protein kinase C (PKC), which in turn stimulates nerve factor- κ B (NF- κ B). NF- κ B usually is complexed with inhibitor proteins collectively called I- κ B, which prevent its translocation to the nucleus. NF- κ B is an important transcription factor for various inflammatory cytokines, and supports inflammatory aspects of the specific immune response. TNF- α , one of the cytokines whose synthesis is stimulated in part by NF- κ B, increases the transcription of NF- κ B and its dissociation from I- κ B.

IP₃ increases the intracellular Ca²⁺ concentration, activating calcineurin, a phosphatase that frees NF-AT (nuclear factor of activated T cells) from a phosphate block. GEFs activate Ras, an important GTPase that activates MAP kinases. The Ras-induced MAP kinases then activate Fos and Jun kinases, which are components of the transcription factor AP-1.

In unstimulated cells, NF-AT is rendered inactive and remains in the cytoplasm by phosphorylation on serine/threonine residues. Ca²⁺-activated calcineurin removes the phosphate block and unmasks the nuclear localization signal, which then directs NF-AT to enter the nucleus of the cell and activate transcription. For NF-AT to remain in the nucleus, however, the function of glycogen synthase kinase (GSK3) must be inhibited. GSK3 can phosphorylate NF-AT, exporting it back to the cytoplasm. Cyclosporin A and tacrolimus are inhibitors of NF-AT.

Signals from the antigen receptor alter the cytoskeleton to produce changes in cell shape, motility, and secretion. Antigen receptor signaling can be inhibited by interactions with inhibitory receptors expressed on the surface of cells such as NK cells and other lymphocytes.

Effector aspects of cell-mediated immunity

In specific CMI, CD4⁺ and CD8⁺ T cells play important roles. CD4⁺ T cells receive antigen stimulation and co-stimulation from dendritic cells (e.g., the Langerhans cells) to secrete key cytokines and growth factors. CD8⁺ T cells receive

antigen stimulation and co-stimulation from infected or neoplastic cells and become primed to receive proliferative and differentiative signals from CD4⁺ T cells. CD8⁺ T cells proliferate and differentiate into cytotoxic T lymphocytes in the presence of TH1 cytokines, such as IL-2, IL-12, and IFN- γ .

Apoptosis. When a cytotoxic T lymphocyte recognizes antigen in association with MHC I molecules on virally infected cells or transformed tumor targets, it may induce *apoptosis* or programmed cell death. The cytotoxic T lymphocyte does this by presenting the target cell with specific membrane-bound signals delivered by Fas ligand, TNF- α and APO2 ligand.²² If the signals are effective, the target cell is induced to die. Target cells express specific TNF-family receptors (TNFRs) for these ligands. Apoptosis, as summarized in Figure 41-5, involves several steps that may be targeted for therapeutic intervention.

Cells possess mechanisms for preventing death by using proteins, such as Bcl-2, and several inhibitor of apoptosis proteins (IAPs).²³ Bcl-2 is expressed on the membranes of intracellular organelles, including the mitochondria, nucleus, and smooth endoplasmic reticulum. Bcl-2 and IAPs delay or prevent apoptosis by inhibiting proteolysis mediated by cysteine proteases, termed *caspases*, that are responsive to apoptotic signals.³¹ Several viruses (including Epstein-Barr virus, adenovirus, African swine fever virus, and cowpox) produce substances similar to Bcl-2 and IAP, which may help them evade host defenses by preventing apoptosis. Also, B-cell lymphomas have been associated with Bcl-2 overexpression. Co-stimulation of T cells and B cells induces the expression of apoptosis-inhibiting molecules after antigen stimulation.⁷

Cytolytic activities. A target cell may become resistant to apoptotic signaling mediated by the above-mentioned surface ligands, especially if the cell is infected by a virus that produces apoptotic inhibitors. In this case, the NK cells and the cytotoxic T lymphocytes must depend on cytolytic factors to kill the damaged cell. Within the vesicular components and

dense cores of these granules are numerous potentially cytotoxic proteins. The vesicles and dense cores are discharged when the cytotoxic granules fuse with the plasma membrane of the NK cell or cytotoxic T lymphocyte.

Granule exocytosis can provide additional death-inducing factors. One factor is perforin. Perforin can form polymeric channels in cell membranes.²⁶ Affected membranes lose their structural integrity, and lysis of the cell soon follows. The second factor is granzyme B. Granzymes may gain access to the target cell, either directly by fusion of the granule vesicles or dense core with the membrane of the target cell, or because of a sublytic quantity of perforin that allows granzymes to gain access to the cytosol of the target cell.²⁶ When in the cytosol, granzyme B can activate apoptotic proteolysis.

Humoral immunity

Humoral immune responses protect the extracellular spaces of the body from being colonized by pathogenic bacteria and guard against the spread of intracellular pathogens from cell to cell. The activation of B cells and their differentiation into antibody-producing plasma cells and memory cells are triggered by the antigen, processes that usually require the assistance of T helper cells.

Antibodies play important roles in active immunity. Antibodies can neutralize the pathogen. Neutralization prevents viruses and intracellular bacteria from binding to specific receptors on the surface of the cells. It also blocks bacterial toxins from gaining access to the cells. Even without neutralization, antibodies can coat the surface of pathogens, thereby enhancing phagocytosis through the process known as *opsonization*. Antibodies support phagocytosis in two ways. First, antibodies bound to the pathogen are recognized by the Fc receptor on phagocytes; second, antibodies activate the complement system, which results in complement binding to the pathogens and recognition by complement receptor on phagocytes.

The BCR binds and delivers antigens to the intracellular compartments where they dissociate. The protein is degraded and returned to the cell surface as peptide bound to MHC II. The MHC II antigen complex stimulates antigen-specific T cells to secrete cytokines and provide co-stimulatory signals directing mature B cells to become plasma cells and memory B cells.

B cells require two simultaneous signals to become activated. The first signal is the binding of antigen to the BCR. The second signal can occur in either of two ways. In T helper cell-dependent pathway, the signal is generated by the binding of the T helper cell to the MHC II antigen complex as assisted by CD40/CD40L co-stimulation. In the T cell-independent pathway, the second signal is caused by the reaction of membrane IgM with a polymeric antigen or by exposure to large concentrations of lipopolysaccharide. In the latter case, the polyclonal activation can activate large numbers of B cells rather indiscriminately.

The B cell co-receptor complex CD19/CD21/CD81 greatly enhances B-cell responsiveness to antigen. B cells and T helper cells must recognize epitopes of the same molecular complex in order to interact. This requirement is termed *liked recognition*. Antigenic peptides bound to self-MHC II molecules trigger armed T helper cells to make CD40L and cytokine IL4/IL5/IL6. Isotype switching is decreased in individuals who lack CD40L. Individuals with CD40L deficiency have hyperimmunoglobulinemia M, a disease characterized by an elevation of IgM and a severe deficiency of almost all other isotypes.

In secondary lymphoid tissues antigen-binding B cells are trapped in the T-cell zones and are activated by armed helper T cells. The second phase of the primary B cell immune response occurs when activated B cells migrate to follicles and proliferate to form germinal centers (GCs). GCs are com-

posed largely of proliferating B cells, with antigen-specific T cells making up 10% of the lymphocytes. Somatic hypermutation, affinity maturation, and isotype switching occurs in GC B cells. Negative selection of B cells in GCs keeps the size of the lymphoid tissues manageable.

Antibodies of the IgA subclass are particularly important in conferring protection to the mucosa and in preventing potentially deleterious "overkill" responses mediated by IgG or IgE. IgG and IgM are important in antibacterial and antifungal host defense, but can also lead to type II (cytotoxic) and type III (immune complex) immunopathologic reactions (see Chapter 3). Antibodies of the IgE subclass not only provide host defense against parasites and worms, but also can lead to type I immunopathologic reactions (anaphylaxis). Rarely, IgA has been associated with type II immunopathologic conditions. The distinct functional and immunopathogenic attributes of the immunoglobulin isotypes provide another area of potential immunotherapeutic intervention.

Shutdown

Mechanisms exist to terminate immune responses when they are no longer required. These mechanisms involve the removal of effector cells that are no longer needed and the suppression of activity of remaining cells.

Proapoptotic apoptosis. In the later stages of antigen exposure, when the concentrations of proinflammatory cytokines are high, T cells may undergo a form of antigen-induced cell death known as *proapoptotic apoptosis*. It may occur as a result of T-cell expression of different co-stimulatory receptors for factors such as B7 proteins. As previously mentioned, the interaction between B7 and CD28 may serve to prepare a cell for early differentiative events in the immune response (resulting in proliferation and functional maturation), but the interaction between B7 and CTLA-4 may prepare a cell for more terminal events (e.g., differentiation leading to death).

Immune regulation and suppression. Suppression is involved in regulating the balance between humoral and CMI responses and in terminating these responses altogether. Regulating the degree of humoral immune response versus CMI seems related to the activities of CD4+ T cells, whereas terminating responses involves CD8+ T cells. CD4+ T cells of the TH1 phenotype suppress CD4+ T cells of the TH2 phenotype and directly inhibit B-cell activity. CD4+ T cells of the TH2 phenotype suppress TH1 activities. CD4+ TH1 T cells also stimulate CD8+ T cells, an event which has been referred to as *suppressor induction*. CD4+CD25+ Treg cells are key regulators that suppress the function of T cells.

Classically, the CD8+ phenotype has been associated with cytotoxicity and suppressor activity. It is becoming apparent that the suppression mechanism of the CD8+ T cell can resemble its cytotoxic action. CD8+ T-cell suppression of specific humoral immunity and the termination of CMI may be accomplished with the CD30 ligand (CD30L). CD30L is a member of the TNF family recognized by CD30 (a member of the TNFR family) found on T cells. In this case, suppression results from the programmed death of the CD4+ T cell.

If there is an imbalance between TH1 and TH2 activities, or if CD8+ T-cell suppression is excessively active, immunodeficiency may occur. If suppression is insufficient, immunopathologic reactions, including autoimmunity, may ensue. Suppression pathways thus play a role in two widely differing defective immune states often considered for immunotherapy: immunodeficiency and autoimmunity.

Mucosal Immunity

The vast majority of infectious agents invade the human body by one of the mucosal routes. Diarrheal diseases, respiratory

infections, parasitic infestations, and diseases such as tuberculosis, measles, hepatitis B, whooping cough, and HIV infection are widespread and continue to cause significant public health problems throughout the world. Another important point regarding the mucosal surfaces is that they are the portal of entry for a great majority of foreign antigens such as food antigens, dusts, pollens, and other materials. In addition, the gastrointestinal tract is colonized by a great number of commensal bacteria, which normally live within their host symbiotically without causing any pathology.

Traditionally, the mucosal immune system has been considered a minor component of the immune system, and to this date little is known regarding the function of immune cells in mucosa. Because of its size and exposure to a wide variety of foreign antigens, the mucosal immune system perhaps forms the largest and the most important part of the immune system. It contains significant numbers of lymphocytes and produces high amounts of Igs in healthy individuals. It also has many distinctive features. In mucosa there is an intimate interaction between mucosal epithelia and the lymphoid tissues. Mucosal epithelial cells contain specialized antigen-uptake mechanisms, and most of the lymphocytes have the activated/memory phenotype even in the absence of infection. The mucosa contains large numbers of regulatory T cells and they have inhibitory macrophages and tolerance-inducing dendritic cells. Finally, there is constitutive down-modulation of immune responses to food and other nonpathogenic antigens.

Mucosal-associated lymphoid tissues are located in anatomically defined compartments of the gut. Lymphocytes, macrophages, and dendritic cells are found throughout the mucosa in organized tissues as well as scattered throughout the surface epithelium and an underlying compartment of the connective tissue called the *lamina propria*. Another important feature of the gut mucosa is the existence specialized epithelial cells called *microfold* (M) cells. These cells are different from the other epithelial cells (e.g., enterocytes in intestines) in that they do not secrete mucus and are the route of entry of foreign antigens. Antigens are engulfed by the M cells and transcytosed via membrane bound vesicles to the basal cell membrane where they are released into the extracellular compartment. The dendritic cells can then take up the antigen, process it, and present it to naïve, antigen-specific T lymphocytes in Peyer's patches, or they migrate through draining lymphatics to present antigen to naïve antigen specific T cells in mesenteric lymph nodes. Dendritic cells are recruited to the epithelial layer through the action of chemokines.

The mucosal immune system contains large numbers of effector lymphocytes even in the absence of disease. In addition to the organized lymphoid organs in the mucosa, there are other immune effectors that are scattered throughout the mucosa. The majority of those that are in the epithelial layer are mainly CD8+ T cells, whereas in the lamina propria large numbers of CD4+ as well as CD8+ T cells, plasma cells, dendritic cells, and macrophages can be found. Neutrophils are rare in healthy intestines, but their numbers increase rapidly upon infection. Therefore, healthy intestinal mucosa displays characteristics that are similar to chronic inflammation in response to the intimate interaction between foreign antigens, commensal bacteria, and mucosal immune cells. Because of the function of regulatory immune effectors, a balance is maintained between inflammation and homeostasis during health and disease.

The trafficking of the lymphocytes within the mucosa is controlled by the actions of specific sets of chemokines and integrins. Gut-specific homing is determined by the expression of $\alpha 4:\beta 7$ integrin on the lymphocytes, which binds to mucosal vascular addressin MADCAM-1 on the endothelial cells. In addition the expression of the CCR9 chemokine

receptor on lymphocytes is important for attracting lymphocytes to mucosa. Indeed, local production of CCL25 by the gut epithelium, which binds to CCR9, is required for the homing of the lymphocytes to the gut. Only lymphocytes that first encounter antigen in the gut are induced to express gut-specific homing receptors and integrins. This action is mediated by the gut dendritic cells, which impart to lymphocytes the ability to express the $\alpha 4:\beta 7$ integrin and CCR9 receptor. These tissue-specific responses explain why vaccination against intestinal infections requires immunization through the mucosal route and not through parenteral routes.

As mentioned previously, IgA is by far the most abundant antibody in mucosal tissues. The ratio of IgA1 to IgA2 in blood is 10:1, whereas in mucosa it is 3:2. Class switching for IgA is under the control of the TGF- β cytokine. IgA2 is resistant to proteolytic cleavage. After secretion of IgA, it will bind to the poly-Ig receptor on epithelial cells and be transported through transcytosis to the apical surface of the epithelial cells. The main function of IgA in mucosa is to prevent the access of pathogen to the mucosal surfaces. Selective IgA deficiency in humans is a common primary immune deficiency in Caucasians, and atopic and auto-immune diseases have been reported in people with IgA deficiency. Most people with IgA deficiency are normal, however, which might result from the fact that IgA can be replaced by IgM.

There are two types of intraepithelial lymphocytes. One has the conventional $\alpha\beta$ T-cell receptor and co-receptor CD8 ($\alpha\beta$ homodimer). These *type a* conventional T cells recognize antigen within the context of MHC I. The second group of lymphocytes has either the $\alpha\beta$ or $\gamma\delta$ T cell receptor and the CD8 $\alpha\alpha$ homodimer. These *type b* T cells do not recognize antigen in the context of MHC I, but rather bind to other ligands, such as MHC Ib. Another nonclassical MHC I molecule is the thymus leukemia (TL) antigen, which can bind to the CD8 $\alpha\alpha$ homodimer with high affinity. The type b T lymphocytes mediate cytotoxicity; they do not undergo positive or negative selection in the thymus.

IMMUNOTHERAPEUTIC AGENTS

Therapies designed to stimulate or replicate endogenous immune reactions have long been used to prevent infectious disease and treat immunodeficiencies. More recently, attempts have been made to provoke immune responses to cancer, and specific antibodies have been developed for a wide range of applications.

In certain clinical situations, it is advantageous to suppress the inflammatory activities of the specific immune system temporarily. Organ transplantation is the best example of an instance in which immunosuppression is beneficial. Immunosuppression is also helpful in the treatment of autoimmune diseases and other immunopathologic conditions.

Vaccination

The most successful area of immunotherapy has been vaccination, or "active immunization." It was first introduced to Western culture by Jenner in the 18th century, who injected individuals with the cowpox virus to protect them against smallpox. Vaccination is a procedure in which the immune system is exposed to an antigen, such as an inactivated toxin or attenuated pathogen, to elicit antigen-specific clonal expansion (i.e., the proliferation of T cells and B cells that recognize the antigen). Active immunization uses the host's immune system itself to generate antigen-specific immunotherapeutic agents (e.g., antibodies). On subsequent exposure to the actual pathogen, the immune response is of sufficient speed, magnitude, duration, and specificity to prevent the pathogen from causing disease (the secondary or anamnestic response).

Clinically, most success has been observed with vaccination designed to elicit humoral immunity rather than CMI. The composition, recommended dosage, and schedule of administration of standard vaccines may be found in several references.^{6,14}

Caries vaccines

A disease of special interest to dentistry is dental caries. Vaccines directed against *Streptococcus mutans* and *Streptococcus sobrinus*—lactic acid bacteria long suspected of being the major cause of dental caries—have been investigated by several laboratories.²⁹ The purpose of these investigations was to induce an immune response that would prevent the adherence or metabolism by these bacteria on the tooth surface. Several types of vaccines have been considered, including (1) oral immunization by whole bacteria or live enteric bacteria that bear antigens of *S. mutans* as a result of recombinant DNA procedures, and (2) immunization by various routes using “subunit” vaccines containing isolated antigens (adhesins, glucosyltransferases, dextranases) believed to be involved in cell adherence and plaque formation. Whole-cell vaccines are anti-cariogenic in many laboratory animals, including primates.

In humans, oral immunization results in the generation of secretory IgA antibodies in salivary secretions. Ingested antigens are subjected to partial breakdown within the stomach and small intestine. As described previously specialized M cell enterocytes in the gut transcytose macromolecular antigens to unencapsulated lymphoid structures known as *Peyer's patches*. Here, in the presence of TH3 T cells, antigen-specific B cells are selected to undergo IgA isotype switching. They eventually migrate to the regional lymph nodes, where they proliferate. IgA-committed progeny enter the blood and are distributed to effector sites, such as the salivary glands, where they produce IgA antibodies for secretion.

Parenteral routes of administration usually lead to IgG antibodies that can gain access to the tooth by way of the gingival crevicular fluid. For parenteral administration, subunit vaccines are preferred because antibodies directed against lipoteichoic acid in the cell wall of *S. mutans* may cross-react with human heart muscle. Although purified antigens are effective in preventing caries in gnotobiotic rodents and lower primates, the actual antigenic components; dosage; route of administration; and potential benefits, costs, and adverse effects in humans must be determined before a vaccine can be considered for routine use.

Several modifications to the subunit vaccine approach embellish traditional methods with purified bacterial antigens. Synthetic pieces of a larger antigen, such as glucosyltransferase, have been used as an immunogen.^{37,38} Synthetic peptides derived from a glucan-binding domain of glucosyltransferase or from the amino terminus have also been used. Antisera or monoclonal antibodies raised in laboratory animals against these synthetic domains inhibit glucosyltransferase by 30% to 80%.

Antigen-delivery strategies. Local immune responses can be elicited within the gingiva. The swabbing of gingiva with a 3800 Da component of *S. mutans* in monkeys elicits increases in IgG in the crevicular fluid and secretory IgA in the saliva.²⁴ From a theoretic point of view, it is difficult to ascribe the IgA response to local (gingival) immunization rather than systemic (enteric) because some antigen must be ingested. From a therapeutic point of view, the method itself may be useful because the swabbing was administered only 10 times over the course of 1 year and resulted in a reduction in *S. mutans* and caries activity.

Liposomes are artificial membrane vesicles that can be prepared to contain hydrophilic solutes internally and hydrophobic molecules within the membrane. One method of increasing antibody responses by gingival immunization has

been the sequestration of candidate antigens (i.e., glucosyltransferase) into liposomes, permitting the liposomes to desiccate, and administering the dehydrated liposomes to humans. This technique resulted in salivary IgA2 antibodies against glucosyltransferase, suggesting that dehydrated liposomes may be useful in generating specific salivary immunity against target antigens in the oral cavity.⁸

Genetic engineering provides an especially efficient possibility for delivering a subunit vaccine. A major problem with subunit vaccines has been the inability to maintain sufficiently high amounts of antigen in the gut to stimulate antibody production in a cost-effective manner. Genes for candidate antigens of *S. mutans* have been introduced into “harmless” enteric bacteria. These bacteria can proliferate in the gut, elaborating antigen for a prolonged time compared with a conventional dosage form (e.g., gelatin capsules).

Anti-idiotypic antibodies. During an infection, the body commonly produces antibodies to its own immunoglobulins used to ward off the offending organism. These antibodies, called *anti-idiotypic antibodies*, contain in their hypervariable regions a peptide sequence (idiotope) that is identical with or structurally analogous to an antigenic determinant (epitope) of the infecting microorganism. Injection of these antibodies into a host generates a second set of anti-idiotypic antibodies directed against them. If the injected antibodies are the same allotype as the host, the host forms anti-idiotypic antibodies against only the idiotope. These antibodies also bind to the bacterial epitope. This method can be used to elicit antibodies against virtually any antigenic target. A vaccine containing anti-idiotypic antibodies with idiotopes equivalent to epitopes of streptococcal antigens has reduced caries in the gnotobiotic rat model.²¹

Adjuvants

The effects of a vaccine may be enhanced by incorporation of adjuvants, substances that increase the immune response. The mechanism of action of some adjuvants, such as alum (aluminum-containing hydroxides or phosphates), is simply to retard removal of the antigen and to attract lymphoid cells by increasing the inflammatory response (often quite severely) in the immediate area of the vaccine. Many adjuvants, such as complete Freund's adjuvant, that are effective in laboratory tests have not been cleared for routine use in humans because they induce long-lasting necrotic lesions in the area of injection. Alum is the only adjuvant currently approved for use with vaccines (e.g., diphtheria and tetanus toxoids) in humans; however, it is not active with all antigens, and it elicits only humoral responses. In mice, alum adjuvants selectively activate TH2 CD4+ T cells; one of the problems facing immunostimulant therapy has been devising methods to stimulate TH1 and CMI responses.

Bacillus Calmette-Guérin (BCG) is a live attenuated strain of *Mycobacterium bovis* that has been used as a vaccine against tuberculosis since the early part of the 20th century. Similar to complete Freund's adjuvant, it contains mycobacterial derivatives and seems to stimulate CMI. BCG has been shown to stimulate specific tumor immunity in experimental animals, to induce responses in immunodeficient individuals, and to reverse the effects of immunosuppressive drugs. It activates macrophages that produce IL-1. IL-1 stimulates the maturation of CD4+ T cells. BCG has been used experimentally in the treatment of melanoma, hepatoma, leukemia, and bladder cancer; it may also have potential against chronic infections involving immunodeficiency. Severe allergic reactions and shock have occurred infrequently during BCG treatments. Other microbially derived immunostimulants that activate macrophages and should help trigger TH1 responses include extracts of pathogenic bacteria and fungal polysaccharides.

Quil-A is a partially purified saponin extract from plants. It forms immunostimulating complexes with cholesterol and various antigens. The complex may intercalate into the membranes of cells, introducing antigen into the cell cytosol. Humoral immunity and CMI are stimulated by increased MHC presentation.

Enhancement of Co-stimulation

Because the presentation and recognition of antigen alone is insufficient to initiate an immune response, immunotherapy has also focused on enhancement of costimulation. One method includes the antibody-mediated cross-linking of costimulatory receptors (e.g., CD28 and CTLA-4). It has been shown to enhance T-cell activity against tumor targets as measured by increased cytokine output. A second method involves immunization of an individual with tumor cells that have been transfected with a B7 gene plus an MHC II gene, causing the cells to express these protein products constitutively. Such immunization has led to rejection of the tumor at a site distant from the immunization site.⁵

Immunostimulants

Thymic extracts

Primary CMI deficiencies may result from absence of the thymus gland or a defect in its function. Treatment has been directed toward inducing maturation of T cells by using thymic tissue or extracts. In several cases, thymus transplants in humans have corrected CMI deficiencies, with subsequent development of immunocompetence. Immunologically immature fetal thymic tissues are used to prevent graft-versus-host reactions.

Thymic extracts have been used nonspecifically to induce CMI competence.³ These extracts, including thymosin, are usually extracted from calf thymus glands. They consist of a family of nonimmunogenic polypeptide hormones. Certain tumors, chronic mucocutaneous candidiasis, and several other diseases caused by primary CMI immunodeficiency have responded favorably to thymosin therapy. Thymic extracts must be administered continually. Although thymosin administration has been found to be of therapeutic benefit, it is still experimental, and routine use awaits further development.

In Europe, several peptides have been purified or synthesized for experimental use in humans,¹⁷ including thymostimulin, which has proved beneficial in the treatment of hepatocellular carcinoma and chronic obstructive pulmonary disease. These hormones function at different stages of CMI development, inducing the maturation of T cells or differentiation of T cells into functional effectors, such as cytotoxic or suppressor cells.

Levamisole

Levamisole is an anthelmintic drug that possesses nonspecific immunostimulatory properties. In deficient animals and humans, it restores many different immunologic functions, suggesting that it acts on multiple populations of cells, including neutrophils, macrophages, and T cells (but not B cells). Its effects on the immune response and its pharmacologic activity indicate that levamisole is a thymomimetic agent.

Levamisole has been used in the treatment of tumors and other diseases in which there are manifestations of immune dysfunction, including rheumatoid arthritis and Crohn's disease. Several investigators have used it successfully in the treatment of recurrent aphthous stomatitis and herpes labialis. It has been suggested that the therapeutic effect of levamisole in aphthous stomatitis, which may have an autoimmune etiology, results from enhancement of suppressor T cells that normally prevent autoimmune responses.²⁵ It is currently approved for use in the United States as an adjunct to fluorouracil in the treatment of colorectal carcinoma.

Polyclonal Antibody Preparations

Human immunoglobulins

Deficiencies in humoral immunity may result from congenital defects in the production of all or selected immunoglobulin classes, or they may be acquired, as occurs with multiple myeloma. Severe deficiencies in humoral immunity, or hypogammaglobulinemias, require "replacement therapy" consisting of weekly or monthly injections of pooled human immunoglobulins, the dose and frequency depending on the patient's status. These treatments are often accompanied by antibiotics. Selective isotype deficiencies involving individual classes of immunoglobulins are usually less severe because the body may compensate by increased production of other immunoglobulin classes. Selective isotype deficiencies also can be treated with immunoglobulins.

Human immunoglobulin is effective against many common diseases, such as measles and infectious hepatitis, because it is derived from the pooled sera of many individuals, including some who would have contracted these infections in the past and produced protective antibodies against them. Although immunopathologic reactions are possible with allogeneic human immunoglobulins, they are much less a problem than with xenogeneic immunoglobulins, and the risk is greatly minimized by using purified or partially purified IgG. In contrast to most other pooled blood products, human immunoglobulin carries no known risk of human immunodeficiency virus (HIV) or hepatitis B transmission. Intravenous, rather than intramuscular, administration of immunoglobulins is preferable because much larger doses can be infused.³⁴

Antisera or purified immunoglobulins may be administered to prevent or treat specific diseases. In some cases, this is referred to as *passive immunization*, a classic term in immunology used to indicate that a donor was immunized with an antigen, and that a recipient host was then injected with the protective antibodies generated by the donor. The injection of antibody obtained from an immune donor into a nonimmune recipient has the advantage of conferring almost instantaneous protection, as opposed to vaccines, which require days or weeks to stimulate a sufficient protective effect. The effects of passive immunization last only 4 to 6 weeks (equivalent to one to two half-lives of IgG *in vivo*), however. Human immunoglobulin preparations specifically directed against hepatitis B, cytomegalovirus, rabies, tetanus, infant botulism, respiratory syncytial virus, and varicella-zoster virus are available.

Rh_o(D) immunoglobulin

Rh_o(D) immunoglobulin represents a special case in which passive immunization is used to induce specific immunosuppression for the prevention of Rh disease. Rh disease occurs when an Rh-negative woman—one whose red blood cells do not contain the Rh_o(D) antigen—becomes sensitized to the antigen by exposure to the blood of her Rh-positive fetus. On subsequent pregnancies, the mother's anti-Rh antibody passes through the placenta and causes massive destruction of fetal erythrocytes, resulting in hemolytic disease of the newborn.

The injection of anti-Rh antibody into Rh-negative mothers who will give birth to Rh-positive infants is effective in preventing the disorder. The goal of treatment is to prevent mothers from generating anti-Rh_o(D) antibodies. High titers of specific antibody against an antigen specifically inhibit the immune response to that antigen, but the mechanism may be more involved than simple binding of the antigenic stimulus. The injection of anti-Rh_o(D) antibodies may induce the mother to generate a set of antibodies against the variable domains of the injected antibodies. This second set of anti-idiotypic antibodies may impede the interaction of B cells with Rh antigen, cause B-cell inactivation or death, or neutralize anti-Rh_o(D)-specific antibodies as they are generated. Such idiotypic-anti-idiotypic inhibitory effects have been

shown in laboratory animals. Alternatively, anti-Rh_o(D) antibody may lead to rapid clearance of fetal red blood cells from the mother's circulation by liver macrophages, which would prevent the elicitation of chronic inflammatory reactions necessary for antibody responses.

Antiserum to the Rh antigen is produced in Rh-negative male volunteers. The γ -globulin fraction containing anti-Rh antibody, in the form of Rh_o(D) immunoglobulin (human), must be given within hours of parturition because the fetal erythrocytes carrying the Rh antigen enter the mother's body at this time and induce the immune response that would cause problems in subsequent pregnancies. This specific immunosuppressive treatment has been very successful in preventing Rh disease, and it is now used routinely.

Antitoxins and antivenins

Immunoglobulin preparations that neutralize toxic compounds, such as rattlesnake venom and diphtheria toxin, are commonly derived from the sera of horses actively immunized against the noxious substances. The regional availability of these xenogeneic antibody products varies widely depending on the perceived risk of exposure. Being bitten by a poisonous animal outside its normal geographic range can delay the administration of the immunoglobulin antidote and increase the risk of injury or death.

If administered parenterally, xenogeneic (or even allogeneic) sera or immunoglobulins may induce immunity in the recipient against animal (or human) serum antigens. Not only would this response lead to rapid clearance of the antibodies—and circumvent their therapeutic effect—but also it can induce type III immunopathologic reactions such as serum sickness or immune complex disease.

Oral administration of xenogeneic antibodies

The oral administration of xenogeneic antibodies offers one possible strategy for highly precise, cost-effective immunotherapeutics. Cows immunized against cariogenic bacteria exhibit antibodies against those bacteria in their milk. The milk (or whey) can confer protection to individuals consuming that milk in a passive manner. In cows' milk and colostrum, the antibodies are of the IgG1 subclass. *S. mutans* and caries scores can be reduced in this manner in gnotobiotic animals.²⁹ Whey from immunized cows also seems to decrease *S. mutans* in human volunteers when it is used as a mouth rinse.

Antithymocyte globulin

Antithymocyte globulin is produced in rabbits and horses by immunization with human thymocytes. It lyses or agglutinates human lymphocytes *in vitro* and produces lymphocytopenia *in vivo*. CMI responses are decreased, and allograft survival is prolonged. Antithymocyte globulin is rich in cytotoxic antibodies directed against numerous antigens expressed by T cells, including CD2, CD3, CD4, CD8, CD11a, CD18, CD25, CD44, CD45, and HLA (human MHC) class I and II molecules. The immunosuppressive effects are transient, and antithymocyte globulin must be given repeatedly. Because the preparation is itself antigenic, however, it can induce an immune response leading to serum sickness. The agent's primary indication is suppression of acute transplant rejection reactions.

Monoclonal Antibody Preparations

A monoclonal antibody (MAb) is an antibody of a single specificity produced by cells derived from a single B-cell clone. In most cases, the MAb is derived from mice (and is xenogeneic). Fusion of a normal mouse plasma cell and a myeloma cell results in the formation of a hybridoma with the antibody-forming properties of the plasma cell and the

proliferative properties of the myeloma cell.¹⁶ When grown in tissue culture, hybridomas are capable of almost unlimited production of MAb. MAbs are increasingly being used diagnostically to assess immunocompetence, to identify infectious diseases, and to monitor the concentrations of hormones and chemotherapeutic agents in the plasma. Some are used as immunosuppressive agents. Their exquisite specificity also makes them ideal guidance systems as carriers for cytotoxic agents (described subsequently). Table 41-2 lists clinically available MAbs and derivatives, their target antigens, and their principal therapeutic indications.

Muromonab-CD3, the first monoclonal antibody to be approved for human use (in 1986), is a mouse MAb that reacts with CD3, a component of the TCR complex (see Figure 41-4). Antibody binding induces internalization of the TCR. Sensitive T cells die in response to complement activation; other T cells redistribute to nonlymphoid tissues and become significantly less responsive to antigenic challenge. Muromonab-CD3 is highly effective in terminating acute cellular rejection episodes. The major adverse effect of therapy, known as the *cytokine release syndrome*, develops from the stimulation of Fc receptors by CD3-bound MAb. Affected T cells release TNF- α , IL-2, and other cytokines, causing high fever, chills, nausea and vomiting, malaise, weakness, and generalized pain. The syndrome usually begins within 30 minutes of drug injection, lasts for hours, and rarely may produce life-threatening cardiovascular and pulmonary disturbances. Repeated MAb treatment may lead to the development of human antimouse antibodies that block the therapeutic effect or sensitize the patient to the drug.

Chimeric antibodies

The most important factor that limits the therapeutic potential of MAbs as a group is their xenogeneic origin, and clinical testing of these reagents has led to some disappointment. One approach to circumvent this problem has been to combine the antigen-specific portions of mouse MAbs with human constant or framework domains. Chimeric MAbs, which represent the second generation of MAbs, are produced by the grafting of the variable regions of rodent immunoglobulin to the constant regions of human immunoglobulin (see Figure 41-2). Because the constant region of an immunoglobulin also confers function to an antibody, chimeric MAb engineering permits the selection of functional attributes. A chimeric MAb possessing an IgG1 isotype constant region would be most effective in complement activation and antibody-dependent cell-mediated cytotoxicity, whereas a chimeric antibody of the IgA subclass may exhibit anti-inflammatory effects.

Basiliximab is a chimeric MAb (60% human, 40% mouse) used to prevent allograft rejection in patients receiving other immunosuppressants. It is directed against the α subunit of the IL-2 receptor on activated T cells (see Figure 41-4). IL-2 is a major cytokine supporting CMI and organ rejection. In general, the drug is administered only twice; the first dose is infused intravenously within 2 hours before transplantation surgery, and the second is given 4 days later. The only adverse events attributable to basiliximab used in this manner are rare cases of allergic reactions and cytokine release syndrome.

Complementarity-defining region-grafted (humanized) antibodies

Although chimeric MAbs may seem exotic, they have been superseded by a third-generation MAb, the complementarity-defining region (CDR)-grafted MAb, more simply known as the "humanized" MAb. As described previously, CDR refers to the hypervariable peptide sequences of an antibody that actually bind to an antigen. These hypervariable regions are joined by intervening framework sequences. A CDR-grafted MAb contains rodent hypervariable sequences, human frame-

TABLE 41-2

Monoclonal Antibodies and Related Agents in Clinical Use

NONPROPRIETARY (GENERIC) NAME	PROPRIETARY (TRADE) NAME	RECEPTOR/TARGET	THERAPEUTIC INDICATION
Abciximab	ReoPro	GPIIb/IIIa	Prevent platelet aggregation in unstable angina or percutaneous cutaneous intervention
Adalimumab	Humira	TNF- α	Ankylosing spondylitis Moderate-severe arthritides Moderate-severe Crohn's disease Moderate-severe plaque psoriasis
Alefacept	Amevive	CD2	Chronic plaque psoriasis (moderate-severe)
Alemtuzumab	Campath	CD52	B-cell chronic lymphocytic leukemia
Basiliximab	Simulect	IL-2	Prevention of renal allograft rejection
Bevacizumab	Avastin	VEGF	Breast cancer Colorectal cancer Glioblastoma Non-small cell lung cancer Renal cancer
Certolizumab	Cimza	TNF- α	Moderate-severe rheumatoid arthritis Moderate-severe Crohn's disease
Cetuximab	Erbix	EGFR	Colorectal and head and neck cancers
Daclizumab	Zenapax	IL-2	Prevention of renal allograft rejection
Digoxin immune Fab	Digibind	Digoxin	Serious digoxin toxicity
Efalizumab	Raptiva	CD11a	Plaque psoriasis (moderate-severe)
Etanercept	Enbrel	TNF	Ankylosing spondylitis Moderate-severe arthritides Moderate-severe plaque psoriasis
Gemtuzumab ozogamicin	Mylotarg	CD33	Relapsed acute myeloid leukemia
Golimumab	Simponi	TNF- α	Ankylosing spondylitis Moderate-severe rheumatoid arthritis Psoriatic arthritis
Ibritumomab tiuxetan	Zevalin	CD20	Non-Hodgkin's lymphoma
Infliximab	Remicade	TNF- α	Ankylosing spondylitis Moderate-severe rheumatoid arthritis Moderate-severe Crohn's disease Moderate-severe plaque psoriasis Ulcerative colitis
Muromonab-CD3	Orthoclone OKT3	CD3	Acute graft rejection
Natalizumab	Tysabri	α 4-integrin	Relapsing multiple sclerosis
Nimotuzumab*		EGFR	Squamous cell cancer Glioma
Ofatumumab	Arzerra	CD20	Chronic lymphocytic leukemia
Palivizumab	Synagis	RSV F protein	Prevention of RSV disease
Panitumumab	Vectibix	EGFR	Colorectal cancer
Rituximab	Rituxan	CD20	Non-Hodgkin's lymphoma
Tositumomab and iodine I 131 tositumomab	Bexxar	CD20	Non-Hodgkin's lymphoma
Trastuzumab	Herceptin	HER2	Metastatic breast cancer

*Not currently available in the United States.

CD, Cluster of differentiation (protein); EGFR, epidermal growth factor receptor; HER2, human epidermal growth factor receptor 2; IL, interleukin; RSV F protein, respiratory syncytial virus fusion protein; TNF, tumor necrosis factor.

work sequences, and human constant regions. There is some loss of affinity in humanized MAbs, but it is usually an acceptable tradeoff for the reduced allergenicity. Humanized MAbs are used clinically to prevent rejection of organ transplants. Other diseases in which CDR-grafted MAbs have been used include rheumatoid arthritis, Crohn's disease, systemic vasculitis, septic shock, various neoplasms, and viral infections.⁴⁴

Daclizumab is a humanized variant of basiliximab in which the murine (mouse) content of the antibody has been reduced to 10%. As expected, daclizumab is less potent than basiliximab in binding to the α subunit of the IL-2 receptor. A one-time five-dose regimen is used, with the first dose given within 24 hours before transplantation surgery and subsequent doses every 14 days thereafter. Few adverse reactions

have been reported for this use of daclizumab; it apparently does not cause cytokine-release syndrome.

Conjugated monoclonal antibodies

Immunotoxins are antibodies coupled with a poison (toxin). Toxins may be derived from many sources, including plants and microbes (e.g., the lectin ricin, *Pseudomonas* exotoxin, diphtheria toxin). The therapeutic strategy is to have the antibody selectively deliver the toxin to undesirable cells, such as those infected by HIV-1, or participate in immunopathologic reactions. Immunotoxins have also been explored for their potential in cancer immunotherapy (including metastatic melanoma; colorectal, ovarian, and breast carcinomas; non-Hodgkin's lymphoma; Hodgkin's disease; B-cell leukemia; and

T-cell lymphoma) and immunosuppression in steroid-resistant graft-versus-host disease. Although immunotoxins have been called “magic bullets” capable of pinpoint target destruction, it has become clear that most of these “bullets” are not as accurate as desired and have significant side effects, including vascular leak syndrome, myalgia, aphasia, paresthesia, encephalopathy, neuropathy, thrombocytopenia, liver destruction, renal insufficiency, proteinuria, hypoalbuminemia, dyspnea, hematuria, and tremors. The toxins themselves have proved quite antigenic, eliciting immune reactions in most cases. Gemtuzumab ozogamicin is the first immunotoxin to be approved for clinical use. It combines the anti-CD33 antibody gemtuzumab with the anticancer agent ozogamicin.¹ When the agent binds its antigen receptor, it is internalized. The active agent is released to kill the cell. The drug is approved for treatment of acute myeloid leukemia.

Immunotoxins have not been explored aggressively as therapeutic agents delivered locally in the oral cavity. Such a strategy might be used to eliminate pathogens selectively or reduce inflammatory activities of the host immune system, and may not result in the same degree of toxicity observed in systemic administration.

Radioimmunotherapy relies on a similar strategy to deliver radioactive substances in a selective manner for diagnostic or therapeutic purposes. In this case, the potential for tissue damage by the toxin has been replaced by the potential for radiation injury. Inasmuch as several radioimmunotherapeutic agents have been approved for human use, the tradeoff seems favorable.

Ibritumomab tiuxetan, approved in 2002, is a covalently linked conjugate of the MAb ibritumomab and the linker-chelater tiuxetan. Ibritumomab is selective for CD20, a cell-surface antigen expressed by normal B cells and more than 90% of B-cell non-Hodgkin's lymphomas. Tiuxetan contains a high-affinity binding site that can accommodate either indium-111 (used for diagnostic imaging) or yttrium-90 (used for target cell destruction). A complex administration schedule involving the prior administration of radiation-free MAb is used to limit damage of healthy lymphoid tissue and maximize destruction of lymphoma cells.¹⁹ Common adverse effects include neutropenia and thrombocytopenia. Infection, hemorrhage, allergic reactions, and new malignancies are potentially life-threatening reactions.

Future developments

Contemporary medicine is witnessing an explosive increase in the development of monoclonal antibodies to diagnose and treat disease. Already, monoclonal antibodies constitute the most widely used form of cancer immunotherapy. In the quarter century since the introduction of muromonab-CD3 into clinical practice, slightly more than 20 monoclonal anti-

bodies have been approved for use. Two hundred more are now in clinical trials or awaiting approval. Among these agents are “fully” human monoclonal antibodies (fourth generation monoclonal antibodies) harvested from mice genetically engineered to produce human antibodies from laboratory bacteria using phage display technology.

Chemolabeled monoclonal antibodies constitute a third strategy for targeting therapeutic agents using monoclonal antibodies. In this case a substance that is not inherently toxic is directed to a specific site where it can produce the desired therapeutic effect. It now seems likely that the early promise to therapeutics represented by the concept of monoclonal antibodies will soon be realized.

Immunophilin Ligands

Cyclosporine (cyclosporin A), tacrolimus (FK506), and sirolimus (rapamycin) are microbial derivatives now classified as immunophilin ligands because they all initially form a complex with cytosolic receptors of the immunophilin family. These drugs seem to have similar but not identical mechanisms of action. Cyclosporine, the first of these agents to gain approval for human use, revolutionized the field of organ transplantation.

Cyclosporine

Cyclosporine was originally isolated from a fungus, *Beauveria nivea*. It is a neutral hydrophobic macrocyclic undecapeptide (Figure 41-6). Cyclosporine binds immunophilins called *cyclophilins*. The cyclosporine-cyclophilin complex interacts with calcineurin, a Ca^{++} -dependent protein phosphatase (see Figure 41-4).²⁷ The calcineurin complex is inhibited from dephosphorylating NF-AT, impeding its translocation into the nucleus and impairing transcription important in the earlier phases of immune responses. The immunosuppressive activity of cyclosporine is usually ascribed to its ability to block IL-2 synthesis, but the drug also suppresses macrophage activation and the release of IL-1, prevents the formation of IL-1 receptors on CD4+ T cells, and blocks the expression of IL-2 receptors on naïve T cells.¹¹ Increased synthesis of TGF- β inhibits IL-2 activity. The primary outcome is that CD4+ T cells are not stimulated to proliferate in response to an antigenic challenge. B-cell function is also impaired by the reduced synthesis of TNF- α , and mast cell degranulation is blocked.

Cyclosporine is commonly used as an immunosuppressive agent to promote graft survival. It has proved successful in preventing rejections of nonmatched kidney, liver, heart, heart-lung, bone marrow, and pancreas transplants. The first-year survival of liver transplants increased from 35% to 70% after the introduction of cyclosporine. Cyclosporine is also effective as a topical agent in the treatment of oral lichen planus,¹⁵ and it has been used systemically to treat other

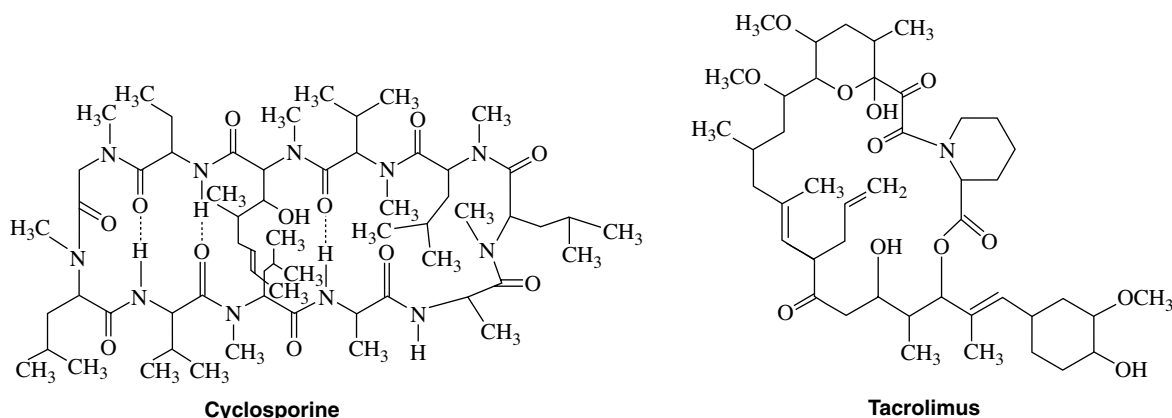

FIGURE 41-6 Structural formulas of cyclosporine and tacrolimus.

autoimmune diseases that may affect oral (bullous pemphigoid, pemphigus) and nonoral (psoriasis, rheumatoid arthritis) tissues. Lastly, cyclosporine has proved effective in the treatment of Behçet's syndrome (a vasculitis that almost always includes oral aphthous ulcers and uveitis), nephrotic syndrome, inflammatory bowel disease, atopic dermatitis, and endogenous uveitis. Cyclosporine is better tolerated than less selective immunosuppressant drugs. The drug is potentially dangerous, however. The two major adverse side effects associated with long-term use are (1) dose-related renal toxicity, which, including mild forms, may occur in 75% of patients, and (2) hypertension, which is not apparently dose related, and occurs in 50% of all renal transplant patients (and is especially common in children). Other side effects include central nervous system toxicity (headache, confusion, depression, seizures), gingival hyperplasia, hirsutism, mild tremor, and hepatotoxicity. The risk of lymphoma and other neoplasias is increased.

The precise mechanism of cyclosporine-induced gingival hyperplasia is unknown; corrective procedures involve mainly drug titration and surgical intervention. Some studies indicate that cyclosporine therapy results in the selection of fibroblasts with cyclosporine receptors, and it has been proposed that there is an associated immunologic cytokine imbalance.¹⁸

The absorption of cyclosporine is incomplete and variable among patients. Because interstitial fibrosis of the kidney has been associated with sustained high concentrations of cyclosporine, monitoring of plasma cyclosporine concentrations is necessary. A microemulsion form offers higher and more reliable absorption than the original product. Cyclosporine is metabolized by CYP3A enzymes; drugs that induce these enzymes (e.g., carbamazepine, phenobarbital, rifampin) reduce plasma concentrations of cyclosporine, whereas drugs that inhibit them (e.g., erythromycin, ketoconazole, prednisolone) have the opposite effect. Nonsteroidal anti-inflammatory drugs, aminoglycosides, and other drugs that cause nephrotoxicity are contraindicated in patients receiving cyclosporine.

Tacrolimus

Tacrolimus is a macrolide antibiotic originally isolated from *Streptomyces tsukubaensis*. Tacrolimus binds to immunophilins known as FK506-binding proteins (FKBPs). The resulting tacrolimus-immunophilin complex produces the same action and effects as described for cyclosporine. Tacrolimus is approximately 100 times more potent than cyclosporine, however. Tacrolimus is approved for prophylaxis against rejection of allogeneic liver transplants. The drug is also potentially as useful as cyclosporine for other conditions. Tacrolimus has been shown to exert profound antipsoriatic effects, probably by direct interaction with keratinocytes.³⁰ Adverse effects of tacrolimus are qualitatively similar to those of cyclosporine except that gingival overgrowth and hirsutism are not observed. Drug interactions are also similar because tacrolimus is metabolized by CYP3A.

Sirolimus

Sirolimus, originally known as rapamycin, was originally detected in the fermentation broth of *Streptomyces hygroscopicus*. A structural analogue of tacrolimus, sirolimus binds to the same FKBP receptors (see Figure 41-4) and is approved for a similar therapeutic indication. The sirolimus-immunophilin complex binds not to calcineurin, but to a serine-threonine kinase often referred to as FKBP-rapamycin-associated protein (FRAP).⁹ The FRAP-sirolimus-FKBP complex cannot phosphorylate a set of proteins involved in protein translation important in later stages of the T cell's immune response (i.e., its response to growth factors, IL-2 in particular).⁴³ It is believed that sirolimus interferes with signals from growth factor receptors, such as the IL-2 receptor

(IL-2R), rather than with signals generated by the TCR. In addition to blocking proliferation of T cells, sirolimus affects nonhematopoietic cells, and may find applications different from those of cyclosporine or tacrolimus.

Sirolimus is free of nephrotoxicity and neurotoxicity, and it does not promote hypertension. Hyperlipidemia is a common dose-dependent side effect. Anemia, thrombocytopenia, and leukopenia may occur. Combined use of sirolimus with cyclosporine significantly worsens renal function, but a positive drug interaction permits use of reduced cyclosporine doses.

Glucocorticoids

Glucocorticoids such as prednisone and dexamethasone have long been used as immunosuppressive agents, but their mechanism of action has been defined only more recently. As discussed in Chapters 32 and 35, glucocorticoids bind to a soluble intracellular receptor and then enter the nucleus of the cell. Specific glucocorticoid response elements on DNA interact with the glucocorticoid receptor, and transcription of specific genes is promoted or inhibited. Several cytokines and other proteins involved in inflammatory reactions are affected. Dexamethasone has also been shown to induce transcription of the I- κ B gene. The subsequent increased synthesis of I- κ B prevents the translocation of NF- κ B from the cytosol to the nucleus.³³ Because NF- κ B promotes IL-6 and IL-8 transcription, glucocorticoids are important as anti-inflammatory agents and as immunosuppressants. Apoptosis contributes to the rapid decline in peripheral lymphocytes.

Corticosteroids alone or with other immunosuppressive agents that inhibit antibody production and phagocytosis are often used to treat severe type II autoimmune reactions. Corticosteroids are also useful in the treatment of type III immune complex immunopathologic conditions, primarily because of their anti-inflammatory properties. In severe cases, another immunosuppressant may be added to block the immune response and allow use of reduced quantities of steroids. The steroids mainly act on CMI. In addition to their lympholytic effects, steroids may interfere with macrophage processing by stabilization of macrophage cell membranes.

Thalidomide and Lenalidomide

Thalidomide, a sedative agent briefly available in Europe more than four decades ago but quickly withdrawn because of its powerful teratogenic effects (see Chapter 3), was approved in 1998 for restricted use by the U.S. Food and Drug Administration (FDA) in the treatment of erythema nodosum leprosum. Although its mechanism of action is unknown, thalidomide decreases excessive production of TNF- α in target patients and downregulates certain surface adhesion molecules involved in leukocyte migration. TH2 cell responses are favored over TH1, yielding increases in IL-4 and IL-5. The drug can be sold only by registered pharmacies, which must obtain informed consent about its use from all patients. Thalidomide should never be used by women who are or may become pregnant; it is also contraindicated in men who are sexually mature and do not agree in writing to the need for using latex condoms when having sexual intercourse with women of childbearing potential. Peripheral neuropathy is an important side effect of the drug.

Lenalidomide is an analogue of thalidomide approved for use in the treatment of certain patients with multiple myeloma or myelodysplastic syndrome. It carries the same prescribing restrictions as thalidomide and is likely to cause neutropenia and thrombocytopenia.

Cytotoxic Drugs

Cytotoxic drugs are of two classes: the first kills lymphocytes, and the second interferes with the proliferative stage of the

immune response. The lympholytic drugs are most effective if given before antigen administration. They include the alkylating agents such as cyclophosphamide and phenylalanine mustard. Drugs that impede cellular proliferation include various metabolite analogues that inhibit DNA synthesis. The general pharmacologic characteristics of most of these drugs are discussed in Chapter 42.

Cyclophosphamide

Cyclophosphamide was originally developed for cancer chemotherapy and has been adapted for immunotherapy in the prevention of allograft rejection, control of autoimmune and rheumatoid diseases mediated by antibody, and control of T-cell-mediated diseases. Although considered an alkylating agent, cyclophosphamide is inactive until it is metabolized within the liver microsomes (the phosphamide ring is hydrolyzed). Cyclophosphamide metabolites are eliminated by the kidney. Liver and kidney function should be considered in the use of this drug. The metabolites of cyclophosphamide exert their effect by alkylating and cross-linking cellular macromolecules, including DNA, ribonucleic acid (RNA), and proteins. Damage to DNA can occur at all stages of the cell cycle, but lethal hits occur mainly in the S phase.

The daily, long-term administration of cyclophosphamide at low therapeutic doses leads to a progressive reduction in circulating lymphocytes, with minimal effect on myeloid cell populations. Within 7 days, B cells, CD4+ T cells, and CD8+ T cells show a 30% to 40% reduction in numbers. Cessation of cyclophosphamide therapy results in a differential rate of recovery of lymphocyte populations. CD8+ T cells recover first, followed by B cells and, finally, CD4+ T cells. Intermittent low-dose administration seems to affect antibody production, but long-term low-dose administration diminishes CMI as assessed by decreased delayed-type allergic reactions. Paradoxical increases in immune activity have also been observed after low-dose cyclophosphamide therapy, attributable to selective depression of T-suppressor cell activity. Cyclophosphamide also depresses myeloid hematopoiesis in the bone marrow, and has been associated with neutropenia and thrombocytopenia.

Metabolite analogues

The purine, pyrimidine, and folate antagonists represent a second group of cytotoxic drugs active against rapidly dividing or metabolizing cells. Included among these are the purine antagonists azathioprine and 6-mercaptopurine, the pyrimidine antagonist floxuridine, and the folate antagonist methotrexate. These agents are given with, or within 48 hours of, antigen administration and inhibit cellular proliferation and initial differentiation, usually through inhibition of DNA or RNA synthesis. They all seem to impair CMI and humoral immunity. Originally developed for cancer therapy, these drugs can affect any group of rapidly proliferating cells. Because they are particularly toxic to hematopoietic tissues, they may induce leukopenia (especially neutropenia), thrombocytopenia, and anemia.

Azathioprine. Azathioprine warrants special mention because it is used solely as an immunosuppressant. Azathioprine is a prodrug that yields 6-mercaptopurine on intracellular exposure to glutathione and other nucleophilic reactants. Although the pharmacologic features of azathioprine are essentially identical to those of 6-mercaptopurine (see Chapter 42), azathioprine is believed to be a more selective immunosuppressant. This advantage may stem from an enhanced uptake or metabolic activation of azathioprine in T cells.

Mycophenolate. Mycophenolate mofetil is an ester that is rapidly hydrolyzed to mycophenolic acid, the active form of

the drug. The active metabolite is now also available for use. Mycophenolate is an inhibitor of inosine monophosphate dehydrogenase, an important enzyme in purine synthesis. Because lymphocytes depend more on the de novo synthesis of purines than other cells, which can reclaim purines by the salvage pathway, mycophenolate is a more selective immunosuppressant than other cytotoxic agents. CMI and humoral immunity are suppressed, and leukocyte recruitment to inflammatory sites is inhibited.

Slow-Acting, Disease-Modifying Antirheumatic Drugs

One potential immunosuppressive strategy involves the inhibition of selected aspects of antigen processing within the endolysosome or by the proteasome. The antimalarial disease-modifying antirheumatic drugs (DMARDs) chloroquine and hydrochloroquine seem to have several effects on the immune system, including inhibition of endolysosomal antigen processing. It has been suggested that these weak bases may impair endolysosomal acidification. As a result, individuals treated with chloroquine or hydrochloroquine exhibit diminished antibody formation (including decreased formation of rheumatoid factor, decreased autoantibodies, and decreased total serum IgG and IgA), which is one of the main rationales for their use in Sjögren's syndrome and other autoimmune rheumatic diseases.

Gold compounds—gold sodium thiomalate, aurothioglucose, and auranofin—function in part by inhibiting transcription activation. Gold compounds may be active against protein kinase C. As a result, not only are various lymphocyte functions diminished, but also the induction of immune function in nonhematopoietic cells is impaired. In the latter situation, it has been shown that the expression of MHC II molecules by endothelial cells can be inhibited by gold compounds.

Penicillamine and sulfasalazine are DMARDs that inhibit proliferation through unknown mechanisms. Penicillamine blocks T-cell proliferation in response to IL-1 and blocks IL-1 production by monocytes; sulfasalazine blocks T-mitogen-induced and B-mitogen-induced proliferation of peripheral blood lymphocytes.¹⁰

Cytokine Therapy

Therapeutics based on the administration of hormones is not new. As more is learned about the activities of immunologic hormones, loosely referred to as *cytokines*, new therapies to increase or decrease immunologic activities will be developed. Currently, over a dozen cytokines have been approved for human use, and others are in clinical trials. In the following discussion, cytokines and soluble cytokine receptors are reviewed in accordance with their principal biologic activities (see Table 41-1).

Hematopoietic growth factors

The hematopoietic growth factors, also referred to as *colony-stimulating factors*, include granulocyte colony-stimulating factor, granulocyte/macrophage colony-stimulating factor, monocyte/macrophage colony-stimulating factor, stem cell factor, erythropoietin, and a number of interleukins. Although it is beyond the scope of this chapter to discuss these growth factors, they are used clinically in the treatment of various hematopoietic deficiencies, including neutropenia, anemia, and thrombocytopenia, and are reviewed in Chapter 30.

Interleukin-1 family

IL-1 occupies the borderland between adaptive, nonspecific immune responses and adaptive, specific immune responses. Several related molecules, including IL-1 α , IL-1 β , IL-1 receptor antagonist (IL-1Ra), and their receptors in soluble form, are under consideration for use in immunotherapeutics.¹³ IL-1 is

TABLE 41-3

Effects of Interleukin-1 on Immune Cells

TARGET CELLS	EFFECTS
Lymphoid Cells	
T cells	Growth factor (primarily owing to its ability to stimulate IL-2) Increased IL-2 receptors Induction of cytokine synthesis (IL-2, IL-3, others) Induction of IFN- γ synthesis Chemoattractant
B cells	Growth factor for transformed B cells (B blasts) Potentiates B-cell growth and differentiation factors (IL-4, IL-6) Chemoattractant
NK cells	Facilitates IL-2 and IFN enhancement of tumor cell lysis Increases binding of NK cells to targets Induces cytokine synthesis (IL-1)
Myeloid Cells	
Neutrophils	Thromboxane synthesis Degranulation (secretion)
Monocytes/macrophages	Induces synthesis of PGE ₂ , IL-1, and other cytokines Induces cytotoxicity Colony-stimulating factors Stimulates migration

IFN, Interferon; IL, interleukin; NK, natural killer; PGE₂, prostaglandin E₂.

produced by many cells, but mainly monocytes/macrophages, in the form of precursor molecules lacking a signal sequence. A large fraction of IL-1 α remains inactive in the cytosol of the cell. In contrast, IL-1 β is rapidly converted to its active form and released extracellularly in large quantities.

IL-1 can exist in soluble and membrane-associated forms. As a soluble molecule, IL-1 is a hormone with wide-ranging systemic effects involving the central nervous system, liver, kidney, hematopoietic system (including neutrophilia and lymphopenia), and vascular system (e.g., promotes leukocyte adherence). The membrane-associated form may be a partially degraded version of IL-1 α , which can function as a costimulatory factor for naïve T cells. Some immunologic effects of IL-1 are listed in Table 41-3. In addition, IL-1 β is important as an osteoclast-activating factor and is believed to be involved in periodontal bone destruction. IL-1 has cytotoxic activities; it kills melanoma cells, thyrocytes, and β -islet (insulin-producing) cells. IL-1 also induces fever, and as such it is one of the more important endogenous pyrogens. The pyrogenic effect of IL-1 is blocked by nonsteroidal anti-inflammatory drugs, suggesting that it depends on the elaboration of cyclooxygenase products.

IL-1Ra, a protein with structural homology to IL-1 α and IL-1 β , is secreted by monocytes. It is found in the urine of patients with fever or monocytic leukemia. The molecule binds to the IL-1 receptor in competition with IL-1 α and IL-1 β , but it does not trigger the cellular responses typical of IL-1. IL-1Ra is considered a natural means of blocking excessive IL-1 inflammatory events, which can lead to shock, arthritis, osteoporosis, colitis, leukemia, diabetes, wasting, and atherosclerosis. IL-1Ra has potential therapeutic application in humans, and clinical trials have shown some efficacy in

septic shock syndrome and more consistent benefits in rheumatoid arthritis.¹²

Interleukin-1 receptors

The IL-1 receptor (IL-1R) is a member of the immunoglobulin superfamily. There are two subtypes of IL-1R. Subtype 1 (IL-1RI) binds IL-1 α preferentially and is found on T cells, endothelial cells, keratinocytes, hepatocytes, and fibroblasts. Subtype 2 (IL-1RII) is expressed by neutrophils, monocytes, B cells, and bone marrow cells, and it binds IL-1 β preferentially. IL-1RI is more sensitive to inhibition by IL-1Ra than IL-1RII. IL-1RII exhibits a very short cytoplasmic domain compared with IL-1RI, suggesting that it may serve as a “decoy” receptor. IL-1R can exist in either a transmembranous form or a soluble form. Soluble receptors exert an antagonistic effect by binding to IL-1. (Because IL-1 and IL-1R can be either membrane-bound or soluble, the distinction between ligand and receptor blurs.) Experiments in mice have shown that recombinant soluble IL-1RI can prolong the survival of cardiac allografts. Much of this survival is attributable to decreased inflammation, rather than to specific immunosuppression. Anakinra, a recombinant form of IL-1RI, has been marketed for the treatment of rheumatoid arthritis not responding to more traditional DMARDs.

Interleukin-2

Lymphocytotropic hormone, or IL-2, is a glycoprotein produced by naïve and TH1 T cells in the presence of antigen-presenting cells. IL-2 abrogates suppressor T-cell activity and is required for IFN- γ production. In specific immune responses, the main function of IL-2 is to induce T-cell proliferative differentiation; as such, IL-2 enhances the growth of naïve CD4+ T cells, TH1 CD4+ T cells, and CD8+ T cells. In nonspecific, innate responses, IL-2 can activate NK cells to form more aggressive lymphokine-activated killer (LAK) cells. Most immunotherapies involving IL-2 are based on its ability to alter NK cell activity.

The IL-2 receptor is a collection of isoforms designated by their relative affinities for IL-2. These isoforms result from unique combinations of three different IL-2R subunits.⁴⁰ The high-affinity form is usually present on less than 1% of the circulating mononuclear cells.

IL-2 therapy has been explored in various immunodeficiency diseases and cancer, and IL-2 replacement has been effective in treating patients with IL-2 deficiency. The cytokine has been given the nonproprietary name of aldesleukin and has been marketed for the treatment of metastatic renal cell carcinoma (see Chapter 42).

The NK cell is believed to be the most important target for IL-2 therapy because depletion of this cell type can negate the protective effects of IL-2 in animal models.⁴ The high doses used in cancer chemotherapy are believed to saturate completely the intermediate-affinity IL-2 receptors of NK cells.³⁹ In animal models, transplanted tumor micrometastases seem to regress when IL-2 is used alone or in combination with LAK cells. In human clinical trials involving advanced melanoma, the coadministration of IL-2 and LAK cells resulted in the complete regression of tumors in approximately 5% of cases, and the partial regression (>50% reduction in tumor mass) in 15% of cases. Comparative values for metastatic renal cancer were 4% and 11%. IL-2 therapy has certain inherent problems not found in classic hormone therapy. IL-2 is a short-range hormone designed to influence cells in an extremely local manner. High-dose IL-2 therapy is toxic, and complications lead to a mortality rate of approximately 4%. Adverse effects include capillary leak syndrome (resulting in edema, reduced organ perfusion, and hypotension), cardiac arrhythmias, myocardial infarction, respiratory insufficiency, mental disturbances, and increased infections.⁴³

Experimentation with lower dosages has greatly influenced IL-2 immunotherapy. Lower dosages are based on the observation that 10% of NK cells express high-affinity receptors for IL-2; a 500-fold decrease in the IL-2 dose (administered as a continuous intravenous infusion) would still be sufficient to saturate all these high-affinity receptors. The low-dose regimen was found to produce a gradual, 10-fold increase in circulating NK cells without causing significant toxicity.³⁹ Such low-dose administration of IL-2 has also been used to increase the number of NK cells in patients with HIV infection or advanced cancer.^{4,39}

Subcutaneous administration of IL-2 has been tested as an immunostimulant in individuals with asymptomatic HIV infection. This route leads to an increase in the proportion of T cells expressing IL-2Rs without increasing NK cells or viral proliferation.³⁹

Interferons

There are two major classes of interferons: type 1 interferons (IFN- α , IFN- β , and IFN- ω), and type 2 interferon (IFN- γ). Type 1 interferons are produced by most nucleated cells. IFN- γ is mainly a product of TH1 T cells and activated NK cells.²⁰

Type 1 interferons act by stimulating the phosphorylation of cytosolic proteins termed *signal transducers and activators of transcription (STAT)*. These STAT proteins form a complex with a specific nonphosphorylated protein; the complex enters the nucleus, binds to its designated response element on DNA, and promotes transcription.³⁶ Only the nonphosphorylated protein constituent actually binds to DNA.

Recombinant forms of IFN- α (interferon alfa-2a, interferon alfa-2b, interferon alfacon-1) and IFN- β (interferon beta-1a, interferon beta-1b) and a purified form from human leukocytes (interferon alfa-N3) have received approval by the FDA for use in the clinical setting, as described in Chapters 40 and 42.³⁵ IFN- α preparations are indicated in the treatment of numerous diseases, including hairy cell leukemia, chronic myelogenous leukemia, condyloma acuminatum, acquired immunodeficiency syndrome-related Kaposi's sarcoma, chronic hepatitis B and C, and malignant melanoma. IFN- β preparations are approved for the treatment of remitting and recurring multiple sclerosis. In addition, trials are ongoing for the use of type 1 interferons in numerous other cancers, AIDS, viral infections, papillomas, and angiogenic disorders.

IFN- γ was initially discovered as a result of its antiviral properties, but it also displays antiproliferative effects against tumors. IFN- γ is a glycosylated protein that exists exclusively as a covalently coupled homodimer. It shares very little DNA sequence homology with either IFN- α or IFN- β , and IFN- γ is more accurately classified as an interleukin. The mechanism by which IFN- γ stimulates transcription is similar, however, to that of the type 1 interferons. The resultant effects of its action include (1) stimulation of CD4+ TH1 T cells and macrophages, (2) suppression of antibody production (IFN- γ antagonizes CD4+ TH2 T cells), (3) induction of immunoglobulin class switching, (4) upregulation of MHC II expression by epithelial tumor cells and macrophages (an effect antagonized by prostaglandin E2), and (5) alteration of antigen processing by changing the mix of peptide products produced by the proteasome.² IFN- γ , in the form of a single polypeptide chain designated *interferon γ 1b*, is approved for managing serious infections associated with granulomatous disease and delaying the progression of malignant osteopetrosis. It is also useful in the management of rheumatoid arthritis.

TH1 and TH2 Cytokines

In later phases of specific immune responses, one function of cytokines is to regulate the nature of the immune response.

TH1 cytokines help guide specific immunity against changes in intracellular, cytosolic antigens, and TH2 cytokines help direct specific immunity against changes in extracellular antigens. These TH1 and TH2 responses are mutually inhibitory: the TH1 cytokines IFN- γ and IL-12 inhibit TH2 responses, and the TH2 cytokines IL-4 and IL-10 inhibit TH1 responses. Pharmacologic regulation of the relative proportions of TH1 and TH2 cytokines may provide a way to treat diseases in which an inappropriate TH1 or TH2 response is a component of the disease process (in contrast to the problem of simply too much or too little immune response).

The types of disorders that may be amenable to cytokine intervention in these later stages include infectious diseases in which there is an inappropriate type of immune response, inflammatory autoimmune diseases, and IgE-mediated allergic diseases.³² Lepromatous leprosy, nonhealing forms of leishmaniasis, tuberculosis, trypanosomiasis, and certain fungal diseases are infections that may be exacerbated by an inappropriately strong TH2 response. The administration of the TH1 cytokine IFN- γ , as mentioned previously, is approved for this indication.

Experimental allergic encephalomyelitis, a potential animal model for multiple sclerosis, seems to involve an overzealous TH1 response and can be transferred by T cells with the TH1 phenotype. In animals, spontaneous recovery from the disease is associated with an expansion of T cells with the TH2 phenotype; a study in humans with multiple sclerosis suggests that the administration of IFN- γ exacerbates the disease process (to the point where the research had to be terminated). Opposite effects occur with IFN- β ,⁴¹ which has FDA approval for the treatment of this form of the disease. The destruction of β -islet cells in insulin-dependent diabetes mellitus has been associated with tissue infiltration by T cells of the TH1 phenotype. For such TH1-mediated disease, it is possible that the administration of TH2 cytokines IL-4 and IL-10 may be beneficial.

IgE-mediated allergic diseases are consistent with the overactivity of TH2 T cells. Well-known examples include allergic rhinitis, immediate drug allergies, and life-threatening anaphylaxis resulting from insect stings. The successful long-term treatment of IgE-mediated allergies empirically corresponds with a shift in antibody isotypes from IgE to IgG; it is widely believed that various desensitization procedures in which the allergen is injected into the allergic host owe their success to the generation of "blocking antibodies" of the IgG subclass. Bee venom immunotherapy is a good model for such procedures; it is associated with a TH2-to-TH1 shift.²⁸ The TH1 cytokine profile favors production of IgG rather than IgE. In local tissues, mast cells and basophils are important sources of IL-4. Local therapies currently being explored include anti-IL-4 antibodies and IFN- α .

Short-term desensitization procedures are also available for dealing with IgE-mediated allergies. Occasionally, it may be essential to treat a patient with a certain drug despite a known allergy to that drug (e.g., using penicillin to treat an infection in an individual with a positive skin test indicative of penicillin allergy). Most individuals are not allergic to penicillin itself, but rather to antigens that form by the covalent linkage between the β -lactam ring of penicillin metabolites and certain proteins. In acute desensitization, penicillin is administered in incrementally increasing dosages over 4 to 6 hours. The goal of these therapies is not to cause a permanent reduction in antipenicillin IgE, but instead to induce rapidly a state of clinical tolerance. The actual mechanism of clinical tolerance is unclear (possible Fc receptor downregulation in mast cells); the end result is a diminished risk of anaphylaxis with only minor urticarial side effects.

DRUGS USED IN IMMUNOTHERAPY

<i>Nonproprietary (generic) name</i>	<i>Proprietary (trade) name</i>
Agents for active immunization	
See references 6 and 14	
Agents for passive immunization	
Botulism immunoglobulin (human)	BabyBIG
Cytomegalovirus immunoglobulin (human)	CytoGam
Hepatitis B immunoglobulin (human)	HepaGam B, HyperHEP B S/D, Nabi-HB
Immunoglobulin (human)	BayGam, Carimune NF, Flebogamma, Gamimune N, Gammagard, Octagan
Palivizumab	Synagis
Rabies immunoglobulin (human)	IMOGAM
Respiratory syncytial virus immunoglobulin (human)	RespiGam
Rho(D) immunoglobulin (human)	HyperRho S/D, RhoGAM, WinRho SDF
Tetanus immunoglobulin	HyperTET S/D
Varicella-zoster immunoglobulin	—
Antitoxins	
Antivenin (Crotalidae), polyvalent	—
Antivenin (<i>Latrodectus mactans</i>)	—
Antivenin (<i>Micrurus fulvius</i>)	—
Crotalidae polyvalent immune fab	CroFab
Rabies immunoglobulin (human)	Hyperab, Imogam
Immunostimulants	
Thymosin*	—
Levamisole*	Ergamisol
Immunomodulators	
Imiquimod	Aldera
Lenalidomide	Revlimid
Mitoxantrone	Novantrone
Thalidomide	Thalomid
Monoclonal antibodies	
See Table 41-2	
Immunosuppressants	
Abatacept	Orencia
Azathioprine	Azasan, Imuran
Basiliximab	Simulect
Cyclophosphamide	Cytoxan
Cyclosporine	Gengraf, Neoral, Sandimmune
daclizumab	ZENAPAX
Glatiramer	Copaxone
Lymphocyte immunoglobulin, antithymocyte globulin (equine)	Atgam

<i>Nonproprietary (generic) name</i>	<i>Proprietary (trade) name</i>
Antithymocyte globulin (rabbit)	Thymoglobulin
Melphalan	Alkeran
Mercaptopurine	Purinethol
Methotrexate	Rheumatrex Dose Pack, Trexall
Muromonab-CD3	Orthoclone OKT3
Mycophenolate mofetil	CellCept
Mycophenolic acid	Myfortic
Prednisone	Sterapred
Sirolimus	Rapamune
Tacrolimus (FK506)	Prograf
Slow-acting disease-modifying antirheumatic drugs	
See Chapter 21	
Cytokines	
Aldesleukin (IL-2)	Proleukin
Anakinra	Kineret
Denileukin diftitox	Ontak
Interferon alpha-2a	Roferon-A
Interferon alpha-2b	Intron A
Interferon alpha-n3	ALFERON N
Interferon alfacon-1	Infergen
Interferon beta-1a	Avonex, Rebif
Interferon beta-1b	Betaseron, Extavia
Interferon gamma-1b	Actimmune
Peginterferon alpha-2a	Pegasys
Peginterferon alpha-2b	PEG-Intron
Hematopoietic growth factors	
See Chapter 30	
Therapy for allergic reactions	
See Chapters 22, 32, and 35	

*Not currently available in the United States.

CITED REFERENCES

- Abou-Jawde R, Choueiri T, Alemany C, et al: An overview of targeted treatments in cancer. *Clin Ther* 25:2122-2137, 2003.
- Akiyama K, Yokota K, Kagawa S, et al: cDNA cloning and interferon γ down-regulation of proteasomal subunits X and Y. *Science* 265:1231-1234, 1994.
- Bach JF, Bach MA, Charreire J, et al: The mode of action of thymic hormones. *Ann N Y Acad Sci* 332:23-32, 1979.
- Baiocchi RA, Caligiuri MA: Low-dose interleukin 2 prevents the development of Epstein-Barr virus (EBV)-associated lymphoproliferative disease in scid/scid mice reconstituted i.p. with EBV-seropositive human peripheral blood lymphocytes. *Proc Natl Acad Sci U S A* 91:5577-5581, 1994.
- Baskar S, Ostrand-Rosenberg S, Nabavi N, et al: Constitutive expression of B7 restores immunogenicity of tumor cells expressing truncated major histocompatibility complex class II molecules. *Proc Natl Acad Sci U S A* 90:5687-5690, 1993.
- Benenson AS, editor: *Control of communicable diseases manual: an official report of the American Public Health Association*, ed 16, Washington, DC, 1995, American Public Health Association.
- Boise LH, Thompson CB: Hierarchical control of lymphocyte survival. *Science* 274:67-68, 1996.
- Childers NK, Zhang SS, Michalek SM: Oral immunization of humans with dehydrated liposomes containing *Streptococcus mutans* glucosyltransferase induces salivary immunoglobulin A2 antibody responses. *Oral Microbiol Immunol* 9:146-153, 1994.
- Choi J, Chen J, Schreiber SL, et al: Structure of the FKBP12-rapamycin complex interacting with the binding domain of human FRAP. *Science* 273:239-242, 1996.

10. Cronstein BN: Second-line antirheumatic drugs. In Gallin JI, Snyderman R, editors: *Inflammation: basic principles and clinical correlates*, ed 3, Philadelphia, 1999, Lippincott Williams & Wilkins.
11. de Camargo PM: Cyclosporin- and nifedipine-induced gingival enlargement: an overview. *J West Soc Periodontol* 37:57-64, 1989.
12. Dinarello CA: Interleukin-1: a proinflammatory cytokine. In Gallin JI, Snyderman R, editors: *Inflammation: basic principles and clinical correlates*, ed 3, Philadelphia, 1999, Lippincott Williams & Wilkins.
13. Dinarello CA: Modalities for reducing interleukin 1 activity in disease. *Immunol Today* 14:260-264, 1993.
14. *Drug facts and comparisons, 2004*, ed 58, St Louis, 2003, Facts and Comparisons.
15. Eisen D, Ellis CN, Duell EA, et al: Effect of topical cyclosporine rinse on oral lichen planus: a double-blind analysis. *N Engl J Med* 323:290-294, 1990.
16. Ferrone S, Dierich MP, editors: *Handbook of monoclonal antibodies: applications in biology and medicine*, Park Ridge, NJ, 1985, Noyes.
17. Goldstein AL, Low TL, McAdoo M, et al: Thymosin α_1 : isolation and sequence analysis of an immunologically active thymic polypeptide. *Proc Natl Acad Sci U S A* 74:725-729, 1977.
18. Hassell TM, Hefti AF: Drug-induced gingival overgrowth: old problem, new problem. *Crit Rev Oral Biol Med* 2:103-137, 1991.
19. Horning SJ: Future directions in radioimmunotherapy for B-cell lymphoma. *Semin Oncol* 30(suppl 17):29-34, 2003.
20. Hsu DH, de Waal Malefyt R, Fiorentino DF, et al: Expression of interleukin-10 activity by Epstein-Barr virus protein BCRF1. *Science* 250:830-832, 1990.
21. Jackson S, Mestecky J, Childers NK, et al: Liposomes containing anti-idiotypic antibodies: an oral vaccine to induce protective secretory immune responses specific for pathogens of mucosal surfaces. *Infect Immun* 58:1932-1936, 1990.
22. Kiechle FL, Zhang X: Apoptosis: biochemical aspects and clinical implications. *Clin Chim Acta* 326:27-45, 2002.
23. LeBlanc AC: Natural cellular inhibitors of caspases. *Prog Neuro-psychopharmacol Biol Psychiatr* 27:215-229, 2003.
24. Lehner T, Mehlert A, Caldwell J: Local active gingival immunization by a 3,800-molecular-weight streptococcal antigen in protection against dental caries. *Infect Immun* 52:682-687, 1986.
25. Lehner T, Wilton JMA, Ivanyi L: Double blind crossover trial of levamisole in recurrent aphthous ulceration. *Lancet* 2:926-929, 1976.
26. Liu C-C, Walsh CM, Young JD-E: Perforin: structure and function. *Immunol Today* 16:194-201, 1995.
27. Liu J, Farmer JD, Jr, Lane WS, et al: Calcineurin is a common target of cyclophilin-cyclosporin A and FKBP-FK506 complexes. *Cell* 66:807-815, 1991.
28. McHugh SM, Deighton J, Stewart AG, et al: Bee venom immunotherapy induces a shift in cytokine responses from a TH-2 to a TH-1 dominant pattern: comparison of rush and conventional immunotherapy. *Clin Exp Allergy* 25:828-838, 1995.
29. Michalek SM, Childers NK: Development and outlook for a caries vaccine. *Crit Rev Oral Biol Med* 1:37-54, 1990.
30. Michel G, Kemeny L, Homey B, et al: FK506 in the treatment of inflammatory skin disease: promises and perspectives. *Immunol Today* 17:106-108, 1996.
31. Mitsiades CS, Poulaki V, Mitsiades N: The role of apoptosis-inducing receptors of the tumor necrosis factor family in thyroid cancer. *J Endocrinol* 178:205-216, 2003.
32. Powrie F, Coffman RL: Cytokine regulation of T-cell function: potential for therapeutic intervention. *Trends Pharmacol Sci* 14:164-168, 1993.
33. Scheinman RI, Cogswell PC, Lofquist AK, et al: Role of transcriptional activation of I- κ B α in mediation of immunosuppression by glucocorticoids. *Science* 270:283-290, 1995.
34. Schiff RI, Rudd C, Johnson R, et al: Use of a chemically modified intravenous IgG preparation in severe primary humoral immunodeficiency: clinical efficacy and attempts to individualize dosage. *Clin Immunol Immunopathol* 31:13-23, 1984.
35. Shankaran V, Schreiber RD: The interferons: basic biology and therapeutic potential. In Austen KF, Burakoff SJ, Rosen FS, et al, editors: *Therapeutic immunology*, ed 2, Cambridge, MA, 2001, Blackwell Science.
36. Shuai K, Schindler C, Prezioso VR, et al: Activation of transcription of IFN- γ : tyrosine phosphorylation of a 91-kD DNA binding protein. *Science* 258:1808-1812, 1992.
37. Smith DJ, Taubman MA, Holmberg CF, et al: Antigenicity and immunogenicity of a synthetic peptide derived from a glucan-binding domain of mutans streptococcal glucosyltransferase. *Infect Immun* 61:2899-2905, 1993.
38. Smith DJ, Taubman MA, King WF, et al: Immunological characteristics of a synthetic peptide associated with a catalytic domain of mutans streptococcal glucosyltransferase. *Infect Immun* 62:5470-5476, 1994.
39. Smith KA: Interleukin-2 immunostimulation. In Austen KF, Burakoff SJ, Rosen FS, et al, editors: *Therapeutic immunology*, ed 2, Cambridge, MA, 2001, Blackwell Science.
40. Taniguchi T, Minami Y: The IL-2/IL-2 receptor system: a current overview. *Cell* 73:5-8, 1993.
41. The IFNB Multiple Sclerosis Study Group: Interferon beta-1b is effective in relapsing-remitting multiple sclerosis. I. Clinical results of a multicenter, randomized, double-blind, placebo-controlled trial. *Neurology* 43:655-661, 1993.
42. Viola A, Lanzavecchia A: T cell activation determined by T cell receptor number and tunable thresholds. *Science* 273:104-106, 1996.
43. Waldmann TA: The IL-2/IL-2 receptor system: a target for rational immune intervention. *Immunol Today* 14:264-270, 1993.
44. Winter G, Harris WJ: Humanized antibodies. *Immunol Today* 14:243-246, 1993.

GENERAL REFERENCES

- Abbas AK, Lichtman AH: *Basic immunology: functions and disorders of the immune system*, Philadelphia, 2001, Saunders.
- Alberts B, Johnson A, Lewis J, et al: *Molecular biology of the cell*, ed 5, New York, 2008, Garland.
- Apostolopoulos V, Yuriev E, Lazoura E, et al: MHC and MHC-like molecules: structural perspectives on the design of molecular vaccines, *Hum Vaccin* 4:400-409, 2008.
- Austen KF, Burakoff SJ, Rosen FS, et al, editors: *Therapeutic immunology*, ed 2, Cambridge, MA, 2001, Blackwell Science.
- Feldmann M: Many cytokines are very useful therapeutic targets in disease, *J Clin Invest* 118:3533-3536, 2008.
- Gallin JI, Snyderman R, editors: *Inflammation: basic principles and clinical correlates*, ed 3, Philadelphia, 1999, Lippincott Williams & Wilkins.
- Gray D, Siepmann K, van Essen D, et al: B-T lymphocyte interactions in the generation and survival of memory cells, *Immunol Rev* 150:45-61, 1996.
- Guy CS, Vignali DA: Organization of proximal signal initiation at the TCR:CD3 complex, *Immunol Rev* 232:7-21, 2009.
- Janeway C Jr, Travers P: *Immunobiology—the immune system in health and disease*, ed 6, London, 2005, Garland.
- Jenkins MR, La Gruta NL, Doherty PC, et al: Visualizing CTL activity for different CD8+ effector T cells supports the idea that lower TCR/epitope avidity may be advantageous for target cell killing, *Cell Death Differ* 16:537-542, 2009.
- Kindt TJ, Goldsby RA, Osborne BA, et al, editors: *Kuby immunology*, 2007, Freeman.
- Loke P, Allison JP: Emerging mechanisms of immune regulation: the extended B7 family and regulatory T cells, *Arthritis Res Ther* 6:208-214, 2004.
- Melzer N, Meuth SG, Wiendl H: CD8+ T cells and neuronal damage: direct and collateral mechanisms of cytotoxicity and impaired electrical excitability, *FASEB J* 23:3659-3673, 2009.
- Nitta T, Murata S, Ueno T, et al: Thymic microenvironments for T-cell repertoire formation, *Adv Immunol* 99:59-94, 2008.
- Rich RR, Fleisher TA, Shearer WT, et al, editors: *Clinical immunology: principles and practice*, ed 32, London, 2001, Mosby International.
- Stavnezer J, Guikema JE, Schrader CE: Mechanism and regulation of class switch recombination, *Annu Rev Immunol* 26:261-292, 2008.
- Turner SJ, La Gruta NL, Kedzierska K, et al: Functional implications of T cell receptor diversity, *Curr Opin Immunol* 21:286-290, 2009.
- von Boehmer H, Melchers F: Checkpoints in lymphocyte development and autoimmune disease, *Nat Immunol* 11:14-20, 2010.

Antineoplastic Drugs

KARL K. KWOK, LINSEY R. CURTIS, AND MARK M. SCHUBERT

The role of antineoplastic drugs in cancer treatment has greatly expanded in the past few decades. These drugs can cure numerous advanced tumors and are the treatment of choice for many widely disseminated malignancies that cannot be reached by surgery or are beyond the limits of safety of radiotherapy. They are also used as adjuncts to surgery and irradiation in the prevention of metastasis from locally treated primary tumors. Research has resulted in the development of new agents, more effective applications of existing agents, and the use of adjunctive drugs to overcome resistance and minimize drug toxicity.

The past decade has also brought about a greater depth of research and understanding of the molecular biology of cancer cell growth. Many mechanisms of growth stimulation and retardation and the actions of growth modulators have been discovered. Gene rearrangements and mutations and their resultant influences on cell growth are being elucidated. These discoveries provide many new targets for the management of abnormal cell growth, and with that have come multiple new approaches to cancer therapy and several new classes of drugs. Antineoplastic regimens that contribute to the goal of eliminating and destroying tumor cells now include traditional chemotherapeutic drugs (i.e., alkylators, antimetabolites, antibiotics, steroids, plant alkaloids, and other agents), biologic response modifiers, novel targeting agents, and agents used specifically to protect the patient from the toxic effects of these drugs. In the last few years, several newer chemotherapy drugs, such as nelarabine, ixabepilone, and others, have been introduced as the antineoplastic agents, and some older therapeutic agents, such as arsenic trioxide, and thalidomide, are experiencing a resurgence of interest in their actions.

Other newer groups of drugs used in managing cancer include specific hormonal agents, such as letrozole, anastrozole, and fulvestrant; differentiating agents, such as tretinoid; and monoclonal antibodies (MAbs), which have a variety of different targets and potential mechanisms of action. Additional groups include drugs that target signal transduction, such as imatinib mesylate; drugs that block crucial cellular receptors, including epidermal growth factor receptors (EGFRs) such as erlotinib; and drugs that inhibit angiogenesis, such as bevacizumab, a MAb that blocks vascular endothelial growth factor (VEGF). There are also groups that include proteasome inhibitors, such as bortezomib, and drugs that may enhance or remove blocks to apoptosis (programmed cell death). As the choices in therapeutic agents, combinations, and approaches increase, the ability to successfully eradicate cancer is improving.

HISTORY OF CANCER CHEMOTHERAPY

The cytotoxic effects of drugs were observed well before the turn of the twentieth century, but their usefulness in the treatment of disease was not appreciated until the mid-1940s. Chemical warfare with sulfur mustard gas in World War I resulted in shrinkage of lymph nodes and myeloid tissues in the victims. The application of these nitrogen mustard compounds for the medical treatment of Hodgkin's disease, malignant lymphomas, and chronic leukemia followed these observations but was not reported until the end of World War II. In 1944, glucocorticoids were shown to have a profound effect on the volume, structure, and function of lymphoid tissue.¹⁷ Subsequently, this effect was used in the control of human leukemia, and since then prednisone and prednisolone have been incorporated in drug protocols designed to ablate lymphoproliferative and myeloproliferative diseases.

In 1948, Farber and colleagues²⁰ obtained temporary remissions in children with acute leukemia who were given the folic acid antagonist 4-aminopteroylglutamic acid (aminopterin). This specially tailored molecule was the first antimetabolite to produce unequivocally beneficial results in a human neoplastic disease.

The folate antagonist approach led to the development of competitive inhibitors of purines and pyrimidines that interfered with the synthesis of nucleic acids in rapidly multiplying neoplastic cells. Observations in animal tumor models of selective uptake of uracil by colon tumor cells resulted in the development of a "designer" antimetabolite, 5-fluorouracil.

The first antibiotic with activity against human tumors was actinomycin D. Introduced as an anticancer agent in 1952, dactinomycin (actinomycin D) is curative in many patients with Wilms' tumor and uterine choriocarcinoma. The anticancer effects of the vinca alkaloids, extracted from the periwinkle plant (*Vinca rosea*), were initially shown in animals with experimental leukemia in 1960.⁴⁰ In the same year, vinblastine was found to be valuable in the treatment of acute forms of leukemia, Hodgkin's disease, and adenocarcinoma of the colon.³⁵ The earliest reports of the use of carmustine, the prototype of the nitrosourea group of cytotoxic compounds, against human malignancies appeared in 1966.

In 1967, the enzyme L-asparaginase was found to produce remissions in some patients with acute leukemia. The first of the heavy metal complexes to have significant success in the treatment of human cancer was cisplatin, introduced in 1969. The 1950s and 1960s brought rapid development of new agents, and continued refinements in their use occurred in the 1970s and early 1980s with additional combination chemo-

therapy regimens and a better understanding of the cytokinetics of tumor cells and the pharmacokinetics of the drugs.^{13,15} The late 1980s and early 1990s contributed several new agents, such as taxanes, topoisomerase I inhibitors, and others with measurable efficacy and decreased toxicity; biologic response modifiers such as interferon and interleukin-2; and chemoprotective agents and newer technologies for the application of these antineoplastic agents.

The late 1990s brought the commercial availability of some MAbs for the treatment of several cancers, as well as important research on the role of angiogenesis, which had started in the 1960s. Angiogenesis, which is the formation of new blood vessels, plays a role in supporting existing tumors with required nutrients and oxygen and in forming metastatic tumors. The identification of angiogenic factors such as VEGF, basic fibroblastic growth factor, and other regulators and inhibitors of angiogenesis is leading to the development of new drugs to target these factors and evaluate their role in starving cancer cells and preventing the formation of metastatic disease.⁴⁴

Several novel strategies are being considered in clinical trials, applying newer drug entities for newly identified targets. Drugs being studied include angiogenesis factors, inhibitors of matrix metalloproteinase, and drugs that affect intracellular signaling pathways (e.g., tyrosine kinase [TK] inhibitors). Many drugs have been developed that can promote apoptosis, target cyclin-dependent kinases, and inhibit the family of enzymes that plays a role in cell cycle progression. The challenge of these clinical trials is to identify agents specific to the cancer cell process and determine the appropriate role of these agents, combined with existing therapies, in enhancing responses to cancer treatment and minimizing side effects.

PRINCIPLES OF CANCER CHEMOTHERAPY

The goal of chemotherapy is to eradicate every viable tumor cell without significantly damaging normal host tissue. Attaining this goal requires that the tumor be inherently sensitive to the chemotherapy agents, that the tumor receptor sites be exposed to adequate concentrations of active drug for sufficient periods, and that the host cells be resistant to the effects of the chemotherapy drugs. Classic chemotherapy agents are not tumor cell specific and kill all cells actively undergoing cell division. In addition to killing the abnormal or malignant cells, normal cells in the gastrointestinal tract, bone marrow, and hair follicles and other tissues are affected.

Chemotherapy drugs kill or impair susceptible tumor cells by blocking a drug-sensitive biochemical or metabolic pathway. Some, such as cell cycle phase-specific antimetabolites, act by inhibiting DNA synthesis and are most effective against rapidly dividing cells. Others, including alkylating agents, act by interfering with nucleic acid function and protein production throughout the cell division cycle and are effective against both proliferating and resting cells (Figures 42-1 and 42-2). All chemotherapy drugs are extremely cytotoxic with low margins of safety. Incorporating the current understanding of tumor biology, the patient's physiologic status, and the drug's pharmacologic features, the principles that govern the useful application of cancer chemotherapy include the following:

1. The tumor must be susceptible to the drugs selected for treatment. Not all tumors are responsive to the same agents.
2. The drugs or methods of administration must not have intolerable local or systemic toxicity that would prevent the completion of an adequate course of treatment.

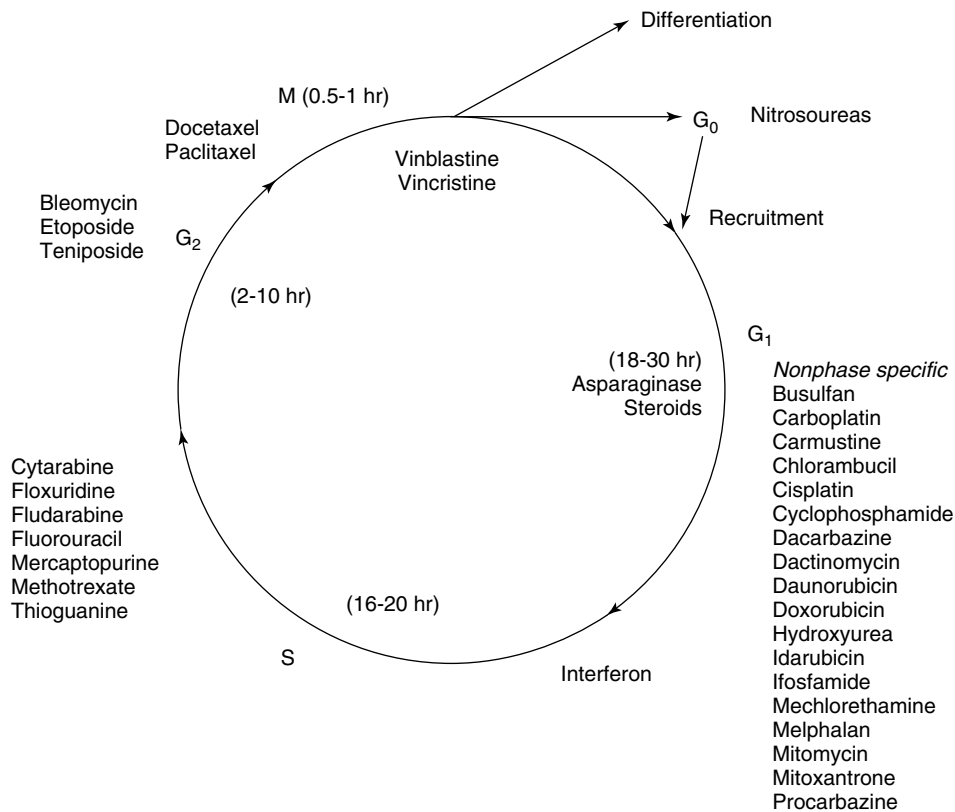

FIGURE 42-1 Cell cycle sites of antineoplastic activity. G₀, Resting phase; G₁, period before DNA synthesis, during which the enzymes necessary for DNA synthesis are synthesized; G₂, period of specialized protein and RNA synthesis and the manufacture of mitotic spindle apparatus; M, mitosis; S, DNA synthesis, during which DNA is replicated.

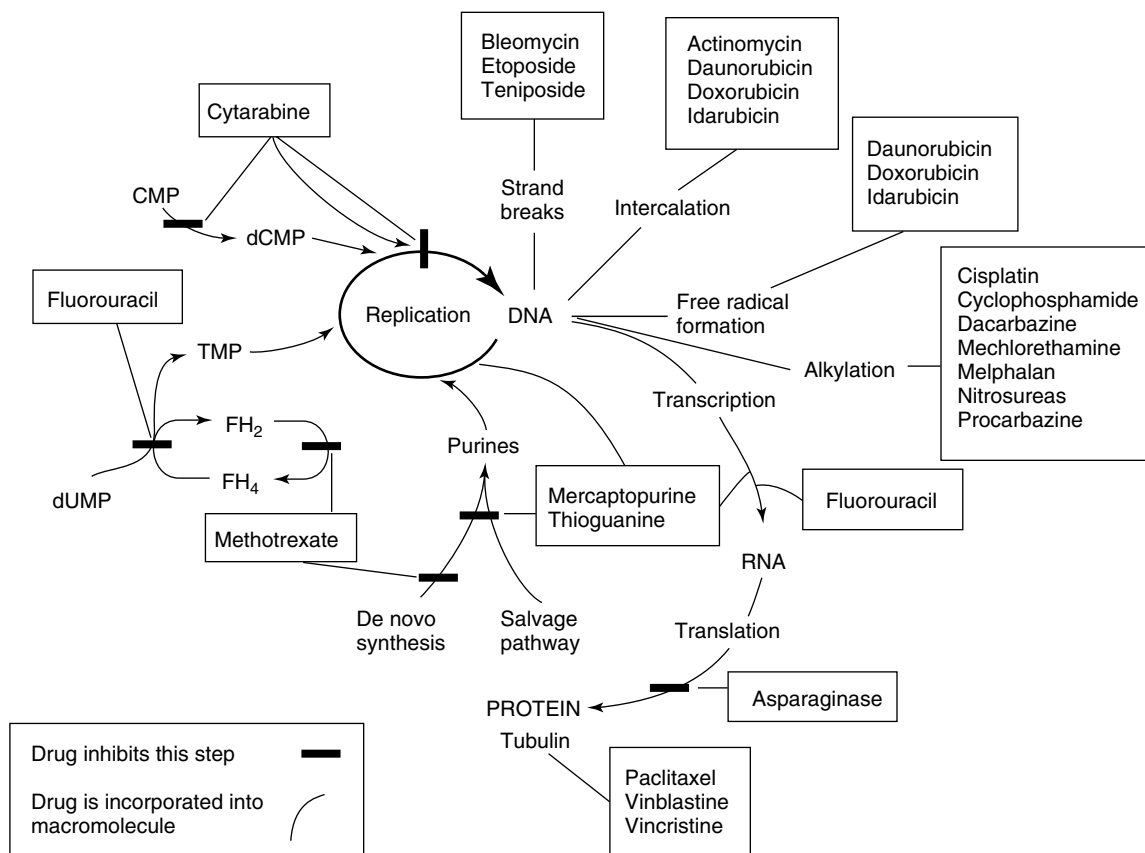

FIGURE 42-2 Potential sites of inhibition and incorporation of antineoplastic agents into the biosynthetic pathways of nucleic acids and proteins. *CMP*, Cytosine monophosphate; *dCMP*, deoxycytosine monophosphate; *dUMP*, deoxyuridine monophosphate; *FH₂*, dihydrofolate; *FH₄*, tetrahydrofolate; *TMP*, thymidine monophosphate.

- The dosages and schedules for the drugs must be calculated to maximize the contact with the tumor cells, and the drugs must be present in sufficient concentration during the crucial periods of the cell's metabolic cycle.
- Cancer chemotherapy is more effective when the tumor mass is small than when the tumor cell burden is high. A larger fraction of the tumor cell population is undergoing active division in a small tumor mass, and the blood supply is more plentiful, allowing for increased sensitivity and delivery of the drugs. Debulking by surgery or irradiation reduces tumor cell burden and can induce resting cell populations into active cell division, increasing the growth fraction of the tumor.
- Anticancer drugs kill cells according to first-order kinetics. Even a drug that destroyed 99.99% of the tumor cells would leave a substantial number of tumor cells intact if the initial quantity was large. Because survival of a few or perhaps even a single malignant cell may lead to tumor regrowth, chemotherapy is generally given in cycles to maximize tumor cell reduction. The optimal interval between cycles is determined by the time required to allow for sufficient bone marrow recovery without allowing significant tumor regrowth.
- The administration of combinations of antineoplastic drugs takes advantage of the different mechanisms of action. By using agents that act at different phases of the cell cycle, synergistic effects and an increase in the collective antitumor effect may be obtained without a concomitant increase in undesirable side effects. Combination chemotherapy may prevent or slow the development of resistant strains.
- Cancer cells may build up resistance to a previously effective drug, which then becomes ineffective. Such resistance has been ascribed to various causes, including decreased drug penetration resulting from a reduction in tumor blood supply, drug-provoked mutations, enzyme alterations, and acquired resistance through natural selection of tumor cells insensitive to the drug. The therapeutic potential of antineoplastic drugs may be enhanced by active antitumor defense mechanisms in the host. Immunotherapy given with chemotherapy, either concurrently or sequentially, may boost the tumoricidal effect of the drugs.

CHEMOTHERAPEUTIC DRUGS

Antineoplastic Alkylating Agents

Alkylating agents (Table 42-1) are composed of six major chemical classes: (1) nitrogen mustards (chlorambucil, cyclophosphamide, estramustine, ifosfamide, mechlorethamine, and melphalan), (2) alkyl sulfonates (busulfan), (3) ethylenimines (thiotepa), (4) triazines (dacarbazine), (5) tetrazines (temozolomide), and (6) nitrosoureas (carmustine, lomustine, and streptozocin). They all share the common chemical characteristic of forming alkyl radicals, which form covalent linkages with nucleophilic moieties such as the phosphate, sulfhydryl, hydroxyl, carboxyl, amino, and imidazole groups. This radical formation allows them to react with organic compounds such as DNA and RNA and proteins essential for cell metabolism and protein synthesis. By binding these groups, they also prevent cell division by cross-linking strands of DNA.

Text continued on p. 692

TABLE 42-1

Classification of Available Antineoplastic and Associated Drugs

CLASS OR TYPE OF AGENT	NONPROPRIETARY (GENERIC) NAME	PROPRIETARY (TRADE) NAME	ADVERSE EFFECTS*	STOMATITIS [†]	CLINICAL APPLICATIONS
Alkylating Agents					
Nitrogen mustards	Chlorambucil	Leukeran	<i>Myelosuppression</i> , [‡] pulmonary fibrosis, dermatotoxicity, hepatotoxicity	0	Chronic lymphocytic leukemia, Hodgkin's disease, lymphosarcoma, ovarian cancer, seminoma
	Cyclophosphamide	Cytoxan	Immunosuppression, <i>myelosuppression</i> , dermatotoxicity, hemorrhagic cystitis, <i>GI enterotoxicity</i> , hepatotoxicity, alopecia, SIADH	+	Hodgkin's disease; lymphoma; leukemia; multiple myeloma; sarcoma; testicular, prostate, lung, breast, and ovarian carcinoma
	Estramustine	Emcyt	<i>Myelosuppression</i> , cardiovascular toxicity, <i>GI enterotoxicity</i> , gynecomastia	+	Prostate cancer
	Ifosfamide	Ifex	<i>Myelosuppression</i> , nausea and vomiting, <i>hemorrhagic cystitis</i> , lethargy, confusion	+	Testicular carcinoma, sarcoma, ovarian carcinoma
	Mechlorethamine	Mustargen	<i>Myelosuppression</i> , <i>nausea and vomiting</i> , tissue necrosis, alopecia, neurotoxicity	0	Hodgkin's disease, lymphoma, mycosis fungoides
	Bendamustine	Treanda	<i>Myelosuppression</i> , <i>nausea and vomiting</i> , <i>hypersensitivity reactions</i> , fever	0	Chronic lymphocytic leukemia
	Melphalan	Alkeran	<i>Myelosuppression</i> , <i>GI enterotoxicity</i> , pulmonary fibrosis, dermatotoxicity, teratogenicity, SIADH	0	Multiple myeloma, ovarian carcinoma
Alkyl sulfonate	Busulfan	Myleran	<i>Myelosuppression</i> , <i>nausea and vomiting</i> , <i>pulmonary fibrosis</i> , dermatotoxicity, cataract formation, gynecomastia	0	Chronic myelocytic leukemia, polycythemia vera
Ethylenimine derivative	Thiotepa	Thioplex	<i>Myelosuppression</i> , infertility, dermatotoxicity, nausea and vomiting	0	Carcinoma of breast, ovary, and bladder; rhabdomyosarcoma
Triazene derivative	Dacarbazine	DTIC	<i>Nausea and vomiting</i> , fever, <i>myelosuppression</i> , alopecia, hepatotoxicity, dermatotoxicity	0	Melanoma, Hodgkin's disease, sarcoma
Tetrazine derivative	Temozolomide	Temodar	<i>Myelosuppression</i> , <i>GI enterotoxicity</i>	+	Brain tumor, melanoma
Nitrosoureas	Carmustine	BiCNU	<i>Myelosuppression</i> , <i>GI enterotoxicity</i> , hepatotoxicity, nephrotoxicity, pulmonary fibrosis	0	Hodgkin's disease, brain tumor, lymphoma, melanoma, multiple myeloma
	Lomustine	CeeNu	<i>Myelosuppression</i> , <i>GI enterotoxicity</i> , hepatotoxicity, nephrotoxicity, pulmonary fibrosis	0	Hodgkin's disease, lung and brain tumors, multiple myeloma, melanoma
	Streptozocin	Zanosar	<i>Nausea and vomiting</i> , <i>nephrotoxicity</i> , hypoglycemia, hepatotoxicity, fever, <i>myelosuppression</i>	0	Islet cell carcinoma of the pancreas

*Myelosuppression includes a suppression of blood cell-forming elements resulting in leukopenia, thrombocytopenia, and anemia. *GI enterotoxicity* includes nausea, vomiting, diarrhea, and mucosal damage. Dermatotoxicity includes cutaneous toxicities such as pigmentation, rashes, erythema, and exfoliation. Neurotoxicity includes peripheral neuropathy, pain, paresthesias, altered sensorium, decrease in sensory and motor activity, and paralytic ileus. Hepatotoxicity includes liver dysfunction such as drug-induced hepatitis, transient elevation of transaminases, bile stasis, cholangitis, and veno-occlusive disease. Cardiotoxicity includes myocardial damage, congestive heart failure, and arrhythmias. Nephrotoxicity may manifest as renal insufficiency or acute renal tubular necrosis.

[†]Stomatitis: 0, rare; +, occasional; ++, frequent or common.

[‡]*Italic type* indicates a frequent or dose-limiting toxicity.

CNS, Central nervous system; *GI*, gastrointestinal; *SIADH*, syndrome of inappropriate antidiuretic hormone secretion.

TABLE 42-1

Classification of Available Antineoplastic and Associated Drugs—cont'd

CLASS OR TYPE OF AGENT	NONPROPRIETARY (GENERIC) NAME	PROPRIETARY (TRADE) NAME	ADVERSE EFFECTS*	STOMATITIS†	CLINICAL APPLICATIONS	
Antimetabolites						
Folic acid analogue	Methotrexate	Trexall	<i>Myelosuppression, mucositis, nausea and vomiting, pulmonary fibrosis, nephrotoxicity, neurotoxicity</i>	++	Choriocarcinoma; carcinomas of head, neck, breast, and lung; lymphocytic leukemia; sarcoma; trophoblastic tumor; testicular and bladder tumors; psoriasis	
	Pemetrexed disodium	Alimta	<i>Myelosuppression, rash, nausea and vomiting, neuropathy and myalgias, stomatitis, pharyngitis</i>	++	Malignant pleural mesothelioma, non—small cell lung cancer	
Purine analogues	Mercaptopurine	Purinethol	<i>Myelosuppression, nausea and vomiting, hepatotoxicity, immunosuppression</i>	++	Acute leukemia, chronic myelogenous leukemia	
	Thioguanine	Tabloid	<i>Myelosuppression, hepatotoxicity, nausea and vomiting</i>	++	Acute leukemia, chronic myelogenous leukemia	
	Fludarabine	Fludara	<i>Myelosuppression, nausea and vomiting, alopecia</i>	++	Chronic lymphocytic leukemia	
	Clofarabine	Clolar	<i>Myelosuppression, nausea and vomiting, hepatotoxicity, systemic inflammatory response syndrome, cardiotoxicity</i>	0	Acute lymphocytic leukemia	
	Nelarabine	Arranon	<i>Myelosuppression, nausea and vomiting, cough, dyspnea, neurologic toxicities, progressive multifocal leukoencephalopathy</i>	0	T-cell acute and lymphoblastic leukemia and lymphoma	
	Pentostatin (2'-deoxycorformycin)	Nipent	<i>Nephrotoxicity, CNS depression, nausea and vomiting</i>	0	Hairy cell leukemia	
	Cladribine (2-CDA, 2-chloro-deoxyadenosine)	Leustatin	<i>Myelosuppression</i>	0	Hairy cell leukemia	
	Pyrimidine analogues	Cytarabine	Cytosar-U	<i>Myelosuppression, nausea and vomiting, hepatotoxicity, dermatotoxicity, CNS, conjunctivitis</i>	++	Acute leukemia, lymphoma, chronic myelogenous leukemia
		Capecitabine	Xeloda	<i>GI enterotoxicity, myelosuppression, dermatotoxicity, neurotoxicity, hepatotoxicity</i>	++	Colorectal cancer, metastatic breast cancer
		Fluorouracil	Adrucil	<i>GI enterotoxicity, myelosuppression, dermatotoxicity, neurotoxicity</i>	++	GI adenocarcinoma; carcinoma of lung, breast, ovary, prostate, cervix, bladder, head and neck
Floxuridine		FUDR	<i>GI enterotoxicity, myelosuppression, dermatotoxicity, hepatotoxicity, neurotoxicity</i>	++	Hepatic metastases from GI adenocarcinomas, carcinomas of head and neck	
	Gemcitabine	Gemzar	<i>Myelosuppression, fever and flulike symptoms</i>	0	Adenocarcinoma of the pancreas	

*Myelosuppression includes a suppression of blood cell—forming elements resulting in leukopenia, thrombocytopenia, and anemia. GI enterotoxicity includes nausea, vomiting, diarrhea, and mucosal damage. Dermatotoxicity includes cutaneous toxicities such as pigmentation, rashes, erythema, and exfoliation. Neurotoxicity includes peripheral neuropathy, pain, paresthesias, altered sensorium, decrease in sensory and motor activity, and paralytic ileus. Hepatotoxicity includes liver dysfunction such as drug-induced hepatitis, transient elevation of transaminases, bile stasis, cholangitis, and veno-occlusive disease. Cardiotoxicity includes myocardial damage, congestive heart failure, and arrhythmias. Nephrotoxicity may manifest as renal insufficiency or acute renal tubular necrosis.

†Stomatitis: 0, rare; +, occasional; ++, frequent or common.

[‡]*Italic type* indicates a frequent or dose-limiting toxicity.

CNS, Central nervous system; GI, gastrointestinal; SIADH, syndrome of inappropriate antidiuretic hormone secretion.

Continued

TABLE 42-1

Classification of Available Antineoplastic and Associated Drugs—cont'd

CLASS OR TYPE OF AGENT	NONPROPRIETARY (GENERIC) NAME	PROPRIETARY (TRADE) NAME	ADVERSE EFFECTS*	STOMATITIS [†]	CLINICAL APPLICATIONS
Vinca Alkaloids					
	Vincristine	Oncovin	<i>Neurotoxicity</i> , SIADH, dermatotoxicity, GI enterotoxicity, alopecia	+	Hodgkin's disease; lymphocytic leukemia; chronic myelogenous leukemia; Wilms' tumor; sarcoma; multiple myeloma; cancer of breast, cervix, lung, and ovary
	Vinblastine	Velban	<i>Myelosuppression</i> , GI enterotoxicity, neurotoxicity, SIADH	+	Hodgkin's disease; lymphoma; cancer of breast, bladder, and testis; Kaposi's sarcoma
	Vinorelbine	Navelbine	<i>Myelosuppression</i> , GI enterotoxicity, neurotoxicity	+	Non—small cell lung carcinoma, breast carcinoma
Antibiotics					
	Bleomycin	Blenoxane	<i>Pulmonary toxicity</i> , GI enterotoxicity, skin reactions, anaphylaxis, fever	+	Testicular cancer, Hodgkin's disease, lymphoma, sarcoma, squamous cell carcinoma of head and neck, GI tumors
	Dactinomycin (actinomycin D)	Cosmegen	<i>Myelosuppression</i> , GI enterotoxicity, dermatotoxicity, tissue necrosis	+	Wilms' tumor, rhabdomyosarcoma, Ewing's sarcoma, neuroblastoma, testicular carcinoma, osteosarcoma, choriocarcinoma
	Daunorubicin, liposomal daunorubicin	Cerubidine, DaunoXome	<i>Myelosuppression</i> , <i>cardiotoxicity</i> , GI enterotoxicity, alopecia, <i>tissue necrosis</i> , radiation recall reaction	+	Acute leukemia
	Doxorubicin, liposomal doxorubicin	Adriamycin, Doxil	<i>Myelosuppression</i> , <i>cardiotoxicity</i> , GI enterotoxicity, alopecia, <i>tissue necrosis</i> , radiation recall reaction	++	Acute leukemia; sarcoma; Hodgkin's disease; neuroblastoma; bladder cancer; carcinoma of lung, GI tract, endometrium, ovary, thyroid, and breast; Wilms' tumor; multiple myeloma
	Epirubicin	Ellence	<i>Myelosuppression</i> , <i>cardiotoxicity</i> , GI enterotoxicity, dermatotoxicity	++	Breast cancer
	Idarubicin	Idamycin	<i>Myelosuppression</i> , alopecia, <i>cardiotoxicity</i> , nausea and vomiting	+	Acute leukemia
	Mitomycin	Mutamycin	<i>Myelosuppression</i> , pulmonary toxicity, alopecia, <i>tissue necrosis</i> , GI enterotoxicity	+	Carcinoma of head, neck, lung, GI tract, breast, cervix, and bladder
	Mitoxantrone	Novantrone	<i>Myelosuppression</i> , hepatotoxicity, GI enterotoxicity, <i>cardiotoxicity</i>	+	Acute leukemia, chronic myelogenous leukemia, lymphoma, breast and ovarian cancer

*Myelosuppression includes a suppression of blood cell-forming elements resulting in leukopenia, thrombocytopenia, and anemia. GI enterotoxicity includes nausea, vomiting, diarrhea, and mucosal damage. Dermatotoxicity includes cutaneous toxicities such as pigmentation, rashes, erythema, and exfoliation. Neurotoxicity includes peripheral neuropathy, pain, paresthesias, altered sensorium, decrease in sensory and motor activity, and paralytic ileus. Hepatotoxicity includes liver dysfunction such as drug-induced hepatitis, transient elevation of transaminases, bile stasis, cholangitis, and veno-occlusive disease. Cardiotoxicity includes myocardial damage, congestive heart failure, and arrhythmias. Nephrotoxicity may manifest as renal insufficiency or acute renal tubular necrosis.

[†]Stomatitis: 0, rare; +, occasional; ++, frequent or common.

[‡]*Italic type* indicates a frequent or dose-limiting toxicity.

CNS, Central nervous system; GI, gastrointestinal; SIADH, syndrome of inappropriate antidiuretic hormone secretion.

TABLE 42-1

Classification of Available Antineoplastic and Associated Drugs—cont'd

CLASS OR TYPE OF AGENT	NONPROPRIETARY (GENERIC) NAME	PROPRIETARY (TRADE) NAME	ADVERSE EFFECTS*	STOMATITIS†	CLINICAL APPLICATIONS
Hormone Agonists and Antagonists					
Adrenal corticosteroids	Prednisone, prednisolone	Deltasone, Delta-Cortef	Peptic ulcer, hypokalemia, hyperglycemia, psychosis, osteoporosis, infections, fluid retention	0	Hodgkin's disease, lymphocytic leukemia, multiple myeloma, breast cancer, hypercalcemia
Androgens	Fluoxymesterone, testosterone	Halotestin, Teslac	Masculinization, edema, alopecia, acne, hypercalcemia	0	Metastatic breast cancer
Estrogens	Chlorotrianisene, diethylstilbestrol, ethinyl estradiol	TACE, Stilphostrol, Estinyl	Gynecomastia, breast tenderness, edema, thrombosis, depression	0	Postmenopausal carcinoma of breast, carcinoma of prostate
Progestins	Hydroxyprogesterone, medroxyprogesterone, megestrol	Delalutin, Depo-Provera, Megace	Edema, alopecia, hirsutism, genitourinary toxicity, neurotoxicity	0	Metastatic endometrial carcinoma, renal and breast carcinoma
Adrenal suppressant	Aminoglutethimide	Cytadren	Hypotension, fever, myelosuppression, neurotoxicity, masculinization	0	Carcinoma of adrenal cortex and breast, Cushing's syndrome
Aromatase inhibitors	Anastrozole, exemestane, letrozole	Arimidex, Aromasin, Femara	Nausea, vomiting, hot flashes, GI enterotoxicity, hepatotoxicity, hypertension	0	Advanced carcinoma of breast
Gonadotropin-releasing hormone analogues (agonist-antagonists)	Goserelin, leuprolide	Zoladex, Lupron	Hot flashes, tumor flares, impotence, amenorrhea, vaginal bleeding	0	Carcinoma of prostate and breast
Antiestrogen	Tamoxifen, toremifene	Nolvadex, Fareston	GI enterotoxicity, hot flashes, tumor flare, vaginal discharge, ocular toxicity	0	Postmenopausal carcinoma of breast, metastatic melanoma
	Raloxifene	Evista	Hot flashes, GI enterotoxicity	0	Breast cancer, osteoporosis
Antiandrogen	Bicalutamide	Casodex	Gynecomastia, nausea, hot flashes	0	Carcinoma of prostate
	Flutamide, nilutamide	Eulexin, Nilandron	Gynecomastia, nausea	0	Carcinoma of prostate
Miscellaneous Classes					
Enzymes	L-asparaginase, PEG-L-asparaginase	Elspar, Oncaspar	Acute hypersensitivity, reaction, fever, hepatotoxicity, coagulation defects, GI enterotoxicity	0	Acute lymphocytic leukemia
Platinum complexes	Cisplatin	Platinol	<i>Nephrotoxicity</i> , ototoxicity, <i>nausea and vomiting</i> , GI enterotoxicity, neurotoxicity, acute allergic reactions	0	Carcinoma of testis, prostate, cervix, ovary, endometrium, lung, bladder, head and neck; sarcoma; neuroblastoma
	Carboplatin	Paraplatin	<i>Myelosuppression</i> , GI enterotoxicity, neurotoxicity	0	Testicular and ovarian carcinoma, head and neck cancers, lung cancer
	Oxaliplatin	Eloxatin	<i>Pharyngolaryngeal dysesthesia, paresthesias</i> , peripheral neuropathy, diarrhea, myelosuppression	0	Colorectal cancer

*Myelosuppression includes a suppression of blood cell-forming elements resulting in leukopenia, thrombocytopenia, and anemia. GI enterotoxicity includes nausea, vomiting, diarrhea, and mucosal damage. Dermatotoxicity includes cutaneous toxicities such as pigmentation, rashes, erythema, and exfoliation. Neurotoxicity includes peripheral neuropathy, pain, paresthesias, altered sensorium, decrease in sensory and motor activity, and paralytic ileus. Hepatotoxicity includes liver dysfunction such as drug-induced hepatitis, transient elevation of transaminases, bile stasis, cholangitis, and veno-occlusive disease. Cardiotoxicity includes myocardial damage, congestive heart failure, and arrhythmias. Nephrotoxicity may manifest as renal insufficiency or acute renal tubular necrosis.

†Stomatitis: 0, rare; +, occasional; ++, frequent or common.

‡*Italic type* indicates a frequent or dose-limiting toxicity.

CNS, Central nervous system; GI, gastrointestinal; SIADH, syndrome of inappropriate antidiuretic hormone secretion.

Continued

TABLE 42-1

Classification of Available Antineoplastic and Associated Drugs—cont'd

CLASS OR TYPE OF AGENT	NONPROPRIETARY (GENERIC) NAME	PROPRIETARY (TRADE) NAME	ADVERSE EFFECTS*	STOMATITIS†	CLINICAL APPLICATIONS
Other Drugs					
	Altretamine	Hexalen	<i>GI enterotoxicity, neurotoxicity, myelosuppression</i>	0	Ovarian cancer
	Arsenic trioxide	Trisenox	<i>GI enterotoxicity, dermatotoxicity, cardiotoxicity, leukocytosis, retinoic acid syndrome</i>	0	Acute promyelocytic leukemia
	Bexarotene	Targretin	Rash, headaches, hypothyroidism, photosensitivity, hypertriglyceridemia, hypercholesterolemia	0	Cutaneous T-cell lymphoma
	BCG, intravesical	TheraCys	Cystitis, flulike symptoms, infections	0	Superficial bladder cancer
	Hydroxyurea	Hydrea	Myelosuppression, alopecia, GI enterotoxicity, rare neurologic disturbances	+	Chronic myelogenous leukemia, sickle cell anemia, polycythemia vera
	Mitotane	Lysodren	GI enterotoxicity, neurotoxicity, hematuria, cystitis, dermatotoxicity, adrenal insufficiency	0	Carcinoma of adrenal cortex
	Porfimer	Photofrin	Photosensitivity, GI enterotoxicity, cardiotoxicity, anemia, fever	0	Endobronchial cancer, esophageal cancer
	Procarbazine	Matulane	GI enterotoxicity, myelosuppression, CNS depression, dermatotoxicity, disulfiram reactions	+	Hodgkin's disease, lymphoma, multiple myeloma
	Thalidomide	Thalomid	<i>Neurotoxicity, dermatotoxicity, fever, GI enterotoxicity, tooth pain, dry mouth, tongue discoloration, taste changes</i>	0/+	Melanoma, multiple myeloma, renal cell carcinoma, erythema nodosum leprosum
	Lenalidomide	Revlimid	<i>Neuropathy, somnolence, constipation, myelosuppression</i>	0	Multiple myeloma, myelodysplastic syndrome
	Tretinoin	Vesanoid	<i>Headache, xerosis, cheilitis, teratogenicity, arthralgia, myalgia, leukocytosis, retinoic acid syndrome</i>	0	Acute promyelocytic leukemia
Natural Products					
	Paclitaxel	Taxol	<i>Myelosuppression, alopecia, hypersensitivity reaction, neuropathy, bradycardia</i>	0	Metastatic carcinoma of ovary and breast
	Docetaxel	Taxotere	<i>Myelosuppression, hypersensitivity reaction, neurologic toxicity, fluid retention</i>	0	Advanced breast carcinoma
	Ixabepilone	Ixempra	<i>Myelosuppression, peripheral neuropathy, mucositis, and diarrhea</i>	+	Breast cancer
	Etoposide	VePesid	<i>Myelosuppression, nausea and vomiting, hypersensitivity reaction</i>	0	Carcinoma of testis and lung, Hodgkin's disease, lymphoma, lung cancer, sarcoma

*Myelosuppression includes a suppression of blood cell-forming elements resulting in leukopenia, thrombocytopenia, and anemia. GI enterotoxicity includes nausea, vomiting, diarrhea, and mucosal damage. Dermatotoxicity includes cutaneous toxicities such as pigmentation, rashes, erythema, and exfoliation. Neurotoxicity includes peripheral neuropathy, pain, paresthesias, altered sensorium, decrease in sensory and motor activity, and paralytic ileus. Hepatotoxicity includes liver dysfunction such as drug-induced hepatitis, transient elevation of transaminases, bile stasis, cholangitis, and veno-occlusive disease. Cardiotoxicity includes myocardial damage, congestive heart failure, and arrhythmias. Nephrotoxicity may manifest as renal insufficiency or acute renal tubular necrosis.

†Stomatitis: 0, rare; +, occasional; ++, frequent or common.

[‡]*Italic type* indicates a frequent or dose-limiting toxicity.

CNS, Central nervous system; GI, gastrointestinal; SIADH, syndrome of inappropriate antidiuretic hormone secretion.

TABLE 42-1

Classification of Available Antineoplastic and Associated Drugs—cont'd

CLASS OR TYPE OF AGENT	NONPROPRIETARY (GENERIC) NAME	PROPRIETARY (TRADE) NAME	ADVERSE EFFECTS*	STOMATITIS†	CLINICAL APPLICATIONS
	Teniposide	Vumon	<i>Myelosuppression</i> , alopecia, neuropathy, nausea and vomiting	0	Acute lymphocytic leukemia, lymphoma, carcinoma of lung and breast
	Irinotecan	Camptosar	<i>Diarrhea</i> , <i>myelosuppression</i> , nausea and vomiting	0	Metastatic carcinoma of colon or rectum
	Topotecan	Hycamtin	<i>Myelosuppression</i> , nausea and vomiting, flulike symptoms	0	Metastatic carcinoma of ovary
DNA Demethylation Agents					
	Azacitidine	Vidaza	<i>Myelosuppression</i> , nausea and vomiting, diarrhea, and mucositis	+	Myelodysplastic syndrome
	Decitabine	Dacogen	<i>Myelosuppression</i> , nausea and vomiting, rash, headache, edema, hyperglycemia, hypokalemia, hypomagnesemia	0	Myelodysplastic syndrome
Biologic Response Modifiers					
	Interferon alfa-2a, interferon alfa-2b, interferon alfa-n3	Roferon-A, Intron-A, Alferon-N	<i>Fever</i> , myalgia, GI enterotoxicity, neurotoxicity, <i>myelosuppression</i>	0	Hairy cell leukemia, chronic myelogenous leukemia, Kaposi's sarcoma, chronic hepatitis
	Aldesleukin (IL-2)	Proleukin	<i>Fever</i> , fluid retention, hypotension, respiratory distress, <i>capillary leak syndrome</i> , nephrotoxicity, rashes	0	Metastatic renal cell carcinoma
	Levamisole	Ergamisol	Flulike symptoms, nausea and vomiting	0	In combination with fluorouracil for colorectal cancer
Protectants					
	Amifostine	Ethylol	<i>Hypotension</i> , nausea and vomiting	0	Administered before cisplatin to reduce incidence of nephrotoxicity, before radiation therapy for head and neck cancer to reduce xerostomia
	Dexrazoxane	Zinecard	Abnormalities in liver and renal function test results, additive <i>myelosuppression</i>	0	In combination with doxorubicin therapy in breast carcinoma to reduce incidence of cardiomyopathy
	Filgrastim, sargramostim	Neupogen, Leukine	<i>Fever</i> , myalgia, bone pain, pericardial effusions	0	Prevent chemotherapy-induced neutropenia, increase neutrophil counts and prevent infections
	Leucovorin	Wellcovorin	Hypocalcemia	0	Methotrexate rescue, used with fluorouracil to increase activity of chemotherapy agent

*Myelosuppression includes a suppression of blood cell-forming elements resulting in leukopenia, thrombocytopenia, and anemia. GI enterotoxicity includes nausea, vomiting, diarrhea, and mucosal damage. Dermatotoxicity includes cutaneous toxicities such as pigmentation, rashes, erythema, and exfoliation. Neurotoxicity includes peripheral neuropathy, pain, paresthesias, altered sensorium, decrease in sensory and motor activity, and paralytic ileus. Hepatotoxicity includes liver dysfunction such as drug-induced hepatitis, transient elevation of transaminases, bile stasis, cholangitis, and veno-occlusive disease. Cardiotoxicity includes myocardial damage, congestive heart failure, and arrhythmias. Nephrotoxicity may manifest as renal insufficiency or acute renal tubular necrosis.

†Stomatitis: 0, rare; +, occasional; ++, frequent or common.

‡*Italic type* indicates a frequent or dose-limiting toxicity.

CNS, Central nervous system; GI, gastrointestinal; SIADH, syndrome of inappropriate antidiuretic hormone secretion.

Continued

TABLE 42-1

Classification of Available Antineoplastic and Associated Drugs—cont'd

CLASS OR TYPE OF AGENT	NONPROPRIETARY (GENERIC) NAME	PROPRIETARY (TRADE) NAME	ADVERSE EFFECTS*	STOMATITIS [†]	CLINICAL APPLICATIONS
	Oprelvekin	Neumega	Edema, dizziness, dyspnea, fatigue, arthralgia, myalgia, palpitations	0	Prevention of chemotherapy-induced thrombocytopenia
	Palifermin	Kepivance	Skin rash, tongue thickening	0	Prevent and reduce mucositis after high-dose chemotherapy
	Mesna	Mesnex	Nausea and vomiting	0	In combination with ifosfamide or cyclophosphamide to prevent hemorrhagic cystitis

*Myelosuppression includes a suppression of blood cell-forming elements resulting in leukopenia, thrombocytopenia, and anemia. GI enterotoxicity includes nausea, vomiting, diarrhea, and mucosal damage. Dermatotoxicity includes cutaneous toxicities such as pigmentation, rashes, erythema, and exfoliation. Neurotoxicity includes peripheral neuropathy, pain, paresthesias, altered sensorium, decrease in sensory and motor activity, and paralytic ileus. Hepatotoxicity includes liver dysfunction such as drug-induced hepatitis, transient elevation of transaminases, bile stasis, cholangitis, and veno-occlusive disease. Cardiotoxicity includes myocardial damage, congestive heart failure, and arrhythmias. Nephrotoxicity may manifest as renal insufficiency or acute renal tubular necrosis.

[†]Stomatitis: 0, rare; +, occasional; ++, frequent or common.

[‡]*Italic type* indicates a frequent or dose-limiting toxicity.

CNS, Central nervous system; GI, gastrointestinal; SIADH, syndrome of inappropriate antidiuretic hormone secretion.

Alkylating agents are not cell cycle specific, although they are most destructive to rapidly proliferating tissues and seem to cause cellular death only when the cell attempts to divide. Because they produce irreversible changes in the DNA molecule, alkylating agents are mutagenic, teratogenic, and carcinogenic in addition to being oncolytic. Alkylating agents are also radiomimetic because they produce morphologic damage in cells similar to the damage caused by radiation injury. Because most of these agents are myelosuppressive, immunosuppression and susceptibility to infection are common outcomes. They vary greatly in lipid solubility, membrane transport, and pharmacokinetic properties and differ in clinical use. The molecular structures of representative alkylating agents are shown in Figure 42-3; adverse effects and clinical applications are summarized in Table 42-1.

Nitrogen mustards

Mechlorethamine. Mechlorethamine was the first nitrogen mustard introduced in clinical practice and the progenitor of antineoplastic alkylating agents. It is still used systemically in the treatment of Hodgkin's disease; in combination with vincristine, procarbazine, and prednisone; and topically to treat mycosis fungoides. The drug is a vesicant that produces severe local tissue necrosis unless administered through a running intravenous infusion. This irritant effect is used to control intractable pleural effusions caused by intrapleural malignancies. In such instances, the drug is administered by intracavitary injection. Usually given intravenously, this drug is highly reactive and has a short stability and biologic half-life. The acute side effects of nitrogen mustard are nausea and vomiting, and these usually begin within 30 minutes after injection and persist for 8 hours.

Bendamustine hydrochloride. Bendamustine hydrochloride (Treanda) is an intravenously administered bifunctional mechlorethamine derivative with alkylator and purine antimetabolite activity. This bifunctional agent may have an advantage to overcome cross-resistance with other alkylating agents. Bendamustine has been studied in combination with

rituximab in the management of patients with indolent or mantle cell lymphoma and has shown significant activity.⁵⁹ It has been approved more recently for the treatment of chronic lymphocytic leukemia and continues to be studied in many other tumor types, including breast cancer and sarcomas. The most common adverse effects (occurring 15% to 20% of the time) include neutropenia, thrombocytopenia, anemia, pyrexia, nausea, and vomiting.

Chlorambucil. Chlorambucil is given orally for chronic lymphocytic leukemia, indolent non-Hodgkin's lymphoma, carcinoma of the ovary and breast, and multiple myeloma. The drug is well absorbed and rapidly metabolized, but its route of excretion is uncertain. Chlorambucil is generally well tolerated with minimal gastrointestinal toxicity in the usual doses.

Cyclophosphamide. Cyclophosphamide is a cyclic mustard that resulted from attempts to produce an alkylating agent with greater selectivity for neoplastic tissues than the original nitrogen mustard mechlorethamine. Cyclophosphamide is a broad-spectrum agent and is valuable in induction, maintenance, and remission therapy for non-Hodgkin's lymphoma, leukemia, and prostate, lung, breast, and ovarian cancers. It is also used in high doses as part of the conditioning regimen for bone marrow transplants. Cyclophosphamide also has excellent immunosuppressive properties and is useful in severe rheumatoid arthritis, allograft rejection, and other immune disorders. The drug may be administered orally or intravenously and is metabolized to the active compounds phosphoramide mustard and acrolein by the liver. Acrolein is toxic to the bladder, producing hemorrhagic cystitis and dysuria that can be minimized by vigorous hydration and frequent bladder emptying. Cyclophosphamide is a powerful myelosuppressant manifested primarily as leukopenia.

Ifosfamide. Ifosfamide is a nitrogen mustard differing from cyclophosphamide only in the location of a chloroethyl moiety. This intravenous drug is also a prodrug that must be metabolized by the liver cytochrome P450 (CYP) system to the active

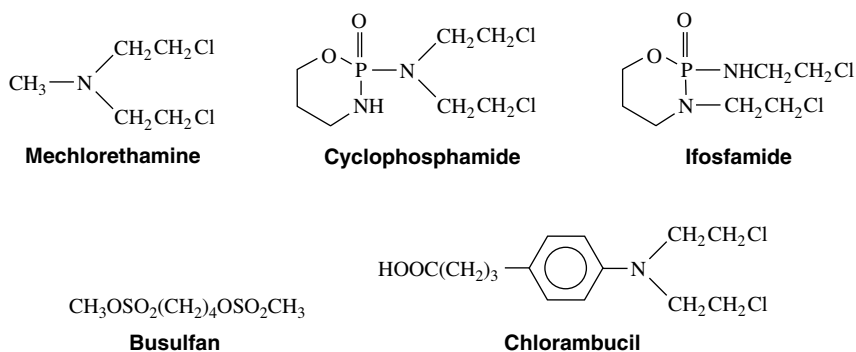

FIGURE 42-3 Structural formulas of representative alkylating agents.

alkylating agent ifosfamide mustard and other toxic metabolites (acrolein and chloroacetic acid). Ifosfamide has a broad spectrum of antineoplastic activity. Although ifosfamide has significant toxic effects, the dose-limiting toxicity of this newest alkylator is hemorrhagic cystitis. The high incidence of this toxicity requires uroprotection with adequate hydration, frequent bladder emptying, and the concurrent use of mesna, a uroprotective agent. Mesna contains a free sulfhydryl group that reacts with and inactivates the toxic metabolites.

Melphalan. Melphalan is a phenylalanine mustard that is available orally for treatment of multiple myeloma and carcinomas of the ovaries and breast. Melphalan is erratically absorbed from the gastrointestinal tract, and intravenous melphalan is available for use in high doses for bone marrow transplant conditioning regimens.

Alkyl sulfonates

Busulfan. Busulfan historically was used almost exclusively in the control of chronic myelogenous leukemia. Today, it is used mostly in high-dose conditioning regimens for bone marrow transplants. A slow-acting sulfur mustard that is well absorbed after oral administration, busulfan is rapidly cleared from the blood and excreted in the urine as inactive metabolites. It has bone marrow-suppressive effects similar to other antineoplastic alkylating drugs; however, with busulfan, the myelosuppression can be quite prolonged.

Ethylenimines

Thiotepa. Thiotepa (triethylenethiophosphoramidate) is an alkylating agent that has produced favorable results in breast and ovarian cancers, lymphoma, and rhabdomyosarcoma. It is clinically used in standard doses for the treatment of superficial bladder cancer, where it is directly instilled into the bladder lumen. This agent has also been used to control malignant effusions, and high doses are used in the treatment of refractory cancer and in bone marrow transplants. After intravenous infusion, most of the drug is excreted unchanged in the urine.

Triazines

Dacarbazine. Dacarbazine (DTIC) is an artificially synthesized congener of the naturally occurring purine precursor 5-aminoimidazole-4-carboxamide. Originally developed as an antimetabolite, DTIC is N-demethylated in the liver to yield an effective alkylating derivative. After intravenous administration, the drug is extensively metabolized and renally excreted. DTIC has an elimination half-life of approximately 5 hours. The drug is most effective in the management of malignant melanoma, soft tissue sarcomas, and Hodgkin's disease. Nausea and vomiting are the predominant side effects, with an onset in the first few hours that may persist for several days. Fatal hepatic damage has occurred rarely.

Tetrazines

Temozolomide. Temozolomide is the first imidazotetrazinone derivative used in clinical practice. Similar to DTIC, temozolomide is metabolized to monomethyl 5-triazinimidazole carboxamide (MTIC), which is ultimately converted to the cytotoxic methyl diazonium ion. Temozolomide has advantages over DTIC: it can be administered orally, and it does not require hepatic conversion to MTIC because temozolomide is spontaneously converted to the active metabolite at physiologic pH.²⁹ Temozolomide penetrates tissues well and is able to cross the blood-brain barrier, allowing it to be used to treat brain tumors such as astrocytoma⁶⁹ and glioblastoma multiforme, an aggressive primary brain tumor. Temozolomide has also been used to treat malignant melanoma. The major toxic effects associated with this alkylating agent include myelosuppression, nausea, vomiting, headache, and fatigue.

Nitrosoureas

Carmustine and lomustine. Two nitrosoureas, carmustine and lomustine, decompose in the body to yield reactive intermediates that act as classic alkylating agents in causing strand breaks and cross-links in DNA. They also produce isocyanates that inhibit DNA repair and RNA synthesis. Carmustine is administered intravenously, whereas lomustine is given orally. Both are rapidly metabolized and slowly excreted in the urine. Nitrosoureas are characterized by their lipophilicity and their ability to cross the blood-brain barrier. This property is useful in the treatment of brain tumors. Each typically produces a delayed bone marrow depression that becomes apparent in 3 to 6 weeks and lasts for an additional 2 to 3 weeks. Side effects include nausea and vomiting in most patients within 2 to 6 hours after administration.

Streptozocin. Streptozocin is a naturally occurring antibiotic that has a mode of action similar to that of nitrosoureas. In contrast to carmustine and lomustine, however, streptozocin does not readily cross the blood-brain barrier, and it is not strongly myelosuppressive. Streptozocin is unique in its special affinity for the islet cells of the pancreas. The drug is diabetogenic in animals and effective against metastatic insulinomas in humans. Streptozocin should be administered intravenously with care because it is a vesicant. It is one of the most emetogenic agents and requires adequate premedication with antiemetics. Potentially fatal renal toxicity and hepatotoxicity have occurred.⁶⁷

Antimetabolite Agents

Antimetabolites bear a marked structural resemblance to folic acid and to the purine and pyrimidine bases involved in the synthesis of DNA, RNA, and certain coenzymes (Figure 42-4). They differ in molecular arrangement from the corresponding metabolite to a degree sufficient to serve as fraudu-

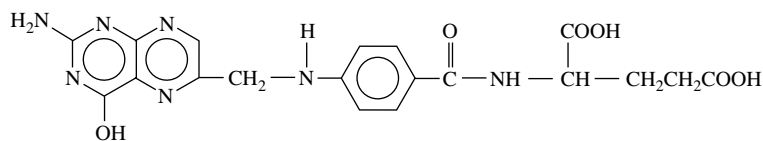

Folic acid

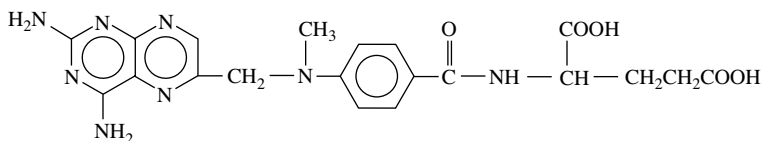

Methotrexate

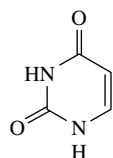

Uracil

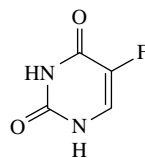

Fluorouracil

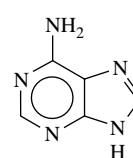

Adenine

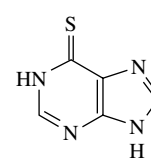

Mercaptopurine

FIGURE 42-4 Structural relationships between several antimetabolites and their respective analogues.

lent substrates for biochemical reactions, either inhibiting synthetic steps or becoming incorporated into molecules and interfering with cellular function or replication. Antimetabolites characteristically exert their major effects during the S (DNA synthesis) phase of the cell cycle. This activity interferes with the growth of rapidly proliferating cells throughout the body—the bone marrow, germinal cells, hair follicles, and lining of the alimentary tract. Oral manifestations are an especially prominent feature of the toxicity of these agents. Three classes of antimetabolites exist: folic acid analogues, purine analogues, and pyrimidine analogues.

Folic acid analogues

Folic acid is an essential vitamin that is converted into metabolically active tetrahydrofolic acid by the enzyme dihydrofolate reductase. Tetrahydrofolic acid participates in the synthesis of purines, thymidylate, and ultimately nucleic acids by transferring one-carbon units to the nucleotide precursors.

Methotrexate

Methotrexate is the 4-amino, 10-methyl analogue of folic acid and a potent inhibitor of dihydrofolate reductase. This inhibition results in the decreased conversion of dihydrofolate to tetrahydrofolate and impaired synthesis of thymidylate and inosinic acid. Deficiencies of these acids retard DNA and RNA synthesis. Protein synthesis is also inhibited because reduced folates are cofactors in the conversion of glycine to serine and homocysteine to methionine.

Methotrexate is readily absorbed from the gastrointestinal tract and is primarily excreted in the urine. There is some enterohepatic recycling of methotrexate, which extends the elimination half-life of the drug and is responsible for most of the marrow and gastrointestinal toxicity. Methotrexate tends to distribute into “third spaces,” such as ascitic, pleural, or peritoneal fluids that can potentially act as a drug reservoir. The presence of these clinical features or renal failure or both contributes to increased toxicity. Depending on the indication, methotrexate may be administered by many different routes with a variable dosing range. Administered orally, the drug is often used to treat rheumatoid arthritis and psoriasis. Intrathecal administration is used to treat central nervous system (CNS) tumors, and intra-arterial administration is

used for regional therapy of head and neck cancers. Given intravenously and intramuscularly, methotrexate is a valuable therapeutic agent in some forms of leukemia, choriocarcinoma, lymphoma, sarcoma, testicular tumors, and carcinoma of the breast and lung. The drug is also used in very high doses for adjuvant and salvage therapies for osteosarcoma and leukemia.

High-dose therapy with methotrexate requires monitoring of serum blood concentrations and the use of folic acid “rescue.” The folic acid (e.g., citrovorum factor, calcium folinate, leucovorin) bypasses the blockade of dihydrofolate reductase in normal cells and may reduce the incidence and severity of mucositis and myelosuppression. Other nontumoricidal applications of methotrexate include its use after allogeneic bone marrow transplants to prevent graft-versus-host disease, to treat systemic lupus erythematosus, and in steroid-dependent asthmatic patients to decrease asthmatic symptoms.

Methotrexate is subject to many important drug interactions. Highly plasma protein-bound drugs such as salicylates, sulfonamides, and phenytoin may displace methotrexate from its protein-binding sites and result in greater toxicity. Organic acids such as salicylate and probenecid inhibit the tubular secretion of methotrexate, resulting in increased concentrations of methotrexate and toxicity. Penicillins can also compete with methotrexate for renal tubular secretion.³² In patients receiving large gram doses of methotrexate, the concurrent use of nonsteroidal anti-inflammatory drugs (NSAIDs) should be avoided because this drug class can also reduce renal blood flow and increase the risk of nephrotoxicity.

Dose-limiting toxic effects of methotrexate include bone marrow depression manifested by leukopenia and thrombocytopenia, which are conducive to secondary infection and hemorrhage; a very painful stomatitis with mucosal and epithelial ulceration; pharyngitis and dysphagia; esophagitis; gastroenterocolitis; and proctitis with associated watery and bloody diarrhea. Large doses can be nephrotoxic, and long-term treatment with methotrexate can lead to changes in hepatic function.

Pemetrexed disodium

Pemetrexed disodium is a new antifolate that can attack multiple enzyme targets, including dihydrofolate reductase, thy-

midylate synthase, and glycinamide ribonucleotide formyl transferase. By inhibiting the formation of precursor purine and pyrimidine nucleotide, pemetrexed prevents the formation of DNA and RNA, which are required for the growth and survival of normal cells and cancer cells. Pemetrexed is approved for treatment of malignant pleural mesothelioma and for use as a second-line agent for treatment of non-small cell lung cancer (NSCLC). Vitamin supplementation with folic acid (1 mg daily) and vitamin B₁₂ (1000 µg intramuscularly every 9 weeks) helps to control the hematologic and nonhematologic toxicities.⁴⁹ Steroid treatment with dexamethasone (4 mg twice a day on the day before, the day of, and the day after pemetrexed therapy) is used to help limit skin rashes. The most common side effects are hematologic, rash, nausea, and vomiting. Occasionally, chest pain, edema, and hypertension may be seen in patients, and neuropathy and myalgias occur in 29% and 13% of patients, respectively. Stomatitis has been reported in about 20% of patients treated with pemetrexed.

Purine analogues

Historically, the most commonly used purine analogues in cancer chemotherapy have been mercaptopurine and thioguanine. Newer agents include fludarabine, pentostatin, cladribine, clofarabine, and nelarabine.

Mercaptopurine and thioguanine. The mechanisms of action of the thiopurines mercaptopurine and thioguanine have not yet been fully established. Presumably, they affect the incorporation of purine derivatives into nucleic acids. The analogues are converted in the body to the ribonucleotide form, which interferes with the conversion of inosinic acid to the nucleotides of adenine and guanine, resulting in the inhibition of DNA and RNA synthesis. They also inhibit de novo biosynthesis of purines from the small molecule precursors (glycine, formate, and phosphate), which ultimately leads to fraudulent DNA.

Orally administered mercaptopurine is readily absorbed but undergoes extensive first-pass metabolism by the liver. After intravenous injection, the plasma half-life is approximately 90 minutes. The drug is metabolized by methylation in the liver and by the hepatic enzyme xanthine oxidase. Concurrent administration with allopurinol, a xanthine oxidase inhibitor originally developed to increase the anticancer effect of mercaptopurine, requires a 50% reduction in the dose of mercaptopurine. Allopurinol is of little clinical value in this setting because it also increases the toxicity of mercaptopurine. The use of allopurinol in the treatment of gout is described in Chapter 21. Currently, mercaptopurine is used mainly for maintenance of remission in acute lymphocytic leukemia. The chief toxic effect is myelosuppression. Pulmonary fibrosis and pancreatitis may also occur. Thioguanine has activity, toxicity, and clinical applications similar to those of mercaptopurine.

Fludarabine. Fludarabine (2-fluoro-ara-AMP) is an analogue of adenosine. This injectable purine antagonist is quickly dephosphorylated in the plasma, enters the cell, and is converted to the triphosphate form. This false nucleotide inhibits ribonucleotide reductase and DNA polymerase, which results in the inhibition of DNA synthesis.³⁷ Fludarabine is indicated for the treatment of B-cell chronic lymphocytic leukemia in patients who have not responded to traditional therapy with an alkylating agent. Fludarabine is primarily excreted by the kidneys and has a long plasma half-life of approximately 10 hours. Transient myelosuppression and immunosuppression, with an increased risk of opportunistic infection, seems to be the major toxicity at current doses. Fludarabine has also been used for treatment of non-Hodgkin's lymphoma, hairy cell

leukemia, and cutaneous T-cell lymphoma and in salvage regimens for the treatment of acute myeloid leukemia.

Pentostatin. Pentostatin is a newer antimetabolite isolated from *Streptomyces antibioticus*. This purine analogue is an inhibitor of adenosine deaminase, which converts adenosine to inosine. This inhibition apparently leads to inhibition of methylation and other reactions. Cytotoxic treatment with pentostatin results in the accumulation of deoxyadenosine 5'-triphosphate. The drug exhibits activity in nonreplicating and dividing cells. Pentostatin is quickly distributed to all body tissues after administration; the plasma half-life is 2.6 to 9.4 hours, with the major portion of the drug recovered in the urine unchanged. Pentostatin has been most active in the treatment of hairy cell leukemia; it also has activity in patients with chronic lymphocytic leukemia. Toxicity is dose-dependent, with acute renal failure and CNS side effects being the most severe.

Cladribine. Cladribine is an adenosine deaminase-resistant purine substrate analogue toxic to lymphocytes and monocytes. It is undergoing clinical trials against hematologic malignancies and is available for the treatment of hairy cell leukemia. The major limiting toxicity is myelosuppression.

Clofarabine and nelarabine

Clofarabine and nelarabine are the newest purine nucleoside antimetabolites approved for the treatment of acute lymphocytic leukemias. Clofarabine is converted intracellularly by deoxycytidine kinase to the 5'-monophosphate metabolite, then via monophosphokinases and diphosphokinases to the active 5'-triphosphate form. The clofarabine 5'-triphosphate inhibits DNA synthesis through its action on ribonucleotide reductase and DNA polymerases. Clofarabine is approved by the U.S. Food and Drug Administration (FDA) for the treatment of pediatric patients with relapsed or refractory acute lymphocytic leukemia after at least two prior treatment regimens.²⁴ It is also being studied for other malignancies, including the treatment of acute myeloid leukemias in adults. The principal toxicities associated with clofarabine are nausea, vomiting, hematologic toxicity, febrile neutropenia, hepatobiliary toxicity, infections, and renal toxicity. Clofarabine can also produce a syndrome manifested by the rapid development of tachypnea, tachycardia, hypotension, shock, and multiorgan failure called *systemic inflammatory response syndrome*, which is similar to a capillary leak syndrome. Cardiac effects include tachycardia and left ventricular systolic dysfunction.

Nelarabine is a prodrug of the deoxyguanosine analogue-9-beta-D-arabinofuranosylguanine (ara-G). Nelarabine is demethylated to ara-G and activated to the active 5'-triphosphate, ara-GTP. The active ara-G is incorporated into the DNA resulting in inhibition of DNA synthesis and cell death. There is a differential accumulation in T cells, and nelarabine is approved for the treatment of patients with T-cell acute lymphoblastic leukemia and lymphoma who have not responded to or have relapsed after treatment with at least two other chemotherapy regimens.⁹ A major adverse effect associated with nelarabine resulting in a "black box" warning involves neurologic events that include severe somnolence, convulsions, peripheral neuropathies, and paralysis. Other adverse effects include fatigue, bone marrow suppression, gastrointestinal side effects, and some pulmonary complaints of cough and dyspnea. Rarely, patients have complained of blurred vision while receiving nelarabine. The combination of nelarabine and adenosine deaminase inhibitors such as pentostatin should be avoided because this combination may result in a decreased conversion of nelarabine to its active substrate, decreasing its efficacy and potentially changing the adverse profile of both drugs.

Pyrimidine analogues

Several pyrimidine congeners have been examined for anti-neoplastic activity. These drugs exert multiple effects on cellular growth and are among the most useful agents for solid tumors and leukemia.

Fluorouracil and floxuridine. The fluorinated pyrimidines fluorouracil and floxuridine are prepared by substituting a stable fluorine atom for hydrogen in position 5 of the uracil and deoxyuridine molecules. These compounds, after intracellular conversion to 5-fluoro-2'-deoxyuridine monophosphate, are potent antimetabolites that bind to and inhibit thymidylate synthetase, inhibiting formation of thymidylate acid and impairing DNA synthesis. Fluorouracil metabolite also produces a critical intermediate, 5-fluorouridine triphosphate, which is incorporated into RNA and interferes with its function. 5-Fluorodeoxyuridine triphosphate (5-FdUTP) may also be incorporated into DNA, producing single-strand breaks contributing to the cytotoxicity.⁵⁴

Fluorouracil is used most often for treatment of gastrointestinal adenocarcinomas, breast cancer, and ovarian cancer. Activity has also been reported in bladder and prostate cancer. The drug is usually given intravenously as a bolus or short infusion or as a prolonged continuous infusion daily, over several days, or for months. Continuous infusion is advantageous because the plasma half-life of the drug is short (10 to 20 minutes), and the drug (similar to other antimetabolites) works primarily in the S phase of the cell cycle. Continuous infusion provides for prolonged exposure of the cells to the drug and the opportunity for cell populations not in the S phase to cycle into that sensitive phase. The toxicity profile of fluorouracil depends on the method of administration. Given as a continuous infusion over a 96-hour period, the dose-limiting toxicity is mucositis, whereas intravenous bolus results in bone marrow suppression. Fluorouracil can be administered topically to treat actinic keratoses and noninvasive skin cancers and, commonly, to improve efficacy of radiation therapy in head and neck cancers by working as a radiosensitizer. Folinic acid (leucovorin) has been combined with fluorouracil to enhance the inhibition of thymidylate synthetase in resistant disease.

Floxuridine, the deoxyribonucleoside of fluorouracil, exerts a more direct inhibition of thymidylate synthetase than fluorouracil. The drug must be given by continuous infusion because it is rapidly catabolized in vivo. Floxuridine administered intra-arterially is indicated for gastrointestinal adenocarcinomas metastatic to the liver and has produced beneficial results in the treatment of head and neck carcinoma, although fluorouracil is now the preferred agent. The adverse effects of fluorinated pyrimidines may be quite severe. Stomatitis, pharyngitis, dysphagia, enteritis, and diarrhea can be life-threatening. Myocardial ischemia caused by coronary artery vasospasm has been described with fluorouracil.

Capecitabine. Capecitabine (5'-deoxy-5-fluoro-N-[(pentuloxycarbonyl)-cytidine]) is a newer oral agent used in the treatment of advanced breast and colorectal cancers. Capecitabine is hydrolyzed in the liver and ultimately converted to the active drug 5-fluorouracil. Its activity profile and pharmacokinetic profile are similar to infusional fluorouracil. Side effects of capecitabine include severe diarrhea, stomatitis, and some mild nausea and vomiting. Severe hand-foot syndrome (palmar/plantar erythrodysesthesia) and other dermatologic changes have been reported.¹⁶

Cytarabine. Cytarabine (cytosine arabinoside) is an analogue of 2'-deoxycytidine that can inhibit DNA synthesis by inhibiting DNA polymerase activity as a result of its incorporation into DNA and the formation of fraudulent DNA. Premature

DNA chain termination results. Cytarabine is primarily a cell cycle S phase-specific agent. When given intravenously, the drug is rapidly cleared from the blood by deamination in the liver, with a plasma half-life of 5 to 20 minutes. With these properties, continuous infusion is often the preferred route of administration. Cytarabine crosses the blood-brain barrier, achieving cerebrospinal fluid concentrations of 40% to 50% of those of plasma. This feature allows for the treatment of CNS disease with systemic high-dose therapy. Cytarabine may be administered intrathecally and produces high concentrations that decline slowly because of the absence of cytidine deaminase in the CNS.¹ Cytarabine is the most active single drug available for the treatment of acute myelogenous leukemia in adults, producing about a 25% incidence of complete remission. It is often used in combination with other agents. It has some modest activity against lymphomas. The major side effect is myelosuppression. High doses produce severe nausea and vomiting, severe diarrhea, cerebellar toxicity, and keratoconjunctivitis.²⁶

Gemcitabine. Gemcitabine (difluorodeoxycytidine) is a newer antimetabolite useful in many experimental tumor models, with clinical responses in NSCLC and breast cancer. It is currently indicated for first-line treatment of patients with locally advanced or metastatic adenocarcinoma of the pancreas.³¹ Recent trials support the use of gemcitabine in combination with cisplatin to treat metastatic NSCLC. Its dose-limiting side effect is myelosuppression characterized by thrombocytopenia. Transient febrile episodes and a flulike syndrome have been commonly reported.

Antibiotics

Numerous substances originally isolated as antibiotics have been found to exert antineoplastic activity because of their cytotoxic properties. These substances, produced naturally by various *Streptomyces* species, operate by binding with DNA to produce irreversible complexes that inhibit cell division. Various other possible mechanisms for cytotoxicity have been proposed for these agents. Antibiotics can work on cells in different phases of the cell cycle, behaving as non-phase-specific agents. Semisynthetic derivatives of some of the antibiotics are being prepared and tested clinically in an effort to reduce toxicity but retain the oncolytic potency of the parent compound.

Dactinomycin

Dactinomycin (actinomycin D) is a crystalline antibiotic composed of a phenoxazone chromophore and two cyclic peptide chains obtained as a product of fermentation by *Streptomyces parvulus*. The drug intercalates into DNA between adjacent guanine-cytosine base pairs and inhibits DNA-directed RNA synthesis. Dactinomycin is rapidly distributed into tissues and has a prolonged terminal half-life. The drug apparently is not metabolized, but is primarily excreted in the bile. Dactinomycin is the main agent for the treatment of pediatric tumors, such as Wilms' tumor, Ewing's sarcoma, and embryonal rhabdomyosarcoma, and is of considerable value in treatment of choriocarcinoma and testicular tumors. Mucositis characterized by oral ulcerations and diarrhea often necessitates limiting the dose. Extravasation from the vein causes severe tissue necrosis.

Daunorubicin

Daunorubicin is a cytotoxic anthracycline antibiotic produced by *Streptomyces peucetius* subsp. *caesius*, which is also the source of doxorubicin and idarubicin (Figure 42-5). The drug combines with DNA in an intercalative mode by slipping into the helical structure between stacked bases. Synthesis of DNA and RNA is inhibited, and preformed DNA is damaged.

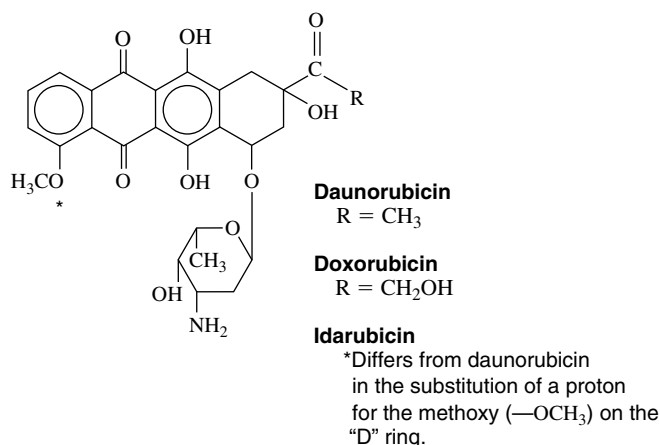

FIGURE 42-5 Structural formulas of anthracycline antibiotics. R = CH₃ for daunorubicin; R = CH₂OH for doxorubicin.

Other possible mechanisms are postulated, including metabolism to form cytotoxic free radicals, a cell membrane surface cytotoxic action, and inhibition of topoisomerase II. The killing effect of daunorubicin is at a maximum in the DNA synthesis S phase of the cell cycle, but damage is not phase specific. Experimental evidence exists for synergy between these antibiotics and drugs such as etoposide.

Daunorubicin is most useful in the treatment of acute myelogenous leukemia and acute lymphocytic leukemia. The drug is extensively tissue bound with a long elimination half-life. The major route of elimination is through biliary excretion, with some urinary excretion. Patients should be warned about red-colored urine a few days after a dose of daunorubicin. Cardiomyopathy manifested by acute congestive heart failure, acute cardiac arrhythmias, radiation recall dermatitis, and local necrosis from extravasation at the injection site are associated with cumulative doses of daunorubicin exceeding total lifetime limits of 450 to 550 mg/m².

Doxorubicin

Doxorubicin differs from daunorubicin by one hydroxy group (see Figure 42-5). This anthracycline glycoside acts by intercalating into DNA and shares other mechanisms of action with daunorubicin. Doxorubicin has a much broader spectrum of antineoplastic activity than daunorubicin.

Doxorubicin is a vesicant that is always given intravenously. It is rapidly cleared from the plasma and concentrated in the tissues. Urinary excretion is low, rarely accounting for more than 10% of the administered dose; in contrast, biliary excretion is high. Plasma concentrations of doxorubicin and its metabolites are markedly elevated, and the rate of elimination is greatly prolonged in the presence of severely impaired liver function.

The major toxic effects begin shortly after drug administration and last 2 to 3 days. Extravasation of the drug produces soft tissue necrosis. Myelosuppression, primarily granulocytopenia, is maximal 10 to 14 days after drug administration. Mucositis manifested mainly as soreness of the mouth with ulcerations occurs in almost all patients. Cardiomyopathy expressed as congestive heart failure becomes a serious risk in patients given a total dose exceeding 550 mg/m². Concurrent administration with dexrazoxane may help reduce the incidence of cardiomyopathy associated with doxorubicin therapy.¹² New liposomal encapsulated forms of doxorubicin and daunorubicin are now available. They allow for increased circulation time and the possibility of enhanced antitumor activity and decreased cardiomyopathy in the treatment of

Kaposi's sarcoma related to acquired immunodeficiency syndrome (AIDS), advanced breast and ovarian cancers, and others.

Epirubicin

Epirubicin is a semisynthetic derivative of doxorubicin that has been extensively evaluated in patients with breast cancer. Epirubicin is also being evaluated for its intravesical use in superficial bladder cancer.⁵¹ The major dose-limiting adverse effects include hematologic and cumulative dose-related cardiotoxicity. Other important side effects include mucositis, nausea and vomiting, alopecia, and local cutaneous reactions.

Idarubicin

Idarubicin is an analogue of daunorubicin lacking the methoxy group on the C4 position of the aglycone (see Figure 42-5). This antibiotic is used for the treatment of acute myelogenous leukemia, breast cancer, and some lymphomas. Oral idarubicin is not currently available. The toxicity of idarubicin seems to be less severe than the toxicity of either daunorubicin or doxorubicin, and it may have a lower risk of cardiotoxicity. Nausea, vomiting, and mucositis seem equivalent to the other anthracyclines.

Mitoxantrone

Mitoxantrone, an anthraquinone antibiotic, is a synthesized drug with antibacterial, antiviral, antiprotozoal, and immunomodulating activities. Its antineoplastic activity results from intercalation to DNA and inhibition of topoisomerase II, producing DNA strand breaks. Mitoxantrone is not phase specific. It is clinically active against breast carcinomas, acute leukemias, and lymphomas. Mitoxantrone has been approved for patients with progressive multiple sclerosis and is recognized for its potential use as first-line therapy in acute myelogenous leukemia.^{39,64} Mitoxantrone exhibits less cumulative cardiotoxicity than anthracyclines. The drug can impart a blue-green color to the urine 24 hours after administration; bluish discoloration of the sclera may also occur.

Bleomycin

Bleomycin is an antibiotic complex of several glycopeptides derived from *Streptomyces verticillus*. The cytotoxic action of bleomycin has been attributed to DNA scission and fragmentation with inhibition of usual DNA repair mechanisms. RNA and protein synthesis seem to be inhibited as well. Bleomycin is rapidly cleared from the blood and concentrated in the liver, lungs, spleen, kidneys, and epithelial tissue. Approximately 80% is excreted in the urine within 24 hours. Bleomycin is cell phase specific, having its major effects on cells in the G₂ and M phases of the cell cycle.²

The main clinical applications of bleomycin are in the treatment of squamous cell carcinoma, testicular tumors, and lymphomas. Bleomycin is also used to treat malignant pleural effusions by direct instillation into the pleural space. The major attractive features of bleomycin include minimal nausea and vomiting, almost no myelosuppression, and lack of local tissue toxicities. This improved toxicity profile accounts for the inclusion of bleomycin into many combination chemotherapy protocols. The major dose-limiting toxicity is pulmonary, manifesting as interstitial pneumonitis that might progress to pulmonary fibrosis and fatal pulmonary insufficiency. This toxicity is associated with a cumulative dose of more than 400 U, age older than 70 years, underlying pulmonary disease, chest irradiation, and high oxygen exposure. Some reports suggest an increase in oxygen-induced pulmonary complications in patients previously treated with bleomycin. For anesthesia and postoperative periods, it is recommended that elevated inspired oxygen concentrations should be administered only when clearly indicated.

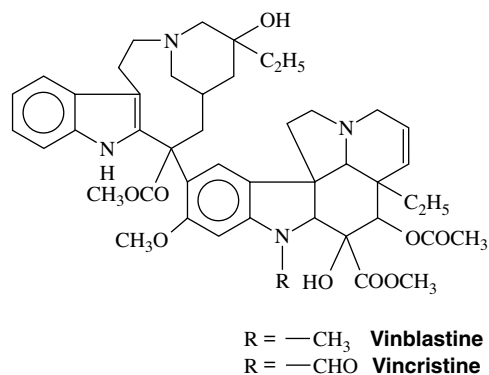

FIGURE 42-6 Structural formulas of vinca alkaloids.

Mitomycin

Mitomycin is derived from *Streptomyces caespitosus*. After intracellular activation, mitomycin inhibits DNA synthesis by reacting with DNA in the manner of the alkylating agents. When combined with fluorouracil or nitrosoureas, mitomycin has been effective against gastrointestinal, head and neck, breast, cervix, and lung carcinomas. Severe toxicity to the bone marrow (neutropenia and thrombocytopenia), reaching a maximum in about 3 to 4 weeks, and to the alimentary tract (nausea, vomiting, oral ulceration, and diarrhea) is the limiting factor in the use of this drug. Pulmonary toxicity and adult hemolytic uremic syndrome are dose-related.

Vinca Alkaloids

Vinblastine and vincristine

Vinblastine and vincristine, the two older alkaloids in clinical use, are derived from asymmetric dimeric compounds extracted from the shrub *Vinca rosea*; they are almost identical in structure (Figure 42-6). Vinblastine contains a methyl group and vincristine contains a formyl group attached to the nitrogen in the dihydroindole portion of the molecule. Vinorelbine, a newer third vinca alkaloid, is a semisynthetic derivative of vinblastine.⁶⁵ The antineoplastic activity of vinca alkaloids has been attributed to their capacity to arrest cell division in metaphase by binding to the microtubular protein tubulin that forms the mitotic spindle.

These drugs are metabolized in the liver and excreted mainly by the biliary and intestinal tracts. Vinblastine and vincristine are of major value in treating Hodgkin's disease and other lymphomas. Vinorelbine is used in the treatment of NSCLC and may have future roles in the treatment of other carcinomas including breast carcinoma.⁶⁸ The most common toxic manifestation of vinblastine is leukopenia. High doses induce gastrointestinal disturbances, including nausea, vomiting, diarrhea, and anorexia. Other side effects of this drug include partial alopecia, headache, paresthesias, mental depression, mild peripheral neuropathy, and phlebitis at the injection site. Vincristine produces dose-related neurotoxicity. Hyponatremia associated with the syndrome of inappropriate antidiuretic hormone secretion has been reported. Tissue damage from extravasated drug requires immediate attention. Myelosuppression and neurotoxicity manifested by decreased deep tendon reflexes seem to be dose-limiting toxic effects of vinorelbine.

Hormone Agonists and Antagonists

The role of hormonal manipulation for cancer therapy was explored in 1896, when ovariectomy was first used in the treatment of breast cancer. Because they share commonality of their steroid ring structure, adrenocorticosteroids, estro-

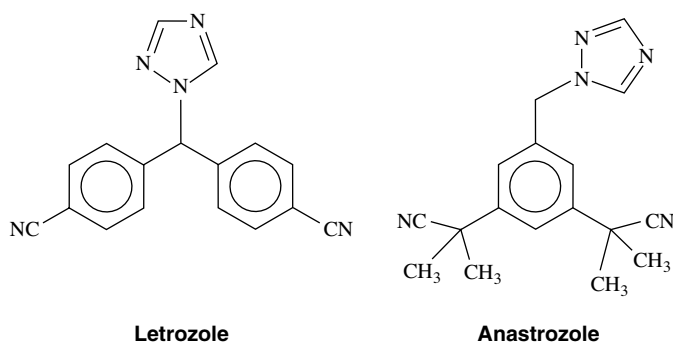

FIGURE 42-7 Structural formulas of representative nonsteroidal aromatase inhibitors.

gens, antiestrogens, androgens, progestational agents, and gonadotropin-releasing factors each have a role in cancer control.

Drugs affecting corticosteroid status

Prednisone, tamoxifen, and toremifene. Prednisone is widely used in combination with other antineoplastic drugs in acute and chronic lymphocytic leukemia, Hodgkin's disease, lymphoma, and multiple myeloma; it is also helpful in reducing hypercalcemia associated with bony metastases. Estrogens are useful in the treatment of advanced prostatic carcinoma and as adjunctive treatment in select patients with postmenopausal breast carcinoma. Although the mode of action is unknown, the therapeutic response in breast cancer is correlated with the presence of estrogen-binding receptor sites in the tumor. The antiestrogen tamoxifen is beneficial in patients whose adenocarcinoma of the breast depends on estrogen for growth, as shown by positive estrogen or progesterone receptor status. Tamoxifen has also been used in endometrial carcinoma and malignant melanoma. The side effects seen with this oral agent include an initial flare-up in disease activity, bone pain, or hypercalcemia; this is associated with efficacy of the medication. Additional side effects include hot flashes, sweating, nausea and vomiting, and increased risk for blood clot formation. Toremifene is a chlorinated derivative of tamoxifen and has shown a similar efficacy and tolerability profile as tamoxifen. Androgens are effective in some cases of metastatic breast cancer. Progestational agents such as megestrol are effective in metastatic endometrial, breast, and renal cell carcinoma. The pharmacologic characteristics of steroid hormones are discussed in detail in Chapters 35 and 37.

Mitotane and aminoglutethimide. Adrenocortical secretion is suppressed by the agents mitotane and aminoglutethimide. Mitotane causes atrophy of the adrenal cortex by inhibiting mitochondrial function. Aminoglutethimide, an inhibitor of several CYP450 enzymes, inhibits the conversion of cholesterol to pregnenolone, reducing the synthesis of corticosteroids and the sex steroids. It also blocks the conversion of androgens to estrogens. These agents are used in patients with adrenal tumors and occasionally in breast cancer patients.⁵

Drugs affecting sex hormone status

Anastrozole and letrozole. Anastrozole and letrozole are nonsteroidal, selective aromatase inhibitors that do not reduce mineralocorticoid or glucocorticoid activity. Their structure and site of action are shown in Figures 42-7 and 42-8. These agents are indicated for use in postmenopausal women with advanced breast cancer that has progressed during therapy with tamoxifen. Randomized clinical trials comparing anastrozole and letrozole with megestrol acetate showed at least similar, if not superior, response rates and duration of response.

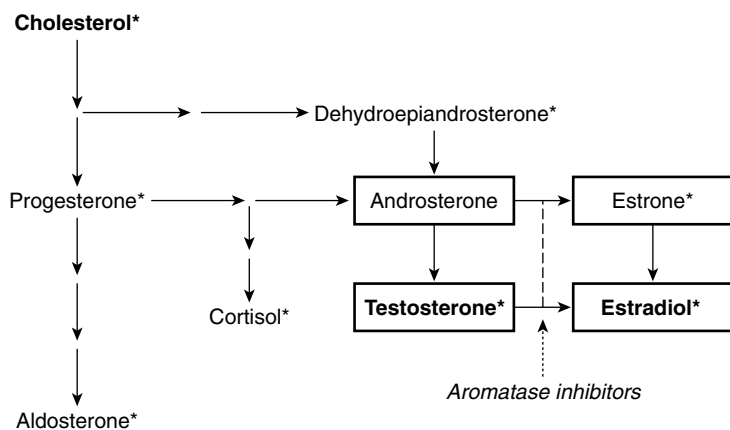

FIGURE 42-8 Aromatase inhibitor site of activity in the steroidogenic pathway. *Biologically active.

Selective aromatase inhibitors are generally well tolerated. Adverse effects include nausea, vomiting, and hot flashes. Letrozole is currently being compared with tamoxifen in studies as a first-line therapy for advanced breast cancer,⁴⁷ and letrozole is useful in preventing recurrence when used as adjuvant therapy for estrogen receptor/progesterone receptor-positive breast cancer after tamoxifen therapy. Exemestane is an orally irreversible steroidal aromatase inhibitor or inactivator. Clinical trials show its effective antitumor activity in postmenopausal breast cancer patients with similar side-effect profiles as the other aromatase inhibitors.⁸

Leuprolide and goserelin. Leuprolide (a nonapeptide) and goserelin (a decapeptide) are synthetic analogues of naturally occurring gonadotropin-releasing hormone (GnRH). They have potent GnRH-agonist properties during short-term or pulsatile therapy, but paradoxically inhibit gonadotropin secretion and suppress ovarian and testicular steroidogenesis during long-term administration. The drugs act principally on the pituitary gland in humans to limit the release of follicle-stimulating hormone and luteinizing hormone. Because of these inhibitory effects, these agents may interfere with the growth of hormone-dependent tumors. The drugs are used clinically for the palliative treatment of advanced carcinoma of the prostate and may be valuable in the control of breast cancer. They are also used to treat endometriosis. Even with continued treatment, acute flare-ups in the diseases are also possible, with pain and hypercalcemia.

Flutamide, bicalutamide, and nilutamide. Flutamide is a nonsteroidal antiandrogen that competes directly for testosterone receptor binding sites in the prostate cells. This agent, used orally for prostate cancer, can help prevent flare-ups when used with a GnRH agonist such as leuprolide. Adverse reactions include gynecomastia and decreased libido. Bicalutamide and nilutamide are nonsteroidal antiandrogen agents similar to flutamide and are used in combination with leuprolide for advanced prostate cancer. Nilutamide has rarely caused interstitial pneumonitis and affects the eyes' ability to adjust to changes from light to dark conditions, such as driving from daylight into a dark tunnel.

Enzymes

Asparaginase

Asparaginase is an enzyme that catalyzes the hydrolysis of L-asparagine to L-aspartic acid and ammonia. The therapeutic drug is one of the isozymes elaborated by *Escherichia coli*. It inhibits protein synthesis in tumor cells by depriving them of the amino acid asparagine. This drug is phase specific, with

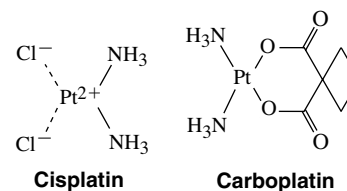

FIGURE 42-9 Structural formulas of platinum compounds.

the greatest activity in the G₁ phase of the cell cycle. Timing and scheduling of asparaginase with other chemotherapy agents is important to prevent the antagonism of the effects of the other agents. Clinical use is confined presently to acute lymphocytic leukemia. The drug may produce acute anaphylaxis with hypotension, sweating, bronchospasm, and urticaria, and test doses are usually administered to help detect the possibility of a hypersensitivity reaction. Other effects in patients taking L-asparaginase include alteration in liver function and the coagulation factors resulting in either increased bleeding or increased clotting. A newer formulation of asparaginase is pegaspargase (PEG-L-asparaginase), which has polyethylene glycol covalently linked to the asparaginase to decrease immunogenicity and to prolong its half-life.

Platinum Complexes

Cisplatin

Cisplatin (*cis*-diamminedichloroplatinum) is a heavy metal complex containing a central atom of platinum surrounded by two chloride ions and two amino groups in the cis position (Figure 42-9). The compound has biochemical properties similar to bifunctional alkylating agents in that it produces interstrand and intrastrand cross-links in DNA, inhibiting its synthesis. Cisplatin is not a cell cycle phase-specific agent. The drug has proved most effective in the treatment of carcinoma of the testis and ovary, transitional cell bladder neoplasia, and head and neck cancers. In particular, it is finding increased use as a radiosensitizer when given at a few very specific points in the provision of radiation therapy for squamous cell carcinomas of the head and neck. It also has activity in small cell lung cancer in combination with etoposide.

After intravenous injection, cisplatin is excreted primarily in the urine; the other excretory pathways are undetermined. Severe emesis is the dose-limiting toxicity. Newer antiemetic agents and protocols usually allow for the completion of therapy. Nephrotoxicity expressed as renal tubular necrosis is another major dose-limiting side effect. The agent can be ototoxic, causing initially high-frequency and later complete hearing loss, and long-term use produces peripheral neuropathy.

thy. Bone marrow suppression is rare in usual doses, but high doses can cause leukopenia. Concurrent administration of amifostine with cisplatin may reduce the cumulative renal toxicity associated with repeated administration in patients with advanced carcinoma of the ovary and NSCLC. Other toxic effects associated with cisplatin in combination with other chemotherapy agents may also be reduced by pretreatment with amifostine.⁴²

Carboplatin

Carboplatin is a second-generation platinum complex designed to maintain antitumor efficacy while decreasing nephrotoxicity, ototoxicity, and neurotoxic effects. The emetogenic potential of carboplatin is less than that of cisplatin. The major dose-limiting side effect is myelosuppression, with thrombocytopenia being more significant than leukopenia. Carboplatin is active in small cell lung cancer, ovarian carcinoma, and head and neck carcinomas.

Oxaliplatin

Oxaliplatin is a newer third-generation platinum derivative with a novel mechanism of action. Oxaliplatin may exert its cytotoxic effects by blocking DNA replication and transcription. It is more potent than other platinum derivatives and has activity against tumors resistant to cisplatin and carboplatin. Early trials suggest synergistic activity in colorectal cancer when used with fluorouracil.⁷ Oxaliplatin has been approved more recently for the treatment of patients with advanced colorectal cancer when administered in combination with fluorouracil and leucovorin. The toxicity profile of oxaliplatin includes some unique neurotoxic effects. There is an acute and chronic presentation of the toxicity. Acute symptoms include paresthesia of the hands, feet, and perioral area; jaw tightness; and laryngopharyngeal dysesthesia. These symptoms can occur with the infusion or within hours after administration and may be triggered by exposure to cold temperatures or cold objects such as ice used for mucositis prophylaxis. Chronic symptoms of peripheral neuropathy may be aggravated by exposure to cold.

Podophyllotoxins

Etoposide

Etoposide, a semisynthetic derivative of the mandrake plant substance podophyllotoxin (Figure 42-10), is indicated for the treatment of advanced testicular cancer. It is also active against Kaposi's sarcoma, small cell lung cancer, NSCLC, and lymphomas. A cell cycle-specific drug, etoposide is unique

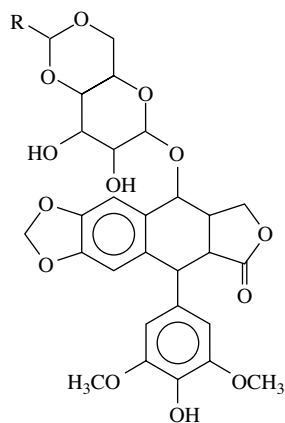

Etoposide R = H₃C—

Teniposide R = 

because it is most active in the G₂ phase of the cycle. The drug seems to prevent cell division by damaging DNA, by inhibiting topoisomerase II, or by forming free radicals. Oral etoposide is commercially available and is approximately 50% bioavailable, but the drug is typically given via slow intravenous administration to avoid hypotension. Myelosuppression, nausea, and vomiting are the most common adverse effects. Etoposide is a prodrug formulation of etoposide. This formulation has greater solubility, allowing for more rapid infusion with less hypersensitivity and hypotensive reactions.³⁰

Teniposide

Teniposide is similar to etoposide, differing in the substitution of a thenylidene group for a methyl group on the carbohydrate moiety (see Figure 42-10). Although the mechanism of action is similar to that of etoposide, its cytotoxic properties are more potent. Current uses include treatment of refractory childhood leukemias and neuroblastoma. Myelosuppression is dose-limiting, and severe allergic reactions have been reported.

Camptothecins

Topotecan

Topotecan is a semisynthetic analogue of camptothecin. Camptothecin is isolated from an ornamental tree, *Camptotheca acuminata*, found in China. The mechanism of action is the inhibition of topoisomerase I, which causes single-strand breaks in DNA. The current indication for topotecan is for the treatment of metastatic ovarian carcinoma. Topotecan in combination with cytarabine is also used to treat advanced myelodysplastic syndromes and acute myelogenous leukemia.³ The major dose-limiting side effect is myelosuppression. Irinotecan, another derivative of camptothecin, is indicated for use in colorectal carcinomas that have not responded to fluorouracil therapy. Irinotecan in combination with fluorouracil/leucovorin has been shown to increase survival in colorectal cancer patients and may become first-line therapy for this disease.⁵⁸ The major side effects of topotecan include myelosuppression and diarrhea requiring aggressive medical management.

Taxoids and Etophilones

Paclitaxel

Paclitaxel is another naturally derived product. Originally extracted from the bark of the western yew tree, *Taxus brevifolia*, paclitaxel induces polymerization and stabilization of microtubules. The development of paclitaxel has been slow because of the laborious process for extracting the active drug and the lack of success in synthesizing it because of its complex chemical structure (Figure 42-11). It is poorly soluble in water and is formulated in a Cremophor El (polyoxyethylated castor oil) and alcohol vehicle. This vehicle may contribute to the high incidence of allergic reactions to the injectable drug. These severe reactions result in dyspnea, hypotension, bronchospasm, urticaria, and erythematous rashes, and they must be managed prophylactically by premedication with steroids or H₁ and H₂ antihistamines or both and by prolonging the infusion. The antineoplastic activity of this drug is broad, and the current approved use of paclitaxel includes treatment of metastatic carcinoma of the ovaries and breast. A new formulation of paclitaxel is available that has the paclitaxel bound to albumin, which is free of toxic solvents, and may provide an improved response rate over traditional paclitaxel. Trials are ongoing to establish the role of this new class of "protein-bound particle" drugs.

Docetaxel

Docetaxel is an antineoplastic agent belonging to the taxoid family. It is a semisynthetic preparation that starts from the needles of yew plants. It works like paclitaxel by binding to free tubulin, promoting the assembly of tubulin and inhibiting its

FIGURE 42-10 Structural formulas of etoposide and teniposide.

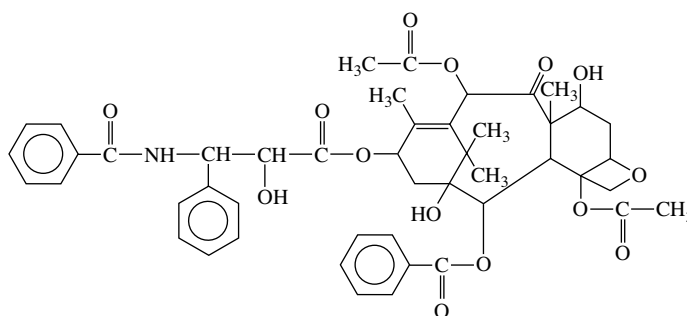

FIGURE 42-11 Structural formula of paclitaxel.

disassembly. Docetaxel is indicated for the treatment of locally advanced breast cancer. Docetaxel has moved rapidly from second-line treatment of breast cancer to current evaluations in large, adjuvant trials in breast cancer and use in NSCLC.^{10,22} Docetaxel has a toxicity profile similar to that of paclitaxel, with allergic reactions requiring premedication with dexamethasone starting 1 day before therapy. Fluid retention and cutaneous toxicity occur more frequently than with paclitaxel, but there are fewer cardiac arrhythmias and myalgias.

Isabepilone

Isabepilone (Ixempra) is the first of the class of epothilones to be approved for use in the treatment of breast cancer. Epothilones are macrolide fermentation products of the myxobacterium *Sorangium cellulosum*. Epothilones A and B can competitively displace paclitaxel from its binding of microtubules and work by stabilizing microtubules, causing cell cycle arrest. Isabepilone is a semisynthetic analogue of epothilone B and has been studied in paclitaxel-resistant breast cancer. It is approved for monotherapy or in combination with capecitabine for treatment of patients with metastatic or locally advanced breast cancer resistant to treatment with an anthracycline and a taxane.

A major toxicity associated with isabepilone is grade III to IV peripheral neuropathy, seen in about 14% of patients receiving monotherapy with isabepilone and 23% of patients receiving the combination with capecitabine. The neuropathies were generally reversible with the discontinuation of treatment. Severe neutropenia was frequently seen in patients treated with the combination of isabepilone and capecitabine. Other adverse effects occurring in more than 20% of the patients treated include anemia, leukopenia, thrombocytopenia, fatigue, myalgia/arthralgia, nausea and vomiting, alopecia, stomatitis/mucositis, and diarrhea. Isabepilone is being studied in numerous other resistant tumors, as are other epothilones such as patupilone, KOS-1584, and sagopilone/ZK-EPO.⁶⁶

Other Agents

Hydroxyurea

Hydroxyurea inhibits DNA synthesis by blocking the action of ribonucleoside diphosphate reductase. Hydroxyurea is readily absorbed from the alimentary tract; tissue distribution includes the CNS. Elimination is mainly by urinary excretion. Hydroxyurea is used principally to treat busulfan-resistant chronic myelogenous leukemia and to reduce rapidly increasing peripheral blast counts in acute leukemia. Hydroxyurea is also used in sickle cell disease and for other myeloproliferative disorders such as polycythemia vera. High doses most often produce myelosuppression and megaloblastic anemia.

Procarbazine

Procarbazine, a derivative of methylhydrazine, was originally synthesized for its use as an antidepressant. It suppresses mitosis and produces chromosomal defects. It is a monoamine

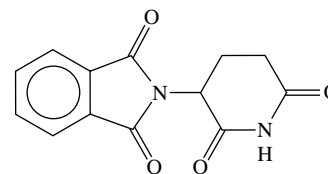

FIGURE 42-12 Structural formula of thalidomide.

oxidase inhibitor that possesses teratogenic and carcinogenic properties in addition to antineoplastic activity. Procarbazine is rapidly absorbed from the alimentary tract, quickly metabolized by the liver, and excreted in the urine mainly in the form of a metabolic breakdown product. Procarbazine is most active against Hodgkin's disease and is modestly effective in other lymphomas and multiple myeloma when given in combination with alkylating agents and vinca alkaloids. Nausea and vomiting occur with high doses, and hematologic toxicity in the form of leukopenia and thrombocytopenia occurs within 3 to 4 weeks. Because procarbazine is a mild monoamine oxidase inhibitor, patients should be warned about concurrent use of tyramine-rich foods, antidepressants, CNS depressants, and other drugs that are known to interact significantly with monoamine oxidase inhibitors. Procarbazine is reported to have some degree of disulfiram-like activity, so alcoholic beverages should be avoided.

Thalidomide

Thalidomide (Figure 42-12) was used in Europe and Canada in the 1950s as an anxiolytic, antiemetic, and sedative drug until it was discovered to cause major teratogenic effects. This agent was not approved for use in the United States at that time because of a potential for irreversible neurotoxicity after long-term use. In the late 1990s, thalidomide was approved by the FDA for the treatment of Hansen's disease (leprosy). Since then, many additional conditions and disease states, such as AIDS-related cachexia, rheumatoid arthritis, graft-versus-host disease, and cancers such as multiple myeloma, have been treated with thalidomide.⁶ The mechanism of thalidomide activity is complex and still not well understood, but it involves two major effects: antiangiogenesis and immune system modulation.

Angiogenesis, as stated previously, is an important mechanism for tumor growth and formation of metastases. On inhibition of angiogenesis, the tumor cells starve without the necessary nutrient supply. In addition, thalidomide can inhibit tumor necrosis factor- α production, stimulate T-cell proliferation, and increase interferon and interleukin-2 release. The role of each of these mechanisms in its antineoplastic effect is unknown. The success rates in treating multiple myeloma as a single agent range from 25% to 75%. The most frequent dose-dependent adverse effects include sedation, rash, fatigue, and constipation. Thalidomide has also been shown to increase

the risk of developing thromboses, and it is recommended that patients receive anticoagulation therapy while on thalidomide. Because of the risk of birth defects, patients and physicians must be enrolled in a drug company program to be able to take or prescribe thalidomide.

Lenalidomide

Lenalidomide is a structural analogue of thalidomide that has more potent activity. It is approved for second-line treatment of multiple myeloma in combination with dexamethasone. The mechanism of action of lenalidomide is not well understood. In multiple myeloma, lenalidomide induces apoptosis in myeloma cells, inhibits the production of cytokines in the bone marrow that allow for the growth of myeloma, stimulates natural killer cell immunity against myeloma cells, decreases the binding of myeloma cells to the bone marrow stromal cells, and stimulates the action of dexamethasone. Lenalidomide in combination with dexamethasone has a response rate of 50% to 60% in multiple myeloma patients.⁵² Lenalidomide is also approved for treatment of myelodysplastic syndromes. For myelodysplastic syndromes, lenalidomide is thought to inhibit tumor necrosis factor- α , inhibit angiogenesis, and have immunomodulatory effects that stimulate CD4⁺ and CD8⁺ cells. It has been shown to be more effective in patients with the cytogenic abnormality of deletion of chromosome 5q. Adverse effects of lenalidomide include myelosuppression, fatigue, neuropathies, constipation, and somnolence. When combined with dexamethasone, lenalidomide has an increased risk of developing deep vein thromboses and should be given with aspirin or anticoagulation therapy. Similar to thalidomide, patients taking lenalidomide and prescribing physicians must be enrolled in a program aimed at preventing birth defects.

Arsenic trioxide

Arsenic trioxide (As₂O₃) has been investigated more recently in clinical trials for treatment of acute promyelocytic leukemia in patients who relapsed after standard treatment with chemotherapy and all-*trans*-retinoic acid or after a bone marrow transplant. The rates of complete remission with low-dose arsenic were impressive in this refractory patient population. The proposed mechanisms of activity of this arsenical compound include induction of apoptosis by activation of cysteine proteases (caspases) and initiation of cytodifferentiation. The adverse effects linked to low-dose arsenic trioxide in clinical trials consisted of lightheadedness during infusion, fatigue, musculoskeletal pain, hyperglycemia, and peripheral neuropathy.⁶² The frequency of oral complications from this treatment is low and includes sore throat, oral blisters, and dry mouth. A more serious but rare side effect is a presentation similar to "retinoic acid syndrome" (discussed later). This condition may be observed in patients with acute promyelocytic leukemia receiving arsenic trioxide. Cardiac side effects include QTc interval prolongation on electrocardiogram.⁴⁸

Decitabine and azacytidine

Decitabine and azacytidine are two newer agents that work by inhibiting DNA methylation. Hypomethylation of the DNA results in the reactivation of genes that have been previously silenced in particular tumor suppressor genes. Decitabine is a deoxycytidine and cytarabine nucleotide derivative that inhibits the process of DNA methyltransferase after being incorporated into the DNA, whereas azacytidine can be incorporated into DNA and RNA. Azacytidine also is a nucleotide analogue and is incorporated in place of cytidine, where it acts as a direct and irreversible inhibitor of DNA methyltransferase. Both of these agents have been approved for the treatment of myelodysplastic disorders. The major adverse effects of these drugs are myelosuppression, resulting in thrombocy-

topenia, neutropenia and febrile episodes, and infection. Common gastrointestinal side effects include nausea and vomiting and mucositis. Other effects include liver dysfunction and creatine elevations.⁴³

Bisphosphonates

The bisphosphonates zoledronic acid and pamidronate have been used to manage hypercalcemia of malignancy and for bone pain associated with metastases arising from breast, prostate, and lung carcinomas and multiple myeloma. The use of these agents has had a favorable impact on the natural history of the disease, improving the quality of life by decreasing pain and skeletal fractures. Side effects include fevers, flulike syndromes, increases in serum creatinine and decreased renal function, and hypocalcemia. A more recently reported side effect associated with the routine use of zoledronic acid and pamidronate is the development of avascular osteonecrosis of the jaw (see Chapter 34).³⁸

Differentiating Agents: Retinoids

Several classes of compounds have the potential *in vitro* and *in vivo* to have a differentiating effect on the malignant clone, inhibiting growth and proliferation. Among these compounds are the retinoids, including some commercially available and experimental agents such as isotretinoic acid (13-*cis*-retinoic acid), 9-*cis*-retinoic acid, all-*trans*-retinoic acid, bexarotene, etretinate, and the arotinoids. Retinoid effects seem to result from changes in gene expression mediated through specific intracellular receptors. There are two subfamilies of retinoid intracellular receptors: the retinoid acid receptors (RARs) and the retinoid X receptors (RXRs). These retinoid receptors each have three subtypes, designated RAR α , RAR β , RAR γ , and the corresponding RXR α , RXR β , and RXR γ . These receptors form dimers with each other or other receptors, and each receptor subtype or combination is thought to control unique and overlapping target genes, regulating their transcription. Retinoids play crucial roles in normal development and physiologic functioning. They are also capable of inhibiting cell growth, inducing differentiation, and inducing apoptosis in various tumor cell lines.

Tretinoin

Tretinoin is the commercial formulation of all-*trans*-retinoic acid. This agent has been the most successful differentiating agent used in the treatment of acute promyelocytic leukemia. Genotypically, these leukemic clones have a characteristic translocation between the long arms of chromosome 15 and 17, which results in fusion between a gene that encodes RAR α and a gene known as *pml*. The *pml*/RAR fusion protein functions as an oncogene and blocks differentiation of the myelocytes at the promyelocyte stage. Orally administered tretinoin induces differentiation and apoptosis of malignant promyelocytes. Tretinoin is metabolized in the liver and can induce its own metabolism, leading to decreased levels and clinical effects with continued administration. Tretinoin, similar to most retinoids, is teratogenic. Common side effects include dry skin, exfoliation, xerostomia, and cheilitis. A rare but potentially lethal dose-limiting toxicity is known as *retinoic acid syndrome*, which consists of fever, chest pain, dyspnea, hypoxia, pulmonary infiltrates, and pleural or pericardial effusions.¹⁴

Bexarotene

Bexarotene is a retinoid that selectively activates RXRs. The approved indication for bexarotene is for the treatment of cutaneous T-cell lymphoma. *In vitro* and animal testing suggests potential applications of bexarotene in other malignancies. This oral retinoid is hepatically metabolized and primarily eliminated through the hepatobiliary system. Bexarotene can

cause major lipid abnormalities in patients and may require monitoring and treatment. Other side effects include headache, asthenia, hypothyroidism, rash, dry skin, leukopenia, and nausea.

Other retinoids

Of all the retinoids, isotretinoic acid (13-*cis*-retinoic acid) has undergone the most extensive clinical examination. The activity of this agent alone in established cancers is limited. This agent has been used to reverse oral leukoplakia in heavy tobacco users.³⁶ The duration of clinical response is brief, and most patients have a relapse if the drug is stopped. Other retinoids, such as 9-*cis*-retinoic acid, which is a pan-agonist for RAR and RXR, are undergoing clinical evaluations for roles in the treatment of other tumors.

Biologic Response Modifiers

The continuing evolution of recombinant technology beginning in the early 1970s has resulted in the availability of clinical agents to modify host responses and aid in killing cancer cells by themselves and in combination with other cytotoxic agents. Known as the fourth modality of cancer therapy, biologic response modifiers are used to assist the body's natural ability to kill cancer cells or to minimize adverse effects on normal cells.

Interferons

Two types of human interferon, interferon alfa-2a and interferon alfa-2b, have been produced by recombinant DNA techniques and marketed for cancer chemotherapy. Each agent is a protein chain of 165 amino acids, differing from each other only at a single amino acid residue. A purified form of interferon- α , prepared from human plasma, is also available under the nonproprietary name of *interferon alfa-n3*.

These agents exert antiviral, immunostimulant, and antiproliferative properties by binding to specific cell membrane receptors; however, the exact mechanism of action remains to be elucidated. They are currently being used to treat hairy cell leukemia, Kaposi's sarcoma, chronic hepatitis, chronic myelogenous leukemia, melanoma, and other malignancies in combination with chemotherapy and as biologic response modifiers in other situations.⁴¹

Interferons are given by subcutaneous or intramuscular injection and have plasma half-lives of 4 to 8 hours. They are hydrolyzed in the kidney, and metabolites are largely reabsorbed from the glomerular filtrate. Interferons have the ability to depress the activity of the hepatic CYP450 system. Numerous side effects have been associated with their use. Most patients have a flulike syndrome with fever, chills, myalgia, fatigue, and headache. Loss of appetite is also common, and patients may have nausea, vomiting, and diarrhea. Dermatologic and CNS disturbances (e.g., ataxia, confusion) occur in a few patients.⁴¹

Aldesleukin

Aldesleukin (interleukin-2 [IL-2]) is a recombinant product produced by a genetically engineered *E. coli* strain. IL-2 has numerous immunoregulatory properties, including enhancement of lymphocyte mitogenesis, lymphocyte cytotoxicity, induction of killer cells (natural and lymphokine activated), and induction of interferon- γ production. IL-2 is administered by intravenous infusion and is metabolized and eliminated by the kidneys. The plasma half-life of IL-2 is short (approximately 90 minutes). Currently, IL-2 is used for the treatment of adults with metastatic renal cell carcinoma. In addition, high-dose IL-2 treatment has produced some long-lasting complete responses or partial remissions in metastatic melanoma patients. The major toxicities of IL-2 are associated with capillary leak syndrome, resulting in clinically significant

hypotension, weight gain, fluid retention and accumulation, pulmonary edema, and acute renal dysfunction with oliguria or anuria. Some of the common side effects (e.g., chills and fevers) can be reduced with appropriate premedication. Pruritic rashes are common.

Oprelvekin

Interleukin-11 (IL-11) is a cytokine that occurs in vivo in many tissues, such as bone marrow, brain, kidneys, heart, lungs, spleen, uterus, and intestines. IL-11 participates in stimulating megakaryocytes and their precursors in the bone marrow. Other important growth factors and cytokines are necessary for megakaryocyte production and maturation. Interleukin-3 acts synergistically with IL-11. Oprelvekin is a recombinant IL-11 produced similarly to aldesleukin. Thrombocytopenia and neutropenia are important dose-limiting toxicities of chemotherapy that can potentially delay treatment or require reduction in the total dose delivered to the patient.

Prevention or reduction in duration and severity of bone marrow toxicity enables the patient to receive a planned chemotherapeutic regimen. IL-11 reduces bone marrow toxicity occurring during chemotherapy. As discussed later, filgrastim and sargramostim stimulate white blood cell production, but they do not have any effects on increasing platelet and red blood cell production. Oprelvekin was found to prevent severe thrombocytopenia and decrease the need for platelet transfusions in several double-blind, randomized clinical trials in cancer patients receiving highly myelosuppressive chemotherapeutic regimens. The widespread use of oprelvekin is limited, however, by its adverse effects profile and cost. Administration of oprelvekin leads to significant fluid retention, which may cause other important complications, such as peripheral edema, dilutional anemia, palpitations, dyspnea, headache, and atrial arrhythmias. Headache, myalgia, arthralgia, and fatigue are also reported frequently.

Filgrastim and sargramostim

Colony-stimulating factors represent a third group of biologic response modifiers (in addition to interferons and interleukins) that has had a clinical effect in the treatment of neoplastic disease. These agents—filgrastim (granulocyte colony-stimulating factor) and sargramostim (granulocyte-macrophage colony-stimulating factor)—are not cytotoxic. They offer the benefit of ameliorating the hematologic toxicity induced by the chemotherapeutic agents. Injected subcutaneously or intravenously, colony-stimulating factors are approved for the treatment of chemotherapy-related and transplant-related neutropenia in bone marrow transplant patients. The growth factors can shorten the overall period of neutropenia, reduce the number of febrile episodes, and decrease the need for broad-spectrum antibiotics. They are used investigationaly for other clinical conditions of neutropenia. They also can mobilize stem cells into the peripheral blood for collection by cell separation for stem cell transplants after high-dose chemotherapy and radiation therapy.

The value of the growth factors may ultimately be to allow more chemotherapy to be administered, with less need for dose reductions because of side effects. Predictably, other adverse effects, such as mucositis, may become dose-limiting as dosages are escalated. Adverse effects of these agents are usually flulike symptoms, fever, chills, bone pain, and myalgia. Pleuritis and pericarditis have been reported.

Palifermin

Palifermin is a human keratinocyte growth factor and binds to the keratinocyte growth factor receptor, which results in proliferation, differentiation, and migration of epithelial cells. It is FDA approved to decrease the incidence and duration of severe oral mucositis in patients with hematologic malignan-

cies receiving myelotoxic therapy requiring hematopoietic stem cell support. This injectable growth factor is given 3 days before and 3 days after chemotherapy. In a clinical trial in autologous transplant patients, it reduced the duration of World Health Organization grade III and IV mucositis duration from 9 to 6 days and incidence from 98% to 63%. Palifermin has also been studied for use with chemotherapy agents such as fluorouracil, which can increase the risk of mucositis, and for the prevention of high-dose methotrexate-induced oral mucositis, where it may reduce the incidence, severity, and duration of the lesions.⁶⁰ Palifermin's current role is to prevent or decrease the duration of mucositis in stem cell transplant patients. It does not yet have an established role in the treatment of chemotherapy-induced mucositis.

Many other biologic response-modifying approaches are being explored in clinical trials. Levamisole, an anthelmintic agent, has a role with fluorouracil for the treatment of Duke's C colon cancer because of its immunomodulating effects. Vaccines, new cytokines, additional interleukins and colony-stimulating factors, and interferon- α all are being evaluated alone and in combination with chemotherapy to increase responses against these neoplastic diseases.

TARGETED ANTINEOPLASTIC THERAPY

Researchers constantly strive to find the "magic bullet" to cure cancer. In the process of discovering new molecules with anticancer activity, the molecular mechanisms and cellular processes are better understood. The idea of targeting a specific molecular pathway in the tumor cell cycle originated from the limitations of traditional antineoplastic drugs such as nonselective toxicity, drug resistance, and suboptimal success rates. Over the past few years, new drugs have been developed that fall into the category of targeted therapy and are summarized in Table 42-2. Tyrosine kinase inhibitors, MAbs, and proteasome inhibitors target a specific receptor or pathway in malignant cells. They are used as single-agent or combination therapy to eradicate specific types of tumor cells, increase response rates, and slow the progression of cancers.

Tyrosine Kinase Inhibitors

Several TKs have been identified in malignant cells and used as targets for new drugs. The overexpression of EGFR-TK has been identified in malignant cells. This glycoprotein spans the cellular membrane and transduces extracellular stimuli into intracellular responses. An abnormally high activity of EGFR-TK has been linked to induction, growth, and metastatic potential of malignant cells. Inhibition of the EGFR-TK-mediated signaling pathway has been shown to result in suppression of tumor growth (Figure 42-13). The most effective drugs target the extracellular ligand-receptor binding or the intracellular phosphorylation step. Another TK target is the Bcr-Abl TK found in chronic myeloid leukemia. A characteristic of this type of leukemia is a translocation between two chromosomes to form the Philadelphia (Ph) chromosome. This translocation occurs at the breakpoint cluster region (*Bcr*) gene on chromosome 22 and the proto-oncogene on chromosome 9, identified by Abelson as *Abl*. This translocation forms the Bcr-Abl fusion gene, which codes for the Bcr-Abl TK. Other TKs that have been identified for targets include VEGF-TK; cKit (stem cell factor); FLT3 (FMS-like TK 3), which is related to the platelet-derived growth factor (PDGF); RAS, Src, and Raf.¹⁸

Erlotinib

Erlotinib is an oral agent that inhibits EGFR-TK that is approved as second-line therapy for advanced NSCLC and first-line therapy for advanced pancreatic cancer in combina-

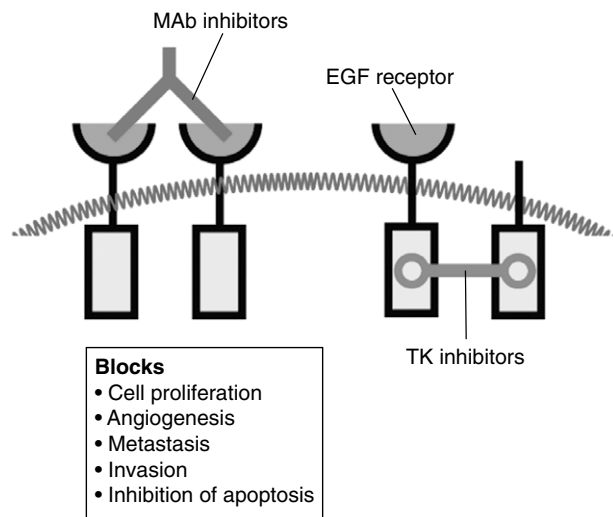

FIGURE 42-13 Inhibition of epidermal growth factor (EGF) receptor and resulting action on cells. *MAB*, Monoclonal antibodies; *TK*, tyrosine kinase.

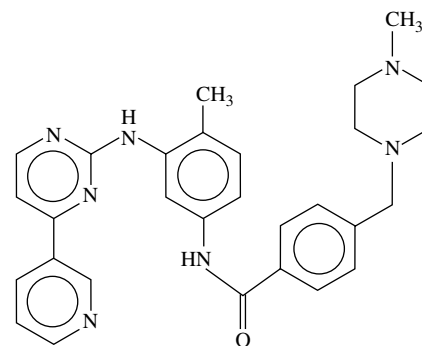

FIGURE 42-14 Structural formula of imatinib.

tion with gemcitabine. Erlotinib may be combined with chemotherapy in NSCLC to increase response rates or given as monotherapy to patients with a poor performance status or who are unable to receive chemotherapy. Nonsmokers and Asian patients seem to benefit the most from erlotinib therapy.⁶³ In pancreatic cancer, erlotinib has been shown to inhibit EGFR activation, which inhibits signal transduction and cell proliferation. It also seems to enhance gemcitabine activity, and the combination has been shown to stabilize disease. Side effects of erlotinib include diarrhea and an acne-like skin rash that may be associated with efficacy.⁵⁷

Imatinib

Imatinib is an oral TK inhibitor that targets Bcr-Abl in chronic myeloid leukemia and Ph⁺ acute lymphocytic leukemia patients; its structure is shown in Figure 42-14. It functions by binding to the adenosine 5'-triphosphate binding site while it is in the closed state, causing signal transduction to end. The IRIS trial evaluated imatinib for first-line therapy in patients with chronic myeloid leukemia. In this trial, 87% of imatinib patients achieved a complete cytogenetic response, only 7% of patients progressed to advanced disease, and there was an overall survival rate of 89% after 5 years. Because of these results, imatinib is considered first-line therapy for chronic myeloid leukemia patients. It has also proven to be successful in treating Ph⁺ acute lymphocytic leukemia patients in combination with standard chemotherapy. Common toxicities

TABLE 42-2

Targeted Therapies

NONPROPRIETARY (GENERIC) NAME	PROPRIETARY (TRADE) NAME	CELLULAR TARGET	TREATMENT INDICATION	ADVERSE EFFECTS
Tyrosine Kinase Inhibitors				
Erlotinib	Tarceva	EGFR	Lung cancer, pancreatic cancer	Acneiform skin rash, diarrhea
Imatinib	Gleevec	Bcr-Abl	CML, Ph ⁺ ALL, GIST	Myelosuppression, peripheral edema, GI pain, nausea, bone pain, rash
Dasatinib	Sprycel	Bcr-Abl	Imatinib-resistant or imatinib-intolerant CML and Ph ⁺ ALL, GIST	Myelosuppression, pleural effusions, nausea and vomiting
Nilotinib	Tasigna	Bcr-Abl	Imatinib-resistant or imatinib-intolerant CML and Ph ⁺ ALL	Myelosuppression, hyperglycemia, increased serum lipase, QTc interval prolongation
Lapatinib	Tykerb	ErbB-1 and ErbB-2	Advanced or metastatic breast cancer	Nausea, fatigue, itching, acne, diarrhea
Sorafenib	Nexavar	VEGF, PDGFR, cKit, FLT3	Renal cell carcinoma	Diarrhea, hand-foot syndrome, hypertension, neutropenia, fatigue, hypophosphatemia
Sunitinib	Sutent	VEGF, PDGFR, cKit, FLT3	Renal cell carcinoma, GIST	Myelosuppression, increased serum lipase, fatigue, nausea and vomiting, diarrhea
Proteasome Inhibitors				
Bortezomib	Velcade	26S Proteasome	Multiple myeloma	Myelosuppression, peripheral neuropathy, fatigue/malaise
Monoclonal Antibodies				
Rituximab	Rituxan	CD20	Lymphomas	Infusion related (chills, fever, flushing, nausea, fatigue, pruritus, angioedema)
Trastuzumab	Herceptin	HER-2/Neu (ErbB-2)	Breast cancer	Infusion related (chills, fever, rigors, headaches, nausea and vomiting, diarrhea, cough/shortness of breath, rash), cardiotoxicity (cardiomyopathy and CHF)
Gemtuzumab ozogamicin	Mylotarg	CD33	Acute myelogenous leukemia	Severe myelosuppression, infusion related (chills, fever, changes in blood pressure, shortness of breath), hepatotoxicity
Ibritumomab	Zevalin	CD20	Lymphomas	Myelosuppression
Tositumomab	Bexxar	CD20	Lymphomas	Myelosuppression
Alemtuzumab	Campath	CD52	Chronic lymphocytic leukemia	Infusion related (chills, fever, nausea and vomiting)
Bevacizumab	Avastin	VEGF	Colorectal cancer	GI bleeding, GI perforations, delayed wound healing, hypertension, reversible posterior leukoencephalopathy syndrome, thromboembolism, mucocutaneous hemorrhage
Cetuximab	Erbix	EGFR	Colorectal cancer, head and neck cancer	Infusion related (chills, fever, anaphylaxis), acneiform rash, interstitial lung disease, hypomagnesemia
Panitumumab	Vectibix	EGFR	Colorectal cancer	Pulmonary fibrosis, hypomagnesemia, rash, paronychia
Histone Deacetylase Inhibitors				
Vorinostat (SAHA)	Zolinza	Histone deacetylase	Cutaneous T-cell lymphoma	Diarrhea, fatigue, nausea, anorexia, pulmonary embolism, thrombocytopenia

ALL, Acute lymphocytic leukemia; CHF, congestive heart failure; CML, chronic myeloid leukemia; EGFR, epidermal growth factor receptor; GI, gastrointestinal; GIST, gastrointestinal stromal tumor; PDGFR, platelet-derived growth factor receptor; Ph⁺, Philadelphia chromosome–positive; VEGF, vascular endothelial growth factor.

include myelosuppression, peripheral edema, nausea, gastrointestinal pain, bone pain, and rash.²¹ Imatinib has also been approved for second-line treatment of gastrointestinal stromal tumors because it inhibits cKit, Abl protein, and PDGF, all of which are overexpressed in gastrointestinal stromal tumor cells.

Dasatinib

Dasatinib is an oral dual Bcr-Abl/Src kinase inhibitor. It has also shown activity against Src family kinases (SFKs), c-Kit,

PDGF, and others. It is the first drug to be approved to treat chronic myeloid leukemia and Ph⁺ acute lymphocytic leukemia patients who are imatinib-resistant or imatinib-intolerant. A series of trials named the START trials illustrated a durable hematologic and cytogenetic response to dasatinib in this patient population. Dasatinib has been shown to be effective against all imatinib-resistant Bcr-Abl mutations except T315I. The side effects of dasatinib include grade III and IV neutropenia and thrombocytopenia (that are generally reversible and easily

managed), nausea and vomiting, and fluid retention. Pleural effusions are common, more so in patients with advanced disease, and may be managed by dose reductions, diuretics, or steroids.⁵⁶

Nilotinib

Nilotinib is an analogue of imatinib that is approved for management of chronic or acute phase chronic myeloid leukemia patients who are intolerant or resistant to imatinib. In vitro testing shows that nilotinib is effective against all imatinib-resistant mutations except T315I, but it has lower activity against P-loop mutations. The toxicities of nilotinib include myelosuppression and biochemical abnormalities, such as increased serum lipase and hyperglycemia. Nilotinib has also been shown to prolong the QTc interval with other cardiotoxicities such as pericardial effusions and atrial fibrillation having been reported in a few patients.⁵⁶

Lapatinib

Lapatinib is a dual inhibitor of ErbB-1 (HER-1) and ErbB-2 (HER-2), two receptors in the EGFR family that are common in breast cancer. It is approved for treatment of advanced or metastatic breast cancer with ErbB-2 (HER-2) overexpression in combination with capecitabine. It has been studied in treatment refractory and therapy-naïve patients and as monotherapy or in combination with other chemotherapy and has been beneficial in all populations. Lapatinib is also able to pass through the blood-brain barrier and is a possible treatment for patients with brain metastases. Side effects of lapatinib include nausea, fatigue, itching, diarrhea, acne, and dry skin. There is little to no cardiotoxicity from lapatinib.⁵³

Sorafenib

Sorafenib is a small molecule TK inhibitor that is active against renal cell carcinoma and liver carcinoma. Sorafenib inhibits VEGF receptor, PDGF receptor, FLT3, and the RAS family of receptors including RAF-1 and BRAF. Sorafenib studies in renal cell carcinoma show a low partial response rate of about 10%, but high rates of disease stabilization and an increase in progression-free survival. Patients who are taking sorafenib may experience side effects such as diarrhea, hand-foot syndrome, hypertension, hypophosphatemia, fatigue, and neutropenia.^{33,46}

Sunitinib

Sunitinib is an oral multitargeted inhibitor that targets VEGF receptor, PDGF receptor, FLT3, and cKit. Sunitinib has been approved for advanced renal cell carcinoma. Studies show it is capable of disease stabilization and an increased rate of progression-free survival compared with placebo or the use of interferon- α . Renal cell carcinoma is very difficult to treat, and sunitinib has shown a modest response rate of around 30%. Another indication for sunitinib is to treat gastrointestinal stromal tumors in patients who fail imatinib treatment or are intolerant of imatinib. Common side effects of sunitinib include neutropenia, thrombocytopenia, elevated lipase, fatigue, nausea, vomiting, and diarrhea.^{33,46}

Other sites for TK inhibition are being identified as targets for anticancer therapy. Tipifarnib, an agent currently in clinical trials, is a farnesyltransferase inhibitor that targets RAS, an oncogene implicated in many cancers. Several more drugs are undergoing clinical trials and development.

Proteasome Inhibitors

Proteasomes are ubiquitous and essential intracellular protein complexes that contain protease active sites that degrade many proteins responsible for regulating the cell cycle, apoptosis, transcription, cell adhesion, angiogenesis, and antigen presentation. Bortezomib is the only approved proteasome inhibitor and is indicated for first-line treatment of multiple

myeloma and second-line treatment of mantle cell lymphoma. Bortezomib's inhibition of the 26S proteasome prevents the degradation of intracellular proteins, leading to activation of signaling cascades, cell cycle arrest, and apoptosis. Major side effects reported include fatigue, malaise, peripheral neuropathy, and bone marrow suppression.

Monoclonal Antibodies

Malignant cells often have unique antigens expressed on their surfaces known as tumor-associated antigens. MAbs are single immunoglobulin antibodies or fragments specific to a targeted surface antigen. These antibodies are produced in vitro in large quantities by an immortalized plasma cell clone. Some of these antibodies have been made in human form by DNA recombinant technology to reduce the formation of human antimouse antibodies against MAbs. Interactions between human antimouse antibodies and MAbs may reduce the effectiveness of MAbs and may initiate an allergic reaction. Another desirable outcome of using a human sequence, such as the Fc portion, may provide sites of interactions for the human immune system to initiate complement and other immune-mediated lysis of the targeted cells. The binding of these MAbs to the targeted surface antigen may lead to complement-mediated lysis, antibody-dependent cellular cytotoxicity, or signal transduction-mediated apoptosis. Cytotoxins and radioisotopes may also be attached to these MAbs, providing additional mechanisms of action by which these antibodies can target and kill malignant cells. Many MAbs are in clinical trials, and some have been approved more recently by the FDA.²⁸

Rituximab

Rituximab is a chimeric MAb consisting of a human and mouse portion, and its target is an antigen CD-20 present on mature B cells. The CD-20 antigen makes an excellent target for a therapeutic approach because this hydrophobic phosphoprotein is present on mature B cells, but not on stem cells, plasma cells, or pre-B cells.²⁷ This antigen also participates in cell cycle initiation and differentiation. Rituximab was approved by the FDA in 1997, and it was the first MAb on the market with an indication for treatment of cancer. This MAb is used to treat low-grade and follicular lymphomas expressing CD-20 antigen. In clinical trials, rituximab was effective as a single agent and in combination with standard chemotherapy; overall response rates were 48% and 100%, respectively.²⁷

The rationale for use of this MAb in combination with chemotherapy is its unique mechanism of action and its adverse effects profile. On binding of rituximab to the CD-20 antigen, the cascade of complement-dependent cell lysis is initiated, and the antibody-dependent cellular cytotoxicity occurs. In addition, rituximab has the ability to sensitize resistant human lymphoma cells. Rituximab is often combined with chemotherapy to treat lymphocytic lymphomas that express the CD-20 antigen. In contrast to chemotherapy-induced adverse effects (e.g., bone marrow suppression, mucositis), the most common adverse effects seen with rituximab are infusion related and include chills, fever, flushing, nausea, fatigue, pruritus, and angioedema. The severity of these infusion-related adverse effects subsides significantly with subsequent infusions.²⁷

Trastuzumab

Trastuzumab is a human MAb against human EGFR-2 that is overexpressed in 25% to 30% of patients with breast cancer.⁶¹ The overexpression of this receptor has been associated with more aggressive tumors, lower response rates to standard chemotherapy regimens, and ultimately decreased survival. The mechanism of action of this MAb consists of at least three major effects: alteration of the signaling potential between the

receptor and the nucleus, stimulation of the immune system components that attack and kill the tumor cells, and augmentation of the cytotoxic activity of antineoplastic drugs. Trastuzumab is given intravenously in weekly intervals for prolonged periods. Infusion-related chills, fever, and rigidity can occur frequently with trastuzumab, especially during the first dose. Other common adverse effects include headache, nausea, diarrhea, vomiting, cough, shortness of breath, and rash.⁶¹

Gemtuzumab ozogamicin

Gemtuzumab ozogamicin is a conjugate of a MAb against CD-33 antigen and a potent antineoplastic agent, calicheamicin. This novel agent has been approved more recently by the FDA for the management of acute myeloid leukemia in elderly patients who are unlikely to tolerate standard induction regimens. The CD-33 antigen is a glycoprotein present on most acute myeloid leukemia cells; however, it is not present on normal stem cells that are necessary for bone marrow recovery. The discovery of a MAb against this leukemic antigen made possible the use of a highly cytotoxic antibiotic, calicheamicin. Calicheamicin is a small molecule that contains two domains, an enediyne portion and a carbohydrate tail, allowing it to bind to the minor groove of the DNA. This binding results in DNA double-stranded breaks.

This potent group of agents has been studied *in vitro* and in animal trials since the 1970s, but could not be used in clinical practice because of severe, nonselective toxicity. The role of the MAb is to deliver this potent antineoplastic drug to the leukemic cell, which, on binding the drug, subsequently engulfs the molecule. When inside the cell, calicheamicin finds its way into the nucleus and binds to the DNA. This activity is illustrated in Figure 42-15. Most patients have infusion-related adverse effects such as chills, fevers, changes in blood pressure, and shortness of breath. Additional adverse effects that occur days after this drug is administered include hepatotoxicity and severe bone marrow toxicity that can last for 4 to 6 weeks. The incidence of severe mucositis is approximately 4% in clinical trials to date.³⁴

Ibritumomab and tositumomab

Two radioimmunoconjugates are available for the treatment of lymphoid malignancies. Tositumomab and ibritumomab are anti-CD-20 murine MAbs that target the same antigen as rituximab. The radionucleotide iodine 131, conjugated to tositumomab, and yttrium 90, conjugated to ibritumomab, provide an additional mechanism of cytotoxicity. The radiation source also allows for greater crossfire effect, radiating

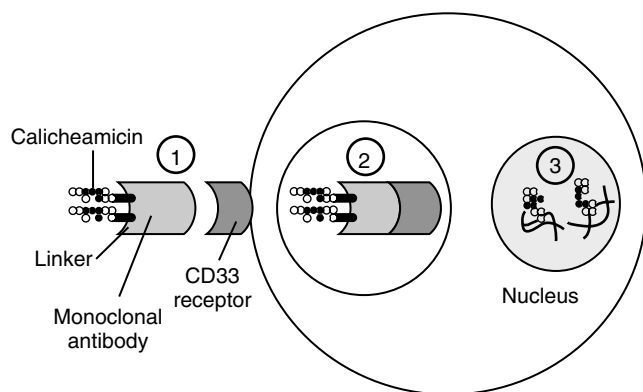

FIGURE 42-15 Gemtuzumab ozogamicin conjugate and its mechanism of action. The three major steps are (1) CD33 receptor binding and receptor complex internalization; (2) calicheamicin transport to the nucleus; and (3) calicheamicin binding to DNA, which causes DNA strand breaks.

nearby malignant lymphoma cells that may not express the CD-20 antigen. It can also bring irradiation to large tumor clusters in which the blood circulation is unable to deliver the MAbs to most of the cells. Both MAbs have been used in refractory indolent non-Hodgkin's lymphoma with good overall response rates.

The toxicity profiles of these radioimmunoconjugates are similar, with the most common toxicity being hematologic (i.e., thrombocytopenia, neutropenia). The onset of myelosuppression is delayed, with a nadir in bone marrow function at 30 to 40 days. The advantages of the ibritumomab-⁹⁰Y are the shorter half-life of yttrium 90, allowing easier use in the outpatient setting and greater radiation penetration for the treatment of bulky lymphomas over rituximab alone.⁵⁵ The radioisotope iodine 131 associated with tositumomab requires more radiation safety precautions because it emits β and γ radiation.

Alemtuzumab

Alemtuzumab is a human MAb that targets the CD-52 antigen found on B and T lymphocytes, inducing complement fixation, cell-mediated cytotoxicity, and apoptosis. The CD-52 antigen is not present in progenitor cells. Infectious complications are the most significant side effect associated with this infusional therapy; the most common side effects are fever, chills, nausea, and vomiting. Alemtuzumab may provide a third-line therapy for chronic lymphocytic leukemia for patients who have been treated with alkylating agents and have not responded to fludarabine therapy.¹⁹

Bevacizumab

Bevacizumab is a recombinant human MAb against VEGF, which is required for blood vessel formation and is produced by many malignant cells. Inhibition of VEGF decreases angiogenesis and increases the permeability of the tumor to chemotherapies. The addition of this MAb to chemotherapy in the treatment of metastatic colorectal cancer has increased the overall response rate and prolonged the median survival by 5 months, improving it from 15.6 months without bevacizumab to 20.3 months in combination with a fluorouracil-based regimen. In addition to its use in colorectal cancer, bevacizumab is being studied for use in combination with chemotherapy for renal cell carcinoma, ovarian cancer, NSCLC, and breast cancer.

The FDA approved bevacizumab for use with chemotherapy for NSCLC and Her-2-negative metastatic breast cancer. The combination of bevacizumab and paclitaxel has prolonged progression-free survival, but not overall survival.⁴⁵ Bevacizumab should be avoided in patients with squamous cell lung cancer because of an increased bleeding risk from the lung. Bevacizumab should not be used within 28 days of a major surgery because of concerns over wound healing. Other adverse effects include gastrointestinal bleeding and perforation, hypertension requiring medical treatment, nephrotic syndrome, heart failure, reversible posterior leukoencephalopathy syndrome, thromboembolism and mucocutaneous hemorrhage.

Cetuximab

Cetuximab is a chimeric MAb directed against EGFR, which is overexpressed in various malignant tumors such as NSCLC, head and neck cancer, and colorectal cancer. Cetuximab was first approved for use in metastatic colorectal cancer therapy with irinotecan. It has been approved more recently for use in combination with radiation therapy for locally or regionally advanced squamous cell carcinoma of the head and neck. Compared with radiation alone, the combination of cetuximab and radiation can nearly double the median survival of patients with certain types of head and neck cancers.⁴ The binding of cetuximab to the EGFR blocks phosphorylation

and activation of receptor-associated kinases, resulting in inhibition of cell growth and induction of apoptosis. The EGFR is expressed in many normal epithelial tissues, including the skin and hair follicle; this accounts for the common adverse effect of an acne-like rash associated with cetuximab. Other adverse reactions include interstitial lung disease, hypomagnesemia, and infusion-related reactions.

Panitumumab

Panitumumab is a human MAb produced in transgenic mice that targets the EGFR. It is approved for the treatment of colorectal cancer that has progressed after treatment with chemotherapy agents such as fluorouracil, oxaliplatin, and irinotecan. The theoretic advantage of this MAb over cetuximab is a lower incidence of infusion reactions, so no premedications are required. Its toxicity profile includes pulmonary fibrosis, hypomagnesemia, paronychia, and similar to many other EGFR inhibitors, dermatologic toxicities.

Histone Deacetylase Inhibitors

Histone acetylation and deacetylation is important in regulating gene expression by making the genes more available or less available for transcription. Histone deacetylase (HDAC) enzymes collapse the DNA around the histones and reduce gene transcription. Deregulation of histone acetylation has been shown to play a part in the development of several hematologic and solid tumor cancers by leading to oncogenes that stop apoptosis or inhibit other cellular pathways. HDAC inhibitors are used to stop transcription inhibition by oncogenes and to reactivate apoptosis, cellular differentiation, and tumor suppressor genes. They also stop cell cycle transition at G₁ and G₂-M phases, break down chromatin, and may inhibit angiogenesis. There are several HDAC inhibitors in clinical trials. Vorinostat (SAHA) has shown activity in several cancers, and has been approved to treat progressive or treatment-refractory cutaneous T-cell lymphoma.²³ In a phase IIB trial, vorinostat was shown to have a 29.7% overall response rate, with 29.5% response in patients with stage IIB or greater cutaneous T-cell lymphoma. Time to progression was 4.9 months overall and greater than 9.8 months for stage IIB or greater patients. Adverse effects include diarrhea, fatigue, nausea, anorexia, pulmonary embolism, and thrombocytopenia.⁵⁰

COMBINATION THERAPY

The previously discussed drugs are rarely used as single entities for the treatment of a specific tumor. Choriocarcinoma is one of only a few malignancies that can be cured with a single agent (doxorubicin). Resistance of tumor cells to chemotherapy may explain poor initial responses and relapses during treatment. A hypothesis for tumor resistance has been proposed by Goldie and Coldman.²⁵ Resistant tumors exhibit either inherent resistance or acquired resistance. The possible mechanisms of acquired resistance include defects in the resistant cells, transport, and activation of the chemotherapeutic prodrug to the active species. Also involved may be an alteration of the DNA repair, gene amplification, altered nucleotide pool, increased salvage pathways, and development of pleiotropic drug resistance or multidrug resistance. Research is ongoing to understand better and overcome tumor resistance.

The current chemotherapeutic approach to prevent resistance is similar to the approach described for combination chemotherapy: (1) use agents with different cell cycle specificity, mechanisms of action, toxicities, and potential combinations for synergy, and (2) administer the drugs in intermittent courses and at maximal tolerated doses to maximize cell kill,

allow for host recovery, and avoid prolonged drug-free intervals. The dose intensity of a regimen is a well-recognized variable for response and cure in sensitive tumors. The use of alternating non-cross-resistant regimens may improve outcome further, as seen with the ABVD regimen (doxorubicin [Adriamycin], bleomycin, vinblastine, and dacarbazine), alternating monthly with the traditional MOPP regimen (mechlorethamine, vincristine [Oncovin], procarbazine, prednisone) for the treatment of advanced Hodgkin's disease. This regimen was made more dose-intensive by combining the two regimens into a monthly cycle MOPP/ABV hybrid program.¹¹ The ultimate dose-intensive regimens include high-dose chemotherapy, with or without irradiation, requiring bone marrow transplantation or peripheral stem cell reinfusion to rescue the host from total marrow aplasia. Antineoplastic agents are also more successful when used in combination with radiation therapy and surgery for the treatment of tumors such as head and neck carcinomas. Combination regimens containing cisplatin and fluorouracil are being used simultaneously with radiotherapy to render the tissue radiosensitive and as a postoperative adjunct to destroy micrometastases that may have been missed during local surgery.

Targeted therapy approaches are being incorporated into combinations with more traditional chemotherapy agents, as they add a different mechanism of killing tumor cells. Combinations such as rituximab plus CHOP (cyclophosphamide, hydroxydaunomycin, vincristine [Oncovin], prednisone) for non-Hodgkin's lymphoma have been shown to be more effective than chemotherapy alone and have become standard of care. Other combinations, especially with TK inhibitors and chemotherapy, have not shown any added benefit. More studies are needed to establish the place of targeted therapy and chemotherapy combinations in cancer treatment. Many of these newer targeting agents are oral agents and provide an opportunity for the long-term management of malignancies.

Potential Drug Interactions and Relative Contraindications

Most antineoplastic drugs have a narrow therapeutic index. Although drug interactions may enhance or diminish the anti-tumor effects and result in improvement or treatment failure, drug interactions may also increase or decrease the side-effect profile of the antineoplastic drug. Caution must be used when adding other therapeutic agents in patients undergoing active anticancer therapy. Interactions may occur between antineoplastic drugs and drugs that have no antineoplastic effects. One example is the relative contraindication for the use of NSAIDs such as ibuprofen, aspirin, and others in patients who may be thrombocytopenic from myelosuppressive antineoplastic agents. NSAIDs may affect platelet function and increase gastrointestinal irritation, increasing the bleeding risk in patients with a low platelet count. Other drug-drug interactions may occur from changes in absorption, clearance, or excretion of the antineoplastic drugs; from changes in protein binding; or through the induction or inhibition of isoenzymes of the CYP450 system that metabolize the particular antineoplastic substrate or its metabolites.

Not all the metabolic pathways and interactions for antineoplastic agents have been identified. Many antineoplastic agents are substrates for metabolism by the CYP3A4, CYP2B6, and CYP2D6 isoenzymes. Concurrent use of an antineoplastic agent and the inhibitors of these and other hepatic isoenzymes may potentially cause delayed elimination of an antineoplastic agent and enhance its activity or toxicity. Examples of inhibitors of the CYP3A4 isoenzyme are the commonly used antifungal drugs, fluconazole and ketoconazole, which may possibly increase blood levels of cyclophosphamide, a substrate of a CYP3A4 isoenzyme. This antineoplastic agent is also metabolized by the CYP2B6 isoenzyme, so the metabo-

lism of cyclophosphamide is only partially affected by the inhibitory effects of these antifungal agents. The antibiotic erythromycin can increase the toxicities of vincristine, possibly through inhibition of vincristine metabolism by CYP3A4. Although many analgesics are substrates for metabolism by CYP isoenzymes, no clinically significant drug interactions from CYP isoenzyme effects on these analgesics and antineoplastic drugs have been reported.

Many antineoplastic drugs are excreted by the kidney. Nephrotoxic drugs may increase the toxicity of these agents by delaying drug elimination. Methotrexate is an antifolate antimetabolite with a wide spectrum of activity. It is a weak acid and is eliminated by tubular secretion in the kidney. The renal clearance may be decreased by drugs that inhibit the tubular secretion of methotrexate and compete for secretion or by reduced renal blood flow resulting from inhibited prostaglandin synthesis. Drugs that decrease methotrexate elimination include salicylates, some NSAIDs, probenecid, sulfonamides, and the penicillins. The toxic effects associated with delayed elimination of methotrexate include pancytopenia and mucositis. The risk of this interaction is lower with low-dose methotrexate used for arthritis. During methotrexate therapy, acetaminophen or celecoxib, a cyclooxygenase-2 inhibitor, should be considered as alternatives to salicylates or other NSAIDs for use as non-narcotic analgesic agents.

Some interactions result from pharmacodynamic mechanisms. Procarbazine is a weak monoamine oxidase inhibitor. Caution should be taken in the administration of indirect-acting sympathomimetics while the patient is taking procarbazine to prevent potentially dangerous hypertensive episodes. Direct-acting sympathomimetics such as epinephrine, isoproterenol, and norepinephrine do not seem to interact to the same degree. While receiving procarbazine, the ingestion of ethanol may result in a disulfiram-like reaction: flushing, headaches, nausea, and hypotension.

Other drugs with harmful interactions include warfarin and antineoplastic agents such as 5-fluorouracil, capecitabine, and ifosfamide; close monitoring of the prothrombin time is necessary to prevent life-threatening bleeding. Many interactions have been reported, and consideration should be given to interactions that can result in clinically significant reactions. Not all drug-drug interactions require avoidance of such therapeutic agents. In some cases, dosages may be titrated and patients monitored to minimize the risk.

IMPLICATIONS FOR DENTISTRY

Currently available antitumor drugs cannot distinguish between malignant cells and dividing normal cells and are potentially damaging to both. The mouth, by virtue of the rapid cellular turnover of the oral mucosa, the daily exposure of oral tissues to minor trauma, and the presence of an extensive and potentially infective microflora, is at special risk of developing drug-induced toxicity. Adverse reactions include stomatitis, hemorrhage, acute and chronic infection, and rapid progression of caries and periodontal bone loss. In addition, the pain associated with these conditions can impair nutrition. These issues and their management are discussed in detail in Chapter 50.

CITED REFERENCES

- Balis FM, Poplack DG: Central nervous system pharmacology of antileukemic drugs. *Am J Pediatr Hematol Oncol* 11:74-86, 1989.
- Bennett JM, Reich SD: Bleomycin. *Ann Intern Med* 90:945-948, 1979.
- Beran M, Kantarjian H: Results of topotecan-based combination therapy in patients with myelodysplastic syndrome and chronic myelomonocytic leukemia. *Semin Hematol* 36:3-10, 1999.
- Bonner JA, Harari PM, Giralt J, et al: Radiotherapy plus cetuximab for squamous-cell carcinoma of the head and neck. *N Engl J Med* 354:567-578, 2008.
- Buzdar AU, Powell KC, Legha SS, et al: Treatment of advanced breast cancer with aminoglutethimide after therapy with tamoxifen. *Cancer* 50:1708-1712, 1982.
- Calabrese L, Fleischer AB: Thalidomide: current and potential clinical applications. *Am J Med* 108:487-496, 2000.
- Cassidy J: Review of oxaliplatin: an active platinum agent in colorectal cancer. *Int J Clin Pract* 54:399-402, 2000.
- Clemett D, Lamb HM: Exemestane: a review of its use in postmenopausal women with advanced breast cancer. *Drugs* 59:1279-1296, 2000.
- Cohen MH, Johnson JR, Justice R, et al: FDA drug approval summary: nelarabine (Arranon) for the treatment of T-cell lymphoblastic leukemia/lymphoma. *Oncologist* 13:709-714, 2008.
- Comer AM, Goa KL: Docetaxel: a review of its use in non-small cell lung cancer. *Drugs Aging* 17:53-80, 2000.
- Connors JM, Klimo P: MOPP/ABV hybrid chemotherapy for advanced Hodgkin's disease. *Semin Hematol* 24(2 Suppl 1):35-40, 1987.
- Curran CF, Narang PK, Reynolds RD: Toxicity profile of dexrazoxane (Zincard, ICRF-187, ADR-529, NSC-169780), a modulator of doxorubicin cardiotoxicity. *Cancer Treat Rev* 18:241-252, 1991.
- Damon LE, Cadman EC: The metabolic basis for combination chemotherapy. *Pharmacol Ther* 38:73-127, 1988.
- Degos L, Dombret H, Chomienne C, et al: All-trans-retinoic acid as a differentiating agent in the treatment of acute promyelocytic leukemia. *Blood* 85:2643-2653, 1995.
- DeVita VT Jr, Young RC, Canellos GP: Combination versus single agent chemotherapy: a review of the basis for selection of drug treatment of cancer. *Cancer* 35:98-110, 1975.
- Dooley M, Goa KL: Capecitabine. *Drugs* 58:69-76, 1999.
- Dougherty TE, White A: Influence of hormones on lymphoid tissue structure and function: the role of the pituitary adrenotropic hormone in the regulation of the lymphocytes and other cellular elements of the blood. *Endocrinology* 35:1-14, 1944.
- Druker BJ, Talpaz M, Resta DJ, et al: Efficacy and safety of a specific inhibitor of the BCR-ABL tyrosine kinase in chronic myeloid leukemia. *N Engl J Med* 344:1031-1037, 2001.
- Dyer MJ: The role of CAMPATH-1 antibodies in the treatment of lymphoid malignancies. *Semin Oncol* 26(Suppl 14):52-57, 1999.
- Farber S, Diamond LK, Mercer RD, et al: Temporary remissions in acute leukemia in children produced by folic acid antagonist, 4-aminopteroyl-glutamic acid (aminopterin). *N Engl J Med* 238:787-793, 1948.
- Fausel C: Targeted chronic myeloid leukemia: seeking a cure. *Am J Health Syst Pharm* 64(Suppl 15):S9-15, 2007.
- Figgitt DP, Wiseman LR: Docetaxel: an update of its use in advanced breast cancer. *Drugs* 59:621-651, 2000.
- Fouladi M: Histone deacetylase inhibitors in cancer therapy. *Cancer Invest* 24:521-527, 2006.
- Gandhi V, Plunkett W: Clofarabine and nelarabine: two new purine nucleoside analogs. *Curr Opin Oncol* 18:584-590, 2006.
- Goldie JH, Coldman AJ: The genetic origin of drug resistance in neoplasms: implications for systemic therapy. *Cancer Res* 44:3643-3653, 1984.
- Graves T, Hooks MA: Drug-induced toxicities associated with high dose cytosine arabinoside infusions. *Pharmacotherapy* 9:23-28, 1989.
- Grillo-Lopez AJ, White CA, Varns C, et al: Overview of the clinical development of rituximab: first monoclonal antibody approved for the treatment of lymphoma. *Semin Oncol* 26(Suppl 14):66-73, 1999.
- Hainsworth JD: Monoclonal antibody therapy in lymphoid malignancies. *Oncologist* 5:376-384, 2000.
- Hammond LA, Eckardt JR, Baker SD, et al: Phase I and pharmacokinetic study of temozolomide on a daily-for-5-days schedule in patients with advanced solid malignancies. *J Clin Oncol* 17:2604-2613, 1999.
- Hande KR: Etoposide: four decades of development of a topoisomerase II inhibitor. *Eur J Cancer* 34:1514-1521, 1998.

31. Heinemann V: Gemcitabine: progress in the treatment of pancreatic cancer. *Oncology* 60:818, 2001.
32. Henriksson R, Grankvist K: Interactions between anticancer drugs and other clinically used pharmaceuticals: a review. *Acta Oncol* 28:451-462, 1989.
33. Hiles JJ, Kolesar JM: Role of sunitinib and sorafenib in the treatment of metastatic renal cell carcinoma. *Am J Health Syst Pharm* 65:123-131, 2008.
34. Hinman LM, Hamann PR, Wallace R, et al: Preparation and characterization of monoclonal antibody conjugates of the calicheamicins: a novel and potent family of antitumor antibiotics. *Cancer Res* 53:3336-3342, 1993.
35. Hodes ME, Rohn RJ, Bond WH: Vincal leukoblastine, I: preliminary clinical studies. *Cancer Res* 20:1041-1049, 1960.
36. Hong WK, Endicott J, Itri LM, et al: 13-cis-retinoic acid in the treatment of oral leukoplakia. *N Engl J Med* 315:1501-1505, 1986.
37. Hood MA, Finley RS: Fludarabine: a review. *DICP Ann Pharmacother* 25:518-524, 1991.
38. Ibrahim T, Barbanti G, Giorgio-Marrano G, et al: Osteonecrosis of the jaw in patients with bone metastases treated with bisphosphonates: a retrospective study. *Oncologist* 13:330-336, 2008.
39. Jain KK: Evaluation of mitoxantrone for the treatment of multiple sclerosis. *Expert Opin Investig Drugs* 9:1139-1149, 2000.
40. Johnson IS, Wright H, Svoboda G, et al: Antitumor principles derived from Vinca rosea Linn, I: vincal leukoblastine and leurosine. *Cancer Res* 20:1016-1022, 1960.
41. Jonasch E, Haluska FG: Interferon in oncological practice: review of interferon biology, clinical applications, and toxicities. *Oncologist* 6:34-55, 2001.
42. Kemp G, Rose P, Lurain J, et al: Amifostine pretreatment for protection against cyclophosphamide-induced and cisplatin-induced toxicities: results of a randomized control trial in patients with advanced ovarian cancer. *J Clin Oncol* 14:2101-2112, 1996.
43. Kuykendall JR: 5-azacytidine and decitabine monotherapies of myelodysplastic disorders. *Ann Pharmacother* 39:1700-1709, 2005.
44. Liekens S, Clercq ED, Neyts J: Angiogenesis: regulators and clinical applications. *Biochem Pharmacol* 61:253-270, 2001.
45. Miller K, Wang M, Gralow J, et al: Paclitaxel plus bevacizumab versus paclitaxel alone for metastatic breast cancer. *N Engl J Med* 357:2666-2676, 2007.
46. Motzer R, Bukowski RM: Targeted therapy for metastatic renal cell carcinoma. *J Clin Oncol* 24:5601-5608, 2006.
47. Njar VC, Brodie AM: Comprehensive pharmacology and clinical efficacy of aromatase inhibitors. *Drugs* 58:233-255, 1999.
48. Novick SC, Warrell RP Jr: Arsenicals in hematologic cancers. *Semin Oncol* 27:495-501, 2000.
49. Ohe Y, Ichinose Y, Nakagawa K, et al: Efficacy and safety of two doses of pemetrexed supplemented with folic acid and vitamin B₁₂ in previously treated patients with non-small cell lung cancer. *Clin Cancer Res* 14:4206-4212, 2008.
50. Olsen EA, Kim YH, Kuzel TM, et al: Phase IIB multicenter trial of vorinostat in patients with persistent, progressive, or treatment refractory cutaneous T-cell lymphoma. *J Clin Oncol* 25:3109-3115, 2007.
51. Onrust SV, Wiseman LR, Goa KL: Epirubicin: a review of its intravesical use in superficial bladder cancer. *Drugs Aging* 15:307-333, 1999.
52. Palumbo A, Miguel JS, Sonneveld P, et al: Lenolidamide: a new therapy for multiple myeloma. *Cancer Treat Rev* 34:283-291, 2008.
53. Petrelli F, Cabiddu M, Cazzaniga ME, et al: Targeted therapies for the treatment of breast cancer in the post-trastuzumab era. *Oncologist* 13:373-381, 2008.
54. Pinedo HM, Peters GJF: Fluorouracil: biochemistry and pharmacology. *J Clin Oncol* 6:1653-1664, 1988.
55. Press OW: Radiolabeled antibody therapy of B-cell lymphomas. *Semin Oncol* 26(Suppl 14):58-65, 1999.
56. Ramirez P, DiPersio JF: Therapy options in imatinib failures. *Oncologist* 13:424-434, 2008.
57. Rocha-Lima CM: New directions in the management of advanced pancreatic cancer: a review. *Anticancer Drugs* 19:435-446, 2008.
58. Rothenberg ML: Irinotecan (CPT-11): recent developments and future directions—colorectal cancer and beyond. *Oncologist* 6:66-80, 2001.
59. Rummel MJ, Al-Batran SE, Kim SZ, et al: Bendamustine plus rituximab is effective and has a favorable toxicity profile in the treatment of mantle cell and low-grade non-Hodgkin's lymphoma. *J Clin Oncol* 23:3383-3389, 2005.
60. Schmidt E, Thoennissen NH, Rudat A, et al: Use of palifermin for the prevention of high-dose methotrexate-induced oral mucositis. *Ann Oncol* 19(9):1644-1649, 2008.
61. Shak S: Overview of the trastuzumab (Herceptin) anti-HER2 monoclonal antibody clinical program in HER2 overexpressing metastatic breast cancer. *Semin Oncol* 26(Suppl 12):71-77, 1999.
62. Soignet SL, Maslak P, Wang ZG, et al: Complete remission after treatment of acute promyelocytic leukemia with arsenic trioxide. *N Engl J Med* 339:1341-1348, 1998.
63. Thatcher N: The place of targeted therapy in the patient management of non-small cell lung cancer. *Lung Cancer* 57(S2):S18-S23, 2007.
64. Thomas X, Archimbaud E: Mitoxantrone in the treatment of acute myelogenous leukemia: a review. *Hematol Cell Ther* 39:63-74, 1997.
65. Toso C, Lindley C: Vinorelbine: a novel vinca alkaloid. *Am J Health Syst Pharm* 52:1287-1304, 1995.
66. Vahdat L: Ixabepilone: a novel antineoplastic agent with low susceptibility to multiple tumor resistance mechanisms. *Oncologist* 13:214-222, 2008.
67. Weiss RB: Streptozocin: a review of its pharmacology, efficacy, and toxicity. *Cancer Treat Rep* 66:427-438, 1982.
68. Wozniak AJ: Single-agent vinorelbine in the treatment of non-small cell lung cancer. *Semin Oncol* 26(Suppl 16):62-66, 1999.
69. Yung AW, Prados MD, Yaya-Tur R, et al: Multicenter phase II trial of temozolomide in patients with anaplastic astrocytoma or anaplastic oligoastrocytoma at first relapse. *J Clin Oncol* 17:2762-2771, 1999.

GENERAL REFERENCES

- Abeloff MD, Armitage JO, Niederhuber JE, et al, editors: *Clinical oncology*, ed 4, Philadelphia, 2008, Churchill Livingstone.
- Chabner BA, Longo DL, editors: *Cancer chemotherapy and biotherapy: principles and practice*, ed 4, Philadelphia, 2006, Lippincott-Williams & Wilkins.
- Chu E, Devita VT Jr: *Physicians' cancer chemotherapy drug manual 2008*, Boston, 2008, Jones & Bartlett Publishers.
- DeVita VT Jr, Hellman S, Rosenberg SA, editors: *Cancer: principles and practice of oncology*, ed 8, Philadelphia, 2008, Lippincott Williams & Wilkins.
- Fischer DS, Knobf MT, Durivage HJ, et al, editors: *The cancer chemotherapy handbook*, ed 6, Philadelphia, 2003, Mosby.
- Perry MC, editor: *The chemotherapy source book*, ed 4, Philadelphia, 2008, Lippincott Williams & Wilkins.
- Solimando DA Jr: *Drug information handbook for oncology: a complete guide to combination chemotherapy regimens*, ed 7, Ohio, 2008, Lexi-Comp.

Aliphatic Alcohols

FRANK J. DOWD

The aliphatic alcohols of therapeutic value are ethyl alcohol (ethanol) and isopropyl alcohol. Methanol and ethylene glycol, the latter a dihydroxy alcohol, are mainly of toxicologic interest. Propylene glycol, another dihydroxy alcohol, is useful as a food additive and in drug compounding. Isopentanol is one of the longer chain alcohols found in small concentrations in alcoholic beverages. The principal medical use of ethyl and isopropyl alcohol is topical disinfection, as discussed in Chapter 46. Although ethanol has limited clinical application, as the most common intoxicant in Western civilization it is of immense importance because of its potential for abuse and dependence and because it is a major contributing factor to individual and social ills in the United States and other nations.

The alcohols discussed in this chapter are hydroxyl derivatives of aliphatic hydrocarbons (Table 43-1). They are clear, colorless, flammable liquids that are completely miscible with water and most organic solvents. Aliphatic monohydroxy alcohols form a homologous series and, with increasing numbers of carbon atoms, display increasing potency as non-selective central nervous system (CNS) depressants. Dihydroxy alcohols (glycols) have similar CNS properties, whereas trihydroxy derivatives lack depressant effects.

ETHANOL

Ethanol can be obtained as anhydrous alcohol (100% ethanol), as neutral spirits (95% ethanol), and as denatured alcohol. Denatured alcohol, intended primarily for industrial use, is ethanol with a substance added to render it unfit for consumption, such as methanol, benzene, diethyl ether, or kerosene.

The social costs of ethanol abuse are staggering. Ethanol abuse-related costs, including health care costs, criminal damage costs, and workplace costs, are estimated to be several hundreds of billions of U.S. dollars worldwide.³ Approximately 50% of all fatal traffic accidents are related to the use of ethanol. Drinking aggravates criminal behavior. Ethanol is involved in approximately one third of suicides and rapes, half of assaults, and one half to two thirds of homicides.

Mechanism of Action

It has long been believed that the effects of ethanol on the CNS are mediated by an increase in membrane fluidity, leading to disorder of the membrane lipids and resulting in abnormal activity of ion channels and other proteins. Although there is evidence to support this mechanism, the focus more recently has been on the effect of ethanol on excitatory and inhibitory amino acids in the brain. Ethanol potentiates the effect of γ -aminobutyric acid (GABA) at GABA_A receptors.

Its mechanism in this respect is similar to that of other sedatives, such as benzodiazepines, which also enhance the effect of GABA at GABA_A receptors and increase Cl⁻ conductance. In addition, ethanol exerts an inhibitory effect on the CNS by reducing glutamate activation of excitatory ion channels. More specifically, ethanol inhibits the response of the N-methyl-D-aspartate (NMDA) receptor to glutamate.

Long-term ethanol abuse may cause a change in the subunit structure of the NMDA receptor, leading to an excitatory toxic effect when ethanol is withdrawn acutely. It may also be possible to attribute other side effects, such as chronic CNS effects, to actions on the NMDA receptor. Consistent with this notion is the observation that certain NMDA receptor antagonists can reduce the intake of ethanol in an animal model given long-term treatment. This observation has led to the search for NMDA receptor antagonists as potential therapeutic agents in treating alcohol dependence.

Biochemical mechanisms involved in the CNS effects of ethanol also seem to involve, among others, dopaminergic, adrenergic, serotonergic, and opioid pathways. Reward mechanisms are enhanced by dopaminergic stimulation and by opioid peptides. Naltrexone, an opioid receptor antagonist, inhibits the desire for alcohol intake, as do dopamine receptor antagonists. Agonists at these respective receptors have the opposite effect. Ethanol can deplete the neurotransmitter 5-hydroxytryptamine, which is consistent with aggressive behavior in an alcohol abuser. Although ethanol has a wide range of effects on neurotransmitters and receptors in the CNS, the exact contributions of these systems to the pharmacologic features of ethanol are unknown at this time. The mechanisms by which these receptors and neurotransmitters are affected are not well described.

Several actions of ethanol seem to be attributable to the drug itself. In many instances, ethanol's effects may result from its primary oxidative metabolite, acetaldehyde.

Pharmacologic Effects

Central nervous system

There is a common but mistaken notion that ethanol is a CNS stimulant. To the contrary, ethanol is a sedative-hypnotic that depresses the CNS in a dose-dependent fashion. Much of the apparent stimulation resulting from ethanol use results from disinhibition of CNS function because of selective depression of inhibitory pathways at lower concentrations of ethanol. Although mental processes, memory, and concentration are reduced, the individual may feel euphoric, confident, and socially uninhibited. Higher doses (intoxication) lead to overall depression of the CNS. As with other CNS depressants, the major acute toxicity of ethanol is respiratory depression from inhibition of the medullary respiratory center.

TABLE 43-1

Aliphatic Alcohols

	SYNONYMS	CHEMICAL FORMULA
Methyl alcohol	Methanol, carbinol, wood alcohol, wood spirit	CH ₃ OH
Ethyl alcohol	Ethanol, grain alcohol	CH ₃ CH ₂ OH
Isopropyl alcohol	Isopropanol, 2-propanol, secondary propyl alcohol	$ \begin{array}{c} \text{H}_3\text{C} \\ \diagdown \\ \text{CHOH} \\ \diagup \\ \text{H}_3\text{C} \end{array} $

TABLE 43-2

Correlates of Blood Alcohol Concentration (BAC)

BAC (mg/dL)	CLINICAL STATE*
50	Dizzy
80	Drunk (legally)
150	Drunk and disorderly
300	Dazed and dejected
400	Dead drunk
500	Dead

*Classification modified from Gaddum JH: *Pharmacology*, ed 5, New York, 1968, Oxford University Press.

The concentration of ethanol in alcoholic beverages is often listed as the “proof.” The actual concentration of ethanol, in percent by volume, is half the proof number: 80 proof equals 40% ethanol by volume. Because of the variability of absorption of different alcoholic beverages, the effects of ethanol are most commonly correlated with the blood alcohol concentration (BAC), as illustrated in Table 43-2. The effects of ethanol are dose-related and progress through the typical sequence of anxiolysis, sedation, hypnosis, anesthesia, and death. Ethanol is a soporific, increasing the time spent in sleep and decreasing the time it takes to get to sleep. With low doses of alcohol, an electroencephalogram displays a reduced frequency and increased amplitude of α waves, and with high doses, the electroencephalogram displays an enhanced δ activity similar to a pattern of deep sleep. At a BAC of approximately 150 mg/dL, there is a reduction in the length, although not in the number, of episodes of rapid eye movement sleep throughout the night, together with reduced movement during sleep. Sleep patterns are disturbed with repeated ingestion, however, so that sleep comes in short segments, and the wake time is actually increased.

At a BAC less than 50 mg/dL, binocular fusion is impaired, and blurred vision occurs. Handwriting deteriorates, fine motor coordination is reduced, and complex sensorimotor tasks begin to show impairment. The Romberg “standing steadiness” test reveals marked unsteadiness and increased body sway at a BAC of 30 mg/dL. At a BAC of 50 to 100 mg/dL, a drinker displays reductions in anxiety, critical judgment, and self-criticism, with enhanced sociability and self-esteem in group situations. Disinhibition, with talkativeness and a feeling of elation, occurs at the same time that mild sedation is produced, along with relaxation, drowsiness, and reduced alertness. Speech, movement, and simple reaction times are slowed. Fear is reduced, and impulsive risk-taking behavior becomes evident. Many performance tasks are unaltered at a

BAC of 50 mg/dL, but most are impaired at 100 mg/dL. Sexual motivation may be enhanced at a lower BAC through a reduction in anxiety and muscular tension, and maximum penile diameter, in response to visual stimulation, is increased at a BAC of 25 mg/dL but is reduced at concentrations greater than 50 mg/dL.

At a BAC of 100 to 200 mg/dL, nausea, vomiting, and loss of self-control are common in an inexperienced drinker, whereas an experienced drinker speaks and moves with exaggerated care. Subjective time passes more slowly. Speech becomes slurred, and ataxia with staggering gait occurs. A unique positional alcohol nystagmus is produced in which, with the head tilted to the side, the eyes drift slowly upward and then jerk rapidly downward. Ethanol produces deficits in short-term and long-term memory, and amnesia (“blackouts”) may occur. Ethanol increases assertive or aggressive behavior and may precipitate a rage-release reaction, especially if the initial mood of the drinker is unpleasant. Significant analgesia is also produced.

In the range of 300 mg/dL of ethanol, intoxication is severe and is accompanied by a loss of consciousness. There may be mydriasis, sweating, hypotension, and hypothermia. At a BAC of 400 to 500 mg/dL, medullary paralysis, cardiovascular depression, and death are likely to occur.

The legal blood limit for drivers in the United States is 80 mg/dL (0.08%). Drivers younger than 21 years are restricted to a BAC of less than 20 mg/dL—the “zero tolerance policy.” Sobriety tests are used to give an indication of BAC.¹³ Certain conditions such as sleepiness may make individuals susceptible to the effects of small amounts of ethanol or to the effects of previous exposure to alcohol even when the BAC is undetectable.

Cardiovascular system

Acute alcohol administration results in an elevated catecholamine concentration in blood and urine. Adrenal monoamine release is accompanied by compensatory increases in the activity of medullary tyrosine hydroxylase, dopamine β -hydroxylase, and phenylethanolamine-N-methyltransferase. Vascular smooth muscle exhibits hyperreactivity to norepinephrine at low ethanol concentrations and hyporeactivity at high concentrations. The latter effect may be caused by ethanol-induced facilitation of neuronal monoamine uptake.

The direct actions of ethanol on vasomotor tone, coupled with its complex adrenergic effects and centrally mediated influences, produce variable cardiovascular responses. In general, coronary blood flow is slightly enhanced, but there is no concomitant increase in myocardial oxygen uptake. Myocardial contractility is depressed by ethanol. Direct vasoconstriction has been observed in cerebral and renal vascular beds in vitro, but in vivo the effect of ethanol, occurring only at large doses, is an increase in blood flow to the brain and kidneys. Mesenteric blood flow also seems to be increased.

A consistent cardiovascular effect of alcohol ingestion is cutaneous vasodilation. The increased blood flow to the skin provides a feeling of warmth. In cold environments, heat loss may be greatly accentuated, and alcohol generally should be avoided in treating hypothermic individuals. At low ambient temperatures, individuals under the influence of ethanol have a high risk of hypothermia.

The ethanol metabolite acetaldehyde causes catecholamine release and produces tachycardia, increased cardiac output, and increased arterial blood pressure, effects that are abolished by adrenoceptor blockade. The concentrations of acetaldehyde normally resulting from low amounts of ingested ethanol have little acute effect on the cardiovascular system, however. Long-term effects of ethanol differ from its short-term effects. When ingested in excess on a long-term basis,

ethanol increases the risk of hypertension and adverse cardiac effects. Long-term ethanol abuse can cause a cardiomyopathy characterized by a decreased ventricular ejection fraction and heart failure. Fibrosis of the myocardium may also occur.

Liver

A number of effects of ethanol on the liver have been documented. Acute ingestion of intoxicating amounts of ethanol leads to a reduced liver-metabolizing activity. This effect is reversed when the ethanol is eliminated. In a long-term alcoholic, induction of liver microsomal enzymes is common; if the individual is not intoxicated, drug metabolism may be enhanced. If cirrhosis of the liver occurs, overall metabolism is reduced because of impaired hepatic blood flow and destruction of liver tissue. The use of ethanol has several implications for drug metabolism.

Ethanol can also influence nutritional status. Ethanol inhibits the activation of vitamins A and D and causes depletion of pyridoxine. Trace metals, such as zinc and selenium, are also depleted. Cirrhosis of the liver leads to further reduction in nutritional status. Nutritional deficiencies are also common because ethanol can marginally meet an alcoholic's caloric needs without supplying other nutritional requirements. Other long-term effects are discussed later.

Kidney

Ethanol has a diuretic effect resulting from inhibition of anti-diuretic hormone secretion by the posterior pituitary. Urinary Na^+ , K^+ , and Cl^- concentrations are reduced, whereas Mg^{++} and norepinephrine are increased.

Sexual function

Ethanol interferes with sexual function in men and women. It can cause temporary impotence even though overall aggressiveness may be enhanced. Long-term alcoholism may lead to more lasting impotence and sterility. Testosterone production may be depressed, and testosterone metabolism may be enhanced, the latter as a result of induction of liver microsomal enzymes. Feminization in men is a possible outcome.

Blood lipids

A potential salutary effect of moderate consumption of ethanol relates to cholesterol status. Intake on the order of one to two drinks a day increases the ratio of high-density to low-density lipoproteins in the plasma, an effect inversely correlated with the incidence of coronary heart disease and myocardial infarction. Other effects, such as reduced platelet aggregation, may also provide a cardioprotective effect. In one study, men who were homozygous for the "slow" form of one of the isozymes of alcohol dehydrogenase, ADH3, had an especially enhanced increase in high-density lipoprotein and decreased risk of myocardial infarction.¹⁰

Alcohol consumption is associated with an increase in serum triglyceride levels. This association may pose a cardiovascular risk, and if the triglyceride levels are high enough, a risk of pancreatitis exists. The overriding issue for the individual and society as a whole is controlling ethanol intake to avoid its many adverse effects.

Other effects

Small oral doses of ethanol temporarily enhance salivary and gastric acid secretion—the increased salivation probably by a conditioned reflex. Large doses of alcohol reduce salivation. Ethanol is a gastric irritant, producing inflammation of the stomach wall in concentrations greater than 15%. Ingestion of solutions of more than 20% ethanol results in increased gastric mucus secretion and in petechial hemorrhage and ulceration. Ethanol retards intestinal absorption of glucose, amino acids, folic acid, thiamine, and vitamin B₁₂. Adrenal gland activation

results in increased blood concentrations of corticosteroids, epinephrine, and glucose.

The effects of ethanol on the peripheral vasculature, CNS, antidiuretic hormone secretion, and sexual function are summarized in the following exchange between Macduff and the porter in Shakespeare's *Macbeth*:

*Macduff: What three things does drink especially provoke?
Porter: Marry, Sir, nose-painting, sleep, and urine. Lechery, sir, it provokes and unprovokes: it provokes the desire but not the performance.¹⁵*

Absorption, Fate, and Excretion

Ethanol is rapidly absorbed from the stomach and small intestine. After oral ingestion, the rate of absorption largely depends on the gastric emptying time because 75% of a dose is rapidly and completely taken up from the small intestine. Patients with gastrectomy often note enhanced effects of ethanol. The rate of gastric absorption is reduced by the presence of food. Concentrations of ethanol greater than 20% retard absorption by inducing gastric mucosal irritation and pylorospasm.

Approximately 60% of inspired ethanol vapor is absorbed through the lungs, and intoxication can be achieved by this route. Percutaneous absorption can also occur and has led to death when infants were wrapped in ethanol-soaked cloth to treat hyperthermia.

After intravenous ethanol administration, the BAC exhibits an abrupt curvilinear decline, lasting 10 to 30 minutes, caused by distribution throughout total body water. This distributional phase is not noted in serial drinking situations, in which distributional equilibrium occurs in concert with gastrointestinal absorption.

After oral intake, the arterial BAC exceeds the venous BAC because of rapid tissue uptake of alcohol from capillary blood. Maximum electroencephalogram changes occur approximately 25 minutes before the maximum venous BAC is achieved. The BAC after ingestion of a fixed amount of alcohol is a function of sex, age, and adiposity of the drinker; the nature of the beverage; and the time over which it is ingested. In Table 43-3, which shows the influence of alcoholic beverage, age, and sex on BAC, the BAC has been calculated on the basis of reported age-corrected and sex-corrected values for total body water and blood water content.

TABLE 43-3

Equivalents of Alcoholic Beverages

FORM OF ALCOHOL	CLASSIFICATION OF DRINKER		POTENTIAL RESULTING BAC (mg/dL)*
	SEX	AGE (yr)	
Regular beer (12 oz, 3.5% ethanol)	Male	17-34	22.7
		57-86	25.5
	Female	20-31	27.7
Distilled spirits (1 oz, 40% ethanol) [†]	Male	60-82	30.7
		17-34	17.1
	Female	57-86	19.3
		20-31	21
		60-82	23.2

*Calculated on the basis of a lean body mass of 153.4 lb (70 kg).

[†]American proof number is twice the percentage of ethanol by volume. BAC, Blood alcohol concentration.

FIGURE 43-1 Metabolism of ethanol and its blockade by disulfiram. Disulfiram inhibits the mitochondrial and cytoplasmic forms of aldehyde dehydrogenase. MEOS, Microsomal enzyme oxidizing system.

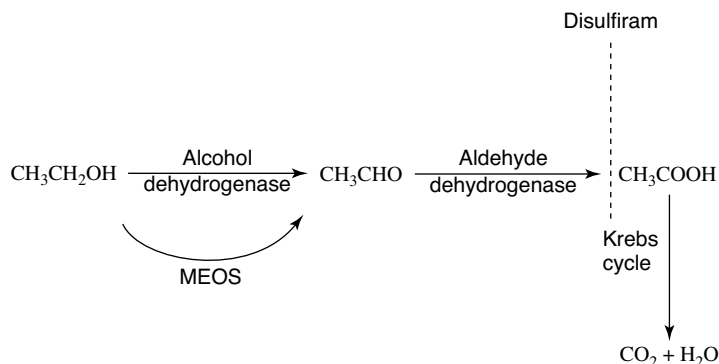

The tissue alcohol concentration is proportional to lean body weight and tissue water content. Considering the BAC as unity, the relative concentration of ethanol at equilibrium is 1.35 in urine, 1.17 in brain, 1.16 in blood plasma, 1.12 in saliva, 0.05 in alveolar air, and 0.02 in fat.

Under normal circumstances, more than 95% of ingested ethanol is metabolized. High doses of ethanol are associated with lower metabolism (approaching 90%). Metabolism occurs mostly by a three-phase hepatic oxidation (Figure 43-1). Ethanol is initially converted to acetaldehyde by alcohol dehydrogenase, which requires nicotinamide adenine dinucleotide (NAD) as the hydrogen acceptor:

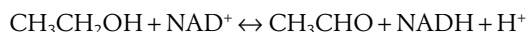

The binding of substrate and coenzyme to alcohol dehydrogenase involves sites on the enzyme containing zinc and sulfhydryl groups. Human alcohol dehydrogenase also oxidizes methanol, isopropyl alcohol, and ethylene glycol. This dehydrogenase reaction is the rate-limiting step in the metabolism of alcohol except in individuals who have a deficiency in the subsequent enzyme.

The second phase, conversion of acetaldehyde to acetate, occurs in liver and other tissues and is catalyzed by aldehyde dehydrogenase, which has a much greater affinity for acetaldehyde than does alcohol dehydrogenase:



In the third step, acetate, as acetyl coenzyme A, is oxidized further through the Krebs cycle to carbon dioxide and water.

The reductive environment resulting from ethanol oxidation upsets hepatic chemistry and results in reduced gluconeogenesis and enhanced triglyceride and lactate formation. Heavy bouts of drinking can cause hypoglycemia, lactic acidosis, and hyperuricemia (because acetate and lactate stimulate the synthesis of uric acid and inhibit its renal excretion), which can precipitate gout, hyperlipidemia, and fatty liver.

An alternative oxidative pathway for alcohol involving the microsomal enzyme oxidation system (MEOS) becomes an important factor in alcohol elimination at high BACs, during which it may account for 10% to 20% of ethanol metabolism.¹¹ This pathway also yields acetaldehyde. The MEOS pathway is inducible and may account for the higher metabolic inactivation of ethanol seen in individuals who abuse ethanol over the long-term.

Ethanol elimination seems to follow zero-order kinetics (it is pseudolinear regarding time) down to a certain BAC, where it assumes a curvilinear, first-order decline. The reported point at which this change occurs varies according to the study. Such elimination kinetics are best described by modified Michaelis-Menten models because the rate of pseudolinear elimination is dose-dependent, ranging from 16 to

25 mg/dL/hr as the peak BAC increases from 50 to 185 mg/dL. After low-moderate doses of ethanol, the rate of ethanol metabolism is approximately 80 mg/kg/hr, or roughly 5.6 g or 0.2 oz (of 100% ethanol) per hour for a 70-kg adult. Approximately 2% to 10% of absorbed alcohol is excreted unchanged, largely through the lungs and kidneys. Minor amounts are detectable in saliva, tears, sweat, and feces. Because ethanol is metabolized to acetate, it can provide calories (a maximum of approximately 1200 kcal/day). It provides no other essential nutrients, however, such as vitamins, amino acids, or fatty acids.

Drug Interactions

Ethanol produces additive effects with all CNS depressants and increases the hypotensive effects of most vasodilators. Long-acting drugs such as diazepam may cause increased depression with ingested alcohol for 24 hours after the drug was given. The benzodiazepine-ethanol combination seems to pose a particular risk. At high BACs, ethanol may inhibit the metabolism of, and potentiate the effects of, benzodiazepines and some other CNS depressants. Short-term alcohol ingestion may also result in exaggerated clinical responses to oral anticoagulants and hypoglycemic agents.

The use of ethanol influences the *in vivo* absorption of certain drugs. Short-term ethanol ingestion increases, although long-term alcoholism reduces, the oral absorption rate of diazepam. Ethanol also inhibits the absorption and enhances the breakdown of penicillins in the stomach for 3 hours after ethanol intake. Aspirin and other nonsteroidal anti-inflammatory drugs (NSAIDs) promote gastric bleeding when combined with ethanol and can cause gastric hemorrhage in alcoholics who have alcoholic gastritis.

In a long-term alcoholic without liver damage, induction of MEOS activity occurs. Increased enzyme activity appears after approximately 3 weeks of heavy drinking and lasts 4 to 9 weeks after the cessation of drinking. A significant reduction in plasma half-life of, and clinical response to, many drugs occurs (e.g., intravenous anesthetics, barbiturates, anti-anxiety drugs). In long-term alcoholics, the development of hepatic damage offsets the effects of enzyme induction, and drug sensitivity may return to normal. Eventually, cirrhosis leads to significantly reduced drug metabolism. The induction of liver microsomal enzymes with long-term ethanol ingestion is the basis for the enhanced toxicity of acetaminophen in long-term alcohol abusers. Induction of the cytochrome enzymes, CYP2E1 and CYP3A4, favors the production of reactive and hepatotoxic metabolites of acetaminophen (see Chapter 21).¹⁷ Under certain circumstances, acute ingestion of ethanol can protect against acetaminophen toxicity because at higher blood alcohol levels the metabolism of acetaminophen to toxic metabolites is inhibited despite a concurrent long-term inductive effect of ethanol.

Drugs that inhibit aldehyde dehydrogenase can lead to unpleasant and potentially life-threatening symptoms after ethanol ingestion. These inhibitors include disulfiram (Antabuse), which is given to prevent the use of ethanol by abusers; metronidazole; certain cephalosporins; and oral hypoglycemics. Acutely, acetaldehyde can cause flushing, headache, nausea and vomiting, hypotension, blurred vision, and mental confusion. Because acetaldehyde concentrations vary directly with ethanol intake, high doses of ethanol alone may lead to these symptoms. If aldehyde dehydrogenase is inhibited by drugs such as disulfiram, even low and moderate amounts of ethanol can lead to adverse reactions because of acetaldehyde accumulation. Individuals with a genetic deficiency in aldehyde dehydrogenase, which is common in certain races, also experience the accumulation of acetaldehyde and have alcohol intolerance.

General Therapeutic Uses

Topically applied 70% ethanol is used as a rubefacient, anhidrotic, and antiseptic and as a means to cool the skin in cases of fever. Ethanol is a solvent for the irritating principle of poison ivy, and its early use on affected skin can markedly reduce resulting dermatitis.

Absolute ethanol has been injected to destroy nerves or ganglia in treating intractable pain arising from conditions such as trigeminal neuralgia and inoperable cancer. Other treatment modalities are usually more desirable, however. Ethanol is also used to treat poisoning by methanol, isopropyl alcohol, and ethylene glycol.

Therapeutic Uses and Implications for Dentistry

Uses of ethanol in dentistry as an antiseptic and disinfectant are discussed in Chapter 46. The dentist can expect to encounter alcoholic patients in everyday practice. Alcoholics usually exhibit signs of deficient oral hygiene, such as coated tongue and heavy plaque and calculus deposits. They have twice the rate of tooth loss of the general population, commonly lack mandibular and maxillary first molars, and frequently have severe chronic periodontitis. Chronic asymptomatic enlargement of the parotid, and sometimes submandibular, glands may be observed. The dentist should be aware of the increased incidence of oral leukoplakia in alcoholics and be familiar with its appearance, particularly the erosive form, because 6% of such individuals develop carcinoma, especially of the tongue, within 9 years of diagnosis of the lesion. Postoperative healing time is prolonged in alcoholics; this may be related to a marked increase in collagenase activity, which has been observed in the liver of alcoholics. The potential interactions of ethanol with acetaminophen and NSAIDs should be kept in mind. Large therapeutic doses of acetaminophen should be avoided in moderate to heavy drinkers. Concurrent intake of NSAIDs and ethanol should be avoided.

Alcohol Dependence

Abuse characteristics

Alcoholism is similar to dependence on CNS depressants except that ethanol produces unique direct neurologic, hepatic, and muscular toxicity. Because ethanol can provide a major source of dietary calories, it also promotes malnutrition in chronic drinkers. Ethanol dependence is characterized by marked psychic and physical dependence, moderate tolerance, and a wide range of pathologic sequelae.

Emotional dependence on alcohol is severe. An alcoholic develops a compulsion to obtain and use the drug to the extent that all other activities become secondary, and deterioration of personal and social concerns ensues. Personal, social, and medical problems appear early in life, and life expectancy is decreased. Alcoholism has a partial genetic basis, with

a degree of heritability approximately that of diabetes mellitus.

Tolerance develops to ethanol after long-term abuse, but the degree of tolerance, as with other sedative-hypnotics, is much less than that which occurs with opioids. Tolerance to ethanol is partly a result of behavioral adaptation to the effects of ethanol. Adaptive changes by receptor mechanisms and membrane fluidity may also play a role. Induction of MEOS increases the rate of ethanol metabolism. The acute lethal dose of ethanol is not greatly increased, however, over that for nonalcoholics. Cross-tolerance with other sedative-hypnotics also occurs.

Alcohol abstinence syndrome

The severity of acute alcohol abstinence syndrome correlates with the amount and duration of preabstinent ethanol intake. The mildest form is the tremulousness and nausea experienced “the morning after,” which is readily reversed by “taking a hair of the dog” (i.e., a small amount of ethanol). The most severe abstinence syndrome is delirium tremens. Severe withdrawal symptoms appear 6 to 8 hours after drinking ceases, peak at 48 to 96 hours, and generally resolve in approximately 2 weeks.

Moderate abstinence results in anorexia, nausea, epigastric upset, tremulousness, sweating, apprehension, and insomnia. In more severe abstinence, additional symptoms of diarrhea, vomiting, nightmares, and agitation occur, together with autonomic signs of tachycardia, hyperpnea, and fever. Delirium tremens, if it occurs, is manifested by all the preceding symptoms together with possible psychosis, seizures, and hyperthermia. Psychotic manifestations include muttering; delirium; paranoia; delusions; and auditory, visual, and tactile hallucinations of a threatening nature. The individual usually displays agitation, confusion, disorientation, and panic. The hallucinatory symptoms appear to be at least partially the result of excessive rebound rapid eye movement sleep that, having been suppressed during the drinking phase, spills over into the waking state during withdrawal. Neuromuscular hyperexcitability is manifested by gross tremors and grand mal convulsions (with a marked sensitivity to stroboscopically induced seizures), both of which correlate with a rapid urinary excretion of Mg^{++} and a resultant hypomagnesemia during withdrawal. Abstinence may also lead to hyperthermia and circulatory collapse.

Pathologic sequelae of alcoholism

Chronic alcoholism is associated with numerous severe physical complications, primarily of the nervous and gastrointestinal systems and of skeletal and cardiac muscle (Table 43-4). Alcohol damage to the liver, in which extensive oxidative ethanol metabolism occurs, results from direct acetaldehyde and ethanol toxicity and the reductive environment brought on by ethanol metabolism. Ethanol metabolism by alcohol dehydrogenase and MEOS activity leads to acetaldehyde production. Acetaldehyde has several short-term and long-term adverse effects. The short-term effects have been previously reviewed. Over the long-term, acetaldehyde is responsible for nutritional depletion in the liver and depletion of glutathione. It enhances lipid peroxidation and membrane damage. Triglyceride accumulation is also favored by the reductive environment from excess NADH production resulting from ethanol oxidation. The incidence of liver cancer is higher in alcoholics.¹⁶

Ethanol has also been shown to change the flora in the gastrointestinal tract, favoring the growth of certain gram-negative bacteria. This growth leads to the production of more bacterial endotoxins (lipopolysaccharides).^{5,12} Damage to the gastrointestinal tract leads to greater absorption of toxins. Endotoxins stimulate liver Kupffer cells, which produce

TABLE 43-4

Pathologic Sequelae of Alcoholism

SYSTEM OF ORIGIN	SYNDROME	CAUSES	SIGNS AND SYMPTOMS
Nervous system	Wernicke's syndrome	Ethanol toxicity, malnutrition	Confusion, amnesia, confabulation, peripheral neuropathy, diplopia, nystagmus, tremor, ataxia
	Korsakoff's psychosis	Ethanol toxicity, malnutrition	Disorientation, amnesia, confabulation, peripheral neuritis
	Cerebral atrophy	Ethanol toxicity, malnutrition	Irreversible degeneration of frontal lobe cortical cells with premature senility, dementia, personality disintegration
	Cerebellar atrophy Peripheral neuropathy	Ethanol toxicity, malnutrition Thiamine deficiency	Irreversible ataxia Diminished tendon reflexes, sensory loss in feet or legs, muscle atrophy
Gastrointestinal tract	Esophagitis and gastritis	Secretory and inflammatory effects of ethanol	Heartburn, vomiting, gastric ulceration, hematemesis
	Peptic ulcers	Secretory and inflammatory effects of ethanol	Epigastric pain, anorexia, vomiting
	Pancreatitis	Secretory effect of ethanol, obstruction of pancreatic duct	Weight loss, abdominal pain, blood loss, shock
Liver	Steatosis or fatty liver	Direct toxicity of acetaldehyde and ethanol, reductive environment	Enlarged liver
	Alcoholic hepatitis	Direct toxicity of acetaldehyde and ethanol, reductive environment	Anorexia, vomiting, weakness, jaundice, ascites, enlarged spleen and liver
	Laënnec's cirrhosis	Direct toxicity of acetaldehyde and ethanol, reductive environment	Jaundice, portal hypertension, mental deterioration, renal failure, coma
Skeletal muscle	Alcoholic myopathy	Ethanol toxicity	Cramping, weakness, edema, atrophy of muscle
Cardiac muscle	Alcoholic heart muscle disease	Direct toxicity of ethanol and acetaldehyde	Weakness, shortness of breath, congestive heart failure, pulmonary congestion
Fetus	Fetal alcohol syndrome	Ethanol toxicity	Microcephaly; reduced IQ; facial, cardiac, and genital defects

inflammatory mediators and oxygen radicals that cause apoptotic changes in hepatic parenchymal cells (Figure 43-2). Damage by this mechanism may account partly for short-term and long-term changes. Free radical production in parenchymal cells may also occur, which could contribute to overall liver damage. Polymorphonuclear leukocytes are stimulated to release damaging mediators.

In addition, induction of cytochrome enzymes, especially CYP2E1, and changes to mitochondria lead to generation of reactive oxygen species, which damage hepatocytes (see Figure 43-2). Apoptosis of hepatocytes may also be favored by the ability of ethanol to inhibit insulin-like growth factor receptor signaling. Alcoholic liver damage is heralded by the appearance of steatosis, or fatty liver, which is a benign and reversible syndrome seen almost universally among heavy drinkers. Hepatomegaly, associated with this early phase of liver disease, is caused by lipid accumulation and water retention, resulting in "ballooning" of hepatocytes. The fatty liver phase of liver damage can progress to generalized hepatic inflammation and "florid" alcoholic hepatitis, a condition that has a 10% to 30% fatality rate. In 10% to 15% of heavy drinkers, fatty liver progresses to Laënnec's cirrhosis. The toxic effects on the liver of long-term ethanol abuse are summarized in Figure 43-2.

Ethanol-induced damage in organs lacking significant ethanol oxidative capacity may result from enzyme-catalyzed esterification of fatty acids with ethanol.² Transient accumulation of such fatty acid ethyl esters, or their fatty acid metabolites, seems to inhibit oxidative phosphorylation and may alter plasma membranes, leading to damage in organs such as the heart, pancreas, and brain.^{2,4}

Cardiovascular complications of alcoholism include cardiac disease, hypertension, and atrial arrhythmias, the first accounting for one third of deaths among heavy drinkers. Alcoholic heart muscle disease results from long-term intake of ethanol.¹⁸ This disease is characterized by cardiomegaly (heart weight doubles in 28% of heavy drinkers), biventricular congestive failure (with pulmonary and peripheral edema), breathlessness, and sometimes arrhythmias. Treatment is the same as for other types of congestive heart failure, coupled with permanent abstinence from ethanol. Alcoholic hypertension is exhibited, especially in white men, as a reversible dose-dependent increase in systolic and diastolic blood pressures and can be associated with only moderately heavy ethanol consumption. The "holiday heart syndrome" refers to severe atrial arrhythmias precipitated by bouts of periodic heavy drinking.¹⁸

The inflammatory effects of alcohol on the gastrointestinal tract lead to esophagitis and chronic gastritis frequently associated with intense episodes of vomiting, which may lead to gastric laceration and hematemesis. There is a high correlation between heavy drinking and cancer of the mouth and throat. Peptic ulcers and pancreatitis are common among alcoholics.

Effects of alcohol on skeletal muscle may produce acute alcoholic myopathy characterized by muscle cramps, weakness, and swelling, which resolve after a few weeks of alcohol abstinence. In severe cases, extensive muscle degeneration results in myoglobinemia, hyperkalemia, and renal failure. A chronic form of alcoholic myopathy ultimately produces marked muscular atrophy, usually of the pelvic girdle and thighs.

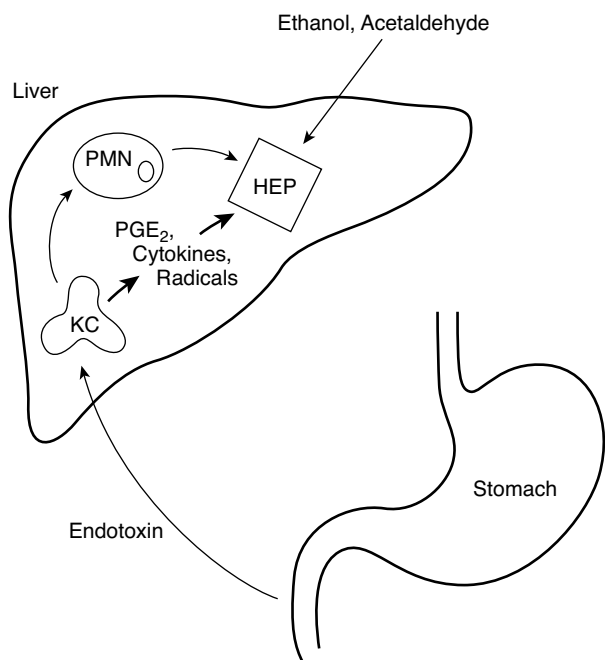

FIGURE 43-2 Mechanism of liver damage from ethanol. Use of ethanol leads to an increase in certain intestinal gram-negative organisms, resulting in an increase in endotoxins. These stimulate Kupffer cells (*KC*) in the liver to produce mediators, including prostaglandin E₂ (*PGE*₂), cytokines, and free radicals, which damage hepatocytes (*HEP*). Effects on *KC* lead to stimulation of polymorphonuclear leukocytes (*PMN*), which also release mediators that damage liver cells.⁵ Ethanol and acetaldehyde induce cytochrome P450 enzymes (*CYP*), especially *CYP2E1*, and damage mitochondria resulting in production of reactive oxygen species that damage hepatic hepatocytes.¹² Ethanol or acetaldehyde may also act directly on hepatocytes to alter lipid metabolism, damage cell macromolecules, or block the effect of insulin-like growth factor. (Modified from Thurman RG: Mechanisms of hepatic toxicity, II: alcoholic liver injury involves activation of Kupffer cells by endotoxin, *Am J Physiol* 275:G605-G611, 1998.)

Fetal alcohol syndrome is a cluster of physical and mental defects occurring in children of women who consume ethanol during pregnancy.⁶ In more than 90% of cases of fetal alcohol syndrome, there is growth deficiency, microcephaly, and short palpebral fissures. Also common are midfacial hypoplasia, mental retardation, and deficiencies in coordination and fine motor skills. The mental and motor deficiencies may be causally related to the developmental abnormalities of cortical neurons, as observed in rats prenatally exposed to ethanol.¹⁴ The degree of dysmorphogenesis correlates with mental deficiency, with IQs ranging from 55 to 82. Neither the dysmorphic nor the intellectual aspects of fetal alcohol syndrome improve with age. Pregnant patients should be advised to avoid alcoholic beverages and to be aware of the alcoholic content of food and drugs.

Central and peripheral nerve degeneration occur, resulting in a wide range of neurologic disorders involving psychological and personality changes and peripheral neuritis, sensory loss, and muscle atrophy. Changes in the nervous system are related partially to malnutrition, and most respond to thiamine administration, indicating a thiamine deficiency.⁹

Ethanol changes plasma membranes and their component lipids and alters protein and DNA synthesis. Mechanisms

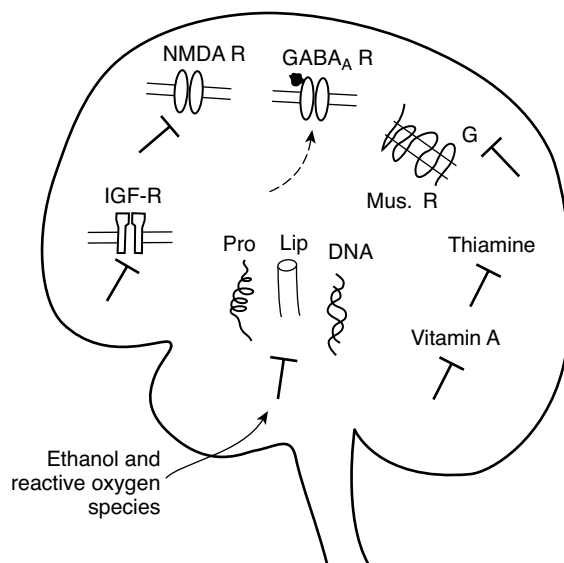

FIGURE 43-3 Mechanisms by which ethanol may damage the brain. Ethanol inhibits N-methyl-D-aspartate (*NMDA*) receptor (*R*) function initially, followed by supersensitivity of the receptor; stimulates *GABA*_A receptor function (arrow); inhibits muscarinic receptor function (*Mus. R*); inhibits insulin-like growth factor receptor function (*IGF-R*); depletes thiamine; and alters the metabolism of vitamin A. In addition, cell toxicity may result from ethanol itself or from reactive oxidative species that alter membrane lipids, proteins, and DNA. *Lip*, Lipid; *Pro*, protein.

accounting for these changes may be at the receptor or signal transduction level, or both, and may be one result of producing reactive oxygen species. Ethanol has also been shown to inhibit the proliferation and growth of glial and neuronal cells resulting from muscarinic receptor stimulation. Muscarinic receptors have been proposed to play a crucial role in synaptogenesis in the developing brain.⁷ Ethanol may disrupt this process by inhibiting signaling at the G protein level. Changes in vitamin A metabolism and the previously mentioned inhibition of the insulin-like growth factor receptor are also potential mechanisms of fetal damage. It has also been reported that ethanol can cause an apoptotic pattern in the developing rat brain that is consistent with its ability to block *NMDA* receptors and to stimulate *GABA*_A receptors. Toxic effects of ethanol on the brain are summarized in Figure 43-3.

Women are more susceptible to the toxic effects of ethanol than men. The smaller average size of women is part of the reason blood alcohol levels are higher than in men for comparable alcohol intakes. Women also have higher levels of alcohol dehydrogenase and produce higher levels of tissue and plasma acetaldehyde. In addition, estrogens enhance the toxic effect of ethanol on the liver. Tissue hypoxia, fibrosis, extent of fat distribution, and level of endotoxin all are elevated in women compared with men, and estrogen seems to be a major factor.

Treatment of alcoholism

The treatment of alcoholism involves the detoxification of an acutely inebriated individual, medication to prevent severe symptoms of abstinence, and long-term rehabilitation. The rate of detoxification is determined largely by the rate at which the liver disposes of the ethanol, but the nature of the withdrawal period also depends on the degree of dependence, the environment, and the nutritional status of the patient. The symptoms associated with abstinence are usually treated with

a benzodiazepine (e.g., diazepam, oxazepam). Supplemental dietary thiamine and other vitamins may be given. In addition, three other drugs are approved for treating alcohol dependence: naltrexone, disulfiram, and acamprosate. All modalities of drug treatment for alcoholics are more clinically effective when accompanied by behavioral therapy.

Naltrexone is a long-acting opioid receptor antagonist. Although it is available orally, for treating alcohol dependence the approved form is a once-a-month extended-release intramuscular injection. Naltrexone reduces the rewarding effects of alcohol by interfering with the activation of dopaminergic reward pathways in the brain. The most common adverse effect of naltrexone is nausea. Liver damage can result from abnormally high doses. The pharmacology of naltrexone is discussed further in Chapter 20.

Disulfiram is used in avoidance therapy for alcoholics because alcohol intake with disulfiram leads to very unpleasant reactions in patients. Disulfiram is rapidly converted to metabolites such as diethylthiocarbamate and diethylthiomethylcarbamate. These and possibly other metabolites probably account for the action of the drug (see Figure 43-1). Disulfiram inhibits aldehyde dehydrogenase through the formation of a covalent disulfide bond between an enzymic thiol group and an active drug metabolite. The enzyme is inhibited irreversibly. Disulfiram also inhibits other enzymes, notably dopamine β -hydroxylase and oxidases of MEOS.

Oral doses of disulfiram have an onset of action of approximately 12 hours, and the effects are evident for 2 weeks after treatment is stopped. The protracted duration of action is based on the irreversible nature of the binding of disulfiram metabolites. Only with the synthesis of new enzyme does the metabolism of ethanol return to normal. Disulfiram itself commonly produces drowsiness, and in large daily doses it may cause paresthesias and muscle weakness. The drug may exaggerate schizophrenia or depression, possibly through alteration of central monoamine concentrations caused by the inhibition of dopamine β -hydroxylase.

If ethanol is ingested during disulfiram treatment, symptoms of acetaldehyde poisoning develop. Drinking 1.2 oz of 80 proof liquor causes flushing, tachycardia, palpitation, and tachypnea, all lasting approximately 30 minutes. Ingestion of more than 1.6 oz of 80 proof liquor produces intense palpitation, dyspnea, nausea, vomiting, and headache lasting up to 90 minutes. Unconsciousness, hypotensive shock, and sudden myocardial infarction may occur. For this reason, disulfiram must be used only under strict medical supervision.

Disulfiram inhibits oxidative biotransformation, but not glucuronide conjugation of benzodiazepines (see Chapter 13). Hypotensive episodes may occur during general anesthesia as a result of dopamine β -hydroxylase inhibition and depletion of neuronal norepinephrine. Even large therapeutic doses fail to alter the cardiovascular response to pressor amines of either the direct-acting or indirect-acting variety. Paraldehyde, because of its metabolic conversion to acetaldehyde, produces toxic reactions in patients taking disulfiram.

Acamprosate (calcium acetylhomotaurine) is a GABA analogue that is used to reduce relapse in alcoholics. The drug can reduce nerve excitotoxicity caused by alcohol; this is likely due to its ability to block group 5 metabotropic glutamate receptors (mGluR5).⁵ This activity seems to promote abstinence and reduce alcohol withdrawal symptoms. Acamprosate can be used in combination with naltrexone or disulfiram. Diarrhea is the most common adverse effect, although other gastrointestinal symptoms may occur. There is evidence from animal studies that acamprosate is a teratogen. Rarely, the drug may be associated with renal failure or suicidal ideation.¹

METHANOL

Methanol is widely used as an industrial solvent, as a denaturing agent for ethanol, and in "canned heat." Poisoning occurs when substances containing methanol are used as beverages in place of alcohol or when industrial workers are exposed to atmospheres containing methanol vapor. The metabolism of methanol involves the same enzyme systems as that of ethanol. Its elimination follows zero-order kinetics, but at a much slower rate than ethanol. This slow metabolism accounts for the delay in symptoms of methanol poisoning, which are caused by its oxidized metabolites formaldehyde and formic acid.

Symptoms of methanol poisoning include early mild inebriation followed in 6 to 30 hours by dizziness, headache, vertigo, and occasional nausea and vomiting. As acidosis is produced by the accumulation of formic acid, extreme abdominal pain develops, respirations increase in depth and frequency, and the patient lapses into coma. Visual symptoms are characteristic of methanol intoxication. Blurred vision, with spots or gray mist, photophobia, and eye tenderness, commonly occurs. The pupils are dilated, and the light reflex becomes sluggish. Permanent blindness is not uncommon even if the victim completely recovers. Visual damage develops because of the high rate of retinal oxidation of methanol, leading to formaldehyde and formic acid accumulation with edema and permanent damage to ganglion cells.

Death follows the ingestion of 2 to 8 oz of methanol and is associated with blood concentrations of 74 to 110 mg/dL of methanol and 9 to 68 mg/dL of formic acid. The urinary methanol concentration is approximately twice that in blood and is diagnostic of methanol poisoning. The direct cause of death is cessation of respiration. Breathing becomes shallow and slow, tonic seizures develop, and the victim dies with a marked terminal inspiratory gasp.

The treatment of choice is hemodialysis, which provides rapid recovery without residual effects. Peritoneal dialysis, although also indicated, is less efficient. Acidosis is treated with intravenous infusions of sodium bicarbonate solution. Because ethanol is the preferred substrate for alcohol dehydrogenase, the administration of ethanol can be used to inhibit the formation of toxic methanol metabolites. For this purpose, ethanol should be administered intravenously or given orally to maintain a BAC of 100 mg/dL.

ISOPENTANOL

Isopentanol is also present in alcoholic beverages, albeit typically at concentrations less than 0.5%. At least some effects of ethanol are shared by isopentanol, including induction of liver microsomal enzymes and enhancement of acetaminophen toxicity. The combination of isopentanol and ethanol may constitute a synergistic combination for some responses.

ISOPROPYL ALCOHOL

Isopropyl alcohol is used as an antiseptic and disinfectant in dentistry. In a concentration of 70%, it is used as rubbing alcohol, and it is present in many hand lotions. Isopropyl alcohol is oxidized in vivo to acetone, which is largely excreted in expired air at 10 times the rate of ethanol.

Toxicity arises if isopropyl alcohol is ingested. Symptoms are similar to the symptoms of ethanol intoxication but are marked by nausea, vomiting, abdominal pain, hematemesis, and melena. Severe renal dysfunction for 2 to 3 weeks is seen in survivors. Extensive hemorrhagic inflammation and edema of the bronchopulmonary tree are observed in fatal cases.

Hemodialysis is the treatment of choice in isopropyl alcohol poisoning. Ethanol seems to increase, rather than reduce, the toxic effects of isopropyl alcohol.

ETHYLENE GLYCOL

Ethylene glycol is used as an antifreeze and is highly toxic if ingested. Ethylene glycol is a CNS depressant. It is metabolized by alcohol dehydrogenase to glycoaldehyde and then by aldehyde dehydrogenase to glycolic acid. Glycolic acid is converted to oxalic acid. Metabolites seem to be largely responsible for the acute renal toxicity seen with ethylene glycol. This finding may be particularly true for oxalic acid, which forms crystals in the renal tubules.

Toxicity caused by ethylene glycol is treated by correcting the metabolic acidosis with sodium bicarbonate. Ethanol is also used to prevent the conversion of ethylene glycol to its metabolites by competing for alcohol dehydrogenase. To treat ethylene glycol toxicity, 4-methylpyrazole, a potent inhibitor of alcohol dehydrogenase, is used.

PROPYLENE GLYCOL

Propylene glycol is used as a replacement for ethylene glycol. It is an effective antifreeze and is much less toxic than ethylene glycol. Propylene glycol is also used as a solvent for drugs and in food. Although it can depress the CNS, little effect is seen at concentrations normally encountered.

DRUGS USED FOR DETOXIFICATION FROM ALCOHOL AND FOR TREATMENT OF ALCOHOL DEPENDENCE

<i>Nonproprietary (generic) name</i>	<i>Proprietary (trade) name</i>
Benzodiazepines	
Diazepam	Valium
Oxazepam	Serax
Opioid antagonist	
Naltrexone	Vivitrol
Alcohol dehydrogenase inhibitor	
Disulfiram	Antabuse
Glutamate (mGluR5) receptor antagonist	
Acamprosate	Campral

CITED REFERENCES

1. Acamprosate campral for alcoholism. *Med Lett Drugs Ther* 47:1-3, 2005.
2. Baker RC, Kramer RE: Cytotoxicity of short-chain alcohols. *Annu Rev Pharmacol Toxicol* 39:127-150, 1999.
3. Baumberg B: The global economic burden of alcohol: a review and some suggestions. *Drug Alcohol Rev* 25:537-551, 2006.
4. Beckemeier ME, Bora PS: Fatty acid ethyl esters: potentially toxic products of myocardial ethanol metabolism. *J Mol Cell Cardiol* 30:2487-2494, 1998.
5. Bode C, Bode JC: Activation of the innate immune system and alcoholic liver disease: effects of ethanol per se or enhanced intestinal translocation of bacterial toxins induced by ethanol? *Alcohol Clin Exp Res* 11(Suppl):166S-171S, 2005.
6. Chiriboga CA: Fetal alcohol and drug effects. *Neurologist* 9:267-279, 2003.
7. Costa LG, Vitalone A, Guizzetti M: Signal transduction mechanisms involved in the antiproliferative effects of ethanol in glial cells. *Toxicol Lett* 149:67-73, 2004.
8. De-Witte P, Littleton J, Parot P, et al: Neuroprotective and abstinence-promoting effects of acamprosate: elucidating the mechanism of action. *CNS Drugs* 19:517-537, 2005.
9. Harper C: The neurotoxicity of alcohol. *Hum Exp Toxicol* 26:251-257, 2007.
10. Hines LM, Stampfer MJ, Ma J, et al: Genetic variation in alcohol dehydrogenase and the beneficial effect of moderate alcohol consumption on myocardial infarction. *N Engl J Med* 344:549-555, 2001.
11. Lieber CS: The discovery of the microsomal ethanol oxidizing system and its physiologic and pathologic role. *Drug Metab Rev* 36:511-529, 2004.
12. Lumeng L, Crabb DW: Alcoholic liver disease. *Curr Opin Gastroenterol* 16:208-218, 2000.
13. McKnight AJ, Langston EA, McKnight AS, et al: Sobriety tests for low blood alcohol concentrations. *Accid Anal Prev* 34:305-311, 2002.
14. Miller MW: Effects of alcohol on the generation and migration of cerebral cortical neurons. *Science* 233:1308-1311, 1986.
15. Shakespeare W: Macbeth. In Wells S, Taylor G, editors: *William Shakespeare, the complete works*, Oxford, 1986, Clarendon Press.
16. Voigt MD: Alcohol in hepatocellular cancer. *Clin Liver Dis* 9:151-169, 2005.
17. Wolf KK, Wood SG, Allard JL, et al: Role of CYP3A and CYP2E1 in alcohol-mediated increases in acetaminophen hepatotoxicity: comparison of wild-type and CYP2E1(−/−) mice. *Drug Metab Dispos* 35:1223-1231, 2007.
18. Zhang X, Li SY, Brown RA, et al: Ethanol and acetaldehyde in alcoholic cardiomyopathy: from bad to ugly en route to oxidative stress. *Alcohol* 32:175-186, 2004.

GENERAL REFERENCES

- Karch SB, editor: *Drug abuse handbook*, Boca Raton, FL, 2007, CRC Press/Taylor Francis.
- Leevy CB, Elbeshbeshy HA: Immunology of alcoholic liver disease. *Clin Liver Dis* 9:55-66, 2005.
- Watson RR, Preedy VR, editors: *Nutrition and alcohol: linking nutrient interactions and dietary intake*, Boca Raton, FL, 2004, CRC Press.

Anticaries Agents*

SARAT THIKKURISY

Dental caries is a pathologic process of microbial etiology that results in localized destruction of tooth tissues. From an anatomic and microbiologic perspective, there are several different types: pit and fissure caries, smooth surface caries, root caries, and deep dentinal caries. The process of tooth destruction involves dissolution of the mineral phase, consisting primarily of hydroxyapatite crystals, by organic acids produced by bacterial fermentation. To appreciate the activities of anticaries agents, it is imperative to understand that the initiation and progression of caries is based on the principle of remineralization versus demineralization as part of a dynamic continuum. The resulting balance between these two directly controls the effusion and diffusion of minerals into and out of the enamel lattice. Figure 44-1 outlines protective and pathologic factors for dental caries.²⁵ The biologic basis of dental caries involves three principal factors: the host, particularly the saliva and teeth; the microflora; and their substrate, the diet. In addition, a fourth factor, time, must be considered in any discussion of the causes of caries. These factors can be portrayed as four overlapping circles (Figure 44-2).

For caries to occur, conditions within each of these factors must be favorable. Caries requires a susceptible host, a cariogenic oral flora, and a suitable substrate, all of which must be present together for a sufficient length of time. Modern-day caries prevention is based on attempts to modify these three core features. Examples include therapies used with the intent to (1) increase the resistance of the host (fluoride therapy, occlusal sealants, immunization), (2) reduce the number of cariogenic microorganisms in contact with the tooth (plaque control and antiplaque agents), (3) modify the substrate by selecting noncariogenic foods, and (4) reduce the time that the microflora is provided with substrate by limiting the frequency of intake of fermentable substrate. Consideration of all four factors is beyond the scope of this chapter. Dietary factors, caries immunization, and occlusal sealants are discussed in detail in textbooks on nutrition and cariology. Concerning host factors, an adequate quantitative and qualitative flow of saliva are well-recognized protective mechanisms. Problems of xerostomia, particularly as a side effect of various drugs, are discussed elsewhere in this book. This chapter addresses fluorides as the anticaries agents for increasing host resistance to decay and as antibacterial agents.

Fluorine is a member of the halogen family. It is the most electronegative of all the elements, which makes it extremely

reactive. Fluorine combines with almost every element. It is also reactive with organic radicals. It is rarely found in the free state in nature but is widely distributed as fluorides* in the earth's crust, ranking seventeenth in abundance (0.06% to 0.09%). It usually occurs in minerals such as fluorspar (CaF_2), cryolite (Na_3AlF_6), or fluorosilicates (Na_2SiF_6) and in rocks in the form of mica, hornblende, and pegmatite. In biologic mineralized tissues, such as bones and teeth, it occurs as an impure apatite crystal, not as fluorapatite ($\text{Ca}_{10}[\text{PO}_4]_6\text{F}_2$). The lattice of biologic apatite crystals contains many impurities, either in the lattice itself or adsorbed on the surface.⁸¹ Carbonate ions (2% to 5%) substitute for some phosphate ions; some Ca^{++} is substituted by other ions, such as Na^+ , K^+ , Mg^{++} , and Zn^{++} ; and some hydroxyl ions are substituted by fluoride. The approximate representation of the formula of this apatite is $\text{Ca}_{10-x}(\text{Na})_x(\text{PO}_4)_{6-y}(\text{CO}_3)_z(\text{OH})_{2-u}(\text{F})_u$. Although only some of the hydroxyls of the apatite lattice are substituted by fluoride (i.e., u is much smaller than 2), this change profoundly alters the resistance of enamel to demineralization.

In this discussion, fluoride therapy for the prevention of dental caries is considered under two main headings: systemic fluoride and topical fluoride. Although such a division is convenient for didactic purposes and serves to distinguish between the very low dosages used systemically and the higher concentrations of fluoride used topically, it has become increasingly evident that such a separation is not absolute and that fluorides, while being ingested for their systemic effect, also have a topical benefit even at low concentrations on teeth that are already erupted. This topical effect can be direct, while the fluoride-containing water, tablets, or drops are being ingested, or indirect, from the slight elevation in salivary fluoride concentration after ingestion. Conversely, topical fluoride agents may be swallowed, particularly by young children, and exert a systemic effect on teeth that are still undergoing mineralization.

Previous theories held that systemically acquired fluoride (pre-eruptive) was of prime importance in caries prevention and that it was unnecessary to continue the use of fluoridated water after the enamel had calcified.⁵² Subsequent findings clearly showed a benefit, however, of posteruptive or topical fluoride exposure; in children in some communities that stopped fluoridating the water or in children who moved away from fluoridated communities, caries rates increased. More recently, some investigators have argued that posteruptive or topical fluoride effects are of sole importance in caries prevention and that systemic benefits are minimal.^{24,47} Careful analyses of caries epidemiology in teeth according to their eruption time, as related to the onset of water fluoridation, have revealed, however, significant pre-eruptive and posteruptive

*The author recognizes Dr. Ernest Newbrun for his past contributions to this chapter.

*In this chapter, the term *fluoride* is used to indicate the element as the free anion or as linked to other elements in molecular form.

Rights were not granted to include this figure in electronic media.
Please refer to the printed publication.

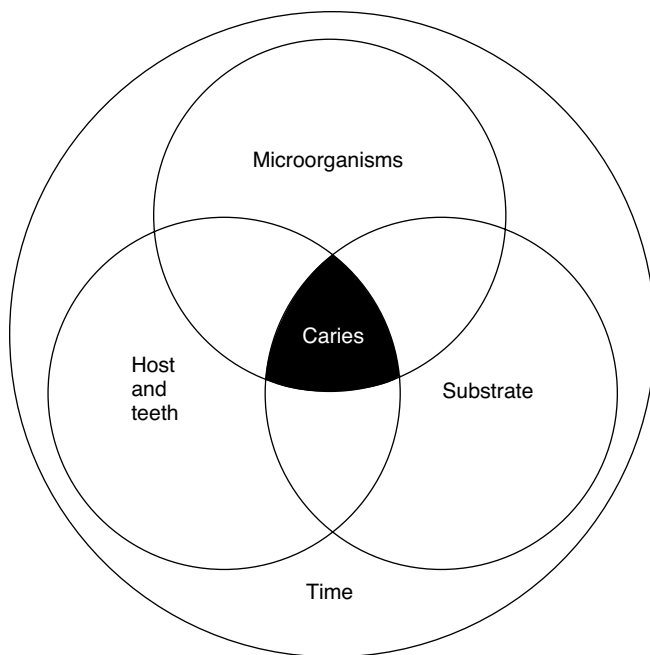

FIGURE 44-2 Etiology of dental caries. The three inner circles represent the factors involved in the carious process; all three must be acting concurrently for caries to occur. The fourth all-inclusive circle represents time, which affects each of the individual factors.

beneficial effects.^{30,77} Approximately two thirds of the greatest reductions in pit and fissure caries came from pre-eruptive fluoride, whereas in smooth surfaces the decrease was only 25%. In approximal surfaces, half the reduction was from pre-eruptive fluoride, and half was from posteruptive fluoride.³¹ Maximal caries-preventive effects of fluoridated water were achieved by optimal pre-eruptive and posteruptive exposure of all surfaces types.⁷⁷

SYSTEMIC FLUORIDE

Fluoridation of Communal Water Supplies

Classic epidemiologic surveys of the prevalence of dental caries, carried out by Dean and others during the late 1930s and early 1940s, showed an inverse relationship between

FIGURE 44-1 Schematic diagram representing the balance between pathologic factors and protective factors in the dental caries process. (From Featherstone JD: The continuum of dental caries—evidence for a dynamic disease process, *J Dent Res* 83[Spec No. C]:C39-C42, 2004.)

caries prevalence and fluoride concentration in drinking water. Initially, these surveys were limited to school-age children residing in different cities with naturally high or low fluoride concentrations in the public water supplies (Figure 44-3). Subsequently, it was shown that adults and children who have continually consumed fluoridated water lose fewer teeth and have lower incidences of decayed, missing, and filled teeth. Of increasing importance regarding geriatric dentistry is the finding that lifelong residence in communities with naturally occurring fluorides is associated with a significant reduction in the prevalence of root caries or root fillings in the population.^{6,79}

Dental fluorosis (discussed later) has been directly related to the concentration of fluoride in the drinking water. An optimal level of fluoride in the water supply provides significant protection against caries yet entails minimal risk of fluorosis. The optimal concentration depends on the annual average maximum daily air temperature in the community (temperature influences the amount of water ingested). In temperate climates, where the annual average maximal daily air temperature is 14.7° C to 17.7° C (58.4° F to 63.8° F), the optimal level of fluoride is 1 ppm. Carefully controlled independent studies conducted during the 1940s-1960s have shown that if fluoride is added to the domestic water supply to bring it up to optimal levels (controlled water fluoridation), decay could be reduced by 50% to 60% (Figure 44-4). These clinical trials were conducted in the United States and Canada, which were the first countries to initiate such programs, and in diverse populations in Australia, Hong Kong, Ireland, Germany, The Netherlands, New Zealand, and the United Kingdom. More recently, because of the widespread daily use of topical fluoride and the ingestion of fluoride-containing foods and beverages made in fluoridated communities, the difference in caries prevalence between fluoridated and non-fluoridated communities has been observed to be 15% to 40% depending on the age group and area examined.⁵⁹

In some regions of the United States, a high proportion of the population is living in optimally fluoridated communities, so that the minority of the population where the water fluoride is suboptimal may be getting significant amounts of fluoride from food and beverage products processed in the optimally fluoridated areas, yielding a “diffusion” or “halo” effect on caries reduction. Failure to account for the diffusion effect may result in underestimation of the total benefit of water fluoridation, especially in high-diffusion exposure regions.²⁹ Studies in Canada have documented the processing of beverages, especially soft drinks, in fluoridated communities and their distribution in nonfluoridated areas.¹⁴ The halo effect does not uniformly apply throughout the United States, however.

FIGURE 44-3 Data from 21 U.S. cities grouped according to fluoride content of the drinking water. An inverse relationship between caries prevalence and fluoride content of the water is illustrated. *DMF*, Decayed, missing, and filled teeth. (From Newbrun E, editor: *Fluorides and dental caries*, ed 3, Springfield, IL, 1986, Charles C Thomas.)

Number of cities studied	Number of children examined	Number of DMF teeth per 100 examinees								Fluoride content of water (ppm)
		0	100	200	300	400	500	600	700	
11	3867	[Bar extending to ~650]								<0.5
3	1140	[Bar extending to ~400]								0.5-0.9
4	1403	[Bar extending to ~300]								1.0-1.4
3	847	[Bar extending to ~200]								>1.4

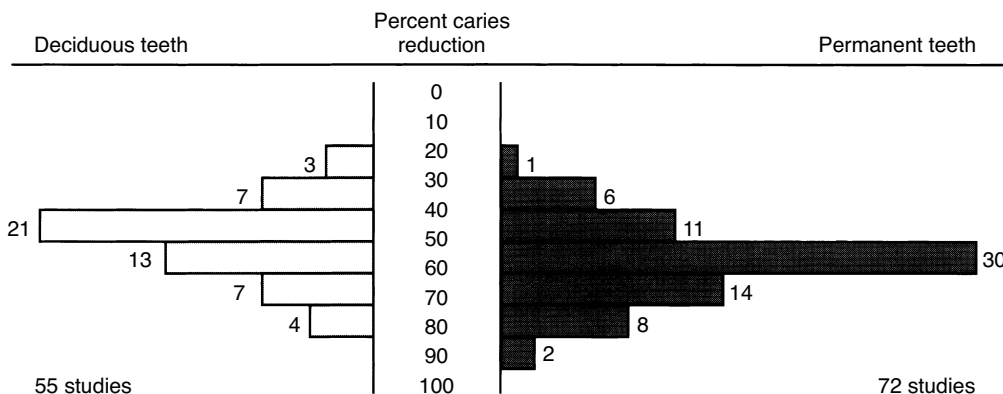

FIGURE 44-4 Caries reductions (percentage) observed in 55 studies on the effectiveness of controlled fluoridation in 20 countries. Fifty-five studies gave results for the deciduous dentition, and 72 studies gave results for the permanent dentition. (From Murray JJ, Rugg-Gunn AJ: *Fluorides in caries prevention*, ed 2, Bristol, 1982, John Wright & Sons.)

Marked regional differences exist; in a 2006 Centers for Disease Control and Prevention (CDC) report on populations receiving optimally fluoridated public drinking water, it was noted that 54% of the population in Utah received optimally fluoridated public drinking water, a 148% increase from a similar 2002 report, whereas regionally close Nevada reported 72% of its population receiving optimally fluoridated public drinking water, an increase of 4%.¹⁰ The state-by-state fluctuations are presented in Table 44-1. In the United States, approximately 184 million individuals (69% of the population) were provided with optimally fluoridated drinking water.¹⁰ These totals were also higher than those reported in 2002 (162 million, 66%).³ Worldwide, more than 300 million individuals are now consuming water that either is adjusted to or naturally contains an optimal concentration of fluoride.

Opponents of water fluoridation have questioned its safety, yet careful comparisons of communities with optimal versus suboptimal concentrations of fluoride in water supplies have found no significant difference in the frequency of birth defects or in mortality statistics (including deaths from heart disease, cancer, and stroke). Optimal fluoridation of drinking water does not pose a detectable cancer risk to humans, as evidenced by extensive human epidemiologic data.⁸⁶ Thorough medical examinations of children in fluoridated and nonfluoridated communities were undertaken in some of the initial studies of controlled water fluoridation; no significant differences in health or in growth and development were found. One study was quite detailed and included tonsillectomy rates; height and weight; onset of menstruation; bone density by x-ray examination of hands and knees; skeletal maturation; blood hemoglobin titer; erythrocyte and leukocyte count; urinalysis; and skin moisture, texture, color, and

eruptions.⁷⁴ The conclusion of this long-term pediatric study was that the reduction in caries was accompanied by no indication of any adverse effect from the use of fluoridated water.

Some concern has been raised about a possible relationship between fluoride in the water supply and frequency of hip fractures. Of several studies, two showed a protective relationship, four found no relationship, and three reported an increased relative risk. These conflicting findings are caused by the multifactorial pathogenesis of osteoporotic fractures (cigarette smoking, having a small thin frame, history of previous fracture, excessive alcohol intake, estrogen deficiency, physical inactivity) and may prove impossible to resolve by current epidemiologic-ecologic methods.⁴³ The collective results of all these studies on hip fracture rates have yielded relatively small or no associations or have had weak statistical power and do not provide a basis for altering public health policy regarding water fluoridation.²⁷ An expert committee of the World Health Organization concluded, "With respect to hip fracture and bone health, there is no scientific evidence for altering current public health policy on the use of fluorides for caries prevention."²³ Finally, a meta-analysis of articles on fluoridation and bone fracture published between 1966 and 1997 found that the relative risk was 1.02. It concluded that water fluoridation has little protective or deleterious effect on fracture risk.⁴⁰

Another area that has garnered much speculation and public attention has been the theorized relationship between fluoride exposure and osteosarcoma. Bassin and colleagues⁷ suggested a potential positive correlation between fluoridated drinking water and osteosarcoma in males. This study had several notable weaknesses, which included being largely interview-based and subject to recall bias, associating fluori-

TABLE 44-1

CDC Data on Water Fluoridation Variance by State (2006)

STATE	%	PERSONS RECEIVING FLUORIDATED WATER	PERSONS SERVED BY CWS	RANK
United States	69.2	184,028,038	265,794,525	
Alabama	82.9	3,814,295	4,599,030	20
Alaska	59.5	308,801	519,379	35
Arizona	56.1	3,147,245	5,611,581	38
Arkansas	64.4	1,648,317	2,561,312	33
California	27.1	9,881,390	36,457,549	48
Colorado	73.6	3,085,319	4,190,698	26 (tie)
Connecticut	88.9	2,393,487	2,691,412	17
Delaware	73.6	603,207	819,176	26 (tie)
District of Columbia	100.0	581,530	581,530	
Florida	77.7	13,006,128	16,729,803	24
Georgia	95.8	8,974,302	9,393,941	5
Hawaii	8.4	107,684	1,285,498	50
Idaho	31.3	316,350	1,011,949	45 (tie)
Illinois	98.9	11,355,747	11,484,994	2
Indiana	95.1	4,327,916	4,550,057	6
Iowa	92.4	2,363,277	2,558,575	12
Kansas	65.1	1,669,657	2,563,505	32
Kentucky	99.8	4,199,519	4,206,074	1
Louisiana	40.4	1,731,807	4,287,768	43
Maine	79.6	501,290	630,136	22
Maryland	93.8	4,549,055	4,847,653	10
Massachusetts	59.1	3,802,732	6,437,193	36
Michigan	90.9	6,664,706	7,335,365	14
Minnesota	98.7	3,905,754	3,956,659	3
Mississippi	50.9	1,480,601	2,910,540	41
Missouri	79.7	3,928,100	4,928,689	21
Montana	31.3	248,850	794,563	45 (tie)
Nebraska	69.8	991,292	1,420,624	31
Nevada	72.0	1,744,984	2,422,152	30
New Hampshire	42.6	354,637	832,656	42
New Jersey	22.6	1,771,324	7,839,608	49
New Mexico	77.0	1,207,034	1,567,857	25
New York	72.9	12,733,582	17,471,590	29
North Carolina	87.6	5,689,906	6,498,294	18
North Dakota	96.2	552,785	574,346	4
Ohio	89.3	8,948,975	10,021,630	16
Oklahoma	73.5	2,493,521	3,392,725	28
Oregon	27.4	839,727	3,069,204	47
Pennsylvania	54.0	5,610,873	10,390,234	40
Rhode Island	84.6	826,863	977,261	19
South Carolina	94.6	3,335,873	3,545,617	9
South Dakota	95.0	657,022	691,333	7 (tie)
Tennessee	93.7	4,889,987	5,220,410	11
Texas	78.1	16,979,975	21,731,824	23
Utah	54.3	1,216,980	2,242,897	39
Vermont	58.7	310,953	529,441	37
Virginia	95.0	5,830,328	6,135,847	7 (tie)
Washington	62.9	3,542,948	5,628,782	34
West Virginia	91.7	1,247,301	1,360,193	13
Wisconsin	89.7	3,471,706	3,868,775	15
Wyoming	36.4	162,396	446,323	44

CDC, Centers for Disease Control and Prevention; CWS, community water systems.

dated community drinking water with actual consumed fluoride, and lack of biologic analysis of fluoride concentrations in bone. Bassin and colleagues⁷ are quick to emphasize that further studies that directly evaluate fluoride uptake and address confounding variables are required before any preliminary conclusions can be made.⁴ More detailed discussion of

some of the claimed health risks of water fluoridation can be found elsewhere.^{34,60}

Opponents have focused more recently on the use of fluorosilicic acid and its Na⁺ salt, which together account for 91% of the fluoridating agents used by American water works.⁸⁴ They have asserted that the fluorosilicate ion (SiF₆⁻) promotes

the solubilization of lead from the distribution system, increasing the lead concentration in the tap. In addition, they believe that residual fluorosilicate is responsible for reducing gastric pH and converting particulate lead to bioavailable lead ion, increasing its uptake in the bloodstream.^{50,51} Supposedly such higher blood lead concentrations account for aggressive and violent behavior. Although the kinetics of the dissociation and hydrolysis of fluorosilicate are poorly understood, all the rate data suggest that equilibrium should have been achieved by the time water reaches the consumer's tap, if not by the time it leaves the water plant.^{84,85} There is no proof that the ingestion of lead or its bioavailability is increased.

Communal water fluoridation continues to be the cornerstone of an ideal caries prevention program. Its efficacy in reducing caries prevalence has been amply shown. Its safety has also been well established. The cost benefits are impressive, but even more important are the value of teeth saved from extraction and the avoidance of pain and discomfort from carious lesions and of time lost from school or work.

Fluoridation of School Water Supplies

Because central water supplies are unavailable to large segments of the world's population, other methods of caries prevention have been sought. Research has shown that adjusting the fluoride content of a school's water supply produces a reduction in dental caries with no objectionable dental fluorosis. Children spend 20% to 25% of their total waking hours in school annually, and this figure may be increased if after-school programs are considered. To compensate for this part-time exposure to fluoride, the currently recommended concentration for school water fluoridation is 4.5 times the optimal value recommended for community water fluoridation in the same geographic area. One disadvantage of school fluoridation is that children are 5 to 6 years old before they begin attending school and drinking the water. Maximal caries prevention accrues when fluoridated water is consumed from birth. Continued protection is not provided when the children leave school. Operating and maintaining small fluoridation systems (i.e., systems serving <500 people) creates practical and logistic difficulties.

Fluoride Supplements

Communal water fluoridation is the best method for providing systemic fluoride because the benefits accrue automatically without any conscious effort required. Where water fluoridation is not feasible because of individual wells (approximately 20% of the U.S. population), or where political opposition, apathy, or lack of funds prevent its implementation (approximately 30% of the U.S. population), supplements offer an alternative source of systemic fluoride. Fluoride tablets, drops, and lozenges have been proved unequivocally to be effective cariostatic agents, provided that such supplements are taken on a daily basis continuously from birth to approximately 16 years of age. The cariostatic effects of fluoride supplements have ranged from less than 10% to more than 80%, generally depending on how soon after birth supplementation starts and on the degree of compliance.¹⁹ The highest caries reductions have been reported in private pediatric practices in which there is a high degree of motivation on the part of the professionals who prescribe the supplements, the parents who give the supplements to their young children, and the children themselves as they get older and become responsible for taking the supplements. When distribution of fluoride supplements has been attempted on a large scale, such as by community health centers, well-baby clinics, and county health departments, long-term compliance has been poor. An estimated 16% of U.S. children younger than 2 years used fluoride supplements in 1986,⁶¹ but compliance tends to decrease in older children. There has been some

TABLE 44-2

American Dental Association Dosage Schedule (mg/day) for Fluoride Supplements*

AGE (yr)	FLUORIDE CONCENTRATION (ppm) IN PRIMARY DRINKING WATER		
	<0.3	0.3-0.6	>0.6
0-0.5	0	0	0
0.5-3	0.25	0	0
3-6	0.5	0.25	0
6-≥16	1	0.5	0

*Council on Dental Therapeutics, 1994.

debate on the efficacy of fluoride supplementation, and a 2008 systematic review commissioned by the American Dental Association (ADA) concluded that "during the first 3 years of life, however, there is only limited evidence regarding the effectiveness of fluoride supplements in preventing caries."³⁹

Professional fluoride supplementation should ideally be based on a caries-risk assessment.¹ The correct dosage in prescribing fluoride supplements depends on two factors: the age of the child and the existing fluoride concentration in the water supply (Table 44-2). The latter information can be obtained from the local water supply authority (except in the case of private well water). Failure to determine the fluoride concentration in the communal water source can result in a fluoride overdosage and consequent dental fluorosis. For young infants, drops are more convenient than tablets because they can be directly dispensed into the child's mouth with a medicine dropper or added to foods (e.g., cereals) or beverages (e.g., milk, formula, or juices). For older children whose primary teeth have erupted, fluoride tablets or lozenges are indicated, which provide systemic benefits when swallowed and topical benefits as they are chewed and swished around the teeth. Fluoride tablets or lozenges are available in 0.25-mg, 0.5-mg, and 1-mg strengths. No more than 120 mg of fluoride (264 mg of sodium fluoride) should be dispensed in any one container, which should be provided with a child-proof top and labeled: "Caution—store out of reach of children." A sample prescription of a fluoride supplement for a 2-year-old residing in a community with 0.1 ppm of fluoride in the water supply is shown in Figure 55-5.

Because fluoride supplements are taken as a single bolus that causes a rapid elevation in blood fluoride concentrations, most studies have identified them as a major risk factor for dental fluorosis.⁷³ Current fluoride prescription practices have undergone close scrutiny, and it is generally agreed that a reduction in dosage is indicated in the age period from birth to 6 years because this is the period when the permanent anterior teeth are vulnerable to dental fluorosis (the "window of vulnerability"). A reduced dosage schedule of fluoride supplements has been accepted by the ADA, American Academy of Pediatric Dentistry, and American Academy of Pediatrics, as shown in Table 44-2.² In the 6-month to 3-year age cohort, it is recommended that fluoride drops be prepared in a more dilute form, such as containing 0.25 mg of fluoride in 0.25 mL (instead of in a single drop), to minimize overdosing errors at home. In Canada, a more drastic reduction in dosage—with no supplements until age 3 years; 0.25 mg at ages 3, 4, and 5 years; and 1 mg from age 6 years—has been recommended.¹³

Insufficient data exist to establish the efficacy of prenatal supplements given to pregnant mothers in reducing caries in offspring. The U.S. Food and Drug Administration (FDA)

does not permit any fluoride preparation to be labeled, represented, or advertised for prenatal use. Only a small portion of the enamel of some of the primary teeth (mostly of the incisors) has entered the stage of secondary mineralization (maturation stage) at birth and almost no permanent teeth except the tips of the first molars (which are at the formative stage).¹⁷ It is more important to ensure that adequate fluoride supplements are taken regularly after birth. The concentration of total fluoride in human milk is approximately 0.05 ppm and in cow's milk, approximately 0.1 ppm. Both types of milk are negligible sources of fluoride. Although an infant gets very little fluoride from a mother's milk, in most cases there is no need to supplement breastfed children who reside in optimally fluoridated communities. Because the average duration of nursing in the United States is only 4 months, the amount of fluoride obtained from optimally fluoridated water supplies used in preparing formula and baby food suffices. If an infant resides in a suboptimally fluoridated community, the dosage schedule shown in Table 44-2 should be followed.

Vitamins neither interfere with nor potentiate the caries-preventive effects of fluoride supplements, but they do increase the cost to the patient. If the child needs vitamins, a fluoride-vitamin combination may be more convenient, but children are unlikely to require vitamins from birth to teens. Some fluoride-vitamin preparations contain 60% total sugar as a sweetener to mask the taste of some of the B vitamins. Such products are contraindicated for caries prevention.

TOPICAL FLUORIDE

Not all fluoride agents and treatments are equal. Different fluoride compounds, different vehicles, and vastly different concentrations of fluoride, ranging nearly 100-fold, have been used with different frequencies and durations of application (Table 44-3). All these variables can influence the clinical outcome regarding caries prevention and management. The efficacy of topical fluoride in caries prevention depends on the concentration of fluoride used, the frequency with which it is applied and probably the duration of application, and, to some extent, the specific fluoride compound used.^{48,57,58}

Regarding the concentration of fluoride used, most fluoride dentifrice studies have shown a dose-response effect,^{57,70} and the trend in clinical effectiveness of professionally applied topical fluoride agents is similar (Table 44-4).^{32,37,88} Regarding the frequency of topical fluoride application, in studies of the same commercial stannous fluoride dentifrice, the efficacy of unsupervised use once per day or *ad libitum* was an approximate 21% caries reduction,^{38,41} whereas the efficacy of supervised use three times per day was an approximate 45% caries reduction (Table 44-5).^{9,64}

No controlled clinical trials have been reported in which the same concentration of a topical fluoride agent has been tested for varying durations of application. In vitro testing of sodium fluoride and acidulated phosphate fluoride (APF) solutions has shown that fluoride uptake is time-related, and in the case of APF solutions the most rapid uptake occurs during the first 4 minutes.⁴² It is unknown, however, whether a more rapid fluoride uptake means greater caries reduction.

**Professional Topical Application of Fluorides
Solutions, gels, and foams**

Semiannual topical application of concentrated fluoride (2% sodium fluoride, 8% stannous fluoride, or APF containing 1.23% fluoride) by a dentist or dental hygienist provides an average 26% reduction of decay of permanent teeth of children living in nonfluoridated areas.⁶⁹ Neutral sodium fluoride solutions (2%) were first tested in the early 1940s and were shown to reduce caries. Teeth were first cleaned with pumice

TABLE 44-3

Range of Therapeutic Fluoride Concentrations in Topical Agents Used to Prevent Caries

METHOD/VEHICLE	FLUORIDE CONCENTRATION (ppm)
Mouth rinse, daily	230
Dentifrices, children	250-500
Mouth rinse, weekly	920
Dentifrices, adult	1000-1500
Self-applied gels or rinses, prescription	5000
Professionally applied sodium fluoride solutions	9200
Professionally applied APF solutions, gels, foams	12,300
Professionally applied stannous fluoride solutions	19,500
Professionally applied varnishes	22,600

APF, Acidulated phosphate fluoride.

TABLE 44-4

Comparative Effectiveness of Professionally Applied Topical Fluoride Agents

AGENT	FLUORIDE CONCENTRATION (ppm)	AVERAGE EFFECTIVENESS (% CARIES REDUCTION)*
2% sodium fluoride	9200	29
APF (1.2% fluoride)	12,300	22
8% stannous fluoride	19,500	32
Fluoride varnish (5% sodium fluoride)	22,600	38

*Effectiveness estimates from several sources.^{32,37,88}

APF, Acidulated phosphate fluoride.

paste, and the solution was applied to the teeth for 3 minutes. The application, but not the pumicing, was repeated at weekly intervals for a total of four applications at ages 3, 7, 11, and 13 years.⁴⁴ This sequence of application was used more widely in public health programs than in private practice. In 1958, 8% stannous fluoride was also shown to be an anticaries agent.⁵⁵ The procedure again involved coronal polishing, and the stannous fluoride was applied for 4 minutes semiannually. Aqueous stannous fluoride solutions have the disadvantages of undergoing rapid hydrolysis and oxidation; because of this instability, they must be freshly prepared for each treatment. Stannous fluoride has a low pH (approximately 2.7) and has a disagreeable acidic and metallic taste. Many investigators have also reported that teeth stain (from light brown to black) at carious lesions, hypocalcified areas, and around the margins of restorations after stannous fluoride application.⁵⁴ This discoloration is caused by the conversion of tin phosphates, which form on the enamel, to tin sulfides, which have the characteristic dark brown or black color.

In the United States, the most popular form of office fluoride therapy is the application of APF in the form of a solution, gel, or foam. APF agents should have a pH of approximately 3.0 and contain 1.23% fluoride and 0.1 mol/L of orthophosphoric acid. The low pH of this agent favors

TABLE 44-5

Frequency of Supervised Tooth Brushing with a Stannous Fluoride Dentifrice (Crest) and Caries Reduction

STUDY	BRUSHING FREQUENCY	SUBJECT AGES (yr)	STUDY LENGTH	DMF REDUCTION (%)
Jordan and Peterson, 1959 ⁴¹	1× day	8-12	2 yr	21
Horowitz et al, 1966 ³⁸	1× day + <i>ad libitum</i> home use	6-10	2 yr	21
Peffley and Muhler, 1960 ⁶⁴	3× day	10-15	2 yr	46
Bixler and Muhler, 1962 ⁹	3× day	12-16	8 mo	45

DMF, Decayed, missing, and filled teeth.

more rapid fluoride uptake by enamel, and the presence of the orthophosphate prevents enamel dissolution by the common ion effect. Application of one of these solutions or gels is preceded by a coronal polishing, and the agent should be applied for 4 minutes, usually in a disposable tray applicator. The procedure should be repeated semiannually. The need for coronal polishing preceding application of APF gels has been called into question, and clinical trials indicate that the efficacy of the gels is similar regardless of whether coronal polishing is performed.⁷¹ Some commercial products have been promoted on the basis of claims that they need to be applied for only 1 minute instead of 4 minutes. Some studies have suggested that prolonged application of APF gels can affect the surface morphology and properties of composite resins.⁴⁶ These claims have not been supported by clinical trials showing caries reductions; until they are, a 4-minute application of the agent should be the designated method.

Because these agents used in the dental office contain relatively high concentrations of fluoride, the operator should observe certain precautions to prevent inadvertent ingestion of them by the patient, who should be in an upright position in the chair.³¹ If fluoride supplementation (in the dental office or at home) is used on younger children, there is typically a reduced likelihood of adequate expectoration. A child's ability to spit should be assessed before use of fluorides.^{62,87} If solutions are used, the teeth should be carefully isolated with cotton rolls or gauze swabs, and solution sufficient only to wet the surfaces of the teeth and keep them wet should be applied. If gels in trays are to be used, only a minimal amount of gel should be dispensed in the tray, sufficient to cover the teeth, but not to exude from the tray. A saliva ejector, or better still high-vacuum suction, should be used during the 4-minute application of the agent. On removal of the tray, any excess gel should be wiped away from the teeth and gingiva with gauze, and the patient should be instructed to expectorate thoroughly. The recommended procedures to reduce fluoride ingestion from professional gel tray applications are summarized in Box 44-1.

Varnishes

The previously discussed agents (sodium fluoride, stannous fluoride, and APF) are all aqueous preparations, but other research has involved nonaqueous solutions that are applied as varnishes with longer retention time on the tooth surface. In 1964, Schmidt⁷⁶ tested the practicality of a 2% sodium fluoride lacquer in an alcoholic solution of natural resins. After clinical trials of this fluoride varnish showed its efficacy as an anticaries agent,³³ it was marketed in Germany as a 5% sodium fluoride preparation under the brand name of Duraphat. This product is now widely used for office topical applications throughout Europe, the Middle East, Australia, New Zealand, and Asia; it is currently used in more than 40 different countries throughout the world.

In the mid-1970s, a difluorosilane agent containing 0.7% fluoride in a polyurethane varnish was introduced for caries

BOX 44-1

Recommended Procedures to Reduce Fluoride Ingestion from Professional Gel Tray Applications

- Place patient in an upright position.
- Warn patient not to swallow the gel.
- Use small amounts (≤ 2.5 mL per tray).
- Use custom-fitted or stock trays with absorptive liners.
- Use suction.
- Remove excess gel from teeth and gingiva with gauze.
- Have patient expectorate thoroughly after treatment.

prevention in Europe as Fluor Protector. This agent boasts a high fluoride uptake by enamel.⁶⁸ It is available in the United States as a cavity varnish to seal and prevent the permeation of fluids and metal ions.

In 1994, a 5% sodium fluoride varnish under the name of Duraflor obtained FDA approval for its use in the United States as a cavity liner. Subsequently, the Duraphat formulation of 5% sodium fluoride varnish received FDA approval as a dentin-desensitizing agent and as a cavity liner "medical device." A practitioner can use fluoride varnish for caries prevention as an off-label use on the basis of professional judgment.⁸⁹ Extensive literature exists on the clinical efficacy of Duraphat varnish as a safe and effective anticaries agent for use in children.^{8,66} One advantage of fluoride varnishes is that they adhere to tooth surfaces, permitting prolonged fluoride exposure and uptake. In a meta-analysis of the efficacy of fluoride varnishes³² using rigid criteria for inclusion of data, a mean caries reduction of 38% for fluoride varnishes was obtained (see Table 44-4).

Self-Applied Topical Fluoride in the Home

One of the most effective means of caries reduction involves the daily (on school days) self-application of 1.1% sodium fluoride gel (about 40% of the concentration of fluoride used for professional office applications) in custom-fitted trays for 5 minutes daily. The custom-fitted maxillary and mandibular trays ("toplicators") are fashioned by vacuum-drawing, heat-treated sheets of polyvinyl over plaster models of the teeth. This procedure, first shown in supervised school programs, reduced decay by approximately 75% after 2 years in nonfluoridated communities²² and by approximately 30% in fluoridated communities.²¹ This form of self-therapy is best suited only for high-risk caries patients who are sufficiently motivated to conform with the daily regimen. It is not intended for very young children, but is appropriate for school-aged children and has been found to be effective for adults with xerostomia after radiation therapy to the head and neck region.¹⁸

The advantage of this technique is that fluoride preparations are held in intimate contact with the teeth daily for 5 minutes. Saliva is excluded from the field of application so that it cannot dilute the effective concentration of the active agent in the gel. Intermittent biting pressure on the plastic trays tends to pump the fluoride into pits, fissures, and interproximal spaces. Because the trays are custom-made, a minimal amount of gel (usually 0.5 mL) is required in each tray. The main disadvantage is the high cost of fabricating individual trays for each patient, which renders it impractical for school-based programs.

Self-application by brushing with a fluoride gel (0.4% stannous fluoride) has been used as an alternative to the custom-fitted tray method and has been actively promoted by several commercial manufacturers of these products. Although published clinical data have not been provided to support the efficacy of these agents, many of the stannous fluoride gels have been accepted by the Council on Scientific Affairs of the ADA, presumably based on the findings with stannous fluoride dentifrices. The gels vary considerably in the amount of available tin ion.⁸² The original formulation, developed at the Veterans Administration Hospitals, had an unpleasant taste, so many high-risk caries patients either refused to use the gel or used it only sporadically. Commercial products have been formulated with more acceptable flavors to encourage better compliance. Because the fluoride uptake is time-dependent, applying a gel containing 1000 ppm of fluoride for approximately 1 minute by brushing does not provide as much fluoride uptake as from a gel in a custom-fitted tray containing 5000 ppm applied for 5 minutes. No direct comparisons are available to determine the clinical efficacy of these two techniques for caries prevention.

Fluoride Mouth Rinses

In the mid-1960s, Scandinavian researchers showed that a biweekly rinse for 1 minute with a solution of 0.2% sodium fluoride (920 ppm of fluoride) was more effective in reducing decay than an annual treatment with 10% stannous fluoride professionally applied, equally effective as four professional treatments with 2% sodium fluoride applied every 3 years, and approximately as effective as the daily use of the fluoride dentifrices then available.⁸³ It was also shown that daily rinsing for 1 minute with an even more dilute solution containing 0.05% sodium fluoride (230 ppm of fluoride) gave even greater caries protection. Fluoride mouth rinsing results in approximately 30% less decay.⁷²

The original Scandinavian findings have since been reproduced in many different countries around the world, and now a weekly fluoride rinse has become widely adopted in many school-based preventive dentistry programs. The popularity is based on the fact that it is safe, effective, relatively inexpensive, and easy to learn; requires little time (approximately 5 minutes of class time weekly); and can be supervised by non-dental personnel. Compliance may vary and is generally better in elementary schools than in junior and senior high schools. Compliance depends on successfully motivating and interesting classroom teachers and the school administrators in the preventive dentistry program.

Fluoride mouth rinses were prescription items when originally introduced, and the 0.2% sodium fluoride rinse still requires a prescription. In 1983, the FDA approved the sale of 0.05% sodium fluoride mouth rinses, 0.1% stannous fluoride mouth rinses, and 0.4% stannous fluoride gels as over-the-counter products. In the case of the 0.05% sodium fluoride rinse, 10 mL of the solution (the recommended dosage) contains only 2.3 mg of fluoride. The products are packaged with childproof caps, and their labels state that use is restricted to individuals 6 years and older. The rinse should be vigorously swished around the mouth for 1 minute and then expecto-

rated. The dentist needs to advise the patient, or parent, of these instructions to ensure that the agent is present for enough time to ensure efficacy and to avoid unnecessary ingestion of the rinse.

Fluoride Dentifrices

In the 1940s, the first clinical evaluations of dentifrices containing fluoride were undertaken with products in which fluoride was simply incorporated into existing dentifrice formulations. Because the abrasive systems used in these early dentifrices contained Ca^{++} salts that interfered with the availability of fluoride, these products were ineffective or less than fully effective in reducing decay. The first report of a clinical decrease in the incidence of caries with a fluoride-containing dentifrice compared with the similar use of a nonfluoride dentifrice involved a dentifrice system containing stannous fluoride (0.4%) with an abrasive, calcium pyrophosphate, that had been heat-treated to increase its compatibility with fluoride.⁵⁶ In 1960, this dentifrice was given provisional acceptance, and in 1964 full acceptance, by the ADA's Council on Dental Therapeutics. This acceptance stimulated other manufacturers to develop and test various fluoride formulations and abrasive systems. Currently, the sale of these products exceeds \$1 billion annually in the United States, and approximately 98% of all toothpastes sold contain some form of fluoride. With few exceptions, fluoride toothpastes dominate dentifrice markets in most Western industrialized countries. The original stannous fluoride formulation has been superseded by more compatible and effective formulations.

Sodium monofluorophosphate (MFP) (Figure 44-5) was first tested as a therapeutic agent in dentifrices in the early 1960s. Numerous clinical trials of dentifrices containing 0.76% or 0.8% MFP have since been conducted by different groups in various countries. In almost all these trials, some degree of effectiveness (i.e., approximately 25% caries reduction) has been shown after 1 to 3 years of use.¹⁶ In the United States, MFP of 0.76%, or 1000 ppm of fluoride, is the most commonly used therapeutic ingredient in commercial toothpastes. A dose-response effect has been shown; dentifrices with less MFP are less effective,^{45,53} and dentifrices with more MFP (1500 ppm, 2000 ppm, and 2500 ppm of fluoride) are more effective.^{11,15,26,35,48,80}

Sodium fluoride was the first fluoride to be tested in a toothpaste and was originally found ineffective because of incompatibility with the earlier abrasive systems used. Later, when tested with acrylic particles or hydrated silica as the abrasive, sodium fluoride-containing dentifrices were found to provide significant cariostatic benefits. A dose-response

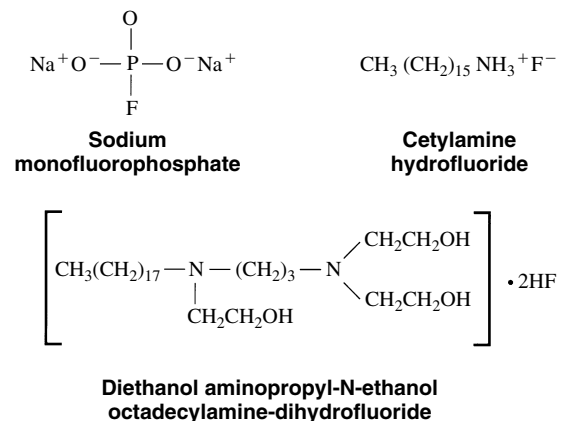

FIGURE 44-5 Structural formulas of sodium monofluorophosphate and the active ingredients in amine fluoride dentifrices.

TABLE 44-6

Clinically Effective Fluoride Abrasive Systems in Dentifrices

FLUORIDE COMPOUND	ABRASIVE SYSTEM	FORMULA
Stannous fluoride (SnF ₂)	Calcium pyrophosphate	Ca ₂ P ₂ O ₇
	Insoluble sodium metaphosphate	(NaPO ₃) _x
Sodium fluoride (NaF)	Silica	SiO ₂
	Calcium pyrophosphate	Ca ₂ P ₂ O ₇
	Insoluble sodium metaphosphate	(Na ₂ PO ₃) _x
	Polymethyl methacrylate	*
Sodium monofluorophosphate (Na ₂ PO ₃ F)	Silica	SiO ₂
	Calcium carbonate	CaCO ₃
	Aluminum oxide	Al ₂ O ₃
	Insoluble sodium metaphosphate	(Na ₂ PO ₃) _x
	Silica	SiO ₂
Amine fluoride	Dibasic calcium phosphate	CaHPO ₄
	Calcium pyrophosphate	Ca ₂ P ₂ O ₇
	Insoluble sodium metaphosphate	(Na ₂ PO ₃) _x
	Silica	SiO ₂

x, ≥2.

*Composed of repeating units of methylmethacrylate:

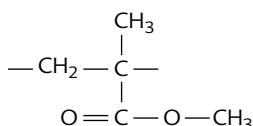

relationship has been reported with sodium fluoride toothpaste tested at 0 ppm, 250 ppm, 500 ppm, and 1000 ppm of fluoride.⁶⁷ A sodium fluoride formulation (1100 ppm of fluoride) with silica abrasive has been found to be more effective than the earlier stannous fluoride–calcium pyrophosphate dentifrice, undoubtedly because of the greater availability of fluoride in this newer system.^{75,92} Several commercial products now use sodium fluoride as the active therapeutic ingredient. The original stannous fluoride formulation has been superseded by more compatible and effective formulations. Clinically effective fluoride toothpastes with compatible abrasive systems are summarized in Table 44-6.

In Europe, an amine fluoride dentifrice containing two compounds—diethanol aminopropyl-N-ethanol octadecylamine-dihydrofluoride and cetylamine hydrofluoride (see Figure 44-5) at a concentration providing 1250 ppm of fluoride—has been used for many years. Both substances have a long aliphatic chain, containing 16 or 18 carbon atoms, which is responsible for the dentifrice's property of lowering surface tension. This dentifrice has also been shown to be effective in reducing dental decay.⁷⁵

The widespread use, most commonly twice a day, of fluoride-containing dentifrices has had a profound effect in reducing caries in many developed countries and accounts for some of the secular decline in caries observed in communities lacking optimal fluoride concentrations in the water supply. The degree of effectiveness may vary with different dentifrice formulations.

As a response to concerns about fluorosis, low-concentration (250 ppm, 400 ppm, and 500 ppm fluoride) toothpastes are available in Austria, Belgium, Czechoslovakia,

Finland, France, Germany, Israel, Luxembourg, The Netherlands, New Zealand, Portugal, Sweden, Switzerland, and the United Kingdom. Dose-response efficacy data indicate, however, that a dentifrice with a lower fluoride concentration provides less caries protection. From the growing literature on dentifrice retention and ingestion, it has been estimated that for children younger than 6 years, the average retention was 27% of the amount placed on the brush.⁷⁰ Because most children brush twice daily, this could contribute 0.3 to 0.6 mg to total fluoride intake, depending on how much toothpaste (0.5 to 1 g) is used habitually. Although several of the early studies that looked at the dentifrice-fluorosis relationship have not found an association, they have generally been small and lacked sufficient statistical power to show such an association if there were one.⁶³ Several more recent studies have attributed much of the increase in fluorosis prevalence to early use of fluoride dentifrice, especially before 2 years of age.^{36,49,63,65,91} To avoid unintentional ingestion of fluoride from dentifrices, the following guidelines are provided:

1. Parents should brush preschool children's teeth until they can do it properly by themselves.
2. Parents should apply the dentifrice to the toothbrush of preschool children until they can do it properly by themselves.
3. Parents of preschool children should supervise their tooth brushing activity, and dentifrices should be stored out of the reach of toddlers.
4. Preschool children should use a child-size toothbrush.
5. Only a smear (younger children) or pea-sized (older children) amount of dentifrice should be applied to the toothbrush bristles.
6. Children should be taught to spit out thoroughly after tooth brushing.

Of increasing interest in recent years is the question as to the bioavailability of fluoride from dentifrice after brushing and the effect of rinsing habits. Studies have shown reduced fluoride concentrations in saliva of adults and children who rinsed with water immediately after brushing, with some studies citing near zero levels of fluoride absorption after multiple water rinses.^{5,78,93}

FLUORIDE TOXICOLOGY

Acute Toxicity

Paracelsus said that "all substances are poison; there is none which is not a poison. The right dose differentiates a poison and a remedy." Fluoride is no exception to this historic observation. When ingested in amounts of 1 to 3 mg/day, as would be the case in optimally fluoridated communities, fluoride is perfectly safe. A dose of 5 to 10 g of sodium fluoride (approximately 2.5 to 5 g of fluoride) is fatal for an adult, however, and lesser amounts are lethal to children. Incidents of acute fluoride poisoning have been recorded, including industrial accidents, fumigant inhalation, ingestion of household insecticides containing fluoride, and suicide attempts.

Patients with severe fluoride poisoning characteristically exhibit nausea, vomiting, and diarrhea; progressive hypotension, pronounced hypocalcemia and hypomagnesemia, and acidosis; and cardiac irregularities, including ventricular tachycardia and sometimes fibrillation and asystole. Successful treatment is based on early initiation of the following procedures:

1. Steps to prevent further systemic absorption of fluoride (e.g., administration of emetics to induce vomiting, gastric lavage with fluids containing Ca⁺⁺)
2. Cardiopulmonary monitoring and preparation for endotracheal intubation and direct-current cardioversion
3. Prompt and frequent blood analyses, especially for plasma Ca⁺⁺, Mg⁺⁺, K⁺, and pH

4. Intravenous infusion of salt solutions as needed to correct acid-base imbalances and restore plasma electrolytes to the normal range
5. Alkaline diuresis to enhance fluoride excretion
6. Appropriate treatment of severe cardiac arrhythmias

A few dentally related fluoride fatalities have been recorded. One case followed office topical therapy in which inappropriate agents and procedures were used, and adequate treatment was not provided for management of the overdose.¹² The other two cases resulted from ingesting fluoride tablets from containers that were not equipped with a child-proof cap.^{20,90} There have been numerous reported and unreported occasions, however, when patients have had transitory nausea from unintentional swallowing of concentrated fluoride topical agents used in the dental office. When recommended procedures are followed, as listed in Box 44-1, the topical application of fluoride agents in the office or the self-application of fluoride agents in the home does not pose a risk of acute toxicity.

Chronic Toxicity

At one time chronic fluoride inhalation was an industrial hazard of cryolite workers handling crushed sodium aluminum fluoride in aluminum refineries. It resulted in crippling skeletal changes with calcification of ligaments, kyphosis, and limitation of motility in the spinal column and thorax. Modern regulations of industrial hygiene require air scrubbers to remove fluoride particles. Crippling skeletal fluorosis is not a public health problem in the United States, as evidenced by the reports of only five cases in 30 years. Of greater concern is fluorosis of the dentition.

Dental fluorosis is a hypomineralization of enamel produced by chronic ingestion of excessive amounts of fluoride during tooth development. Fluorosis may range in severity from a few white flecks to extensive brown staining and pitting. Pits are secondarily produced defects of posteruptive origin rather than true hypoplasias. The hypomineralization is mostly in the outer third of enamel. The secretory stage of enamel development is a crucial time for fluorosis to occur. Ameloblasts are more sensitive to fluoride than are other cells. The mineralization phase is also affected. In excess, fluoride interferes with the normal postsecretory, pre-eruptive development of enamel. Chronically high concentrations of fluoride interfere with deposition of mineral, degradation of matrix proteins (amelogenin and enamelin), and withdrawal of water during enamel maturation.

The prevalence and severity of fluorosis depend on the amount or concentration of fluoride, the duration of exposure, the state of tooth development (i.e., age when exposed), and individual variations in susceptibility (e.g., body weight). In the oral health survey of U.S. schoolchildren sponsored by the National Institute of Dental Research in 1987, 52% were found to have questionable, very mild, or mild fluorosis—forms that are not a serious cosmetic problem. Only 1.3% had moderate or severe fluorosis involving pitting or brown staining. Approximately 2% of U.S. schoolchildren may have perceived esthetic problems that could be attributed to currently recommended levels of fluoride in the drinking water.²⁸ If the natural water supply contains in excess of 2 ppm of fluoride, the prevalence of fluorosis can be reduced by changing the source of the water supply or by defluoridation with activated alumina or bone char for adsorption.

Some fluorosis can also be prevented by stopping the use of fluoride supplements in communities that already provide optimal levels in the water supply. Because supplements require a prescription, dentists, physicians (particularly pediatricians), and pharmacists need to be better educated on when supplementation is indicated and when it is not. Finally, some

fluorosis can be prevented by decreasing the unintentional ingestion of fluoride from dentifrices by young children. Children younger than 6 years need to be instructed to use only a pea-size portion of paste, to spit out thoroughly after brushing, and to avoid swallowing the paste. Dentifrice manufacturers have a responsibility to provide better and more conspicuous labeling in this regard. These data support the concept that use of fluoride supplements during the first years of life, especially in the first year of life, has been associated with an increased risk of fluorosis.³⁹

CITED REFERENCES

1. American Academy of Pediatric Dentistry: Fluoride therapy. *Pediatr Dent* 30:121-124, 2009.
2. American Dental Association: *Fluoridation facts*, Chicago, 2005, ADA Publishing Division. Available at: http://www.ada.org/public/topics/fluoride/facts/fluoridation_facts.pdf. Accessed March 9, 2009.
3. Apanian D, Malvitz D, Presson S: Populations receiving optimally fluoridated public drinking water—United States, 2000. *MMWR Morb Mortal Wkly Rep* 51:144-147, 2002.
4. Armfield JM: The extent of water fluoridation coverage in Australia. *Aust N Z J Public Health* 30:581-582, 2006.
5. Attin T, Hellwing E: Salivary fluoride content after toothbrushing with a sodium fluoride and an amine fluoride dentifrice followed by different mouthrinsing procedures. *J Clin Dent* 7:6-8, 1996.
6. Banting DW: Dental caries in the elderly. *Gerodontology* 3:55-61, 1984.
7. Bassin EB, Wypij D, Davies RB, et al: Age-specific exposure in drinking water and osteosarcoma (United States). *Cancer Causes Control* 17:421-428, 2006.
8. Beltrán-Aguilar ED, Goldstein JW, Lockwood SA: Fluoride varnishes: a review of their clinical use, cariostatic mechanism, efficacy, and safety. *J Am Dent Assoc* 131:589-596, 2000.
9. Bixler D, Muhler JC: Experimental clinical human caries test design and interpretation. *J Am Dent Assoc* 65:482-490, 1962.
10. Centers for Disease Control and Prevention: *Water fluoridation statistics for 2006*. Available at: <http://www.cdc.gov/FLUORIDATION/statistics/2006stats.htm>. Accessed January 22, 2010.
11. Chesters R, Pitts N, Matuliene G, et al: An abbreviated caries clinical trial design validated over 24 months. *J Dent Res* 81:637-640, 2002.
12. Church LE: Fluorides—use with caution. *J Maryland State Dent Assoc* 19:106, 1976.
13. Clark DC: Appropriate uses of fluorides for children: guidelines from the Canadian Workshop on the Evaluation of Current Recommendations Concerning Fluorides. *Can Med Assoc J* 149:1787-1793, 1993.
14. Clovis J, Hargreaves JA, Thomson GW: Caries prevalence and the length of residency in fluoridated and non-fluoridated communities. *Caries Res* 22:311-315, 1988.
15. Conti AJ, Lotzkar S, Daley R, et al: A 3-year clinical trial to compare efficacy of dentifrices containing 1.14% and 0.76% sodium monofluorophosphate. *Community Dent Oral Epidemiol* 16:135-138, 1988.
16. DePaola PF: Clinical studies of monofluorophosphate dentifrices. *Caries Res* 17(Suppl 1):119-135, 1983.
17. Deutsch D, Pe'er E: Development of enamel in human fetal teeth. *J Dent Res* 61:1543-1551, 1982.
18. Dreizen S, Brown LR, Daly TE, et al: Prevention of xerostomia-related dental caries in irradiated cancer patients. *J Dent Res* 56:99-104, 1977.
19. Driscoll W: The use of fluoride tablets for the prevention of dental caries. In Forrester D, Schulz E, editors: *International workshop on fluorides and dental caries reduction*, Baltimore, 1974, University of Maryland.
20. Eichler HG, Lenz K, Fuhrmann M, et al: Accidental ingestion of NaF tablets by children—report of a poison control center and one case. *Int J Clin Pharmacol Ther Toxicol* 20:334-338, 1982.
21. Englander HA, Sherrill LT, Miller BG, et al: Incremental rates of dental caries after repeated topical sodium fluoride applications in children with lifelong consumption of fluoridated water. *J Am Dent Assoc* 82:354-358, 1971.

22. Englander HR, Keyes PH, Gestwicki M, et al: Clinical anticaries effect of repeated topical sodium fluoride applications by mouthpieces. *J Am Dent Assoc* 78:354-358, 1967.
23. Expert Committee on Oral Health Status and Fluoride Use, World Health Organization: *Fluorides and oral health*, Geneva, 1994, World Health Organization.
24. Featherstone JDB: Prevention and reversal of dental caries: role of low level fluoride. *Community Dent Oral Epidemiol* 27:31-40, 1999.
25. Featherstone JDB: The continuum of dental caries—evidence for a dynamic disease process. *J Dent Res* 83:C39-C42, 2004.
26. Fogels HR, Meade JJ, Griffith J, et al: A clinical investigation of a high-level fluoride dentifrice. *J Dent Child* 55:210-215, 1988.
27. Gordon SL, Corbin SB: Summary of workshop on drinking water fluoride influence on hip fracture on bone health (National Institutes of Health, 10 April, 1991). *Osteoporos Int* 2:109-117, 1992.
28. Griffin S, Beltran E, Lockwood S, et al: Esthetically objectionable fluorosis attributable to water fluoridation. *Community Dent Oral Epidemiol* 30:199-209, 2002.
29. Griffin SO, Gooch BF, Lockwood SA, et al: Quantifying the diffused benefit from water fluoridation in the United States. *Community Dent Oral Epidemiol* 29:120-129, 2001.
30. Groeneveld A, van Eck AAJM, Backer Dirks O: Fluoride in caries prevention: is the effect pre- or post-eruptive? *J Dent Res* 69(Special Issue):751-755, 1990.
31. Heifetz SB, Horowitz HS: The amounts of fluoride in current fluoride therapies: safety considerations for children. *J Dent Child* 51:257-269, 1984.
32. Helfenstein U, Steiner M: Fluoride varnishes (Duraphat): a meta-analysis. *Community Dent Oral Epidemiol* 22:1-5, 1994.
33. Heuser H, Schmidt HF: Zahnkariesprophylaxe durch tiefenimpregnierung des zahnschmelzes mit Fluor-Lack. *Stoma* 21:91-100, 1968.
34. Hodge HC: Evaluation of some of the objections to water fluoridation. In Newbrun E, editor: *Fluorides and dental caries*, ed 3, Springfield, IL, 1986, Charles C Thomas.
35. Hodge HC, Holloway PJ, Davies TGH, et al: Caries prevention by dentifrices containing a combination of sodium monofluorophosphate and sodium fluoride. *Br Dent J* 149:201-204, 1980.
36. Horowitz HS: The need for toothpastes with lower than conventional fluoride concentrations for preschool-aged children. *J Public Health Dent* 52:216-221, 1992.
37. Horowitz HS, Heifetz SB: Topically applied fluorides. In Newbrun E, editor: *Fluorides and dental caries*, ed 3, Springfield, IL, 1986, Charles C Thomas.
38. Horowitz HS, Law FE, Thompson MP, et al: Evaluation of a stannous fluoride dentifrice for use in dental public health programs, I: basic findings. *J Am Dent Assoc* 72:408-422, 1966.
39. Ismail AI, Hasson H: Fluoride supplements, dental caries and fluorosis. *J Am Dent Assoc* 139:1457-1467, 2008.
40. Jones G, Riley M, Couper D, et al: Water fluoridation, bone mass and fracture: a quantitative overview of the literature. *Aust N Z J Public Health* 23:34-40, 1999.
41. Jordan WA, Peterson JK: Caries-inhibiting value of a dentifrice containing stannous fluoride: final report of a two-year study. *J Am Dent Assoc* 58:42-46, 1959.
42. Joyston-Bechal S, Duckworth R, Braden M: The mechanism of uptake of ¹⁸F by enamel from sodium fluoride and acidulated phosphate fluoride solution labeled with ¹⁸F. *Arch Oral Biol* 18:1077-1089, 1973.
43. Kleerekoper M: Fluoride and the skeleton. In Bilezikian JP, Raisz LG, Rodan GA, editors: *Principles of bone biology*, San Diego, 1996, Academic Press.
44. Knutson JW: Sodium fluoride solutions: technic for application to the teeth. *J Am Dent Assoc* 36:37-39, 1948.
45. Koch G, Bergmann-Arnadottir S, Bjarnason S, et al: Caries-preventive effect of fluoride dentifrices with and without anticalculus agents: a 3-year controlled clinical trial. *Caries Res* 24:72-79, 1990.
46. Kula K, Webb EL, Kula TJ: Effect of 1- and 4-minute treatments of topical fluorides on a composite resin. *Pediatr Dent* 18:24-28, 1996.
47. Limeback H: A re-examination of the pre-eruptive and post-eruptive mechanism of the anti-caries effects of fluoride: is there any anti-caries benefit from swallowing fluoride? *Community Dent Oral Epidemiol* 27:62-71, 1999.
48. Marks RG, Conti AJ, Moorhead JE, et al: Results from a three-year clinical trial comparing NaF and SMFP fluoride formulations. *Int Dent J* 44:275-285, 1994.
49. Mascarenhas AK, Burt BA: Fluorosis risk from early exposure to fluoride toothpaste. *Community Dent Oral Epidemiol* 26:241-248, 1998.
50. Masters RJ, Coplan MJ: Water treatment with silicofluorides and lead toxicity. *Int J Environ Studies* 56:435-449, 1999.
51. Masters RJ, Coplan MJ, Hone BT, et al: Association of silicofluoride treated water with elevated blood lead. *Neurotoxicity* 21:1091-1100, 2000.
52. McCay FS: The study of mottled enamel (dental fluorosis). *J Am Dent Assoc* 44:133-137, 1952.
53. Mitropoulos CM, Holloway PJ, Davies TGH, et al: Relative efficacy of dentifrices containing 250 to 1000 ppm F⁻ in preventing dental caries—report of a 32-month clinical trial. *Community Dent Health* 1:193-200, 1984.
54. Muhler JC: Effect on gingiva and occurrence of pigmentation on teeth following the topical application of stannous fluoride or stannous chlorofluoride. *J Periodontol* 28:281-286, 1957.
55. Muhler JC: The effect of a single topical application of stannous fluoride on the incidence of dental caries in adults. *J Dent Res* 37:415-416, 1958.
56. Muhler JC, Radike AW, Nebergall WH, et al: The effect of stannous fluoride-containing dentifrice on caries reduction in children. *J Dent Res* 33:606-612, 1954.
57. Newbrun E: Current regulations and recommendations concerning water fluoridation, fluoride supplements and topical fluoride agents. *J Dent Res* 71(Special Issue):1255-1265, 1992.
58. Newbrun E: Current treatment modalities of oral problems of patients with Sjögren's syndrome: caries prevention. *Adv Dent Res* 10:29-34, 1996.
59. Newbrun E: Effectiveness of water fluoridation. *J Public Health Dent* 49:279-289, 1989.
60. Newbrun E, Horowitz H: Why we have not changed our minds about the safety and efficacy of water fluoridation. *Perspect Biol Med* 42:526-543, 1999.
61. Nourjah P, Horowitz A, Wagener D: Factors associated with the use of fluoride supplements and fluoride dentifrice by infants and toddlers. *J Public Health Dent* 54:47-54, 1994.
62. Oliveira MJ, Paiva SM, Martins LH, et al: Influence of rinsing and expectoration after toothbrushing on fluoride dose and ingested amount by use of conventional and children's fluoride dentifrices. *Braz Dent J* 17:100-105, 2006.
63. Osuji OO, Leake JL, Chipman ML, et al: Risk factors for dental fluorosis in a fluoridated community. *J Dent Res* 67:1488-1492, 1988.
64. Peffley GE, Muhler JC: The effect of a commercially available stannous fluoride dentifrice under controlled brushing habits on dental caries incidence in children: preliminary report. *J Dent Res* 39:871-875, 1960.
65. Pendrys DG, Katz RV, Morse DE: Risk factors for enamel fluorosis in a nonfluoridated population. *Am J Epidemiol* 143:808-815, 1996.
66. Petersson L, Twetman S, Pakhomov GN: *Fluoride varnish for community-based caries prevention in children*, Geneva, 1997, World Health Organization.
67. Reed MW: Clinical evaluation of three concentrations of sodium fluoride in dentifrices. *J Am Dent Assoc* 87:1401-1403, 1973.
68. Retief DH, Bradley EL, Holbrook M, et al: Enamel fluoride uptake, distribution and retention from topical fluoride agents. *Caries Res* 17:44-51, 1983.
69. Ripa L: An evaluation of the use of professionally (operator-applied) topical fluorides. *J Dent Res* 69:786-796, 1990.
70. Ripa LW: Clinical studies of high-potency fluoride dentifrices: a review. *J Am Dent Assoc* 118:85-91, 1989.
71. Ripa LW: Need for prior toothcleaning when performing a professional topical fluoride application: review and recommendations for change. *J Am Dent Assoc* 109:281-285, 1984.
72. Ripa LW: Rinses for the control of dental decay. *Int Dent J* 42:263-269, 1992.
73. Rozier RG, Beck JD: Epidemiology of oral diseases. *Curr Opin Dent* 1:308-315, 1991.
74. Schlesinger ER, Overton DE, Chase HC: A long-term medical study of children in a community with fluoridated water supply.

- In Shaw JH, editor: *Fluoridation as a public health measure*, Washington, DC, 1954, American Association for the Advancement of Science.
75. Schmid R, Barbakow F, Mühlemann H, et al: Amine fluoride and monofluorophosphate, I: historical review of fluoride dentifrices. *ASDC J Dent Child* 51:99-103, 1984.
 76. Schmidt HF: Ein neues tauchierungsmittel mit besonders lang anhaltendem intensivem fluoridierungseffekt. *Stoma* 17:14-20, 1964.
 77. Singh KA, Spencer AJ, Armfield JM: Pre- and post-eruption fluoride exposure and caries by surface type. *J Dent Res* 79:159, 2000.
 78. Sjogren K, Birkhed D: Effect of various post-brushing activities on salivary fluoride concentration after toothbrushing with a sodium fluoride dentifrice. *Caries Res* 28:127-131, 1994.
 79. Stamm JW, Banting DW, Imrey PB: Adult root caries survey of two similar communities with contrasting natural water fluoride levels. *J Am Dent Assoc* 120:143-149, 1990.
 80. Stephen KW, Creanor SL, Russell JI, et al: A 3-year oral health dose-response study of sodium monofluorophosphate dentifrices with and without zinc citrate: anti-caries results. *Community Dent Oral Epidemiol* 16:321-325, 1988.
 81. ten Cate JM, Featherstone JDB: Physicochemical aspects of fluoride-enamel interactions. In Fejerskov O, Ekstrand J, Burt BA, editors: *Fluoride in dentistry*, Copenhagen, 1996, Munksgaard.
 82. Tinanoff N: Stannous fluoride in clinical dentistry. In Wei SHY, editor: *Clinical uses of fluorides*, Philadelphia, 1985, Lea & Febiger.
 83. Torell P, Ericsson Y: Two-year clinical tests with different methods of local caries-preventive fluorine application in Swedish schoolchildren. *Acta Odontol Scand* 23:287-322, 1965.
 84. Urbansky ET: Fate of fluorosilicate drinking water additives. *Chem Rev* 102:2837-2854, 2002.
 85. Urbansky ET, Schock MR: Can fluoridation affect lead (II) in potable water? Hexafluorosilicate and fluoride equilibria in aqueous solution. *Int J Environ Studies* 57:597-637, 2000.
 86. U.S. Department of Health and Human Services: *Review of fluoride benefits and risks: report of the Ad Hoc Subcommittee on Fluoride of the Committee to Coordinate Environmental Health and Related Programs*, U.S. Public Health Service, Washington, DC, 1991, U.S. Government Printing Office.
 87. van Loveren C, Ketley CE, Cochran JA, et al: Fluoride ingestion from toothpaste: fluoride recovered from the toothbrush, the expectorate and the after-brush rinses. *Community Dent Oral Epidemiol* 32(Suppl 1):54-61, 2004.
 88. van Rijkom HM, Truin GJ, van't Hof MA: A meta-analysis of clinical studies on the caries inhibiting effect of fluoride gel treatment. *Caries Res* 32:83-92, 1998.
 89. Wakeen L: Legal implications of using drugs and devices in the dental office. *J Public Health Dent* 52:403-408, 1992.
 90. Waldbott GL: Another fluoride fatality: a physician's dilemma. *Fluoride* 12:55-57, 1979.
 91. Warren JJ, Levy S: A review of fluoride dentifrice related to dental fluorosis. *Pediatr Dent* 21:265-271, 1999.
 92. Zacherl WA: A three-year clinical caries evaluation of the effect of a sodium fluoride-silica abrasive dentifrice. *Pharmacol Ther Dent* 6:1-7, 1981.
 93. Zamataro CB, Tenuta LM, Cury JA: Low-fluoride dentifrice and the effect of postbrushing rinsing on fluoride availability in saliva. *Eur Arch Paediatr Dent* 9:90-93, 2008.

GENERAL REFERENCES

- American Academy of Pediatric Dentistry: Policy on use of a caries-risk assessment tool (CAT) for infants, children and adolescents, *Pediatr Dent* 30(7 Suppl):29-33, 2008.
- American Academy of Pediatric Dentistry: Oral health policy of use of fluoride, *Pediatr Dent* 30:34-36, 2008.
- Centers for Disease Control and Prevention: Recommendations for using fluoride to prevent and control dental caries in the United States, *MMWR Morb Mortal Wkly Rep* 50:1-42, 2001.
- Ciancio SG, editor: *ADA Guide to dental therapeutics*, ed 4, Chicago, 2007, American Dental Association.
- McClure FJ: *Fluoride drinking waters*, Public Health Service Publication No. 825, Washington, DC, 1962, U.S. Government Printing Office.
- Mellberg JR, Ripa LW: Fluoride in preventive dentistry, *Quintessence Int* 14:733-736, 1983.
- Murray JJ, Rugg-Gunn AJ: *Fluorides in caries prevention*, ed 3, Bristol, 1991, Butterworth-Heinemann Ltd.
- Naylor MN, Pindborg JJ, editors: The contribution of dentifrices to oral health, *Community Dent Oral Epidemiol* 8:217-285, 1980.
- Newbrun E, editor: *Fluorides and dental caries: contemporary concepts for practitioners and students*, ed 3, Springfield, IL, 1986, Charles C Thomas.
- Ripa LW, editor: *A guide to the use of fluorides for the prevention of dental caries*, ed 2, Chicago, 1986, American Dental Association.
- Wei SHY, editor: *Clinical uses of fluorides: a state of the art conference on the uses of fluorides in dentistry*, Philadelphia, 1985, Lea & Febiger.

Antiplateque and Antigingivitis Agents*

ANGELO J. MARIOTTI

The periodontium, which is responsible for the retention of teeth in the maxilla and mandible, consists of four different tissue types. Cementum and alveolar bone are the hard tissues to which the fibrous periodontal ligament anchors the tooth into the skeleton, and the gingiva is the covering tissue of the periodontium (Figure 45-1). The gingiva is a unique body tissue because it allows the penetration of calcified tissue (i.e., teeth) into an intact mucosa, while protecting the underlying periodontal tissues. The buildup of infectious organisms on these structures give rise to some of the most common diseases in humans.

The accumulation of microorganisms on the tooth surface along the gingival margin can alter the structure and function of the gingiva, inducing an oral inflammatory reaction; clinically, this is known as *gingivitis*.⁶⁴ During adolescence, the occurrence of gingivitis is almost universal, and in adulthood, it affects approximately 50% of the population.² Because of the frequent appearance of gingivitis, this disease remains a principal concern for the dentist, as it can be converted to other, more destructive forms of periodontal disease.⁶⁴ The prevention or cure of gingivitis is of particular interest to dentists.

Dental caries is another common oral disease the prevalence of which varies in regard to the tooth surface and age of the individual.²⁵ Although caries is a worldwide problem associated with dental plaque and refined carbohydrates, some individuals, particularly individuals in lower educational, lower socioeconomic, and older age groups, are at greater risk.²⁵

The most common method of eliminating gingivitis or preventing dental caries is by the mechanical removal of the microorganisms found in dental plaque via tooth brushing and flossing. Effective mechanical removal of plaque is a tedious, time-consuming process, however, which is affected by an individual's gingival architecture, tooth position, dexterity, and motivation. Consequently, incomplete removal of dental plaque by mechanical means allows for the induction and continued progression of gingivitis and dental caries. Pharmacologic agents that prevent or reduce plaque can aid the dentist by effectively preventing or eliminating these diseases. The development of safe, effective, topically applied anti-infective agents would help in the maintenance of healthy hard and soft tissues. This chapter examines the relationship of the unique pharmacokinetic characteristics of common antiplateque and antigingivitis agents and drugs available in mouth rinses and dentifrices to manage dental plaque.

RATIONALE FOR BIOFILM DRUG THERAPY

Many different types of materials accumulate on teeth. The most ubiquitous and important deposit is dental plaque or

dental biofilm. Dental biofilm consists primarily of microorganisms in an organized matrix of organic and inorganic components.⁸⁵ Bacteria account for at least 70% of the mass of the biofilm; 1 mm³ of dental biofilm contains more than 100 million bacteria consisting of more than 400 different species.^{41,69} The organic matrix of biofilm consists of polysaccharide, protein, and lipid components, whereas the inorganic matrix is primarily composed of calcium and phosphorus ions.⁸⁵

The dental biofilm found above the gingival margin of the tooth is called *supragingival*, and the dental biofilm found below the gingival margin (i.e., in the gingival sulcus or pocket) is called *subgingival*. Dental biofilm has been considered to be a common denominator in caries and periodontal diseases. This concept is a gross oversimplification, however, because there are different types of bacteria, some of which may be cariogenic, some of which may be periodontopathic (with subsets leading to different forms of periodontal diseases), and some of which may be relatively innocuous and cause only low-grade dental disease.

Gingivitis is due principally to the accumulation and retention of dental biofilm coronal to the gingival margin.^{45,62} The accumulation of supragingival biofilm is also a prime influence in the development of the subgingival biofilm.¹⁶ As undisturbed biofilm matures, it changes in composition and becomes more complex. A bacterial succession occurs whereby microorganisms associated with gingival health (i.e., gram-positive rods and cocci) are replaced by microorganisms associated with gingivitis (i.e., gram-negative cocci and rods) and spiral-shaped organisms and spirochetes. As a consequence of the change in microflora, inflammation-induced changes in the gingiva cause an increase in epithelial cell turnover and connective tissue degradation, resulting in anatomic changes that tend to deepen the gingival sulcus causing a gingival pocket to form.³⁷ This change in gingival architecture and the subgingival environment provides a new and better protected niche for bacteria to grow. Here, they are continually bathed by exudate from the gingival crevice and end products from the supragingival biofilm. Control of supragingival biofilm also has a profound influence on the developing composition of periodontitis-associated subgingival biofilm.³⁷

Dental caries is a chronic disease that is characterized by the progressive decalcification of tooth structure. The biofilm contains bacterial species (e.g., *Streptococcus mutans*) that convert refined carbohydrates to lactic acid and other acids.¹⁰³ These acids can dissolve tooth mineral, resulting in a subsurface lesion initially and a cavity if the process continues over time. The unimpeded progress of dental caries can penetrate the enamel or cementum and progress through the dentin to the dental pulp. When the dental pulp is affected, a pulpitis develops resulting in tooth pain (i.e., toothache).

Some current commercially available therapeutic measures for control of biofilms include agents that act directly

*The author recognizes Dr. Ernest Newbrun for his past contributions to this chapter.

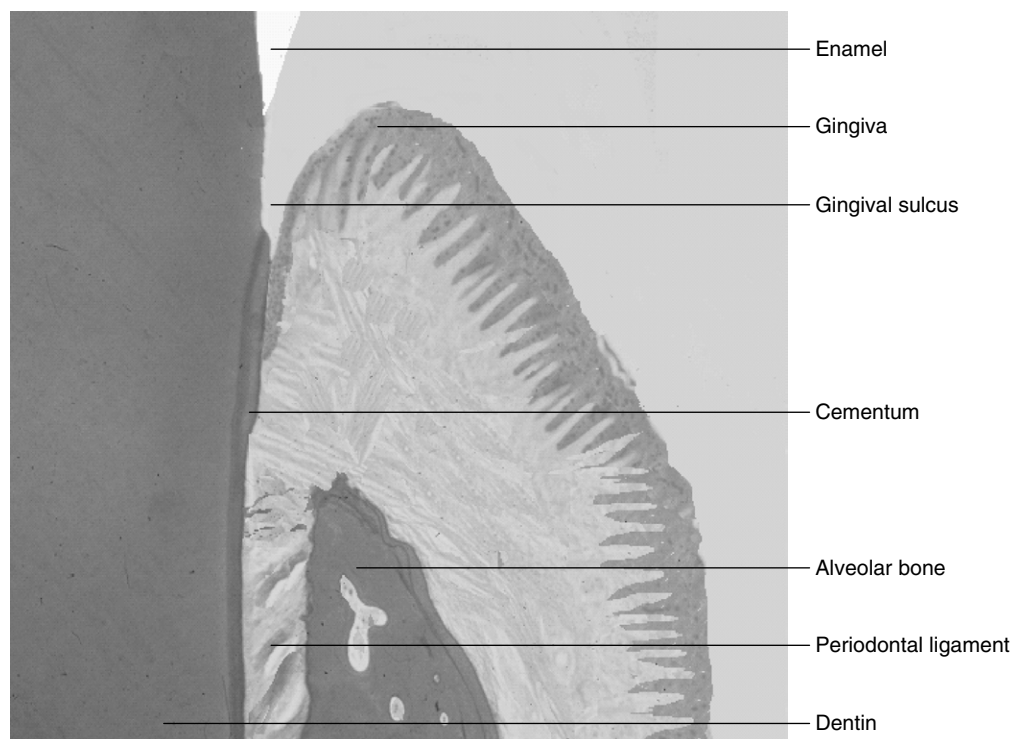

FIGURE 45-1 Photomicrograph of periodontium. (Courtesy Dr. Rudi Melfi, The Ohio State University.)

on the microflora and agents that interfere with bacterial attachment or the mechanical removal of the biofilm or both. Discussion of mechanical techniques is beyond the scope of this chapter, but excellent comprehensive reviews on mechanical plaque control can be found elsewhere in the dental literature.^{15,29}

PHARMACOKINETICS OF THE ORAL CAVITY

The therapeutic outcome of topically applied agents used to control oral infections depends on the characteristics of drugs that take advantage of the unique physiologic and anatomic circumstances found in the oral cavity. This section is a broad overview of important oral pharmacokinetic principles.

Absorption

The vascularity of the oral cavity, combined with a thin epithelial lining in some areas, allows for the absorption of drugs at a rapid rate.^{43,94} Nonionized drugs, such as nitroglycerin, take advantage of these tissue characteristics and diffuse rapidly across the oral mucosa into the bloodstream. In contrast to most drugs, for which the principal objective is to introduce the agent into the bloodstream rapidly, the goal of oral topical agents is to be retained in the oral cavity for as long as possible.³⁵ Rapid oral absorption can lead to toxic effects elsewhere in the body and a significant reduction of the free drug in the oral cavity. In most instances, the drugs used to restrain plaque levels are highly ionized and are generally unable to penetrate the oral mucosa.

Distribution

When an agent is topically applied in the oral cavity, the free drug can act at the primary site (i.e., bacteria in the plaque), or it can be partitioned to compartments where the drug binds nonspecifically. These drug reservoirs include the enamel,

dentin, and cementum of the tooth; the oral mucosa; the organic and inorganic components of plaque; and salivary proteins.²⁰

The fraction of the administered dose that is nonspecifically bound to oral reservoirs depends on the concentration, amount of time, and chemical nature of the agent used. A 1-minute rinse with 0.2% chlorhexidine results in approximately 30% of the total amount dispensed being retained after 1 hour, whereas a 3-minute rinse with 0.1% sodium fluoride results in less than 1% of the administered dose being found in the oral cavity after 1 hour.³¹ The ability of oral agents to bind nonspecifically and reversibly to oral reservoirs is an important quality for a sustained release of drugs to occur.

Metabolism

In the oral cavity, drug metabolism occurs in mucosal epithelial cells, microorganisms, and enzymes found in the saliva and in renal and hepatic tissue after the drug is swallowed. Although biotransformation of agents in the oral cavity is potentially an important aspect of reducing effective drug concentrations, quantitatively it accounts only for a small percentage of drug inactivation.

Clearance from the Oral Cavity

Salivary flow is crucial in the removal of many agents from the oral cavity. Human saliva has a diurnal flow that varies from 500 to 1500 mL of secretion in the daytime to less than 10 mL of secretion at night.⁵ The rate of clearance of a drug from the oral cavity is of profound importance in determining the duration of time a drug is in contact with the tooth surface.²⁰

Substantivity

The time that a drug is in contact with a particular substrate in the oral cavity is defined as *substantivity*.¹⁰⁴ Drugs that have a prolonged duration of contact are considered to have high

FIGURE 45-2 Pharmacokinetic factors that affect substantivity of agents. C, Clearance from the oral cavity.

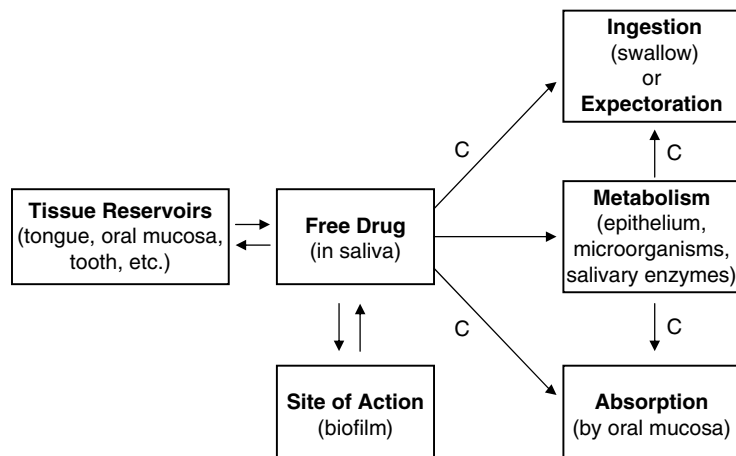

substantivity.¹⁰⁵ In the oral cavity, substantivity depends on two important pharmacokinetic features: (1) the degree of reversible, nonspecific binding to oral reservoirs and (2) the rate of clearance by salivary flow (Figure 45-2).

Oral reservoirs are an important source for the continued release of drugs. The oral compartments that accumulate a drug must be able to bind reversibly large portions of the administered dose and release therapeutic concentrations of free drug to the site of action over long periods. Effective agents with high substantivity ideally would not bind irreversibly or with high affinity to oral reservoirs.^{20,31}

Salivary flow also significantly affects the substantivity of topically applied liquid agents. The clearance of an agent from the oral cavity is directly proportional to the rate of salivary flow. During periods of high salivary flow, there would need to be a greater release of drug from oral reservoirs to maintain therapeutic concentrations.^{20,31} Strategies that use natural or drug-induced periods of low salivary flow can increase the substantivity of an oral agent.

IDEAL PROPERTIES OF ANTIPLAQUE AGENTS

The pursuit of an ideal agent to reduce dental biofilms has been an ongoing search in dentistry for centuries.¹⁰⁷ In 1890, Willoughby D. Miller, an American dental surgeon, stated in his now-famous book, *The Micro-Organisms of the Human Mouth*, that “we ought to be able by means of properly chosen antiseptic material . . . to prevent as well as arrest microbial-induced diseases in the oral cavity.”⁶⁷ Since that time, numerous antiplaque mouth rinses have been introduced to the public, many with dubious claims, and only more recently have dentists been able to prescribe therapeutically effective agents. Considering that the average time a person spends mechanically removing plaque from teeth is approximately 37 seconds,¹⁰⁶ having a “chemical” toothbrush would be a great benefit to improve oral health.

The principal properties of an ideal antiplaque agent include efficacy, stability, low clearance, safety, and taste (Box 45-1). An antiplaque agent must be able to suppress meaningfully or eliminate specific pathogens with no untoward local or systemic side effects. It should not allow the overgrowth of opportunistic organisms or encourage the development of resistant organisms. When used, it should be slowly released over time in the oral cavity with continued antimicrobial effect. The agent should be stable at room temperature and have a color and taste that is pleasing to the consumer. Last but not least, it should be relatively inexpensive to purchase. No such perfect antiplaque agent exists today.

BOX 45-1

Properties of an Ideal Antiplaque Agent

- Safety (nontoxic, nonallergenic, nonirritating)
- Efficacy (statistically and clinically meaningful reduction of plaque and gingivitis)
- Specificity (affects only the pathogenic flora)
- Substantivity (binds to and releases slowly from the tooth surface)
- No induced drug resistance
- Acceptable taste
- Low cost

The myriad claims regarding antiplaque efficiency of drugs has led the American Dental Association (ADA) Council on Scientific Affairs¹⁹ to develop guidelines for testing the long-term efficacy of chemotherapeutic products for control of supragingival dental plaque and gingivitis. The requirements of these guidelines are summarized in Box 45-2 and have been adopted, in some cases with modifications, by the U.S. Food and Drug Administration (FDA), the Canadian Dental Association, and the British Dental Association. To be considered acceptable, a product should be tested in at least two, independently conducted, 6-month clinical trials in populations that represent individuals for whom the product is intended.

The Council on Scientific Affairs has set a mean estimated proportionate reduction in gingival inflammation across two studies of no less than 20% for establishing definite improvement (i.e., clinical significance) of mean gingivitis scores when measured against a masked placebo agent. This last requirement is important because participants in studies that use a placebo agent often show improvement simply because they are in a dental study; have had their teeth, plaque, and gingiva examined; and subsequently are more dentally aware. The Council also recommends that, in addition to measuring plaque quantitatively by any of the traditional indexes, investigators should obtain microbiologic samples from several supragingival sites and should characterize the oral flora in a control group and in the test group. In evaluating the efficacy of a chemotherapeutic agent on gingivitis, the Council recommends that subjective scoring of gingiva, based on tissue color or estimated degree of swelling, and objective measures, such as extent of gingival bleeding on probing or the amount of crevicular fluid flow, should be made.

ANTIPLAQUE AND ANTINGINGIVITIS AGENTS

Bis-biguanides

The bis-biguanides, chlorhexidine and alexidine, are cationic agents with fungicidal activity and bactericidal action against gram-positive and gram-negative organisms. Chlorhexidine is a chlorophenyl biguanide (Figure 45-3) that has been used as the acetate and, more commonly, the gluconate salt (which is more soluble) in mouth rinses, gels, and dentifrices for control of plaque and gingivitis. It binds to anionic groups on the bacterial surface, probably the phosphate groups of teichoic acid in gram-positive bacteria and the phosphate groups of lipopolysaccharides in gram-negative bacteria. When the bis-biguanide binds to the organism, the cell's membrane becomes permeable, allowing the cytoplasmic contents to leak. At higher concentrations, chlorhexidine causes precipitation of cytoplasmic proteins. By virtue of their cationic properties, the bis-biguanides also bind electrostatically to hydroxyapatite of teeth, to acquired pellicle, to plaque, and to buccal mucosa.

In one of the earliest studies on the dental applications of chlorhexidine, Schroeder⁹¹ showed a 73% reduction of supragingival calculus plaques formed on carrier foils in short-term

(3-day) tests. Subsequently, Løe and Rindom Schiøtt⁶¹ showed that chlorhexidine was the most effective antiplaque and anti- gingivitis agent that had been tested until that time. In short-term trials with an experimental gingivitis model, a twice-daily rinse with 0.2% chlorhexidine gluconate completely prevented accumulation of plaque and the onset of gingivitis. These observations have been confirmed in numerous trials in humans and animals. Chlorhexidine mouth rinse in this experimental model prevented the development of white-spot lesions associated with incipient caries.⁶³

The efficacy of chlorhexidine mouth rinse as an anti- plaque/antigingivitis agent is dose-dependent in the range of 0.03% to 0.2%.^{6,55} The volume and frequency of use and the concentration are important in determining the clinical response.⁵⁷ Although no significant difference in response was found between a 0.2% and a 0.12% chlorhexidine mouth rinse when administered in a 15-mL dose twice daily (delivering a total of 60 mg and 36 mg of the agent),⁹² a significant difference in response was found between a 0.2% and a 0.1% chlorhexidine mouth rinse when administered in a 10-mL dose twice daily (providing 40 mg and 20 mg of the agent).⁶ Additional factors, such as bioavailability of the formulation, may also affect the dose response.

Long-term use (6 months) of chlorhexidine mouth rinses has shown plaque reduction and significant prevention of gingivitis in children⁵⁷ and adults.³⁸ In a short-term study (21 days), 0.12% chlorhexidine mouth rinse used twice daily was clearly effective in reducing plaque (62% to 99%) compared with placebo, whereas rinsing with a phenolic compound containing essential oils, or sanguinarine with zinc chloride, resulted in no significant reduction in plaque.⁹⁵ The chlorhexidine rinse was superior to the other agents in its ability to maintain optimal gingival health during the entire 3 weeks the mouth rinses were used. Similarly, a 0.2% chlorhexidine rinse was approximately twice as effective as a sanguinarine rinse in a 19-day nonbrushing study in which plaque and gingivitis scores were assessed.⁷⁰ Fluoride (100 ppm), when combined with chlorhexidine (0.12%), does not interfere with the antiplaque/antigingivitis activity of a mouthwash.⁴⁹ The ADA Council on Scientific Affairs has accepted a mouth rinse containing 0.12% chlorhexidine gluconate as a safe and effective adjunct to brushing and flossing and regular professional care in helping prevent and reduce supragingival plaque and gingivitis.¹⁸

Chlorhexidine rinses occasionally produce some undesirable side effects, the most conspicuous being the development of yellow-brown stains on the teeth, anterior restorations, and the dorsum of the tongue. Although the stain is extrinsic, it cannot be removed by brushing with a normal toothpaste; mechanical polishing is necessary for its removal. Chlorhexidine also tends to promote supragingival calculus formation. A few individuals have had mucosal desquamation and soreness. Solutions containing bis-biguanides have a disagreeable, bitter taste that requires masking by compatible flavoring agents to be palatable. Some patients have a persistent after-taste or disturbed taste sensation.

BOX 45-2

Guidelines for Evaluating Chemotherapeutic Products for the Control of Supragingival Plaque and Gingivitis

Rights were not granted to include this box in electronic media. Please refer to the printed publication.

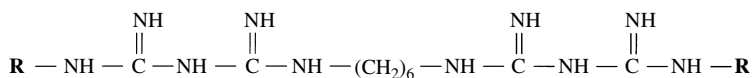

Bis-biguanide

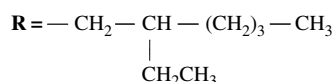

Alexidine

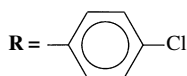

Chlorhexidine

FIGURE 45-3 Structural formulas of bis-biguanides.

Extensive safety testing of the short-term and long-term effects of these compounds shows extremely low levels of toxicity locally and systemically. The low toxicity is a result of the poor absorption of chlorhexidine by the oral cavity and gastrointestinal tract, resulting in a limited amount entering the bloodstream. When chlorhexidine directly contacts mammalian connective tissue cells, there is usually a harmful effect. In cell culture, chlorhexidine can adversely affect gingival fibroblast attachment to root surfaces.¹⁴ Protein production in human gingival fibroblasts was reduced at chlorhexidine concentrations that would not normally affect cell proliferation.⁶⁵ Such findings corroborate earlier studies showing delayed wound healing in standardized mucosal wounds after rinsing with a 0.5% chlorhexidine solution.⁸ No teratogenic or reproductive changes have been found.

Bis-biguanides are effective as antiplaque and antigingivitis agents. They should not be used prophylactically, but as therapeutic agents for patients with active disease. This use requires proper diagnosis and supervised care until the disease is controlled. In the United States, these agents are for prescription use only. Chlorhexidine mouth rinses can serve as an important adjunct to regular oral hygiene for short-term application, particularly in the healing phase after periodontal surgery, oral surgery, and insertion of immediate dentures and for the treatment of acute necrotizing ulcerative gingivitis.⁵⁵ Chlorhexidine rinses can also be used for intermittent short-term application three to four times a year to prevent repeated denture stomatitis, limit plaque and gingivitis in patients with dental implants, and suppress the salivary titers of *S. mutans* in patients with high caries activity. Finally, long-term use of such a mouth rinse on a daily, weekly, or biweekly basis may benefit special patients with agranulocytosis, leukemia, hemophilia, thrombocytopenia, kidney disease, bone marrow transplantation, or acquired immunodeficiency syndrome (AIDS); patients being treated with cytotoxic or immunosuppressive drugs or radiation therapy; and patients who are physically handicapped or mentally retarded (Box 45-3).

Investigators have tested more intensive, professionally applied antimicrobial treatment with varnishes containing high concentrations of chlorhexidine compounds: 5%, 10%, 20%, and 40%.^{54,82-84,86-89} The goals were to suppress *S. mutans* for an extended period, to prevent the increase of *S. mutans* normally accompanying placement of fixed orthodontic appliances, and possibly to eliminate them from the mouth. In these studies, *S. mutans* was successfully suppressed and in some cases eliminated for up to 22 months. There was no long-term effect on *Actinomyces* species or *Streptococcus sanguis*, however. A 40% chlorhexidine varnish, applied to exposed root surfaces of patients who had had periodontal surgery, was as effective as a fluoride varnish in preventing root caries.⁸⁷

Bis-biguanides are useful adjuncts in the treatment of periodontal disease or rampant caries. They are not a panacea or magic bullet; in the absence of conventional therapeutic and preventive measures, bis-biguanides alone have been unable to cure periodontal disease or prevent caries.

Nonionic Bisphenols

Triclosan is a broad-spectrum antimicrobial compound whose chemical name is 2,4,4'-trichloro-2'-hydroxydiphenyl ether (Figure 45-4).⁹⁰ Originally, triclosan was used extensively in soaps, antiperspirants, and cosmetic toiletries as a germicide.⁹⁰ Currently, triclosan has been incorporated into toothpaste and mouth rinse because of its wide spectrum of antimicrobial effects, anti-inflammatory actions, and only modest toxicity.⁶⁶

Triclosan is active against a broad range of oral gram-positive and gram-negative bacteria.⁹⁰ The antibacterial ac-

BOX 45-3

Clinical Indications for Chlorhexidine

Rights were not granted to include this box in electronic media. Please refer to the printed publication.

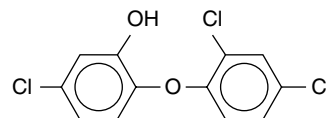

FIGURE 45-4 Structural formula of triclosan.

tions of triclosan were originally thought to affect cell membrane integrity by binding to membrane targets and interfering with transport mechanisms.⁹⁰ More recent work has shown that the effects of triclosan in bacteria occur by inhibiting the enzyme enoyl-acyl carrier protein reductase, which results in a reduction of type II bacterial fatty acid synthesis and lipid synthesis.^{59,66,97}

Although triclosan has broad antimicrobial activity, the compound is rapidly released from oral tissues resulting in poor antiplaque properties as assessed in clinical studies of plaque formation. Improvement of triclosan substantivity was accomplished by incorporation of triclosan in a polyvinylmethyl ether maleic acid (PVM/MA) copolymer.⁷⁴ With the combination of PVM/MA copolymer and triclosan, the substantivity of triclosan has been increased up to 12 hours in the oral cavity.²⁸ Triclosan plus PVM/MA copolymer is available in the United States as a toothpaste. The commercially available dentifrice contains 0.3% triclosan with 2% PVM/MA copolymer. This product was tested in numerous short-term clinical studies and in controlled clinical trials.²¹ In a review of 16 clinical trials, a meta-analysis showed a 49% reduction

in plaque and a 49% reduction in gingival inflammation.²¹ The same toothpaste composition also exhibited significant anti-calculus properties with reported reductions in calculus formation of 55%.⁷⁴ Finally, of considerable interest is the observation that triclosan inhibits gingival inflammation by a mechanism independent of its antiplaque activity. An explanation of this surprising effect stems from research that shows triclosan can reduce prostaglandin E₂ production by cells stimulated with cytokines or by direct suppression of microsomal prostaglandin E synthase-1 expression in gingival fibroblasts.²⁸

Extensive safety testing of the short-term and long-term effects of triclosan has shown extremely low levels of toxicity locally and systemically.²⁸ Nonetheless, triclosan infrequently gives rise to some undesirable side effects. There are concerns that triclosan, similar to many other disinfectants, has the potential to induce bacterial resistance, but the data to support this contention have been controversial.¹³ Although triclosan has a low allergenic potential, contact dermatitis has been reported in the literature.¹³ In addition to bacterial resistance and allergenic potential, there are environmental concerns about triclosan. It has been suggested that triclosan may combine with chlorine from tap water to produce chloroform gas, a potential human carcinogen. It has been reported, however, that the chloroform gas produced from triclosan and tap water was less than the amount present in regular chlorinated water.¹³

Phenolic Compounds

Phenol and its derivatives, thymol, chlorothymol, and hexylresorcinol, although used in many mouth rinses, have several limitations, including objectionable taste, poor water solubility, rapid discoloration, and toxicologic and allergenic properties. Phenolic compounds used in clinical trials have shown mixed results as antiplaque agents, with some studies reporting no reduction compared with placebo and others claiming reduced plaque and gingivitis scores.^{6,27} In several studies of long-term, twice-daily use of a rinse containing thymol and essential oils (menthol, eucalyptol, methyl salicylate), in combination with normal oral hygiene, plaque and gingivitis were reduced below levels seen with a placebo rinse.^{22,26,80} In one long-term study of this agent, the observed reductions in plaque and gingivitis scores were not impressive, however.³⁴

The modest effect of these essential oils on supragingival biofilms may be a result of their poor substantivity and a modest effect on inhibiting bacterial enzymes. No adverse reactions have been reported. Antiseptic mouth rinses containing a combination of these essential oils (thymol, 0.064%; menthol, 0.042%; eucalyptol, 0.092%; methyl salicylate, 0.06%; plus alcohol, 26.9%) have received the ADA Council on Scientific Affairs Seal of Acceptance as a safe and effective adjunct to brushing and flossing and regular professional care in helping to reduce supragingival plaque and gingivitis.¹⁷

Quaternary Ammonium Compounds

Surface-active compounds characteristically have hydrophobic and hydrophilic groups in their molecule. They are classified as anionic (e.g., detergents such as sodium lauryl sulfate), cationic (e.g., quaternary ammonium compounds), and non-ionic (e.g., polysorbate). In general, they exert their bactericidal effect by inactivating membrane-associated enzymes or by physically disorganizing the membrane itself.

Quaternary ammonium compounds are represented by cetylpyridinium chloride (Figure 45-5). Quaternary ammonium compounds are capable of reducing surface tension and adsorbing to negatively charged surfaces. They have greater activity against gram-positive bacteria than against gram-negative bacteria and are inactivated by the presence of organic matter; by low pH; and by anionic compounds, soaps,

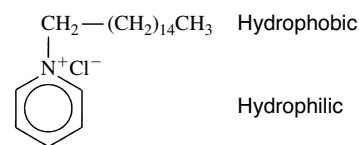

FIGURE 45-5 Structural formula of cetylpyridinium chloride showing the hydrophobic and hydrophilic substituents characteristic of quaternary ammonium disinfectants.

and metallic ions. Several over-the-counter mouth rinses contain cetylpyridinium chloride, benzethonium chloride, or domiphen bromide at concentrations of 0.025% to 0.075%. Studies of these agents have reported modest plaque reductions compared with placebo rinses.^{11,60} Occasional side effects of quaternary ammonium compounds include oral ulceration and discomfort and a mild burning sensation of the tongue. Quaternary ammonium compounds have a lingering bitter, unpleasant taste. Judicious flavoring can overcome this limitation. As a group, the quaternary ammonium compounds are moderately effective antiplaque agents.

Fluorides

Fluorides are widely used in caries prevention, for which they have been highly effective. For caries prevention, systemic application via drinking water (1 mg/L), tablets (0.25 to 1 mg), or drops (0.125 to 0.5 mg) or topical application by mouthwashes (200 to 1000 mg/L), gels for home use (900 mg/kg) and professional use (9000 to 19,000 mg/kg), and dentifrices (1000 mg/kg) are available. In contrast to the efficacy of fluorides in preventing carious lesions, these agents have relatively poor antibacterial properties. The weak therapeutic benefit of fluorides on gingivitis is due to a modest inhibition of glycolysis in plaque bacteria. At sufficiently high concentrations, fluorides can act as antibacterial agents, however, by their ability to inhibit many enzymatic reactions involved in glycolysis and in glucose transport into cells. The antimicrobial activity varies with the particular organism and type of compound and with the fluoride concentration, pH, and length of exposure. Sodium fluoride, monofluorophosphate, and stannous fluoride are the compounds used in topical agents.

A few well-controlled clinical studies suggested a potential plaque-inhibiting effect for dentifrices containing stannous fluoride. These results were most likely due to the stannous ion rather than to fluoride, however. It has been proposed that the positive charge of the stannous ion may interfere with bacterial membrane function, bacterial adhesion, and glucose uptake, inhibiting the formation of plaque. When the antimicrobial potencies of sodium fluoride and stannous fluoride were compared directly in vitro, stannous fluoride was the more effective agent, suggesting an additive effect of the stannous ion. Several short-term in vivo studies^{10,73,101} have shown that rinsing with stannous fluoride or using a toothpaste with stannous fluoride diminishes the formation of plaque. A meta-analysis of several clinical studies evaluating the effects of stannous fluoride in toothpaste showed a modest reduction of dental plaque⁷⁵ with a statistically significant decrease in gingival inflammation when stannous fluoride was compared with sodium fluoride controls.^{39,75}

In addition to being a component of toothpaste, stannous fluoride has been added to mouth rinses. Daily rinsing with stannous fluoride (0.3%) for 1 minute resulted in less plaque, measured by tooth surface area and plaque thickness, than daily rinsing with sodium fluoride (0.2%).⁹ When all oral hygiene was stopped (no brushing) and only rinsing was permitted, subjects using a stannous fluoride solution formed significantly less plaque than subjects using a placebo rinse.

Several studies have also shown that rinsing with stannous fluoride solutions or application of stannous fluoride gels improved gingival health; the benefits were not as great as with chlorhexidine,⁴⁵ and other studies have not found the improvement to be statistically significant.^{56,58,73,111} In a long-term (18 months) clinical trial, no differences were observed in gingivitis, bleeding, or mean proportions of microbial forms in the stannous fluoride (0.4%) or sodium fluoride (0.22%) groups compared with the placebo group. Daily rinsing with stannous fluoride resulted in more exogenous staining of the teeth than sodium fluoride or placebo rinses.¹¹¹

When used as topical agents, fluorides can exert antibacterial effects. Their efficacy in clinical trials in reducing plaque and gingivitis remains unproved. The lack of statistically significant effects may result from too brief an application. Commercially available 0.4% stannous fluoride gels vary considerably (from 21% to 102% of what is theoretically claimed) in the availability of the stannous ion.¹⁰² Clinical studies to test the benefits of stannous fluoride as an adjunct to plaque control and reduction of gingivitis should ensure that the agent contains the maximal available stannous and fluoride ions, that it is applied for an adequate period, and that there is good patient compliance with the regimen.

Oxygenating Agents

Agents such as peroxides and perborates release molecular oxygen. Periodontal pathogenic bacteria can be killed by peroxides in vitro.⁶⁸ Hydrogen peroxide has been used in aqueous form, in gels, in dentifrices, and in a paste with sodium bicarbonate⁵¹ for treatment of periodontal disease. Some studies have reported that the salt and peroxide regimen is effective in changing clinical measures of periodontal disease when combined with professional care,^{79,112} but it is generally no more effective than conventional oral hygiene. Mouth rinses with hydrogen peroxide have been reported to reduce plaque formation and gingivitis and to arrest ulcerative gingivitis. In one long-term study (18 months) of orthodontic patients with fixed appliances, a once-daily rinse with 1.5% hydrogen peroxide and 0.05% sodium fluoride as an adjuvant to normal oral hygiene prevented the increase in gingival indices and bleeding tendency scores seen in the control group that used 0.05% sodium fluoride only.¹² In a short-term study (7 days) with no tooth brushing, 1.5% hydrogen peroxide, used as a mouth rinse or in an oral irrigator, was of no therapeutic value in the prevention or the treatment of experimental gingivitis.⁵⁰

Antiplaque and antigingivitis claims have been made for some commercial products, but because of their rapid breakdown in the presence of organic material and bacterial catalase, their effects are at best transient. The oxygenating cleansers approved by the FDA for over-the-counter use include (1) hydrogen peroxide, 3%, applied full strength or diluted to half-strength for use as an oral rinse; (2) carbamide peroxide, 10% to 11%, applied directly or swished as a rinse; and (3) sodium perborate monohydrate, 1 to 2 g in 30 mL of warm water, as an oral rinse. These products should not be swallowed. Occasionally, patients have oral ulceration after frequent use (three times per day) of 3% hydrogen peroxide mouth rinse.⁷⁸

Morpholino Compounds

Delmopinol is a morpholino-ethanol compound (2-[3-(4-propylheptyl)morpholin-4-yl]ethanol) that acts as a cationic surfactant and prevents the attachment and the adherence of plaque bacteria to the tooth surface (Figure 45-6). The hydrochloride salt is marketed in the United States as a 0.2% oral rinse, and this is the first mouth rinse that the FDA has approved as a device.⁴⁷

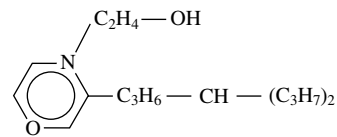

FIGURE 45-6 Structural formula of delmopinol.

In two long-term supervised studies (6 months), delmopinol (0.2%), when used as a 60-second rinse twice a day (as a supplement to normal mechanical oral hygiene), reduced plaque, gingivitis, and bleeding sites compared with a placebo rinse, but caused significantly greater staining of the teeth and transient anesthesia of the oral mucosa.^{44,56} In both studies, chlorhexidine was more effective than delmopinol in limiting plaque formation and gingivitis, but was considered less tolerable by the patients because of the tooth discoloration. A later review of a pooled analysis of eight clinical studies, in which patients rinsed with 0.2% delmopinol with and without supervision, found a 20% reduction in plaque and an 8% reduction in gingival inflammation (i.e., bleeding on probing) when delmopinol was compared with placebo controls.¹ Local side effects reported from the pooled studies included modest staining of tooth and tongue, transient anesthesia of the tongue, disruption of taste, and infrequent mucosal soreness and erosion.¹ Oral rinses of 0.2% delmopinol are well tolerated and effective in preventing the accumulation of dental plaque.

Table 45-1 summarizes information on antiplaque agents. Some proprietary sources of antimicrobial agents are listed in Table 45-2.

Photodisinfection

Photodynamic disinfection is a nonantibiotic therapy for the treatment of a broad spectrum of bacterial, fungal, and viral infections. In the oral cavity, a photosensitive compound can be used to destroy microorganisms within the periodontal pocket without the use of antibiotics or antiseptics. In a simple, two-step process, methylene blue is added to the subgingival biofilm where it selectively binds to periodontal pathogens. The second step is the excitation of methylene blue (Figure 45-7) with a nonthermal diode laser at a wavelength of 670 nm. The energy gained by methylene blue allows it to react lethally with the microorganism via a redox reaction or the formation of highly reactive oxygen species. This form of photodynamic action has been shown to inactivate bacterial virulence factors and disrupt selectively the bacterial membranes of a wide range of periodontal pathogens.^{52,110} Preliminary clinical studies have shown that photodisinfection in combination with scaling and root planing can lead to statistically significant improvements in periodontal probing depths, clinical attachment levels, and inflammation compared with scaling and root planing alone at 12 weeks after therapy.⁴

Systemic Antibiotics

Although some human studies have shown plaque reductions after administration of penicillin and erythromycin, enteral and intravenously administered antibiotics are not indicated for control of oral biofilms. The principal reasons for not typically using systemic antibiotics for the control of supragingival or subgingival biofilms is that local infections can be addressed directly by the individual or dentist, and antibiotic administration would require daily application with increased risk of potentially serious drug side effects and the emergence of drug-resistant microorganisms.

TABLE 45-1

Comparison of Antiplaque Agents

ACTIVE AGENT	CONCENTRATION (%)	PHARMACOLOGIC ACTIONS	HOW DISPENSED	EFFECT ON PLAQUE*	EFFECT ON GINGIVITIS*
Chlorhexidine	0.12	Disrupts cell membranes; precipitates intracellular proteins	Prescription	↑↑↑	↑↑↑
Delmopinol hydrochloride	0.2	Prevents attachment and adherence of bacteria to tooth surface	Prescription	↑↑	↑
Stannous fluoride	0.454	Suppresses select bacterial enzymes and alters bacterial aggregation	Over-the-counter	↔	↑↑
Thymol [†]	0.064	Suppresses bacterial enzymes	Over-the-counter	↑	↑
Triclosan	0.3	Inhibits enoyl-acyl carrier protein reductase; reduces type II bacterial fatty acid synthesis and lipid synthesis	Over-the-counter	↑↑	↑↑

*Effect: ↑↑↑ = significant; ↑↑ = moderate; ↑ = modest; ↔ = none.

[†]Antiseptic rinses also contain eucalyptol, methyl salicylate, and menthol.

TABLE 45-2

Antimicrobial Agents Used in Proprietary Mouth Rinses, Toothpastes, and Oral Products

TYPE	AGENT	PROPRIETARY (TRADE) NAMES
Phenolic compounds	Phenol	Chloraseptic, Phenaseptic, Cepastat
	Thymol	Listerine, generic antiseptic products
Nonionic bisphenols	Triclosan	Colgate Total
Oxygenating agents	Sodium peroxyborate	Amosan
	Carbamide peroxide	Gly-Oxide
	Hydrogen peroxide	Peroxyl, Orajel, Perioseptic Rinse
Quaternary ammonium compounds	Cetylpyridinium chloride	Cepacol, Anitbacterial Mouthwash Gold, Scope, Viadent Advanced Care
	Domiphen bromide	Scope
Fluoride	Stannous fluoride	Proctor & Gamble Crest Pro Health
	Decapinol	Decapinol
Morpholino compounds	Delmopinol hydrochloride	
Bis-biguanides	Chlorhexidine	Peridex, PerioGard, generic chlorhexidine products

Local Drug Delivery of Anti-infective Agents

Controlled drug delivery in the mouth allows sustained local availability of high concentrations of chemotherapeutic agents, such as tetracyclines (minocycline, doxycycline), chlorhexidine, or metronidazole. Intraperiodontal pocket devices permit the release of agents into the crevicular fluid at bactericidal concentrations, while avoiding wasteful and potentially toxic systemic administration. Local delivery devices, originally consisting of drug-filled cellulose hollow fibers containing tetracycline, were pioneered by Goodson and colleagues in the late 1970s.³² In the past 35 years,

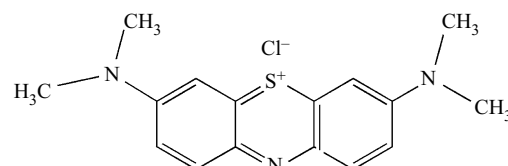

FIGURE 45-7 Structural formula of methylene blue.

improved products have been developed and marketed (Table 45-3), such as Actisite (nonresorbable monolithic fiber of ethylene-vinyl acetate impregnated with tetracycline), PerioChip (bioabsorbable wafer of cross-linked gelatin containing 2.5 mg of chlorhexidine), Arestin (bioresorbable polymer microspheres containing 1 mg of minocycline), Atridox (bioabsorbable polymer gel containing 42.5 mg of doxycycline hyclate), and Elysol (glycerol mono-oleate and sesame oil containing 25% metronidazole).

The FDA has approved Actisite, PerioChip, and Arestin as adjuncts to scaling and root planing. Atridox has FDA approval as a stand-alone therapy for the reduction of probing depths, bleeding on probing, and gain of clinical attachment. Although Actisite was the first of the controlled-release antimicrobial products to be made commercially available in 1994, it is no longer marketed. Because it was nonresorbable, it needed to be removed at the end of therapy. It was also time-consuming and tedious to insert into pockets and had a tendency to dislodge. Elysol is not available in the United States; it is marketed in Asia and Europe.

The pharmacokinetics of release of all these products indicates antimicrobial concentrations at levels in excess of the minimum inhibitory concentrations for periodontal pathogens.^{33,77} A meta-analysis of relative effects on probing depth reduction from studies comparing scaling and root planing plus local sustained-release agents with scaling and root planing alone have shown statistically significant probing depth reductions with adjunctive use of minocycline gel and microencapsulated minocycline, whereas gains in clinical attachment levels were observed only with chlorhexidine chip and doxycycline gel.⁴² Their efficacy in clinical studies is similar, with an average greater reduction of 0.5 mm or less in probing pocket depth compared with scaling and root planing alone.^{23,48,72,98,109}

TABLE 45-3

Controlled Local Drug Delivery Products

PRODUCT	RESERVOIR ACTIVE INGREDIENT	AMOUNT	DESCRIPTION	FDA APPROVED	DURATION
Actisite	Tetracycline	0.55 mg/cm of filament, 12.7 mg/dose	Nonresorbable ethyl-vinyl acetate monofilament	Yes, but no longer available in U.S.	>240 hr
Arestin	Minocycline	1 mg/dose	Biodegradable polyglycolide-lactide polymer microspheres	Yes	>14 days
Atridox	Doxycycline	42.5 mg/dose	Biodegradable polymer	Yes	>7 days
Elysol	Metronidazole	25%	Bioresorbable glyceryl mono-oleate + sesame oil gel	No, sold only in Europe, Asia	<12 hr
PerioChip	Chlorhexidine	2.5 mg/dose	Bioabsorbable cross-linked gelatin wafer	Yes	>200 hr

FDA, U.S. Food and Drug Administration.

Some authors consider the clinical benefits of most slow-release devices, even when showing statistical significance, as not impressive and do not recommend their routine use.⁷⁷ Local delivery systems have potential limitations and benefits. If used as a monotherapy (e.g., Atridox),³⁰ problems can include failure to remove calculus. The benefits include the ease of application, selectivity in targeting a few diseased sites that were unresponsive to conventional therapy, and possible enhanced treatment results at specific locations.³ Limited data also suggest that local delivery of anti-infectives may be beneficial in preventing recurrent attachment loss in the absence of maintenance therapy. Because of the limited efficacy of these agents in clinical studies of periodontal parameters, ultimately the choice may hinge on an agent's handling characteristics.

LIMITATIONS OF TOPICAL ANTIMICROBIAL THERAPY

After reviewing specific chemotherapeutic agents, several problems common to their general use need to be considered. Effective therapy requires that an adequate amount of the drug remain at the plaque site long enough for the drug to exert a therapeutic effect. This principle has been largely ignored by many who have tried to prevent or treat bacterial infections of tooth surfaces with antimicrobial agents. Most compounds have been tested as topical agents in vehicles such as mouth rinses, dentifrices, chewing gums, and gels, all requiring repeated application.¹⁰⁴ Investigators have usually performed these studies without knowing the concentration of the drug necessary to inhibit the growth of the odontopathic plaque microorganisms. Such highly empiric modes of administration may not accurately reflect a given drug's therapeutic potential. As might be expected, the results have been variable.

In most cases, *in vitro* tests have been conducted on planktonic plaque organisms (freely floating in a tube of culture medium) to determine the minimum inhibitory and bactericidal concentrations of an active agent used in topically applied products.⁷¹ Although these measurements provide important information about the antimicrobial spectrum and potency of a formulation, by themselves they are not predictive of clinical effectiveness.⁷ This is because plaque microbiota exist not just as planktonic organisms in saliva, but as a biofilm of densely packed bacteria, often in an extracellular matrix. Biofilm experiments indicate that the necessary minimum inhibitory concentrations of antimicrobial agents are at least 50 times higher than for bacteria growing under

planktonic conditions.⁷⁷ Laboratory tests with biofilm models have been developed that may be more predictive of clinical effectiveness.⁹³ Such tests still do not include potential interactions, however, between salivary components or other oral hygiene products and the active ingredient. Such interactions can be tested only by a clinical trial.

A relationship between dental plaque accumulation and gingivitis has been well established by the gingivitis that develops when volunteers cease all oral hygiene.⁶² In general, when such subjects resume cleaning their teeth, the gingivitis resolves. In studies in which various mouth rinses or dentifrices are used as the vehicle to deliver chemotherapeutic agents, a reduction in plaque scores is not always accompanied by a parallel decrease in the gingival index, however.¹⁰⁰ No convincing evidence supports a linear relationship between the quantity of plaque and the extent of oral disease.⁵³ There are three explanations for this apparent paradox.

First, plaque scoring does not consider the specific periodontal pathogenic components of that plaque. Second, the indices that have been used for measuring oral hygiene are based on plaque surface area score^{36,76} or on plaque thickness⁹⁶ and depend on the amount of plaque on the buccal or lingual surfaces. They do not emphasize fissure or interproximal plaque, although a modification of the Navy plaque index has attempted to give more emphasis to interproximal areas.⁸¹ Similarly, the plaque thickness index⁹⁶ can be adapted to score interproximal areas. Third, current plaque indices do not consider subgingival extension, only supragingival sites. Most of these standard methods for measuring the efficacy of chemotherapeutic antiplaque agents ignore the sites that are most likely to be involved in periodontal diseases and caries.

Another important problem in the topical use of chemotherapeutic antiplaque agents is their continuous dilution and elimination by saliva. Even if the minimum inhibitory concentration of a drug were initially used, rapid clearance from the oral cavity may prevent maintenance of an effective concentration. The failure or limited success of many agents in preventing caries or periodontal diseases can be attributed to their transitory presence in the mouth. It is not that they cannot kill plaque microflora or hydrolyze plaque matrices; many of them do so in the test tube. It is primarily a problem of effective delivery. To overcome this limitation, agents with substantivity have been sought. Investigators have explored the use of controlled-release devices for delivering chemotherapeutic drugs into the periodontal pocket, overcoming the problem of salivary dilution. The agent either is embedded in a polymer matrix that permits gradual local release for days or weeks after insertion or is incorporated into a biodegradable

matrix. Extensive animal and clinical trials are necessary to determine which drugs and concentrations would be most effective.

Not all mouth rinses used to control plaque and gingivitis can be used by all individuals. More specifically, alcohol, which is important in placing ingredients into solution, can have disadvantages for the patient to use. Most mouth rinses contain alcohol at a concentration of 5% to 27%, to dissolve active (e.g., chlorhexidine, essential oils) and many inactive (e.g., flavoring agents) ingredients to prevent their separation or precipitation. When alcohol is present, it can be potentially toxic to young children^{46,99} or possibly tempt alcoholics who accidentally swallow the mouth rinse.²⁴ Alcohol-containing mouth rinses can affect many types of dental materials (e.g., composite resins, glass ionomer cements) used in the oral cavity.^{40,108}

FUTURE DIRECTIONS

Today, prevention of periodontal disease and dental caries is achieved most effectively and principally through mechanical plaque control; however, a dentition free of supragingival and subgingival biofilm is extremely difficult to accomplish and to maintain. On an annual basis, Americans spend more than three quarters of a billion dollars on oral rinsing agents, although few effective, plaque-inhibiting oral rinses are available at this time, and many are associated with side effects that prohibit long-term use.

The goal of future product development is not so much an improvement in the antiplaque performance of the existing, effective compounds, but rather a lessening of their side effects and a development of better delivery systems. Products that combine various known compounds with well-established plaque-inhibiting properties are currently under investigation. In the future, chemoprevention of supragingival biofilm will depend on products that are effective, substantive, and safe.

CITED REFERENCES

1. Addy M, Moran J, Newcombe RG: Meta-analysis of studies of 0.2% delmopinol mouth rinse as an adjunct to gingival health and plaque control measures. *J Clin Periodontol* 34:58-65, 2007.
2. Albandar JM: Periodontal diseases in North America. *Periodontol* 2000 29:31-69, 2002.
3. American Academy of Periodontology: Treatment of plaque-induced gingivitis, chronic periodontitis, and other clinical conditions. *J Periodontol* 72:1790-1800, 2001.
4. Anderson R, Loebel N, Hammond D, et al: Treatment of periodontal disease by photodisinfection compared to scaling and root planning. *J Clin Dent* 18:34-38, 2007.
5. Arglebe A: Biochemistry of human saliva. *Adv Otorhinolaryngol* 26:97-234, 1981.
6. Axelsson P, Lindhe J: Efficacy of mouthrinses in inhibiting dental plaque and gingivitis in man. *J Clin Periodontol* 14:205-212, 1987.
7. Barnett ML: The role of therapeutic antimicrobial mouthrinses in clinical practice: control of supragingival plaque and gingivitis. *J Am Dent Assoc* 134:699-704, 2003.
8. Bassetti C, Kallenberger A: Influence of chlorhexidine rinsing on the healing of oral mucosal and osseous lesions. *J Clin Periodontol* 7:443-456, 1980.
9. Bay I, Rølla G: Morphological studies of plaque formation and growth after NaF and SnF₂ rinses. In Rølla G, Sonju T, Embury G, editors: *Tooth surface interactions and preventive dentistry*, London, 1981, IRL Press.
10. Bay I, Rølla G: Plaque inhibition and improved gingival condition by the use of stannous fluoride toothpaste. *Scand J Dent Res* 88:313-315, 1980.
11. Bonesvol P, Gjerme P: A comparison between chlorhexidine and some quaternary ammonium compounds with regard to retention, salivary concentration and plaque-inhibiting effect in the human mouth after mouthrinses. *Arch Oral Biol* 23:289-294, 1978.
12. Boyd RL: Effects on gingivitis of daily rinsing with 1.5% H₂O₂. *J Clin Periodontol* 16:557-562, 1989.
13. Campbell L, Zirwas MJ: Triclosan. *Dermatitis* 17:204-207, 2006.
14. Cline NV, Layman DL: The effects of chlorhexidine on the attachment and growth of cultured human periodontal cells. *J Periodontol* 63:598-602, 1992.
15. Cobb CM: Clinical significance of non-surgical periodontal therapy: an evidence-based perspective of scaling and root planning. *J Clin Periodontol* 29(Suppl 2):6-16, 2002.
16. Corbet EF, Davies WIR: The role of supragingival plaque in the control of progressive periodontal disease: a review. *J Clin Periodontol* 20:307-313, 1993.
17. Council on Dental Therapeutics: Council on Dental Therapeutics accepts Listerine. *J Am Dent Assoc* 117:515-516, 1988.
18. Council on Dental Therapeutics: Council on Dental Therapeutics accepts Peridex. *J Am Dent Assoc* 117:516-517, 1988.
19. Council on Dental Therapeutics: Guidelines for acceptance of chemotherapeutic products for the control of supragingival dental plaque and gingivitis. *J Am Dent Assoc* 112:529-532, 1986.
20. Cummins D, Creeth JE: Delivery of antiplaque agents from dentifrices, gels, and mouthrinses. *J Dent Res* 71:1439-1449, 1992.
21. Davies RM, Ellwood RP, Davies GM: The effectiveness of a toothpaste containing triclosan and polyvinyl-methyl ether maleic acid copolymer in improving plaque control and gingival health: a systematic review. *J Clin Periodontol* 31:1029-1033, 2004.
22. DePaola LG, Overholser CD, Meiller TF, et al: Chemotherapeutic inhibition of supragingival plaque and gingivitis development. *J Clin Periodontol* 16:311-315, 1989.
23. Drisko CH, Cobb CM, Killjoy WJ, et al: Evaluation of periodontal treatments using controlled release tetracycline fibers: clinical response. *J Periodontol* 66:692-699, 1995.
24. Egbert AM, Reed JS, Powell BJ, et al: Alcoholics who drink mouthwash: the spectrum of nonbeverage alcohol use. *J Stud Alcohol* 46:473-481, 1985.
25. Ettlinger RL: Epidemiology of dental caries: a broad review. *Dent Clin North Am* 43:679-694, 1999.
26. Fine DH, Letizia J, Mandel I: The effect of rinsing with Listerine antiseptic on the properties of developing dental plaque. *J Clin Periodontol* 12:660-666, 1985.
27. Fornell J, Sundin Y, Lindhe J: Effect of Listerine on dental plaque and gingivitis. *Scand J Dent Res* 83:18-25, 1975.
28. Gaffar A, Afflitto J, Nabi N, et al: Recent advances in plaque, gingivitis, tartar and caries prevention technology. *Int Dent J* 44:63-70, 1994.
29. Garrett JS: Effects of nonsurgical periodontal therapy on periodontitis in humans: a review. *J Clin Periodontol* 10:515-523, 1983.
30. Garrett S, Johnson L, Drisko CH, et al: Two multicenter studies evaluating locally delivered doxycycline hyclate, placebo control, oral hygiene, and scaling and root planing in the treatment of periodontitis. *J Periodontol* 70:490-503, 1999.
31. Goodson JM: Pharmacokinetic principles controlling efficacy of oral therapy. *J Dent Res* 68(Special Issue):1625, 1989.
32. Goodson JM, Holborow D, Dunn RL, et al: Monolithic tetracycline-containing fibers for controlled delivery to periodontal pockets. *J Periodontol* 54:575-579, 1983.
33. Goodson JM, Tanner A, McArdle S, et al: Multicenter evaluation of tetracycline fiber therapy, III: microbiological response. *J Periodont Res* 26:440-451, 1991.
34. Gordon JM, Lamster IB, Seiger MC: Efficacy of Listerine antiseptic in inhibiting the growth of plaque and gingivitis. *J Clin Periodontol* 12:697-704, 1985.
35. Goswami T, Jasti B, Li X: Sublingual drug delivery. *Crit Rev Ther Drug Carrier Syst* 25:449-484, 2008.
36. Greene JC, Vermillion JR: The simplified oral hygiene index. *J Am Dent Assoc* 68:7-13, 1964.

37. Greenstein G, Caton J, Polson AM: Histologic characteristics associated with bleeding after probing and visual signs of inflammation. *J Periodontol* 52:420-425, 1981.
38. Grossman E, Reiter G, Sturzenberger OP, et al: Six-month study of the effects of a chlorhexidine mouthrinse on gingivitis in adults. *J Periodont Res* 21:33-43, 1986.
39. Gunsolley JC: A meta-analysis of six-month studies of anti-plaque and antigingivitis agents. *J Am Dent Assoc* 137:1649-1657, 2006.
40. Gurgan S, Onen A, Koprula H: In vitro effects of alcohol-containing and alcohol-free mouthrinses on micro-hardness of some restorative materials. *J Oral Rehabil* 24:244-246, 1997.
41. Haffajee AD, Socransky SS: Microbial etiological agents of destructive periodontal diseases. *Periodontol* 2000 5:78-111, 1994.
42. Hanes PJ, Purvis JP: Local anti-infective therapy: pharmacological agents. A systematic review. *Ann Periodontol* 8:79-98, 2003.
43. Hao J, Heng PW: Buccal delivery system. *Drug Dev Ind Pharm* 29:821-832, 2003.
44. Hase JC, Attström R, Edwardsson S, et al: 6-month use of 0.2% delmopinol hydrochloride in comparison with 0.2% chlorhexidine digluconate and placebo, I: effect on plaque formation and gingivitis. *J Clin Periodontol* 25:746-753, 1998.
45. Helldén L, Camosci D, Hock J, et al: Clinical study to compare the effect of stannous fluoride and chlorhexidine mouthrinses on plaque formation. *J Clin Periodontol* 8:12-16, 1981.
46. Hornfeldt CS: A report of acute ethanol poisoning in a child: mouthwash verses cologne perfume and after-shave. *J Toxicol Clin Toxicol* 30:115-121, 1992.
47. http://www.accessdata.fda.gov/cdrh_docs/pdf4/k041482.pdf. U.S. Dept of Health and Human Services, U.S. Food and Drug Administration website. Accessed November 11, 2009.
48. Jeffcoat MK, Bray KS, Ciancio SG: Adjunctive use of a subgingival controlled-release chlorhexidine chip reduces probing depth and improves attachment level compared with scaling and root planing alone. *J Periodontol* 69:989-997, 1998.
49. Jenkins S, Addy M, Newcombe R: Evaluation of a mouthrinse containing chlorhexidine and fluoride as an adjunct to oral hygiene. *J Clin Periodontol* 20:20-25, 1993.
50. Jones CM, Blinkhorn AS, White E: Hydrogen peroxide, the effect on plaque and gingivitis when used in an oral irrigator. *Clin Prev Dent* 12:15-18, 1990.
51. Keyes P, Wright WE, Howard SA: The use of phase-contrast microscopy and chemotherapy in the diagnosis and treatment of periodontal lesions—an initial report (I). *Quintessence Int* 9:51-56, 1978.
52. Komerik N, Wilson M, Poole S: The effect of photodynamic action on two virulence factors of gram-negative bacteria. *Photochem Photobiol* 72:767-780, 2000.
53. Kornman KS: *Antimicrobial agents*, Oxford, 1986, IRL Press.
54. Kozai K, Wang DS, Sandham HJ, et al: Changes in strains of mutans streptococci induced by treatment with chlorhexidine varnish. *J Dent Res* 70:1252-1257, 1991.
55. Lang NP, Brex MC: Chlorhexidine digluconate—an agent for chemical plaque control and prevention of gingival inflammation. *J Periodont Res* 21:74-89, 1986.
56. Lang NP, Hase JC, Grassi M, et al: Plaque formation and gingivitis after supervised mouthrinsing with 0.2% delmopinol hydrochloride, 0.2% chlorhexidine digluconate and placebo for 6 months. *Oral Dis* 4:105-113, 1998.
57. Lang NP, Hotz P, Graf H, et al: Effects of supervised chlorhexidine mouthrinses in children. *J Periodont Res* 17:101-111, 1982.
58. Larson LC, Allen JM, Hyman JJ, et al: Effect of a 0.2% SnF₂ mouthrinse on gingival tissues and associated microflora. *Clin Prev Dent* 7:5-8, 1985.
59. Levy CW, Roujeinikova A, Sedelnikova S, et al: Molecular basis of triclosan activity. *Nature* 398:383-384, 1999.
60. Llewelyn J: A double-blind crossover trial on the effect of cetylpyridinium chloride 0.05 per cent (Merocet) on plaque accumulation. *Br Dent J* 148:103-104, 1980.
61. Løe H, Rindom Schiøtt C: The effect of mouthrinses and topical applications of chlorhexidine on the development of dental plaque and gingivitis in man. *J Periodont Res* 5:79-83, 1970.
62. Løe H, Theilade E, Jensen SB: Experimental gingivitis in man. *J Periodontol* 36:177-187, 1965.
63. Løe H, Von der Fehr FR, Rindom Schiøtt C: Inhibition of experimental caries by plaque prevention: the effect of chlorhexidine mouthrinses. *Scand J Dent Res* 80:1-9, 1972.
64. Mariotti A: Dental plaque-induced gingival diseases. *Ann Periodontol* 4:7-19, 1999.
65. Mariotti A, Rumpf DAH: Chlorhexidine-induced changes to human gingival fibroblast collagen and non-collagen protein production. *J Periodontol* 70:1443-1448, 1999.
66. McMurry LM, Oethinger M, Levy SB: Triclosan targets lipid synthesis. *Nature* 394:531-532, 1998.
67. Miller WD: *The micro-organisms of the human mouth*, Philadelphia, 1980, SS White Dental Mfg Co.
68. Miyasaki KT, Genco RJ, Wilson M: Antimicrobial properties of hydrogen peroxide and sodium bicarbonate individually and in combination against selected oral gram-negative facultative bacteria. *J Dent Res* 65:1142-1148, 1986.
69. Moore WE, Holdeman LV, Cato EP, et al: Bacteriology of moderate (chronic) periodontitis in mature adult humans. *Infect Immun* 42:510-551, 1983.
70. Moran J, Addy M: Comparison between chlorhexidine and sanguinarine mouthrinses on plaque and gingivitis [abstract]. *J Dent Res* 66:1381, 1987.
71. Newbrun E, Felton RA, Bulkacz J: Susceptibility of some plaque microorganisms to chemotherapeutic agents. *J Dent Res* 55:574-579, 1976.
72. Newman MG, Kornman KS, Doherty FM: A 6-month multicenter evaluation of adjunctive tetracycline fiber therapy used in conjunction with scaling and root planing in maintenance patients: clinical results. *J Periodontol* 65:685-691, 1994.
73. Ogaard B, Gjerme P, Rolla G: Plaque-inhibiting effect in orthodontic patients of a dentifrice containing stannous fluoride. *Am J Orthod* 78:266-272, 1980.
74. Panagakos FS, Cummins D: A dentifrice for the 21st century. *Inside Dentistry* 2(Special Issue 1):1-9, 2006.
75. Paraskevas S, van der Weijden GA: A review of the effects of stannous fluoride on gingivitis. *J Clin Periodontol* 33:1-13, 2006.
76. Quigley G, Hein J: Comparative cleansing efficiency of manual and power brushing. *J Am Dent Assoc* 65:26-29, 1962.
77. Quirynen M, Teughels W, De Soete M, et al: Topical antiseptics and antibiotics in the initial therapy of chronic adult periodontitis: microbiological aspects. *Periodontol* 2000 28:72-90, 2002.
78. Rees TD, Orth CF: Oral ulceration with use of hydrogen peroxide. *J Periodontol* 57:689-692, 1986.
79. Rosling BG, Slots J, Webber RL, et al: Microbiological and clinical effect of topical subgingival antimicrobial treatment of human periodontal disease. *J Clin Periodontol* 10:487-514, 1983.
80. Ross NM, Charles CH, Dills SS: Long-term effects of Listerine antiseptic on dental plaque and gingivitis. *J Clin Dent* 1:92-95, 1989.
81. Rustogi KN, Curtis JP, Volpe AR, et al: Refinement of the modified Navy plaque index to increase plaque scoring efficiency in gumline and interproximal tooth areas. *J Clin Dent* 3:C9-C12, 1992.
82. Sandham HJ, Brown J, Chan KH, et al: Clinical trial in adults of an antimicrobial varnish for reducing mutans streptococci. *J Dent Res* 70:1401-1408, 1991.
83. Sandham HJ, Brown J, Phillips HI, et al: A preliminary report of long-term elimination of detectable mutans streptococci in man. *J Dent Res* 67:9-14, 1988.
84. Sandham HJ, Nadeau L, Phillips HI: The effect of chlorhexidine varnish treatment on salivary mutans streptococcal levels in child orthodontic patients. *J Dent Res* 71:32-35, 1992.
85. Sbordone L, Bortolaia C: Oral biofilms and plaque-related diseases: microbial communities and their role in the shift from oral health to disease. *Clin Oral Investig* 7:181-188, 2003.
86. Schaecken MJM, de Jong MH, Franken HCM, et al: Effect of chlorhexidine and iodine on the composition of the human dental plaque flora. *Caries Res* 18:404-407, 1984.
87. Schaecken MJM, Keltjens HMAM, Van Der Hoeven JS: Effects of fluoride and chlorhexidine on the microflora of dental root-surface caries. *J Dent Res* 70:150-153, 1991.
88. Schaecken MJM, van der Hoeven JS, Franken HCM: Comparative recovery of *Streptococcus mutans* on five isolation media, including a new simple selective medium. *J Dent Res* 65:906-908, 1986.

89. Schaeken MJM, van der Hoeven JS, Hendricks JCM: Effects of varnishes containing chlorhexidine on the human dental plaque flora. *J Dent Res* 68:1786-1789, 1989.
90. Scheie AA: Modes of action of currently known chemical antiplaque agents other than chlorhexidine. *J Dent Res* 68(Special Issue):1609-1616, 1989.
91. Schroeder HE: Quantitative in-vivo-Studie mit Zahnstein-hemmstoffen. *Schweiz Monatsschr Zahnheilkunde* 72:294-312, 1962.
92. Segreto VA, Collins EM, Beiswanger BB, et al: A comparison of mouthrinses containing two concentrations of chlorhexidine. *J Periodont Res* 21(Special Issue 16):23-32, 1986.
93. Shapiro S, Giertsen E, Guggenheim B: An in vitro biofilm model for comparing the efficacy of antimicrobial mouthrinses. *Caries Res* 36:93-100, 2002.
94. Shojaei AH: Buccal mucosa as a route for systemic drug delivery: a review. *J Pharm Pharm Sci* 1:15-30, 1998.
95. Siegrist BE, Gusberti FA, Brex MC, et al: Efficacy of supervised rinsing with chlorhexidine digluconate in comparison to phenolic and plant alkaloid compounds. *J Periodont Res* 21:60-73, 1986.
96. Silness J, Løe H: Periodontal disease in pregnancy, II: correlation between oral hygiene and periodontal condition. *Acta Odont Scand* 22:121-135, 1964.
97. Sivaraman S, Zwahlen J, Bell AF: Structure-activity studies of inhibition of FabI, the enoyl reductase from *Escherichia coli*, by triclosan: kinetic analysis of mutant FabIs. *Biochemistry* 42:4406-4413, 2003.
98. Soskolne WA, Heasman PA, Stabholz A, et al: Sustained local delivery of chlorhexidine in the treatment of periodontitis: a multicenter study. *J Periodontol* 68:32-38, 1997.
99. Sperry K, Pfalzgraf R: Fatal ethanol intoxication from a household product not intended for ingestion. *J Forensic Sci* 35:1138-1142, 1990.
100. Spindel LM, Chauncey HH, Person P: Plaque reduction unaccompanied by gingivitis reduction. *J Periodontol* 57:551-554, 1986.
101. Svantun B, Gjerme P, Eriksen HM, et al: A comparison of the plaque-inhibiting effect of stannous fluoride and chlorhexidine. *Acta Odont Scand* 35:247-250, 1977.
102. Tinanoff N: Stannous fluoride in clinical dentistry. In Wei SHY, editor: *Clinical uses of fluorides*, Philadelphia, 1985, Lea & Febiger.
103. Touger-Decker R, van Loveren C: Sugars and dental caries. *Am J Clin Nutr* 78:881S-892S, 2003.
104. Van Abbe NJ: The substantivity of cosmetic ingredients to the skin, hair, and teeth. *J Soc Cosmetic Chem* 25:23-31, 1974.
105. Van der Ouderaa FJG: Anti-plaque agents: rationale and prospects for prevention of gingivitis and periodontal disease. *J Clin Periodontol* 18:447-454, 1991.
106. Vander Ouderaa FJG, Cummins D: Delivery systems for agents in supra- and subgingival plaque control. *J Dent Res* 68(Special issue):1617-1624, 1989.
107. Weinberger B: *Introduction to the history of dentistry*, St. Louis, 1948, Mosby.
108. Weiner R, Millstein P, Hoang E, et al: The effect of alcoholic and non-alcoholic mouthwashes on heat-treated compound resin. *Oper Dent* 22:249-253, 1992.
109. Williams RC, Paquette DW, Offenbacher S, et al: Treatment of periodontitis by local administration of minocycline microspheres: a controlled clinical trial. *J Periodontol* 72:1535-1544, 2001.
110. Wilson M: Bactericidal effect of laser light and its potential use in the treatment of plaque-related diseases. *Int Dent J* 44:181-189, 1994.
111. Wolff LF, Pihlstrom BL, Bakdash MB, et al: Effect of toothbrushing with 0.4% stannous fluoride and 0.22% sodium fluoride gel on gingivitis for 18 months. *J Am Dent Assoc* 119:283-289, 1989.
112. Wolff LF, Pihlstrom BL, Bakdash MB, et al: Four-year investigation of salt and peroxide regimen compared with conventional oral hygiene. *J Am Dent Assoc* 118:67-72, 1989.

GENERAL REFERENCES

- Addy M, Renton-Harper P: The role of antiseptics in secondary prevention. In Lang NP, Karring T, Lindhe J, editors: *Proceedings of the 2nd European Workshop on Periodontology*, London, 1997, Quintessenz Verlag.
- Adriaens PA, Gjerme P: Anti-plaque and anti-gingivitis efficacy of toothpastes. In Lang NP, Karring T, Lindhe J, editors: *Proceedings of the 2nd European Workshop on Periodontology*, London, 1997, Quintessenz Verlag.
- Garmyn P, van Steenberghe D, Quirynen M: Efficacy of plaque control in the maintenance of gingival health. In Lang NP, Attstrom R, Løe H, editors: *Plaque control in primary and secondary prevention. Proceedings of the European Workshop on Mechanical Plaque Control*, London, 1998, Quintessenz Verlag.
- Mariotti A, Burrell KH: Mouthrinses and dentifrices. In Ciancio SG, editor: *ADA/PDR guide to dental therapeutics*, ed 4, Chicago, 2006, ADA Publishing.
- Rölla G, Kjaerheim V, Waaler SM: The role of antiseptics in primary prevention. In Lang NP, Karring T, Lindhe J, editors: *Proceedings of the 2nd European Workshop on Periodontology*, London, 1997, Quintessenz Verlag.
- Wennström JL: Rinsing, irrigation and sustained local delivery. In Lang NP, Karring T, Lindhe J, editors: *Proceedings of the 2nd European Workshop on Periodontology*, London, 1997, Quintessenz Verlag.

Antiseptics and Disinfectants

JOHN A. MOLINARI

The historical importance for routine infection control procedures was underscored by epidemiologic investigations and other scientific evidence in the 1970s and 1980s. It was estimated at that time that an office treating 20 patients a day would encounter one active carrier of hepatitis B virus (HBV) every 7 days.⁹ This early finding, coupled with the fact that most microbial infections, including those caused by HBV, hepatitis C virus (HCV), and human immunodeficiency virus (HIV), can be infectious before distinct signs and symptoms appear, makes the likelihood of unknowingly treating an infectious patient a certainty. Failure to treat every patient as potentially infectious—that is, with *standard precautions*, previously termed *universal precautions*—places the health care worker and all patients at needlessly increased risk of infection.^{5,7}

The overall goals of infection control programs are as follows: (1) to reduce the numbers of pathogenic microorganisms to levels where patients' normal defense mechanisms can prevent infection, (2) to break the cycle of infection and eliminate cross-contamination, (3) to treat every patient and instrument as capable of transmitting infectious disease, and (4) to protect patients and health care workers from infection and its consequences.^{7,15} The proper use of barrier techniques (gloves, mask, gown, eye protection, rubber dam), proper sterilization, disinfection, and antisepsis protocols accomplishes these goals.

It is important at the beginning of this chapter to understand the differences between the terms *sterilization*, *disinfection*, and *antisepsis*.^{8,28} *Sterilization* is the ultimate goal of any infection control protocol because it is the killing of all forms of microorganisms. To eradicate resistant viruses and bacterial endospores effectively requires the application of high heat or chemicals or both for a sufficient time. The most widely used means of attaining this objective in a dental office are *dry heat*, *steam*, and *chemical vapor sterilization units*. In medicine and industry, sterilization includes *ethylene oxide* and *formaldehyde gases*, *ultraviolet* and *gamma radiation*, and *filtration*. *Disinfection* is the application of chemicals to destroy most pathogenic organisms on inanimate surfaces. Although some chemicals used for disinfection are capable of achieving sterilization given sufficient time of exposure, their use to effect sterilization is discouraged because of the number of conditions that can lead to failure in this application. *Antisepsis* is the use of chemicals to destroy or inhibit pathogenic organisms on skin or living tissue. The difference between disinfection and antisepsis may seem small, but it leads to a wide divergence in the products used and the regulation of the products. Disinfectants fall under the regulatory authority of the U.S. Environmental Protection Agency and are subject to that agency's rules for demonstration of effectiveness and use in the workplace. *Antiseptics*, because they are intended for

application on living tissue, fall under the regulations of the U.S. Food and Drug Administration (FDA) regarding effectiveness and clinical use.

Numerous treatment area surfaces can become contaminated with *saliva*, *blood*, and other potentially infectious substances during provision of care. The *routine use of chemical disinfectants and disposable supplies* has become historically more appropriate in certain instances because it is neither possible nor necessary to sterilize all contaminated items or surfaces. This trend is especially applicable in dentistry, where many instruments and environmental surfaces become contaminated with saliva and blood during routine procedures.^{8,9} Organisms contained in these fluids include *staphylococci*, *streptococci*, *Mycobacterium tuberculosis*, *cytomegalovirus*, *herpes simplex virus (HSV)*, *HBV*, *HCV*, *HIV*, and a number of *upper respiratory tract viruses such as influenza and rhinoviruses*. Environmental surfaces in particular do not lend themselves to sterilization and must be cleaned and disinfected or covered with disposable barriers.^{5,7,11}

Before selecting an environmental surface disinfectant, products under consideration should be compared with criteria for an ideal disinfectant. These criteria are as follows: The disinfectant should have the widest possible antimicrobial spectrum, including the ability to kill the vegetative form of all pathogenic organisms. The chemical agent should be able to remain active in the presence of organic matter (i.e., blood, saliva, sputum). It should be inexpensive, odorless, effective at room temperature, noncorrosive, nonstaining, nontoxic to humans, and require a short time of exposure. Given the numerous similarities in chemical composition and metabolism between humans and microorganisms, this ideal is unlikely to be achieved. In practice, however, proper use of available chemical disinfectants reduces the numbers of viable pathogenic organisms on surfaces to levels that allow a healthy person's natural defenses to prevent infection.

The ideal antiseptic would have properties similar to those of an ideal disinfectant. Selective toxicity to microorganisms but not to human cells is of primary importance for antiseptics. The degree of selectivity of the antiseptic agents can vary depending on the tissues with which they come in contact. An antiseptic intended for handwashing can be less selective than one used in an oral rinse because the highly keratinized epithelium of the skin affords a greater degree of protection from the antiseptic than does the oral epithelium.

Various antiseptics and disinfectants can be classified according to mechanism of action: agents that denature proteins, agents that cause osmotic disruption of the cell, and agents that interfere with specific metabolic processes. Agents that cause protein denaturation or osmotic disruption tend to kill the organisms and are described as bactericidal, virucidal,

TABLE 46-1

Antimicrobial Activity of Different Classes of Disinfectants and Antiseptics

CLASS OR AGENT	GRAM-POSITIVE BACTERIA	GRAM-NEGATIVE BACTERIA	BACTERIAL SPORES	TUBERCLE BACILLI	VIRUSES		
					HBV	HIV	FUNGI
Halogens	+	+	±	±	+	+	+
Aldehydes	+	+	+	+	+	+	+
Phenols	+	+	-	+	-	+	+
Alcohols	+	+	-	+	±	+	±
Chlorhexidine	+	+	-	-	-	+	±
Surface-active agents							
Anionic	+	-	-	-	-		-
Cationic	+	±	-	-	-		+
Oxidizing agents	+	+	+	+	+	+	+
Heavy metals	+	±	-	-	±		+

HBV, Hepatitis B virus; HIV, human immunodeficiency virus.

TABLE 46-2

Characteristics of Common Chemical Disinfectants

AGENT	ACTIVITY	LIABILITIES
Chlorine dioxide	Rapid disinfection activity; can be used for sterilization with 6 hr of exposure	Corrosive; activity greatly reduced in the presence of protein and organic debris; requires good ventilation
Glutaraldehyde	As 2%-3.2% immersion preparation, broad-spectrum antimicrobial activity; sporicidal after 10 hr of contact; long use life	Very irritating to skin and mucous membranes; allergenic with repeated exposures
Hypochlorite	Rapidly acting, broad-spectrum bactericidal, sporicidal, virucidal disinfectant	Irritating to skin; corrosive; can degrade some plastics
Iodophors	Rapidly acting, broad-spectrum bactericidal disinfectant; residual antimicrobial activity remains on surface after drying	Corrosive to some metals; may discolor some surfaces; inactivated by hard water
Phenols	Broad-spectrum antimicrobial activity; effective in presence of detergents	Can degrade plastics; irritating to skin and eyes; inactivated by hard water and organic debris

or fungicidal in nature. Interference with specific metabolic processes usually affects cell growth and reproduction without killing the cell, causing a bacteriostatic/virustatic/fungistatic effect.

Table 46-1 lists representative classes of compounds used as disinfectants or antiseptics with their effectiveness against various representative organisms. The aldehyde and certain halogen-based and oxidizing compounds have the broadest range of effectiveness. These agents also tend to be the most toxic to human tissue. Consequently, their use has been primarily limited to disinfection. The other chemical classes are less effective antimicrobial agents, but also tend to be less harmful to human tissue and find use as disinfectants and antiseptics. Some distinguishing features of the chemical groups are listed in Table 46-2, and their major clinical uses are noted in Table 46-3.

HALOGENS AND HALOGEN-RELEASING COMPOUNDS

Halogens and halogen-releasing compounds include some of the most effective antimicrobial compounds used for disinfection and antiseptics. Their primary mode of action seems to depend on the free halogen reacting covalently with key

TABLE 46-3

Miscellaneous Uses of Disinfectants and Antiseptics

AGENT	FORMULATION (WEIGHT/VOLUME)	USE
Alcohol	70%	Solvent and adjuvant for other agents; prevention of bedsores
Parachlorophenol	Variable	Root canal debridement
Phenol	0.5%-1.4%	Relief of sore throat
Eugenol	Variable	Relief of pulpal pain
Guaiacol	Variable	Relief of pulpal pain
Sodium hypochlorite	5% solution	Root canal debridement
Iodine solution	8%-9% iodine	Plaque-disclosing solution
Povidone-iodine	Solution with 1% available iodine	Plaque-disclosing solution
Formaldehyde	4% (10% formalin)	Fixative for tissue biopsy specimen
Hydrogen peroxide	3%	Wound cleaning
	30%	Tooth bleaching

microbial enzyme systems.¹⁰ Despite many years of research and use, the exact mechanism is unknown, although reactions with **sulfhydryls and disulfides within proteins** seem to be the most likely sites of action. **Chlorine and iodine** have historically been the most useful and effective halogens.

Chlorines

The salts (Na^+ , Ca^{++} , and Li^+) of **hypochlorite, in the form of chloride lime**, have been used since the mid-1800s as a source of chlorine for disinfection and as an antiseptic. Because of the **irritating nature of sodium hypochlorite formulations**, they are currently used **primarily as disinfectants**. This halogen primarily functions as an antimicrobial in the form of **hypochlorous acid**, into which it is **rapidly converted in water**. Elemental chlorine is a potent germicide and kills most bacteria in **15 to 30 seconds** at concentrations of **0.10 to 0.25 ppm**.¹⁰ The presence of a base in commercial preparations of sodium hypochlorite helps to stabilize the hypochlorite, which **first must be converted to hypochlorous acid before it can release the chlorine**. Useful dilutions for surface disinfection range from **1:10 to 1:100 in water**, with **exposure times of 10 to 30 minutes**.⁵ Sodium hypochlorite surface disinfectants have an efficacious, broad antimicrobial spectrum dating back to the 1970s, when a **1:10 dilution of bleach in water was shown to be effective against HBV in hospitals**. Disadvantages of bleach solutions include a **strong tendency to corrode metals**, an **odor** that some people find offensive, and the need for **diluted disinfectant solutions to be prepared fresh daily**. Current commercially available diluted hypochlorite disinfectants are more stable and remain active longer than earlier formulations. In addition, even though they are destroyed during disinfection, **tubercle bacilli seem to be more resistant to hypochlorite** compared with other common pathogens.²⁵

Iodine and Iodophors

Iodine compounds have a **long infection-control history** as antiseptics and disinfectants. Iodine is relatively **nontoxic and noncorrosive**; it is not **inhibited by the presence of organic compounds**, and it **possesses a broad spectrum of activity**. Iodine makes a nearly ideal antimicrobial agent. Originally used as elemental iodine (with **potassium iodide or sodium iodide added for increased solubility**) in aqueous solutions or in tinctures (alcohol solutions), iodine has the disadvantages of **discoloring skin and other material**, having an odor, and being **painful on open wounds**.

The development of **iodophors—iodine or triiodide complexed with natural polymers such as polyvinyl pyrrolidone or polyether glycols**—led to the application of iodine-containing preparations as antiseptics and surface disinfectants. One of the reasons for this application is their additional capability as **surfactants**, allowing them to be used as excellent cleaning agents. **Iodophors have little or no odor**, increase the solubility of iodine, are **less allergenic than** tinctures of iodine, reduce discoloration of surfaces, and provide a reservoir for sustained halogen release. Compared with aqueous solutions with the same total iodine concentration, the concentration of free molecular iodine (the active antimicrobial agent) is lower in iodophor preparations. This liability is offset by the release of iodine from the polymer complex as the free iodine, which reacts with microorganisms. **When used with a spray-wipe-spray technique, iodophor disinfectants are efficient cleaning agents and effective surface disinfectants**.^{8,28}

Iodophors are also widely accepted as antiseptics for hand hygiene. The combination of **iodine with water-soluble carrier molecules** offers unique advantages for routine hand and surgical washing by prolonging the release of halogen to epithelial tissues and reducing skin irritation resulting from frequent wash procedures. **Active iodine that is released from the sur-**

factant also **increases tissue permeability** and has a residual antimicrobial effect.

The **combination of sodium chloride with sodium bromide** has been introduced within the last few years and has proved to be an effective, broad-spectrum, tuberculocidal surface disinfectant. The **active ingredients are prepared separately in tablet form** (one containing sodium chloride and the other containing sodium bromide). When the tablets are dissolved in water, the **resultant solution provides an appropriate broad-spectrum antimicrobial effect and is compatible with most dental equipment surfaces**.

ALDEHYDES

Glutaraldehyde (1,5-pentanedial) was first proposed as an antimicrobial in the early 1960s, and achieved wide use in dentistry and medicine as an **immersion disinfectant**.²⁹ The antimicrobial action seems to be the result of the **cross-linking of microbial proteins**. Glutaraldehydes are **not significantly affected** by the presence of **organic material**.¹⁶ In health care facilities, caution must be used with glutaraldehyde because **repeated exposure of skin and mucous membranes can cause sensitization, irritation, and damage**. At least **10 cases of occupational asthma** have been reported from the use of glutaraldehydes, which underscores the importance of using them only in well-ventilated areas and **never using glutaraldehyde as a surface disinfectant**.¹¹

Marketed primarily as **alkaline 3.2% aqueous solutions**, glutaraldehydes can retain activity against tubercle bacilli, spores, viruses, and fungi when **stored for 30 days after activation**. Activation occurs by alkalization of the glutaraldehyde solution. Alkalization also can reduce the stability of the solution, however. The reuse life of a **glutaraldehyde solution (i.e., the length of time the solution remains effective when challenged by dirty instruments, dilution, and evaporation)** may be considerably **shorter than 30 days**.²³

The use of glutaraldehyde in dentistry as a **“cold sterilant”** has declined considerably in recent years. The most recent *CDC Guidelines for Infection Control in Health-Care Settings—2003* discouraged processing heat-sensitive semicritical items using chemical sterilization.⁷ At best, its use should be limited to **the few instruments and small items** that should be sterilized but cannot withstand the high heat required by sterilization methods available in a dental office. Such use requires **initial cleaning** of the item to remove contaminating bioburden, prolonged (**i.e., 6 to 10 hours**) immersion in the solution, and a terminal **thorough rinse with sterile water** to **remove all glutaraldehyde** from the sterilized material.

PHENOLS AND RELATED COMPOUNDS

Lister introduced a simple **phenol (i.e., carbolic acid)** as an all-purpose surgical disinfectant and antiseptic into hospitals in the mid-1850s, but its **irritating and toxic nature** led to its replacement by numerous substituted phenolic compounds. These substitutions have increased the antimicrobial effect of phenol without significantly increasing its human toxicity. Later generations of phenolic compounds also have been shown to be effective as **handwash antiseptics** and disinfectants in health care settings.

A few historically important phenolics exhibited a local anesthetic effect, making them useful antiseptics particularly when pain is associated with infection. In general, the phenols have the advantage of retaining their antimicrobial effectiveness in the presence of organic material, which makes them useful when the complete removal of tissue and debris is impossible or impractical. Cresol, the active ingredient in

coal-tar disinfectants, is a mixture of the three isomers of methylphenol. It has 3 to 10 times the antimicrobial activity of phenol but approximately the same human toxicity. Mixtures of cresol with detergents formed by the saponification of various vegetable oils have been used as surface disinfectants since the early 1900s.¹⁴ The original proprietary formulation of Lysol was a 50% mixture of cresol in saponified vegetable oil.

Eugenol (2-methoxy-4-allylphenol) and guaiacol (o-methoxyphenol) have weak antimicrobial activity, but are useful for their rapid analgesic properties. Eugenol remains a common component in many sedative pastes used in dentistry and is the active phenolic component in oil of cloves. Prolonged contact of eugenol with tissue, as when sealed in a root canal preparation, can lead to severe tissue damage without pain, however, because of the agent's analgesic properties.⁴ The use of eugenol in dentistry has dramatically declined in recent years because of its potential for allergic sensitization with repeated exposure.

Bisphenols include numerous phenolics, which have primary usage as handwash antiseptics. These include hexachlorophene, chlorhexidine gluconate, and parachlorometaxylenol. This class of agents, especially hexachlorophene (2,2'-methylene-bis[3,4,6-trichlorophenol]), proved to be effective antimicrobials a few decades ago when used with detergents. Hexachlorophene was shown to accumulate on the skin with repeated use, reaching a maximal level in 3 to 4 days, at which time the resident bacterial count on the skin was reduced by 95% to 99%. It was shown to be most effective against gram-positive organisms, which constitute the most common components of the bacterial skin flora and remain major potential pathogens for cross-infection. The substantivity and effectiveness of hexachlorophene made it a widely used component in surgical soaps. Over-the-counter soaps containing greater than 0.1% hexachlorophene were banned by the FDA in the late 1970s, however, after clinical reports were published concerning their accumulation in scalp tissues of infants, cutaneous absorption, and neurotoxicity.¹⁷

Chlorhexidine gluconate (CHG) antiseptics (see Chapter 45) are among the most used and effective phenolic derivatives for hand hygiene. CHG is a cationic bis-biguanide whose antimicrobial activity derives from its attachment onto microbial cytoplasmic membranes, with resultant disruption of membrane function. Subsequent precipitation of intracellular contents ultimately leads to cell death.⁶ Many different CHG handwash preparations are available. Although aqueous or detergent antiseptics containing 0.5% to 0.75% CHG show a greater antimicrobial effect than plain soap (i.e., anionic detergent), most health professional facilities that use CHG-containing products use more effective 2% to 4% CHG products.^{20,21}

As shown in Table 46-1, the antimicrobial spectrum of CHG is maximal against gram-positive bacteria, with less activity against gram-negative bacteria and fungi. Only minimal activity, at best, is observed against *M. tuberculosis*. CHG's antiviral effectiveness in vitro is significantly better against enveloped viruses, such as HSV, HIV, and influenza, compared with nonenveloped viruses (i.e., rotaviruses, adenoviruses, and enteroviruses). Despite this finding, chlorhexidine has been shown to be an effective virucidal agent, with demonstrated in vitro activity against HSV, cytomegaloviruses, influenza viruses, parainfluenza viruses, and HBV within a 30-second exposure. Although CHG hand antiseptics exert their antimicrobial effects more slowly than alcohol-based formulations, CHG has a major functional advantage because it remains effective in the presence of blood. CHG and alcohol antiseptics have also been included in the same hand hygiene preparations, and shown to be effective, because

of the observation that 0.5% to 1% CHG added to alcohol sanitizers can dramatically increase the residual activity of products containing only alcohol. Of major importance for this class of chemical is the fact that CHG hand antiseptics exhibit remarkable persistence by accumulating in epithelial tissues during the course of multiple handwashes throughout the day. This property is termed *substantivity* and is the result of the active chemical form accumulating in the epithelium, leaving a residual antimicrobial effect after each wash procedure.

In Europe, 0.2% solutions of chlorhexidine have been used as oral rinses since the 1970s.¹³ The effectiveness of chlorhexidine in oral rinses results primarily from its substantivity. The cationic nature of chlorhexidine allows it to bind to hard and soft tissues within the oral cavity; it is released over time to provide a continuing bacteriostatic effect. Used twice daily, these solutions have been shown to be effective in reducing plaque formation and gingivitis.^{1,3,22} The major side effects are staining of the teeth, an increase in calculus formation, and alteration in taste perception.

Parachlorometaxylenol (PCMX), also termed *chloroxylenol*, is a halogen-substituted phenolic compound that has found widespread use as an effective handwash antiseptic. Its antimicrobial activity against susceptible bacteria occurs from disruption of the microbial cell wall and enzyme inactivation. PCMX is more active than chlorhexidine as a broad-spectrum antiseptic because it is most effective against gram-positive bacteria, is less active against gram-negative organisms, and exerts some antifungal effects. Of special importance in health care settings is the ability of PCMX to kill *Pseudomonas* species. Because of its ability to penetrate epithelial surfaces, PCMX has been shown to be an effective alternative to chlorhexidine gluconate in many handwash preparations, with little reported allergic sensitization potential.²¹

Triclosan (2,4,4'-trichloro-2'-hydroxydiphenyl ether) has been used in antimicrobial soaps and investigated in numerous mouth rinses and dentifrices as an antiplaque agent.^{19,22} This bacteriostatic antimicrobial has been added to soaps and other consumer products (i.e., toothpastes) in concentrations ranging from 0.2% to 2%. The chemical exerts its antimicrobial action at multiple sites on and in bacterial cells. Its actions include affecting cytoplasmic membrane functions and synthesis of RNA, fatty acids, and proteins by binding with the carrier protein reductase. Triclosan is bacteriostatic and fungistatic, with a reasonably broad-spectrum range of antimicrobial activity with substantivity. A relatively low toxic effect on *Pseudomonas aeruginosa* strains diminishes some of its clinical usefulness, but its epithelial substantivity has allowed inclusion of triclosan in many medicated hand soaps, antiperspirants, and dentifrices. Although this chemical is included in numerous commercial formulations, triclosan is less effective than CHG, iodophors, or alcohol-based antiseptics at reducing bacterial counts on hands after a 1-minute handwash. The antimicrobial efficacy may also be affected by pH changes, and the presence of surfactants and emollients on epithelial tissues. In addition to its antimicrobial activity, triclosan seems to have a direct anti-inflammatory effect. This effect may result from the inhibition of a portion of the histamine cascade.¹⁸

As mentioned at the beginning of this section, carbolic acid was the first antimicrobial to have widespread use in hospitals as an antiseptic and a disinfectant. In addition to the later generations of phenolics discussed earlier, numerous phenolic compounds have found widespread use as environmental surface disinfectants.¹⁴ The introduction and subsequent widespread use of phenolic surface disinfectants that are synthetic mixtures of two or three phenolic compounds have led to the commercial availability of numerous similar products. The phenols are chosen to act synergistically, yield-

ing a product that is a more effective disinfectant than a comparable concentration of its individual components. In addition, many synthetic mixtures are diluted with water before use, which enhances their cleaning effectiveness relative to alcohol-phenol-based products.²⁴ One common example is the combination of *o*-phenylphenol and *o*-benzyl-*p*-chlorophenol. These cidal antimicrobials act as cytoplasmic poisons by penetrating and disrupting cell walls, which triggers denaturation of intracellular microbial cell proteins. These phenolics are able to penetrate target microbial cells more intensely than many other antimicrobial chemicals, which can cause localized tissue damage if they accumulate onto intact skin. Because of this potential toxicity issue, most phenolic derivatives are primarily used as disinfectants, with the exception of bisphenols.¹⁴

ALCOHOLS

Alcohols (see Chapter 43), especially ethanol and isopropanol, have been used for many years as antimicrobials and as carriers for other water-insoluble antimicrobials such as iodine and phenols. Only a brief discussion is included here; the reader is directed to Chapter 43 for a more detailed description of alcohols as antimicrobials. Their low cost, rapid evaporation, and lack of residue make them useful for disinfecting inanimate objects. Their ability to denature and precipitate proteins greatly decreases their antimicrobial effectiveness in the presence of bioburden (blood and saliva), however, and they have a detrimental effect on dental equipment surfaces, such as leather-like chair coverings and plastic items. Precipitated proteins can coat microorganisms, protecting them from direct exposure to the destructive alcohols. The ineffectiveness of alcohols against many bacterial spores, viruses, and fungi further reduces their usefulness as disinfectants for surfaces or instruments.

The use of alcohols as topical antiseptics in addition to disinfection has also been documented for more than 100 years. The use of isopropanol, ethanol, or *n*-propanol in combination with other antimicrobials, such as chlorhexidine gluconate, iodine, or quaternary ammonium compounds, can effectively reduce bacterial concentration on hands.^{2,21} Their rapid, broad-spectrum antimicrobial activity against gram-positive and gram-negative bacteria, tubercle bacilli, and a wide array of viruses is augmented by the fact that regrowth of bacteria on washed hands occurs slowly. In recent years, an increasing number of studies have investigated the clinical use of waterless, alcohol-based hand sanitizers in gel or rub delivery systems. These products were developed partly to overcome the longer times required for soap and water handwashing procedures and an observed lack of handwashing compliance by health care workers in clinical facilities. Investigations of these formulations in medical settings have shown them to be effective alternatives to washing unsoiled hands with soap and water or antimicrobial soap and water, along with improving health care professional compliance.^{12,26,27}

SURFACE-ACTIVE AGENTS

Surface-active agents are compounds that produce a detergent effect because of their ability to interact noncovalently with membrane proteins and lipids. Anionic agents such as common soaps and dodecylsulfate phosphate detergents seem to be effective primarily because of their cleaning and emulsifying ability. Agents that possess specific antimicrobial activity are almost exclusively effective against gram-positive bacteria only.

Cationic agents, as exemplified by the quaternary ammonium compounds, were used for many years as cold sterilization solutions. Referring to them as sterilizing solutions was a grave misnomer because they are totally ineffective against bacterial spores, tubercle bacilli, many gram-negative bacteria, fungi, and viruses. Bioburden, hard water, and time reduce the effectiveness of these solutions against even gram-positive bacteria.^{8,11} As a result of these limitations, the Council on Dental Therapeutics of the American Dental Association (ADA) eliminated these compounds in 1978 as disinfectants from the ADA's Accepted Product List. Despite these antimicrobial drawbacks, various surface disinfectant solutions and impregnated cloth wipes containing later generation quaternary ammoniums are marketed. These preparations are good cleaning agents and are often formulated with other antimicrobial agents that serve as the primary broad-spectrum disinfectants. Cetylpyridinium chloride, benzethonium chloride, and similar cationic agents are also used in mouth rinses (see Chapter 45) and sore throat remedies.

OXIDIZING COMPOUNDS

Hydrogen peroxide is the most common of numerous oxidizing compounds that have been used primarily as antiseptics in health care. Hydroxyl radicals released during decomposition of the parent molecule are believed to be responsible for the primary microbicidal effect. Concentrations potentially useful for antiseptics (e.g., 3%) are active against vegetative bacteria; higher concentrations ($\geq 6\%$) are sporicidal. These agents are also referred to as oxygenating compounds because they release molecular oxygen. For many years, hydrogen peroxide has been marketed only as an antiseptic, although in addition to its antimicrobial activity, it serves as an effective debridement agent for treating soft tissue wounds and infections. Hydrogen peroxide yields high concentrations of antimicrobial hydroxyl radicals in tissues and target microorganisms, with adverse effects on bacterial membrane lipids, DNA, and other cell components. More recently, hydrogen peroxide environmental surface disinfectants have become available, with tuberculocidal activity.

In combination with sodium bicarbonate, hydrogen peroxide was advocated for use against the anaerobic bacteria prevalent in periodontal disease. The basis for this use was the assumption that the oxygen released by the peroxide would be toxic to the anaerobic bacteria. This was not true; the ubiquitous presence of peroxidase enzymes in the periodontal tissues and fluids quickly destroys any peroxide, resulting in little, if any, toxicity to the microorganisms present.

HEAVY METALS

Heavy metals, particularly mercury and silver compounds, have a long history as antimicrobial agents. Organic mercurials are still used in some countries as fumigants, but they have been replaced by more effective and less toxic compounds in dentistry and medicine. Silver nitrate was commonly used in dentistry to treat oral ulcers, but is no longer used because it delays healing and alters cellular morphology. In medicine, silver nitrate eye drops remain useful in the prophylaxis of gonococcal infection in newborns.

Tin, the stannous ion, is an effective antimicrobial. As a disinfectant, it is complexed with organic anions, forming triorganotinols. The primary applications of these compounds are in industry and agriculture. In dentistry, stannous fluoride has become popular again as a fluoride source in dentifrices, particularly in dentifrices marketed for their effect on gingival health. The ability of tin to inhibit bacterial growth and

plaque formation supported its initial use in dentifrices and as a topical fluorine salt. Subsequently, problems with stability, taste, and staining led to its replacement for a time by sodium fluoride and monofluorophosphate as a source of fluoride in these products.

USES IN DENTISTRY

Many commercially available antiseptics and disinfectants continue to play important roles in accomplishing infection control goals. The dental team can do much to reduce the presence of pathogenic organisms and greatly enhance the potential for an uneventful recovery from dental procedures. Effective infection control protocols include thorough hand-washing techniques with appropriate antiseptics, combined with appropriate barrier techniques (gloves, masks, eye protection, rubber dam), disposable covers for surfaces, disinfection of nonsterilizable surfaces and equipment, and heat sterilization of all compatible equipment. Disinfectants are an important tool in achieving effective infection control.

The range of antiseptics for home use in control of oral microorganisms, plaque reduction, and prevention of gingivitis has mushroomed in recent years. New prerinses, dentifrices, and mouth rinses appear every day using new antiseptic compounds and reformulations of old ones. These agents and their uses are considered in Chapter 45.

REPRESENTATIVE ANTISEPTICS AND DISINFECTANTS

<i>Nonproprietary (generic) name</i>	<i>Proprietary (trade) name</i>
Halogens and halogen-releasing compounds	
<i>Chlorine-based</i>	
Chlorine dioxide	Dent-A-Gene
Hypochlorite solution	Dispatch
<i>Iodine-based</i>	
Iodine solution	—
Iodine tincture	—
Iodoform gauze	Nu Gauze
Oxychlorosene	Clorpactin WCS-90
Povidone-iodine	Betadine, ACU-dyne
Miscellaneous iodophors	Biocide, Surficide, Wescodyne
Aldehydes	
Formaldehyde	Formalyde-10
Glutaraldehyde	Banicide, Cidex 7, Cidex Plus, Multicide Plus, Omnicide, ProCide D, Sterall, Vital Defense-D
Phenols	
Combined phenols in 57% ethanol	Coe Spray II
Eugenol	—
Formocresol	Buckley's Formo Cresol
Hexachlorophene	pHisoHex, Septisol
Parachlorometaxyleneol	Medical Lotion Soap
Phenol	Vicks Chloraseptic
o-phenylphenol and o-benzyl-p-chlorophenol	Birex SE, Multicide, Omni II, Vital Defense

<i>Nonproprietary (generic) name</i>	<i>Proprietary (trade) name</i>
Phenylphenol in 67%-79% ethanol or isopropanol	Lysol IC spray, MSD Surface Disinfectant
Triclosan	Septi-Soft, Septisol NPD, Stridex Face Wash
Alcohols	
Ethanol	Alcare, Alco-Gel
Isopropyl alcohol	Stat-One Isopropyl Rubbing Alcohol
Alcohols and quaternary ammonium compounds	
Aseptic wipes	Metriwipes, Discide Ultra Wipes, Sani-Cloths
Biguanides	
Chlorhexidine	Dyna-Hex, Hibistat, Hibiclens, Peridex, PerioGard
Surface-active agents (cationic)	
Benzalkonium chloride	Mycocide, Zephiran
Benzethonium chloride	Critic-Aid, Puri-Clens
Cetyldimethylethyl ammonium bromide	(Cetylclide-G)
Cetylpyridinium chloride	Cepacol
Cetyltrimethyl ammonium bromide	Cetrimide B.P., Cetavlon
Methylbenzethonium chloride	In Orasept
Oxidizing compounds	
Hydrogen peroxide	Stat-One Hydrogen Peroxide
Carbamide peroxide (urea peroxide)	Cankaid, Gly-Oxide, Proxigel
Heavy metals	
<i>Organic mercurials</i>	
Merbromin	Mercurochrome
Nitromersol	Metaphen
Thimerosal	—
Silver compounds	—
Silver nitrate	—
Silver protein	Argyrol S.S. 10%

CITED REFERENCES

- Adams D, Addy M: Mouthrinses. *Adv Dent Res* 8:291-301, 1994.
- Ali Y, Dolan MJ, Fendler EJ, et al: Alcohols. In Block SS, editor: *Disinfection, sterilization, and preservation*, ed 5, Philadelphia, 2001, Lippincott Williams & Wilkins.
- al-Tannir MA, Goodman HS: A review of chlorhexidine and its use in special populations. *Spec Care Dent* 14:116-122, 1994.
- Araki K, Suda H, Barbosa SV, et al: Reduced cytotoxicity of a root canal sealer through eugenol substitution. *J Endod* 19:554-557, 1993.
- Centers for Disease Control and Prevention: Recommended infection-control practices for dentistry, 1993. *MMWR Morb Mortal Wkly Rep* 42(RR-8):1-12, 1993.
- Centers for Disease Control and Prevention: Guideline for hand hygiene in health-care settings: recommendations of the

- Healthcare Infection Control Practices Advisory Committee and the HICPAAC/SHEA/APIC/IDSA Hand hygiene Task Force. *MMWR Morb Mortal Wkly Rep* 51(RR-16):1-46, 2002.
7. Centers for Disease Control and Prevention: Guidelines for infection control in dental health-care settings—2003. *MMWR Morb Mortal Wkly Rep* 52(RR-17):1-66, 2003.
 8. Cottone JA, Terezhalmay GZ, Molinari JA: *Practical infection control in dentistry*, ed 2, Baltimore, 1996, Williams & Wilkins.
 9. Crawford JJ: State-of-the-art: practical infection control in dentistry. *J Am Dent Assoc* 110:629-633, 1985.
 10. Dychdala GR: Chlorine and chlorine compounds. In Block SS, editor: *Disinfection, sterilization, and preservation*, ed 5, Philadelphia, 2001, Lippincott Williams & Wilkins.
 11. Favero MS, Bond WW: Chemical disinfection of medical and surgical materials. In Block SS, editor: *Disinfection, sterilization, and preservation*, ed 5, Philadelphia, 2001, Lippincott Williams & Wilkins.
 12. Fendler EJ, Ali Y, Hammond BS, et al: The impact of alcohol hand sanitizer use on infection rates in an extended care facility. *Am J Infect Control* 30:226-233, 2002.
 13. Gjermo P, Bonesvoll P, Rølla G: Relationship between plaque-inhibiting effect and retention of chlorhexidine in the human oral cavity. *Arch Oral Biol* 19:1031-1034, 1974.
 14. Goddard PA, McCue KA: Phenolic compounds. In Block SS, editor: *Disinfection, sterilization, and preservation*, ed 5, Philadelphia, 2001, Lippincott Williams & Wilkins.
 15. Infection control recommendations for the dental office and the dental laboratory. *J Am Dent Assoc* 127:672-680, 1996.
 16. Jordan SL: The correct use of glutaraldehyde in the healthcare environment. *Gastroenterol Nurs* 18:143-145, 1995.
 17. Kimbrough RD: Review of the toxicity of hexachlorophene, including its neurotoxicity. *J Clin Pharmacol* 13:439-444, 1973.
 18. Kjaerheim V, Barkvoll P, Waaler SM, et al: Triclosan inhibits histamine-induced inflammation in human skin. *J Clin Periodontol* 22:423-426, 1995.
 19. Kjaerheim V, Waaler SM, Kalvik A: Experiments with two-phase plaque-inhibiting mouthrinses. *Eur J Oral Sci* 103:179-181, 1995.
 20. Larson EL: APIC guideline for handwashing and hand antisepsis in health care settings. *Am J Infect Control* 23:251-269, 1995.
 21. Lowbury EJJ, Lilly HA: Use of 4% chlorhexidine detergent solution (Hibiclens) and other methods of skin disinfection. *BMJ* 1:510-515, 1973.
 22. Mandel ID: Antimicrobial mouthrinses: overview and update. *J Am Dent Assoc* 125(Suppl):2S-10S, 1994.
 23. Mbithi JN, Springthorpe VS, Satar SA, et al: Bactericidal, virucidal, and mycobactericidal activities of reused alkaline glutaraldehyde in an endoscopy unit. *J Clin Microbiol* 31:2988-2995, 1993.
 24. Molinari JA, Gleason MJ, Cottone JA, et al: Cleaning and disinfectant properties of dental surface disinfectants. *J Am Dent Assoc* 117:179-182, 1988.
 25. Piskin B, Turkun M: Stability of various sodium hypochlorite solutions. *J Endod* 21:253-255, 1995.
 26. Pittet D: Improving compliance with hand hygiene in hospitals. *Infect Cont Hosp Epidemiol* 21:381-386, 2002.
 27. Pittet D, Hugonnet S, Harbarth S, et al: Effectiveness of a hospital-wide programme to improve compliance with hand hygiene. *Lancet* 356:1307-1312, 2000.
 28. Rutala WA: APIC guideline for selection and use of disinfectants. *Am J Infect Control* 24:313-342, 1996.
 29. Stonehill AA, Krop S, Borick PM: Buffered glutaraldehyde: a new chemical sterilizing solution. *Am J Hosp Pharm* 20:458-465, 1963.

PART

III

*Special Subjects in
Pharmacology and
Therapeutics*

Analgesic Use for Effective Pain Control*

PAUL J. DESJARDINS AND ELLIOT V. HERSH

Fear of pain is a significant reason why many people avoid seeking dental care. No matter how successful or how effectively performed, most dental surgical procedures produce tissue trauma and release potent mediators of inflammation and pain. In the past, postoperative pain was thought to be inevitable and harmless. We now know that unrelieved pain after surgery or trauma has negative physical and psychological consequences. Acute pain is often associated with a reactive anxiety and an increase in sympathetic nervous system activity, resulting in tachycardia, hypertension, diaphoresis, mydriasis, and pallor. A patient with severe tooth or jaw pain may avoid eating or drinking and may become malnourished and dehydrated. Severe chest, abdominal, or back pain may lead to shallow breathing and cough suppression in an attempt to “splint” the injured site, followed by retained pulmonary secretions and pneumonia.^{19,37} Unrelieved pain may also delay the return of normal gastric and bowel function in a postoperative patient.⁴¹ If managed aggressively, pain is preventable or controllable in most cases.

Undertreatment of pain is a significant medical problem. Numerous clinical surveys have shown that postoperative pain is often inadequately treated because of undermedication, leaving patients to suffer needlessly.^{14,31} Recognition of the widespread inadequacy of pain management and the detrimental effects of untreated pain has led to corrective efforts in numerous health care disciplines involved with pain management. These efforts culminated in 1992, when the Agency for Health Care Policy and Research, a division of the U.S. Public Health Service, published its *Clinical Practice Guideline for Acute Pain Management: Operative or Medical Procedures and Trauma*.² This guideline represents the efforts of a multidisciplinary panel of expert clinicians and researchers. It provides an excellent framework for the care of patients with acute pain and includes a section on pain control specifically for dental surgery.

PAIN CLASSIFICATION

Successful treatment of painful conditions with analgesics requires a basic understanding of the relevant pathophysiology. Painful conditions can be divided into two basic categories—**nociceptive pain** and **neuropathic pain**—based on the condition’s underlying pathophysiologic features. **Nociceptive pain** is a result of mechanical, thermal, or chemical activation of nociceptive afferent receptors and can be classified as either somatic or visceral in origin. Somatic nociception involves

pathologic conditions of the skin, muscles, fascia, and bones and is well localized. Examples include the pain associated with traumatic injuries and pain after the completion of oral surgery procedures. In both conditions, **inflammatory mediators sensitize** or **activate nociceptive receptors**, resulting in transduction of the noxious stimulus into electrical and biochemical signals between neurons. The electrical signals are conducted to the brain for interpretation. **Visceral nociceptive pain** is poorly localized, may be referred to superficial somatic regions, and involves pathologic conditions in deep, visceral tissues. An example is **angina resulting from myocardial ischemia**, which can be referred to the jaw, neck, or arm.

B- Neuropathic pain is thought to be a result of aberrant somatosensory activity either in the peripheral nervous system or the central nervous system (CNS) (see Chapter 23). It is frequently characterized by **paroxysmal shooting or electrical shock-like pains**, often on a background of burning or constricting sensation. Examples of neuropathic pain encountered in the orofacial region include **trigeminal neuralgia**, **burning mouth syndrome**, and **postherpetic neuralgia**. Orofacial pain of neuropathic origin generally requires more sophisticated diagnostic testing and management; this sort of care is frequently available at specialized clinical practices.

Pain may also be characterized as **acute or chronic** based on its temporal and other characteristics. **Acute pain** frequently has a known cause, has identifiable tissue damage, responds to conventional analgesic therapy such as nonsteroidal anti-inflammatory drugs (NSAIDs) and opioids, usually subsides as healing occurs, and has a predictable end point. Acute pain is associated with anxiety and the physiologic “flight or fight” responses of **increased pulse, blood pressure, and respiratory rate**. In contrast, **chronic pain** is of greater than **3 to 6 months’** duration, and patients with chronic pain do not usually manifest the physiologic arousal seen with acute pain because the body has adapted to the pain state. These patients may exhibit, however, **reactive depression and decreased function**. Often, despite numerous diagnostic tests, the area where the pain seems to emanate appears normal or adequately healed, if there was an initial injury. The psychological aspects of the chronic pain syndrome can become so entwined with the patient’s presentation of pain that these aspects must now also be adequately addressed to increase the likelihood of a successful treatment outcome.

PAIN ASSESSMENT

Successful assessment and control of pain depend partly on establishing effective communication between the dentist and the patient. Patients should be informed that pain relief is an

*The authors recognize Dr. Warren Vallerand for his past contributions to this chapter.

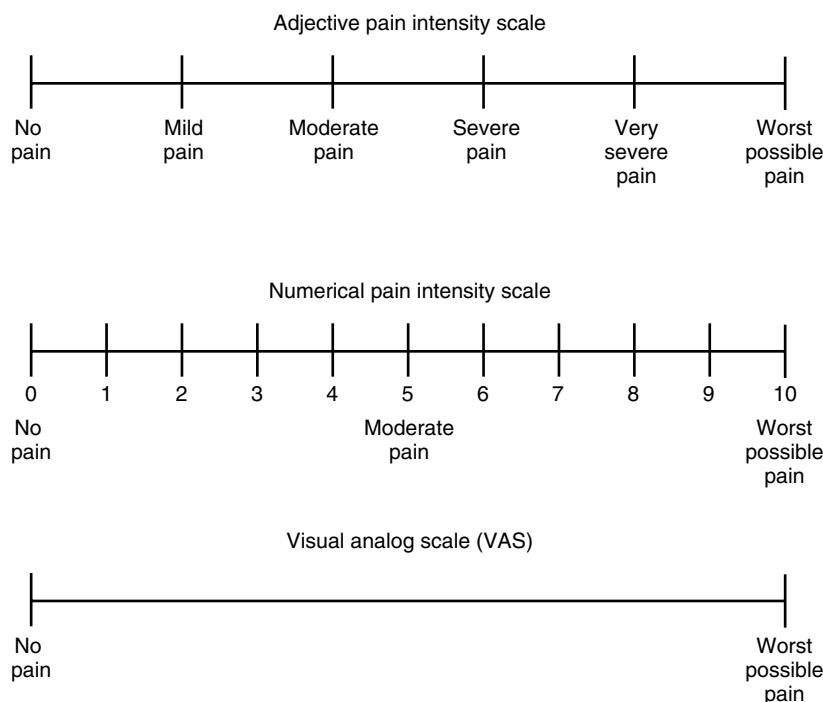

FIGURE 47-1 Pain intensity scales. A 10-cm baseline is recommended for the visual analog scale and for the other scales if used for graphic rating (i.e., linear measurement of patient responses).

important part of their health care. Because pain is a subjective phenomenon, the care provider must accept that the patient's self-report is the most accurate and reliable indicator of the existence and intensity of pain and any resultant distress.² This orientation is reflected in a commonly cited definition of pain: Pain is whatever the person experiencing it says it is and exists whenever he or she says it does.²⁷ Self-report measurement tools such as adjective or numerical rating scales or visual analogue scales can assist the patient in quantifying and characterizing the pain (Figure 47-1).

These tools are reliable, valid, and easy for the patient and the dentist or assistant to use. They may be administered by showing a diagram to the patient and asking the patient to indicate the appropriate rating. Some tools may also be used by simply asking the patient for a verbal response (e.g., "On a scale of 0 to 10, with 0 as no pain and 10 as the worst pain possible, how would you rate your pain?"). Patients who may have difficulty communicating require particular attention. This group includes patients who are cognitively impaired; psychologically or severely emotionally disturbed patients; young children; very old patients; and patients whose language, level of education, or cultural background differs significantly from that of the health care team.

Assessment of the patient's pain is a crucial part of the initial evaluation to estimate analgesic requirements. To determine the adequacy of the chosen analgesic regimen, the clinician must also assess pain intensity and pain relief at the peak of the analgesic effect and at regular intervals after the initiation of analgesic treatment.⁹

MISCONCEPTIONS REGARDING PAIN AND ANALGESICS

A significant barrier to the effective use of analgesics in managing pain involves several misconceptions regarding pain and analgesia held by patients and health care providers.

- **Misconception 1:** *Patients who are in pain always have observable signs.* Although many patients in acute pain exhibit evidence of anxiety, distress, or decreased func-

tion, many do not. Such overt pain behaviors also may not be seen at all in patients attempting to adapt to, and cope with, persistent pain. Expecting patients to display these pain behaviors and making the decision to dispense analgesics contingent on the display of these behaviors only serve to reinforce pain behaviors that may interfere with recovery. To treat the pain effectively, the clinician first must believe the patient's complaint of pain irrespective of the patient's physical presentation.

- **Misconception 2:** *Obvious pathology, test results, and the type of surgery determine the existence and the intensity of pain.* Although the ability to identify a pathologic process underlying a patient's pain complaint is a key element in planning and initiating definitive treatment, failure to identify the source of a patient's pain does not mean that it does not exist. Patients with chronic neuropathic pain frequently present such diagnostic challenges. As medical and diagnostic technology progresses, clinicians are better able to understand the mechanisms underlying disease processes that might have gone undiagnosed, or misdiagnosed, in the past. Failure to identify an organic source for a patient's pain does not mean that the pain does not exist.
- **Misconception 3:** *Patients should wait as long as possible before taking a pain medication because this period of abstinence teaches them to have a better tolerance for pain. Pain that is untreated often escalates in severity and disability. Without treatment, sensory input from injured tissue reaches spinal cord neurons and causes subsequent responses to be enhanced. Pain receptors in the periphery also become more sensitive after injury. Studies have shown long-lasting changes in cells within the spinal cord pain pathways after brief painful stimuli.*⁷ These physiologic studies confirm long-standing clinical impressions that established pain is more difficult to suppress.^{2,7,15} *Aggressive pain prevention and control that occurs before, during, and after a painful event such as dental surgery can yield short-term and long-term benefits.* Patients should be encouraged to use analgesics before pain becomes severe and difficult to control.

CHOICE OF ANALGESIC REGIMEN

Pharmacologic control of pain can be directed at any of three nociceptive processes: (1) initiation of impulses, (2) propagation of the impulses, and (3) perception of painful stimuli. NSAIDs are thought to act primarily at the site of initiation of nociceptive impulses. Although separating their anti-inflammatory effects from their analgesic effects is difficult, nonopioid drugs, such as salicylates, other NSAIDs, and cyclooxygenase (COX)-2 inhibitors, work predominantly in the periphery by preventing the synthesis and release of inflammatory mediators that sensitize nociceptive receptors to other algic mediators, such as bradykinin, and to physical forces. More recent studies suggest that NSAIDs may also have central effects.^{6,24} Acetaminophen has been shown to have analgesic and antipyretic properties, but it lacks significant anti-inflammatory effects. Acetaminophen seems to exert its effects in the CNS and in the periphery.^{1,28,39}

Local anesthetics can be administered topically or parenterally to block the propagation of nerve impulses originating from nociceptive stimuli at a peripheral site so that they do not reach the spinal cord or brain. Administration of long-acting local anesthetics can have significant value in delaying the onset of pain after oral surgery procedures and decreasing the overall level of discomfort in the immediate recovery period. The systemic use of local anesthetics also has some use in the management of chronic pain.

Opioids decrease the perception of pain in the CNS. Opioid analgesics act in the CNS at receptors in the spinal cord, rostral medulla, and periaqueductal gray matter. These anatomic loci are considered important to the perception of pain (see Chapter 20). Laboratory studies have also identified and characterized opioid receptors in peripheral tissue. This finding has led to clinical studies that have identified opioids as contributors to antinociceptive responses in the peripheral nervous system.^{22,29} Likewise, there has been a search for drugs that reduce the incidence of opioid peripheral side effects, most notably constipation, in patients taking these drugs for various types of pain.⁴

Analgesic Selection

Before initiating treatment with analgesics, the practitioner must choose a specific drug or drugs, each with its own route of administration, dose, and frequency. Given the myriad analgesics available, how does one select the most effective agent? It is important to analyze each situation and individualize the analgesic regimen to fit each patient's current condition best.

The cause of the pain, the pain severity, and the medical history of the patient are the most important pieces of information in choosing an analgesic regimen. Equally important, and often overlooked, is the patient's recent and past history of painful conditions and how they were treated. A patient who has had episodes of pain treated with analgesics in the past may be acutely aware of which analgesics are likely to be most effective in a new situation and which are not, so asking the patient which analgesic has worked best in the past and which he or she would prefer is appropriate. Some practitioners may be uncomfortable with this approach because they believe that it amounts to the patient dictating treatment and may arouse suspicion regarding drug-seeking behavior. The patient, however, should be considered the authority on his or her pain.² Unless the requested drug is inappropriate, the patient's judgment and preference should be taken into account. This strategy increases the likelihood of compliance with the prescribed regimen.

In considering the choice of analgesic, it is reasonable to estimate the degree of pain that might be anticipated after a certain procedure based on the clinical and personal experi-

ence of the practitioner and to base the choice of analgesic on that estimate. The empiric nature of this approach must always be kept in mind. Inadequate pain relief may indicate the need for an increase in dose, more frequent administration, or a different drug. A common misconception is that a given stimulus will produce the same amount of pain in different patients. No data support this assumption. Pain threshold and tolerance and analgesic requirements vary widely among patients.

Local anesthetics

In addition to providing the pain control required to carry out most operative dentistry or dentoalveolar surgery, local anesthetics may also decrease pain after treatment. The perioperative administration of a long-acting anesthetic agent (e.g., bupivacaine) as an addition to or substitute for an agent with shorter duration (e.g., lidocaine) can delay the onset of postprocedural pain after dental surgery. Even in the presence of general anesthesia, the administration of local anesthetic agents during oral surgery procedures significantly reduces the quantity of postoperative pain medications consumed.¹⁵ Because of the potential for self-inflicted injury and a lack of relevant clinical data, long-acting agents are not recommended for use in children younger than 12 years. In the case of acute pulpitis pain, topical benzocaine 20% applied to the open tooth cavity and surrounding soft tissue seems to provide rapid and temporary pain relief.¹⁸

Nonopioid analgesics

The category of nonopioid analgesics is composed of various drugs (e.g., NSAIDs, COX-2 inhibitors, acetaminophen) that have a similar mechanism of action and share clinically important analgesic, anti-inflammatory, and antipyretic properties. These agents differ from opioid analgesics in the following ways: (1) there is a ceiling effect to the analgesia; (2) they do not produce tolerance or physical dependence; (3) they are antipyretic, which in the dental postsurgical setting is a disadvantage because this property can mask a sign of infection; and (4) they possess anti-inflammatory and analgesic properties except for acetaminophen, which has minimal anti-inflammatory activity. Pharmacologic management of mild-moderate dental and orofacial pain should begin, unless there is a contraindication, with a nonopioid analgesic drug. As a general rule, any analgesic regimen should include a nonopioid drug, even if pain is severe enough to require the addition of an opioid. Most controlled clinical trials in postoperative dental pain directly comparing full doses of aspirin, acetaminophen, ibuprofen, and other NSAIDs with oral doses of single-entity opioids such as codeine, 60 mg, or oxycodone, 5 mg, have shown the superiority of nonopioids in analgesic efficacy.

Nonopioids of the conventional NSAID or highly selective COX-2 class are most effective in treating postprocedural pain when given before the procedure or immediately after a short procedure, preventing the synthesis of prostaglandins that quickly follow the surgical insult. The delayed use of NSAIDs postoperatively inhibits the subsequent prostaglandin synthesis and provides analgesia, but it does not interfere with the effects of the prostaglandins already produced. Preoperative administration of NSAIDs or COX-2 inhibitors delays the onset of postoperative dental pain and lessens its severity and subsequent analgesic requirements (Figure 47-2).^{10,11,13,21} A recommended strategy that takes advantage of these properties would be to administer a full therapeutic dose of an NSAID preoperatively and after the surgical procedure simply to dose "around-the-clock" for the first day or two, in an effort to prevent breakthrough pain.

NSAIDs all share a qualitatively similar side-effect profile. With the exception of true allergic reactions; bronchoconstriction in asthmatics (see Chapter 21); and prior gastroin-

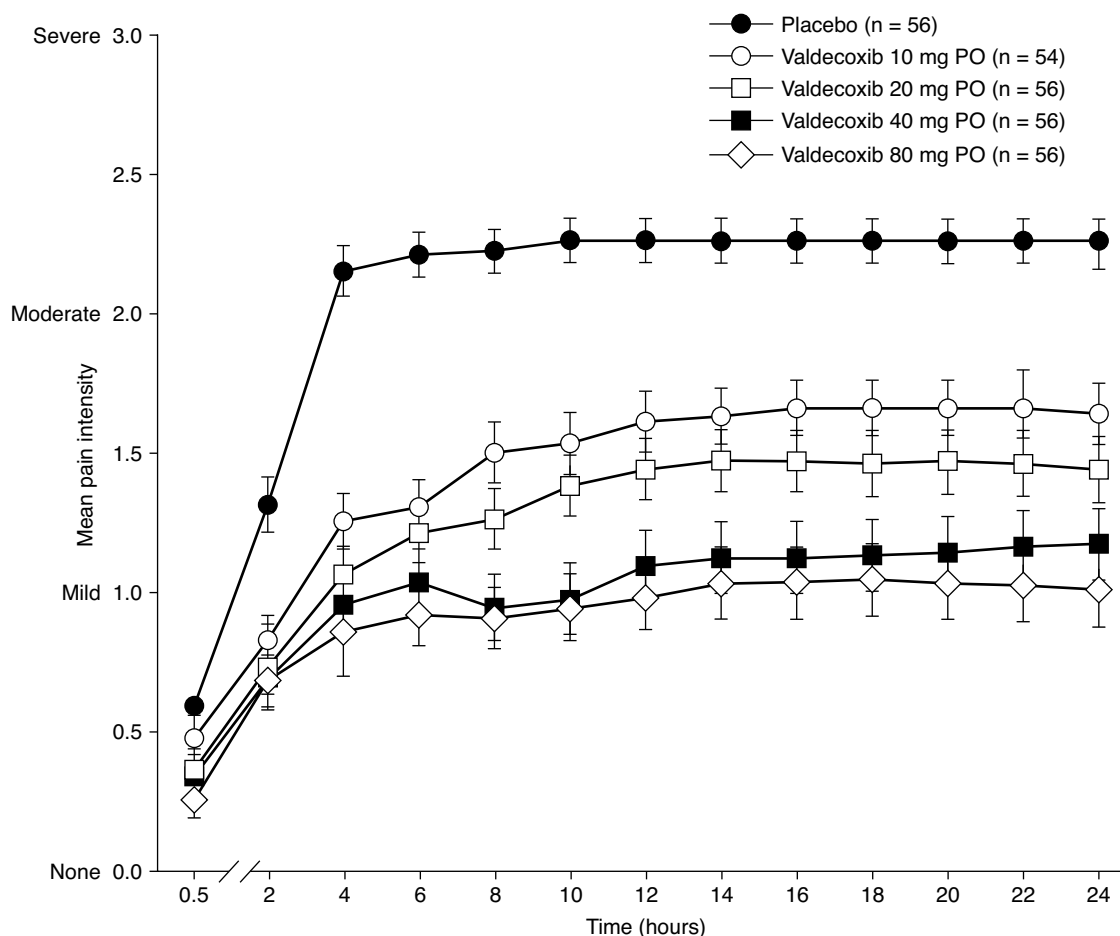

FIGURE 47-2 Effect of single preoperative doses of the cyclooxygenase-2 inhibitor valdecoxib on mean pain intensity after dental impaction surgery. Brackets indicate the standard error. (From Desjardins PJ, Shu VS, Recker DP, et al: A single preoperative oral dose of valdecoxib, a new cyclooxygenase-2 specific inhibitor relieves post-oral surgery or bunionectomy pain, *Anesthesiology* 97:565-573, 2002.)

testinal perforations, ulcerations, or serious bleeding reactions, however, a patient's inability to tolerate one specific NSAID or COX-2 does not mean the patient would be intolerant of all other NSAIDs. Also, patients may vary in their relative analgesic response to various NSAIDs. If a patient did not respond previously to a particular drug at the maximal therapeutic dose, an alternative NSAID can be considered. When treating chronic temporomandibular joint disease and other chronic orofacial pains, if a benefit is not apparent within 3 to 4 weeks, a change to an alternative drug class, such as a tricyclic antidepressant or an anticonvulsant (gabapentin), should be considered to avoid additional NSAID side effects in the absence of a therapeutic response.¹⁶

The oral route of administration is preferred for nonopioids. Some patients, such as young children or patients with intermaxillary fixation after maxillofacial surgery or trauma, are unable to swallow tablets or capsules. For these patients, liquid formulations of acetaminophen or ibuprofen should be considered. For the rare dental patient who is unable to take any medications by mouth, parenteral (ketorolac) or rectal (acetaminophen, aspirin) dosage forms are available.

As discussed in Chapter 21, only one highly selective COX-2 inhibitor, celecoxib, remains on the market in the United States. Its use in acute pain should be considered only in patients who are at increased risk for serious gastrointestinal events, such as patients with a previous history of gastrointestinal ulcers. Although a more appropriate role for celecoxib would be the management of more chronic orofacial pain,

in which the duration of NSAID therapy may be measured in weeks or months, increasing the likelihood of untoward gastrointestinal events, the one published clinical trial of celecoxib, 100 mg twice a day, in temporomandibular joint disease patients could not show a therapeutic advantage of this drug over placebo after 6 weeks of therapy. The nonselective NSAID naproxen at a dose of 500 mg twice a day was superior to placebo and celecoxib in several measures of analgesic efficacy and function.³⁸

Opioid analgesics

Opioid analgesics are added to nonopioids to manage pain that is moderate to severe or that does not respond to nonopioids alone. Opioids differ from nonopioids in that there is no ceiling effect on their analgesic response. The only dosing limitation is based on side effects. Although injectable opioids and oral opioid combinations are effective for management of moderate-severe acute pain, they are frequently underused and prescribed at subtherapeutic doses as a result of misconceptions and fears regarding their use. Fear of possible respiratory depression and habituation causes some practitioners to underprescribe and underdose opioids. At therapeutic doses employed in peripheral-narcotic combination drugs (see Table 21-7), clinically significant or even measurable respiratory depression does not occur. Even with increasing doses, this adverse event rarely occurs when appropriate starting doses are used and then titrated to effect based on the patient's analgesic response and side effects. Patients vary greatly in

their analgesic dose requirements and responses to opioid analgesics. Relative potency estimates provide a rational basis for selecting the appropriate dose to initiate analgesic therapy or when switching from one opioid to another or from one route of administration to another.

Physical dependence and tolerance can occur in virtually all patients taking opioid analgesics for a prolonged period. In most instances in which opioids or opioid combinations are used in dentistry, the duration of therapy is so short (generally ≤ 7 days) that these clinical phenomena are not seen. Tolerance is managed with careful upward titration of the dose until adequate pain relief is reobtained. The effects of physical dependence are easily avoided by the gradual tapering of opioids on discontinuation of therapy as opposed to abrupt withdrawal, which is likely to cause withdrawal symptoms. Addiction is a phenomenon that rarely occurs in patients taking opioid analgesics for pain (see Chapter 51).⁴⁰ Most patients taking pain medication stop taking the medication when the pain stops.

Early reports on the incidence of medical patients with addiction problems were fraught with methodologic flaws and significantly overestimated the risk.^{26,35} More recent studies provide a more accurate estimate. In 1980, the Boston Collaborative Drug Surveillance Project identified only four cases of addiction among 11,882 hospitalized patients with no history of substance abuse who received at least one dose of an opioid.³⁴ A national survey of burn units found no cases of addiction in almost 10,000 patients treated for burn pain.³² Another study surveying patients attending a headache clinic revealed that only 3 of 2369 patients had a management problem with analgesics used to treat intermittent headaches.³⁰

Dentists must remain vigilant, however, for drug-seeking patients, who often request a specific opioid (often oxycodone) at a specific dose that is at the higher end of the therapeutic range for pain that is not readily evident or should not be that severe. In addition, dentists who overprescribe opioids are subject to punitive actions by their state dental boards and the U.S. Drug Enforcement Administration.

Opioid analgesics include pure agonists, such as codeine and oxycodone, and agonist/antagonists, such as pentazocine and butorphanol. As a general rule, agonist/antagonists should not be used as first-line therapy. There is no convincing evidence that these drugs offer any advantage over pure opioid agonists. Agonist/antagonists become less effective at high doses because they have a ceiling effect (see Chapter 20), frequently cause dysphoria, and may cause confusion and hallucinations. In addition, they may cause withdrawal symptoms when given to patients physically dependent on opioid agonists. Occasionally, agonist/antagonists may be useful in treating individuals unable to tolerate other opioids.³

In 1990, the World Health Organization proposed a stepwise approach for the management of cancer pain.⁹ This approach (Figure 47-3) has subsequently been recommended for the treatment of noncancer pain as well. The first step, representing treatment of mild pain, is to administer a nonopioid drug. In many dental surgical procedures, NSAIDs alone can achieve excellent pain control.^{8,12} Nonopioid therapy should be considered the cornerstone for management of acute dental pain. Pain that does not respond adequately to nonopioid agents should be treated with the combination of a nonopioid and an opioid such as codeine, hydrocodone, or oxycodone. Even when insufficient alone to control pain, NSAIDs can reduce the dose of opioid required to achieve relief.^{20,25} A few recent studies suggest that combining a full therapeutic dose of an NSAID with a full therapeutic dose of acetaminophen may produce pain relief equivalent to an NSAID/opioid combination without the typical opioid-mediated side effects.⁵ A limitation to the studies is that

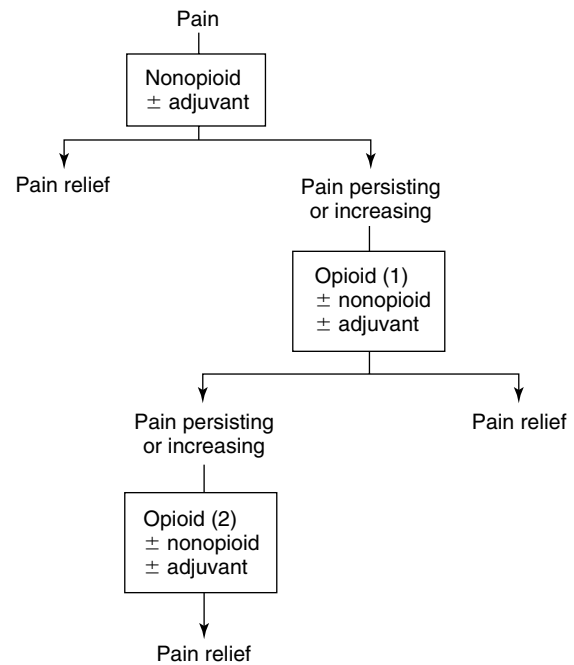

FIGURE 47-3 Stepwise process in choosing analgesic medication. Opioid (1) indicates a standard oral opioid in a conventional dose; opioid (2) indicates increasing doses or a change in opioid to increase the analgesic effect. (Based on recommendations of the World Health Organization, as described in Deglin JH, Vallerand AH: *Davis's drug guide for nurses*, ed 5, Philadelphia, 1997, Davis.)

the typically strong analgesic action of the NSAID was not observed because of the dose, formulation, or study design used.

More severe pain, or pain that persists, should be treated with a combination of a nonopioid and a more potent opioid, such as morphine or hydromorphone. Adjuvant agents, such as certain anticonvulsants or tricyclic antidepressants, may be added when indicated. Several adjuvant agents, including the anticonvulsant gabapentin and several tricyclic antidepressants, have proved effective in the treatment of temporomandibular joint and neuropathic orofacial pain when NSAIDs and opioids have failed.^{23,33,36} Chapter 23 contains a more thorough discussion of medications employed in chronic orofacial pain.

Because most dental care is provided to ambulatory dental outpatients, oral administration of opioid analgesics is preferred whenever possible. It is convenient and inexpensive. Even severe postsurgical pain can be treated effectively with orally administered opioids in the proper doses. For a patient who is unable to swallow a tablet or capsule, numerous liquid formulations of opioids are available (e.g., codeine, hydrocodone, oxycodone). Peak drug effects (including side effects) occur 1.5 to 2 hours after the oral administration of most opioids (except for sustained-release tablets). Patients may take a second opioid dose safely 2 hours after the first dose if the pain persists and side effects are mild at that time.^{3,9}

For patients unable to take medications by mouth, intravenous, intramuscular, or rectal routes of administration can be considered. Use of the intravenous or intramuscular route to deliver analgesics is almost exclusively limited to inpatient hospital settings. Of the two routes, intravenous administration is preferred. Intravenous bolus administration provides the most rapid and predictable onset of effect. Time to peak effect varies with drug lipid solubility, ranging from 1 to 5 minutes for fentanyl to 20 minutes or longer for morphine.

Although commonly used, intramuscular injections can themselves cause pain and trauma and may deter patients from requesting pain medication. Also, absorption from intramuscular sites can be erratic and variable. Several opioids are available in rectal suppository form (e.g., hydromorphone, morphine). Sustained-release opioids (e.g., controlled-release morphine and oxycodone) seem to have little role in the management of acute dental pain.

As mentioned previously, opioids almost always should be administered with nonopioids for maximal pain relief in cases of dental pain. Many opioids are marketed in combination with a nonopioid, and it is the latter component that limits the dose. The upper dose limit for acetaminophen is 4000 mg/day. For combinations containing 325 mg of acetaminophen, the maximum number of tablets per day is 12. For combinations containing 500 mg of acetaminophen, the maximum number of tablets per day is eight. In children who weigh less than 45 kg, the limit is 90 mg/kg of acetaminophen.

One controversial area of change in pain therapeutics is in the use of potent opioids in patients with severe or unremitting chronic pain from either malignant or nonmalignant disease. Pain specialists have advocated the use of potent opioids in such patients when all other reasonable therapeutic approaches have failed. Special considerations and management approaches, including documenting failed approaches, closely monitoring refill records, and having patients sign contracts with the health care provider, are thought to be essential to avoid future medical and legal challenges to the patient and provider.

Principles of Analgesic Use

Analgesics should be administered initially on a regular time schedule. If the patient is likely to have pain requiring analgesics for 48 hours after dental surgery, analgesics might be ordered on a fixed time schedule (e.g., every 4 hours) while awake, not as needed, for the first 36 hours. This schedule provides more stable plasma concentrations of the agent with less breakthrough pain. If only as-needed medications are used, several hours and higher doses may be required to relieve pain, leading to a cycle of undermedication and pain alternating with periods of overmedication and unnecessary adverse effects. Later in the postoperative course, as the patient's analgesic dose requirement diminishes, dosing may be switched to an as-needed basis.

Children should also be given adequate doses of analgesics. Children may not communicate their pain effectively and are frequently undermedicated for pain. The clinical effects and pharmacokinetics of opioids in children older than 6 months are approximately the same as in adults. Starting doses of opioids and nonopioids may be calculated according to weight. Aspirin should be avoided in children because of its well known association with Reye's syndrome.

Dentists should be familiar with several opioid and nonopioid analgesics. Different patients vary greatly in their response to, and ability to tolerate, different agents. For this reason, it is important to be familiar with the recommended dose, side-effect profile, and time course of several agents in each category. Because of the potential for adverse drug interactions between commonly prescribed analgesic drugs and other drugs a patient may be taking (see Chapter 21), an up-to-date medical history is also crucial.¹⁷

Patients should be followed closely, particularly when beginning or changing analgesic regimens. Analgesics are more beneficial if the clinician monitors pain relief and adverse effects frequently and adjusts the regimen as needed to optimize therapy. This monitoring is particularly important when using an agent or combination with which the physician has little or no experience or when changing from one analgesic to another.

Although pain is a common occurrence in patients seeking or undergoing dental care, it is generally manageable and often avoidable. Tools required to keep pain at a minimum include accurate assessment, methodical preventive regimens, and aggressive treatment. Rational clinical practice guidelines² and equianalgesic charts allow practitioners to determine the appropriate analgesic regimen and dose for each patient.

CITED REFERENCES

1. Abbadie JC, Besson JM: Chronic treatment with aspirin or acetaminophen reduce both the development of polyarthritis and Fos-like immunoreactivity in rat lumbar spinal cord. *Pain* 57:45-54, 1994.
2. Acute Pain Management Guideline Panel: *Acute pain management: operative or medical procedures and trauma*, Clinical Practice Guideline No. 1, AHCPR Publication No. 92-0032, Rockville, MD, 1992, U.S. Department of Health and Human Services, Public Health Service, Agency for Health Care Policy and Research.
3. American Pain Society: *Principles of analgesic use in the treatment of acute pain and cancer pain*, ed 3, Skokie, IL, 1992, American Pain Society.
4. Becker G, Galandi D, Blum HE: Peripherally acting opioid antagonists in the treatment of opiate-related constipation: a systematic review. *J Pain Symptom Manage* 34:547-565, 2007.
5. Breivik EK, Barkvoll P, Skovlund E: Combining diclofenac with acetaminophen or acetaminophen-codeine after oral surgery: a randomized, double-blind single-dose study. *Clin Pharmacol Ther* 66:625-635, 1999.
6. Chapman V, Dickenson AH: The spinal and peripheral roles of bradykinin and prostaglandins in nociceptive processing in the rat. *Eur J Pharmacol* 219:427-433, 1992.
- 7.Coderre TJ, Katz J, Vaccarino AL, et al: Contribution of central neuroplasticity to pathological pain: review of clinical and experimental evidence. *Pain* 52:259-285, 1993.
8. Davie IT, Slawson KB, Burt RA: A double-blind comparison of parenteral morphine, placebo, and oral fentanyl in management of postoperative pain. *Anesth Analg* 61:1002-1005, 1982.
9. Deglin JH, Vallerand AH: *Davis's drug guide for nurses*, ed 5, Philadelphia, 1997, Davis.
10. Desjardins PJ, Dhadda S, Hubbard RC, et al: Preoperative valdecoxib, a COX-2 specific inhibitor, provides effective and long lasting analgesia following bunionectomy surgery [abstract]. *Anesthesiology* 95:A811, 2001.
11. Desjardins PJ, Shu VS, Recker DP, et al: A single preoperative oral dose of valdecoxib, a new cyclooxygenase-2 specific inhibitor relieves post-oral surgery or bunionectomy pain. *Anesthesiology* 97:565-575, 2002.
12. Dionne RA, Berthold CW: Therapeutic uses of non-steroidal anti-inflammatory drugs in dentistry. *Crit Rev Oral Biol Med* 12:315-330, 2001.
13. Dionne RA, Cooper SA: Evaluation of preoperative ibuprofen for postoperative pain after removal of third molars. *Oral Surg* 45:851-856, 1978.
14. Donovan M, Dillon P, McGuire L: Incidence and characteristics of pain in a sample of medical-surgical inpatients. *Pain* 30:69-78, 1987.
15. Gordon SM, Dionne RA, Brahim J, et al: Blockade of peripheral neuronal barrages reduces post-operative pain. *Pain* 70:209-215, 1997.
16. Hersh EV, Balasubramaniam R, Pinto A: Pharmacologic management of temporomandibular disorders. *Oral Maxillofac Surg Clin North Am* 20:197-210, 2008.
17. Hersh EV, Pinto A, Moore PA: Adverse drug interactions involving common prescription and over-the-counter analgesic agents. *Clin Ther* 29:2477-2497, 2007.
18. Hersh EV, Stoopler ET, Secreto SA, et al: A study for benzocaine gel dosing for toothache. *J Clin Dent* 16:103-108, 2005.
19. Hewlett AM, Branthwaite MA: Postoperative pulmonary function. *Br J Anaesth* 47:102-107, 1975.
20. Hodsman NB, Burns J, Blyth A, et al: The morphine sparing effects of diclofenac sodium following abdominal surgery. *Anaesthesia* 42:1005-1008, 1987.

21. Jackson DL, Moore PA, Hargreaves KM: Preoperative nonsteroidal anti-inflammatory medication for the prevention of postoperative dental pain. *J Am Dent Assoc* 119:641-647, 1989.
22. Joshi GP, McCarroll SM, O'Brien TM, et al: Intraarticular analgesia following knee arthroscopy. *Anesth Analg* 76:333-336, 1993.
23. Kimos P, Biggs C, Mah J, et al: Analgesic action of gabapentin on chronic pain in the masticatory muscles: a randomized controlled trial. *Pain* 127:151-160, 2007.
24. Malmberg AB, Yaksh TL: Antinociceptive actions of spinal nonsteroidal anti-inflammatory agents on the formalin test in the rat. *J Pharmacol Exp Ther* 263:136-146, 1992.
25. Martens M: A significant decrease of narcotic drug dosage after orthopaedic surgery: a double-blind study with naproxen. *Acta Orthop Belg* 48:900-906, 1982.
26. Maruta T, Swanson DW, Finlayson RE: Drug abuse and dependency in patients with chronic pain. *Mayo Clin Proc* 54:241-244, 1979.
27. McCaffery M, Beebe A: *Pain: clinical manual for nursing practice*, St Louis, 1989, Mosby.
28. McQueen DS, Iggo A, Birrel GJ, et al: Effects of paracetamol and aspirin on neural activity of joint mechanonociceptors in adjuvant arthritis. *Br J Pharmacol* 104:178-182, 1991.
29. McSwiney MM, Joshi GP, Kenny P, et al: Analgesia following arthroscopic knee surgery: a controlled study of intra-articular morphine, bupivacaine or both combined. *Anaesth Intensive Care* 21:201-203, 1993.
30. Medina JL, Diamond S: Drug dependency in patients with chronic headaches. *Headache* 17:12-14, 1977.
31. Oden R: Acute postoperative pain: incidence, severity, and the etiology of inadequate treatment. *Anesthesiol Clin North Am* 7:1-15, 1989.
32. Perry S, Heidrich G: Management of pain during debridement: a survey of U.S. burn units. *Pain* 13:267-280, 1982.
33. Plesh O, Curtis D, Levine J, et al: Amitriptyline treatment of chronic pain in patients with temporomandibular disorders. *J Oral Rehabil* 27:834-841, 2000.
34. Porter J, Jick H: Addiction rare in patients treated with narcotics. *N Engl J Med* 302:123, 1980.
35. Rayport M: Experience in the management of patients medically addicted to narcotics. *JAMA* 156:684-691, 1954.
36. Rizzatti-Barbosa CM, Nogueira MT, de Andrade ED, et al: Clinical evaluation of amitriptyline for the control of chronic pain caused by temporomandibular joint disorders. *Cranio* 21:221-225, 2003.
37. Sydow F-W: The influence of anesthesia and postoperative analgesic management of lung function. *Acta Chir Scand* 550(Suppl): 159-165, 1989.
38. Ta LE, Dionne RA: Treatment of painful temporomandibular joints with a cyclooxygenase-2 inhibitor: a randomized placebo-controlled comparison of celecoxib to naproxen. *Pain* 111:13-21, 2004.
39. Tjølsen A, Lund A, Hole K: Antinociceptive effect of paracetamol in rats is partly dependent on spinal serotonergic systems. *Eur J Pharmacol* 193:193-201, 1991.
40. Vallerand AH: Street addicts and patients with pain: similarities and differences. *Clin Nurse Spec* 8:11-15, 1994.
41. Wattwil M: Postoperative pain relief and gastrointestinal motility. *Acta Chir Scand* 550(Suppl):140-145, 1989.

Management of Fear and Anxiety

DANIEL A. HAAS

Fear and anxiety of dental procedures are common emotions. The severity ranges widely, with mild apprehension being reported by 75% of the population,⁵⁹ and severe anxiety, leading to avoidance of dental treatment, being reported by 4% to 21%.^{11,21,49} As shown in Table 48-1, the prevalence of fear and anxiety is not restricted to one culture but shows consistency internationally.¹¹ Dental anxiety has not diminished but has remained stable over the past 50 years despite advances in the delivery of dentistry.⁶¹ It has also been shown that this fear begins in childhood and can persist throughout life, leading to avoidance of dental care and contributing to diminished oral health.²³ Although mild fear may have only a minor effect on oral health, detrimental consequences for overall health can result if true phobia causes patients to avoid treatment despite significant symptoms.^{8,49}

Approximately 40% of the population do not receive routine dental care, with apprehension being cited as the most common reason.⁴ These patients often require special non-pharmacologic or pharmacologic approaches to allow dental procedures to be done. Pharmacologic approaches involve drugs that produce effects ranging from minimal sedation to general anesthesia.

Dentistry has historically been at the forefront in the development of anesthetic techniques to manage fear and anxiety. As described in Chapter 17, two dentists, Horace Wells and William Morton, were largely responsible for the clinical introduction of general anesthesia. The first description of nitrous oxide (N₂O) as a sedative, as opposed to a general anesthetic, appeared in a textbook on anesthesia for dentistry published in 1908.¹⁷ The modern form of N₂O and oxygen sedation evolved in the 1940s and 1950s, and this practice has become a standard component of the predoctoral dental curriculum.³ Intravenous anesthesia with hexobarbital was pioneered by the English dentist S.L. Drummond-Jackson in the 1930s. Shortly after World War II, Harold Krogh and Adrian Hubbell developed the use of thiopental for oral surgery. Intravenous conscious sedation (now termed *moderate sedation*) was introduced by Niels Jorgensen in 1945.

Behavioral or psychological techniques to manage anxiety in dental patients are unquestionably important, but their detailed description lies beyond the scope of this textbook. This chapter summarizes the pharmacologic approaches to the management of fear and anxiety in dental patients, with emphasis on the administration of minimal-moderate sedation. Complete understanding of this subject requires comprehension of the pharmacologic features of the specific drugs, which are described in other chapters.

GENERAL PRINCIPLES

Indications for Use

The primary indication for pharmacologic methods of patient management is the presence of anxiety, fear, or phobia sufficient to prevent the delivery of needed dental care. *Anxiety* may be defined as a stress response to an ill-defined or anticipated situation⁴⁶ and may consist of patterns of autonomic arousal with thoughts of fear and feelings of threat.⁵⁴ Dental anxiety may be related to specific dental procedures or may be precipitated by a mere visit to the dentist's office. Although anxiety of dentistry usually originates from past experiences as a child,⁴⁰ it may develop in adulthood and not be associated with any previous adverse event.⁶⁶

Fear is defined as an emotional response to a perceived immediate threat.^{24,57} Fear of dentistry may evolve from many sources, including past traumatic experiences, concerns about physical loss and disfigurement, observation of anxiety or fear in others, and exposure to frightening anecdotes by friends or the mass media.⁵⁹ Specifically, fears of the anesthetic "shot" and dental "drill" are the most common.^{36,47} A *phobia* is a persistent and irrational fear that results in a compulsion to avoid a specific object, activity, or situation.

A strong relationship exists between anxiety and pain. Expectation of pain contributes significantly to dental anxiety, and anxiety can reduce pain tolerance⁵⁹ to the extent that normally innocuous stimuli, such as touch, may be interpreted as pain. Many cases of failed mandibular block are a result of patient anxiety.⁶⁷ Anxiety can also contribute to adverse reactions in the dental chair; these are commonly misdiagnosed as either allergic or toxic reactions to the local anesthetic or vasoconstrictor. Comprehensive pain control requires an ability to manage fear and anxiety.

Other potential indications for the use of pharmacologic methods for patient management include cognitive impairment, such as in mentally challenged patients or patients with Alzheimer's dementia. These patients may be unable to cooperate sufficiently to permit treatment or perhaps even an adequate intraoral examination. Another indication is the presence of motor dysfunction, such as in patients with cerebral palsy or Parkinson's disease, whose tremor or uncoordinated movements may be exacerbated by the anxiety of being in the dental office. Pharmacologic management may also be required for a pediatric patient who may not understand the treatment and is reacting normally for a young child. Traumatic or extensive dental procedures are additional potential indications when coupled with anxiety, the need to immobilize the patient, or inability to render the patient pain-free with local anesthesia. Finally, some patients cannot physiologically tolerate the stress that even a minimal amount of anxiety

TABLE 48-1

International Prevalence of Dental Fear and Anxiety

COUNTRY	PREVALENCE OF HIGH DENTAL FEAR AND ANXIETY
Australia	13.7%
Canada	4.4-16.4%
Denmark	4.2%
Iceland	4.8%
Japan	20.9%
Netherlands	3.9-10.8%
New Zealand	12.5-21.1%
Singapore	7.8-20.8%
Sweden	3.9-6.7%
United States	10-19%

Data compiled by Chanpong B, Haas DA, Locker D: Need and demand for sedation or general anesthesia in dentistry: a national survey of the Canadian population, *Anesth Prog* 52:3-11, 2005.

may induce; patients with ischemic heart disease, labile hypertension, or stress-induced asthma are included in this group. Any of the modalities defined subsequently—minimal sedation, moderate sedation, deep sedation, or general anesthesia—may be used to treat these patients.

Identification of Fearful or Anxious Patients

To address the needs of fearful or anxious patients, the dentist must first be able to recognize or diagnose anxiety and fear. Discussion of how to identify these patients accurately is beyond the scope of this chapter but can be found in other excellent sources.^{24,48} The degree of anxiety should be determined as part of an appropriate history and patient evaluation. Observation of the patient and questions addressing possible anxiety caused by dentistry may aid in diagnosis. Patient interviews can identify specific concerns, such as fear of the injection of local anesthetic, the sound of the handpiece, or certain surgical procedures. Standardized measures of anxiety, such as the Corah scale,¹³ may be useful in quantifying the severity of anxiety.

Treatment Planning

After identifying an anxious, fearful, or phobic patient, thought should be given to the optimal method of managing the patient. Initially, nonpharmacologic methods of anxiety reduction should be considered.^{41,54,57} Appropriate chairside manner is often all that is required; this includes use of basic behavioral modification, positive suggestion, and reassurance. This approach is valuable not only when used alone, but also when used with more specific therapies for anxiety reduction. Specific psychological interventions that may be helpful include desensitization and hypnosis. Although these techniques would not overcome poor chairside manner, they can effectively aid the dentist in achieving patient comfort.

Despite effective chairside manner, many patients still wish to receive sedation or anesthesia. It has been reported that more than 50% of Americans classified as having high fear or anxiety preferred sedation for their dental care.²¹ The same study showed that three times as many subjects reported a preference for parenteral sedation or general anesthesia when undergoing dental treatment than were actually receiving these modalities.²¹ This same pattern was seen in a subsequent Canadian study in which patients were asked if they would prefer to have sedation or general anesthesia for each of five procedures.¹¹ There were large differences in this pref-

BOX 48-1

American Society of Anesthesiologists Physical Status Classification System

CLASS	DESCRIPTION
I	Normal, healthy patient
II	Patient with mild systemic disease
III	Patient with severe systemic disease that limits activity, but is not incapacitating
IV	Patient with incapacitating systemic disease that is a constant threat to life
V	Moribund patient not expected to survive 24 hr with or without operation
E	Emergency operation of any type; E is appended to the patient's physical status

erence compared with actual prevalence for each procedure—specifically, 3.8-fold difference for cleaning, 2.8-fold difference for restorative dentistry, 9.6-fold difference for endodontics, 15.9-fold difference for periodontal surgery, and 2.2-fold difference for extraction. The low preference/prevalence ratio for extractions suggests that dental patients have better access to sedation/anesthesia services for extractions than for other procedures. Extrapolation of these results suggests that nearly 25 million American adults are definitely interested in sedation or general anesthesia for dentistry regardless of the cost.

An absolute requirement basic to the success of patient management is effective local anesthesia. One cannot avoid this necessity in most invasive dental procedures unless complete general anesthesia is being administered. Even then, there may be benefits to the so-called preemptive use of local anesthetic.^{34,45,68} The dentist should not be misled into thinking that poor local anesthetic technique can be overcome by administering a sedative. Only when the anesthetic failure is strictly caused by anxiety⁶⁷ would sedation be fully effective.

The approach to anxiety control should be individualized. It is as faulty to assume that every patient requires general anesthesia for the removal of impacted teeth as it is to assume that no patient requires anxiety control for a simple dental procedure or examination.

The ability to use a particular pharmacologic approach depends on the level of training of the dentist and the applicable laws and regulations.³ Education for minimal sedation, such as given through inhalation and oral administration, is within the realm of the predoctoral dental curriculum. More advanced forms, such as moderate sedation, given either orally or parenterally, usually require training at a postdoctoral or continuing education level, although some dental schools have shown that it can be part of a predoctoral program. The most advanced modalities—deep sedation and general anesthesia—require the most formal training. Education for advanced modalities entails a specific postgraduate program devoted to anesthesia (i.e., an accredited residency in dental anesthesiology or an accredited oral and maxillofacial surgery residency, which must include advanced training in anesthesia as part of its curriculum).

Patient Selection

Before choosing pharmacologic adjuncts for patient management, the dentist should carefully review the patient's medical history. In this context, the American Society of Anesthesiologists (ASA) Physical Status Classification System can be helpful (Box 48-1). This assessment tool can be used to estimate the patient's overall ability to tolerate the stress of a

planned procedure. It can also help determine the need for further patient evaluation and the degree of monitoring required for the procedure.

ASA I and II patients are usually suitable candidates for sedation or general anesthesia in the outpatient setting. Although outpatient general anesthesia is often inappropriate for ASA III patients, these same patients are at increased risk during stressful procedures when fear and anxiety are not adequately controlled. Techniques to control anxiety involving minimal, moderate, or possibly even deep sedation may be particularly valuable to ASA III patients because they reduce the release of endogenous catecholamines.^{18,20} ASA IV (and higher) patients are not candidates for sedation or anesthesia in the dental office.

PHARMACOLOGIC APPROACHES

Several pharmacologic approaches can be used to manage fear and anxiety in dental patients. These are commonly referred to collectively as the *spectrum of pain and anxiety control*, which incorporates all major routes of administration and levels of central nervous system (CNS) depression.⁴³ The route of administration is not synonymous with the level of CNS depression. A spectrum of fear and anxiety control as depicted in Figure 48-1 shows the range of sedation or anesthesia normally sought from the various routes and techniques of administration. In its simplest form, this spectrum is divided into techniques expected to leave the patient awake or to render the patient unconscious. These modalities correspond to sedation and general anesthesia. More recently, definitions of the various levels of sedation have been standardized to include the states of minimal, moderate, and deep sedation.³ The characteristics of these states and of general anesthesia are defined next and compared in Table 48-2:

Minimal sedation is a minimally depressed level of consciousness, produced by a pharmacologic method, that retains the patient's ability to maintain an airway independently

and continuously and to respond normally to tactile stimulation and verbal command. Although cognitive function and coordination may be modestly impaired, ventilatory and cardiovascular functions are unaffected.

Moderate sedation is a drug-induced depression of consciousness during which patients respond purposefully to verbal commands, either alone or accompanied by light tactile stimulation. No interventions are required to maintain a patent airway, and spontaneous ventilation is adequate. Cardiovascular function is usually maintained.

Deep sedation is a drug-induced depression of consciousness during which patients cannot be easily aroused but respond purposefully after repeated or painful stimulation. The ability to maintain ventilatory function independently may be impaired. Patients may require assistance in maintaining a patent airway, and spontaneous ventilation may be inadequate. Cardiovascular function is usually maintained.

General anesthesia is a drug-induced loss of consciousness during which patients are unarousable, even by painful stimulation. The ability to maintain ventilatory function independently is often impaired. Patients often require assistance in maintaining a patent airway, and positive-pressure ventilation may be required because of depressed spontaneous ventilation or drug-induced depression of neuromuscular function. Cardiovascular function may be impaired.

Minimal and moderate forms of sedation are not substitutes for appropriate chairside manner and use of behavioral techniques but are used to reinforce positive suggestion and reassurance in a way that allows dental treatment to be performed with minimal physiologic and psychological stress. These techniques should carry a margin of safety wide enough to render unintended loss of consciousness unlikely.⁵⁵ Deep sedation or general anesthesia can be induced by many of the same drugs that induce moderate sedation. The resulting state depends on patient susceptibility, age, medical status, and degree of anxiety and the drug or drugs used and doses admin-

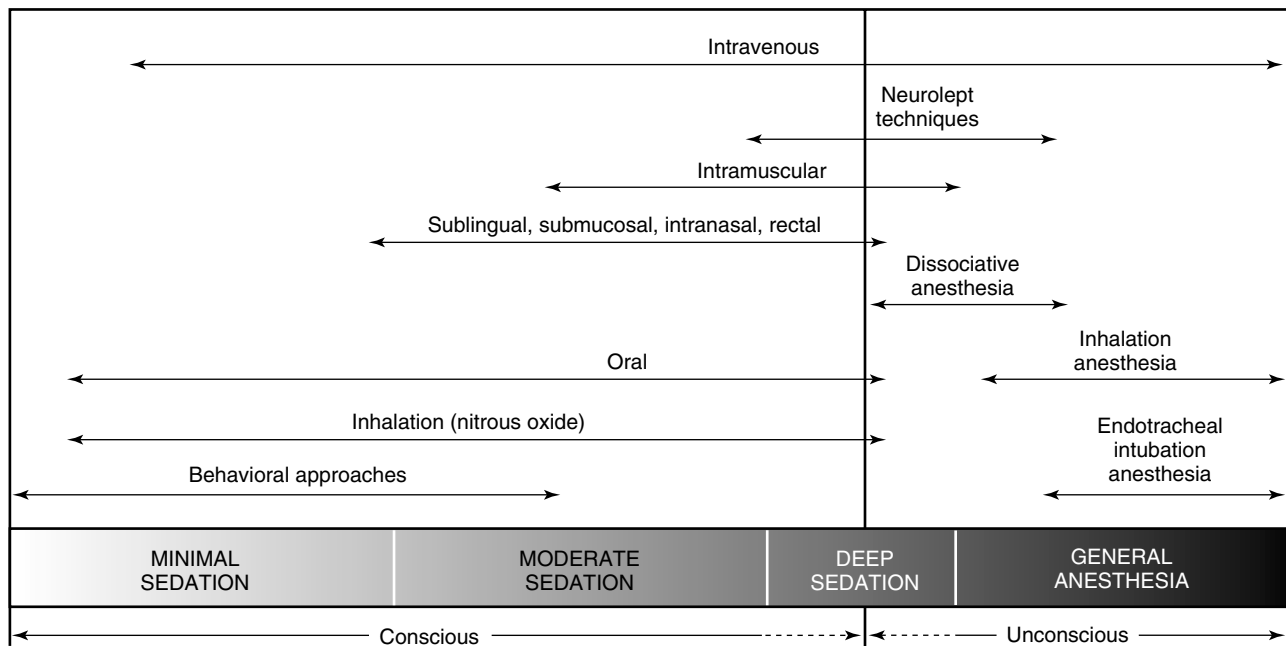

FIGURE 48-1 The spectrum of fear and anxiety control in dentistry. The range of central nervous system depression normally achieved by various techniques is illustrated by arrows. The depth of sedation or anesthesia induced by a given drug primarily depends on the dose administered, route used, and susceptibility of the patient.

TABLE 48-2

Comparison of Minimal Sedation, Moderate Sedation, Deep Sedation, and General Anesthesia

CHARACTERISTICS	MINIMAL SEDATION	MODERATE SEDATION	DEEP SEDATION	GENERAL ANESTHESIA
Consciousness	Maintained	Maintained	Obtunded	Unconscious
Protective reflexes	Intact	Intact	Depressed	Absent
Unassisted airway maintenance	Present	Present	May be absent	Absent
Response to verbal command	Present	May be obtunded	Absent	Absent
Response to tactile stimulation	Present	Present	Absent	Absent
Response to painful stimulation	Present	Present	Reflex withdrawal	Absent
Vital signs	Stable	Usually stable	Usually stable	May be labile
Anxiety	Decreased	Decreased	Absent	Absent
Monitoring required	Basic	Intermediate	Advanced	Advanced
Efficacy	Mild anxiety	Moderate anxiety or fear	Most patients	All patients
Relative risk	Low	Low to intermediate	Intermediate	High
Recovery time	Rapid	Intermediate	Intermediate	May be prolonged
Postoperative sequelae	Uncommon	Uncommon	Uncommon	More common

istered. Either deep sedation or general anesthesia may be indicated when lighter forms of CNS depression are insufficient to permit treatment.

If a separate trained anesthesia provider is not used to administer deep sedation or general anesthesia, a team approach is indicated. For this approach, at least three individuals must be in the operator: the dentist (trained in anesthesia), the anesthetic assistant, and the operative assistant. Under the direction of the dentist, the primary functions of the anesthetic assistant are to assess the patient; monitor vital signs; record appropriate information; and, as required or permitted by relevant laws and regulations, establish intravenous access, administer medications, assist in the maintenance of a patent airway, monitor recovery, and assist in any emergency procedures. The primary functions of the operative assistant are to keep the operative field free of blood, mucus, and debris and to assist in the management of the dental procedure.

Reliable morbidity and mortality data for the different forms of sedation or general anesthesia are scarce, but several studies have shown that, overall, the techniques used in dentistry should be considered safe.^{22,39,42,51,69} Increased mortality is usually associated with inadequate training or inadequate monitoring of the patient.^{15,16,25,33,38} In a review of adverse events related to sedation in pediatric patients, the use of three or more sedating drugs was more strongly associated with adverse outcomes than was the use of only one or two.^{15,16} If the goal is minimal or moderate sedation, one must avoid administering excessive doses of a sedative to a patient who remains uncooperative while conscious because it could easily lead to a deepening of sedation in which airway patency and protective reflexes may be lost. Any subsequent lack of oxygenation can rapidly lead to a tragic result. Although the progression from moderate to deep sedation can be accomplished easily, it requires a significantly increased degree of practitioner training, patient monitoring, and physical resources (e.g., anesthetic equipment and supplies) to be performed safely.

MINIMAL AND MODERATE SEDATION

Numerous routes of administration can be used to achieve minimal or moderate sedation: inhalation, oral, intravenous, intramuscular, submucosal, sublingual, rectal, and intranasal. The first three are commonly used and are discussed in detail

in this chapter, whereas the latter five are used less frequently and are reviewed only briefly here.

The intramuscular route provides an onset and uptake intermediate between that of oral and intravenous routes. There is a limited ability to titrate with this route, but it can be particularly advantageous for patients who are incapable of cooperating, such as cognitively impaired patients.⁶ Its use should be restricted to clinicians with training in at least partial moderate sedation.

The submucosal route is analogous to a subcutaneous injection given intraorally and shares many of the same characteristics as the intramuscular route. The submucosal route has no apparent advantage over any of the others, other than the fact that the dentist may be more comfortable giving an injection by this route. The sublingual (or transmucosal) route, restricted to drugs with high lipid solubility and available in suitable formulations, is similar to the oral route except that there is a more rapid absorption by the oral mucosa and no first-pass effect. The difference in recommended dosages can be large when comparing oral versus sublingual absorption depending on the extent of first-pass metabolism in the intestine and liver. The onset of effect after sublingual administration may take several minutes for some drugs and considerably longer for others.

The rectal route is not often used in dentistry, with the exception of pediatric patients. Disadvantages of this route include inability to titrate, inconsistencies in absorption, often poor patient acceptance, and inconvenience.

The intranasal route involves the topical application to the nasal mucosa and is characterized by a potentially rapid absorption and onset of action. It is sometimes used as an alternative to intramuscular injection for uncooperative children. Its benefits are diminished, however, by variable absorption (especially if the patient sneezes), the discomfort of mucosal irritation, and the potential for damage to the nasal mucosa.

As stated earlier, the route of administration is not synonymous with the depth of sedation. Any route has the potential to induce any degree of sedation or anesthesia. Management of an anxious patient can be discussed according to route of administration, however, because the inhalation and oral techniques are most commonly used for minimal and moderate sedation and are normally the first to be considered. The intravenous route is more likely to be selected to induce a greater depth of effect. Table 48-3 compares the routes of administration for sedation. Commonly used drugs, their

TABLE 48-3

Comparison of Routes of Administration for Sedation

CHARACTERISTIC	INHALATION	ORAL	INTRAVENOUS
Ability to titrate	Excellent	Minimal	Excellent
Technique difficulty	Easy	Very easy	Moderate
Ability to reverse	Excellent	Variable*	Variable*
Onset	Rapid	Slow and variable	Rapid
Duration	Controlled	Prolonged	May be prolonged
Patient acceptance	Good	Very good	Fair
Efficacy	Good	Good	Very good
Need for escort home	No	Yes	Yes

*Requires availability and administration of specific reversal agents.

TABLE 48-4

Drugs, Routes, and Doses for Minimal or Moderate Sedation

DRUG	ROUTE OF ADMINISTRATION	APPROXIMATE DOSE*
Nitrous oxide	Inhalation	20-50%
Diazepam	Oral, IV	0.05-0.3
Midazolam	Oral, IV	0.03-0.1 (IV), 0.3-1 (oral)
Alprazolam	Oral	0.002-0.007
Lorazepam	Oral	0.015-0.06
Triazolam	Oral	0.002-0.007
Hydroxyzine	Oral	0.5-1
Promethazine	Oral	0.5-1
Chloral hydrate	Oral	40-50
Fentanyl	IV	0.0006-0.0015
Meperidine	IV	0.5-1
Morphine	IV	0.05-0.1
Nalbuphine	IV	0.05-0.1
Propofol [†]	IV infusion	0.025-0.1/min

*In mg/kg unless otherwise marked.

[†]The use of propofol is generally restricted in the United States to dentists with formal advanced training in general anesthesia.

routes of administration, and doses for minimal and moderate sedation are summarized in Table 48-4.

Inhalation Sedation

Inhalation sedation refers to the administration of N₂O and oxygen (N₂O-O₂) (pharmacologic features are described in Chapters 17 and 18). N₂O-O₂ inhalation is a technique of choice for dental procedures that require minimal-moderate sedation. The analgesia produced by N₂O-O₂ ameliorates the incidental discomforts associated with dental treatment. As with other modalities of sedation, however, N₂O-O₂ is not a substitute for effective local anesthesia.

Inhalation sedation units must meet stringent safety standards, including color coding of compressed gas cylinders, a pin-indexed or diameter-indexed safety system to prevent incorrect connection of gas cylinders, minimum O₂ flow, and an O₂ fail-safe valve to shut off the N₂O if O₂ delivery is interrupted. All mechanical devices can fail, however, and careful technique and continuous observation of the patient are more effective in preventing accidents than simple reliance on mechanical safeguards.⁶⁴ The reader is referred elsewhere for a thorough discussion of the safety and design features of inhalation equipment.^{12,43}

Advantages

The advantages (and disadvantages) of the inhalation route are summarized in Table 48-3. Because of its relative insolubility in blood, N₂O has a rapid onset of action, with clinical effects becoming apparent within a few minutes. This property of N₂O allows for titration to effect. In this context, *titration* is defined as the incremental administration of small amounts of a drug until a desired clinical effect is observed. The ability to titrate a drug enables the dentist to control its ultimate effect and eliminates the need to guess the correct dose for a particular patient. This characteristic is a major reason why N₂O-O₂ has long been considered a near-ideal technique for minimal or moderate sedation. In the event that a patient inadvertently receives too much drug, the effect can be rapidly decreased by reducing the concentration administered. The inhalation route is the only one in which the actions of a drug can be quickly adjusted in either direction.

Another major advantage of N₂O-O₂ inhalation is that recovery is rapid. Normally, there is no residual effect on the patient's psychomotor skills and ability to operate a motor vehicle soon after termination of N₂O-O₂ inhalation.^{31,37} When it is not combined with any other sedative agent, N₂O-O₂ is the only sedation technique in which a patient may be discharged home alone; all other sedation techniques require that the patient be discharged in the care of a responsible adult.

Disadvantages

N₂O-O₂ sedation for typical dental procedures has comparatively few disadvantages. There are a few patients for whom this method would be ineffective. Most patients have the desired clinical effect between 20% and 50% N₂O. Another disadvantage is the requirement for patient cooperation. Success with this technique requires the patient to breathe through the nose and to leave a nasal hood in place throughout the procedure. Claustrophobic patients and apprehensive children may be unable to tolerate the nasal hood.

Acute or chronic nasal obstruction precludes the use of N₂O-O₂ because the patient is unable to inhale the administered gases. Patients who are mouth breathers for other reasons are also unsuitable candidates. Because of a risk of expansion and rupture of enclosed gas spaces, contraindications include recent vitreoretinal surgery with intraocular gas infusion, pulmonary bullae, pneumothorax, intestinal obstruction, or an obstructed middle ear. Pregnancy may be considered a relative contraindication because of the usual preference to avoid the administration of any drug during pregnancy. Nevertheless, if drug-induced sedation is to be carried out for a pregnant patient, N₂O-O₂ is preferred over most other sedatives and may be the technique of choice for a short procedure.

(e.g., <1 hour). Two minor disadvantages are the cost and space needed for the N₂O-O₂ equipment.

The potential risks stemming from the ability of N₂O to disrupt vitamin B₁₂-dependent biochemical pathways are discussed in Chapters 17 and 18. It is currently unknown to what extent these concerns apply to the use of inhalation sedation for typical dental procedures. Patients with known mutations causing abnormalities in folate-cycle enzymes may be at risk when administered N₂O.⁶⁰ A postulated link between autism and genetically based disturbances in the folate metabolic pathway may be exacerbated by prolonged administration of N₂O.³⁰ A final disadvantage is the occupational health hazards from trace anesthetic gases, as discussed in Chapters 17 and 18.

For two groups of patients, it is not the N₂O that is the concern, but the high inspired O₂. First, patients with severe chronic obstructive pulmonary disease may have chronically elevated carbon dioxide tensions and depend on the hypoxic drive to stimulate breathing. When elevated O₂ concentrations occur, as during N₂O-O₂ administration, the stimulus for involuntary breathing may be removed, leading to respiratory depression and a worsening of respiratory acidosis. Second, patients who have had bleomycin chemotherapy within the past year may be predisposed to pulmonary fibrosis after exposure to high O₂ concentrations.⁵

Clinical application

Administration begins with 100% O₂ at an appropriate flow rate, approximately 6 L/min for most adults. With the reservoir bag filled and O₂ flowing, the mask is placed on the patient. The operator initially adjusts the O₂ flow to meet the patient's minute respiratory volume and then administers a 20% concentration of N₂O to the patient (keeping total gas flow unchanged) and waits 1 to 2 minutes to judge clinical effectiveness. As necessary, the operator increases the N₂O concentration in 5% to 10% increments until the patient exhibits the desired clinical signs and symptoms. In a few patients, doses of 20% or less may be sufficient.

The dentist should advise the patient of the symptoms that may be experienced and that the goal is to feel comfortable. Symptoms occurring during inhalation sedation may include lightheadedness; tingling of the fingers, toes, or lips; warmth; and euphoria. The clinician should not be dogmatic in describing potential symptoms because failure to experience one or more of them may be misinterpreted by the patient as a failure of the technique. When the patient reports being comfortable, the dentist stops increasing the N₂O percentage and begins treatment. Oversedation may be indicated by excessive drowsiness, loss of response to verbal command, inappropriate movement, hearing abnormalities, visual disturbances, sweating, or nausea. Patients should be monitored by clinical assessment of level of consciousness, adequacy of respiration, heart rate, and blood pressure.

Recovery is accomplished by terminating N₂O flow and administering 100% O₂ at the previously established flow rate for approximately 5 minutes (to allow for scavenging of exhaled N₂O) or longer if clinical signs and symptoms warrant. Recovery should be evaluated by visual observation, patient report, and, if necessary, assessment of the postoperative vital signs relative to baseline values.

Oral Sedation

The oral route is the second most frequently used route to accomplish minimal or moderate sedation in dentistry. It has numerous advantages and disadvantages (see Table 48-3).

Advantages

The oral route is commonly used to achieve minimal or moderate sedation because of the ease of administration. Most

adults readily accept oral medication; however, young children, mentally challenged patients, and demented patients may not willingly swallow drugs, particularly in tablet or capsule form. Problems such as overdose, idiosyncratic reactions, allergy, and other adverse events may occur whenever drugs are administered, but such reactions are less likely to arise when drugs are given orally, and if they do develop, they are often less intense. Nevertheless, careful administration of any drug by even this route is required because fatal reactions have resulted from oral sedation.^{15,16,32}

Disadvantages

The major disadvantage of oral sedation is the inability to titrate reliably, so the dentist cannot adjust for individual patient response. After a drug is taken orally, it is often impractical to provide an additional dose because of the delay in absorption and onset of action. There can also be a delay in drug equilibration between the plasma and effect site concentrations, which can lead to overdose if additional doses are administered on the basis of patient anxiety.^{23,29} A predetermined dose is best administered while recognizing, on one hand, the risk of an excessive dose leading to prolonged action or inadvertent deep sedation and, on the other hand, the risk of an insufficient dose, in which case the patient would be inadequately sedated to allow dental treatment.

A further disadvantage of oral sedation is the potential for a prolonged duration of action. The patient can remain under the influence of the drug postoperatively and should not leave the dental office unescorted. Specific contraindications to oral sedation depend on the drug used.

Clinical application

The oral route may be used the night before the dental procedure if the patient needs a hypnotic to ensure adequate sleep. Preoperative anxiety reduction before the patient is transported to the dental office may be a second indication for oral premedication. Dosages for these two indications should be kept low enough to minimize the likelihood of oversedation because the dentist is not present to deal with any potential adverse event. The third indication is the most common one: the administration of an oral drug for minimal or moderate sedation during the dental procedure. Ideally, a dose used to induce sedation should be administered to the patient in the dental office, taking into account the time required for drug absorption. Although great variability exists, initial clinical effects are often evident approximately 30 minutes after ingestion, with peak effects occurring at about 1 hour. Patients should be monitored by clinical assessment of level of consciousness, adequacy of respiration, heart rate, and blood pressure as necessary. At the end of the case, patients should be discharged to the care of a responsible adult only when they are oriented and ambulatory, have stable vital signs, and show signs of increasing alertness. The patient should be instructed not to drive a vehicle, operate hazardous machinery, or consume alcohol for the remainder of the day.

Determinants of dose. The suggested doses for sedation recommended in this chapter apply to a typical 70-kg, healthy adult. Some factors modify these recommendations. The first consideration is the patient's weight. Determining a dose based on body surface area is theoretically more accurate, but using body weight has the advantage of simplicity. Extremes of age are another consideration. The dosage regimens for pediatric patients may often be determined by body weight or surface area calculations. Specific doses for certain drugs may differ in young children, however, for reasons other than body size.¹⁴ Geriatric patients may react much more profoundly to CNS depressants with respect to depth and duration of action. As a general recommendation, one should

consider an initial dose for an elderly patient of half that usually administered for a typical adult of the same body size.

Medical history and concurrent medication may influence the dose to be used. In particular, drugs affecting the CNS must be assessed, not only regarding interactive potential leading to excessive CNS depression and subsequent respiratory and cardiovascular depression, but also regarding the possibility of cross-tolerance and decreased effect of the planned medications. History of the patient's response to mood-altering drugs such as alcohol may indicate an altered dose requirement.

Patients with chemical dependencies require special consideration. Patients who take large amounts of alcohol, opioids, or other mood-altering drugs may require an increased dose of sedative because of tolerance. A patient who is recovering from chemical dependency should ideally have an oral sedative administered only after thorough consultation with the patient and the health professional treating the dependency.

Finally, increased anxiety often correlates with increased dose requirement. Larger doses (although still within the acceptable range) are generally indicated for patients with an increased need for pharmacologic sedation.

Specific drugs

Numerous drugs are available for oral sedation. The following is a summary of the drugs commonly used in dentistry.

Benzodiazepines. Benzodiazepines are typically the drugs of choice for oral sedation. As described in Chapter 13, benzodiazepines have a wide margin of safety compared with other antianxiety and sedative drugs. They are well absorbed, and most have a rapid onset of action. Relative contraindications to the use of benzodiazepines include myasthenia gravis, obstructive sleep apnea, and acute angle-closure glaucoma.

Diazepam is the prototypic benzodiazepine and has a long history of use in dentistry. It is efficacious, but it has active metabolites and may have a prolonged duration of action. It may be administered orally for minimal or moderate sedation in adults in doses ranging from 2 to 30 mg. For children, doses of 0.3 to 0.6 mg/kg have been suggested.^{50,63} It is available in tablets (2 mg, 5 mg, and 10 mg) and as a syrup (5 mg/5 mL and 25 mg/5 mL).

Triazolam is an effective anxiolytic and amnestic agent; it has a rapid onset of action and a short elimination half-life. This short duration of action is ideally suited to dentistry, allowing for rapid recovery, which is important for outpatient procedures.⁹ Triazolam has been shown to be as effective as intravenous diazepam for moderate sedation.³⁵ Significant adverse reactions of triazolam (e.g., behavioral abnormalities), widely publicized in the lay press, are associated with repeated use of high doses, particularly in elderly patients.^{26,56} A significant interaction can occur with drugs that inhibit the biotransformation pathway of triazolam. Specifically, CYP3A4, which metabolizes triazolam, can be inhibited by numerous drugs, including erythromycin, clarithromycin, azole antifungals (ketoconazole, fluconazole, itraconazole), cimetidine, fluvoxamine, and several antiviral drugs including ritonavir. Concurrent administration of these drugs inhibits triazolam's intestinal and hepatic breakdown, leading to increased and prolonged plasma concentrations; grapefruit juice has the same effect.²⁸ These drugs may potentiate the magnitude and duration of triazolam's sedative effect.

Overall, triazolam's pharmacologic advantages make it a drug of choice for oral sedation in dentistry. The adult dose range is 0.125 to 0.5 mg, and it is available in 0.125-mg or 0.25-mg tablets. A more recent trend in dentistry is to use triazolam in multiple doses to increase or extend the sedative effect. Increased patient monitoring (including continuous pulse oximetry and repeated checks for patient verbal respon-

siveness) and avoiding spacing doses too close to each other are important considerations to ensuring patient safety.

Lorazepam is an effective premedicant. Although it can elicit satisfactory sedation for dental procedures, it has the potential drawbacks of profound anterograde amnesia and an unusually long duration of action. Peak effects may occur 1 to 6 hours after administration, making appropriate scheduling difficult. It may be considered for longer dental appointments, (e.g., >3 hours). Doses typically of 2 mg (range 0.5 to 4 mg) are suggested for adults; it is available as 0.5-mg, 1-mg, or 2-mg tablets. Lorazepam is not recommended in pediatric patients.

Midazolam, widely used parenterally, is also available as an oral formulation for use in pediatric patients. It is not normally used orally in adults in the United States or Canada. It has a rapid onset and short duration of action. Similar to triazolam, oral midazolam is contraindicated in patients taking erythromycin or other strong CYP3A4 inhibitors because the resulting interaction can lead to increased plasma concentrations of midazolam with subsequent increased and prolonged sedation.²⁸ Midazolam's high first-pass effect leads to large differences in the parenteral and oral dosing recommendations. For oral midazolam, the usual dose is 0.5 to 0.6 mg/kg, but doses of 1 mg/kg (to a maximum of 20 mg) have been approved.²⁷

Alprazolam may be given for longer procedures as an alternative to lorazepam. Alprazolam (but not lorazepam) is subject to the same CYP3A4 interactions as triazolam. The usual adult dose is 0.25 to 0.5 mg. Other benzodiazepines, such as flurazepam, oxazepam, temazepam, and nitrazepam, may also be considered for use in minimal or moderate sedation.

Zolpidem and zaleplon. Zolpidem and zaleplon are sedative-hypnotics related pharmacologically to benzodiazepines because they interact with a subtype of benzodiazepine receptors (see Chapter 13). They are similar to triazolam (also classified as a sedative-hypnotic) in providing anxiolysis, sedation, and a rapid onset of action, with peak effects occurring in 20 minutes. Prolonged sedation is not a problem because of their short metabolic half-lives and conversion to inactive derivatives. Possible disadvantages are their relative lack of anticonvulsant and muscle relaxant properties. Some question remains regarding whether zolpidem and zaleplon produce specific anxiolytic effects common to the benzodiazepines. The average adult dose is 10 mg; zolpidem and zaleplon are available in 5-mg and 10-mg tablets (zolpidem) and capsules (zaleplon). Zolpidem is characterized as a category B drug with regard to pregnancy and may be considered an oral sedative of choice for pregnant women. These drugs are contraindicated in patients with liver disease.

Alcohols. Chloral hydrate has been widely administered for moderate sedation in pediatric dentistry.¹⁶ The drawbacks to this agent are outlined in Chapter 18. It is usually administered in the form of a syrup, with the recommended dose of 40 to 50 mg/kg when administered alone, not to exceed 1000 mg. Although commonly considered to be safe,² chloral hydrate has a narrower safety margin than benzodiazepines. It also is a mucosal irritant, may precipitate cardiac arrhythmias, and can produce prolonged recoveries. As with other sedative-hypnotics intended for pediatric sedation, chloral hydrate should not be administered at home. It is usually available at a concentration of 500 mg/5 mL.

Antihistamines. Promethazine is a phenothiazine derivative with antihistaminic properties that is used for minimal-moderate sedation, particularly in pediatric patients. In addition to causing sedation, it is also noted for having

anticholinergic and antiemetic effects. Promethazine may also have modest antidopaminergic properties that can lead to dyskinesia in sensitive individuals. The recommended dose for oral sedation is 25 to 50 mg in adults and 0.5 to 1 mg/kg in children if administered alone. Promethazine has been used in combination with opioids, in which case doses should be reduced. It is available in tablet form (12.5 mg, 25 mg, and 50 mg) and as a syrup in a concentration of 6.25 or 25 mg/5 mL.

Hydroxyzine, the only antihistamine approved specifically as an anti-anxiety drug, is similar to promethazine in that it is an antihistamine and induces sedation and has anticholinergic and antiemetic effects. Recommended doses range from 50 to 100 mg for adults, if given alone, and 0.65 to 1 mg/kg for children. If it is combined with either chloral hydrate or an opioid, doses should be reduced. It is available in tablet (10 mg, 25 mg, and 50 mg), capsule (25 mg, 50 mg, and 100 mg), and liquid (10 mg/5 mL syrup and 25 mg/5 mL suspension) formulations.

Ketamine. Ketamine is discussed in more detail later because it is primarily used intramuscularly or intravenously to induce dissociative anesthesia, an anesthetic state considered deeper than moderate sedation. It is best used by clinicians trained in deep sedation and general anesthesia. It has been used orally in doses approximating 6 mg/kg as a premedicant (see Chapter 18).^{1,62}

Opioids. As described in Chapter 18, opioids are important in sedation and anesthesia but are much more effective intravenously than orally because of their high first-pass metabolism.

Intravenous Sedation

The intravenous route is the most effective method to achieve any level of sedation.⁷ The advantages and disadvantages of this route of administration are summarized in Table 48-3.

Advantages

The intravenous route makes possible the rapid attainment of blood concentrations at which drugs are clinically effective. Intravenous injection leads to a very short latent period, which ranges from 30 seconds—the time it may take to go from the intravenous site to the site of action in the brain—to a few minutes (or longer for drugs of low lipid solubility). The ability to titrate drugs and minimize the likelihood of overdose and to enhance drug action rapidly are other advantages. In clinical practice, the operator requires 2 to 15 minutes to titrate a drug to a desired clinical end point. One more advantage is that a patent intravenous line provides the ideal route for drug administration in the event of an emergency.

Disadvantages

Patients must be cooperative to permit venipuncture. Many children actively resist, and intravenous sedation for children is often undesirable or impossible. Another disadvantage of this route is that the rapid onset of action and the accentuated drug effects likely to be observed tend to magnify problems associated with drug overdose or side effects. As stated earlier, administering intravenous sedation requires advanced training, in part because adverse effects may occur more readily and with more severe consequences.

Clinical applications

For intravenous sedation, monitoring should include, at a minimum, oxyhemoglobin saturation, heart rate, blood pressure, and adequacy of respiration.

Benzodiazepines. As with the oral route, benzodiazepines are the ideal drugs to induce intravenous sedation. Diazepam is

lipid-soluble and water-insoluble and is formulated in propylene glycol. This vehicle is often irritating on intravenous administration and may lead to thrombophlebitis.⁵⁸ Irritation may be minimized by slow administration into large-caliber veins or by use of a formulation of diazepam dissolved in an injectable emulsion (not currently available in the United States). Diazepam is prepared as a 5-mg/mL solution. The drug must be titrated slowly, with sedative and anxiolytic effects usually beginning at doses of 2 to 10 mg, although great interpatient variability is possible. Appropriate moderate sedation often corresponds with ptosis. By this route, diazepam has a rapid onset of 30 to 60 seconds, with peak effects occurring after approximately 3 minutes. The duration of sedation is dose-dependent, but averages approximately 45 to 60 minutes for sedative doses. Overall, diazepam is an effective agent for intravenous sedation, but it has the disadvantages of slow elimination, active metabolites, and the potential for thrombophlebitis.

Midazolam injection is water-soluble and, when administered intravenously, does not cause venous irritation. Midazolam is rapidly eliminated and is converted to essentially inactive metabolites. After intravenous administration, it has a rapid onset of 30 to 60 seconds, with peak effects reported to occur after 3 to 5 minutes, which may be slightly slower than with diazepam. The distributional half-life is very short, 6 to 15 minutes, leading to a short duration of action of approximately 45 minutes. The duration of action is dose-dependent. It has been suggested that midazolam is approximately three times as potent as diazepam. Moderate sedation is achieved by doses approximating 0.07 mg/kg, titrated slowly in 1-mg increments. Midazolam is provided in strengths of 1 mg/mL and 5 mg/mL. A 1-mg/mL solution is recommended for moderate sedation to facilitate accurate titration.

Barbiturates. As discussed in Chapter 18, barbiturates have continued application in general anesthetic induction, but they are inferior to benzodiazepines for minimal-moderate sedation. Pentobarbital, which has been used parenterally as part of the Jorgensen technique, may be administered in divided doses usually up to 100 mg. When administered intravenously, it has a clinical action lasting 2 to 3 hours. It may be useful for long dental procedures.

Opioids. The pharmacologic characteristics of opioids are discussed in Chapter 20. These drugs are not used alone for sedation, but are commonly given to supplement benzodiazepines or other sedatives either to facilitate moderate sedation or, with increasing doses, to induce deep sedation or general anesthesia. They are useful for painful procedures such as those common in dentistry and oral surgery. Opioids typically provide the advantages of profound analgesia and sedation with minimal cardiovascular effects. The duration of action varies with the drug. Administration of an opioid should be timed so that the peak effect coincides with the most painful part of the procedure.

In general, ASA III patients, such as patients with significant cardiovascular disease, and elderly patients require lower doses of opioids than younger ASA I or II patients. Specific concerns with intravenous opioids include respiratory depression and chest wall rigidity. The latter syndrome is characterized by an increase in muscle tone leading to severe truncal stiffness. It seems to be more prevalent with high doses, with bolus administration of rapidly acting opioids, in elderly patients, and when N₂O is coadministered. Chest wall rigidity is treated with either naloxone or a neuromuscular blocker.

Opioids and related drugs commonly used for sedation include fentanyl, meperidine, morphine, pentazocine, nalbuphine, and butorphanol. Fentanyl is particularly suited for procedures of short duration. The dose for sedation is on the

order of 1 µg/kg. At this dose, it can be expected to have a duration of action of 30 to 60 minutes. Advantages of fentanyl over other opioids include cardiovascular stability, a relatively short duration of action, and lack of histamine release. Fentanyl is more likely to produce chest wall rigidity.⁶⁵ Remifentanyl is related to fentanyl and is given by intravenous infusion. Its advantages are its rapid onset and its very short duration of action.

Meperidine is administered for sedation in doses of 0.5 to 1 mg/kg, usually not exceeding 100 mg. At these doses, meperidine can be expected to have a duration of action of 1 to 2 hours. In addition to its expected effects of analgesia and sedation, meperidine is noted for its antisialagogue effect and potential to induce tachycardia. It is contraindicated in patients taking monoamine oxidase inhibitors or amphetamines and should be used cautiously, or not at all, in patients with asthma because of the potential for histamine release. A more recent concern is its potential to interact with other drugs—serotonin-selective reuptake inhibitors and various other antidepressants—that can increase the activity of endogenous 5-hydroxytryptamine (serotonin).

Morphine, the first opioid to be isolated in pure form, is still used for intravenous sedation in cases lasting more than 2 hours. Its slow onset of action (peak effect takes 20 minutes or longer) makes titration difficult, so the drug is usually given initially in standard doses, such as 5 mg, with additional increments given only after the drug has had time to become effective and as needed by patient response.

Pentazocine is a mixed agonist-antagonist, which results in a ceiling effect regarding analgesia and respiratory depression. Adverse reactions include a potential for psychotomimetic effects, such as disorientation, confusion, depression, hallucinations, dysphoria, diaphoresis, and dizziness. In doses approximating 0.5 mg/kg, to a maximum of 30 mg, pentazocine can be expected to have a duration of action of 1 to 2 hours. Nalbuphine is also a mixed agonist-antagonist used for sedation. A dose of 0.1 mg/kg, up to a maximum of 10 mg, may be considered. A third agonist-antagonist, butorphanol, has been used for sedation in doses of 0.02 mg/kg, usually to a maximum of 2 mg.

Jorgensen technique. The Jorgensen technique, also known as the Loma Linda technique, has had a long history of safe use. This technique involved the titration of pentobarbital incrementally until the patient was minimally sedated. At this point, a solution containing 25 mg of meperidine and 0.32 mg of scopolamine was administered in a ratio of 1 mL of solution per 20 mg of pentobarbital to a maximum of 5 mL. A final 10% of the baseline barbiturate dose was then given. Although the classic Jorgensen technique is rarely used today, it did prove the practicality and safety of intravenous sedation in restorative dentistry when drugs are carefully titrated and the patient remains responsive to verbal command.

Propofol. Propofol, an intravenous general anesthetic, is described in Chapter 18. In low doses, propofol can be used for moderate sedation or deep sedation.⁵³ This use requires careful infusion at a rate of 25 to 100 µg/kg/min. Fospropofol, a prodrug that releases propofol on hydrolysis by the enzyme alkaline phosphatase, has been developed specifically for moderate intravenous sedation. Compared with propofol, it has a slower onset and extended duration of action.

Dexmedetomidine. Dexmedetomidine is a centrally acting α_2 -adrenoceptor agonist similar in properties to clonidine. Originally indicated for sedation of intubated patients in the intensive care unit, the drug has been approved for moderate sedation. Xerostomia, hypotension, and bradycardia are the most common side effects. An initial evaluation of

dexmedetomidine given as a loading dose of 0.1 µg/kg/min for 5 minutes and followed by a continuous infusion of 0.2 µg/kg/hr seemed to be safe and effective for dental patients.⁵²

DEEP SEDATION AND GENERAL ANESTHESIA

Many of the drugs described for intravenous moderate sedation can also induce deep sedation or general anesthesia. The characteristics of these deeper levels of CNS depression are summarized in Table 48-1. Drugs used only for general anesthesia, such as volatile anesthetics, are described in Chapter 18. These techniques require more advanced monitoring than does moderate sedation. Techniques used for deep sedation are described next.

Benzodiazepine-Opioid Combinations

The combination of midazolam with fentanyl has been shown to be effective and safe for the induction of moderate sedation.^{19,22} These same drug combinations, when administered in higher doses or in more susceptible patients, are also effective in inducing deep sedation. Use of either diazepam or midazolam with an opioid such as fentanyl, meperidine, or morphine can provide effective deep sedation. These drugs are often combined further with N₂O-O₂, propofol, or methohexital.

Neuroleptanalgesia and anesthesia

Neuroleptanalgesia, a drug-induced state of indifference to one's surroundings, was commonly used in the past.¹⁰ In its strictest sense, neuroleptanalgesia is rarely used today, but it was the forerunner of deep sedation techniques now practiced. Classically, neuroleptanalgesia was induced by using droperidol, a butyrophenone antipsychotic, in combination with an opioid, usually fentanyl. This state is characterized by somnolence without total unconsciousness, psychological indifference, good analgesia, amnesia, and decreased motor activity. When droperidol and fentanyl were combined with N₂O-O₂, the effect was referred to as *neuroleptanesthesia*. Droperidol, which also had wide use as an antiemetic, is used much less commonly today because of governmental concerns regarding its potential to induce serious cardiac dysrhythmias, including QT interval prolongation and torsades de pointes.

Methohexital

The ultrashort-acting barbiturate methohexital is administered for outpatient deep sedation and general anesthesia in dentistry, but its use has diminished since the introduction of propofol.⁴⁴ It may be administered alone for procedures of short duration, although it is more commonly administered in combination with other agents, such as benzodiazepines, opioids, and N₂O-O₂.²² A dose of 1 to 1.5 mg/kg is used for the induction of general anesthesia, whereas increments of 10 mg can be injected for maintenance of deep sedation. The use of methohexital is characterized by a more rapid induction, more rapid recovery, and increased heart rate compared with thiopental. Its disadvantages include the potential for respiratory depression, apnea, hiccough, and coughing. It is contraindicated in patients with certain forms of porphyria, as described in Chapter 13.

Propofol

Propofol (see Chapter 18) is characterized by its short duration of action even after repeated administrations or continuous infusion. The rapid recovery makes it advantageous for ambulatory sedation and general anesthesia in the dental

office. Propofol compares favorably with methohexital for providing sedation and anesthesia for regional blockade, dentistry, and other short procedures. The most frequent adverse effects of propofol include pain on injection and apnea and hypotension in higher doses.

Propofol has been administered by continuous infusion specifically for moderate sedation in dentistry.⁵³ Because of the increased likelihood of inducing deep sedation or general anesthesia, it is best to monitor the patient with these deeper states in mind. The dose for induction of general anesthesia is 2 to 2.5 mg/kg. If used alone, a titrated infusion of 25 to 100 µg/kg/min should accomplish moderate sedation in healthy adults. Similar doses can produce deep sedation when used after benzodiazepine or opioid injection.

Ketamine

In addition to its use as an oral or intramuscular agent, ketamine can be administered intravenously as an adjunct for deep sedation or general anesthesia. It has been suggested that administering ketamine as a sole agent by low-dose intravenous infusion may provide analgesia, amnesia, and sedation.⁷ For use as a general anesthetic agent, ketamine is administered in a dose of 1 to 2 mg/kg intravenously or 5 to 10 mg/kg intramuscularly. For use in sedation or analgesia only, the suggested doses are 200 to 750 µg/kg intravenously, followed by 5 to 20 µg/kg/min as a continuous infusion, or 2 to 4 mg/kg if given intramuscularly.

REVERSAL AGENTS

Specific antagonists are available for opioids and benzodiazepines.

Naloxone

As described in Chapters 18 and 20, naloxone is a reversal agent for the opioid analgesics. The primary indication is in the treatment of opioid-induced respiratory depression, chest wall rigidity, or overly deep sedation. The drug has a peak effect in 5 to 15 minutes, with a duration of action of 45 minutes. Naloxone should be used with caution. Particular concern is warranted regarding patients with cardiac irritability or opioid dependency. Convulsions, alterations in blood pressure, ventricular tachycardia, and ventricular fibrillation have been reported to occur. Therapeutic doses are best administered by titrating slowly in 0.1-mg increments to effect, often to a final dose of 0.4 to 0.8 mg in cases of true opioid overdosage. The duration of action is short, so there is a danger that the antagonistic effect of naloxone will wear off before the agonistic effect of the opioid, resulting in a return of respiratory difficulties. After the administration of naloxone, the patient should be carefully monitored for 1 hour or more, depending on the opioid being antagonized.

Flumazenil

Flumazenil, a specific benzodiazepine receptor antagonist, exerts little effect by itself. When administered to reverse benzodiazepine-induced CNS depression, however, it causes a rapid reversal of unconsciousness, sedation, amnesia, and psychomotor dysfunction. In the presence of a high dose of agonist, flumazenil first reverses the loss of consciousness and respiratory depression, but drowsiness and amnesia may persist. These latter two signs diminish after higher doses of flumazenil. Onset is rapid, with the peak effect occurring in 1 to 3 minutes. The duration of action is dose-dependent, depending on the specific agonist being reversed and how much of it was administered. Incremental doses of 0.1 to 0.2 mg of flumazenil intravenously (up to 3 mg) can be used.

Reports indicate that 3 mg may provide 45 to 90 minutes of antagonism.

Flumazenil seems to have few adverse effects other than the important possibility of re sedation. The adverse cardiovascular sequelae sometimes seen with naloxone after reversal of opioid overdosage do not occur with flumazenil. Agitation and headache have been reported. Convulsions have occurred in epileptic patients taking benzodiazepines for their condition. Patients taking medications that may cause seizures, such as tricyclic antidepressants, may also be susceptible to convulsions. Flumazenil is indicated whenever rapid reversal of benzodiazepine agonist action is required. As with any reversal agent, the potential for re sedation demands that whenever this agent is used to treat an emergency, the patient must be monitored in recovery beyond the potential duration of action of flumazenil.

SUMMARY

Significant progress in the science of dentistry has resulted in important advances in the prevention and treatment of caries and periodontal disease. Many patients fail to benefit from modern dentistry, however, because of fear and anxiety regarding dental treatment. Dentists who are able to use the techniques discussed in this chapter have the capability to carry out dentistry in a compassionate manner for these patients. Patients deserve and expect to be treated as atraumatically as possible, and the administration of judiciously selected drugs can help achieve this goal.

CITED REFERENCES

1. Alfonzo-Echeverri EC, Berg JH, Wild TW, et al: Oral ketamine for pediatric outpatient dental surgery sedation. *Pediatr Dent* 15:182-185, 1993.
2. American Academy of Pediatrics Committee on Drugs and Committee on Environmental Health: Use of chloral hydrate for sedation in children. *Pediatrics* 92:471-473, 1993.
3. American Dental Association: *Guidelines for teaching the comprehensive control of anxiety and pain in dentistry*, Chicago, 2007, American Dental Association.
4. Ayer WA Jr, Domoto PK, Gale EN, et al: Overcoming dental fear: strategies for its prevention and management. *J Am Dent Assoc* 107:18-27, 1983.
5. Barash PG, Cullen BF, Stoelting RK, editors: *Clinical anesthesia*, ed 5, Philadelphia, 2005, Lippincott Williams & Wilkins.
6. Becker DE, Bennett CR: Intravenous and intramuscular sedation. In Dionne RA, Phero JC, Becker DE, editors: *Management of pain and anxiety in the dental office*, Philadelphia, 2002, Saunders.
7. Bennett CR: Dissociative-sedation: a new concept. *Compendium* 11:34, 36-38, 1990.
8. Berggren U, Meynert G: Dental fear and avoidance: causes, symptoms, and consequences. *J Am Dent Assoc* 109:247-251, 1984.
9. Berthold CW, Schneider A, Dionne RA: Using triazolam to reduce dental anxiety. *J Am Dent Assoc* 124:58-64, 1993.
10. Bissonnette B, Swan H, Ravussin P, et al: Neuroleptanesthesia: current status. *Can J Anesth* 46:154-168, 1999.
11. Chanpong B, Haas DA, Locker D: Need and demand for sedation or general anesthesia in dentistry: a national survey of the Canadian population. *Anesth Prog* 52:3-11, 2005.
12. Clark M, Brunick A: *Handbook of nitrous oxide and oxygen sedation*, ed 3, St Louis, 2008, Mosby.
13. Corah NL, Gale EN, Illig SJ: Assessment of a dental anxiety scale. *J Am Dent Assoc* 97:816-819, 1978.
14. Coté CJ: Sedation for the pediatric patient: a review. *Pediatr Clin North Am* 41:31-58, 1994.
15. Coté CJ, Karl HW, Notterman DA, et al: Adverse sedation events in pediatrics: analysis of medications used for sedation. *Pediatrics* 106:633-644, 2000.

16. Coté CJ, Notterman DA, Karl HW, et al: Adverse sedation events in pediatrics: a critical incident analysis of contributing factors. *Pediatrics* 105:805-814, 2000.
17. DeFord WH: *Lectures on general anesthetics in dentistry*, Kansas City, MO, 1908, John T Nolde.
18. Dionne RA, Driscoll EJ, Gelfman SS, et al: Cardiovascular and respiratory response to intravenous diazepam, fentanyl, and methohexital in dental outpatients. *J Oral Surg* 39:343-349, 1981.
19. Dionne RA, Gift HC: Drugs used for parenteral sedation in dental practice. *Anesth Prog* 35:199-205, 1988.
20. Dionne RA, Goldstein DS, Wirdzek PR: Effects of diazepam premedication and epinephrine-containing local anesthetic on cardiovascular and plasma catecholamine responses to oral surgery. *Anesth Analg* 63:640-646, 1984.
21. Dionne RA, Gordon SM, McCullagh LM, et al: Assessing the need for anesthesia and sedation in the general population. *J Am Dent Assoc* 129:167-173, 1998.
22. Dionne RA, Yagiela JA, Moore PA, et al: Comparing efficacy and safety of four intravenous sedation regimens in dental outpatients. *J Am Dent Assoc* 132:740-751, 2001.
23. Dionne RA, Yagiela JA, Coté CJ, et al: Balancing efficacy and safety for the use of oral sedation in dental outpatients. *J Am Dent Assoc* 137:502-513, 2006.
24. Gift H: Issues to consider in the control of acute pain, fear and anxiety. In Dionne RA, Phero JC, editors: *Management of pain and anxiety in dental practice*, New York, 1991, Elsevier Science.
25. Goodson JM, Moore PA: Life-threatening reactions after pedodontic sedation: an assessment of narcotic, local anesthetic, and antiemetic drug interaction. *J Am Dent Assoc* 107:239-245, 1983.
26. Greenblatt DJ, Harmatz JS, Shapiro L, et al: Sensitivity to triazolam in the elderly. *N Engl J Med* 324:1691-1698, 1991.
27. Haas DA, Nenniger SA, Yacobi R, et al: A pilot study of the efficacy of oral midazolam for sedation in paediatric dental patients. *Anesth Prog* 43:1-8, 1996.
28. Hersh EV: Adverse drug interactions in dental practice: interactions involving antibiotics. *J Am Dent Assoc* 130:236-251, 1999.
29. Jackson DL, Milgrom P, Heacox GA, et al: Pharmacokinetics and clinical effects of multidose sublingual triazolam in healthy volunteers. *J Clin Psychopharmacol* 26:4-8, 2006.
30. James SJ, Cutler P, Melnyk S, et al: Metabolic biomarkers of increased oxidative stress and impaired methylation capacity in children with autism. *Am J Clin Nutr* 80:1611-1617, 2004.
31. Jastak JT, Orendurff D: Recovery from nitrous sedation. *Anesth Prog* 22:113-116, 1975.
32. Jastak JT, Pallasch T: Death after chloral hydrate sedation: report of case. *J Am Dent Assoc* 116:345-348, 1988.
33. Jastak JT, Peskin RM: Major morbidity or mortality from office anesthetic procedures: a closed-claim analysis of 13 cases. *Anesth Prog* 38:39-44, 1991.
34. Katz J, Kavanagh BP, Sandler AN, et al: Preemptive analgesia: clinical evidence of neuroplasticity contributing to postoperative pain. *Anesthesiology* 77:439-446, 1992.
35. Kaufman E, Hargreaves KM, Dionne RA: Comparison of oral triazolam and nitrous oxide with placebo and intravenous diazepam for outpatient premedication. *Oral Surg Oral Med Oral Pathol* 75:156-164, 1993.
36. Kleinknecht RA, Thorndike RM, McGlynn FD, et al: Factor analysis of the dental fear survey with cross-validation. *J Am Dent Assoc* 108:59-61, 1984.
37. Korttila K, Ghoneim MM, Jacobs L, et al: Time course of mental and psychomotor effects of 30 per cent N₂O during inhalation and recovery. *Anesthesiology* 54:220-226, 1981.
38. Krippaehne JA, Montgomery MT: Morbidity and mortality from pharmacosedation and general anesthesia in the dental office. *J Oral Maxillofac Surg* 50:691-698, 1992.
39. Leelataweedwud P, Vann WF: Adverse events and outcomes of conscious sedation for pediatric patients: study of an oral sedation regimen. *J Am Dent Assoc* 132:1531-1539, 2001.
40. Liddell A: Personality characteristics versus medical and dental experiences of dentally anxious children. *J Behav Med* 13:183-194, 1990.
41. Liddell A, Ackerman C, Locker D: What dental phobias say about their dental experiences. *J Can Dent Assoc* 56:863-866, 1990.
42. Lytle JJ, Stamper EP: The 1988 survey of the Southern California Society of Oral and Maxillofacial Surgeons. *J Oral Maxillofac Surg* 47:834-842, 1989.
43. Malamed SF: *Sedation: a guide to patient management*, ed 4, St Louis, 2003, Mosby.
44. Martone CH, Nagelhout J, Wolf SM: Methohexital: a practical review for outpatient dental anesthesia. *Anesth Prog* 38:195-199, 1991.
45. McQuay HJ, Carroll D, Moore RA: Postoperative orthopaedic pain—the effect of opiate premedication and local anaesthetic blocks. *Pain* 33:291-295, 1988.
46. Merskey H: Pain terms: a list with definitions and notes on usage. *Pain* 6:249-252, 1979.
47. Milgrom P, Coldwell SE, Getz T, et al: Four dimensions of fear of dental injections. *J Am Dent Assoc* 128:756-762, 1997.
48. Milgrom P, Weinstein P, Kleinknecht R, et al: *Treating fearful dental patients: a patient management handbook*, Reston, VA, 1995, Reston.
49. Mills MP: Periodontal implications: anxiety. *Ann Periodontol* 1:358-389, 1996.
50. Moore PA, Houpt M: Sedative drug therapy in pediatric dentistry. In Dionne RA, Phero JC, editors: *Management of pain and anxiety in dental practice*, New York, 1991, Elsevier Science.
51. Nkansah PJ, Haas DA, Saso JA: Mortality incidence in outpatient anesthesia for dentistry in Ontario. *Oral Surg Oral Med Oral Pathol Oral Radiol Endod* 83:646-651, 1997.
52. Ogawa S, Seino H, Ito H, et al: Intravenous sedation with low-dose dexmedetomidine: its potential for use in dentistry. *Anesth Prog* 55:82-88, 2008.
53. Oei-Lim LB, Vermeulen-Cranch DME, Bouvy-Berends ECM: Conscious sedation with propofol in dentistry. *Br Dent J* 170:340-342, 1991.
54. Pawlicki RE: Psychological/behavioral techniques in managing pain and anxiety in the dental patient. In Dionne RA, Phero JC, editors: *Management of pain and anxiety in dental practice*, New York, 1991, Elsevier Science.
55. Poswillo DE: *General anaesthesia, sedation and resuscitation in dentistry. Report of an expert working party*, London, 1990, Standing Dental Advisory Committee.
56. Rothschild AJ: Disinhibition, amnestic reactions, and other adverse reactions secondary to triazolam: a review of the literature. *J Clin Psychiatry* 53(Suppl):69-79, 1992.
57. Rubin JG, Slovin M, Krochak M: The psychodynamics of dental anxiety and dental phobia. *Dent Clin North Am* 32:647-656, 1988.
58. Schou Olesen A, Hüttel MS: Local reactions to i.v. diazepam in three different formulations. *Br J Anaesth* 52:609-611, 1980.
59. Scott DS, Hirschman R: Psychological aspects of dental anxiety in adults. *J Am Dent Assoc* 104:27-31, 1982.
60. Selzer RR, Rosenblatt DS, Laxova R, et al: Adverse effect of nitrous oxide in a child with 5,10-methylenetetrahydrofolate reductase deficiency. *N Engl J Med* 349:45-50, 2003.
61. Smith TA, Heaton LJ: Fear of dental care: are we making any progress? *J Am Dent Assoc* 134:1101-1108, 2003.
62. Stewart KG, Rowbottom SJ, Aitken AW, et al: Oral ketamine premedication for paediatric cardiac surgery—a comparison with intramuscular morphine (both after oral trimeprazine). *Anaesth Intensive Care* 18:11-14, 1990.
63. Trapp LD: Pharmacologic management of pain and anxiety. In Stewart RE, Barber TK, Troutman KC, et al, editors: *Pediatric dentistry: scientific foundations and clinical practice*, St Louis, 1982, Mosby.
64. Upton LG, Robert RC Jr: Hazard in administering nitrous oxide analgesia: report of case. *J Am Dent Assoc* 94:696-697, 1977.
65. Vaughn RL, Bennett CR: Fentanyl chest wall rigidity syndrome—a case report. *Anesth Prog* 28:50-51, 1981.
66. Weiner AA: Dental anxiety: differentiation, identification and behavioral management. *J Can Dent Assoc* 58:580-585, 1992.
67. Wong MKS, Jacobsen PL: Reasons for local anesthesia failures. *J Am Dent Assoc* 123:69-73, 1992.
68. Woolf CJ, Chong M-S: Preemptive analgesia—treating postoperative pain by preventing the establishment of central sensitization. *Anesth Analg* 77:362-379, 1993.
69. Yagiela JA: Making patients safe and comfortable for a lifetime of dentistry: frontiers in office-based sedation. *J Dent Educ* 65:1348-1356, 2001.

GENERAL REFERENCES

- American Academy of Pediatrics and the American Academy of Pediatric Dentistry: Guideline for monitoring and management of pediatric patients during and after sedation for diagnostic and therapeutic procedures, Adopted 2006. Available at: http://www.aapd.org/media/Policies_Guidelines/G_Sedation.pdf. Accessed January 11, 2010.
- American Dental Association: Guidelines for the use of sedation and general anesthesia by dentists, Adopted 2007. Available at: http://www.ada.org/prof/resources/positions/statements/anesthesia_guidelines.pdf. Accessed January 11, 2010.
- Clark M, Brunick A: *Handbook of nitrous oxide and oxygen sedation*, ed 3, St Louis, 2008, Mosby.
- Dionne RA, Phero JC, Becker DE, editors: *Management of pain and anxiety in the dental office*, Philadelphia, 2002, Saunders.
- Malamed SF: *Sedation: a guide to patient management*, ed 4, St Louis, 2003, Mosby.

Antibiotic Prophylaxis

THOMAS J. PALLASCH

The discussion in this chapter is as evidence-based as possible in a field where evidence established by observational studies and randomized controlled trials is limited or nonexistent and where “expert” opinion has reigned often with total disregard for whatever evidence was available. Antibiotic prophylaxis has often been and is still used to “prevent” accusations that all was not done for the patient, in the hope of thwarting malpractice litigation. This practice has led to a gross overuse of antibiotics for defensive medicine with ensuing adverse effects and increased microbial resistance for which plaintiff’s attorneys have consistently refused to take responsibility. Often the justification for antibiotic prophylaxis to prevent metastatic or surgical infection is based on surrogate markers that do not reflect the true clinical situation. Antibiotic prophylaxis may reduce bacteremias associated with dental treatment, but that is not proof that this also reduces infective endocarditis (IE).⁹³

The 2007 American Heart Association (AHA) Guidelines for the Prevention of Infective Endocarditis have assiduously reviewed all the evidence, particularly the alleged association of dental treatment procedures and IE and the efficacy of antibiotic prophylaxis for prevention of IE along with suitable recommendations based on current evidence.⁹³ Some of that evidence is not repeated in this chapter, and the reader is encouraged to consult the original document.⁹³ Other excellent and exhaustive studies have explored the basis for antibiotic prophylaxis for nonvalvular cardiovascular devices,⁹ prosthetic joints, and other situations associated with controversial antibiotic prophylaxis^{46,56} and, finally, the basis for it all—“the focal infection theory.”⁵⁹

Concerns have been repeatedly expressed about the risk versus benefit for β -lactams as prophylactic agents and the risk of anaphylactic shock,⁵⁸ particularly if antibiotic prophylactic prevention of IE does not work. In addition, data have now appeared showing that surgical prophylaxis in hospitals is associated with increased risk of *Clostridium difficile* infection,¹⁴ and hospital and community use of antibiotics enhances colonization by methicillin-resistant *Staphylococcus aureus*.⁸⁵

PRINCIPLES OF ANTIBIOTIC PROPHYLAXIS

Antibiotic prophylaxis may be indicated if the infection to be prevented is common but not fatal or if it is rare but carries an unacceptably high mortality rate.⁶ The principles of antibiotic prophylaxis were established 30 to 40 years ago but have not often been appreciated.^{52,60,83,90} These principles are as follows: (1) satisfactory risk and cost/benefit ratios should exist in which the benefit to the patient significantly outweighs medical and financial risks, (2) the antibiotic must be

in high concentrations at the target site (blood or tissue) before the onset of the bacteremia or surgery, (3) an antibiotic loading dose (two to four times the maintenance dose) must be used, (4) the antibiotic chosen should be effective against the most likely microorganism to cause the infection, and (5) the antibiotic is continued only as long as microbial contamination of or from the operative site continues.^{58,83,90}

The adverse effects of antibiotic prophylaxis include (1) antibiotic allergy and toxicity, (2) superinfections (onset of a new infection while treating another infection), (3) selection of antibiotic-resistant organisms, and (4) induction of resistance gene transfer.⁵⁶⁻⁵⁸ Contraindications to antibiotic prophylaxis include the following: (1) an at-risk group cannot be sufficiently defined to prevent overuse and abuse of antibiotic prophylaxis, (2) efficacy of prophylaxis is too limited or unreliable, (3) the bacteremia to be prevented is too seldom a cause of infection, and (4) prophylaxis is directed at any and all potential microbial pathogens, rather than the colonization of a single pathogen.^{56,58} Antibiotic prophylaxis is primarily intended for two clinical situations: (1) to prevent metastatic bacteremias and (2) to prevent postsurgical infections. The science to support either of these situations is limited or essentially nonexistent.

PREVENTION OF METASTATIC INFECTIONS

With the advent of the 2007 AHA endocarditis prevention guidelines,⁹³ the guidelines for the prevention of endocarditis of the Working Party of the British Society for Antimicrobial Chemotherapy (BSAC)²⁴ and the guidelines of the National Institute of Health and Clinical Excellence (NICE) of Britain,⁸² the indications for IE prophylaxis have declined to a very few situations or, in the case of the NICE recommendations, to none. Box 49-1 lists these indications according to the AHA. There are none for NICE because this organization could find no evidence for any prophylaxis, including IE. Box 49-2 lists the general conclusions of the AHA, and Box 49-3 lists the cardiovascular and noncardiovascular conditions for which there is no evidence for benefit from antibiotic prophylaxis.

A systematic review of the literature by Lockhart and colleagues⁴⁶ concluded that the evidence for antibiotic prophylaxis is essentially only “expert” opinion (author’s quotation marks) or case studies with general agreement that such prophylaxis is not useful or effective and in some cases potentially harmful. These clinical situations include native heart valves; prosthetic heart valves and pacemakers; hip, knee, and shoulder prosthetic joints; renal dialysis shunts; vascular grafts; immunosuppression secondary to cancer or cancer

BOX 49-1

Recommendations of 2007 American Heart Association Endocarditis Prevention Guideline

Dental Procedures for Which Endocarditis Prophylaxis Is Recommended

All dental procedures that involve manipulation of gingival tissue or the periapical region of the teeth or perforation of the oral mucosa*

Cardiac Conditions Associated with the Highest Risk of Adverse Outcomes from Endocarditis for Which Prophylaxis with Dental Procedures Is Reasonable

- Prosthetic cardiac valves or prosthetic material used for cardiac valve repair
- Previous IE
- CHD[†]
- Unrepaired cyanotic CHD, including palliative shunts and conduits
- Completely repaired congenital heart defect with prosthetic material or device, whether placed by surgery or catheter intervention, during the first 6 months after the procedure[‡]
- Repaired CHD with residual defects at the site or adjacent to the site of a prosthetic patch or prosthetic device (which inhibit endothelialization)
- Cardiac transplant recipients who develop cardiac valvulopathy

Oral Prophylaxis Regimens Before a Dental Procedure in Situations with High Risk

Single dose 30-60 minutes before procedure

	AGENT	ADULTS	CHILDREN	
Oral	Amoxicillin	2 g	50 mg/kg	
Allergic to penicillins or ampicillin	Cephalexin [§] or Clindamycin or Azithromycin or clarithromycin	2 g 600 mg 500 mg	50 mg/kg 20 mg/kg 15 mg/kg	
	Allergic to penicillins or ampicillin and unable to take oral medication	Cefazolin or ceftriaxone or Clindamycin	1 g IM or IV 600 mg IM or IV	50 mg/kg IM or IV 20 mg/kg IM or IV

From Wilson W, Taubert KA, Gewitz M, et al: Prevention of infective endocarditis: guidelines from the American Heart Association. A guideline from the American Heart Association Rheumatic Fever, Endocarditis, and Kawasaki Disease Committee, Council on Cardiovascular Disease in the Young and the Council on Clinical Cardiology, Council on Cardiovascular Surgery and Anesthesia and the Quality Care and Outcomes Research Interdisciplinary Working Group, *Circulation* 116:1736-1754, 2007.

*The following procedures and events do not need prophylaxis: routine anesthetic injections through uninfected tissue, taking dental radiographs, placement of removable prosthodontic or orthodontic appliances, adjustment of orthodontic appliances, placement of orthodontic brackets, shedding of deciduous teeth, and bleeding from trauma to lips or oral mucosa.

[†]Except for the conditions listed, antibiotic prophylaxis is no longer recommended for any other form of CHD.

[‡]Prophylaxis is reasonable because endothelialization of prosthetic material occurs within 6 months after the procedure.

[§]Cephalosporins should not be used in an individual with a history of anaphylaxis, angioedema, or urticaria with penicillins or ampicillin. CHD, Congenital heart disease; IE, infective endocarditis; IM, intramuscular; IV, intravenous.

chemotherapy; systemic lupus erythematosus; and insulin-dependent type 1 diabetes.

A review by Baddour and coworkers⁹ concluded that there is no evidence to support antibiotic prophylaxis before dental treatment for patients with arterial grafts, cardiac pacemakers and implanted defibrillators, Dacron carotid patches, left ventricular assist devices, and peripheral or coronary artery stents. There is still considerable confusion regarding antibiotic prophylaxis before dental treatment in patients with various orthopedic prosthetic devices. The 1997 and 2003 Advisory Statements of the American Dental Association (ADA) and the American Academy of Orthopaedic Surgeons (AAOS) clearly advise that: "Presently no scientific evidence supports the position that antibiotic prophylaxis to prevent hematogenous infections is required prior to dental treatment in patients with total joint prosthesis."^{1,2} The confusion regarding the use of prophylaxis for certain immunocompromised patients and patients less than 2 years after device placement is discussed subsequently.

History of Endocarditis and Antibiotic Prophylaxis

Antibiotic prophylaxis to prevent IE began in 1955 based on some limited animal data, but primarily on the assumption that if antibiotics treat infections, they surely must prevent them. IE prophylaxis arose from the observation that dental treatment was associated with an increase in bacteremia rates, although it was well known at that time that daily living activities also produced bacteremias at roughly the same

intensity as dental treatment. This emphasis on possible prevention was understandable considering that in the preantibiotic era, IE in all its forms (acute, subacute, and chronic) was universally fatal, with the only question being how soon the patient would die.

Currently, most studies on antibiotic prophylaxis given before dental treatment have been shown to reduce, but not eliminate, these bacteremias. It is still unknown how many bacteria (inoculum size) are necessary to induce IE. It was also assumed that if the bacteremias were reduced, endocarditis would be prevented. There have never been any data to support this assumption; however, thousands of lawsuits have been filed alleging negligence against dentists with millions of dollars transferred from them and their insurance carriers to the dental patient allegedly developing IE. This hypothesis was expanded to promote antibiotic prophylaxis to prevent orthopedic joint prosthesis infections. Many other alleged metastatic diseases have supported the 100-year-old observation that: "Previously sclerosed endocarditis was in most cases due to mouth organisms."⁸

This theory that metastatic bacteremias were the cause of anatomically distant diseases was embodied in the focal infection theory. At the turn of the 20th century, the focal infection theory proposed that a focus of infection (a confined area that contained bacteria) disseminated these microorganisms and their products in blood to distant body sites where a new infection arose.⁵⁹ These foci of infection were primarily located in the mouth, tonsils, and gallbladder and were alleg-

BOX 49-2**Conclusions of the American Heart Association****Primary Reasons for Revision of Infective Endocarditis Prophylaxis Guidelines**

IE is much more likely to result from frequent exposure to random bacteremias associated with daily activities than from bacteremia caused by a dental, GI tract, or GU tract procedure.

Prophylaxis may prevent very few cases of IE, if any, in individuals who undergo a dental, GI tract, or GU tract procedure.

The risk of antibiotic-associated events exceeds the benefit, if any, from prophylactic antibiotic therapy.

Maintenance of optimal oral health and hygiene may reduce the incidence of bacteremia from daily activities and is more important than prophylactic antibiotics for a dental procedure to reduce the risk of IE.

Summary of Major Changes in Updated Document

Bacteremia resulting from daily activities is much more likely to cause IE than bacteremia associated with a dental procedure.

Only a very few cases of IE might be prevented by antibiotic prophylaxis even if prophylaxis is 100% effective.

Antibiotic prophylaxis is not recommended based solely on an increased lifetime risk of acquisition of IE.

Recommendations for IE prophylaxis are limited only to the conditions in Box 49-1.

Antibiotic prophylaxis is no longer recommended for any other form of CHD except for the conditions listed in Box 49-1.

Antibiotic prophylaxis is reasonable for all dental procedures that involve manipulation of gingival tissues or periapical region of the teeth or perforation of oral mucosa only for patients with underlying cardiac conditions associated with the highest adverse outcome from IE (see Box 49-1).

From Wilson W, Taubert KA, Gewitz M, et al: Prevention of infective endocarditis: guidelines from the American Heart Association. A guideline from the American Heart Association Rheumatic Fever, Endocarditis, and Kawasaki Disease Committee, Council on Cardiovascular Disease in the Young and the Council on Clinical Cardiology, Council on Cardiovascular Surgery and Anesthesia and the Quality Care and Outcomes Research Interdisciplinary Working Group, *Circulation* 116:1736-1754, 2007.
CHD, Congenital heart disease; GI, gastrointestinal; GU, genitourinary; IE, infective endocarditis.

edly responsible for myriad diseases, including arthritis, neuralgias, myalgias, asthma, cancer, pancreatitis, thyroid disease, and “nervous diseases of all kinds.”⁵⁹ After the loss of millions of teeth, tonsils, and gallbladders, the focal infection theory faded away in the 1930s and 1940s, only to be resurrected today with alleged causation of sarcoidosis, multiple sclerosis, amyotrophic lateral sclerosis, myasthenia gravis, Tourette’s syndrome, and other diseases by focal infections. The “oral-systemic connection” is another resurrection of the focal infection theory with as much “evidence” as in the past but with an ever-expanding group of associated diseases, including cardiovascular disease, preterm birth, diabetes mellitus, and Alzheimer’s disease.⁵⁹

IE is a bacterial or fungal infection of one or more of the cardiac valves (aortic, mitral, tricuspid, or pulmonary) or the mural endocardium. The primary pathology is the formation of valvular vegetations composed of fibrin and platelets resulting from abnormal jets of blood that damage the valves over time and lead to the vegetations, which become infected by microorganisms in the blood (bactere-

BOX 49-3**Medical Conditions for Which No Antibiotic Prophylaxis Is Recommended Before Dental Treatment**

Arterial grafts
Asplenia
Breast and penile implants
Cardiac pacemakers and implanted defibrillators
Cardiac suture pledgets
Cerebrospinal fluid shunts
Collagen and myeloproliferative disorders*
Counterpulsation catheters
Dacron carotid patches
Devices for patent ductus arteriosus, atrial septal defect, ventricular septal defect
Diabetes mellitus
Fen-phen[†] valvulopathy
Hereditary hemorrhagic telangiectasia
Human immunodeficiency virus/acquired immunodeficiency syndrome
Immunosuppression secondary to cancer chemotherapy or cancer
Intra-aortic balloons
Left ventricular assist devices
Orthopedic pins and screws
Orthopedic joint prostheses
Peripheral vascular and coronary artery stents
Renal dialysis shunts
Solid organ transplants without valvulopathy
Total artificial hearts
Vascular closure devices
Venocaval filters

Data from references 9, 46, 56, and 59.

*Systemic lupus erythematosus, Marfan syndrome, Ehlers-Danlos syndrome, Hurler’s syndrome, pseudoxanthoma elasticum, polycythemia vera, essential thrombocytopenia.

[†]Fenfluramine-phentermine.

mias, fungemias). Most IE is caused by staphylococci and streptococci owing to their ability to attach to surfaces using various adhesion molecules.⁹³

The rationale for antibiotic prophylaxis to prevent IE with cardiac valvulopathy has been that (1) certain cardiac defects predispose to endocarditis, (2) most microbes causing IE are susceptible to antibiotics, (3) the risk of bacteremias is increased by certain invasive medical and dental procedures, (4) antibiotic prophylaxis reduces the incidence and magnitude of such bacteremias, and (5) antibiotics prevent bacterial attachment to damaged cardiac valves or their multiplication after they become attached.^{57,58,93} These suppositions remain valid for the greater risk of IE in individuals with damaged cardiac valves, but it is becoming increasingly obvious that routine bacteremic sensitivity to antibiotics is now unlikely, that it does not follow that reducing bacteremias reduces IE, and that bacteremias associated with daily living are much more likely to produce IE than a few dental appointments in a given year. The lack of evidence for dental treatment being the cause of IE, prosthetic joint infections (PJIs), brain abscesses (BAs), and other potentially bacteremic infections has been challenged since the mid-1970s by numerous individuals,⁵⁵ and this has resulted in the new guidelines by the AHA, BSAC, and NICE. Reason and science have finally prevailed after 100 years.

EVIDENCE BASE FOR ANTIBIOTIC PROPHYLAXIS**Data Included in the American Heart Association Guidelines**

The 2007 AHA statement on the prevention of IE has been an extensively reviewed document. Twenty-three members of the Writing Group; several content and foreign reviewers; and all members of the AHA Science and Advisory Group encompassing some 70 experts, including cardiologists, infectious disease specialists, and dentists, were involved. The AHA statement has been endorsed by the American College of Cardiology, the Infectious Diseases Society of America, the American Academy of Dermatology, the American Academy of Pediatrics, the International Society of Chemotherapy for Infection and Cancer, the Pediatric Infectious Disease Society, and the American Dental Association.⁹³ The following discussion summarizes the findings of the AHA and presents relevant data.

An overriding concept that guided the development of the AHA 2007 endocarditis prevention guidelines was that prophylaxis should no longer be based on the lifetime risk of acquiring endocarditis but rather on the highest risk for an adverse outcome from IE. The risk of serious morbidity and higher mortality is much greater in a patient with a prosthetic heart valve than a patient with a bicuspid aortic valve infected with viridans group streptococci (VGS). This greater risk does not mean that antibiotic prophylaxis has a better chance of preventing IE in a patient with a prosthetic valve, only that the pathologic sequelae are greater, and that in the remote chance that prophylaxis would work, it is worth the attempt. This conclusion was based on a thorough review of the literature on IE regarding its etiology, causative factors, pathophysiology, and risk factors for acquisition. Particular emphasis was placed on the role of dental treatment bacteremias in IE causation and the role of antibiotic prophylaxis in its prevention. The document also included a thorough discussion of the various AHA recommendations over the years since 1955 and their progression to the present form.

Essentially, the guidelines state that there is no evidence that antibiotic prophylaxis is effective in preventing IE associated with dental treatment procedures, that the risk of bacteremias from daily living activities is magnitudes greater than that associated with dental treatment, and that such dental treatment procedures are a very small risk for IE. In addition, the guidelines clearly state the following: (1) there is no evidence that the incidence of IE is greater with a higher versus a lower magnitude of bacteremia, (2) the role of the duration of bacteremias is uncertain, (3) a presumed relationship between poor oral hygiene and IE risk is controversial, (4) bleeding from a dental procedure is an unreliable predictor of bacteremia, and (5) no data indicate that a reduction in bacteremia with amoxicillin reduces the risk of or prevents IE. The absolute risk rate for IE from a single dental procedure was between 100,000 and 1 million depending on the type and severity of the cardiac valvular pathology (Box 49-4).^{56,59,93}

The absolute risk rate for endocarditis from a dental treatment procedure is essential to the determination of a risk/benefit assessment of antibiotic prophylaxis to prevent IE.^{56,59} One would need to premedicate 100,000 to 1 million patients to achieve one successful IE prevention, assuming that antibiotic prophylaxis works and dental treatment bacteremias cause 1% of VGS-induced IE (see Box 49-4).⁵⁶ Because the mortality rate from VGS-associated IE is less than 10%, and the rate of anaphylactic death from penicillin is at least 1 per 1 million, it is likely that the risk of death is greater from the prevention than the disease.^{57,87}

In 1975, Podgrell and Welsby⁶⁴ published an estimate of the odds of IE occurring after a single dental procedure as 1 per 140,000. These data remained unappreciated until the

BOX 49-4*Absolute Risk Rate for Various Metastatic Focal Infections From a Single Dental Treatment Procedure***Brain Abscess**

1 per 1 million to 1 per 10 million

Prosthetic Joint Infection

1 per 2.5 million

Infective Endocarditis

If all general population VGS-IE cases were caused by dental treatment: 1 per 143,000

If only 1% of VGS-IE cases were caused by dental treatment: 1 per 14 million

If 1% of VGS-IE cases were caused by dental treatment bacteremias

Risk with previous IE: 1 per 90,000

Risk with cardiac valve prosthesis: 1 per 114,000

Risk with rheumatic heart disease: 1 per 142,000

Risk with congenital heart disease: 1 per 475,000

Risk with mitral valve prolapse with regurgitation: 1 per 1.1 million

Data from references 57, 58, and 93.

IE, Infectious endocarditis; VGS-IE, viridans group streptococci-associated infectious endocarditis.

popularization of evidence-based medicine. More specifically, the concept of absolute risk rates for disease incidence and prevalence determination were used to determine how many in a given population actually get the disease or benefit from its treatment. Steckelberg and Wilson⁷⁸ published the absolute risk rates for IE in individuals with varying severity of cardiac valvular pathology. Using data from the United States about the annual dental visits per year (1.6), the annual incidence of community IE (11,200 cases), and the percent caused by VGS (25%), it was calculated that (1) the risk for VGS-caused IE in the general population, if all were caused by dental treatment-induced bacteremias, is 1 per 142,000 (very close to the Podgrell-Welsby estimate), and (2) if only 1% were caused by dental treatment, the odds were approximately 1 per 14 million.^{56,59}

The risk rate increased substantially depending on the severity of the cardiac pathology using the Steckelberg and Wilson criteria.⁷⁸ The odds for patients with (1) previous endocarditis are 1 per 95,000; (2) heart valve prostheses, 1 per 114,000; (3) rheumatic heart disease, 1 per 142,000; (4) congenital heart disease, 1 per 475,000; and (5) mitral valve prolapse with regurgitation, 1.1 per 1 million.^{56,59,78} It has likewise been calculated that the risk for PJIs from dental treatment was 1 per 2.5 million, and for BAs the odds ranged from 1 per 1 million to 10 million dental procedures.⁵⁸

Another important consideration is the difference between the incidence of oral bacteremias resulting from dental treatment and oral bacteremias resulting from daily living activities (e.g., brushing, flossing, chewing, mastication, bruxing, and water spray devices). In 1984, Guntheroth²⁶ estimated the cumulative time for bacteremias from a single dental extraction was 6 to 30 minutes, but 5370 minutes for bacteremias over 1 month of daily living activities. Roberts⁷⁰ estimated that tooth brushing twice daily for 1 year gave a 154,000 times greater bacteremic exposure than a single tooth extraction exposure and a cumulative yearly risk 5.6 million times from daily living activities versus a single tooth extraction.

BOX 49-5

Relative Bacteremia Incidence with Dental Treatment Bacteremias Versus Activities of Daily Living

Dental Treatment Bacteremias	
Tooth extraction	40-80%
Periodontal surgery	36-88%
Simple prophylaxis	0-40%
Buccal anesthetic injection	16%
Intraligamentous injection	97%
Rubber dam/matrix/wedge	9-32%
Nonsurgical endodontic treatment	0-15%
Activities of Daily Living	
Tooth brushing	0-26%
Dental flossing	20-58%
Wooden cleansing devices	20-40%
Water irrigation devices	7-50%
Mastication	17-51%

From Pallasch TJ: Antibiotic prophylaxis: problems in paradise, *Dent Clin North Am* 47:665-679, 2003.

The data in Box 49-5 on the relative incidence of bacteremias comparing dental procedures versus daily living activities have been available for many years.

A determination of the incubation period for IE (from the onset of the bacteremic event to the onset of signs and symptoms) is important for determination of causation. Only one such study has been performed for enterococci and VGS.⁷⁷ The median incubation period for 77 cases was 5 days for enterococci and 7 days for VGS, with 84% displaying signs and symptoms within 14 days.⁷⁷ The difficulties with this calculation are that the early signs and symptoms of IE are vague and resemble influenza (e.g., fever, chills, night sweats, myalgias, arthralgias) and could be due to a bacteremia occurring days before the dental procedure or some days after.

All of the various IE prevention guidelines stress “good or optimal oral hygiene” as a primary prevention measure, although there are no evidence-based data to support the contention that good oral hygiene reduces the incidence of IE. What constitutes good or optimal oral hygiene has never been defined. It is well established that VGS are antagonistic to periodontopathic microorganisms and that VGS are associated with good oral health.^{29,81} Periodontal disease is not a significant factor in IE causation because only about 120 cases of IE have been associated with periodontal pathogens (i.e., mostly with *Aggregatibacter actinomycetemcomitans*).⁵⁶ Undocumented opinion prevails regarding the role of oral hygiene in IE prevention.

Another difficulty with antibiotic prophylaxis using β -lactam antibiotics is in regard to their mechanism of action. Many studies claim that penicillins given before a bacteremia-producing procedure reduce the bacterial level commonly within seconds to minutes after initiating the procedure. Other studies indicate no significant effect.⁹³ Based on the mechanism of action of β -lactams (slow bacterial killing by inhibition of cell wall synthesis), it is difficult to understand how an antibiotic that kills in hours reduces bacteremias in seconds to minutes.¹⁷ It is also known that many oral bacteria, particularly VGS, are resistant to β -lactams, further compromising the efficacy of antibiotic prophylaxis (see Chapter 39).

The claim that a single dose of antibiotic is not a factor in the global epidemic of microbial resistance to antibiotics ignores the millions of other practitioners who may be doing

the same thing daily for similar reasons around the globe. This prescribing pattern leads to cumulatively millions of unnecessary antibiotic doses annually. This attitude underlies the concept of health care practitioners who tend to focus on the patient in front of them and forget about the effects of their treatment on others whom they may unintentionally harm.

It has been customary to place the entire blame for IE on the bacteria that attach to the damaged cardiac valve and the health practitioners who initiate the bacteremia. It was always an enigma as to why this belief was held to be true because it has been documented that ongoing bacteremias are a way of life for humans—even to the possibility of millions per year.⁷⁰ Yet IE is a very rare disease with an incidence of 11 to 50 per 1 million individuals annually in the United States. One answer often overlooked is the failure of the host defense system of the patient. One of the major defenses against blood-borne bacteria is the blood platelet, which possesses a remarkable ability to kill bacteria in the blood and in or on the cardiac valve vegetation. This antibacterial activity is related to aggregating bacteria to clear them from the blood and the release of microbicidal agents similar to other antimicrobial proteins.^{16,40,95} These platelet antimicrobial proteins are synergistic with penicillins but are antagonized by tetracyclines over a wide range of minimum inhibitory concentrations (0.16 to 1.25 $\mu\text{g/mL}$), as seen with low-dose doxycycline in the treatment of periodontal disease.⁹⁴ It may take a combination of bacteremias, vegetations, and a failure in host platelet antimicrobial defenses to precipitate IE.

When considering the economic impact of antibiotics on IE, it has been estimated that all antibiotic prophylaxis regimens are less cost-effective than clarithromycin, which has a price tag of \$88,007 per quality-adjusted life-year saved.⁸⁵ Other estimates are \$20 million to prevent 35 IE cases with erythromycin in mitral valve prolapse, \$1 million per life saved with penicillin for mitral valve prolapse prophylaxis, and \$96 million to prevent 32 fatal cases of VGS-associated IE or \$300,000 for every nonfatal case assuming a 10% fatality rate using the 1997 AHA guidelines.⁵⁸

The risk/benefit ratio for penicillin prophylaxis in the prevention of IE has always been contentious. Two studies in the 1980s indicated that the mortality from penicillin prophylaxis exceeds that of IE. The risk/benefit ratio for penicillin is favorable only in cases when the highest incidence (50 per 1 million population) and the highest mortality rate (40%) coexist.⁵³ A study by Tzukert and associates⁸⁷ found that 1.36 individuals per 1 million population were likely to die from penicillin anaphylaxis, whereas only 0.26 deaths per 1 million could be ascribed to dental treatment-induced IE. A more recent study calculated that penicillin prophylaxis might prevent 9 cases of IE per 10 million population at moderate to high risk for IE, but would cause 181 penicillin-induced anaphylactic deaths (18 per 1 million).³ According to these studies, penicillin prophylaxis would result in a net loss of life and be unethical. Added to this finding may be the increase in methicillin-resistant *S. aureus* colonization with community and hospital use of antibiotics⁸⁵ and the increase in hospital-acquired *C. difficile* with surgical antibiotic prophylaxis.¹⁴

The diagnosis of IE can be difficult, leading to underdiagnosis with subsequent serious morbidity and mortality and overdiagnosis leading to iatrogenic disease, antibiotic misuse, and malpractice allegations against dentists without merit. Although the incubation period can be useful to rule out causation of IE, a disturbing practice has developed to diagnose IE. On the basis of a self-reported fever, an unconfirmed cardiac murmur, or one or two positive blood cultures, IE has been diagnosed. In 1994, the Endocarditis Service of the Duke University Hospital devised a list of criteria for the diagnosis

BOX 49-6*Modified Duke Criteria for Diagnosis of Infective Endocarditis***Major Criteria**

Blood culture positive for IE

Typical microorganisms consistent with IE from two separate blood cultures: viridans streptococci, *Streptococcus bovis*, HACEK group, *Staphylococcus aureus*, or community-acquired enterococci in the absence of a primary focus, or

Microorganisms consistent with IE from persistently positive blood cultures defined as follows: at least two positive blood samples drawn >12 hours apart or all of three or most of greater than or equal to four separate cultures of blood (with the first and last sample drawn at least 1 hour apart)

Evidence of endocardial involvement

Echocardiogram positive for IE defined as follows: oscillating intracardiac mass on valve or supporting structures in the path of regurgitant jets or on implanted material in the absence of an alternative anatomic explanation; or abscess; or new partial dehiscence of a prosthetic valve—new valvular regurgitation (worsening or changing of preexisting murmur is insufficient)

Minor Criteria

Predisposition: heart condition, intravenous drug use

Fever: temperature >38° C

Vascular phenomena: major arterial emboli, septic pulmonary infarcts mycotic aneurysm, intracranial hemorrhage, conjunctival hemorrhages, Janeway's lesions

Immunologic phenomena: glomerulonephritis, Osler's nodes, Roth's spots, rheumatoid factor

Microbiologic evidence: positive blood culture, but does not meet a major criterion as noted above (excludes single blood cultures for coagulase-negative staphylococci and organisms that do not cause endocarditis), or serologic evidence of active infection with organism consistent with IE

Definition of Infective Endocarditis**Definite Infective Endocarditis**

Pathologic criteria: microorganisms shown by culture of histologic examination of a vegetation, a vegetation that has embolized, or an intracardiac abscess specimen; or vegetation or intracardiac abscess confirmed by histologic examination showing active endocarditis

Clinical criteria: two major criteria; or one major criterion and three minor criteria; or five minor criteria

Possible Infective Endocarditis

One major criterion and one minor criterion; or three minor criteria

Rejected

Firm alternative diagnosis explaining evidence of IE; or

Resolution of IE syndrome with antibiotic therapy for ≤4 days; or

No pathologic evidence of IE at surgery or autopsy, with antibiotic therapy ≤4 days; or

Does not meet criteria for possible IE as listed

From Li JS, Sexton DJ, Mick N, et al: Proposed modifications to the Duke Criteria for the diagnosis of infective endocarditis, *Clin Infect Dis* 30:633-638, 2000. HACEK, *Haemophilus*, *Actinobacillus*, *Cardiobacterium*, *Eikenella*, *Kingella*; IE, infective endocarditis.

of IE based primarily, but not exclusively, on the echocardiogram.¹⁸ This list was later modified with additional criteria and is now known as the Modified Duke Criteria.^{37,42}

The Modified Duke Criteria are often used in research studies to establish a strict case definition of IE because the data accumulated would be worthless and misleading if the disease studied was not IE. These criteria are used far less often in the community and hospital diagnosis of IE. Attempts may be made in the future to assess whether the incidence of IE has increased with the virtual elimination of dental antibiotic prophylaxis to prevent IE. Unless the Modified Duke Criteria (Box 49-6) are used in this analysis, the data generated would greatly overestimate the IE incidence. Because IE has not declined since the advent of antibiotic prophylaxis, such data would require scrutiny and skepticism.

The question has arisen regarding whether the 2007 guidelines, listed in Box 49-1, are indicated for patients with heart murmurs. The simple answer is that heart murmurs do not need premedication with antibiotics. According to the study by Lockhart and colleagues,⁴⁶ only individuals with cardiac transplants require prophylaxis, but it may be wise to consult with the physician to ascertain if other solid organ transplants may also have developed cardiac valvulopathy. In a retrospective study of 1000 patients using M-mode, two-dimensional, and pulsed continuous color Doppler echocardiograms, it was determined that cardiac valve abnormalities greatly increase with age.¹⁵ According to this study, if the 1997 AHA guidelines were used, 30% of individuals younger than age 30, 50% of individuals older than age 60, and 42% of all individuals would have required antibiotic prophylaxis

before dental treatment. If these data are correct, an enormous number of patients "needing" antibiotic prophylaxis according to these guidelines never received it, yet there was no subsequent increase in IE incidence.

In the discussion of antibiotic prophylaxis to prevent metastatic bacteremias, important concepts or data are often overlooked or not fully appreciated. Two studies have published data on bacteremias present before dental treatment. In one study, an 80% incidence of bacteremia (1.5 cfu/mL of blood) was present before dental extraction versus 90% (2.1 cfu/mL of blood) after extraction.³⁰ In the second study, a pre-extraction bacteremia of 31% (3.6 cfu/mL of blood) was present versus 42.9% incidence (5.9 cfu/mL of blood) after extraction.⁴⁷ A reduction in these bacterial counts by prophylaxis is a surrogate marker intended to substitute for the actual clinical end point (IE reduction).^{4,7,65} A randomized trial to determine whether prophylactic antibiotics were effective in preventing IE would require 6000 patients and be prohibitively expensive for a disease that is so rare.⁹³

A reduction in bacteremias alone does not translate to a reduction in IE because it is unknown just how many bacteria (i.e., inoculum size) are required to initiate IE.⁹³ Virtually all studies on the reduction of bacteremias by antibiotic prophylaxis have relied on statistical significance to determine clinical significance. Statistical significance is useful to determine whether the result happens by chance, but this sometimes has only a modest bearing on whether the finding would benefit the patient (i.e., clinical significance). Statistical significance must be placed into perspective with clinical significance for any study.^{4,65,80}

There are some additional items for the clinician to remember concerning the 2007 AHA guidelines.⁹³ First, if antibiotic prophylaxis is inadvertently not administered before dental treatment, it may be given 2 hours after the procedure. The addition of a preprocedural antibacterial mouth rinse has not been proven to be beneficial in the prevention of IE. Lastly, if an antibiotic is used for prophylaxis, that same antibiotic should not be used again unless the next appointment has been scheduled 10 days later. If this cannot be done, another approved antibiotic should be considered.

A final question concerns methods to inform physicians who have been prescribing for a patient who has been taking antibiotic prophylaxis before dental treatment for situations that are no longer recommended by the AHA. These guidelines recommend several talking points, which include the greater risk from random bacteremias than bacteremias associated with dental treatment, the limited or nonexistent efficacy of prophylaxis, its associated adverse effects, and the possible benefits of good oral hygiene.⁹³ Further help in regard to dentist-physician interactions can be found in an article by Brown and associates¹³ that addresses the proper format for the dentist-physician consultation.

POTENTIAL BUT UNDOCUMENTED ANTIBIOTIC PROPHYLAXIS SITUATIONS

Antibiotic prophylaxis has sometimes been recommended for the following clinical situations, but without any randomized controlled trials or observational studies to address efficacy. Currently, there are two case-control studies that evaluate the relationship between dental patient treatment and IE.^{35,84} There are no case-control studies available for the situations listed in Box 49-3. What evidence exists is presented here.

Orthopedic Joint Prostheses

The 1997 and 2003 Advisory Statements of the ADA and the AAOS state: "Presently no scientific evidence supports the position that antibiotic prophylaxis to prevent hematogenous infections is required prior to dental treatment in patients with total joint prostheses."^{1,2} The absolute risk rate for a PJI from a dental treatment procedure has been estimated, in the worst-case scenario, to be 1 per 2.5 million assuming 30 to 40 cases of PJIs per 100,000 person-years (0.03% to 0.04%).^{56,59} No documented case of dental treatment bacteremia infecting a joint prosthesis exists. Four genetically identical *Streptococcus sanguis* organisms, from highly septic oral cavities, were isolated from the mouth and the prosthetic joint, but were unrelated to dental treatment.¹⁰ To place PJIs in added perspective, two studies have determined a 9% and 17% bacterial contamination of the prosthetic joint surgical site before placement,^{5,21} an 11% microbial contamination of allografts of the femoral head,⁸⁹ and a 6.4% to 15% contamination of the surgical blades used in prosthetic joint replacements.⁷¹

The incubation period for PJIs allegedly caused by dental treatment procedures is difficult to determine but is likely considerably longer than that associated with VGS-associated IE. An incubation period of 5 to 60 months (average 31 months) was determined⁵⁰ with the inherent difficulty of determining the precise time of the onset of the bacteremia. Another estimate was 4 to 104 months (average 39 months),⁶⁶ and two cases from *Clostridium perfringens* and *Streptococcus pneumoniae* estimated incubation periods of 10 months (*C. perfringens*) and 7 months (*S. pneumoniae*).⁴⁸ The advantage of these two cases was that the onset of the bacteremia could be precisely determined.

Depending on the particular version of the ADA/AAOS guidelines, it is advised that the practitioner may or should consider antibiotic prophylaxis for certain immunocom-

promised patients, such as patients with systemic lupus erythematosus, drug-induced or radiation-induced immunosuppression, hemophilia, human immunodeficiency virus/acquired immunodeficiency syndrome (HIV/AIDS), insulin-dependent diabetes mellitus, malignancy, malnourishment, and previous PJIs. There are no data to support the contention that the aforementioned patients are at greater risk for PJIs than patients without these disorders.

The ADA/AAOS guidelines have been misinterpreted regarding the 2-year period after prosthetic joint placement, with some advocating mandatory prophylaxis during this period. There is no such admonition in the guidelines. Data from the Mayo Clinic indicate an exponential decline in PJIs over this 2-year period ending in a very low plateau level at about 2 years after placement.⁵⁴ If, despite these data, the practitioner wishes to use antibiotic prophylaxis in such patients, the dose is 2 g of amoxicillin, cephalexin, or cephadrine or 600 mg of clindamycin 1 hour orally before the dental procedure.^{1,2}

A preponderance of evidence supports the premise that antibiotic prophylaxis is not beneficial in preventing hematogenous infections in patients with prosthetic joints. However, in February 2009, the AAOS recommended that antibiotic prophylaxis, prior to any procedure that may cause a bacteremia, is recommended in patients undergoing a joint replacement or with a prosthetic joint.² Even though the position was not based on new data or a cogent rationale, the report from the AAOS stated that "given the potential adverse outcomes and cost of treating an infected joint replacement, the AAOS recommends that clinicians consider antibiotic prophylaxis for all total joint replacement patients prior to any invasive procedure that may cause a bacteremia."²

Breast and Penile Implants

No scientific evidence supports antibiotic prophylaxis before dental treatment for patients with breast^{12,63} or penile implants. The risk of late infections (>7 months after placement) for breast implants is 1 per 10,000.⁶² In a survey of urologists, most believed that prophylaxis before dental treatment was inappropriate.⁴⁴

Brain Abscess

After IE and PJIs, the third metastatic infection likely to involve a dentist in negligence litigation comprises BAs, subdural empyemas, and spinal epidural abscesses. Data show that streptococci are the most likely cause of BAs and that most occur in the frontal and temporal lobes supplied by the middle cerebral artery. Microbes can reach the brain by direct contiguous spread (sinuses, middle ear), via head trauma, or via blood (hematogenous). Microbial penetration into the brain past the blood-brain barrier may occur by three mechanisms: (1) transcellularly (e.g., streptococci, *Escherichia coli*, *Neisseria meningitidis*, *Candida* species), (2) paracellularly (e.g., *Borrelia* species, trypanosomes), and (3) via "Trojan Horses" within infected phagocytes (e.g., *Listeria monocytogenes* and *Mycobacterium tuberculosis*).³⁴ The oral cavity is not the most likely source of BA because otitis media and sinusitis account for 50% to 60% of BAs in the United States, with 20% having no known source.^{58,59}

VGS are found in BAs attributed to other anatomic sources, such as otitis media/mastoiditis (23.3%), sinusitis (15.7%), and hematogenous (10%).⁵⁸ It is often unappreciated that VGS are ubiquitous microorganisms found commonly not only in the oral cavity, but also in the gastrointestinal and genitourinary tracts, skin, mucosa, and eye owing to their ability to stick to surfaces and their survivability in various environments.

BAs are very rare and are diagnosed at a rate of 1 per 10,000 hospital admissions with an absolute risk rate for

dental treatment association of 1 per 1 million to 1 per 10 million.⁵⁸ The incubation period for BAs is approximately 16 to 18 days with a mean time to hospitalization of 12 days. The mean time from onset of bacteremia to diagnosis and hospitalization is approximately 30 days.⁵⁶

It is occasionally alleged that epidural abscesses and subdural empyemas are caused by oral streptococci from dental treatment procedures. Historically, the incidence of spinal epidural abscesses has been similar to BAs at 0.2 to 1.2 to 3 per 10,000 hospital admissions.⁷⁴ The microbial etiology of epidural abscesses includes staphylococci (57% to 93%), streptococci (18%), and gram-negative organisms (13%) as determined in 830 patients.²⁵ Subdural empyema is usually attributed to sinusitis, meningitis, or trauma or surgery.⁵³ Possibly 1% of subdural empyemas are of oral microbial origin, and the etiology is often polymicrobial, which includes staphylococci, streptococci, and various anaerobes.³⁸

Hereditary Hemorrhagic Telangiectasia

Hereditary hemorrhagic telangiectasia is an autosomal dominant disorder characterized by abnormal vascular development; nosebleeds and telangiectasia at multiple sites (lips, oral cavity, nose); and a family history of arteriovenous malformations of the lungs, liver, brain, spine, and gastrointestinal tract.^{75,86} The prevalence of the disorder is 1 per 5000 to 1 per 8000 individuals,⁷⁶ and it predisposes to BAs and ischemic stroke because of bypassing of the blood filtering system of the pulmonary capillaries, blood hypoxia, or infection of a previously sterile embolus.⁷⁶

Two more recent studies have examined the incidence of BAs in patients with hereditary hemorrhagic telangiectasia with regard to microbial etiology.^{73,76} One recommended antibiotic prophylaxis before dental treatment without addressing the AHA data on antibiotic prophylaxis or BA data.⁷⁶ Sell and coworkers⁷³ examined 55 cases with 15 caused by various streptococci, which included 9 by peptostreptococci (*Micromonas micros*), 3 by *Fusobacterium* species, 2 by *Actinomyces* species, and 1 by *Capnocytophaga* species. The authors did not recommend antibiotic prophylaxis. Shovlin and colleagues⁷⁶ examined 210 cases including 57 experiencing either BA or ischemic stroke between the ages of 9 and 70 years (9.05% over this time period). The time from the alleged onset of dental treatment-induced bacteremia to diagnosis was "weeks." Antibiotic prophylaxis before dental treatment in patients with hereditary hemorrhagic telangiectasia cannot be recommended on an evidence-based approach.

Nonvalvular Cardiovascular Devices

The issue of whether bacteremias from dental treatment are responsible for infections of various nonvalvular cardiovascular devices has been addressed with literature reviews by Baddour and associates⁹ and Lockhart and colleagues⁴⁶ and subsequent studies.²³ No relationship between VGS bacteremias and infections has been shown in these patients (see Box 49-6).

Hemodialysis

No observational or randomized controlled studies have been done to determine if antibiotic prophylaxis in patients on hemodialysis or with indwelling catheters results in IE. Lockhart and colleagues⁴⁶ found no correlation with dental procedures in such patients. In a study of long-term hemodialysis patients from 1983-1997, 20 cases of IE occurred in 1559 patients, with 3 attributed to VGS.⁴⁹ In 1445 patients receiving long-term hemodialysis, 63 cases of bacteremia were detected (0.7 per 100 patient-months), with 2 associated with VGS.²⁸ Virtually all IE cases were caused by staphylococci.^{9,46}

Splenectomy

Individuals without spleens have a small but significant life-long susceptibility to infection, particularly with *S. pneumoniae*, *Haemophilus influenzae*, and *N. meningitidis*. None of these are typical oral flora. In 5902 cases of post-splenectomy infection, 0.8% were caused by VGS.³¹ In 77 more recent cases, none were caused by VGS.⁹¹

Solid Organ Transplants

Antibiotic prophylaxis for the prevention of IE in patients with solid organs transplants is not generally recommended because no study has determined that such patients are at risk for bacteremic infections,⁶¹ but the AHA recommends prophylaxis for cardiac transplant patients who develop cardiac valvulopathy.⁹³ The AHA guidelines do not address valvulopathy and prophylaxis in patients with other solid organ transplants. Patients with liver, pancreas, kidney, and other solid organ transplants have a tendency to develop marantic valve lesions (nonbacterial thrombotic endocarditis) similar to that seen in patients with systemic lupus erythematosus.⁷⁹ A medical consultation may be called for to determine if marantic lesions are present.

Diabetes Mellitus

No data support the use of antibiotic prophylaxis in diabetic dental patients.⁴⁶ Only 2% of surveyed infectious disease specialists would recommend prophylaxis before dental treatment in patients with poorly controlled diabetes.⁴⁵

Immunocompromised Patients

Dental patients with a suppressed granulocyte count of 500 to 1000 have been suggested to be at risk for bacteremia-related infections, but there are no evidence-based studies to support this contention. In patients with bone marrow transplants, the greatest risk for VGS infections is in the early stages and is proportional to the magnitude of the oral mucositis present.^{20,88} Severely neutropenic patients should receive only emergency dental care. Dental patients with HIV/AIDS are not at greater risk for IE or its complications.^{56,69} Intravenous drug users have an IE rate of 3.8 per 1000 if HIV-negative and 13.8 per 1000 if HIV-positive.²² The microorganisms involved are virtually all commensals, and greater than 70% of cases involve the tricuspid valve with a 5% mortality rate.^{22,41} The question of antibiotic prophylaxis for patients with head and neck radiation to prevent osteoradionecrosis has never been settled. A review by Wahl⁹² found no evidence that prophylaxis prevents osteoradionecrosis infections. If antibiotic prophylaxis is used, there is no consensus regarding the drug, dose, timing, or duration.³³

Collagen and Myeloproliferative Disorders

Many patients with collagen or myeloproliferative disorders are at risk for developing cardiac valvular disorders, which include systemic lupus erythematosus, Marfan syndrome, Ehlers-Danlos syndrome, Hurler's syndrome, pseudoxanthoma elasticum, polycythemia vera, and essential thrombocytopenia.^{67,68} The valvular damage is usually of the Libman-Sacks type (e.g., marantic, nonbacterial thrombotic vegetations), which then may become infected. Libman-Sacks/marantic endocarditis may also be seen in patients with cancer, burns, septicemia, disseminated intravascular coagulation, rheumatoid arthritis, and primary antiphospholipid syndrome.

DENTAL SURGICAL PROPHYLAXIS

More recent systematic reviews and meta-analyses strongly suggest that antibiotic prophylaxis after dental treatment is

ineffective in preventing infection or other postoperative complications.^{68,72} Such an approach violates the principles of antibiotic prophylaxis established more than 40 years ago, which require an antibiotic be in the target site (blood or tissues) before the bacteremia or surgery for it to be successful.^{60,83,90}

More recent studies are now beginning antibiotic prophylaxis 1 hour before the surgery and terminating the antibiotic at the end of the surgery because the risk of postoperative infection greatly increases if the prophylaxis is continued more than 1 to 2 days after the surgery.⁶⁰ Most of these studies done to date have shown no benefit,^{11,27,32,43,72} with one meta-analysis indicating the number needed to treat (NNT) to prevent one alveolar osteitis or infection was 13 to 25 patients.⁶⁸ In a meta-analysis of local antibiotics or antiseptics to prevent localized osteitis, the antibiotic judged best was tetracycline with NNT of 3 to 8 to prevent 1 localized osteitis, and the antiseptic was chlorhexidine with NNT of 4 to 36 to prevent 1 localized osteitis.²⁷

All these meta-analyses suggest that these studies on antibiotic prophylaxis for the prevention of oral surgical infections primarily in third molar extractions were poorly performed with none meeting the strict criteria of the Cochrane Research Group.^{39,68,72} In general, these studies had limited value because of (1) small sample sizes with limited power, (2) lack of comparison groups, (3) no monitoring of patient compliance with the antibiotic protocol, and (4) poor monitoring of the interventions.

It is also difficult to support dental surgical antibiotic prophylaxis based on biologic plausibility and the increasing incidence and prevalence of microbial resistance to antibiotics. All postoperative infections in dentistry are polymicrobial, and one of the tenets of antibiotic prophylaxis is to direct it toward the most likely microorganism to cause the infection.^{60,90} Antibiotic prophylaxis has been documented to be effective only for the prevention of surgical infections in clean-clean and some clean-contaminated surgeries. With an estimated 700 potential pathogens in the oral cavity, it hardly qualifies as a "clean" operating area. In addition, oral microorganisms show a 20% to 40% resistance rate to common antibiotics, and orofacial infections are rarely life-threatening. More recent data on the increased colonization rates with methicillin-resistant *S. aureus* on antibiotic exposure⁸⁵ and the increase in *C. difficile* infections associated with hospital antibiotic prophylaxis¹⁴ must now be added to the risk/benefit calculation for dental surgical antibiotic prophylaxis.

FUTURE OF ANTIBIOTIC PROPHYLAXIS

There is an old adage that new scientific theories go through three phases on the road to acceptance: (1) the theory is not true; (2) the theory is true but unimportant; and (3) the theory is true and it is important, but we knew it all along.¹⁹ Relying on current evidence-based science, it is now established that bacteremias from dental treatment are rarely, if ever, a cause of IE, PJIs, and myriad other systemic disorders. The future use of antibiotic prophylaxis should be restricted to the AHA guidelines for IE prevention and surgical prophylaxis in the hospital environment.

In the future, evaluations of IE associated with dental treatment cannot rely solely on hospital discharge records because of potential errors (e.g., 28% to 45% of death certificates incorrectly identify the cause of death) in discharge records.^{36,51} To ascertain the true number of IEs associated with any procedure, the strict case definition of the Modified Duke Criteria must be used.

CITED REFERENCES

1. Advisory statement. Antibiotic prophylaxis for dental patients with total joint replacements. *J Am Dent Assoc* 134:895-899, 2003.
2. Advisory statement. American Academy of Orthopaedic Surgeons. Antibiotic prophylaxis for bacteremia in patients with joint replacements. Available at: <http://www.aaos.org/about/papers/advistmt/1033.asp>. Accessed January 25, 2010.
3. Agha Z, Lofgren RP, Van Ruiswyk JV: Is antibacterial prophylaxis for bacterial endocarditis cost effective? *Med Decision Making* 25:308-320, 2005.
4. Akobeng AK: Understanding measures of treatment effect in clinical trials. *Arch Dis Child* 90:54-56, 2005.
5. Al-Maiyah M, Hill D, Baywa A, et al: Bacterial contaminants and antibiotic prophylaxis in total hip arthroplasty. *J Bone Joint Surg* 87B:1256-1258, 2005.
6. Antibiotic prophylaxis in surgery. *Med Lett Drugs Therap* 35:91-94, 1996.
7. Aronson JK: Biomarkers and surrogate endpoints. *Br J Clin Pharmacol* 59:491-494, 2005.
8. Ashrafian K, Bogle RG: Antibiotic prophylaxis for surgery: emotion or science? *Heart* 93:5-6, 2007.
9. Baddour LM, Bettman MA, Bolger AF, et al: Nonvalvular cardiovascular device-related infections. *Circulation* 108:2015-2031, 2003.
10. Bartzokas CA, Johnson R, Jane M, et al: Relation between mouth and haematogenous infection in total joint replacements. *BMJ* 309:506-508, 1994.
11. Bergdahl M, Hedstrom I: Metronidazole for the prevention of dry socket after removal of partially impacted mandibular third molars: a randomized controlled trial. *Br J Oral Maxillofac Surg* 42:55-58, 2004.
12. Brand KG: Infection of mammary prostheses: a survey and question of prevention. *Ann Plast Surg* 30:289-295, 1993.
13. Brown RS, Farquharson AA, Pallasch TJ: Medical consultations for medically complex dental patients. *Calif Dent Assoc J* 35:343-349, 2007.
14. Carignan A, Allard C, Pepin J, et al: Risk of *Clostridium difficile* infection after perioperative antibacterial prophylaxis before and during an outbreak due to a hypervirulent strain. *Clin Infect Dis* 46:1838-1843, 2008.
15. Croft LB, Donnino R, Shapiro R, et al: Age-related prevalence of cardiac valvular abnormalities warranting infectious endocarditis prophylaxis. *Am J Cardiol* 94:386-389, 2004.
16. Dankert J, Krigsveld J, Van Der Werff J, et al: Platelet microbicidal activity is an important defense factor against viridans streptococcal endocarditis. *J Infect Dis* 184:597-605, 2001.
17. Drusano GL: Antimicrobial pharmacodynamics: critical interactions of "bug" and "drug." *Nat Rev Microbiol* 2:289-300, 2004.
18. Durack DT, Lukes AS, Bright DK; Duke Endocarditis Service: New criteria for diagnosis of infective endocarditis: utilization of specific echocardiographic findings. *Am J Med* 96:200-209, 1994.
19. Editorial: False, trivial, obvious: why new and revolutionary theories are typically disrespected. *Med Hypotheses* 71:1-3, 2008.
20. Emmanouilides C, Glaspy J: Opportunistic infections in oncologic patients. *Hematol/Oncol Clin North Am* 10:841-860, 1996.
21. Gill GS, Mills DM: Long-term follow-up evaluation of 1000 consecutive total knee arthroplasties. *Clin Orthop Rel Res* 273:66-76, 1991.
22. Gordon RL, Lowy FD: Bacterial infections in drug users. *N Engl J Med* 353:1945-1954, 2005.
23. Gordon RJ, Quagliarello B, Lowy FD: Ventricular assist device-related infections. *Lancet Infect Dis* 6:426-437, 2006.
24. Gould FK, Elliott TSJ, Fowleraker J, et al: Guidelines for the prevention of infective endocarditis: report of the Working Party of the British Society for Antimicrobial Chemotherapy. *J Antimicrob Chemother* 57:1035-1042, 2006.
25. Grewal D, Hocking G, Wildsmith JAW: Epidural abscess. *Br J Anaesth* 96:292-302, 2006.
26. Guntheroth WG: How important are dental procedures as a cause of infective endocarditis? *Am J Cardiol* 54:797-801, 1984.
27. Hedstrom L, Sjogren P: Effect estimates and methodological quality of randomized controlled trials about prevention of alveo-

- lar osteitis following tooth extraction: a systematic review. *Oral Surg Oral Med Oral Pathol Oral Radiol Endod* 103:8-15, 2007.
28. Hessler M, Hoen B, Mayeux B: Bacteremia in patients on chronic hemodialysis: a multicenter prospective study. *Nephron* 64:95-100, 1993.
 29. Hillman JD, Socransky SS, Shivers M: The relationship between streptococcal species and periodontopathic bacteria in human dental plaque. *Arch Oral Biol* 30:791-793, 1985.
 30. Hockett RN, Loesche WJ, Sodeman TM: Bacteremias in asymptomatic subjects. *Arch Oral Biol* 22:91-98, 1972.
 31. Holdsworth RJ, Irvins AD, Cuschieri A: Postsplenectomy sepsis and its mortality rate: actual versus perceived risks. *Br J Surg* 78:1031-1035, 1991.
 32. Kaczmarzyk T, Wicklinski J, Stypulowska J, et al: Single-dose and multiple-dose clindamycin therapy fails to demonstrate efficacy in preventing infectious and inflammatory complications in third molar surgery. *Int J Oral Maxillofac Surg* 36:417-422, 2007.
 33. Kanatas AN, Rogers SN, Martin MV: The antibiotic prescription habits of consultants on postradiotherapy: a survey of antibiotic prescribing of maxillofacial consultants for dental extractions following radiotherapy to the oral cavity. *Br Dent J* 192:157-160, 2002.
 34. Kim KS: Mechanisms of microbial transversal of the blood-brain barrier. *Nat Rev Microbiol* 6:625-634, 2008.
 35. Lacassin F, Hoen B, Leport C, et al: Procedures associated with infective endocarditis in adults: a case control study. *Eur Heart J* 16:1968-1974, 1995.
 36. Lakkireddy DR, Gowda MS, Murray CW, et al: Death certificate completion: how well are physicians trained and are cardiovascular causes overestimated? *Am J Med* 117:492-498, 2004.
 37. Lamas CC, Eykyn SJ: Suggested modifications to the Duke Criteria for the clinical diagnosis of native valve or prosthetic valve endocarditis: analysis of 118 pathologically proven cases. *Clin Infect Dis* 25:713-719, 1997.
 38. Laupland KB: Vascular and parameningeal infections of the head and neck. *Infect Dis Clin North Am* 21:577-590, 2007.
 39. Lawler B, Sambrook PJ, Gloss AN, et al: Antibiotic prophylaxis for dental surgery: is it indicated? *Austral Dent J* 50(Suppl 2):S54-S59, 2005.
 40. Lee SY, Choe S-J: Penicillin-induced killing and postantibiotic effect in oral streptococci are enhanced by platelet microbicidal proteins. *Int J Antimicrob Agents* 23:457-461, 2004.
 41. Levine DP, Crane LR, Zervac MJ: Bacteria in narcotic addicts at Detroit Medical Center, II: infective endocarditis: a prospective comparative study. *Rev Infect Dis* 18:374-396, 1986.
 42. Li JS, Sexton DJ, Mick N, et al: Proposed modifications to the Duke Criteria for the diagnosis of infective endocarditis. *Clin Infect Dis* 30:633-638, 2000.
 43. Lindeboom JAH, Frenken JWAH, Valkenberg P, et al: The role of perioperative prophylactic antibiotic administration in periapical endodontic surgery: a randomized prospective double-blind placebo-controlled study. *Int Endod J* 38:877-881, 2005.
 44. Little JW, Rhodus NI: The need for antibiotic prophylaxis of patients with penile implants during invasive dental procedures: a national survey of urologists. *J Urol* 148:1801-1804, 1992.
 45. Lockhart PG, Brennan MT, Fox PC, et al: Decision making and the use of antimicrobial prophylaxis for dental procedures: a survey of infectious disease consultants and review. *Clin Infect Dis* 34:1621-1626, 2002.
 46. Lockhart PB, Loven B, Brennan MT, et al: The evidence base for the efficacy of antibiotic prophylaxis in dental practice. *J Am Dent Assoc* 138:458-474, 2007.
 47. Lucas VS, Lytra V, Hassan T, et al: Comparison of lysis filtration and an automated blood culture system (BACTEC) for detection, quantification and identification of odontogenic bacteremia in children. *J Clin Microbiol* 40:3416-3420, 2002.
 48. Maniloff G, Greenwald R, Laskin R, et al: Delayed postbacteremic prosthetic joint infections. *Clin Orthop Rel Res* 223:194-197, 1987.
 49. McCarthy JT, Stekelberg JM: Infective endocarditis in patients receiving long-term hemodialysis. *Mayo Clin Proc* 75:1008-1014, 2000.
 50. McGowan DA, Hendry JM: Is antibiotic prophylaxis required for dental patients with joint replacements? *Br Dent J* 158:336-338, 1985.
 51. Nashelsky MB, Lawrence CH: Accuracy of cause of death determination without forensic autopsy examination. *Am J Forensic Med Pathol* 24:313-319, 2003.
 52. Neu HC: Prophylaxis—has it at last come of age? *J Antimicrob Chemother* 5:331-333, 1979.
 53. Osborn MK, Steinberg JP: Subdural empyema and other suppurative complications of paranasal sinusitis. *Lancet Infect Dis* 7:62-67, 2007.
 54. Osmon DR: Antibiotic prophylaxis in adults. *Mayo Clin Proc* 75:98-109, 2000.
 55. Pallasch TJ: Perspectives on the 2007 AHA endocarditis prevention guidelines. *Calif Dent Assoc J* 35:507-513, 2007.
 56. Pallasch TJ: Antibiotic prophylaxis: problems in paradise. *Dent Clin North Am* 47:665-679, 2003.
 57. Pallasch TJ: A critical appraisal of antibiotic prophylaxis. *Int Dent J* 39:183-196, 1989.
 58. Pallasch TJ, Slots J: Antibiotic prophylaxis and the medically compromised patient. *Periodontol* 2000 10:107-128, 1996.
 59. Pallasch TJ, Wahl MJ: Focal infection: new age or ancient history? *Endod Topics* 4:323-345, 2003.
 60. Paluzzi RG: Antibiotic prophylaxis for surgery. *Med Clin North Am* 77:427-441, 1993.
 61. Paterson DL, Dominguez FDA, Chang FY, et al: Infective endocarditis in solid organ transplant recipients. *Clin Infect Dis* 26:689-6934, 1998.
 62. Peri WA Jr: Infections in breast transplant recipients. *Clin Infect Dis* 18:141-148, 1994.
 63. Pittet B, Moutandon D, Pittet D: Infection in breast implants. *Lancet Infect Dis* 5:94-106, 2004.
 64. Podgell MA, Welsby PD: The dentist and prevention of infective endocarditis. *Br Dent J* 139:112-116, 1975.
 65. Poole C: Low P-values or confidence intervals: which are more durable? *Epidemiology* 12:291-294, 2001.
 66. Poss R, Thornhill TS, Ewald FC, et al: Factors influencing the incidence and outcome of infection following total joint arthroplasty. *Clin Orthop Rel Res* 182:117-126, 1984.
 67. Reiser SA, Rinkevich D, Mariewicz W, et al: Cardiac involvement in patients with myeloproliferative disorders. *Am J Med* 93:498-504, 1992.
 68. Ren Y-F, Malmstrom HS: Effectiveness of antibiotic prophylaxis in third molar surgery: a meta-analysis of randomized controlled trials. *J Oral Maxillofac Surg* 65:1909-1921, 2007.
 69. Ribera E, Miro JM, Cortes E, et al: Influence of human immunodeficiency virus I infection and degree of immunodeficiency characteristics and outcome of infective endocarditis in intravenous drug users. *Arch Intern Med* 158:2043-2050, 1998.
 70. Roberts GJ: Dentists are innocent! "Everyday" bacteremia is the real culprit: a review and assessment of the evidence that dental surgical procedures are principal causes of bacterial endocarditis in children. *Pediatr Cardiol* 20:317-325, 1999.
 71. Schindler OS, Spencer RF, Smith MD: Should we use a separate knife for the skin? *J Bone Joint Surg* 88B:382-385, 2006.
 72. Schwartz AB, Larson EL: Antibiotic prophylaxis and postoperative complications after tooth extraction and implant placement: a review of the literature. *J Dent* 35:881-888, 2007.
 73. Sell B, Evans J, Horn B: Brain abscess and hereditary telangiectasia. *South Med J* 101:616-618, 2008.
 74. Sendi P, Bregenzer T, Zimmerli A: Spinal epidural abscess in clinical practice. *QJM* 101:1-12, 2008.
 75. Shovlin CL, Guttmacher AE, Buscarini E, et al: Diagnostic criteria for hereditary hemorrhagic telangiectasia (Rendu-Osler-Weber syndrome). *Am J Med Genet* 91:66-67, 2000.
 76. Shovlin CL, Jackson JE, Bamford KB, et al: Primary determinants of ischaemic stroke/brain abscess risk are independent of severity of pulmonary arteriovenous malformations in hereditary hemorrhagic telangiectasis. *Thorax* 63:259-266, 2000.
 77. Starkbaum M, Durack D, Beeson P: The "incubation period" for subacute bacterial endocarditis. *Yale J Biol Med* 50:49-58, 1977.
 78. Steckelberg JM, Wilson WR: Risk factors for infective endocarditis. *Infect Dis Clin North Am* 7:9-19, 1993.
 79. Steiner I: Nonbacterial thrombotic versus infective endocarditis: a necropsy study of 320 cases. *Cardiovasc Pathol* 4:207-208, 1995.
 80. Sterne JAC, Davey Smith G, Cox DR: Sifting the evidence—what's wrong with significance tests? *BMJ* 322:226-231, 2001.

81. Stingu C-S, Eschrich K, Rodloff AC, et al: Periodontitis is associated with loss of colonization of *Streptococcus sanguis*. *J Med Microbiol* 57:495-499, 2008.
82. Stokes T, Ritchey R, Wrayon D: Prophylaxis against infective endocarditis: summary of the NICE guidelines. *Heart* 94:930-931, 2008.
83. Stone HH: Basic principles in the use of antibiotic prophylaxis. *J Antimicrob Chemother* 14:33-37, 1981.
84. Strom BL, Abrutyn E, Berlin JA, et al: Dental and cardiac risk factors for infective endocarditis: a population based, case-control study. *Ann Intern Med* 120:761-769, 1998.
85. Tacconelli E, De Angelis G, Cataldo MA, et al: Does antibiotic exposure increase the risk of methicillin-resistant *Staphylococcus aureus* (MRSA) isolation? A systematic review and meta-analysis. *J Antimicrob Chemother* 61:26-38, 2008.
86. teVeldhuis EC, teVeldhuis AH, van Dijk FS, et al: Rendu-Osler-Weber disease: update of medical and dental considerations. *Oral Surg Oral Med Oral Pathol Oral Radiol Endod* 105:e38-e41, 2008.
87. Tzukert AA, Leviner E, Benoliel R, et al: Analysis of the American Heart Association's recommendations for the prevention of infective endocarditis. *Oral Surg Oral Med Oral Pathol* 62:276-279, 1986.
88. van Burik JAK, Wesendorf DJ: Infections in recipients of blood and bone marrow transplantations. *Hematol/Oncol Clin North Am* 13:1005-1009, 1999.
89. van de Pol GJ, Stunn PDJ, van Loon CJ, et al: Microbiological cultures of allografts of the femoral head just before transplantation. *J Bone Joint Surg* 89B:1225-1228, 2007.
90. Waddell TK, Rotstein OD; Committee on Antimicrobial Agents, Canadian Infectious Disease Society: Antimicrobial prophylaxis in surgery. *CMAJ* 151:925-931, 1994.
91. Waghorn DJ: Overwhelming infection in asplenic patients: current best practice preventive measures are not being followed. *J Clin Pathol* 54:214-218, 2001.
92. Wahl MJ: Osteoradionecrosis prevention myths. *Int J Radiat Oncol Biol Physics* 64:661-669, 2006.
93. Wilson W, Taubert KA, Gewitz M, et al: Prevention of infective endocarditis: guidelines from the American Heart Association. A guideline from the American Heart Association Rheumatic Fever, Endocarditis, and Kawasaki Disease Committee, Council on Cardiovascular Disease in the Young and the Council on Clinical Cardiology, Council on Cardiovascular Surgery and Anesthesia and the Quality Care and Outcomes Research Interdisciplinary Working Group. *Circulation* 116:1736-1754, 2007.
94. Xiong Y-O, Yeaman MR, Bayer AS: In vitro antibacterial activities of platelet microbicidal protein and neutrophil defensin against *Staphylococcus aureus* are influenced by antibiotics differing in mechanisms of action. *Antimicrob Agents Chemother* 443:1111-1117, 1999.
95. Yeaman MR: The role of platelets in antimicrobial host defense. *Clin Infect Dis* 25:951-970, 1997.

Oral Complications of Cancer Therapy

RAJESH V. LALLA, MICHAEL T. BRENNAN, AND MARK M. SCHUBERT

The management of cancer has become increasingly complex with the use of more aggressive chemotherapy and radiation protocols, plus the expanded application of combination protocols. Such protocols include several modalities of treatment including surgery, chemotherapy, radiation therapy, and newer immune-mediated treatments. The result is the opportunity for increased disease control and cure. Protocols that use high-dose regimens of chemotherapy, or chemotherapy combined with radiation therapy followed by hematopoietic cell transplantation (HCT), are also increasingly being used to treat many cancers.

These various advances in cancer therapy are lifesaving, but often have significant morbidity and complications. Considerable attention is now being paid to the medical significance of complications of cancer therapy and the effects these complications have on quality of life. Studies have shown that the oral complications of cancer therapy can significantly interfere with the course of cancer therapy, adversely affect general quality of life, and increase the cost of care.⁷⁸ In addition, a number of chronic orofacial complications can significantly affect long-term quality of life and oral function after cancer therapy. Successful prevention and treatment of the oral complications of cancer therapy can reduce pain, suffering, and disability while decreasing the risk of complications that may interfere with ongoing cancer therapy or result in lifelong functional compromise.

The oral complications of chemotherapy and radiation therapy are similar in many respects, but some complications are unique to the specific treatment modality. Both treatment approaches cause oral mucositis, taste dysfunction, and salivary gland dysfunction. A significant difference exists between the two modalities relative to whether the toxicity is transient (i.e., during chemotherapy) or progressive and permanent (as is often the case with radiation therapy). Because cancer chemotherapy is predominantly administered systemically, systemic toxicities can increase the risk of oral complications (e.g., myelosuppression resulting in oral infection and bleeding). In contrast, the effects of radiation are primarily limited to the irradiated tissues.

ORAL COMPLICATIONS OF CHEMOTHERAPY

In general, the therapeutic effects and toxicities of cancer chemotherapy arise from damage to rapidly dividing cancer and normal cells. Only a few anticancer agents can specifically target cancer cells. Consequently, most cancer chemotherapeutic agents inadvertently damage normal tissues of the body. Because the growth fraction for cancer is usually much higher than most normal tissue compartments, there is a quantitative difference in damage to the cancer cells compared

with normal cells. Although systemic toxic effects of cancer chemotherapy usually result from damage to rapidly dividing cells, some toxicities result from damage that is not specifically related to cell division (Box 50-1).

Oral complications of cancer therapy may result directly from the cytotoxic effects (direct toxic effects) of the drugs on oral tissues (including salivary glands) or result from therapy involving distant tissues (indirect toxic effects). The clinical presentation of complications generally represents the results of complex interactions among multiple factors. These oral complications are listed in Box 50-2.

A number of factors affect the clinical expression of oral toxic effects of chemotherapy, the most prominent being which chemotherapeutic agent is administered along with its dose and schedule. The high turnover rate of oral mucosal tissues puts them at risk for the cytotoxic effects of many antineoplastic agents. Direct mucosal damage may be accentuated by many factors, including (1) salivary gland dysfunction, which compromises the barrier and lubricating functions provided by saliva; (2) mucosal trauma or irritation (e.g., from normal oral function, medications, and mouth breathing); and (3) infections caused by indigenous oral flora (especially opportunistic oral pathogens), acquired pathogens, and the reactivation of latent herpesviruses that cause local and systemic complications in patients who become immunosuppressed.⁶²

Direct Oral Toxic Effects

Oral mucositis

The terms *oral mucositis* and *stomatitis* were often used interchangeably in the past, but they do not reflect identical processes. *Stomatitis* is a more general term and is applied to any inflammatory condition of the oral tissues, regardless of cause, including infections and autoimmune disorders. The term *oral mucositis* is increasingly being applied to inflammation and breakdown of the oral mucosa resulting from damage caused by chemotherapeutic agents or radiation therapy.⁶⁴ *Oral mucositis* is the preferred term to represent the direct mucosal toxicity of cancer therapies on oral mucosal tissues.

Epidemiology. Oral mucositis is a significant problem in patients receiving chemotherapy for solid tumors. In one study, 303 of 599 (51%) patients receiving chemotherapy for solid tumors or lymphoma developed oral or gastrointestinal (GI) mucositis, or both.¹⁷ Oral mucositis developed in 22% of 1236 cycles of chemotherapy, GI mucositis developed in 7% of cycles, and oral and GI mucositis developed in 8% of cycles. Among patients who receive high-dose chemotherapy before HCT, an even higher percentage (approximately 75% to 80%) developed clinically significant oral mucositis.⁸³

BOX 50-1

Systemic Toxicity of Cancer Chemotherapy

DIRECT TOXICITIES	OTHER TOXICITIES
Bone marrow	Heart
Neutropenia	Liver
Thrombocytopenia	Lung
Anemia	CNS
Gastrointestinal mucosa	Kidney
Mucositis	
Nausea, vomiting, diarrhea	
Nutritional disturbances	
Oral mucosa	
Skin	
Hair follicles	
Gonads	



FIGURE 50-1 Oral mucositis ulcer involving the right lateral and ventral tongue.

BOX 50-2

Oral Complications of Cancer Chemotherapy

DIRECT TOXICITIES	INDIRECT TOXICITIES
Oral mucositis	Myelosuppression
Salivary gland dysfunction	Neutropenia, immunosuppression
Neurotoxicity	Anemia
Trigeminal nerve neuropathies	Thrombocytopenia
Taste dysfunction	Infection
Dentinal hypersensitivity	Viral (HSV, VZV, CMV, EBV, other)
Temporomandibular dysfunction	Fungal (<i>Candida</i> , <i>Aspergillus</i> , other)
Myofascial pain	Bacterial
Temporomandibular joint dysfunction	Gastrointestinal mucositis
Dental and skeletal growth and development (pediatric patients)	Nutritional disturbances
Abnormalities in dentition	Nausea and vomiting
Changes in jaw development	Acidic damage to oral tissues
Osteonecrosis related to bisphosphonate therapy	Heightened gag reflexes

Morbidity. Oral mucositis can be very painful and can significantly affect nutritional intake, mouth care, and quality of life.^{16,42} For patients receiving high-dose chemotherapy before HCT, oral mucositis has been reported to be the most debilitating complication of transplantation.^{4,80} In patients immunosuppressed because of chemotherapy, increased severity of oral mucositis was found to be significantly associated with an increased number of days requiring total parenteral nutrition and parenteral narcotic therapy, increased number of days with fever, incidence of significant infection, increased time in the hospital, and increased total inpatient charges.⁸³ A reduction in the next dose of chemotherapy was twice as common after cycles with mucositis than after cycles without mucositis.¹⁷ Mucositis is not only a concern for pain and suffering, but can also cause dose-limiting toxicity of cancer chemotherapy with direct effects on patient survival.

Pathogenesis and clinical presentation. The mucosal surfaces throughout the oral cavity have different cellular turnover rates, which can vary from 4 to 5 days for nonkeratinized buccal and labial mucosa to 14 days for the orthokeratinized hard palate. The more rapid the cell division rate of the progenitor epithelial cells, the higher the susceptibility to damage from chemotherapy and radiation therapy. The mechanisms involved are more complex, however, than simply direct damage to oral epithelial cells from chemotherapy or radiation therapy. The currently accepted model for the pathogenesis of mucositis postulates five stages associated with tissue damage and healing. Initiation of direct tissue injury is thought to be mediated by production of reactive oxygen species resulting in cell death. This stage is followed by activation of second messengers that upregulate the production of proinflammatory cytokines in mucosal epithelium and submucosal tissues and lead to widespread tissue injury. Through feedback mechanisms, these cytokines can amplify the cascade of tissue injury further, leading to ulceration and secondary infection. The final stage is characterized by the stimulation of epithelial proliferation and differentiation, leading to mucosal healing.⁷⁷

Histologically, the mucosal damage is characterized by mucosal atrophy, inflammatory cell infiltrates, collagen degradation, and edema.⁴⁹ Clinically, these changes are initially evident as mucosal redness. As the damage increases to basal epithelial cells, ulceration can manifest as isolated lesions. The process progresses to confluent ulcers, often covered by a white pseudomembranous fibrin exudate (Figure 50-1).

Because of the complex cascade of events that occur, lesions may arise 1 to 2 weeks after stomatotoxic chemotherapy. Lesions are usually limited to nonkeratinized areas such as the buccal and labial mucosa, lateral tongue, and soft palate. Keratinized tissues, such as the attached gingiva, dorsal tongue, and hard palate, are less commonly affected. Mucositis typically heals 2 to 4 weeks after the last dose of stomatotoxic therapy has been delivered.⁴³ Oral infections caused by organisms acquired during hospitalization and the reactivation of latent viruses (e.g., herpes simplex virus [HSV], cytomegalovirus [CMV], varicella-zoster virus [VZV]) can also influence the clinical presentation of mucositis and may prolong the duration of ulcerative lesions.

The presence of oral dryness resulting from direct toxic effects of chemotherapeutic agents on the salivary glands concomitant nonchemotherapeutic agents with xerostomic side

TABLE 50-1

Agents Studied for Oral Mucositis

CLASS OF AGENT	AGENT	STATUS OR MASCC/ISOO* GUIDELINE REGARDING MANAGEMENT OF ORAL MUCOSITIS
Cryotherapy	Ice chips placed in the mouth starting 5 min before administration of chemotherapy and replenished as needed for 30-60 min, depending on half-life of agent	Recommended during administration of bolus chemotherapy with 5-fluorouracil, edatrexate, and melphalan ⁵⁵
Growth factor	IV keratinocyte growth factor-1 (Kevivance, Amgen)	Recommended in patients with hematologic malignancies receiving high-dose chemotherapy and total body irradiation before autologous stem cell transplantation; FDA-approved in this population ^{79,85}
	IV fibroblast growth factor-20 (Velafermin, CuraGen)	Development for chemotherapy-induced mucositis recently halted because of negative results from clinical trials ⁴⁵
Anti-inflammatory agents	Benzydamine hydrochloride mouth rinse	Recommended for patients receiving moderate-dose RT, based on previous evidence, ^{24,44} but not FDA-approved; phase III trial halted because of negative results of interim analysis
Antioxidants	IV amifostine (Ethyol, MedImmune)	No guideline; insufficient evidence of benefit for radiation-induced oral mucositis ^{6,9}
	Topical N-acetyl cysteine (RK-0202, RxKinetic)	Currently in clinical trials for radiation-induced oral mucositis ⁶⁸
Promoters of healing	Topical glutamine (Saforis, MGI Pharma)	Currently in clinical trials for chemotherapy-induced oral mucositis ⁶³
Antimicrobial agents	Antimicrobial lozenges	Not recommended for prevention of radiation-induced oral mucositis ³
	Systemic acyclovir and analogues	Not recommended for prevention of chemotherapy-induced oral mucositis ³
	Chlorhexidine mouth rinse	Not recommended for prevention of radiation-induced oral mucositis or for treatment of chemotherapy-induced oral mucositis ³
Topical coating agents	Topical sucralfate	Not recommended for prevention of radiation-induced oral mucositis ³
Laser therapy	Laser	Suggested when necessary technology/training is available in patients receiving high-dose chemotherapy or chemoradiotherapy before hematopoietic cell transplant ^{5,55,71}

*Multinational Association for Supportive Care in Cancer and the International Society of Oral Oncology.
 FDA, Food and Drug Administration; RT, Radiation therapy.

effects, or dehydration leads to decreased hydration and lubrication of the mucosa. This oral dryness may exacerbate mucositis lesions by traumatizing existing lesions or cause sufficient trauma that may initiate a new oral lesion.

Management. Management of mucositis currently is focused on palliation of pain and efforts to reduce the influence of secondary factors on mucositis. Based on an extensive systematic review of the literature, the Mucositis Study Group of the Multinational Association for Supportive Care in Cancer and the International Society of Oral Oncology (MASCC/ISOO) has developed clinical practice guidelines for the management of mucositis.³⁷ These guidelines are discussed subsequently and addressed in Table 50-1.

Pain control. Pain control is provided through various strategies, including topical anesthetics, mucosal coating agents, and systemic pain medications. Focal application of topical anesthetic agents is preferred over widespread oral administration for many reasons. Generalized oral mucosal anesthesia carries the risk of accidental mucosal trauma. Generalized rinsing with anesthetics also may reduce or eliminate the gag reflex, which may increase the risk of aspiration pneumonia. Systemic absorption or swallowing of anesthetics from ulcerated mucosa can result in systemic toxicity, depending on the agent and the dose that is swallowed. However, when muco-

sitis becomes extensive, intentional generalized topical applications of anesthetics are often used to reduce pain.

A common approach to managing oral mucositis is to use a combination solution that includes many different agents, such as topical anesthetics, coating agents, and antifungal drugs. When using these rinses, the clinician faces numerous considerations, as follows:

1. Are all the agents necessary? Topical antifungals have not been shown to be effective for prophylaxis, especially in immunosuppressed patients. Is a topical coating agent necessary, or would a simple topical anesthetic suffice? Are the agents collectively compatible?
2. Are all the agents and their nonactive ingredients well tolerated? Diphenhydramine elixir contains alcohol, coloring, and flavoring agents, all of which can irritate damaged mucosa.
3. Have the medications been compounded in the correct proportions, and is the patient using an adequate volume for appropriate dosing? Does compounding reduce the concentration of each agent to a suboptimal level?
4. What is the cost/benefit ratio for the rinse, and are the added pharmacy costs for compounding a combination rinse offset by significantly improved effectiveness and convenience compared with single agents? Because the primary goal of these rinses is to provide pain relief, this can be an important consideration.

When topical pain control strategies become inadequate for controlling pain, systemic analgesics are necessary. Opioids are usually the drugs of choice. Various delivery systems such as time-release oral tablets, dermal patches, and suppositories can also be used to provide adequate pain relief.

The combination of long-term indwelling venous catheters and computerized drug administration pumps to provide patient-controlled analgesia has significantly increased the ability to control severe mucositis pain while reducing the dose and side effects of opioid analgesics. The MASCC/ISOO guidelines recommend patient-controlled analgesia with morphine for patients undergoing HCT.³

Maintenance of oral hygiene. Multiple studies have shown that good oral hygiene plays an important role in the management of oral mucositis.^{8,10,47} The MASCC/ISOO guidelines recommend use of a standardized oral care protocol including brushing with a soft toothbrush, flossing, and use of nonmedicated rinses (e.g., saline or sodium bicarbonate rinses). Patients and caregivers should be educated regarding the importance of effective oral hygiene.⁵³

Therapeutic interventions. Various agents have been studied to prevent oral mucositis or to reduce its severity, including cryotherapy, growth factors, anti-inflammatory agents, antibacterial agents, promoters of healing, and mucosal coating agents. Table 50-1 lists selected agents studied more recently for oral mucositis. The MASCC/ISOO recommendations are also provided for agents where a guideline exists.

Salivary gland dysfunction

Saliva has an important role in maintaining oral health. Although the effects of ionizing radiation on salivary gland tissue have been well documented, the corresponding effects of cancer chemotherapy have not. Overall, the studies on effects of various chemotherapeutic agents on salivary gland function have produced inconsistent results, with trials showing varied effects on flow rate, sialochemistry, and dry mouth complaints.^{34,41,60} No histopathologic investigations of major salivary glands have been reported, but a postmortem study showed minor salivary gland damage after the administration of various chemotherapeutic agents, with changes evident in the first 3 weeks after chemotherapy administration followed by gradual healing with minimal or no sequelae several weeks to months after therapy. Clinical observations support the contention that alterations in salivary function associated with cancer chemotherapy are generally reversible, in contrast to the alterations seen after salivary gland exposure to radiation therapy.

Patients with salivary gland dysfunction should be assessed to determine whether they are receiving other drugs that can alter salivary function (e.g., anticholinergics, antiemetic drugs, or tricyclic antidepressants). Oral dryness can also be exacerbated by mouth breathing, oxygen administration, or dehydration.

Attempts to manage salivary gland dysfunction can have beneficial effects on the quality of oral health of cancer patients. Frequent rinsing with normal saline can help keep mucosal surfaces moist, clear debris, and stimulate salivary gland function for short periods. Saliva replacements (mouth-wetting agents) may provide temporary symptomatic relief. Other strategies to stimulate salivary glands include the use of “taste stimulation” with sugar-free gum or candies and regimens that use cholinergic drugs. Bethanechol, cevimeline, and pilocarpine, which directly stimulate salivary glands, have been reported to be useful for treating xerostomia when functional salivary gland tissue remains.⁴⁶ Increasing the ingestion of moist foods (e.g., flavored gelatins), sauces, and gravies can ameliorate the discomfort of eating. Dry or cracked lips

should be kept lubricated with agents such as lanolin-based creams and nonperfumed, nonmedicated skin moisturizing agents. The use of antibiotic-containing topical agents on the lips may be indicated to prevent secondary infection, especially in immunosuppressed patients.

Neurotoxicity

Direct neurotoxicity from cancer chemotherapy has been noted with certain chemotherapeutic drugs (most commonly the microtubular agents vincristine and vinblastine, and taxol). This neurotoxicity may result in severe, deep-seated, throbbing mandibular or maxillary pain that can mimic dental pathology (i.e., toothache). Neurotoxicity is generally considered a dose-limiting complication for these drugs, and prompt diagnosis is important.⁵² Appropriate dental/periodontal examinations (including tooth vitality testing as necessary) must be performed to rule out pulpal or periodontal sources of pain. Opioid-containing analgesics may be useful in controlling pain, and the use of neurologically active medications may be considered. The neurotoxicity may be transient and generally subsides shortly after dose reduction or cessation of chemotherapy.

Tooth thermal hypersensitivity is occasionally reported by patients after chemotherapy. Symptoms usually resolve spontaneously within a few weeks to months after the discontinuation of chemotherapy. Topical brush-on fluorides, desensitizing toothpastes, and dentin varnishes can be helpful in reducing or eliminating symptoms.

Taste dysfunction is a neurosensory problem that can be associated with cancer chemotherapy.^{12,22} Taste receptors are neuroepithelium-derived cells, with a turnover rate of approximately 10 days. They generally regenerate if not irreversibly damaged. In addition, the damage to olfactory receptor cells must be considered when a patient has taste dysfunction. Aberrations in taste perception can vary from hypergeusia to hypogeusia to dysgeusia. Some patients simultaneously report several different symptoms—hypergeusia with some tastes and dysgeusia with others. Patients receiving cancer chemotherapy occasionally report a bad taste that results from the diffusion of drug into the oral cavity, known as “venous taste phenomenon.”

Temporomandibular joint and myofascial pain disorders may manifest as facial pain, headache, temporomandibular joint dysfunction, and occasionally ear or throat pain. The myofascial-based complaints generally result from clenching or bruxing in response to stress, sleep dysfunction, or occasionally central nervous system (CNS) toxicity from certain medications. The short-term use of muscle relaxants or anxiolytic agents plus physical therapy (i.e., moist heat applications, massage, and gentle stretching) often resolves these problems. Occlusal splints can be used while sleeping to help patients with more persistent clenching/bruxing tendencies and who present with pain on awakening.

Alterations in dental and skeletal growth and development

As the number of long-term survivors of childhood cancer has increased, the risk for damage to developing dental and skeletal structures from cancer therapies has become apparent. Chemotherapy-related damage to developing teeth includes hypoplastic dentin and enamel, shortened and conical roots, taurodontic-like teeth, microdontia, incomplete enamel formation, and complete agenesis of teeth.^{15,33,50,67} Eruption patterns may be altered, and changes in alveolar, mandibular, and maxillary bone growth and development can have orthodontic and cosmetic implications. The addition of radiation to treatment protocols (e.g., cranial irradiation for leukemia or total body irradiation for HCT) significantly increases the risk for damage to developing teeth.

Rights were not granted to include this figure in electronic media.
Please refer to the printed publication.

FIGURE 50-2 Osteonecrosis of the jaw related to bisphosphonate therapy. (Courtesy Dr. Cesar Migliorati. From Migliorati CA, Siegel MA, Elting LS: Bisphosphonate-associated osteonecrosis: a long-term complication of bisphosphonate treatment, *Lancet Oncol* 7(6):508-514, 2006.)

Osteonecrosis of the jaws related to bisphosphonate therapy

In recent years, osteonecrosis of the jaws (ONJ) has emerged as a new oral complication in patients receiving bisphosphonate therapy. Although this complication has also been reported in patients receiving oral bisphosphonates for osteoporosis, cancer patients receiving intravenous bisphosphonates are at significantly higher risk.⁵⁶ The complication manifests as exposed bone in the mandible or maxilla, often accompanied by infection, pain, and swelling (Figure 50-2). The risk for bisphosphonate-associated ONJ seems to be related to a combination of (1) the antiresorptive potency of the bisphosphonate administered, (2) the amount of the drug deposited in bone, and (3) the occurrence of situations requiring bone to heal or remodel. Most cases have been reported after dental extractions or dental surgeries, but bisphosphonate-associated ONJ can also occur spontaneously.

Studies have shown that the risk for osteonecrosis increases with duration of bisphosphonate therapy and varies by the bisphosphonate agent used. One study reported that of 105 patients receiving intravenous zoledronic acid, risk for osteonecrosis was 1% after 12 months of use, 7% at 24 months, and 21% after 24 months. In the same study, of 127 patients receiving either intravenous pamidronate alone or intravenous pamidronate before or after intravenous zoledronic acid, risk for osteonecrosis was 0% up to 24 months, 2% at 36 months, and 7% at 48 months.² Another study found that the frequency of ONJ in bone malignancy cases, treated with mainly intravenous zoledronate or pamidronate, was 1 in 87 to 114 (0.88% to 1.15%). If extractions were done, the calculated frequency of ONJ was 1 in 11 to 15 (6.67% to 9.1%). In this study, the frequency of ONJ in osteoporotic patients, mainly receiving weekly oral alendronate, was 1 in 2260 to 8470 (0.01% to 0.04%). If extractions were done, the calculated frequency was 1 in 296 to 1130 (0.09% to 0.34%). The median time from initiation of therapy to the onset of ONJ was 12 months for zoledronate, 24 months for pamidronate, and 24 months for alendronate.⁵¹

Effective treatment protocols have not yet been identified for ONJ. It is generally believed that stopping bisphosphonate administration may not promote healing because it is estimated that bisphosphonates may remain in bone for up to 10 years. Prevention is crucial. Patients should receive a dental

evaluation before receiving intravenous bisphosphonates. Any dental disease requiring surgery or extractions should ideally be completed and allowed to initially heal before the start of bisphosphonate therapy.⁵⁴

Indirect Oral Toxic Effects

Although direct toxic effects are generally the most visible oral complications of cancer chemotherapy, indirect oral effects can potentially be of more concern. The most important indirect toxicities are oral infections associated with myelosuppression and immunosuppression associated with damage to myelogenous stem cells and cellular elements of the immune system. Preexisting oral and dental infections can spread, with the oral cavity serving as the point of entry for organisms into deeper tissues and the systemic circulation.^{32,40} Other indirect toxic effects to the oral cavity are thrombocytopenia, anemia, and GI toxicity (i.e., nausea, vomiting, and alteration in absorption of nutrients).

Oral mucosal infections

The risk for infection increases as the degree and duration of immunosuppression increase. In addition, as immunosuppression worsens, the classic signs and symptoms of oral infection (e.g., redness, swelling, pain) may be reduced because of the same diminished immune responses. Patients who receive cancer therapy can have chronic low-grade oral infections (periodontal disease and endodontic infections) that can become serious infections when the patients become immunocompromised, yet these infections may also go undetected longer because of a lack of cellular response by the immune system. Because of the myelotoxic effects of many cancer therapies, as the neutrophil and platelet numbers decrease, many cancer patients are instructed to stop tooth brushing and flossing when blood counts decrease below certain thresholds. Stopping oral hygiene may unfortunately increase the risk of oral infection.

Fungal infections. Superficial colonization by *Candida* species, especially *Candida albicans*, is a common finding in cancer patients receiving chemotherapy. As the degree and duration of immunosuppression increase in patients receiving myelosuppressive/immunosuppressive therapy, there is a distinct increase in the risk for invasive oral fungal infections such as aspergillosis and mucormycosis and numerous other invasive fungal organisms. Yeast and fungal organisms generally have low infectivity, but with changes in the local or systemic immunity, they can pose a significant infectious risk.

Factors affecting oral colonization and infection risk include alterations in competing oral bacterial flora (most commonly associated with the use of systemic antimicrobials), decreased salivary gland flow rates, and immunosuppression. The latter is especially related to neutropenia. Alteration in host oral bacterial flora in cancer patients with myelosuppression supports increased candidal colonization. With the development of new strategies to prevent and treat fungal infections, however, the fungal organisms associated with oral infections are changing. The widespread use of fluconazole prophylaxis has been associated with increasing numbers of *Candida glabrata* (*Torulopsis glabrata*) and *Candida krusei* infections that may have decreased sensitivity to fluconazole and other antifungal agents.⁸⁴

Oral candidal infections can have various clinical presentations—pseudomembranous, erythematous, atrophic, hyperplastic, and invasive. The most common form is pseudomembranous candidiasis, in which mild to heavy surface colonization occurs with raised, white, debris-like masses of organisms. With hyphal invasion of the upper cellular layers of the mucosal epithelium, the mucosal surface can become atrophic, often with little or no evidence of pseudomembra-

nous masses. Atrophic or erythematous candidiasis is particularly common on the dorsal tongue, where the only clinical evidence of infection may be a patchy loss of filiform papillae. Candidal infections of the lip commissures usually manifest with cracking, pain, and varying degrees of erythema. With deeper mucosal invasion, a hyperplastic or ulcerative lesion can be noted. Invasive candidiasis is usually characterized by discrete, firm, almost leathery, white-yellow lesions with marginal erythema. These lesions are primarily noted in patients who are significantly immunocompromised and are at high risk of systemic dissemination. Although oral candidal infections are classically reported to be associated with symptoms of “metallic taste” and “increased sensitivity to spices,” this is not frequently noted in infections associated with cancer therapy.

The diagnosis of *Candida* infection often requires correlation of the clinical presentation of lesions with laboratory tests. Clinical lesions are often nonspecific, and because *Candida* can be a normal inhabitant, reliance only on fungal cultures may lead to false-positive results. Using direct microscopic examination (with Gram stain or potassium hydroxide to identify pseudobranched hyphae) followed by culture to determine the species of the fungus can be helpful. Increasing numbers of *Candida* organisms on culture (1+ to 4+) generally correlate with increasing significance of infection. Because different species of *Candida* can have different sensitivities to different antifungals, speciation becomes particularly important in cases in which the patient has not responded to therapy or when there is frequent recurrence of oral candidiasis. For hyperplastic and invasive candidiasis, cultures from surface swabs and scrapings can produce false-negative results, and biopsy with culture from tissue samples along with specific stains for *Candida* may be required to establish a definitive diagnosis.

More recent Cochrane reviews addressed the efficacy of various antifungal drugs in prevention and treatment of oral candidiasis in cancer patients.^{11,87} Nystatin, although commonly used, was found to be ineffective, possibly because it is not absorbed in the GI tract. Drugs partially absorbed from the GI tract, such as topical clotrimazole or miconazole, were found to be effective and can be useful for superficial oral infection. Persistent or locally invasive infection (including atrophic and erythematous candidiasis), especially when a risk exists for systemic spread, should be treated with appropriate systemic agents. Systemic azoles (e.g., fluconazole, itraconazole, ketoconazole) that are fully absorbed in the GI tract are very effective against the organisms and generally considered the most effective way to prevent or reduce fungal colonization and subsequent infection. These drugs are secreted in saliva; salivary concentrations of fluconazole are directly proportional to plasma concentrations.³⁸ It has been suggested that systemic antifungals may be less effective for oral candidiasis in patients with decreased salivary production because of reduced oral delivery of the drug through saliva. In one study, salivary concentrations of fluconazole were not found to correlate to response to therapy,²⁷ however; this area requires further research.

The treatment of disseminated candidal infections remains difficult and can be complicated by the presence of azole-resistant organisms. Amphotericin B and the newer agent caspofungin are the systemic antifungals of choice for severe deep mycoses, especially in immunocompromised patients. Organisms that can cause serious oral infections in immunocompromised cancer patients include *Aspergillus*, *Mucor*, and *Rhizopus*. These infections often have a nonspecific appearance and can be confused with other oral toxic effects. Diagnosis depends on laboratory tests, and systemic therapy must be instituted immediately because these infections can spread systemically and lead to fatal outcomes.

Viral infections. Herpes group viruses can cause significant oral disease in patients receiving cancer chemotherapy.^{70,72,73} HSV, VZV, CMV, and Epstein-Barr virus (EBV) are recognized causes of oral lesions in cancer patients. Most infections with HSV, VZV, and EBV represent reactivation of latent virus, whereas CMV infections can result from either reactivation of latent virus or newly acquired virus. Other viruses causing oral lesions in cancer chemotherapy and HCT patients are adenovirus, coxsackieviruses, and human herpesvirus. The diagnosis of viral lesions in the mouth can be made through direct immunofluorescent examination of scrapings from lesions, through viral culture, and sometimes through examination of biopsy material with immunohistologic stains specific for each virus.

HERPES SIMPLEX VIRUS. The clinical presentation of oropharyngeal HSV infections can vary from localized herpes labialis to widespread oropharyngeal ulcerations. When they are superimposed on chemotherapy-induced mucositis, HSV lesions can be difficult to recognize clinically. A sudden and dramatic onset or worsening of ulcerative mucositis in patients who are HSV antibody-positive or who have possibly been exposed to HSV often warrants testing to determine the possibility of oral HSV infection.

Acyclovir and valacyclovir prophylaxis for HSV is effective²⁸ and is routinely used in most transplant centers for HSV-seropositive patients undergoing HCT. Oral dosing may be switched to parenteral administration if the patient is unable to tolerate oral drugs because of nausea or oral or esophageal ulcerative mucositis, or if GI absorption is inadequate. Many cases of HSV infection initially suspected to be caused by acyclovir resistance may be related to inadequate dosing or decreased GI absorption of oral acyclovir. Acyclovir-resistant HSV is, however, a growing concern. Early diagnosis of HSV infection is important, and infections are usually successfully managed with systemic acyclovir. Topical antiviral therapy is not encouraged in this setting.

VARICELLA-ZOSTER VIRUS. The most frequent presentation of VZV infection in patients receiving cancer therapies is herpes zoster lesions that are characterized by vesicular eruptions that follow dermatomal distributions. In immunocompromised patients, severe VZV infections can involve multiple dermatomes, and a significant risk exists for dissemination that can result in a serious, life-threatening disease. In susceptible patients, primary VZV infection can manifest with the typical vesicular skin lesions of chickenpox; however, in immunosuppressed patients, primary VZV infection represents a potentially fatal infection. Direct immunofluorescent examination of swab material and viral cultures are used to diagnose VZV infections. Acyclovir and famciclovir are currently the drugs of choice to treat these infections.⁷⁵

CYTOMEGALOVIRUS. CMV can cause oral lesions in immunosuppressed patients. CMV lesions have a nonspecific appearance with a tendency for irregular ulcerations covered with a pseudomembranous fibrin exudate.^{48,72} Surface swabs for direct immunofluorescence have only a fair reliability for diagnosing CMV, possibly because the virus seems to infect primarily endothelial cells and fibroblasts (i.e., deep to the surface) and yields low numbers of free virus. Cultures may improve the detection of CMV, but the most reliable technique to diagnose this disease seems to be biopsy with immunohistochemical stains specific for CMV. Ganciclovir is the drug of choice.

EPSTEIN-BARR VIRUS. EBV-related hairy leukoplakia lesions have been described in immunosuppressed patients without human immunodeficiency virus infection, including bone

marrow transplant patients.⁷ These lesions have no apparent clinical significance. EBV-related lymphomas and immunoblastic sarcomas can manifest, however, with oral lesions and head and neck lymphadenopathy with a potentially fatal outcome. T-cell-depleted grafts for HCT patients have been associated with an increased risk for EBV lymphomas. These lymphomas are generally responsive to radiation therapy.

Bacterial infections. The different environmental niches of the oral cavity—mucosal surfaces, periodontal sulci, and tooth surfaces—harbor a wide array of organisms. In immunosuppressed patients, the potential for acquisition of nonoral bacteria must also be considered. As with fungal and viral infections, the risk for bacterial infection increases as the severity and duration of immunosuppression increase. Neutropenia is the primary risk factor predisposing to bacterial infection, with risk increasing significantly when the neutrophil count decreases to less than 500/mm³. Antibiotic prophylaxis is indicated in these situations.¹⁴ As infectious disease protocols and antibiotics have evolved, the pressures on the oral microflora have been constantly altered. Over the years, oral flora in cancer patients have shown a shift from a risk for overgrowth by primarily gram-negative enteric bacilli (e.g., *Pseudomonas*, *Escherichia coli*, *Serratia*, and *Klebsiella*) to the re-emergence of a risk for infection primarily from gram-positive organisms, especially streptococcal and staphylococcal species. Mucositis and mechanical disruption in the oral mucosa can create a point of entry for oral bacteria, and oral colonization or secondary infection of the oral tissues can increase the severity and course of oral mucositis.⁷⁷

Chlorhexidine oral rinses can promote a decreased rate of colonization by bacteria in and around teeth and reduce gingival infections. Although topical chlorhexidine (0.12% to 0.2%) is effective in reducing gram-positive bacterial colonization and associated periodontal infections, studies using chlorhexidine to diminish the severity and duration of mucositis have produced inconsistent results, with some studies showing benefit and others showing no benefit.³

Poorly fitting removable prosthetic appliances can abrade oral mucosa and increase the risk of microbial invasion into deeper tissues. The dentist should adjust dentures before the start of chemotherapy and instruct patients to change soaking solutions daily. Patients undergoing chemotherapy who are at risk for mucositis are encouraged to reduce or eliminate denture use during chemotherapy to decrease the risk of mucosal trauma and irritation that may exacerbate oral mucositis. Denture-soaking cups that do not use an antiseptic solution can readily become colonized with various pathogens, including *Pseudomonas aeruginosa*, *E. coli*, *Enterobacter* species, *Staphylococcus aureus*, *Klebsiella* species, *T. glabrata*, and *C. albicans*. Routine cleaning of denture cups with a weak bleach solution can prevent contamination and reduce the risk for denture-associated oral infections.

DENTAL PLAQUE, DENTAL CARIES, AND PULPAL INFECTIONS. Dental bacterial plaque can increase the risk of local and systemic infection, and efforts should be directed at keeping bacterial plaque accumulation as low as possible. A clear need exists to maintain the highest compliance with effective oral hygiene protocols for mechanical plaque removal (e.g., brushing, flossing), augmented with topical antimicrobial regimens (e.g., chlorhexidine) as needed.

Deep dental decay at risk for infecting the pulp should be stabilized before therapy to prevent the risk of pulpal infection and pain during therapy. Pulpal/periapical infections can have a significant effect on cancer chemotherapy and may be difficult to manage in patients receiving chemotherapy; considerable attention should be paid to stabilizing infections before medical management. Careful and complete diagnostic

tests should be performed to determine pulpal vitality and endodontic status. The clinician should distinguish osteolytic periapical infections and endodontic failures versus noninfectious periapical conditions, such as apical scars, metastatic cancer lesions, or leukemic infiltrates that mimic periapical infection. If an endodontic procedure is necessary, it is prudent to allow enough time to assess infection stabilization and treatment success before cancer chemotherapy begins. Prophylactic antibiotics may be indicated if the risk for subsequent infection is considered clinically significant. If the periapical and pulpal disease is associated with nonrestorable teeth, every effort should be made to extract these teeth as soon as possible and allow maximal time for healing before cancer treatment begins.

Temporary materials can be placed until the patient has recovered from cancer therapy. Incipient minimal decay can be treated with fluorides and sealants until more definitive therapy can be completed.

Invasive dental and surgical procedures should be undertaken only with a clear understanding of a patient's immune and coagulation status. Table 50-2 presents guidelines for antibiotic and platelet support. Every case should be individually assessed, and the patient's physician and other appropriate specialists should be consulted before the clinician renders care. Extractions should be as atraumatic as possible, and efforts should be instituted to promote rapid stabilization and healing. Socket sites should be debrided and copiously irrigated. Consideration should be given to obtaining primary closure with conservative alveolectomy. In general, an acceptable time interval for initial healing before starting chemotherapy is 10 to 14 days. If less time is available, more vigorous supportive care and more frequent follow-up evaluations may be necessary. If documented infection is associated with the teeth scheduled for extraction, antibiotics (ideally chosen with the benefit of sensitivity testing) should be administered for at least 7 to 10 days after the extraction.

If extraction of teeth with endodontic infections is impossible for medical reasons, the clinician may consider providing initial endodontic therapy (open and broach) and sealing antimicrobial medicaments in the root canal and pulpal chamber. Antibiotics should be administered for 7 to 10 days. Extraction of the tooth can be performed after the patient's medical status has stabilized at or near normal. Appropriate treatment to eliminate the risk of infection is important because pathogens can readily disseminate directly from the dental pulp into periapical tissues and then into the systemic circulation.

PERIODONTAL INFECTIONS. Periodontal infection can be a major concern for cancer chemotherapy patients. Sites with preexisting periodontal disease in immunosuppressed patients can flare up, resulting in an acute infection. Improved protocols for managing immunosuppressed patients can reduce this risk. The signs and symptoms of periodontal disease may be decreased in immunosuppressed patients or patients with hematologic malignancies, which can lead to underrecognition of the degree of periodontal disease. In addition, extensive ulceration of sulcular epithelium, which may be present with periodontal disease, is not directly observable, yet may represent a significant entry point for a future disseminated infection by various organisms. Bacteremias from colonizing organisms have been noted to develop in these patients. In patients with leukemic gingival infiltrates, the enlargements shrink with appropriate chemotherapy, which permits improved hygiene care.

Chronic periodontal disease may develop into acute periodontal infections with associated systemic sequelae during neutropenia.^{29,40,65} Dental disease prevention programs have been shown to reduce the risk of potential oral sequelae associated with cancer therapy, with complications being pre-

TABLE 50-2

Management Suggestions Relative to Invasive Dental Procedures

MEDICAL STATUS	GUIDELINE	COMMENTS
Patients with chronic indwelling venous access catheters (e.g., Hickman)	Regimens recommended by American Heart Association for infective endocarditis prophylaxis are often used	There is no clear scientific proof detailing infectious risk for these lines after dental procedures; this is not an evidence-based practice
Neutrophils $\geq 1500/\text{mm}^3$	Prophylactic antibiotics for mild neutropenia are usually unnecessary	Order CBC with differential Other indications for prophylaxis may be present
$< 1500/\text{mm}^3$	Antibiotic prophylaxis should be considered, especially $< 1000/\text{mm}^3$; regimens recommended by American Heart Association for infective endocarditis prophylaxis are often used; clinical judgment is crucial—if infection is present or neutropenia is severe, more aggressive antibiotic therapy may be indicated, based on consultation with an infectious diseases specialist	If organisms are known or suspected, appropriate adjustments to antibiotic regimens should be made based on sensitivities
Platelets* $> 75,000/\text{mm}^3$	No additional support needed	Order platelet count and coagulation tests
$40,000\text{--}75,000/\text{mm}^3$	Platelet transfusions are optional for surgical procedures; consider administering preoperatively and 24 hr later based on clinical course; platelet support is generally not required for hygiene and restorative procedures	Use techniques to promote establishing and maintaining control of bleeding (e.g., sutures, pressure packs, minimize trauma)
$< 40,000/\text{mm}^3$	Platelets should be transfused 30 min before surgical procedure; obtain platelet count immediately, and transfuse regularly until bleeding risk is no longer present; dental hygiene procedures, including curettage, can be done with counts $> 25,000/\text{mm}^3$	In addition to above, consider using hemostatic agents (e.g., microfibrillar collagen, topical thrombin, fibrin glues); monitor sites carefully

*Assumes that all other coagulation parameters are normal and that platelet counts will be maintained at or above the specified level until initial stabilization/healing has occurred.

CBC, Complete blood count.

vented, reduced in severity, or alleviated.⁸ When acute periodontal infection is diagnosed, broad-spectrum antibiotic therapy should be considered while culture results are pending. Local therapy may include chlorhexidine rinsing or irrigation with effervescent agents (e.g., hydrogen peroxide, which can release oxygen locally) that may affect anaerobic bacteria colonizing the periodontal pocket and gentle mechanical plaque removal (dental brushing and flossing); placement of local periodontal antibacterials (minocycline microspherules) may also be considered. The key to reducing the risk of significant gingiva-associated infections (and bleeding) is to perform dental prophylaxis before myelosuppression and to maintain excellent oral hygiene throughout treatment.

Oral hemorrhage

Hemorrhage from oral tissues in patients receiving cancer therapy can result from thrombocytopenia, loss of coagulation factors from disseminated intravascular coagulation or liver disease, mucosal infections (including gingivitis and periodontitis), and trauma. Spontaneous mucosal petechiae and gingival bleeding may be observed when the platelet count decreases to less than $20,000/\text{mm}^3$. Damage to mucosal tissues, such as damage resulting from oral HSV infections, increases the risk of bleeding. Trauma associated with oral function can also induce minor hemorrhage.

Oral hemorrhage in cancer patients with thrombocytopenia is rarely a debilitating complication, although its occurrence can be alarming to patients, caregivers, and family. Local measures center on forming an adequate clot and protecting the clot until healing has occurred. Direct pressure applied by moist gauze or gauze soaked in topical thrombin can be used. A vasoconstrictor such as epinephrine can help

with initial control, but rebound vasodilation can occur as the drug's effect wears off. Clot-forming agents, such as those made from microfibrillar collagen hemostatic products (Avitene Hemostat, INSTAT), fibrin glue, and chitosan (HemCon), can also be used to organize and stabilize clots. Platelet transfusions are usually not required except for patients whose platelet counts are profoundly suppressed, resulting in insufficient clot formation and repeated significant bleeding episodes. Aprotinin or aminocaproic acid can be used adjunctively to promote coagulation, especially when platelet transfusions are marginally effective in controlling bleeding.

Gastrointestinal effects—nutritional disturbances, nausea, and emesis

A frequent and often significant site of toxicity of cancer chemotherapy is the GI tract. As it does with the oral mucosa, chemotherapy can damage the rapidly proliferating mucosal lining of the stomach and intestines. The resulting mucositis can lead to significant discomfort (cramping, pain), diarrhea, ulceration, and disruption in the absorption of nutrients. In addition, gastric injury plus CNS toxicity from chemotherapy can cause patients to have frequent and profound nausea and emesis. This complication can significantly affect the patient's quality of life during and after cancer chemotherapy.^{4,61}

In addition to the effect of emesis on the quality of life is the negative influence on oral nutrition intake and the potential damage to oral tissues after emesis; the pH of oral tissues can decrease to approximately 2.0. In the presence of mucositis, the exposure of compromised mucosa to this acidic fluid can potentially damage the tissues further. Also, the vigorous tongue movements usually associated with chemotherapy-associated emesis can result in increased trauma to the tongue

and floor of the mouth as these tissues move against incisal and occlusal surfaces.

Protocols to reduce or prevent nausea and vomiting during chemotherapy have become remarkably effective. Often initiated prophylactically, these therapies can minimize the problem and ensure patient comfort. Strategies often combine approaches that target the GI mucosa and the CNS nausea and vomiting centers.^{1,36} The nausea and vomiting associated with chemotherapy can result in adverse conditioning such that normal smells, tastes, and other associated stimuli can induce nausea and vomiting—even just driving by the clinic or hospital where the therapy was administered can be a trigger. Patients may even develop an aversion to swallowing their own saliva, tooth brushing, or wearing removable dental appliances. These conditions may also trigger a heightened gag reflex. Systematic deconditioning strategies can generally help control or eliminate this problem and allow for the resumption of routine oral care.

HEMATOPOIETIC CELL TRANSPLANTATION

Myeloablative HCT is one of the most aggressive forms of cancer therapy. Patients are given supralethal doses of chemotherapy with or without total body irradiation. The patient's stored hematopoietic stem cells or stem cells from the best available human leukocyte antigen-matched donor are infused into the patient to restore bone marrow function and re-establish an immune system. Oral complications frequently associated with HCT are similar to complications noted in patients undergoing high-dose chemotherapy. Mucositis, salivary gland dysfunction, infections, taste dysfunction, and bleeding are common acute oral complications in the first 4 weeks after transplantation. Risk of oral infection slowly declines over the first several months as neutrophil and macrophage counts recover, although oral candidiasis and reactivation of HSV and VZV can occur in susceptible patients for many months after engraftment. Full immune recovery takes up to 6 months after autologous transplantation and 12 months after allogeneic transplantation.

The severity of mucositis is related to the type of conditioning regimen used. Oral mucosal healing partially depends on the rate of engraftment (especially following the neutrophil counts). Mucositis tends to heal more slowly in allogeneic transplant patients (versus autologous/syngeneic transplant recipients) because of post-transplantation prophylaxis for acute graft-versus-host disease (GVHD) (see later).

Oral infections noted in HCT recipients are similar to infections seen in immunosuppressed patients receiving high-dose chemotherapy without transplantation. Use of prophylactic fluconazole reduces the incidence of oral and disseminated candidal and other fungal infections. The risk for reactivation of latent HSV and the risk for reactivation or acquisition of CMV are very high in the early period after HCT. Prophylaxis with acyclovir for HSV and the use of CMV-negative blood products with ganciclovir for CMV have significantly reduced the frequency and effect of these infections. Risk of oral bacterial infection has decreased over the past decade, which may be attributable to oral hygiene protocols and improved antibiotic prophylactic and treatment protocols. Opportunistic gram-negative bacterial pathogens, such as *P. aeruginosa*, *Neisseria* species, and *E. coli*, and gram-positive cocci, such as staphylococci and streptococci, remain a concern.

GVHD is an immune-mediated disease that occurs after transplantation and results from immunologic reactions and damage mediated by donor-derived lymphocytes and cytokines against the patient's tissues. GVHD is potentially lethal. In the oral cavity, GVHD mimics numerous, naturally occur-

ring autoimmune disorders (e.g., lichen planus, lupus erythematosus, scleroderma, Sjögren's syndrome). Oral acute GVHD can become apparent 7 to 21 days after transplantation and is characterized by mucosal erythema, atrophy, ulceration, and (later) hyperkeratotic striae and plaques.⁷⁴ Chronic oral GVHD manifests similarly and becomes apparent more than 100 days after transplantation. Topical steroid rinses/creams/gels and topical azathioprine can help reduce symptoms and promote healing of ulcerations, but resolution generally depends on successful systemic therapy with prednisone, cyclosporine, mycophenolate, tacrolimus, and other immunosuppressive agents. Cutaneous GVHD has been shown to be responsive to treatment with psoralen plus ultraviolet A (PUVA).³⁹ Intraoral PUVA therapy with UVA light sources that can directly expose oral mucosal surfaces has also been reported to help manage oral GVHD lesions.⁶⁶ GVHD can also damage salivary glands with resulting xerostomia and mucoceles involving major and minor salivary gland tissue.⁵⁸

Patients with long-term salivary gland dysfunction are at increased risk for dental decay. For these patients, the dental professional should promote excellent dental plaque removal, prescribe 1.1% neutral sodium fluoride toothpastes or gel with daily brush-on or gel tray protocols, and promote low sugar intake. Tables 50-3 and 50-4 list dental management suggestions for patients who have received HCT, according to type of HCT and time since transplant.

Other late complications of HCT include recurrence of the primary malignancy, occurrence of second primary or secondary cancers (especially in long-term survivors), and viral infections, especially VZV. Dental and facial skeletal growth abnormalities have been noted in children younger than 12 years receiving transplants, primarily resulting from damage induced by conditioning regimens, especially total body irradiation. Children frequently show delayed exfoliation of primary teeth, which correlates with the delayed or arrested development of succeeding permanent teeth. Teeth developing after transplantation often exhibit short, conical-shaped roots. Skeletal changes in jaws generally are manifested as decreased jaw length and reduced alveolar ridge height (the latter most likely from decreased root length).¹⁵

ORAL COMPLICATIONS OF RADIATION THERAPY FOR CANCER

Radiation therapy is a primary treatment modality for head and neck cancer. The oral complications of radiation therapy arise from direct damage to progenitor cells of epithelium, parenchyma, and bone and from vasculitis and endarteritis that adversely affect the oral mucosa, salivary glands, musculature, bone, and connective tissue. These injuries directly or indirectly result in clinical consequences that manifest as mucositis, taste loss, infection, xerostomia, rampant dental decay, soft tissue necrosis, bone necrosis, and fibrosis of oral and perioral tissue including skin and muscles (Box 50-3).

Current changes in the management of the primary disease, including accelerated fractionation of radiation therapy, hyperfractionated radiation schedules, and addition of specific kinds of chemotherapy to the radiation therapy protocols, have been associated with an increased incidence and severity of many of the oral complications. Conversely, the improvement in diagnostic imaging coupled with intensity modulated radiation therapy has significantly decreased the scope and severity of many oral complications.

The importance of dentistry in the overall management of patients with head and neck cancer receiving radiation therapy is well established. The elimination of dental disease and establishment of oral care protocols to maintain maximal oral health must be part of patient assessment and care before

TABLE 50-3

Dental Management Suggestions for Patients Who Have Received a Hematopoietic Cell Transplant (Autologous Transplants)

	<6 MONTHS AFTER TRANSPLANT	>6 MONTHS AFTER TRANSPLANT	
		INCREASED RISK*	NOT INCREASED RISK
Examination	Yes	Yes	Yes
Routine cleanings	No	No	Yes
Restorations	No elective treatment; urgent/emergency care only; consult with oncologist; CBC with differential; prophylactic antibiotics [†]	No elective treatment; urgent/emergency care only; consult with oncologist; CBC with differential; prophylactic antibiotics [†]	Routine dental care
Dental infections	Treat as medically indicated; consult with oncologist; CBC with differential; antibiotic therapy [‡] ; appropriate dental treatment	Treat as medically indicated; consult with oncologist; CBC with differential; antibiotic therapy [‡] ; appropriate dental treatment	Routine dental care; consider consultation with oncologist if there are any unusual or extenuating circumstances

*Patients with CD34-selected transplant and patients with neutropenia or at risk of developing neutropenia (e.g., receiving maintenance rituximab after transplant) should be treated the same as patients <6 months after transplant.

[†]Prophylactic antibiotics: consider using American Heart Association Guidelines for the Prevention of Bacterial Endocarditis or other antibiotics as deemed appropriate.

[‡]Treatment antibiotics: use antibiotics appropriate for type and severity of infection.

TABLE 50-4

Dental Management Suggestions for Patients Who Have Received a Hematopoietic Cell Transplant (Allogeneic Transplants)

	<1 YEAR AFTER TRANSPLANT	>1 YEAR AFTER TRANSPLANT	
		NO GVHD AND NO IMMUNOSUPPRESSION	ACTIVE GVHD OR ON IMMUNOSUPPRESSIVE TREATMENT
Examination	Yes	Yes	Yes
Cleanings	No routine cleanings	Routine dental care	Only to treat significant periodontal disease; prophylactic antibiotics*
Restorations	No elective treatment; urgent/emergency care only; consult with oncologist; CBC with differential; prophylactic antibiotics*	Routine dental care; prophylactic antibiotics*	Urgent dental care; consult with oncologist; CBC with differential; prophylactic antibiotics*
Dental infections	Treat vigorously as medically indicated; consult with oncologist; CBC with differential; antibiotics therapy [†] ; appropriate dental treatment	Routine dental care	Treat vigorously; consult with oncologist; CBC with differential; antibiotic therapy [†] ; appropriate dental treatment

*Prophylactic antibiotics: consider using American Heart Association Guidelines for the Prevention of Bacterial Endocarditis or other antibiotics as deemed appropriate.

[†]Treatment antibiotics: use antibiotics appropriate for type and severity of infection.

CBC, Complete blood count; GVHD, graft versus host disease.

radiation therapy. During and after radiation therapy, dental involvement is dictated by the specific care needs of the patient, who may require more frequent assessments and earlier interventions than most general dental patients.

Detailed oral and dental assessment is necessary to identify conditions that should be treated before radiation therapy. Sites of potential mechanical irritation should be eliminated. Dental treatment such as extractions can delay the start of therapy if undertaken late in the preradiation evaluation phase. Early referral and coordination between oncologists and the dental team can reduce this problem. Attempts to reduce the risk of osteoradionecrosis (described later) generally involve extraction of nonrestorable or questionable teeth, root tips, and periodontally involved teeth in the planned radiation field with enough time before the start of radiation

therapy to allow for adequate initial healing. If time permits, asymptomatic periapical radiolucent lesions can be managed. Endodontics can be performed and completed after radiation, if managed expertly. Providing the patient with a detailed review of oral hygiene, oral care during radiation therapy, and oral care after radiation therapy are important components of long-term care.

Acute Reactions

Acute reactions arise from direct toxicity to tissues in the radiated treatment volume. They generally become apparent shortly after the start of radiation therapy and worsen throughout the course of therapy. After the cessation of therapy, although most complications resolve, some can remain and evolve into chronic conditions.

BOX 50-3**Oral Complications of Radiation Therapy**

ACUTE	CHRONIC
Oral mucositis	Xerostomia
Infection	Dental caries
Fungal	Infection
Bacterial	Fungal
Salivary gland dysfunction	Bacterial
Sialadenitis	Mucosal fibrosis and atrophy
Xerostomia	Muscular/cutaneous fibrosis
Taste dysfunction	Soft tissue necrosis
Dysgeusia	Osteoradionecrosis
Ageusia	Taste dysfunction
	Dysgeusia
	Ageusia

Radiation-induced oral mucositis

Epidemiology. Almost all patients treated with radiation therapy for head and neck cancer develop some degree of oral mucositis. In more recent studies, severe oral mucositis occurred in 29% to 66% of all patients receiving radiation therapy for head and neck cancer.^{18,82} The incidence of oral mucositis was especially high in (1) patients with primary tumors in the oral cavity, oropharynx, or nasopharynx; (2) patients who also received chemotherapy; (3) patients who received a total dose greater than 50 Gy; and (4) patients who were treated with hyperfractionation radiation schedules (e.g., more than one radiation treatment per day).

Morbidity. Mucositis is the major source of treatment-related morbidity in patients receiving radiation therapy for head and neck cancer. These patients are often unable to continue eating by mouth because of mucositis pain and receive nutrition through a gastrostomy tube or intravenous line. Patients with oral mucositis are significantly more likely to have severe pain and weight loss of 5% or more.¹⁸ In one study, approximately 16% of patients receiving radiation therapy for head and neck cancer were hospitalized because of mucositis.⁸¹ Of the patients receiving radiation therapy for head and neck cancer, 11% had unplanned breaks in radiation therapy because of severe mucositis.⁸¹ Oral mucositis is a major dose-limiting toxicity of radiation therapy to the head and neck region.

Pathogenesis and clinical appearance. The pathogenesis of radiation-induced oral mucositis is believed to be generally similar to the pathogenesis of chemotherapy-induced mucositis. The clinical appearance is also similar. In radiation mucositis, lesions are limited to the fields of radiation. With commonly used fractionated dose levels of approximately 200 cGy/day, mucosal erythema is noted 1 to 2 weeks after the start of therapy, followed by ulceration in the third or fourth week. Lesions progress throughout the course of therapy and heal within 4 to 8 weeks after completion of therapy.^{42,43}

The principal factors affecting the development and severity of radiation mucositis are dose, fraction, and duration of radiation. Marked individual variability is seen, however. When the primary radiation beam strikes metallic dental restorations and appliances, a secondary backscatter radiation is produced. Backscatter radiation is of lower energy than the primary beam and travels only a short distance. Tissues that directly contact these metal surfaces are exposed to

the primary beam and the additional backscatter radiation, increasing the total absorbed dose of radiation and potentially causing more mucosal breakdown. Consequently, removable dental appliances should be taken out during treatment sessions. Metal fixed restorations are usually not removed; efforts to hold tissues away from metal surfaces (e.g., using vinyl mouth guards or cotton rolls) have been reported anecdotally to reduce mucosal damage.⁸⁶

Management. Management strategies described previously for chemotherapy patients are generally also useful for cancer patients undergoing head or neck radiation. In addition, two radiation-specific issues emerge:

1. Radiation injury is oral site-specific and depends on dosage and portals of therapy.
2. Duration of radiation-induced oral mucositis typically extends for 2 to 8 weeks after the cessation of therapy compared with the approximate 5 to 14 days observed in chemotherapy patients. Extended radiation treatment protocols produce more significant damage to mucosal tissues and submucosal vasculature and connective tissues, which accounts for this difference.

An additional, more global issue needs to be addressed for head and neck cancer patients receiving radiation therapy. Because the primary cause of oral cancer is tobacco and alcohol abuse, continuation of these habits escalates risk. Research has shown that patients who do not stop smoking after primary therapy for oral cancer are at increased risk of recurrence or second primary lesions. Patients with head and neck cancer should be encouraged and supported in efforts to cease tobacco use permanently. In addition, more severe mucositis occurs in patients who smoke and consume alcohol during radiation therapy; they should be strongly encouraged to discontinue such activities.

Infection during radiation therapy

Radiation therapy to oral tissues can compromise local immunity because of damage to oral mucosa, tissue-based white blood cells, immune cells migrating into oral tissues during radiation therapy, and loss of salivary function. Systemic immunity generally remains intact, however. The pattern of infections seen in head and neck radiation patients is characterized primarily by *Candida* infections. Viral and significant bacterial infections are uncommon.

Candidiasis is the most common oropharyngeal infection in patients undergoing radiation therapy.⁶⁰ Patients receiving head and neck radiation therapy are frequently colonized with *Candida* and show an increase in quantitative counts and clinical infection. Although the contribution of *Candida* to oral mucositis associated with radiation therapy is unclear, candidiasis may increase the discomfort of mucositis. Treatment of oral candidiasis during radiation therapy has primarily focused on the use of topical antifungals such as nystatin and clotrimazole. Compliance can be a problem with these topical antimicrobial agents for patients with mucositis because of irritation, nausea, pain (nystatin solutions), and difficulty in dissolving the medication forms (nystatin pastilles and clotrimazole troches) owing to hyposalivation. Topical antifungals, especially nystatin, may have limited efficacy, especially in patients immunosuppressed because of concomitant chemotherapy. In such patients, systemic antifungals such as fluconazole and ketoconazole can be used.

Salivary gland dysfunction

Salivary gland tissue is particularly sensitive to radiation. During the first several weeks of radiation therapy, painless enlargement of salivary glands may be noted. Over the following weeks, this swelling generally resolves. Shortly after the start of radiation, changes in salivary flow rate and saliva

composition are often noted. The serous acini are more susceptible to radiation damage than mucous acini, which in addition to reducing flow rates also results in saliva having a thicker, more mucous character. Patients report the sensation of dryness and having more difficulty clearing secretions. During the first several weeks of radiation therapy, salivary flow rates modestly recover over days of rest (i.e., over week-ends) only to decline rapidly during the succeeding 5 days of therapy. After several weeks of therapy, the ability of salivary glands to recover at all is lost, and flow rates steadily decrease over the course of therapy. When radiation doses to salivary glands exceed approximately 25 to 30 Gy, the ability for glands to recover is significantly limited.

Amifostine is a prodrug that is dephosphorylated in tissues to a pharmacologically active free thiol metabolite. This thiol metabolite can scavenge reactive oxygen species generated by exposure to radiation. The effects of intravenous amifostine on xerostomia and mucositis secondary to head and neck radiation therapy were studied in an open-label phase III trial.⁹ There was a significant reduction in the incidence of grade 2 or higher acute and late xerostomia in the amifostine group, as assessed by nonblinded investigators. There was no significant difference in the incidence or severity of mucositis between the two groups. Based on these results, intravenous amifostine has been approved by the U.S. Food and Drug Administration (FDA) to reduce the incidence of moderate-severe xerostomia in patients undergoing postoperative radiation treatment for head and neck cancer, in which the radiation port includes a substantial portion of the parotid glands. Intravenous amifostine must be administered within 30 minutes of radiation therapy and is associated with significant side effects, including transient hypotension and nausea and vomiting. Although subcutaneous delivery of amifostine has been reported to have reduced side effects, this route of delivery of amifostine for this indication has not been approved by the FDA as of this writing.

Taste dysfunction

Shortly after the start of external-beam radiation therapy to oral fields, including the tongue and posterior oropharyngeal tissues, patients often begin to report diminishing senses of taste and smell. A total dose of more than 30 Gy reduces the acuity of all taste sensations.¹³ Direct damage to the microvilli and outer surface of the taste cells, damage to nerves supplying taste cells, xerostomia, and mucosal infection all may affect taste. In most instances, taste acuity recovers by 6 months after radiation therapy,⁶⁹ but some patients are left with residual hypogeusia. Treatment with zinc sulfate is often tried in various populations with taste changes, despite inconsistent evidence of its efficacy. A more recent phase III double-blind, placebo-controlled study did not show any benefit from zinc sulfate in patients with taste changes secondary to radiation therapy.³⁰ Palliative measures, such as chewing sugar-free flavored gum, may be beneficial to some patients.

Late Reactions

Late oral complications of radiation therapy primarily represent residual effects from direct damage to the vasculature, salivary glands, mucosa, connective tissue, and bone in the irradiated field. The most common patient symptoms are related to hyposalivation. The types and severity of pathologic changes are directly related to the total dose of radiation, the size of fractions administered, and the duration of treatment. Irradiated mucosa shows epithelial atrophy, disrupted vascular supply, and submucosal fibrosis, all of which result in an atrophic, friable mucosa. Fibrosis in skin, muscle, and joint tissue results in limited jaw function and trismus. In salivary glands, loss of acinar cells, alteration in duct epithelium,

gland fibrosis, and fatty degeneration occur. In bone, hyper-vascularity and hypocellularity result in an increased risk of osteoradionecrosis.

Salivary gland dysfunction

Bilateral exposure of the major salivary glands to tumoricidal doses of radiation predictably results in xerostomia. Individuals who receive total radiation doses greater than 30 Gy are at risk for profound xerostomia if all the major glands are in the field. As the total dose of radiation increases, saliva production decreases. Some salivary function may recover within 6 months after radiation, but in most cases the loss of function is permanent, and strategies to prevent oral complications related to xerostomia need to be continued indefinitely.

Xerostomia results in a loss of oral mucosal lubrication, reduced pellicle formation (with subsequent reduced resistance to abrasion and chemical damage), and decreased remineralization of hard dental tissue. Changes in antimicrobial proteins (e.g., lactoferrin, lactoperoxidase, statins, and defensins) and pH also affect the microbial population, resulting in a more cariogenic microflora.

Stimulation of salivary gland function. The treatment of radiation-induced salivary gland hyposalivation should begin with an initial assessment of residual function by measurement of whole resting and stimulated saliva volumes. If salivary glands have remaining functional tissue, residual function may be stimulated naturally (i.e., through taste) or with the use of cholinergic or other agents capable of improving gland function. Sugar-free chewing gum and candy may help stimulate salivary flow from residual major and minor salivary gland cells that were spared from exposure or able to recover from the irradiation. Citric acid is considered to be the strongest "natural" tastant for stimulation of salivary glands, making sugar-free lemon candies a reasonable choice for patients with dry mouth. (Many of the "sugar-free" candies use sorbitol as a sweetener. Because this sugar can pass through the GI tract without being absorbed, patients who consume large quantities of sorbitol may have diarrhea.) Xylitol is another artificial sweetener often found in sugar-free candies. The advantage of xylitol over other sweeteners is the additional benefit of anticaries activity.³¹

Salivary secretion is caused mainly by the release of acetylcholine from parasympathetic nerves, acting via muscarinic acetylcholine receptors on salivary secretory cells. In the presence of functional secretory cells, cholinergic agonists such as pilocarpine and cevimeline are able to stimulate salivary secretion. Pilocarpine tablets have been approved by the FDA for (1) the treatment of symptoms of dry mouth from salivary gland hypofunction caused by radiation therapy for cancer of the head and neck and (2) the treatment of symptoms of dry mouth in patients with Sjögren's syndrome. The recommended initial dose of pilocarpine tablets is 1 tablet (5 mg) taken three times a day. Dosage can be titrated according to therapeutic response and tolerance. The usual dose range is 3 to 6 tablets or 15 to 30 mg/day, not to exceed 2 tablets per dose. At least 6 to 12 weeks of uninterrupted therapy with pilocarpine tablets may be necessary to assess whether a beneficial response has been achieved.

Cevimeline is a newer cholinergic agent that has a similar mechanism of action as pilocarpine. Cevimeline tablets have been approved by the FDA for the treatment of symptoms of dry mouth in patients with Sjögren's syndrome. The recommended dose of cevimeline hydrochloride is 30 mg taken three times a day. There is insufficient safety and efficacy information to support doses greater than 30 mg three times a day. Pilocarpine and cevimeline tablets are contraindicated in patients with uncontrolled asthma, in patients with known hypersensitivity to either agent, and in patients in whom

contraction of the pupil is undesirable (e.g., in acute iritis and in narrow-angle [angle-closure] glaucoma).

The most frequent adverse effects associated with these sialogogues are due to their general mechanism of action and include sweating, nausea, rhinitis, diarrhea, chills, flushing, increased urinary frequency, dizziness, and asthenia. Taking these medications with food can reduce the frequency and severity of these side effects. If a patient sweats excessively while taking these medications and cannot drink enough liquid, the patient should consult a physician because dehydration may develop. Patients should also be informed that these drugs may cause visual disturbances, especially at night, which could impair their ability to drive safely. These medications should be used with caution in patients with a history of cardiovascular disease because they can potentially alter cardiac conduction and heart rate. They should also be used with caution in patients with controlled asthma, chronic bronchitis, or chronic obstructive pulmonary disease because they can potentially increase airway resistance, bronchial smooth muscle tone, and bronchial secretions. Bethanechol is an older cholinergic agonist that is approved by the FDA for the management of urinary retention. Some studies have indicated that it may be beneficial in patients with salivary dysfunction secondary to radiation therapy for head and neck cancer.^{19,35}

Palliation of xerostomia. Saliva substitutes and oral lubricating agents may be used when stimulation of salivary function is impossible. Most commercial products are more viscous than saliva, do not mimic the changing viscosity after secretion of saliva, and do not contain salivary enzymes and antibodies. Most products currently available are based on carboxymethylcellulose solutions; animal mucins have been incorporated in some European products. Acceptance of these palliative products can vary, and comparative trials have identified patient-preferred products.²⁵ Most commercial products have not been subjected to controlled clinical study.

One line of xerostomia products (Biotene/Oral Balance; Laclede, Inc., Rancho Dominguez, Calif.) includes salivary enzymes that may improve oral health and not merely increase moisturization. A double-blind, placebo-controlled crossover trial of Oral Balance gel and Biotene toothpaste in patients with xerostomia after radiation therapy found that the palliative effects of these products were superior to the effects of placebo (carboxymethylcellulose gel and regular toothpaste). No effect on oral colonization by *Candida* species and cariogenic oral microflora was seen, however, with use of these topical agents for 2 weeks.²⁰ In contrast, another placebo-controlled, single-blind study reported that use of the Oral Balance gel for 4 weeks decreased the number of periodontal-associated bacteria and candidal species identified in saliva.⁵⁹ Because saliva substitutes generally have a limited duration of activity, they have to be administered repeatedly, creating problems in patient acceptance and cost. Patients commonly discontinue these products and instead rely on frequent sipping of water.

Dental caries

Salivary gland dysfunction increases the risk of dental caries because of such factors as a shift to a more cariogenic flora, decreased titers of salivary antimicrobial substances, and loss of mineralizing components. Management of decay secondary to decreased salivary flow must address each component of the caries process. Oral hygiene techniques to remove bacterial dental plaque must be scrupulously maintained. Hyposalivation should be managed whenever possible, and sialogogues should be used if effective. The tooth structure may be made more caries-resistant by the use of topical fluorides (gels and varnishes) and remineralization may be enhanced by the combined use of fluorides and remineralizing products. The

use of trays for home-based fluoride application is believed to be more effective because of increased contact time. Compliance with fluoride trays may be poor,²⁶ however, and brush-on fluoride gels can also be effectively used. The two forms of topical fluoride that are commonly used are stannous fluoride and neutral sodium fluoride. Stannous fluoride can cause staining with persistent use, but this tooth discoloration can generally be removed through standard professional dental cleaning.

The high-risk caries secondary to xerostomia is significantly influenced by shifts in resident oral flora, especially increased colonization by *Streptococcus mutans* and *Lactobacillus* species. Ideally, laboratory assessments to quantify cariogenic organisms should be done before proceeding with the use of antimicrobials. Topical fluorides may reduce levels of *S. mutans*, but they may not decrease the numbers of lactobacilli. Chlorhexidine rinses can help control the numbers of *S. mutans*; *Lactobacillus* species are more resistant.²¹ If the underlying risk factors are not controlled, rapid recolonization by cariogenic organisms occurs, necessitating continuing use of topical chlorhexidine and fluoride. Because of ionic interactions, fluoride (negatively charged ions) bonds with chlorhexidine (positively charged molecules), and use of the two agents should be separated by several hours. In addition, tooth remineralization products high in calcium phosphate and fluoride have been developed and have shown useful in vitro effects that are supported by clinical experience.

Late oral infections

Oral infections occurring after radiation therapy are usually not a major clinical problem for patients recovering from acute radiation toxicities. Oral infections at this time are primarily associated with overgrowth or high carriage rates of bacterial and yeast organisms that are usually attributable to risk factors imposed by reduction or loss of normal salivary function.

Bacterial infections. The shift in predominant bacterial species colonizing dental surfaces is noted to involve bacteria associated with dental caries. Other than bacterial infections associated with dental caries and endodontic disease, mucosal bacterial infections are generally not a significant clinical problem. Unless chlorhexidine is used continuously to control gram-positive bacteria in dental plaque, increased colonization of mucosal surfaces by gram-negative organisms is not noted.

Candidiasis. With continuing xerostomia, oral candidiasis can persist and may cause discomfort and altered taste. The treatment of choice has been primarily topical antifungal agents. Systemic antifungals may have some benefit, however, when topical agents are unacceptable or ineffective. Nystatin is commonly used, but has limited effectiveness. Better topical antifungal drugs currently available include clotrimazole and amphotericin B. These agents can be applied topically as rinses, troches (or pastilles), or creams—particularly if the patient wears dentures. When prescribing topical antifungal drugs, the clinician should note the presence of sucrose in the product because frequent use of products with sucrose, especially in patients with xerostomia, can promote caries. Limited compliance with the topical agents may be overcome with systemic azoles (e.g., ketoconazole, fluconazole) that can be taken once a day for clinically symptomatic infections and then once a week for prophylaxis.

Tissue necrosis

Any oral tissues included in the field of radiation can be irreversibly damaged and potentially be at risk for postradiation soft tissue and bone necrosis. The late toxic effects to oral

mucosa and bone result from endarteritis and vascular changes that produce a relatively hypervascular, hypocellular, and hypoxic tissue that is unable to repair or remodel itself effectively if trauma occurs. In addition, connective tissue changes can compromise tissues and result in soft tissue necrosis. Where necrosis occurs in tissues over bone, the subsequent exposure of bone can lead to osteoradionecrosis. Risk for tissue necrosis (soft tissue and bone) increases as the dose and volume of tissue irradiated increase, with most cases of osteoradionecrosis reported in sites that have received greater than 55 Gy.⁷⁶

Osteoradionecrosis results from the vascular changes that occur in bone and from damage to the cells of the bone (osteoblasts, osteocytes, and osteoclasts). Although the mineralized portion of bone is unaffected by radiation, the destruction of the cellular elements of bone and the hypovascularization result in minimally viable bone that is unable to remodel or repair itself. The posterior mandible is the most common site involved with osteoradionecrosis, although necrosis can occur in any irradiated area, including the maxilla. Symptoms and signs may include discomfort or tenderness at the site, bad taste, paresthesia and anesthesia, fistula formation, and secondary infection. Pathologic fracture can occur from extensive tissue involvement. The risk of necrosis is lifelong, increases with time, and may occur many years after radiation. As long as a risk for dental or periodontal disease or trauma in irradiated fields exists, so does the risk of osteoradionecrosis. This condition is usually initiated by trauma (e.g., denture trauma) or surgical procedures, but it may also be idiopathic, occurring spontaneously with no identifiable cause. Although the lesions may become secondarily infected, osteoradionecrosis is not primarily an infectious process. The overall risk of developing osteoradionecrosis has been estimated to be 2.6% to 15%.²³

Prevention of osteoradionecrosis begins with preradiation dental stabilization or management of dental disease. The goals are to eliminate the need for dental surgery after radiation and to prevent future infection or trauma in the irradiated areas. Teeth in high-dose fields with questionable prognosis, particularly because of periodontal or endodontic disease or in patients who are unlikely to maintain acceptable oral health, should be extracted before radiation therapy. If possible, 14 days should be allowed for healing; some authors have suggested 21 days.²³ Surgery should be performed carefully to reduce the degree of trauma to the bone, using primary closure if possible, eliminating infections, and supporting the general health of the patient.

When osteoradionecrosis develops, management includes avoidance of further local irritants, discontinuation of dental appliances if they encroach on the lesion, maintenance of nutritional status, and cessation of smoking and alcohol consumption. Topical antibiotics (e.g., tetracycline) or antiseptics (e.g., chlorhexidine) may reduce the potential for local irritation by the microbial flora. For chronic localized osteoradionecrosis, this treatment along with regular follow-up care may be the best approach. Every attempt should be made to promote mucosal coverage of the exposed bone. Appropriate analgesics should be provided.

If worsening pain, infection, and osteoradionecrosis progression are noted, hyperbaric oxygen therapy (HBO₂) is recommended. HBO₂ has been shown to increase oxygenation of irradiated tissue, induce angiogenesis, and promote osteoblast repopulation and fibroblast function. HBO₂ is usually prescribed as 30 to 60 “dives” at 100% oxygen at 2 to 2.5 atm of pressure.⁵⁷ If surgery is needed, postsurgical HBO₂ of 10 dives is recommended. Bone sequestra may be managed with local resection or, in severe cases involving the mandible, mandibulectomy. The mandible can be reconstructed to provide continuity for esthetics and function. In one general

cancer clinic, postradiation extractions performed with expert surgery resulted in only 5% of extractions showing delayed healing.²³ This record suggests that when extractions are performed by experienced clinicians, HBO₂ might be reserved for patients in whom osteoradionecrosis develops. However, most centers accept prophylactic HBO₂ as the standard of care prior to any surgical intervention in the post-radiation fields.

Taste changes

Taste and smell dysfunction can be a chronic disability after exposure to radiation. As noted earlier, taste acuity generally recovers over the 2- to 4-month period after the end of radiation treatment. Some individuals are left with permanent hypogeusia, however. The efficacy of zinc supplementation in helping to recover the sense of taste is controversial. If the patient's sense of smell is intact, eating pleasure can be enhanced by trying to make food as “aromatic” as possible (e.g., by warming food) and adding spices to help enhance the taste experience. Nutritional counseling may be necessary to ensure adequate nutritional intake if patients are unable to maintain adequate calorie levels because eating is not enjoyable.

Nutrition

Loss of appetite is common because of radiation-induced complications such as sore mouth, xerostomia, taste loss, dysphagia, nausea, and vomiting. Eating becomes pleasureless and may be painful, resulting in selection of foods that do not aggravate the oral tissues, often at the expense of adequate nutrition. Nutritional complications and deficiencies may be avoided by modifying the texture and consistency of the diet; by adding between-meal snacks to increase protein and caloric intake; and by administering caloric, vitamin, and mineral supplements. High-calorie and protein liquid dietary supplements can be used to augment diets to maintain body weight and ensure adequate nutritional intake. Nutritional counseling is advisable during and after therapy. Nasogastric feeding tubes or percutaneous endoscopic gastrostomy may be required when swallowing is impeded or impossible. After treatment and after mucositis has resolved, nutritional counseling must consider any long-term complications that may be present, including xerostomia, increased caries risk, altered ability to chew, difficulty in forming the food bolus, and dysphagia. Consideration must be given to taste, texture, moisture, and caloric and nutrient content.

Temporomandibular Dysfunction

Musculoskeletal syndromes may arise because of fibrosis of skin and muscles after radiation and surgery, mandibular discontinuity after surgery, and parafunction (clenching/bruxism) associated with the emotional stress caused by the disease and its treatment. Limitation of jaw opening is related to radiation exposure of the lateral pterygoid muscles. Mandibular stretching exercises and prosthetic aids to help reduce the severity of the fibrosis should be instituted before restriction of movement has occurred. Therapy of mandibular dysfunction may include occlusal stabilization appliances, physiotherapy, exercises, trigger-point injections, analgesics, muscle relaxants, tricyclic antidepressants, and other pain management strategies.

SUMMARY

The oral cavity is highly susceptible to the direct and indirect toxic effects of cancer chemotherapy and therapeutic ionizing radiation. Stabilization of oral health before treatment and supportive oral and dental care are crucial components of the patient's overall management, affecting all phases of therapy.

Oral complications occurring during and after therapy can profoundly add to the suffering of the patient, adversely affect the success of therapy, and significantly increase the overall cost of care. Oral care should be preventive and therapeutic to minimize oral and associated systemic complications.

Oral complications of chemotherapy are generally acute (i.e., during therapy) and resolve shortly after the cessation of therapy. Ionizing radiation can cause not only significant intra-therapy oral complications, but also permanent toxic effects. Consequently, the dentist must clearly understand the specifics of the proposed therapy and the potential oral problems based on the patient's current oral health and develop a plan that covers all phases of therapy.

Future research should be targeted at developing strategies and technologies to address the quality of life and oral function (1) to reduce the incidence and severity of oral mucositis; (2) to improve infection prevention, detection, and treatment; (3) to prevent salivary gland dysfunction; and (4), specifically for radiation therapy patients, to reduce the incidence and severity of chronic oral complications.

CITED REFERENCES

1. Aapro MS: How do we manage patients with refractory or breakthrough emesis? *Support Care Cancer* 10:106-109, 2002.
2. Bamias A, Kastritis E, Bamia C, et al: Osteonecrosis of the jaw in cancer after treatment with bisphosphonates: incidence and risk factors. *J Clin Oncol* 23:8580-8587, 2005.
3. Barasch A, Elad S, Altman A, et al: Antimicrobials, mucosal coating agents, anesthetics, analgesics, and nutritional supplements for alimentary tract mucositis. *Support Care Cancer* 14:528-532, 2006.
4. Bellm LA, Epstein JB, Rose-Ped A, et al: Patient reports of complications of bone marrow transplantation. *Support Care Cancer* 8:33-39, 2000.
5. Bensadoun RJ, Franquin JC, Ciais G, et al: Low-energy He/Ne laser in the prevention of radiation-induced mucositis: a multicenter phase III randomized study in patients with head and neck cancer. *Support Care Cancer* 7:244-252, 1999.
6. Bensadoun RJ, Schubert MM, Lalla RV, et al: Amifostine in the management of radiation-induced and chemo-induced mucositis. *Support Care Cancer* 14:566-572, 2006.
7. Birek C, Patterson B, Maximiw WC, et al: EBV and HSV infections in a patient who had undergone bone marrow transplantation: oral manifestations and diagnosis by in situ nucleic acid hybridization. *Oral Surg Oral Med Oral Pathol* 68:612-617, 1989.
8. Borowski B, Benhamou E, Pico JL, et al: Prevention of oral mucositis in patients treated with high-dose chemotherapy and bone marrow transplantation: a randomised controlled trial comparing two protocols of dental care. *Eur J Cancer B Oral Oncol* 30B:93-97, 1994.
9. Brizel DM, Wasserman TH, Henke M, et al: Phase III randomized trial of amifostine as a radioprotector in head and neck cancer. *J Clin Oncol* 18:3339-3345, 2000.
10. Cheng KK, Molassiotis A, Chang AM, et al: Evaluation of an oral care protocol intervention in the prevention of chemotherapy-induced oral mucositis in paediatric cancer patients. *Eur J Cancer* 37:2056-2063, 2001.
11. Clarkson JE, Worthington HV, Eden OB: Interventions for preventing oral candidiasis for patients with cancer receiving treatment. *Cochrane Database Syst Rev* (1):CD003807, 2007.
12. Comeau TB, Epstein JB, Migas C: Taste and smell dysfunction in patients receiving chemotherapy: a review of current knowledge. *Support Care Cancer* 9:575-580, 2001.
13. Conger AD: Loss and recovery of taste acuity in patients irradiated to the oral cavity. *Radiat Res* 53:338-347, 1973.
14. Cullen M, Steven N, Billingham L, et al: Antibacterial prophylaxis after chemotherapy for solid tumors and lymphomas. *N Engl J Med* 353:988-998, 2005.
15. Dahllof G, Barr M, Bolme P, et al: Disturbances in dental development after total body irradiation in bone marrow transplant recipients. *Oral Surg Oral Med Oral Pathol* 65:41-44, 1988.
16. Duncan GG, Epstein JB, Tu D, et al: Quality of life, mucositis, and xerostomia from radiotherapy for head and neck cancers: a report from the NCIC CTG HN2 randomized trial of an antimicrobial lozenge to prevent mucositis. *Head Neck* 27:421-428, 2005.
17. Elting LS, Cooksley C, Chambers M, et al: The burdens of cancer therapy: clinical and economic outcomes of chemotherapy-induced mucositis. *Cancer* 98:1531-1539, 2003.
18. Elting LS, Cooksley CD, Chambers MS, et al: Risk, outcomes, and costs of radiation-induced oral mucositis among patients with head-and-neck malignancies. *Int J Radiat Oncol Biol Phys* 68(4):1110-1120, 2007.
19. Epstein JB, Burchell JL, Emerton S, et al: A clinical trial of bethanechol in patients with xerostomia after radiation therapy: a pilot study. *Oral Surg Oral Med Oral Pathol* 77:610-614, 1994.
20. Epstein JB, Emerton S, Le ND, et al: A double-blind crossover trial of Oral Balance gel and Biotene toothpaste versus placebo in patients with xerostomia following radiation therapy. *Oral Oncol* 35:132-137, 1999.
21. Epstein JB, Loh R, Stevenson-Moore P, et al: Chlorhexidine rinse in prevention of dental caries in patients following radiation therapy. *Oral Surg Oral Med Oral Pathol* 68:401-405, 1989.
22. Epstein JB, Phillips N, Parry J, et al: Quality of life, taste, olfactory and oral function following high-dose chemotherapy and allogeneic hematopoietic cell transplantation. *Bone Marrow Transplant* 30:785-792, 2002.
23. Epstein JB, Rea G, Wong FL, et al: Osteonecrosis: study of the relationship of dental extractions in patients receiving radiotherapy. *Head Neck Surg* 10:48-54, 1987.
24. Epstein JB, Silverman S Jr, Paggiarino DA, et al: Benzylamine HCl for prophylaxis of radiation-induced oral mucositis: results from a multicenter, randomized, double-blind, placebo-controlled clinical trial. *Cancer* 92:875-885, 2001.
25. Epstein JB, Stevenson-Moore P: A clinical comparative trial of saliva substitutes in radiation-induced salivary gland hypofunction. *Spec Care Dentist* 12:21-23, 1992.
26. Epstein JB, van der Meij EH, Lunn R, et al: Effects of compliance with fluoride gel application on caries and caries risk in patients after radiation therapy for head and neck cancer. *Oral Surg Oral Med Oral Pathol Oral Radiol Endod* 82:268-275, 1996.
27. Garcia-Hermoso D, Dromer F, Improvisi L, et al: Fluconazole concentrations in saliva from AIDS patients with oropharyngeal candidiasis refractory to treatment with fluconazole. *Antimicrob Agents Chemother* 39:656-660, 1995.
28. Gluckman E, Lotsberg J, Devergie A, et al: Oral acyclovir prophylactic treatment of herpes simplex infection after bone marrow transplantation. *J Antimicrob Chemother* 12(Suppl B):161-167, 1983.
29. Greenberg MS, Cohen SG, McKittrick JC, et al: The oral flora as a source of septicemia in patients with acute leukemia. *Oral Surg Oral Med Oral Pathol* 53:32-36, 1982.
30. Halyard MY, Jatoi A, Sloan JA, et al: Does zinc sulfate prevent therapy-induced taste alterations in head and neck cancer patients? Results of phase III double-blind, placebo-controlled trial from the North Central Cancer Treatment Group (N01C4). *Int J Radiat Oncol Biol Phys* 67:1318-1322, 2007.
31. Hayes C: The effect of non-cariogenic sweeteners on the prevention of dental caries: a review of the evidence. *J Dent Educ* 65:1106-1109, 2001.
32. Huang WT, Chang LY, Hsueh PR, et al: Clinical features and complications of viridans streptococci bloodstream infection in pediatric hemato-oncology patients. *J Microbiol Immunol Infect* 40:349-354, 2007.
33. Jaffe N, Toth BB, Hoar RE, et al: Dental and maxillofacial abnormalities in long-term survivors of childhood cancer: effects of treatment with chemotherapy and radiation to the head and neck. *Pediatrics* 73:816-823, 1984.
34. Jankovic L, Jelic S, Filipovic-Ljeskovic I, et al: Salivary immunoglobulins in cancer patients with chemotherapy-related oral mucosa damage. *Eur J Cancer B Oral Oncol* 31B:160-165, 1995.
35. Jham BC, Teixeira IV, Aboud CG, et al: A randomized phase III prospective trial of bethanechol to prevent radiotherapy-induced salivary gland damage in patients with head and neck cancer. *Oral Oncol* 43:137-142, 2007.
36. Jordan K, Sippel C, Schmoll HJ: Guidelines for antiemetic treatment of chemotherapy-induced nausea and vomiting: past,

- present, and future recommendations. *Oncologist* 12:1143-1150, 2007.
37. Keefe DM, Schubert MM, Elting LS, et al: Updated clinical practice guidelines for the prevention and treatment of mucositis. *Cancer* 109:820-831, 2007.
 38. Koks CH, Crommentuyn KM, Hoetelmans RM, et al: Can fluconazole concentrations in saliva be used for therapeutic drug monitoring? *Ther Drug Monit* 23:449-453, 2001.
 39. Kunz M, Wilhelm S, Freund M, et al: Treatment of severe erythrodermic acute graft-versus-host disease with photochemotherapy. *Br J Dermatol* 144:901-902, 2001.
 40. Laine PO, Lindqvist JC, Pyrhonen SO, et al: Oral infection as a reason for febrile episodes in lymphoma patients receiving cytostatic drugs. *Eur J Cancer B Oral Oncol* 28B:103-107, 1992.
 41. Laine P, Meurman JH, Tenovuo J, et al: Salivary flow and composition in lymphoma patients before, during and after treatment with cytostatic drugs. *Eur J Cancer B Oral Oncol* 28B:125-128, 1992.
 42. Lalla RV, Peterson DE: Oral mucositis. *Dent Clin North Am* 49:167-184, 2005.
 43. Lalla RV, Peterson DE: Treatment of mucositis, including new medications. *Cancer J* 12:348-354, 2006.
 44. Lalla RV, Schubert MM, Bensadoun RJ, et al: Anti-inflammatory agents in the management of alimentary mucositis. *Support Care Cancer* 14:558-565, 2006.
 45. Lalla RV, Velafermin (CuraGen). *Curr Opin Investig Drugs* 6:1179-1185, 2005.
 46. LeVeque FG, Montgomery M, Potter D, et al: A multicenter, randomized, double-blind, placebo-controlled, dose-titration study of oral pilocarpine for treatment of radiation-induced xerostomia in head and neck cancer patients. *J Clin Oncol* 11:1124-1131, 1993.
 47. Levy-Polack MP, Sebelli P, Polack NL: Incidence of oral complications and application of a preventive protocol in children with acute leukemia. *Spec Care Dentist* 18:189-193, 1998.
 48. Lloid ME, Schubert MM, Myerson D, et al: Cytomegalovirus infection of the tongue following marrow transplantation. *Bone Marrow Transplant* 14:99-104, 1994.
 49. Lockhart PB, Sonis ST: Alterations in the oral mucosa caused by chemotherapeutic agents: a histologic study. *J Dermatol Surg Oncol* 7:1019-1025, 1981.
 50. Maguire A, Welbury RR: Long-term effects of antineoplastic chemotherapy and radiotherapy on dental development. *Dent Update* 23:188-194, 1996.
 51. Mavrokokki T, Cheng A, Stein B, et al: Nature and frequency of bisphosphonate-associated osteonecrosis of the jaws in Australia. *J Oral Maxillofac Surg* 65:415-423, 2007.
 52. McCarthy GM, Skillings JR: A prospective cohort study of the orofacial effects of vincristine neurotoxicity. *J Oral Pathol Med* 20:345-349, 1991.
 53. McGuire DB, Correa ME, Johnson J, et al: The role of basic oral care and good clinical practice principles in the management of oral mucositis. *Support Care Cancer* 14:541-547, 2006.
 54. Migliorati CA, Casiglia J, Epstein J, et al: Managing the care of patients with bisphosphonate-associated osteonecrosis: an American Academy of Oral Medicine position paper. *J Am Dent Assoc* 136:1658-1668, 2005.
 55. Migliorati CA, Oberle-Edwards L, Schubert M: The role of alternative and natural agents, cryotherapy, and/or laser for management of alimentary mucositis. *Support Care Cancer* 14:533-540, 2006.
 56. Migliorati CA, Siegel MA, Elting LS: Bisphosphonate-associated osteonecrosis: a long-term complication of bisphosphonate treatment. *Lancet Oncol* 7:508-514, 2006.
 57. Myers RA, Marx RE: Use of hyperbaric oxygen in postradiation head and neck surgery. *NCI Monogr* 9:151-157, 1990.
 58. Nagler RM, Nagler A: Major salivary gland involvement in graft-versus-host disease: considerations related to pathogenesis, the role of cytokines and therapy. *Cytokines Cell Mol Ther* 5:227-232, 1998.
 59. Nagy K, Urban E, Fazekas O, et al: Controlled study of lactoperoxidase gel on oral flora and saliva in irradiated patients with oral cancer. *J Craniofac Surg* 18:1157-1164, 2007.
 60. Oneschuk D, Hanson J, Bruera E: A survey of mouth pain and dryness in patients with advanced cancer. *Support Care Cancer* 8:372-376, 2000.
 61. Osoba D, Zee B, Warr D, et al: Effect of postchemotherapy nausea and vomiting on health-related quality of life. The Quality of Life and Symptom Control Committees of the National Cancer Institute of Canada Clinical Trials Group. *Support Care Cancer* 5:307-313, 1997.
 62. Peterson DE: Pretreatment strategies for infection prevention in chemotherapy patients. *NCI Monogr* 9:61-71, 1990.
 63. Peterson DE, Jones JB, Petit RG 2nd: Randomized, placebo-controlled trial of Saporin for prevention and treatment of oral mucositis in breast cancer patients receiving anthracycline-based chemotherapy. *Cancer* 109:322-331, 2007.
 64. Peterson DE, Keefe DM, Hutchins RD, et al: Alimentary tract mucositis in cancer patients: impact of terminology and assessment on research and clinical practice. *Support Care Cancer* 14:499-504, 2006.
 65. Pizzo PA, Ladisch S, Witebsky FG: Alpha-hemolytic streptococci: clinical significance in the cancer patient. *Med Pediatr Oncol* 4:367-370, 1978.
 66. Redding SW, Callander NS, Haveman CW, et al: Treatment of oral chronic graft-versus-host disease with PUVA therapy: case report and literature review. *Oral Surg Oral Med Oral Pathol Oral Radiol Endod* 86:183-187, 1998.
 67. Rosenberg SW, Kolodney H, Wong GY, et al: Altered dental root development in long-term survivors of pediatric acute lymphoblastic leukemia: a review of 17 cases. *Cancer* 59:1640-1648, 1987.
 68. *RxKinetics completes its end of phase 2 meeting with the FDA for RK-0202 in oral mucositis and is now moving into phase 3* (press release), Boulder, CO, 2006, RxKinetics, Inc.
 69. Sandow PL, Hejrat-Yazdi M, Heft MW: Taste loss and recovery following radiation therapy. *J Dent Res* 85:608-611, 2006.
 70. Schubert MM: Oral manifestations of viral infections in immunocompromised patients. *Curr Opin Dent* 1:384-397, 1991.
 71. Schubert MM, Eduardo FP, Guthrie KA, et al: A phase III randomized double-blind placebo-controlled clinical trial to determine the efficacy of low level laser therapy for the prevention of oral mucositis in patients undergoing hematopoietic cell transplantation. *Support Care Cancer* 15(10):1145-1154, 2007.
 72. Schubert MM, Epstein JB, Lloid ME, et al: Oral infections due to cytomegalovirus in immunocompromised patients. *J Oral Pathol Med* 1993;22:268-273.
 73. Schubert MM, Peterson DE, Flournoy N, et al: Oral and pharyngeal herpes simplex virus infection after allogeneic bone marrow transplantation: analysis of factors associated with infection. *Oral Surg Oral Med Oral Pathol* 70:286-293, 1990.
 74. Schubert MM, Sullivan KM, Morton TH, et al: Oral manifestations of chronic graft-v-host disease. *Arch Intern Med* 144:1591-1595, 1984.
 75. Shafran SD, Tying SK, Ashton R, et al: Once, twice, or three times daily famciclovir compared with aciclovir for the oral treatment of herpes zoster in immunocompetent adults: a randomized, multicenter, double-blind clinical trial. *J Clin Virol* 29:248-253, 2004.
 76. Silverman S Jr: Oral cancer: complications of therapy. *Oral Surg Oral Med Oral Pathol Oral Radiol Endod* 88:122-126, 1999.
 77. Sonis ST, Elting LS, Keefe D, et al: Perspectives on cancer therapy-induced mucosal injury: pathogenesis, measurement, epidemiology, and consequences for patients. *Cancer* 100(9 Suppl):1995-2025, 2004.
 78. Sonis ST, Oster G, Fuchs H, et al: Oral mucositis and the clinical and economic outcomes of hematopoietic stem-cell transplantation. *J Clin Oncol* 19:2201-2205, 2001.
 79. Spielberger R, Stiff P, Bensinger W, et al: Palifermin for oral mucositis after intensive therapy for hematologic cancers. *N Engl J Med* 351:2590-2598, 2004.
 80. Stiff P: Mucositis associated with stem cell transplantation: current status and innovative approaches to management. *Bone Marrow Transplant* 27(Suppl 2):S3-S11, 2001.
 81. Trotti A, Bellm LA, Epstein JB, et al: Mucositis incidence, severity and associated outcomes in patients with head and neck cancer receiving radiotherapy with or without chemotherapy: a systematic literature review. *Radiother Oncol* 66:253-262, 2003.

82. Vera-Llonch M, Oster G, Ford CM, et al: Oral mucositis and outcomes of allogeneic hematopoietic stem-cell transplantation in patients with hematologic malignancies. *Support Care Cancer* 15:491-496, 2007.
83. Vera-Llonch M, Oster G, Hagiwara M, et al: Oral mucositis in patients undergoing radiation treatment for head and neck carcinoma. *Cancer* 106:329-336, 2006.
84. Vigouroux S, Morin O, Moreau P, et al: Candidemia in patients with hematologic malignancies: analysis of 7 years' experience in a single center. *Haematologica* 91:717-718, 2006.
85. von Bultzingslowen I, Brennan MT, Spijkervet FK, et al: Growth factors and cytokines in the prevention and treatment of oral and gastrointestinal mucositis. *Support Care Cancer* 14:519-527, 2006.
86. Wang R, Boyle A: A convenient method for guarding against localized mucositis during radiation therapy. *J Prosthodont* 3:198-201, 1994.

87. Worthington HV, Clarkson JE, Eden OB: Interventions for treating oral candidiasis for patients with cancer receiving treatment. *Cochrane Database Syst Rev* (2):CD001972, 2007.

GENERAL REFERENCES

- Lalla RV, Peterson DE, Brennan MT, et al: Oral toxicity. In Perry MC, editor: *The chemotherapy sourcebook*, ed 4, Lippincott, 2008, Williams & Wilkins.
- National Cancer Institute: *Oral complications of chemotherapy and head/neck radiation*. Available at: <http://www.cancer.gov/cancertopics/pdq/supportivecare/oralcomplications/healthprofessional>. Accessed January 23, 2010.
- Schubert MM, Peterson DE: Oral complications. In Thomas ED, Blume KG, Forman SJ, editors: *Hematopoietic cell transplantation*, ed 3, Oxford, 2008, Blackwell Science.

Drugs of Abuse

CHARLES S. BOCKMAN AND PETER W. ABEL

Drug abuse can be defined as an inappropriate use of a drug for a nonmedical purpose. Drug abuse is considered to cause harm to the individual abuser and to society as a whole. Many variables not directly related to a drug can influence whether a given individual becomes a drug abuser. Many experts argue that cocaine possesses the greatest potential for abuse based on its pharmacologic characteristics alone. For individuals who try nicotine, the risk of developing an addiction is approximately twice that for individuals who try cocaine, however.⁷ This statement is not meant to infer that the pharmacologic abuse potential of nicotine is twice that of cocaine; rather, some psychosocial factors are equally important in affecting onset and continuation of drug abuse and addiction. It is beyond the scope of this chapter to discuss these factors related to drug users and their environment; this chapter concentrates solely on the pharmacologic aspects of drugs of abuse.

A wide variety of different types of drugs and other chemical substances are subject to abuse. Anabolic steroids are abused by bodybuilders and other athletes to add muscle mass and enhance athletic performance. The most commonly abused groups of drugs are those that act on the central nervous system (CNS) to alter perception. This chapter focuses on drugs that are abused because they have effects in the CNS that are perceived by some individuals as desirable.

HISTORIC PERSPECTIVE

Natural products such as hemp flowers, opium, and coca leaves have been used for thousands of years for their ability to cause pleasurable sensations or other alterations in consciousness. Other than alcohol, the first major drugs of abuse in the United States were cocaine and opioids. Throughout the nineteenth century, unregulated opium use led to a plethora of patent medicines containing opium derivatives. As a result, many middle-class Americans became dependent on opium because of promiscuous use of such preparations. Nevertheless, social attitudes toward drug abuse remained relaxed until after the Civil War. The widespread use of morphine by injection for dysentery, malaria, and pain resulted in such large numbers of morphine-addicted veterans that morphine dependence became known as “soldier’s disease.”¹⁰

The chemical isolation of the alkaloid cocaine in 1859 was followed by a rapid increase in the use of that drug. It was enthusiastically promoted for various disorders, and by the turn of the twentieth century, oral abuse of cocaine in the form of patent medicines and tonics was widespread. The manufacturers of Coca-Cola did not stop using cocaine-containing syrup in their soft drink until 1903, after 17 years in production.

In the early 1900s, the mass media developed the myth of cocaine-crazed renegades committing heinous crimes against society. Opioid dependence was still prevalent, and morphine was the major opioid of abuse. During this period, federal laws were enacted to control the widespread drug abuse problem. The introduction of the Pure Food and Drug Act in 1906, the Harrison Narcotic Act in 1914, and the Narcotic Drugs Import and Export Act in 1922 and the enforcement of these acts by law enforcement officials led to the virtual disappearance of cocaine abuse by the 1930s. The increased cost and reduced street availability of cocaine helped lead to the increase of amphetamine as a stimulant drug of abuse. Intravenous (IV) heroin use was also becoming popular, and by 1935 it was as widely abused as morphine. Between World Wars I and II, addiction began to be widely equated with criminality.¹⁰ In the case of marijuana, sensationalized accounts of murders perpetrated by individuals under the influence of the “killer weed” led to the passage of the Marihuana Tax Act of 1937, which effectively banned its production, distribution, and sale.

In the 1960s, drug abuse began to make major inroads into middle-class society. The baby-boom generation began experimenting with lysergic acid diethylamide (LSD) and marijuana. Epidemic amphetamine abuse developed during the 1960s, peaking in 1967 with 32 million legal prescriptions written for amphetamines that suppress appetite and lead to weight loss. To combat the rising tide of drug abuse, the Comprehensive Drug Abuse Prevention and Control Act was enacted in 1970 and replaced previous laws in this area. This act classified drugs into five schedules according to their abuse liability and provided a graded set of penalties for violation of regulations relating to the manufacture, sale, prescription, and record keeping of drugs of abuse. A summary of the abuse potential and examples of drugs falling under this act are provided in Table 55-5. This act is the major regulatory legislation controlling drugs of abuse (see Chapter 55).

In the early 1970s, cocaine was rediscovered as a recreational drug by the young, upwardly mobile, affluent generation. This second cocaine epidemic necessitated a redefinition of the picture of the typical drug abuser as an unemployed, minority male criminal. The 1993 National Household Survey on Drug Abuse reported that 70% of illicit drug abusers are employed, 80% are white, and 75% live in areas outside of the city.⁴³ As of 2006, the characteristics of the typical drug abuser remain similar to those of 1993.⁴⁴

In 1983, a glut in the world market for cocaine combined with the development of a smokable, inexpensive, and very addictive form of the drug called “crack” brought the third cocaine epidemic to the inner cities, where availability of powdered forms of the drug was limited because of its cost.

In the 1990s, the preparation of a smokable form of methamphetamine led to the widespread abuse of this stimulant, called “ice” and “crank” on the street. More severe abuse patterns than had ever been seen before emerged with the appearance of these smokable, freebase forms of cocaine and methamphetamine. Smoking these drugs results in a more rapid onset of action and a more intense effect, conferring on them more abuse liability than other forms of these drugs that must be sniffed or taken orally. The abuse potential of these drugs increased so dramatically with this mode of administration that drug seeking became more paramount to this population of abusers than it previously had been. Equally insidious was the emergence of clandestine laboratories that make “designer drugs,” synthetic substances that are inexpensive to produce and difficult to detect. These include the amphetamine analogue 3,4-methylenedioxymethamphetamine (MDMA) (otherwise known as “ecstasy”) and “China white,” a synthetic opioid analogue of fentanyl with 1000 to 2000 times its potency.

The economic effect of these new patterns of abuse can be felt in hospital emergency departments and in board rooms across the United States. Although cocaine and methamphetamine abuse has generally declined since the 1980s, the incidence of cocaine-related and methamphetamine-related medical emergencies has increased threefold since 1981.⁶ This increase may reflect the increased toxicity of smokable drug preparations because smoking leads to a greater concentration of drug in the body than other routes of administration. Potential costs of illicit drug use in the workplace include payment for substance abuse treatment programs, loss of productivity from absenteeism, accidents, disability claims, theft, and employee screening for drug use. Among full-time workers, 43% reported that tests for illicit drug or alcohol use occurred at their place of employment during the hiring process; in the employed 18- to 64-year-old age group, 8% reported positive for an illicit drug in the previous month.³⁷

In general the incidence of illicit drug use has declined modestly since 1975.^{31,32} In 1979, 51% of American high school seniors reported using marijuana annually; that figure decreased to 32% in 2007. Similar trends were reported for cocaine (6% in 1975 and 5% in 2007), hallucinogens (8% in 1975 and 5% in 2007), barbiturates and other sedative-hypnotics (10% in 1975 and 6% in 2007), heroin (1% in 1975 and 1% in 2007), inhalants (3% in 1976 and 4% in 2007), and amphetamines (16% in 1975 and 9% in 2001). There are some important exceptions to the decline in illicit drug use since the 1970s. Although overall amphetamine use has decreased, annual use of the smokable preparation of methamphetamine has increased from 1.5% in 1990 to a peak in 2004 (3.5%), followed by a decline to 1.7% in 2007. A note-

worthy increase in MDMA use from trace levels in 1985 to 3.5% in 1995 to 4.5% in 2007 reflects the current upward trend in overall use of so-called “club drugs.” In addition, an emerging trend indicates that nonmedical use of prescription drugs such as clonazepam (Klonopin), methylphenidate (Ritalin), and oxycodone (OxyContin) is extremely prevalent with 15% of high school seniors reporting recreational use of at least one prescription medication within the past year.

DRUG ABUSE CHARACTERISTICS AND TERMINOLOGY

The term *addiction* refers to a compulsion to take a drug on a continuous or periodic basis to experience its psychoactive effects.⁴ For addiction to exist, the abuser must have a mental obsession to continue drug administration to produce pleasure. Additional characteristics of addiction, which may or may not be present, are dependence and tolerance. When the administration of a drug is discontinued or, in the case of certain drugs, significantly reduced, *dependence* leads to the appearance of a characteristic and specific group of symptoms, termed a *withdrawal* or *abstinence syndrome*.²⁸ *Tolerance* exists when administration of the same dose of a drug has progressively less effect. This decreased response to the effects of a drug requires that increasingly larger doses of a drug be given to produce the same pharmacologic actions. The development of tolerance depends on the dose of the drug and the frequency of its administration. Tolerance is caused by compensatory responses that act to decrease the body's response to a drug. The cellular basis for drug tolerance may be related to a decrease in receptors for the drug, a reduction in enzyme activity associated with signal transduction pathways, or other effects. *Cross-tolerance* is the phenomenon whereby chronic use of a drug produces tolerance to that drug's effects and to other drugs that produce the same effect. Cross-tolerance may be observed among drugs of similar or different chemical types. A related but different phenomenon is *cross-dependence*, which refers to an ability of one drug to substitute for another drug, usually in the same class, in a dependent individual without precipitating a withdrawal syndrome.

On the basis of common pharmacologic actions and of cross-tolerance and cross-dependence, the major drugs of abuse can be divided into distinct categories: opioid analgesics; general depressants of the CNS, including sedative-hypnotics and anti-anxiety drugs; cocaine, amphetamines, and related psychomotor stimulants; hallucinogens; marijuana; and inhalants. Table 51-1 lists the major abuse characteristics of these six drug groups—the degree of addiction and dependence and tolerance development commonly associated with

TABLE 51-1

Abuse Characteristics of Drug Groups

	PSYCHOLOGICAL DEPENDENCE	PHYSICAL DEPENDENCE	TOLERANCE
Opioid analgesics	++++	++++	++++
Sedative-hypnotics	+++	++++	+++
Amphetamines	+++	++	++++
Cocaine	++++	++	++
Hallucinogens			
LSD	+	+	++
PCP	+	+	+
Marijuana	++	+	++
Inhalants	+	U	U

++++, Marked; +++, moderate; ++, some; +, slight; U, unknown.

the abuse of each drug group. In the following discussion, each drug group is described in terms of three major factors: (1) the pharmacologic effects produced by the drug group; (2) the abuse characteristics of the drug group, including addiction, tolerance, dependence, withdrawal, and other characteristics; and (3) the toxicity caused by the drug group and how it is treated.

ABUSE OF OPIOID ANALGESICS

Opioid analgesics most commonly abused include heroin, morphine, and, among health care professionals, meperidine and fentanyl. In addition to these agonists, various other synthetic and semisynthetic derivatives are subject to abuse. These agents differ from each other in their abuse characteristics, their onset and duration of action, the intensity of their effects, and, to some extent, the pattern of their abuse. Many of the mechanisms involved in the analgesic response to opioids also produce euphoria or a perceived state of well-being, and much research has been generated in an attempt to develop efficacious analgesics that are not euphoric and have less abuse potential. Although this research has led to a greater understanding of the physiologic characteristics of pain, at present no opioids or other types of analgesics are superior to morphine. In the following discussion, morphine is considered the prototype for this group, unless another drug is specifically mentioned.

Pharmacologic Effects

In the following discussion, the subjective effects of opioids are the effects observed in individuals who are opioid abusers. Although opioids produce similar pharmacologic effects in most individuals (see Chapter 20), not everyone reports the subjective effects of warmth, contentment, orgasm, and euphoria. In nonabusing individuals, the nausea and vomiting caused by opioids are construed as unpleasant and may obfuscate many of the reinforcing characteristics of these drugs. Many individuals view the mental clouding produced by opioids as an undesirable inability to concentrate, whereas addicts find this quality appealing. Most important, because opioids are the mainstay in the treatment of moderate-severe pain, it is relevant to know that in the therapeutic setting little substantive evidence suggests that effective pain management with opioids in individuals leads them to develop into opioid abusers.

For individuals who abuse opioids, the IV administration of heroin causes an immediate overwhelming sense of warmth that permeates the abdominal area and that has been described as orgasmic. Nausea, vomiting, and histamine release occur soon after, causing a sense of itching, reddening of the eyes, and a decrease in blood pressure. Feelings of increased energy with talkativeness (“soapboxing”) alternate with periods of relaxation or tranquility (“coasting”). This intense euphoria may last several minutes. The depressant effects on the CNS then appear and include mental clouding, decreased visual acuity, and sedation accompanied by a feeling of heaviness in the extremities. The abuser has no motivation to participate in physical activity; the individual appears to be asleep, but only the head and facial muscles are relaxed (“nodding”). This period is followed by episodes of light sleeping accompanied by vivid dreaming. Feelings of anxiety and worry are absent, and a pervasive sense of contentment is present. Taken together, the early euphoric period followed by the sedation and sleeping may last 3 to 5 hours.

Abuse Characteristics

The development of tolerance is a characteristic feature of all opioid agonists. Regardless of whether opioids are administered in a therapeutic setting or are self-administered, repeti-

tive use leads to tolerance or a reduction in response, such that a greater dose of drug is required to achieve the same effect that was produced on initial administration of the drug. Tolerance develops most readily when opioids are given in large doses at short intervals or during constant infusion of the drug; the phenomenon can be observed within days after drug therapy has begun. Tolerance or desensitization to the effects of opioids develops at the cellular level and may be viewed as a homeostatic response by the cell to constant exposure to an agonist. Because the development of tolerance to the effects of opioids is a physiologic phenomenon, it inevitably occurs in patients after repeated drug administration. The development of tolerance is not a predictor of whether the patient will become an opioid abuser.

Because most fatalities resulting from opioid overdose are caused by respiratory depression, the prescribing physician must understand that tolerance develops similarly to the respiratory depressant effect and to the analgesic and euphoric effects of opioids. This fact has important ramifications for the clinician, who may be wary about administering 10 times the normal dose of morphine for adequate pain control in a patient who has developed tolerance to the analgesic effects. Out of concern for the respiratory depressant or addictive properties of morphine, the clinician may not provide adequate pain control even though the patient has developed a similar degree of tolerance to the respiratory depressant and euphoric effects of morphine. Because of this use-induced decrease in the ability of opioids to suppress respiration, considerable tolerance to the lethal effects of opioids may develop. Tolerance to the respiratory effect of opioids is rapidly lost during abstinence, however, and death may result if an addict returns to the previously maintained dosage after withdrawal has been completed.

Similar to tolerance, dependence on opioids is also a result of repeated administration of an agonist and occurs for all opioids. Dependence results from cellular adaptation caused by uninterrupted agonist occupation of opioid receptors. Normal function of the individual now requires the presence of an opioid drug at its receptor. When the drug is removed from the receptor during drug withdrawal, an acute withdrawal syndrome ensues. The intensity of the withdrawal syndrome is related to the degree of dependence. As with tolerance, dependence develops most rapidly and to the greatest extent when the opioid receptors are constantly occupied. No outward signs of dependence are observed until the drug is withdrawn.

Withdrawal symptoms in an opioid-dependent individual include rhinorrhea, lacrimation, vomiting, sweating, yawning, diarrhea, irritability, restlessness, chills, piloerection (“cold turkey”), mydriasis, hyperventilation, tachycardia, hypertension, tremors, and involuntary muscle movements. In general, the appearance and severity of withdrawal signs depend on the duration of action of the opioid being taken. Signs of withdrawal in a heroin-dependent individual appear approximately 6 hours after the last dose, increase in intensity over the next 36 to 72 hours, and subside after about 1 week. In contrast, dependence on a long-acting opioid, such as methadone, results in a mild but protracted withdrawal syndrome with delayed onset. A withdrawal syndrome can also be precipitated in dependent individuals by displacing the opioid from the receptor with an antagonist (naloxone), an agonist-antagonist (pentazocine), or a partial agonist (buprenorphine). Death from opioid withdrawal is rare; however, when it does occur, it is because of cardiovascular collapse from dehydration and acid-base imbalance.

The development of dependence to opioids is a physiologic response seen in all individuals; it does not predict whether they become abusers. In patients who become dependent, the dose of opioid can be decreased by 50% every

other day and eventually stopped without overt signs of withdrawal.

Addiction to opioids is significant, as exemplified by the high relapse rate among addicts after withdrawal. The euphoria, tranquillity, and abdominal effects, described as orgasmic, promote abuse of opioids. The rapidity with which opioids penetrate the CNS to cause their psychoactive effects correlates with their ability to cause addiction. Opioid addicts prefer the “rush” sensation produced by the rapid onset of psychoactive effects characteristic of IV administration over the slower onset of effects produced by other routes of administration. Heroin is preferred because its high lipid solubility confers rapid penetration into the brain and an intense effect. Conversely, orally administered methadone for control of chronic pain has much less potential for creating addiction.

Addiction to opioids occurs independently from tolerance and physical dependence and is a result of an addict craving the feelings produced by opioids. This craving may even occur before, or in the absence of, the development of tolerance and dependence. The fact that discontinuance of opioids may precipitate a withdrawal syndrome may provide an incentive to continue their use, however. Because of the short duration of action of heroin, a dependent addict oscillates between feelings of euphoria and sickness related to withdrawal and exhibits drug-seeking behavior. Drug-seeking behavior is manifested by pleas, complaints, demands, and other activities directed toward obtaining the drug to alleviate the discomfort caused by drug withdrawal. An individual may become dependent on the psychological effects of opioids, however, before developing fear of withdrawal.

Patients in need of pain control should not be denied adequate opioid medication because they show evidence of tolerance or exhibit withdrawal symptoms if the medication is stopped, as these signs do not indicate addiction. In addition, a patient who is in pain and receiving opioids does not respond the same way a psychologically dependent addict responds to opioids. Patients who are able to self-administer their opioid analgesic take the drug solely to reduce the pain, do not increase the dose greatly over time, and stop administration when the pain goes away.²⁴

Toxicity

In acute opioid overdose, the classic triad of coma, respiratory depression, and pinpoint pupils is common to all opioid agonists (except meperidine, in which case the pupils may be dilated in tolerant individuals). Hypoventilation leads to marked hypoxemia and cyanosis, and acute pulmonary edema evidenced by a pink, frothy sputum may occur, especially with heroin overdose. Nausea and vomiting may be prominent. Hypotension, as a result of cerebral ischemia, develops gradually and may eventually lead to circulatory shock. Convulsions do not occur with most opioids, although they have been reported in children with codeine overdose, in addicts in response to meperidine, and in cases of propoxyphene poisoning.

The treatment of choice is rapid IV administration of 0.4 mg of naloxone, repeated if necessary at 2- to 3-minute intervals. Dramatic improvement occurs within minutes, with enhanced ventilation and dilation of the pinpoint pupils. The patient must be closely monitored because the antagonist's effect lasts only 1 to 4 hours. Monitoring is especially important with methadone overdose because respiratory depression may last 48 hours. If vital signs return to normal, no attempt should be made to arouse the patient with additional naloxone because if the patient is an opioid addict, large doses of the antagonist may precipitate an acute withdrawal syndrome.

The toxic effects of chronic abuse of opioids are minimal. Other than constipation, addicts with a stable supply of drug, individuals enrolled in a methadone maintenance program, or patients taking opioids long-term for pain control have few

difficulties as long as they continue taking the drug. Many addicts share unsterile needles and equipment, however, which increases their risk of contracting acquired immunodeficiency syndrome (AIDS), hepatitis, skin abscesses, deep infections, and endocarditis.

When the supply of an addict's preferred drug is compromised, the addict may substitute substances of unknown content and potency or drugs thought to have a similar effect. Many addicts like the effects caused by IV injection of the agonist-antagonist pentazocine with the antihistamine tripeleminamine. The talc contained in the crushed tripeleminamine tablet has caused deaths as a result of lung emboli. Overdose leading to death may occur when an addict injects a purer sample than that to which he or she is accustomed or a sample containing a much more potent opioid, such as those seen with China white in the 1980s and fentanyl in the 1990s. Unexpected toxic effects also occurred in the late 1970s and early 1980s, when “bathtub chemists” trying to synthesize potent opioids produced a compound contaminated with 1-methyl-4-phenyl-1,2,3,6-tetrahydropyridine (MPTP), which caused Parkinson-like symptoms in many young abusers (see Chapter 15). Abuse of prescription opioid analgesics has also resulted in unexpected deaths. In the late 1990s and early 2000s, deaths from overdose resulted when individuals crushed tablets of the controlled-release formulation of oxycodone to make the entire dose available for intranasal or IV administration.

Opioid withdrawal or detoxification of heroin addicts or other opioid-dependent individuals can be managed with methadone because cross-dependence exists between it and other opioids.^{36,45} Because methadone and all other opioid analgesics act at opioid receptors, methadone can be substituted for the opioid being abused without precipitating a withdrawal syndrome. By substituting longer acting methadone for a short-acting opioid such as heroin, the addict is spared the undesirable effects of withdrawal because the opioid receptor remains occupied. Methadone can be withdrawn from the addict over weeks. Methadone, with its long duration of action, produces a protracted but tolerable withdrawal syndrome.

The α_2 -adrenoceptor agonist clonidine can also be used alone or in combination with methadone to assist in the detoxification of an opioid-dependent individual. Many of the unpleasant effects experienced during opioid withdrawal, such as nausea, vomiting, sweating, tachycardia, cramps, and hypertension, are caused by hyperactivity of the autonomic nervous system. Clonidine, through its action at α_2 adrenoceptors in the brain, suppresses the outflow of sympathetic nervous system activity, reducing the discomfort of opioid withdrawal.

Although management of acute opioid withdrawal is easy, the recidivism rate (i.e., the number of addicts who return to abusing opioids) is very high. Methadone maintenance therapy can also be used in the long-term treatment of opioid abuse. The pharmacologic basis of methadone maintenance depends on its oral effectiveness, long duration of action, and the development of cross-tolerance between it and other opioids, particularly heroin. Tolerance to the effects of opioids is mediated at the cellular level and develops to any opioid acting at the same receptor.

The first step in maintenance therapy is to provide an oral dose of methadone that is not sedating but prevents signs of withdrawal. Maintenance therapy is performed at a government-regulated clinic and is feasible because of the long duration of action of methadone. Patients function normally and do not have the “rush” associated with other routes of administration. If the patient relapses into opioid abuse, the development of cross-tolerance between methadone and heroin or other agents results in a blockade or diminution of the euphoric effect of the abused substance, removing the

reinforcing properties of the abused agent. Although the patient is now dependent on methadone, withdrawal from a long-acting opioid results in a mild but protracted abstinence syndrome with delayed onset. The dose of methadone is gradually reduced until the patient is opioid-free. Methadone maintenance therapy is effective only if the patient wants to quit abusing opioids and if, over the time of the therapy, the patient breaks the psychological dependence on opioids.

In 2000, Congress passed the Drug Addiction Treatment Act (DATA), allowing certified physicians to prescribe narcotic medications for the treatment of opioid addiction. DATA produced an important paradigm shift that allowed for the treatment of addiction to opioids such as heroin to occur in physicians' offices, rather than limiting it to highly stigmatized government-regulated methadone clinics. Buprenorphine, an agent now being used under this new legislation, is a long-acting partial agonist that acts on the same receptors as heroin and morphine; it relieves opioid cravings in mildly to moderately addicted individuals and produces less respiratory depression and withdrawal symptoms than the full agonist methadone.²¹

ABUSE OF SEDATIVE-HYPNOTICS

Drugs in the sedative-hypnotic group are general CNS depressants and include sedative-hypnotic and antianxiety drugs (discussed in Chapter 13). Older sedative-hypnotic drugs, including barbiturates, glutethimide, and the widely abused but no longer approved drug methaqualone, have substantial abuse potential. Benzodiazepines and related drugs are now the most commonly used sedative-hypnotic and antianxiety drugs. Although these newer drugs have significant abuse potential, they are less frequently abused than the older sedative-hypnotic agents. Sedative-hypnotic drugs are readily available from illicit sources and by prescription abuse when large amounts of the drugs are accumulated by drug abusers visiting different prescribers.

Pharmacologic Effects

The signs of intoxication with sedative-hypnotic and antianxiety drugs are similar to signs produced by alcohol—drowsiness, impairment of motor coordination, ataxia, and slurred speech. Sluggishness, difficulty in reasoning, mood swings, and irritability are also seen. Subjective effects include sensations of well-being, euphoria, and sometimes stimulation. The next day the abuser may experience nervousness, anxiety, tremor, headache, and insomnia. The exact constellation of effects depends on the dose of the drug, the route of drug administration, the frequency of administration, and the user's expectations.

Abuse Characteristics

The degree of addiction with sedative-hypnotic drugs depends on the dose of the drug, the frequency of administration, and the duration of drug use. Sedative-hypnotic drugs differ in onset and duration of action (short-acting and long-acting barbiturates and benzodiazepines are available). Addiction is most commonly associated with abuse of short-acting drugs, such as secobarbital, pentobarbital, oxazepam, and lorazepam. Dependence on longer acting agents, such as phenobarbital and chlorthalidone, is less common.^{3,22} Dependence occurs only rarely with intravenously administered ultrashort-acting sedative-hypnotics because they cannot be taken frequently enough to maintain adequate plasma concentrations.

For benzodiazepines, drugs with a higher affinity for the BZ₂ benzodiazepine receptor subtype (e.g., alprazolam) seem to have a greater potential for abuse than drugs with a higher affinity for the BZ₁ benzodiazepine receptor.³⁰ Initial exposure to sedative-hypnotics may occur when the drug is prescribed

to relieve anxiety or insomnia. The dose is slowly increased, and the abuser may become preoccupied with obtaining and using the drug. So-called date rape drugs, such as γ -hydroxybutyrate, a metabolite of γ -aminobutyric acid, and the prescription benzodiazepine flunitrazepam ("roofies") are also subject to misuse. Both drugs have similar effects as sedative-hypnotics; however, their rapid oral absorption, onset of action, and ability to cause anterograde amnesia have resulted in their surreptitious use as sedatives to facilitate rape of unwitting individuals.

In contrast to opioids, sedative-hypnotics do not induce dependence unless increased doses of drugs are taken over a long period (≥ 1 month). The onset and severity of the abstinence syndrome also depend, in part, on the dose and the duration of drug use. Minimal withdrawal symptoms are elicited by abrupt withdrawal from chronic daily use of 400 to 500 mg of pentobarbital or secobarbital.²⁰ With chronic use of larger doses, progressively more severe symptoms of withdrawal can be precipitated, even by abruptly reducing the accustomed dose by half. Although withdrawal from daily doses of 600 to 800 mg of secobarbital after 1 month produces a minor withdrawal syndrome, withdrawal from daily doses of 800 to 900 mg after 2 months or more produces major withdrawal symptoms. Another important determinant of the onset, severity, and duration of the withdrawal syndrome is the half-life of the specific drug. Drugs with relatively short half-lives (8 to 30 hours) tend to produce a severe withdrawal syndrome that develops quite rapidly. Drugs with longer half-lives (40 to 100 hours) produce a slower onset but less severe withdrawal syndrome of long duration.

The withdrawal syndrome after cessation of sedative-hypnotics resembles that seen after alcohol withdrawal. After a usually symptomless period (8 to 18 hours after the last dose), the individual exhibits increasing symptoms of anxiety, insomnia, agitation, and confusion. Anorexia, nausea and vomiting, sweating, and muscle weakness are also seen. Coarse tremors in the face and hands; dilation of the pupils; and increases in respiratory rate, heart rate, and blood pressure may occur. Orthostatic hypotension and syncope may also occur. These symptoms become more severe during the first 24 to 30 hours of drug withdrawal. By the third or fourth day, major manifestations of abstinence may develop, which include delirium, hallucinations, agitation, hyperthermia, convulsions, and nonspecific symptoms of anxiety. Symptoms associated with benzodiazepine withdrawal also occur; these are persistent tinnitus (≤ 8 months), muscle twitching, paresthesias, visual disturbances, and confusion and depersonalization.³⁸ Reports of xerostomia and pain in the jaws and teeth have particular dental significance.⁸

Muscle fasciculations and enhanced deep reflexes may progress to frank seizures. One or more grand mal convulsions lasting less than 3 minutes may occur, with consciousness being regained within 5 minutes. In some cases, status epilepticus may ensue. The prolonged postictal stupor typical of epileptic seizures is not seen, but confusion may persist for 1 or 2 hours. Delirium develops gradually over 2 to 4 days and is heralded by a period of insomnia. Delirium is characterized by confusion, disorientation of time and place, nightmares, and vivid auditory and visual hallucinations. Paranoid delusions with extreme fear and agitation may develop, especially at night ("night terrors"). The symptoms terminate spontaneously after a prolonged period of sleep. This withdrawal psychosis may be caused by rebound rapid eye movement sleep, which, having been suppressed during the period of intoxication, intrudes into the waking state. During the phase of delirium, body temperature is elevated. A continuous marked hyperthermia is a life-threatening problem that, if not immediately and vigorously treated, may (along with agitation) lead to fatal exhaustion and cardiovascular collapse.

After the acute withdrawal syndrome, recovery is gradual but complete after approximately 8 days, although residual weakness may be noted for 6 to 12 weeks. Abrupt withdrawal from large doses of sedative-hypnotics can precipitate a severe, life-threatening withdrawal syndrome that has a significant mortality rate. The withdrawal syndrome from sedative-hypnotics may be more severe than withdrawal caused by opioids.

Tolerance develops to sedative-hypnotic drugs, and partial cross-tolerance also occurs among the various drugs in this class. Tolerance is usually complete to doses of short-acting barbiturates of up to 500 mg/day, but doses of greater than 800 mg/day are associated with signs of intoxication. The onset of tolerance to benzodiazepines in humans develops slowly, beginning in 3 to 5 days, with maximal tolerance in 7 to 10 days.³⁸ The mechanisms of tolerance to these drugs are unclear. Much of the tolerance to large doses of short-acting barbiturates is associated with hepatic enzyme induction that results in enhanced barbiturate elimination. This metabolic tolerance plays less of a role for benzodiazepines, for which cellular tolerance, a decreased responsiveness of neuronal pathways in the CNS, seems to play a more prominent role.

Toxicity

Ingestion of large doses of sedative-hypnotic drugs may be life-threatening. Coma may develop with progressive deterioration of respiration and blood pressure. The victim exhibits hypoxia, cyanosis, shock, hypothermia, and anuria. Death is usually from cerebral anoxia caused by respiratory failure. Therapy is mainly supportive, consisting of oxygen administered by artificial respiration and fluids or pressor agents (or both) to maintain circulation. For barbiturates, osmotic diuretics with sodium bicarbonate are also used to alkalinize the urine and hasten elimination of the drug. The benzodiazepine receptor antagonist flumazenil has been used specifically to block toxic effects in the treatment of acute benzodiazepine overdose.

Withdrawal from chronic therapeutic abuse of sedative-hypnotic drugs is associated with drug craving, nausea and abdominal cramps, tachycardia, palpitation, and generalized seizures. Panic attacks and disorientation may occur, progressing to paranoid psychosis with aggression, delusions, and visual hallucinations.^{8,38} Coma and respiratory depression cause a significant mortality rate. Treatment includes substitution with a long-acting sedative-hypnotic drug, such as phenobarbital, followed by a modest daily reduction in the maintenance dose.²⁶ Seizures represent a medical emergency and are treated by immediate administration of diazepam, pentobarbital, or carbamazepine. Withdrawal from sedative-hypnotic drugs should be carried out in a hospital setting because life-threatening complications may develop.

Other Sedative-Hypnotic Drugs

Various other sedative-hypnotic drugs may be classified according to chemical structure into aldehyde derivatives (chloral hydrate, paraldehyde), 1,2-propanediol carbamates (meprobamate), and heterocyclics (glutethimide, methypylon, methaqualone). All drugs in these groups produce patterns of intoxication, tolerance, dependence, and addiction that are similar to the patterns produced by barbiturates and benzodiazepines. All these drugs exhibit some degree of cross-tolerance and can suppress the abstinence symptoms of other depressants of the CNS.

ABUSE OF AMPHETAMINES, COCAINE, AND OTHER PSYCHOMOTOR STIMULANTS

Psychomotor stimulants include analogues of phenylethylamine (*d*-amphetamine and methamphetamine), a group of

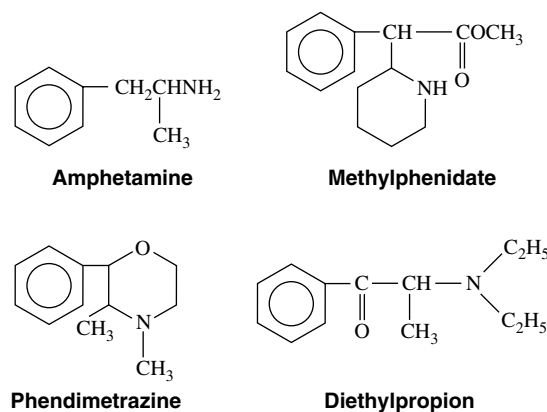

FIGURE 51-1 Structural formulas of amphetamine and related stimulant drugs.

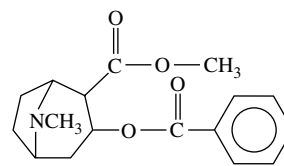

FIGURE 51-2 Structural formula of cocaine.

amphetamine derivatives in which the terminal amine nitrogen is part of a heterocyclic group (methylphenidate, phendimetrazine) or a diethylated group (diethylpropion), and cocaine. The chemical structures of some of these drugs are shown in Figure 51-1. Amphetamines and methylphenidate are generally used for treatment of narcolepsy and attention-deficit/hyperactivity disorder; phendimetrazine and diethylpropion are anorectics. These drugs are available on the street and by prescription. Cocaine is the most widely abused member of this class. The chemical structure of cocaine is shown in Figure 51-2. It has been estimated that 3 million Americans abuse the various forms of cocaine. Generally, the effects of and abuse patterns associated with the individual drugs in this group are quite similar.

Amphetamine and Related Drugs

Pharmacologic effects

Single oral doses of amphetamine and related drugs produce wakefulness, reduced fatigue and reaction times, and improved performance of psychomotor tasks, especially in sleep-deprived individuals. Feelings of enhanced well-being, moderate exhilaration, and euphoria are common. Judgment may be impaired, and irrational behavior may occur. These drugs can cause signs of increased peripheral adrenergic nerve activity, such as an increase in blood pressure, tachycardia, mydriasis, sweating, and constipation. These effects probably result from the release of norepinephrine from central and peripheral neurons or the blockade of neuronal uptake of norepinephrine at these sites. High oral doses of CNS stimulants induce feelings of cleverness, enhanced abilities, aggressiveness, and fearlessness and may cause a manic "high," paranoid rage, violent diarrhea, and vomiting.

Abuse characteristics

Patterns of oral use are usually intermittent and involve lower doses causing milder effects. Oral amphetamines have been abused by students who want to study through the night and by truck drivers who want to stay awake for long hauls. Amphetamine abusers also take these drugs intranasally, intravenously, and by smoking. IV administration of methamphet-

amine results in a markedly pleasurable rush described as an expanding, flashing, vibration feeling, or a total body orgasm. IV administration of amphetamines is more apt to promote repeated use than oral administration. Because the euphoric effect of IV methamphetamine is long, it can be injected every 3 hours to maintain its euphoric effect.

The standard hydrochloride salt form of methamphetamine can be converted into its freebase, resulting in a form of the drug called “ice” or “crank” that can be administered by smoking cigarettes laced with the drug. Smoking methamphetamine in its freebase has become the most popular abused form of this drug in recent years. Because smoking the drug is a more acceptable route of administration, the easy availability of this form of the drug has been suggested to be responsible for the more recent increase in its abuse. The onset of effects and the intensity of the euphoria produced by smoking “ice” are reported to be at least as great as those seen when methamphetamine is injected intravenously. Both chemical forms of the drug are usually taken continuously for 2 to 5 days, during which time the abuser does not sleep or eat. This is called a “run” or “binge.” The next stage is the “crash,” during which the abuser sleeps for 24 to 48 hours. This stage is often followed by hunger, depression, dysphoria, and restlessness.

The degree of addiction and abuse potential is high for all the drugs in this group. Individuals dependent on these drugs have a very strong compulsion to engage in drug-seeking behavior. Marked tolerance to the stimulant effects of amphetamine develops readily. Although the therapeutic dose of amphetamine is 10 to 15 mg, abusers may inject intravenously 2 g/day. The mechanism of tolerance is unknown but has been attributed to the depletion of central catecholamine stores with replacement by *p*-hydroxynorephedrine, a metabolite of amphetamine that may function as a false neurotransmitter in adrenergic nerves.

Dependence on amphetamine is not easily demonstrable because it may be difficult to differentiate true withdrawal symptoms from the body’s response to prolonged sleep and food deprivation and enhanced physical activity. Withdrawal from the drug after a “run” is followed, however, by a prolonged sleep and then by a ravenous appetite, fatigue, apathy, and depression. This complex of symptoms is interpreted as evidence of dependence. In humans, the depression associated with amphetamine withdrawal is correlated with a CNS reduction in 3-methoxy-4-hydroxyphenylglycol, a norepinephrine metabolite, which indicates that CNS catecholamines are depleted. This finding provides a neurochemical mechanism to explain the depression caused by drug withdrawal.

Toxicity

Acute severe overdose, although uncommon, is characterized by CNS and cardiovascular stimulation. Coma and convulsions occur, which may develop into status epilepticus. These convulsions may be controlled with IV diazepam. Cardiac arrhythmias and hypertension, occasionally precipitating subarachnoid hemorrhage or intracerebral hematomas, may lead to cardiovascular collapse. Enhanced autonomic activity, including hyperthermia and dilated pupils, may also be seen.

A chronic amphetamine abuser typically displays anxiety, akathisia, volatile mood, headaches, and cramps. In addition, the abuser frequently shows signs of mental and physical fatigue, poor personal hygiene, and facial twitching. Of particular interest to dentistry are the worn teeth and chewed tongue that result from continuous oral movements. Chronic stimulant abuse leads to stereotypy, psychosis, and overt violence. Stereotypic compulsive behavior is characterized by pleasurable curiosity and fascination with detail. Compulsive, repetitive activity develops, such as cleaning an immaculate

home or disassembling and reconstructing mechanical objects. Chronic abuse can cause a drug-induced paranoid psychosis that resembles acute paranoid schizophrenia. Psychosis may develop within 1 to 5 days after beginning drug use and usually lasts 6 to 7 days. The most common symptoms are delusions of persecution; auditory, tactile, and especially visual hallucinations; and hyperactivity. Anxiety, agitation, aggressiveness, and depression are often observed. Paranoia, hallucinations, and terror reactions lead to hostility and difficulty in controlling rage. Amphetamine abusers display a high incidence of unpremeditated, unprovoked, and bizarre acts of violence and assaultive and even homicidal behavior.

After amphetamine use is discontinued, confusion, delusions, and loss of memory may persist for several weeks or months. Treatment of toxicity is based on enhancing the elimination of the drug from the body. Acidification of the urine with ammonium chloride increases the rate of urinary excretion of amphetamine and causes rapid reduction of psychotic symptoms.⁵

Cocaine

The leaves of the coca plant, which contain up to 1.8% of the pure alkaloid, are the primary source of cocaine. The Andean Indians have chewed coca leaves, mixed with an alkaline substance to promote release of cocaine, for many years. Although peak blood concentrations of 95 ng/mL are achieved, little drug-induced euphoria is reported among Andean Indians who chew coca leaves. The leaves are used to make cocaine paste (30% to 90% cocaine), which is converted to pure cocaine hydrochloride, primarily in South America. Many samples of street cocaine apparently contain adulterants such as amphetamines, mannitol, or lidocaine. The local anesthetic procaine shares some characteristics with cocaine and can produce euphoria. Procaine powder is frequently used to cut cocaine and, mixed with mannitol or lactose, is sold as cocaine.

Pharmacologic effects

Cocaine is a local anesthetic that produces adrenergic effects by blocking neuronal uptake of norepinephrine. Pharmacologic responses to cocaine are mainly cardiovascular and are similar to those of amphetamine. Cocaine produces a dose-related tachycardia and increase in blood pressure, especially systolic. The onset of action is 2 to 5 minutes by the IV route and approximately 30 minutes by the intranasal route. In both cases the cardiovascular response dissipates over roughly 30 minutes. In IV doses of 32 mg, cocaine promotes a moderate mydriasis and hyperglycemia, but no effects on the electrocardiogram, respiratory rate, or body temperature.⁴⁷

As a recreational drug, cocaine uniformly causes euphoria and signs of CNS stimulation. The subjective effects of cocaine include elation, arousal, and alertness. Garrulousness and enhanced friendliness facilitate social interaction in group settings. Hunger and fatigue are suppressed. The user has a subjective feeling of increased mental agility. As is true of amphetamine, performance may be enhanced in sleep-deprived, but not in rested, subjects. Cocaine can delay ejaculation, which together with heightened sensory awareness and elevated mood, enhances the sexual experience. The orgasmic rush produced by IV cocaine use may become a substitute for coitus. This essentially pleasant high is produced by doses of about 100 mg, 25 mg, and 10 mg of cocaine by the oral, intranasal, and IV routes, respectively.⁴⁷

Negative subjective effects occur in 3% of intoxications in the early stages of abuse, but occur in 82% of compulsive cocaine abusers. The euphoric effects of the drug are followed by restlessness, irritability, and psychomotor agitation. Hyperexcitability and paranoia may occur. Chronic, high-dose cocaine abuse may result in aberrant sexual behavior, such as

marathons of promiscuity. Men may have reduced libido, with an inability to maintain an erection or to ejaculate. Women may be unable to achieve orgasm.¹⁴

Abuse characteristics

Although ingested cocaine can have stimulant effects, it is rarely taken orally. The intranasal route ("snorting") is more commonly used by cocaine abusers. Cocaine hydrochloride usually is inhaled as a "line" of powder containing 20 to 30 mg of the drug. It produces a maximum effect in 15 to 20 minutes and a duration of effect lasting 1 hour or more. Nasal mucosal vasoconstriction and paralysis of membrane cilia prevent complete absorption by this route, and measurable cocaine remains on the nasal mucosa for 3 hours after use. Snorting of cocaine in solution produces effects in 5 to 15 minutes that last 2 to 4 hours. The euphoric effect of cocaine is less intense when the intranasal route is used compared with IV injection or smoking the drug.

When cocaine is injected, the IV route is preferred over the intramuscular or the subcutaneous route because local vasoconstriction delays the onset of action by the latter routes. IV injection produces an intense orgasmic rush in approximately 1 minute that lasts 30 to 40 minutes. Abusers average 16 mg of cocaine per injection in a recreational setting. Cocaine is also used intravenously with heroin. The mixture, referred to as a "speedball," is used to attenuate the excessive stimulation caused by large doses of cocaine.

The smoking of cocaine requires conversion of the hydrochloride salt of the drug to the freebase form. The salt form, when heated, decomposes before the vaporization temperature is reached. The freebase volatilizes at temperatures of approximately 90° C and is not destroyed by heating. Smokers may manufacture their own freebase by dissolving the salt in an alkaline solution and extracting the alkaloid with a solvent such as ether. Since the mid-1980s, the freebase form has become commonly available as "crack," a form of freebase melted down into crystalline balls that can be smoked. Crack may be smoked in cigarettes or by heating with an alcohol flame in a pipe. Because the lung-brain circulation time is only 8 seconds, and the inhalation route bypasses the liver, the effects of smoking cocaine base are just as rapid and intense as IV cocaine and last approximately 20 minutes. Smokers average 100 mg of base with each smoke, increasing to 250 mg with rapid tolerance development. Smoking may be repeated every 5 minutes, with intake in compulsive abusers totaling 1.5 g/day. Smoking freebase cocaine has become the most popular method for administration of this drug, and similar to methamphetamine freebase, the freebase form of cocaine has contributed significantly to the increase in its abuse.

Used intranasally as a low-dose recreational drug, cocaine produces moderate addiction. High-dose IV or inhalation use produces compulsive behavior characterized by loss of control over drug use and an inability to stop the drug despite repeated attempts. Cocaine shares with other addictive drugs a reinforcing property that results in rapid acquisition of self-administration behavior. This reinforcing property may result from activation of a CNS dopaminergic reward system with cell bodies located in the ventral tegmentum projecting to the nucleus accumbens. Cocaine enhances dopaminergic activity at the latter site by blocking dopamine uptake by nerve endings. This endogenous reward system is normally activated by responding to physiologic imperatives such as hunger, thirst, and sex drive. Cocaine directly stimulates this reward circuitry, dominating motivation for essential physiologic needs. Rats given free access to IV cocaine take the drug in preference to food and die of starvation in a few weeks.

Significant tolerance does not develop with occasional cocaine use because of the short half-life of the drug. Frequent use resulting in constant cocaine concentrations in the body

does cause tolerance, however. Acute tolerance to subjective and cardiovascular effects is observed within 1 hour after repeated IV doses. Dependence occurs primarily in compulsive, high-dose cocaine abusers. With chronic cocaine use, CNS dopamine depletion may occur, resulting in adverse symptoms during periods of abstinence. Withdrawal results in depression, dysphoria, social withdrawal, craving for the drug, appetite disturbances, tremor, and muscle pain. Such withdrawal phenomena may be severe enough to prevent some abusers from stopping the drug, even though toxic delirium may develop with continued drug use. Oral diazepam has been useful in treating withdrawal anxiety; psychotherapy or cautious use of tricyclic antidepressants is recommended for prolonged depression.

Toxicity

Medical complications of cocaine abuse most often involve the CNS and the cardiovascular system.¹⁴ The CNS effects include a toxic psychosis, similar to that caused by amphetamine, which often develops in chronic, heavy abusers of cocaine. The syndrome is characterized by intense anxiety, inability to concentrate, stereotyped compulsive behavior, paranoid delusions, and violent loss of impulse control. Hallucinations may develop that are typically tactile, with sensations of insects burrowing under the skin or snakes crawling over the body. Such psychotic crises are reported in 10% of intoxications in compulsive abusers. Acute depression with suicidal ideation also may develop. Longer term personality changes include a tendency to paranoia with features of depression, reduced frustration threshold, difficulties in impulse regulation, and social maladjustment.

Cardiovascular complications of cocaine include cardiac arrhythmias, with sinus and ventricular tachycardia, ventricular fibrillation, and fatal cardiac arrest. Acute myocardial infarction is a particular hazard among abusers with preexisting coronary artery disease because of the increased systolic blood pressure, heart rate, and myocardial oxygen consumption engendered by cocaine.²⁵ Abrupt increases in arterial blood pressure, occurring within minutes of intranasal use of cocaine, have resulted in subarachnoid hemorrhage, particularly in individuals with aneurysms of cerebral vessels. One case of fatal rupture of the ascending aorta was reported in an individual with preexisting chronic hypertension who had smoked freebase cocaine. Acute cardiac events may occur even with recreational intranasal use of cocaine in individuals without predisposing cardiac disease.²⁹

Hepatotoxicity, with clinical findings of elevated titers of serum transaminases and jaundice, has been reported in chronic cocaine abusers. Such liver damage may occur in plasma cholinesterase-deficient individuals, in whom cocaine metabolism is shunted through hepatic oxidative pathways, resulting in the production of cytolytic superoxides.³⁴ A significantly increased rate of spontaneous abortion has been noted in pregnant women. Because cocaine can cross the placental barrier, infants born to cocaine abusers may exhibit tremulousness. Frequent intranasal use leads to chronic rhinitis and rhinorrhea, atrophy of the nasal mucosa, loss of sense of smell, and necrosis and perforation of the nasal septum. These changes, occurring as a result of chronic ischemia, should alert the clinician to possible intranasal cocaine abuse. Bruxism and temporomandibular joint disorders are also more frequent in cocaine abusers.

Death from cocaine overdose usually is attributable to generalized convulsions, respiratory failure, or cardiac arrhythmias. Deaths have occurred with each route of cocaine administration and may be so rapid that treatment comes too late. Because cocaine is metabolized by plasma esterases, individuals with low cholinesterase activity are at high risk of cocaine fatality.¹⁴ Treatment of cocaine overdose is symptomatic.

CNS stimulation can be treated with IV diazepam, ventricular arrhythmias can be treated with IV lidocaine, and respiratory depression can be treated with oxygen and positive-pressure ventilation.

ABUSE OF HALLUCINOGENS

Hallucinogens are defined as drugs that alter perception, mood, and thought without changes in consciousness or orientation. These drugs are also referred to as *psychotomimetics* because some of their effects mimic naturally occurring psychoses or as *psychedelics* because of their use by some people to induce mystical experiences. These drugs are claimed to provide the abuser with enhanced insight and self-knowledge, leading to new ways of looking at life and new insights into personal relationships.

Psychedelic Hallucinogens

Psychedelic hallucinogens can be divided into different chemical classes. The chemical structures of some psychedelic hallucinogens are shown in Figure 51-3. The lysergic acid derivative LSD is a semisynthetic chemical that does not occur in nature. LSD is a commonly used hallucinogen and has become the standard with which other hallucinogenic substances are compared. Drugs derived from tryptamine include the synthetic compound dimethyltryptamine and its derivative, psilocin, and the naturally occurring phosphorylated form of psilocin, psilocybin. The third class of hallucinogens includes amphetamine analogues such as MDMA and mescaline. Mescaline and psilocybin produce effects that are nearly the same as those produced by LSD. MDMA has stimulant effects similar to those of amphetamine and some psychedelic effects similar to those of LSD. Because MDMA possesses mild psychedelic and stimulant properties, it has become popular in club or dance settings, where it can enhance the light and sound experience and enable users to dance vigorously for extended periods. Under these conditions of prolonged physical exertion, MDMA can cause dangerous levels of dehydration and hyperthermia.

Pharmacologic effects

Symptoms associated with the LSD experience occur sequentially, with somatic symptoms developing first, followed by perceptual and mood changes, and then by psychic or psychedelic phenomena.⁵⁰ Within a half hour of ingestion of LSD, a feeling of inner tension develops, accompanied by somatic symptoms of mild sympathetic stimulation and motor alterations. The individual feels dizzy, weak, vaguely numb, and nauseated. Marked mydriasis is accompanied by an increase in blood pressure and pulse rate, tremor, hyperreflexia, and, at high doses, ataxia. These somatic effects are soon sub-

merged by perceptual and psychic effects, which begin approximately 45 minutes after the drug is taken. Some individuals experience euphoria, elation, serenity, or ecstasy, whereas in others the initial tension may progress to anxiety and depression, evoking a panic reaction. A paranoid rage reaction occasionally occurs, although most subjects tend to be passive, quiet, and withdrawn.

Abuse characteristics

The subjective effects of LSD are highly dependent on the psychological makeup of the individual, the environmental influences at the time of the drug experience, the expectations of the individual, and the size of the dose. Distortion of sense perception is the most specific symptom of the LSD experience, affecting all modalities but especially vision. Colors seem unusually bright and vivid, and objects appear distorted and seem to undulate and flow. Fixed objects appear to shift from near to far; fine surface details appear in deep relief; and colorful, dreamlike images occur as vivid streaming filmstrips even with the eyes closed. Frank visual hallucinations are rare, but visual illusions are common, as when a spot on the wall is mistaken for a face. There are distortions of body image, enhanced auditory perception, and, more rarely, alteration of other sensory modalities. Time sense is distorted; it is often described as stopping or going backward. Synesthesias are common, so that music may be experienced visually, or colors may be "heard."

The changes in sensory perception are soon followed by the psychedelic "trip." Subjects may experience depersonalization, and the separation between the self and the environment melts away. The user has a sense of profound insight, revelation, and expanded consciousness. This loss of self is interpreted as a "good trip" by psychedelic drug abusers, but occasionally loss of control and fear of self-disintegration foster panic and even attempts at self-destruction. The individual remains oriented and alert throughout the experience and often remembers all events during the "trip" even months later.

In general, use of these drugs is not associated with marked dependence, and no clear withdrawal syndrome has been reported. If addiction develops at all, it is mild and infrequent. Tolerance to the effects of LSD is not common but has been reported, and cross-tolerance is seen among members of the psychedelic hallucinogens. With repeated use, tolerance to LSD develops within 1 week but lasts only a few days after discontinuance of the drug.

Toxicity

The adult human lethal dose of LSD has been estimated to be 2 mg/kg, although no deaths caused directly by LSD overdosage have been reported. Adverse psychological reactions to hallucinogens are common.⁵¹ Panic reactions or "bad trips"

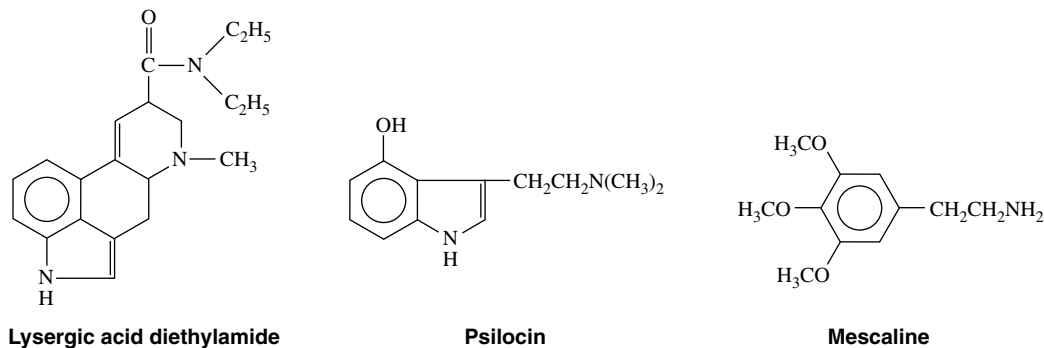

FIGURE 51-3 Structural formulas of representative hallucinogenic drugs.

are relatively frequent and are related to an overdose of the drug. Often, companionship and reassurance, or “talking down,” is sufficient to control this reaction; if this is insufficient, other treatments include sedation with oral diazepam. Acute depression or psychotic reactions can also occur. Ingestion of 50 mg results in hyperactivity, psychosis, amnesia, upper gastrointestinal tract bleeding, and coma.

Approximately 1 in 20 LSD abusers has “flashbacks,” in which episodic visual disturbances resembling previous LSD experiences occur during abstinence from the drug.² This alteration is now called *hallucinogen persisting perception disorder*.⁴ This disorder may occur months after the previous trip and last a few minutes to a few hours. It is thought to be caused by a drug-induced permanent change in the visual system. This disorder is treated in the same way as panic reactions. In addition, prolonged psychotic states may be precipitated by LSD use, requiring long-term hospitalization and treatment with antipsychotic drugs.⁴¹

Deliriant Hallucinogens

The ketamine derivative phencyclidine, also called PCP or “angel dust,” is a synthetic drug that produces a unique state characterized by delirium, hallucinations, insomnia, and agitation. PCP produces what is called a “dissociative state” because it is said to dissociate the mind from the body without loss of consciousness. The drug was investigated in 1958 as an anesthetic in humans, but was subsequently abandoned because of severe postanesthetic dysphoria and hallucinations. Derivatives of PCP, such as thienyl and N-ethyl analogues, are also available on the street. The chemical structure of PCP is shown in Figure 51-4.

Pharmacologic effects

To produce its effects, PCP binds to receptors in the CNS that are associated with the N-methyl-D-aspartate acid (NMDA) type of glutamate receptor. NMDA receptors mediate some of the CNS effects of the excitatory amino acid glutamate. The PCP binding site resides within the NMDA-gated Ca^{++} channel complex, where PCP acts as a noncompetitive antagonist at the NMDA receptor and inhibits some of the CNS effects of glutamate. Receptors that bind PCP have been identified in the CNS in the limbic system and frontal cortex, areas involved in memory, emotion, and behavior. PCP has also been reported to cause dopamine release and to inhibit the active reuptake of dopamine into dopaminergic nerves. This inhibition enhances and prolongs the effects of dopaminergic nerve stimulation.

With lower doses, PCP abusers usually remain alert and oriented, while exhibiting euphoria, agitation, or bizarre behavior. Individuals may be irritable or mute and rigid, stare suspiciously, and exhibit impaired reasoning. They are easily provoked to anger and may exhibit violent behavior. The dissociative state, coupled with effects on limbic-mediated emotional control, may provoke feats of superhuman strength, causing harm to self and others. Inappropriate behavior, such as strolling down a street nude, may occur.⁵¹ Detachment, disorientation, stupor, and coma may also occur, but are more common at higher doses.

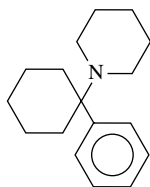

FIGURE 51-4 Structural formula of phencyclidine.

Abuse characteristics

Currently, the most common route of administration of PCP is by smoking, in which the drug is mixed with tobacco or marijuana. At the burning tip of a cigarette, PCP is converted to 1-phenyl-1-cyclohexene (PC), which is largely inactive. In smoking PCP cigarettes, approximately 40% of the dose is received by the smoker as PCP and approximately 30% as PC. Some abusers snort PCP powder or ingest it mixed with alcoholic beverages or in pill form. A small percentage of abusers inject the drug intravenously. Urine and serum concentrations of PCP do not correlate with the state of intoxication. PCP disappears from urine 2 to 4 hours after a single use (largely because of sequestration in fatty tissues), but it may be detected in the urine of chronic abusers for 30 days.^{13,49}

Most PCP use is intermittent rather than chronic. Some PCP abusers develop addiction to the drug, although this is less common than with the drugs of abuse previously discussed. No clearly defined dependence on PCP has been identified, but withdrawal from chronic use has been reported to result in depression, irritability, confusion, and sleep disturbances along with a strong craving for the drug.

Toxicity

Symptoms of acute intoxication appear 15 to 30 minutes after ingestion. Marked analgesia, shivering, salivation, bronchospasm, urinary retention, hypertension, tachycardia, and hyperpyrexia result. Nystagmus is observed in approximately two thirds of intoxications. Grimacing, localized dystonias, and tremor may progress to grand mal seizures or status epilepticus at doses greater than 70 mg, which also produce deep and prolonged coma with loss of protective reflexes that may last for 1 week or more. Death has been attributed to intracranial hemorrhage, status epilepticus, and respiratory failure. Life-threatening hyperthermia may also develop, sometimes in association with hepatic necrosis. Individuals under the influence of PCP act violently with some regularity, and accidents, including drownings, have been documented in many cases. Acute treatment centers on acidification of the urine to hasten renal excretion of PCP. IV diazepam is used to control seizures and the agitated or excited state caused by the drug. Prolonged psychotic episodes may require treatment with antipsychotic drugs.

ABUSE OF MARIJUANA

Marijuana is ground-up leaves and flowers from the hemp plant, *Cannabis sativa*, and is one of the most frequently abused drugs in the United States. A cannabinoid known as Δ -9-tetrahydrocannabinol (THC) (Figure 51-5) seems to be the main psychoactive ingredient. Preparations of marijuana vary widely in their THC content, depending on the variety and part of the plant used and the environment in which the plant is raised. Stalk fibers from any variety of hemp contain no psychoactive agents,⁴⁶ and the type of hemp plant from which stalk fibers are used commercially in the production of rope, twine, cord, and clothing is virtually drug-free because

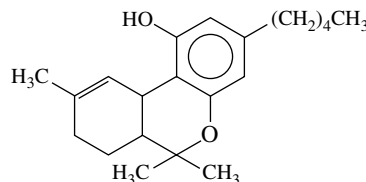

FIGURE 51-5 Structural formula of Δ -9-tetrahydrocannabinol.

it is grown under conditions that favor high fiber and low THC content. Conversely, more potent samples of marijuana are made from the younger, topmost leaves of hemp varieties that can contain approximately 5% THC by weight. Another component of the *C. sativa* plant that is commonly abused is an extract called *hashish*. In contrast to marijuana, which is ground-up plant material, hashish is an extract containing only the THC-rich resin that is secreted by the hemp plant. Hashish is more potent than marijuana, and it can contain 12% THC by weight. Marijuana and hashish are usually smoked in the form of cigarettes or from a pipe.

Pharmacologic Effects

Early theories on the mechanism of action of THC in causing effects in the CNS suggested that THC interacted with the lipid component of neuronal membranes affecting their permeability to crucial ions. With the identification¹⁶ and cloning⁴⁰ of a cannabinoid receptor and the discovery that an arachidonic acid derivative, anandamide, may be the endogenous ligand for the cannabinoid receptor,¹⁷ it is now agreed that THC acts stereospecifically with a G protein-coupled, transmembrane-spanning receptor. Although the physiologic role of the cannabinoid receptor and its putative ligand remains undefined, these receptors are located in the cerebellum, hippocampus, and basal ganglia.²³

Intoxication with marijuana is unique, causing changes in mood, motivation, and perception that are similar to some of the effects caused by amphetamines, LSD, alcohol, sedative-hypnotics, and opioids. Within minutes of inhaling marijuana smoke, the typical abuser reports feelings of euphoria, uncontrollable laughter, depersonalization, alterations in judgment of time and space, and sharpened vision. Mild visual hallucinations may occur, particularly when the eyes are closed. Similar to LSD, the abuser knows that these visual disturbances are drug-induced. Later, the abuser experiences generalized feelings of well-being, relaxation, and tranquillity that may last 2 to 3 hours. The abuser experiences a reduction in attention span, difficulty in thinking and concentrating, and impairment of short-term memory. All these effects are considered desirable by the abuser and are described as “mellowing out.” Many abusers report that the feelings of intoxication, dreaminess, and sedation can be more easily suppressed voluntarily than the equivalent effects produced by alcohol. The sedative-hypnotic property of marijuana facilitates the onset of sleep and resembles the effects caused by CNS depressants. This property of marijuana is in sharp contrast to the effects of LSD and other hallucinogens. Although it is generally agreed that a dose-related impairment in psychomotor performance occurs, many experienced abusers exhibit no such decrement in their performance; perhaps this is why no clear correlation has been shown between blood concentrations of THC and an individual’s ability to drive a car.²⁷

Physiologic effects of smoking marijuana occur within a few minutes, peak in their action in approximately 20 minutes, and wane over 2 to 3 hours.¹¹ Moderate marijuana use causes reddening of the eyes in association with a euphoric high that is followed by drowsiness.^{18,27,42} Autonomic effects of marijuana include xerostomia, tachycardia, reduced peripheral resistance, and in large doses, orthostatic hypotension.⁴² These effects may be deleterious in individuals with ischemic heart disease or cardiac failure.²⁷ Marijuana does not affect respiratory rate, blood glucose concentrations, or pupillary diameter⁴²; however, marijuana does reduce intraocular pressure.

Studies of the potential therapeutic uses of dronabinol, the nonproprietary name of THC, show it to be effective in treating some conditions. Oral administration of dronabinol has been approved as an antiemetic in cancer patients under-

going chemotherapy and as an appetite stimulant in patients with weight loss resulting from AIDS-related anorexia. Smoking marijuana may also have beneficial effects in the treatment of weight loss in patients with AIDS. Whether smoking marijuana has an advantage over orally administered dronabinol in the treatment of AIDS-related anorexia remains to be determined. Although THC is effective in reducing intraocular pressure in patients with glaucoma, its psychoactive properties make THC less desirable than other forms of drug therapy for this indication.

Abuse Characteristics

In humans, the development of tolerance to marijuana is most apparent among heavy chronic abusers and is evidenced by increases in the amount of drug used over time. Although chronic use of marijuana has a long history, whether dependence on marijuana develops in humans remains controversial. Abrupt withdrawal of marijuana from chronic abusers has been reported to cause sleep disturbances, decreased appetite, nausea, and vomiting.⁴² Whether these alterations in normal function are alleviated by the readministration of marijuana has not been shown, and this is necessary to prove that constant exposure to marijuana causes the development of dependence. Although the magnitude of addiction to marijuana is difficult to quantify, marijuana clearly possesses some abuse potential because it is the most commonly used illegal drug in the United States. Perhaps the lack of understanding of the abuse potential of marijuana is related to the fact that few individuals ever seek treatment for marijuana addiction, combined with the knowledge that the extensive and frequent use of this drug has led to few reports of severe toxicity.

Toxicity

Although few reports exist of adverse effects caused by acute administration of marijuana, the most common adverse reaction usually seen in naïve abusers is an acute nonpsychotic panic reaction characterized by anxiety and fear of losing one’s mind. Many inexperienced elderly abusers interpret the THC-induced tachycardia combined with the psychological effects of THC as evidence that they are dying. Both of these conditions are best treated with authoritative reassurance or anti-anxiety agents of the benzodiazepine class. Very high doses of THC may result in self-limiting toxic delirium, acute paranoia, and psychotic episodes.

Chronic use of marijuana seems to cause no functional changes in the CNS; however, heavy smokers may be prone to chronic bronchitis, airway obstruction, poor dentition, and squamous cell metaplasia (similar to smokers of tobacco). Contamination of marijuana with *Aspergillus*³³ or the herbicide paraquat can lead to severe pulmonary damage in abusers. Chronic, intensive use of 5 to 18 marijuana cigarettes weekly is reported to reduce testosterone concentration and cause oligospermia in men.³⁵ Other studies of shorter exposures to marijuana have not confirmed these findings, although they do show that secondary sexual characteristics in very young abusers can be suppressed by marijuana.²⁷ Teratogenic effects of THC are known to occur in animals; no such reports exist for humans smoking marijuana. Anecdotal reports suggest marijuana use produces an amotivational syndrome, which is described as an affliction of young abusers of marijuana who drop out of social activities and show little interest in school, work, or other goal-directed activities. Laboratory studies and cross-cultural analyses of marijuana smokers in countries where marijuana use is acceptable do not support the contention that THC use leads to psychosocial deterioration.³⁹ Others have suggested that the lifestyle and goals of an abuser of any kind of illicit drug may more satisfactorily explain the amotivational syndrome.

ABUSE OF INHALANTS

Modern awareness of the consciousness-altering effects of inhaled compounds began with the discovery of anesthetic agents such as ether, chloroform, and nitrous oxide in the early nineteenth century. Today this list also includes halothane and other halogenated compounds. The use of general anesthetics is discussed in Chapter 18. Although nitrous oxide, halothane, and other volatile anesthetics are usually available only to medical or health care personnel, nitrous oxide can also be found in restaurant supply stores as a propellant for making whipped cream and packaged in small metal canisters called whippets. Although ether and chloroform are no longer used as anesthetics, they are available through chemical supply houses.

In addition to volatile anesthetics, three other main classes of inhalants are subject to abuse. The first are volatile solvents, which include glue, paint thinners, cleaning fluids, degreasers, and gasoline. The generalized depressant effects on the CNS caused by these solvents are mediated by ingredients such as trichloroethylene, benzene, toluene, naphthalene, hexane, heptane, and acetone. This class of inhalants is widely abused because of ready availability.

The second class of inhalants includes aerosol propellants such as methanol, ethanol, and isopropanol used in spray paint and cooking sprays. Trichlorofluoromethane and other fluorocarbons used as refrigerants may also be abused. The alcohols are less rewarding than other volatile solvents, and ethanol is more prone to be abused by the oral route of administration.

The third class includes organic nitrites, which include amyl, butyl, and isobutyl nitrite. Amyl nitrite is used as a vasodilator in the treatment of angina pectoris (discussed in Chapter 26) and is packaged in mesh-enclosed glass ampules designed to be crushed between the fingers, allowing for inhalation of the vapors for relief of the pain of angina. Amyl nitrite ampules are commonly referred to as “poppers” because of the popping sound resulting from their being broken. Amyl nitrite and isobutyl nitrite are perceived to be sexual enhancers, which increases their abuse potential. Although amyl nitrite is available only by prescription, isobutyl nitrite is used as a room deodorizer and can be purchased from shops that sell drug paraphernalia under the names “Locker Room,” “Doctor Bananas,” and “Rush.”

Pharmacologic Effects

With the exception of the organic nitrites, all the abused inhalants have a generalized depressant effect on the CNS similar to that of volatile general anesthetics. Low doses of these agents first produce signs of stimulation followed by depression, unconsciousness, and, with larger doses, death. The desirable effects of these compounds—euphoria, perceptual distortions, ataxia, giddiness, and slurred speech—occur within seconds of inhalation and last 5 to 45 minutes. Undesirable effects may be experienced during use and for variable periods afterward and include coughing, vomiting, rhinitis, photophobia, irritation of the eyes, tinnitus, nausea, and sneezing. The vasodilatory action of the organic nitrites is immediate and produces a feeling of warmth and lightheadedness that is commonly referred to as a “head rush.” The “head rush” is brief and is considered desirable; however, it may result in loss of consciousness as a consequence of postural hypotension if the drug is inhaled while standing. Headaches commonly occur after use of organic nitrites and are caused by vasodilation of cerebral blood vessels.

Abuse Characteristics

The euphoria, disinhibition, and general feelings of drunkenness are thought to be the reinforcing characteristics of inhaled

CNS depressants; abusers take these agents repeatedly, suggesting addiction to them. Few controlled studies have been performed on the development of tolerance to solvents, aerosols, and nitrites. Because solvents, aerosols, ethanol, barbiturates, and benzodiazepines share many of the same pharmacologic effects, however, considerable interest remains in whether cross-tolerance exists among these agents. There is little evidence that signs of abstinence occur in individuals when inhalants are withdrawn, suggesting that dependence is not part of the experience of these abusers.

Toxicity

Ascribing the toxic effects of an abused inhalant to an individual agent is difficult because the toxic effects of inhaled solvents and aerosols may be caused by more than one substance and because solvents typically contain several volatile compounds or may be tainted with heavy metals such as lead and cadmium. The major health risks associated with acute use of anesthetic gases and volatile liquids are sudden death from asphyxiation, respiratory depression, or arrhythmia-induced cardiopulmonary arrest. Halogenated hydrocarbons, such as trichloroethylene, are particularly likely to cause arrhythmias.

Repeated abuse of inhalation agents may lead to toxic effects caused by chronic exposure. Industrial solvents are known to cause liver and kidney damage, sensory and motor neuropathies, bone marrow suppression, and pulmonary disease. The toxic effects of chloroform on the liver and kidney are so well known that chloroform has not been used as an anesthetic for decades and has been eliminated from commercially available products. Continuous exposure to nitrous oxide can cause megaloblastic anemia, methemoglobinemia, and, rarely, peripheral neuropathy. In industrial settings where chronic exposure to organic nitrites occurs, cases of methemoglobinemia have been reported; however, this is rare in abusers of these compounds.

POLYDRUG ABUSE

Drug abuse problems are often compounded by the practice of taking two or more drugs in combination or in sequence. Polydrug abusers may seek additive or potentiated effects (e.g., the simultaneous use of alcohol and another sedative) or the modulation or termination of effects (e.g., the sequential use of amphetamines and barbiturates). Approximately 20% of chronic alcoholics abuse other drugs, especially barbiturates, anti-anxiety drugs, and marijuana. Primary heavy abusers of marijuana frequently use amphetamines or psychedelic agents, whereas heroin addicts are particularly apt to abuse amphetamines, cocaine, hallucinogens, and barbiturates. Most patients in methadone maintenance programs apparently are polydrug abusers. When multiple drug dependencies develop, the withdrawal syndrome becomes difficult to treat and is associated with a significantly enhanced mortality rate.

IMPLICATIONS FOR DENTISTRY

Certain signs may alert the dentist to the possible parenteral abuse of drugs. Telltale cutaneous lesions may result from chronic hypodermic administration of drugs of abuse. These lesions include acute septic complications, such as subcutaneous abscesses, cellulitis, and thrombophlebitis, and chronic cutaneous complications, including skin tracks and infected lesions, which occur most commonly in the thigh or antecubital or deltoid regions. Skin tracks result from frequent, multiple injections that produce chronic tissue inflammation.

These are typically linear or bifurcated erythematous lesions that become indurated and hyperpigmented. Another sign that may alert the clinician to the problem of drug abuse is the presence of an ill-defined febrile illness. This finding often reflects a low-grade bacteremia resulting from the injection of drugs.

In ascertaining whether a patient is abusing drugs, the dentist cannot depend on being able to identify a particular personality type, recognize cutaneous lesions (which may be concealed under clothing), or diagnose a mild febrile illness. Rather, the dentist must rely on careful and thorough questioning of the patient and on the skillful use of a well-designed medical history questionnaire. Drug abuse is a subject of considerable importance to dentists because they are occasionally the unwitting target or victim of drug abusers' need to secure drugs. Also, drug abuse among health professionals has a long history, numerous medical and dental abnormalities are associated with drug abuse, and interactions may occur between drugs that dentists customarily prescribe and drugs the patient is abusing.

Dentists as a Target of Drug Abusers

Inevitably, drug abusers, through pretense and subterfuge, attempt to obtain drugs from dentists. The dentist should be aware of any patient who complains of pain from pulpitis or an abscess and who refuses endodontic or surgical intervention. An opioid abuser may claim to be allergic to codeine or pentazocine in an effort to obtain more positively reinforcing drugs, such as meperidine, morphine, or hydrocodone.¹ As a general defense against drug abusers, the dentist should never let patients know where such drugs are kept, never leave prescription pads out where they may be taken, and avoid the use of prewritten prescription forms.

Drug Use Among Dentists

Dentists are not immune to the hazards of drug abuse. Similar to physicians, they may be in greater danger of developing drug dependencies than the general population because of the ready accessibility of opioid analgesics and sedative-hypnotic drugs. Opioid addiction among medical personnel is much higher than that of the general population. One form of drug abuse common among dentists and other health professionals is the inhalation of nitrous oxide. Evidence suggests that the pleasurable effects of nitrous oxide inhalation can lead to a craving for the drug in some individuals.⁹ The abuse potential of nitrous oxide coupled with the ease of availability of the drug contributes to its relatively frequent abuse by dentists.

Medical and Dental Complications of Drug Abuse

The most common and serious medical complications in drug-abusing patients are AIDS, endocarditis, and hepatitis. IV drug abusers are at risk of AIDS. Sharing needles for IV injections spreads the AIDS virus. IV drug abusers are responsible for a significant number of AIDS cases among heterosexuals.

Bacterial endocarditis in drug abusers is most commonly caused by *Staphylococcus aureus*, which seems to derive from an increase in endogenous pathogens in the addict rather than from contaminated drugs or drug paraphernalia. In drug-abusing patients, the disease often affects the tricuspid valve, which is unusual in nonabusers. *Pseudomonas* endocarditis, although less common, primarily involves the tricuspid valve and has an overall mortality rate of 50%. *Candida albicans* infects the left-sided valves and is almost invariably fatal. Candidiasis may be disseminated to skin, eyes, bones, or joints.

Viral hepatitis is often seen among drug abusers and is probably transmitted by contaminated needles. The disease is usually mild, but individuals displaying early signs of elevated prothrombin time, fever, elevated leukocyte count, or enceph-

alopathy have a poor prognosis. In 50% to 80% of cases, the acute infection results in chronic inflammatory hepatic disease.

Opioid drugs have been reported to depress the immune system by interacting with opioid receptors on T lymphocytes and leukocytes. Other drugs of abuse have also been suggested either to suppress or to enhance the activity of the immune system. Whether the development of infectious diseases in drug abusers is caused by a direct effect of these drugs on the immune system is unknown.

Specific dental complications of drug use include rampant caries and rapidly progressing periodontal disorders, probably resulting from nutritional deficiencies and neglect of personal hygiene. Xerostomia with an enhanced rate of dental caries has been reported in individuals who abuse opioids, amphetamines, sedative-hypnotic drugs, and marijuana. In other studies, opioid and marijuana use do not seem to reduce the rate of salivary secretion, however.^{19,48} Self-mutilation has occurred among drug abusers; teeth may be deliberately damaged in an effort to obtain drugs. Long-term cocaine and amphetamine abusers may develop facial tics and bruxism, which result in a traumatized tongue and worn teeth.¹² These subjects may also chronically rub the tongue along the inside of the lower lip, producing ulcers on the abraded tissues.¹²

Drug Interactions in Drug Abuse

Drug interactions in drug abusers are not unique, but depend on the drug of abuse.¹⁵ Barbiturates and other sedative-hypnotic drugs induce hepatic cytochrome P450 enzyme activity. Abusers of such substances may be resistant to the therapeutic effects of corticosteroids, oral anticoagulants, and many CNS depressants because the metabolism of these drugs is enhanced by enzyme induction. Opioid abusers generally show tolerance to other opioid analgesics. The dentist should beware of giving pentazocine to such patients because this and other agonist-antagonists may precipitate an acute withdrawal syndrome in opioid-dependent patients. Marijuana may intensify CNS depression produced by barbiturates, general anesthetics, and other CNS depressant drugs. The sympathomimetic effects of cocaine, amphetamine, and marijuana may be enhanced by drugs used in dental practice. Administration of local anesthetics containing epinephrine or gingival retraction cords impregnated with epinephrine may enhance tachycardia and elevations in blood pressure caused by these drugs.

Pain Control and Drug Abusers

Drug abusers may be more anxious and fearful of dental procedures and may have a lower pain tolerance than patients who do not abuse drugs. To counteract these fears, abusers may take their favorite drug of abuse before dental appointments. If the dentist knows that the drug abuser has taken such a drug, the dental procedure should be rescheduled, and the patient should be counseled to avoid drug use before the next visit. Complicating this picture is that tolerance to sedative drugs and local anesthetics has also been reported, particularly in parenteral drug abusers. These patients may need larger amounts of these drugs for pain-free dental treatment. Larger doses of sedatives and local anesthetics carry the risk of enhanced adverse effects caused by these drugs.

Treatment of pain and anxiety in a recovering or reformed substance abuser presents a problem to the dentist.⁹ Whether the patient has abused alcohol or other drugs in the past, proper dental care demands a preoperative evaluation of the patient's personal attitude toward drug treatment. Many of these individuals refuse mood-altering drugs, and such wishes must be respected. As a rule, it is best never to administer a drug, or another of its class, that has previously been abused by the patient. In cases in which anxiety is predominantly somatic (e.g., tachycardia, breathlessness, and tremulousness),

oral propranolol may be valuable. Intraoperative pain control can be accomplished with local anesthetics, but systemic exposure to epinephrine should be minimized in patients being treated with neuronal uptake pump inhibitors such as desipramine for postdependence depression. Postoperative pain can usually be adequately controlled with nonsteroidal anti-inflammatory drugs.

CITED REFERENCES

- Abbott L: Don't be deceived by a drug addict. *Am Med Assoc News* 19:1-4, 1976.
- Abraham HD, Aldridge AM: Adverse consequences of lysergic acid diethylamide. *Addiction* 88:1327-1330, 1993.
- American Psychiatric Association: *Benzodiazepine dependence, toxicity and abuse. A Task Force Report of the American Psychiatric Association*, Washington, DC, 1990, American Psychiatric Association.
- American Psychiatric Association: *Diagnostic and statistical manual of mental disorders (DSM-IV)*, ed 4, Washington, DC, 1994, American Psychiatric Association.
- Anggard E, Sjoquist B, Fryo B, et al: Amphetamine metabolism in amphetamine psychosis. *Clin Pharmacol Ther* 14:870-880, 1973.
- Annual emergency room data*, Washington, DC, 1991, Drug Abuse Warning Network (DAWN), National Institute on Drug Abuse, Department of Health and Human Services, US Government Printing Office.
- Anthony JC, Warner LA, Kessler KC: Comparative epidemiology of dependence on tobacco, alcohol, controlled substances and the inhalants: basic findings from the national comorbidity survey. *Exp Clin Psychopharmacol* 2:244-268, 1994.
- Ashton H: Benzodiazepine withdrawal: an unfinished story. *BMJ* 288:1135-1140, 1984.
- Aston R: Treating pain and anxiety in the reformed substance abuser. *J Mich Dent Assoc* 69:279-280, 1987.
- Brill H: The treatment of drug dependence: a brief history. In National Commission on Marihuana and Drug Abuse: *Drug use in America: problem in perspective*, vol 4, Washington, DC, 1973, US Government Printing Office.
- Cone EJ, Johnson RE: Contact highs and urinary cannabinoid excretion after passive exposure to marijuana smoke. *Clin Pharmacol Ther* 40:247-256, 1986.
- Connell PH: Clinical manifestations and treatment of amphetamine type of dependence. *JAMA* 196:718-723, 1966.
- Cook CE, Perez-Reyes M, Jeffcoat AR, et al: Phencyclidine disposition in humans after small doses of radiolabeled drug. *Fed Proc* 42:2566-2569, 1983.
- Cregler LL, Mark H: Medical complications of cocaine abuse. *N Engl J Med* 315:1495-1500, 1986.
- Davis JM, Sekerke HJ, Janowsky DS: Drug interactions involving the drugs of abuse. In National Commission on Marihuana and Drug Abuse: *Drug use in America: problem in perspective*, vol 4, Washington DC, 1973, US Government Printing Office.
- Devane WA, Dysarz FA, Johnson MR, et al: Determination and characterization of a cannabinoid receptor in rat brain. *Mol Pharmacol* 34:605-613, 1988.
- Devane WA, Hanus L, Breuer A, et al: Isolation and structure of a brain constituent that binds to the cannabinoid receptor. *Science* 258:1946-1949, 1992.
- Dewey WL: Cannabinoid pharmacology. *Pharmacol Rev* 38:151-178, 1986.
- DiCugno F, Perce CJ, Tocci AA: Salivary secretion and dental caries experience in drug addicts. *Arch Oral Biol* 26:363-367, 1981.
- Fraser HF, Wikler A, Essig CF, et al: Degree of physical dependence induced by secobarbital or pentobarbital. *JAMA* 166:126-129, 1958.
- Fudala PJ, Bridge TP, Herbert S, et al: Office-based treatment of opiate addiction with a sublingual-tablet formulation of buprenorphine and naloxone. *N Engl J Med* 349:949-958, 2003.
- Griffiths RR, Wolf B: Relative abuse liability of different benzodiazepines in drug abusers. *J Clin Psychopharmacol* 10:237-243, 1990.
- Herkenham M, Lynn AB, Little MD, et al: Cannabinoid receptor localization in brain. *Proc Natl Acad Sci U S A* 87:1932-1936, 1990.
- Hill HF, Chapman CR, Kornell JA, et al: Self-administration of morphine in bone marrow transplant patients reduces drug requirement. *Pain* 40:121-129, 1990.
- Hollander JE: The management of cocaine-associated myocardial ischemia. *N Engl J Med* 333:1267-1272, 1995.
- Hollister LE: Dependence on benzodiazepines. In Szara SI, Ludford JP, editors: *Benzodiazepines: a review of research results, 1980*, NIDA Research Monograph No. 33, Rockville, MD, 1980, US Department of Health and Human Services.
- Hollister LE: Health aspects of cannabis. *Pharmacol Rev* 38:1-20, 1986.
- Isbell H, Chrusciel TL: Dependence liability of "non-narcotic" drugs. *Bull WHO* 43(Suppl):1-111, 1970.
- Isner JM, Estes NA, Thompson PD, et al: Acute cardiac events temporally related to cocaine abuse. *N Engl J Med* 315:1438-1443, 1986.
- Jaffe JH, Ciraulo DA, Nies A, et al: Abuse potential of halazepam and of diazepam in patients recently treated for acute alcohol withdrawal. *Clin Pharmacol Ther* 34:623-630, 1983.
- Johnston LD, O'Malley PM, Bachman JG: *Monitoring the future. National results on adolescent drug use: overview of key findings*, NIH Publication No. 02-5105, Washington, DC, 2002, US Government Printing Office.
- Johnston LD, O'Malley PM, Bachman JG, et al: *Monitoring the future. National results on adolescent drug use: overview of key findings, 2007*, NIH Publication No. 08-6418, Bethesda, MD, 2008, National Institute on Drug Abuse.
- Kagen SI: *Aspergillus*: an inhalable contaminant of marihuana. *N Engl J Med* 304:483-484, 1981.
- Kloss MW, Rosen GM, Rauckman EJ: Cocaine-mediated hepatotoxicity: a critical review. *Biochem Pharmacol* 33:169-173, 1984.
- Kolodny RC, Masters WH, Kolodner RM, et al: Depression of plasma testosterone levels after chronic intensive marijuana use. *N Engl J Med* 290:872-874, 1974.
- Kreek MJ: Rationale for maintenance pharmacotherapy of opiate dependence. In O'Brien CP, Jaffe J, editors: *Addictive states*, New York, 1992, Raven Press.
- Larson SL, Eyerman J, Foster MS, et al: *Worker substance use and workplace policies and programs*, Substance Abuse and Mental Health Services Administration, Office of Applied Studies, Publication No. SMA 07-4273, Analytic Series A-29, Rockville, MD, 2007, National Institute on Drug Abuse, Department of Health and Human Services.
- Mackinnon GL, Parker WA: Benzodiazepine withdrawal syndrome: a literature review and evaluation. *Am J Drug Alcohol Abuse* 9:19-33, 1982.
- Marihuana: a signal of misunderstanding*, Washington, DC, 1972, National Commission on Marihuana and Drug Abuse, US Government Printing Office.
- Matsuda LA, Lolait SJ, Brownstein MJ, et al: Structure of a cannabinoid receptor and functional expression of the cloned cDNA. *Nature* 346:561-564, 1990.
- McLellan AT, Luborsky L, Woody GE, et al: Are the "addiction-related" problems of substance abusers really related? *J Nerv Ment Dis* 169:232-239, 1981.
- Meyer RE: Behavioral pharmacology of marihuana. In Lipton MA, DiMascio A, Killam KF, editors: *Psychopharmacology: a generation of progress*, New York, 1978, Raven Press.
- National household survey on drug abuse*, Rockville, MD, 1993, National Institute on Drug Abuse, Department of Health and Human Services, US Government Printing Office.
- National survey on drug use and health: 2006 national findings*, NSDUH Series H-32, Publication No. SMA 07, Rockville, MD, 2007, Substance Abuse and Mental Health Services Administration, Office of Applied Studies, National Institute on Drug Abuse, Department of Health and Human Services.
- O'Brien CP, Childress AR, McLellan AT, et al: Classical conditioning in drug-dependent humans. *Ann N Y Acad Sci* 654:400-415, 1992.
- Paris M, Nahas GG: Botany: the unstabilized species. In Nahas GG, editor: *Marihuana in science and medicine*, New York, 1984, Raven Press.

47. Resnick RB, Kestenbaum RS, Schwartz LK: Acute systemic effects of cocaine in man: a controlled study by intranasal and intravenous routes. *Science* 195:696-698, 1977.
48. Scheutz F: Saliva secretion rate in a group of drug addicts. *Scand J Dent Res* 91:496-498, 1983.
49. Simpson GM, Khajawall AM, Alatorre E, et al: Urinary phencyclidine excretion in chronic abusers. *J Toxicol Clin Toxicol* 19:1051-1059, 1982.
50. Snyder SH: Hallucinogens. In National Commission on Marihuana and Drug Abuse: *Drug use in America: problem in perspective*, vol 1, Washington, DC, 1973, US Government Printing Office.
51. Strassman RJ: Adverse reactions to psychedelic drugs: a review of the literature. *J Nerv Ment Dis* 172:577-595, 1984.
- Aston R: Drug abuse: its relationship to dental practice, *Dent Clin North Am* 28:595-610, 1984.
- Clouet DH, editor: *Phencyclidine: an update*, NIDA Research Monograph No. 64, Rockville, MD, 1986, US Department of Health and Human Services.
- Gawin FH, Ellinwood EH Jr: Cocaine and other stimulants: actions, abuse, and treatment, *N Engl J Med* 318:1173-1182, 1988.
- Grabowski J, editor: *Cocaine: pharmacology, effects, and treatment of abuse*, NIDA Research Monograph No. 50, Rockville, MD, 1984, US Department of Health and Human Services.
- Karch SB: *The pathology of drug abuse*, Boca Raton, FL, 1993, CRC Press.
- O'Brien CP: Drug addiction and drug abuse. In Brunton LL, Lazo JS, Parker KL, editors: *Goodman & Gilman's the pharmacological basis of therapeutics*, ed 11, New York, 2006, McGraw-Hill.
- Rees TD: Oral effects of drug abuse, *Crit Rev Oral Biol Med* 3:163-184, 1982.
- Winger G, Woods JH, Hofmann FG: *A handbook on drug and alcohol abuse: the biomedical aspects*, ed 3, New York, 2004, Oxford University Press.

GENERAL REFERENCES

- Abbott A, editor: Drugs of abuse, *Trends Pharmacol Sci* 13(special issue):169-219, 1992.
- Acute reactions to drugs of abuse, *Med Lett Drug Ther* 44:21-24, 2002.

Toxicology

HARRELL E. HURST AND MICHAEL D. MARTIN

Toxicology is a basic science that is concerned with information regarding poisonous substances and their toxic actions. This discipline draws on biology, chemistry, and medicine to coordinate knowledge regarding toxic materials. Toxicology strives to understand key features of biology relevant to adverse interactions of chemicals with living systems. A principal objective is to promote the safe use of chemicals, particularly among humans, whether encountered as medicines, as food additives or contaminants, as industrial materials, as household products, or in the environment. Topics of interest to toxicologists include analysis of toxic agents, identification of toxic effects, elucidation of mechanisms of toxicity, management of poisoning, characterization of potential chemical risks, forensic and legal applications, and timely application of knowledge to prevent potentially disastrous consequences of chemical use.

The toxicology of therapeutic agents is integral to their pharmacologic characteristics and is described in appropriate chapters of this text. This chapter reviews general principles of toxicology, summarizes key organ systems that are susceptible to toxic effects, and outlines prevention and management of acute poisoning. Toxic materials not described elsewhere in the text are reviewed, and relevant topics related to dental practice are discussed.

GENERAL PRINCIPLES

All chemical substances can cause harm or kill if encountered at sufficiently large concentrations over crucial periods of time. This statement embodies insight articulated by Paracelsus in the sixteenth century that dose is the major determinant of toxicity. A subset of substances has relatively specific toxic effects, however. These are considered very harmful based on human experience and are considered poisons or toxins. Beyond this base of experience exists a vast number of uncharacterized, potential toxicants. As of 2007, the Chemical Abstracts Service¹⁰ reported counts of more than 32 million organic and inorganic substances, 245,000 inventoried or regulated substances, and some 15 million commercially available chemicals. Because many of these are potentially toxic, this array dictates that toxicologists use some means of triage toward assessment of potential toxicants. At present, selection of chemicals for toxicologic testing is dictated by their potential for use, by funding of basic research on the chemicals, and initial evidence of their specific adverse effects.

The ultimate aim of toxicologic science in society is to guide safe use of chemicals. The definitions in Box 52-1 can assist in understanding and promoting concise communication in the approach to this objective. Safety is a negative entity—that is, the absence of threat of injury. As such, safety cannot

be proved directly. Society often simplistically considers chemicals “safe” or “toxic.” Such naive characterization can preclude the rational judgment that enables safe uses of chemicals. Critical judgment requires understanding of the distinction between the terms *toxicity* and *hazard* to enable assessment of risks (see Box 52-1). Toxicologic assessment promotes safety by defining hazardous situations of use so that the unsafe use of chemicals can be avoided.

A primary concern of toxicology is evaluation of risk. All useful chemicals have some degree of risk associated with their use. Toxicologic science has developed testing paradigms to define toxicity to assess potential risk. Benefits also must be considered relative to the risk of use. A high degree of risk may be acceptable when benefits are great (e.g., use of toxic but potentially life-extending drugs such as chemotherapeutic agents). Otherwise, risk may be unacceptable for less essential uses (e.g., food coloring). In contrast to the science inherent in testing methods, judgment of risk acceptability involves policy. Such judgment invokes economic, social, and ethical values and should consider factors such as needs met by a chemical under consideration, alternative solutions and their risks, anticipated extent of use and public exposure, effects on environmental quality, and conservation of natural resources.

Within such considerations is an issue of major importance to toxicology and to society in general, which is determination of cause-and-effect relationships. This objective of epidemiologic studies is elusive for chronic diseases, such as many types of cancer. Such diseases may involve confounded potential causes, such as chemical or viral exposure and genetic susceptibility factors. Uncritical publication of unscientific observations or incomplete studies leads the public to inappropriate conclusions, which should be characterized more correctly as hypotheses. Adequate processes for determination of causation, as opposed to simple unrelated association or correlation, require scientific discipline and judgment based on considerable experience.

The criteria developed by Sir Austin Bradford Hill³⁶ provide a sound basis for consideration of causal relationships and should be considered a touchstone for expert opinion regarding cause and effect (Box 52-2). None of these criteria should be considered as absolutely essential, and they cannot be considered as proof of causal relationships. Their careful application during evaluation of potential cause-and-effect relationships can assist, however, in organizing knowledge toward a weight-of-evidence judgment and may provide an alternative interpretation for consideration.

Dose-Response Relationships

As mentioned earlier, the relationship between dose and toxic response is the fundamental axiom of the science of toxicol-

BOX 52-1

Definitions Relevant to Principles of Toxicology

Safety	Condition of being secure from threat of danger, harm, or injury
Toxicity	Property of grave harmfulness or deadliness associated with a chemical that is expressed on biologic exposure
Hazard	Threat of danger directly related to circumstances of use of a chemical
Risk	Expected frequency of occurrence of an adverse effect in a given situation

BOX 52-2

Hill Criteria for Consideration of Causal Relationships

CRITERION	EXPLANATION
Strength of association	Observed magnitude of the association compared with other relevant observations should be considered as a primary indicator in assessment of cause and effect
Consistency	Association of cause and effect can be observed repeatedly by others under appropriate circumstances
Specificity	Particular conditions produce the effect, or a specific group is affected. Bounds of causal relationship should be delimited
Temporality	Causation generally occurs before effect, whereas correlational effects can vary in temporality
Biologic gradient	Demonstration of a fundamental dose relationship provides convincing evidence of cause and effect
Plausibility	Some basis in previous knowledge provides a means of common understanding (remember, however, that all phenomena were novel at some point)
Coherence	Care should be taken that interpretation of cause and effect does not unduly conflict with scientifically established facts of biology and medicine
Experiment	Manipulation of accessible variables in the potential cause-and-effect relationship has an effect
Analogy	Previously understood examples provide basis for formulation of testable hypotheses

From Hill A: The environment and disease: association or causation? *Proc Roy Soc Med* 58:295, 1965.

ogy. Studies are designed to ascertain dose-response functions associated with specific adverse effects. When simple all-or-nothing criteria, such as death, are used, quantitation of response is simple. More often, objectives require more subtle means of assessment, however, that are less readily quantified. Beyond simple indication of the quantity of material required for the toxic effect, dose-response relationships provide strong

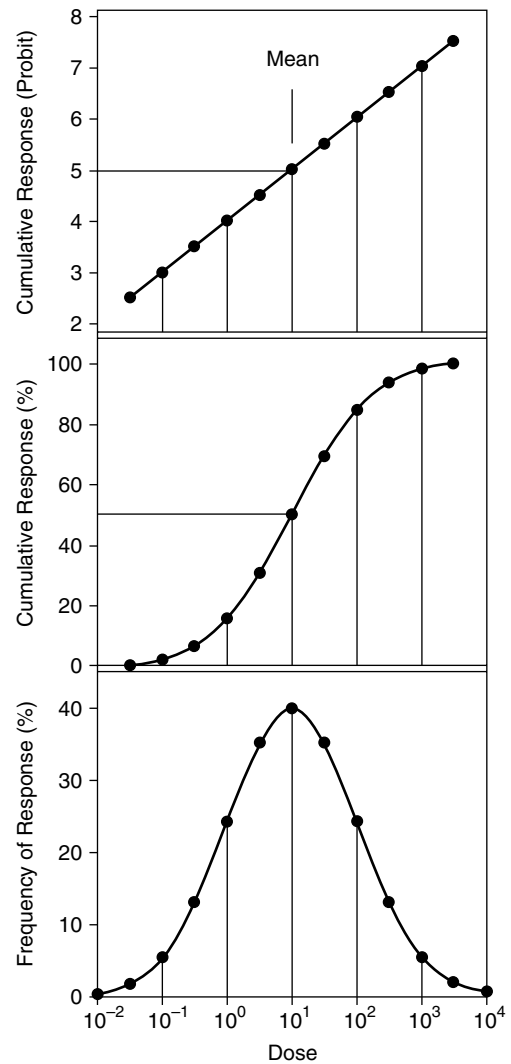

FIGURE 52-1 Various techniques for graphic display of quantal response versus dose data, including frequency of response (*bottom panel*), cumulative response (*middle panel*), and cumulative response linearized by probit transformation (*top panel*).

evidence of the causal relationship between the observed effect and the chemical under study, as noted previously.

Figure 52-1 presents three modes of display of idealized dose-response data to illustrate and describe the dose required for median response in subjects tested. These data are typical of quantal or all-or-nothing responses such as lethality. In this example, the dose axis is logarithmically spaced, and the data describe a log-normal distribution. Responses that arise from mass action, such as reversible occupancy of receptor by drugs, often are most easily plotted on a logarithmic axis. Alternatively, effects caused by limited biologic capacity, such as irreversible enzyme inhibition, can exhibit abrupt threshold-like effects and may be more easily analyzed on a linear dose axis. The rule is to plot the data to see what type axis is most applicable.

The *lower panel* of Figure 52-1 indicates distribution of responses across the dose axis, with a mean of 10 and standard deviation (SD) of one log₁₀ unit. Response percentages include approximately 68.3% within ±1 SD of the mean, 95.5% within ±2 SD, and 99.7% within ±3 SD of the mean. The distribution indicates hypersusceptibility for individuals at the lowest doses and resistant responders at the highest doses.

Such a plot gives a convenient way to visualize the distribution of responses across dose within the test groups.

The *middle panel* of Figure 52-1 plots the cumulative response versus dose across all treated groups. Here the response data are practically linear in the range from -1 SD to $+1$ SD for these ideal data. This plot provides convenient, accurate estimation of dose required for a 50% response, such as the median lethal dose (LD_{50}). Real data are rarely so well behaved, however, because too few animals may be included for adequate definition of the sigmoid curve. Another disadvantage is that the sigmoid curve presents difficulty in estimating doses that elicit extremes of response, such as 1% or 99%.

An alternative presented in the *top panel* of Figure 52-1 uses the probit transform⁴⁵ for the cumulative response. Probit units are derived by conversion of cumulative response percentages to units of deviation from the mean. The scale uses normal equivalent deviation units (NED), for which the mean is arbitrarily set to a NED value of 5 to give positive values along the axis. As is evident in the example, the probit transform linearizes the extreme values of the response function, which allows accurate estimation of doses affecting 1% or 99% of subjects exposed. In addition, the probit transform facilitates determination of the slope, which enables comparison of the dose-response function with other agents or responses.

Such plots are inadequate in dealing with issues of societal risk, however, for which policy often requires estimation of exposure posing a theoretic risk of 1 in 1 million, otherwise described as a 10^{-6} risk factor. Practical problems intervene, including the impracticality of experimental studies involving sufficient animals to define adequately the dose-response function at low response levels. A classic toxicologic experiment conducted at the National Center for Toxicological Research illustrates this point. Officially termed the *ED₀₁ Study*,³³ this experiment examined in detail the response function of mice treated with low doses of the experimental carcinogen 2-acetylaminofluorene. The study, sometimes termed the *megamouse study*, involved more than 24,000 mice to determine, with precision, the dose effective in producing a 1% tumor rate. This work advanced toxicologic understanding of the complexity of genotoxic and proliferative cellular events in chronic cancer bioassays. It also exhibited logistic difficulties in conducting statistical studies of low incidence and illustrated gaps in the evolving understanding of chemically induced cancer.

Factors That Change Dose-Response Relationships

Dose-response relationships can vary with many factors, including differences within and among individuals. As described in Chapter 3, factors responsible for dose-response variations within an individual over time may include age and nutritional status, environmental influences, functional status of organs of excretion, concomitant disease, and various combinations of factors. Changes in pharmacokinetics of toxicants are a frequent basis for altered dose-response relationships. Known influences include increased toxicant bioactivation by enzyme induction,³¹ such as occurs in certain variants of cytochrome P450¹³ with exposure to phenobarbital or polychlorinated biphenyls. Conversely, inhibition of metabolic clearance is possible with interacting chemicals, increasing the pharmacodynamic action of drugs and chemicals.

Cytochrome P450 variant 3A4 is an important enzyme in human drug metabolism, and its presence in the gut and liver subjects it to inhibition by many drugs and dietary components, such as grapefruit juice.¹⁹ Conversely, substances are often less toxic by the oral route when administered with food as a consequence of less rapid absorption. The time and frequency of administration can be important in altering dose-response relationships through functional changes. Many

compounds induce tolerance on repeated administration, whereas others can become more toxic with closely repeated administration. Receptor densities and sensitivity may vary with time or as a consequence of previous exposure. An example of the latter is the well-known tolerance that develops to long-term administration of opioids.

Responses among individuals differ as a consequence of different genetic traits, a subject of intense interest as knowledge emerges from the Human Genome Project, and use of efficient molecular techniques and transgenic animals becomes widespread in research. Recognition and understanding of relevant aspects of human diversity derived from functional genomic research offer potential for therapeutic gains.²⁶ The rationale is to use appropriate drugs in patients best suited to benefit, and to reduce use in patients with genetic traits that might result in toxicity. These efforts have spawned new terms, including *pharmacogenetics*, representing characterized genetic differences in drug metabolism and disposition, and *pharmacogenomics*, used to describe the broad spectrum of genes that affect drug response. A summary is available²⁵ that describes progress in determining genetic polymorphisms relevant to drug action and disposition. Known variants linked to altered drug effects in humans include phase I cytochrome P450 enzymes, phase II enzymes such as N-acetyltransferases and glutathione-S-transferases, small molecule transporters, drug and endogenous substrate receptors, and ion channel variants. Chapters 2 and 4 provide additional information on these topics.

Similar advances are likely to be applied to understand genetic differences that result in toxic effects aside from those that arise during drug therapy. Approximately 400 million individuals worldwide exhibit a heritable deficiency in the cytoplasmic enzyme glucose-6-phosphate dehydrogenase. Because this enzyme is essential to the cell's capacity to withstand oxidant stress through production of reducing equivalents, sensitive individuals with this enzymatic deficiency have chemically mediated hemolytic anemia when exposed to oxidants.⁶

Of particular importance to the interpretation of toxicologic studies are interspecies differences, which may confound understanding and interpretation of results from animal models. Well-known differences in physiology, metabolic rates, pharmacokinetics of toxicant metabolism and excretion, and sites of toxicant action mediate these interspecies differences. Advances involving physiologically based pharmacokinetic modeling and use of predictive, mechanistically based biomarkers offer promise of augmenting, or in some cases obviating, conventional toxicity testing.

Acute Versus Chronic Toxicity

Toxicity can be classified by the amount of time required for development of the adverse effect. For this purpose, the term *acute* describes toxicity with a sudden onset, whereas *chronic* describes a long latency or duration. In epidemiology, this classification typically describes the time between exposure and onset of toxicity. Intoxication is an acute effect that results from ingestion of a large quantity of ethanol over a brief time. Alternatively, the progressive diffuse architectural damage to the liver known as cirrhosis occurs over years with chronic ethanol exposure. In experimental toxicology, these terms are used to refer to experimental paradigms involving the duration of treatment or exposure. *Acute testing* typically describes a single treatment, whereas *chronic toxicity testing* usually involves dosing or feeding a chemical over the lifetime of a species, as in a rodent carcinogenicity bioassay.

If exposure occurs repeatedly at intervals more frequent than the time required to eliminate a toxicant, the material accumulates in the body throughout the duration of exposure. Although each exposure may be less than toxic, accumulation

may produce toxic concentrations if exposure continues for sufficient time. The primary determinant is the rapidity of elimination relative to the frequency and magnitude of exposure. Slowly eliminated toxicants, such as lipophilic chemicals or materials readily bound in tissues, have the greatest potential for accumulation.

Chronic toxicity may exhibit little or no apparent relationship to acute toxicity. In such cases, understanding of cause and effect requires careful study. Of the many examples of chronic toxicity, carcinogenesis currently is of greatest concern in society. Precancerous cellular changes occur and develop slowly and may remain undetected over long periods. Periodic dental examinations often play a significant role in detection of cancers of the oral cavity. Knowledge of patient habits with adverse potential health effects, such as the link between tobacco use and occurrence of oral lesions,⁷⁵ assists the dental practitioner in being vigilant against such chronic toxicity.

Chemically Related Toxicants

Understanding of chemical toxicity requires knowledge of related chemicals that may be present as impurities because of manufacturing or exist as a result of environmental effects. A classic example is 2,3,7,8-tetrachlorodibenzo-p-dioxin (dioxin, or TCDD), which was discovered in the herbicide mixture known as Agent Orange used in the Vietnam War. Although dioxin existed at low part-per-million levels in the herbicide mixture, the extreme toxicity of this contaminant in certain species created grave concern for contaminated areas. This concern led to a ban on the use of the herbicide 2,4,5-trichlorophenoxyacetic acid because TCDD is formed through a condensation reaction involving two molecules of 2,4,5-trichlorophenol. Dioxin also can be formed from other sources, such as combustion of municipal waste, iron ore sintering, and wood pulp and paper mills. The toxic actions of TCDD are mediated through its binding to the aryl hydrocarbon nuclear receptor,⁵⁷ which regulates transcription of genes encoding cytochrome P450 enzymes in the CYP1A subfamily and several other genes that regulate cell growth and differentiation. Despite its extreme toxic potential in some species, epidemiologic studies regarding the effect of TCDD exposure on humans have been inconclusive to date.

The consequences of metabolism of drugs and chemicals after ingestion are extremely important. The following example illustrates the importance of understanding toxic effects relative to drug metabolism. Terfenadine is a non-sedating histamine H₁ receptor antagonist that was widely used for relief of symptoms of seasonal allergy. This drug was removed from the market because studies revealed cardiotoxicity when terfenadine was given with erythromycin.⁹³ The toxic interaction was traced to the antibiotic's inhibition of the high-affinity oxidative enzyme system CYP3A in human liver and intestinal membranes.¹⁹ This interaction inhibited normal clearance of terfenadine, and the abnormally elevated concentrations produced toxicity in the form of a prolonged QT interval and the cardiac arrhythmia torsades de pointes. This antihistamine has been replaced with its active metabolite, fexofenadine, which apparently does not elicit this toxicity (see Chapter 22).

Local Versus Systemic Effects

Toxic effects can occur at a site of exposure, such as dermal contact, or at some site remote from the point of chemical contact or entry. Local effects dependent on applied concentration are usually diminished by dilution with physiologic fluids and diffusion within tissue away from the site of application. The toxic effect depends on the nature of the interaction at the local site. If the effect is caused by reversible interaction with a receptor, such as that of a local anesthetic,

toxicity is attenuated by diffusion, and the system is returned to a more normal state as the drug dissociates from receptors. For toxicants that act through destruction of normal cellular architecture, such as a caustic agent, return to normality requires repair of membranes and cellular structures.

Systemic effects are facilitated by transport within the body fluids and may be influenced by metabolism. Depending on whether biotransformation activates a protoxicant or detoxifies a toxicant, the effects of systemic processing can increase or attenuate toxicity. Compounds may be more or less toxic by the oral route than by other means of systemic exposure, as the first-pass effect of intestine or liver serves to activate or remove toxicants before distribution in the systemic circulation. Alternative systemic exposures, such as inhalation, are not modulated in this manner because systemic exposure occurs directly.

Target Organ Systems

Most toxic chemicals exhibit specificity in their action on target tissues or organs because these targeted biologic systems reach crucial points in which their physiologic functions are interrupted under the influence of the chemical. This section presents crucial physiologic systems and their characteristics that are important in understanding organ-specific toxicity.

Nervous system

Given the primary importance in control of integrated function, the central nervous system (CNS) is a target of paramount importance for many toxicants. Individual neurons exhibit high metabolic rates and are unable to rely on anaerobic glycolysis. These characteristics make these cells susceptible to toxicants that adversely affect cellular respiration and energy production and lead to neuronal damage when central or peripherally acting toxicants interrupt neuronal metabolism, cerebral circulation, oxygen-carrying capacity of blood, or pulmonary ventilation.

A remarkable cell-selective neurotoxicant is 1-methyl-4-phenyl-1,2,3,6-tetrahydropyridine (MPTP), an impurity discovered⁴² after attempted illicit synthesis and injection of a meperidine analogue. This compound is a protoxicant for 1-methyl-4-phenylpyridinium, which is formed by monoamine oxidase and concentrated by high-affinity carrier into dopaminergic neurons. The molecular target of 1-methyl-4-phenylpyridinium is reduced nicotinamide adenine dinucleotide dehydrogenase, and the interaction blocks the cellular respiratory exchange of electrons in mitochondria of cells. Its toxic actions result in destruction of dopaminergic neurons in the substantia nigra (see Chapter 15). Death of these cells produces symptoms strikingly similar to Parkinson's disease, leading to loss of willful motor actions.

Loss of integrity of neuronal cell metabolism can alter neuronal architecture, particularly the myelin sheath of peripheral neurons. Such effects are common to many forms of toxicity expressed in the nervous system. Various compounds, such as tri-*o*-cresyl phosphate, acrylamide, and metabolites of hexane, cause degeneration of long axons that control neuromuscular activities. Termed *distal axonopathy*,³⁹ this toxicity involves a "dying back" or retrograde degeneration of distal axons and leads to loss of control of motor functions such as gait. Other effects, such as sensory neuropathy and paresthesia, can result from similar effects of toxicants on small sensory fibers.

Blood and hematopoietic system

Because of the crucial roles of the elements of blood in delivering oxygen and maintaining immune function, toxic effects on blood or the hematopoietic system can be life-threatening. Of these, perhaps no poisoning is more common, preventable, or treatable with timely therapy than the toxic interaction of

carbon monoxide (CO) with hemoglobin (Hb). This interaction blocks the vital oxygen-carrying capacity by formation of carboxyhemoglobin (CO-Hb). Characteristics of CO and its toxic effect on various tissues sensitive to anoxia have been concisely reviewed.⁸⁶ Details of treatment, which involves displacement of Hb-bound CO with oxygen, are provided in the comprehensive text *Medical Toxicology*.⁸⁹ In mild (CO-Hb <30%) or moderate (CO-Hb 30% to 40%) cases, therapy includes use of 100% oxygen by nonbreathing mask until CO-Hb is less than 5%. Severe poisoning can mandate hyperbaric use of oxygen to hasten the exchange.

Another toxic effect that alters the oxygen-carrying capacity of erythrocytes is the formation of methemoglobin. In this toxicity, the heme iron is oxidized from the ferrous (Fe^{2+}) to ferric (Fe^{3+}) state by exposure to oxidizing chemicals such as nitrites or aromatic amines.⁹² As with CO-Hb, methemoglobin is incapable of carrying molecular oxygen to tissues. Although the effects of resultant anoxia are similar, the treatment differs. The treatment involves use of methylene blue, as a precursor to its metabolite leukomethylene blue, a cofactor that enables erythrocytes to reduce methemoglobin in the presence of reduced nicotinamide adenine dinucleotide phosphate (NADPH). This therapy has complications of potential hemolysis for treatment of infants and individuals with glucose-6-phosphate dehydrogenase deficiency⁹² because this enzyme is essential in the production of NADPH.

Other adverse actions affect the blood-forming cells of the bone marrow. Such effects can cause loss of immune functions mediated through leukocytes, as noted with induction of agranulocytosis during treatment with thioamide antithyroid drugs, such as propylthiouracil. Although rare, this adverse effect is devastating because it leaves the patient susceptible to sepsis. Aplastic anemia is a complication of therapy with the antiepileptic drugs felbamate and carbamazepine. This condition is very serious because the marrow loses the ability to produce cells. This potential effect requires vigilance for signs of blood dyscrasias and requires laboratory monitoring of blood cell counts during the first months of treatment.

Other adverse effects on the hematopoietic system include overexpression of certain types of cells, such as that noted in the development of acute myelogenous leukemia from benzene. Benzene is a toxicant commonly encountered in petroleum distillates such as gasoline and is considered a causative agent in human leukemia, probably through an active hydroquinone³⁸ or benzoquinone⁵³ metabolite. The process of leukemia development seems to involve preferential selection and clonal expansion of stem and progenitor cells through interaction of the toxic benzene metabolites by multiple independent genetic and epigenetic factors.

Respiratory system

The effect of toxicants on the respiratory tract is largely determined by the area of intimate cellular exposure to inhaled chemicals. Such contact is dictated by the structure of the conducting airways and the physical and chemical properties of the toxicant. Larger particles and more water-soluble compounds deposit in the upper regions of the respiratory tract, whereas very fine particles and less soluble gases reach more deeply into the lungs.

Compounds that are rapidly absorbed or highly caustic generally affect the nasal passages. Formaldehyde has a detectable pungent odor at concentrations greater than 0.5 ppm and is highly irritating to the nasal passages. The nasopharyngeal region serves as a filter for particles 10 to 30 μm in diameter. Many of these particles are cleared upward by mucociliary action. Highly water-soluble gases, such as sulfur dioxide, dissolve in moisture present in the upper respiratory

membranes and form irritating sulfurous acid. Less soluble compounds, such as oxides of nitrogen and ozone, penetrate more deeply into lung and generally exert effects at membranes in the smallest airways or alveoli. Particles smaller than 5 μm may travel well down into the bronchiolar region, whereas fine particles of 1 μm nominal size reach the alveolar region.⁹¹

Lung toxicity typically involves damage to the delicate architecture vital for efficient gas exchange. Because lung tissues contain many cytokines and immunologic mechanisms for particle clearance and tissue repair, inflammation is a common result of inspired toxic gases such as ozone. With severe acute injury, an exudative phase may progress to pulmonary edema, which alters ventilation, diffusion of oxygen and carbon dioxide, and perfusion. Severity depends on the extent of damage to bronchiolar and alveolar cells and the resolution of inflammation through mitogenic or fibrinogenic processes.

Chronic injury to the lung may result from inhalation of fine particles. Phagocytic mechanisms attempting to remove insoluble particles may produce tissue scarring and interstitial fibrosis, in which collagen fibers replace normal membranes and occupy alveolar interstitial space. This kind of injury is common with inhalation of silicate particles such as asbestos.⁶⁴ These actions produce inflexible tissue, diminish surface area, and lead to poor surfaces for gas exchange. Another chronic lung toxicity is emphysema; its major cause is cigarette smoking. This toxic effect produces distended, enlarged air spaces that are poorly compliant but without fibrosis. The pathogenesis of this condition is not fully understood, but an imbalance between proteolytic activities of lung elastase and antiproteases seems to be involved.³ Lung cancer became a major concern with the increase in popularity of smoking; this health scourge of today was a rare disease a century ago. Smoking is believed to be the most important risk factor for this disease, presenting a 10-fold and 20-fold increase in risk for average and heavy smokers.⁹¹

Organs of excretion

The primary organs of toxicant elimination are the liver and kidneys. The liver provides the major site for metabolic transformation, rendering compounds generally more water-soluble and subject to more efficient excretion in urine by the kidney. The unique physiologic features of each organ provide crucial characteristics that are susceptible to toxic actions and subsequent adverse consequences of impaired function.

The liver possesses remarkable capabilities for regeneration. Hepatotoxicity often results in necrosis and loss of the vital capacities of the liver, however. Essential functions include protein synthesis, nutrient homeostasis, biotransformation, particle filtration, and formation and excretion of bile. Impaired production of proteins such as albumin, clotting factors, and lipoproteins may cause hypoalbuminemia, hemorrhage, and fatty liver. Toxic actions that alter glucose synthesis and storage often lead to hypoglycemia and confusion, whereas effects on cholesterol uptake may produce hypercholesterolemia. Altered biotransformation or biliary excretion of endogenous substrates such as steroid hormones or bilirubin may affect a wide variety of hormonal functions or cause jaundice.

As previously noted, various membrane and cytosolic enzymes in the liver provide the essential metabolic functions of oxidation and glucuronide, sulfate, and mercapturate conjugation for removal of toxicants. These reactions usually detoxify compounds, but occasionally metabolic products exhibit enhanced toxicity. Interactions can occur among effects of toxicants within the liver through induction of enzymes or depletion of metabolic resources. Acetaminophen

has been widely used as an over-the-counter analgesic without adverse effects on the liver at therapeutic doses. In circumstances of glutathione depletion, however, which occurs with large acetaminophen overdose, malnutrition, or CYP2E1 induction by long-term ethanol use, a reactive electrophilic intermediate forms in sufficient amounts to produce covalent adducts that severely damage the liver (see Chapter 21).

The kidney plays a vital role in regulating extracellular fluid and excreting soluble wastes through filtration of blood, concentration of wastes, and elimination. To accomplish these vital functions, nephrons are composed of vascular, glomerular, and tubular components. The kidneys possess metabolic and regenerative capabilities, but these resources lead to renal failure when overwhelmed. Nephrotoxicity can be classified as acute or chronic. Acute renal failure can be caused by hypoperfusion from renal vasoconstriction, as elicited by the antifungal amphotericin B, or hypofiltration through glomerular injury resulting from cyclosporine and aminoglycosides. Numerous compounds, including nonsteroidal anti-inflammatory drugs, various antibiotics, and heavy metals, cause acute renal failure by nephritis, acute tubular necrosis, or obstruction. Causes of chronic renal failure from many of these toxicants include nephritis from inflammatory and immunologic mechanisms and papillary necrosis through ischemia or cellular injury. Compensatory mechanisms may include hypertrophy and induction of metallothionein synthesis in response to heavy metal exposure.

PREVENTION AND MANAGEMENT OF POISONING

Prevention of chemical toxicity is a responsibility of the entire community. Governmental agencies and private corporations must act in concert to minimize toxic hazards in the workplace and the environment. In the home, parents have a responsibility to protect children from harm as they explore their surroundings. Numerous sources of information are available to aid families in protecting against accidental poisoning. Steps can be taken by practitioners to limit the possibility of accidental poisoning. Patients should be encouraged to keep all medications out of the reach of children, and drugs should always be kept in child-resistant containers. Information on the label of a prescribed drug should be understandable and include the name of the agent and clear directions for use. The prescribing physician or dentist should always indicate the purpose of the medication in the label information on the prescription. This procedure helps reduce confusion about drugs in the medicine cabinet and facilitates rapid identification of the drug involved in cases of accidental ingestion. Patients should be instructed to discard unused medication rather than attempt self-medication with drugs remaining from a previous course of therapy.

Diagnosis and treatment of poisoning are the purview of the physician. Principles of therapy for poisoning are summarized in Box 52-3 and apply to the management of any drug overdose. A dentist may be called on to provide emergency treatment of acute poisoning, however, within the practice environment or because of training as a health care professional.

Principles of Therapy for Poisoning

Summon help

When acute poisoning is evident, help should be sought through the emergency 911 telephone service if available. For less critical situations, the community poison control center provides an invaluable service. These centers are equipped with extensive files describing the signs and symptoms of

BOX 52-3

First Aid for Poisoning

1. Summon help
2. Stabilize the patient
3. Evaluate the cause
4. Terminate absorption
5. Consider specific antidotes
6. Enhance elimination
7. Provide for supportive care

poisoning and recommended methods of treatment for most toxic substances distributed within the United States. Poison control centers can be reached by telephone on a 24-hour basis, and phone numbers are usually published inside the cover of telephone directories. If the toxic reaction is serious, expert medical assistance should be sought immediately. In addition, most major medical centers have drug information centers that provide information to practitioners about drugs and drug interactions.

Stabilize the patient

Supportive therapy should be provided. Because hypoxia and shock are two common manifestations of serious toxicity, respiration and circulation must be monitored and assisted if required. For convulsions, physical protective measures may suffice along with the administration of oxygen to help avoid hypoxia. Intravenous diazepam is a drug of choice for pharmacologic control of continuing seizures.

Evaluate the cause

Proper therapy to eliminate exposure to the toxin or reverse its effects depends on identifying the poison. Questioning the victim or the victim's associates, searching for empty containers, or looking for physical signs on the patient (e.g., miosis or needle tracks for opiate or opioid overdose, burn marks in the mouth for ingestion of caustic chemicals) can be important in establishing the cause of poisoning.

Terminate absorption

Any obvious means of contact with the poison should be removed. For dermal exposure to chemicals, removal of contaminated clothing and repeated washing with soap and water are indicated. With ingested compounds other than petroleum products and corrosive substances, vomiting can be induced, but only in a conscious patient. Vomiting should not be induced for poisoning by petroleum products or agents producing loss of consciousness because of the risk of aspiration. Likewise, corrosive damage to the esophagus and gastric perforations may result from corrosive substances if emesis is induced. Modern practice is to avoid inducing vomiting because it does not reliably remove ingested poisons. Gastric lavage can be used by qualified personnel if care is taken to avoid aspiration of stomach contents by the victim. Prevention of absorption of many drugs within the gastrointestinal tract can be achieved by activated charcoal (10 to 50 g in water), and cathartics may be used to hasten the exit of drugs from the intestine. The merits and limitations of gastrointestinal decontamination measures have been reviewed in detail.¹⁵

Consider specific antidotes

Specific antidotes are available to treat poisoning by certain classes of compounds. Antidotes may be useful in preventing

the absorption of ingested agents (e.g., Ca^{++} salts for F^-), increasing their rate of elimination (e.g., dimercaprol for inorganic mercury), blocking specific receptors (e.g., naloxone for morphine), or blocking other toxic activity (e.g., N-acetyl cysteine for acetaminophen overdose). One specific antidote should be remembered by dentists. For ingestion of toxic amounts of fluoride, which might occur with prescribed tablets or with topical liquids or gels, the local antidote to prevent absorption is Ca^{++} (in milk, calcium lactate, calcium gluconate, or lime water). If necessary, 2 to 10 mL of 10% calcium gluconate may be injected intravenously to bind fluoride and overcome hypocalcemia. Dentists who use benzodiazepines and opioid analgesics for conscious sedation must be familiar with the use of flumazenil and naloxone, respectively, to reverse respiratory depression caused by these drugs (see Chapters 13 and 20).

Enhance elimination

Measures to facilitate elimination of toxicants are in the realm of emergency care physicians; they are mentioned briefly here for completeness. The renal excretion of weak electrolytes can often be accelerated by appropriate modification of urinary pH. Administration of an osmotic diuretic in conjunction with large volumes of water is helpful in promoting urinary excretion and reducing the renal concentration of nephrotoxic poisons. In some instances, peritoneal dialysis or hemodialysis may be useful.

Provide for supportive care

Medical assessment of poisoning and continuing treatment, as needed, should be provided by physicians, nurses, and staff in an appropriate health care facility. Professionals with a full range of medical treatment resources may be required to address additional sequelae during the course of recovery.

OCCUPATIONAL SAFETY IN DENTISTRY

Although dentistry is considered to be relatively “occupationally safe,” numerous potentially hazardous substances are used in the dental office or laboratory. In addition, dental environments may provide exposure to radiation or to blood-borne pathogens. Since 1988 the Occupational Safety and Health Administration (OSHA) has been writing, implementing, and enforcing regulations designed to ensure that employees are informed of hazardous materials in their work environment and given appropriate instruction in the risks and handling of these materials. The primary components of this program include (1) labeling of containers for materials, (2) on-site maintenance of material safety data sheets for materials used in the workplace that contain hazardous chemicals, and (3) employee education and training. For dentistry, OSHA regulations and guidelines include potential exposures to blood-borne pathogens and biologic agents in addition to chemicals. To assist in fulfilling the requirements of OSHA regulations, the American Dental Association has published several helpful documents on OSHA, including a step-by-step guide to compliance and a video OSHA refresher course.²

To meet OSHA regulations, drugs and chemicals must be labeled with the name of the chemical, appropriate risk warnings regarding the chemical, and name and address of the manufacturer or other responsible party. If a hazardous material is transferred to another container at any time other than for immediate use, an appropriate label must be affixed to the new container.

Material safety data sheets are central to the safety program and are the primary source of risk and hazard infor-

mation. These sheets are required to be provided by the manufacturer on request and must identify the hazardous substances included in the preparation, the physical and chemical characteristics, the fire and explosion danger, and other health hazard data. Material safety data sheets must also provide information on handling, storage, cleanup, disposal, and emergency and first aid procedures. These sheets must be present in the workplace and available to employees at all times. Dentists are required to provide appropriate training for employees in the use and management of hazardous substances when they are hired, whenever new hazardous substances are brought into the workplace, and when new information regarding the use of existing substances becomes available.

SPECIFIC TOXICANTS

The toxic effects of several classes of substances are presented. Agents that illustrate general principles presented earlier and that have public health importance or importance in the practice of dentistry are described.

Metals

Metals as a class are toxic primarily because of their ability to bind with biologic structures such as thiol groups in enzymes and other proteins. The major effect in humans is the inhibition of enzyme function. Because of this binding affinity, the effect of metals may be widespread in the organism, but usually a primary or most sensitive system in which clinical manifestations may be detected is evident. Metals as a class are important because of their ubiquitous nature in modern medicine and technology and in nature. Two metals of importance in public health and dental practice are mercury and lead.

Mercury

Mercury is present virtually everywhere in the environment. An estimated 2700 to 6000 tons is released annually from the oceans and the earth's crust into the atmosphere. An additional 2000 to 3000 tons is released through human activities, including the burning of fossil fuels. Mercury exists in three chemical classes: elemental mercury (Hg^0), which is a liquid at room temperature and is used as a primary component in dental amalgam; inorganic mercury salts; and organic mercury salts. Inorganic mercury salts may exist as mercurous (Hg^+) or mercuric (Hg^{++}) forms. Of the many organic forms of mercury, methylmercury is the most important toxicologically because of its ability to permeate membranes and the blood-brain barrier, its potency for biologic damage, and its widespread use in human activities.⁵⁸

Mercury toxicity provides an interesting example of several important toxicologic principles. The first is that a single substance may produce differing effects depending on presentation to the organism. Hg^0 is essentially nontoxic when ingested because of a lack of absorption in the gastrointestinal tract. It may be toxic, however, when injected subcutaneously.⁷⁶ In addition, because of its high vapor pressure, it vaporizes readily and is easily inhaled. When inhaled, Hg^0 is absorbed readily into the blood, with absorption rates estimated at 74% to nearly 100% of inhaled dose.^{29,37} When in the blood, it is oxidized and is available for binding to enzymes and other proteins, producing toxic effects. Another important principle exhibited by mercury is that when a substance can exist in different chemical forms, the forms may present strikingly different health effects. Organic mercury typically produces signs of toxicity that are neurologic in nature, whereas inorganic salts often produce gastrointestinal destruc-

tion and, secondarily, nephritis. These effects are discussed further subsequently.

Inorganic mercury salts are used widely in industry; mercuric chloride is an example of a mercury compound with a wide variety of industrial uses. These compounds, in contrast to organic mercury compounds, are not well absorbed through the gastrointestinal tract and do not readily cross biologic membranes when absorbed. Only approximately 10% of an inorganic mercury dose is absorbed through the gastrointestinal tract compared with more than 90% of an ingested dose of methylmercury. Nevertheless, inorganic salts such as mercuric chloride are severely corrosive to tissue and when absorbed produce toxic effects through binding of enzymes. Inorganic mercury compounds have been used medicinally and applied dermally in makeup for hundreds of years until recent times; calomel (a cathartic) and mercurochrome (an antiseptic) are common examples. Virtually all such uses have been discontinued.

Organic mercury compounds represent the most important form of mercury from a toxicologic perspective. This is particularly true of methylmercury because of its widespread use and because it is a by-product of many industrial processes. Organic mercury is known to accumulate in the food chain, and this is particularly evident in seafood, where the pelagic and top-level predators accumulate significant amounts of methylmercury in their flesh.

A number of tragic, inadvertent organic mercury poisonings have occurred in modern times. Two incidents are particularly well documented. From 1932-1968, the Chisso Corporation, a company located in Kumamoto, Japan, dumped an estimated 27 tons of mercury compounds into Minamata Bay. Kumamoto is a small town approximately 570 miles southwest of Tokyo. The town consists of mostly farmers and fisherman whose normal diet included fish from the bay. Symptoms of methylmercury poisoning unexpectedly developed in thousands of these people. The illness became known as Minamata disease. Methylmercury has also been widely used to prevent grain spoilage through its antifungal effect. The second major outbreak occurred in the early 1970s when more than 500 people died and many others were made severely ill in Iraq when grain seed treated with methylmercury was inadvertently ground into flour and consumed. In both of these instances, because organic mercury readily crosses the blood-brain and placental barriers, a significant number of fetal deaths and teratogenic results occurred.

Hg^0 is the form of concern in dentistry because it is a primary component of dental amalgam, constituting approximately 50% by volume of the material. The greatest risk of exposure from Hg^0 is by inhalation of the vapor. Hg^0 vapor is highly lipid-soluble and readily crosses membranes; this gives it ready access to the CNS and other body components, where it is easily oxidized to the mercuric form. Acute, high-level exposure to Hg^0 vapor produces corrosive inflammation of the upper and lower respiratory tract and nephrotoxic and CNS effects. Long-term exposure to low or moderate levels of Hg^0 vapor damages enzymes and structural proteins in the CNS, resulting in blockage of neuromuscular and synaptic transmission. Figure 52-2 shows the currently known range of effects based on urinary mercury concentrations. Urinary mercury concentration is considered a reasonable indicator of recent Hg^0 exposure, but because mercury is sequestered in organ systems, urinary mercury concentration is not a true indicator of total body burden.⁴⁹ Although the three forms of mercury (inorganic, organic, and elemental) produce differing toxicologic effects, the two major target organs of any mercury exposure are the CNS and the kidneys.

Although the earliest indicators of CNS effects of mercury exposure are not always clinically evident, they are measurable with neurobehavioral testing.^{7,20} As exposure increases,

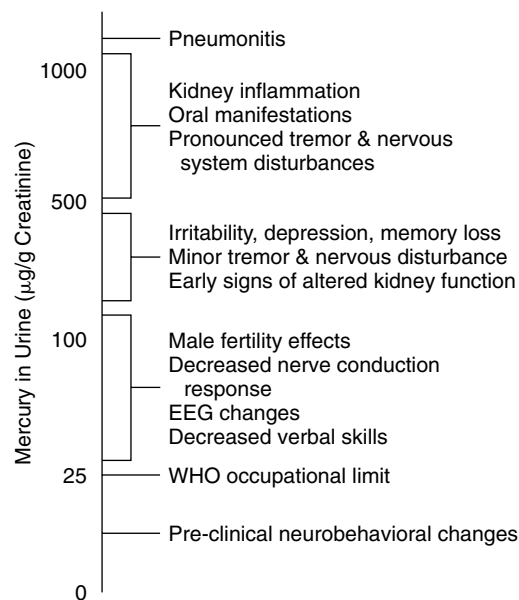

FIGURE 52-2 Signs and symptoms of mercury toxicity relative to concentrations in urine. EEG, Electroencephalogram; WHO, World Health Organization.

behavioral changes may be noticed, such as irritability, memory disturbances, personality changes, drowsiness, or depression. Fine muscle tremors are noted, especially of the fingers, eyelids, and lips, and this loss of neuromuscular control increases as exposure levels increase. Renal damage in the form of tubular necrosis increases in a dose-dependent manner. Oral manifestations of mercury intoxication include hypersalivation, gingivitis, and gingival discoloration. Cases of periodontal destruction with tooth loss have been reported at high levels of exposure.⁵¹ Also present at high levels of exposure is a yellow-brown discoloration of the lens of the eye.

Mercury in dentistry

Since the introduction of mercury amalgam into dentistry in the early nineteenth century, concerns about its safety have been expressed from time to time. Claims of toxic effects cover virtually the entire spectrum of disease, and a vocal "anti-amalgam" contingent currently exists. Much of the confusion regarding the potential health effects of mercury exposure from dental sources is caused by false claims and by flawed studies used to support these claims by anti-amalgam proponents. Two areas of potential concern have been the subject of more recent and ongoing studies. One is the potential occupational risk to dental personnel working with dental amalgam, and the other is to the consumer or patient who has mercury amalgam placed in the teeth as a treatment.

OSHA and the National Institute for Occupational Safety and Health have recognized the need to set occupational thresholds over which exposure to mercury must not occur. These organizations have set a threshold limit value of 50 µg of Hg^0 per cubic meter of air as a time-weighted average based on a 40-hour work week.¹⁷ The World Health Organization has set a more restrictive threshold limit value of 25 µg/m³.²² Hg^0 , which is readily vaporized, can achieve concentrations of 2000 µg/m³ in a closed room. Studies of ambient air mercury concentrations in dental offices have shown that, under conditions of careless handling of mercury, the occupational threshold levels can be exceeded.⁶⁹ These high con-

centrations may occur after contamination through accidental spills of Hg⁰.

Studies examining occupational exposure among dental personnel show that certain practices in dental offices—now considered outmoded—are the most significant contributors to occupational exposure. These practices include the use of squeeze cloths to express mercury from amalgam; dispensing mercury from a central supply, which leads to accidental spills; and the use of office-prepared capsules.⁵⁰ Neurobehavioral changes have been noted in dentists exposed to mercury.²⁰ Modern dental offices that have good hygiene practices with respect to mercury pose minimal risk to dental personnel, however. Excellent hygiene remains vital to preventing unnecessary mercury exposure.

With regard to mercury exposure that patients receive from the placement of amalgams in the course of treatment, anecdotal claims of disease states of every sort attributed to such exposure have been reported. Although rare individuals may be sensitive to very low level mercury exposure, little or no valid scientific evidence supports such claims in the general population. An important reason for the controversy is the reliance of some individuals on false claims and dubious studies about the dangers of dental amalgams. To date, no scientific studies have supported a health risk from dental amalgams to patients in whom these restorations have been placed.^{48,52}

Two large-scale, randomized, prospective clinical trials have been completed that studied the effect of mercury exposure from dental amalgam in children.^{5,16} These studies each included more than 500 children who were randomly assigned to dental treatment groups that would receive either amalgam or resin composites for necessary restorations in posterior teeth. The subjects were followed annually for 5 years in the study by Bellinger and colleagues⁵ and 7 years in the study by DeRouen and colleagues.¹⁶ Outcome measures included comprehensive batteries of neurobehavioral tests including IQ testing, neurologic examinations including nerve conduction velocities, and renal function tests. Although there were measurable differences in urinary mercury concentrations between the amalgam and nonamalgam treatment groups, there were no significant differences found for any of the outcome measures between groups, indicating that the level of mercury exposure from routine dental treatment with amalgam does not present an important health risk for neurologic or renal outcomes.

A study of 1663 adults participating in the ongoing Air Force Health Study of Vietnam-era veterans to determine possible associations between amalgam exposure and neurologic abnormalities found no association between amalgam exposure and neurologic signs or clinically evident peripheral neuropathy.⁴¹ The body of evidence also indicates no detectable negative effect on general health at the levels of mercury exposure produced by the presence of dental amalgam fillings except in rare cases of allergy to amalgams.¹⁷ Following the mercury hygiene guidelines listed in Box 52-4 minimizes any exposure to patients beyond that which results from the amalgam itself.

Lead

Lead has been a toxicologic problem for humans from the earliest times. It was found in early utensils and food storage and preparation vessels. It has been used extensively in plumbing, contaminating drinking water. Occupational exposures to lead occur in miners, smelters, and lead acid battery workers, but the most common chronic exposure is through diet. Perhaps the best recognized sources of lead exposure are from lead-based paint and combustion products of tetraethyl lead antiknock compound added to gasoline before the change to unleaded gasoline. Although Congress produced legislation limiting the lead concentration in paint to 0.06% in the 1970s,

BOX 52-4

Recommended Guidelines for Minimizing Mercury Exposure in the Dental Environment

1. Use precapsulated amalgam preparations only. Reclose disposable capsules after use.
2. Do not use squeeze cloths for expressing mercury from amalgam mix.
3. Monitor office levels of Hg⁰ yearly or whenever contamination is suspected.
4. Use exposure badges that sample the air for Hg⁰ concentration.
5. Provide periodic urinary mercury concentration testing for personnel.
6. If “free” mercury (rather than precapsulated) must be used to mix amalgam, store it away from heat in unbreakable, tightly sealed containers.
7. Store amalgam scrap in a sulfide solution (e.g., used x-ray fixer) or under water.
8. Do not touch amalgam with bare hands.
9. Use a rubber dam for restorative procedures.
10. Use a high-velocity vacuum when manipulating the amalgam and vacuum and water spray when removing old amalgam restorations.
11. In the event of a mercury spill (even a small one), use a mercury spill cleanup kit (commercially available). Do not vacuum the spill because this hastens the volatilization of the mercury into the air.

many older buildings still contain significant amounts of lead-based paint with very high concentrations of lead. A relatively small chip of this paint may contain 100 mg of lead. When consumed by a child, this amount exceeds the daily allowable intake by a factor of at least 30.³⁴ Because lead compounds that were included in paint formulas have a sweet taste, young children have frequently consumed these paint chips. (The condition of eating unnatural foods is called *pica*.)

Adults absorb approximately 10% of dietary lead, although children may absorb significantly larger amounts. With normal renal function, absorbed lead is primarily excreted by the kidneys. In the body, lead primarily concentrates in the hard tissues such as bone and teeth. Similar to mercury, lead produces toxic effects primarily by binding with proteins necessary for cellular function. Toxic signs exhibited at various blood levels are illustrated in Figure 52-3. One early effect of lead exposure is inhibition of the heme biosynthetic pathway. Intermediary products of heme biosynthesis called *porphyrins* are excreted in the urine in a characteristic pattern indicative of lead poisoning.⁶⁸

Chronic lead poisoning, known as *plumbism*, produces a spectrum of effects depending on the duration and severity of exposure. A microcytic hypochromic anemia may be produced early in exposure and cause lethargy and weakness. Neurologic effects may produce restlessness, irritability, hyperactivity, and impaired intellect. Chronic low-level lead exposure can produce deficits in gross and fine motor development and in cognitive and intellectual development. Early detection and management of lead exposure is crucial to prevent these permanent effects in children.⁴⁷ Peripheral neuropathies may be seen and are manifested as wristdrop, foot-drop, and muscular weakness. Gastrointestinal signs such as intestinal spasms may progress to severe abdominal cramping with increased or continued exposure.

The greatest threat from lead poisoning is encephalopathy, which occurs more often in children. Early neurologic

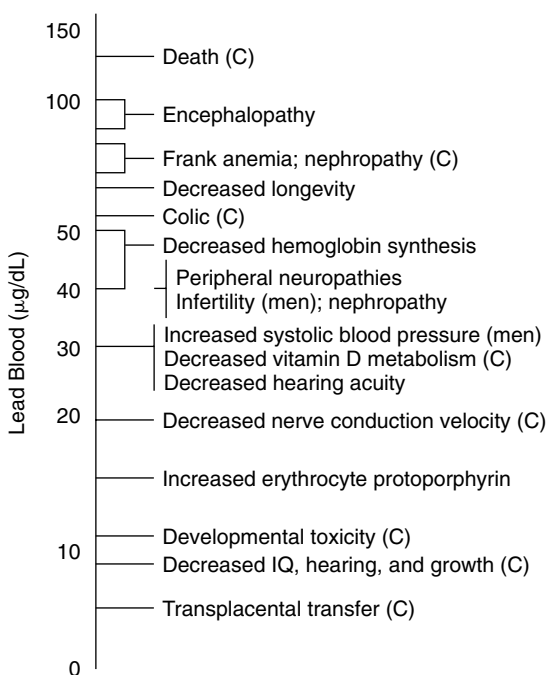

FIGURE 52-3 Signs and symptoms of lead toxicity relative to concentrations in blood. Children are represented at the more sensitive end of the designated ranges. (C), Denotes observations in children. (Adapted from Ellenhorn M, Schonwald S, Ordog G, et al: *Metals and related compounds: lead*. In Cooke D, editor: *Ellenhorn's medical toxicology: diagnosis and treatment of human poisoning*, ed 2, Baltimore, 1997, Williams & Wilkins.)

signs and symptoms develop as described earlier and progress to delirium, convulsions, and coma. One fourth of patients with lead encephalopathy do not survive, and 40% of survivors are left with severe neurologic dysfunction.^{66,70} Lead is toxic to the kidney, and reversible tubular damage and irreversible interstitial fibrosis may be seen. Long-term exposure to lead is classically associated with a blue-black line that appears along the gingival margin. This deposit of lead sulfide is known as Burton's lines, and although associated with lead exposure, it may also be caused by exposures to other metals, such as silver, iron, or mercury.

For treatment, removal of the subject from the source of lead exposure is paramount. Depending on the blood lead levels, chelation therapy is instituted according to protocols²³ for the treatment of lead poisoning recommended by the U.S. Centers for Disease Control and Prevention and the American Academy of Pediatrics. Succimer, edetate calcium disodium, dimercaprol, and penicillamine all are effective, but differ in advantages of routes of administration and specificities relative to other essential trace metals.

Iron

The pharmacologic features of iron are discussed in Chapter 30. Iron is a heavy metal that is required to sustain life and is commonly used therapeutically. The daily adult consumption of iron is equivalent to approximately 15 to 40 mg of elemental iron, only a portion of which is absorbed. An allowance of 10 mg/day is recommended for children, with small additional increments during puberty to account for rapid growth. Inappropriate levels of exposure can lead to significant toxicity, however. Iron toxicity can be either chronic or acute. More than 2000 cases of iron poisoning are reported in the United States each year. Chronic toxicity seems to be more common in individuals who have a genetic predisposition to absorb

excessive amounts of iron taken orally. Pathologic changes include hemosiderin accumulation in the liver and spleen and hemochromatosis. Deferoxamine, a drug that selectively chelates iron (especially the ferric form) and removes iron from hemosiderin, is used to treat chronic toxicity.

Acute toxicity occurs most frequently in children, in whom accidental ingestion is most likely to occur.²⁷ The lethal dose of ferrous sulfate for a 2-year-old is approximately 3 g. The first signs of acute oral toxicity occur in the gastrointestinal tract. Vomiting and diarrhea are common. The vomitus may appear brown, and the stool may be bloody. Gastric scarring can also occur. Acidosis and shock occur a few hours later. A delayed phase, occurring 24 to 48 hours later, is characterized by convulsions, cardiovascular collapse, and coma. Treatment consists of evacuation of the stomach contents by lavage or induction of vomiting. Support of the cardiovascular system and kidneys by maintaining blood pressure, plasma volume, and correction of acidosis is often necessary. Deferoxamine given intravenously or intramuscularly is effective in chelating iron after it is absorbed. Deferoxamine is not well absorbed by the oral route, and oral administration is ineffective in preventing absorption of iron from the gastrointestinal tract.

Treatment of poisoning: heavy metal chelators

Chelators are compounds that form complexes with metal ions. The word *chelator* is derived from the Greek word *chele*, meaning "claw." A chelator molecule binds a metal ion by two or more polar functions, such as sulfhydryl, carbonyl, amino, or hydroxyl groups. These form bonds similar to the bonds of the protein functional units attacked by metal ions. Through this action, chelators spare endogenous ligands and promote excretion of metals as the chelator-metal complexes. Dimercaprol, succimer, and penicillamine are drugs currently marketed to promote the excretion of mercury, lead, and other metals. A few additional agents are available to treat poisoning by metals other than mercury, such as edetate calcium disodium for lead and cadmium and deferoxamine for iron. Structures of these chelators are shown in Figure 52-4. Selectivity for metal ions varies among chelators. Some, such as edetate, aggressively remove vital nutrient metals, such as calcium and zinc. Such selectivity is important in the choice of the chelator, which should be matched for the heavy metal and circumstances of therapy. Selectivity of chelators for specific heavy metals is presented in Table 52-1.

Dimercaprol (2,3-dimercapto-1-propanol) was developed during World War II as an antidote for the arsenical gas lewisite, and it was formerly known as British antilewisite. Subsequently, dimercaprol was found to be an active chelator of various heavy metals. Dimercaprol is prepared as a 10% solution in a peanut oil vehicle (beware of peanut allergy!) and must be injected intramuscularly. It is maximally effective when given shortly after an acute exposure to mercury; however, it is valuable even in chronic mercurialism. Dimercaprol is used with edetate calcium disodium in protocols for treatment of lead poisoning.²³ The drug is usually injected two to three times a day initially, with doses tapering off to once or twice a day over about 10 days. The dimercaprol-mercury complex (actually two dimercaprol molecules to a single mercury atom) is excreted in the urine, which must be kept alkaline to avoid dissociation of the conjugate.

Succimer (meso-2,3-dimercaptosuccinic acid) is structurally similar to dimercaprol. This drug has the advantage of being effective after oral administration and being less toxic than dimercaprol. Succimer is more water-soluble and is the drug of choice for the treatment of lead poisoning because it is more specific for lead chelation than edetate calcium disodium and removes fewer essential minerals such as calcium, copper, iron, and zinc. The dose for lead chelation is 10 mg/

TABLE 52-1

Metals and Chelators That Enhance Excretion

METAL	CHELATOR	OTHER NAMES	ADMINISTRATION
Arsenic	Succimer; dimercaprol	Dimercaptosuccinic acid, DMSA; 2,3-dimercapto-1-propanol, BAL	Oral; IM
Cadmium	CaNa ₂ EDTA	Edetate calcium disodium	IV infusion
Copper	D-Penicillamine	3-Mercapto-D-valine	Oral
Iron	Deferoxamine		IM
Lead	Succimer; dimercaprol + CaNa ₂ EDTA; D-penicillamine		Oral; IM + IV infusion; oral
Mercury	Succimer; dimercaprol; penicillamine		Oral; IM; oral

IM, Intramuscular; IV, intravenous.

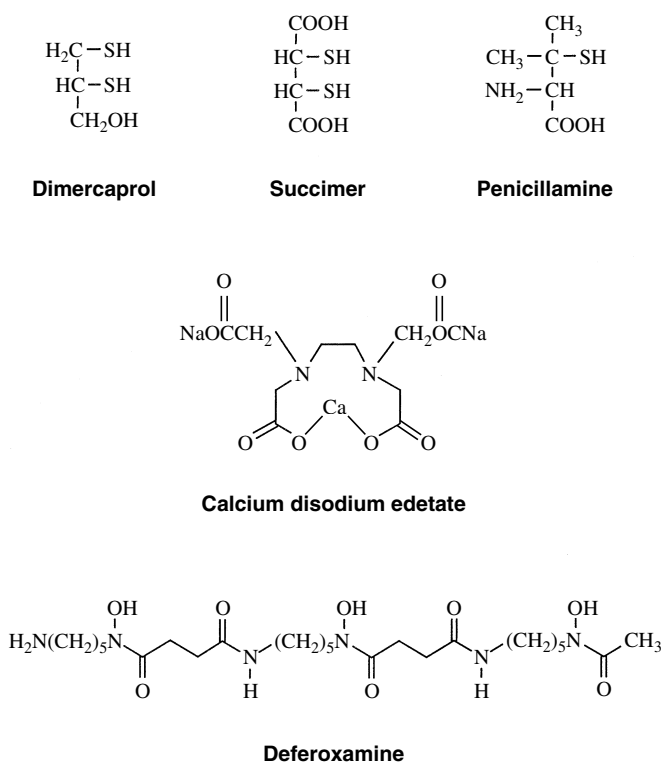

FIGURE 52-4 Chemical structures of chelating agents.

kg every 8 hours for 5 days, then 10 mg/kg every 12 hours for 14 days. In animal studies, succimer was more effective than dimercaprol in alleviating acute toxicity and preventing distribution of orally administered mercury from mercuric chloride, particularly to the brain. In addition, oral administration was more efficient than parenteral administration in reducing retention and organ deposition of oral mercuric chloride, probably because of decreased intestinal uptake.

Penicillamine (3-mercapto-D-valine) is a highly effective chelator of copper and is of primary importance in the management of Wilson's disease (hepatolenticular degeneration). Although less effective against other metals, penicillamine is often a useful drug for asymptomatic patients with a moderate body burden of metal because it is orally effective. In general, 1 to 2 g/day is administered as needed for therapy of mercury poisoning. The penicillamine-mercury complex (also involving two drug molecules for each mercury atom) is excreted in the urine.

Edetate calcium disodium complex is a chelator for divalent and trivalent metals that can displace calcium from the molecule. Typically, these metals include lead, zinc, cadmium, manganese, iron, and mercury. Edetate calcium disodium is poorly absorbed from the gastrointestinal tract and is given intramuscularly or intravenously. Edetate calcium disodium must be used carefully according to suppliers' protocols because it can produce nephrotoxicity. Edetate calcium disodium can aggravate symptoms of severe lead poisoning, such as cerebral edema and renal tubular necrosis, and in high doses can lead to severe zinc deficiency.

Deferoxamine is a specific chelating agent for iron. It is available only for parenteral administration. The preferred route is intramuscular; acute iron intoxication treatment involves 1 g as an initial dose, followed by 500 mg every 4 hours for two doses and additional doses of 500 mg every 4 to 12 hours as needed based on clinical response.

Treatment of mercury poisoning

Therapy depends on the type of mercury poisoning. Exposure to elemental or inorganic mercury can be treated with dimercaprol (higher mercury levels) or penicillamine (lower mercury levels). Hemodialysis may be needed to protect the kidney. Succimer is also effective. For short-chain organic mercurials such as methylmercury, chelation therapy is ineffective, and dimercaprol is contraindicated because it concentrates mercury in the brain. Hemodialysis is ineffective. Methylmercury can possibly be bound in the gut with a polythiol resin.

Gases

Perhaps no other toxic pollution issue stirs such universal concern as air pollution because gaseous pollutants are dispersed over broad regions, and inhalation exposure is insidious. Significant regulatory effort is devoted to decreasing air pollutants by the Clean Air Act, and general information on topics important in the control of air pollution is available from the Internet.⁷⁸ The U.S. Environmental Protection Agency (EPA) uses six "criteria pollutants" as indicators of air quality and has established a maximum concentration for each to preclude adverse effects on human health. The four gaseous criteria pollutants are discussed subsequently; the remaining two are airborne lead and fine particulate material that is 10 μm or smaller in diameter.

Carbon monoxide

The origin of CO, a colorless, odorless gas, is incomplete combustion of carbon. The toxicity of CO results from its combination with Hb and exclusion of oxygen from this vital oxygen transfer mechanism. CO exhibits an affinity for Hb 210 to 300 times that of oxygen, and the resultant complex

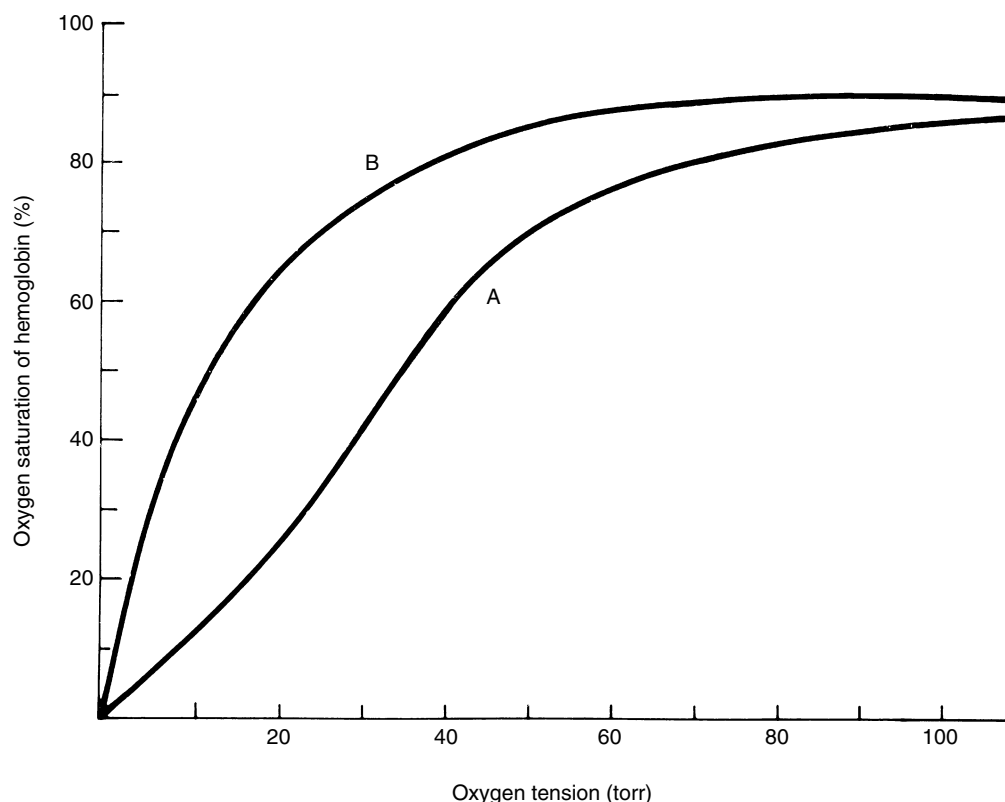

FIGURE 52-5 Effect of carbon monoxide on oxygen dissociation. *Curve A* represents the normal desaturation curve for oxyhemoglobin and shows that half of the bound oxygen is made available to tissues as the oxygen tension (P_{O_2}) decreases to slightly more than 30 mm Hg (~30 torr). In the presence of 50% carboxyhemoglobin (*curve B*), P_{O_2} must decrease to a hypoxic value of 10 mm Hg before a similar percentage of oxygen is released from hemoglobin binding sites.

with reduced heme iron, CO-Hb, is incapable of combining with oxygen.⁸⁶ The relationship between CO air levels and CO-Hb in blood can be predicted by the Coburn-Foster-Kane equation⁷²; typical symptoms associated with varying CO-Hb levels are presented in the review by Von Burg.⁸⁶ The effect of CO-Hb on oxygen dissociation is shown in Figure 52-5.

Ozone

Ozone (O_3) is an odorless, colorless gas composed of three oxygen atoms. Typically, O_3 is not emitted into the air, but is created at ground level by photochemical reactions among nitrogen oxides and volatile organic compounds in the presence of heat and sunlight. O_3 occurs naturally in the stratosphere (approximately 10 to 20 miles above the earth) and forms a protective barrier that absorbs the sun's harmful ultraviolet rays. In the earth's lower atmosphere and at ground level, O_3 is considered unhealthy because of its oxidative effects. Because of its relative insolubility, inspired O_3 is carried deep into the lung, where it oxidizes membranes in the alveoli. O_3 irritates lung airways and causes inflammation, reduced lung capacity, and increased susceptibility to respiratory illnesses such as pneumonia and bronchitis. Other symptoms include wheezing, coughing, and pain with deep breathing. Oxidation products arising from O_3 reactions with lung proteins or lipids initiate numerous cellular responses, including generation of cytokines and expression of adhesion molecules. These responses promote an influx of inflammatory cells to the lung in the absence of a pathogenic challenge, resulting in modification of cellular tight junctions, increased lung permeability, and development of edema.⁵⁵ Individuals with preexisting respiratory problems, such as asthma or

chronic obstructive pulmonary disease, are most vulnerable. Repeated exposure to O_3 pollution for several months may cause permanent lung damage.

Sulfur dioxide

Sulfur dioxide (SO_2) is a colorless gas with a pungent, irritating odor. SO_2 is used as a preservative of fruits and vegetables, a disinfectant in wineries and breweries, and a bleaching agent in paper and textile industries. It is generated as an air pollutant by industry, such as high-sulfur coal-fired electric power plants, and is largely responsible for the environmental and public health impact of acid rain.⁴⁴ In contrast to the properties and site of impact of O_3 , SO_2 is highly soluble in aqueous fluids and affects the upper respiratory tract. On dissolution, it forms sulfurous acid, which is extremely irritating to the nasopharyngeal and respiratory tracts. Acute exposure causes dryness of the nose and throat and a decrease in tidal respiratory volume. Coughing, sneezing, choking, and nasal discharge occur. In dentistry, chronic exposure at levels causing these symptoms has been associated with dental caries and gingival and periodontal disorders. Patients noted rapid dental destruction, loss of restorations, and increased sensitivity of teeth to temperature change.⁸⁷

Nitrogen oxides

Nitrogen dioxide (NO_2) is a brownish, highly reactive gas that is present in all urban atmospheres. The major mechanism for the formation of NO_2 in the atmosphere is the oxidation of the primary air pollutant nitric oxide (NO). Mixtures of nitrogen oxides (NO_x) play a major role, together with volatile organic hydrocarbons, in complex atmospheric reactions that

produce O₃ and are important precursors to acid rain. NO₂ is relatively insoluble in aqueous media and decomposes in water to form nitric acid (HNO₃) and NO, a potent vasodilator. When inspired, it reaches deep into the lungs. NO₂ can cause bronchitis, pneumonia, hemorrhagic pulmonary edema, and diffuse alveolar damage. Exposure also seems to reduce resistance to respiratory infections. Acute exposure to nitrogen oxides causes a relatively rare condition known as *silo filler's disease*. Most cases involve young, otherwise healthy farm workers who enter silos freshly filled with corn silage without adequate ventilation. The most common presenting feature is dyspnea, but the disease was fatal in 5 of 20 reviewed cases.⁹⁴

Liquids and Vapors

The organic liquid that presents the greatest risks to humans is ethanol. The toxicologic profile of this compound is unique among organic liquids and is presented in detail with other aliphatic alcohols in Chapter 43. Considered in this section are the organic solvents, including hydrocarbons and chlorinated compounds, and methyl methacrylate (because of its common use in dentistry). Figure 52-6 shows structures of the compounds discussed here.

Solvents

Although transient exposure to solvents may occur in the home, more significant exposure most commonly occurs in the workplace. Exposure most often occurs through inhalation; absorption through the skin is also a common route of exposure. Absorption from the gastrointestinal tract is variable. Compounds that are well absorbed, such as benzene or toluene, can produce significant systemic toxicity. Others, such as naphtha or gasoline, are not as well absorbed. A major risk from ingestion is the potential for pneumonitis as a result of emesis and aspiration.

Regardless of the site of absorption, the great lipid solubility of this group of compounds allows them to cross the blood-brain barrier readily. Individuals exposed to high concentrations of organic solvents usually exhibit profound CNS depression. Chronic exposure to lower concentrations of these chemicals produces toxic effects characteristic of the individual compounds.

Chlorinated solvents

Dichloromethane, otherwise known as methylene chloride, is a common solvent in paint remover and is used for liquid-

liquid extraction in laboratories. Acute toxicity is caused by CNS depression, and fatalities have resulted from exposure. Symptoms include mental confusion, fatigue, lethargy, headache, and chest pain. Dichloromethane is metabolized to carbon monoxide. Evidence of its carcinogenicity, obtained in mice, seems to be related to toxic metabolites formed by glutathione-S-transferase and may be specific to the very high activity and localization of this enzyme in this species.³⁵

Carbon tetrachloride is metabolized in the liver to a highly reactive metabolite (a free radical) that, in the presence of oxygen, reacts with proteins and lipids. The resulting hepatotoxicity may take days to develop and is accompanied by severe renal toxicity. Compounds that increase the rate of carbon tetrachloride biotransformation, such as cytochrome P450 enzyme inducers, increase the danger of toxicity. Substances that inhibit its metabolism are protective.

In a similar manner, perchloroethylene (also known as tetrachloroethylene) has been found to produce reactive metabolites that are thought to produce renal toxicity. This compound has also been associated with an increased risk of oral, laryngeal, and esophageal cancer in workers occupationally exposed to dry-cleaning processes that use perchloroethylene.⁸⁵

Benzene

Benzene is another widely used industrial solvent commonly encountered in petroleum distillates such as gasoline. Benzene is considered a causative agent in human leukemia, probably through active hydroquinone or benzoquinone metabolites formed at oxidation.³⁸

Methyl methacrylate

Methyl methacrylate is widely used in dentistry for the production of prosthetic devices and in orthopedic medicine as a luting agent. Although properly cured polymers from methyl methacrylate seem to be biologically inert, numerous adverse effects have been associated with the monomer. Exposure to the monomer can lead to toxicity and allergic reactions.¹⁴ A slight, transient decrease in blood pressure has occasionally been reported when methyl methacrylate was used to cement orthopedic devices. The assumption in these cases was that the effects were caused by absorption of the monomer into the patient's vasculature. Adverse effects have also been reported by personnel in operating rooms, where, because of improper mixing, concentrations of more than 200 ppm have been measured. Surgeons have developed contact dermatitis and paresthesias,³⁰ and nurses have reported dizziness, nausea, and vomiting.

A survey of dental laboratories suggests that these were exposed to more moderate concentrations (≤ 5 ppm) of the monomer,¹² although peak concentrations can be double that amount.⁵⁶ Although the concentrations to which dental technicians are exposed are moderate, a study of dental technicians suggested that cutaneous absorption of the monomer, a result of dipping the fingers in the liquid to smooth and improve the finish of the polymer surface, caused a localized slowing of nerve conduction.⁶⁷ Other studies have found more generalized neuropathies attributed to methyl methacrylate exposure in dental technicians.^{18,65} In addition, cutaneous reactions have been reported from monomer and "cured" methacrylate polymer.^{46,59}

Numerous studies have confirmed more recently that dental resins and composites release methyl methacrylate and many similar plastic components that are known to have the potential for endocrine-disrupting effects.^{1,40,74,88} The term *endocrine-disrupting* refers to alterations in the natural biosynthesis, metabolism, or receptor occupancy of hormones such as estrogen and testosterone. Many of these endocrine-disrupting compounds found in dental filling materials are

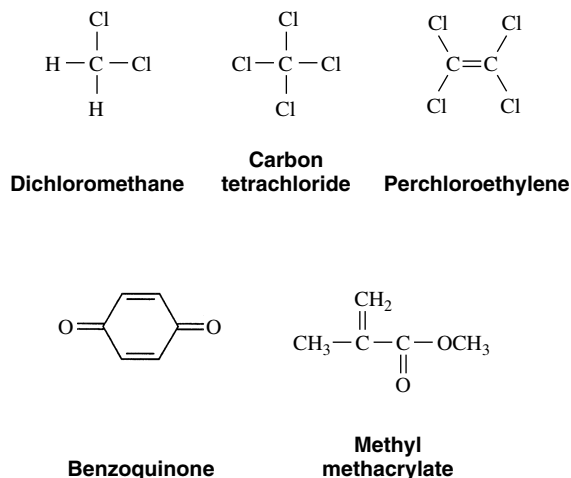

FIGURE 52-6 Chemical structures of chlorinated solvents, the benzene metabolite benzoquinone, and the acrylic plastic monomer methyl methacrylate.

uncured monomers, such as bisphenol A (BPA) and bisphenol A glycidylmethacrylate (Bis-GMA), and chemically related compounds such as phthalates.

Although little is definitively known about the effects of low-dose exposure of these components of dental composites and sealants, evidence exists of the potential for detectable effects on human metabolic systems. Much of this evidence is from animal model and human *in vitro* studies, and little or no research has been reported that uses *in vivo* studies to examine these potential effects. Potential systemic effects on the organism of endocrine disruption are wide-ranging and biologically important. These may include developmental defects, behavioral effects, fertility problems, and tumorigenic effects. There have been no safety studies or randomized clinical trials in humans to examine the potential effects of low-dose exposures to these substances, such as one might get from dental sources, but available data suggest that such exposures produce minimal effects, if any.

Pesticides

Pesticides represent a unique segment of the chemical market because these products are designed and produced for their toxic effects. Considerable efforts have been devoted to the concept of selective toxicity, in which products are developed with the objectives of toxic action on pests, while affording some advantage to other species. In the United States, pesticides are regulated under the Federal Insecticide, Fungicide, and Rodenticide Act (FIFRA),⁸⁰ which delegates regulatory authority to the EPA. Before a pesticide can be legally used, it must be registered with the Office of Pesticide Programs (OPP). Pesticide registration is the process by which the EPA examines the ingredients of a pesticide; the site or crop on which it is to be used; the amount, timing, and frequency of its use; and storage and disposal practices. The EPA OPP evaluates each pesticide to ensure no adverse effects on humans, nontarget species, or the environment under specified use before initial registration; older, previously registered pesticides undergo re-registration to assess health effects as new information becomes available.

Depending on the toxicity of the marketed product, pesticides are registered for general public use or are classified for restricted use only by a certificated pesticide applicator or under the direct supervision of a certified applicator. Pesticides are restricted from residential or institutional use if the product, as diluted for use, has an oral LD₅₀ of 1.5 g/kg or less and restricted for other uses if the product, as diluted for use, has an oral LD₅₀ of 50 mg/kg or less.

Certain pesticides have been banned or severely restricted for export or import through the auspices of the United Nations Environment Programme and the Food and Agriculture Organization, which developed internationally accepted guidelines for exchange of information on banned or severely restricted industrial chemicals and pesticides. These guidelines eventually evolved into the United Nations Rotterdam Convention on the Prior Informed Consent Procedure, which lists banned and restricted pesticides.⁷⁷

The Food Quality Protection Act⁸¹ of 1996 amended FIFRA to require evaluation of pesticide safety with consideration of potential aggregate exposures from nondietary and dietary routes. From this mandate, pesticide registrations are being revised. The current status of pesticides is available electronically via a website⁸² that the EPA OPP maintains with extensive information regarding pesticide use, regulation, data sources, consumer alerts, and educational materials. The EPA OPP also has supported production of a manual, available electronically,⁶² that is designed to provide health professionals with current information regarding health hazards of pesticides.

Insecticides

Most insecticides in common use by the public today fall into two classes based on their mode of toxic action: anticholinesterases, characterized by their inhibitory action on acetylcholinesterase, and pyrethroid insecticides, so named after their origin as pyrethrum extract from flowers of the genus *Chrysanthemum*. Organochlorine insecticides, such as DDT, were widely used from 1945-1969, but have been banned for use in the United States because of their adverse effects, including their biologic and environmental persistence, biomagnification through diet in lipid tissues of higher organisms, demonstrated interaction with estrogen receptors, and enzyme-inducing properties.

The anticholinesterase insecticides are analogues of organophosphate or methylcarbamate esters. Representative structures are shown in Figure 52-7. The mechanism of action of anticholinesterase drugs is described in greater detail in Chapter 8. These compounds inhibit the hydrolytic action of the neurologically essential enzyme system, acetylcholinesterase.^{54,61} Anticholinesterases interact with the enzyme in a manner similar to the endogenous substrate, but with turnover numbers several orders of magnitude smaller than the substrate, acetylcholine. This interaction leaves the enzyme phosphorylated or carbamylated and inactive regarding physiologic function. Poisoning results in great overabundance of acetylcholine at cholinergic receptors on autonomic nerves, at the neuromuscular junction, in the adrenal medulla, and in the CNS.

Approximately 100 organophosphate-class insecticides are currently in use in the United States. Many are analogues of phosphorothioic acid; these are activated preferentially in insects to phosphate homologues by oxidative mechanisms. A classic example of differences in toxicity of thio versus oxo organophosphate homologues is exhibited by parathion (rat oral LD₅₀ 13 mg/kg)³² versus paraoxon (rat oral LD₅₀ 1.8 mg/

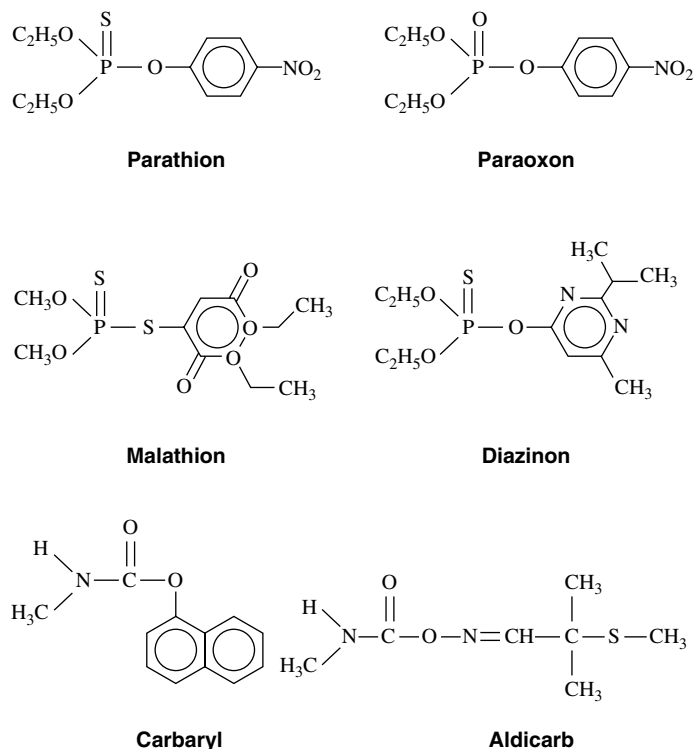

FIGURE 52-7 Chemical structures of organophosphate and methylcarbamate anticholinesterase insecticides.

kg).⁶⁰ The venerable compound malathion has been used widely for nonagricultural applications, whereas chlorpyrifos, diazinon, parathion, and terbufos are now restricted to use only by certified applicators.

Of some 22 methylcarbamates in use, carbaryl (rat oral LD₅₀ 250 mg/kg)⁸⁴ has been used most widely in home and garden applications. It is relatively nontoxic to mammals but is highly toxic to honeybees. In contrast, aldicarb, a methylcarbamate designed with molecular dimensions based on acetylcholine, is much more toxic to mammals (LD₅₀ approximately 1 mg/kg).⁶³ Aldicarb is available only to certified applicators; it is applied to the soil and taken up for systemic action in plants. Treatment of acute anticholinesterase poisoning by either organophosphates or methylcarbamates involves liberal use of anticholinergic drugs, particularly atropine, to antagonize muscarinic cholinergic signs. Pralidoxime has been used successfully to reverse cholinesterase inhibition when used early in cases of organophosphate poisoning, but may aggravate poisoning with methylcarbamate insecticides.⁴³

The pyrethroids consist of a group of natural or synthetic compounds that modify properties of ion channels in nerves. Pyrethroids maintain Na⁺ channels open for prolonged periods, leading to hyperexcitation of the nervous system. These compounds elicit repetitive nerve activity, particularly in sensory nerves, along with membrane depolarization, enhanced neurotransmitter release, and eventual block of excitation. These actions occur as a consequence of prolongation of Na⁺ ion current in voltage-dependent Na⁺ channels. The pyrethroids have remarkably selective toxicity for insects relative to mammals. They are largely contact insecticides with rapid "knock-down" properties.

Natural pyrethroids (pyrethrin I, pyrethrin II) are short-lived as a consequence of rapid oxidation and photodegradation in the environment and are rapidly hydrolyzed or oxidized when taken orally. These properties have resulted in rapid acceptance with minimal risk from use, but disadvantages are short duration of action and expense of natural product isolation. Synthetic pyrethroids are designed to be more persistent. These include two types, determined by the presence or absence of a cyano function; two examples are shown in Figure 52-8. Of these, permethrin is stable to light and has low toxicity in adult mammals, but is more toxic to neonates with undeveloped hydrolytic and oxida-

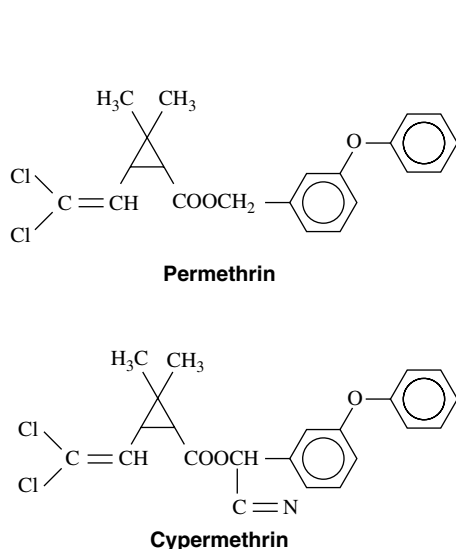

FIGURE 52-8 Chemical structures of several synthetic pyrethroid insecticides.

tive mechanisms (rat oral LD₅₀ 1500 mg/kg for adults, 340 mg/kg for 8-day-old rats).⁹ Other synthetic analogues substituted with a cyano group are more toxic. Cypermethrin, a cyano homologue of permethrin, enables comparison of the effect of the cyano modification (rat oral LD₅₀ 250 mg/kg for adults, 14.9 mg/kg for 8-day-old rats).⁹ Occupational exposure to pyrethroid insecticides leads to temporary paresthesia and respiratory irritation. Treatment is generally supportive.

Organochlorine insecticides, previously used extensively, are now only of historic importance in the United States, but some are still used in other regions of the world because of their low cost, stability, and efficacy. Figure 52-9 shows structures of some of these organochlorine insecticides. The Nobel Prize for Physiology and Medicine in 1948 was awarded to Paul Mueller, who discovered the insecticidal properties of the prototype, DDT. DDT is a member of the dichlorodiphenylethane subclass of organochlorine insecticides, but is now restricted under the UN PIC (Prior Informed Consent) procedure.⁷⁷ The chlorinated cyclodiene structure subclass includes chlordane, dieldrin, and heptachlor, which also are restricted under the UN PIC procedure. Chlordecone and mirex represent another unique subgroup of cage-like, highly chlorinated C₁₀ structures that are restricted from use. The hexachlorocyclohexane-type compounds include lindane, a specific insecticidal isomer that is still used in Kwell shampoo and topical creams as an ectoparasiticide and ovide for crab and head lice and in certain home and garden pest control products.

The toxic actions of organochlorines, similar to pyrethroids, alter conduction in the ion channels of nerves. DDT alters Na⁺ and K⁺ ion permeability, Na⁺-dependent and K⁺-dependent adenosine triphosphatase (ATPase) and Ca⁺⁺-dependent ATPase functions, and inhibition of calmodulin in nerves. These actions reduce the rate of nerve membrane repolarization and increase sensitivity to small stimuli. The chlorinated cyclodienes are different because their actions seem to be more localized within the CNS. These compounds inhibit Na⁺-dependent and K⁺-dependent ATPase and Ca⁺⁺-dependent ATPase and act as γ -aminobutyric acid antagonists, eliciting uncontrolled neurotoxic excitation.²¹

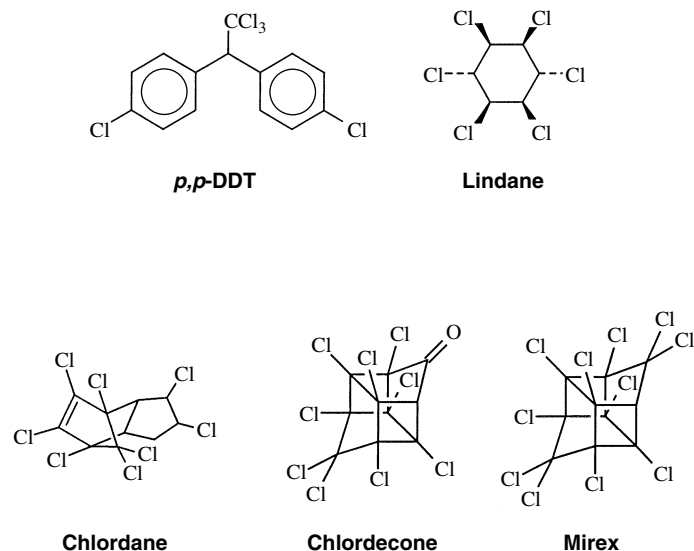

FIGURE 52-9 Chemical structures of several organochlorine insecticides.

Fumigants

Fumigants may be gases, volatile liquids, or solids that release toxic gas on treatment with water or acid. Typically, fumigants are not selective in toxicity; rather, they are used for their asphyxiant, highly reactive, or cytotoxic properties. Examples of gaseous fumigants include carbon dioxide, which is a relatively nontoxic asphyxiant; ethylene oxide, largely used as a sterilizing agent in the health care industry; and methyl bromide, previously in wide use as a soil fumigant but undergoing phaseout because it is an ozone-depleting agent. Liquids include ethylene dibromide, bromochloropropane, 1,3-dichloropropene, and formaldehyde. Solids that liberate toxic gases for fumigation are zinc phosphide and aluminum phosphide, which produce toxic phosphine. Many fumigants form covalent adducts with important protein structures, including enzymes. 1,2-Dibromo-3-chloropropane, perhaps the best-known occupational testicular toxin, has been banned because of this action. Toxic effects of fumigants have been reviewed with particular attention to mutagenic activities.²⁸

Herbicides

Herbicides are the most widely used type of pesticides. Given the broad use of these pesticides with apparently low relative risk in normal use, some herbicides in common use are presented, with selection based on high usage or significant toxicity where evident. Research efforts by crop scientists in recent decades have produced diverse structures, many of which offer selective toxicity against weeds, while sparing economic crops. An example is the use of herbicides in "no-till" production of grains, in which fields are sprayed to kill grasses, and seeds are planted without the need for plowing fields. Structures of some herbicides are illustrated in Figure 52-10.

Atrazine is a member of the class of chemically similar compounds known as the triazine herbicides that block photosynthesis in plants. Atrazine is one of the most widely used agricultural pesticides in the United States. Approximately 80 million pounds of the atrazine active ingredient are applied annually to control broadleaf weeds in field corn and sorghum, in lawns and turf, and after production of wheat. Epidemiologic studies of workers exposed in chemical plants and farming populations have not shown a significant incidence of disease related to atrazine use, and little acute toxicity is evident in suicide attempts with atrazine. Atrazine has under-

gone review, however, for re-registration by the EPA Health Effects Division.⁷⁹ This decision for re-review was based on the high volume of use, persistence of atrazine in surface and ground water, and more recent research indicating that atrazine diminished secretion of hypothalamic gonadotropin-releasing hormone in rats. Previous work¹¹ had indicated that atrazine given by gavage in high doses altered luteinizing hormone and prolactin serum levels in two strains of female rats by altering the hypothalamic control of these hormones. Subsequent studies at more relevant concentrations in amphibians did not find that atrazine adversely affected amphibian gonadal development.⁷⁹

Glyphosate has broad-spectrum herbicidal activity, sometimes called "total kill," against a wide range of weeds. Glyphosate kills plants by inhibiting an essential plant enzyme involved in biosynthesis of aromatic compounds, which is absent in nonplant life forms. As a result, under normal use glyphosate is practically nontoxic to mammals, aquatic organisms, and avian species. Irritation of the oral mucous membrane and gastrointestinal tract was frequently reported with ingestion of the concentrate. Other effects recorded were pulmonary dysfunction, oliguria, metabolic acidosis, hypotension, leukocytosis, and fever. Various reviews, which indicated absence of toxicity in long-term animal studies of glyphosate, have been summarized.⁹⁰

Chlorophenoxy compounds, typified by 2,4-dichlorophenoxyacetic acid (2,4-D) and 2-(2-methyl-4-chlorophenoxy)propionic acid, are used to control broadleaf weeds. They act as stimulants of uncontrolled growth in plants by mimicking and disrupting the actions of plant growth regulators such as indole acetic acid. In animals 2,4-D exhibits various mechanisms of toxicity, including uncoupling of oxidative phosphorylation, damage to cell membranes, and disruption of acetyl coenzyme A metabolism. Ingestion of large doses can cause nausea, gastrointestinal hemorrhage, hypotension, muscular twitching and stiffness, metabolic acidosis, and renal failure. Significant dermal exposure and occupational inhalation are associated with progressive sensory and motor peripheral neuropathy.⁸ One analogue, 2,4,5-trichlorophenoxyacetic acid (2,4,5-T), was removed from use in the United States in 1979 because of its contamination with the toxic by-product, 2,3,7,8-tetrachlorodibenzodioxin, as previously noted. Agent Orange, the notorious herbicide used in the Vietnam War, was a 50:50 mixture of 2,4-D and 2,4,5-T.

Nitrophenolic compounds formerly used as herbicides, such as dinitroresol and dinitrophenol, are highly toxic to humans and animals, with LD₅₀ values in the range of 25 to 50 mg/kg.⁶² These stimulate energy metabolism in mitochondria by uncoupling oxidative phosphorylation; this leads to hyperthermia, causing profuse sweating, fever, thirst, and tachycardia. Because of this toxicity, the registrations for herbicidal uses of dinitroresol and dinitrophenol and similar compounds have been canceled. In contrast, certain dinitroaminobenzene herbicides, including butralin, oryzalin, and pendimethalin, and fluorodinitrotoluidine derivatives, such as benfluralin, dinitramine, fluchloralin, and trifluralin, do not uncouple oxidative phosphorylation or generate methemoglobinemia. These herbicides inhibit cell division in plants. Acute oral LD₅₀ values are equal to or greater than that of fluchloralin (1550 mg/kg), and some are greater than 10,000 mg/kg.

Paraquat is the most important dipyridyl herbicide for consideration because it has delayed, severe, and specific pulmonary toxicity. Paraquat exhibits its particular and unique toxicity (LD₅₀ in humans of approximately 3 to 5 mg/kg)⁶² in part because of its selective accumulation in lung tissue by a diamine transport system located in the alveolar epithelium. In addition, paraquat is involved in a single-electron cyclic

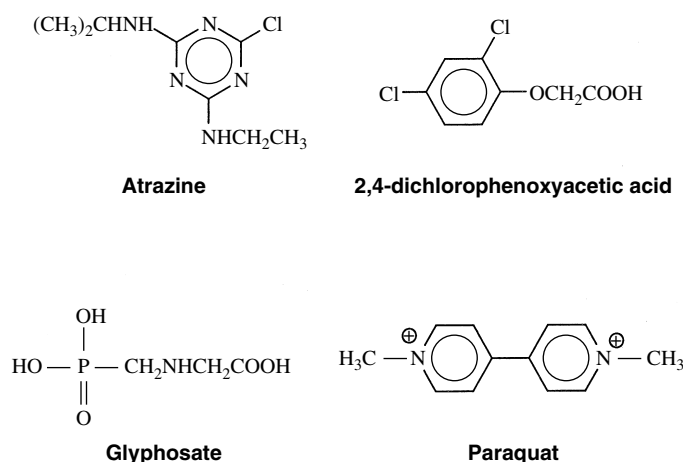

FIGURE 52-10 Chemical structures of various herbicides.

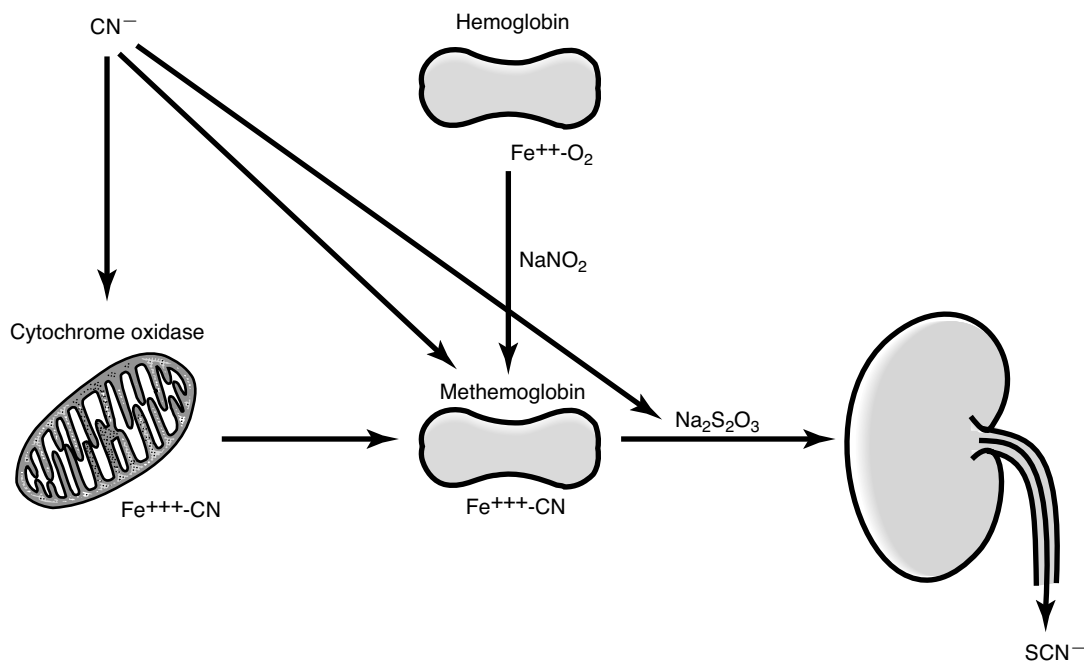

FIGURE 52-11 Treatment of cyanide poisoning. Cyanide (CN^-), whether inhaled or ingested, combines with ferric ions (Fe^{+++}) in cytochrome oxidase to inhibit cellular respiration. Therapy is aimed at eliminating cyanide from the cells by a two-step process: (1) Sodium nitrite (NaNO_2) is administered intravenously to oxidize the iron in hemoglobin from the ferrous (Fe^{++}) to the ferric state; the methemoglobin that is formed competes for cyanide, freeing cytochrome oxidase from attack by cyanide. (2) Cyanide is inactivated by the administration of sodium thiosulfate ($\text{Na}_2\text{S}_2\text{O}_3$) to yield thiocyanate (SCN^-), which is readily excreted in the urine. Experimentally, these steps reduce the lethal potency of cyanide by 80%.

reduction-oxidation reaction that attacks unsaturated lipids in membranes to form lipid peroxides.⁷¹ The oxidative destruction and subsequent fibrotic lesions developed during reparative processes lead to severely diminished lung function, anoxia, and death days after ingestion of paraquat. The comprehensive treatise by Ellenhorn and associates²⁴ presents pharmacokinetic plots indicating likely survival or death based on blood concentrations versus time after ingestion.

Predicides

Predicides are pesticides used to control predatory animals such as coyote, fox, and wild dog populations that are likely to prey on livestock, poultry, or endangered species or that are vectors of communicable diseases. Sodium cyanide, which liberates hydrogen cyanide, is one such predicide, and this is the only current registered use for sodium cyanide as a pesticide. Because of its extreme toxicity, sodium cyanide is restricted to use only by trained applicators. Cyanide inactivates cellular oxidative phosphorylation by binding to the Fe^+ in the cytochrome $a\text{-a}_3$ complex. The inability of cells to use oxygen, particularly in the brain and heart, is rapidly lethal to warm-blooded animals. Therapy for poisoning involves treatment with 100% oxygen and rapid provision of an alternative, less critical source of Fe^{+++} for cyanide binding. This is accomplished by inducing methemoglobinemia by administering amyl nitrite or sodium nitrite. This is followed by treatment with sodium thiosulfate solution to assist conversion of cyanide to thiocyanate by the mitochondrial enzyme rhodanese (Figure 52-11).

Rodenticides

Various compounds have been used to attack rodents. Some are quite toxic to rodents, humans, and wildlife through acute

exposure, whereas others require multiple doses to elicit significant toxicity. Most of these act as anticoagulants, and their structures are shown in Figure 52-12. The oldest, warfarin, is a coumarin derivative that has been used as a rodenticide since 1950. Warfarin derives its action through antagonism of vitamin K action as a cofactor in synthesis of coagulation factors (see Chapter 31). Warfarin exhibits LD_{50} values in the range of 9 to 100 mg/kg in rats, with females being more susceptible.⁴ Other multiple-dose anticoagulants are derivatives of 1,3-indandione. These include diphaceneone (LD_{50} approximately 2.5 mg/kg) and chlorophacinone (LD_{50} approximately 6.2 mg/kg).

Resistant strains of rodents have emerged, which has led to development of new hydroxycoumarin derivatives (so-called "superwarfarins") that are much more potent and do not require repeated doses to kill. Brodifacoum (LD_{50} approximately 0.5 mg/kg) and bromadiolone (LD_{50} approximately 0.7 mg/kg) are characterized as single dose in use.^{4,83} Necropsies after poisonings support the diagnosis of coagulopathy with findings of hemoperitoneum, hemothorax, and pulmonary hemorrhage. Because of the increased potency and increased duration of action in some of these newer rodenticides, poisoning has occurred in pets, wildlife, and exposed humans.⁷³ Treatment is based on assessment of prothrombin time, which should be monitored at 24 hours and 48 hours after ingestion. If prothrombin time is elevated at these times, treatment with phytonadione (phyloquinone, vitamin K_1) should be instituted with continued assessment of prothrombin time over 4 to 5 days.⁶² Other compounds in use as single-dose rodenticides include strychnine, zinc phosphide, and bromethaline, which is a dinitroaniline derivative that uncouples oxidative phosphorylation.

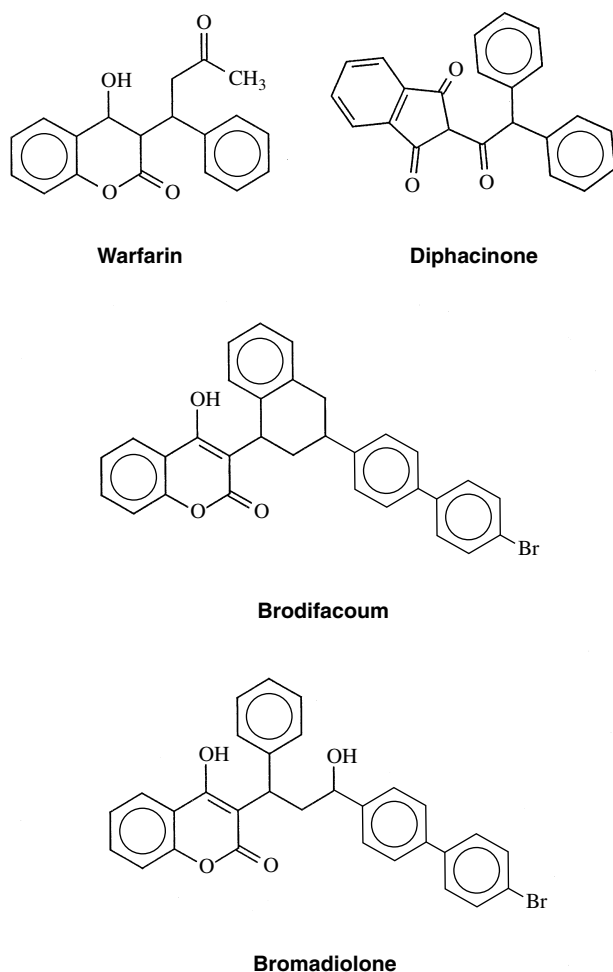

FIGURE 52-12 Chemical structures of anticoagulant rodenticides.

CITED REFERENCES

- Al-Hiyasat AS, Darmani H, Elbetieha AM: Leached components from dental composites and their effects on fertility of female mice. *Eur J Oral Sci* 112:267-272, 2004.
- American Dental Association: *OSHA: A step-by-step guide to compliance*; and *Video OSHA refresher course*, available in the ADA catalogue or call 1-800-947-4746, www.ada.org/prof/ed/careers/infopaks/osha.asp, American Dental Association, Accessed November, 12, 2009.
- Ayad MS, Knight KR, Burdon JG, et al: Secretory leukocyte proteinase inhibitor, alpha-1-antitrypsin deficiency and emphysema: preliminary study, speculation and an hypothesis. *Respirology* 8:175-180, 2003.
- Back N, Steger R, Glassman JM: Comparative acute oral toxicity of sodium warfarin and microcrystalline warfarin in the Sprague-Dawley rat. *Pharmacol Res Commun* 10:445-452, 1978.
- Bellinger DC, Trachtenberg F, Barregard L, et al: Neuropsychological and renal effects of dental amalgam in children: a randomized clinical trial. *JAMA* 295:1775-1783, 2006.
- Beutler E: G6PD deficiency. *Blood* 84:3613-3636, 1994.
- Bittner AC Jr, Echeverria D, Woods JS, et al: Behavioral effects of low-level exposure to Hg⁰ among dental professionals: a cross-study evaluation of psychomotor effects. *Neurotoxicol Teratol* 20:429-439, 1998.
- Bradberry SM, Watt BE, Proudfoot AT, et al: Mechanisms of toxicity, clinical features, and management of acute chlorophenoxy herbicide poisoning: a review. *J Toxicol Clin Toxicol* 38:111-122, 2000.
- Cantalamesa F: Acute toxicity of two pyrethroids, permethrin, and cypermethrin in neonatal and adult rats. *Arch Toxicol* 67:510-513, 1993.
- Chemical Abstracts Service: Latest CAS registry number and substance count. Available at: <http://www.cas.org/cgi-bin/regreport.pl>. Accessed August 13, 2007.
- Cooper RL, Stoker TE, Tyrey L, et al: Atrazine disrupts the hypothalamic control of pituitary-ovarian function. *Toxicol Sci* 53:297-307, 2000.
- Cromer J, Kronoveter KA: *Study of methyl methacrylate exposure and employee health*, DHEW Pub. No. (NIOSH) 77-119. Washington, DC, 1976, US Government Printing Office.
- Danielson PB: The cytochrome P450 superfamily: biochemistry, evolution and drug metabolism in humans. *Curr Drug Metab* 3:561-597, 2002.
- Danilewicz-Stysiak Z: Experimental investigations on the cytotoxic nature of methyl methacrylate. *J Prosthet Dent* 44:13-16, 1980.
- Dart RC, Bond GR: Gastrointestinal decontamination. In Dart RC, editor: *Medical toxicology*, Philadelphia, 2004, Lippincott Williams & Wilkins.
- DeRouen TA, Martin MD, Leroux BG, et al: Neurobehavioral effects of dental amalgam in children: a randomized clinical trial. *JAMA* 295:1784-1792, 2006.
- Dodes JE: The amalgam controversy: an evidence-based analysis. *J Am Dent Assoc* 132:348-356, 2001.
- Donaghy M, Rushworth G, Jacobs JM: Generalized peripheral neuropathy in a dental technician exposed to methyl methacrylate monomer. *Neurology* 41:1112-1116, 1991.
- Dresser GK, Spence JD, Bailey DG: Pharmacokinetic-pharmacodynamic consequences and clinical relevance of cytochrome P450 3A4 inhibition. *Clin Pharmacokinet* 38:41-57, 2000.
- Echeverria D, Heyer NJ, Martin MD, et al: Behavioral effects of low-level exposure to elemental Hg among dentists. *Neurotoxicol Teratol* 17:161-168, 1995.
- Ecobichon D: Toxic effects of pesticides. In Klaassen C, editor: *Casarett and Doull's toxicology: the basic science of poisons*, ed 6, New York, 2001, McGraw-Hill.
- Eley BM: The future of dental amalgam: a review of the literature, part 4: mercury exposure hazards and risk assessment. *Br Dent J* 182:373-381, 1997.
- Ellenhorn M: Metals and related compounds: lead. In *Ellenhorn's medical toxicology: diagnosis and treatment of human poisoning*, ed 2, Baltimore, 1997, Williams & Wilkins.
- Ellenhorn M: Pesticides: paraquat. In *Ellenhorn's medical toxicology: diagnosis and treatment of human poisoning*, ed 2, Baltimore, 1997, Williams & Wilkins.
- Evans W, Relling MV: Pharmacogenomics: translating functional genomics into rational therapeutics. Available at: <http://sciencemag.org/feature/data/1044449.shl>. Accessed January 23, 2010.
- Evans WE: Pharmacogenomics: marshalling the human genome to individualise drug therapy. *Gut* 52(Suppl 2):ii10-ii18, 2003.
- Fine JS: Iron poisoning. *Curr Probl Pediatr* 30:71-90, 2000.
- Fishbein L: Potential hazards of fumigant residues. *Environ Health Perspect* 14:39-45, 1976.
- Friberg L, Nordberg GF: Inorganic mercury—a toxicological and epidemiological appraisal. In Miller MW, Clarkson TW, editors: *Mercury mercurials and mercaptans*, Springfield, IL, 1973, Charles Thomas.
- Fries IB, Fisher AA, Salvati EA: Contact dermatitis in surgeons from methylmethacrylate bone cement. *J Bone Joint Surg Am* 57:547-549, 1975.
- Fuhr U: Induction of drug metabolising enzymes: pharmacokinetic and toxicological consequences in humans. *Clin Pharmacokinet* 38:493-504, 2000.
- Gaines TB: Acute toxicity of pesticides. *Toxicol Appl Pharmacol* 14:515-534, 1969.
- Gaylor DW: The ED01 study: summary and conclusions. *J Environ Pathol Toxicol* 3(3 Spec No):179-183, 1980.
- Gossel T, Bricker JD: *Principles of clinical toxicology*, ed 3, New York, 1994, Raven Press.
- Green T: Methylene chloride induced mouse liver and lung tumours: an overview of the role of mechanistic studies in human safety assessment. *Hum Exp Toxicol* 16:3-13, 1997.

36. Hill A: The environment and disease: association or causation? *Proc Roy Soc Med* 58:295-300, 1965.
37. Hursh JB, Cherian MG, Clarkson TW, et al: Clearance of mercury (HG-197, HG-203) vapor inhaled by human subjects. *Arch Environ Health* 31:302-309, 1976.
38. Irons RD, Stillman WS: The effects of benzene and other leukemogenic agents on haematopoietic stem and progenitor cell differentiation. *Eur J Haematol* 60(Suppl):119-124, 1996.
39. Jortner BS: Mechanisms of toxic injury in the peripheral nervous system: neuropathologic considerations. *Toxicol Pathol* 28:54-69, 2000.
40. Kawahara T, Nomura Y, Tanaka N, et al: Leachability of plasticizer and residual monomer from commercial temporary restorative resins. *J Dent* 32:277-283, 2004.
41. Kingman A, Albers JW, Arezzo JC, et al: Amalgam exposure and neurological function. *Neurotoxicology* 26:241-255, 2005.
42. Langston JW, Ballard P, Tetrud JW, et al: Chronic parkinsonism in humans due to a product of meperidine-analog synthesis. *Science* 219:979-980, 1983.
43. Lieske CN, Clark JH, Maxwell DM, et al: Studies of the amplification of carbaryl toxicity by various oximes. *Toxicol Lett* 62:127-137, 1992.
44. Liou PJ, Waldman JM: Acidic sulfate aerosols: characterization and exposure. *Environ Health Perspect* 79:15-34, 1989.
45. Litchfield J, Wilcoxon F: A simplified method of evaluating dose-effect experiments. *J Pharmacol Exp Ther* 96:99-113, 1949.
46. Lunder T, Rogl-Butina M: Chronic urticaria from an acrylic dental prosthesis. *Contact Dermatitis* 43:232-233, 2000.
47. Markowitz M: Lead poisoning: a disease for the next millennium. *Curr Probl Pediatr* 30:62-70, 2000.
48. Martin MD, DeRouen TA, Leroux BG: Is mercury amalgam safe for dental fillings? *Washington Public Health* 15:30-32, 1997.
49. Martin MD, McCann T, Naleway C, et al: The validity of spot urine samples for low-level occupational mercury exposure assessment and relationship to porphyrin and creatinine excretion rates. *J Pharmacol Exp Ther* 277:239-244, 1996.
50. Martin MD, Naleway C, Chou HN: Factors contributing to mercury exposure in dentists. *J Am Dent Assoc* 126:1502-1511, 1995.
51. Martin MD, Williams BJ, Charleston JD, et al: Spontaneous exfoliation of teeth following severe elemental mercury poisoning: case report and histological investigation for mechanism. *Oral Surg Oral Med Oral Pathol Oral Radiol Endod* 84:495-501, 1997.
52. Martin MD, Woods JS: The safety of dental amalgam in children. *Expert Opin Drug Saf* 5:773-781, 2006.
53. Mason DE, Liebler DC: Characterization of benzoquinone-peptide adducts by electrospray mass spectrometry. *Chem Res Toxicol* 13:976-982, 2000.
54. Moretto A: Experimental and clinical toxicology of anticholinesterase agents. *Toxicol Lett* 102-103:509-513, 1998.
55. Mudway IS, Kelly FJ: Ozone and the lung: a sensitive issue. *Mol Aspects Med* 21:1-48, 2000.
56. Nayebzadeh A, Dufresne A: Evaluation of exposure to methyl methacrylate among dental laboratory technicians. *Am Ind Hyg Assoc J* 60:625-628, 1999.
57. Okey AB, Riddick DS, Harper PA: The Ah receptor: mediator of the toxicity of 2,3,7,8-tetrachlorodibenzo-p-dioxin (TCDD) and related compounds. *Toxicol Lett* 70:1-22, 1994.
58. Ozuah PO: Mercury poisoning. *Curr Probl Pediatr* 30:91-99, 2000.
59. Pegum JS, Medhurst FA: Contact dermatitis from penetration of rubber gloves by acrylic monomer. *BMJ* 2:141-143, 1971.
60. Pickering WR, Malone JC: The acute toxicity of dichloroalkyl aryl phosphates in relation to chemical structure. *Biochem Pharmacol* 16:1183-1194, 1967.
61. Pope CN: Organophosphorus pesticides: do they all have the same mechanism of toxicity? *J Toxicol Environ Health B Crit Rev* 2:161-181, 1999.
62. Reigart J, Roberts JR: *Recognition and management of pesticide poisonings*, ed 5, US Environmental Protection Agency Office of Pesticide Programs, 1999. Available at: <http://www.epa.gov/oppead1/safety/healthcare/handbook/handbook.htm>. Accessed January 23, 2010.
63. Risher JF, Mink FL, Stara JF: The toxicologic effects of the carbamate insecticide aldicarb in mammals: a review. *Environ Health Perspect* 72:267-281, 1987.
64. Robledo R, Mossman B: Cellular and molecular mechanisms of asbestos-induced fibrosis. *J Cell Physiol* 180:158-166, 1999.
65. Sadoh DR, Sharief MK, Howard RS: Occupational exposure to methyl methacrylate monomer induces generalised neuropathy in a dental technician. *Br Dent J* 186:380-381, 1999.
66. Sanford H: Lead poisoning in young children. *Postgrad Med* 17:162-169, 1955.
67. Seppalainen AM, Rajaniemi R: Local neurotoxicity of methyl methacrylate among dental technicians. *Am J Ind Med* 5:471-477, 1984.
68. Simmonds PL, Luckhurst CL, Woods JS: Quantitative evaluation of heme biosynthetic pathway parameters as biomarkers of low-level lead exposure in rats. *J Toxicol Environ Health* 44:351-367, 1995.
69. Skuba A, Matthew C, Goldhawk M: Survey for mercury vapour in Manitoba dental offices: summer 1983. *J Can Dent Assoc* 50:517-522, 1984.
70. Smith H, Boehner RL, Carney T, et al: The sequelae of pica with and without lead poisoning. *Am J Dis Child* 105:609-615, 1963.
71. Smith LL: Mechanism of paraquat toxicity in lung and its relevance to treatment. *Hum Toxicol* 6:31-36, 1987.
72. Smith SR, Steinberg S, Gaydos JC: Errors in derivations of the Coburn-Forster-Kane equation for predicting carboxyhemoglobin. *Am Ind Hyg Assoc J* 57:621-625, 1996.
73. Swigar ME, Clemow LP, Saidi P, et al: "Superwarfarin" ingestion: a new problem in covert anticoagulant overdose. *Gen Hosp Psychiatry* 12:309-312, 1990.
74. Tarumi H, Imazato S, Narimatsu M, et al: Estrogenicity of fissure sealants and adhesive resins determined by reporter gene assay. *J Dent Res* 79:1838-1843, 2000.
75. Taybos G: Oral changes associated with tobacco use. *Am J Med Sci* 326:179-182, 2003.
76. Teitelbaum D, Ott JE: Elemental mercury self-poisoning. *Clin Toxicol* 2:243-248, 1969.
77. United Nations Environment Programme (UNEP) and the Food and Agriculture Organization (FAO): *Rotterdam Convention*. Available at: <http://www.pic.int/home.php?type=t&id=5&sid=16>. Accessed January 23, 2010.
78. United States Environmental Protection Agency: *Air and radiation*. Available at: <http://www.epa.gov/air/>. Accessed January 23, 2010.
79. US EPA Office of Pesticide Programs: *Atrazine*. Available at: <http://www.epa.gov/oppsrrd1/reregistration/atrazine/>. Accessed January 23, 2010.
80. US EPA Office of Pesticide Programs: *Federal Insecticide, Fungicide, and Rodenticide Act (FIFRA)*. Available at: <http://www.epa.gov/pesticides/regulating/index.htm>. Accessed January 23, 2010.
81. US EPA Office of Pesticide Programs: *Food Quality Protection Act (FQPA) of 1996*. Available at: <http://www.epa.gov/pesticides/regulating/laws/fqpa/index.htm>. Accessed January 23, 2010.
82. US EPA Office of Pesticide Programs: *Pesticides*. Available at: <http://www.epa.gov/pesticides/>. Accessed January 23, 2010.
83. US EPA Office of Pesticide Programs: *Reregistration eligibility decision: rodenticide cluster*. 1998. Available at: <http://www.epa.gov/oppsrrd1/REDs/2100red.pdf>. Accessed January 23, 2010.
84. Vandekar M, Plestina R, Wilhelm K: Toxicity of carbamates for mammals. *Bull World Health Organ* 44:241-249, 1971.
85. Vaughan TL, Stewart PA, Davis S, et al: Work in dry cleaning and the incidence of cancer of the oral cavity, larynx, and oesophagus. *Occup Environ Med* 54:692-695, 1997.
86. Von Burg R: Carbon monoxide. *J Appl Toxicol* 19:379-386, 1999.
87. Von Burg R: Sulfur dioxide. *J Appl Toxicol* 16:365-371, 1996.
88. Wada H, Tarumi H, Imazato S, et al: In vitro estrogenicity of resin composites. *J Dent Res* 83:222-226, 2004.
89. Weaver LK: Carbon monoxide. In Dart RC, editor: *Medical toxicology*, ed 3, Philadelphia, 2004, Lippincott Williams & Wilkins.

90. Williams GM, Kroes R, Munro IC: Safety evaluation and risk assessment of the herbicide Roundup and its active ingredient, glyphosate, for humans. *Regul Toxicol Pharmacol* 31:117-165, 2000.
91. Witschi HR, Last JA: Toxic responses of the respiratory system. In Klaassen CD, editor: *Casarett and Doull's toxicology: the basic science of poisons*, ed 5, New York, 1996, McGraw-Hill.
92. Wright RO, Lewander WJ, Woolf AD: Methemoglobinemia: etiology, pharmacology, and clinical management. *Ann Emerg Med* 34:646-656, 1999.
93. Yap YG, Camm AJ: Potential cardiac toxicity of H1-antihistamines. *Clin Allergy Immunol* 17:389-419, 2002.
94. Zwemer FL Jr, Pratt DS, May JJ: Silo filler's disease in New York State. *Am Rev Respir Dis* 146:650-653, 1992.

Geriatric Pharmacology

MARC W. HEFT AND ANGELO J. MARIOTTI

With the demographic change that has resulted in a “graying” of the population, a compelling interest in the health and health concerns of older adults has arisen. The increasing incidence and prevalence of systemic diseases among older adults, especially chronic diseases, and the concomitant increase in medication use have provided the impetus for the subspecialty of geriatric pharmacology. Although it has long been apparent that some reduction of drug dosage is appropriate because children are smaller than adults, it was not understood until more recently how elderly patients differ from younger adults. Some misconceptions about aging are widely held, such as the idea that senility or a progressive increase in blood pressure are normal outcomes of aging. Geriatric pharmacology did not emerge out of a specific incident, as occurred with the thalidomide disaster, which highlighted the fetus as an area of special concern for the pharmacologist. Rather, the field of geriatric pharmacology has developed out of changes in demographics that have been accompanied by an increasing knowledge of and sensitivity to the special physiologic, pharmacologic, pathologic, psychological, economic, and emotional problems of older adults.

In 2008, the elderly—individuals 65 years old or older—numbered 38.9 million and represented 12.8% of the U.S. population⁶⁰; by 2030, they are expected to represent 20% of the population and number approximately 72 million. Not only is the total ≥65 years group growing faster than the population as a whole, but between the years 2003 and 2030 the group 85 years old and older is expected to increase from 4.7 million to 9.6 million.⁶¹

Of special interest to dentists is the fact that the newer cohorts of older adults are and will be in better oral health than before.^{21,43} The rate of edentulousness has declined,^{39,62,63,70} and the number of retained teeth among dentate adults has increased.^{29,37,39,62,63} With this trend among dentate older adults has emerged an understanding that this population has similar needs for routine restorative and periodontal treatments as younger adults.^{20,29,63} An increasing number of elderly individuals will need the kind of dental treatment that was formerly rare in elderly patients. This treatment requires, among other things, anti-anxiety drugs, analgesics, local anesthetics, and anti-inflammatory drugs. The dentist will be confronted by an increasing number of ambulatory, community-dwelling elderly patients with a significant burden of systemic disease and medication use.

Normative aging studies have shown that healthy elderly individuals are substantially and measurably different from their younger counterparts. More recently, pharmacologists have begun to appreciate how these changes affect the pharmacokinetics and pharmacodynamics of drugs.

As people age, they are more likely to be seen at the dental office with various diseases, especially chronic diseases, for which they take numerous drugs that are strong in effect and potentially toxic. Americans 65 years old and older take a disproportionately high percentage of all drugs prescribed.^{13,44} Studies of ambulatory populations indicate that although 80% to 90% of older adults take at least one medication, most take two or more. The most commonly used drugs are agents affecting the cardiovascular system, analgesic and anti-inflammatory drugs, psychotherapeutic medications, and gastrointestinal preparations such as laxatives and antacids. Approximately 40% of the medications are prescribed to patients to be taken “as necessary,” with an average of three drugs per patient.^{47,50}

The number of medications prescribed to individuals of any age increases the risk of adverse drug reactions, drug interactions, and other health-related problems associated with the use and misuse of medications.^{27,47,50} Potential problems in older adults are compounded by age-related physiologic changes that may place these individuals at greater risk. The misuse of medications among elderly patients is considered a major health care problem.^{19,41,50} Finally, many segments of society, not the least important of which are health care providers, have become sensitized to the nonmedical problems common among elderly individuals (loneliness, depression, poverty, poor nutritional status) and have come to understand how these can complicate therapeutic management.

This chapter presents a view of geriatric pharmacology that deals mainly with alterations in drug responsiveness that can be attributed directly to aging. The psychosocial factors that indirectly influence the way elderly individuals use and react to drugs are addressed only briefly.

PHYSIOLOGIC CHANGES ASSOCIATED WITH AGING

Studies of the aging process in community-dwelling, healthy (presumed disease-free) individuals have provided insights into the process of biologic aging. These studies have been either cross-sectional studies, in which different-aged individuals are assessed at the same point in time, or longitudinal studies, in which the same individuals are assessed at different times as they “age in place.” Although the former studies are easier and quicker to complete, they limit inferences to age differences rather than age-related changes because of the limitations in controlling for and measuring individual differences in biology and behavior. Results of cross-sectional and longitudinal studies have reported a gradual decline in performance from the third decade through the seventh and eighth

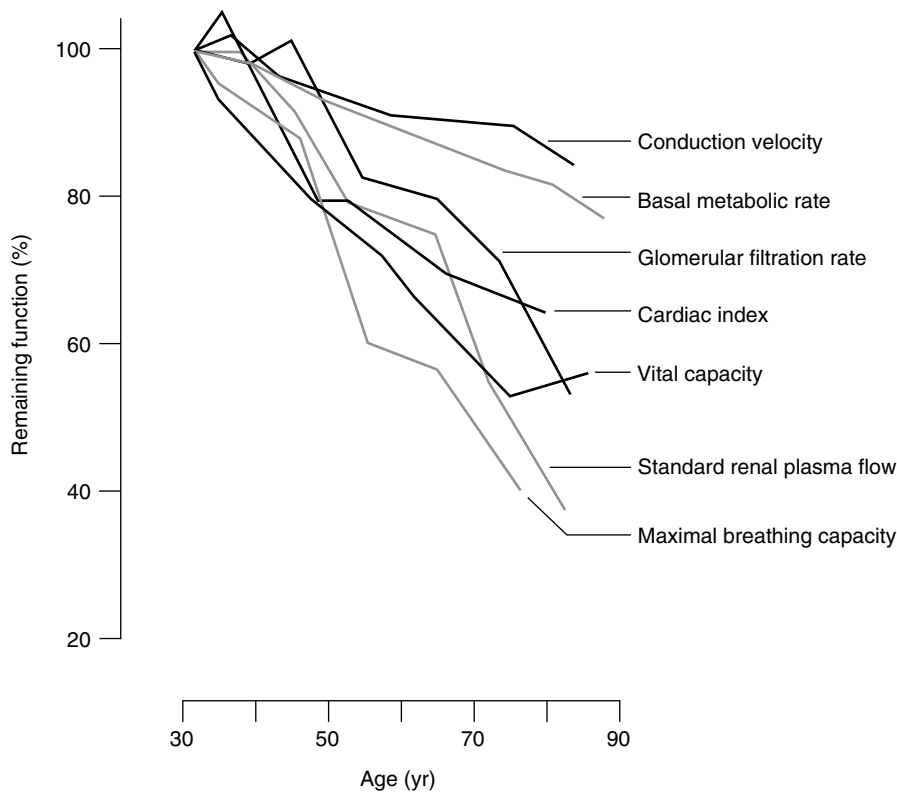

FIGURE 53-1 Influence of age on measures of physiologic function beginning at age 30 (100% of remaining function). (From Miller RD: *Anesthesia for the elderly*. In Miller RD, editor: *Anesthesia*, ed 2, New York, 1986, Churchill Livingstone.)

decades in a broad range of physiologic functions, including renal function, pulmonary function, cardiac function, and nerve conduction velocity (Figure 53-1).⁵⁴

Findings from these studies have shown that (1) broad individual intersubject differences exist in the rate of aging; (2) not all organ systems age at the same rate; (3) the pattern of age-related declines in organ systems can vary among individuals; (4) with increasing age, greater variability in measures of organ function occurs among individuals within an age cohort; (5) age-associated declines are greater in more complex integrative functions (e.g., maximum breathing capacity) than in basic functions (e.g., the velocity of propagation of a nerve impulse along a nerve); and (6) the latency and capacity for achieving adaptive responses are greater and smaller for older individuals compared with younger individuals. Variability is a cardinal feature of the aging process. At least some of the apparent decline in functioning may reflect changes in lifestyle rather than chronologic aging per se (e.g., declining muscle mass associated with the adaptation of a more sedentary lifestyle).

Table 53-1 summarizes age-related changes in drug disposition that have potential importance to drug use. These alterations affect the absorption, distribution, biotransformation, and excretion of drugs; the specific features of these changes are considered later. A well-documented decline in homeostatic competence occurs in elderly individuals, which accounts for the increased incidence of postural hypotension with age,¹⁰ the increasing sluggishness of thermoregulation, and the fact that elderly individuals are less able to compensate rapidly for the hypotensive effects of an antihypertensive drug.²⁴ Elderly individuals undergo physiologic changes that can be characterized as normal concomitants of the aging process, but they also experience changes related to disease and medication. Aging represents an interplay among the physiology of aging, disease, and the cumulative effects of behavioral and lifestyle choices (e.g., sedentary living and tobacco use versus regular exercise and abstention from

tobacco); as a result, the elderly population is a more heterogeneous population than that of children between birth and puberty.⁶⁵

NONPHYSIOLOGIC ASPECTS OF AGING

Multiple Disease States

Elderly individuals have more health problems, especially chronic diseases and conditions, than younger individuals. Table 53-2 lists the most prevalent chronic conditions among older adults. Some of these diseases are degenerative (e.g., cataracts, detached retina), others are caused by cumulative exposure to environmental contaminants (e.g., cases of chronic obstructive pulmonary disease and cancer), and still others are the consequence of changing metabolic processes commonly seen in aging (e.g., decreased bone density with increasing age). Older adults have an increased incidence of all varieties of heart disease (e.g., arrhythmias, myocardial infarction, valvular disease), renal disease, atherosclerosis, arthritis, diabetes, osteoporosis, and various gastrointestinal problems. They also experience declines in humoral-mediated and cell-mediated immune responses (leading to a decreased resistance to infectious diseases) and various sensory and musculoskeletal impairments. More than four out of five individuals 65 years old and older have at least one chronic illness, and multiple coexisting conditions are common. The leading chronic health conditions for this age group are arthritis, hypertensive disease, and heart disease.^{2,12}

Although elderly individuals represent less than 13% of the population, they account for 30% of hospitalizations²³ and 32% of drug use.¹⁷ The symptoms of disease in older adults may often manifest differently in elderly individuals compared with younger individuals. Infections are sometimes manifested by tachycardia instead of fever in older individuals. Transient or episodic symptoms may be forgotten, misreported, or misinterpreted.

TABLE 53-1

Summary of Age-Related Changes That Affect Drug Disposition in Older Adults

PHARMACOKINETIC PROPERTY	PHYSIOLOGIC CHANGE	POSSIBLE INFLUENCE ON DRUG EFFECT
Absorption	↑Gastric pH	Increased absorption of drugs inactivated by stomach acid
	↓Absorptive surface	Minor effect
	↓Splanchnic blood flow	Minor effect
Distribution	↓Gastrointestinal motility	Minor effect
	↓Cardiac output	Impaired delivery of drugs to organs of greater acute elimination; effects on CNS
	↓Total body water	Increased concentration and effect of drugs distributed in body water
	↓Lean body mass	Increased concentration and effect of drugs distributed in lean body mass
	↓Plasma albumin	Increased effect of, and interaction between, drugs extensively bound to albumin
Metabolism	↑ α_1 -Acid glycoprotein	Minor effect
	↑Body fat	Increased sequestration of lipophilic drugs in fat
	↓Hepatic mass and enzyme activity	Decreased phase I metabolism of some drugs
Excretion	↓Hepatic blood flow	Decreased metabolism of drugs normally rapidly cleared by the liver
	↓Renal blood flow	Decreased renal elimination of water-soluble drugs and metabolites
	↓Glomerular filtration rate	Decreased renal excretion of water-soluble drugs and metabolites
	↓Tubular secretion	Decreased renal elimination of drugs and metabolites actively secreted into urine

CNS, Central nervous system.

TABLE 53-2

Rank Ordering and Prevalence of Selected Reported Chronic Conditions

CONDITION	PREVALENCE BY AGE (IN YEARS)		
	65-74	>75	ALL AGES
Arthritis	444.7	550.4	129.9
Hypertension	372.6	373.6	121.5
Hearing impairment	273.7	380.7	90.8
Heart disease	271.8	333.6	84.1
Chronic sinusitis	176.2	167.8	139.7
Cataract formation	118.1	246	25.3
Deformity or orthopedic impairment	151.4	176.6	111.6
Diabetes	95.2	87.8	25.8
Visual impairment	67.4	127.6	34.7
Tinnitus	89.4	75.1	26.4

Prevalence data (no. cases/1000 persons) from Adams PF, Hardy AM: *Current estimates from the National Health Interview Survey, 1988. Vital and health statistics, Series 10, No. 173*, Hyattsville, MD, 1989, US Department of Health and Human Services.

Numerous studies have shown that older adults, because of the higher prevalence of chronic disease, are the principal consumers of drugs.^{44,48} Their use of over-the-counter and prescription medications for the treatment of chronic diseases has dual implications. These agents can provide a cure or palliative treatment of a disease in a nontoxic and economical manner. Because of the age-related changes in physiologic status and age-dependent and age-related diseases,⁹ however, medications can induce adverse reactions that can be a major source of morbidity or mortality.^{27,49}

Adverse Drug Reactions

The incidence of adverse drug reactions among older adults is much greater than among younger individuals; this increase is related mostly to polypharmacy (multiple drug use). Other important factors in the occurrence of adverse drug reactions include multiple diseases (especially chronic diseases), hepatic or renal insufficiency, small body size, malnutrition, and previous drug reactions. Important adverse reactions include side effects (e.g., dry mouth with tricyclic antidepressant medication), drug allergy (e.g., pruritus or hives), and toxic reactions (e.g., digitalis toxicity).³⁵ Toxic reactions are especially important in older adults and may be caused by a broad range of potential pharmacodynamic changes (age-related changes in drug sensitivity) or pharmacokinetic changes (including decreased renal function and changes in lean body mass and water content).

Adverse drug reactions can be categorized into two principal groups: unexpected and unpredictable versus predictable and preventable. An unexpected, unpredictable reaction is an unwanted consequence of drug administration that occurs at appropriate doses for prophylaxis, diagnosis, or therapy. Examples of such reactions include allergic responses, idiosyncratic reactions, and secondary pharmacologic effects. In contrast, predictable, preventable drug reactions involve an unwanted consequence of drug administration that occurs because of failure in decision making by the health care provider. Failure by the physician or dentist to choose the appropriate agent can occur, as in prescribing the wrong drug for a disease or prescribing a drug with known potential adverse effects in a susceptible patient.

Because most adverse drug reactions are preventable, the clinician should be aware of the patient's medical history, drug history, current list of medications (over-the-counter and prescribed), the pharmacologic characteristics of each agent used, and any abnormal physiologic factors that can affect drug action. Although the incidence of adverse reactions increases among older patients in part because of polypharmacy, actions of a single powerful agent can produce severe

TABLE 53-3

Age-Related Increased Risk of Toxicity with Commonly Prescribed Dental Agents

DRUG	INCREASED RISK FOR ELDERLY PATIENTS
Clindamycin	Diarrhea and colitis
Metronidazole	Toxic plasma concentrations (patients >70 yr old)
Cephalosporins	Impaired clotting mechanisms and bleeding problems
NSAIDs	Compromised renal and gastrointestinal function
Opioid analgesics	Increased plasma half-life, respiratory depression
Glucocorticoids	Muscle wasting and osteoporosis with long-term therapy
Benzodiazepines	Impaired memory and decrements in psychomotor performance

adverse reactions for elderly patients. Many drugs commonly prescribed by dentists can produce various harmful reactions in patients. As illustrated in Table 53-3, various drug classes can be of potential risk to older patients. Cephalosporins commonly prescribed to treat infections can produce deleterious effects. Cefoperazone, cefamandole, and cefotetan can prolong prothrombin time and partial thromboplastin time, which can impair hemostasis.^{16,46} Other antibiotics, such as clindamycin, can markedly increase the incidence of gastrointestinal problems such as diarrhea and colitis in patients older than 60 years.^{26,45}

In addition to antibiotics, nonsteroidal anti-inflammatory drugs (NSAIDs) can cause morbidity in elderly patients. NSAIDs are commonly used for postoperative pain control in dental practice; however, NSAID use among older adults can be problematic, as documented by associations of NSAID intake with impaired renal function, gastrointestinal toxicity, or hypertension.^{1,7,28} Traditional alternatives to NSAIDs have included the use of cyclooxygenase-2 (COX-2) inhibitors such as celecoxib. Because NSAIDs inhibit the COX-1 and COX-2 pathways, the use of selective COX-2 inhibitors provides anti-inflammatory and analgesic properties with less gastrointestinal toxicity.⁵⁵ Although drugs with COX-2 selectivity do not have the same adverse gastrointestinal effects of NSAIDs, more recent results showing other adverse reactions with COX-2 agents have brought concern that an increased risk of heart attack, thrombosis, and stroke may be associated with these agents (e.g., rofecoxib [Vioxx] was removed from the market in 2004 because of these issues).

Another dilemma encountered by older adults that complicates their dental treatment plan involves medications that may cause xerostomia. Drug-induced xerostomia is a concern because (1) older adults take prescription and nonprescription medications at a higher rate than the general population, (2) numerous medications have xerostomic potential (>400 medications have been implicated), and (3) the oral health sequelae of xerostomia are consequential. Xerostomia induced by sympathomimetics, diuretics, anticholinergics, tricyclic antidepressants, antihistamines, anti-Parkinson drugs, psychotropic agents, cardiovascular agents, and muscle relaxants can greatly impair oral health and function.⁵⁷ Potential sequelae of xerostomia include rampant dental caries, periodontal problems, difficulty in speech and swallowing, mouth soreness, impaired denture retention, greater likelihood of oral infection, and altered sense of taste.^{18,42}

Polypharmacy is a special attribute of drug use among older adults. One fourth of hospitalized patients older than 65 years receive six or more drugs daily⁵⁶; older adults average 13 prescriptions per year³²; and approximately 90% of patients 75 years old and older take drugs regularly, with more than one third taking three or more drugs daily.³³ The major consequence of multiple drug use is an increased incidence of adverse drug reactions. These adverse drug reactions result from many factors, including incorrect identification of medications, multiple prescriptions from more than one health provider (because of a lack of awareness or communication among providers), and the use of medications prescribed for someone else.

Because most adverse drug reactions are preventable, dentists should take advantage of available resources to minimize the likelihood of these untoward sequelae. Consultation with other health professionals (including physicians and pharmacists) or use of a comprehensive drug reference book assists in determining the appropriate drug and dose schedule. In addition, computer-based data retrieval systems and newsletters can keep the dentist informed regarding appropriate drug selection. Finally, the dentist should always be aware and concerned about the onset of new symptoms that do not normally arise from the anticipated course of the disease process but do occur after dental treatment.

Adverse drug reactions in older adults are largely preventable. A sound approach to avoiding adverse drug reactions involves (1) understanding the physical and psychosocial changes that occur in older adults, (2) knowing the pharmacokinetics and pharmacodynamics of the medications a patient is taking and medications the dentist is planning to use or prescribe, (3) evaluating the existing prescription drug burden of a patient when considering further prescription needs, (4) prudent drug monitoring, and (5) careful record keeping.

Patient Compliance

Patient compliance can be a major source of medication errors. Ample evidence exists that a substantial percentage of elderly patients make serious or potentially serious medication errors.²² Failure to comply with drug regimens consists of omitting medications; using medications not prescribed by the physician or dentist; and making errors of dosage, sequence, and timing. Problems especially identified with elderly patients that contribute to compliance errors include poor comprehension and memory, deficits in vision and hearing, financial restrictions, inability to cope with the environment, self-neglect, cultural attitudes, and physical obstacles to getting medications out of the bottle (particularly child-resistant containers) and self-administering them. Whenever possible, unnecessary medications should be eliminated, and drugs with simplified dosing schedules should be selected. Prescription strategies by the dentist, including written instructions, use of drugs that require fewer doses per day (e.g., doxycycline instead of tetracycline), selection of less expensive generic alternatives, and packaging of drugs in easy-open daily dosing boxes, may increase the likelihood of compliance.

Psychosocial Factors

Any discussion of geriatric pharmacology would be incomplete without mention of the various psychosocial and economic challenges that frequently confront elderly individuals. Although elderly individuals no longer inevitably have a serious reduction in income, 10.5% live in poverty, and elderly single women (14% are below the poverty line) are worse off than men or couples. Poverty rates are higher for elderly African Americans (25%) and Hispanics (24%) than for elderly whites (9%).⁵⁹ Elderly individuals may also live in increasing isolation, away from families, children, and spouses, and have depression, loneliness, and sometimes senility. They

also receive three times as many prescriptions for psychotropic drugs as do younger people, even though they are more vulnerable to the adverse effects of these drugs and take twice as long to recover from the adverse effects than do young patients.³¹

This constellation of factors places older adults at risk for many problems, including inadequate diet, poor nutrition, unintentional weight loss, forgetfulness and inattention to medical and pharmacologic needs, and an inability or lack of desire to fill prescriptions and take them as directed. One widely held belief about elderly adults is that their nutritional status is compounded by losses in salivary secretory ability and taste acuity that are presumed to occur with aging and naturally interfere with the enjoyment of food. Although some studies showed a decrease in parotid gland secretion, salivary amylase activity and morphologic age-related changes in the salivary gland, most studies have not found a diminution of salivary flow in older individuals,^{4,5} and the decline in gustatory function is at most modest among elderly individuals.⁶⁹ Pathologic aging may have an adverse effect on salivary function, and many of the drugs and treatments to which an older individual is subject can cause xerostomia of varying degrees of severity.

PHARMACOLOGIC CHANGES ASSOCIATED WITH AGING

Two basic mechanisms have been developed to explain age-related differences in drug effects.³⁵ The pharmacodynamic mechanism suggests that changes in drug responsiveness account for such differences.^{8,25} These changes presumably involve either an alteration in the number or activity of receptors on the target cell or a change in intracellular responses to receptor activation. Documentation in support of this mechanism is modest, involving only a few drug classes. The more widely accepted pharmacokinetic mechanism suggests that age differences in drug response are related to changes in drug disposition as a result of alterations in drug absorption, distribution, metabolism, excretion, or combinations of these processes. A general review of these factors with particular regard to aging is provided.

Pharmacokinetics of Drugs

Absorption

Most medications prescribed to patients living independently are taken orally. These medications are absorbed through the gastrointestinal tract. The documented age-related alterations that might predispose older adults to potential declines in absorption are increased gastric pH, decreased absorptive surface, decreased gastric emptying, decreased splanchnic blood flow, and impaired intestinal motility.^{6,40} Little evidence exists, however, to support an age-related decline in absorption.²⁵ Decreased stomach acidity could improve absorption of drugs normally inactivated by stomach acid. An important consideration for patients of all ages is the possible interaction of medications with food. The absence of food in the gastrointestinal tract improves the efficiency of absorption of some drugs, such as erythromycin. The absorption of other medications is relatively unimpaired.³⁵ Although food-drug interactions are not a problem of aging per se, they are important in older adults, who have a heavier medication burden.

Distribution

The distribution of a drug to potential receptor sites occurs after absorption of the drug through the gastrointestinal tract and then into the bloodstream. Distribution is influenced by body composition (lean body mass, body water, and adipose tissue mass), plasma protein binding (particularly albumin),

and blood flow to organs. The documented age-related changes that might affect drug distribution in older patients include decreased lean body mass, decreased body water, increased body fat, decreased cardiac output, and decreased albumin level.⁴⁰

The change in lean body mass may reflect other factors, including a potential lifestyle change in physical activity or dietary change, rather than an aging effect per se; nevertheless, this consistent finding in older adults must be considered when evaluating a patient. The net effect is a decrease in lean body mass and total body water and an increase in total body fat. The respective volumes of distribution for water-soluble medications and fat-soluble medications are decreased and increased.⁴⁰ Water-soluble drugs, such as acetaminophen, ethanol, digoxin, and cimetidine, are distributed in a smaller volume in older individuals and have higher concentrations at the same dose.^{25,40} Similarly, more lipid-soluble drugs, such as diazepam and lidocaine, are more widely distributed (yielding a lower concentration at the receptor site) and have a longer terminal half-life in older adults.^{25,40}

Although decreased plasma titers of albumin are probably not a concomitant of aging, they may accompany chronic disease seen in an aging population. A decrease in plasma albumin increases the availability of highly bound drug, effectively increasing the drug concentration at the receptor. A higher concentration of free drug in the plasma has been shown for salicylic acid, metronidazole,³⁶ and phenytoin, but not for warfarin.⁶⁴ Theoretically at least, in situations of reduced plasma albumin, therapeutic and toxic effects should be achieved at lower blood concentrations for drugs that are extensively protein bound.⁶⁸ This effect may be especially important with malnutrition. Many drugs have no documented age-related difference in protein binding; two examples are diazepam and penicillin G.¹⁴

Metabolism

The metabolism of most drugs begins with the obligatory passage through the liver after absorption from the gastrointestinal tract. Hepatic metabolism depends on hepatic blood flow, the liver enzymes responsible for biotransformation of the drug, and genetic factors that influence the hepatic enzyme system.^{35,40} The reported age-related declines that might be responsible for altered drug disposition include decreased liver mass and decreased hepatic blood flow.⁴⁰ Biologic variability, drug use, behavioral factors (e.g., smoking or alcohol use), or a combination of these factors may exert a greater effect than age on hepatic metabolism.

The documented age-related effects may impair the efficiency of the phase I pathways of metabolism—oxidation, reduction, and hydrolysis. The phase II pathways of glucuronidation, acetylation, and sulfation are unaffected.⁴⁰ For drugs that are rapidly cleared by the liver, the rate-limiting step in biotransformation is the hepatic blood flow. The metabolism of drugs with high clearance, such as propranolol, is reduced when hepatic blood flow is reduced. Caution should be exercised with concurrent administration of drugs (e.g., some antiarrhythmic medications) that may reduce hepatic blood flow. For drugs with low clearance, metabolism depends on the efficiency of the hepatic enzyme systems. Some benzodiazepines (e.g., desmethyldiazepam) that depend on microsomal oxidation have a prolonged half-life, whereas others (e.g., lorazepam) that undergo conjugation are unaffected by age.

The clinician should also consider the route of administration when assessing the potential for hepatic metabolism. The preceding discussion presumes the oral route of administration, which involves the absorption of the drug from the gastrointestinal tract and then transport through the liver via the hepatic portal circulation. The parenteral route of admin-

istration may eliminate the liver as the organ primarily influencing disposition of the drug.

Excretion

The elimination of drugs by the kidney provides the eventual pathway for removal of most medications. The documented age-related changes that might impair kidney function and excretion include decreased renal blood flow, decreased glomerular filtration rate, and decreased tubular secretion.⁴⁰ Renal function is typically evaluated by the creatinine clearance, which has been reported to decline by approximately one third between the ages of 20 and 90 years in the ambulatory, community-dwelling volunteers of the Baltimore Longitudinal Study on Aging.⁵² More recent data from the same study have shown, however, that for approximately one third of older subjects, renal function did not decline, and quite variable declines occurred among other older subjects.³⁴ These latter data underscore the need to establish adequate dosing schedules for medications based on blood concentrations, rather than interpretation of age-adjusted “normative” data.

Drugs that are eliminated primarily unchanged in the kidney include digoxin, gentamicin, amantadine, lithium, nadolol, and lisinopril. Dosages for drugs with a high therapeutic index, such as penicillins and cephalosporins, are usually not adjusted for older adults (in the absence of renal disease or polypharmacy). Dosages for medications with active metabolites, such as the benzodiazepines diazepam and flurazepam, should be adjusted.²⁵

The response of elderly patients to drugs is affected by alterations in renal drug clearance and the fact that altered renal function may make them more sensitive to the nephrotoxicity of drugs such as NSAIDs and aminoglycosides. Conversely, the decreased activity of the renin-angiotensin system may blunt the effects of drugs that inhibit renin secretion, such as β -adrenergic blocking agents and angiotensin-converting enzyme inhibitors, diminishing their therapeutic effectiveness in the treatment of hypertension.³⁸

The complex and potentially serious alterations in kidney function mandate that consideration be given to renal excretory capacity when prescribing drugs to elderly patients. Although a diminution in renal function that is related to age does occur, kidney disease is not restricted to elderly patients.

Pharmacodynamic Changes

Studies investigating age-related changes in pharmacodynamics are difficult to pursue, and, consequently, scant data exist in this area. Available evidence suggests no global age-related changes in drug sensitivity. Increased sensitivity to certain benzodiazepine anxiolytic medications and decreased sensitivity to β -adrenergic agonists and antagonists have been reported in older individuals.

There are several possibilities for pharmacodynamic alterations in drug reactivity with aging, including a change in the number of receptors, a change in their affinity for the drug, or a change in tissue responsiveness to drug-receptor binding. Discovering which of these possibilities accounts for a particular reaction is difficult because it requires knowledge of receptor number, binding affinity, and quantitation of the sequential steps after the drug-receptor interaction to the final observed response. Experimental evidence exists that one or more of these changes does occur with several groups of drugs, but interpretation of the results of some of these experiments is confounded by the fact that elderly individuals also show decreases in homeostatic competence, speed of performance, thermoregulation, and immunocompetence.

Changes in sensitivity to β -adrenergic agonists and antagonists have been reported in many studies. With the production of cyclic adenosine 3',5'-monophosphate by lymphocytes

as an indicator of responsiveness to isoproterenol in young and old individuals, a decrease in adenylyl cyclase occurs in normal subjects 67 to 90 years old compared with subjects 18 to 27 years old.¹⁵ Sensitivity of young men to isoproterenol and propranolol was shown to be greater than in elderly men, but the well-documented increase in the blood concentration of norepinephrine in elderly individuals may possibly create competition for receptor sites.⁶⁶ In a series of investigations involving rat myocardial and human lymphocytic β -adrenergic function, a decreased responsiveness of the β receptors to catecholamines was found, along with decreased adenylyl cyclase activity, but no decline in receptor density.⁵³

Increased sensitivity to central nervous system depressants is a recognized fact. In tests involving nitrazepam, age-related decrements in psychomotor performance were described and linked to pharmacodynamic, not pharmacokinetic, changes.¹¹ Elderly patients who were given diazepam for a surgical procedure required lower doses than younger patients to reach the same level of sedation.⁵¹ This observation has been confirmed in other studies for diazepam and temazepam.⁵⁸ Determination of the minimum alveolar concentration for isoflurane showed an 18% decrease in anesthetic requirement in older adults compared with young adults; similar results have been obtained with other anesthetics.⁶⁷ In contrast to the generalization that brain function in elderly individuals seems to be inherently more susceptible to disruption by anesthetic drugs, the greater sensitivity of older patients to etomidate seems to result from a decreased initial distribution of the anesthetic after intravenous injection.³

In addition to pharmacodynamic changes, the genetic characteristics of an individual may also influence the behavior of drugs in elderly patients. The apparent volume distribution of the acetylator phenotype of isoniazid decreases significantly with age.³⁰ Pharmacogenetics for elderly patients is important because genetically determined enhancement or impairment of drug action in the body can amplify the toxicity of a drug or diminish the efficacy of a drug.

IMPLICATIONS FOR DENTISTRY

Elderly patients differ from younger patients in ways that have the potential to affect responses to drugs. Changes potentially affecting pharmacokinetics and pharmacodynamics occur during aging, but at this stage in the development of the science of geriatric pharmacology, remarkably few instances of problems with drugs that arise directly from these changes have been documented. Responses to drugs in elderly patients are confounded by multiple medications; pathologic states; compliance errors; and various psychological, sociologic, and economic difficulties that beset older individuals. Some precautions appropriate to dentistry are as follows:

1. Elderly patients usually take more prescription and non-prescription drugs than the general adult population. Drug interactions and adverse drug reactions are more likely to occur with this polypharmacy. The dentist should take a careful history of the patient's medical and pharmacologic status and update it at regular intervals during treatment.
2. Elderly patients are more sensitive than young adults to the depressant effects of drugs. The dosages of analgesics, antianxiety drugs, sedative-hypnotics, and general anesthetics may need to be reduced.
3. Because of the known loss in homeostatic competence, drugs that alter blood pressure, heart rate, and smooth muscle tone should be used with caution in elderly patients. Conversely, immunosenescence may dictate more aggressive antibiotic therapy than normal for the prevention and treatment of infections.

4. Elderly patients are more susceptible to orthostatic hypotension than younger adults. Special attention is called for when elderly patients go from a reclining posture in the dental chair to a standing position.
5. A decline in renal function occurs in healthy elderly patients, and an even greater decrease occurs in patients with kidney disease. This fact should be considered when prescribing drugs whose principal route of elimination is the kidney. Conventionally, dosage intervals are increased in such circumstances, but the dose of the drug or drugs may have to be reduced.
6. The dentist should be aware of the psychosocial considerations for elderly patients and be sensitive to such problems as the expense of the medications and the possibility of forgetfulness and poor compliance. Special packaging, clear labeling, simplified dosage regimens, and recruiting a responsible relative or friend to monitor drug therapy may improve compliance.

CITED REFERENCES

1. Adams DH, Howie AJ, Michael J, et al: Non-steroidal anti-inflammatory drugs and renal failure. *Lancet* 1:57-60, 1986.
2. Adams PF, Hardy AM: *Current estimates from the National Health Interview Survey, 1988, Vital and Health Statistics, Series 10*, Hyattsville, MD, 1989, US Department of Health and Human Services.
3. Arden JR, Holley FO, Stanski DR: Increased sensitivity to etomidate in the elderly: initial distribution versus altered brain response. *Anesthesiology* 65:19-27, 1986.
4. Atkinson JC, Fox PC: Salivary gland dysfunction. *Clin Geriatr Med* 8:499-511, 1992.
5. Baum BJ: Salivary gland fluid secretion during aging. *J Am Geriatr Soc* 37:453-458, 1989.
6. Bender AD: Pharmacodynamic principles of drug therapy in the aged. *J Am Geriatr Soc* 22:296-303, 1974.
7. Berger RG: Intelligent use of NSAIDs—where do we stand? *Expert Opin Pharmacother* 2:19-30, 2001.
8. Bleich HL, Boro ES, Rowe JW: Clinical research on aging: strategies and directions. *N Engl J Med* 297:1332-1336, 1977.
9. Brody JA, Schneider EL: Diseases and disorders of aging: an hypothesis. *J Chronic Dis* 39:871-876, 1986.
10. Caird FI, Andrews GR, Kennedy RD: Effect of posture on blood pressure in the elderly. *Br Heart J* 35:527-530, 1973.
11. Castleden CM, George CF, Marcer D, et al: Increased sensitivity to nitrazepam in old age. *BMJ* 1:10-12, 1977.
12. Centers for Disease Control and Prevention: *Unrealized prevention opportunities: reducing the health and economic burden of chronic disease*, Atlanta, 1997, National Center for Chronic Disease Prevention and Health Promotion.
13. Centers for Disease Control and Prevention, National Center for Health Statistics, Health Data Interactive: Prescription medication use among noninstitutionalized Medicare beneficiaries, aged 65+: US, 1992-2005, Medicare Current Beneficiary Survey. Available at: www.cdc.gov/nchs/hdi/htm. Accessed March 19, 2009.
14. Crooks J, O'Malley K, Stevenson IH: Pharmacokinetics in the elderly. *Clin Pharmacokinet* 1:280-296, 1976.
15. Dillon N, Chung S, Kelly J, et al: Age and beta adrenoceptor-mediated function. *Clin Pharmacol Ther* 27:769-772, 1980.
16. Donowitz GR, Mandell GL: Beta-lactam antibiotics, part 2. *N Engl J Med* 318:490-500, 1988.
17. *Drug utilization in the U.S.—1987: eighth annual review*, Publication No. PB88-146527, Springfield, VA, 1987, Food and Drug Administration.
18. Fox PC, van der Ven PF, Sonies BC, et al: Xerostomia: evaluation of a symptom with increasing significance. *J Am Dent Assoc* 110:519-525, 1985.
19. German PS, Burton LC: Medication and the elderly: issues of prescription and use. *J Aging Health* 1:4-34, 1989.
20. Gilbert GH, Duncan RP, Crandall LA, et al: Attitudinal and behavioral characteristics of older Floridians with tooth loss. *Community Dent Oral Epidemiol* 21:384-389, 1993.
21. Gilbert GH, Heft MW: Periodontal status of older Floridians attending senior activity centers. *J Clin Periodontol* 19:249-255, 1992.
22. Gillum RF, Barsky AJ: Diagnosis and management of patient noncompliance. *JAMA* 228:1563-1567, 1974.
23. Graves EJ: *Utilization of short-stay hospitals, United States: annual summary, vital and health statistics, 1985, Series 13, No. 91*. Hyattsville, MD, 1987, US Department of Health and Human Services.
24. Greenblatt DJ, Koch-Weser J: Adverse reactions to propranolol in hospitalized medical patients: a report from the Boston Collaborative Drug Surveillance Program. *Am Heart J* 86:478-484, 1973.
25. Greenblatt DJ, Sellers EM, Shader RI: Drug therapy: drug disposition in old age. *N Engl J Med* 306:1081-1088, 1982.
26. Gurwith MJ, Rabin HR, Love K: Diarrhea associated with clindamycin and ampicillin therapy: preliminary results of a cooperative study. *J Infect Dis* 135:S104-S110, 1977.
27. Gurwitz JH, Avorn J: The ambiguous relation between aging and adverse drug reactions. *Ann Intern Med* 114:956-966, 1991.
28. Gurwitz JH, Avorn J, Bohn RL, et al: Initiation of antihypertensive treatment during nonsteroidal anti-inflammatory drug therapy. *JAMA* 272:781-786, 1994.
29. Heft MW, Gilbert GH: Tooth loss and caries prevalence in older Floridians attending senior activity centers. *Community Dent Oral Epidemiol* 19:228-232, 1991.
30. Kergueris MF, Bourin M, Larousse C: Pharmacokinetics of isoniazid: influence of age. *Eur J Clin Pharmacol* 30:335-340, 1986.
31. Lamy PP: *Prescribing for the elderly*, Littleton, MA, 1980, PSG.
32. Lamy PP, Vestal RE: Drug prescribing for the elderly. *Hosp Pract* 11:111-118, 1976.
33. Law R, Chalmers C: Medicines and elderly people: a general practice survey. *BMJ* 1:565-568, 1976.
34. Lindeman RD, Tobin J, Shock NW: Longitudinal studies on the rate of decline in renal function with age. *J Am Geriatr Soc* 33:278-285, 1985.
35. Lipton HL, Lee PR: *Drugs and the elderly: clinical, social, and policy perspectives*, Stanford, CA, 1988, Stanford University Press.
36. Ludwig E, Csiba A, Magyar T, et al: Age-associated pharmacokinetic changes of metronidazole. *Int J Clin Pharmacol Ther Toxicol* 21:87-91, 1983.
37. Marcus SE, Drury TF, Brown LF, et al: Tooth retention and tooth loss in the permanent dentition of adults: United States, 1988-94. *J Dent Res* 75(Special Issue):684-695, 1996.
38. Meyer BR, Bellucci A: Renal function in the elderly. *Cardiol Clin* 4:227-234, 1986.
39. Miller AJ, Brunelle JA, Carlos JP, et al: *Oral health of U.S. adults: the National Survey of Oral Health in U.S. employed adults and seniors, 1985-1986: national findings*, Publication No. (NIH) 87-2868, Bethesda, MD, 1987, US Department of Health and Human Services.
40. Montamat SC, Cusack BJ, Vestal RE: Management of drug therapy in the elderly. *N Engl J Med* 321:303-309, 1989.
41. Morrow D, Leirer V, Sheikh J: Adherence and medication instructions: review and recommendations. *J Am Geriatr Soc* 36:1147-1160, 1988.
42. Narhi TO, Meurman JH, Ainamo A: Xerostomia and hyposalivation: causes, consequences and treatment in the elderly. *Drugs Aging* 15:103-116, 1999.
43. National Health and Nutrition Examination Survey: *Perceived oral health status among adults with teeth in the United States, 1988-94*, US Department of Health and Human Services, Center for Disease Control and Prevention, National Center for Health Statistics. Available at: <http://www.cdc.gov/nchs/data/nhanes/databriefs/oralhealth.pdf>. Accessed January 22, 2010.
44. Nelson CR, Knapp DE: *Medication therapy in ambulatory medical care: national ambulatory medical care survey and national hospital care survey, Advance Data from Vital and Health Statistics*, No. 290. Hyattsville, MD, 1992, National Center for Health Statistics.
45. Neu HC, Prince A, Neu CO, et al: Incidence of diarrhea and colitis associated with clindamycin therapy. *J Infect Dis* 135:S120-S125, 1977.
46. Nichols RL, Wikler MA, McDevitt JT, et al: Coagulopathy associated with extended-spectrum cephalosporins in patients with

- serious infections. *Antimicrob Agents Chemother* 31:281-285, 1987.
47. Nolan L, O'Malley K: Prescribing for the elderly, part II: prescribing patterns: differences due to age. *J Am Geriatr Soc* 36:245-254, 1988.
 48. Ouslander JG: Drug therapy in the elderly. *Ann Intern Med* 95:711-722, 1981.
 49. Porter J, Jick H: Drug-related deaths among medical inpatients. *JAMA* 237:879-881, 1977.
 50. Qato DM, Alexander GC, Conti RM, et al: Use of prescription and over-the-counter medications and dietary supplements among older adults in the United States. *JAMA* 300:2867-2878, 2008.
 51. Reidenberg MM, Levy M, Warner H, et al: Relationship between diazepam dose, plasma level, age, and central nervous system depression. *Clin Pharmacol Ther* 23:371-374, 1978.
 52. Rowe JW, Andres R, Tobin JD, et al: The effect of age on creatinine clearance in men: a cross-sectional and longitudinal study. *J Gerontol* 31:155-163, 1976.
 53. Scarpace PJ: Decreased β -adrenergic responsiveness during senescence. *Fed Proc* 45:51-54, 1986.
 54. Shock NW: Aging of regulatory mechanisms. In Cape RDT, Coe RM, Rossman I, editors: *Fundamentals of geriatric medicine*, New York, 1983, Raven Press.
 55. Silverstein FE, Faich G, Goldstein JL, et al: Gastrointestinal toxicity with celecoxib vs nonsteroidal anti-inflammatory drugs for osteoarthritis and rheumatoid arthritis: the CLASS study: a randomized controlled trial. Celecoxib Long-term Arthritis Safety Study. *JAMA* 284:1247-1255, 2000.
 56. Smith CR: Use of drugs in the aged. *Johns Hopkins Med J* 145:61-64, 1979.
 57. Sreebny LM, Schwartz SS: A reference guide to drugs and dry mouth, ed 2, *Gerodontology* 14:33-47, 1997.
 58. Swift CG, Haythorne JM, Clarke P, et al: Chlormethiazole and temazepam. *BMJ* 280:1322, 1980.
 59. Taeuber C: Diversity: the dramatic reality. In Bass S, Kutza EA, Torres-Gil FM, editors: *Diversity in aging: the issues facing the White House Conference on Aging and Beyond*, Glenview, IL, 1990, Scott, Foresman.
 60. U.S. Census Bureau, Population Division: *Annual estimates of the resident population by sex and five-year age groups for the United States: April 1, 2000 to July 1, 2008*. Available at: <http://www.census.gov/popest/national/asrh/NC-EST2008-sa.html>. Accessed January 22, 2010.
 61. U.S. Census Bureau, Population Division: *US interim projections by age, sex, race, and Hispanic origin: 2000-2050*. Available at: <http://www.census.gov/ipc/www/usinterimproj>. Accessed January 22, 2010.
 62. US Department of Health and Human Services, Centers for Disease Control and Prevention, National Center for Health Statistics: *Summary health statistics for U.S. adults, National Health Interview Survey*, 2006. Available at: http://www.cdc.gov/nchs/nhis_series.htm. Accessed January 22, 2010.
 63. US Department of Health and Human Services, National Center for Health Statistics: *Third National Health and Nutrition Examination Survey, 1988-94*, Public Use Data File No. 7-0627, Hyattsville, MD, 1997, Centers for Disease Control.
 64. Verbeeck RK, Cardinal J-A, Wallace SM: Effect of age and sex on the plasma binding of acidic and basic drugs. *Eur J Clin Pharmacol* 27:91-97, 1984.
 65. Vestal RE: Drug use in the elderly: a review of problems and special considerations. *Drugs* 16:358-382, 1978.
 66. Vestal RE, Wood AJ, Shand DG: Reduced β -adrenoceptor sensitivity in the elderly. *Clin Pharmacol Ther* 26:181-186, 1979.
 67. Wade JG, Stevens WC: Isoflurane: an anesthetic for the eighties? *Anesth Analg* 60:666-682, 1981.
 68. Wallace S, Whiting B: Factors affecting drug binding in plasma of elderly patients. *Br J Clin Pharmacol* 3:327-330, 1976.
 69. Weiffenbach JM, Bartoshuk LM: Taste and smell. *Clin Geriatr Med* 8:543-555, 1992.
 70. Weintraub JA, Burt BA: Oral health status in the United States: tooth loss and edentulism. *J Dent Educ* 49:368-378, 1985.

GENERAL REFERENCES

- Evans JG, Williams TF, Beattie BL, et al, editors: *The Oxford textbook of geriatric medicine*, ed 2, Oxford, 2000, Oxford University Press.
- Hazzard WR, Blass JP, Ettinger WH, et al: *Principles of geriatric medicine and gerontology*, ed 4, New York, 1999, McGraw-Hill.
- Holm-Pedersen P, Løe H, editors: *Textbook of geriatric dentistry*, ed 2, Copenhagen, 1996, Munksgaard.
- Martínez-González J, Badimon L: Mechanisms underlying the cardiovascular effects of COX-inhibition: benefits and risks, *Curr Pharm Des* 13:2215-2227, 2007.
- Schwartz JB: The current state of knowledge on age, sex, and their interactions on clinical pharmacology, *Clin Pharmacol Ther* 82:87-96, 2007.
- Shi S, Morike K, Klotz U: The clinical implications of ageing for rational drug therapy, *Eur J Clin Pharmacol* 64:183-199, 2008.
- Tallis R, Fillit H, Brocklehurst JC, editors: *Brocklehurst's textbook of geriatric medicine and gerontology*, ed 6, London, 2003, Churchill Livingstone.

Drugs for Medical Emergencies

MORTON B. ROSENBERG

Every dentist can expect to be involved in the diagnosis and treatment of medical emergencies during the course of clinical practice. These emergencies may be directly related to dental therapy, or they may simply occur by chance in the dental environment. In studies surveying the incidence and type of medical emergencies in dental practice, 95.6% of the respondents reported such emergencies. Although most of the reported emergencies were minor (e.g., 53% were syncopal episodes), life-threatening or major emergencies were also described.^{14,33} Many medical emergencies occur during the administration of local anesthesia and during painful procedures such as extractions and pulp extirpation.³⁵ The potential need for acute medical intervention during dental treatment may be increased for practitioners treating a high percentage of elderly patients, patients with special needs, or medically compromised patients, and practitioners using minimal, moderate, or deep sedation and general anesthesia.

It has been postulated that the incidence of medical emergencies in dentistry as a whole is increasing.³⁴ This increase may be attributed to the following factors:

1. *Increasing age of the general population.* As the number of elderly individuals in the general population increases, the likelihood of encountering a medical emergency as a result of the physiologic and pathologic changes associated with aging also increases. In addition to the normal deterioration of major organ systems that occurs with age, elderly patients are more likely to exhibit chronic clinical manifestations of organ derangement (e.g., angina pectoris, congestive heart failure, chronic obstructive lung disease) that may become acute during the dental visit and require intervention. Elderly patients take more prescription and over-the-counter drugs than young patients, and the effects of these compounds can be significantly different from the effects seen in younger patients. The pharmacokinetics of many drugs are altered by aging; pharmacodynamic and physiologic changes also may result in greater sensitivity to many drugs, especially central nervous system (CNS) depressants (see Chapter 53).¹¹
2. *Effect of medical advances.* Advances in the diagnosis and treatment of many medical conditions have permitted an increasing population of compromised patients to survive and seek comprehensive dental treatment. Pharmacologic advances in such diverse areas as cancer, cardiovascular disease, and psychiatric illness and surgical advances such as organ transplants, cardiac valve replacements, coronary artery revascularization, pacemakers, and automatic implantable cardioverter-defibrillators have significant ramifications for dental therapy and can be directly related to acute medical problems in the dental office. In

general, the growing number of medically stabilized yet chronically ill patients seeking dental treatment is paralleled by a concomitant increase in the incidence of medical emergencies during dental treatment. Dental advances such as intraosseous implants and comprehensive periodontal treatment combined with extensive restorative dentistry leading to “lifelong dentistry” are attracting older, less healthy patients into the dental environment.

3. *Pharmacologic therapies.* Therapeutic choices for dentists are constantly increasing with the introduction of new generations of antibiotics, analgesics, local anesthetics, and sedative drugs. Each new drug has its own inherent indications, contraindications, and possible side effects. These drugs also have the capacity to interact with each other and with other drugs the patient may be taking for medical conditions. Such drug interactions have the potential to elicit acute adverse reactions during the dental appointment.³⁶ The growing popularity of herbal supplements and other alternative medical therapies has implications that are just being realized and studied. Many of the side effects of these alternative medical therapies, such as anti-hemostatic, hypotensive, and hypoglycemic properties, can directly affect dental treatment.²⁹
4. *Drug abuse.* Substance abuse is a fact of life in modern society. Many dental patients “premedicate” themselves with prescribed or illicit CNS depressants before dental therapy. These drugs may present acute problems by themselves or interact with drugs administered or prescribed by the dentist.

EMERGENCY PREPARATION

Many chronic medical conditions, such as asthma, congestive heart failure, coronary artery disease, and cerebrovascular disease, may become acute medical emergencies when exacerbated by the stress of the dental appointment. Stress, anxiety, fear, and phobia may cause other minor stress-related emergencies, such as syncopal episodes and hyperventilation syndrome. A thorough preoperative evaluation, meticulous detail to achieving profound local anesthesia in a safe manner, consideration of nonpharmacologic stress reduction protocols, and the use of pharmacologic sedative techniques to minimize pain, fear, and anxiety help reduce this risk.

Preoperative evaluation includes the use of a medical history questionnaire, oral history, review of systems, physical examination, vital signs, and appropriate laboratory tests and consultations. This evaluation should determine the risk/benefit ratio of the contemplated procedure, what drugs

BOX 54-1*Medical Emergencies of Relevance to Dental Practice*

Syncope
 Hyperventilation
 Angina pectoris
 Myocardial infarction
 Hypertension
 Hypotension
 Hemorrhage
 Cerebrovascular accident
 Grand mal seizure
 Insulin shock/diabetic coma
 Asthma
 Anaphylaxis/other allergic reactions

should be used or avoided, the potential for a medical emergency, and the type of monitoring best suited for the particular patient.

EMERGENCY PREPAREDNESS

Although almost any medical emergency can occur during the course of dental treatment—which means that dental personnel must be prepared to provide effective basic life support (BLS) and seek emergency medical services in a timely manner—dentists must be able to diagnose and treat common medical problems (e.g., syncope or hyperventilation syndrome) definitively and respond effectively to certain less common (or even rare) but potentially life-threatening emergencies, especially emergencies that may arise as a result of dental treatment (e.g., anaphylactic reaction to an administered drug).⁹ These emergencies are listed in Box 54-1.

Many factors determine the degree of preparedness for medical emergencies needed in a specific dental practice, but all dental offices must be ready at some minimal level.³⁰ The use of local anesthesia is an indication for the dentist to be prepared to handle medical emergencies, as evidenced by the following language in product literature approved by the U.S. Food and Drug Administration: “Dental practitioners who employ local anesthetic agents should be well versed in diagnosis and management of emergencies that may arise from their use. Resuscitative equipment, oxygen and other emergency drugs should be immediately available for immediate use.”⁶ An overall emergency preparedness plan, as outlined in Box 54-2, is essential for every dental practice. Implicit in Box 54-2 is the necessity to develop a team approach in preparing for and responding to medical emergencies in the dental office, with each staff member (receptionist, dental auxiliary, dental hygienist, and dentist) responsible for a specific role.

Preparedness must be individually tailored according to the type of patient treated (e.g., young, healthy patients in an orthodontic practice versus medically compromised patients in a periodontal practice), location (an urban setting where emergency help is close at hand versus a rural location where there may be a significant delay until help arrives), and training (whether the dentist and staff are capable of performing advanced emergency procedures and protocols). Although a comprehensive guide to the pathophysiologic characteristics, prevention, diagnosis, and management of specific medical emergencies is beyond the scope of this chapter, several sources for this purpose are listed in the general references. In practices where sedation or general anesthesia is adminis-

BOX 54-2*Emergency Preparedness Checklist*

Rights were not granted to include this box in electronic media. Please refer to the printed publication.

tered, advanced emergency training and equipment are required and often promulgated by state dental practice acts.

EMERGENCY DRUGS

Although many medical emergencies may be properly treated without the use of drugs, every dental office must contain an emergency kit with drugs appropriate to the training of the individual dentist, the patient being treated, and the type of procedures being performed.^{2,18} No drug can take the place of a properly trained health professional and support staff in diagnosing and treating emergencies. Nevertheless, the design and purchase of an appropriate emergency kit often play an integral role in dictating the course and outcome of emergency treatment.

Besides determining which drugs should be included in an emergency kit, the dentist must understand that he or she must maintain the knowledge base to use them. In the midst of a medical emergency, with the patient by definition in an acutely abnormal or even critical situation, there is no time to begin reading labels, leafing through emergency texts, or administering drugs as suggested by a brochure in the emergency kit. In addition, there is a significant difference between the theoretic knowledge of how to treat an emergency and being able to put such cognitive skills to practical use. Constant review and training keeps the dental team sharp. Regular continuing education in medical emergencies, review of new advances in pharmacology, certification and recertification in BLS and advanced cardiac life support (ACLS), and emergency drills are the best methods to prepare for emergencies.

Many states mandate certification in BLS for dental licensure, and in offices that use deep sedation/general anesthesia, training in ACLS is a standard of care. Without prompt attention to the *ABCDs* (*airway, breathing, circulation, defibrillation*) of cardiopulmonary resuscitation (CPR), drugs are of

little value. The advent of automatic external defibrillators has made early defibrillation an integral part of the BLS “chain of survival” for the treatment of cardiac arrest. Since January 1998, health care provider CPR courses conducted by the American Heart Association include a mandated module on automatic external defibrillator application and use.⁷ Some states have begun to mandate the presence of an automatic external defibrillator in general dental offices.

The role of drugs and the type of intervention that should be attempted by a dentist during a medical emergency are controversial issues. If any consequence of dental treatment is foreseeable and results in harm, liability may be imposed.⁴¹ Emergency drugs are generally powerful, rapidly acting compounds. The correct approach to the use of drugs in any medical emergency should be essentially supportive and conservative. In a review covering the use over a 2-year period of 8500 emergency drug systems purchased by dentists, a 0.75% incidence of use was reported.⁴⁷

Emergency kits either can be organized by the individual practitioner or can be purchased commercially. Many dentists are uncomfortable choosing and purchasing individual drugs for their emergency kits, and the purchase of a high-quality, commercially available emergency drug kit modified for dentistry can provide consistent drug availability (i.e., periodic drug updating) in an organized fashion.

There is a general tendency to overequip basic dental emergency kits with drugs that are beyond the needs and expertise of many general dentists. The drugs placed in an office emergency kit should include only drugs familiar to the dentist. Only one agent should be included for each particular need. The fewer drugs in an emergency kit, the easier it is to know their proper use, especially during an emergency.³⁷ Many authors, state boards of dental registration, commercial vendors, and professional groups have suggested the composition of dental medical emergency kits.³² The composition of these kits varies greatly and depends on the training and philosophy of emergency care of the creator, whether the kit is dental specific, and whether sedation or anesthesia is used. The definitive pharmacologic features of these drugs are discussed in other chapters.

Critical Emergency Drugs

All dentists must keep certain drugs readily available in the office in fresh supply for immediate administration (Table 54-1). Dentists must know reflexively when, how, and in what doses to give these specific agents for acutely life-threatening situations.

Oxygen

Oxygen is a primary, if not the primary, emergency drug indicated in any medical emergency in which hypoxemia may be present. These emergencies include, but are not limited, to acute disturbances involving the cardiovascular system, respiratory system, and the CNS. In a hypoxemic patient, breathing enriched oxygen elevates the arterial oxygen tension, which improves oxygenation of peripheral tissues. Because of the steepness of the oxyhemoglobin dissociation curve, a modest increase in oxygen tension can significantly alter hemoglobin saturation in a hypoxemic individual. Hypoxemia leads to anaerobic metabolism and metabolic acidosis, which often adversely affect the efficacy of emergency pharmacologic interventions.

Oxygen can be delivered to a spontaneously breathing patient by full facemask, nasal cannula, or nasal hood. Dental offices also must have the capacity to deliver oxygen via positive-pressure ventilation. Controlled ventilation may be accomplished with the use of a bag-valve-mask device (consisting of a mask, self-inflating bag, and nonbreathing valve) or with a manually triggered oxygen-powered breathing

TABLE 54-1

Critical Emergency Drugs

DRUG	INDICATIONS	PREPARATIONS
Oxygen	For use in all medical emergencies in which hypoxemia may be present	Steel cylinders (green); E tanks, 690 L
Epinephrine	Acute allergic reactions, acute asthma (not responding to adrenergic inhaler)	Ampules, 1 mg; vials, 1 and 30 mg; syringes, 0.3 and 1 mg
Nitroglycerin	Angina pectoris, acute myocardial infarction	Tablets (sublingual), 0.15, 0.3, 0.4, and 0.6 mg; spray, 0.4 mg/actuation
Albuterol	For bronchodilation	Aerosol, 90 µg/actuation
Glucose	Hypoglycemic episode	Various oral/transmucosal preparations (orange juice, cake icing, cola)
Aspirin	For reducing platelet aggregation	Chewable aspirin, 81-325 mg

Data compiled from Curriculum guidelines for management of medical emergencies in dental education, *J Dent Educ* 54:337-338, 1990; Fast TB, Martin MD, Ellis TM: Emergency preparedness: a survey of dental practitioners, *J Am Dent Assoc* 112:449-501, 1986; Lipp M, Kubota Y, Malamed SF, et al: Management of an emergency: to be prepared for the unwanted event, *Anesth Pain Control Dent* 2:90-102, 1992; Malamed SF: *Medical emergencies in the dental office*, ed 5, St Louis, 2000, Mosby; Malamed SF: Drugs for medical emergencies in the dental office. In Ciancio SG, editor: *ADA guide to dental therapeutics*, ed 3, Chicago, 2003, ADA Publishing; Moore PA: Review of medical emergencies in dentistry: staff training and prevention, part 1, *Gen Dent* 36:14-17, 1988; Phero JC: Maintaining preparedness for the life-threatening office medical emergency, *Dent Econ* 81:47-50, 1991; Stewart D: Emergency resuscitation kits, *SAAD Digest* 6:223-231, 1987.

device (consisting of a mask connected by a valve activated by a lever and high-pressure tubing to the oxygen supply). Each method of providing positive-pressure ventilation requires practice for effective use. Providing a seal around the nose and mouth while ventilating the patient can be difficult with the bag-valve-mask device. The oxygen-powered device is easier to use, but care must be taken not to inflate the stomach. Both techniques are preferred, however, over mouth-to-mouth, mouth-to-nose, or mouth-to-mask techniques.³ Airway adjuncts such as oropharyngeal and nasopharyngeal airways, endotracheal equipment, laryngeal mask airways, and the means of establishing an emergency airway by cricothyrotomy and transtracheal ventilation can be useful or even lifesaving in the hands of a trained and experienced health professional. Without appropriate training, however, their use may prove deleterious in an acute emergency.

Although oxygen toxicity may occur after prolonged therapy with high concentrations of oxygen, it is not an issue during clinical resuscitation. This statement is true even for the rare patient whose respiratory drive depends on hypoxemia because of chronically elevated carbon dioxide concentrations. If clinically indicated, oxygen should never be withheld during any medical emergency.⁸ Inspired oxygen concentrations depend on the delivery system used (Box 54-3).

BOX 54-3

Inspired Oxygen Concentration with Different Delivery Systems

DELIVERY SYSTEM	INSPIRED OXYGEN CONCENTRATION (%)
Spontaneous breathing	
Nasal cannula	25-45
Facemask	40-60
Positive-pressure ventilation	
Mouth-to-mouth	17
Mouth-to-mask (oxygen flow to mask of 10 L/min)	80
Bag-valve-mask	75-95
Manually triggered, oxygen-powered breathing device	75-95

Epinephrine

Epinephrine is the most important injectable drug in the dental emergency kit. Epinephrine is an endogenous catecholamine with α -adrenergic receptor-stimulating and β -adrenergic receptor-stimulating activity. It is the drug of choice for the management of the cardiovascular and respiratory manifestations of acute allergic reactions. The beneficial pharmacologic actions of epinephrine when used in resuscitative dosages include bronchodilation, increased systemic vascular resistance, increased arterial blood pressure, increased heart rate, increased myocardial contractility, and increased myocardial and cerebral blood flow.

For the effective treatment of acute allergic reactions, epinephrine must be administered as soon as the condition is diagnosed. The drug can be injected subcutaneously, 0.3 to 0.5 mL of a 1:1000 solution, or intramuscularly (for a more serious emergency). Epinephrine should be available in pre-loaded syringes or autoinjectors for immediate use. The intravenous route (slow infusion) is also advocated, but it may induce or exacerbate ventricular ectopy, especially in patients receiving digitalis.

Because of its profound bronchodilating effects, epinephrine is also indicated for the treatment of acute asthmatic attacks unrelieved by sprays or aerosols of β_2 -adrenergic receptor agonists. Epinephrine may also be instilled directly into the tracheobronchial tree by an endotracheal tube with good results.¹⁹ Epinephrine is one of the major vasoactive compounds indicated for use during cardiac arrest because of its ability to elevate coronary perfusion pressure.^{3,42}

Nitroglycerin

Although nitroglycerin is available in many preparations—long-acting oral and transmucosal preparations, transcutaneous patches, and intravenous solutions—the appropriate forms for the dental office are the sublingual tablet or translingual spray. Nitroglycerin is the treatment of choice for acute angina pectoris. It acts primarily by relaxing vascular smooth muscle, dilating systemic venous and arterial vascular beds, and leading to a reduction in venous return and systemic vascular resistance. These actions all combine to reduce myocardial oxygen consumption. One tablet or spray (0.4 mg) should be given initially. This dose may be repeated twice at 5-minute intervals to a total dose of three administrations. Relief should occur within 1 to 2 minutes; if the discomfort is not relieved, the diagnosis of evolving myocardial infarction must be considered.⁵³

TABLE 54-2

Primary Emergency Support Drugs

CATEGORY	REPRESENTATIVE DRUG	PREPARATIONS
Anticonvulsant	Diazepam (Valium)	Ampules and syringes, 10 mg; vials, 10, 20, and 50 mg
Corticosteroid	Hydrocortisone sodium succinate (Solu-Cortef)	Vials, 100, 250, 500 mg, and 1 g
Antihistamine	Diphenhydramine (Benadryl, Benahist, Nordryl)	Ampules, 50 mg; vials, 50, 100, 300, and 500 mg
Respiratory stimulant	Aromatic ammonia spirit (Aromatic Ammonia Aspirols)	Ampules, 0.4 mL

Contraindications to the administration of nitroglycerin include patients who are hypotensive and patients who have taken sildenafil (Viagra) recently. The combination of nitroglycerin and sildenafil can lead to profound hypotension and unconsciousness.

Bronchodilator

Inhalation of a β_2 -adrenergic receptor agonist, such as metaproterenol, terbutaline, or albuterol, is used in the treatment of acute bronchospasm encountered during asthma and anaphylaxis.³⁹ Use results in bronchial smooth muscle relaxation and the inhibition of chemical mediators released during hypersensitivity reactions. Albuterol or levalbuterol is an excellent choice because either has fewer cardiovascular side effects than other bronchodilators.

Glucose

Glucose preparations are used to treat hypoglycemia that results either from fasting or insulin/carbohydrate imbalance in a patient with diabetes mellitus. If the patient is conscious, oral carbohydrates, such as orange juice, a chocolate bar, cake icing, or a cola drink, act rapidly to restore circulating blood glucose. If the patient is unconscious, and acute hypoglycemia is suspected, intravenous administration of 50% dextrose solution or intravenous or intramuscular administration of glucagon (which increases blood glucose by its effects on liver glycogen) is the treatment of choice. There is no place for insulin in the dental office.

Aspirin

The antiplatelet properties of aspirin have been shown to decrease myocardial ischemia dramatically when administered to patients during an evolving myocardial infarction; aspirin has no substitute for this indication. Contraindications to aspirin use include patients with aspirin intolerance and patients with severe bleeding disorders.²⁴

Primary Support Drugs

Primary support drugs are helpful for treating medical emergencies that are usually not acutely life-threatening (Table 54-2). Although dentists do not have to include these drugs in the emergency kit, they all are useful, particularly for situations in which the dentist is familiar with their use and

where emergency medical services may not be immediately available.

Anticonvulsant

Seizures that may require acute medical intervention may be associated with epilepsy, hyperventilation episodes, cerebrovascular accidents, hypoglycemic reactions, or vasodepressor syncope. Local anesthetic overdoses or accidental intravascular injection may also require the administration of an anticonvulsant. Current management of a seizure that interferes with ventilation or persists for longer than 5 minutes includes the use of an intravenous benzodiazepine such as diazepam or the water-soluble benzodiazepine midazolam, which may also be administered intramuscularly.^{38,40,48}

Corticosteroid

Corticosteroids are used in the definitive management of acute allergic reactions and acute adrenal insufficiency. The onset of even an intravenous corticosteroid such as hydrocortisone sodium succinate is delayed, but the drug can be useful in halting the progression of a major allergic or anaphylactoid reaction.⁴⁶ The dentist may encounter what initially appears to be a syncopal episode but is actually the more serious problem of acute adrenal insufficiency in a patient taking long-term systemic corticosteroids to treat a chronic medical condition or a patient with primary adrenal insufficiency such as Addison's disease. For this life-threatening emergency, prompt diagnosis, BLS techniques, and infusion of corticosteroids are needed.²¹

Antihistamine

Antihistamines such as diphenhydramine are useful in the treatment of minor or delayed allergic reactions and as adjuncts in the management of an acute allergic or anaphylactoid reaction. Adverse effects of antihistamines include CNS depression resulting in sedation, thickening of tracheobronchial secretions, and decreased blood pressure.

Respiratory stimulant

Aromatic ammonia is a pungent, noxious irritant to the mucous membranes and stimulates the respiratory and vasomotor centers of the medulla. It is used as a general arousal agent during syncopal episodes.

Drugs for Advanced Cardiac Life Support

ACLS is the standard of care for comprehensive resuscitation by health care providers with advanced skills and training. Cardiac arrest and sudden cardiac death are major causes of mortality. Pharmacotherapy plays an important role in the management of these patients; guidelines for ACLS provide recommendations for specific drug therapies. These guidelines are constantly reviewed and updated and are now subdivided into ACLS²² and pediatric advanced life support.²³ Included in this training is the use of many antiarrhythmic and vasoactive drugs (Table 54-3).¹⁰ Training in ACLS is necessary for dentists administering deep sedation or general anesthesia and is often required by state law for providers of moderate sedation. State regulations should be consulted to determine which of the drugs described here must be available in locations where sedation or anesthesia is administered. The greatest changes in the newest ACLS guidelines are reduced emphasis on additional medications, rhythm checks, and any maneuver that interprets chest compressions for more than 10 seconds and the increased emphasis on searching for and addressing the cause for sudden cardiac arrest (Table 54-4).

Pulseless arrest rhythms are divided into shockable and nonshockable rhythms. Shockable rhythms are ventricular fibrillation (VF) or ventricular tachycardia (VT). In VT/VF,

TABLE 54-3

Advanced Cardiac Life Support Drugs

DRUG	INDICATION
Antiarrhythmics	
Lidocaine	Ventricular tachycardia, pulseless ventricular tachycardia or ventricular fibrillation
Amiodarone	Pulseless ventricular tachycardia or ventricular fibrillation, supraventricular tachycardia (most forms)
Procainamide	Intermittent/recurrent ventricular tachycardia
Verapamil, diltiazem	Atrial flutter or atrial fibrillation, supraventricular tachycardia
Adenosine	Supraventricular tachycardia
Atropine	Bradycardia, asystole, certain types of atrioventricular block
Magnesium sulfate	Torsades de pointes, ventricular fibrillation (if hypomagnesemia is present)
β Blockers (e.g., propranolol)	Atrial flutter or atrial fibrillation, supraventricular tachycardia, refractory ventricular tachycardia
Inotropes	
Epinephrine	Anaphylactic shock, asystole, pulseless electrical activity, pulseless ventricular tachycardia or ventricular fibrillation, bradycardia
Vasopressin	Pulseless ventricular tachycardia or ventricular fibrillation
Norepinephrine	Refractory hypotension
Dopamine	Bradycardia, hypotension
Dobutamine	Congestive heart failure
Isoproterenol	Refractory symptomatic bradycardia, long QT syndrome
Digoxin	Atrial flutter, fibrillation, heart failure
Inamrinone	Refractory congestive heart failure
Milrinone	Refractory congestive heart failure
Vasodilators/Antihypertensives	
Nitroprusside	Hypertension, acute heart failure
Nitroglycerin	Hypertension, acute heart failure, anginal pain
Others	
Sodium bicarbonate	Hyperkalemia, metabolic acidosis with bicarbonate loss, hypoxic lactic acidosis
Morphine	Acute pulmonary edema, pain, and anxiety
Furosemide	Acute pulmonary edema
Thrombolytic agents (e.g., alteplase, streptokinase)	Acute thrombosis

definitive therapy consists of basic CPR with electrical shocks. Drug therapy may be administered via intravenous, intraosseous, and endotracheal routes. If VT/VF persists, vasoactive drugs such as epinephrine or vasopressin or both are recommended to facilitate defibrillation. Antiarrhythmics such as amiodarone or lidocaine are also indicated. Nonshockable pulseless arrest rhythms include asystole and pulseless electrical activity. Drug therapy includes epinephrine and vasopressin. If pulseless electrical activity or asystole persists, atropine should be given.

TABLE 54-4

Advanced Cardiac Life Support Classification of Core Drugs (2005)

DRUG	RHYTHM INDICATION	DOSE	CLASS RECOMMENDATION	COMMENTS
Adenosine	SVT	6 mg	I	Must be administered rapidly. May be repeated at dose of 12 mg for 2 additional doses. In patients taking carbamazepine or dipyridamole, or in cardiac transplant recipients, use initial dose of 3 mg
Amiodarone	Pulseless VT or VF	300-mg IV bolus	IIb	No dilution required. May repeat with 150 mg IV in 3-5 min
	Stable VT	150 mg	IIb	To avoid hypotension, administer over 10 min. Dose may be repeated as needed to a maximum 2.2 g/24 hr. One option is to follow the bolus with a continuous 1 mg/min for 6 hr, then reduce to 0.5 mg/min for 18 hr. Supplementary boluses of 150 mg can be repeated every 10 min as necessary for recurrent or resistant arrhythmias
Atropine	Symptomatic bradycardia	0.5 mg IV or IO	IIa	Maximum dose of 3 mg
	Asystole	1 mg IV or IO	Indeterminate	Repeat every 3-5 min, 3 mg maximum
	PEA	1 mg IV or IO	Indeterminate	Repeat every 3-5 min, 3 mg maximum, only indicated if rate is slow
Diltiazem	Atrial fibrillation	0.25 mg/kg	IIa	May repeat dose in 15-20 min at 0.35 mg/kg. Administer over 2 min. Bolus is followed by infusion at 5-15 mg/hr
	SVT	0.25 mg/kg	IIb	May repeat dose in 15-20 min at 0.35 mg/kg. Administer over 2 min. Bolus is followed by infusion at 5-15 mg/hr
Dopamine	Symptomatic bradycardia	2-10 µg/kg/min	IIb	Administer as a continuous infusion
Epinephrine	Pulseless VT or VF	1 mg IV or IO	IIb	Repeat every 3-5 min
	Symptomatic bradycardia	2-10 µg/min infusion	IIb	Administer as a continuous infusion
	PEA	1 mg IV or IO	IIb	Repeat every 3-5 min
Ibutilide	Asystole	1 mg IV or IO	IIb	Repeat every 3-5 min
	Atrial fibrillation	1 mg if ≥60 kg, 0.01 mg/kg if <60 kg	IIb	Administer over 10 min. Dose may be repeated 10 min after completion of first dose
Lidocaine	Pulseless VT or VF	1-1.5 mg/kg IV or IO	Indeterminate	Repeat doses of 0.5-0.75 mg/kg may be given every 5-10 min (maximum dose of 3 mg/kg). Continuous infusion rate is 1-4 mg/min
	Stable VT	0.5-0.75 mg/kg IV or IO	Indeterminate	Repeat doses of 0.5-0.75 mg/kg may be given every 5-10 min (maximum dose of 3 mg/kg). Continuous infusion rate is 1-4 mg/min
Magnesium	Pulseless VT or VF associated with torsades de pointes	1-2 g IV or IO	IIa	If pulse absent, dilute in 10 mL of 5% dextrose in water, and administer over 5-10 min. If pulse present, mix in 50-100 mL of 5% dextrose in water, and administer over 5-60 min
Procainamide	Stable VT	20 mg/min	IIa	Administer until arrhythmia is suppressed, hypotension occurs, QRS widens >50% from baseline, or total of 17 mg/kg has been administered. Maintenance infusion rate is 1-4 mg/min
	Atrial fibrillation	20 mg/min	Not rated	Administer until arrhythmia is suppressed, hypotension occurs, QRS widens >50% from baseline, or total of 17 mg/kg has been administered. Maintenance infusion rate is 1-4 mg/min. Avoid use in patients with impaired left ventricular function

IO, Intraosseous; IV, intravenous; PEA, pulseless electrical activity; SVT, supraventricular tachycardia; VF, ventricular fibrillation; VT, ventricular tachycardia.

Continued

TABLE 54-4

Advanced Cardiac Life Support Classification of Core Drugs (2005)—cont'd

DRUG	RHYTHM INDICATION	DOSE	CLASS RECOMMENDATION	COMMENTS
Vasopressin	Pulseless VT or VF, PEA or asystole	40 U IV or IO	Indeterminate	May be given once. May replace first or second dose of epinephrine
Verapamil	SVT	2.5-5 mg IV	Ila	Administer over 2 min. Dose of 5-10 mg may be repeated in 15-30 min (total dose 20 mg). Alternative dosing is 5 mg every 15 min (total dose 30 mg)

From Emergency Cardiovascular Care Committee, Subcommittees and Task Forces of the American Heart Association: 2005 American Heart Association Guidelines for cardiopulmonary resuscitation and emergency cardiovascular care, *Circulation* 112 (Suppl 24):IV-1-IV-203, 2005.

IO, Intraosseous; IV, intravenous; PEA, pulseless electrical activity; SVT, supraventricular tachycardia; VF, ventricular fibrillation; VT, ventricular tachycardia.

Symptomatic bradycardia is defined as a heart rate less than 60 beats/min combined with symptoms such as hypotension, altered mental status, chest pain, syncope, or other signs of shock. Besides basic CPR, atropine doses or epinephrine, dobutamine, or dopamine infusions may be indicated depending on the degree of atrioventricular (AV) block followed by transcutaneous pacing if these medications are ineffective.

Symptomatic tachycardia is defined as a heart rate greater than 100 beats/min combined with symptoms of shock. Treatment can range from immediate synchronized cardioversion to drug therapy. Treatment for stable patients is based on the classification of the rhythm into narrow-complex or wide-complex tachycardia. Vagal maneuvers, administration of adenosine, or administration of second-line drugs such as calcium channel blockers or β blockers may be considered. These drugs should not be used for Wolff-Parkinson-White syndrome.

Regular, wide-complex tachycardias (QRS >0.12 second) include VT, supraventricular tachycardia with aberrancy, and tachycardias associated with or mediated by accessory pathways. Immediate synchronized cardioversion is performed for unstable supraventricular tachycardia owing to reentry, unstable atrial fibrillation, unstable flutter, and unstable monomorphic VT. Adenosine is recommended for wide-complex tachycardias that are believed to be supraventricular tachycardia. If the tachycardia is VT, and the patient is stable, an antiarrhythmic drug, such as amiodarone or procainamide, may be given.

Antiarrhythmic agents

Beyond defibrillation, which is the only proven intervention to achieve return of spontaneous circulation in patients experiencing VF, antiarrhythmic drugs have been advocated as adjunctive treatments potentially to normalize abnormally depolarizing and conducting myocardial cells.¹ Amiodarone is recommended for the treatment of VF or pulseless VT unresponsive to other measures. Amiodarone is a complex drug that acts on Na^+ , K^+ , and Ca^{++} channels and has α -adrenergic and β -adrenergic-blocking properties. In the emergency setting, it is administered as an intravenous bolus of 150 mg over 15 minutes followed by a maintenance infusion of 1 mg/min for the next 6 hours with a maximum cumulative dose of 2.2 g over 24 hours. The patient should be monitored carefully for hypotension and bradycardia.

Lidocaine, a class IB antiarrhythmic, acts by inhibiting the ion flux via Na^+ channels and has been used for years for pulseless VT/VF. It has been relegated more recently to an alternative drug for the treatment of VF and pulseless VT, but still has utility as an alternative to amiodarone when amiodarone is unavailable.⁵¹

The 2005 ACLS guidelines no longer recommend the use of procainamide for the suppression of pulseless VT/VF. It may be useful for patients who have been resuscitated and are still unstable despite doses of amiodarone or lidocaine.¹⁶ Bretylium is no longer advocated for the treatment of VT and VF.^{22,28}

Verapamil and diltiazem are nondihydropyridine Ca^{++} channel blockers that inhibit extracellular Ca^{++} influx through slow Ca^{++} channels, inhibiting automaticity in the sinoatrial node and conduction via the AV node. Verapamil is used to terminate reentrant tachyarrhythmias that require AV nodal conduction for their continuation and to control the ventricular rate in patients with atrial fibrillation or flutter or multifocal atrial tachycardia. Diltiazem is used for the same indications, but seems to produce less myocardial depression than verapamil.⁴⁹ Because of its narrow safety margin, digitalis has been largely superseded by Ca^{++} channel blockers and β blockers to manage acute atrial fibrillation.^{20,22}

Adenosine is an endogenous purine nucleoside that acts by temporarily depressing AV and sinus node activity. It is an important drug for controlling AV nodal reentrant tachycardia and junctional tachycardias.¹³ Bolus administration is indicated for paroxysmal supraventricular tachycardia.

Atropine inhibits cholinergic responses that decrease heart rate and systemic vascular resistance and is used to increase heart rate during periods of symptomatic sinus bradycardia resulting from excessive parasympathetic nervous system activity. It is also administered for asystole and slow pulseless electrical activity with the assumption that excessive vagal stimulation was responsible for the cardiovascular collapse. Because atropine can increase myocardial oxygen demand, precipitate tachyarrhythmias, and expand the zone of infarction, it must be used carefully in patients with presumptive myocardial infarction.⁵⁰

Hypotensive patients may require a continuous infusion of a powerful inotrope or vasopressor for hemodynamic support. Typical infusions include epinephrine, dopamine, dobutamine, phenylephrine, norepinephrine, or vasopressin.

Mg^{++} replacement is advocated when hypomagnesemia is present. Hypomagnesemia can precipitate polymorphic VT (torsades de pointes) and VF.⁵

β -Adrenergic blockers, such as atenolol, metoprolol, propranolol, and esmolol, may enhance the benefits of thrombolytic agents in patients receiving these agents and have been shown to reduce the incidence of VF in post-myocardial infarction patients not receiving thrombolytic agents. These drugs are also used to control the ventricular rate in the presence of atrial tachyarrhythmias. Adverse effects of β -adrenergic blockers relate to their actions on the cardiac conduction system and to exacerbation of bronchospasm in patients with preexisting lung disease.⁵⁴

Vasoactive drugs

In the absence of adequate circulation, vasoconstricting drugs such as catecholamines or vasopressin may enhance organ perfusion by increasing arterial and aortic pressures, resulting in desirable increases in cerebral and coronary perfusion pressures, while reducing blood flow to visceral and muscle tissues. Indications for their use include ischemic heart disease, acute heart failure, cardiogenic shock, and cardiac arrest.

Epinephrine is currently the preferred initial catecholamine recommended in ACLS for pulseless VT/VF, asystole, and pulseless electrical activity arrest. The benefits of epinephrine in this application are its ability to cause vasoconstriction, to act as a cardiostimulant, and to facilitate cardiac perfusion during CPR, thus increasing the success of defibrillation.⁴⁵

Vasopressin causes peripheral vasoconstriction by stimulation of vasopressin receptors located in skin and skeletal muscle and vasopressin receptors located in the mesenteric circulation, resulting in shunting of blood to vital organs.¹ In addition, vasopressin potentiates the effects of catecholamines, enhancing vasoconstriction and resulting in greater coronary perfusion, which leads to more effective CPR and greater survival.⁵²

Hypotensive patients may require a continuous infusion of a powerful inotrope or vasopressor for hemodynamic support. Typical infusions include epinephrine, dopamine, dobutamine, phenylephrine, norepinephrine, or vasopressin.

Norepinephrine is indicated in patients with low peripheral resistance and severe hypotension. Under these conditions, the drug is a potent vasoconstrictor and inotropic agent. Sloughing and necrosis of tissues may occur if extravasation occurs during administration. Dopamine is a chemical precursor of norepinephrine and has α_1 -adrenergic-stimulating and β_1 -adrenergic-stimulating properties. Specific dopaminergic receptors also contribute to the drug's cardiovascular pharmacologic characteristics. Indications for dopamine include certain types of shock, such as that associated with heart failure.^{8,43} Dobutamine is a synthetic catecholamine and potent inotrope used in the treatment of heart failure when signs and symptoms of shock are absent.^{8,43} Inamrinone and milrinone are nonadrenergic cardiostimulant agents that also cause vasodilation with hemodynamic effects similar to dobutamine. They increase cardiac function and induce peripheral vasodilation.²⁶ Calcium chloride was initially thought to be beneficial during resuscitation by increasing myocardial contractility, but studies have shown that high concentrations of Ca^{++} may be detrimental.¹²

Vasodilators

Intravenous nitroglycerin permits controlled titration in relaxing vascular smooth muscle. This drug may cause severe hypotension when administered to a hypovolemic patient.²⁵ Sodium nitroprusside is an extremely potent, rapidly acting, direct peripheral vasodilator. It is used for the treatment of acute heart failure and hypertensive emergencies.⁴⁴

Sodium bicarbonate

Sodium bicarbonate is administered to correct metabolic acidosis occurring during protracted resuscitative efforts. The use of this drug should be guided by blood gas analysis if possible.¹⁵

Diuretics

Diuretics such as furosemide are used for their venodilating and diuretic effects for the treatment of acute pulmonary edema and cerebral edema after cardiac arrest.

Morphine

Morphine is the opioid of choice to manage ischemic chest pain and acute pulmonary edema. The drug is titrated in small intravenous doses to avoid respiratory depression.

Thrombolytic agents

Thrombolytic therapy is often instituted early in evolving myocardial infarction to promote fibrin digestion and clot dissolution. Many studies are being conducted with streptokinase, urokinase, anistreplase, and alteplase to determine their respective roles in the early treatment of myocardial infarction.¹⁷

Supplementary Drugs

Supplementary drugs are additional emergency drugs that must be available when certain sedative or anesthetic drugs are administered. They include drugs that are used to reverse untoward effects of anesthetics and others that are used to treat specific medical conditions that may occur during anesthesia.

Naloxone is a specific opioid antagonist that reverses opioid-induced respiratory depression. It is mandatory in practices where parenteral opioids are administered.³¹ Flumazenil is a specific benzodiazepine antagonist that reverses sedation and respiratory depression resulting from benzodiazepine administration.²⁷ Succinylcholine is used to overcome laryngospasm during deep sedation/general anesthesia by relaxing skeletal muscle controlling the vocal cords. It should be used only by practitioners with advanced anesthesia training. Dantrolene arrests the syndrome of malignant hyperthermia, a genetically transmitted disorder of excessive Ca^{++} release in skeletal muscle occurring during general anesthesia in which succinylcholine or volatile inhalation anesthetics are routinely administered.⁴

The use of parenteral vasopressors to treat hypotension is sometimes indicated during anesthesia. Some vasopressors, such as methoxamine and phenylephrine, increase blood pressure by causing peripheral vasoconstriction selectively, and others, such as ephedrine and mephentermine, act by a combination of peripheral vasoconstriction and cardiac stimulation.

CITED REFERENCES

1. ACLS core and supplemental drugs: *Advanced Cardiovascular Life Support provider manual and student CD*, Dallas, 2006, American Heart Association.
2. ADA Council on Scientific Affairs: Office Emergencies and emergency kits. *J Am Dental Assoc* 133:364-365, 2002.
3. Becker DE, Haas DA: Management of complications during moderate and deep sedation: respiratory and cardiovascular considerations. *Anesth Prog* 54:59-69, 2007.
4. Britt BA: Dantrolene. *Can Anaesth Soc J* 31:61-75, 1984.
5. Ceremuzynski L, Jurgiel R, Kulakowski P, et al: Threatening arrhythmias in acute myocardial infarction are prevented by intravenous magnesium sulfate. *Am Heart J* 118:1333-1334, 1989.
6. Cook-Waite *Anesthetics*, Eastman Kodak, Rochester, NY, 1993.
7. Cummings RO, Ornato JP, Thies WH, et al: Improving survival from sudden cardiac death: the "chain of survival" concept: a statement for health care professionals from the Advanced Cardiac Life Support Subcommittee and the Emergency Cardiac Care Committee, American Heart Association. *Circulation* 83:1832-1847, 1991.
8. Cummins RO, editor: *Textbook of advanced cardiac life support*, Dallas, 1997, American Heart Association.
9. Curriculum guidelines for management of medical emergencies in dental education. *J Dent Educ* 54:337-338, 1990.
10. Dager WE, Sanoksi CA, Wiggins BS, et al. Pharmacotherapy considerations in Advanced Cardiac Life Support. *Pharmacotherapy* 2006;26:1703-1729.
11. Davenport HT: *Anaesthesia in the elderly*, New York, 1986, Elsevier Science.
12. Dembo DH: Calcium in advanced life support. *Crit Care Med* 9:358-359, 1981.
13. DiMarco JP, Sellers TD, Berne RM, et al: Adenosine: electrophysiologic effects and therapeutic use for terminating paroxys-

- mal supraventricular tachycardia. *Circulation* 68:1254-1263, 1983.
14. Fast TB, Martin MD, Ellis TM: Emergency preparedness: a survey of dental practitioners. *J Am Dent Assoc* 112:449-501, 1986.
 15. Federiuk CS, Sanders AB, Kerb KB, et al: The effect of bicarbonate on resuscitation from cardiac arrest. *Ann Emerg Med* 20:1173-1177, 1991.
 16. Giardina E-GV, Heissenbuttel RH, Bigger JT Jr: Intermittent intravenous procaine amide to treat ventricular arrhythmias: correlation of plasma concentration with effect on arrhythmia, electrocardiogram, and blood pressure. *Ann Intern Med* 78:183-193, 1973.
 17. Guidelines for the early management of patients with acute myocardial infarction: a report of the American College of Cardiology/American Heart Association Task Force on Assessment of Diagnostic and Therapeutic Cardiovascular Procedures (Subcommittee to Develop Guidelines for the Early Management of Patients with Acute Myocardial Infarction). *J Am Coll Cardiol* 16:249-292, 1990.
 18. Haas DA: Emergency drugs. *Dent Clin North Am* 46: 815-830, 2002.
 19. Hasegawa EA: The endotracheal use of emergency drugs. *Heart Lung* 15:60-63, 1986.
 20. Heywood JT, Graham B, Marais GE, et al: Effects of intravenous diltiazem on rapid atrial fibrillation accompanied by congestive heart failure. *Am J Cardiol* 67:1150-1152, 1991.
 21. Himathongkam T, Newmark SR, Greenfield M, et al: Acute adrenal insufficiency. *JAMA* 230:1317-1318, 1974.
 22. International Consensus on Science: Guidelines 2005 for cardiopulmonary resuscitation and emergency cardiovascular care, part 4: advanced cardiovascular life support. *Circulation* 112(Suppl 1):III25-III54, 2005.
 23. International Consensus on Science: Guidelines 2005 for cardiopulmonary resuscitation and emergency cardiovascular care, part 6: pediatric basic and advanced life support. *Circulation* 112(Suppl 1):III73-III90, 2005.
 24. ISIS-2 (Second International Study of Infarct Survival Collaborative Group): Randomised trial of intravenous streptokinase, oral aspirin, both, or neither among 17,187 cases of suspected myocardial infarction: ISIS-2. *Lancet* 2:349-361, 1988.
 25. Jaffe AS, Roberts R: The use of intravenous nitroglycerin in cardiovascular disease. *Pharmacotherapy* 2:273-280, 1982.
 26. Klein NA, Siskind SJ, Frishman WH, et al: Hemodynamic comparison of intravenous amrinone and dobutamine in patients with chronic congestive heart failure. *Am J Cardiol* 48:170-175, 1981.
 27. Klotz U, Kanto J: Pharmacokinetics and clinical use of flumazenil (Ro 15-1788). *Clin Pharmacokinet* 14:1-12, 1988.
 28. Koch-Weser J: Bretylium. *N Engl J Med* 300:473-477, 1979.
 29. Lam FYW, Huang SM, Hall SD, editors: *Herbal supplements-drug interactions: scientific and regulatory perspectives*, New York, 2006, Inform Healthcare.
 30. Lipp M, Kubota Y, Malamed SF, et al: Management of an emergency: to be prepared for the unwanted event. *Anesth Pain Control Dent* 2:90-102, 1992.
 31. Longnecker DE, Grazis PA, Eggers GW Jr: Naloxone for antagonism of morphine-induced respiratory depression. *Anesth Analg* 52:447-453, 1973.
 32. Malamed SF: Drugs for medical emergencies in the dental office. In Ciancio SG, editor: *ADA/PDR guide to dental therapeutics*, ed 4, Chicago, 2006, Thompson Healthcare.
 33. Malamed SF: Managing medical emergencies. *J Am Dent Assoc* 124:40-53, 1993.
 34. Malamed SF: *Medical emergencies in the dental office*, ed 5, St Louis, 2000, Mosby.
 35. Matsuura H: Time and occurrence of systemic complications. *Anesth Prog* 36:219-228, 1989.
 36. Miller CS, Kaplan AL, Guest GF, et al: Documenting medication use in adult dental patients: 1987-1991. *J Am Dent Assoc* 123:40-48, 1992.
 37. Moore PA: Review of medical emergencies in dentistry: staff training and prevention, part 1. *Gen Dent* 36:14-17, 1988.
 38. Munson ES, Wagman IH: Diazepam treatment of local anesthetic-induced seizures. *Anesthesiology* 37:523-528, 1972.
 39. Newhouse MT, Dolovich MB: Control of asthma by aerosols. *N Engl J Med* 315:870-874, 1986.
 40. Nordt SP, Clark RF: Midazolam: a review of therapeutic uses and toxicity. *J Emerg Med* 15:357-367, 1997.
 41. Orr D II: Legal considerations. In Malamed SF, editor: *Medical emergencies in the dental office*, ed 6, St Louis, 2007, Mosby.
 42. Otto CW, Yakaitis RW: The role of epinephrine in CPR: a reappraisal. *Ann Emerg Med* 13:840-843, 1984.
 43. Otto CW, Yakaitis RW, Redding JS, et al: Comparison of dopamine, dobutamine, and epinephrine in CPR. *Crit Care Med* 9:640-643, 1981.
 44. Palmer RF, Lasseter KC: Sodium nitroprusside. *N Engl J Med* 292:294-297, 1975.
 45. Paradis NA, Koscove EM: Epinephrine in cardiac arrest: a critical review. *Ann Emerg Med* 19:1288-1301, 1990.
 46. Patterson R, Anderson J: Allergic reactions to drugs and biologic agents. *JAMA* 248:2637-2645, 1982.
 47. Phero JC: Maintaining preparedness for the life-threatening office medical emergency. *Dent Econ* 81:47-50, 1991.
 48. Raines A, Henderson TR, Swinyard EA, et al: Comparison of midazolam and diazepam by the IM route for control of seizures in a mouse model of status epilepticus. *Epilepsia* 31:313-317, 1990.
 49. Salerno DM, Dias VC, Kleiger RE, et al: Efficacy and safety of intravenous diltiazem for treatment of atrial fibrillation and atrial flutter. *Am J Cardiol* 63:1046-1051, 1989.
 50. Scheinman MM, Thorburn D, Abbott JA: Use of atropine in patients with acute myocardial infarction and sinus bradycardia. *Circulation* 52:627-633, 1975.
 51. Somberg JC, Bailin SJ, Haffajee CI, et al: Intravenous lidocaine versus intravenous amiodarone for incessant ventricular tachycardia. *Am J Cardiol* 90:853-859, 2002.
 52. Wenzel V, Krismer AC, Arntz HR, et al: A comparison of vasopressin and epinephrine for out-of-hospital cardiopulmonary resuscitation. *N Engl J Med* 350:105-113, 2004.
 53. Yacobi A, Amann AH, Baaski DM: Pharmaceutical considerations of nitroglycerin. *Drug Intell Clin Pharm* 17:255-263, 1983.
 54. Yusuf S, Wittes J, Friedman L: Overview of results of randomized clinical trials in heart disease, I: treatments following myocardial infarction. *JAMA* 260:2088-2093, 1988.

GENERAL REFERENCES

- Adler JN, Plantz SH, Stearns DA, et al: *Emergency medicine*, Baltimore, 1999, Lippincott Williams & Wilkins.
- Bennett JD, Rosenberg MB, editors: *Medical emergencies in dentistry*, Philadelphia, 2002, Saunders.
- Bresler MJ, Sternbach G: *Manual of emergency medicine*, St Louis, 1998, Mosby.
- Ciancio SG, editor: *ADA/PDR guide to dental therapeutics*, ed 4, Chicago, 2006, Thompson Healthcare.
- Field JM, editor: *ACLS provider manual*, Dallas, 2006, American Heart Association.
- International Consensus on Science: Guidelines 2005 for cardiopulmonary resuscitation and emergency cardiovascular care, *Circulation* 112(Suppl 1):1-384, 2005.
- Lewis DP, McMullin A: *Advanced protocols for medical emergencies*, ed 2, Hudson, OH, Lexi-Comp, 2008.
- Ma JO, Cline D, Kelen GD, et al: *Emergency medical manual*, ed 6, New York, 2003, McGraw-Hill.
- Malamed SF: *Medical emergencies in the dental office*, ed 6, St Louis, 2007, Mosby.
- McCarthy FM, editor: *Medical emergencies in dentistry*, Philadelphia, 1982, Saunders.
- Meiller TF, Wynn RL, McMillan AM, et al: *Dental office medical emergencies*, ed 3, Hudson, OH, 2008, Lexi-Comp.
- Scully C, Cawson R: *Medical problems in dentistry*, London, 2004, Elsevier.
- Terezhalmay GT, Batizy LG, editors: *Urgent care in the dental office: an essential handbook*, Chicago, 1998, Quintessence Publishing.
- Wynn RL, Meiller TF, Crossley HL, editors: *Drug information handbook for dentistry*, ed 15, Hudson, OH, 2009, Lexi-Comp.

Prescription Writing and Drug Regulations

VAHN A. LEWIS

PRESCRIPTION

A *prescription* is a written or verbal order for medication to be used for the diagnosis, prevention, or treatment of a specific patient's disease by a licensed physician, dentist, podiatrist, or veterinarian. In some states, a prescription may also be written by appropriately trained optometrists, physician's assistants, and registered nurses. A prescription is a legal document for which the prescriber and the pharmacist are responsible. Prescriptions are subject to state, federal, and local regulations.

The writing of a prescription is one step in many that must be properly performed to initiate a course of therapy (Figure 55-1). This process starts with establishing a proper prescriber-patient relationship, which includes patient identification, proper diagnostic procedures, presentation and discussion of a treatment plan to the patient, availability of counseling, and follow-up care. These fundamental concepts have been reasserted more recently by the medical profession with respect to online prescribing for patients who are unknown to the practitioner. A prescription is *prima facie* evidence in court that such a relationship exists. Selection of therapy requires a multitude of factors to be considered: factors related to the patient (e.g., has difficulty swallowing tablets) and the therapeutic goal (cure or symptom control); evaluation of drug interactions; recognition of the various relationships among the patient, prescriber, and insurance companies and governmental bodies (that may establish guidelines or limits on payment for medications); and the medication costs and whether the patient can afford to buy it. Prescribing outside the proper prescriber-patient relationship is unprofessional conduct.

Prescribing should be done in a thoughtful and deliberate way, and the conditions for error-free prescribing must be ensured. In 1999, The Institute of Medicine report "To Err is Human" documented an increasing frequency of medical errors.⁹ The report analyzed the nature of errors and categorized them into slips, lapses, and mistakes. Slips and lapses occur when the prescriber knows the correct procedure, but fails to perform it properly. Mistakes result from incorrect understanding of the correct course of action.

Slips and lapses can be influenced by the conditions under which the prescribing is done, interruptions during the writing of the prescription, or writing an incorrect drug name from memory, although the intended drug choice was sound. In this regard, several suggestions were made, including standardizing prescribing rules, using automated prescriber drug order entry systems and pharmaceutical software, having necessary patient information available at the point of care, and improving the patient's knowledge about his or her treatment. Some areas in which errors often occur include poor hand-

writing, incorrect calculation of pediatric drug doses, look-alike drug name mix-ups, prescriptions for drugs to which the patient is allergic or intolerant, and inappropriate dosage forms. There is a relationship between increased admissions (practitioner overloading) and increased errors. New errors also occur as new therapeutic entities are introduced. Surveys of prescriptions find errors not only within single prescriptions, but also between multiple prescriptions for the same patient in the form of drug interactions or incompatibilities.

Legal Categories of Drugs

Drugs may be categorized according to legal restrictions governing their use as over-the-counter (OTC), prescription, or controlled drugs. As determined by the U.S. Food and Drug Administration (FDA), a prescription drug is one that requires a prescription to be dispensed by a pharmacist, whereas an OTC drug can be purchased without a prescription. The 1997 FDA Modernization Act changed the indication of a prescription drug to "RX only." Several state laws refer to prescription drugs as "dangerous" drugs, meaning that they are unsafe for use except under the supervision of a practitioner licensed to administer them. Drugs such as antibiotics, local anesthetics, and systemic corticosteroids are examples of prescription drugs.

Drugs with an abuse potential, called *controlled substances*, have additional restrictions placed on their use. The Drug Enforcement Administration (DEA) of the Department of Justice is responsible for identifying and regulating such drugs. Controlled substances may be OTC, prescription, or unavailable for medical use. Examples of controlled drugs include cough remedies with codeine, opioids such as morphine that are characterized as having medical use, and opioids such as heroin that are said to have no accepted medical use. Most controlled substances have their principal site of action in the central nervous system. The widely abused anabolic steroids are an important exception to this rule and are controlled substances.

OTC agents are deemed to be safe and effective without professional guidance when used according to their labeled instructions. Examples of OTC, or nonprescription, drugs include some nonopioid analgesics, cold remedies, vitamins, topical antibiotics, and topical corticosteroids. These medications are manufactured under the same quality control standards that apply to prescription drugs; their safety and effectiveness are also monitored by the FDA.

As a result of legislative changes during the 1990s (Table 55-1), several additional sources of treatments have become more available. Dietary supplements may contain "dietary ingredients," which can include vitamins, minerals, herbs, amino acids, enzymes, organ tissues, metabolites, extracts, or

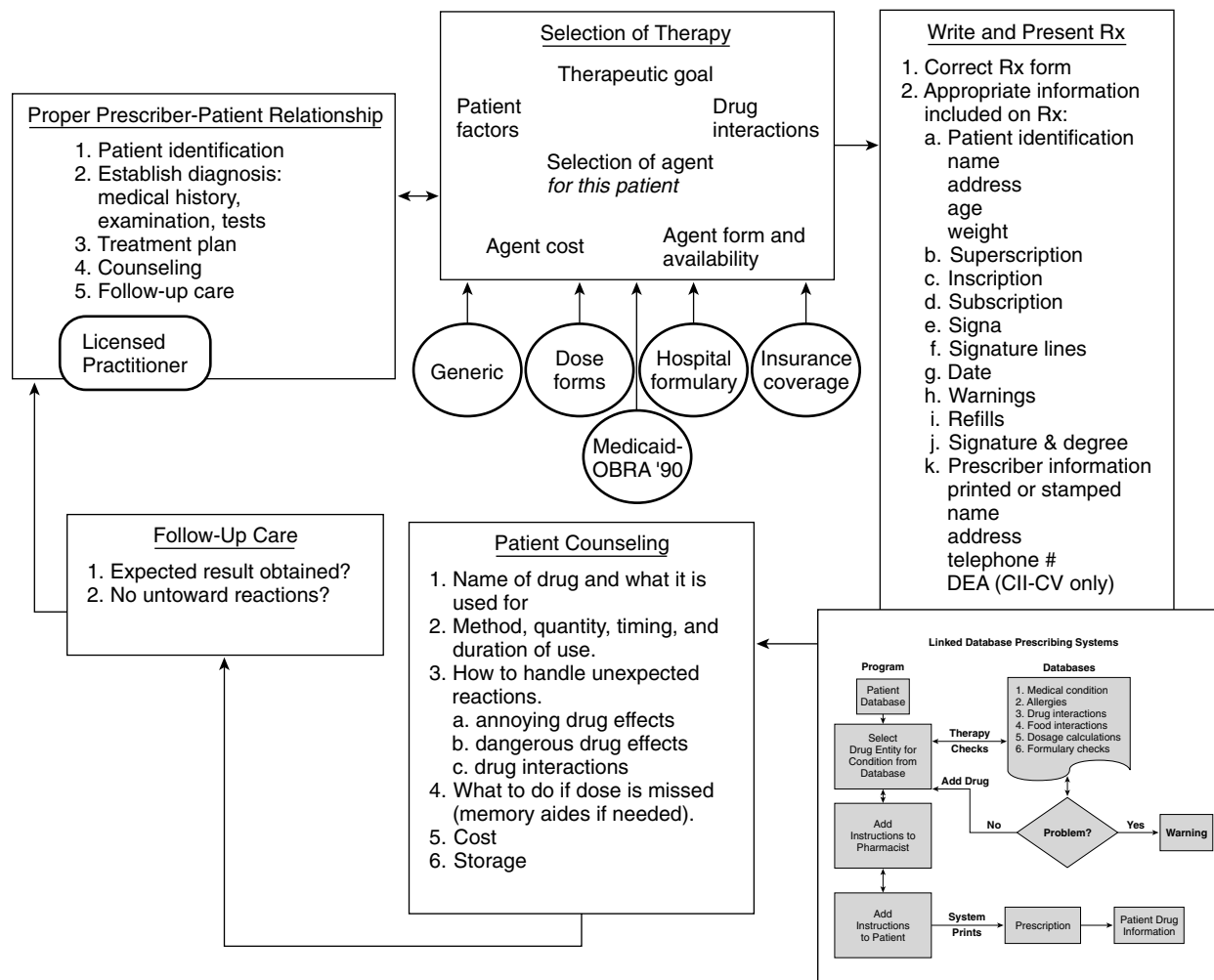

FIGURE 55-1 Steps involved in proper prescribing. After selecting the correct therapy, the prescriber must fill out the various components of the prescription to meet professional and legal requirements established by state, federal, and professional organizations. The next step is to present the prescription to the patient and provide the name of the drug and what it is being prescribed for, how to take it, what kinds of untoward effects the patient might expect, and what the patient should do about them if they occur. Some discussion of storage and cost of the medication may be included when indicated. After the presentation of the prescription, it is still important to monitor the progress of the patient. If the therapeutic goals are not being achieved, the process may need to be started over. *OBRA*, Omnibus Budget Reconciliation Act.

concentrates. These products must be labeled as dietary supplements. The manufacturer is responsible for (1) truthful information, (2) nonmisleading information, and (3) ensuring that the dietary ingredients in the supplements are safe. Manufacturers do not need to register with the FDA or obtain FDA approval. Complementary and alternative medical approaches may use “biologicals,” which can include herbal remedies, special diets, or food products used for therapy. Herbs are defined as plants or plant products that produce or contain chemicals that act on the body.

The National Center for Complementary and Alternative Medicine sponsors many projects to investigate the potential therapeutic value of treatments such as St. John’s wort, shark cartilage, and glucosamine. The goal is to determine whether these treatments can aid in the treatment of various disorders. This Center is also concerned with assessing the value of nondrug therapies and nontraditional medical systems such as acupuncture, Eastern medicine, and homeopathic medicine. The FDA can provide guidelines for the therapeutic claims made for these various products through the Center for Food Safety and Applied Nutrition, whose role is primarily educa-

tional. The United States Pharmacopeia (USP) has developed a Dietary Supplement Verification (DSV) Program. For a dietary supplement to bear the USP-DSV seal, it must include its ingredients on the label; indicate the strength and amounts of ingredients; prove that the product is shown to be absorbable when taken; and document that it has been screened for heavy metals, microbes, and pesticides and been manufactured in safe, sanitary, and controlled conditions. (See Chapter 56 for a more complete review of herbal products and alternative medicine.)

A new class of drugs has been created by the Combat Methamphetamine Epidemic Act of 2005, which created restrictions for the sale of ephedrine and phenylpropanolamine from retail stores. These products require the buyer to present identification and limit the monthly quantities that can be purchased.

Single-Entity Versus Combination Prescriptions

A single-entity prescription is one written for a preparation with only one active ingredient, the agent that produces the desired effect (e.g., ibuprofen, 600-mg tablets), in contrast to

TABLE 55-1

Federal Laws Regulating Drugs and Prescribing

LAW	EFFECT
Pure Food and Drug Act 1906 (Wiley Act)	Prohibited mislabeling and adulteration of drugs ²⁶
Opium Exclusion Act of 1909	Prohibited importation of opium
Amendment (1912) to the Pure Food and Drug Act	Prohibited false or fraudulent advertising claims
Harrison Narcotic Act of 1914	Established regulations for use of opium, opiates, and cocaine (marijuana added in 1937)
Food, Drug and Cosmetic Act of 1938	Required that new drugs be safe and pure (but did not require proof of efficacy); enforcement by FDA ²⁷
Durham-Humphrey Amendment of 1951	Vested in the FDA the power to determine which products could be sold without prescription
Kefauver-Harris Amendments (1962) to the Food, Drug and Cosmetic Act	Required proof of efficacy and safety for new drugs and for drugs released since 1938; established guidelines for reporting information about adverse reactions, clinical testing, and advertising of new drugs
Comprehensive Drug Abuse Prevention and Control Act (1970), Controlled Substances Act, as amended	Outlined strict controls in the manufacture, distribution, and prescribing of habit-forming drugs; established programs to prevent and treat drug addiction ³²
Orphan Drug Amendments of 1983	Amended Food, Drug and Cosmetic Act of 1938, providing incentives for the development of drugs to treat conditions suffered by <200,000 patients in the United States. ³³
Drug Price Competition and Patent Restoration Act of 1984 (Waxman-Hatch Act)	Abbreviated NDA for generic drugs; required bioequivalence data; patent life extended by amount of time delayed by FDA review process; cannot exceed 5 extra yr or extend >14 yr post-NDA approval; authorized abbreviated NDA
Omnibus Budget Reconciliation Act of 1990	Deepened governmental involvement in prescription writing through legislation relating to “best discount prices,” rebates, formularies, and pharmacy reimbursements; placed restrictions on payment for prescriptions for barbiturates and benzodiazepines
Generic Drug Debarment Act of 1991 and the Food, Drug, Cosmetic and Device Enforcement Amendment of 1991	Increased penalties for abuses of generic drug regulations
1992 Expedited Drug Approval Act	Allowed accelerated FDA approval for drugs of high medical need; required detailed postmarketing patient surveillance
1992 Prescription Drug User Fee Act	Required manufacturers to pay user fees for certain NDAs; FDA states review time for new chemical entities has decreased from 30 mo in 1992 to 20 mo in 1994 ³¹
1994 Dietary Supplements and Health Education Act	Required dietary supplement manufacturers to ensure that a dietary supplement is safe before it is marketed; FDA is responsible for taking action against any unsafe dietary supplement product after it reaches the market; generally, manufacturers do not need to register with FDA or get FDA approval before producing or selling dietary supplements; manufacturers must ensure that product label information is truthful and not misleading ²⁵
North American Free Trade Act (1994) and General Agreement on Tariffs and Trade (1948), World Trade Organization (1995)	Necessitated harmonization of pharmacopeias and drug regulations between trading partners
1996 Health Insurance Portability and Accountability Act (HIPAA)	Standardized third-party payment for medical treatment and increased confidentiality and privacy for patient information maintained in medical databases ²⁰
1997 FDA Modernization Act	Replaced “legend” with label “Rx only”; allowed manufacturer to discuss off-label uses of drugs with practitioners; revised accelerated track approval for drugs that treat life-threatening disorders; made provisions for pediatric drug research; revised interaction of agency with individuals doing clinical trials ⁶
2005 Combat Methamphetamine Epidemic Act	Establishes new regulations for the sale of ephedrine, pseudoephedrine, and phenylpropanolamine that differ from the Control Substance V regulations by not requiring sale in a pharmacy
U.S. Troop Readiness, Veterans’ Care, Katrina Recovery, and Iraq Accountability Appropriations Act of 2007	Established requirement for the use of tamper-resistant written prescriptions for Medicaid prescription reimbursement. Prescriptions must have three tamper-resistant features

NDA, New Drug Application.

a combination prescription, which calls for a preparation with more than one active ingredient (e.g., aspirin, 230 mg; acetaminophen, 150 mg; caffeine, 30 mg; and hydrocodone bitartrate, 5 mg). Many combination formulations are available precompounded, in a single fixed-dosage form, and may be prescribed in the same manner as a single drug (e.g., acetaminophen and hydrocodone tablets).

When the combination is a rational one (as is the combination of a nonopioid and an opioid analgesic for enhanced

pain relief), the ease of prescribing and using the preparation may justify its selection. Too frequently, however, unnecessary drugs (e.g., caffeine) or inappropriate combinations (e.g., the mixing of two nonopioid analgesics) are used. Fixed-dosage formulations prepared by the manufacturer are not subject to dosage adjustment to suit the needs of the individual patient. Differences in the half-lives of the individual agents may lead to ineffective or excessive action of one or more of the drugs. Nevertheless, at certain times therapeutic

advantages can be obtained by using a combination drug to reduce confusion related to taking numerous individual medications at irregular times.

Drug Names and Generic Substitution

As discussed in Chapter 3, any drug may be identified by more than one designation in various references, texts, and package inserts. Of special interest here are nonproprietary and proprietary names. The nonproprietary name is also referred to as the *generic name*. This name is selected by the U.S. Adopted Names Council. The steady increase in the number of new drugs and the marketing of existing drugs by different manufacturers are making similarities between different drug names an increasing challenge. The practitioner must be vigilant in prescribing the correct agent and spelling drug names correctly. Because, with few exceptions, individual drugs have only one nonproprietary name, it is this name by which the drug is primarily identified. Nonproprietary names may differ among countries, however. The same agent may also have many proprietary or trade names, which are given to it by the various manufacturers or marketers to identify their brand of the drug. In advertisements and labeling with the trade name, the nonproprietary name of the drug must also be prominently identified.

In recent years, governmental regulatory agencies have had a strong tendency to encourage or mandate the prescription and dispensation of drugs by nonproprietary name.¹⁵ The principal motivation for these regulations is to control rapidly increasing drug costs. Currently, all states and the District of Columbia have repealed their existing ant substitution laws and replaced them with drug substitution laws permitting or, in some states, requiring the pharmacist to dispense generic drugs (preparations containing the same active chemicals in identical amounts, but sold under the common nonproprietary name), unless specifically prohibited by the prescriber. Also, the federal government has instituted "maximum allowable cost" programs in an effort to contain the cost of prescription drugs to the consumer by limiting prescription by proprietary name. These programs require the prescriber to certify the necessity of prescribing a specific brand of drug rather than its nonproprietary counterpart. According to the FDA, the savings may range from 30% to 80%.²⁸

Equivalence: Chemical, Pharmaceutical, Biologic, and Therapeutic

If two brands of the same drug are to be considered for substitution, the basis for identifying them as equivalent must be carefully defined.¹² Drug products that contain the same amounts of the same active ingredients in the same dosage forms and meet current official compendium standards are considered chemical equivalents. Pharmaceutical equivalents are drug products that contain the same amounts of the same therapeutic or active ingredients in the same dosage form and meet standards based on the best currently available technology. This description means that pharmaceutical equivalents are formulated identically and must pass certain laboratory tests for equivalent activity, including dissolution tests when appropriate, by standards set for various classes of drugs.

Bioavailability refers to the extent and rate of absorption of a dosage form as reflected by the time-concentration curve of the administered drug in the systemic circulation. Bioequivalent drugs are drugs that, when administered to the same individual in the same dosage regimen, result in comparable bioavailability. Insofar as the extent of absorption is concerned, pharmaceutical equivalence presumably ensures biologic equivalence.

Therapeutic equivalents are chemical or pharmaceutical equivalents that, when administered to the same individual in the same dosage regimen, provide essentially the same efficacy

(and toxicity). Therapeutic equivalency can be shown only by controlled human clinical trials, which are expensive and time-consuming. In the absence of contradictory clinical evidence, drugs that are bioequivalent are assumed to be therapeutically equivalent.

Chemically equivalent drugs may not share comparable bioavailability. Problems of bioequivalence can arise from many areas. First, although the amounts of the therapeutic ingredients may be the same in two dosage forms, the preparations may contain different binders, diluents, stabilizers, preservatives, and various other pharmacologically inactive ingredients to give them their physical form. Second, the pressure used to compress the mixture into the tablet or capsule dosage form may vary and alter the dissolution rate. For suspensions or solutions, the methods used to dissolve, disperse, or suspend the drug in a liquid formulation may differ. Third, the quality control, age, purity, and physical consistency of any of the chemical constituents contained in different formulations of chemically equivalent products can differ. All these various and sometimes poorly controlled factors can influence the rate at which the product disintegrates or dissolves in the gastrointestinal tract, affecting absorption of the active ingredients.

Variations in bioavailability have been shown to be responsible for some treatment failures with certain categories of drugs. Approximately 5% of drug products pose challenges to generic drug manufacturers. Drugs with poor bioavailability, high lipid solubility, nonlinear pharmacokinetics, or narrow therapeutic ranges cause difficulty; examples include steroids, digitalis glycosides, anticoagulants, thyroid preparations, theophylline, antineoplastic drugs, and anticonvulsants. Advanced or complex dosage forms with coatings or layers are also difficult to match. Drugs with potential bioavailability problems that are likely to be used by dentists include the various dosage forms of erythromycin, diazepam, and ibuprofen.

To facilitate the wider use of generic drugs, the FDA has published a list of all FDA-approved drugs that it regards as therapeutically equivalent, entitled *Approved Drug Products with Therapeutic Equivalence Evaluations* (also known as the *Orange Book*).¹⁶ This source can be used as a guide to identifying less expensive generic alternatives that pharmacists can substitute for a brand name product designated the "reference listed drug," that is, the innovator drug. This list indicates drugs that are considered therapeutically equivalent (termed a *positive formulary*), designated with a rating beginning with the letter *A*; drugs that may not be therapeutically equivalent (termed a *negative formulary*), designated with a starting letter *B*; and drugs about which the agency has not yet made a determination (blanks). The FDA's policy is to consider pharmaceutically equivalent drugs as therapeutically equivalent unless scientific evidence to the contrary exists. In the *Orange Book* (available on the Internet⁵), the reference-listed drug, therapeutically equivalent rating, and generic drug rating are provided in tabular form. If a generic oral dosage form preparation is considered therapeutically equivalent, it is given the designation of *AB* (the second letter, *B* in this case, refers to the class of dose form). At the time of this writing, 96% of ibuprofen tablets were judged *AB*, 100% of diazepam tablets were *AB*, and all erythromycin ethyl succinate suspensions were considered *AB*.

Although FDA recalls of generic drugs greatly outnumber recalls of brand name drugs, most American pharmaceutical firms follow Good Manufacturing Practice regulations and are inspected periodically by the FDA for compliance with quality control standards. In addition, many generic products are manufactured and distributed by the same company that markets the original proprietary drug. For these reasons, a generic product should not be assumed to be inferior to its

brand name counterpart. It is left to the practitioner to know the properties of the drugs used and to decide whether to prescribe by trade or nonproprietary name. If the condition being treated is not serious or life-threatening, and if the therapeutic index of the drug category being prescribed is not critical, a generic drug can save the patient a substantial amount of money, and the drug should be prescribed by its nonproprietary name.

Component Parts of the Prescription

A complete, ideal prescription comprises several parts, each of which provides specific information about the prescriber, the patient, and the drug. The patient's full name and address are required on prescriptions for DEA-controlled substances. Including the patient's age may be required and is especially desirable on prescriptions for children younger than 12 years, permitting the pharmacist to confirm the dosage. The name and full address of the prescriber are necessary. The telephone number may be required and is usually included as a convenience to the pharmacist. The date on which the prescription is written and signed is always desirable and is required on prescriptions for DEA-controlled substances or in states in which prescriptions expire.

The symbol *Rx*, known as the *superscription*, is generally understood to be an abbreviation of the Latin *recipe*, meaning "take thou," but was probably derived from the ancient Roman symbol for Jupiter and used in the physician's prayer for the survival of the patient.

The inscription provides specific information about the drug preparation: (1) the name of the drug, which can be either the nonproprietary or the proprietary name, or possibly both, with the proprietary name following the nonproprietary name in parentheses, as with pentazocine (Talwin), and (2) the unit dosage or amount of the drug in milligrams (e.g., penicillin VK 500 mg) or other appropriate unit of measure (e.g., penicillin G 250,000 U) and the dosage form (e.g., tablets, suspension, sprinkles). If the prescription is for a liquid preparation, the individual unit of dosage is usually contained in a teaspoonful or 5 mL (e.g., amoxicillin 125 mg/5 mL). The inscription should provide an unambiguous identification of the drug and any other ingredients that the pharmacist must assemble to fill the prescription order.

Drug products are available in unique strengths and dosage forms. When prescribing, a product, strength, and dosage form that is available to the pharmacist should be designated. The inscription should be written just below and to the right of the superscription.

Several sources of drug information should be available during selection of drug therapy (also discussed in Chapter 3). Good sources for identifying the drug, dosage form, and dose include *The Physicians' Desk Reference*, *Facts and Comparisons*, *Mosby's Drug Reference for Health Professions*, and *ePocrates Rx*. In addition, it is valuable to have a compilation of drug interactions available to screen for possible adverse interactions. A book such as *Drugs in Pregnancy and Lactation* by Briggs and colleagues² is helpful when a course of therapy is being planned for women of childbearing potential and for pregnant or nursing women. The American Pharmacists Association's *Handbook of Nonprescription Drugs* may be useful if the practitioner is uncertain whether an OTC drug might affect therapy. References on herbal drugs and dietary supplements may also be useful (see Chapter 56).

Additional sources of drug information are available as computer software programs, compact disks, and personal digital assistant programs and on the Internet. Electronic resources can have advantages if the text is accompanied by a sophisticated search engine. An innovation in prescribing is the concept of "linked database prescribing" (Figure 55-2). This type of system has the potential to reduce several sources of prescribing errors, such as poor handwriting, selection of the wrong drug name (selection is based on therapeutic classification), nonexistent product strengths and dosage forms, orders for drugs to which patients are allergic, and therapeutic incompatibilities. Other errors such as dosing and patient instruction errors could also be reduced by appropriately designed systems.

Although this concept seems to have a bright future, implementation would be challenging for professional, technical, and legal reasons. If patient data are entered into such a system, the system would need to comply with the Health Insurance Portability and Accountability Act of 1996 (HIPAA). Specialties such as dentistry may use drugs in a different way than the drugs are generally used in medicine; this can lead to false rejections or warnings for valid prescrip-

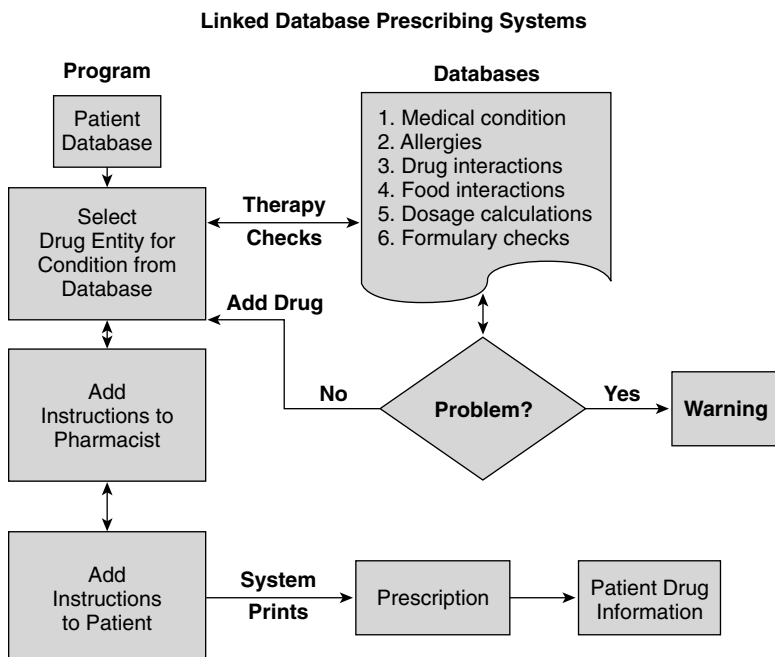

FIGURE 55-2 The complex process of prescribing can be facilitated by a linked database prescribing system. These systems can assist the prescriber by putting patient, drug, drug interaction, and formulary information at the prescriber's fingertips. The systems can provide warnings when problems are discovered. Current systems leave the instructions to the pharmacist and patient up to the prescriber. Written drug information for the patient is frequently generated automatically.

tions. Who would be responsible for programming and maintaining the quality of the databases? Who would pay for the use of such a system? An example of a linked database prescribing system is *Clinical Pharmacology*, an Internet-based program created by Gold Standard Multimedia.

The next part of the prescription is the subscription. The subscription is the prescriber's directions to the pharmacist regarding fulfilling the inscription. Because almost all drugs used by dentists are available in precompounded form, the subscription is usually brief, including the following:

1. The quantity and dosage form of the drug to be dispensed; that is, the number of tablets or capsules or the volume of a liquid preparation needed for a course of therapy (e.g., "dispense 28 tablets"). This direction is written, preferably in Arabic numerals, for an appropriate amount of the drug as determined by the manner in which it would be used by the patient and the amount of time the patient would need it. The prescriber also considers the toxicity and abuse potential of the drug and the cost to the patient. For DEA-controlled drugs, the quantity must be written in numbers and spelled out (in English, not Latin) to avoid alteration. (Without this precaution, 15 is easily changed to 45, 75, or 150.) Alternatively, the prescription must have a check-off box for the range of doses that includes the amount to be dispensed. In any prescription, no greater quantity of drug than is needed should be ordered. In some cases the amount prescribed should be limited to prevent obscuring symptoms, such as prescribing analgesics for 3 or 4 days rather than the 7 to 10 days common for antibiotics. If multiple appointments are anticipated, it may be more cost-effective to write the amount to reflect several appointments. The subscription should be written on the line below the last line of the inscription.
2. The number of authorized refills of the prescription. The number and its time limitation are specified for DEA-controlled drugs, but are otherwise left to the discretion of the practitioner. Some state laws dictate, however, that prescriptions expire at the end of each year. If refill directions are not authorized by the prescriber, no refills may be dispensed. With controlled substances, care should be taken to devise a refill authorization system that is not easily altered, such as crossing out all except the desired number in a series (e.g., 0, 1, 2, 3). The refill instructions are usually physically located below the transcription (described later) of the prescription.
3. Directions to the pharmacist to list the medication on the container label. The current trend in most states is to require the pharmacist to identify medications on the label unless such identification is not considered to be in the patient's best interest and is specifically prohibited by the prescriber. Identifying the drug can prevent allergic reactions or adverse interactions with other medications and misuse of the unused portion of the prescription. It may be especially helpful in directing the management of victims of drug poisoning. When present, this information is often physically located below the transcription on the prescription.

The transcription, or signature—from the Latin *signa*, meaning "label" or "let it be labeled," and indicated on the prescription by "Label:" or "Sig:"—is the prescriber's directions to the patient that appear on the medicine container. At one time, such directions were uniformly written in Latin, but modern practice is to use English. Latin abbreviations are still used by many clinicians in prescriptions and progress notes to save time (Table 55-2); however, such gains are minor in general dental practice and may contribute to prescription errors (e.g., "q4h" instead of "qid" represents a 50% dosage increase). Figure 55-3 depicts the same signature for an analgesic medication, one written entirely in English and the other

TABLE 55-2

Latin Abbreviations Used in Prescription Writing

ABBREVIATION	LATIN	ENGLISH
ad lib.	<i>ad libitum</i>	at pleasure
a.c.	<i>ante cibum</i>	before meals
aq.	<i>aqua</i>	water
b.i.d.	<i>bis in die</i>	twice a day
caps.	<i>capsula</i>	capsule
c̄	<i>cum</i>	with
d.	<i>dies</i>	a day, daily
disp.	<i>dispensa</i>	dispense
gtt.	<i>guttae</i>	drops
h.	<i>hora</i>	hour
h.s.	<i>hora somni</i>	at bedtime
non rep.	<i>non repetatur</i>	do not repeat (or refill)
no.	<i>numerus</i>	number, amount
p.c.	<i>post cibum</i>	after meals
p.r.n.	<i>pro re nata</i>	as needed
q.h.	<i>quaque hora</i>	every hour
q.4h.	<i>quaque quarta hora</i>	every 4 hours
q.i.d.	<i>quater in die</i>	four times a day
Sig.	<i>signa</i>	let it be labeled, label
stat.	<i>statim</i>	immediately
tab.	<i>tabella</i>	tablet
t.i.d.	<i>ter in die</i>	three times a day

Label: Take two tablets immediately. Take one or two tablets every 4 hours as needed for relief of pain.

Sig: Tab 2 stat. Tab 1 or 2 q.4h. p.r.n. for relief of pain.

FIGURE 55-3 Sample of the same transcription or signature (instructions to the patient) written in English and with Latin abbreviations.

written in Latin abbreviations. Items written in the transcription are transferred onto the prescription bottle label by the pharmacist, so they should be complete but concise.

The phrase "use as directed" should not be used. Rather, the transcription should be explicit and include (1) the route and method (e.g., take, instill, or insert); (2) the number of dose forms to be taken each time (e.g., take two tablets); (3) how frequently to administer the medication (e.g., every 6 hours or at bedtime); (4) for what length of therapy (e.g., for 7 days or until all taken); (5) for what purpose (now required by law in some states; e.g., for an analgesic, "to relieve pain" or "for pain"); and (6) any special instructions (e.g., shake well before using or refrigerate). The instructions to the patient should be consistent with the patient characteristics, drug, and dosage form. Prescriptions written for children should use the verb *give* instead of *take* to indicate that the parent or guardian is to administer the drug. Enteric-coated drugs should be swallowed whole to ensure that the coating is still intact when the drug reaches the stomach. Directions for suspensions should include the phrase "shake well then take ..." to ensure administration of a uniform dose. The transcription should be located on the next line after the subscription. (The arrangement of information on the prescription is by custom, but by

observing this order the practitioner is less likely to omit an essential part of the instructions.)

The handwritten signature and professional degree of the prescriber convey the authority of the prescriber to order the medication and of the pharmacist to fill the prescription. Although all prescriptions should be signed, a signature is required by law only for certain controlled substances (Schedule II drugs); other prescriptions may be telephoned to a pharmacy, where the pharmacist writes them down. When it appears, the dentist's signature is followed by the prescriber's professional degree rather than preceded by "Dr." as the abbreviation for "Doctor." If several dentists work in a clinic that uses the same prescription form, several states require that the prescriber's name be mechanically printed or stamped on the prescription on an extra line under the signature line. Most state dental practice acts specify that prescriptions may be written only for patients under active care. Many state laws stipulate that only the classes of drugs directly involved with dental treatment may be prescribed by the dentist. Another form of identifier needed on some prescriptions is the National Provider Identifier (NPI), which was established by HIPAA (see Table 55-1). The NPI serves as a unique provider identifier for all electronic prescribing and billing.³

Finally, the prescriber's DEA registration number must appear on any prescription for a controlled or scheduled drug in compliance with the Controlled Substances Act of 1970. This number should not be routinely entered on prescriptions that do not require it, however, to prevent its use by potential drug abusers.

Many states have their own acts related to controlled substances. If state, federal, or local regulations governing any drug or procedure differ, the most stringent of the regulations applies. The state and federal certificates of registration must be renewed periodically. DEA registration is not required of practitioners in the military or the Public Health Service or of recent graduates in internship or residency programs; in the latter case, the institutional DEA registration number may be used.

After the prescribing of the drug, but before the prescription is filled, the pharmacist evaluates the prescription again. The pharmacist has responsibility to the patient and the practitioner to check the prescription for possible errors in drug selection, dosage form and dosage, and patient instructions.

Increasingly, prescriptions are being filled at sites remote from where the patient lives. Prescriptions may be mailed or in some cases submitted by the telephone or Internet to a pharmacy. Remote pharmacies may be used to obtain medications at a better price or may be required by insurance carriers. In some cases, these pharmacies may not be in the United States.

The FDA is charged with regulating the production of prescription drugs from development to distribution. It has set standards that require compliance during drug development (e.g., New Drug Application [NDA]), labeling (package inserts), drug manufacturing (i.e., Good Manufacturing Practices), and drug distribution and postmarketing surveillance (e.g., MedWatch). The FDA is challenged, however, by limited funding (Prescription Drug User Fee Act), changes in international agreements (the North American Free Trade Agreement [NAFTA] and the General Agreement on Tariffs and Trade [GATT]), changes in public attitudes toward regulation of medications (1994 Dietary Supplements and Health Education Act), increased threats to drug and food safety (bioterrorism, "mad cow disease"), and the use of the Internet to market drugs.

Mail order pharmacies

For long-term medications where the cost is covered by an insurance company, patients may be directed to submit the

prescription to a central pharmacy if the company is to cover the cost. The medication is shipped to the patient by domestic mail, and if the shipment crosses state or national borders, the medications must comply with FDA requirements.

Internet prescriptions

The development of Internet drug distribution has added an additional area of challenge for the control of the drug supply. Many of the solicitations for drug sales over the Internet are illegal, and the FDA has moved to close such practices.²³ These sites may come and go, however, before the FDA can act. The medications sold may be of unknown quality and may come from distant sources. Cursory Internet health histories may not properly reflect the patient's health status or may not be reviewed by qualified personnel. Drugs can be used more safely when appropriate medical histories are obtained and considered by practitioners during the prescribing process. In addition, if a patient has an adverse reaction to a drug obtained from a distant source, recognizing and treating adverse reactions may be difficult. There is also a potential financial risk to the patient when using the Internet because the seller may be unknown to the buyer. *Caveat Emptor* ("Buyer beware") is very much the operating principle for these transactions. To help reduce some of the risks associated with the use of Internet pharmacies, the National Association of Boards of Pharmacy has developed a voluntary certification program called *Verified Internet Pharmacy Practices Site* (VIPPS). A VIPPS seal of approval indicates that the pharmacy complies with state licensing and additional requirements, including the patient's right to privacy.

Reimportation of Drugs

Technically, no unapproved drugs may be imported into the United States. Travelers and immigrants may feel more comfortable, however, taking medications they are familiar with from their home countries. The FDA and U.S. Customs Service regulate drug importation for personal use by guidance documents used for interpreting the various laws administered by the FDA.²⁹ Small quantities of medications unavailable in the United States, intended to continue a course of treatment begun in a foreign country, may be allowed to enter. The FDA narrows the scope of such drug importations to small amounts (generally less than a 3-month supply) for personal use. If the product's use is properly identified, it is not for a serious condition, and it is deemed not a health risk, it can be approved. If it is an unapproved product for treatment of a serious illness for which treatment is unavailable domestically, not for commercial sale, and not deemed to pose an unreasonable risk, and the patient can document that a physician is responsible for the patient's care, it may be approvable. These provisions were prompted by the concerns for patients with acquired immunodeficiency syndrome who were willing to assume the greater risk of non-FDA-approved drugs to treat their often fatal condition.

Commercial importation or reimportation of drugs into the United States is illegal without FDA approval. The Medicine Equity and Drug Safety Act of 2000 permits reimportation of drugs manufactured in the United States back into this country. Before the law can go into effect, however, it needs the approval of the U.S. Health and Human Services Secretary. So far, approval has not been given. The concern is that when a drug is out of the United States it is no longer subject to U.S. laws, and its composition cannot be guaranteed. Although most foreign governments have departments that regulate drugs sold to their own populations, many do not regulate businesses that market drugs to countries beyond their borders. There is a valid concern that for drug entities imported from various sources, assembled into a dosage form in one country, and then sold in another, there would be no

way to ensure the purity, safety, efficacy, or proper labeling of the result.

Agents from the FDA may cooperate with the U.S. Customs Service to enforce the Federal Food, Drug and Cosmetics Act with respect to medications that are carried or mailed into the United States. In a pilot survey program, hundreds of packages containing drugs were detained. Some of these packages failed to declare medications properly, which could result in Customs penalties. If the recipient cannot show the FDA that the shipment is in response to valid prescriptions or letters of instruction from a physician, drugs can be destroyed or returned to their source.

There are examples of seized drugs that were previously banned from the United States for safety concerns being illegally imported into the United States. In some cases, labeling for the imported drugs fails to mention offending agents contained in the container. Drugs that are outright counterfeits have been discovered. Control over the manufacturing of imported products is unknown, and they are sometimes contaminated with bacteria or other "filth." In some cases, drugs that are older than their expiration date are received, resulting in subtherapeutic blood concentrations or, in worst cases, toxicity from a degraded drug.

The cost savings of using drugs from foreign sources can be substantial, however. A prescription that may cost more than \$100 to fill in the United States may be available from Canada for less than half that amount and may be available from India for pennies per dose. Mexico is also a source for low-cost medicines. In many cases, these foreign drugs are just as effective as the more expensive versions available in the United States. For patients taking lifesaving medications and who have no insurance or have a fixed or low income, their choice may be between no medication or cheaper imported drugs. Programs have been developed for physicians licensed to practice in the United States and Canada to write prescriptions for busloads of patients who get their prescriptions filled in Canada and then return to the United States. The more recent decline in the value of the dollar has reduced some of these savings; nevertheless, there are still considerable savings in buying outside the United States. In other cases, "store-front" pharmacies have opened that receive prescriptions in various cities in the United States, fax them to Canadian pharmacies for filling, and then deliver the medications to the patients by mail. The FDA has judged the latter operations to be illegal commercial importers and has moved to shut them down.

Noncompliance

A subject of current interest regarding directions on prescriptions is patient compliance or, more accurately, noncompliance. Twenty-five percent to 60% of all patients fail to take medications as intended by their physicians. Noncompliance includes such practices as improper or inappropriate timing of doses or premature discontinuation of the medication. The many possible reasons for patient noncompliance may involve a lack of knowledge or understanding of the drug or the purpose for which it was prescribed, misinformation from nonmedical sources, negative patient attitudes toward illness or "taking drugs," development of an adverse effect, economic factors, or inadequate communication (instruction and emphasis) by the practitioner.

Patient compliance is probably improved when the prescriber explains the condition for which the patient is being treated, what the alternative treatment regimens are, and the anticipated benefits of the selected drug treatment.¹³ After the drug therapy is selected, patients should be informed of the name of the drug and, in layman's terms, its therapeutic purpose. This information helps the patient recognize the importance of each prescription. Specific instructions on drug

use should include how and when to take the medication, how much to take, and when to expect the benefits. The patient should also be made aware of possible adverse reactions and side effects. Some side effects such as drowsiness may be disturbing and interfere to an extent with daily living, but do not require discontinuation of therapy. Other adverse reactions, such as acute allergic reactions, require immediate discontinuation of therapy. Finally, drug and food interactions should be mentioned. The patient should be given an opportunity to ask questions or clarify the instructions.

A logical presentation of this information, as given in the preceding paragraph, improves instruction recall and understanding of the instructions.¹⁸ For patients on a strict budget, a discussion of drug costs may be important. Little is accomplished by prescribing a drug that the patient is unable or unwilling to buy. The patient should also be informed of what to do if a dose is missed and whether the drug should be taken immediately or at the next dosing interval. It is also useful to tell the patient about any special storage requirements, such as the need for keeping the drug refrigerated (emulsions) or at room temperature (syrups). Practitioners need to familiarize themselves with the instructions for use and storage of the medications they prescribe because these instructions can vary among dosage forms and preparations of the same drug entity.

Patient information sheets for numerous drugs, especially newly approved agents, are available online from the FDA.³⁰ These sheets may be downloaded and given to patients to help address many of the informational issues that can influence compliance.

The prescription enhances the physician-patient relationship and contributes to patient compliance if care is used in presenting it. Writing a prescription in English and in the patient's presence and then explaining it, in addition to improving compliance, may equip the patient to detect any errors that may occur in prescribing or filling the prescription.

Because few patients are able to recall oral instructions accurately, the labeled directions should be specific. Failure to be specific can provide the basis for malpractice lawsuits. If the patient has many prescriptions or has a special difficulty with oral instructions, a written reminder should accompany the prescription.

Patient compliance may also be improved by selecting drugs that need to be taken only once or twice daily instead of agents that have to be administered more frequently. When multiple drug therapy is necessary, combination products, when appropriate, are helpful in reducing the "confusion over pill profusion," as is prescribing drugs with distinctive physical characteristics (e.g., a red tablet, a white tablet, and a capsule instead of three white tablets).

Prescription Format and Pad Forms

Prescriptions should be written concisely, accurately, and legibly. Ink, indelible pencil, or typing is required for prescriptions for Schedule II drugs and is preferable for all prescriptions. Use of "gel" pens to write prescriptions to prevent washing away of the original prescription information is recommended because gel pen ink is absorbed into a paper's fibers and resists its removal by chemical solvents. These pens are widely available. With the advent of safe and effective drugs, consumer education, and the concept of informed consent, the need for therapeutic mysticism of an illegible prescription written in a foreign language (e.g., medical Latin) no longer exists. Similarity between the names of some highly active and potentially toxic drugs makes illegibility all the more indefensible.

Prescription pads should also be kept secured in a locked drawer or under similar cover when not in use to avoid loss or theft. Inventories of prescription pads and drug stocks

should be performed regularly to detect theft and diversion of prescription forms and drugs. Sequentially numbered prescription blanks make detection of diversion easier. If theft of a prescription pad is suspected, such loss should be reported to the local pharmacies or state board or drug control agency. In addition, for good dental practice and for medicolegal reasons, a duplicate of each prescription or a record thereof should be kept in the patient's chart or record.

Blank printed prescription pads should not have the name of a pharmacy or pharmaceutical company imprinted anywhere on the form because such an implicit endorsement may direct the patient to a particular pharmacy or manufacturer's product. Similarly, phone, fax, or electronic prescriptions should be sent to the pharmacy of the patient's choice, not the practitioner's.

The U.S. Troop Readiness, Veterans' Care, Katrina Recovery, and Iraq Accountability Appropriations Act of 2007 now requires the use of tamper-resistant prescription forms for prescriptions for Medicaid patients. To be considered tamper-resistant, a prescription pad must contain industry-recognized features designed to prevent (1) unauthorized copying, (2) erasure or modification, and (3) counterfeiting of a completed or blank prescription form. The prescription should include a statement alerting the pharmacist of the tamper-resistant features and how the pharmacist can verify authenticity. The rule applies to all written and computer-generated prescriptions (OTC, Rx, and controlled) delivered to patients for which Medicaid reimbursement is expected.

Exceptions to the rules include (1) prescriptions phoned, faxed, or emailed from the prescriber to the pharmacy; (2) refills of written prescriptions presented to a pharmacy before the act was in force; (3) emergency fills on a noncompliant prescription form, for which a prescriber provides the pharmacy with a verbal, faxed, electronic, or compliant written prescription within 72 hours after the date on which the prescription was filled; and (4) prescriptions for certain specified institutions and clinical settings. The need for tamper-resistant prescription forms for non-Medicaid prescriptions varies on a state-by-state basis and needs to be determined for the dentist's the area of practice.

Figure 55-4 presents a typical preprinted prescription form used, with minor variations, by most practitioners.

Because of state laws permitting or, in some instances, mandating the substitution of a generic preparation for a proprietary drug unless specifically prohibited by the prescriber, the prescription form may have a feature to allow the clinician to indicate whether a substitution is permitted. Because no physical prescription is written for telephone orders, the practitioner must indicate verbally to the pharmacist whether substitution is permitted. Some states also permit the transmission of prescriptions by electronic means (e.g., fax or computer network). In some hospitals, prescriptions are generated by the patient information system and sent directly to the pharmacy. Pharmacists occasionally note prescriptions that make no sense for a particular patient. On review, these prescriptions generally were for agents or doses on the computer medication screen that were adjacent to the desired drugs.

Figure 55-5 presents three sample prescriptions. The first, for antibiotic prophylaxis before dental therapy, is written by nonproprietary name; the second, for postoperative pain relief, is written by proprietary name for the sake of convenience. In the latter case, the dosage is implicit in the particular formulation selected (e.g., Tylenol with Codeine No. 3: acetaminophen [Tylenol] 325 mg and codeine 30 mg, with the notation 3 indicating the 30-mg strength of codeine). The third prescription, for fluoride supplementation in a child (2 years old) living in a low-fluoride area, is one of the few instances in which long-term drug use is appropriate in clinical dentistry.

Dosage Calculations (Posology)

The dosage of a prescribed drug may vary according to several factors: the degree or severity of the condition for which it is being prescribed; the age, weight, sex, or temperament of the patient; the route, frequency, or timing of administration; concurrent medication; patient suggestibility (placebo effect), habits, sensitivities, or previous medication history (hyperreaction or hyporeaction); and the systemic health of the patient. Important changes in clearance or volume of distribution can produce changes in expected half-lives of drugs. Because drug metabolism and elimination are primarily accomplished by the liver and kidneys, any significant change in the function of these organs may necessitate a change in dosing. For the fluoride prescription in Figure 55-5, the age

John R. Brown, D.M.D. 123 Main St. Metropolis, N.J. Phone: 625-7846	
For _____	Age _____
_____	Date _____
Rx	
Substitution	
<input type="checkbox"/> permitted	
<input type="checkbox"/> not permitted	
Refill 0 1 2 3	Signature _____
	DEA # _____

FIGURE 55-4 Typical prescription form.

<p>R Amoxicillin 500 mg Dispense 4 capsules Sig: Take 4 capsules with water 1 hour before dental appointment.</p> <p>Substitution <input type="checkbox"/> permitted <input type="checkbox"/> not permitted</p> <p>Refill X X 2 X</p>	<p>_____</p> <p>Signature</p> <p>DEA# _____</p>
<p>R Tylenol with Codeine #3 Dispense twenty-four (24) tablets Sig: Take 2 tablets every 4 hours as needed for relief of pain.</p> <p>Substitution <input checked="" type="checkbox"/> permitted <input type="checkbox"/> not permitted</p> <p>Refill 0 X X X</p>	<p>_____</p> <p>Signature</p> <p>DEA# <u>AB1234567</u></p>
<p>R Sodium fluoride oral solution 0.5 mg fluoride/1 ml Dispense 50 mL Sig: Give one-half dropperful (0.5 ml) once daily.</p> <p>Substitution <input type="checkbox"/> permitted <input type="checkbox"/> not permitted</p> <p>Label <input checked="" type="checkbox"/> Refill X X X 3</p>	<p>_____</p> <p>Signature</p> <p>DEA# _____</p>

FIGURE 55-5 Sample prescriptions. The top and bottom prescriptions are by nonproprietary name. The middle prescription, for a combination product, is written by trade name for convenience (generic substitution is permitted).

of the patient and the amount of fluoride in the water supply are the primary determinants of the dosage.

The manufacturer's package insert, pharmacology texts, and the compendial sources mentioned earlier in this chapter and in Chapter 3 list the official, average, or usual 150-lb adult dose for a drug. A listed dose or dosage range is a guide for prescription purposes, and although it does not carry the weight of a regulation, it does have medicolegal implications if an adverse effect occurs. Practitioners are well advised to stay within the recommended dosage range unless they have a sound reason to vary from it (see later).

No uniform format is used in references to express dosing information. For most drugs, the dose is reported as the amount of drug to be given at a single dose, which is repeated at a stated interval each day. Alternatively, the manufacturer may indicate the total amount of drug to be administered "in divided doses" per day. The practitioner is expected to know what dosage forms are available and how often to give them on the basis of the pharmacokinetics of the drug and the nature of the patient (these can be found

in an appropriate reference or drug database). For dosage determination, an "adult" is usually interpreted to mean an individual 18 years old or older and weighing approximately 70 kg (150 lb).

Children and many underweight, diseased, or elderly patients require a dosage of pharmacologically active agent that is lower than that suggested for a normal adult. Very large or obese patients may require dosage adjustment,⁷ but this adjustment can depend on the characteristics of each drug; with some drugs (e.g., gentamicin), the increased dosage can increase the risk of toxicity.¹⁷ Patient pharmacogenomics can also be a factor, such as a patient who is a CYP2D6 poor or ultra metabolizer.

Several rules have been proposed for computing the dosage of a drug for children, as follows:

1. Clark's rule,

$$\frac{\text{child's weight (lb [or kg])}}{150 \text{ lb (or 70 kg)}} \times \text{adult dose} = \text{child's dose}$$

determines the dose suitable for a child based on the typical adult weight of 150 lb (or 70 kg).

2. Young's rule,

$$\frac{\text{child's age (yr)}}{\text{child's age} + 12 \text{ (yr)}} \times \text{adult dose} = \text{child's dose}$$

calculates the dose for the child based on age, with a 12-year-old receiving half the adult dose.

3. Surface area, extrapolated from the patient's height and weight, is divided by the average adult surface area to determine the fraction of the adult dose. This method is seldom used in dentistry. Dosage tables or graphs (Figure 55-6) are available, which obviates time-consuming and error-prone calculations.

Of all these methods, Clark's rule is the most widely used, and Young's rule is the most subject to error. Because physiologic functions dealing with drug disposition are generally proportional to body surface area, the surface area method is probably the most accurate of the three. This distinction is dubious, however, because drug responses in children, especially very young children, are modified by factors other than body size (see Chapter 3). When dosage information is unavailable, and one of these methods has to be used to esti-

mate the child dose, it is important to monitor the patient carefully to ensure that therapeutic effects are obtained, and toxic reactions are minimized.

Weights and Measures

Two systems of designating weights and measures of drugs and preparations are the apothecary and the metric systems. Although the older apothecary measures may still be used by some clinicians for some drugs, the metric system is now standard. Roman numerals are generally used with the apothecary system, and Arabic numbers are used with the metric system. The grain is the unit of weight, and the minim is the unit of liquid measure (volume) in the apothecary system. There are 480 grains in 1 ounce and 480 minims in a fluid ounce. In the metric system, the gram is the unit of mass, and the liter is the unit of volume. Approximate equivalents between the two systems are given in Table 55-3. Apothecary measures are not equivalent to measures used for commercial purposes in the United States, which use the avoirdupois system. Although the grain is the same in avoirdupois, the ounce is 437.5 grains, and there are 16 ounces to the pound in avoirdupois.

Household measures are commonly encountered when liquid preparations are prescribed. If the directions call for the patient to take a certain volume of drug solution, the phar-

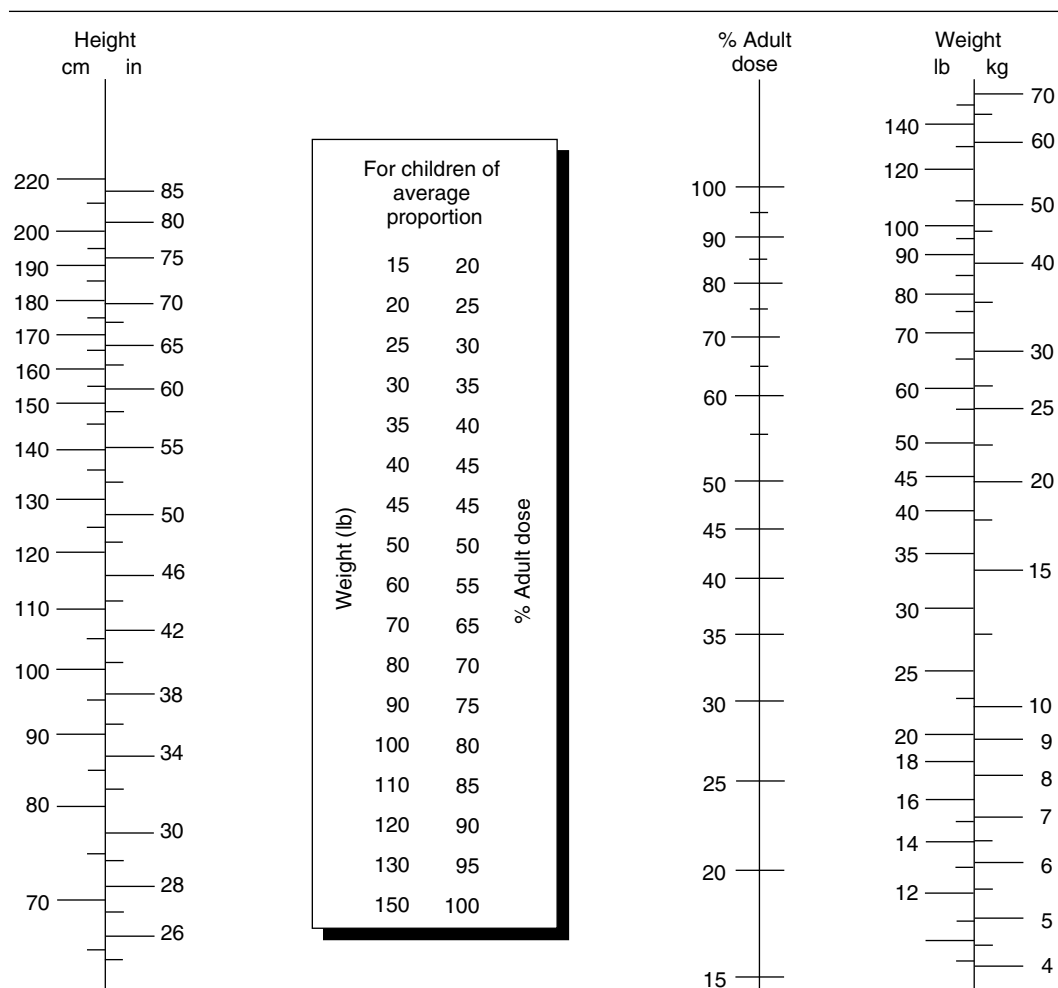

FIGURE 55-6 Nomogram for estimating dose based on surface area. A value of 1.73 m² is used as the adult surface area standard. The intersection of a *straight line* connecting the patient's height and weight with the dosage column indicates the correct percentage of the adult dose. A simplified table for children of normal height and weight is also provided.

TABLE 55-3

Approximate Apothecary and Metric Equivalents

APOTHECARY	METRIC
Weight	
$\frac{1}{65}$ grain	1 mg
1 grain	65 mg
15 grains	1 g
1 dram	4 g
1 ounce	30 g
Volume	
1 minim	0.06 mL
16 minims	1 mL
1 fluid dram	4 mL
1 fluid ounce	30 mL
1 pint	480 mL

TABLE 55-4

Metric Equivalents of Common Household Measures

HOUSEHOLD MEASURE	METRIC VOLUME
1 USP drop	0.05 mL
1 teaspoon	5 mL
1 tablespoon	15 mL
1 teacup	120 mL
1 glass	240 mL
1 pint	480 mL

macist converts the metric value given into its household equivalent, as indicated in Table 55-4. Utensils likely to be used by patients may yield different volumes of medicine than were initially intended. To circumvent this problem, many commercial products are provided with calibrated measuring devices; patients should be encouraged to use these when taking their medications.

Calculating the appropriate patient dose, calculating the amount of drug product needed to achieve this dose, expressing the dose in a household measure, and calculating the total amount of the drug to be dispensed by the pharmacist are common calculations performed in the practice of dentistry. Such calculations are required when prescribing an antibiotic suspension for a child. Although the mathematics is simple, teaching experience indicates that 40% of students are unable to perform calculations correctly on examination. The 1999 Institute of Medicine report on medical error noted that dosing errors are frequently made in children's dosing.¹⁸ Students should practice performing such calculations, and any time drug doses are calculated for a patient they should be double-checked for accuracy.

DRUG LAWS

Various federal, state, and local laws have been enacted to control the manufacture, sale, and dispensing of drugs. To comply with these regulations, the clinician should be aware that the most stringent of these laws takes precedence, whether it is federal, state, or local. A summary of federal laws that affect dental prescribing is provided in Table 55-1.

Historical Development of Drug Legislation

A major concern of nations has always been the establishment of criteria for drug identity and purity; to this end, the development of pharmacopeias has proved invaluable. A pharmacopeia is a written description of the source, identification, and preparation of medicinal agents. The first pharmacopeia to gain legal status was one adopted by the city-state of Nuremberg in the early sixteenth century.

The first USP was published in 1820 by a group of physicians, pharmacists, and chemists. This first United States Pharmacopeial Convention established certain policies—notably that only drugs of proven merit would be included in the USP and that regular revisions of the document would be issued. The USP published in 2009 is the thirty-second edition. Because most multiple drug entities and various commonly prescribed remedies were excluded from the USP, the need remained for a compendium for standardization of these medicinals. In 1888, the American Pharmaceutical Association began to publish the *National Formulary of Unofficial Preparations*. In 1975, the National Formulary was merged into the USP, and it is in its twenty-seventh edition.

Around the turn of the twentieth century, a growing public clamor over the quality, purity, and safety of food and drug products led to the passage of the Federal Food and Drugs Act of 1906, also known as the Pure Food and Drug Act.²⁶ In this legislation, the USP and National Formulary were given legal status regarding defining the purity and quality of drugs. Standards were also established for the labeling of medicinal products. In the years that followed, these standards were extended by court decisions and congressional actions to cover promotional materials in addition to the products themselves.

Before 1937, the testing of drugs and ingredients used in the preparation of medications was unnecessary before marketing. In 1937, a relatively new solvent, diethylene glycol, was used in an "elixir of sulfonamide." This agent caused the death of many children and was responsible for the swift passage of the Federal Food, Drug and Cosmetic Act of 1938.²⁷ This act required manufacturers to provide the FDA with evidence of drug safety in the form of an NDA before distributing the agent. The Act of 1938 also introduced the principle of separating drugs into prescription and nonprescription categories by requiring companies selling OTC drugs to furnish purchasers with the information necessary for their safe and effective use. Questions concerning which drugs could be sold OTC and which had to be reserved for prescription use were not resolved, however, until passage of the Durham-Humphrey Amendment in 1951 (discussed subsequently).

In response to the thalidomide tragedy in Europe, Congress passed the Kefauver-Harris Amendments of 1962. These amendments to the 1938 Act required manufacturers of new drugs to follow set standards of animal and human pharmacologic and toxicologic testing, with the data from each step to be reviewed by the FDA. Requirements for evaluating safety and studying chronic and fetal toxicity and efficacy (omissions of the 1938 Act) were included in this legislation.

Two federal laws controlling prescription drugs are the Durham-Humphrey Amendment (Section 503B) of 1951 to the Food, Drug and Cosmetic Act of 1938 and the Comprehensive Drug Abuse Prevention and Control Act (Controlled Substances Act) of 1970. The Durham-Humphrey law prohibited the dispensing of certain kinds of drugs (e.g., systemic antibiotics and corticosteroids and other agents whose unsupervised use may be unsafe) except on the prescription order of a licensed practitioner. Under this law, a prescription for these drugs may not be refilled unless authorized by the prescriber.

The FDA has the responsibility for determining how a drug may be dispensed. The FDA is also responsible for reviewing the labeling and advertising of the use of prescription and OTC drugs. This review, based on documented clinical studies, limits the labeled indications and uses of the product, but it does not limit the right of practitioners to use the drug only in these situations because such action would represent interference with the practice of medicine, which the 1938 Act enjoined the FDA from ever doing. The practitioner can be liable, however, under civil law for mishaps that occur with “off-label” uses of a drug. Several drug sources, including the American Hospital Formulary Service Drug Information, provides prescribing information for off-label uses generally recognized as valid indications.

In 2006, the FDA incorporated new conventions in the formatting of the drug labeling for the “package insert” information.²² The labeling now includes a half page summary of major points at the beginning of the labeling. The new labeling also makes provisions for electronic hot links between the summary and full discussion in the label. “Black box” warnings indicate adverse effects with particularly serious consequences that are featured prominently at the top of the drug labeling. The new labels are being phased in between 2006 and 2111.

In the 1980s, the high cost of drugs became the subject of congressional legislation. Substantive changes in drug substitution laws, simplified approval of generic drugs, and Medicaid drug reimbursement controls were introduced in attempts to curtail explosive drug costs. One component of the increased cost stems from the development of new drug entities. Because of the complexity of the approval process, much of the patent protection for a drug can expire before a drug is ever marketed. To recover their investments, manufacturers charge high prices for new drugs, contributing to the upsurge in medical costs. To blunt this trend, the Drug Price Competition and Patent Term Restoration Act of 1984 (Waxman-Hatch Act) was passed. It extended marketing protection for innovator drugs. An innovator product is an original, newly developed drug that requires an approved NDA for marketing; a synonym is New Molecular Entity (NME).

Under the Waxman-Hatch Act, innovator drugs may be given extensions on their patent protection. The law also simplified the process of obtaining an Abbreviated NDA for approval to market generic drugs to help reduce overall drug costs of known agents. In conjunction with the Orphan Drug Amendment of 1983, this law also made provisions for the development of “orphan drugs”—drugs used for rare diseases. In general, it is not economically feasible to produce these drugs for the small groups of patients (often <200,000) who need them. Exclusive rights can be granted under this law for production and marketing of a drug or for specific labeling to permit the use of a drug in a rare disease. No price restrictions are placed on drugs developed under the Orphan Drug Act, and these treatments can be expensive.

Drug companies have taken an interest in “discovering” new uses of known drugs in small population groups. The drug thalidomide, which was withdrawn from the market when it produced the severe birth defect phocomelia, has been rereleased for use in treating leprosy and aphthous ulcers seen in human immunodeficiency virus and Behçet’s disease based on data indicating that it inhibits tumor necrosis factor- α production. Because of advances in understanding of the human genome and the development of diagnostic gene chips, more populations of disorders are expected to fit within the Orphan Drug Act. For the years 2004-2007, the FDA averaged 12 New Molecular Entity NDAs, two Biological License Applications, six orphan drug NDAs, and 103 labeling updates per year.²⁴ Although relatively few novel new drugs are approved, there are numerous changes in the labeling for

existing entities (changes include new indications, dosage forms, or new warnings).

The 1984 Waxman-Hatch Act led to a surge of Abbreviated NDAs by generic manufacturers, and FDA personnel became overloaded with work. In an attempt to speed up the processing of their applications, several generic drug manufacturers bribed FDA officials for quick approval, and others submitted samples of the innovator drug as examples of their own product.¹¹ Other problems that have occurred include the selling of counterfeit drugs and physician drug samples to pharmacists at below-market prices. Their use may lead to therapeutic failure. To discourage these practices, the Generic Drug Debarment Act of 1991 and the Food, Drug, Cosmetic and Device Enforcement Amendment of 1991 were passed to increase substantially the penalties for such activities.

The 1990s represented a revolutionary period for drug regulation. Lawsuits and legal challenges of FDA actions led to substantial changes in the regulation of dietary supplements, natural product drugs, and complementary and alternative medications. In 1994, Congress passed the Dietary Supplements and Health Education Act, which allows numerous agents with pharmaceutical activity to be identified as dietary supplements. In addition, international trade agreements such as NAFTA and GATT necessitated the development of harmonization agreements between member countries by the International Conference on Harmonization. Harmonization seeks to unify pharmacopeias and laws related to the international pharmaceutical trade. Outside these agreements, there are additional trade agreements, such as those associated with normalization of the United States’ relations with China.

These changes have led to increased availability of natural products from domestic and foreign sources. Natural products can have therapeutic potential, but also can complicate therapy by inducing unexpected toxic effects and drug interactions. One example is St. John’s wort, which has been found to produce an antidepressant effect. It can also induce hepatic drug metabolism, however, and decrease blood concentrations of other drugs, such as antiviral protease inhibitors. In addition, imported natural products are occasionally found to be adulterated with conventional drugs such as phenylbutazone or chlorthalidone. These findings underscore the need for complete patient medical histories, including questions on prescription drugs, OTC drugs, dietary supplements, alternative medicines, and drugs of abuse.

The 1992 Prescription Drug User Fee Act (PDUFA)³¹ authorized the FDA to charge pharmaceutical companies who are having their NDAs evaluated by the agency. This financial resource has enabled the FDA to double the rate of approval of new drug entities. An increased number of postmarketing withdrawals of new drugs has also occurred. The 1997 FDA Modernization Act has modified the role of the FDA further. For dentists, a key provision allows manufacturers to disseminate information about nonlabeled or unapproved uses of drugs and medical devices. This provision may increase drug company interest in promoting off-label dental uses of medical drugs and promoting dosing of agents that were not studied in the original application.

Evidence-based medicine is a movement that seeks to base clinical practice on scientifically validated treatments. This trend has many benefits, but also some unintended consequences. Most controlled clinical drug trials are funded by drug manufacturers, who can influence clinical decision making by providing published clinical data. The experimental design and statistical analysis of the results of these comparisons can be influenced or performed by the drug developers,⁸ even though the actual studies are performed in universities or apparently independent laboratories. By a narrow selection of the study conditions and doses—and omis-

sion of other comparisons—biases can result. A review of treatments for hypertension provides a striking example. Although the manufacturers have shown that Ca⁺⁺ channel blockers, angiotensin-converting enzyme inhibitors, and α_1 -adrenergic blockers are effective compared with placebo medication, the ALLHAT study, a long-term, multicenter trial supported by the National Heart, Lung, and Blood Institute (NHLBI),¹⁰ approached the question of drug activity by comparing different classes of drugs used to initiate treatment for high blood pressure against each other. The ALLHAT study found that the older and less expensive diuretic treatment was as or more effective than the newer drugs in lowering blood pressure and preventing some forms of heart disease.¹⁴ Most published articles contain disclosure statements that reveal the role of various influences on the article; these should not be ignored.

A second source of bias can come from selective publication of drug trial results. The FDA has determined that studies of antidepressants with positive results were 12 times more likely to be published than studies of the same medications where the outcomes suggested questionable or no benefit.¹⁹ Because of this bias in publication, the drugs seem to be more effective than they would be if all of the available results were published. The ratio of manufacturer-sponsored trials to independent investigator studies may be 100:1, which makes it a challenge to find the independent studies. Knowledge of these practices should make practitioners wary of manufacturer claims and look for unbiased sources of evidence.

Although pharmaceutical companies are crucial for development of new therapeutic entities, they have sought to prolong the sales life of many legacy drugs through reformulation, including the marketing of congeners with minor chemical modification (“me too drugs”), prodrugs, active drug metabolites, isolated enantiomers, and specialized dosage forms (e.g., extended release, layered, combination). Although these adaptations can provide valuable therapeutic alternatives, they sometimes support only higher profit margins. Zolpidem was initially marketed as an agent that produced little next-day hangover. It has been reformulated as a controlled-release product for prolonged action, however, reducing the significance of the original claims.

Another area of more recent concern involves health care practitioners accepting gifts from drug manufacturers, such as sample drugs, food (including breakfasts and luncheons at drug company-sponsored seminars), and trips to meetings. These marketing efforts have been found to bias prescribing habits, usually to the disadvantage of patients. Even trivial gifts that include drug name logos have the potential to alter prescriber practice. These influences are pervasive in many universities and have stimulated efforts to develop appropriate behavioral guidelines for students, faculty, and residents.¹

Modern prescribing therapy is complicated by the relationships among the patient, physician, pharmacist, manufacturer, third-party payer, and government. Today, patients may rely on nontraditional payments for drug purchases. Group purchase plans may require copayments, the use of specific formularies, mail-order pharmacy services, and drug-use reviews. The practitioner who is informed about these processes is better able to elicit patient compliance and accomplish the therapeutic goal.

HIPAA also affects dental prescribers (see Table 55-1). This legislation is concerned with standardizing the process of third-party payment for medical treatment (requiring each practitioner to obtain an individual NPI number for use in insurance forms), but it has also substantially tightened the standards for confidentiality and privacy of patient information maintained in medical databases. As an unintended outcome, it has occasionally become more difficult for dentists to obtain medical information necessary to evaluate their

patients for prescribing purposes. The fines for violating these new rules can be substantial.

Although the federal government has set no standards concerning which prescription drugs a dentist may use clinically, many state laws regulating the practice of dentistry restrict drugs used to those associated with dental treatment. A typical law of this kind states that dentists can “diagnose, treat, operate, or prescribe for any disease, pain, injury, deficiency, deformity, or physical condition of the human teeth, alveolar process, gums, or jaws.”

The dispensing of drugs by physicians and dentists is a more recent development in the United States. The Federal Trade Commission has agreed to allow the sale of drugs by practitioners to their patients, and almost all states have recognized physician/dentist dispensing under strict regulatory requirements regarding storage, labeling, and record keeping. The ethical implications of this practice have been questioned on numerous grounds, including conflict of interest, lack of training and facilities for appropriate drug handling, and loss of the traditional practitioner-pharmacist double-checking of prescriptions.

Controlled Substance Laws

In addition to laws regulating drugs in general, special legislation has been enacted pertaining to drugs of abuse. A historical perspective of this legislation is given in Chapter 51. Control of the distribution of commonly abused drugs (e.g., opioids, barbiturates, and amphetamines) by the DEA is regulated by the Controlled Substances Act. This act divides drugs of abuse into five schedules based on the drugs’ potential for abuse, their medical usefulness, and the degree to which they may lead to physical or psychological dependence. The criteria for inclusion within the five schedules are presented in Table 55-5.

To prescribe controlled substances, the licensed practitioner must register with the DEA. Many of these regulations are administered by the DEA Office of Diversion Control.²¹ The registration must be renewed periodically, and the certificate of registration must be retained and displayed by the practitioner. When registered, the practitioner assumes several responsibilities, including keeping records of all controlled substances obtained, administered, dispensed, prescribed, lost, destroyed (DEA Form 106), or surrendered to the DEA (DEA form 41) and the secure storage of the drugs and prescription pads. To purchase Schedule II drugs, the practitioner must use the DEA 222C order form. Although Schedules III, IV, and V drugs may be obtained without special forms, a biennial inventory of all controlled substances on hand must be performed. This inventory must be kept for inspection and copying by officers for at least 2 years.

Schedule I drugs may not be prescribed. Schedule II drug prescriptions may not be refilled. Emergency, partially filled prescriptions must be completely filled within 72 hours. For patients in long-term care facilities or for patients with terminal illnesses, partial filling of Schedule II drugs may be permitted for 60 days after the date on the prescription. Multiple sequentially dated prescriptions for Schedule II drugs can be written for legitimate medical purposes to extend treatment to 90 days from the initial prescription’s inception.⁴ In many states, special prescription forms or restrictions are applied to Schedule II drugs. Controlled substances in Schedules III, IV, and V can be refilled five times within 6 months, assuming that the prescriber authorizes these refills. After the final permitted refill, a new prescription for the product must be obtained. Drugs in Schedule V, which consist of preparations containing limited quantities of certain opioid agents, may be sold without a prescription (if permitted by the state), assuming that the drug is dispensed by a pharmacist to a purchaser who is at least 18

TABLE 55-5

Classification of Controlled Substances

SCHEDULE	CRITERIA FOR INCLUSION	EXAMPLES OF DRUGS
I	High abuse potential, no currently accepted medical use, may lead to severe dependence	Research use only: heroin, lysergic acid diethylamide, marijuana, mescaline, methaqualone, peyote, psilocybin
II	High abuse potential, accepted medical use, may lead to severe dependence	Amphetamines, cocaine, codeine, dronabinol, meperidine, methadone, methylphenidate, morphine, oxycodone, pentobarbital, secobarbital
III	Abuse potential less than drugs in Schedules I or II, accepted medical use, moderate to low physical dependence liability, possibly high psychological dependence	Benzphetamine, butabarbital, methyprylon, mixtures of codeine or hydrocodone with aspirin or acetaminophen, stanozolol
IV	Abuse potential less than drugs in Schedule III, accepted medical use, low dependence liability	Chloral hydrate, diazepam, meprobamate, phenobarbital, propoxyphene, triazolam
V	Abuse potential less than drugs in Schedule IV, accepted medical use, limited dependence liability	Cough preparations containing codeine or similar opioid derivatives

years old and that a record of the transaction is kept by the pharmacist.

A pharmacist is permitted to fill oral prescriptions for any prescription drug except Schedule II products, provided that they are subsequently committed to writing and filed by the pharmacist. The law allows for the dispensing of verbal prescriptions for opioid and other Schedule II drugs in emergency situations, but the quantity must be limited to the amount needed for the emergency, the prescription must be put in writing by the pharmacist, and the prescriber must furnish the pharmacist with a signed, written prescription within 72 hours. Labeling of prescriptions for all controlled substances must contain the warning "Caution: Federal law prohibits the transfer of this drug to any person other than the patient for whom it was prescribed."

Small amounts of controlled substances in Schedules II through V may be imported or exported by U.S. citizens for their personal use if the following conditions are met: (1) the controlled substance is in its original container dispensed to the individual, and (2) the prescription is declared to the Customs Service stating that (a) the controlled substance is for his or her personal use or for an animal traveling with him or her, and (b) the trade name and schedule symbol are on the label or the name and address of the dispenser and the prescription number are on the label. In addition, the total of controlled substance dosage units cannot exceed 50.

Information and applications for registration may be obtained from the DEA, Office of Diversion Control, Registration Unit, PO Box 28083, Central Station, Washington, DC 20005; online at http://www.dea.gov/diversion.usdoj.gov/online_forms.htm; or from the DEA Regional Office in the area in which the applicant practices. The DEA has created a website²¹ that provides current information on registration and contacts and laws dealing with controlled substances. It is now possible to submit registration documents electronically to this website or to print out forms that can be mailed to the DEA for registration.

The DEA offers the following suggestions for writing prescriptions for controlled substances:

1. Keep prescription blanks in a safe place where they cannot be stolen easily. Minimize the number of prescription pads in use.
2. Write prescription orders for Schedule II drugs in ink or indelible pencil, or use a typewriter. They must be signed by the clinician. Prescribing controlled substances by telephone is discouraged unless the patient is familiar or the validity of the request can be substantiated.

3. Write out the actual amount prescribed, in addition to giving an Arabic number or roman numeral, to discourage the alteration of prescription orders.
4. Avoid writing prescription orders for large quantities of medications, especially controlled drugs, unless such quantities are necessary.
5. Maintain only a minimum stock of controlled drugs in the office.
6. Keep all controlled drugs under lock.
7. Be cautious when a patient says that another clinician has been prescribing a specific controlled drug product or claims that only one product works for him or her. Consult the clinician or the hospital records, or examine the patient thoroughly and decide independently whether the drug product should be prescribed.
8. Prescription blanks should be used only for writing prescription orders, not for notes or memos. A drug abuser could easily erase the message and use the blank to forge a prescription order.
9. Never sign prescription blanks in advance.
10. Maintain an accurate record of controlled drug products that have been dispensed or administered, as required by the Controlled Substances Act of 1970 and its regulations.
11. Assist the pharmacist who telephones in verifying information about a prescription order. A corresponding responsibility rests with the pharmacist who dispenses the prescribed medication.
12. Telephone the nearest office of the DEA to obtain or furnish information. Calls are held in the strictest confidence.

CITED REFERENCES

1. Brennan TA, Rothman DJ, Blank L, et al: Health industry practices that create conflicts of interest: a policy proposal for academic medical centers. *JAMA* 295:429-433, 2006.
2. Briggs GG, Freeman RK, Yaffe SJ: *Drugs in pregnancy and lactation: a reference guide to fetal and neonatal risk*, ed 7, Baltimore, 2005, Williams & Wilkins.
3. Centers for Medicare and Medicaid Services: *National provider identifier standard (NPI)*. Available at: <http://www.cms.hhs.gov/NationalProvIdentStand>. Accessed January 22, 2010.
4. Department of Justice: Drug Enforcement Administration 21 CFR Part 1306, Issuance of Multiple Prescriptions for Schedule II Controlled Substances. *Fed Reg* 72:64921-64930, 2007.

5. *Electronic orange book: approved drug products with therapeutic equivalence evaluations*. Available at: <http://www.fda.gov/cder/ob>. Accessed January 22, 2010.
6. *Food and Drug Administration Modernization Act of 1997*. Available at: <http://www.fda.gov/RegulatoryInformation/Legislation/FederalFoodDrugandCosmeticActFDCAAct/SignificantAmendmentsstotheFDCAAct/FDAMA/default.htm>. Accessed January 22, 2010.
7. Han PY, Duffull SB, Kirkpatrick CM, et al: Dosing in obesity: a simple solution to a big problem. *Clin Pharmacol Ther* 82:505-508, 2007.
8. Jankovic J, Watts RL, Martin W, et al: Transdermal rotigotine: double-blind, placebo-controlled trial in Parkinson disease. *Arch Neurol* 64:676-682, 2007.
9. Kohn L, Corrigan J, Donaldson M, editors: *To err is human: building a safer health system*, Washington, DC, 1999, Institute of Medicine, National Academy Press.
10. Levy D: Hypertension from Framingham to ALLHAT: translating clinical trials into practice. *Cleve Clin J Med* 74:672-678, 2007.
11. Major events during the generic drug investigations. *Am Pharm NS*30:38-39, 1990.
12. Meyer MC: Drug product selection, part 2: scientific basis of bioavailability and bioequivalence testing. *Am Pharm NS*31:47-52, 1991.
13. Morrow DG, Leirer VO, Andrassy JM, et al: Medication instruction design: younger and older adult schemas for taking medications. *Hum Factors* 38:556-573, 1996.
14. National Institutes of Health; National Heart, Lung, and Blood Institute: NHLBI study finds traditional diuretics better than newer medicines for treating hypertension. Available at: <http://www.nhlbi.nih.gov/new/press/02-12-17.htm>. Accessed January 22, 2010.
15. Parker RE, Martinez DR, Covington TR: Drug product selection, part 1: history and legal overview. *Am Pharm NS*31:72-79, 1991.
16. Parker RE, Martinez DR, Covington TR: Drug product selection, part 3: the Orange Book. *Am Pharm NS*31:47-56, 1991.
17. Salazar DE, Schentag JJ, Corcoran GB: Obesity as a risk factor in drug-induced organ injury, V: toxicokinetics of gentamicin in the obese overfed rat. *Drug Metab Dispos* 20:402-406, 1992.
18. Talley CR: Counseling patients about drug use. *Am J Hosp Pharm* 48:1196, 1991.
19. Turner EH, Matthews AM, Linardatos, E, et al: Selective publication of antidepressant trials and its influence on apparent efficacy. *N Engl J Med* 358:252-260, 2008.
20. U.S. Department of Health and Human Services: *Health information privacy*. Available at: <http://www.hhs.gov/ocr/privacy/index.html>. Accessed January 23, 2010.
21. U.S. Department of Justice, Drug Enforcement Administration, Office of Diversion Control: *Registration*. Available at: <http://www.deadiversion.usdoj.gov/drugreg/index.html>. Accessed January 23, 2010.
22. U.S. Food and Drug Administration: *An introduction to improved FDA prescription drug labeling*. Available at: <http://www.fda.gov/Training/ForHealthProfessionals/ucm090590.htm>. Accessed January 23, 2010.
23. U.S. Food and Drug Administration: *Buying prescription medicine online: a consumer safety guide*. Available at: <http://www.fda.gov/Drugs/ResourcesForYou/ucm080588.htm>. Accessed January 23, 2010.
24. U.S. Food and Drug Administration: *CDER drug and biologic approval reports*. Available at: <http://www.fda.gov/Drugs/DevelopmentApprovalProcess/HowDrugsareDevelopedandApproved/DrugandBiologicApprovalReports/default.htm>. Accessed January 23, 2010.
25. U.S. Food and Drug Administration: *Dietary Supplement Health and Education Act of 1994*. Available at: <http://www.fda.gov/RegulatoryInformation/Legislation/FederalFoodDrugandCosmeticActFDCAAct/SignificantAmendmentsstotheFDCAAct/ucm148003.htm>. Accessed January 23, 2010.
26. U.S. Food and Drug Administration: *Federal Food and Drugs Act of 1906 (The "Wiley Act")*. Available at: <http://www.fda.gov/opacom/laws/wileyact.htm>. Accessed January 23, 2010.
27. U.S. Food and Drug Administration: *Federal Food, Drug, and Cosmetic Act (FD&C Act)*. Available at: <http://www.fda.gov/RegulatoryInformation/Legislation/FederalFoodDrugandCosmeticActFDCAAct/default.htm>. Accessed January 23, 2010.
28. U.S. Food and Drug Administration: *Generic initiative for value and efficiency (GIVE) page*. Available at: <http://www.fda.gov/NewsEvents/Newsroom/PressAnnouncements/2007/ucm109001.htm>. Accessed January 23, 2010.
29. U.S. Food and Drug Administration: *Importing prescription drugs*. Available at: <http://www.fda.gov/Drugs/DrugSafety/ucm170594.htm>. Accessed January 23, 2010.
30. U.S. Food and Drug Administration: *Index to drug-specific information*. Available at: <http://www.fda.gov/Cder/drug/DrugSafety/DrugIndex.htm>. Accessed January 23, 2010.
31. U.S. Food and Drug Administration: *Prescription drug user fees act (PDUFA)*. Available at: <http://www.fda.gov/oc/pdufa>. Accessed January 23, 2010.
32. U.S. Food and Drug Administration: *Controlled Substances Act, Title 21—food and drugs, chapter 13: drug abuse prevention and control, subchapter 1: control and enforcement*. Available at: <http://www.fda.gov/RegulatoryInformation/Legislation/ucm148726.htm>. Accessed January 23, 2010.
33. U.S. Food and Drug Administration: *The Orphan Drug Act (as amended)*. Available at: <http://www.fda.gov/ForIndustry/DevelopingProductsforRareDiseasesConditions/overview/ucm119477.htm>. Accessed January 23, 2010.

Use of Herbs and Herbal Dietary Supplements in Dentistry

RICHARD P. COHAN AND MARK BLUMENTHAL

Alternative (integrative, complementary, natural, holistic) medicine is composed of a broad range of treatments that are often preventive in nature and commonly directed at treating the whole person rather than a specific disease. Substances used in alternative therapies are most often derived from natural sources. Many of these—particularly herbal medicines—have been used for more than 2000 years and are relied on by approximately 80% of the world's population in developing countries. Most people who use alternative care modalities do so because they are following traditions handed down from one generation to the next. What Western culture calls *alternative treatments* are in most cultures often the only available options for health care. Most such treatments have lacked rigorous scientific evidence of efficacy; however, there is a growing body of clinical research documenting the activity and utility of some of these regimens. The National Institutes of Health have designated such therapies as *complementary and alternative medicine (CAM)*. In contrast, Western medicine (sometimes referred to as *allopathic*) includes a diverse array of scientific, mostly evidence-based pharmacologic and surgical technologies, which, although described as “mainstream,” “conventional,” “orthodox,” or “traditional,” have been practiced for little more than a century. These treatments focus almost exclusively on eliminating disease.

The term *alternative medicine* is used in this chapter to indicate “interventions neither taught widely in medical schools nor generally available in hospitals.”¹⁰ This selection is not meant to exclude other terms. The increasingly popular term *integrative medicine* may be preferable because it stresses that these treatment protocols often can be effectively integrated with conventional medicine to optimize the health of the patient.

For decades in the United States and in some European countries, alternative medicine—and alternative (or holistic) dentistry—has implied care at the “fringe” of accepted medical (or dental) practice. There is an increasing trend now to incorporate many of these forms of care into the mainstream and include them as covered benefits in health insurance plans. Alternative medical therapies, depending on how they are defined (e.g., whether prayer is included as a CAM therapy) are used by an estimated 25% to 42% of the U.S. population.^{4,10,18} About 20% use natural products, including vitamins, minerals, herbs, and other dietary supplements. Table 56-1 lists the reasons why patients pursue CAM therapies. Visits to alternative care practitioners exceed visits to allopathic primary care physicians by more than 200 million annually, and Americans spend an estimated \$30 billion a year on these services plus \$18.8 billion on dietary supplements; most of these expenses are not reimbursed.¹⁰ In response to

these trends, most medical and some dental schools in the United States now provide at least introductory coursework in CAM.

A survey of 46,000 subscribers to *Consumer Reports* magazine found that 60% of individuals who used alternative therapies told their physicians they were doing so, and most physicians approved of (55%) or were neutral to (40%) their actions.¹⁶ One in four patients tried alternative therapies at the recommendation of a physician or nurse. Another national survey concluded that individuals who use alternative therapies are better educated but often less healthy than individuals who do not use them.³ These individuals are not dissatisfied with conventional medicine, but they find alternative therapies “more congruent with their own values, beliefs, and philosophical orientations toward health and life.”³ Although most people using herbal medicines do so in a manner consistent with evidence-based medicine, there is concern that “evidence-based information is not reaching the consumer” and that “health care professionals should proactively educate consumers.”⁵ This conclusion presumes that health care professionals themselves are first educated on the scientifically established benefits of botanicals. The health benefits of an increasing number of CAM treatments are being supported by published peer-reviewed research. One such study documented that healthy individuals who regularly consume one or more dietary supplements (e.g., vitamin C) may have superior health, increased longevity, or both compared with their peers.²⁰ Chiropractic and acupuncture for certain chronic and acute conditions have been accepted by the American Medical Association (AMA), which often is reserved in accepting new or unconventional treatment modalities. Most CAM therapies are not so endorsed because the AMA considers scientific evidence regarding their efficacy lacking or insufficient. The AMA does not endorse the sale of dietary supplements from physicians' offices based on concerns that the inventorying and sale of such products may inappropriately affect physicians' clinical judgments.

Although some authors claim that alternative medicine differs from allopathic medicine by virtue of treating the patient as a whole person rather than for the specific disease or collection of diseases, alternative therapies do offer disease-specific methods of care. CAM treatment modalities also constitute a more self-determined form of health care, especially because they are frequently integrated with nutritional and lifestyle modifications. This chapter focuses on natural pharmacologic and therapeutic agents—principally botanical (herbal) remedies—that constitute one of the alternative or integrative means of health maintenance and disease treatment.

TABLE 56-1

Reasons for Using Complementary and Alternative Medicine Therapies*

Thought CAM combined with conventional medicine would help	54.9%
Thought CAM would be interesting to try	50.1%
Thought conventional medicine would not help	27.7%
Conventional medicine professional suggested CAM	25.8%
Conventional medicine too expensive	13.2%

From Reference 4.

*Based on survey of 31,044 adults ≥ 18 years old from the U.S. civilian noninstitutionalized population.

CAM, Complementary and alternative medicine.

REGULATIONS AND QUALITY CONTROL

The growth of alternative therapies in the United States was spurred by the passage of the Dietary Supplement Health and Education Act (DSHEA) of 1994. This act greatly boosted the market for dietary supplements, including vitamins, minerals, and botanical remedies. Under DSHEA (Box 56-1), manufacturers could promote herbal products for the maintenance of health by using “structure/function” claims, such as the product “enhances the immune system” and “improves memory.” It also permits, but does not require, manufacturers to list product safety precautions. Clarification of DSHEA in 1998 allowed herbal product manufacturers and distributors to make some additional claims, primarily to suggest their use for modifying natural life events, including menopause, pregnancy, and aging.

Under DSHEA, dietary supplements, including herbal products, are legally classified as foods. They are exempted from the normal review process the U.S. Food and Drug Administration (FDA) requires for drugs. New drugs require extensive documentation of purity, safety, and efficacy before FDA approval is given. Dietary supplements require no prior approval, however, of the manufacturer’s claims. Nevertheless, the FDA can rely on third-party research to remove products from the market deemed to be unsafe. The FDA’s 2004 ban on the sale of ephedra (*Ephedra sinica*, ma-huang) was the first successful action taken by the FDA since DSHEA to remove a potentially dangerous herbal product from the marketplace.

DSHEA also requires that manufacturers must be able to substantiate, when challenged, all claims made either on the container or in the literature that accompanies the dietary supplement product. Such challenges can come from the FDA or from self-regulatory mechanisms, such as the industry-funded program of the National Advertising Division of the Better Business Bureau, wherein ad claims are being reviewed for accuracy, resulting in the revision of such claims where evidence may be lacking or, if the manufacturer does not comply, referral to the Federal Trade Commission for possible action. DSHEA also authorized the FDA to establish Good Manufacturing Practices (GMP) for dietary supplements. The final rule by the FDA regarding current good manufacturing practice for dietary supplements was published in June 2007, and companies are required to comply with all provisions in 1, 2, or 3 years, depending on whether the companies are large-sized, medium-sized, or small-sized. Standard testing remains an ongoing major challenge, however, in the herb and dietary supplement industries and in the analytic laboratory industry.

BOX 56-1

Important Components of the Dietary Supplement Health and Education Act**Definition of Dietary Supplement**

1. A product (other than tobacco) that
 - a. Contains one or more vitamins, minerals, herbs, amino acids
 - b. Is formulated in capsules, tablets, liquids, powders, soft gels
 - c. Is not a conventional food or sole item of a meal or diet
 - d. Is labeled as a dietary supplement

Safety of Dietary Supplements

1. FDA has burden of proof that the supplement is dangerous or constitutes a risk to public health
2. New dietary ingredients introduced into the market after October 15, 1994, must have safety data submitted to FDA for premarket acceptance

Supplement Claims and Labeling

1. Manufacturers can make nutrient content claims and claims on how dietary supplement affects structure or function of body
2. Manufacturer must have reasonable evidence/research supporting claims, but is normally not required to disclose it
3. FDA has burden of proof that claim is inadequately substantiated

Statement of Nutritional Support (on Label or in Advertising)

1. Permitted if a classic nutrient-deficiency benefit is claimed
2. Permitted if role of supplement is to affect structure or function of body
3. Can include documented mechanism of action
4. Can describe general well-being from consuming the ingredients
5. Must prominently display disclaimer that statements have not been evaluated by FDA and that product is not intended to treat, mitigate, cure, or prevent a disease

Supplement Ingredient Labeling and Nutrition Information

1. Must include the following (or would be considered misbranded and removed)
 - a. Commonly accepted name of each ingredient
 - b. Quantity of each ingredient
 - c. Total weight of ingredients
 - d. Part(s) of the plant from which ingredients is (are) derived
 - e. Term *dietary supplement*

Adapted from Israelsen LD: *Summary of the Dietary Supplement Health and Education Act of 1994. Quarterly review of natural medicine*, Seattle, WA, Spring 1995, Natural Product Research Consultants.

Because credibility is an increasingly important factor with consumers, some manufacturing companies of natural products, eager to gain and retain the public’s trust, voluntarily established relatively stringent GMP in advance of the final GMP rule published by the FDA for dietary supplements. The botanical product industry is represented by the American Herbal Products Association, the leading organization that works exclusively with herbal product manufacturers to enhance their quality and credibility. Several other trade associations also work with herbal manufacturers (e.g., Council for Responsible Nutrition, Natural Products Associa-

tion, and United Natural Products Alliance). These organizations work with their respective industry members and with the FDA to help promote quality manufacturing standards for herbal and other dietary supplements in cases in which such quality has been shown to be lacking.

For professionals and the lay public, ConsumerLab publishes results of random tests of CAM products on its website (www.consumerlab.com). Products approved by ConsumerLab are eligible to receive its "CL" seal of approval if the manufacturer wishes to pay for the privilege. Currently, approximately 7% of these approved products carry this seal, and the number of such products is expected to increase. The United States Pharmacopeia is also conducting GMP and product quality audits and is offering a seal in its Dietary Supplement Verification Program. Another nonprofit group, NSF International (the world's largest certifier of the purity of drinking water and water filters), also has a program to monitor supplement manufacturers' GMP adherence and product identity and quality.

In addition to a growing trend within the industry to improve quality control, efforts are being made to document the efficacy of natural products for disease prevention and therapy. U.S. investigators face special challenges regarding herbal and other natural products. Much of the existing scientific evidence is reported in languages other than English. The problems of product purity, standardization, and quality control that have plagued this sector are potential research confounders in the United States.

Herbal supplement claims allowed under DSHEA are sometimes based on limited scientific data and may contain no detailed information concerning the types and concentrations of known active ingredients in the preparations.³¹ Nevertheless, credible information is accumulating for certain herbal remedies. *Ginkgo biloba* does have antiplatelet effects and may have antioxidant properties; however, its suggested benefit in treating dementia and depression has yet to be reliably shown.⁶ Saw palmetto (*Serenoa repens*) has been documented to decrease symptoms associated with benign prostatic hyperplasia.^{7,12,30}

In industrialized nations, the German Commission E has been generally acknowledged as the leading regulatory model regarding the therapeutic actions of herbs. The German Commission E published 380 monographs in 1983-1995 based on extensive research. Its work has promoted product standardization, high manufacturing quality, and the acceptance and prescribing of herbal medicines (phytomedicines) by physicians in Germany, although the work of the Commission is now largely that of an advisory role to the German government,⁷ as the role of evaluating and approving herbal medicines is now being conducted on a pan-European basis by the European Medicines Evaluation Agency. In the United States, the National Center for Complementary and Alternative Medicine (NCCAM, a division of the National Institutes of Health) is charged with developing evidence-based research information on the full range of alternative therapies, including the use of herbal supplements, by funding a large battery of randomized controlled trials and basic research at more than a dozen research centers documenting the mechanisms of actions of these complex natural substances.

TYPES OF HERBAL DIETARY SUPPLEMENTS AND RELATED BOTANICAL PRODUCTS

Natural products of plants are marketed in unmodified forms, such as the whole leaf, bark, berry, or root; as powders in capsules and tablets; as herbal teas; and in various extracts and other derivatives. The recorded use of natural preparations for

their pharmacologic effects dates from at least 2735 BC, when a Chinese emperor recommended the use of ephedra (*Ephedra sinica*, which contains ephedrine and at least five other sympathomimetic agents) for a respiratory condition. Approximately 25% to 30% of prescription medications commonly used to treat diseases today are derived from natural sources. Examples include digoxin from the foxglove plant (*Digitalis purpurea* and *Digitalis lanata*, used to treat congestive heart failure) and quinidine from the cinchona plant (*Cinchona* species, used as an antiarrhythmic drug). Table 56-2 summarizes some common herbal remedies; their possible uses and indications; and their potential liabilities, including potential adverse drug interactions.

Most therapeutic products used as alternative therapies are the natural herb material or extracts of the herb. Water-based extracts include infusions (teas) and decoctions, whereas alcohol extracts are usually marketed as tinctures or other forms of extracts. An increasing number of products are combinations of herbs or mixtures of herbs and so-called nutraceuticals. *Nutraceuticals* are nutritional compounds—usually food extracts or their derivatives (e.g., the carotenoid lycopene derived from tomato)—promoted for use in a therapeutic way to treat or prevent specific problems or diseases. There is also an increasing trend to incorporate herbal derivatives into conventional products ranging from vitamin waters to shampoos to toothpastes (which have long relied on herbal essential oils, such as mint, for flavoring). A potential problem is the surreptitious adulteration of imported herbal products by the inclusion of conventional drugs. A few products have been identified, including the sale of so-called herbal supplements promoted for erectile dysfunction that contain pharmaceutical drug ingredients. Such products are not representative of most herbal dietary supplements sold by reputable manufacturers in the United States and are usually traced to foreign (usually Asian) sources.

Alternative therapies, especially herbs from which pharmacologic or therapeutic agents are derived, may be targeted toward the treatment of specific diseases, although the current regulatory system under DSHEA does not permit such claims for dietary supplements. There is usually some consensus regarding the specific disease for which a preparation is most appropriate. At the same time, there is a wide range of alternative practitioners, and many natural preparations have multiple uses, so when a patient reveals the use of a particular herbal product, the disease or condition being treated cannot always be predicted.

As previously mentioned, a prominent aspect of alternative therapy is the maintenance of health. The trend toward self-help encourages the use of many alternative preparations, which are considered safer than prescription drugs by the public because they are natural and usually less concentrated than conventional drugs. This assumption is often correct, but some substitute preparations (including the aforementioned adulterated product) may be just as or more harmful than the prescription drug, and injudicious use (especially combining the alternative product and the similar drug) can lead to untoward effects.

INTEGRATED HEALTH CARE AND DENTISTRY

Patient Evaluation

With all dental patients, it is essential to take a thorough health history. Various signs and symptoms may be revealed and diagnoses of specific diseases that may influence dental care. An important part of the health history is the solicitation of the patient's medication usage. All health history forms should specifically include questions regarding the patient's

TABLE 56-2
Pharmacologic Profiles of Common Herbal Products

HERBAL PRODUCT*	USES/EFFECTS	PRECAUTIONS/ADVERSE EFFECTS	DRUG INTERACTIONS
Aloe vera — <i>Aloe vera</i> (and related species); aloe, zanzibar	Topical anesthetic (gel). Soothes wounds and burns; accelerates wound healing. Latex form is a laxative	Topical use to abraded skin may cause burning sensation. Ingestion of latex derivative causes powerful catharsis by irritating the large intestine; may cause GI cramps and congenital malformation	Cathartic effect of latex form often hastens passage of oral medications, often inhibiting their absorption, and may potentiate anticoagulant therapy by reducing intestinal absorption of vitamin K
Asian ginseng — <i>Panax ginseng</i> ; Chinese ginseng	Adaptogen and immunomodulator. Fights fatigue; improves concentration and performance; enhances healing; generally increases ability to tolerate stress and recuperate. Principal male adaptogen in Chinese medicine	Inhibited blood clotting from effects on platelet adhesion and blood coagulation. May reduce blood glucose concentrations. A “ginseng abuse syndrome,” with diarrhea, hypertension, and nervousness, has been described, which may be linked to concomitant intake of caffeine and large doses of unknown “ginseng” preparations	May increase effect of hypoglycemic drugs, but promote diuretic resistance when combined with loop diuretics. May potentiate headache, tremors, and mania with MAO inhibitors and increase responses to caffeine. May potentiate bleeding with antiplatelet agents and anticoagulants (but may decrease effect of warfarin)
Astragalus — <i>Astragalus membranaceus</i> ; milk vetch, huang chi	Adaptogen and immunostimulant. Speeds metabolism	Subject to bacterial degradation when used as a component of denture adhesive. Mutagenic by the Ames test	May decrease effectiveness of immunosuppressants
Bilberry fruit — <i>Vaccinium myrtillus</i> ; huckleberry, European blueberry	Mild anti-inflammatory of mucous membranes. Slows cataracts, diabetic retinopathy; leaf used as a tea to treat diarrhea	Mild antiplatelet effects. May cause diarrhea in some individuals and should be discontinued if it persists for >3 days. Bilberry leaf is toxic and can cause hypoglycemia	Potentiation of antiplatelet and anticoagulant drugs. Effects may be inhibited by phenobarbital. Leaf may increase effect of hypoglycemic drugs
Cascara sagrada — <i>Rhamnus purshiana</i> ; buckthorn, sacred bark	Laxative/cathartic	K ⁺ may be lost, causing weakness and coagulation deficits	Cathartic-induced hypokalemia may potentiate or increase toxicity of muscle relaxants, antiarrhythmics, cardiac glycosides, and K ⁺ -depleting diuretics
Dong quai — <i>Angelica sinensis</i> ; Chinese angelica	Manage pain from injury, arthritis; improve circulation, treat allergic reactions. Principal female remedy in Chinese medicine for overcoming fatigue and treating gynecologic/menopausal symptoms	Excessive doses may cause hypotension and interfere with platelet activity	Increased hypotensive effects with antihypertensives and opioids. Potentiation of antiplatelet and anticoagulant drugs
Echinacea — <i>Echinacea purpurea</i> (and related species); purple cone flower	Immunomodulator. Boost immunity and treat symptoms of upper respiratory infections	Possible allergic reactions in individuals with ragweed and related allergies. Potential aggravation of autoimmune illness (e.g., lupus) and progressive diseases (HIV, tuberculosis)	Anti-inflammatory activity of herb can be inhibited by phenobarbital and other microsomal enzyme inducers. Potential adverse interactions with immunosuppressants (e.g., corticosteroids, cyclosporine)
Feverfew — <i>Tanacetum parthenium</i>	Antipyretic anti-inflammatory. Used for prophylaxis of migraine headache and to treat arthritis, premenstrual and menstrual discomfort, and fevers	Chewing fresh leaves or seeds may cause mouth irritation (swelling, ulcers), dysgeusia, nausea, vomiting, insomnia, and diarrhea. Discontinuation may cause postfeverfew syndrome of nervousness, tension headaches, insomnia, and joint discomfort. May cause abortion during pregnancy and interfere with platelet aggregation	Possible increased bleeding with concurrent use of antiplatelet and anticoagulant drugs

Garlic — <i>Allium sativum</i> ; allium, stinking rose	Used as digestive aid and to treat hypertension and as broad-spectrum topical antibiotic. May decrease LDL cholesterol and triglycerides and increase HDL cholesterol	Possible bleeding from inhibition of platelet aggregation and antithrombotic effects. Allergic reactions possible. Ingestion of large dose may cause burning sensation in mouth and throat. Theoretic risk of increased autoimmune reactions and organ transplant rejection	Possible increased bleeding with concurrent use of antiplatelet and anticoagulant drugs. Possible increased hypoglycemia in patients taking insulin
Ginger — <i>Zingiber officinale</i> ; black ginger, zingiberis rhizoma	Antibiotic, antioxidant, anti-inflammatory, and antiemetic. Used principally for prophylaxis of motion sickness and to treat digestive disorders, nausea, and vomiting (via local action on stomach receptors)	Possible bleeding from inhibition of platelet aggregation	Possible increased bleeding with concurrent use of antiplatelet and anticoagulant drugs
Ginkgo — <i>Ginkgo biloba</i> ; maidenhair tree	Leaf extract is used to improve cerebral and peripheral circulation, for enhanced concentration, memory, and hearing; amelioration of dementia; and relief of peripheral vascular disease	Possible bleeding from inhibition of platelet aggregation. Mild GI upset and headache, occasional nausea and vomiting	Possible increased bleeding with concurrent use of antiplatelet and anticoagulant drugs
Goldenseal — <i>Hydrastis canadensis</i> ; yellow root, orange root, Indian turmeric	Anti-inflammatory and broad-spectrum antimicrobial. Treats digestive and respiratory infections; promotes wound healing	Fresh plant or high doses may cause irritation to oral mucosa and GI distress	None documented
Kava-kava — <i>Piper methysticum</i> ; kava-kava	Anxiolytic, sedative-hypnotic. Used to treat anxiety, insomnia, and muscle tension	Local anesthetic action causes temporary mouth numbness. May rarely cause hepatotoxicity and liver failure. High doses may cause inebriation, with incoordination, ataxia, and drowsiness. Long-term use may cause reversible scaly skin rash	Summation of effects with benzodiazepines and other CNS depressants. High doses may increase dystonic reactions with antipsychotics and levodopa
Red yeast rice — <i>Monascus purpureus</i> ; ZhiTai	Antihypercholesterolemic. Blocks cholesterol synthesis and decreases total plasma cholesterol, LDL cholesterol, and triglycerides	Allergic reactions in individuals sensitive to yeast or rice	Inhibitors of CYP3A4 (e.g., erythromycin, ketoconazole) potentiate hepatic and skeletal muscle toxicity. Risk is also increased with coadministration of other lipid-lowering drugs (statins, fibrates, gemfibrozil, niacin). Oral anticoagulant effects are potentiated
Saw palmetto — <i>Serenoa repens</i> ; sabal	Treats benign prostatic hypertrophy. May inhibit dihydrotestosterone; may have antiestrogenic effects	May occasionally cause GI disturbances	Possible interaction with sex steroids
St. John's wort — <i>Hypericum perforatum</i> ; Klamath weed	Treats mild-moderate depression and anxiety. Anti-inflammatory in GI and respiratory tracts; eases menstrual cramps. Antiviral in large doses against enveloped viruses in vitro. Topical use as an antibacterial and anti-inflammatory analgesic for minor wounds and infections	Photosensitivity in rare cases, such as with high doses, prolonged treatment, and excessive sun exposure. Induces CYP3A4, CYP1A2, and several CYP2 enzymes in liver and GI tract. May cause drowsiness	Increased phototoxic/photoallergic reactions with tetracyclines, sulfonamides, and proton pump inhibitors. Summation effects with benzodiazepines, opioids, and other CNS depressants. Serotonergic crisis possible with meperidine, MAO inhibitors, and other antidepressants. Decreases plasma concentrations of protease inhibitors, cyclosporine, digoxin, and warfarin
Valerian — <i>Valeriana officinalis</i>	Sedative-hypnotic. Used to reduce anxiety, alleviate motor activity and muscle spasms, and promote sleep	Drowsiness	Summation of effects with benzodiazepines, sedative-hypnotics, and other CNS depressants

*Listed in order are the principal **common name**, *scientific name*, and other common names. Some of the uses described in this table have not been validated by well-controlled clinical studies; likewise, many of the adverse effects and drug interactions listed are either speculative or of potential concern but not proved to be clinically significant.

CNS, Central nervous system; GI, gastrointestinal; HDL, high-density lipoprotein; HIV, human immunodeficiency virus; LDL, low-density lipoprotein; MAO, monoamine oxidase.

use of alternative or natural therapeutic agents. Although some patients provide this information unsolicited under the “medication” question usually asked in health questionnaires, other patients do not for various reasons. One reason is that they may not believe or understand that their alternative therapy products are considered medications. They also may not feel comfortable telling a conventional health care provider that they are using alternative therapies for fear of disapproval. In either case, there is a much greater probability that they would provide the information if it is specifically solicited, such as by a question requesting the patient to list “natural remedies” being taken.

If a dental patient is taking any alternative product, the dentist should inquire about its identity and doses and whether the product is being used preventively or to treat specific problems. Various natural products potentially may influence dental therapy, but most commonly the dose is low enough, the patient is healthy enough, and the dental procedure is sufficiently minor that specific interactions between alternative medicines and dental procedures do not occur. Still, it is important to be aware of the potential interactions and, if necessary, to acquire reliable information to advise the patient whether consultation with the health care provider is necessary to determine if modification of the patient’s use of the

alternative therapy during prescription drug therapy is appropriate. Another aspect of obtaining an accurate alternative medicine health history is that the product and the patient’s reason for taking it provide information concerning the patient’s overall health. If a patient is taking coenzyme Q₁₀ (CoQ₁₀), it provides an opportunity to ask questions regarding the patient’s general health and whether signs or symptoms suggestive of cardiac or other problems have been experienced.

Modifications of Dental Treatment

Sometimes the use of alternative medicines by a dental patient requires modification of the treatment plan. Most commonly, before surgical procedures, modification involves stopping herbal remedies that inhibit hemostasis. As listed in Tables 56-2 and 56-3, numerous alternative products may potentially exert antiplatelet or anticoagulant activity, but chief among them are garlic and ginger. The practitioner should be aware that the food form of the herb may be just as potent as the supplement. Bleeding can pose a significant problem after major oral and maxillofacial surgery and be a nuisance during the performance of minor surgical procedures.² Hospitals and surgeons are increasingly requiring patients to stop taking specific herbal products for 2 weeks before surgery. Although

TABLE 56-3

*Potential Herbal and Other Dietary Supplement Drug Interactions in Dentistry**

DENTAL DRUG	HERBAL/NUTRACEUTICAL PRODUCT	EFFECT	RECOMMENDATION
NSAIDs	Bilberry fruit, bromelain, cat’s claw, coleus, cordyceps, devil’s claw, evening primrose, feverfew, fish oils, garlic, ginger, ginkgo, ginseng, grape seed, green tea, guggul, horse chestnut, licorice, prickly ash, red clover, reishi, S-adenosylmethionine, turmeric, vitamin E	Antihemostatic effects (primarily antiplatelet actions) may result in increased bleeding after surgical procedures for which NSAIDs are prescribed	Avoid aspirin; use other NSAIDs cautiously after procedures likely to cause postoperative bleeding
	Deglycyrrhizinated licorice	May reduce or prevent GI bleeding	Dissolve deglycyrrhizinated licorice sublingually 20-30 min before consuming NSAID [†]
Meperidine, tramadol	5-hydroxytryptophan, L-tryptophan, S-adenosylmethionine, St. John’s wort	Theoretic concern of serotonin syndrome	Avoid combined use
Benzodiazepines, barbiturates, opioids, other CNS depressants	Kava, melatonin, St. John’s wort, valerian, Astragalus, coleus, hawthorn, dong quai, garlic, parsley, sage	Increased CNS depression Postural hypotension more likely	Avoid combined use Protect patient against postural hypotension: change position slowly; avoid dehydration
Penicillin VK	Guar gum	Penicillin absorption inhibited	Avoid concurrent administration
Sulfamethoxazole-trimethoprim	p-Aminobenzoic acid	Competitive inhibition of antimicrobial effect	Avoid combination
Sulfamethoxazole-trimethoprim, tetracyclines	Dong quai (related species), St. John’s wort	Phototoxic/photoallergic reactions more likely	Avoid combination
Tetracyclines	Calcium, iron, magnesium, zinc salts	Decreased tetracycline absorption	Avoid concurrent administration
Antibiotics	Probiotic supplements [‡]	Possible decreased GI adverse effects	Administer probiotic 20-30 min before or 2-3 hr after antibiotic

*Many of the interactions noted in this table are speculative and theoretic and are lacking adequate clinical evidence in humans. For an evidence-based assessment of hundreds of herbs and their potential or actual interactions with conventional pharmaceutical medications, see Brinker F: *Herb contraindications and drug interactions*, ed 3, Sandy, OR, 2001, Eclectic Medical Publications. Electronic updates with new information not included in the book are available at: <http://www.eclecticherb.com/emp>. Accessed January 8, 2010.

[†]Some of the proposed interactions noted in this table are beneficial (e.g., the effect of sublingual licorice on reducing potential gastric irritation caused by oral administration of NSAIDs).

[‡]Preparations of normal gut flora used to help restore the normal microbial ecology disrupted by the antibiotic.
CNS, Central nervous system; GI, gastrointestinal; NSAIDs, nonsteroidal anti-inflammatory drugs.

this policy is undoubtedly excessive in most cases, the pervasive lack of knowledge concerning the identity, concentration, and pharmacokinetics of the active principles in most herbal products suggests that a restrictive policy is justified because of the risks and benefits involved. A second consideration regarding these herbal medicines is the possibility of postoperative bleeding if the dentist prescribes a nonsteroidal anti-inflammatory drug for postoperative pain relief (see Table 56-3). There is a potential for added risk of bleeding if a nonsteroidal anti-inflammatory drug, especially aspirin, is administered to a patient taking supplemental garlic or ginkgo.¹¹ The use of acetaminophen, opioids, or the cyclooxygenase-2-selective analgesic celecoxib may avoid this potential drug interaction.

Orthostatic hypotension may be more likely to occur in patients taking herbal products capable of decreasing arterial blood pressure. Such products include astragalus, dong quai, and sage. Patients taking these remedies—especially elderly patients, patients with cardiovascular disease, and patients fasting for sedation or anesthesia—should be monitored for hypotension. In addition, changes in body position (as in moving from the supine to the standing position) should be made slowly and with careful patient observation.

Several herbal agents, including kava and valerian, can cause sedation.²² Their combination with standard doses of prescribed anxiolytics and sedative-hypnotics may result in severe central nervous system depression. Conversely, long-term use of these agents may decrease responsiveness to benzodiazepines and related drugs. Meperidine and tramadol probably should be avoided in patients taking St. John's wort because of the agents' shared potential for increasing 5-hydroxytryptamine activity in the brain, possibly resulting in a serotonergic syndrome of restlessness, motor hyperactivity, and coma.

St. John's wort may interact with a diverse array of medications because of its ability to stimulate microsomal enzyme activity.^{15,17} Although increased drug metabolism is less of a problem in dentistry than it is in medicine, the increased first-pass metabolism of triazolam and related benzodiazepines may decrease benzodiazepine effectiveness when given by the oral route. Conversely, fresh garlic may significantly inhibit the first-pass effect, resulting in exaggerated triazolam effects.¹³

Herbal Therapies for Oral Conditions

An important area of interest for dentists, hygienists, and patients is the use of alternative remedies to manage dental and other oral problems. Agents listed in Table 56-2 that have antimicrobial, immunostimulant, and anti-inflammatory actions may be used systemically for various oral conditions. In addition, there is a growing range of natural and herbal products formulated for topical oral use, including numerous mouth rinses, toothpastes, and irrigating solutions. Herbal dental products typically include agents that may be classified as astringents, antimicrobials, anti-inflammatories, immunostimulants, circulation enhancers, tissue healers and soothers, and breath fresheners. Some of these natural agents are listed in Table 56-4.

Because of the importance of antiplaque/antigingivitis effects on gingival health and because of evidence suggesting antimicrobial effectiveness, numerous natural products for this use are now marketed. Most of these products contain essential oils and other herbal derivatives. Essential oils distilled from plants have been used for centuries as antimicrobials. Specifically, eugenol, thymol, carvacrol, and oil of cloves have a 200-year history of use in dental products. Essential oils are extracted from the glands, veins, sacs, and glandular hairs of aromatic plants. The essential oils are said to penetrate

the oral mucosa between cells and through lipids and salivary ducts, allowing for enhanced adherence and a longer lasting effect.²⁵

Few of the natural antigingivitis/antiplaque mouth rinses currently available have been scientifically evaluated. As previously mentioned, the quality of herbal extracts can vary greatly from one product to another. In addition, manufacturers may use a wide range of extraction processes,²⁸ which creates variability among products that are formulated with the same ingredients and for a similar purpose. Nevertheless, some herbal products contain antimicrobial substances similar in efficacy to chlorhexidine (the "gold standard" of periodontal maintenance therapy) without causing the tooth staining that commonly occurs with chlorhexidine.

Tinctures of chamomile and myrrh have an inhibitory effect in vitro on certain anaerobic microorganisms comparable to that of chlorhexidine.²¹ Derivatives from plants such as goldenseal, rhatany, and sage are also reported to exert anti-inflammatory, astringent, and antiseptic actions.^{27,29} Echinacea, gotu kola, and calendula are included in oral rinses to provide anti-inflammatory and tissue-regenerative properties. Goldenseal extracts contain variable quantities of berberine, hydrastine, canadine, and canadoline, one or more of which may be active against herpes labialis, mucositis, and gingivitis. These anti-inflammatory and antimicrobial benefits have been shown in cell culture and animal studies.^{1,23}

Currently, the Council on Scientific Affairs of the American Dental Association (ADA) has four categories of dental therapeutic agents (antiplaque/antigingivitis drugs, anticaries agents, antihypersensitivity agents, and tooth-whitening products), each with specific criteria for evaluating the safety and efficacy of over-the-counter dental products. The potential exists for natural or herbal ingredients to be incorporated in multiple products for use in all these areas. One example is xylitol (an anticaries agent), found in toothpastes, mints, and gum and adhesive products, among others. Another is an herbal-related product, Listerine, which has the ADA Seal of Acceptance for antiplaque/antigingivitis activity. Listerine contains the essential oils menthol, thymol, eucalyptol, and methyl salicylate (although these oils are no longer naturally derived). Numerous herbal dentifrices with antimicrobial effects have been marketed. Most have effects against one or more oral pathogens; however, in one study, most did not show consistent antimicrobial activity against all four of the oral microorganisms tested: *Streptococcus mutans*, *Streptococcus sanguis*, *Actinomyces viscosus*, and *Candida albicans*.²⁴

Kaim and coworkers¹⁹ compared, in vitro, the antimicrobial activities of Listerine, 0.12% chlorhexidine gluconate, and a mouth rinse (Herbal Mouth and Gum Therapy) containing *Echinacea*, goldenseal, and other natural ingredients. All three oral rinses were found to exhibit significant antimicrobial activity against the microorganisms tested. In a separate examiner-blinded, parallel-group clinical trial, the herbal mouth rinse was shown to reduce gingival bleeding compared with a control mouth rinse.²⁶ For patients who prefer natural remedies, products such as this mouth rinse may offer motivational, psychological, and self-care benefits along with some specific antiplaque/antigingivitis efficacy.

The potential for interactions between herbal supplements and conventional medications used in dentistry has been an increasing concern among practitioners as more consumers use more herbal products along with conventional medications. A *Prevention* magazine survey found adult consumers use herbal supplements with prescription drugs (31%) and with over-the-counter drugs (48%), suggesting an increased potential for herb-drug interactions (HDIs).¹⁸ Although there is a documented growth in the use of the herbal products with conventional medications, there has not

TABLE 56-4

Herbal Ingredients in Oral Health Care Products

HERBAL INGREDIENT	PRODUCTS	POSSIBLE USES AND EFFECTS
Aloe vera (<i>Aloe vera</i>)	Mouth rinse, toothpaste, lubricating gel, antiseptic gel	Anti-inflammatory, antiseptic, promotes healing of canker sores and wounds
Anise (<i>Pimpinella anisum</i>)	Mouth rinse, toothpaste	Breath freshener; may increase bleeding
Bloodroot (<i>Sanguinaria canadensis</i>)	Mouth rinse, toothpaste	Inhibits oral bacteria, used for gingivitis/periodontitis; may cause leukoplakia
Calendula (<i>Calendula officinalis</i>)	Mouth rinse, toothpaste	Anti-inflammatory, promotes wound healing
Carrageenan (from red seaweed)	Toothpaste, tooth gel	Stabilizer, thickener
Cinnamon (<i>Cinnamomum verum</i> and related species)	Mouth rinse, toothpaste	Breath freshener
Clove (<i>Eugenia caryophyllata</i>)*	Toothache balm, mouth rinse, toothpaste, temporary filling material	Anti-inflammatory, analgesic, antifungal; may cause increased bleeding
Eucalyptus (<i>Eucalyptus globulus</i>)	Mouth rinse, toothpaste	Antiseptic
Ginkgo (<i>Ginkgo biloba</i>)	Toothpaste	No use reported
Goldenseal (<i>Hydrastis canadensis</i>)	Mouth rinse, toothpaste, antiseptic gel, tooth gel	Immunostimulant, antibiotic, used for cold sores
Green tea (<i>Camellia sinensis</i>)	Toothpaste	Antiviral, cariostatic, antineoplastic, used for gingivitis/periodontitis; if swallowed may decrease absorption of basic drugs
Lemon balm (<i>Melissa officinalis</i>)	Antiseptic gel, lip balm	Antiherpetic; used to treat cold sores, nerve pain; may increase intraocular pressure
Licorice (<i>Glycyrrhiza glabra</i>)	Toothpaste, topical gel	Flavoring, antiherpetic, used to treat cold sores, canker sores
Myrrh (<i>Commiphora molmol</i>)	Mouth rinse, floss, tincture	Anti-inflammatory, anticandidal, breath freshener, astringent; used to promote healing and for gingivitis
Neem (<i>Azadirachta indica</i>)	Toothpaste	Antimicrobial, mild abrasive, plaque inhibitor
Peelu (<i>Salvadora persica</i>)	Toothpaste, natural toothbrush	Mild abrasive, antibacterial, hemostatic, breath freshener
Peppermint (<i>Mentha piperita</i>) [†]	Mouth rinse, oral gel, dental gum, breath freshener, antiseptic gel, temporary filling material	Antibacterial, breath freshener, used for gingivitis/periodontitis and externally for myalgia and neuralgia; peppermint oil can cause burning sensation; possible tongue spasm; respiratory arrest contraindicates use in young children
Prickly ash (<i>Zanthoxylum americanum</i>)	Mouth rinse	None reported (analgesic and promotes healing?)
Propolis (propolis balsam)	Toothpaste, flossing ribbon, in lysine gel	Analgesic, antibacterial, antifungal, mild anti-inflammatory, promotes healing
Spearmint (<i>Mentha spicata</i>) [‡]	Toothpaste	Breath freshener
Stevia (<i>Stevia rebaudiana</i>)	Dental gel, mouth rinse	Cariostatic sweetener, weak antimicrobial
Tea tree oil (<i>Melaleuca alternifolia</i>)	Mouth rinse, breath freshener, antiseptic (in lozenges, toothpicks)	Antibacterial, antifungal, antiviral; may cause irritation in sensitive individuals
Thyme (<i>Thymus vulgaris</i>)	Mouth rinse	Antiseptic, breath freshener
Vegetable glycerin (glycerol)	Toothpaste, antiseptic gel	Lubricant, soother, sweetener
Witch hazel (<i>Hamamelis virginiana</i>)	Mouth rinse (alcoholic extract)	Anti-inflammatory, soothing astringent (from alcoholic content), promotes wound healing; may cause stomach irritation if accidentally ingested
Xylitol (from birch tree bark)	Toothpaste, chewing gum	Cariostatic sweetener [§]

*Derivatives used in dentistry: eugenol, clove oil.

[†]Derivatives used in dentistry: menthol, peppermint oil.

[‡]Distillate used in dentistry: spearmint oil.

[§]Bacteria cannot metabolize xylitol, which is converted to glucose in the liver.

been a significant increase in reports of adverse HDIs associated with the growing herb use. Several more recent published reports support this lack of adverse HDIs.

In one 2007 report, researchers concluded that numerous potential adverse HDIs were detected and a few mild adverse interactions were observed, primarily in diabetics taking nopal (prickly pear cactus, *Opuntia* species) with oral hypoglycemic drugs. Screening for herbal medicine usage in 804 patients did not uncover any serious adverse interactions

with prescription medications.⁸ A Canadian study of 7652 cognitively functional elderly individuals found only 1.3% using combinations of prescription medicines and herbal products that are considered potentially dangerous. In this study, the low incidence of potentially dangerous interactions was credited by researchers to greater awareness of potential risks among consumers and physicians.⁹ About two thirds of adults consuming herbs (*Echinacea* was excluded) did not take the herbs according to evidence-based indications,

TABLE 56-5

Web-based Sources of Information on Herbal Medicine and Herbal Dietary Supplements

WEBSITE (ORGANIZATION)	COMMENTS
www.consumerlab.com (ConsumerLab)	Free quality ratings of herbal and nutraceutical products. Subscription includes access to <i>Natural Products Encyclopedia</i>
www.factsandcomparisons.com (Facts and Comparisons)	Access for subscription to <i>Review of Natural Products</i> and <i>Drug Interaction Facts: Herbal Supplements and Food</i> and for purchase of printed versions
www.herbalgram.org (American Botanical Council)	Membership access to various information sources, including <i>HerbClip</i> , a biweekly abstract service; <i>Herbalgram</i> , a bimonthly journal; <i>HerbMedPro</i> , an evidence-based herbal database; and the German Commission E monographs
www.herbmed.org (Alternative Medicine Foundation)	Subscription access to <i>HerbMedPro</i> and free access to <i>Herbmed</i> (75 herbal products) and <i>Resource Guides</i> on alternative medicine modalities, including herbal medicine
www.naturaldatabase.com (Therapeutic Research Center)	Subscription access to the <i>Natural Medicines Comprehensive Database</i> and purchase access to printed and handheld computer versions
www.naturalstandard.com (Natural Standard)	Free and expanded subscription access to the <i>Natural Standard</i> databases, which provide evidence-based information about alternative therapies, including herbal supplements
www.nccam.nih.gov (National Center for Complementary and Alternative Medicine)	General information on complementary and alternative medicines, listing of alerts and advisories, and research results

however.⁵ This finding points out the need for greater education of the public by health care professionals. A 2001 review concluded that many of the HDI reports found in the clinical literature up to that time were inadequately documented, preventing an appropriate evaluation of the clinical significance of many of these reports.¹⁴

In a 2008 survey of 1818 patients, 1795 responded, and 710 (40%) of respondents reported use of dietary supplements. A total of 107 interactions with potential clinical significance were identified. The five most common natural products with a potential for interaction (garlic, valerian, kava, ginkgo, and St John's wort) accounted for 68% of the potential clinically significant interactions. The four most common classes of prescription medications with a potential for interaction (antithrombotic medications, sedatives, antidepressants, and antidiabetic agents) accounted for 94% of the potential clinically significant interactions. No patient was seriously harmed from any interaction. The researchers concluded that a few prescription medications and dietary supplements accounted for most of the interactions. The actual potential for harm was deemed to be low.²⁷

SOURCES OF RELIABLE INFORMATION

As noted, the field of alternative medicine has grown quickly since 1994. This growth is expected to continue. Because the demand for information is coming from health professionals and laypersons, numerous resources have been developed for each audience. Textbooks such as this can present a brief overview of alternative medicine, but cannot provide in-depth information or remain current in such a rapidly developing discipline. Some published sources of information pertaining to herbal products are listed as general references. Table 56-5 contains a list of websites that provide access, often for a fee, to current, detailed information on alternative therapies, particularly herbs and dietary supplements. A dental professional wishing to keep abreast of this area may wish to subscribe to one of these sites. One website sponsored by NCCAM can be consulted free of charge for the latest information on research projects that the center is sponsoring.

CITED REFERENCES

- Amin AH, Subbaiah TV, Abbasi KM: Berberine sulfate: antimicrobial activity, bioassay, and mode of action. *Can J Microbiol* 15:1067-1076, 1969.
- Ang-Lee MK, Moss J, Yuan C-S: Herbal medicines and perioperative care. *JAMA* 286:208-216, 2001.
- Astin JA: Why patients use alternative medicine: results of a national study. *JAMA* 279:1548-1553, 1998.
- Barnes P, Powell-Griner E, McFann K, et al: *Complementary and alternative medicine use among adults: United States, 2002*, CDC Advance Data Report #343, 2004. Available at: <http://www.ncbi.nlm.nih.gov/pubmed/1518873>. Accessed January 8, 2010.
- Bardia, A, Nisly NL, Zimmerman MB, et al: Use of herbs among adults based one-based indications. *Mayo Clin Proc* 82:561-566, 2007.
- Birks J, Grimley EJ: Ginkgo biloba for cognitive impairment and dementia. *Cochrane Database Syst Rev* (1):CD003120, 2009.
- Blumenthal M, Busse WR, Goldberg A, et al, editors: *The complete German Commission E monographs: therapeutic guide to herbal medicines*, Austin, TX, 1998, American Botanical Council.
- Bush T, Rayburn K, Holloway S, et al: Adverse interactions between herbal and dietary substances and prescription medications: a clinical survey. *Altern Ther Health Med* 13:30-35, 2007.
- Edmundson A: Herb-drug interactions uncommon: study shows few people taking dangerous combos. *WebMD* 2006. Available at <http://webmd.com/heart-disease/news/20060525/herb-drug-interactions-uncommon>. Accessed January 23, 2010.
- Eisenberg DM, Davis RB, Ettner SL, et al: Trends in alternative medicine use in the United States, 1990-1997: results of a follow-up national survey. *JAMA* 280:1569-1575, 1998.
- Elmer GW, Lafferty WE, Tyree PT, et al: Potential interactions between complementary/alternative products and conventional medicines in a Medicare population. *Ann Pharmacother* 41:1617-1624, 2007.
- Ernst E: The risk-benefit profile of commonly used herbal therapies: ginkgo, St. John's wort, ginseng, echinacea, saw palmetto, and kava. *Ann Intern Med* 136:42-53, 2002.
- Foster BC, Foster MS, Vandenhoeck S, et al: An in vitro evaluation of human cytochrome P4503A4 and P-glycoprotein inhibition by garlic. *J Pharm Pharmacol Sci* 4:176-184, 2001.
- Fugh-Berman A, Ernst E: Herb-drug interactions: review and assessment of report reliability. *Br J Clin Pharmacol* 52:587-595, 2001.

15. Henderson L, Yue QY, Bergquist C, et al: St John's wort (*Hypericum perforatum*): drug interactions and clinical outcomes. *Br J Clin Pharmacol* 54:349-356, 2002.
16. Herbal Rx: the promises and pitfalls. *Consumer Reports* March 19:44-48, 1999.
17. Ioannidis C: Pharmacokinetic interactions between herbal remedies and medicinal drugs. *Xenobiotica* 32:451-478, 2002.
18. Johnston BA: *Prevention* magazine assesses use of dietary supplements. *HerbalGram* 48:65-72, 2000.
19. Kaim JM, Gultz J, Do L, et al: An in vitro investigation of the antimicrobial activity of an herbal mouthrinse. *J Clin Dent* 9:46-48, 1998.
20. Khaw K-T, Bingham S, Welch A, et al: Relation between plasma ascorbic acid and mortality in men and women in EPIC-Norfolk prospective study: a prospective population study. *Lancet* 357:657-663, 2001.
21. Kitagaki K: In vitro herbal inhibition of anaerobes. *Antibact Anti-fung Agents* 11:451, 1983.
22. Kuhn MA: Herbal remedies: drug-herb interactions. *Crit Care Nurse* 22:22-32, 2002.
23. Kuo CL, Chi CW, Liu TY: The anti-inflammatory potential of berberine in vitro and in vivo. *Cancer Lett* 203:127-137, 2004.
24. Lee SS, Zhang W, Li Y: The antimicrobial potential of 14 natural herbal dentifrices: result of an in vitro diffusion method study. *J Am Dent Assoc* 135:1133-1141, 2004.
25. Schechter B: Time-tested botanical remedies for modern periodontal therapy. *Dent Today* 17:110-115, 1998.
26. Scherer K, Gultz J, Lee SS, et al: The ability of an herbal mouthrinse to reduce gingival bleeding. *J Clin Dent* 9:97-100, 1998.
27. Sood A, Sood R, Brinker FJ, et al: Potential for interactions between dietary supplements and prescription medications. *Am J Med* 121:207-211, 2008.
28. Van der Weijden GA, Timmer CJ, Timmerman MF, et al: The effect of herbal extracts in an experimental mouthrinse on established plaque and gingivitis. *J Clin Periodontol* 25:399-403, 1998.
29. Willershausen B, Gruber I, Hamm G: The influence of herbal ingredients on the plaque index and bleeding tendency of the gingiva. *J Clin Dent* 2:75-78, 1991.
30. Wilt T, Ishani A, Stark G, et al: *Serenoa repens* for benign prostatic hyperplasia. *JAMA* 280:1604-1609, 1998.
31. Wyandt CM, Williamson JS: For physicians and pharmacists: a comprehensive overview of popular herbs, their pharmacologic activities and potential uses. In Saltmarsh N, Falcon M, Micozzi MS, et al, editors: *Physician's guide to alternative medicine*, Atlanta, GA, 1999, American Health Consultants.

GENERAL REFERENCES

- 2007 *Mosby's drug consult*, St Louis, 2007, Mosby.
- Barnes J, Anderson L, Phillipson JD: *Herbal medicines*, ed 5, London, 2007, Pharmaceutical Press.
- Blumenthal M, editor: *The ABC clinical guide to herbs*, Austin, TX, 2003, American Botanical Council.
- Bratman S, Girman AM: *Mosby's handbook of herbs and supplements and their therapeutic uses*, St Louis, 2003, Mosby.
- ESCOP (European Scientific Cooperative on Phytotherapy): *ESCOP monographs: the scientific foundation for herbal medicinal products*, New York, 2003, Thieme.
- Freeman LW, Lawlis GF: *Mosby's complementary and alternative medicine: a research-based approach*, ed 2, St Louis, 2004, Mosby.
- Gruenewald J, Brendler T, Jaenicke C, editors: *PDR for herbal medicines*, ed 4, Montvale, NJ, 2007, Thomson Healthcare.
- Harkness R, Bratman S: *Mosby's handbook of drug-herb and drug-supplement interactions*, St Louis, 2003, Mosby.
- Jellin JM, editor-in-chief: *Pharmacist's letter/prescriber's letter natural medicines comprehensive database*, ed 11, Stockton, CA, 2009, Therapeutic Research Faculty.
- Krinsky DL, LaValle JB, Hawkins EB, et al: *Natural therapeutics pocket guide*, ed 2, Hudson, OH, 2003, Lexi-Comp.
- Micozzi MS: *Fundamentals of complementary and alternative medicine*, ed 2, New York, 2001, Churchill Livingstone.
- Parsa Stay F: *The complete book of dental remedies*, Garden City, NJ, 1996, Avery.
- Pizzorno JE Jr, Murray MT, Joiner-Bey H: *The clinician's handbook of natural medicine*, London, UK, 2003, Churchill Livingstone.
- Yuan C-S, Bieber EJ, editors: *Textbook of complementary and alternative medicine*, New York, 2003, Parthenon.

Drug Interactions in Clinical Dentistry*

Numerous studies have documented that drugs are rarely taken in isolation. For example, adults in contemporary society may take an average of four to five drugs daily, and hospitalized patients may receive from 9 to 13 different agents every 24 hours, depending on the institution, the patient's status, and the intercommunication among attending physicians. As the number of administered drugs increases arithmetically, the risk of an adverse drug reaction increases geometrically. Although some of this increase undoubtedly reflects a greater severity of disease and reduced physiologic reserve in patients requiring multidrug therapy, it also underscores the fact that drugs may interact with each other in producing toxicologic effects. Drug interactions, in fact, account for 5% to 10% of all adverse reactions to drugs and may be responsible for extending the hospital stay of approximately 15% of admitted patients. However, not all drug interactions are clinically significant or undesired, and some are actively sought in pharmacotherapeutics to increase drug effectiveness, decrease toxicity, or both. This section reviews the basic principles and general mechanisms of drug interactions and illustrates these interactions with selected examples. Some interactions are not included here, for example, medication interference with laboratory tests and metabolic interactions with environmental chemicals, such as pesticides that alter *in vivo* enzyme activity. Interactions involving herbal products are described in Chapter 56. Finally, it is generally assumed for the sake of simplicity that only two agents are interacting concurrently.

The sources of drugs that may be involved in drug interactions are varied. They may be prescribed or administered by a single physician or dentist or by several practitioners. Patients may also medicate themselves with over-the-counter preparations, with drugs provided by relatives or friends, or with medication remaining from a previous prescription. Finally, certain substances in foods and in cigarette smoke may interact with administered drugs. Potential interactions between concurrently administered drugs are both dose and duration dependent; nevertheless, the degree or severity of an adverse

interaction is seldom predictable. In the discussion that follows, drug interactions are reviewed according to type and mechanism, and examples of each are included for illustration.

Classification of Drug Interactions

Drug interactions are expressed in a bewildering diversity of altered responses. Quantitative changes in reactions to one or more drugs can occur, and complex systems of nomenclature and mathematic description have been developed to characterize the combined effects of drugs. Although such approaches are of theoretic and experimental value, they are less useful in the clinical setting and fail to take into account some qualitative changes in drug effect that can occur.

The simplest clinical classification scheme recognizes three basic types of drug interactions: *antagonism*, *potentiation*, and *unexpected drug effect*. Implicit in this classification is a primary or "object" drug whose effects are modified (i.e., reduced, increased, or transformed) and an interacting or "precipitant" drug responsible for altering the effects of the object drug. Omitted, however, are drugs that produce identical or similar actions, yielding a *summation* of drug effects when the drugs are administered together. Inasmuch as summation is commonly exploited in therapeutics and is often responsible for adverse drug reactions, it is included here. A last category, *synergism*, is used to identify agonist combinations that yield a magnitude of effect beyond that obtainable with a single agonist regardless of dose.

Antagonism

Antagonism indicates that the biologic or clinical response to a drug is reduced by administering a second agent. In some cases, the action of one or both of the drugs might be diminished or completely lost. An example of this type of interaction is occasionally seen in antibiotic therapy, where the combined use of a drug that acts by inhibiting the synthesis of bacterial cell walls, such as penicillin, and one that acts by inhibiting bacterial protein synthesis, such as tetracycline,

*This appendix lists important interactions that may occur between drugs a patient is taking for nondental conditions and common antimicrobial, analgesic, local anesthetic, and antianxiety-sedative preparations prescribed or used in clinical practice. It is assumed that all prescriptions are for short-term therapy (i.e., ≤ 1 week) and that all drugs are in conventional dosages. Antimicrobial drugs include oral forms of penicillins (e.g., penicillin V, amoxicillin), cephalosporins (e.g., cephalexin, cefaclor), macrolides (including the various salt forms of erythromycin), tetracyclines (e.g., tetracycline, doxycycline), clindamycin, metronidazole, and parenteral ampicillin. Analgesics

covered consist of peripherally acting NSAIDs, acetaminophen and opioid analgesics, opioid agonist-antagonists, and their combinations. Local anesthetics include all formulations currently available for dental use in the United States. Antianxiety-sedative drugs include short-acting and ultrashort-acting barbiturates, propofol, benzodiazepines, chloral hydrate, and hydroxyzine. The term *use cautiously* indicates that the interaction is rare or not usually dangerous (or both), and that careful administration within recommended dosage limits and increased surveillance of drug effects should suffice to avoid serious toxicity.

results in less antimicrobial activity than might have been obtained by adequate doses of either antibiotic used alone.

Antagonism can directly occur when an antagonist produces a physical or chemical change in the agonist, reducing or abolishing its activity. An example of this is the chelation of divalent cations in antacids by tetracycline, reducing the absorption and therefore the therapeutic effectiveness of that antibiotic. A second form of antagonism may develop when one drug modifies the disposition of a second agent. An antagonism of this nature is caused by a compound that stimulates drug metabolism and shortens the biologic half-life of the agonist. Third, competition can develop between drugs for the same receptor site, diminishing or even abolishing the effectiveness of the active drug. Such pharmacologic antagonisms frequently occur with drugs that act on the autonomic nervous system, such as the blockade of sympathomimetic amines by α - and β -adrenergic antagonists. Fourth, antagonism of receptor activation may be of a noncompetitive nature, such as when one drug allosterically modifies the affinity of a receptor for a second agent. Finally, drugs having opposing actions at different receptor sites may partially or completely antagonize the effects of either or both drugs. Examples of this type of antagonism are the opposing effects of simultaneous administration of central nervous system (CNS) stimulants and depressants or the physiologic antagonism of glucocorticoids and insulin.

Potentiation

Potentiation is said to occur when a combination of two drugs that do not share similar pharmacologic activities results in an effect of one of the drugs that is greater than expected. Although not active in producing the effect by itself, the precipitant or potentiating drug sensitizes the person to the active object drug. Often, this form of interaction occurs when the precipitant drug elevates the free concentration of the active drug by increasing its absorption, altering its distribution, or inhibiting its elimination. A typical example of potentiation is the increased neuromuscular blocking activity of succinylcholine occurring in patients receiving a pseudocholinesterase inhibitor, such as neostigmine, which inhibits the inactivation of succinylcholine.

Unexpected drug effect

On occasion, the combination of two or more drugs can result in a response typically not observed when any of the drugs is given singly, even in overdose. One possible way in which such a novel drug effect may occur involves perturbation of the metabolism of one drug by another, leading to the formation of a highly active metabolite. For instance, disulfiram inhibits the intermediary metabolism of alcohol, resulting in the accumulation of acetaldehyde if alcohol is ingested by the patient. The symptoms of acetaldehyde intoxication—throbbing headache, blurred vision, pronounced hypotension, chest pain, dysphoria, and mental confusion—constitute a syndrome that does not normally occur with either drug administered alone.

Summation

Summation refers to the combined activities of two or more drugs that elicit identical or related pharmacologic effects. If the drugs act at the same site and produce simple arithmetic summation of effects, they are said to be *additive*. In this case, the drugs are interchangeable when the dose of each drug is expressed as a percentage of that drug's median effective dose. *Infraadditive* and *supraadditive effects* indicate, respectively, interactions that yield less than or more than an expected additive response. In all these situations, however, the maximum effect that can be obtained is no greater than what can be achieved by sufficient doses of a single drug. Examples

of drugs that summate by acting at identical and at different sites include the opioid analgesics morphine and meperidine and the general anesthetics midazolam and sevoflurane.

Synergism

Occasionally, the combination of two or more agonists produces an effect that is greater quantitatively than what can be achieved by maximally effective doses of any one drug given alone. Common examples of *synergism* used therapeutically include the combination of chemotherapeutic agents to treat certain infections (e.g., tuberculosis) and neoplastic diseases. In these situations, the emergence of drug resistance is reduced and the cure rate is enhanced. The combination of alcohol and carbon tetrachloride provides an example of synergism leading to acute toxicity. Here, hepatotoxicity is much greater than what is typically associated with either drug given alone.

Mechanisms of Drug Interactions

Drug interactions can occur at any point along the pharmacologic pathway of the agonist, from even before the drug is administered to a patient, to the period when it is in contact with its site of action, to the point at which it is eliminated. The various mechanisms involved in drug interactions can be grouped taxonomically into three broad categories: pharmaceutical, pharmacokinetic, and pharmacodynamic interactions.

Pharmaceutical interactions

Pharmaceutical interactions represent drug incompatibilities of a physical or chemical nature. In general, pharmaceutical interactions can be anticipated between organic acids and bases, resulting in precipitation of one or both drugs. Chemical reactions between drugs may also occur, but these are less common. Most pharmaceutical interactions of importance to dentistry involve drugs that are given parenterally for intravenous sedation. As a general rule, drugs should not be mixed within the same syringe.

Pharmacokinetic interactions

Pharmacokinetic interactions derive from the influence of one drug on the absorption, distribution, biotransformation, or excretion of another drug.

Absorption. Many times an interaction affects the rate or extent of effective absorption of a drug into the systemic circulation, causing a decrease or increase in that drug's effect. Factors influencing absorption include the pH of lumen fluids, enzyme activity, and intestinal motility. Familiar examples of interactions that decrease drug absorption include the previously mentioned chelation by tetracycline of multivalent cations (Ca, Mg, Fe, and Al) in dairy products, antacids, or ferrous salts and the hydrolysis of penicillin G by fruit juice acids, resulting in a decrease in the amount of antibiotic available for absorption and therefore a decrease in the therapeutic effect. Dentists are familiar with combining vasoconstrictors with local anesthetics to retard absorption of the anesthetic from the site of administration.

A well-known example of an interaction that facilitates or increases absorption occurs in patients taking monoamine oxidase (MAO) inhibitors. Tyramine in beer, ripened cheese, red wine, and many other fermented foods is normally not absorbed because it is enzymatically inactivated by MAOs in the intestinal mucosa and liver. When MAO inhibitors suppress these enzymes, tyramine, a sympathomimetic amine, is absorbed in excessive amounts, releasing norepinephrine from sympathetic nerve endings. The effect frequently results in drug toxicity, including severe headache and, occasionally, hypertensive crisis and death.

Distribution. After a drug is absorbed, an interaction may modify its distribution or the rate of transfer of the drug from one location to another. Drugs may be free in the bloodstream or become reversibly bound to plasma or tissue components. Plasma proteins, primarily albumin and α_1 -acid glycoprotein, act as acceptor or storage sites for many drugs. Protein-bound drugs are inactive, being unavailable for active combination with a receptor site, for biotransformation, or for glomerular filtration. Because a bound drug is in equilibrium with the free drug in plasma and tissue fluids, an interacting drug that displaces an agonist from its protein-binding sites raises the plasma concentration of the pharmacologically active, unbound agonist. This potentially increases its pharmacologic activity; it may also increase the amount available for metabolism and excretion, thus shortening its duration of action. Warfarin, which is highly protein bound, is displaced from its plasma protein binding sites by chloral hydrate (specifically, the trichloroethanol metabolite), transiently potentiating the anticoagulant effect and increasing the possibility of spontaneous hemorrhage. Of course, this interaction is more likely to become clinically evident in patients with a variant CYP2C9 phenotype.

Distribution across cellular membranes can be influenced by drugs that compete for or otherwise block active transport mechanisms such as the P-glycoprotein transporter, alter pH gradients, or disrupt membrane diffusion barriers. Inhibition of the active uptake of adrenergic vasoconstrictors into sympathetic nerve terminals by tricyclic antidepressants increases the concentration of the adrenergic drugs in the synaptic cleft. Drugs that cause acute respiratory acidosis tend to shift the distribution of opioid analgesics from intracellular locations to the extracellular space. Because the opioid receptors are located on the external surface of the plasma membrane, increased opioid effects result. The intra-arterial administration of osmotic agents to shrink the endothelial cells forming the bulk of the blood-brain barrier increases the entry of anticancer drugs into the CNS.

Metabolism. The degree and duration of activity of a drug are often functions of its metabolism; therefore an interacting drug can modify the effect of an agonist by altering its rate of biotransformation. Most drugs used therapeutically are metabolized in the liver by the microsomal enzyme system. As discussed in Chapter 2, the CYP family of enzymes is commonly involved in these reactions. Inhibition of CYP isozymes provides a rich source of drug interactions. Erythromycin, for instance, irreversibly inhibits CYP3A4; its nitrosoalkane metabolite forms complexes with the CYP3A4 iron, blocking the metabolism of other drugs dependent on the same CYP. These agents include the opioid agonist alfentanil, the hypnotic agent triazolam, the immunosuppressant cyclosporine, and a host of other pharmacologically unrelated compounds. Additional agents that are capable of inhibiting the metabolism of multiple drugs include amiodarone, cimetidine, fluvoxamine, disulfiram, and the MAO inhibitors. In the latter two cases, nonmicrosomal enzymes are the targets of inhibition (alcohol dehydrogenase and MAO, respectively).

The anticonvulsants phenobarbital, phenytoin, and carbamazepine are known to induce the production of hepatic microsomal enzymes that are responsible for their own biotransformation. These same microsomal enzymes, however, also metabolize other drugs, such as oral anticoagulants, resulting in an increase in the rate of biotransformation of the anticoagulant and a consequent decrease in the active form, with a resultant loss of therapeutic effectiveness. Because the effect of the enzyme-inducing agent is not permanent, care must be taken to reassess the anticoagulant dosage when the inducer is withdrawn, because effective doses of the anticoagulant in the presence of enzyme induc-

tion may lead to spontaneous hemorrhage after the induction is lost. The antibiotic rifampin also causes enzyme induction, resulting, for instance, in a decreased efficiency of hydrocortisone used in the treatment of acute asthma.

The hepatic biotransformation of some drugs may be indirectly affected by other agents that influence hepatic blood flow. Part of the inhibition of lidocaine clearance by the liver in patients receiving propranolol, for example, is believed to result from the fact that propranolol reduces cardiac output, hepatic blood flow, and therefore the transport of lidocaine to the liver, its primary site of elimination.

Excretion. Increasing or decreasing the rate of excretion, or renal or biliary clearance, of a drug also alters its elimination rate constant and therefore the amount of drug available in the circulating plasma, thus affecting the duration and the degree of activity of the drug. Renal excretion is influenced by urinary pH and tubular reabsorption, as well as inhibition of active transport. For example, weak acids such as aspirin are more rapidly excreted in an alkaline urine produced by sodium bicarbonate, whereas weak bases such as amphetamine are more readily excreted in a urine acidified by ammonium chloride. Tubular secretion of an object drug might also be decreased by an interacting agent. A common example is that of probenecid, which, by competing for the same renal transport system as the penicillins, increases the serum concentration and the duration of action of the penicillins.

Pharmacodynamic interactions

Pharmacodynamic interactions represent modifications in the pharmacologic effects of a drug independent of any change in the quantitative disposition of that drug. Such interactions may increase, diminish, or qualitatively alter the therapeutic effect.

Many interactions take place at or near receptor sites. The mechanisms involved can include competition for the receptor or alterations of either the receptor or its natural ligand. This type of interaction is especially common among autonomic drugs. For instance, phenolamine and propranolol are specific competitive antagonists for epinephrine at α - and β -adrenergic receptors. A drug such as guanethidine affects the synthesis, storage, release, and reuptake of norepinephrine, resulting in depletion of norepinephrine in the neuronal vesicles. Subsequent administration of an agent that acts by evoking the release of norepinephrine (e.g., ephedrine or amphetamine) is less effective. An example of the opposite effect is that of MAO inhibitors, such as pargyline, which permit the accumulation of norepinephrine by forming complexes with the enzyme that metabolizes the neuromediator within the nerve terminals. In this instance, ephedrine or amphetamine produces markedly exaggerated effects.

Interacting drugs may also exert their effects at sites of action in different locations. A previously cited example of this phenomenon is the physiologic antagonism of CNS stimulants, such as caffeine or amphetamine, by CNS depressants, such as the benzodiazepines or anticonvulsants. When the agents are administered simultaneously, these drug groups produce opposing actions. Probably the most common interactions involve drugs that evoke similar pharmacologic effects. Combinations of alcohol, barbiturates, benzodiazepines, phenothiazines, antihistamines, bromides, or other drugs capable of producing CNS depression are sometimes unwittingly consumed by people, resulting in somnolence, unconsciousness, or even death.

Factors Influencing Drug Interactions

Several variables can affect the occurrence and intensity of potential drug interactions. Prime among these are variations in the handling of and reaction to administered drugs,

including the genetic-based differences described in Chapter 4. Drug interactions and drug effects are both dose dependent and duration dependent; thus an interaction may not be clinically discernible each time interacting drugs are administered. The higher the dosage and the longer the administration, the greater the chance that an interaction may occur. Previous exposure affecting drug transport, metabolism, or responsiveness may alter the potential for interaction. In addition, many drugs have a long biologic half-life, and effective concentrations may be present in the blood or tissue for many days after the cessation of therapy; interactions may occur, therefore, days and occasionally weeks after discontinuation of therapy with one of the interacting drugs.

Drug Interactions Used in Pharmacotherapeutics

Combinations of drugs are used in therapy to provide enhanced effects and to prevent adverse reactions. Purposeful drug interactions are especially common in the treatment of certain diseases, such as essential hypertension, tuberculosis, and cancer, in which the concurrent administration of two or more drugs is routine. Drugs may also be given sequentially so the second agent abruptly terminates the action of the first. Thus edrophonium, a cholinesterase inhibitor, is administered to reverse the neuromuscular blockade of vecuronium, and leucovorin (folinic acid) is administered to “rescue” patients given potentially lethal doses of methotrexate, a folic acid analogue used in cancer chemotherapy. Agents useful as specific antidotes in accidental drug overdosage include protamine for heparin, naloxone for opioid analgesics, and atropine for anticholinesterases.

Particular mention should be made of fixed-dose combination products. Such preparations make up a significant frac-

tion of all drugs sold in the United States, from over-the-counter remedies to prescription items to agents administered by practitioners. The fixed combination of a local anesthetic with epinephrine to provide more effective and more prolonged anesthesia is a notable example. In general, drug mixtures include a principal ingredient for the main therapeutic effect; adjuvants that summate with, potentiate, or otherwise complement the first drug; and correctives that antagonize or minimize undesired side effects.

The major criticisms of fixed-dose combinations are (1) the inability to adjust the dosages of the individual ingredients to the needs of a particular patient; (2) discrepancies in half-lives of individual agents, leading to the accumulation of some, but not other, constituents during repeated administration; (3) the likelihood of taking unnecessary drugs; (4) the possibility of increased toxicity or allergenicity without correspondingly increased therapeutic efficacy; and (5) the possibility of a higher cost from the manufacturer. However, fixed-dose combinations have certain potential advantages. Certain mixtures offer therapeutic gains in effectiveness or safety (e.g., acetaminophen with hydrocodone combinations, local anesthetic-vasoconstrictor solutions, and hydrochlorothiazide with triamterene). In addition, drug combinations may improve patient compliance by reducing the number of medications the patient must take. Finally, the reduced number of individual prescriptions can be less expensive to the patient. Although certain fixed-dose combinations are useful, such preparations should be avoided as a general rule, and only those mixtures that have been demonstrated to be therapeutically advantageous to the patient should be used.

DRUG	INTERACTING DRUG	EFFECT AND RECOMMENDATION
Antibiotics		
Penicillins, cephalosporins	Bacteriostatic antibiotics (e.g., macrolides, tetracyclines, clindamycin)	Bacteriostatic antibiotics (second group) may interfere with the action of bactericidal antibiotics (first group). Consult with other practitioners for optimal therapy
Penicillins, cephalosporins, tetracyclines, ciprofloxacin	Oral contraceptives	There is a low risk that these antibiotics may stimulate estrogen elimination and may decrease effectiveness of contraceptive agent. Advise patient accordingly
Penicillins, cephalosporins	Probenecid	Urinary excretion of antibiotic is retarded. Consult with physician for appropriate dosage schedule
Penicillins	Enoxaparin, heparin Methotrexate	High-dose penicillins can increase bleeding time. Use cautiously Urinary excretion of methotrexate may be inhibited. Use cautiously
Ampicillin	Allopurinol	High incidence of skin rash has been reported. Substitute amoxicillin for ampicillin
Cephalosporins	Atenolol Drugs that cause nephrotoxicity or ototoxicity (e.g., aminoglycosides, aspirin, amphotericin B, cisplatin, cephalosporins, colistimethate)	Atenolol concentrations may be reduced. Use cautiously Additive toxicity may occur. Cephalexin and cefoxitin are apparently safe
Clindamycin, macrolides, tetracyclines	Bactericidal antibiotics (e.g., penicillins, cephalosporins)	Action of bactericidal antibiotics may be inhibited. Avoid concurrent use, or consult with other practitioners
Clindamycin	Erythromycin, clarithromycin, azithromycin	Antagonism can occur between these drugs. Avoid concurrent use. Do not use one agent for prophylaxis of endocarditis after recent use of other agent
	Kaolin	Absorption of clindamycin is delayed. Avoid concurrent use of clindamycin
Macrolides	Chloramphenicol, clindamycin, lincomycin	Erythromycin and other macrolides may interfere with the antibacterial effects of the other agents. Avoid concurrent use. Do not give clarithromycin or azithromycin for prophylaxis of endocarditis after recent use of one of these drugs

DRUG	INTERACTING DRUG	EFFECT AND RECOMMENDATION
Macrolides, tetracyclines	Digoxin	Absorption of digoxin preparations may be increased. Advise patient accordingly
Erythromycin, clarithromycin	Alfentanil, bromocriptine, caffeine, carbamazepine, corticosteroids, cyclosporine, disopyramide, ergot drugs, felodipine, midazolam, theophylline drugs, triazolam, valproic acid, warfarin	Erythromycin and clarithromycin may interfere with metabolism of these drugs. Use intravenous agents cautiously. Administration of clarithromycin prophylaxis of endocarditis is probably of little consequence, but a full course of macrolide therapy requires consultation with physician, especially regarding carbamazepine, cyclosporine, and warfarin
	HMG-CoA reductase inhibitors (statins)	Erythromycin and clarithromycin interfere with metabolism of these agents, possibly causing rhabdomyolysis. Avoid concurrent use.
Erythromycin	Drugs that cause ototoxicity or especially hepatotoxicity (e.g., furosemide, fluorouracil)	Use of erythromycin for prophylaxis of endocarditis is probably not a problem. Increased risk of ototoxicity or hepatotoxicity may warrant consultation with physician
Tetracyclines	Antacids, bismuth, Ca ⁺⁺ , iron, Mg ⁺⁺ , or zinc salts, H ₂ antihistamines, colestipol	Absorption of tetracycline is impaired. Space administration schedules to avoid simultaneous ingestion. Occasionally, increased dosage necessary
	Li ⁺ salts	Plasma Li ⁺ concentrations may be increased. Advise patient accordingly
	Anisindione, warfarin	In patients with poor dietary vitamin K, tetracyclines may increase effect of oral anticoagulants. Use cautiously
Doxycycline	Barbiturates, alcohol (chronic use), carbamazepine, phenytoin	Hepatic clearance of doxycycline is increased. Adjust dosage upward, or use alternative tetracycline
Oxytetracycline	Insulin	Hypoglycemic action of oxytetracycline reduces insulin requirements. Substitute with another antibiotic
Metronidazole	Alcohol	Alcohol metabolism is altered, leading to buildup of acetaldehyde. Avoid concurrent use
	Cimetidine	Hepatic clearance of metronidazole is decreased. Use cautiously
	Chloroquine, disulfiram Barbiturates, phenytoin	Psychotomimetic reactions possible. Avoid concurrent use Hepatic clearance of metronidazole is increased. Consider increasing dose if therapy proves to be suboptimal. Metronidazole may decrease phenytoin, however, which may warrant consultation with physician
	Li ⁺ salts	Renal toxicity of Li ⁺ may occur. Avoid concurrent use
	Warfarin	Hepatic clearance of warfarin is decreased. Full course of therapy requires consultation with physician
Analgesics		
Aspirin and other NSAIDs	NSAIDs	Ulcerogenic and platelet-inhibiting effects of these agents are increased, but not the analgesia. Aspirin may decrease effectiveness of some NSAIDs. Avoid concurrent use, but ensure optimal NSAID therapy
	Drugs that cause nephrotoxicity and ototoxicity (e.g., aminoglycosides, cyclosporine, furosemide, vancomycin)	Short courses for pain relief are probably of little concern, but avoid or minimize concurrent use
	Antidiabetic sulfonyleurea drugs	Hypoglycemic effects are enhanced. Substitute with acetaminophen
	Baclofen, methotrexate, Li ⁺ salts, phenytoin, Ca ⁺⁺ channel blockers	Plasma concentrations of these agents are increased by aspirin-like drugs. Substitute with acetaminophen
	Probenecid, sulfapyrazone	Probenecid interferes with renal and biliary excretion of NSAIDs. Aspirin may block uricosuric effects of probenecid and sulfapyrazone. Substitute with acetaminophen
	Alcohol, corticosteroids	Combination may result in gastrointestinal ulceration and bleeding. Corticosteroid may also increase salicylate clearance. Avoid concurrent use
	ACE inhibitors, β blockers, diuretics	Hypotensive effect of ACE inhibitors, β blockers, and diuretics may be reduced. Advise patient accordingly
Aspirin, other NSAIDs, and acetaminophen	Anticoagulants and thrombolytics, broad- spectrum β-lactam antibiotics (e.g., ticarcillin)	Combination may result in increased bleeding, especially with aspirin. Cautious use of acetaminophen acceptable (<2 g/day)
Aspirin	Valproic acid	Increased plasma concentrations of valproic acid and additive antiplatelet effects may increase bleeding tendencies. Use cautiously

Continued

DRUG	INTERACTING DRUG	EFFECT AND RECOMMENDATION
	Carbonic anhydrase inhibitors	Increased central nervous system (CNS) toxicity from aspirin or carbonic anhydrase inhibitor may result. Use cautiously
Ibuprofen	Antacids, griseofulvin Digoxin	Salicylate concentrations reduced. Use alternative NSAID Ibuprofen decreases clearance of digoxin. Substitute acetaminophen to avoid possibility of increased toxicity
Acetaminophen	Alcohol Cholestyramine	Acetaminophen hepatotoxicity is more likely in chronic alcoholics. Use cautiously Concurrent ingestion inhibits acetaminophen absorption. Administer acetaminophen at least 1 hr before cholestyramine
Opioid analgesics and agonist-antagonists	β Blockers, barbiturates, isoniazid, phenytoin, sulfipyrazone Alcohol, CNS depressants, local anesthetics, antidepressants, antipsychotics, centrally acting antihypertensives, antihistamines, cimetidine, MgSO ₄ (parenteral) Antimuscarinics, antidiarrheals, antihypertensives Naltrexone, opioid agonist-antagonists	Alteration of acetaminophen metabolism may increase risk of hepatotoxicity. Use cautiously Increased CNS and respiratory depression may occur. Use cautiously, perhaps in reduced dosage Opioids increase effects of these drugs. Use cautiously
Codeine, hydrocodone, oxycodone	Monoamine oxidase inhibitors, furazolidone, procarbazine Aprepitant, diltiazem, ketoconazole, HIV protease inhibitors, verapamil	Meperidine results in marked toxicity and is absolutely contraindicated. Use other opioids cautiously These drugs may increase the plasma concentrations and effects of the opioids. Avoid concurrent use if possible.
Alfentanil	Fluoxetine, paroxetine, quinidine, ritonavir, sertraline	Conversion to analgesic metabolites may be impaired. Avoid use of codeine; may need increased doses of hydrocodone or oxycodone
Propoxyphene	Erythromycin	Erythromycin may interfere with metabolism of alfentanil. Use cautiously
Opioid agonist/antagonist	Alprazolam, carbamazepine, doxepin, warfarin	Propoxyphene inhibits metabolism of these agents. Substitute with another analgesic
Local Anesthetic Preparations	Opioid analgesics	Antagonism of opioid analgesic effect may lead to withdrawal symptoms in dependent patients. Avoid concurrent use
Local anesthetics	Alcohol, CNS depressants, opioids, antidepressants, antipsychotics, centrally acting antihypertensives, antihistamines, MgSO ₄ (parenteral) Antiarrhythmic drugs Anticholinesterases	Increased CNS and respiratory depression may occur. Use cautiously Increased cardiac depression may occur. Use cautiously Local anesthetics may antagonize effects of anticholinesterases on muscle contractility. Treat myasthenic patients in consultation with physician
Amides	Amiodarone, β blockers, cimetidine	Metabolism of amides in liver is reduced. Use cautiously
Esters	Anticholinesterases Sulfonamides	Metabolism of esters is reduced. Use cautiously Inhibition of sulfonamide action may occur. Avoid concurrent use
Adrenergic vasoconstrictors	Inhalation anesthetics Methyldopa, tricyclic antidepressants β Blockers, adrenergic neuron blockers, entacapone, tolcapone Antipsychotics	Increased possibility of cardiac arrhythmias exists with some agents. Consult with anesthesiologist Sympathomimetic effects may be enhanced. Use epinephrine cautiously. Avoid levonordefrin and norepinephrine Hypertensive and cardiac reactions are more likely. Use cautiously Vasoconstrictor action is inhibited, which may lead to hypotensive responses. Use cautiously
Antianxiety-Sedative Agents		
Barbiturates, benzodiazepines, chloral hydrate, hydroxyzine, propofol	Alcohol, CNS depressants, opioids, local anesthetics, antidepressants, antipsychotics, centrally acting antihypertensives, antihistamines, MgSO ₄ (parenteral)	Increased CNS and respiratory depression may occur. Use cautiously, perhaps in reduced dosage
Barbiturates, benzodiazepines, propofol	Antihypertensives, antipsychotics, intravenous opioids, Li ⁺ salts	Intravenous administration in patients receiving these medications can lead to hypotension. Use cautiously

DRUG	INTERACTING DRUG	EFFECT AND RECOMMENDATION
Barbiturates	Acetaminophen, anticoagulants (oral), β blockers (except renally excreted congeners), carbamazepine, chloramphenicol, cimetidine, corticosteroids, corticotropin, cyclophosphamide, cyclosporine, dacarbazine, digoxin, disopyramide, doxorubicin, doxycycline, estrogen and estrogen-containing contraceptives, fenoprofen, griseofulvin, guanfacine, haloperidol, hydantoin anticonvulsants, levothyroxine, methadone, metronidazole, mexiletine, phenothiazines, quinidine, theophylline-containing preparations, tricyclic antidepressants, valproic acid, verapamil	Barbiturates stimulate metabolism of many drugs. Avoid multidose use. Single administration of short-acting drug (e.g., pentobarbital) is not known to be a problem
	Antipsychotics	Increased tendency for hypothermia. Evaluate temperature as needed
	Chloramphenicol, methylphenidate, valproic acid	Metabolism of barbiturate decreased. Avoid multidose use. Advise patient of possibility of postsedation drowsiness
Thiopental, methohexital	Methsuximide	Metabolism of the barbiturate is decreased. Avoid multidose use. Advise patient of possibility of postsedation drowsiness
	Probenecid, sulfonamides	Decreased binding of barbiturate to plasma proteins can potentiate anesthetic effect. Use cautiously
Benzodiazepines	H ₂ antihistamines	Delayed absorption of benzodiazepine. Advise patient accordingly
	Carbamazepine	Increased metabolism of both agents. Avoid multidose use
	Cimetidine, disulfiram, fluoxetine, ketoconazole, isoniazid, itraconazole, metoprolol, omeprazole, oral contraceptives, propranolol, probenecid, valproic acid	Metabolism of benzodiazepine may be decreased. Lorazepam and oxazepam least likely to be affected; avoid multidose use of other agents. Advise patient of possibility of postsedation drowsiness
	Levodopa	Decreased therapeutic effect of levodopa. Advise patient accordingly
	Amiodarone Digoxin	Increased cardiovascular toxicity. Avoid concurrent use Digoxin elimination rate may be decreased. Substitute with short-acting benzodiazepine (e.g., triazolam), and avoid multidose use
Lorazepam	Alcohol, scopolamine	Increased anxiety with alcohol and irrational behavior with scopolamine. Avoid concurrent use
Midazolam, triazolam	Diltiazem, cimetidine, erythromycin, fluoxetine, fluvoxamine, ketoconazole, itraconazole, quinupristin/dalfopristin, nefazodone, verapamil	Metabolism of midazolam and triazolam impaired. Avoid concurrent oral use; otherwise use cautiously
Chloral hydrate	Clozapine, HIV protease inhibitors	Serious CNS adverse effects may occur. Avoid concurrent use
	Anisindione, warfarin	Oral anticoagulants are displaced from protein binding sites, which may lead to bleeding. Avoid concurrent use
	Alcohol	Combination causes increased cardiovascular toxicity and CNS depression. Avoid concurrent use

Common examples of drug groups listed in Appendix 1.

α Blockers: doxazosin, phenoxybenzamine, phentolamine, prazosin, terazosin

ACE inhibitors (angiotensin-converting enzyme inhibitors): benazepril, captopril, enalapril, fosinopril, lisinopril, moexipril, perindopril, quinapril, ramipril,trandolapril

Adrenergic neuron blockers: alseroxyton, deserpidine, guanadrel, guanethidine, rauwolfia, rescinnamine, reserpine

Adrenergic vasoconstrictors: epinephrine, levonordefrin, norepinephrine

Aminoglycosides: amikacin, gentamicin, kanamycin, neomycin, netilmicin, streptomycin, tobramycin

Angiotensin II receptor blockers: candesartan, eprosartan, irbesartan, losartan, olmesartan, telmisartan, valsartan

Antacids: aluminum hydroxide, aluminum carbonate, magnesium oxide, magaldrate, calcium carbonate, sodium bicarbonate

Antiarrhythmic drugs: amiodarone, β blockers, diltiazem, disopyramide, dofetilide, flecainide, ibutilide, mexiletine, procainamide, propafenone, quinidine, verapamil

Anticholinesterases: ambenonium, donepezil, echothiophate, edrophonium, galantamine, isofluorophate, neostigmine, physostigmine, pyridostigmine, rivastigmine, tacrine

Anticoagulants and thrombolytics: anticoagulants: anisindione, enoxaparin, heparin, warfarin; thrombolytics: alteplase, anistreplase, streptokinase, urokinase

Antidepressants: bupropion, fluoxetine, MAO inhibitors, paroxetine, sertraline, trazodone, tricyclic antidepressants, venlafaxine

Antidiarrheals: bismuth subsalicylate, difenoxin, diphenoxylate, loperamide

Antihistamines: H₁ antihistamines: brompheniramine, chlorpheniramine, diphenhydramine, promethazine, pyrilamine, tripeleminamine, triprolidine; H₂ antihistamines: cimetidine, famotidine, nizatidine, ranitidine

Antihypertensives: ACE inhibitors, alikiren, angiotensin II receptor blockers, adrenergic neuron blockers, α blockers, β blockers, Ca⁺⁺ channel blockers, centrally acting antihypertensives, diuretics, hydralazine, mecamylamine, metyrosine, minoxidil

Antimuscarinics: atropine, benztropine, clidinium, darifenacin, dicyclomine, flavoxate, glycopyrrolate, methantheline, oxybutynin, propantheline, solifenacin, tolterodine, trihexyphenidyl

Antipsychotics: aripiprazole, chlorpromazine, chlorprothixene, clozapine, haloperidol, olanzapine, perphenazine, prochlorperazine, quetiapine, risperidone, thioridazine

Barbiturates: amobarbital, butabarbital, mephobarbital, methohexital, pentobarbital, phenobarbital, secobarbital, thiamylal, thiopental

β Blockers: acebutolol, atenolol, betaxolol, bisoprolol, carteolol, carvedilol, labetalol,* metoprolol, nadolol, pindolol, propranolol, sotalol, timolol

Benzodiazepines: alprazolam, chlordiazepoxide, clonazepam, clorazepate, diazepam, estazolam, flurazepam, halazepam, lorazepam, midazolam, oxazepam, prazepam, quazepam, temazepam, triazolam

Ca⁺⁺ channel blockers: amlodipine, diltiazem, felodipine, isradipine, nicardipine, nifedipine, verapamil

Carbonic anhydrase inhibitors: acetazolamide, dichlorphenamide, methazolamide

Centrally acting antihypertensives: clonidine, guanabenz, guanfacine, methyl dopa

Centrally acting muscle relaxants: carisoprodol, chlorphenesin, chlorzoxazone, cyclobenzaprine, methocarbamol, orphenadrine, baclofen

Cephalosporins: cefaclor, cefixime, cefotaxime, cefoxitin, ceftazidime, ceftriaxone, cephalixin, cephalothin

CNS depressants: acetylcarbromal, barbiturates, benzodiazepines, centrally acting muscle relaxants, chloral hydrate, ethchlorvynol, eszopiclone, ethinamate, etomidate, glutethimide, inhalation anesthetics, ketamine, meprobamate, methypylon, nitrous oxide, paraldehyde, propofol, propiomazine, zaleplon, zolpidem

Corticosteroids: cortisone, dexamethasone, hydrocortisone, methylprednisolone, prednisolone, prednisone, triamcinolone

Diuretics: amiloride, bumetanide, chlorothiazide, chlorthalidone, ethacrynic acid, furosemide, hydrochlorothiazide, spironolactone, torsemide, triamterene

Ergot drugs: dihydroergotamine, ergotamine, ergoloid mesylates, methysergide

HIV protease inhibitors: atazanavir, darunavir, fosamprenavir, indinavir, lopinavir/ritonavir, nelfinavir, ritonavir, saquinavir, tipranavir

HMG-CoA reductase inhibitors: atorvastatin, fluvastatin, lovastatin, pravastatin, rosuvastatin, simvastatin

Inhalation anesthetics: desflurane, enflurane, halothane, isoflurane, sevoflurane

Local anesthetics: amides: bupivacaine, etidocaine, lidocaine, mepivacaine, prilocaine, ropivacaine; esters: benzocaine, chloroprocaine, cocaine, procaine, propoxycaine, tetracaine; combination: articaine

Macrolides: azithromycin, clarithromycin, dirithromycin, erythromycin, troleandomycin

MAO inhibitors: isocarboxazid, phenelzine, tranylcypromine

NSAIDs (nonsteroidal anti-inflammatory drugs): aspirin, diclofenac, diflunisal, etodolac, fenoprofen, flurbiprofen, ibuprofen, indomethacin, ketoprofen, ketorolac, meclizolamine, mefenamic acid, nabumetone, naproxen, oxaprozin, piroxicam, sulindac, tolmetin

Opioid agonist-antagonists: buprenorphine, butorphanol, dezocine, nalbuphine, pentazocine

Opioid analgesics: alfentanil, codeine, dihydrocodeine, fentanyl, hydrocodone, hydromorphone, levorphanol, meperidine, methadone, morphine, oxycodone, oxymorphone, remifentanyl, sufentanyl

Oral sulfonylurea antidiabetic agents: chlorpropamide, glimepiride, glipizide, glyburide, tolazamide, tolbutamide

Penicillins: amoxicillin, ampicillin, carbenicillin, dicloxacillin, methicillin, mezlocillin, oxacillin, penicillin G, penicillin V, ticarcillin

Sulfonamides: sulfacytine, sulfadiazine, sulfamethizole, sulfamethoxazole, sulfasalazine, sulfisoxazole

Tetracyclines: demeclocycline, doxycycline, minocycline, oxytetracycline, tetracycline

Tricyclic antidepressants: amitriptyline, amoxapine, clomipramine, desipramine, doxepin, imipramine, nortriptyline, trimipramine

*Also α_1 blockers.

Glossary of Abbreviations*

–	negative	ABCD	airway, breathing, circulation, defibrillation
←	increase/upper	abd	abdomen
#	number	ABG	arterial blood gas
@	at	ABO	antigenic determinants
Δ	change	ABVD	Adriamycin (doxorubicin), bleomycin, vinblastine, dacarbazine (regimen)
̄	with	ABX	antibiotics
̄	after	AC	adenylate cyclase
̄	without (sans)	AC	anterior chamber
̄	except	ACE	angiotensin-converting enzyme
↓	decrease/lower	ACh	acetylcholine
+	positive	AChE	acetylcholinesterase
<	less than	AChR	acetylcholine receptor
=	equal	ACLS	advanced cardiac life support
>	greater than	ACTH	adrenocorticotrophic hormone
≈	approximately	ACVD	acute cardiovascular disease
→	leading to	AD	right ear
♀	female	ad lib	as much as desired
♂	male	ADA	adenosine deaminase
1,25[OH]D	1,25-dihydroxycholecalciferol, calcitriol	ADA	American Dental Association
2°	secondary to	ADH	antidiuretic hormone
25[OH]D	calcifediol	ADHD	attention-deficit/hyperactivity disorder
5-FdUTP	5-fluorodeoxyuridine triphosphate	ADL	activities of daily living
5-FU	fluorouracil	adm	admission
5-FUdR	floxuridine	ADP	adenosine 5'-diphosphate
5-HIAA	5-hydroxyindoleacetic acid	ADT	<i>Accepted Dental Therapeutics</i>
5-HT	5-hydroxytryptamine (serotonin)	AED	automatic external defibrillator
5-HTT	5-hydroxytryptamine transporter	AF (A. fib)	atrial fibrillation
6-APA	6-β-aminopenicillanic acid	AFB	acid-fast bacillus
6-MNA	6-methoxy-2-naphthylacetic acid	AFHS DI	American Hospital Formulary Service Drug Information
̄	before	AGA	appropriate gestational age
Å	angstrom	AGN	acute glomerulonephritis
A + P	auscultation and percussion	AgNO ₃	silver nitrate
A&O × 3	alert and oriented to person, place, time	AHA	American Heart Association
A&W	alive and well	AHPA	American Herbal Products Association
a.c.	before meals (<i>ante cibum</i>)	AI	aortic insufficiency
A/G ratio	albumin/globulin ratio	AICD	automatic implanted cardiac defibrillator
A:	assessment	AIDS	acquired immunodeficiency syndrome
A ₁ , A ₂ , A ₃	adenosine receptors	AIMS	abnormal involuntary movements
A ₂	aortic second sound	AIP	acute intermittent porphyria
AA	aortic aneurysm	AKA	above-knee amputation
AAOS	American Academy of Orthopaedic Surgeons	Al ⁺⁺⁺	aluminum ion
Ab	abortion	ALA	δ-aminolevulinic acid
ABC	ATP-binding cassette	A-Line	arterial line
		ALL	acute lymphocytic leukemia
		ALS	amyotrophic lateral sclerosis
		ALS	antilymphocytic serum

*This list includes abbreviations commonly used in medicine in addition to those used in the book.

ALT	alanine aminotransferase (formerly SGPT)	BBB	blood-brain barrier
AMA	against medical advice	BBB	bundle branch block
AMA	American Medical Association	BCC	bacillus Calmette-Guérin
amb	ambulatory	BCL-ABL	breakpoint cluster region-Abelson
AMI	acute myocardial infarction	BCNU	carmustine
AMI	anterior wall myocardial infarction	BCP	birth control pills
AML	acute monocytic leukemia	BCR	β-cell antigen receptor
AMP	adenosine 5'-monophosphate	<i>bcr</i>	breakpoint cluster region
amp	ampule	BDP	beclomethasone dipropionate
AMPA	α-amino-3-hydroxy-5-methyl-4-isoxazole propionate	β-arr	β-arrestin
AMPT	α-methylparatyrosine	BE	bacterial endocarditis
amt	amount	bFGF	basic fibroblastic growth factor
ANA	antinuclear antibody	BG	blood glucose
ANS	autonomic nervous system	BGTI	basal-ganglia thalamic inhibitor
ANUG	acute necrotizing ulcerative gingivitis	BHK	baby hamster kidney
AOB	alcohol on breath	BHR	bronchial hyperreactivity
AODM	adult-onset diabetes mellitus	bid	twice a day (<i>bis in die</i>)
AP	anteroposterior, apical pulse, abdominoperitoneal, antepartum	Bis-GMA	bisphenol A glycidylmethacrylate
AP	antiplasmin	BKA	below-knee amputation
AP-1	activating protein-1	BLS	basic life support
AP5	2-amino-5-phosphonovaleric acid	BM	bowel movement
AP7	2-amino-7-phosphonoheptanoic acid	BMD	beclomethasone dipropionate
APAP	acetaminophen	BMP	beclomethasone monopropionate
APC	aspirin-phenacetin-caffeine	BMR	basal metabolic rate
aPC	activated protein C	BMT	bone marrow transplant
APD	action potential duration	BOLD	blood oxygen(ation) level dependent
APF	acidulated phosphate fluoride	BOM	bilateral otitis media
approx	approximately	BoNT-A	Botulinum toxin type A
APSAC	anisoylated plasminogen—SK activator complex	BoNT-B	Botulinum toxin type B
aPTT	activated partial thromboplastin time	BP	blood pressure
AR	adrenergic receptor	BPA	bisphenol A
AR	aortic regurgitation	BPD	bronchopulmonary dysplasia
Ara-A	vidarabine, adenosine arabinoside	BPH	benign prostatic hypertrophy
ARA-C	cytosine arabinoside (cytarabine)	BR	bathroom
ara-g	analogue-9-beta-D-arabinofuranosylguanine	BR	bed rest
ARAS	ascending reticular activating system	BRP	bathroom privileges
ARC	AIDS-related complex	BS	breath sound/bowel sounds
ARDS	acute respiratory distress syndrome	BSA	body surface area
ARF	acute respiratory failure	BSAC	British Society for Antimicrobial Chemotherapy
AROM	artificial rupture of membranes	BSO	bilateral salpingo-oophorectomy
AS	aortic stenosis	BTL	bilateral tubal ligation
AS	left ear	BuChE	butyrylcholinesterase
as tol	as tolerated	BUN	blood urea nitrogen
ASA	American Society of Anesthesiologists	BVH	bilateral ventricular hypertrophy
ASA	aspirin	Bx	biopsy
ASAP	as soon as possible	BZ ₁ , BZ ₂	benzodiazepine receptors
ASD	atrial septal defect	C	centigrade
ASHD	atherosclerotic heart disease	C&S	culture and sensitivity
AST	aspartate aminotransferase (formerly SGOT)	<i>c/o</i>	complaints of
ATIII	antithrombin III	<i>c/w</i>	consistent with
ATM	atmosphere	C ₁ , C ₂ , ...	first cervical vertebra, second cervical vertebra, ...
ATN	acute tubular necrosis	C6	hexamethonium
ATP	adenosine 5'-triphosphate	CA	cancer/carcinoma
ATPase	adenosine triphosphatase	Ca ⁺⁺ , Ca ²⁺	calcium ion
AU	both ears	CABG	coronary artery bypass graft
AV	atrioventricular/arteriovenous	CAD	coronary artery disease
AVM	arteriovenous malformation	CAM	Complementary and alternative medicine
AVR	aortic valve replacement	cAMP	cyclic adenosine 3',5'-monophosphate
AZT	zidovudine (azidothymidine)	Cap	capsule
Ba	barium	CAPD	continuous ambulatory peritoneal dialysis
BA	brain abscesses	CAT	computerized axial tomography
BAC	blood alcohol concentration	cath	catheter/catheterization/catheterize
BaE	barium enema	CBC	complete blood count
		CBD	common bile duct
		CC	chief complaint
		cc	cubic centimeter
		CCB	calcium channel blocker

CCMS	clean-catch midstream	CTZ	chemoreceptor trigger zone
CCNU	lomustine	CV	cardiovascular
CCR5	cysteine-cysteine chemokine receptor 5	CVA	cerebrovascular accident
CCU	cardiac care unit	CVA	costovertebral angle
CD	cluster of differentiation	CVC	central venous catheter
CD40L	CD40 ligand	CVP	central venous pressure
CDAC	<i>Clostridium difficile</i> —associated colitis	CXCR4	β-chemokine receptor 4
CDAD	<i>Clostridium difficile</i> —associated diarrhea	CXR	chest x-ray
CDC	Centers for Disease Control and Prevention	CYP	cytochrome P450
CDE	common duct exploration	Cys	cysteinyl
CDH	congenital dislocation of hip	cysLTs	cysteinyl leukotrienes
CDK	cyclin-dependent kinase	D	dopamine (receptor)
Cdk5	cyclin-dependent kinase 5	d	dalton
cDNA	complementary DNA	DAT	dopamine transporter
CDR	complementarity-defining region	DATA	Drug Addiction Treatment Act
CE	cardiac enlargement	D&C	dilation and curettage
CE	cataract extraction	D/C	discharge/discontinue
CETP	cholesteryl ester transfer protein	D/Dx	differential diagnosis
CF	cystic fibrosis	D ₅ LR	dextrose 5% in lactated Ringer's
CG	chorionic gonadotropin	D ₅ W	dextrose 5% in water
cGMP	cyclic guanosine 3',5'-monophosphate	DAG	diacylglycerol
CGN	chronic glomerulonephritis	DATATOP	deprenyl and tocopherol antioxidant therapy of parkinsonism
CGRP	calcitonin gene—related peptide	DCC	daycare center
ChAc	choline acetylase	DDAVP	desmopressin
CHD	congenital or coronary heart disease	DDT	dichlorodiphenyltrichloroethane
CHF	congestive heart failure	DEA	Drug Enforcement Administration
CHG	chlorhexidine gluconate	DES	diethylstilbestrol
CHI	closed head injury	DFP	isofluorophate (formerly diisopropylfluorophosphate)
CHO	Chinese hamster ovary	DHFR	dihydrofolate reductase
CI	color index/cardiac index	DHT	dihydrotachysterol
CIWA	Clinical Institute Withdrawal Assessment (alcohol/drug toxicology screen tool)	DIC	disseminated intravascular coagulation/coagulopathy
CL	clearance	dist H ₂ O	distilled water
CL	ConsumerLab	DIT	diiodotyrosine
Cl ⁻	chloride ion	DIV	divorced
cl liq	clear liquid	div	divide
CLL	chronic lymphatic/lymphocytic leukemia	DJD	degenerative joint disease
cm	centimeter	DKA	diabetic ketoacidosis
CMI	cell-mediated immunity	DL	direct laryngoscopy
CML	chronic myelogenous/myelocytic leukemia	DM	diabetes mellitus
CMV	cytomegalovirus	DMARD	disease-modifying antirheumatic drug
CNS	central nervous system	DMFT	decayed, missing, and filled teeth
CO	cardiac output	DMPP	dimethylphenylpiperazinium
CO	carbon monoxide	DMSO	dimethyl sulfoxide
CO ₂	carbon dioxide	DMT	dimethyltryptamine
CoA	coenzyme A	DNA	deoxyribonucleic acid
CO-Hb	carboxyhemoglobin	DNR	do not resuscitate
COMT	catechol-O-methyltransferase	DOA	dead on arrival
CoNS	coagulase-negative staphylococci	DOB	date of birth
COPD	chronic obstructive pulmonary disease	DOE	dyspnea on exertion
cor	heart	Dopa (DOPA)	dihydroxyphenylalanine
COX	cyclooxygenase	DPP-4	dipeptidyl peptidase 4
CP	cerebral palsy	DPT	diphtheria, pertussis, tetanus vaccine
CPAP	continuous positive airway pressure	DR	delivery room
CPC	clinical pathologic conference	DR	diabetic retinopathy
CPK	creatine phosphokinase	DRG	diagnosis-related groups
CPR	cardiopulmonary resuscitation	dsg	dressing/dosage
CRF	chronic renal failure	DSHEA	Dietary Supplement Health and Education Act of 1994
CRH	corticotropin-releasing hormone	DSM-IV-R	<i>Diagnostic and Statistical Manual of Mental Disorders</i> , ed 4
CRP	C-reactive protein	DSV	Dietary Supplement Verification Program
CS or C/S	cesarean section	DT	delirium tremens
CSF	cerebrospinal fluid	DTI	diffusion tensor imaging
CSW	clinical social worker	DTH	dihydrotachysterol
CT	computed tomography	DTIC	dacarbazine
CTLA-4	cytotoxic T-lymphocyte—associated antigen-4	DTR	deep tendon reflex
C-Tube	chest tube		

DU	dermal ulcer	FAS	fetal alcohol syndrome
DU	duodenal ulcer	FBG	fasting blood glucose
DUB	dysfunctional uterine bleeding	FBS	fasting blood sugar
DVD	dissociated vertical divergence	Fc	crystallizable fragment (region)
DVT	deep vein thrombosis	FD	fetal demise
Dx	diagnosis	FDA	U.S. Food and Drug Administration
E	epinephrine	Fe ⁺⁺	ferrous ion
e.g.	for example	Fe ⁺⁺⁺	ferric ion
ea	each	FEV ₁	forced expiratory volume in 1 second
EACA	ε-aminocaproic acid	FFP	fresh frozen plasma
EATT	excitatory amino acid transporter	FH/FHx	family history
EBL	estimated blood loss	FHR	fetal heart rate
EBV	Epstein-Barr virus	FHT	fetal heart tones
EC ₅₀	concentration that yields a half-maximal response	fib	fibrillation
ECCE	extracapsular cataract extraction	FIFRA	Federal Insecticide, Fungicide, and Rodenticide Act
ECCG	electrocardiogram	FKBP	tacrolimus-binding protein
ECHO	echocardiogram	fl	fluid
ECL	enterochromaffin-like cell	FMG	fine mesh gauze
ECMO	extracorporeal membrane oxygenation	FMO	flavine monooxygenase
ECT	electroconvulsive therapy	FNA	fine needle aspiration
ED	emergency department	FRAP	FKBP-rapamycin-associated protein
ED ₅₀	median effective dose	FROM	full range of motion
ED ₉₉	dose effective in 99% of the population	FSE	fetal scalp electrode
EDRF	endothelium-derived relaxing factor	FSH	follicle-stimulating hormone
EDTA	ethylenediamine tetraacetic acid	FSS	fetal scalp sampling
EEG	electroencephalogram/ electroencephalography	FTA-Abs	fluorescent treponemal antibody, absorbed
EENT	eye, ear, nose, and throat	FTNB	full-term newborn
EGA	estimated gestational age	FTSG	full-thickness skin graft
EGFR	epidermal growth factor receptor	FTT	failure to thrive
EGFR-TK	epidermal growth factor receptor— tyrosine kinase	FUO	fever of unknown origin
eIF-2	eukaryotic initiation factor	FUTP	fluoridine 5'-triphosphate
EKG	electrocardiogram	FVC	forced vital capacity
elix	elixir	Fx	fracture
EMG	electromyogram	G	gravid
EMLA	eutectic mixture of local anesthetics	G protein	guanine nucleotide-binding regulatory protein
ENG	electronystagmograph	ga	gestational age
ENT	ear, nose, and throat	GA	gastric analysis/general anesthesia
EOM	extraocular movements	GABA	γ-aminobutyric acid
EOMI	extraocular muscles intact	GAT	GAMA transporter
EPA	Environmental Protection Agency	GB	gallbladder
EPO	erythropoietin	GC	gonococcus
EPP	end plate potential	G-CSF	granulocyte colony-stimulating factor (filgrastim)
EPSP	excitatory postsynaptic potential	GDP	guanosine diphosphate
ER	emergency room	GERD	gastroesophageal reflux disease
ER/PR	estrogen receptor/progesterone receptor	GH	growth hormone
ERCP	endoscopic retrograde cholangiopancreatography	GHBA	good health before admission
erm	erythromycin-resistant methylase	GHD	growth hormone deficiency
ERP	effective refractory period	GHRF	growth hormone—releasing factor
ESBL	extended-spectrum β-lactamase	GI	gastrointestinal
ESR	erythrocyte sedimentation rate	GILZ	glucocorticoid-induced leucine zipper protein
ESRD	end-stage renal disease	GINA	Global Initiative for Asthma
ESWL	extracorporeal shock wave lithotripsy	GIP	glucose-dependent insulinotropic polypeptide
ET	ejection time	Gla	amino-terminal γ-carboxyglutamic acid
ET, ETT	endotracheal tube	GLP-1	glucagon-like peptide 1
ETOH	ethyl alcohol	GLSA	glycopeptide <i>Staphylococcus aureus</i>
ETS	endotracheal suction	Glut 4	glucose transporter 4
EUA	examination under anesthesia	GlyT	glycine transporter
Ex	examination	gm	gram
ext	external	GM-CSF	granulocyte-macrophage colony- stimulating factor (sargramostim)
ext	extract	GMP	Good Manufacturing Practices
ext	extremity	GNB	gram-negative bacilli
ext fl	fluid extract	GNR	gram-negative rods
F	factor		
F ⁻	fluoride ion		
F/U	follow-up		

GnRH	gonadotropin-releasing hormone	HOB	head of bed
GOAL	Gaining Optimal Asthma control study	HPF	high-power field
GOLD	Global Initiative for Chronic Obstructive Lung Disease	HPI	history of present illness
GP	glycoprotein	HPV	human papillomavirus
GPCR	G protein-coupled receptor	hr	hour
gr	grain	HR	heart rate
Grav. I	primigravida/one pregnancy	hs	at bedtime (<i>hora somni</i>)
GRE	glucocorticoid response element	HSCT	hematopoietic stem cell transplant
GRIP-1	glucocorticoid receptor interacting protein-1	HSV	herpes simplex virus
GRK	G protein-coupled receptor kinase	Ht	height
GSK-3 β	glycogen synthase kinase-3 β	HTN	hypertension
GSW	gunshot wound	HVD	hypertensive vascular disease
GTP	guanosine 5'-triphosphate	Hx	history
GTT	glucose tolerance test	Hz	hertz
G-tube	gastrostomy tube	HZV	herpes zoster virus
GU	genitourinary	I ⁻	iodide ion
GVHD	graft-versus-host disease	I&D	incision and drainage
GYN/Gyn	gynecology	I&O	intake and output
H&P	history and physical	i.e.	that is
H/O	history of	IADHS	inappropriate antidiuretic hormone syndrome
H ⁺	hydrogen ion	IAP	inhibitor of apoptosis protein
H ₁ , H ₂ , H ₃	histamine receptor	IBS	irritable bowel syndrome
H ₂ O	water	ICCE	intracapsular cataract extraction
H ₂ O ₂	hydrogen peroxide	ICD	implanted cardiac defibrillator
HA	headache	ICS	intercostal space
HAA	hepatitis-associated antigen	ICU	intensive care unit
HAART	highly active antiretroviral therapy	ID	infectious disease
HACEK (group)	<i>Haemophilus influenzae</i> , <i>Aggregatibacter actinomycetemcomitans</i> , <i>Cardiobacterium hominis</i> , <i>Eikenella corrodens</i> , <i>Kingella kingae</i>	IDDM	insulin-dependent diabetes mellitus
HAV	hepatitis A virus	IDL	intermediate-density lipoprotein
Hb, Hgb	hemoglobin	IDM	infant of diabetic mother
HbA _{1c}	hemoglobin A _{1c}	IE	infective endocarditis
HBO, HBO ₂	hyperbaric oxygen therapy	IFIS	inoperable floppy iris syndrome
HBP	high blood pressure	IFN	interferon
HBV	hepatitis B virus	IFN- γ	interferon- γ
HCG	human chorionic gonadotropin	Ig	immunoglobulin
Hcl	hydrochloric acid	IgA	gamma A immunoglobulin
HCP	home care partners	IgD	gamma D immunoglobulin
HCT	hematopoietic cell transplantation	IgE	gamma E immunoglobulin
Hct	hematocrit	IGF, IGF-I	insulin-like growth factor I
HCV	hepatitis C virus	IgG	gamma G immunoglobulin
HCVD	hypertensive cardiovascular disease	IgM	gamma M immunoglobulin
hd	high dose	IHD	ischemic heart disease
HDAC	histone deacetylase	IHSS	idiopathic hypertrophic subaortic stenosis
HDI	herb-drug interactions	IL	interleukin
HDL	high-density lipoprotein	IL-1	interleukin-1
HEENT	head, eyes, ears, nose, throat	IL-1R	interleukin-1 receptor
HETE	hydroxyecosatetraenoic acid	IL-1RA	interleukin-1 receptor antagonist
Hg ⁺	mercurous	IL-2	interleukin-2
Hg ⁺⁺	mercuric	IL-3	interleukin-3
Hg ⁰	elemental mercury (dental amalgam)	ILAE	International League Against Epilepsy
Hgb	hemoglobin	IM	intramuscular
HGT	horizontal gene transfer	IMF	intermaxillary fixation
HHN	handheld nebulizer	IND	Notice of Claimed Investigational Exemption for a New Drug
HIO	hypoiodous acid	INH	isonicotinic hydrazide
HIPAA	Health Insurance Portability and Accountability Act (of 1996)	iNOS	inducible nitric oxide synthetase (or synthase)
HIT	heparin-induced thrombocytopenia	INR	International Normalized Ratio
HIV	human immunodeficiency virus	int	internal
HLA	human leukocyte antigen	IOL	intraocular lens
HM	hand motion	IOP	intraocular pressure
HMG-CoA	3-hydroxy-3-methylglutaryl coenzyme A	IP	inositol phosphate
HMWK	high-molecular-weight kininogen	IP	<i>International Pharmacopoeia</i>
HNP	herniated nucleus pulposus	IP ₂	inositol bisphosphate
HO	house officer	IP ₃	inositol 1,4,5-triphosphate
		IPG	inositol phosphoglycan
		IPPB	intermittent positive pressure breathing
		IPPF	immediate postsurgical prosthetic fitting

IPSP	inhibitory postsynaptic potential	LGA	large for gestational age
IQ	intelligence quotient	LGV	lymphogranuloma venereum
IR	delayed outwardly rectifying current	LH	luteinizing hormone
irreg	irregular	LHRH	luteinizing hormone—releasing hormone
irrig	irrigation	Li ⁺	lithium ion
irrig/deb	irrigation/debridement	liq	aqueous solution
IS	incentive spirometer	LIS	low intermittent suction
ISA	intrinsic sympathomimetic activity	LJP	localized juvenile periodontitis
ITP	idiopathic thrombocytopenia purpura	LLL	left lower lobe
IU	international unit	LLQ	left lower quadrant
IUC	intrauterine catheter	LMP	last menstrual period
IUD	intrauterine device	LMWH	low-molecular-weight heparin
IUFD	intrauterine fetal demise	LNAT	large neutral amino acid transporter
IUFT	intrauterine fetal transmission	LND	lymph node dissection
IUGR	intrauterine growth retardation	LOA	left occipital anterior
IUP	intrauterine pregnancy	LOC	level/loss of consciousness
IV	intravenous	LOP	left occipital posterior
IV Cath	intravenous catheter	LP	lumbar puncture
IV Push	intravenous push	LPH	lipotropic pituitary hormone
IVC	inferior vena cava	LPO	left posterior oblique
IVC	intravenous cholangiogram	LPr	light perception
IVDA	intravenous drug abuse	LR	lactated Ringer's solution
IVF	in vitro fertilization	LRK2	leucine-rich repeat kinase 2
IVP	intravenous pyelogram	L-S	lumbosacral
IVPB	intravenous piggyback	LSD	lysergic acid diethylamide
IVVC	intravenous venacavogram	LSK	liver, spleen, kidney
JODM	juvenile-onset diabetes mellitus	LT	leukotriene
JRA	juvenile rheumatoid arthritis	LTB4	leukotriene B4
J-tube	jejunostomy tube	LTCF	long-term care facility
JVD	jugular vein distention	LTOT	long-term low-flow oxygen therapy
K ⁺	potassium ion	LUL	left upper lobe
K _d	dissociation constant	LUQ	left upper quadrant
kDa	kilodaltons	LV	left ventricle
Kg, kg	kilogram	LVAD	left ventricular assist device
KGD	lysine-glycine-aspartic acid sequence	L VH	left ventricular hypertrophy
KO	keep open	LVN	licensed vocational nurse
KUB	kidney, ureter, bladder	LVRS	lung volume reduction surgery
L	large	M	married
L	left	M	million
L	liter	M	muscarinic receptor (protein)
L	long-lasting current	m, m	murmur/meter
L ₁ , L ₂ , ...	first lumbar vertebrae, second lumbar vertebrae, ...	MA	mental age
LA	left atrium	Mab	monoclonal antibody
LAD	left anterior descending (coronary artery)	MAC	medical ambulatory care
LAE	left atrial enlargement	MAC	minimum alveolar concentration
LAK	lymphokine-activated killer (cell)	MAC	monitored anesthesia care
LAO	left anterior oblique	MAO	monoamine oxidase
LAP	laparotomy	MAOI	monoamine oxidase inhibitor
LAP	left atrial pressure	MAP	mean arterial blood pressure
LAP	leucine amino peptidase	MASCC/ISOO	Multinational Association for Supportive Care in Cancer and the International Society of Oral Oncology
LAP	leukocyte alkaline phosphatase		
LASH	left interior superior hemiblock	MAT	multifocal atrial tachycardia
lat	lateral	mcg, μg	microgram
LAV	lymphadenopathy-associated virus	MCH	mean corpuscular hemoglobin
lb	pound	MCHC	mean corpuscular hemoglobin concentration
LB BB	left bundle branch block		
LC	locus coeruleus	mChR	muscarinic cholinergic receptor
LCS	low constant suction	MCL	midclavicular line
LD	lattice degeneration	MCP	mean corpuscular volume
LD	light difference	MCP	metacarpophalangeal
LD ₅₀	median lethal dose	MCP-1	monocyte chemoattractive protein-1
LDH	lactic dehydrogenase	m-CPP	<i>m</i> -chlorophenylpiperazine
LDL	low-density lipoprotein	M-CSF	monocyte/macrophage colony-stimulating factor
L-dopa	levodopa		
LE	lower extremity	MCV	mean corpuscular volume
LEEP	loop electrosurgical excision procedure	MD	muscular dystrophy
LFA-1	leukocyte function antigen-1	MDD	major depressive disorder
LFT	liver function test	MDMA	3,4-methylenedioxymethamphetamine

MDP	maximum diastolic potential	MVR	mitral valve replacement/regurgitation
MDR	multidrug resistant protein	MW	molecular weight
MDR-1	multidrug resistance protein-1	N	nicotinic
MDS	myelodysplastic syndrome	N&V	nausea and vomiting
MEA	multiple endocrine adenoma syndrome	N/A	not applicable
meds	medications/medicine	N ₂ O	nitrous oxide
MEOS	microsomal enzyme oxidation system	Na ⁺	sodium ion
MEPP	miniature end plate potential	Na ⁺ ,K ⁺ -ATPase	Na ⁺ ,K ⁺ -activated adenosine triphosphatase
mEq	milliequivalent	NAD	no acute distress
mets	metastatic	NAD (NADH)	nicotinamide adenine dinucleotide
MFP	sodium monofluorophosphate	NADPH	nicotinamide adenine dinucleotide phosphate
MG	myasthenia gravis	NAM	N-acetylmuramic acid
mg	milligram	NAPA	N-acetylprocainamide
Mg ⁺⁺	magnesium ion	NAPQI	N-acetyl- <i>p</i> -benzoquinoneimine
MGLuR	metabotropic glutamate receptor	NB	newborn
MH	malignant hyperthermia	NBD	nucleotide-binding domain
MHC	major histocompatibility gene complex	NC	noncontributory
MHPG	3-methoxy-4-hydroxyphenylglycol	NC/AT	normocephalic/atramatic
MI	mitral insufficiency	NCCAM	National Center for Complementary and Alternative Medicine
MI	myocardial infarction	NCCLS	National Committee for Clinical Laboratory Standards
MIC	minimum inhibitory concentration	NCEP	National Cholesterol Education Program
MICU	medical intensive care unit	NDA	New Drug Application
MIT	monoiodotyrosine	NE	norepinephrine
MKP-1	mitogen-activated protein kinase phosphatase-1	NEC	necrotizing enterocolitis
μL	microliter	NED	normal equivalent deviation units
mL	milliliter	neg	negative
MLC	minimum lethal concentration	NET	nasoendotracheal
MLCK	myosin light-chain kinase	NET	norepinephrine transporter
MLKS (resistance)	macrolide, lincosamide, ketolide, streptogramin	NF	<i>National Formulary</i>
MLS _B	macrolide-lincosamide-streptogramin B (aggregate gene)	NF-ATc	cytoplasmic component of nuclear factor of activated T cells
mm	millimeter	NF-ATn	nuclear component of nuclear factor of activated T cells
MM	mucous membrane	NF-κB	nuclear factor (κB)
MMAD	mass median aerodynamic diameter	Ng	nicotinic receptor, ganglia
MMPI	matrix metalloprotease inhibitor	NG	nasogastric
MN	midnight	NGB	neurogenic bladder
Mod	moderate	NGT	nasogastric tube
MOM	milk of magnesia	NGTD	no growth to date (bacterial cultures)
MOPP	mechlorethamine, Oncovin (vincristine), procarbazine, prednisone (regimen)	NHANES	National Health and Nutrition Examination Survey
MPHG	3-methyl-4-phenyl-pyridinium	NHL	non-Hodgkin's lymphoma
MPP ⁺	1-methyl-4-phenylpyridinium	NHLBI	National Heart, Lung, and Blood Institute
MPTP	1-methyl-4-phenyl-1,2,3,6-tetrahydropyridine	NI	nosocomial infection
MR	may repeat	NICE	National Institute of Health and Clinical Excellence
MR	mental retardation	NICU	neonatal intensive care unit
MR	mitral regurgitation	NIDDM	non—insulin-dependent diabetes mellitus
MRCoNS	methicillin-resistant coagulase-negative staphylococci	NK	natural killer (cell)
MRI	magnetic resonance imaging	NKA	no known allergies
MRP	multidrug resistance-associated protein	NKDA	no known drug allergies
MRSA	methicillin-resistant <i>Staphylococcus aureus</i>	NLD	nasolacrimal duct
MS	mitral stenosis	NLP	no light perception
MS	morphine sulfate	N _M	nictonic (receptor), muscle type
MS	multiple sclerosis	Nm	nicotinic receptor on neuromuscular junction
MSKL	musculoskeletal	NMDA	N-methyl-D-aspartate
MSL	midsternal line	NME	new molecular entity
MSSA	methicillin-sensitive <i>Staphylococcus aureus</i>	NMR	nuclear magnetic resonance
MTIC	monomethyl 5-triazinoimidazole carboxamide	NMS	neuroleptic malignant syndrome
MUGA	multigated acquisition (a nuclear echocardiogram)	N _N	nicotinic (receptor), nerve type
MVA	motor vehicle accident	Nn	nicotinic receptor on postganglionic cells
MVI	multivitamins	NNT	number needed to treat
MVP	mitral valve prolapse	NO	nitric oxide
		noc	night

NOS	nitric acid synthetase (or synthase)	PaCO ₂	partial pressure of carbon dioxide in arterial blood
NPH (insulin)	neutral protamine Hagedorn	PACU	postanesthesia care unit
NPI	National Provider Identifier	PAE	postantibiotic effect
NPN	nonprotein nitrogen	PAF	platelet-activating factor
NPO	nothing by mouth	PAG	periaqueductal gray matter
NPT-1	Na ⁺ /phosphate transporter-1	PAI-1	plasminogen activator inhibitor type 1
NPY	neuropeptide Y	PALC	postantibiotic leukocyte effect
NRM	nucleus raphe magnus	PALS	pediatric advance life support
NS	normal saline/neurosurgery	PaO ₂	partial pressure of oxygen in arterial blood
NSAID	nonsteroidal anti-inflammatory drug	PAP	pulmonary artery pressure
NSCLC	non—small cell lung cancer	Pap S	Papanicolaou smear
NSILA	nonsuppressible insulin-like activity	PAR	postanesthesia recovery
NSPH	nonspecific plaque hypothesis	PAR	protease-activated receptor
NSR	normal sinus rhythm	Para I	primipara/one live birth
NSVD	normal spontaneous vaginal delivery	PAS	p-aminosalicylic acid
NTG	nitroglycerin	PAT	paroxysmal atrial tachycardia (now usually said SVT)
NTS	nucleus tractus solitarius	Path	pathology
NTT	nasotracheal tube	PAWP	pulmonary artery wedge pressure
NVDC	nausea, vomiting, diarrhea, constipation	PBI	protein-bound iodine
NYHA	New York Heart Association	PBP	penicillin-binding protein
O&P	ova and parasites	PBSCT	peripheral blood stem cell transplants
O:	objective	PC	1-phenyl-1-cyclohexene
O ₂	oxygen	PC	posterior chamber
O ₃	ozone	pc	after meals (post cibum)
OA	occiput anterior	PCA	patient-controlled analgesia
OA	osteoarthritis	PCMX	parachlorometaxyleneol
OAT	organic anion transporter	PCN	penicillin
OATP	organic anion—transporting polypeptide	PCP	phenacyclidine
OB	obstetrics	PCP	<i>Pneumocystis carinii</i> pneumonia
ob	occult blood	PCP	primary care physician
OBRA	Omnibus Budget Reconciliation Act	PCTA	percutaneous coronary transluminal angioplasty
OBS	organic brain syndrome	PDA	patent ductus arteriosus
OCT	organic cation transporter	PDC	potential-dependent channel
OD	right eye (oculus dexter)	PDGF	platelet-derived growth factor
OD	overdose	PDR	<i>Physicians' Desk Reference</i>
oint	ointment	PDUFA	Prescription Drug User Fee Act
OM	otitis media	PE	physical examination
OMPA	octamethyl pyrophosphamide	PE	pulmonary edema
OmpF	outer membrane protein F	PE	pulmonary emboli
ONJ	osteonecrosis of the jaw	PEEP	positive end-expiratory pressure
OP	occiput posterior	PEG	percutaneous enterogastric tube
OP, op	operation	PEG	pneumoencephalogram
OPC	outpatient clinic	PEG	polyethylene glycol
OPD	outpatient department	PEG-MGDF	pegylated megakaryocyte growth and development factor
ophth	ophthalmic	per	by/through
OPP	Office of Pesticide Programs	PERRLA	pupils equal, round, reactive to light and accommodation
OPS	outpatient surgery	PET	positron emission tomography
OR	operating room	P-F	phosphofluoride linkage
ORIF	open reduction internal fixation	PF-3	platelet factor 3
ORL	opioid receptor—like	PFC	perfluorocarbon
ORN	osteoradionecrosis	PFTs	pulmonary function tests
Ortho	orthopedics	PG	prostaglandin
OS	left eye (oculus sinister)	PGG ₂ , PGH ₂	prostaglandin endoperoxides
OSHA	Occupational Safety and Health Administration	PGI ₂	prostacyclin
OT	occupational therapy	pH	acidity index
OTC	over-the-counter	PHPV	primary hyperplastic vitreous
Oto	otology	PHx	past history
OU	both eyes (oculus uterque)	PI	peripheral iridectomy
p	para	PI	present illness
P	peptidergic receptor	PI	principal investigator
P	pulse	PICC	peripherally inserted central catheter
P	purine receptor	PID	pelvic inflammatory disease
P:	plan		
P&A	percussion and auscultation		
PA	posteroanterior		
PABA	p-aminobenzoic acid		
PAC	premature atrial contraction		

plgR	polymeric immunoglobulin receptor	q.h.	every hour, hourly
PIP	proximal interphalangeal	q.h.s.	every night at bedtime
PIP ₂	phosphatidylinositol 4-5-bisphosphate	q.i.d.	four times daily (quarter in die)
PJC	premature junctional contraction	q.n.s.	quantity not sufficient
PJI	prosthetic joint infection	q.o.d.	every other day
pK _a	negative log of the dissociation constant	q.o.h.	every other hour
PKP	penetrating keratoplasty	q.s.	quantity sufficient
PKU	phenylketonuria	q2 (3, 4, ...) d.	every 2 (3, 4, ...) days
PLC	phospholipase C	q2 (3, 4, ...) h.	every 2 (3, 4, ...) hours
PLO	pleuronic lecithin organogel	q2 (3, 4, ...) n.	every 2 (3, 4, ...) nights
plt	platelet	R	resistance factor
pm	postmeridian	R	respiration
PMB	postmenopausal bleeding	R	right
PMC	pseudomembranous colitis	R/O	rule out
PMD	private medical doctor	RA	rheumatoid arthritis
PMH/PMHx	past medical history	RA	right atrium
PMI	point of maximum impulse	RAE	right atrial enlargement
PMN	polymorphonuclear (leukocyte)	RAI	radioactive iodine
PMP	previous menstrual period	RANKL	RANK ligand
PND	paroxysmal nocturnal dyspnea	RAO	right anterior oblique
PND	postnasal drip	RAR	retinoid acid receptor
PNMT	phenylethanolamine-N-methyltransferase	RBBB	right bundle branch block
PNP	pediatric nurse practitioner	RBC	red blood count
po	by mouth (per os)	RD	Raynaud's disease
PO	postoperative	RD	retinal detachment
POC	products of conception	RDS	respiratory distress syndrome
PO/IM	oral/intramuscular potency ratio	reg	regular
PP	postpartum	Rehab	rehabilitation
PP	postprandial	REM	rapid eye movement (sleep)
PPAR α	peroxisomal proliferators—activated receptor α	RF	rheumatic fever
PPBS	postprandial blood sugar	RGD	arginine-glycine—aspartic acid sequence
PPD	purified protein derivative	RH	releasing hormone
PPH	postpartum hemorrhage	Rh	Rhesus factor
PPI	protein pump inhibitor	RHD	rheumatic heart disease
ppm	parts per million	RLL	right lower lobe
PPP	postpartum psychosis	RLQ	right lower quadrant
pr	per rectum	RML	right middle lobe
PRBC	packed red blood cells	RN	Registered Nurse
pre-op	preoperative	RNA	ribonucleic acid
PRH	prolactin-releasing hormone	RND	radical neck dissection
prn	<i>pro re nata</i> (as needed)	RNP	ribonucleoprotein
PROM	premature rupture of membranes	ROA	right occipital anterior
PRON	postradiation osteonecrosis	ROC	receptor-operated channel
PRSTN	postradiation soft tissue necrosis	ROM	range of motion
PS	pulmonary stenosis	ROM	right otitis media
PSI, psi	pounds per square inch	ROM	rupture of membranes
PSS	progressive systemic sclerosis	ROP	right occipital posterior
Psy	psychiatry/psychology	ROS	reactive oxygen species
PT	prothrombin time	ROS	review of systems
PT	physical therapy	RPO	right posterior oblique
pt	patient	RPT	Registered Physical Therapist
PTA	prior to admission/plasma thromboplastin antecedent	RR	respiratory rate
PTCA	percutaneous transluminal coronary angioplasty	RRR	regular rate and rhythm
PTH	parathyroid hormone	RSR	regular sinus rhythm
PTT	partial thromboplastin time	RSV	respiratory syncytial virus
PUD	peptic ulcer disease	RT	respiratory therapy
PUFA	polyunsaturated fatty acids	RT/RAD Rh	radiation therapy
pulv	powder	RTC	return to clinic
PUVA	psoralen plus ultraviolet A	RTF	resistance transfer factor
pv	per vagina	RUA	routine urinalysis
PVC	premature ventricular contraction	RUL	right upper lobe
PVR	postvoid residual	RUQ	right upper quadrant
q	every (<i>quaque</i>)	RV	right ventricle
q.a.m./q.p.m.	every morning/every evening	RVH	right ventricular hypertrophy
q.d.	every day, daily	RVM	rostromedullary medulla
		R _x	prescription
		RXR	retinoid X receptor
		S	Svedberg unit

S/P	status post	SRS-A	slow-reacting substance of anaphylaxis (leukotrienes)
S/S	signs/symptoms	SSRI	selective serotonin reuptake inhibitor
S:	subjective	SSS	sick sinus syndrome
S ₁ , S ₂ , S ₃	first, second, and third sacral vertebrae	STAT	signal transducers and activators of transcription
S ₁ , S ₂ , S ₃ , S ₄	systolic heart sounds	STAT	immediately (<i>statum</i>)/at once
SA	sinoatrial (node)	STD	sexually transmitted disease
Sab	spontaneous abortion	STD	skin test dose
SAD	seasonal affective disorder	STD	standard
SaO ₂	saturation of oxygen in arterial blood	STS	serology test for syphilis
SAR	structure-activity relationship	STSG	split-thickness skin graft
SB	stillbirth	subcut	subcutaneous
SBA	standby assistance	supp	suppository
SBE	subacute bacterial endocarditis	SV2	synaptic plasma membrane protein
SBFA	single baby for adoption	SVT	supraventricular tachycardia
SBO	small bowel obstruction	Sx	symptom(s)
SBP	spontaneous bacterial peritonitis	syr	syrup
SC	subcutaneous	T	temperature
SCF	stem cell factor	T	tension
SD	standard deviation	T	tonsillectomy and adenoidectomy
SDA	same-day admission	T&A	thoracic vertebrae first, second, ...
SEM	standard error of the mean/scanning electron microscope	T ₁ , T ₂ , ...	half-life, half-time
SEM	systolic ejection murmur	T _{1/2}	triiodothyronine, liothyronine
Sep	separated	T ₃	tetraiodothyronine/thyroxine/levothyroxine
SERM	selective estrogen receptor modulator	T ₄	
SGA	small for gestational age	tab	tablet
SGOT	serum glutamic-oxaloacetic transaminase (now AST)	TAB	therapeutic abortion
SGPT	serum glutamic-pyruvic transaminase (now ALT)	TAH	total abdominal hysterectomy
SHV	sulfhydryl variable	TALH	thick ascending limb of the loop of Henle
SI	serious illnesses	TAT	tetanus antitoxin
SIADH	syndrome of inappropriate antidiuretic hormone secretion	TAT	toxin-antitoxin
SIF	small, intensely fluorescent (cell)	TB	tuberculosis
Sig	let it be labeled	TBG	thyroxine-binding globulin
Sig	significant	TBI	total body irradiation
SK	streptokinase	TBI	traumatic brain injury
SKB	single, keeping baby	tblsp	tablespoon
SKF 525A	proadifen	TCA	tricyclic antidepressant
SL	sublingual	TCC	transitional cell carcinoma
SLC	solute carrier	TCDB	turn, cough, deep breath
SLE	systemic lupus erythematosus	TCDD	dioxin
SLUD	salivation, lacrimation, urination, defecation	TCR	T-cell antigen receptor
SMA	sequential multiple analyzer	TD ₅₀	median therapeutic dose
SMART	Salmeterol Multi-Center Asthma Research Trial	TEA	tetraethylammonium
SMR	submucous reaction	TEF	tracheoesophageal fistula
SNARE (complex)	synaptobrevin, syntaxin, SNAP-25	TF	tissue factor
SNC	substantia nigra pars compacta	TF	tube feeding
SNP	single nucleotide polymorphism	TFPI	tissue factor pathway inhibitor
SNS	sympathetic nervous system	TGF- γ	transforming growth factor- γ
SO ₂	Sulfur dioxide	TGV	transposition of great vessels
SOB	shortness of breath	THC	tetrahydrocannabinol
sol	solution	THC	transhepatic cholangiogram
SP	substance P	THO	activated T cells that have yet to differentiate
SP	suprapubic	THR	total hip replacement
sp gr	specific gravity	TI	therapeutic index
SPA	stimulation-produced analgesia	TIA	transient ischemic attack
SPECT	single-photon emitted computed tomography	TIBC	total iron-binding capacity
SPH	specific plaque hypothesis	tid	three times a day
SQ	subcutaneous	TIPS	transjugular intrahepatic portosystemic shunt
SR	sarcoplasmic reticulum	TKO	to keep open
SRC-1	steroid receptor coactivator-1	TKR	total knee replacement
SROM	spontaneous rupture of membranes	TLC	total lung capacity
SRS	slow-reacting substance (leukotrienes)	TM	transmembrane helice
		TM	tympanic membrane
		TM1	transmembrane helix 1
		TMD	temporomandibular disorder

TMD	transmembrane domain	UTI	urinary tract infection
TMJ	temporomandibular joint	UTZ	ultrasound
TMN	tumor, metastases, nodes	UV	ultraviolet
TNF	tumor necrosis factor	V Fib	ventricular fibrillation
TNF- α	tumor necrosis factor- α	VA	visual acuity
TNFR	tumor necrosis/nerve growth factor receptor	VC	vital capacity
TO	telephone order	VCUG	voiding cystourethrogram
TOA	tubo-ovarian abscess	V _d	volume of distribution
TOF	tetralogy of Fallot	VD	venereal disease
t-PA	tissue-type plasminogen activator	VDRL	Venereal Disease Research Laboratory (test for syphilis)
TPMT	thiopurine S-methyltransferase	V _D V _T	physiologic dead space in percent of tidal volume
TPN	total parenteral nutrition	VE	vacuum extraction
TPO	thrombopoietin	VEGF	vascular endothelial growth factor
TPR	total peripheral resistance	VF	ventricular fibrillation
TPR	temperature, pulse, and respiration	VGS	viridans group streptococci
tr	tincture	VIP	vasoactive intestinal peptide
TRH	thyrotropin-releasing hormone	VIPPS	Verified Internet Pharmacy Practices Site
TRP	transient receptor potential (channels)	VISA	vancomycin-intermediate-resistant <i>Staphylococcus aureus</i>
TRPV1	transient receptor potential vanilloid receptor 1	viz	namely
tRNA	transfer RNA	VKOR	vitamin K epoxide reductase
trt	treatment	VLDL	very-low-density lipoprotein
TS	thoracic surgery	VMA	vanillylmandelic acid
TSH	thyroid-stimulating hormone; thyrotropin	VO	verbal order
tsp	teaspoon	vol	volume
TT	thrombin time	VRE	vancomycin-resistant enterococci
TTA	transtracheal aspiration	VRG	vessel-rich group
TTN	transient tachypnea of newborn	vs	versus
TURB	transurethral resection of the bladder	VS	vital signs
TURP	transurethral resection of the prostate	VSD	ventricular septal defect
TV	tidal volume	VSS	vital signs stable
TVH	total vaginal hysterectomy	VT	ventricular fibrillation
Tx	treatment, therapy	vWD	von Willebrand's disease
TXA ₂	thromboxane A ₂	vWf	von Willebrand factor
U	uptake	VZV	varicella-zoster virus
UA	umbilical artery	w/c	wheelchair
UA	urinalysis	w/d	wet to dry
UC	uterine contraction	w/o	without
UCHD, UCD	usual childhood diseases	w/u	workup
UE	upper extremity	w/w	wet to wet
UGI	upper gastrointestinal	W-3 PUFA	W-3 polyunsaturated fatty acid
UGT	uridine diphosphate glucuronosyltransferase	WB	whole blood
UNPIC	Prior Informed Consent (procedure)	WBC	white blood cell, leukocyte count
UOP	urinary output	wd	wound
u-PA	urokinase plasminogen activator	WDWN	well-developed, well-nourished
UPDRS	Unified Parkinson's Disease Rating Scale	WF, BF	white female, black female
UPP	urethral pressure profile	WHO	World Health Organization
URI	upper respiratory infection	WM, BM	white male, black male
USAN	United States Adopted Name	WNL	within normal limits
USANC	United States Adopted Name Council	wt	weight
USN	ultrasonic nebulizer	x	times
USP	<i>United States Pharmacopeia</i>	y/o, yo, yrs	years old
USPDI	<i>United States Pharmacopeia Dispensing Information</i>		

This page intentionally left blank

A

- Abacavir, for human immunodeficiency virus infection, 655
- Abatacept, for rheumatoid arthritis, 352
- ABC transporters. *See* ATP-binding cassette (ABC) transporters.
- Abciximab
for myocardial infarction prevention, 429
for platelet inhibition, 506
proprietary name of and indications for, 675t
- Abnormal involuntary movements, in
Parkinson's disease, levodopa and, 237
- Abortion, spontaneous, from cocaine, 806
- Abscess(es)
antibiotic use and, 592
brain
absolute risk rate for, from single dental procedure, 774b
antibiotic prophylaxis for dental patients with, 777-778
orofacial, 600
microorganisms associated with, 601t
periodontal, 601-602
- Absence seizures, 212, 213t
drugs exacerbating, 214-215
succinimides for, 221-222
valproic acid for, 220-221
- Absorption, major pathways of, 18f
- Abstinence syndrome, definition of, 800
- Abuse
benzodiazepines, potential for, 194
drug, 59. *See also* Drug abuse.
drugs of, 799-813. *See also* Drug abuse.
- Acamprosate, for alcoholism, 718
- Acanthocytes, description of, 471b
- Acarbose
for diabetes, 564
structural formula of, 561f
- ACE inhibitors. *See* Angiotensin-converting enzyme (ACE) inhibitors.
- Acebutolol
for arrhythmias, 404
pharmacologic effects of, 110t
- Acetaldehyde
ethanol intolerance and, 715
production of, in ethanol metabolism, adverse effects of, 715
- Acetaminophen, 345-348
absorption, fate, and excretion of, 346f, 347
actions of, 302
adverse effects of, 347-348
aspirin combinations with, 348, 349t
chemistry of, 345
COX inhibitory activity of, vs. nonsteroidal anti-inflammatory drugs, 332t
dosages of, 346t
ethanol and, 714
mechanism of action of, 345-346
for pain control, 754
pharmacologic effects of, 346-347
phase I reactions in, 35t-36t
phase II metabolic reactions in, 37t
in renal failure, dosage adjustments needed in, 51t
structural formula of, 346f
therapeutic uses of, 347
in dentistry, 347
- Acetanilid
phase I reactions in, 35t-36t
structural formula of, 346f
- Acetazolamide, 438
for seizures, 224
therapeutic uses of, 216t
- Page numbers followed by *b* indicated boxes; *f*, figures; *t*, tables.
- Acetohexamide, pharmacokinetics of, 562t
- Acetylation, genetic polymorphisms in, 72
- Acetylcholine (ACh), 80-82
actions of, 119f, 121, 122f, 129-130
agents mimicking actions of, 117-128.
See also Cholinergic drugs.
atropine inhibition of, 11
deficiency of, in Alzheimer's disease, 127
fate of, 85
histamine and, 362
in neuromuscular transmission, 140
in neurotransmission, 136, 155, 156t
pharmacologic effects of, 118-119
receptor for, in myasthenia gravis, 126
release of, mechanism of, 82, 83f
synthesis and release of, 82, 83f, 85
- Acetylcholine chloride, structure of, 118f
- ACh. *See* Acetylcholine (ACh).
- Acid-base status. *See* pH.
- Acid ionization constant, of local anesthetics, 246-248, 247t, 248f
- Acidity, tissue, local anesthetic action and, 246-248
- Acidulated phosphofluoride solutions, professional application of, 725-726
- Acne, tetracycline for, 625
- Acquired immunodeficiency syndrome (AIDS)
anorexia related to, dronabinol for, 809
in drug-abusing patient, 811
drugs active against, 654-656. *See also* Human immunodeficiency virus (HIV), drugs active against.
oral viral lesions with, treatment for, 656-657
- Acrivastine, structural formula and dosages of, 363t-364t
- ACTH. *See* Adrenocorticotropic hormone (ACTH).
- Actin, in platelet activation, 488, 488f
- Actinomycin D, for cancer, 686t-692t, 696
- Actinomycosis, cervicofacial, microbiology of, 603
- Action potential(s)
antiarrhythmic drug effects on, 398f
local anesthetic action and, 248, 249f
membrane, 393, 395f
of SA nodal cell and purkinje fiber, 393, 395f
in neurotransmitter release, 157-158
- Actisite, for local oral drug delivery, 739
- Activated charcoal, as adsorbent, 530
- Activated partial thromboplastin time, 492
in heparin activity monitoring, 502
- Active immunization, 671-672
- Active transport
across membranes, 19-20
drug absorption by, 23, 23f
in renal excretion of drugs, 40
- Activities of daily living, oral bacteremia resulting from, vs. dental procedures, 772, 774-775, 775b
- Acute coronary insufficiency, 422
- Acyclovir
for herpes virus infections, 648t, 651-652, 651f
for herpetic oral mucosal lesions, 656
mechanism of action of, 651f
for oral HSV infections, 787
prophylactic, for HSV infections in immunocompromised patients, 790
structural formula of, 650f
- Adalimumab
proprietary names of and indications for, 675t
for rheumatoid arthritis, 352
- Adaptive immunologic responses, 661
- Addiction
to cocaine, 806
definition of, 314, 800
to marijuana, 809
to opioid analgesics, 756
- Addison's disease, replacement therapy for, 552
- Adefovir dipivoxil, for hepatitis B virus, 654
- Adenine, structural formula of, 694f
- Adenyl cyclase
in G protein-linked receptor action, 3-4
in opioid analgesia, 311
- Adenosine
actions of, 400t
adverse effects of, 407, 408t
for arrhythmias, 406-407
for emergency use, 846t-848t, 848
indications for, 407t
pharmacokinetic properties of, 401t
pharmacologic effects of, 406-407
structural formula of, 406f
- Adenosine arabinoside (ara-A), for herpes virus infections, 650-651
- Adenosine diphosphate (ADP)
inhibitors of, for platelet inhibition, 506
in platelet activation, 487-489
- Adenosine triphosphate (ATP)
in cardiac muscle contraction, 410
norepinephrine and, co-release of, 88-89, 88f
in purinergic transmission, 88
- Adenosine triphosphate P2X receptors, on nociceptive neurons, 301
- Adenylyl cyclase
muscarinic receptor activity and, 118
serotonin receptor activity and, 376-378
- Adjuvants, for vaccines, 672-673
- Adrenal cortex, compartments and hormones of, 549, 550f
- Adrenal corticosteroids. *See* Corticosteroids.
- Adrenal insufficiency, acute, replacement therapy for, 552
- Adrenal medulla, tissue from, grafting of, for Parkinson's disease, 241
- Adrenal suppressants, for cancer, 686t-692t
- Adrenal suppression, glucocorticoid therapy and
dental practice and, 554-555
surgical procedures and, 555
- Adrenergic agonists, 91-105
 α , 96-97
pharmacologic effects of, 96
absorption, fate, and excretion of, 98-99, 98f
adverse effects of, 103
classification of, 91
history of, 91
for hypertension, 101, 103b-104b
mixed and indirect-acting, 97-98
names of, 103b-104b
pharmacologic effects of, 93-98, 93t
receptor selectivity of, 93t
structural formulas of, 91-92, 92f
structure-activity relationships of, 91-93, 92t
therapeutic uses of, 99-101
in dentistry, 101-103, 101t
- Adrenergic antagonists, 106-116
 α
names of, 115b
nonselective, adverse effects of, 113t
 α_1 , selective, adverse effects of, 113t
 α/β , names of, 115b
 β , 109-114
adverse effects of, 113t
for arrhythmias, 111
chemistry of, 109, 111f

- Adrenergic antagonists (*Continued*)
 comparison of, 110t
 for congestive heart failure, 413
 history of, 109
 for hypertension, 111-112
 names of, 115b
 nonselective, 109, 110t
 pharmacologic effects of, 109-112, 110t
 selective, 110t
 structural formula of, 111f
 therapeutic uses of, 112-113
 in dentistry, 115
 history of, 106
 names of, 115b
- Adrenergic junctions
 drugs acting in, 89t
 locations of, 82
- Adrenergic neuron blocking drugs
 adverse effects of, 113t
 names of, 115b
- Adrenergic neurotransmission, 82-85
 adrenergic receptors in, 83-85
 biosynthesis of neurotransmitters in, 85f
 catecholamine release and synthesis in, 82-83, 85f
 drugs affecting, for hypertension, 450-451
- Adrenergic receptor agonists. *See also* Catecholamines.
 α , structural formula of, 96f
 α_2
 for muscle relaxation, 206-207
 selective, adverse effects of, 113t
 for asthma, epinephrine as, 515-516
 β
 pharmacologic effects of, 97
 sensitivity to, in elderly, 839
 β_2
 for asthma
 adverse effects of, 514-515
 albuterol as, 515
 corticosteroids interacting with, 515
 mechanism of action of, 513-514
 metaproterenol as, 515
 pharmacologic effects of, 514
 salmeterol as, 515
 terbutaline as, 515
 selective, pharmacologic effects of, 97
 structural formulas of, 514f
 β_3 , 109
 for glaucoma, 125t
- Adrenergic receptor antagonists
 α
 names of, 456b-457b
 nonselective, 108-109, 108f
 α_1 , selective
 adverse effects of, 107-108
 for hypertension, 449-450
 therapeutic uses of, 107
 α/β , 114
 names of, 456b-457b
 α_1/β , for hypertension, 450
 β
 absorption, fate, and excretion of, 112
 adverse effects of, 113-114, 113t
 for angina, 112, 422
 absorption, fate, and excretion of, 426
 adverse effects of, 426
 pharmacologic effects of, 426
 sites of action of, 423f
 for anxiety, 206
 for arrhythmias, 113, 404-405
 for emergency use, 846t, 848
 for glaucoma, 125t
 for hypertension, 448-450
 absorption, fate, and excretion of, 448
 adverse effects of, 448-449
 pharmacologic effects of, 448
 indications for, 407t
 local anesthetic vasoconstrictor interactions with, 455-456
 for migraine, 384, 384t
 for myocardial infarction prevention, 429
 names of, 429t-430t, 456b-457b
 for Parkinson's disease, 241
 sensitivity to, in elderly, 839, 843
- Adrenergic receptor(s), 82-85
 α , drugs acting at
 names of, 391t
 for neuropathic orofacial pain, 389
 α_1 , anesthetic action of, 272
 α_2 , anesthetic action of, 270
 in antidepressant action, 174
 β , genetic polymorphisms of, 74
 β_2 , norepinephrine binding to, 6-7, 6f
 blockade of, 163t
 classification of, 91
- Adrenocorticosteroids, for chronic orofacial pain, 385
- Adrenocorticotrophic hormone (ACTH)
 in corticosteroid production, 549
 suppression of, glucocorticoid therapy and, 554
- Adsorbents, 530
- Advanced cardiac life support (ACLS)
 emergency drugs for, 846-849, 846t
 training in, 843-844
- Adverse drug reactions, 54-59. *See also* Drug interactions; *subheading* adverse effects of *under specific drug names*.
 allergic, 56-58
 carcinogenic, 58
 classification of, 54-58
 in elderly, 836-837, 837t
 prevention of, 836-837
 from extension of therapeutic effect, 54-55, 55t
 genetic factors and, 52, 304
 idiosyncratic, 55-56, 57t
 pseudoallergic, 58
 secondary, 58
 from side effects, 55, 56t
- Aerosol propellants, abuse of, 810
- Aerosols, drug absorption and, 24
- Affective disorders, 164-165
- Afterdepolarization, in cardiac arrhythmias, 394-395, 394f
- Age/aging. *See also* Elderly patients.
 dental practice and, 839-840
 drug effects and, 49-50
 drug metabolism and, 39
 medical emergencies and, 842
 nonphysiologic changes associated with, 835-838
 pharmacologic changes associated with, 838-839
 physiologic changes associated with, 834-835, 835f
- Agent Orange, 817, 829
- Agomelatine, for sleep disturbances, 198
- Agonist(s)
 action of, 9-10
 stimulus-response theory and, 11
 inverse, 13-15
- Agranulocytosis, antibiotic-induced, 594
- AIDS. *See* Acquired immunodeficiency syndrome (AIDS).
- Airway smooth muscle, β blocker effects on, 111, 114
- Airways, hyperresponsiveness of, in asthma, 511
- Akathisia, antipsychotic drug action and, 169-170
- Albumin, in drug binding, 29
- Albuterol
 for asthma, 515
 duration of action of, 513
 for emergency use, 844t, 845
 pharmacologic effects of, 97
 structural formula of, 514f
 structure-activity relationships of, 92t
- Alcohol(s)
 acetaminophen interactions with, 348
 aliphatic, 711-719, 712t
 ethanol as, 711-718. *See also* Alcoholism; Ethanol.
 ethylene glycol as, 719
 isopentanol as, 718
 isopropyl alcohol as, 718-719
 methanol as, 718
 propylene glycol as, 719
 antimicrobial activity of, 745t
- Alcohol(s) (*Continued*)
 aspirin interactions with, 336
 beverages containing, blood alcohol equivalents of, 713t
 capacity-limited kinetics of, 41
 chloral hydrate with, 195t, 202
 denatured, 711
 as disinfectants and antiseptics, 748
 names of, 749b
 for oral sedation, 765
 for sedation, 294-295
 thiopental with, 200-201
- Alcohol abstinence syndrome, 715
- Alcohol dehydrogenase, in ethanol metabolism, 713-714
- Alcohol withdrawal, benzodiazepine therapy for, 197-198
- Alcoholism, 715-718
 pathologic sequelae of, 715-717, 716t
 treatment of, 717-718
- Aldactazide, components of, 434t
- Aldehyde dehydrogenase, inhibition of, ethanol ingestion and, 715
- Aldehydes
 antimicrobial activity of, 745t
 as antiseptics and disinfectants, 746
 names of, 749b
- Aldesleukin, for cancer, 686t-692t, 703
- Aldicarb
 structural formula of, 827f
 toxicity of, 828
- Aldosterone
 antagonists of, for chronic heart failure, 411-413
 potency of, 550t
 secretion of, 549
 sodium reabsorption by kidney and, 431-432, 433f
 structural formula of, 550f
- Alefacept, proprietary names of and indications for, 675t
- Alemtuzumab
 for cancer, 705t, 707
 proprietary names of and indications for, 675t
- Alendronate, 544. *See also* Bisphosphonates.
- Alexidine
 for plaque prevention/control, 735-736
 structural formula of, 735f
- Alfentanil
 dose, duration, and administration of, 315t
 for intravenous anesthesia, 293t, 294
 structural formula of, 318f
 structure and analgesic effects of, 317-318
- Alfuzosin, 108
 chemical structure of, 110t
- Alginate acid, for peptic ulcer disease, 528-529
- Aliphatic alcohols, 711-719, 712t. *See also* Alcohol(s), aliphatic.
- Aliskiren, for hypertension, 447
- Alkalinization, urinary, for treatment of toxicity, 40
- Alkaloids, natural, 117
- Alkyl sulfonate, for cancer, 686t-692t
- Alkylamines
 names of, 370t-371t
 structural formulas and dosages of, 363t-364t
- Alkylating agents
 antineoplastic, 685-693, 686t-692t
 for cancer, 685-693
- N-Alkylbarbiturate, 199t
- Allergic encephalomyelitis, TH1 response in, 680
- Allergic reactions
 adrenergic agonists for, 100
 antihistamines for, 366-367
 to aspirin, 336
 to benzodiazepines, 194
 to cephalosporins, 617
 delayed, in inflammatory process, 328
 to drugs, 56-58
 glucocorticoids for, 553
 to H₁ antihistamines, 367
 in histamine release, 360, 361f
 IgE-mediated, TH2 activity in, 680

- Allergic reactions (*Continued*)
 to local anesthetics, 257-258
 multiple antibiotic allergy syndrome as, 612-613
 to penicillins, 612
 antigenic determinants of, 612, 613f
- Allodynia, central sensitization of pain and, 303
- Allopurinol
 for gout, 353-354
 structural formula of, 353f
 phase I reactions in, 35t-36t
- Allosteric binding, 155-156
- Allosteric model, of drug action, 10, 15
- Alloxanthine, for gout, 353-354
- Allylamine antifungal drugs, 646
- Almotriptan
 dosage forms and T_{max} of, 380t
 for migraine, 381
- Aloe vera, pharmacologic profile of, 870t-871t
- Alosetron, for irritable bowel syndrome, 535
- α granules
 contents of, 488b
 in platelet activation, 488, 488f
- Alprazolam, 189
 absorption, metabolism, and excretion of, 193-194, 193t
 for anxiety, 197t
 for depression, 181
 metabolism of, 193f
 for oral sedation, 765
 in renal failure, dosage adjustments needed in, 51t
 structural formula of, 189f
- Alteplase
 for emergency use, 846t, 849
 for myocardial thrombosis, 500
- Alternative medicine
 dental practice and, 869-875
 herbal therapies for oral disease and, 873-875
 in modifications of treatment, 872-873
 in patient evaluation, 869-872
 diuretics and, 440
 health benefits of, 867
 in health history, 869-872
 history of, 869
 regulations and quality control for, 868-869
 sources of information about, 875t
 types of products used in, 869
 in United States, 867
- Altitude sickness, carbonic anhydrase inhibitors for, 438
- Altretamine, for cancer, 686t-692t
- Alum, for vaccines, 672
- Aluminum phosphide, toxicity of, 829
- Aluminum salts, for peptic ulcer disease, 528
- Alveolar concentration, of inhalation anesthetics, 274, 274f
- Alveolar membrane, drug absorption and, 24
- Alzheimer's disease, treatment of, 127
- Amanita* mushrooms, adverse effects of, 117, 120-121
- Amantadine
 for Parkinson's disease, 236t, 240
 side effects of
 in dental practice, 243
 useful, 56t
 structural formula of, 647f
 for viral infections, 647, 648t
- Amibenonium, structural formula of, 121f
- American Dental Association, Council on Scientific Affairs of, evaluation of dental products by, 873
- American Dental Association Guide to Dental Therapeutics*, 67
- Amifostine, for cancer, 686t-692t
- Amikacin. *See also* Aminoglycosides.
 development of, 628
- Amiloride
 structural formula of, 433f
 urinary effects and mechanisms of action of, 432t
- Amine fluoride, in fluoride dentifrices, 728, 728t
- Amine hypothesis, of depression, 165
- Amino acid(s)
 as central nervous system transmitters, 155-157, 156t
 excitatory
 antagonists of, experimental drugs for, 225
 in trigeminal nociceptive afferents in nucleus caudalis, 303
 receptors of, on nociceptive neurons, 301
 residues of, in local anesthetic binding, 249, 251f
- α -Amino-3-hydroxy-5-methyl-4-isoxazole propionate (AMPA) receptors
 anesthetic action and, 269
 in nociceptive mechanisms, 303
- p*-Aminobenzoic acid, chemistry of, 631, 632f
- γ -Aminobutyric acid (GABA), in neurotransmission, drugs affecting, in inhibition of seizure activity, 222-224, 222f
- Aminocaproic acid
 in dental procedures in coagulopathies, 508
 for fibrinolysis prevention, 500
- 7-Aminocephalosporanic acid, structural formula of, 615f
- γ -Aminobutyric acid (GABA)
 in neural control of Parkinson's disease, 231-232
 in neurotransmission, 156, 156t, 304
 valproic acid and, 221
 receptor complex of
 allosteric binding domains on, 191f
 anesthetic action and, 269
 barbiturate action and, 199
 benzodiazepine action and, 189-192, 190f
 ethanol and, 711
 structural model of, 191f
- Aminogluthimide, for cancer, 686t-692t, 698
- Aminoglycosides, 628-630
 absorption, fate, and excretion of, 629
 adverse effects of, 629-630
 antibacterial spectrum of, 629
 bacterial resistance to, 629
 chemistry of, 628-629, 629f
 drug interactions with, 630
 mechanism of action of, 581-583, 629
 names of, 636b-637b
 neuromuscular blocking drug action with, 145, 145t
 therapeutic uses of, 629
- 6-Aminopenicillanic, structural formula of, 615f
- Aminopenicillins, 606t-607t
- p*-Aminosalicylic acid, vitamin B₁₂ and, absorption and, 479
- Amiodarone
 absorption, fate, and excretion of, 405-406
 actions of, 400t
 adverse effects of, 406, 408t
 for arrhythmias, 405-406
 digoxin interactions with, 419
 drug interactions with, 407-408
 for emergency use, 846t-848t, 848
 indications for, 407t
 pharmacokinetic properties of, 401t
 pharmacologic effects of, 405
 structural formula of, 405f
- Amisulpride, antipsychotic activity of, 167-168
- Amitriptyline, 175
 adverse effects of, 176t
 for atypical facial pain, 183
 for neuropathic pain, 383
- Amlodipine, for hypertension, 447-448
- Ammonia, aromatic, emergency use of, 845t, 846
- Ammonium chloride, as expectorant, 522
- Amnesia
 anesthetic-induced suppression of limbic system and, 271-272
 benzodiazepines and, 192, 194
 definition of, 267
- Amobarbital, duration of action of, 200t
- Amotivational syndrome, from marijuana use, 809
- Amoxapine, 177-178
 adverse effects of, 176t
 structural formula of, 178f
- Amoxicillin, 605-608, 606t-607t
 adverse reactions to, 613
 in dentistry, 610
 diseases responsive to, 608b
 microorganisms sensitive to, 608b
 pharmacokinetics of, 608, 609t
 recommended dosages of, 614t
 side effects of, 56t
 volume of distribution of, 28t
- Amoxicillin-clavulanate, 606t-607t
 pharmacokinetics of, 609t
 recommended dosages of, 614t
- Amphetamine(s)
 abuse of, 804-805
 characteristics of, 804-805
 history of, 799
 recent trends in, 800
 analogues of, abuse of, 807
 for attention-deficit/hyperactivity disorder, 100-101
 meperidine interactions with, 293
 pharmacologic effects of, 97-98, 804
 phase I reactions in, 35t-36t
 side effects of, useful, 56t
 structural formula of, 804f
 structure-activity relationships of, 92t
 toxic effects of, 103
 toxicity of, 805
 for weight loss, 101
- Amphotericin B, 640-642
 adverse effects of, 642
 for candidiasis in cancer patients, 787
 digoxin interactions with, 419
 for fungal infections, 640-642
 mechanism of action and clinical uses of, 641t
 structural formula of, 641f
- Ampicillin, 606t-607t
 adverse reactions to, 613
 microorganisms sensitive to, 608b
 plus sulbactam, 606t-607t, 609
- Amprenavir, for human immunodeficiency virus infection, 656
- Amyl nitrite
 abuse of, 810
 for angina, 424. *See also* Nitrates/nitrites.
 structural formula of, 424f
- Amylin, analogue of, for diabetes, 564
- Anakinra, for rheumatoid arthritis, 352
- Analgesia
 definition of, 267
 opioid action and, 310
 peripheral, morphine administration and, 313
 stimulation-produced, 374
- Analgesics
 acetaminophen as, 345-348. *See also* Acetaminophen.
 choice of, 754-757
 local anesthetics for, 754
 nonopioid, 754-755
 opioid, 755-757
 steps in, 756, 756f
 combination, 348-350
 in dentistry, 349t
 names for, 354b
 nonopioid, 348
 proprietary names for, 349t
 for effective pain control, 752-758
 half-lives of, 42t
 for inflammatory pain, 324-358
 mechanism of action of
 for central pain, 303-304
 for peripheral pain, 302
 misconceptions about, 753
 names of, 354b
 nephropathy associated with, 335
 nonopioid
 combined with opioid, 334-335
 proprietary names of, 346t
 vs. opioid, 754
 NSAIDs as. *See* Nonsteroidal anti-inflammatory drugs (NSAIDs).

- Anesthetics (Continued)
- opioid. *See* Opioid analgesics; Opioid(s).
 - for cough suppression, 521
 - oral, used in dentistry, 350
 - in peptic ulcer disease, 529
 - preoperative administration of, 754, 755f
 - principles of use of, 757
 - proprietary names of, 346t
 - in renal failure, dosage adjustments needed in, 51t
 - sedatives with, 349
 - systemic, for oral mucositis, 785
 - Analogue of amylin, for diabetes, 564
 - Anaphylatoxins, 330
 - Anaphylaxis
 - cephalosporin-induced, 617
 - drug-induced, 57
 - glucocorticoids for, 553
 - penicillin-induced, 612
 - slow-reacting substance of, 328
 - Anastrozole
 - for cancer, 686t-692t, 698-699
 - structural formula of, 698f
 - Ancestim, for stimulation of stem cells, 482
 - Androgen(s)
 - administration of, 567
 - adverse effects of, 573
 - antagonists of, 574, 575t
 - names of, 577b
 - for cancer, 686t-692t, 698
 - drug interactions with, 574
 - names, indications, and doses of, 569t
 - names of, 577b
 - structural formulas of, 568f
 - structure and functions of, 567-568
 - therapeutic uses of, 571
 - Androstane receptor, constitutive, 38
 - Anemia, 469-473
 - aplastic, from chloramphenicol, 633
 - causes of, 469
 - classification of, 470, 471t
 - drugs for, names of, 485t
 - iron deficiency, 470-473
 - megaloblastic, 476-477
 - pernicious, 479
 - vitamin B₁₂ deficiency and, 477
 - sickle cell, 476
 - tests for, 469
 - thalassemia as, 475-476
 - treatment of, in dentistry, 484-485
 - Anesthesia
 - adjuvants for, 295-296
 - balanced, nitrous oxide in, 283-284
 - in dentistry, history of, 266-267
 - dissociative, 290
 - ether, stages of, 272-273, 272f
 - general
 - adjuvants and premedication for, 295t
 - behavioral manifestations and, 272-273
 - blood solubility of anesthetic and, 275t
 - definition of, 267
 - depth of, with modern anesthetics, 273
 - drugs used for, 767-768
 - inhalation, 281-288. *See also* Inhalation anesthetics.
 - intravenous, 288-295. *See also* Intravenous agents, for general anesthesia.
 - neuromuscular blocking drugs and, 145
 - potency of, lipid solubility and, 268, 268f
 - proprietary names for, 296b
 - goals of, 267-268
 - history of, 266-267
 - induction of, 273-274
 - blood solubility of anesthetic and, 275
 - mechanisms of, 268-273
 - critical volume hypothesis of, 268
 - involving membrane proteins, 269-270
 - lateral phase separation theory of, 266
 - lipid perturbation theories of, 269
 - membrane expansion theory of, 269
 - membrane lipid theories of, 268-269
 - molecular, 268-270
 - Anesthesia (Continued)
 - partition coefficient in, 273, 273f, 275t
 - pharmacologic approaches to, 761
 - principles of, 266-280
 - recovery from, 274f, 276
 - team approach to, 762
 - terms used in, 267
 - theories of action in
 - membrane molecular, 268-270
 - neurophysiologic, 270-272, 271f
 - vs. ether anesthesia, 273
 - vs. minimal, moderate, and deep sedation, 762t
 - local. *See* Local anesthetics.
 - maintenance of, definition of, 267
 - spinal, with local anesthetics, 259
 - surgical, definition of, 266-267
 - systemic, for oral mucositis, 785
 - topical, for oral mucositis, 784
 - Anesthetics, 188
 - Angina
 - Ludwig's, pathogens causing, 603
 - preinfarction, 422
 - stable, chronic, 422
 - unstable, 422
 - variant, 422
 - Angina pectoris
 - accelerated, 422
 - drugs for, 422-430. *See also* Adrenergic receptor antagonists, β ; Antianginal drugs; Calcium channel blockers; Nitrovasodilators.
 - pathophysiology and precipitating causes of, 423f
 - prevention of, 425
 - β blockers in, 112
 - types of, 422
 - Angioedema, H₁ antihistamines for, 366-367
 - Angiogenesis, cancer chemotherapy and, 684
 - Angiotensin-converting enzyme (ACE) inhibitors
 - absorption, fate, and excretion of, 446
 - adverse effects of, 446
 - for congestive heart failure, 413
 - for diabetes, 564
 - for hypertension, 446, 447f
 - names of, 456b-457b
 - pharmacologic effects of, 446
 - Angiotensin II, in hypertension, 445
 - Angiotensin II receptor antagonists
 - for chronic heart failure, 413
 - names of, 456b-457b
 - Angiotensin receptor antagonists, for hypertension, 446-447
 - Anidulafungin
 - for fungal infections, 645
 - mechanism of action and clinical uses of, 641t
 - structural formula of, 645f
 - Animals, drug testing in, 61-64
 - Anionic agents, as disinfectants, 748
 - Anisidione, structural formula of, 503f
 - Anisocytosis, description of, 471b
 - Anistreplase
 - for emergency use, 849
 - as fibrinolytic, 500
 - Anorexia
 - AIDS-related, dronabinol for, 809
 - digoxin administration and, 417
 - sympathomimetic drugs for, 101
 - Anorexiant, proprietary names of, 103b-104b
 - Antacids
 - digoxin and, 419
 - names of, 536b
 - for peptic ulcer disease, 528
 - Antagonists, action of
 - competitive and noncompetitive, 10, 10f
 - stimulus-response theory and, 11-13
 - Anti-ictogenic drugs, definition of, 215
 - Anti-inflammatory drugs, nonsteroidal. *See* Nonsteroidal anti-inflammatory drugs (NSAIDs).
 - Anti-parkinson drugs, 230-245. *See also* Parkinson's disease, drug therapy for.
 - Antiandrogens, for cancer, 686t-692t, 698
 - Antianginal drugs, 422-430
 - β -adrenergic receptor-blocking drugs for, 426
 - calcium channel blockers as, 426-428. *See also* Calcium channel blockers, for angina.
 - nitrites/nitrites as, 422, 424-426. *See also* Nitrates/nitrites.
 - ranolazine as, 428
 - Antianxiety agents, 188-189
 - abuse of, 803-804
 - characteristics of, 803-804
 - benzodiazepines as, 192, 197, 197t
 - centrally acting muscle relaxants, sedative-hypnotics, and antihistamines vs., 205t
 - delayed action, 162. *See also* Selective serotonin reuptake inhibitors (SSRIs).
 - in dentistry, 207-209, 209b
 - drug interactions with, 195, 195t
 - indications for, 759-760
 - names of, 209b
 - pharmacologic effects of, 803
 - therapeutic uses of, 761-762, 761f
 - Antiarrhythmic drugs, 393-409. *See also* *specific drugs, e.g.* Quinidine.
 - actions of, 400t
 - β blockers as, 111, 113, 404-405
 - classes of, 397-399, 400t
 - drug interactions with, 407-408
 - for emergency use, 846t, 848
 - indications for, 407, 407t
 - pharmacokinetic properties of, 401t
 - selection of, 397
 - Antibiotics
 - adverse reactions to, 535, 594-596
 - gastrointestinal, 535
 - agricultural use of, antibiotic resistance and, 595
 - for cancer, 686t-692t, 696-698
 - cationic peptide, 597
 - mechanism of action of, 581
 - combination therapy with, 593
 - concentration-dependent vs. time-dependent, 590
 - coumarin-indandione action and, 504
 - digoxin and, 419-420
 - dosages of, 589-592, 614t
 - loading, 591
 - dosing of, principles of, 589-592
 - duration of use of, 591-592
 - glycopeptide, 630. *See also* Vancomycin.
 - half-lives of, 42t
 - herbal product interactions with, 872t
 - host-microbe interactions with, 593-594
 - β -lactam, 604-618. *See also* Cephalosporin(s), Penicillin(s), and *specific drugs, e.g.* Methicillin.
 - local delivery devices for, 739-740, 740t
 - macrolide. *See* Macrolide antibiotics.
 - mean inhibitory concentration of, microbial resistance and, 603
 - mechanisms of action of, 581-583, 582f, 582t
 - microbial resistance to, 583-584, 591
 - agent-specific, 587-589
 - agricultural, 595
 - to fluoroquinolones, 587-588
 - to heavy metals, 588-589
 - historical aspects of, 579
 - to macrolides, 587
 - mechanisms of, 583t, 584-586
 - β -lactamases in, 584
 - horizontal gene transfer as, 585-586
 - integrons in, 585
 - multidrug antibiotic efflux pump as, 584-585
 - transposable elements in, 585
 - in microbial pathogens, 586-587
 - in orofacial pathogens, 603-604
 - to tetracyclines, 588
 - to vancomycin, 586-587
 - minimal inhibitory concentration of, 590
 - multiple antibiotic allergy syndrome and, 612-613
 - names of, 636b-637b

- Antibiotics (Continued)**
 neuromuscular blocking drug action with, 145, 145t
 new, developing, 596-597
 oral contraceptives and, 574
 for oral infections, 610t-611t
 overuse of, 580-581
 for peptic ulcer disease, 527-528
 peptide, 597
 pharmacokinetics and pharmacodynamics of, 589
 polyene, for fungal infections, 640-642
 polymyxin B, mechanism of action of, 581
 postantibiotic effects of, 583
 prophylaxis with, 771-781
 adverse effects of, 771
 economic impact of, 775
 future of, 779
 for infective endocarditis. *See also* Infective endocarditis, antibiotic prophylaxis for.
 medical conditions not requiring, 773b
 in metastatic infection prevention, 771-773
 microbial resistance and, 775, 779
 principles of, 771
 problems with, 771
 risk-benefit ratio of, 775
 uses of, 771
 for various clinical situations, 777-778
 pseudomembranous colitis and, 595-596
 in renal failure, 51t, 592
 systemic, for plaque control, 738
 therapy with
 failures in, 593, 593b
 new approaches to, 596-597
 principles of, 579-599
 topical, 634
 names of, 636b-637b
 toxicity risk with, in elderly, 836-837
 for traveler's diarrhea prophylaxis, 534
 use and misuse of, 580-581
- Antibody(ies)**
 anti-idiotypic, in caries vaccines, 672
 humoral, in immune system, 664f, 665-670
 inhibitor, to factor VIII products, in hemophilia management, 498
 monoclonal. *See* Monoclonal antibody(ies).
 polyclonal preparations of, 673
 secretory IgA, vaccination systems and, 663
 xenogeneic, oral administration of, 674
- Anticaries agents, 720-731. *See also* Fluoride.**
- Anticholinergic drugs. *See also* Antimuscarinic drugs.**
 for asthma, 517
 names of, 522b-523b
 digoxin and, 419
 for irritable bowel syndrome, 535
 levodopa-induced interactions with, in dental practice, 243
 for Parkinson's disease, 236t
- Anticholinesterase(s), 121-124**
 absorption, fate, and excretion of, 123
 adverse effects of, 123-124, 124b
 for Alzheimer's disease, 127
 chemistry of, 121
 classification of, 121
 direct-acting muscarinic drugs vs., 123
 for glaucoma, 125, 125t
 historical background on, 121
 insecticides containing
 structural formula of, 827f
 toxicity of, 820-824
 mechanism of action of, 122-123, 122f
 for myasthenia gravis, 126
 names of, 127b
 neuromuscular blocking drug action and, 144-145, 145t
 pharmacologic effects of, 123
 for reversal of nondepolarizing agent overdose, 144
 structural formulas of, 121f
 therapeutic uses of, 124-127
 toxicity of, atropine for, 133
 uses of, 122t
- Anticoagulant(s)**
 antidotes for, names of, 509t
 in dentistry, 500-504, 506-508
 direct-acting, 500-502
 names of, 509t
 heparins as, 500-502. *See also* Heparin(s).
 indirect-acting, 502-504
 adverse effects of, 504
 drug-drug interactions involving, 505b
 mechanism of action of, 502-503, 503f
 names of, 509t
 oral, opioid interactions with, 321
 pharmacologic characteristics of, 504
 rodenticides containing
 structural formula of, 831f
 toxicity of, 830
 therapeutic uses of, 490
- Anticonvulsants, 212-229**
 adverse reactions to, 215, 219t
 affecting GABA transmission as, 222-224, 222f
 barbiturates as, 218-220
 carbamazepine as, 220
 chemistry and structure-activity relationships of, 215-217, 217f
 definition of, 214-215
 in dental practice, 226-227
 emergency use of, 845t, 846
 experimental, 225-226
 hydantoins as, 217-218. *See also* Hydantoins.
 mechanisms of action of, 216t
 names of, 227b-228b
 succinimides as, 221-222
 therapeutic uses of, 216t, 226
 tolerance to, 226
 for trigeminal neuralgia, 387-388
 valproic acid as, 220-221
- Anticytomegalovirus agents, 652**
- Antidepressants, 173-183**
 actions of, 175b
 anesic actions of, 304
 for chronic pain syndromes, 383-384
 delayed onset of action of, hypotheses of, 173-174
 in dentistry, 183
 historical development of, 165-166
 mechanism of action of, 173, 173t
 names of, 185b-186b
 for Parkinson's disease, 236t, 241
 potential, 181
 potentiators of, 181
 propionic acid derivative interactions with, 339-340
 receptors bound by, therapeutic and adverse effects of, 163t
 second- and third-generation, 177-179
 absorption, fate, and excretion of, 178
 adverse effects of, 176t, 178-179
 characteristics of, 177-178
 in dentistry, 182-183
 pharmacologic effects of, 178
 therapeutic uses of, 182
 therapeutic uses of, 181-183
 tricyclic. *See* Tricyclic antidepressants.
- Antidiarrheal agents, 533-535**
 names of, 536b
- Antidiuretic hormone (ADH), 431**
- Antidiuretic hormone antagonists, 438-439**
- Antiemetics, 531-532. *See also* Nausea and vomiting.**
 antipsychotic drug action and, 169
 in dentistry, 526t
 dronabinol as, 809
 for migraines, 381-382
 names of, 391t, 536b
- Antiepileptogenic agents, 215**
- Anti estrogen, for cancer, 686t-692t, 698**
- Antifibrinolytics, 500. *See also* Fibrinolysis.**
- Antifungal agents, 640-646, 641t, 657b**
 allylamine, 646
 amphotericin B as, 640-642. *See also* Amphotericin B.
 clinical uses of, 641t
 echinocandin, 644-645, 645f
 imidazole, 642-644, 643f
 in immunosuppressed patients, 787
- Antifungal agents (Continued)**
 mechanisms of action of, 641t
 names of, 657b
 nystatin as, 642
 polyene, 640-642
 triazole, 642-644, 643f
- Antigen(s)**
 extracellular, in antigen processing, 665-667
 intracellular, in antigen processing, 665-667
 presentation of, in specific immune response, 666f, 667-669
 processing of, in specific immune response, 665, 666f
- Antihyperthermic agents, 649-653**
 in immunosuppressed patients, 787
 for oral infections, 656
- Antihistamines, 202, 362-370**
 absorption, fate, and excretion of, 202
 adverse effects and drug interactions with, 202
 centrally acting muscle relaxants, sedative-hypnotics, and antianxiety drugs vs., 205t
 emergency use of, 845t, 846
- H₁, 363-368**
 absorption, fate, and excretion of, 365-366
 adverse effects of, 367
 as antiemetics, 531
 chemistry and classification of, 363, 363t-364t
 clinical applications of, 366-367
 names of, 370t-371t
 pharmacologic effects of, 363-365, 365f
 therapeutic uses of, 366-367
 in dentistry, 367-368
- H₂, 368-370**
 absorption, fate, and excretion of, 368-369
 adverse effects of, 370
 chemistry and classification of, 368, 368f
 names of, 370t-371t
 for peptic ulcer disease, 526-527
 comparison of, 527t
 pharmacologic effects of, 368, 369f
 therapeutic uses of, 369-370
 for migraine, 384
 for oral sedation, 765-766
 pharmacologic effects of, 202
 for premedication in anesthesia, 295-296, 295t
 second-generation, 363
 for sedation, 294
 uses of, 325
- Antihyperglycemic agents**
 names of, 565b
 oral, for diabetes mellitus, 561-564
- Antihypertensive drug withdrawal syndrome, 455**
- Antihypertensive drugs, 442-457**
 actions of, in CNS, 150t
 adrenergic agonists as, 101
 names of, 103b-104b
 adrenergic transmission and, 450-451
 adverse effects of, 456
 α_1 , adrenergic blockers as, 449-450
 α_1 - β -adrenergic blockers as, 450
 angiotensin-converting enzyme inhibitors as, 446, 447f
 β -adrenergic blockers as, 111-112, 448-450
 calcium channel blockers as, 447-448
 centrally acting, 451-452
 names of, 456b-457b
 combinations of, names of, 456b-457b
 in dentistry, 455-456
 direct-acting vasodilators as, 452-454
 diuretics as, 445
 drug interactions with, 455-456
 for emergency use, 846t
 general aims of, 444
 miscellaneous, 454
 names of, 103b-104b, 456b-457b
 renin inhibitors as, 447
 sites of action of, 445f
 withdrawal of, 455

- Antimalarial agents, for rheumatoid arthritis, 335
- Antimanic drugs, 183-185
- Antimetabolites
for cancer, 693-696
ligand competition and, 7
- Antimicrobial activity, of disinfectants and antiseptics, 745t
- Antimuscarinic activity, of antihistamines, 365
- Antimuscarinic drugs, 129-135. *See also* Anticholinergic drugs.
absorption, fate, and excretion of, 132
adverse effects of, 134
chemistry of, 129
classification of, 129
in dentistry, 134-135
drug interactions with, 134
with antiarrhythmic drugs, 407
with digoxin, 420
for dystonic syndromes, 242
historical background of, 129
mechanism of action of, 129-130
names of, 135t
onset and duration of action of, 131t
for Parkinson's disease, 236t, 240
for peptic ulcer disease, 529
pharmacologic effects of, 130-132, 130t-131t
for premedication in anesthesia, 295-296, 295t
for sedation, 295
structural formulas of, 130t
susceptibility of effectors to, 131t
therapeutic uses of, 132-133
- Antineoplastic drugs. *See* Cancer chemotherapy.
activity of, cell cycle sites of, 684-685, 684f
alkylating agents as, 685-693
antibiotics as, 696-698
arsenic trioxide as, 702
azacytadine as, 702
biologic response modifiers as, 703-704
bisphosphonates as, 702
camptothecins as, 700
classification of, 686t-692t
combination, 708-709
decitabine as, 702
dental practice and, 709
drug interactions with, 708-709
enzymes as, 699
epothilones as, 700-701
hormone agonists and antagonists as, 698-699
hydroxyurea as, 701
inhibition and incorporation of, potential sites of, 685f
lenalidomide as, 702
oral complications of, 782-790
platinum complexes as, 699-700
podophyllotoxins as, 700
procarbazine as, 701
relative contraindications to, 708-709
retinoids as, 702-703
for rheumatoid arthritis, 351-352
for sickle cell anemia, 476
targeted, 704-708, 705t
histone deacetylase inhibitors as, 705t, 708
monoclonal antibodies as, 705t, 706-708
proteasome inhibitors as, 705t, 706
tyrosine kinase inhibitors as, 704-706, 704f, 705t
taxoids as, 700-701
thalidomide as, 701-702
vinca alkaloids as, 698
- Antinociceptive drugs, 299-306
for pain management, 305
for pain prevention, 304-305
use of, 304-305
- Antioxidants, for Parkinson's disease, 241
- Antiparkinson drugs. *See also* Parkinson's disease, drug therapy for.
actions of, in CNS, 150t
- Antiplatelet/antigingivitis agents, 732-743
antibiotics as, 738
bis-biguanydes as, 735-736
comparison of, 739t
controlled local drug delivery of, 739-740, 740t
effectiveness of, 739t
evaluation guidelines for, 734, 735b
fluorides as, 737-738
herbal, 873, 874t
ideal properties of, 734, 734b
morpholino compounds as, 738
nonionic bisphenols as, 736-737
in oral products, agent and proprietary names of, 739t
oxygenating agents as, 738
phenolic compounds as, 737
photodisinfection and, 738
quaternary ammonium compounds as, 737
rationale for, 732-733
topical, limitations of, 740-741
 α_2 -Antiplasmin, in fibrinolysis, 499-500
- Antiplatelet agents, 333-334, 334t, 505-506.
See also Aspirin; Salicylates.
in myocardial infarction prevention, 429
names of, 429t-430t, 509t
- Antipsychotic drugs, 166-173
absorption, fate, and excretion of, 170
actions of
in central nervous system, 150t
dopaminergic cell groups and, 163t
adverse effects of, 170-172
as antiemetics, 531
atypical, 166, 166t
for Parkinson's disease, 241
pharmacological effects of, 168-170
side effects of, 171t
therapeutic uses of, 172-173
dental practice and, 173
dopaminergic cell groups and, 163, 163t
dose of, 172
historical development of, 165-166
for Huntington's disease, 241
interactions with, 172t
long-acting depot preparations of, 172
metabolism of, 172t
names of, 185b-186b
pharmacologic effects of, 168-170
receptor antagonist affinities of, relative potency of, 166t
receptors bound by, therapeutic and adverse effects of, 163t
side effects of, dopaminergic cell groups and, 163t
structural formulas of, 167f
therapeutic uses of, 172-173
typical, 166, 166t
pharmacologic effects of, 168-170
side effects of, 171t
- Antiseizure drugs. *See* Anticonvulsants.
- Antiseptics
classification of, 744-745, 745t
definition of, 744
in dentistry, 749
ideal, 744
names of, 749b
urinary, 634-635
- Antisialagogues, 530
in dentistry, 526t
- Antispasmodics
for irritable bowel syndrome, 535
names of, 536b
- Antithrombin III
clotting inhibition by, 492-493
in hemostasis, 492-493
in heparin action, 501
- Antithymocyte globulin, effects and uses of, 674-676
- Antitoxins, 674
names of, 681b
- Antitussives
for coughing, 521
names of, 522b-523b
- Anti-varicella-zoster virus agents, 652-653
- Antivenins, 674
- Antiviral agents, 610t-611t, 647-656
antiviral spectrum, uses, and mechanisms of action of, 648t
for cytomegalovirus, 652
for herpesvirus infections, 649-653. *See also* Herpes simplex virus, drugs active against.
for human immunodeficiency virus infections, 654-656. *See also* Human immunodeficiency virus (HIV), drugs active against.
for influenza, 647-649. *See also* Influenza, antiviral agents for.
names of, 657b
for oral mucosal lesions, 656-657
for respiratory syncytial virus, 653
for varicella-zoster virus, 652-653
for viral hepatitis, 653-654
- Anxiety, 188
benzodiazepine therapy for, 192, 197, 197t
definition of, 759
dental, prevalence of, 759, 760t
management of, 759-770
pain and, 752, 759
patient experiencing, identification of, 760
pharmacologic management of. *See also* Antianxiety agents.
approaches to, 188, 761-762, 761f
indications for, 759-760, 767
patient selection for, 760-761, 760b
treatment planning for, 760
preoperative, reduction of, 295
selective serotonin reuptake inhibitors for, 383
- Anxiolysis, definition of, 267
- Anxiolytics, 188. *See also* Antianxiety agents.
- Aplastic anemia, from chloramphenicol, 633
- Apolipoprotein E, genetic polymorphisms of, 74
- Apomorphine
as emetic, 530
for Parkinson's disease, 236t, 240
- Apoptosis, in lipoprotein metabolism, 458-459
- Apoptosis
of hepatocytes in alcoholism, 716
in immune response, 669, 669f
propriocidal, 670
- Apothecary system of weights and measures, 861, 862t
- Approved Drug Products with Therapeutic Equivalence Evaluations*, 854
- Aprepitant, as antiemetic, 531
- Aprotinin, anticoagulant action of, 502
- Aquaporins, 19
- Arachidonic acid metabolism
in inflammatory process, 325-327, 326f
leukotrienes in, 326f, 328
- Arecoline, 117
- Arestin, for local oral drug delivery, 739, 740t
- Argatroban, as thrombin inhibitor, 502
- Aripiprazole
antipsychotic effects of, 167-168
metabolism of, 172t
relative potency of receptor antagonist affinities in, 166t
for schizophrenia, 166
side effects of, 171t
- Aromatase inhibitors
for cancer, 686t-692t, 698-699
names of, 577b
site of activity of, 699f
- Aromatic ammonia, emergency use of, 845t, 846
- Arrhythmias
basic physiology of, 393-394
common, electrocardiographic patterns of, 396-397, 397f
digoxin for, 418
drugs for, 259, 393-409. *See also* Antiarrhythmic drugs and specific drugs, e.g. Quinidine.
from H₁ antihistamines, 367
neuromuscular blocking drug use and, 143-144
origins of, 394-396

- Arsenic poisoning, chelator treatment for, 824t
- Arsenic trioxide, for cancer, 686t-692t, 702
- Arthritis
gouty, 328
rheumatoid. *See* Rheumatoid arthritis.
- Articaine
activity of, physicochemical correlates of, 247t
for dental anesthesia, 260
preparations and dosage of, 261-262
structural formula of, 247f
- Asbestos injury, 818
- Asian ginseng, pharmacologic profile of, 870t-871t
- Asparaginase, for cancer, 699
- L-Asparaginase, for cancer, 686t-692t
- Aspirin. *See also* Salicylates.
absorption, fate, and excretion of, 334-335, 334f
gastric absorption and, 21, 21f
acetaminophen combinations with, 348, 349t
actions of, 302
adverse effects of, 56t, 335-336
gastrointestinal, 535
for angina, 422-423
asthma induced by, 519-520
capacity-limited kinetics and, 41
contraindications to, 336, 336t
coumarin-indandione action and, 504
COX inhibitory activity of, 330-331, 331f, 332t
vs. acetaminophen, 332t
in dentistry, 345
dosages of, 346t
drug interactions of, 336, 337t
with antihypertensives, 455
for emergency use, 844t, 845
low-dose therapy with, 333
overdose of, 59, 335
for pain, 332, 346t
vs. codeine, 332, 332f
peptic ulcer disease and, 529
for platelet inhibition, 505-506
for prevention of myocardial infarction, 429
propionic acid derivative interactions with, 340
in renal failure, dosage adjustments needs in, 51t
structural formula of, 331f
therapeutic effects of, 332-334
- Aspirin-like drugs, actions of, 302
- Astemizole, adverse effects of, 367
- Asthma
aspirin-induced, 519-520
aspirin intolerance and, 336
control of
drug therapy for, steps in, 519t
levels of, 519t
definition of, 511
dentistry for patients with, 520-521
drugs for, 512-519
anticholinergics as, 517
bronchodilators as, 513-515
commonly used, properties of, 520t
corticosteroids as, 512-513, 552
names of, 522b-523b
cromolyn as, 517-518
ketotifen as, 518
leukotriene modifiers as, 517
methotrexate as, 518
names of, 522b-523b
nedocromil as, 518
omalizumab as, 518-519
prophylactic, names of, 522b-523b
theophylline as, 516-517
pathophysiology of, 511
pharmacotherapy for, 519
prevalence of, 511
- Astragalus, pharmacologic profile of, 870t-871t
- Astringents
for bleeding control, 495
names of, 509t
- Astrocytes, 153
- Astroglia, 153
- Atazanavir, for human immunodeficiency virus infection, 656
- Atenolol. *See also* Adrenergic receptor antagonists, β
for emergency use, 848
pharmacologic effects of, 110t
structural formula of, 111f, 449f
- Atheromatous plaques, 458
- Atherosclerosis
causes and effects of, 458
cholesterol and, 458-462
clinical disorders resulting from, 444b
lipoproteins in, 460
risk factors for, 461
- Atipamezole, as α_2 adrenergic agonist antagonist, 207
- Atomoxetine, 180
- Atonic seizures, 212, 213t
- Atopic dermatitis, H_1 antihistamines for, 366
- Atorvastatin
for hyperlipidemia, 464-465
side effects of, 56t
- ATP-binding cassette (ABC) transporters, 19-20
in renal drug excretion, 40
- Atracurium
action and chemical structure of, 140, 141f
pharmacologic properties of, 142t
- Atrazine
structural formula of, 829f
toxicity of, 829
- Atrial fibrillation, electrocardiographic appearance of, 396-397, 397f
- Atridox, for local oral drug delivery, 739, 740t
- Atripla, for human immunodeficiency virus infection, 656
- Atropine. *See also* Antimuscarinic drugs.
absorption and excretion of, 132
acetylcholine inhibition by, 11
for anticholinesterase toxicity, 133
in dentistry, oral doses and preparations for, 134t
effects of, 48
antimuscarinic, scopolamine vs., 130-131, 130t
on central nervous system, 132
on peripheral nervous system, 131-132
for emergency use, 846t-848t, 848
for mushroom poisoning, 120-121, 133
poisoning with, 126, 134
for premedication in anesthesia, 295-296, 295t
structural formula of, 130t
volume of distribution of, 28t
- Atropine-like drugs. *See* Antimuscarinic drugs.
- Attention-deficit/hyperactivity disorder, amphetamine for, 100-101
- Auranofin, for rheumatoid arthritis, 351
- Aurothioglucose, for rheumatoid arthritis, 351
- Autacoids, 359
- Automatic external defibrillator, use of, 843-844
- Autonomic effects, of tricyclic antidepressants, 175
- Autonomic nervous system, 78-90
anatomy of, 78-79, 80f
antihypertensive drug effects on, 448-454
antipsychotic drug effects on, 170
drugs affecting, mechanisms and sites of action of, 89, 89t
function of, 79-80, 79f, 81t
central control of, 89
ganglionic transmission in, 136, 137f
neuromuscular blocking drug effects on, 143
parasympathetic division of, 78-79, 80f
stimulation of, effector responses to, 81t
sympathetic division of, 78, 80f
- Autoreceptor
somatodendritic, function of, 376
terminal, 373
function of, 376
- Axonopathy, distal, 817
- Axons, 151-152
of serotonin neurons, 375
susceptibility of, to local anesthetics, 253f
- Azacitidine, for cancer, 686t-692t
- Azacytadine, for cancer, 702
- Azaspirodecanediones, 203
- Azathioprine
in immunotherapy, 678
for rheumatoid arthritis, 351
- Azatidine maleate, structural formula and dosages of, 363t-364t
- Azelastine
for nasal allergies, 366
structural formula and dosages of, 363t-364t
- Azithromycin. *See also* Macrolide antibiotics.
in dentistry, 620
introduction of, 618
recommended dosages of, 614t
for traveler's diarrhea, 534
- Azoles, for fungal infections, 642-644, 643f
- Aztreonam, 615b
characteristics of, 618
structural formula of, 618f
- B**
- B cells
cytokines in, factors stimulating, 663t
interleukin-1 effects on, 679t
- Bacampicillin, 606t-607t, 607
- Bacilli
gram-negative, infections due to, antibiotics for, 610t-611t
gram-positive, infections due to, antibiotics for, 610t-611t
- Bacillus Calmette-Guérin (BCG), 672, 686t-692t
- Bacitracin, topical, 634
- Baclofen
adverse effects of, 206
for muscle relaxation, 206
for musculoskeletal pain, 205, 385-386
neuromuscular transmission and, 146
side effects of, 56t
structural formula of, 204f
- Bacterial endocarditis. *See* Infective endocarditis.
- Bacterial infections
in immunosuppressed patients, 788-789
postradiation therapy, 794
- Bacteriophages, therapy with, 633-634
- Barbiturates, 198-201
absorption, fate, and excretion of, 200, 220
abuse of, recent trends in, 800
adverse effects of, 200-201, 219t, 220
as anticonvulsants, 218-220
benzodiazepines vs., 191
chemistry and structure-activity relationships of, 198-199, 198f, 199t
for deep sedation and general anesthesia, 767
in dentistry, 207
drug interactions with, 195t
duration of action of, 200t
herbal product interactions with, 872t
for intravenous anesthesia and sedation, 288-291
for intravenous sedation, 766
mechanisms of action of, 199, 216t
pharmacologic effects of, 199-200, 219-220
therapeutic uses of, 201, 216t
- Barbituric acid, structural formula of, 198f
- Baroreceptors, in blood pressure control, 442-443
- Basal ganglia thalamic inhibitor, in Parkinson's disease, 231-232
- Basic life support (BLS), training in, 843-844
- Basiliximab
as chimeric MAb, 674
proprietary names of and indicators for, 675t
- Basolateral transporters, in renal drug excretion, 40
- Basophils, histamine in, 324, 359
- Bcl-2, in apoptosis inhibition, 663, 669f
- Beclomethasone dipropionate
for asthma, 513
intranasal, for rhinitis, 522
- Belladonna alkaloids. *See also* Antimuscarinic drugs.
absorption and excretion of, 132
- Bendamustine, for cancer, 686t-692t

- Bendamustine hydrochloride, for cancer, 693f
- Bendroflumethiazide, pharmacokinetic data on, 434t
- Benzathine penicillin G, 606t-607t
pharmacokinetics of, 608-609
- Benzene, toxic effects of, 818
- Benzene toxicity, 826
- Benzisoxazoles
side effects of, 171t
structure and activity relationships of, 168
- Benzo[*a*]pyrene, induction of, in metabolism, 38
- Benzocaine
phase I reactions in, 35t-36t
preparations and dosages of, 262
structural formula of, 247f
water insolubility of, 17-18
- Benzodiazepine(s), 189-198
absorption, fate, and excretion of, 192-194, 193t
abuse of, 194, 803-804
characteristics of, 803
actions of, in CNS, 150t
adverse effects of, 194-196
for alcoholism, 717-718
antagonists of, 196, 196f
as antiemetics, 531
as antipsychotic drugs, 168
barbiturates vs., 191
characteristics of, 189
chemistry and structure-activity relationships of, 189, 189f, 190t
in dentistry, 207-208
drug interactions with, 194-196, 195t
for emergency use, 846
ethanol and, 714
herbal product interactions with, 872t
hypnotic, 192
for intravenous anesthesia, 291-292
mechanisms of action of, 189-192, 216t
GABA_A receptor complex and, 190f-191f
in limbic system, 150-151
for muscle relaxation, 205
for musculoskeletal pain, 386
opioids with, for deep sedation, 767-768
for oral sedation, 765
for Parkinson's disease, 241
pharmacologic effects of, 192
for premedication in anesthesia, 295-296, 295t
receptors for, 191-192
reversal agents for, 768
for seizures, 222-223
due to local anesthesia, 257
mechanisms of action of, GABA_A receptor complex and, 222-223
therapeutic uses of, 197-198, 197t, 216t
toxicity risk with, in elderly, 194, 837t
- Benzonatate, for cough suppression, 521
- Benzoquinone, structural formula of, 826f
- Benztropine
for Parkinson's disease, 236t
structural formula of, 130t
- Bepridil, cardiovascular effects of, vs. other calcium channel blockers, 428t
- β blockers. *See* Adrenergic receptor antagonists, β.
- Betamethasone
dose, administration, and preparations of, 556t
potency of, 550t
- Betaxolol, for chronic heart failure, 413
- Betazole, therapeutic uses of, 362
- Bethanechol
for gastrointestinal stimulation, 535
mechanism of action of, 117-118
for paralytic ileus, 126-127
pharmacologic effects of, 119
for salivary gland stimulation, 794
structure of, 118f
- Bevacizumab, for cancer, 705t, 707
- Bexarotene, for cancer, 686t-692t, 702-703
- Bicalutamide
as androgen receptor blocker, 574
for cancer, 686t-692t, 699
- Biguanides
for diabetes, 563
adverse effects of, 563
contraindications to, 563
mechanism of action of, 563
pharmacokinetics of, 563
names of, 749b
- Bilberry fruit, pharmacologic profile of, 870t-871t
- Bile acid sequestrants
for hyperlipidemia, 464
structural formulas of, 464f
- Biliary excretion, 40-41
- Bioavailability, of drugs
chemical and biologic equivalence and, 854
drug formulations and, 23
- Biofilm, dental. *See also* Plaque.
drug therapy for, 732-743. *See also* Antiplaque/antigingivitis agents.
supragingival and subgingival, 732
- Biogenic amine hypothesis, of depression, 165
- Biologic agents, for rheumatoid arthritis, 352
- Biologic response modifiers, for cancer, 686t-692t, 703-704
- Biologicals, regulations concerning, 851-852
- Biperiden, for Parkinson's disease, 236t
- Bipolar cells, 152-153
- Bipolar disorder, 164-165
drugs for, 183-185
- Birth defects
antibiotic therapy and, 594
phenytoin and, 218
- Bis-biguamide(s)
in plaque prevention/control, 735-736
in oral products, agent and proprietary names of, 739t
structural formula of, 735f
- Bis-GMA-based resins, safety of, 576
- Bisacodyl, as laxative, 532
- Bismuth subsalicylate
for diarrhea, 533-534
for prevention of traveler's diarrhea, 534-535
- Bisoprolol, for chronic heart failure, 413
- Bisphenols
as antiseptics, 747
nonionic, in plaque prevention/control, 736-737
in oral products, agent and proprietary name of, 739t
- Bisphosphonates, 544-546
adverse effects of, 546
for cancer, 702
osteonecrosis of jaws related to, 786, 786f
effects of, 546f
functional pathways of, 546f
pharmacokinetics of, 544-545
therapeutic uses of, 545-546
- Bites, insect, antihistamines for, 366
- Bivalirudin, as thrombin inhibitor, 502
- Bladder atony, cholinergic drugs for, 126-127
- Bleach, as disinfectant, 746
- Bleeding
aspirin therapy and, 335
control of
astringents for, 495
local measures for, 493-494
methods of, 494t
procoagulant agents for, 493-498
styptics for, 495
systemic measures for, 495-498
topically applied clotting factors for, 494-495
vasoconstrictors for, 495
herbal product use and, 872-873
oral, in cancer patients, 789
vitamin K deficiency and, 503
- Bleomycin, for cancer, 686t-692t, 697
- Block
epidural, 259
heart, in cardiac arrhythmias, 396, 396f
nerve
differential, 251-254, 253f
frequency dependent, 250-251
with local anesthetics, 250-254, 259
- Block (*Continued*)
phasic, 250
transitional, 250
use-dependent, 250-251
- Blood
artificial, 483
clotting of, 487-493. *See also* Hemostasis.
substitutes for, 483-484
supply of, to brain, 153
as toxic target, 817-818
- Blood alcohol concentration, in ethanol metabolism, 712-714, 712t
- Blood-brain barrier
barbiturate absorption and, 200
CNS drug effect termination and, 159
drug action and, 27, 151
- Blood cells, in immune system, 660, 661f
- Blood-cerebrospinal fluid barrier, drug distribution and, 27
- Blood clot, retraction of, platelet action in, 490
- Blood clotting. *See* Clotting factors and specific factors, e.g. Factor VIII.
- Blood dyscrasias, from H₁ antihistamines, 367
- Blood flow, inhalation anesthetic uptake and, 275-276
- Blood-gas partition coefficient, of inhalation anesthetics, 275t
- Blood glucose, insulin actions and, 558, 559f
- Blood lipids, ethanol effects on, 713
- Blood loss
anemia and, 469-470
iron deficiency anemia and, 470-472
- Blood pressure. *See also* Hypertension.
regulation of, 442-443, 443f
thiazide diuretic action and, 435
- Body composition, drug effects and, 49
- Body fat, glucocorticoid therapy and, 554
- Body flora, antibiotic effects on, 595
- Body temperature. *See also* Malignant hyperthermia.
antimuscarinic drug action on, 132
- Body water compartments, 28, 28f
- Body weight. *See* Weight, body.
- Bonds, covalent, in drug-receptor interactions, 5, 5f
- Bone
drug storage in, 30
normal physiologic processes of, 545f
- Bone marrow
depression of, from chloramphenicol, 633
hematopoiesis and, 469
in immune system, 660, 661f
as toxic target, 818
transplantation of, for sickle cell anemia, 476
- Bortezomib, for multiple myeloma, 705t
- Bosentan, for hypertension, 454
- Botulinum toxin, 134
neuromuscular transmission and, 146
type A
and B, for orofacial pain, 390-391
for dystonic syndromes, 242
- Bradykinin
in inflammatory process, 329
pharmacologic effects of, 329
- Brain
abscess of
absolute risk rate for, from single dental procedure, 774b
antibiotic prophylaxis for dental patients with, 777-778
alcohol toxicity and, 717, 717f
blood supply to, 153
functional changes in, in Parkinson's disease, 231-232
imaging of, 151-152
investigation of, 149
in schizophrenia, 164
stimulation of, for Parkinson's disease, 236t
- Brain tissue, grafting of, for Parkinson's disease, 241
- Brainstem, 151
anatomy of, 151
pain modulation in, 300-301, 300f
pharmacology of, 151

- Breast implants, antibiotic prophylaxis for dental patients with, 777
- Breast milk
drug effects and, 50
drug excretion in, 41
H₁ antihistamine excretion in, 367
- Bretium
actions of, 400t
pharmacokinetic properties of, 401t
- Bretium tosylate
absorption, fate, and excretion of, 405
adverse effects of, 405
for arrhythmias, 405
indications for, 407t
pharmacologic effects of, 405
- Brodifacoum
structural formula of, 831f
toxicity of, 830
- Bromadiolone
structural formula of, 831f
toxicity of, 830
- Bromochloropropane, toxicity of, 829
- Bromocriptine
for dystonic syndromes, 242
for Parkinson's disease, 236t, 239
structural formula of, 237f
therapeutic applications of, 95-96
- Brompheniramine maleate, structural formula of and dosages of, 363t-364t
- Bronchial hyperreactivity, in asthma, 511
- Bronchial smooth muscle
cholinergic drug effects on, 120
isoproterenol effects on, 97
- Bronchoconstriction, in aspirin intolerance, 336
- Bronchodilator, endogenous catecholamine-induced, 95
- Bronchodilators
adrenergic agonists as, 100
for asthma, 513-515
ephedrine as, 516
epinephrine as, 515-516
isoproterenol as, 516
names of, 522b-523b
for emergency use, 845
names of, 103b-104b
- Bronchoscopy, neuromuscular blocking drugs in, 144
- Bronchospasm
adverse β blocker effects on, 114
antihistamine action and, 365
- Bucizine hydrochloride, structural formula and dosages of, 363t-364t
- Budesonide, intranasal, for rhinitis, 522
- Buformin, for diabetes, 563. *See also* Biguanides, for diabetes.
- Bulk-forming agents, as laxatives, 532f, 533
- Bumetanide
absorption, fate, and excretion of, 437
structural formula of, 436f
- α -Bungarotoxin, neuromuscular transmission and, 146
- Bupivacaine
activity of, physicochemical correlates of, 247t
cardiotoxicity of, 254
for dental anesthesia, 260
preparations and dosages of, 262
side effects of, 56t
structural formula of, 247f
- Buprenorphine
dose, duration, and administration of, 315t
for opioid addiction, 803
pharmacologic effects of, 320
- Bupropion, 177-178
adverse effects of, 176t
structural formula of, 178f
therapeutic uses of, 182
- Burimamide, discovery of, 363, 368
- Burton's lines, from lead exposure, 822-823
- Buspirone
as antidepressant, 181
for anxiety, 188, 203
benzodiazepine use and, 203
structural formula of, 203f
- Busulfan
for cancer, 686t-692t, 693
structural formula of, 693f
- Butorphanol
dose, duration, and administration of, 315t
for intravenous anesthesia, 293t, 294, 767
pharmacologic effects of, 319-320
- Butyl nitrite, abuse of, 810
- Butyrophenones
side effects of, 171t
structure and activity relationships of, 165f, 166
- C**
- Cadmium poisoning, chelator treatment for, 824t
- Caffeine, in combination with nonopioid analgesics, 348, 349t
- Calcifediol, actions of, 544
- Calcitonin, 543
- Calcitonin gene-related peptide (CGRP), in neurogenic inflammation, 302
- Calcitriol
actions of, 544
structural formula of, 544f
- Calcium
antagonists of. *See* Calcium channel blockers.
in cardiac muscle contraction, 410
homeostasis of, hormones of, 543-546
metabolism of, drugs affecting, names for, 546b-547b
parathyroid hormone secretion and, 543
plasma, digoxin therapy and, 418-419
in platelet activation, 488-489, 488f
release of
in malignant hyperthermia, 147
in nerve stimulation, 157-158
thiazide diuretics and, 434
- Calcium carbonate, for peptic ulcer disease, 528
- Calcium channel(s)
in cardiac electrophysiology, 393-394, 395f
arrhythmias and, 396
effects of calcium channel blockers on, 427, 427b
on nociceptive neurons, 301, 311
phenytoin action at, 217-218
- Calcium channel blockers
for angina, 422, 426-428
absorption, fate, and excretion of, 427
adverse effects of, 428
chemistry and classification of, 426-427
pharmacologic effects of, 427
gingival hyperplasia from, 535
for hypertension, 447-448
absorption, fate, and excretion of, 448
pharmacologic effects of, 447-448
indications for, 427
for migraine and cluster headaches, 384
names of, 429t-430t
pharmacologic effects of, 428t
sites of action of, 429t-430t
structural formulas of, 427f
- Calcium chloride ion channels, in GABA_A receptor system, valproic acid and, 221
- Calcium entry blockers. *See* Calcium channel blockers.
- Calcium sensitizers, for congestive heart failure, 420
- Camptothecins, for cancer, 700
- Cancer
bisphosphonates for, 545-546
chemotherapy for, 683-710. *See also* Antineoplastic drugs, Cancer chemotherapy.
epoetin alpha for, 481-482
hematopoietic cell transplantation for, oral infections and, 790, 791t
radiation therapy for, oral complications of, 790-795, 792b
acute, 791-793
late, 793-795
- Cancer chemotherapy, 683-710
angiogenesis and, 684
dental and skeletal growth and development alterations and, 785
drugs used for, 685-704. *See also* Antineoplastic drugs.
epoetin alpha in, 481-482
gastrointestinal effects of, 789-790
history of, 683-684
nausea and vomiting from
dronabinol for, 809
drug treatment for, 531
nausea from, drug treatment for, 789-790
neurotoxic effects of, 785
novel approaches to, 684
oral complications of, 782-798, 783b
oral hemorrhage and, 789
oral mucosal infections and, 786-789
bacterial, 788-789
fungal, 786-787
viral, 787-788
oral toxic effects of, 782-790
direct, 782-786, 783b
indirect, 783b, 786-790
principles of, 684-685
salivary gland dysfunction and, 785
systemic toxic effects of, 783b
- Cancer disruption theory, 545f
- Candidiasis
in drug-abusing patient, 811
oral
in immunosuppressed patients, 786-787
postradiation, 792
treatment of, 646
oropharyngeal, from inhaled corticosteroids, 513
postradiation therapy, 794
- Cannabinoids
as antiemetics, 531
as central nervous system transmitters, 156t, 157
- Cannabis sativa*, 808-809
- Capacity-limited reactions, in absorption and elimination, 41
- Capecitabine, for cancer, 686t-692t, 696
- Capillary penetration, drug distribution and, 26
- Capillary walls, simple diffusion across, 19
- Capsaicin, topical, for orofacial neuropathic pain, 389-390
- Captopril
absorption, fate, and excretion of, 446
structural formula of, 446f
- Carbachol
for glaucoma treatment, 125, 125t
pharmacologic effects of, 119
structure of, 118f
- Carbamazepine
absorption, fate, and excretion of, 220
adverse reactions to, 219t, 220
interactions of, with benzodiazepines, 195, 195t
for mania, 185
mechanisms of action and therapeutic uses of, 216t
neuromuscular blocking drug action with, 145t
pharmacologic effects of, 220
for seizures in sedative-hypnotic withdrawal, 804
seizures promoted by, 215
structural formula of, 217f
toxic effects of, 818
for trigeminal neuralgia, 387
- Carbapenems, 615b, 618
- Carbaryl
structural formula of, 827f
toxicity of, 828
- Carbenicillin, 606t-607t, 607
- Carbidopa
plus levodopa, for Parkinson's disease, 234-235, 236t
structural formula of, 237f
- Carbinoxamine maleate, structural formula and dosages of, 363t-364t

- Carbohydrate metabolism
glucocorticoid effects on, 550
insulin actions on, 560t
- Carbon dioxide
local anesthetic action and, 248
toxicity of, 829
- Carbon monoxide
interactions of, with hemoglobin, 817-818
toxic effects of, 824-825, 825f
- Carbon tetrachloride
structural formula of, 826f
toxic effects of, 826
- Carbonic anhydrase inhibitors
absorption, fate, and excretion of, 438
adverse effects of, 438
mechanism of action and therapeutic uses of, 216t
pharmacologic effects and uses of, 438
for seizures, 224
therapeutic uses of, 438
urinary effects and mechanisms of action of, 432t
- Carboplatin
for cancer, 686t-692t, 700
structural formula of, 699f
- Carboxyhemoglobin, effect on oxygen dissociation, 824-825, 825f
- Carboxylic acid, mechanisms of action and therapeutic uses of, 216t
- Carboxypenicillins, 606t-607t
- Carcinogenic drug reactions, 58
- Carcinoid, histamine secretion from, 359-360
- Carcinoid syndrome, 359-360
- Cardiac arrhythmias. *See* Arrhythmias.
- Cardiac electrophysiology, basic, 393-394
- Cardiac glycosides, digoxin as, 414-418.
See also Digoxin.
- Cardiac ischemia, prevention of, β blockers for, 112
- Cardiac muscle contraction
in heart failure, 410-411, 411f
digoxin and, 415
rate of, digoxin effects on, 415
- Cardiac output, inhalation anesthetic uptake and, 275-276
- Cardiogenic shock, treatment of, 100
- Cardiovascular abnormalities, β -adrenergic receptor polymorphisms and, 74
- Cardiovascular agents, in renal failure, dosage adjustments needed in, 51t
- Cardiovascular devices, nonvalvular, antibiotic prophylaxis for dental patients with, 778
- Cardiovascular system
abnormalities of, infective endocarditis risk and, 772
alcoholism effects on, 716, 716t
antimuscarinic drug effects on, 131-133
antipsychotic drug effects on, 170, 171t
barbiturate effects on, 200
benzodiazepine effects on, 192
 β blocker effects on, 111
adverse, 113
chloral hydrate effects on, 201
cocaine abuse effects on, 806
desflurane effects on, 285f
dopamine effects on, 95
endogenous catecholamine effects on, 93, 94f
ethanol effects on, 712-713
ganglionic blocking drug effects on, 139
 H_1 antihistamine effects on, 367
halothane effects on, 284-285, 285f
histamine effects on, 361-362
inhalation anesthetic effects on, 276-277
isoflurane effects on, 285f, 286
isoproterenol effects of, 97
ketamine effects on, 290
levodopa effects on, 238
local anesthetic effects on, 254-255
meperidine effects on, 293
morphine effects on, 292-293, 313
neuromuscular blocking drug effects on, 143
nitrous oxide effects on, 281-282
propofol effects on, 289
sevoflurane effects on, 285f
thiopental effects on, 289
- Cardiovascular system (*Continued*)
tricyclic antidepressant effects on, 175-176
vasoconstrictor effects of local anesthetics on, 255-256, 258
- Caries
anticaries agents for, 720-731
antidepressant use and, 183
in cancer chemotherapy, 788
causes of, 720, 721f
dental plaque and, 732
rampant, in drug-abusing patients, 811
topical fluoride and, 725-728
vaccines for, 672
xerostomia-induced, 794
- Carisoprodol
chemical structure of, 204f
for muscle relaxation, 204
doses of, 205t
for musculoskeletal pain, 385-386
- Carmustine, for cancer, 686t-692t
- Carotid body, dopamine effects on, 95
- Carrier, silent, of thalassemia, 475
- Carrier-mediated transport, across membranes, 19-20
- Carvedilol
actions and therapeutic uses of, 114
for congestive heart failure, 413
for hypertension, 450
- Cascara sagrada
as laxative, 532
pharmacologic profile of, 870t-871t
- Caspases, in apoptosis, 669, 669f
- Caspofungin
for candidiasis in cancer patients, 787
introduction of, 596
- Caspofungin acetate
for fungal infections, 644
mechanism of action and clinical uses of, 641t
structural formula of, 645f
- Castor oil, as laxative, 532
- Catamenial epilepsy, 212, 224
- Catechol-O-methyltransferase (COMT)
carbidopa and, 234-235, 235f
in catecholamine metabolism, 98-99, 98f
inhibitors of
in dental practice, 243
for Parkinson's disease, 238-239, 238f
- Catecholamines. *See also* Adrenergic receptor agonists; Dopamine; Epinephrine; Norepinephrine.
biotransformation and excretion of, 98, 98f
for congestive heart failure, 419
endogenous
cardiac effects of, 94
CNS effects of, 95
metabolic effects of, 95
nonvascular smooth muscle effects of, 94-95
pharmacologic effects of, 93-95
salivary gland effects of, 95
vascular effects of, 93-94
fate of, 85
release of, 82-83
secretion of, histamine in, 362
synthesis of, 82
- Cathartics
osmotic, 532-533, 532f
for irritable bowel syndrome, 535
saline, as laxatives, 532-533, 532f
- Cation- π interactions, in drug-receptor interactions, 5, 5f
- Cationic agents
as disinfectants, 748
names of, 749b
- Cationic antimicrobial peptides, 581, 597
- Caveolae, in endocytosis, 20
- Cefactor, recommended dosages of, 614t
- Cefoxitin, in renal failure, dosage adjustments needed in, 51t
- Ceiling effect, of drug, 8
- Celecoxib
for chronic orofacial pain, 755
COX inhibitory activity of, 331f
for inflammatory conditions, 343-344
structural formula of, 343f
- Cell(s)
entry of drug into, drug distribution and, 26-27
functions of, local anesthetic action and, 255
immune, 660
in pain perception, 302
- Cell-mediated immunity (CMI), 660
cytokines in. *See also* Cytokines.
functional relationships of, 663t
effector aspects of, 669
immunostimulants for, 673, 681b
in type IV drug reactions, 57
- Cell membrane
antibiotic action and, 581, 582f, 582t
entry of drug into, 26-27
- Cell wall synthesis, antibiotic inhibition of, 581, 582f, 582t
- Cellulitis, orofacial, 600
microorganisms associated with, 601t
- Cellulose agents, as laxatives, 533
- Cellulose sponge, for bleeding control, 494
- Central nervous system
adrenergic agonist effects on, 100-101
alcoholism and, 716t, 717, 717f
anatomy of, 149-153
anticholinesterase effects on, 123, 124b
antihistamine effects on, 365
antimuscarinic drug use and, 132-133
autonomic nervous system regulation by, 89
barbiturate effects on, 199-200
benzodiazepine effects on, 192
 β blocker effects on, 112
adverse, 114
biochemical organization of, 155-157
chloral hydrate effects on, 201-202
cholinergic drug effects on, 120
cocaine abuse effects on, 806
depressants of, 188-211
 α -adrenergic receptor agonist drugs as, 206-207
 β -adrenergic receptor-blocking drugs as, 206
antihistamines as, 202. *See also* Antihistamines.
azaspirodecanediones as, 203
barbiturates as, 198-201
benzodiazepine-like sedative-hypnotics as, 198
benzodiazepines as, 189-198. *See also* Benzodiazepines.
centrally acting muscle relaxants as, 203-206. *See also* Muscle relaxants, centrally acting.
chloral hydrate as, 201-202. *See also* Chloral hydrate.
melatonin receptor agonists as, 198
depression of
drugs producing, 188, 208-209. *See also* Antianxiety agents; Muscle relaxants, centrally acting; Sedative-hypnotics.
herbal product interactions with, 872t
opioid interactions with, 321
in ether anesthesia, 272-273, 272f
by H_1 antihistamines, 367
in renal failure, drug dosage adjustments and, 51t
sensitivity to, in elderly, 839
in surgical anesthesia, 273
drugs acting on, 149-161, 150t
in dentistry, 150t
drug distribution and, 27
effects of, termination of, 159-160
endogenous catecholamine effects on, 95
ethanol effects on, 711-712
ganglionic blocking drug effects on, 139
glucocorticoid effects on, 554
 H_2 antihistamine effects on, 368
adverse, 370
levodopa effects on, 236-238
local anesthetic effects on, 254
neuromuscular blocking drug effects on, 142-143
neurotransmitter release in, 157-158
opioid peptides in, 308

- Central nervous system (*Continued*)
 propionic acid derivative effects on, 339
 stimulation of
 by adrenergic agonists, 100-101
 adrenergic agonists in, names of, 103b-104b
 by H₁ antihistamines, 367
 local anesthetic use and, 254
 synaptic organization of, 153-155
 as toxic target, 817
 tricyclic antidepressant effects on, 175
- Central sensitization, in pain prevention, 303
- Centripetal obesity, 550-551
- Cephalexin, recommended dosages of, 614t
- Cephalosporin(s), 614-618
 absorption, fate, and excretion of, 617
 adverse effects of, 617
 antibacterial spectrum of, 614-616
 bacterial resistance to, 616-617
 chemistry of, 614
 classification of, 614, 615b, 616t
 contraindications to, 618
 cross-sensitivity of, with penicillins, 617
 drug interactions with, 617
 mechanism of action of, 614-616
 microorganisms susceptible to, 616t
 therapeutic uses of, 617
 in dentistry, 617
 toxicity risk of, in elderly, 836-837, 837t
- Cephadrine, recommended dosages of, 614t
- Cerebral cortex, 150
 anatomy of, 150
 nuclei of, in anesthetic action, 271, 271f
 pain perception and modulation by, 301
 pharmacology of, 150
- Cerebral effects
 of halothane, 285
 of isoflurane, 286-287
 of ketamine, 290-291
 of propofol for intravenous anesthesia, 290
- Cerebrospinal fluid, barrier to, drug distribution and, 27
- Cerivastatin, for hyperlipidemia, 464-465
- Cervicofacial actinomycosis, microbiology of, 603
- Cetirizine, structural formula and dosages of, 363t-364t
- Cetuximab, for cancer, 705t, 707-708
- Cetylamine hydrofluoride
 in fluoride dentifrices, 728
 structural formula of, 727f
- Cetylpyridinium chloride
 for plaque prevention/control, 737
 structural formula of, 737f
- Cevimeline, 117
 absorption and metabolism of, 120
 adverse reactions to, 120
 for salivary gland stimulation, 793-794
 for xerostomia, 125-126
- Charcoal, activated, as adsorbent, 530
- Chelating agents
 for heavy metal poisoning, 823-824, 824f, 824t
 for lead poisoning, 823
- Chemical(s), toxic. *See also* Toxic effects; Toxicity.
 epidermal absorption of, 25-26
 relationships between, 817
 target organs of, 817-819
- Chemical bonds, in drug-receptor interactions, 5-6, 5f
- Chemical communication, neuronal, in central nervous system, 153
- Chemically reactive agents, 15
- Chemoreceptor trigger zone (CTZ), in vomiting, 531
- Chemotactic factors, in inflammatory process, 328
- Chemotherapeutic drugs, 685-704. *See also* Antineoplastic drugs.
- Chemotherapy, cancer. *See* Cancer chemotherapy.
- Children
 analgesic use in, 757
 antimuscarinic drug overdose in, 134
 antipsychotic drug use in, 172
- Children (*Continued*)
 aspirin therapy in, Reye's syndrome and, 335
 dental and skeletal development of, cancer chemotherapy and, 785
 drug dosage calculations for, 860-861, 861f
 drug poisoning in, 59
 febrile seizures in, 226
 iron deficiency anemia in, 470-472
 local anesthetic use in, 260
 vs. adults, drug effects and, 49
- Chimeric monoclonal antibodies, 674
- Chloral hydrate
 absorption, fate, and excretion of, 201
 adverse effects of, 201
 adverse gastrointestinal reactions to, 535
 chemical structure of, 201f
 in dentistry, 209
 drug interactions with, 195t, 201
 for oral sedation, 765
 pharmacologic effects of, 201
 phase I reactions in, 35t-36t
 for sedation, 294-295
- Chlorambucil
 for cancer, 686t-692t, 692
 structural formula of, 693f
- Chloramphenicol, 633
 structural formula of, 633f
- Chlorazepate, adverse reactions to, 219t
- Chlorbutanol, preparations and dosages of, 262
- Chlordane
 structural formula of, 828f
 toxicity of, 828
- Chlordecone
 structural formula of, 828f
 toxicity of, 828
- Chlordiazepoxide
 absorption, fate, and excretion of, 193t
 abuse of, 802
 for anxiety, dose and administration of, 197t
 metabolism of, 193f
 for muscle relaxation, doses of, 205t
 structural formula of, 189f
- Chlorhexidine
 antimicrobial activity of, 745t
 as antiseptic, 747
 clinical indications for, 736b
 for oral candidiasis, 646
 for oral mucositis in cancer patients, 788
 for plaque prevention/control, 735-736, 739t
 structural formula of, 735f
- Chloride ion channels, in GABA_A receptor system
 anesthetic action and, 269
 barbiturate action and, 199
 benzodiazepine action and, 189-192, 190f-191f
- Chlorinated solvents
 structural formula of, 826f
 toxic effects of, 826
- Chlorine dioxide, characteristics of, 745t
- Chloroform
 abuse of, 810
 chemical properties of, 276
- Chlorophacinone toxicity, 830
- Chlorophenoxy compounds, toxicity of, 829
- Chloroquine
 for rheumatoid arthritis, 351
 volume of distribution of, 28t
- Chlorothiazide
 pharmacokinetic data on, 434t
 side effects of, useful, 56t
 structural formula for, 434f
- Chlorothymol, in plaque prevention/control, 737
- Chlorotrianisene, for cancer, 686t-692t
- Chlorphenesin, for muscle relaxation, 204
- Chlorpheniramine
 for common cold, 366
 structural formula and dosages of, 363t-364t
- Chlorpromazine
 cardiovascular effects of, 170
 discovery of, 165
 metabolism of, 172t
- Chlorpromazine (*Continued*)
 pharmacologic effects of, 168-170
 phase I reactions in, 35t-36t
 for schizophrenia, relative potency of
 receptor antagonist affinities in, 166t
 side effects of, 56t, 171t
 structure-activity relationships of, 166
 volume of distribution of, 28t
- Chlorpropamide, pharmacokinetics of, 562t
- Chlortetracycline, 624. *See also* Tetracycline(s).
- Chlorthalidone, pharmacokinetic data on, 434t
- Chlorzoxazone, structural formula of, 204f
- Cholecalciferol, 543
- Cholestatic hepatitis, erythromycin use and, 620
- Cholesterol
 atherosclerosis and, 458-462
 drugs lowering, 462-466. *See also* Lipid-lowering drugs.
 for myocardial infarction prevention, 429
 metabolism of, 460f
- Cholesteryl ester transfer protein (CETP), inhibitors of, for hyperlipidemia, 466
- Cholestyramine
 digoxin and, 419
 for hyperlipidemia, 464
 properties of, 463t
 structural formula of, 464f
- Choline esters, structure of, 117, 118f
- Cholinergic crisis, in myasthenia gravis, 126
- Cholinergic drugs, 117-128
 digoxin interactions with, 419
 indirect-acting, 121. *See also* Anticholinesterase(s).
 names of, 127b
 therapeutic uses of, 124-127
 in dentistry, 127
- Cholinergic junction, 83f
 drugs acting on, 89t
 location of, 82
- Cholinergic nerves, 82, 83f
 neurotransmission in, 85-86
- Cholinergic receptors, 82, 83f, 85-86
- Cholinomimetic agents, as gastrointestinal stimulants, 535
- Cholinomimetic agonists, 117-121
 absorption, fate, and excretion of, 120
 adverse effects of, 120-121
 in glaucoma, 125
 mechanism of action of, 117-118, 119f
 names of, 127b
 pharmacologic effects of, 120
 structural formula of, 118f
- Chondrotoxicity, of fluorquinolones, 628
- Chorea, Huntington's, 241
- Choroid plexus, drug access to central nervous system and, 27
- Christmas disease, 496
- Chromaffin autograft, for Parkinson's disease, 241
- Chromatin remodeling proteins, in asthma, corticosteroid effects on, 512
- Chronic obstructive pulmonary disease (COPD)
 definition of, 511
 dentistry for patients with, 520-521
 pathophysiology of, 512
 pharmacotherapy for, 520
 prevalence of, 511
- Chronic pain syndromes, drugs for, 382-385
 mechanisms of, 389b
 prophylactic, 382-385
 tricyclic antidepressants as, 181, 383
- Chronobiology, 150
- Chrysotherapy, for rheumatoid arthritis, 351
- Chylomicron remnants
 characteristics of, 459t
 in lipoprotein metabolism, 459
- Chylomicrons
 characteristics of, 459t
 in lipoprotein metabolism, 458-459
- Ciclesonide, for asthma, 513
- Cidofovir
 for CMV infections, 652
 for viral infections, 648t

- Cigarette smoking. *See* Smoking.
- Cimetidine
 adverse effects of, 370
 development of, 368
 drug interactions with, 195-196, 195t, 370
 for duodenal ulcers, 526-527
 other H₂ antihistamines vs., 527t
 structural formula of, 368f
- Cinchonism, 399
- Ciprofloxacin
 recommended dosages of, 614t
 side effects of, 56t
 structural formula of, 626f
 for traveler's diarrhea, 534
- Circadian rhythms, drug effects and, 50
- Cisatracurium, pharmacologic properties of, 142t
- Cisplatin
 for cancer, 686t-692t, 699-700
 structural formula of, 699f
- Citalopram
 adverse effects of, 176t
 structural formula of, 179f
- Citric acid, for salivary gland stimulation, 793
- Cladribine, for cancer, 686t-692t, 695
- Clarithromycin. *See also* Macrolide antibiotics.
 in dentistry, 620
 introduction of, 618
 recommended dosages of, 614t
- Clarke, William E., 266
- Clark's rule, for drug dosage calculations, 860-861
- Clathrin, 20
- Clavulanate, with amoxicillin, 606t-607t, 609t
- Clavulanic acid
 with amoxicillin, 609, 614t
 characteristics of, 609
- Cleaning fluids, abuse of, 810
- Clemastine fumarate, structural formula and dosages of, 363t-364t
- Clindamycin, 621-622
 absorption, fate, and excretion of, 622
 adverse effects of, 622
 antibacterial spectrum of, 621-622
 bacterial resistance to, 622
C. difficile diarrhea and, 596, 622
 contraindications to, 622
 drug interactions with, 622
 mechanism of action of, 581-583, 621-622
 recommended dosages of, 614t
 structural formula of, 621f
 therapeutic uses of, 622
 in dentistry, 622
 toxicity risk with, in elderly, 836-837, 837t
- Clinical trials, of new drugs, 64
- Clobazam, 223
- Clodronate, 544. *See also* Bisphosphonates.
- Clofarabine, for cancer, 686t-692t
- Clofibrate
 for hyperlipidemia, 462-463
 properties of, 463t
 structural formula of, 462f, 464f
- Clomiphene
 as estrogen receptor partial agonist, 575-576
 structural formula of, 575f
- Clomipramine, adverse effects of, 176t
- Clonazepam
 abuse of, recent trends in, 800
 adverse reactions to, 219t
 for chronic pain, 386
 for depression, 181
 for mania, 185
 mechanisms of action and therapeutic uses of, 216t
 for Parkinson's disease, 241
 for seizures, 222-223
 structural formula of, 190t
- Clonic seizures, 213t
- Clonidine
 absorption, fate, and excretion of, 451
 adverse effects of, 113t, 451
 for anxiety, 206
 for hypertension, 451-452
 for mania, 185
 for opioid withdrawal, 96-97, 802
 for orofacial neuropathic pain, 390
- Clonidine (*Continued*)
 pharmacologic effects of, 96-97, 451
 side effects of, 56t
 structural formula of, 96f, 451f
 for Tourette's syndrome, 241-242
 xerostomia from, 115
- Clopidogrel
 for myocardial infarction prevention, 429
 for platelet inhibition, 506
- Cloramphenicol, phase I reactions in, 35t-36t
- Clorazepate
 absorption, fate, and excretion of, 192-193, 193t
 for anxiety, dose and administration of, 197t
 mechanisms of action and therapeutic uses of, 216t
 metabolism of, 193f
 for seizures, 222-223
 structural formula of, 190t
- Clostridium difficile*, diarrhea associated with, 595-596
 antibiotics and, 535
 clindamycin and, 622
- Clotrimazole
 for candidiasis in cancer patients, 792
 for fungal infections, 643
 mechanism of action and clinical uses of, 641t
 for oral candidiasis, 646
 structural formula of, 648t
- Clotting factors, 491t. *See also and specific factors, e.g.,* Factor VIII.
 topical, 494-495
 vitamin K-dependent, 490
 in coagulation cascade, 490
 enzymatic cofactors of, 490-492
- Cloxacillin, 605-607, 606t-607t
- Clozapine
 adverse effects of, 170
 autonomic effects of, 170
 metabolism of, 172t
 pharmacologic effects of, 168
 for schizophrenia, relative potency of
 receptor antagonist affinities in, 166t
 side effects of, 171t
 structure and activity relationships of, 167
 structure of, 167f
- Coagulation. *See also* Hemostasis.
 regulation of, 492-493
- Coagulation cascade, 490-492, 491f
- Coated pit, 20
- Cobalamins
 absorption and transport of, 477-478
 malabsorption of, vitamin B₁₂ deficiency from, 478
 physiologic characteristics of, 477-478
 synthesis of, 477
 for vitamin B₁₂ deficiency, 479
- Cobalt, red cell formation and, 474
- Cocaine
 abuse of, 805-807
 characteristics of, 806
 history of, 799-800
 recent trends in, 800
 discovery of, 246
 pharmacologic effects of, 805-806
 structural formula of, 247f, 804f
 time course of effect of, 46, 46f
 topical use of, 262
 toxicity of, 806-807
- Cocci
 gram-negative, infections due to, antibiotics for, 610t-611t
 gram-positive, infections due to, antibiotics for, 610t-611t
- Codeine
 in combination analgesics, 350
 for cough suppression, 521
 dose, duration, and administration of, 315t
 effects of, 315-316
 gastric absorption of, 21-22, 21f
 genetic polymorphisms in, 70
 for pain vs. aspirin, 332, 332f
 in renal failure, dosage adjustments needed in, 51t
 structural formula of, 315-316, 316f
- Colchicine for gout, 354
 structural formula of, 353f
- Cold, perception of, 301
- Cold remedies
 H₁ antihistamines as, 366
 names of, 103b-104b
- Colesevelam hydrochloride, for hyperlipidemia, 464
- Colestipol
 for hyperlipidemia, 464
 properties of, 463t
- Colitis, pseudomembranous, antibiotic-associated, 595-596
- Collagen
 disease of, antibiotic prophylaxis for dental patients with, 778
 microfibrillar, for bleeding control, 494
 in platelet adhesion, 487, 488f
- Colton, Gardner Quincy, 266
- Coma, myxedematous, 542-543
- Combat Methamphetamine Act of 2005, 852
- Complement system, in inflammatory process, 329-330, 329f
- Complementary and alternative medicine (CAM), 867
- Complementary medicine. *See also* Alternative medicine.
- Complex regional pain syndrome, diagnostic criteria for, 387b
- Compliance/noncompliance
 drug effects and, 54
 in elderly, 837
 medication errors and, 837
 prescriptions and, 858
- Comprehensive Drug Abuse Prevention and Control Act of 1970, 799, 862
- COMT. *See* Catechol-O-methyltransferase (COMT).
- Conduction abnormalities, cardiac arrhythmias and, 395-396, 396f
- Conduction velocity, myocardial, 393, 394f
- Conformational induction, 7-8
 in drug binding, 7-8
- Conformational selection, 8
 in drug binding, 8
- Congenital malformations
 antibiotic therapy and, 594
 phenytoin and, 218
- Congestive heart failure. *See also* Heart failure.
 β blockers for, 112-113. *See also* Adrenergic receptor antagonists, β.
 carbonic anhydrase inhibitors for, 438
 catecholamines for, 419
 digoxin for, 418
 drugs used for, names of, 420t-421t
 loop diuretic use and, 437
- Conivaptan, 438-439
- Conjugation reactions, nonmicrosomal, in drug metabolism, 34-36
- Conjunctival dilation, decongestants for, 99
- Conscious sedation. *See* Sedation, minimal; Sedation, moderate.
- Consciousness, definition of, 267
- Constipation, laxatives for, 532-533
 names of, 536b
- Constitutive androstane receptor, 38
- ConsumerLab, testing of dietary supplements by, 869
- Contact dermatitis, local anesthetic use and, 257
- Contraceptives, oral, 571-572
 adverse effects of, 573-574
 antibiotics and, 574, 594
 proprietary names and content of, 571t
- Contractility, myocardial
 digoxin effects on, 415
 in heart failure, digoxin ad, 415
 heart failure and, 410-411, 411f
- Controlled substances, 851
 classification of, 864-865, 865t
 government regulations on, 851, 864-865
- Controlled Substances Act, 862
- Convective movement of drugs, 19
- Convulsions. *See* Seizures.
 definition of, 212

- COPD. *See* Chronic obstructive pulmonary disease (COPD).
- Copper
chelation of, for Wilson's disease, 242
deficiency of, 474
poisoning by, chelator treatment for, 824t
- Coproporphyrin, hereditary, safe and unsafe drugs in, 474-475, 475b
- Corticosteroids, 549-557. *See also* Glucocorticoids.
absorption, fate, and excretion of, 551-552
adverse effects of, 553-555, 554b
as antiemetics, 531
for asthma, 512-513
adverse effects of, 513
 β_2 -adrenergic receptor agonists interacting with, 515
efficacy and safety of, 513
mechanism of action of, 512
names of, 522b-523b
pharmacologic effects of, 512-513
biologic half-lives of, 556b
for cancer, 686t-692t, 698
digoxin interactions with, 419
disorders treated by, 552, 552b
diuretic use and, 439-440
emergency use of, 845t, 846
for headache and chronic pain syndromes, 385
in immunosuppression, 677
intranasal, for rhinitis, 522
long-term use of, 552
names of, 556t
peptic ulcer disease and, 530
physiologic and pharmacologic actions of, 549-551
potency of, 550t
preparations of, 555-556, 556t
for rhinitis, intranasal, 522
therapeutic uses of, 552
in dentistry, 552-553, 555
- Corticotropin-releasing hormone, 539t
- Cortisol, physiologic actions of, 549
- Cortisone
potency of, 550t
for temporomandibular joint inflammation, 385-386
- Cost, of drugs, 858
legislation and, 863
- Costimulation, in specific immune response, 666f, 667
enhancement of, 673
- Cough suppression
antitussive medications for, 521
morphine-induced, 312
- Coumarin-indandiones, 502-504
adverse effects of, 504
drug-drug interactions involving, 505b
mechanism of action of, 502-503, 503f
prothrombin time INR value for, 506-507
structural formulas of, 503f
toxicity of, antidotes for, 504
- Coumarin-indanediones, 502-504
- Covalent bonds, in drug-receptor interactions, 5, 5f
- COX activity. *See* Cyclooxygenase (COX) activity.
- Cranial nerves, pain transmission in orofacial region and, 300
- Cresol, as disinfectant, 746-747
- Cromolyn, for asthma prophylaxis, 517-518
- Cross-dependence, definition of, 800
- Cross-tolerance, definition of, 800
- Cryoprecipitate, therapeutic use of, 497
- Culture and sensitivity testing, for orofacial infections, 589
- Curare, 136
- Cyanide poisoning, 830, 830f
- Cyanocobalamin. *See also* Cobalamins.
structure and function of, 477
for vitamin B₁₂ deficiency, 479
- Cyclic adenosine 3'5'-monophosphate
in cardiac contractility, 410
in G protein-linked receptor action, 4, 86, 87f, 311
platelet adhesion inhibition and, 487
- Cyclic guanosine 3'5'-monophosphate
in G protein-linked receptor action, 118
intracellular receptor action and, 5
muscarinic receptor stimulation and, 118
- Cyclizine
as antiemetic, 531
structural formula and dosages of, 363t-364t
- Cyclobenzaprine
for muscle relaxation, 205
drug interactions with, 206
for musculoskeletal pain, 385-386
neuromuscular transmission and, 146
structural formula of, 204f
- Cyclooxygenase-2 (COX-2) inhibitors
selective, 343-345
celecoxib as, 343-344
etoricoxib as, 345
lumiracoxib as, 345
parecoxib as, 345
rofecoxib as, 344-345
valdecoxib as, 345
toxicity risk with, in elderly, 837
- Cyclooxygenase (COX), in arachidonic acid metabolism, 325-327
- Cyclooxygenase (COX) activity
inhibitors of
adverse effects of, 335
COX-2
for pain control, 754-755, 755f
selective, 343-345. *See also* Cyclooxygenase-2-selective inhibitors.
traditional NSAIDs vs., 755
in dentistry, 345
NSAIDs vs. acetaminophen as, 332t
for platelet inhibition, 505-506
in salicylate action, 330-331, 331f
isoforms of
COX-1, 327, 327f
COX-2, 327, 327f, 343-345
physiologic roles of, 327, 327f
in prostaglandin synthesis, 302
- Cyclophilins, 675
- Cyclophosphamide
for cancer, 686t-692t, 692
in immunotherapy, 678
for rheumatoid arthritis, 351
side effects of, 56t
structural formula of, 693f
- Cycloplegia
antimuscarinic drug-induced, 131, 131t
atropine and scopolamine use for, 132
- Cyclopropane, chemical properties of, 276
- Cyclosporine
gingival hyperplasia from, 219f, 535
in immunotherapy, 676-677
for rheumatoid arthritis, 351-352
structural formula of, 676f
- Cypermethrin
structural formula of, 828f
toxicity of, 828
- Cyproheptadine
for migraine, 384
structural formula and dosages of, 363t-364t
- Cyproterone acetate
as androgen receptor antagonist, 574
structural formula of, 574f
- Cytarabine
action of, 16
for cancer, 686t-692t, 696
side effects of, 56t
- Cytochrome P-450
in drug metabolism, 38-39
drug metabolism inhibition and, 38
enzymes of, 33t
genetic polymorphisms in, 72
isoenzymes of
CYP3A4/5, in drug inactivation, 23-24
CYP2C9, 72-73
CYP2C19, 72-73
CYP2D6, 72
CYP2D6 as, 70
drug interactions with, 708-709
in microsomal oxidation, 31, 32f, 33t
substrates, inhibitors, and inducers of, 33t
- Cytokines
functional relationships of, 663t
in immune system, 662
immunotherapeutic uses of, 678-680
in inflammatory process, 328
names of, 681b
TH1 and TH2, therapeutic uses of, 680
- Cytolysis, lymphocyte-induced, in immune response, 669, 669f
- Cytomegalovirus (CMV)
drugs active against, 652
infection from, oral, in immunosuppressed patients, 787
- Cytotoxic drug reactions, 57
- Cytotoxic drugs, 677-678
- D**
- Dacarbazine, for cancer, 686t-692t, 693
- Daclizumab
proprietary names of and indications for, 675t
sd humanized MAb, 675
- Dactinomycin, for cancer, 686t-692t, 696
- Dadatinib, for cancer, 705t
- Dalfopristin, 630
- Dalton's law, 273, 273f
- Danaparoid, anticoagulant action of, 502
- Danazol
indications for and dose of, 569t
structural formula of, 568f
- Dantrolene
for emergency use, 849
for malignant hyperthermia from halothane, 286
neuromuscular transmission and, 146-147
side effects of, 56t
structural formula of, 146f
- Dapsone, for leprosy, 636
- Daptomycin, introduction of, 596
- Darbeopetin alfa, 481-482
- Darifenacin, antimuscarinic action of, 130
- Darunavir, for human immunodeficiency virus infection, 656
- Darusentan, for hypertension, 454
- Dasatinib, for cancer, 705-706
- Datura innoxia*, poisoning from, 134
- Daunorubicin
for cancer, 686t-692t, 696-697
structural formula of, 697f
- Davy, Humphrey, 266
- DDT
structural formula of, 828f
toxicity of, 827-828
- Decarboxylase, in serotonin synthesis, 374f, 375-376
- Decitabine, for cancer, 686t-692t, 702
- Decongestants, nasal
adrenergic agonists as, 99
names of, 103b-104b, 522b-523b
overdose of, 99
- Deep neck space infections, microbiology of, 603
- Deep sedation
benzodiazepine-opioid combinations for, 767-768
drugs used for, 767-768
pharmacologic approaches to, 761
reversal agents for, 768
vs. minimal and moderate sedation and general anesthesia, 762t
- Deferoxamine
for heavy metal poisoning, 823-824, 824t
for iron poisoning, 473
structural formula of, 824f
- Defibrillator, automatic external, 843-844
- Degratulation, in histamine release, 359
- Degreasers, abuse of, 810
- Dehalogenation, by microsomal enzymes, 33-34, 35t-36t
- Delavirdine, for human immunodeficiency virus infection, 655
- Deliriant hallucinogens, 808
- Delirium, withdrawal from sedative-hypnotics and, 803

- Delmopinol hydrochloride
in plaque prevention/control, 738, 739t
structural formula of, 738f
- δ receptor, characterization of, 309t
- Demeclocycline, 624. *See also* Tetracycline(s).
- Dementia, senile, treatment of, 121
- Dendrites, 151-152
- Dense granules, in platelet activation, 488, 488f
- Dental amalgam, mercury content of, 821-822
- Dental caries. *See* Caries.
- Dental fluorosis, 724, 729. *See also* Fluoride(s).
- Dental plaque. *See* Plaque, dental.
- Dental procedures
oral bacteremia resulting from, vs. activities of daily living, 772, 774-775, 775b
surgical, endocarditis prophylaxis and, 778-779
- Dentifrices
fluoride-containing, 727-728, 728t
herbal ingredients in, 874t
stannous fluoride-containing, in plaque prevention/control, 737
- Dentistry
adrenergic agonists in, 101-103, 101t
analgesics in
nonopioid, 346t
oral, 349t, 350
anesthesia in, history of, 266-267
antianemic drugs in, 484-485
antianginal drugs in, 429
anti-anxiety drugs in, 207-209, 209b
antiarrhythmic drugs in, 408
antibiotics in
macrolide, 620
overuse of, 580-581
for specific microorganisms, 610t-611t
anticoagulants in, 500-504, 506-508
anticonvulsant therapy in, 226-227
antidepressants in, 183
antiemetics in, 526t
antihypertensives in, 455-456
antimuscarinic drugs in, 134-135, 134t
antineoplastic therapy and, 709
antipsychotic drugs in, 173
antiseptics and disinfectants in, 749
anxiolytic and sedative drugs in, drug interactions with, 195t
aspirin and other NSAIDs in, 345
asthmatic patients in, 520-521
for cardiac patient, 420
centrally acting muscle relaxants in, 209, 210b
cephalosporins in, 617
clindamycin in, 622
diabetic patients in, 564-565
drug abuse and, 810-812
drugs used in
by elderly, 834, 839-840
for emergencies, 842-850
interactions of, with herbal products, 872t
sources of information on, 67
emergencies in
drugs for, 842-850
factors influencing, 842
preparation for, 842-843, 843b
ganglionic blocking drugs in, 140
glucocorticoid therapy in, 555
H₁ antihistamines in, 367-368
implications of pharmacogenetics and pharmacogenomics for, 74
integrated health care and, 869-875
herbal therapies for oral disease and, 873-875
modifications of dental treatment and, 872-873
patient evaluation in, 869-872
lithium use in, 185
local anesthetic use in, 259-261
medical emergencies relevant to, 843, 843b
mercury in, 821-822
neuromuscular blocking drugs in, 145-146
occupational safety in, 820
opioids in, 321
- Dentistry (*Continued*)
pain in
analgesics for
acetaminophen, 347
nonopioid, 346t
opioid, 321
oral, 335, 349t
management of, 305
prevention of, 304-305
penicillins in, 610
peptic ulcer disease treatment in, 529-530
prothrombin time INR value in, 506-507, 507f
sedative-hypnotics in, 207, 209b-210b
seizures in, management of, 226-227
sex steroid hormones in, 576
tetracyclines in, 625
tobacco cessation and, 137-138
- Dentists
antibiotic overuse by, 580-581
drug abuse among, 811
as target of drug abusers, 811
- Denture fitting, in cancer chemotherapy patients, 788
- Deoxyadenosine, structural formula of, 650f
- Deoxyadenosylcobalamin, function of, 477
- 2'-Deoxycorformycin, for cancer, 686t-692t
- Dependence
on amphetamines, 805
on benzodiazepines, 194
on cocaine, 806
definition of, 314, 800
on mixed opioid agonists-antagonists, 318-319
opioid analgesics subject to, 314, 315t
physical
definition of, 314
on opioid analgesics, 756
psychological, 314
- Deprenyl, for Parkinson's disease, 236t, 241
- Depression, 164-165. *See also* Antidepressants; Tricyclic antidepressants.
- CNS
in ether anesthesia, 272-273, 272f
in surgical anesthesia, 273
respiratory, morphine-induced, 312
- Dermatitis
atopic, H₁ antihistamines for, 366
contact, local anesthetic use and, 257
- Dermatoses, allergic, H₁ antihistamines for, 366
- Desensitization
of cocaine, 46, 46f
of motor endplate receptor, 141
pharmacodynamic, 13, 14f
- Desflurane, 287
pharmacologic properties of, 284t
physical properties of, 282t
properties of, 275t
structural formula of, 282f
- Desipramine, 175
adverse effects of, 176t
- Desmopressin, for bleeding disorders, 497-498
- Desmopressin acetate, therapeutic uses of, 538
- 11-Desoxycorticosterone, potency of, 550t
- Detoxification, 31
- Dexamethasone
as antiemetic, 531-532
dose, administration, and preparations of, 556t
for neuroma, 385
potency of, 550t
side effects of, 56t
structural formula of, 555f
- Dexchlorpheniramine maleate, structural formula and dosages of, 363t-364t
- Dexmedetomidine
for intravenous anesthesia, 291
for intravenous sedation, 767
as sedative-hypnotic, 206-207
- Dexrazoxane, for cancer, 686t-692t
- Dextran
in histamine release, 360
as plasma extender, 484
- Dextromethorphan
for chronic pain treatment, 389
for cough suppression, 521
- Dezocine
dose, duration, and administration of, 315t
pharmacologic effects of, 320
- Diabetes insipidus, polyuria in, thiazide diuretics for, 435
- Diabetes mellitus, 559-561
α-glucosidase inhibitors for, 564
angiotensin-converting enzyme inhibitors for, 564
antibiotic prophylaxis for dental patients with, 778
inositolphosphoglycans for, 564
insulin therapy for, 560-561. *See also* Insulin.
oral antihyperglycemic agents for, 561-564. *See also* Oral antihyperglycemic agents.
treatment of, dental considerations with, 564-565
type 1, 560
type 2, 560
- Diacylglycerol, in G protein-dependent events, 87, 87f
- Diarrhea
antibiotic-induced, 535, 595-596
clindamycin and, 622
drug treatment for, 533-535
names of, 536b
traveler's, prevention and treatment of, 534-535
- Diazepam, 189
absorption, metabolism, and excretion of, 192, 193t
abuse potential of, 194
adverse reactions to, 219t
for anxiety, dose and administration of, 197t
for chronic pain, 386
for cocaine withdrawal, 806
in dentistry, 207, 208f, 209
for emergency use, 845t, 846
for intravenous anesthesia or sedation, 292, 766
mechanisms of action and therapeutic uses of, 216t
metabolism of, 193f
for muscle relaxation, 205
doses of, 205t
neuromuscular transmission and, 146
for oral sedation, 765
for premedication in anesthesia, 295t
for seizures, 222-223
in dental office, 226-227
due to local anesthetics, 257
in sedative-hypnotic withdrawal, 804
side effects of, 56t
structural formula of, 190t, 204f
- Diazinon
structural formula of, 827f
toxicity of, 827-828
- Diazoxide
for hypertension, 452-453
structural formula of, 452f
- Dibenzazepine, structural formula of, 175f
- Dibenzocycloheptadiene, structural formula of, 175f
- Dibenzodiazepines
side effects of, 171t
structure and activity relationships of, 167
- Dibenzothiazepine, side effects of, 171t
- Dibenzoxazepines
side effects of, 171t
structural formula of, 175f
structure and activity relationships of, 167
- 1,2-Dibromo-3-chloropropane, toxicity of, 829
- Dichloralphenazone, for migraine, 381
- Dichloromethane
structural formula of, 826f
toxicity of, 826
- 2,4-Dichlorophenoxyacetic acid
structural formula of, 829f
toxicity of, 829
- 1,2-Dichloropropene, toxicity of, 829

- Diclofenac
for inflammatory conditions, 341-342
for pain, dosage of, 346t
structural formula of, 340f
- Dicloxacillin, 605-607, 606t-607t
pharmacokinetics of, 609t
recommended dosages of, 614t
- Dicumarol
chloral hydrate with, 202
phenobarbital and, 38-39
- Dicyclomine, for irritable bowel syndrome, 535
- Didanosine, for human immunodeficiency virus infection, 654-655
- Dieldrin toxicity, 828
- Diet
fish oils in, for hyperlipidemia, 466
folic acid sources in, 479
iron in, 472
ketogenic, for seizure prevention, 226
salt-restricted, lithium use and, 184
vitamin B₁₂ deficiency and, 477-478
- Dietary Supplement Health and Education Act of 1994, 868-869, 868b
- Dietary supplements
coumarin-indandione action and, 505b
government regulations of, 851-852, 868
for platelet inhibition, 506
- Dietary Supplements and Health and Education Act of 1994, 863
- Diethanol aminopropyl-N-ethanol octadecylamine-dihydrofluoride
in fluoride dentifrices, 728
structural formula of, 727f
- Diethylpropion, structural formula of, 804f
- Diethylstilbestrol
for cancer, 686t-692t
indications for and dose of, 569t
structural formula of, 568f
- Difenoxin, for diarrhea, 534
- Differential nerve block, local anesthetics and, 251-254, 253f
- Diffusion
facilitated, across membranes, 19
passive, passage of drugs across membranes by, 17-19
- Diffusion hypoxia, nitrous oxide effects and, 283
- Diffusion microkinetic theory, 513
- Diflunisal, 336-337
adverse effects of, 337
indications for, 337
for pain, dosage of, 346t
structural formula of, 331f
- Digitalis, 414. *See also* Digoxin.
positive inotropic action of, 411f
- Digoxin
absorption, fate, and excretion of, 417
adverse effects of, 417-418, 417b
for arrhythmias, 407
cardiac effects of, 414-416
chemistry and classification of, 414
for chronic heart failure, 414-418
conditions affecting use of, 418-419
diuretic effects of, 416-417
electrocardiographic effect of, 416, 416f
electrophysiologic effects of, 416, 416t
for emergency use, 846t
mechanism of action of, 414
pharmacokinetics of, 417t
pharmacologic effects of, 414-417
side effects of, 56t
structural formula and composition of, 414, 414f
systemic vascular effects of, 416
therapeutic uses of, 418
toxic effects of, 417-418
antibiotics and, 419
drug monitoring for, 418
loop diuretics and, 437
treatment of, 418
- Digoxin immune Fab, proprietary names of and indications for, 675t
- Dihydrocarbotryl, side effects of, 171t
- Dihydrocodeine, structure and effects of, 316
- Dihydroergotamine, for migraine, 379-380
- Dihydroindolones
side effects of, 171t
structure and activity relationships of, 166-167
- Dihydropyrimidine dehydrogenase, genetic polymorphisms in, 73
- Dihydroxyphenylalanine, biosynthesis of, 82, 85f
- Diltiazem
actions of, 400t
cardiovascular effects of, 427, 428t
drug interactions of
with benzodiazepines, 195, 195t
with digoxin, 419
for emergency use, 846t-848t, 848
for hypertension, 447-448
pharmacokinetic properties of, 401t
in renal failure, dosage adjustments needed in, 51t
structural formula of, 427f
- Dimenhydrinate
as antiemetic, 531
structural formula and dosages of, 363t-364t
- Dimercaprol
action of, 15
for heavy metal poisoning, 823, 824t
for lead poisoning, 823
structural formula of, 824f
- Dimethyl sulfoxide, percutaneous absorption of water-soluble drugs and, 26
- Dinitroaminobenzene herbicide toxicity, 829
- Dinitroresol toxicity, 829
- Dinitrophenol toxicity, 829
- Dioxin toxicity, 817
- Dipeptidyl carboxypeptidase, 445
- Diphacene toxicity, 830
- Diphacinone, 831f
- Diphenhydramine
as antiemetic, 531
for emergency use, 845t
for Parkinson's disease, 236t
in renal failure, dosage adjustments needed in, 51t
side effects of, 56t
useful, 56t
structural formula and dosages of, 363t-364t
- Diphenoxylate, for diarrhea, 534
- Diphenylbutylpiperidine, side effects of, 171t
- Diphenylbutylpiperidines, structure and activity relationships of, 167
- Diphenylhydantoin, 217. *See also* Phenytoin.
- Dipyridamole, for myocardial infarction prevention, 429
- Dirithromycin, 618. *See also* Macrolide antibiotics.
- Disease(s)
antirheumatic drugs modifying, immunosuppressive actions of, 678
drug effects and, 50-52
drug metabolism and, 38-39
focal infection theory of, 580
multiple, in elderly, 835-836, 836t
- Disinfectant(s)
characteristics of, 745t
classification of, 744-745, 745t
definition of, 744
in dentistry, 749
ideal, criteria for, 744
names of, 749b
- Disintegrins, for platelet inhibition, 506
- Disopyramide
absorption, fate, and excretion of, 402
actions of, 400t
adverse effects of, 402
for arrhythmias, 402
drug interactions with, 407
pharmacokinetic properties of, 401t
pharmacologic effects of, 402
structural formula of, 402f
- Dissociative anesthesia, 290
- Distribution, major pathways of, 18f
- Disulfiram
for alcoholism, 715, 718
phase 1 reactions in, 35t-36t
- Diuretic effects, of digoxin, 416-417
- Diuretic(s), 431-441
carbonic anhydrase inhibitors as, 438
classes of, 431-439
for congestive heart failure, 411
in dentistry, 439-440
digoxin interactions with, 419
drug interactions with, 439t
for emergency use, 849
loop, 436-438
absorption, fate, and excretion of, 437
actions of, 436f
adverse reactions to, 437-438
digoxin interactions with, 419
drug interactions with, 439t
pharmacologic effects of, 436-437
therapeutic uses of, 437
urinary effects and mechanisms of action of, 432t
names of, 440t
osmotic, 438
absorption, fate, and excretion of, 438
adverse effects of, 438
pharmacologic effects and uses of, 438
therapeutic uses of, 438
urinary effects and mechanisms of action of, 432t
potassium-sparing, 431-433
absorption, fate, and excretion of, 433
actions of, 433f
adverse effects of, 433
combined with thiazide diuretics, names of, 434t
drug interactions with, 439t
pharmacologic effects of, 432-433, 432t
structural formula of, 433f
therapeutic effects of, 433
urinary effects and mechanisms of action of, 432t
sites of action of, along nephron, 431, 432f
thiazide, 433-436
absorption, fate, and excretion of, 435
adverse effects of, 435-436
for chronic heart failure, 411
currently available in United States, 434t
digoxin interactions with, 419
drug interactions with, 439t
for essential hypertension, 445
pharmacologic effects of, 434-435
proprietary names of, 434t
structural formula of, 434f
therapeutic uses of, 435
urinary effects and mechanisms of action of, 432t
urinary effects and mechanisms of action of, 432t
- DNA
carcinogenic drug effects and, 58
drug-receptor interaction and, 2, 4-5
synthesis of, vitamin B₁₂ and folic acid deficiency and, 476
- DNA demethylation agents, for cancer, 686t-692t
- Dobutamine
for congestive heart failure, 419
for emergency use, 846t, 848-849
pharmacologic effects of, 97
structure-activity relationships of, 92t
- Docetaxel, for cancer, 686t-692t, 700-701
- Docosahexaenoic acid, in fish oil, for hyperlipidemia, 466
- Docosanol, for herpes labialis, 652
- Docosate sodium, as laxative, 532, 532f
- Dodecylsulfate phosphate detergents, as disinfectants, 748
- Dofetilide
actions of, 400t
for arrhythmias, 406
indications for, 407t
pharmacokinetic properties of, 401t
structural formula of, 406f
- Dolasetron, as antiemetic, 531
- Dong quai, pharmacologic profile of, 870t-871t

- Dopamine, 80-82. *See also* Catecholamines.
antagonists of, for Huntington's disease, 241
antipsychotic drug effects and, 163
biosynthesis of, 84f-85f
biotransformation and excretion of, 98-99
as central nervous system neurotransmitter, 155, 156t
for congestive heart failure, 419
for emergency use, 846t-848t, 848-849
extrapyramidal motor function and, 234
metabolism of, oxygen free radicals and, 232, 233f
in neural control of Parkinson's disease, 232
pharmacologic effects of, 95-96
in schizophrenia, 163
structural formula of, 92f
structure-activity relationships of, 92t
- Dopamine receptor(s)
in antipsychotic drug action, 165-166, 168
blockade of, 163, 163t
direct agonists of
in Parkinson's disease, 236t, 239-240
side effects of, in dental practice, 243
genetic polymorphisms of, 74
in neural control in Parkinson's disease, 232, 235
- Dopaminergic transmission, 87
- Dorfeuille, Joseph, 266
- Doripenem, 615b
characteristics of, 618
- Dorsal horn(s)
central sensitization in, 303
components of, 301
nociceptive activity in, serotonin receptors and, 378
in pain perception, 300-301
- Dorsal horn lamina, serotonin concentrations in, 375
- Dorsal raphe nuclei, serotonin concentrations in, 375
- Dose
calculations for, 859-861
median effective, 48, 62-63
median lethal, 62-63
- Dose-response curve, 3-4
quantal, 48, 49f
- Dose-response relationships, 8-13
occupation theory in, 8-11, 9f
limitations of, 10-11
receptor diversity in, 13
stimulus-response coupling in, 11-13, 12f
- Downregulation, 13, 14f
- Doxazosin
absorption, fate, and excretion of, 450
bioavailability of, 107
for hypertension, 449-450
therapeutic uses of, 107
- Doxepin, 175
adverse effects of, 176t
- Doxorubicin
for cancer, 686t-692t, 697
structural formula of, 697f
- Doxycycline, 624. *See also* Tetracycline(s).
recommended dosages of, 614t
- Doxylamine, in pregnancy, 367
- Doxylamine succinate, structural formula and dosages of, 363t-364t
- Dressings, for bleeding control, 494
- Dronabinol
as antiemetic, 531
therapeutic uses of, 809
- Droperidol
as antiemetic, 531-532
for neuleptanalgesia, 767
side effects of, 171t
structure-activity relationships of, 166
- Drowsiness, from benzodiazepines, 192, 194
- Drug(s) (*Continued*)
absorption of, 21-26
by active transport, 23, 23f
in elderly, 838
kinetics of, 41
in oral cavity, 733
abuse of. *See* Drug abuse.
- Drug(s) (*Continued*)
administration of. *See* Drug administration.
agonist action of, 9-10
stimulus-response theory and, 11
antagonist action of
competitive and noncompetitive, 10, 10f
stimulus-response theory and, 11-13
binding of, 29-30
bioavailability of
chemical and biologic equivalence and, 854
drug formulations and, 23
ceiling effect of, 8, 9f
chemically reactive, 15
clearance of, from oral cavity, 733
clinical uses of, 48-68
controlled, 851
classification of, 864-865, 865t
government regulations of, 851, 864-865
cost of, 858
legislation and, 863
counterfeit biochemical, 16
cytotoxic, 677-678
development of, 61-65, 62f
dissolution of, in gastrointestinal tract, 22
distribution of. *See* Drug distribution.
dosage calculations for, 859-861
dose-response curve of, 8, 9f, 48, 49f
dose-response relationships of, 8-13
occupation theory in, 9f
limitations of, 10-11
emergency, 843-849
for advanced cardiac life support, 846-849, 846t
critical, 844-845, 844t
for primary support, 845-846, 845t
supplementary, 849
equivalence of, 854-855
errors in prescribing or administration of, 54
excretion of, 39-41
biliary, 40-41
by breast milk, 41
in elderly, 839
kinetics of, 27
of local anesthetics, 256
minor routes of, 41
plasma protein binding and, 29
pulmonary, 41
formulation of, drug absorption and, 22-23
generic and proprietary names of, 854
in histamine release, 360
inactivation of, in oral ingestion, 23-24
information on, sources of, 65-67, 855
intrinsic activity of, 9
laws regulating. *See* Drug laws.
legal categories of, 851-852
mechanisms of action of
allosteric model of, 15
dose-response relationships in, 8-13
multistate model of, 13-15
receptor independent, 13
receptor interactions in, 2
metabolism of. *See* Drug metabolism.
new
approval and continued surveillance of, 64
clinical trials of, 64
development of, 61-65, 62f
evaluation of, 61-65
impact of government regulations on, 64-65
preclinical testing of, 61-64
sources of, 61
nomenclature of, 65, 65f
orphan, 863
OTC, 851
pharmacokinetics of. *See* Pharmacokinetics.
physically active, 15-16
porphyrinogenic, 474-475, 475b
potency of, 9-10
prescription, 851. *See also* Prescription(s).
laws regulating, 853t
receptor-independent, 15-16
and receptors, interactions between, 2-8
reimportation of, 857-858
- Drug(s) (*Continued*)
safety of, preclinical testing of, in animals, 61-64
side effects of, 55, 56t
useful, 56t
substantivity of, in oral cavity, 733-734
therapeutic equivalents of, 854
threshold concentration of, 8, 9f
toxicity risk with, in elderly, 836-837, 837t
weights and measures of, 861-862, 862t
- Drug abuse, 59, 799-813
among dentists, 811
of amphetamines, 804-805
characteristics of, 800-801, 800t
of cocaine, 805-807
definition of, 799
dental implications of, 810-812
drug interactions in, 811
economic effect of, 800
of hallucinogens, 807-808
historic perspective on, 799-800
incidence of, 800
of inhalants, 810
of marijuana, 808-809
medical and dental complications of, 811
medical emergencies and, 842
of opioid analgesics, 801-803
pain control and, 811-812
parenteral, signs of, 810-811
polydrug, 810
of sedative-hypnotics, 803-804
terminology of, 800
- Drug action
delayed, 46, 46f
time course of, 41-44
context-sensitive half-lives of, 44, 45f
multiple-compartment models of, 44, 45f
pharmacokinetic-pharmacodynamic modeling of, 46, 46f
single-compartment model of, 41-44, 42f
- Drug Addiction Treatment Act (DATA), 803
- Drug administration
drug effects and, 52
drug formulation and, 22-23
routes of
inhalation, 24
oral, 21-24
parenteral, 24-25
subcutaneous, 25
topical, 25-26
- Drug allergy, 56-58
- Drug binding, 29-30
consequences of, 7-8
receptor response to, 7
structure-activity relationships in, 6-7, 6f
- Drug-binding forces
cooperation of, 6
types of, 5-6, 5f
- Drug distribution, 26-31
capillary penetration and, 26
delayed, of lorazepam, 46
drug binding and storage and, 28-30
in elderly, 835, 836t, 838
entry of drug into cells and, 26-27
in oral cavity, 733
redistribution and, 30
restricted, 27-28
volume of, 28, 28f, 28t
in real drug excretion, 40
- Drug effects
adverse, 54-59. *See also* Adverse drug reactions.
factors influencing, 48-54
variations in
drug factors influencing, 52-53
factors associated with therapeutic regimen, 53-54
patient factors influencing, 49-52
- Drug Enforcement Administration (DEA), prescriptions for controlled substances and, 864-865
- Drug holidays, in levodopa therapy, 241

- Drug Information Handbook for Dentistry*, 67
- Drug interactions
- with acetaminophen and alcohol, 348
 - with adrenergic agonists, 98
 - with adrenergic blocking drugs, 115
 - with aminoglycosides, 630
 - with antihypertensives, 455-456
 - with antimuscarinics, 134
 - with antineoplastic drugs, 708-709
 - with antipsychotics, 172t
 - with aspirin, 336, 337t
 - with barbiturates, 195t, 200-201
 - with benzodiazepines, 194-196
 - with cephalosporins, 617
 - with clindamycin, 622
 - in dentistry
 - with adrenergic blocking drugs, 115
 - with herbal products, 872t
 - with levodopa, 242-243
 - with digoxin, 419
 - with diuretics, 439t
 - in drug abusers, 811
 - drug metabolism and, 38
 - enzyme induction and, 38-39
 - with fluoroquinolones, 628
 - with genes, 70
 - with H₂ antihistamines, 370
 - with linezolid, 631
 - with lithium, 185
 - with local anesthetics, 258
 - with macrolide antibiotics, 620, 621t
 - with metronidazole, 624
 - with monoamine oxidase inhibitors, 177
 - in dentistry, 182
 - with neuromuscular blocking drugs, 144-145, 145t
 - with opioids, 321
 - with penicillins, 613
 - plasma protein binding and, 29
 - with St. John's wort, 181
 - with streptogramins, 631
 - with tricyclic antidepressants, 177
 - with vancomycin, 630
- Drug laws, 857, 862-865
- on controlled substances, 864-865
 - on dietary and health supplements, 868-869
 - on drug categories and controlled substances, 851, 853t
 - historical development of, 862-864
 - on new drug development, 65, 214
 - on prescription writing, 853t
- Drug metabolism, 31-39
- in elderly, 838-839
 - entry into liver and, 37-38
 - factors affecting, 37-39
 - hepatic microsomal, 31-34, 35t-36t
 - of local anesthetics, 256
 - nonhepatic, 36-37
 - nonmicrosomal, 34-36
 - in oral cavity, 733
 - phase I, 31, 35t-36t
 - enzymes involved in, 32f
 - phase II, enzymes involved in, 32f, 37t
 - toxic effects and, 817
- Drug Price Competition and Patent Term Restoration Act of 1984, 65
- Drug transporter polymorphisms, 73
- Dry mouth. *See* Xerostomia.
- Duke Criteria, Modified, for infective endocarditis diagnosis, 776, 776b
- Duloxetine, 180
- for migraine, 383
- Duraphat varnish, for topical fluoride application, 726
- Durham-Humphrey Amendment of 1951, 862
- Dutasteride, as androgen receptor antagonist, 574
- Dyclonine
- preparation and dosages of, 262
 - structural formula of, 247f
- Dynamine, 20
- Dynorphins, 307-309, 308f
- physiologic functions of, 310
- Dyspepsia, 525
- Dysphonia, from inhaled corticosteroids, 513
- Dystonia
- antipsychotic drug action an, 169-170
 - treatment of, drugs used for, 242
- E**
- Ears, toxicity of drugs for. *See* Ototoxicity.
- Echinacea, pharmacologic profile of, 870t-871t
- Echinocandin antifungal drugs, 644-645, 645f
- Echinocandins, 640
- Echothiophate, structural formula of, 122f
- Eclampsia, convulsions with, magnesium salts for, 225
- Econazole, for fungal infections, 644
- Ecstasy, abuse of, 799-800
- Edema
- carbonic anhydrase inhibitors for, 438
 - glucocorticoid therapy and, 554
 - loop diuretics for, 437
- Edetate calcium disodium, for lead poisoning, 823
- Edetate calcium disodium complex
- for heavy metal poisoning, 823-824, 824t
 - structural formula of, 824f
- Edrophonium, structural formula of, 122f
- Efalizumab, proprietary names of and indications for, 675t
- Efavirenz, for human immunodeficiency virus infection, 655
- Eicosapentanoic acid, in fish oil, for hyperlipidemia, 466
- Elderly patients
- antibiotic dosing and, 592
 - benzodiazepine paradoxical reactions in, 194
 - compliance of, medication errors and, 837
 - drug disposition in, 835, 836t
 - drug dosage calculations for, 860
 - drug effects and, 49-50
 - drug use in, dental treatment and, 834
 - medical emergencies and, 842
 - multiple disease states in, 835-836, 836t
 - painful conditions in, 299
 - penicillin-induced allergic reactions in, 612
 - pharmacologic changes associated with, 838-839
 - pharmacology for, 834-841
 - physiologic changes in, 834-835, 835f
 - psychosocial factors in, adverse drug effects and, 837-838
 - sedative-hypnotic use in, 207
- Electrocardiography
- common arrhythmias on, 396-397, 397f
 - digoxin effects on, 416, 416f
 - normal heart rhythm on, 396, 396f
- Electrochemical gradient, passive diffusion and, 19
- Electroconvulsive therapy, neuromuscular blocking drugs in, 144
- Electroencephalographic effects, of barbiturates, 199
- Electrolyte(s)
- glucocorticoid effects on, 551
 - plasma, digoxin toxicity and, 418-419
- Electronic media, drug information in, 67
- Electrophysiologic effects, of digoxin, 416, 416t
- Electrophysiology, cardiac, basic, 393-394
- Elementary osmotic pump, drug absorption and, 23
- Eletriptan
- dosage forms and T_{max} of, 380t
 - for migraine, 381
- Elysol, for local oral drug delivery, 739, 740t
- Emergence
- from anesthesia, definition of, 267
 - from ketamine anesthesia, 291
- Emergency(ies)
- continuing education for, 843
 - in dentistry
 - factors influencing, 842
 - preparation for, 842-843, 843b
 - drugs used in, 843-849
 - for advanced cardiac life support, 846-849, 846t
 - critical, 844-845, 844t
 - for primary support, 845-846, 845t
 - supplementary, 849
- Emergency(ies) (*Continued*)
- emergency kit for, 843-844
 - hypertensive, 455
 - treatment of, 455t
 - medical
 - drugs used for, 842-850
 - relevant to dentistry, 843, 843b
- Emesis. *See also* Antiemetics.
- antihistamine-induced, 367
 - cancer chemotherapy-induced, 531, 789-790
 - digoxin and, 417
 - morphine-induced, 312
- Emetics, 530
- names of, 536b
- Emphysema, 818
- Emtricitabine, for human immunodeficiency virus infection, 655
- Enalapril
- absorption, fate, and excretion of, 446
 - for chronic heart failure, 413
 - structural formula of, 446f
 - volume of distribution of, 28t
- Encephalomyelitis, allergic, TH1 response in, 680
- Endocarditis
- bacterial. *See* Infective endocarditis.
 - infective. *See* Infective endocarditis.
- Endocrine system
- antipsychotic drug effects on, 169-170
 - drug metabolism and, 39
 - H₂ antihistamine effects on, 370
- Endocytosis, drug transport by, 20
- Endomorphins, 308f
- neurons containing, 308
 - physiologic functions of, 310
 - structure and function of, 307
- Endoperoxides, prostaglandin, 325-327
- Endorphins
- derivation and function of, 308
 - physiologic functions of, 310
- Endosome, 20
- Endothelin receptor antagonists, for hypertension, 454
- Endothelium-derived relaxing factor, 424
- platelet adhesion inhibition and, 487
- Endotracheal intubation, neuromuscular blocking drugs for, 144
- Enflurane
- characteristics of, 275t
 - structural formula of, 282f
- Enfuvirtide
- for HIV infection, 648t
 - for human immunodeficiency virus infection, 656
- Enkephalins, 308f
- derivation and function of, 307
 - neurons containing, 308
 - physiologic functions of, 310
- Entacapone
- for Parkinson's disease, 236t, 238-239
 - structural formula of, 238f
- Entecavir, for hepatitis B virus, 654
- Enteric coating, on tablets, 22-23
- Enterochromaffin-like cells, histamine containing, 359-360
- Enterococci, antibiotic resistance of, 586
- Enterohepatic cycling, in cholesterol metabolism and transport, 460
- Environmental factors
- drug effects and, 50
 - in Parkinson's disease, 231
- Environmental Protection Agency, in disinfectant regulation, 744
- Enzyme(s)
- for cancer, 686t-692t, 699
 - cofactors of, in blood clotting, 490-492
 - definition of, 2
 - in drug inactivation, 23-24
 - in drug metabolism, 31-33, 32f, 33t, 35t-37t, 38-39
 - drug responsiveness and, 69
 - genetic polymorphisms in, 72-73
 - hepatic microsomal
 - anticonvulsant action and, 215, 215b, 227
 - in barbiturate metabolism, 200
 - in drug metabolism, 31-34, 35t-36t

- Enzyme(s) (*Continued*)
 histamine release triggered by, 360
 lysosomal, in inflammatory process, 328
 microsomal, in alcohol elimination, 714
 nonmicrosomal
 in drug metabolism, 35t-36t
 drugs used as inhibitors of, 38
 penicillin-sensitive, 607-608
- Enzyme-linked receptors, 3f, 4
- Eosinophils, inflammatory mediators released by, 329
- Eperezolid, 631
- Ephedra
 ban on, 868
 pharmacologic profile of, 870t-871t
 for weight loss and increased energy, 101
- Ephedrine
 for asthma, 516
 for emergency use, 849
 for nasal decongestion, 522
 pharmacologic effects of, 97-98
 structure-activity relationships of, 92t
 for weight loss and increased energy, 101
- Epidermal growth factor receptor tyrosine kinase, 704
- Epidermis, resistance of, to drug absorption, 25
- Epidural block, with local anesthetics, 259
- Epilepsy. *See also* Seizures.
 anticonvulsant therapy for, 214-215. *See also* Anticonvulsants.
 benzodiazepine therapy for, 197-198
 carbonic anhydrase inhibitors for, 438
 catamenial, 224
 classification of, 212-213, 213t
 in dental practice, 226-227
 experimental drugs for, 225-226
 jacksonian, 213, 213t
 nonpharmacologic treatment for, 226
 pathophysiology of, 213-214
- Epinephrine, 80-82. *See also* Catecholamines.
 aerosol administration of, 24
 for asthma, 515-516
 biosynthesis of, 82, 85f
 biotransformation and excretion of, 98-99, 98f
 as central nervous system transmitter, 155
 for emergency use, 844t, 845, 846t-848t, 848-849
 endogenous, cardiac effects of, 94
 endogenous administration of, effects of, 93-95, 94f
 in local anesthetic formulations, 101, 101t, 255-256
 tissue injury from, 257
 for nasal decongestion, 522
 racemic, in dentistry, 102
 structural formula of, 92f
 structure-activity relationships of, 92t
 for systemic anaphylaxis, 366
 topical, for bleeding control, 465
 toxic effects of, 103
- Epirubicin, for cancer, 686t-692t, 697
- Eplerenone, for chronic heart failure, 413
- EPO. *See* Erythropoietin (EPO).
- ePocrates Rx, 67
- Epoetin alfa, 481-482
- Epoprostenol, for hypertension, 452-453
- Epothilones, for cancer, 700-701
- Epstein-Barr virus infection, oral, in immunosuppressed patients, 656-657, 787-788
- Eptifibatid
 for myocardial infarction prevention, 429
 for platelet inhibition, 506
- Ergocalciferol, 543
- Ergoline, for Parkinson's disease, 236t
- Ergonovine, side effects of, 56t
- Ergot derivatives
 contraindications to, 379b, 381
 migraine and, 379-380
 names of, 391t
 side effects of, 379b
- Ergotamine, 379
 mode of action of, 379
- Erlotinib, for cancer, 704, 705t
- Ertapenem, 615b
 characteristics of, 618
- Erythema multiforme, macrolide use and, 620
- Erythrocytes
 artificial, creation of, 484
 in detection of anemia, 469
 distributed production or increased destruction of, in anemia, 469
 hemoglobin changes and, 470
 in megaloblastic anemia, 476
 morphologic characteristics of, 471b
 nucleated, description of, 471b
 shape of, 470
 substitutes for, 483-484
- Erythroleukemia, 469
- Erythromycin
 absorption, fate, and excretion of, 619-620
 adverse effects of, 620
 chemistry and classification of, 618
 contraindications to, 620-621
 digoxin interactions with, 419-420
 dosages of, recommended, 614t
 drug interactions with, 620, 621t
 for gastroparesis, 535
 mechanism of action of, 618-619
 microbial resistance to, 587, 619
 microorganisms susceptible to, 618-619, 619b
 in plaque prevention/control, 738
 in renal failure, dosage adjustments needed in, 51t
 side effects of, 56t
 structural formula of, 619f
 therapeutic uses of, 620
 in dentistry, 620
- Erythropoietin (EPO)
 pathophysiologic characteristics of, 481
 physiologic characteristics of, 480-481
 therapeutic use of, 481-482
- Escherichia coli*, enterotoxigenic, traveler's diarrhea and, 534
- Eserine, historical background of, 121
- Esmolol
 actions of, 400t
 for arrhythmias, 404
 for emergency use, 848
 pharmacokinetic properties of, 401t
 pharmacologic effects of, 110t
- Esomeprazole, as proton pump inhibitors, 525-526
- Essential oils, herbal, 873
- Estazolam
 absorption, metabolism, and excretion of, 193t
 metabolism of, 193f
 structural formula of, 190t
- Estradiol, structural formula of, 568f
- Estramustine, for cancer, 686t-692t
- Estrogen(s)
 administration of, 569
 adverse effects of, 573
 antagonists of, 574-576, 575t
 as antidepressants, 181
 for cancer, 686t-692t, 698
 conjugated, indications for and dose of, 569t
 drug interactions with, 574
 indications for and doses of, 569t
 names of, 569t, 577b
 in oral contraceptives, 571-572, 571t
 partial agonists of, names of, 577b
 structural formula of, 568f
 structure and functions of, 568-569
 therapeutic uses of, 571-572
- Estrone, structural formula of, 568f
- Etanercept
 proprietary names of and indications for, 675t
 for rheumatoid arthritis, 352
- Eteramine. *See also* Serotonin.
 isolation of, 374
- Ethacrynic acid
 absorption, fate, and excretion of, 437
 structural formula of, 436f
- Ethambutol, for tuberculosis, 636
- Ethanol, 711-718
 absorption, fate, and excretion of, 713-714, 714f
 abuse of, 711
 aerosol, abuse of, 810
 aspirin interactions with, 336
 dependence on, 715-718
 as disinfectant and antiseptic, 748
 drug interactions with, 714-715
 forms of, 711
 mechanism of action of, 711
 in mouth rinses, 741
 pharmacologic effects of, 711-713
 phase I reactions in, 35t-36t
 therapeutic uses of, 715
 in dentistry, 715
 tolerance to, 52, 715
- Ethanolamines, structural formula and dosages of, 363t-364t
- Ether
 abuse of, 810
 anesthesia with, stages of, 272-273, 272f
 chemical properties of, 276
 early use of, 266-267
 properties of, 275t, 282t, 284
 structural formula of, 282f
- Ethinyl estradiol
 for cancer, 686t-692t
 indications for and dose of, 569t
 structural formula of, 568f
- Ethnic differences, in pharmacogenetics, 72
- Ethosuximide
 for absence seizures, 221-222
 adverse reactions to, 219t
 mechanism of action and therapeutic uses of, 216t
- Ethotoin, mechanisms of action and therapeutic uses of, 216t
- Ethylene dibromide toxicity, 829
- Ethylene glycol toxicity, 719
- Ethylene oxide toxicity, 829
- Ethylenediamines
 names of, 370t-371t
 structural formula and dosages of, 363t-364t
- Ethylenimine derivative, for cancer, 686t-692t
- Etidronate, 544. *See also* Bisphosphonates.
- Etodolac
 COX inhibitory activity of, 331f
 for inflammatory conditions, 341
 for pain, dosage of, 346t
 structural formula of, 340f
- Etomidate
 for intravenous anesthesia, 291
 structural formula of, 282f
- Etoposide
 for cancer, 686t-692t, 700
 structural formula of, 700f
- Etoricoxib, 345
 COX inhibitory activity of, 331f
 structural formula of, 343f
- Etravirine, for human immunodeficiency virus infection, 655
- Eugenol, characteristics of, 747
- Eutectic mixture of local anesthetics, for orofacial neuropathic pain, 390
- Evans blue dye, volume of distribution of, 28t
- Excretion, major pathways of, 18f
- Exemestane, for cancer, 686t-692t, 698-699
- Exenatide, for diabetes, 563-564
- Exocrine glands, histamine effects on, 362
- Exocytosis
 drug transport by, 20-21
 of histamine, 359
- Exosite, 513
- Expectorants, 522
 names of, 522b-523b
- Expedited Drug Approval Act and Prescription Drug User Fee Act (1992), 214
- Extracellular antigens, in antigen processing, 665
- Extracellular fluid volume, thiazide diuretic action and, 435
- Extraction, tooth, cancer chemotherapy and, 788, 789t

- Extrapyramidal abnormalities
 antipsychotic drugs and, 171t
 dopamine and, 234
 from psychotic drugs, 169-170
- Exzopiclone, 198
- Eye(s). *See also* Ocular effects.
 antimuscarinic drug effects on, 131-132
 β blocker effects on, 112
 bloodshot, decongestants for, 99
 cholinergic drug effects on, 119
 ganglionic blocking drug effects on, 139
 glucocorticoid therapy and, 554
 nitrous oxide effects on, 283
- Ezetimibe
 for hyperlipidemia, 465-466
 properties of, 463t
- F**
- Facial nerve, pain transmission and, 300
- Facial pain. *See also* Orofacial pain; Orofacial pain syndromes.
 atypical, antidepressant use and, 183
 Facilitated diffusion, across membranes, 19
- Factor VII
 in hemostasis, 490-492
 vitamin K deficiency and, 502
- Factor VIIa
 in hemophiliacs with high-titer inhibitor antibodies, 498
 products of, for bleeding disorders, 496t
- Factor VIII
 deficiency of, in hemophilia A, 495-496
 plasma-derived products of, for bleeding disorders, 497
 porcine, for hemorrhage in hemophiliacs, 498
 products of, for bleeding disorders, 496t
 recombinant products of, for bleeding disorders, 497
 in von Willebrand's disease, 496-497
- Factor IX
 concentrates of, for bleeding disorders, 498
 deficiency of, in hemophilia B, 496
 products of, for bleeding disorders, 496t
 recombinant preparation of, for bleeding disorders, 498
- Factor IX complex, for bleeding disorders, 498
- Factor Xa, in hemostasis, 490-492
- Factor XI deficiency, bleeding and, 492
- Factor eight inhibitor bypass activity (FEIBA), for hemorrhage in hemophiliacs, 498
- Facts and Comparisons*, drug information in, 66
- Famciclovir, for viral infections, 648t, 652
- Familial apoprotein CII deficiency, 461t
- Familial hypercholesterolemia, 461t
- Familial hypertriglyceridemia, 461t
- Familial lipoprotein lipase deficiency, 461t
- Familial type 3 hyperlipoproteinemia, 461t
- Famotidine
 other H₂ antihistamines vs., 527t
 for peptic ulcer disease, 527
 structural formula of, 368f
- Faraday, Michael, 266
- Fat
 body, glucocorticoid therapy and, 554
 drug binding in, 29-30
 drug storage in, 30
 in gastric emptying, drug absorption and, 22
 metabolism of, insulin actions on, 560t
- FDA. *See* Food and Drug Administration (FDA).
- FDA Modernization Act (1997), 863
- Fear
 definition of, 759
 dental, prevalence of, 759, 760t
 management of, 759-770
 of pain, 752
 patient experiencing, identification of, 760
 pharmacologic management of
 approaches to, 761-762, 761f
 indications for, 759-760
 patient selection for, 760-761, 760b
 treatment planning for, 760
- Febuxostat, for gout, 354
- Federal Food, Drug and Cosmetic Act of 1938, 862
- Federal Food and Drugs Act of 1906, 862
- FEIBA, for hemorrhage in hemophiliacs, 498
- Felbamate
 mechanism of action and therapeutic uses of, 216t
 for seizures, 224
 toxic effects of, 818
- Felodipine, for hypertension, 447-448
- Felypressin, for vasoconstriction with local anesthetics, 258
- Fenamates
 for inflammatory conditions, 342
 structural formulas of, 340f
- Fenofibrate, for hyperlipidemia, 462-463
- Fenoldopam
 effects of, 95
 for hypertension, 453-454
 structural formula of, 454f
- Fenopropfen, 339
 for pain, dosage of, 346t
 structural formula of, 338f
- Fentanyl
 dose, duration, and administration of, 315t
 with droperidol for neuroleptanalgesia, 767
 for intravenous anesthesia or sedation, 293-294, 293t
 for intravenous sedation, 766-767
 with midazolam, for deep sedation, 767
 for premedication in anesthesia, 295t
 structural formula of, 318f
 structure and analgesic effects of, 317-318
- Ferritin, in iron storage, 472
- Ferrous sulfate for iron deficiency anemia, 473
- Fetal alcohol syndrome, 716t, 717
- Fetal hydantoin syndrome, 218
- Fetal tissue, surgical brain grafting of, for Parkinson's disease, 236t
- Fetus
 malformations of
 from benzodiazepines, 194-195
 drug teratogenicity and, 59, 60t
 placental transfer of drugs to, 27-28
- Fever, salicylates for, 333
- Feverfew, pharmacologic profile of, 870t-871t
- Fexofenadine hydrochloride, structural formula and dosages of, 363t-364t
- Fibric acid derivatives, for hyperlipidemia, 462-463
- Fibrin sealant, 494-495
- Fibrinogen
 in blood clotting, 489
 in platelet activation, 488, 488f
- Fibrinolysis, 498-499, 499f
 agents promoting, 498-500
 drugs inhibiting, 500
 drugs promoting or inhibiting, names of, 509t
- Fibrinolytics, 498-500
- Fibromyalgia, SSRIs for, 383
- Fibronectin, in platelet adhesion, 487
- Fibronlysis, drugs promoting or inhibiting, for emergency use, 849
- Fibrotic reaction, to methysergide and methylergonovine, 382-383
- Filgrastim, 482
 for cancer, 686t-692t, 703
 therapeutic use of, 483
- Finasteride
 as androgen receptor antagonist, 574
 structural formula of, 574f
- First-dose effect, 450
- First-order kinetics, of absorption and elimination, 41, 42f, 42t
- Fish oils, for hyperlipidemia, 466
- Flecainide
 absorption, fate, and excretion of, 403
 actions of, 400t
 adverse effects of, 403, 408t
 for arrhythmias, 403
 drug interactions with, 407
 indications for, 407t
 pharmacokinetic properties of, 401t
 pharmacologic effects of, 403
 structural formula of, 403f
- Floxuridine
 for cancer, 686t-692t, 696
 in immunotherapy, 678
- Fluconazole
 for candidiasis in cancer patients, 787
 for fungal infections, 644
 mechanism of action and clinical uses of, 641t
 for oral candidiasis, 646
 prophylactic, for candidiasis in immunocompromised patients, 790
- Flucytosine
 for fungal infections, 645-646
 mechanism of action and clinical uses of, 641t
 structural formula of, 645f
- Fludarabine, for cancer, 686t-692t, 695
- Fludrocortisone, potency of, 550t
- Fluid balance, glucocorticoid effects on, 551
- Fluid volume
 loop diuretics and, 437
 thiazide diuretics and, 435
- Flumazenil
 for benzodiazepine overdose, 804
 for emergency use, 849
 for reversal
 of benzodiazepine overdose, 194, 196, 208-209, 768
 of midazolam sedation, 196, 196f
 structural formula of, 196f
- Flunisolide, intranasal, for rhinitis, 522
- Fluoride(s)
 in plaque prevention/control, 737-738
 in oral products, agent and proprietary name of, 739t
 posteruptive and pre-eruptive use of, 720-721
 stannous, 725, 726t
 state by state levels of, 723t
 supplements of, 724-725
 dosage schedule for, 724t
 systemic, 721-725
 in communal water supplies, 721-724
 safety of, 722-724
 topical, 725-728
 agents used for, fluoride concentrations in, 725t
 comparative effectiveness of, 725t
 dentifrices containing, 727-728, 728t
 mouth rinses containing, 727
 professional application of, 725-726, 725t
 self-application of, in home, 726-727
 toxicology of, 728-729
 uptake of, by iontophoresis, 26
- Fluorine, characteristics of, 720
- Fluorodinitrotoluidine derivative herbicides, toxicity of, 829
- Fluoroquinolones, 626-628
 absorption, fate, and excretion of, 628
 adverse effects of, 628
 antibacterial spectrum of, 627, 627b
 classification of, 626-627, 626b-627b
 contraindications to, 628
 drug interactions with, 628
 mechanism of action of, 583, 627
 microbial resistance to, 587-588, 627-628
 multidrug antibiotic efflux pumps in, 584-585
 structural formula of, 626f
 therapeutic uses of, 610t-611t, 628
 in dentistry, 628
 for traveler's diarrhea, 534-535
- Fluorosis, dental, 724, 729
- Fluorouracil
 for cancer, 686t-692t, 696
 genetic enzyme polymorphisms and, 73
 structural formula of, 694f
- Fluoxetine
 adverse effects of, 176t
 characteristics of, 174
 structural formula of, 179f
 suicide and, 180
- Fluoxymesterone
 for cancer, 686t-692t
 indications for and dose of, 569t
 structural formula of, 568f

- Fluphenazine, side effects of, 171t
 Flurazepam
 absorption, metabolism, and excretion of, 192-193, 193t
 metabolism of, 193f
 structural formula of, 190t
 Flurbiprofen
 characteristics of, 379
 COX inhibitory activity of, 331f
 structural formula of, 338f
 Flutamide
 as androgen receptor blocker, 574
 for cancer, 686t-692t, 699
 structural formula of, 574f
 Fluticasone, intranasal, for rhinitis, 522
 Fluvastatin, for hyperlipidemia, 464-465
 Fluvoxamine
 adverse effects of, 176t
 structural formula of, 179f
 Foam cells, 458
 Folic acid, 479-480
 analogues of, for cancer, 686t-692t, 694
 deficiency of, 477, 479-480
 dietary sources of, 479
 metabolism of, 479
 pathways of, 481f
 pathophysiologic characteristics of, 479-480
 physiologic characteristics of, 479
 preparations of, names of, 485t
 structural formula of, 480f, 632f, 694f
 synthesis of
 antibiotic inhibition of, 582t, 583
 sulfonamide mode of action and, 631-632, 632f
 therapeutic use of, 480
 Follicle-stimulating hormone, 576
 Fomivirsen, for herpesvirus infections, 648t
 Food(s)
 amine-containing, monoamine oxidase inhibitor use and, 177
 gastric emptying and, drug absorption and, 22
 mercury in, 821
 Food and Drug Administration (FDA)
 on drug dispensing, 863
 drug evaluation by, 61
 drug importation and reimportation and, 857-858
 on drug labeling, 863
 drug laws and, 851-852. *See also* Drug laws.
 exemption for dietary supplements by, 868
 labeling and, pharmacogenetics in, 48
 modern changes in, 863
 pregnancy risk categories of, 60t
 regulations of
 on drug development and distribution, 64-65, 857
 on new drug development, 64-65
 Formaldehyde, toxicity of, 818, 829
 Formivirsen, for CMV infections, 652
 Formoterol
 duration of action of, 513
 structural formula of, 514f
 Fosaprenavir, for human immunodeficiency virus infection, 656
 Fosfocarnet
 for herpes viral infections, 652
 for viral infections, 648t
 Fosfomycin, as urinary antiseptic, 634
 Fosphenytoin
 adverse reactions to, 219t
 mechanisms of action and therapeutic uses of, 216t
 for seizures, 227
 structural formula of, 217f
 Fractures
 hip, fluoridated water supplies and, 722
 setting of, neuromuscular blocking drugs and, 144
 Frank-Starling mechanism, 410, 411f
 Frequency-dependent block, by local anesthetics, 250-251
 Freund's adjuvant, 663
 Frovatriptan
 dosage forms and T_{max} of, 380t
 for migraine, 381
 Fulvestrant, as estrogen receptor antagonist, 575-576
 Fumigants, toxicity of, 829
 Fungal infection(s)
 oral, in immunosuppressed patients, 786-787
 postradiation, 792, 794
 treatment of, 640-646, 641t, 657b. *See also* Antifungal agents.
 Furosemide
 absorption, fate, and excretion of, 437
 chloral hydrate with, 195t, 202
 for emergency use, 846t, 849
 in renal failure, dosage adjustments needed in, 51t
 side effects of, 56t
 structural formula of, 436f
 toxicity with, 55t
 Fusion inhibitor
 for HIV infection, 648t
 for human immunodeficiency virus infection, 656
G
 G protein-dependent events, 86-87, 87f
 G protein-linked opioid receptors, 308
 G protein-linked receptors, 2, 3f, 86, 87f, 118
 5-HT₂, in signal transduction pathways, 378
 in opioid tolerance, 313-314
 GABA. *See* γ -Aminobutyric acid (GABA).
 Gabapentin
 adverse reactions to, 219t
 clinical toxicology of, 215
 for mania, 185
 mechanisms of action and therapeutic uses of, 216t
 for seizures, 224
 structural formula of, 223f
 for trigeminal neuralgia, 387
 Galactorrhea, from cimetidine, 370
 Ganaxolone, structural formula of, 223f
 Ganciclovir
 for CMV infections, 652
 in cancer patients, 787
 in immunocompromised patients, prophylactic, 790
 for viral infections, 648t
 Ganglia
 parasympathetic, 78-79, 80f
 sympathetic, 78, 80f
 ganglionic transmission in, 136, 137f
 Ganglionic blockers, 138-140
 absorption, fate, and excretion of, 139
 adverse effects of, 140
 classification of, 138
 in dentistry, 140
 for hypertension, 454
 names of, 147b
 nondepolarizing
 pharmacologic effects of, 138-139, 139t
 structural formula of, 138, 138f
 therapeutic uses of, 139-140
 Ganglionic transmission, 136, 137f
 drugs affecting, 136-140
 drugs stimulating, 136-138
 Gardasil, as human papillomavirus vaccine, 648t
 Garlic, pharmacologic profile of, 870t-871t
 Gases
 as central nervous system transmitters, 157
 toxic effects of, 824-826
 Gasoline, abuse of, 810
 Gastric acid
 drug inactivation and, 23-24
 reducing, drugs for, 525-530
 antibiotics as, 527-528
 H₂-receptor antihistamines as, 526-527
 proton pump inhibitors as, 525-526
 secretion of
 H₂ antihistamine control of, 368, 369f
 histamine in, 362
 Gastric emptying, drug absorption and, 22
 Gastric mucosa, enterochromaffin-like cells in, 359-360
 Gastric ulcer, glucocorticoid therapy and, 554
 Gastrin, histamine and, 362
 Gastroesophageal reflux disease (GERD), 525
 dentistry for patients with, 529
 H₂ antihistamines for, 369
 Gastrointestinal tract
 adverse reactions of, to drugs, 535
 alcoholism effects on, 715-716, 716t
 antimuscarinic drug effects on, 131, 133
 β blocker effects on, 111
 cancer chemotherapy effects on, 789-790
 drug binding in, 29-30
 drugs acting on, 525-537
 adsorbents as, 530
 antidiarrheal agents as, 533-535
 antiemetics as, 531-532
 antispasmodics as, 530
 emetics as, 530
 gastrointestinal stimulants as, 535
 for irritable bowel syndrome, 535
 laxatives as, 532-533
 names of, 536b
 to reduce gastric acid, 525-530
 endogenous catecholamine effects on, 94-95
 fluoroquinolone effects on, 628
 ganglionic blocking drug effects on, 139
 iron absorption in, 472
 levodopa effects on, 238
 morphine effects on, 312
 salicylate effects on, 335
 selective COX-2 inhibitor effects on, 343
 smooth muscle of, cholinergic drug effects on, 120
 stimulants of, 535
 names of, 536b
 Gastroparesis, 535
 Gelatin sponge, for bleeding control, 494
 Gemcitabine, for cancer, 686t-692t, 696
 Gemfibrozil
 for hyperlipidemia, 462-463
 properties of, 463t
 structural formula of, 462f
 Gemtuzumab ozogamicin
 for cancer, 705t, 707, 707f
 proprietary names of and indications for, 675t
 Gene(s)
 drug interactions with, in dentistry, 70
 expression of, in corticosteroid actions, 549
 resistance
 in antibiotic resistance, 585, 595
 microbial resistance patterns and, 604
 sulfonamide use and, 632
 of tetracyclines, 624-625
 Gene therapy, for hemophilia, 498
 Genetic controlling elements, in antibiotic resistance, 585
 Genetic differences
 in pharmacodynamics, 70, 71f
 in pharmacokinetics, 70, 71f
 Genetic factors
 in drug metabolism, 39
 in drug responsiveness, 52, 69, 71f, 304
 in pain, 304
 in schizophrenia, 164
 Genetic mutations, in carcinogenesis, 58
 Genetic polymorphisms, in drug-metabolizing enzymes, 72-73
 Genetic traits, toxic dose-response relationships and, 816
 Genitourinary tract, antimuscarinic drug use for, 133
 Genome, drug responsiveness and, 69
 Genotype, determination of, 70-71
 Gentamicin. *See also* Aminoglycosides.
 development of, 628
 side effects of, 56t
 structural formula of, 629f
 GERD. *See* Gastroesophageal reflux disease (GERD).
 Geriatric pharmacology, 834-841. *See also* Elderly patients.
 German Commission E, 869
 Gilles de la Tourette's syndrome, drugs used for, 241-242
 Ginger, pharmacologic profile of, 870t-871t

- Gingiva
 abnormalities of
 oral contraceptive use and, 573-574
 sex steroid hormone and, 576
 overgrowth of
 cyclosporine-induced, 218, 677
 drugs causing, 535
 phenytoin-induced, 218, 219f, 227
 retraction of, racemic epinephrine for, 102
 swabbing of, with anti-carries antigen, 663
 Gingival retraction cords, in patients taking digoxin, 420
 Gingivitis
 acute necrotizing ulcerative, microbiology of, 602
 agents active against, 732-743. *See also* Antiplaque/antigingivitis agents.
 plaque and, 732
 prevalence of, 732
 Ginkgo, pharmacologic profile of, 870t-871t
 Ginseng, Asian, pharmacologic profile of, 870t-871t
 Glaucoma
 carbonic anhydrase inhibitors for, 438
 treatment of, 125, 125t
 wide-angle, adrenergic agonists for, 100
 Gliosis, 153
 Glipizide, pharmacokinetics of, 562t
 Globin chains, in hemoglobin, 469-470
 disorders of, anemia from, 475-476. *See also* Thalassemia.
 Globulin(s)
 immune. *See* Immunoglobulins.
 sex hormone-binding, 567
 Globus pallidus, surgery of, for Parkinson's disease, 241
 Glomerular filtration, in renal excretion of drugs, 40
 Glossopharyngeal nerve, pain transmission and, 300
 Glucagon, 564
 adverse effects of, 564
 pharmacokinetics of, 564
 therapeutic uses of, 564
 Glucocorticoids, 549. *See also* Corticosteroids.
 adverse effects of, 553-555, 554b
 anti-inflammatory properties of, 551
 antiinflammatory effects of, 302
 in arachidonic acid metabolism, 325
 biologic half-lives of, 556b
 as immunosuppressive agents, 677
 names of, 556b, 556t
 pharmacologic effects of, 550
 preparations of, 555-556, 556t
 structural formula of, 555f
 therapeutic uses of, 552
 toxicity risk with, in elderly, 837t
 Glucose
 blood, insulin actions and, 559f
 for emergency use, 844t, 845
 Glucose transporter 4, 559f
 α -Glucosidase inhibitors, for diabetes, 564
 adverse effects of, 564
 contraindications to, 564
 drug interactions with, 564
 pharmacokinetics of, 564
 Glucuronide conjugation, by microsomal enzymes, 34
 Glue, abuse of, 810
 Glumepiride, pharmacokinetics of, 562t
 Glutamate, as central nervous system transmitter, 155-156, 156t, 303
 Glutaraldehyde
 characteristics of, 745t
 as disinfectant, 746
 Glyburide, pharmacokinetics of, 562t
 Glycerin, as laxative, 533
 Glycerol derivatives, for anxiety, 203-204
 Glycine
 as central nervous system transmitter, 156-157, 156t
 receptors of, anesthetic action and, 269
 Glycogen synthase kinase-3 β , inhibition of, by lithium salts, 183-184, 184f
 Glycopeptide antibiotics, 630. *See also* Vancomycin.
 Glycopeptides, mechanism of action of, 581
 Glycoprotein(s)
 cell surface, of lymphocytes in immune system, 662-665
 Ia/IIa receptor of, in platelet adhesion, 487, 488f
 Ib/IX/V receptor of, in platelet adhesion, 487, 488f
 IIb/IIIa receptor of, inhibitors of
 in myocardial infarction prevention, 429
 for platelet inhibition, 506
 von Willebrand factor, 496-497
 Glycopyrolate
 in dentistry, oral doses and preparations used in, 134t
 for premedication in anesthesia, 295-296, 295t
 Glycosides, cardiac, digoxin as, 414-418. *See also* Digoxin.
 Glycosuria, glucocorticoid therapy and, 553
 Glycylines, 626
 Glyphosphate
 structural formula of, 829f
 toxicity of, 829
 Goiter
 diffuse toxic, 541
 toxic nodular, 541
 Gold compounds
 immunosuppressive actions of, 678
 for rheumatoid arthritis, 350-351
 Goldenseal, pharmacologic profile of, 870t-871t
 Gonadotropin(s)
 human menopausal, 576
 names of, 577b
 Gonadotropin releasing hormone, 539t
 analogues of, names of, 577b
 antagonists of, names of, 577b
 Gonadotropin-releasing hormone analogues, for cancer, 686t-692t, 699
 Goserelin, for cancer, 686t-692t, 699
 Gout, drugs used for, 352-354
 names of, 354b
 structural formulas of, 353f
 Graft-versus-host disease (GVHD), in hematopoietic cell transplantation, 790
 Granisetron, as antiemetic, 531-532
 Granules, in platelet activation, 488, 488f
 Granulocyte colony-stimulating factor (G-CSF)
 in hematopoiesis, 482
 recombinant human (filgrastim), 482
 Granulocyte/macrophage colony-stimulating factor (GM-CSF)
 in hematopoiesis, 482
 in inflammatory process, 328
 Graves' disease, 541
 Gray baby syndrome, chloramphenicol and, 633
 Griseofulvin
 for fungal infections, 646
 mechanism of action and clinical uses of, 641t
 side effects of, 56t
 Growth, suppression of, glucocorticoid therapy and, 554
 Growth factors
 hematopoietic, 480-483
 insulin-like, 539, 558
 myeloid
 physiologic characteristics of, 482-483
 therapeutic use of, 483
 Growth-hormone releasing hormone, 539t
 Growth hormone (somatotropin), 538-539
 actions of, 539
 adverse effects of, 539
 pharmacokinetics of, 539
 therapeutic uses of, 539
 Guaiaicol, antimicrobial activity of, 747
 Guaifenesin, as expectorant, 522
 Guanabenz
 absorption, fate, and excretion of, 451
 adverse effects of, 452
 for hypertension, 451-452
 pharmacologic effects of, 96, 451
 structural formula of, 96f, 451f
 Guanadrel
 absorption, fate, and excretion of, 450-451
 adverse effects of, 451
 for hypertension, 450-451
 pharmacologic effects of, 450
 Guanethidine
 absorption, fate, and excretion of, 450-451
 adverse effects of, 113t, 451
 for hypertension, 450-451
 local anesthetic vasoconstrictor interactions with, 455-456
 pharmacologic effects of, 450
 side effects of, 56t
 Guanfacine
 absorption, fate, and excretion of, 451
 adverse effects of, 452
 for hypertension, 451-452
 pharmacologic effects of, 96, 451
 structural formula of, 96f, 451f
 Guedel's scheme, of ether anesthesia, 272, 272f
 Gynecomastia, from cimetidine, 370
H
 H₂-receptor antagonists, names of, 536b
 Hageman factor, in clotting cascade, 329
 Hairy leukoplakia, Epstein-Barr related, in immunosuppressed patients, 656-657, 787-788
 Halazepam
 absorption, metabolism, and excretion of, 193t
 for anxiety, dose and administration of, 197t
 mechanism of action of, 191-192
 metabolism of, 193f
 structural formula of, 190t
 Half-life(ves)
 context-sensitive, 44, 45f
 in multi-compartment model, 44, 45f
 with repeated doses, 43-44, 44f
 with single dose administration, 43, 43f
 in time course of drug action, 41, 42f, 42t
 Hallucinogen persisting perception disorder, 808
 Hallucinogens
 abuse of, 807-808
 recent trends in, 800
 definition of, 807
 deliriant, 808
 psychedelics, 807-808
 β -Haloalkylamines, actions of, 108-109
 Halogens
 antimicrobial activity of, 745t
 as disinfectants and antiseptics, 745-746
 names of, 749b
 Haloperidol
 autonomic effects of, 170
 for mania, 185
 metabolism of, 172t
 in neuropathology of Parkinson's disease, 231
 pharmacologic effects of, 168
 relative potency of receptor antagonist affinities in, 166t
 side effects of, 171t
 structure-activity relationships of, 166
 Halothane, 284-286
 abuse of, 810
 adverse effects of, 285-286
 anesthetic properties of, 284-285, 284t
 blood-gas partition coefficient of, 273, 273f, 275t
 metabolism of, 285
 neuromuscular blocking drug action with, 145t
 pharmacologic properties of, 284t
 phase I reactions in, 35t-36t
 physical and chemical properties of, 282t, 284
 structural formula of, 282f
 therapeutic uses of, 286
 Halothane hepatitis, 285-286
 Harrison Narcotics Act (1914), 799

- Hashimoto's thyroiditis, 541
 Hashish, abuse of, 808-809
 Hazard
 definition of, 815b
 toxicity vs., 814
 Hazardous materials, regulations concerning, 820
 Headache. *See also* Migraine.
 "histamine," 362
 indomethacin-responsive, 384-385, 385b
 Healing, wound, phenytoin for, 227
 Health care workers, nitrous oxide exposure and, 278-279, 283
 Health history, medication usage in, 869-872
 Hearing loss, macrolide-induced, 620
 Heart. *See also* Arrhythmias; Cardiovascular effects; Heart failure.
 automaticity of, 393, 394f
 increased, arrhythmias from, 394-395
 cholinergic drug effects on, 119
 conduction abnormalities in, cardiac arrhythmias and, 396f
 conduction velocity of, 393, 394f
 contractility of
 digoxin effects on, 414-416
 in heart failure, digoxin and, 415
 heart failure and, 410-411, 411f
 effects of β blockers on, adverse, 113
 electrophysiology of, basic, 393-394
 endogenous catecholamine effects on, 94, 94f
 isoproterenol effects on, 97
 local anesthetic effects on, 254
 myocardial infarction of. *See* Myocardial infarction.
 β blockers for, 112
 refractoriness of, 393, 394f
 size of, in congestive heart failure, digoxin and, 415
 Heart block
 in cardiac arrhythmias, 396, 396f
 electrocardiographic appearance of, 396-397, 397f
 Heart failure
 adaptive mechanisms in, 410-411, 412f
 backward, 410
 cardiac muscle contraction and, 410-411, 411f
 congestive. *See* Congestive heart failure.
 diuretic use and, 437
 drugs used for, 411-413, 412f, 412t
 names of, 420t-421t
 Heart valves
 defects in, infective endocarditis risk and, 776
 in drug-abusing patient, 811
 Heartburn, 525
 Heat, perception of, 301
 Heavy metals. *See also specific metal, e.g., Lead, Mercury.*
 antimicrobial activity of, 745t
 as disinfectants, 748-749
 microbial resistance to, 588-589
 names of, 749b
 poisoning with, treatment of, 823-824
Helicobacter pylori infection
 antibiotic resistance in, 586-587
 antibiotics for, names of, 536b
 peptic ulcer disease and, 369, 525
 antibiotics for, 527-528
 Hemarthroses, in hemophiliacs, 508
 Hematocrit
 for anemia detection, 469
 normal values of, 469
 Hematopoiesis, 469, 470f
 cobalt in, 474
 copper in, 474
 lithium salts in, 474
 lymphoid, cytokines in, functional relationships of, 663t
 nitrous oxide effects and, 283
 as toxic target, 817-818
 vitamin B₁₂ and folic acid deficiency and, 476-477
 Hematopoietic cell transplantation, for cancer, oral infections and, 790, 791t
 Hematopoietic growth factors, 480-483
 names of, 485t
 therapeutic uses of, 678
 Heme, 469
 deficiency of, in porphyrias, 474
 structural formula of, 471f
 Hemicholinium, neuromuscular transmission and, 146
 Hemin
 lyophilized, for porphyria treatment, 475
 structural formula of, 471f
 Hemodialysis
 antibiotic prophylaxis for dental patients on, 778
 for mercury poisoning, 824
 Hemoglobin
 carbon monoxide interactions with, 817-818, 824-825, 825f
 components of, 469
 deficiency of, in β -thalassemias, 475-476
 in erythrocytes, evaluation of, 470
 globin chains in, 469-470
 disorders of, anemia from, 475-476.
 See also Thalassemia.
 glycosylation of, in diabetes, 560
 substitute, 483-484
 tetramers of, 483
 Hemoglobin A, genetic defects in, in thalassemia, 475
 Hemoglobin A_{1c}, 560
 Hemoglobin F, 469-470
 stimulation of, in sickle cell anemia, 476
 Hemoglobin H disease, 475
 Hemoglobin S, in sickle cell anemia, 476
 Hemophilia
 bleeding in, 495-496
 dental procedures and, 508
 factor VIII treatment for, antibody inhibitors and, in hemophilia management, 498
 gene therapy for, 498
 hemorrhage or emergencies in, treatment of, 498
 tissue factor pathway inhibitor in, 493
 treatment of, 497-498
 Hemorrhage. *See also* Bleeding.
 oral, in cancer patients, 789
 Hemorrhagic telangiectasia, hereditary, antibiotic prophylaxis for dental patients with, 778
 Hemosiderin, in iron storage, 472
 Hemostasis
 adrenergic agonists for, 99
 coagulation cascade in, 490-492, 491f
 local measures for, 493-494
 natural inhibitors of, 492
 platelet activation in, 487-489, 488f
 platelet adhesion in, 487, 488f
 platelet aggregation in, 489-490
 process of, 487-493
 procoagulant agents in, 493-498
 vascular constriction in, 487
 Henderson-Hasselbalch equation, 21, 246-248, 248f
 Henry's law, 273, 273f
 Heparin(s), 500-502
 absorption, fate, and excretion of, 501-502
 antidotes to, 502
 in dentistry, 507-508
 low-molecular weight, 501
 in dentistry, 507-508
 names of, 509t
 mechanism of action of, 501
 in myocardial infarction prevention, 429
 structural formula of, 501f
 toxicity of, 55t
 Hepatic disease
 antibiotic dosing and, 592
 drug effects and, 50-51
 volume retention in, loop diuretics for, 437
 Hepatic microsomal enzyme activity, 35t-36t
 anticonvulsant action and, 215, 215b, 227
 barbiturate metabolism and, 200
 Hepatic microsomal metabolism, 31-34
 Hepatic portal system, drug inactivation and, 24
 Hepatitis
 cholestatic, erythromycin use and, 620
 halothane, 285-286
 viral
 antiviral agents for, 648t
 in drug-abusing patient, 811
 drugs active against, 653-654
 Hepatitis B virus DNA polymerase inhibitors, 654
 Hepatomegaly, from alcoholism, 716
 Hepatotoxicity, 818-819
 acetaminophen overdose and, 347-348
 of cocaine, 806
 halothane use and, 285-286
 monoamine oxidase inhibitor use and, 177
 Heptachlor, toxicity of, 828
 Herbal products
 coumarin-indandione action and, 505b
 diuretics and, 440
 drug interactions with, in dentistry, 872t
 government regulation of, 851-852, 868-869
 pharmacologic profiles of, 870t-871t
 for platelet inhibition, 506
 Herbal therapies, for oral conditions, 873-875
 Herbicides
 structural formula of, 829f
 toxicity of, 829-830
 Hereditary hemorrhagic telangiectasia, antibiotic prophylaxis for dental patients with, 778
 Heredity. *See* Gene(s); Genetic factors.
 Heroin
 abuse of
 history of, 799
 recent trends in, 800
 dose, duration, and administration of, 315t
 for pain, 321
 Herpes simplex virus
 drugs active against, 648t, 649-652
 acyclovir as, 651-652
 docosanol as, 652
 foscarnet as, 652
 idoxuridine as, 649-650
 penciclovir as, 652
 trifluridine as, 651
 valacyclovir as, 651-652
 vidarabine as, 650-651
 oral lesions from, 656
 Herpes virus infections
 drugs for, 649-653
 oral
 in cancer patients, 787
 drugs for, 656-657
 in immunosuppressed patients, 787
 Herpes zoster
 acute, corticosteroids for, 385
 vaccine for, 652-653
 Herpesvirus infections, antiviral agents for, 648t
 Hetastarch, as plasma extender, 484
 Hexachlorophene, as antiseptic, 747
 Hexafluorenum, neuromuscular blocking drug action with, 145
 Hexamethonium
 as ganglionic blocker, 138
 structural formula of, 138f
 Hexfluorenum, neuromuscular blocking drug action with, 145t
 Hexylresorcinol, in plaque prevention/control, 737
 Hickman, Henry Hills, 266
 Hip fractures, fluoridated water supplies and, 722
 Hippocampus, nuclei of, in anesthetic action, 271, 271f
 Hirudin, heparin vs., 502
 Histamine, 359-362
 adverse effects of, 362
 as central nervous system neurotransmitter, 155
 discovery, 359
 distribution of, in tissues/cells, 360t
 formation, distribution and release of, 359-360
 in inflammatory process, 324-325
 metabolism of, 361

- Histamine (*Continued*)
 pharmacologic effects of, 361-362
 receptors of, 361
 antagonists of, 362-370. *See also* Antihistamines.
 blockade of, 163t
 release of, 324, 360
 allergic reactions in, 360, 361f
 drugs/foreign compounds in, 360
 morphine administration and, 313
 neuromuscular blocking drug effects on, 142t, 143
 tissue injury in, 360
 structural formula of, 360f
 synthesis of, 359, 360f
 tachyphylaxis and, 52-53
 therapeutic uses of, 362
 in tissues/cells, 360t
 triple response to, 362
- Histidine, histamine synthesis from, 360f
- Histone deacetylase inhibitors, for cancer, 705t, 708
- HIV. *See* Human immunodeficiency virus (HIV).
- HMG CoA reductase inhibitors
 for hyperlipidemia, 464-465
 properties of, 463t
 structural formulas of, 465f
- Holistic medicine. *See* Alternative medicine.
- Homotropine, toxic effects of, 134
- Horizontal gene transfer, in antibiotic resistance, 585-586
- Hormone(s)
 anterior pituitary, release of, dopamine and, 95-96
 of calcium homeostasis, 543-546
 as central nervous system transmitters, 157
 corticotropin-releasing, 539t
 gonadotropin-releasing, 539t
 growth hormone-releasing, 539t
 growth (somatotropin), 538-539. *See also* Growth hormone (somatotropin).
 hypothalamic, 538, 539t
 of islets of Langerhans, 558, 559t
 ovarian, as antidepressant, 181
 parathyroid, 543
 peptide, 576
 pituitary, 538
 anterior, 538-540, 539t
 posterior, 538
 sex steroid. *See also* Steroid hormones, sex steroid, 567-578. *See also* Steroid hormones.
 thyroid, 540-541. *See also* Thyroid hormones.
 as antidepressants, 181
 names of, 546b-547b
 thyrotropin-releasing, 539t
- Hormone agonists, for cancer, 686t-692t, 698-699
- Hormone antagonists, for cancer, 686t-692t, 698-699
- Host defenses, antibiotic and microbe interactions with, 593
- Household system of weights and measures, 861-862, 862t
- Howell-Jolly bodies, description of, 471b
- 5-HT₃-receptor antagonists
 as antiemetics, 531-532
 for irritable bowel syndrome, 535
- 5-HT₄-receptor antagonists, for irritable bowel syndrome, 535
- Human chorionic gonadotropin, 576
- Human immunodeficiency virus (HIV).
See also Acquired immunodeficiency syndrome (AIDS).
 antibiotic resistance in, 587
 drugs active against, 648t, 654-656
 fusion inhibitor as, 656
 protease inhibitors as, 655-656. *See also* Protease inhibitors, for HIV infections.
 reverse transcription inhibitors as, 654-655. *See also* Reverse transcription inhibitors, for HIV infections.
- Human immunodeficiency virus (HIV).
(Continued)
 oral viral lesions with, 656-657
 vaccine for, 656
- Human immunoglobulins, uses of, 673
- Human papillomavirus vaccine, 648t
- Humanized monoclonal antibodies, 674
- Humoral antibodies. *See also* Antibody(ies).
 in immune system, 664f, 665-670
- Humoral immunity, 660, 670
 deficiencies in
 human immunoglobulins for, 673-674
 vaccinations and, 671-672
- Huntington's disease, drugs used for, 241
- Hyaluronidase, in subcutaneous administration for drug absorption, 38
- Hydantoins, 217-218, 217f
 absorption, fate, and excretion of, 218
 adverse reactions to, 218, 219f, 219t
 mechanisms of action and therapeutic uses of, 216t
 pharmacologic effects of, 217-218
- Hydralazine
 for congestive heart failure, 413
 for hypertension, 452
 side effects of, 56t
 structural formula of, 452f
- Hydrochloroquine, immunosuppressive actions of, 678
- Hydrochlorothiazide, pharmacokinetic data on, 434t
- Hydrocodone
 in combination analgesics, 350
 for cough suppression, 521
 dose, duration, and administration of, 315t
 structure and effects of, 316
- Hydrocortisone
 absorption, fate, and excretion of, 551-552
 dose, administration, and preparations of, 556t
 potency of, 550t
 structural formula of, 550f
 for temporomandibular joint inflammation, 385
- Hydrocortisone sodium succinate, for emergency use, 845t
- Hydroflumethiazide, pharmacokinetic data on, 434t
- Hydrogen bonds, in drug-receptor interactions, 5-6, 5f
- Hydrogen ion secretion, by gastric parietal cell, antisecretory drug action and, 526f
- Hydrogen peroxide
 action of, 15-16
 as antiseptic, 748
 for plaque control, 738
- Hydrolysis, of drugs
 microsomal, 33, 35t-36t
 nonmicrosomal, 34-36, 35t-36t
- Hydromorphone, dose, duration, and administration of, 315t
- Hydrophobic interactions
 in drug-receptor interactions, 5f, 6
 in simple diffusion, 17
- Hydroxocobalamin. *See also* Cobalamins.
 structure and function of, 477
- 3-Hydroxy-3-methylglutaryl-coenzyme A, half-reduced, structural formula of, 465f
- 3-Hydroxy-3-methylglutaryl-coenzyme A reductase inhibitors
 for hyperlipidemias, 464-465
 properties of, 463t
- 5-Hydroxytryptamine, phase I reactions in, 35t-36t
- Hydroxyamphetamine, structure-activity relationships of, 92t
- Hydroxychloroquine, for rheumatoid arthritis, 351
- Hydroxycobalamin, for vitamin B₁₂ deficiency, 479
- Hydroxyprogesterone, for cancer, 686t-692t
- 5-Hydroxytryptamine, 373-379. *See also* Serotonin.
 antidepressant action and, 173
 in benzodiazepine action, 192
 buspirone and, 203
- 5-Hydroxytryptamine (*Continued*)
 as central nervous system transmitter, 155, 156t
 in depression, 165
 receptor of, blockade of, 163-164, 163t
 by atypical antipsychotics, 168
- 5-Hydroxytryptamine system
 drug intervention and, 378-379, 378f
 pain and, 374
 physiologic function of, 378-379
- 5-Hydroxytryptophan, in serotonin synthesis, 375
- Hydroxyurea, for cancer, 686t-692t, 701
- Hydroxyzine, 202
 for anxiety, dose and administration of, 197t
 levodopa-induced interactions with, in dental practice, 242-243
 for migraine, 384
 for oral sedation, 766
 for sedation, 294, 295t
 structural formula of, 202f
- Hydroxyzine hydrochloride, structural formula and dosages of, 363t-364t
- Hydroxyzine pamoate, structural formula and dosages of, 363t-364t
- Hygiene, oral, maintenance of, for oral mucositis, 785
- Hyperalgesia
 after tissue injury, 301
 central sensitization of pain and, 303
 serotonin receptors and, 376-377
- Hyperbaric oxygen therapy, for osteoradionecrosis, 795
- Hypercalcemia, loop diuretics for, 437
- Hypercatabolic reaction, to halothane, 286
- Hypercholesterolemia, polygenic, characteristics of, 461t
- Hyperglycemia, glucocorticoid therapy and, 553
- Hyperglycemic agents, names of, 565b
- Hyperlipemia, 458
- Hyperlipidemia(s), 458
 drugs for, 462-466. *See also* Lipid-lowering drugs.
 primary, 460, 461t
 secondary, 460
 treatment of, National Cholesterol Education Program guidelines for, 462
- Hyperlipoproteinemia(s), 458
 lipid-lowering drugs for, 462-466. *See also* Lipid-lowering drugs.
 types and characteristics of, 461t
- Hyperreactivity, to drugs, 48
- Hypersalivation, dental practice and, 173
- Hypersensitivity
 to local anesthetic, 257-258
 pulpal, glucocorticoids for, 553
 thermal, of teeth, from cancer chemotherapy, 785
- Hypertension. *See also and specific drugs and classes of drugs, e.g.,* Calcium channel blockers; Antihypertensive drugs.
 acute
 drugs for, 455t
 treatment of, 455t
 α_1 - β and selective α_1 antagonists for, 450
 blood pressure regulation and, 442-443, 443f
 classification of, 442, 443t
 clinical aspects of, 442-444
 clinical disorders resulting from, 444b
 detection of, 456
 drugs for, 442-457. *See also* Antihypertensive drugs.
 essential, 442
 mortality associated with, 444, 444f
 pathophysiologic characteristics of, 443-444
 renin-angiotensin system function and, 445
 risk factors for, 443b
 thiazide diuretics for, 435
 monoamine oxidase inhibitors for, 114
 refractory, loop diuretics for, 437
 secondary, 442
 selective α_1 antagonists for, 449-450

- Hypertension (*Continued*)
 treatment of, 454-455
 adrenergic agonists for, 101
 β blockers for, 111-112, 448-450
 long-term, drugs for, 454b
- Hypertensive crisis, MAO inhibitor-food interactions and, 177
- Hypertensive emergencies, 455
- Hyperthermia
 malignant. *See* Malignant hyperthermia.
 from succinylcholine, 142, 147
 treatment of, 147
 sedative-hypnotic withdrawal and, 803
- Hyperthyroidism, 541
 in dental practice, 543
 treatment of, drugs used for, 541-542
 names of, 546b-547b
- Hyperventilation, in aspirin poisoning, 335-336
- Hypnotics, 188
 benzodiazepines as, 192
 in dentistry, 207
 eszopiclone as, 198
 for sleep disturbances, 197
 zaleplon as, 198
 zolpidem as, 198
 zopiclone as, 198
- Hypocalcemia, from loop diuretics, 437-438
- Hypochlorite, characteristics of, 745t
- Hypochromic anemias, 470
- Hypogammaglobulinemias, replacement therapy for, 673
- Hypoglycemia, insulin-induced, 561
- Hypoglycemic agents, oral, aspirin interactions with, 336
- Hypokalemia
 diuretics and, 439
 glucocorticoid therapy and, 554
 loop diuretics and, 437
 thiazide diuretics and, 435
- Hypomagnesemia, from loop diuretics, 437-438
- Hyponatremia
 loop diuretics and, 437
 thiazide diuretics and, 435-436
- Hyporeactivity, to drugs, 48
- Hyposalivation, dental practice and, 173
- Hypotension
 from histamine, 362
 neuromuscular blocking drugs and, 143
 orthostatic
 antihypertensive drug use and, 456
 antipsychotic drug action and, 170, 171t
 levodopa-induced, in dental practice, 242
 treatment of, adrenergic agonists for, 99-100
- Hypothalamic drugs, names of, 546b-547b
- Hypothalamic hormones, 538, 539t
- Hypothalamic inhibitory releasing factors, 539t
- Hypothalamic-pituitary-adrenal axis, 551f
- Hypothalamic-pituitary-thyroid axis, 540
- Hypothalamic stimulatory releasing factors, 539t
- Hypothalamus, 150
 histamine-containing neurons in, 359-360
- Hypothyroidism, 541
 in dental practice, 542-543
 replacement therapy for, 541
 names of, 546b-547b
 signs and symptoms of, 541
 signs of, 542, 543b
- Hypovolemic shock, treatment of, 99-100
- Hypoxia, diffusion, nitrous oxide effects and, 283
- I**
- Ibandronate, 544. *See also* Bisphosphonates.
- Ibritumomab tiuxetan
 for cancer, 705t, 707
 proprietary names of and indications for, 675t
- Ibuprofen, 337-338
 characteristics of, 337-338
 COX inhibitory activity of, 331f
 dosage of, 346t
 pretreatment with, 302
 structural formula of, 338f
- Ibutilide
 actions of, 400t
 for arrhythmias, 406
 for emergency use, 847t-848t
 indications for, 407t
 pharmacokinetic properties of, 401t
 structural formula of, 406f
- Idarubicin
 for cancer, 686t-692t, 697
 structural formula of, 697f
- Idoxuridine
 for herpes virus infections, 648t, 649-650
 structural formula of, 650f
- Ifosfamide
 for cancer, 686t-692t, 692-693
 structural formula of, 693f
- Ileum, problems with, vitamin B₁₂ and, deficiency from, 479
- Ileus, paralytic, cholinergic drugs for, 126-127
- Imatinib mesylate
 for cancer, 704-706, 705t
 structural formula of, 704f
- Imidazole antifungal drugs, 642-644, 643f
- Imidazolines, 108
 structural formula of, 108f
- Iminostilbenes, mechanisms of action and therapeutic uses of, 216t
- Imipenem, 615b
 characteristics of, 618
 structural formula of, 615f
- Imipramine, 175
 adverse effects of, 176t
- Immune cells,
 in pain perception, 302
- Immune-complex drug reactions, 57
- Immune responses
 glucocorticoid effects on, 551
 modification of, immunotherapeutic agents for, 671
 specific, initiation, progression, and termination of, 665-667, 666f
- Immune system, 660-682
 antibiotic and microbe interactions with, 593-594
 in blocking nociceptive impulses, 302
 components of, 660-665, 661f
 cells in, 660-661
 in pain perception, 302
 mediators in, 662-665
 receptors in, 661-662
 specific immune responses in, 665, 666f
- Immune tolerance, to inhibitor antibodies in hemophiliacs, 498
- Immunity
 cell-mediated, 660. *See also* Cell-mediated immunity (CMI).
 in type IV drug reactions, 57
 humoral, 660, 670. *See also* Humoral immunity.
 specific, overview of, 660-671
- Immunization
 active, 671
 passive, 673
 agents use for, names of, 681b
- Immunocompromised patients. *See also* Cancer chemotherapy.
 antibiotic prophylaxis for dental procedures in, 778
 fungal infections in, 640
 oral mucosal infections in, 786-789
- Immunocytes, endogenous opioid peptides secreted by, 302
- Immunoglobulin A (IgA), 664
 secretory, antibodies of, vaccination systems and, 663
- Immunoglobulin antibodies, in immune system, 662, 664f
- Immunoglobulin D (IgD), 665
- Immunoglobulin E (IgE), 665
 allergic reactions mediated by, TH2 activity in, 680
 anaphylactic drug responses and, 57
- Immunoglobulin G (IgG), 664
- Immunoglobulin M (IgM), 664
- Immunoglobulins
 human, 673
 Rh,₁(D), 673
- Immunologic memory, 661
- Immunomodulators, names of, 681b
- Immunopharmacology, definition of, 660
- Immunophilin ligands, 676-677
- Immunostimulants, 673
 names of, 681b
- Immunosuppressants
 in hemophiliacs, 498
 in myasthenia gravis, 126
 names of, 681b
 in rheumatoid arthritis, 351-352
- Immunotherapeutic agents, 671
 adjuvants as, 672
 cytokine therapy as, 678-680, 679t
 cytotoxic drugs as, 677-678
 glucocorticoids as, 677
 immunophilin ligands as, 676-677
 immunostimulants as, 673
 interferons as, 680
 monoclonal antibody preparations as, 674, 675t
 names of, 681b
 polyclonal antibody preparations as, 673
 slow-acting, disease-modifying antirheumatic drugs as, 678
 thalidomide as, 677
 vaccines as, 671
- Immunotherapy, 660-682
 definition of, 660
- Implants
 breast, antibiotic prophylaxis for dental patients and, 777
 penile, antibiotic prophylaxis for dental patients and, 777
- Inamrinone
 for congestive heart failure, 419-420
 for emergency use, 846t, 849
- Incision and drainage, antibiotic use and, 592
- Incretin-related drugs, for diabetes, 563-564
- IND application, for new drug, 64
- Indandiones. *See* Coumarin-indandiones.
- Indapamide, pharmacokinetic data on, 434t
- Indinavir, for human immunodeficiency virus infections, 656
- Indole and indene derivatives
 for inflammatory conditions, 340-341
 etodolac as, 341
 indomethacin as, 340-341
 sulindac as, 341
 structural formulas of, 340f
- Indomethacin
 COX inhibitory activity of, vs. acetaminophen, 332t
 headaches responsive to, 384-385, 385b
 for inflammatory conditions, 340-341
 structural formula of, 340f
- Induction
 of anesthesia, 273-274
 blood solubility of anesthetic and, 275
 definition of, 267
- Infants. *See also* Neonates.
 antibiotic dosing and, 592
 fluoride supplements for, 724-725
- Infection(s)
 bacterial
 in immunosuppressed patients, 788-789
 postradiation therapy, 794
 control of
 goals of, 744
 routine measures for, 744. *See also* Antiseptics; Disinfectants.
 drug metabolism and, 39
 emerging, 580
 foci of, in theory of disease, 580
 fungal
 in cancer radiotherapy, 794
 in immunosuppressed patients, 786-787
 postradiation, 792
 treatment of. *See* Antifungal agents.
 historical aspects of, 579-580
 mediastinal, oral pathogens causing, 603

- Infection(s) (*Continued*)
- metastatic
 - absolute risk rate for, from single dental procedure, 774b
 - prevention of, antibiotics in, 771-773
 - nosocomial, 579
 - oral
 - antibiotics for, specific microorganisms causing, 610t-611t
 - in immunosuppressed patients, 786-789
 - postradiation, 792
 - postradiation therapy, 794
 - oral mucosal, immunosuppression and, 786-789
 - orofacial, 600-604
 - culture and sensitivity testing for, 589
 - microbial resistance in, 603-604
 - oral microbial pathogens causing, 600-603, 601t
 - periodontal, in cancer chemotherapy, 788
 - prosthetic joint, absolute risk rate for, from single dental procedure, 774b
 - pulpal, in cancer chemotherapy, 788
 - in sickle cell anemia, 476
 - susceptibility to, glucocorticoid therapy and, 554
 - viral
 - antibiotics for, 610t-611t
 - antiviral agents for, names of, 657b
 - in drug-abusing patient, hepatitis as, 811
 - oral, in immunosuppressed patient, 787-788
 - transmission of, in hemophiliacs, 508
- Infective endocarditis
- absolute risk rate for, from single dental procedure, 774b
 - antibiotic prophylaxis for
 - AHA recommendations on, 771, 772b-773b
 - data included in, 774-777
 - dental surgical procedures and, 778-779
 - evidence base for, 774-777
 - history of, 772-773
 - indications for, 771, 772b
 - penicillin in, risk/benefit ratio for, 775
 - rationale for, 773
 - diagnosis of, 775-776, 776b
 - in drug-abusing patient, 811
 - microbial causes of, 773
 - oral hygiene and, 775
- Infiltration and nerve block, of local anesthetics, 259
- Inflammation
- in asthma, 511
 - causes of, 324-330
 - homeostatic function of, 324
 - issue mediators of, 324-329, 325t
 - local anesthetic action and, 253-254
 - pain with
 - nociceptor activation and, 301-302
 - nonopioid analgesics and nonsteroidal anti-inflammatory drugs for, 324-358
 - phases of, 324
 - plasma mediators of, 325t, 329-330
 - complement system as, 329-330
 - kinins as, 329
 - nitric oxide as, 330
 - tissue mediators of
 - histamine as, 324-325
 - leukotrienes as, 328
 - lymphocyte products as, 328
 - lysosomal products as, 328
 - prostaglandins as, 325-328
- Inflammatory diseases, salicylates for, 333
- Inflammatory response
- glucocorticoid effects on, 551
 - intermediate endoperoxides in, 327
 - in rheumatoid arthritis, 333
- Infliximab, for rheumatoid arthritis, 352
- Influenza
- antiviral agents for, 648t
 - amantidine as, 647, 647f
 - oseltamivir as, 647-649
 - rimantidine as, 647, 647f
 - zanamivir as, 647-649
 - vaccine for, 648t, 649
- Information encoding, 153-155
- Ingestion, oral, of drugs, 21-24, 21f
- Inhalants, abuse of, 810
- Inhalation
- of cocaine, 806
 - of drugs, 24
- Inhalation anesthetics, 281-288. *See also specific agents, e.g.,* Halothane.
- actions of, in central nervous system, 150t
 - administration of, 277f-278f, 278-279
 - delivery systems for, 277f-278f, 278-279
 - alveolar concentration of, 274, 274f
 - blood-gas partition coefficients of, 275t
 - blood solubility of, 275, 275t
 - cardiac output and blood flow and, 275-276
 - chemical properties of, 276
 - concentration effect of, 275
 - concentration of, in inspired air, 274
 - desflurane as, 287
 - elimination and metabolism of, 276
 - ether as, 284. *See also* Ether.
 - halothane as, 284-286. *See also* Halothane.
 - ideal characteristics of, 282b
 - isoflurane as, 286-287
 - nitrous oxide as, 281-284. *See also* Nitrous oxide.
 - pharmacologic effects of, 276-278
 - properties of, 275t, 281, 282t
 - pharmacologic, 284t
 - recovery from, 274f, 276
 - definition of, 267
 - second gas effect of, 275
 - sevoflurane as, 287-288
 - uptake and distribution of, 284-285
 - ventilation rate and depth of, 274-275
- Inhalation sedation, 763-764
- advantages of, 763
 - clinical application of, 764
 - disadvantages of, 763-764
 - drug and doses for, 763t
 - oral and intravenous sedation compared with, 763t
- Inhibitor of apoptosis proteins (IAPs), 669, 669f
- Injection(s)
- intravascular, of local anesthetics, 259
 - accidental, 260
 - parenteral, drug absorption and, 24-25
 - Inoculum effect, antibiotic dosing and, 592
 - Inocybe lateraria* mushroom, poisoning with, 120-121, 133
 - Inositol 1,4,5-triphosphate
 - in G protein-dependent events, 87, 87f
 - signaling with, lithium salt action and, 183, 184f
 - Inositolphosphoglycans, 559
 - for diabetes, 564
 - Inotropes, for emergency use, 846t, 848-849
 - INR (international normalized ratio), of prothrombin time, 499-500, 506-507, 507f
- Insect bites, H₁ antihistamines for, 366
- Insecticides
- organochlorine, 827-828
 - structural formula of, 828f
 - organophosphate
 - absorption and metabolism of, 123
 - adverse effects of, 123, 124b
 - historical background of, 121
 - neuromuscular blocking drug action and, 144
 - structural formula of, 827f
 - toxicity of, 827-828
 - treatment of, 124
 - toxicity of, 827-828
- Insomnia, 188
- benzodiazepine therapy for, 197
 - melatonin receptor agonists for, 198
 - rebound, 197
- Insulin (*Continued*)
- endocytosis and, 20
 - glucocorticoid effects on, 550
 - pharmacokinetics of, 558, 561
 - preparations of, 560, 561t
 - receptor of, interactions with, 558-559
 - in renal failure, dosage adjustments needed in, 51t
 - resistance to, peripheral, 560
 - secretion of, regulation of, 558
 - signaling pathways of, 559, 559f
 - toxic extension of therapeutic effect of, 55t
- Insulin analogues, 560
- Insulin-like growth factors, 539, 558
- Integrins, in antibiotic resistance, 585
- Interferon(s)
- for cancer, 686t-692t, 703
 - mechanism of action of, 653f
 - therapeutic uses of, 680
 - for viral hepatitis prophylaxis/treatment, 653-654
- Interferon- α
- in inflammatory process, 328
 - for viral infections, 648t
- Interleukin(s), 662
- in inflammatory process, 328
- Interleukin-1 (IL-1)
- effects of, on immune cells, 679t
 - in inflammatory process, 329
 - receptors of, in cytokine therapy, 679
 - therapeutic uses of, 678-679
- Interleukin-2 (IL-2), for cancer, 703
- Interleukin-3 (IL-3), as hematopoietic growth factor, 482-483
- Interleukin-11 (IL-11)
- for cancer, 703
 - as hematopoietic growth factor, 483
- Intermediate coronary syndrome, 422
- Intermediate syndrome, organophosphate poisoning and, 124
- International normalized ratio (INR), of prothrombin time, 506-507, 507f
- Internet, drug information in, 67
- Internet prescriptions, 857
- Intestine
- in drug metabolism, 36-37
 - small, drug absorption in, 21-22
- Intoxication, opioid, acute, 313
- Intra-arterial injection, drug absorption and, 25
- Intracellular antigens, in antigen processing, 665
- Intracellular receptors, 3f, 4-5
- Intramuscular administration, drug absorption and, 25
- Intraocular pressure. *See also* Glaucoma.
- reduction of, adrenergic agonists for, 100
- Intraosseous administration, of drugs, 25
- Intraperitoneal infusion, of drugs, 25
- Intrathecal administration, of drugs, 25
- Intravascular injection, of local anesthetics, 259
- accidental, 260
- Intravenous administration, of drugs, 24-25
- Intravenous agents, for general anesthesia, 288-295
- barbiturates as, 288-291
 - benzodiazepines as, 291-292
 - characteristics of, 288, 288b
 - dexmedetomidine as, 291
 - etomidate as, 291
 - ideal, 288b
 - ketamine as, 290-291
 - methohexital as, 289
 - opioids as, 292-294, 293t
 - propofol as, 289-290
 - thiopental as, 288-289
- Intravenous sedation, 766-767
- advantages of, 766
 - clinical application of, 766-767
 - disadvantages of, 766
 - drugs and doses for, 763t
 - oral and inhalation sedation compared with, 763t
- Intraventricular pressure, angina pectoris and, 422

- Intrinsic factor
 antibodies against, in pernicious anemia, 479
 in cobalamin transport, 477-478
- Intubation, endotracheal, neuromuscular blocking drugs for, 144
- Inulin, volume of distribution of, 28t
- Inverse agonists, 13-15
- Involuntary movements, abnormal, in Parkinson's disease, levodopa and, 237
- Iodides, for hyperthyroidism, 542
- Iodine 131-albumin, volume of distribution of, 28t
- Iodine-131 tositumomab, proprietary names of and indications for, 675t
- Iodine compounds
 as disinfectants and antiseptics, 746
 radioactive, for hyperthyroidism, 541-542
- Iodophors
 characteristics of, 746
 as disinfectants and antiseptics, 746
- Ion channels
 chloride. *See* Chloride ion channels.
 in electrophysiologic cardiac mechanisms, 393-394, 395f
 defects in, arrhythmias from, 396
 ligand-gated, 3, 3f
 anesthetic action and, 269-270
 in GABA_A receptor system, valproic acid and, 221
 on nociceptive neurons, 301
 passive diffusion and, 19
 receptors linked to, 2-3, 3f, 86-87, 87f
 voltage-gated, 2
 anesthetic action and, 270
- Ion trapping, in plasma, in drug absorption, 21-22
- Ionic bonds, in drug-receptor interactions, 5, 5f
- Ionic inhibitors, in hyperthyroidism treatment, 542
- Ionic permeability, local anesthetic action and, 248-249, 249f
- Ionotropic receptors, 86, 158
- Iontophoresis, drug administration by, 26
- Ipecac, syrup of, as emetic, 530
- Ipratropium, for asthma, 517
- Irinotecan, for cancer, 686t-692t
- Iron
 absorption, transport, and storage of, 472, 472f
 dietary sources of, 472
 excretion of, 473
 in hemoglobin, 469
 preparations of, names of, 485t
 storage of, 472-473, 472f
 toxicity with, 473, 823
 chelator treatment for, 824t
 transport of, 472, 472f
- Iron deficiency anemia, 470-473
 causes of, 470-472
 laboratory findings in, 473
 nutrition and, 470-473
 pathophysiologic characteristics of, 473
 therapy for, 473
- Iron dextran, for iron deficiency anemia, 473
- Iron poisoning, 473, 823
 chelator treatment for, 824t
- Iron sucrose, for iron deficiency anemia, 473
- Irritable bowel syndrome, 535
- Ischemic heart disease, β blockers for, 112
- Islet cell, in pain perception, 301
- Islets of Langerhans, secretions of, 558, 559t
- Isobutyl nitrite, abuse of, 810
- Isoetharine
 pharmacologic effects of, 97
 structure-activity relationships of, 92t
- Isoflurane, 286-287
 neuromuscular blocking drug action with, 145t
 properties of, 275t
 pharmacologic, 284t
 physical, 282t
 side effects of, 56t
 structural formula of, 282f
- Isoflurophate, structural formula of, 122f
- Isometheptene, for migraine, 381
- Isoniazid, for tuberculosis, 635
- Isopentanol, 718
- Isopropanol
 aerosol, abuse of, 810
 as disinfectant and antiseptic, 748
- Isopropyl alcohol, toxicity of, 718-719
- Isoproterenol. *See also* Catecholamines.
 aerosol administration of, 24
 for asthma, 516
 for emergency use, 846t
 pharmacologic effects of, 97
 structure-activity relationships of, 92t
- Isosorbide dinitrate. *See also* Nitrates/nitrites.
 for angina, 425
 for chronic heart failure, 413
 structural formula of, 424f
- Isotretinoic acid, for cancer, 703
- Isradipine, for hypertension, 447-448
- Itraconazole
 for candidiasis in cancer patients, 787
 for fungal infections, 643-644
 mechanism of action and clinical use of, 641t
 structural formula of, 643f
- Ixabepilone, for cancer, 701
- J**
- Jackson, Charles T., 267
- Jacksonian epilepsy, 213, 213t
- Jaws, osteonecrosis of, bisphosphonate therapy and, 786, 786f
- Joint(s), prosthetic
 antibiotic prophylaxis for dental patients and, 777
 infection of, absolute risk rate for, from single dental procedure, 774b
- Jorgensen technique, for intravenous sedation, 767
- Journals, drug information in, 66-67
- K**
- Kallikrein, 329
- Kanamycin. *See also* Aminoglycosides.
 development of, 628
- Kaolin, for diarrhea, 533
- Kaolin-pectin, digoxin and, 419
- κ receptor, characterization of, 309t
- Kava, pharmacologic profile of, 870t-871t
- Kefauver-Harris Amendments of 1962, 862
- Ketamine
 for chronic pain treatment, 388-389
 for deep sedation and general anesthesia, 768
 derivatives of, abuse of, 808
 for intravenous anesthesia, 290-291
 for oral sedation, 766
 side effects of, 56t
 structural formula of, 282f
 therapeutic uses of, 291
 topical, for orofacial neuropathic pain, 390
- Ketoconazole
 as androgen receptor antagonist, 574
 for fungal infections, 642
 structural formula of, 648t
- Ketogenic diet, for seizure prevention, 226
- Ketolides, 621
- Ketoprofen
 for analgesia
 characteristics of, 339
 dosage of, 346t
 COX inhibitory activity of, 331f
 structural formula of, 338f
 topical, for orofacial neuropathic pain, 390
- Ketorolac
 COX inhibitory activity of, 331f
 dosage of, 346t
 for inflammatory conditions, 341
 for musculoskeletal pain, 386
 selectivity of, for inhibition of COX-1 over COX-2, 341
 structural formula of, 340f
- Ketotifen, for asthma prophylaxis, 518
- Kidney(s)
 in blood pressure control, 443
 drug excretion and, 40
 in drug metabolism, 36-37
 dysfunction of, antibiotic dosing and, 592
- Kidney(s) (*Continued*)
 effects of aspirin nad NSAIDs on, 335
 elimination and, 29
 ethanol effects on, 713
 failure of
 chronic, epoetin alfa for, 481-482
 dosage adjustments needed in, 51t, 592
 loop diuretics for, 437
 inhalation anesthetic effects on, 277
 reabsorptive function of, 431
 as toxic target, 819
 toxicity of aminoglycosides for, 629
- Kindling
 in depression, 164-165
 of seizures, 214
- Kinetics, of absorption and elimination
 first-order, 41, 42f, 42t
 zero-order, 41
- Kininase II, 445
- Kinins, in inflammatory process, mediators of, 329
- L**
- Labetalol
 actions and therapeutic uses of, 114
 for hypertension, 450
 structural formula of, 449f
- Labor, meperidine for, 316
- Laboratory animals, drug testing in, 61-64, 62f, 63t
- (lactamase) β -Lactamase, inhibitors of, therapeutic use of, 610
- β -Lactamase
 inhibitors of, characteristics of, 609-610
 microbial resistance of, 584, 604-618
 to cephalosporins, 616-617
 to penicillins, 608
- β -Lactam antibiotics, 618
 mechanism of action of, 581
- Lactation
 drug effects and, 50
 drug excretion in breast milk and, 41
 H₁ antihistamine use and, 367
- Lactulose, as laxative, 533
- Lamifiban, for platelet inhibition, 506
- Laminin, in platelet adhesion, 487
- Lamivudine
 for hepatitis B virus, 654
 for human immunodeficiency virus infection, 655
- Lamotrigine
 adverse reaction to, 219t
 for mania, 185
 mechanisms of action and therapeutic uses of, 216t
 for seizures, 224
 structural formula of, 223f
 for trigeminal neuralgia, 388
- Lansoprazole, as proton pump inhibitors, 525-526
- Lapatinib, for cancer, 705t, 706
- Laryngospasm, neuromuscular blocking drugs in, 144
- Latin abbreviations, in prescriptions, 856, 856f, 856t
- "Laughing gas," 266
- Laws, drug. *See* Drug laws.
- Laxatives, 532-533
 names of, 536b
 sites of action of, 532f
- Lead, toxic effects of, 822-823, 823f
 chelator treatment for, 824t
- Leflunomide, for rheumatoid arthritis, 352
- Legislation, drug, 862-865. *See also* Drug laws.
- Lenalidomide, for cancer, 686t-692t, 702
- Leprosy, drugs used for, 636
- Leptocytes, description of, 471b
- Lethality, in drug testing in animals, 62-63, 63t
- Letrozole
 for cancer, 686t-692t, 698-699
 structural formula of, 698f
- Leucovorin
 for cancer, 686t-692t
 for folic acid deficiency, 480
 structural formula of, 480f

- Leukoplakia, oral hairy, 656-657
 EBV-related, in immunosuppressed patients, 787-788
- Leukotriene modifiers, for asthma prophylaxis, 517
- Leukotriene(s)
 in arachidonic acid metabolism, 326f, 328
 in inflammatory process, 328
- Leuprolide, for cancer, 686t-692t, 699
- Levamisole
 for cancer, 686t-692t
 as immunostimulant, 673
- Levetiracetam
 adverse reactions to, 219t
 mechanism of action and therapeutic uses of, 216t
 for seizures, 225
 structural formula of, 223f
- Levocabastine hydrochloride, structural formula and dosages of, 363t-364t
- Levodopa
 for dystonic syndromes, 242
 extrapyramidal motor function and, 234
 for Parkinson's disease, 27, 236-238, 236t
 absorption, fate, and excretion of, 238
 adverse effects of, 238
 combined with decarboxylase inhibitors, 234-235, 235f, 238
 in dental practice, 242-243
 diminishing response to, 237
 pharmacologic effects of, 236-238
 side effects of, 56t
 structural formula of, 237f
 for Wilson's disease, 242
- Levodopa-carbidopa, for Parkinson's disease, 234-235, 235f, 238
- Levofloxacin, for traveler's diarrhea, 534
- Levonordefrin
 in local anesthetic cartridges, 101, 101t
 structure-activity relationships of, 92t
- Levorphanol, dose, duration, and administration of, 315t
- Levosimendan, for congestive heart failure, 420
- Levothyroxine sodium, 541
- Lexi-Comp ONLINE, 67
- Lidocaine
 absorption, fate, and excretion of, 402
 actions of, 400t
 activity of, physicochemical correlates of, 247t
 adverse effects of, 402, 408t
 for arrhythmias, 402
 for dental anesthesia, 260
 for emergency use, 846t-848t, 848
 indications for, 407t
 interactions with, 258
 parenteral application of, preparations and dosages of, 261
 pharmacokinetic properties of, 401t
 pharmacologic effects of, 402
 side effects of, 56t
 useful, 56t
 structural formula of, 247f
 surface application of, preparations and dosages of, 262
 volume of distribution of, 28t
- Ligand(s)
 of ion channel-linked receptors, 3, 3f, 86
 anesthetic action and, 269-270
 of GABA_A receptors, valproic acid and, 221
 on nociceptive neurons, 301
 multiple binding sites of, receptors with, 13
 of opioid receptors, characterization of, 309t
- Ligand competition, 7
 in drug binding, 7
- Limbic system, 150-151
 anatomy of, 150
 pharmacology of, 150-151
- Lincomycin, 621
- Lincosamides, 621-622. *See also* Clindamycin.
- Lindane, structural formula of, 828f
- Linezolid, 631
 introduction of, 596
 recommended dosages of, 614t
- Linked database prescribing system, 855, 855f
- Liothyronine sodium, 541
- Liotrix, 541
- Lipid bilayer, of plasma membrane, anesthetic action and, 269
- Lipid-lowering drugs, 458-468
 bile acid sequestrants as, 464
 cholesterol absorption inhibitors as, 465-466
 combinations of, 466
 fibric acid derivatives as, 462-463
 HMG CoA reductase inhibitors as, 464-465
 names of, 466b
 nicotinic acid as, 463-464
 properties of, 463t
- Lipid metabolism
 ethanol effects on, 713
 glucocorticoid effects on, 550-551
- Lipid solubility, of drugs
 anesthetic potency and, 268, 268f
 antibiotics dosage and, 592
 drug absorption and, 21
 entry of drugs into CNS and, 27
 volume of distribution and, 28
- Lipid-water partition coefficient, 17, 18f
- Lipocortin, 302
- Lipoid barrier, placental transfer and, 27-28
- Lipoprotein(s), 458
 in atherosclerosis, 460
 classification and characteristics of, 459t
 high-density, 458
 characteristics of, 459t
 intermediate-density, 458
 characteristics of, 459t
 low-density, 458
 characteristics of, 459t
 endocytosis and, 20
 transportation pathways of, 458, 459f
 very-low-density, 458
 characteristics of, 459t
- Lipoprotein lipase, heparin action and, 501
- Lipoprotein(a), 458
 characteristics of, 459t
- Liposomes, for salivary immunization, 672
- Lipoxygenase, in arachidonic acid metabolism, 325, 326f
- Liquids, toxic effects of, 826-827
- Lisinopril
 absorption, fate, and excretion of, 446
 in renal failure, dosage adjustments needed in, 51t
- Listerine, 873
- Lisuride
 for Parkinson's disease, 236t, 239
 structural formula of, 237f
- Lithium
 for aplastic anemia, leukemias, and thrombocytopenia, 474
 side effects of, 56t
- Lithium salts, 183-185
 absorption, fate, and excretion of, 184
 adverse effects of, 184-185
 as antidepressants, 181
 for bipolar disorder, 165-166, 183, 185
 in dental practice, 185
 drug interactions with, 185
 neuromuscular blocking drug action with, 145
 pharmacologic effects of, 183-184, 184f
 therapeutic uses of, 185
- Liver
 alcoholism and, 713, 715-716, 716t, 717f
 barbiturate metabolism in, 200
 cocaine effects on, 806
 disease of
 antibiotic dosing in, 592
 drug effects and, 50-51
 volume retention in, loop diuretics for, 437
 drug binding in, 29-30
 drug uptake into, plasma protein binding and, 37-38
 inhalation anesthetic effects on, 277
 microsomal enzyme activity in, 35t-36t.
See also Hepatic microsomal enzyme activity.
 as toxic target, 818
- Local anesthetics, 246-265, 754
 absorption, fate, and excretion of, 256
 absorption of, 256
 actions of, in central nervous system, 150t
 activity of, physicochemical correlates of, 247t
 administration of
 parenteral, 261-262
 techniques of, 259
 topical, 262-263
 adverse effects of, 256-258
 seizures as, 226
 for cardiac arrhythmias, 259
 chemistry of, 246-248
 classification of, 246
 comparison of, 255t
 differential nerve block and, 251-254, 253f
 distribution of, 256
 drug interactions with, 258
 with antihypertensive drugs, 455-456
 with levodopa, 242-243
 esters of, sulfonamides and, 258
 eutectic mixture of, for orofacial neuropathic pain, 390
 half-lives of, 42t
 idiosyncratic reactions to, 257
 long-acting, pretreatment with, 305
 mechanism of action of, 248-254, 302
 names of, 263b
 pH and, 246-248
 pharmacologic effects of, 254-256
 preparations and dosages of, 261-263
 for parenteral administration, 261-262
 for surface application, 262-263
 selection of drug for, 260-261
 selectivity of, for sensory vs. motor nerve fibers, 253
 structural formulas of, 247f
 structure-activity relationships of, 246, 247f
 therapeutic uses of, 259
 in dentistry, 259-261
 topical, compound, 262-263
 topical application of, 26
 use-dependent block and, 250-251
 vasoconstrictors in
 in dentistry, 101-103, 101t
 effects of, 255-256, 455-456
- Locus coeruleus, in antidepressant action, 174
- Loma Linda technique, for intravenous sedation, 767
- Lomustine, for cancer, 686t-692t
- Long, Crawford W., 266
- Long QT interval syndrome, 396
 antibiotic-induced, 594, 620
 antidepressant use and, 182
 antipsychotic use and, 170, 171t
- Loop diuretics, 436-438. *See also* Diuretic(s), loop.
- Loperamide
 for diarrhea, 534
 for irritable bowel syndrome, 535
 for traveler's diarrhea, 535
- Lopinavir, for human immunodeficiency virus infection, 656
- Loracarbef, structural formula of, 615f
- Loratadine hydrochloride, structural formula and dosages of, 363t-364t
- Lorazepam
 absorption, metabolism, and excretion and, 192-193, 193t
 abuse of, 802
 adverse reactions to, 219t
 as antiemetic, 531
 for anxiety, dose and administration of, 197t
 delay in effect of, 46
 in dentistry, 208
 for depression, 181
 for intravenous anesthesia, 292
 for mania, 185
 mechanisms of action and therapeutic uses of, 216t
 for oral sedation, 765
 for premedication in anesthesia, 295t
 in renal failure, dosage adjustments needed in, 51t

- Lorazepam (*Continued*)
 for seizures, 222-223
 structural formula of, 190t
- Losartan
 for chronic heart failure, 413
 for hypertension, 446-447, 447f
- Lotrafiban, for platelet inhibition, 506
- Lovastatin
 for hyperlipidemia, 464-465
 structural formula of, 465f
- Loxapine
 autonomic effects of, 170
 pharmacologic effects of, 168
 side effects of, 171t
 structure and activity relationships of, 167
 structure of, 167f
- Lp(a) hyperlipoproteinemia, characteristics of, 461t
- LSD (lysergic acid diethylamide)
 abuse of, 799, 807-808
 structural formula of, 807f
- Lubricants, 532
- Luciferase, 269
- Ludwig's angina, pathogens causing, 603
- Lumiracoxib, 345
 structural formula of, 343f
- Lung(s)
 in drug disposition, 37
 in drug excretion, 41
- Lung toxicity, 818
- Luteinizing hormone, 576
- Lymphocyte-induced cytotoxicity, in immune response, 669, 669f
- Lymphocyte products, in inflammatory process, 328
- Lymphocytes, cell surface glycoproteins of, 662-665
- Lymphocytotropic hormone, in cytokine therapy, 679-680
- Lymphoid cells, interleukin-1 effects on, 679t
- Lymphoid hematopoiesis, cytokines in, functional relationships of, 663t
- Lymphoid progenitors, in immune system, 660
- Lymphoid stem cells, in immune system, 660, 661f
- Lysergic acid diethylamide (LSD)
 abuse of, 799, 807-808
 structural formula of, 807f
- Lysosomal products, in inflammatory process, 328
- M**
- Ma huang, 91
 ban on, 868
 for weight loss and increased energy, 101
- Macrocytic anemias, 470, 471t
- Macrocytic erythrocytes, 470
- Macrolide antibiotics, 618-621
 absorption, fate, and excretion of, 619-620
 adverse effects of, 620
 antibacterial spectrum of, 618-619, 619b
 available in United States, 618b
 chemistry and classification of, 618
 contraindications to, 620-621
 digoxin interactions with, 419
 drug interactions with, 620, 621t
 mechanism of action of, 581-583, 618-619
 microbial resistance to, 587, 619
 recommended dosages of, 614t
 therapeutic uses of, 620
 in dentistry, 620
- Macromolecular compounds, in histamine release, 360
- Macrophage products, in inflammatory process, 329
- Magnesium
 plasma, digoxin therapy and, 418-419
 replacement, for emergency use, 846t-848t, 848
- Magnesium salts
 for convulsions of eclampsia, 225
 as laxatives, 532-533
 neuromuscular blocking drug action with, 145t
 for peptic ulcer disease, 528
- Magnesium sulfate, 15-16
 for arrhythmias, 407
 indications for, 407t
- Mail order pharmacies, 857
- Maintenance, of anesthesia, definition of, 267
- Major histocompatibility gene complex (MHC), 662
- Malaria, agents for, for rheumatoid arthritis, 351
- Malathion
 structural formula of, 827f
 toxicity of, 827-828
- Malignant hyperthermia
 drug target polymorphisms and, 73-74
 halothane use and, 286
 local anesthetic use and, 257
 from succinylcholine, 142, 147
 treatment of, 147
- Malonic acid, structural formula of, 198f
- Mandibular dysfunction, postradiation, 795
- Mania
 antibiotic-induced, 594
 drugs for, 183-185
- Manic disorder
 clinical presentation of, 164
 drugs for, 183-185
- Mannitol
 absorption, fate, and excretion of, 438
 action of, 15-16
 adverse effects of, 438
 pharmacologic effects and therapeutic uses of, 438
 therapeutic uses of, 438
 volume of distribution of, 28t
- MAO inhibitors. *See* Monoamine oxidase (MAO) inhibitors.
- Maprotiline, 177-178
 adverse effects of, 176t
 structural formula of, 178f
- Marijuana abuse, 808-809
 history of, 799
 recent trends in, 800
- Marijuana Tax Act of 1937, 799
- Mast cell(s)
 histamine in, 324, 359
 inflammatory mediators released by, 329
- Material safety data sheets, 820
- Maxzide, components of, 434t
- MDMA abuse, 799-800, 807
 recent trends in, 800
- Mean corpuscular volume (MCV), 470
- Mean inhibitory concentration, breakpoint of, antibiotic resistance and, 603
- Mecamylamine, structural formula of, 138f
- Mechanical stimuli, perception of, 301
- Mechanical ventilation, neuromuscular blocking drugs in, 144
- Mechlorethamine
 for cancer, 686t-692t, 692
 structural formula of, 693f
- Mecizine
 as antiemetic, 531
 structural formula and dosages of, 363t-364t
- Meclofenamate, 342
 dosages of, 346t
 for inflammatory conditions, 342
 structural formula of, 340f
- Median effective dose (ED₅₀), 48, 62-63
- Median lethal dose, definition of, 62-63
- Mediastinal infections, oral pathogens causing, 603
- Medication errors, drug effects and, 54
- Medroxyprogesterone acetate
 for cancer, 686t-692t
 indications for and dose of, 570t
 structural formula of, 570f
- Medulla, antimuscarinic drug action on, 132
- Medullary dorsal horn, in pain perception, 301
- Mefenamic acid, 342
 for inflammatory conditions, 342
 for pain, dosage of, 346t
- Megaloblastic anemias, 470, 476-477
- Megestrol, for cancer, 686t-692t, 698
- Meglitinides, for diabetes, 562-563
 adverse effects of, 563
 drug interactions with, 563
 pharmacokinetics of, 562
- Melatonin receptor agonists, 198
- Meloxicam
 COX inhibitory activity of, 331f
 for osteoarthritis, 342
- Melphalan, for cancer, 686t-692t, 693
- Memantine, for Alzheimer's and migraine, 389
- Membrane(s)
 cell
 entry of drug into, 26-27
 passage of drugs across, 17-21
 receptors of, 2
 plasma
 anesthetic action and, 269-270
 structure of, 17, 18f
 trophoblastic, placental transfer of drugs and, 27-28
- Membrane receptors, characteristics of, 2
- Membrane-stabilizing activity, by β -blockers, 109-111
- Membrane transport
 carrier-mediated, 19
 by endocytosis and exocytosis, 20-21
 by passive diffusion, 17-19
- Memory, immunologic, 661
- Men, iron stores in, 472
- Menadiol sodium diphosphate, structural formula of, 503f
- Meniere's disease
 antimuscarinic drugs for, 133
 H₁ antihistamines for, 366
- Menstrual cycle, hormonal changes during, 568f
- Meperidine
 abuse of, 317
 analgesic effects of, 316-317
 dose, duration, and administration of, 315t
 herbal product interactions with, 872t
 for intravenous anesthesia, 293, 293t
 for intravenous sedation, 767
 phase I reactions in, 35t-36t
 for premedication in anesthesia, 295t
 in renal failure, dosage adjustments needed in, 51t
 side effects of, 56t
 structure of, 316f
 volume of distribution of, 28t
- Mephesisin
 for muscle relaxation, 204
 doses of, 205t
 structural formula of, 204f
- Mephentermine, for emergency use, 849
- Mephentoin, mechanisms of action and therapeutic uses of, 216t
- Mephobarbital, 218
 mechanisms of action and therapeutic uses of, 216t
 structural formula of, 199t
- Mepivacaine
 activity of, physicochemical correlates of, 247t
 for dental anesthesia, 260
 preparations and dosage of, 261
 structural formula of, 247f
- Meprobamate
 for anxiety, 188, 203
 dose and administration of, 197t
 for muscle relaxation, doses of, 205t
 structural formula of, 204f
- Mercaptopurine
 for cancer, 686t-692t, 695
 in immunotherapy, 678
 structural formula of, 694f
- Mercury
 dental amalgam, microbial resistance and, 588-589
 in dentistry, 821-822
 as disinfectant, 748
 microbial resistance to, 588-589
 toxic effects of, 820-821
 treatment of, 824, 824t
- Meropenem, 615b
 characteristics of, 618

- Mescaline
 abuse of, 807
 structural formula of, 807f
- Mesencephalic reticular activating formation,
 in anesthetic action, 271
- Mesna, for cancer, 686t-692t
- Mesoridazine, side effects of, 171t
- Mestranol, structural formula of, 568f
- Metabolic effects
 of β blockers, 111-112
 adverse, 114
 of endogenous catecholamines, 95
 of isoproterenol, 97
- Metabolism, major pathways of, 18f
- Metabolite analogues, in immunotherapy, 678
- Metabotropic receptors, 3-4, 158
 in trigeminal nociceptive mechanisms, 303
- Metals
 heavy. *See* Heavy metals.
 toxic, 820-824
- Metaproterenol
 for asthma, 515
 for emergency use, 845
 pharmacologic effects of, 97
 structure-activity relationships of, 92t
- Metaraminol, structure-activity relationships
 of, 92t
- Metastatic infections
 absolute risk rate for, from single dental
 procedure, 774b
 prevention of, antibiotics in, 771-773
- Metaxalone, for musculoskeletal pain, 385-386
- Metformin
 for diabetes, 563. *See also* Biguanides, for
 diabetes.
 structural formula of, 561f
- Methacholine
 pharmacologic effects of, 118-119
 structure of, 118f
- Methacycline, 624. *See also* Tetracycline(s).
- Methadone
 dose, duration, and administration of, 315t
 for opioid toxicity, 802-803
 for pain, 321
 side effects of, useful, 56t
 structural formula of, 317f
 structure and analgesic effects of, 317
- Methamphetamine(s)
 abuse of, 804-805
 history of, 799-800
 recent trends in, 800
 structure-activity relationships of, 92t
- Methandrostenolone, side effects of, 56t
- Methanol
 aerosol, abuse of, 810
 toxicity of, 718
- Methdilazine hydrochloride, structural formula
 and dosages of, 363t-364t
- Methemoglobin toxicity, 818
- Methenamine, as urinary antiseptic, 634
- Methicillin, 605-607, 606t-607t
 staphylococci resistant to, 586
 vancomycin resistance and, 587
- Methimazole
 for hyperthyroidism, 542
 structural formula of, 542f
- Methionine deficiency, 477
 nitrous oxide effects and, 283
- Methionine synthase, 477
- Methocarbamol, for musculoskeletal pain, 204,
 385-386
- Methohexital
 for deep sedation and general anesthesia,
 767
 for intravenous anesthesia, 289
 side effects of, 56t
- Methonium compounds
 development of, 138
 structural formulas of, 138f
- Methotrexate
 for asthma, 518
 for cancer, 686t-692t, 694
 drug interactions with, 709
 in immunotherapy, 678
 for rheumatoid arthritis, 351-352
 structural formula of, 694f
- Methoxamine
 for emergency use, 849
 pharmacologic effects of, 96
 structure-activity relationships of, 92t
- Methoxyflurane, 275t
- Methscopolamine, structural formula of,
 130t
- Methsuximide
 as anticonvulsant, 221
 mechanisms of action and therapeutic uses
 of, 216t
- Methylclothiazide, pharmacokinetic data on,
 434t
- Methyl methacrylate
 structural formula of, 826f
 toxic effects of, 826-827
- 1-Methyl-4-phenyl-1,2,3,6-tetrahydropyridine,
 as neurotoxicant, 817
- Methyl salicylate, structural formula of,
 331f
- Methylcarbamate insecticides
 structural formula of, 827f
 toxicity of, 828
- Methylcellulose, as laxative, 533
- Methylcobalamin, function of, 477
- Methylidopa
 absorption, fate, and excretion of, 451
 adverse effects of, 113t, 451
 for hypertension, 451-452
 pharmacologic effects of, 96, 451
 structural formula of, 96f, 451f
 toxic effects of, 103
- Methylene blue
 for oral photodisinfection, 738
 structural formula of, 739f
- Methylene chloride, toxicity of, 826
- Methylergonovine, for migraine prophylaxis,
 382-383
- Methylmalonyl coenzyme A, in vitamin B₁₂
 deficiency, 477
- Methylmercury, in food, 821
- Methylphenidate
 abuse of, recent trends in, 800
 for attention-deficit/hyperactivity disorder,
 100-101
 structural formula of, 804f
- Methylprednisolone, as antiemetic, 531
- Methyltestosterone
 indications for and dose of, 569t
 structural formula of, 568f
- Methysergide, for migraine prophylaxis,
 382-383
- Metiamide, 368
 structural formula of, 368f
- Metoclopramide
 digoxin interactions with, 419
 for gastroparesis, 535
 levodopa-induced interactions with, in
 dental practice, 242-243
 for migraine, 381-382
 for nausea and vomiting, 531-532
- Metoprolol. *See also* Adrenergic receptor
 antagonists, β .
 for arrhythmias, 404
 for chronic heart failure, 413
 for emergency use, 848
 pharmacologic effects of, 110t
 structural formula of, 111f, 449f
- Metozalone, pharmacokinetic data on, 434t
- Metric system of weights and measures, 861,
 862t
- Metronidazole, 622-624
 absorption, fate, and excretion of, 623
 adverse effects of, 623-624
 antibacterial spectrum of, 623
 bacterial resistance to, 623
 for *C. difficile* diarrhea, 596
 drug interactions with, 624
 mechanism of action of, 583, 623
 recommended dosages of, 614t
 side effects of, useful, 56t
 structural formula of, 622f
 therapeutic uses of, 623
 in dentistry, 623
 toxicity risk with, in elderly, 837t
- Metyrosine, for hypertension, 454
- Mexiletine
 actions of, 400t
 for arrhythmias, 402-403
 pharmacokinetic properties of, 401t
 structural formula of, 403f
- Meyer-Overton relationship, in anesthetic
 action, 268-269
- Mezlocillin, 606t-607t, 607
 adverse reactions to, 613
- Micafungin
 for fungal infections, 644-645
 mechanism of action and clinical uses of,
 641t
 structural formula of, 645f
- Michaelis-Menton equation, in quantifying
 drug effects, 8
- "Mickey Finn," 202
- Miconazole
 for candidiasis in cancer patients, 787
 for fungal infections, 643
 mechanism of action and clinical uses of,
 641t
 structural formula of, 643f
- Microcytic anemias, 470, 471t
- Microcytic erythrocytes, 470
- Micromedex, 67
- Micronization, drug dissolution and, 22
- Microorganisms
 in acute necrotizing ulcerative gingivitis, 602
 antibiotic and host interactions with,
 593-594
 antibiotic resistance of, 583-586, 583t. *See
 also* Antibiotics, microbial resistance to.
 antibiotic susceptibilities of
 to aminoglycosides, 629
 to cephalosporins, 616t
 to fluoroquinolones, 627, 627b
 to lincosamides, 621-622
 to macrolide antibiotics, 618-619, 619b
 to metronidazole, 623
 to streptogramins, 630
 to sulfonamides and trimethoprim,
 631-632
 to vancomycin, 630
 in cervicofacial actinomycosis, 603
 in deep neck space infections, 603
 in infective endocarditis, 773
 lincosamide-resistant, 622
 in Ludwig's angina, 603
 metronidazole-resistant, 623
 in necrotizing fasciitis, 603
 in oral infections, 600-603, 601t
 antibiotics of choice for, 610t-611t
 in oral osteomyelitis, 602
 in orofacial infections, antibiotic resistance
 of, 603-604
 in pericoronitis, 602
 in periimplantitis, 602
 periodontal, 601-602
 plaque-related, 732
 pulp/periapical, 601, 602b
 virulence of, factors affecting, 594
- Microsomal enzyme activity, hepatic. *See also*
 Hepatic microsomal enzyme activity.
 competitive inhibition of, 38
 in drug metabolism, 31-34, 35t-36t, 200
 induction of, 38-39
 intermediary substances in, toxicity of, 39
- Microsomal enzyme oxidation system
 (MEOS), in alcohol elimination, 714
- Midazolam
 absorption, metabolism, and excretion of,
 193t
 adverse reactions to, 219t
 for anxiety, dose and administration of, 197t
 for deep sedation, with fentanyl, 767
 for emergency use, 846
 for intravenous anesthesia, 292
 for intravenous sedation, 766
 mechanisms of action and therapeutic uses
 of, 216t
 metabolism of, 193f
 for muscle relaxation, 206
 for oral sedation, 765
 for premedication in anesthesia, 207-208,
 295t

- Midazolam (*Continued*)
 sedation with, reversal of, flumazenil for, 196, 196f
 for seizures, 222-223
 in dental office, 226-227
 due to local anesthetics, 257
 structural formula of, 189f
- Midbrain, 151
 anatomy of, drug action in, 151
 pharmacology of, 151
- Midorine, pharmacologic effect of, 96
- Midrin, for migraine, 381
- Mifepristone
 as progesterone receptor antagonist, 576
 structural formula of, 575f
- Miglitol, for diabetes, 564
- Migraine
 drugs for
 for acute treatment, 379-382
 5-hydroxytryptamine receptor subtypes and, 377t
 names of, 391t
 prophylactic
 adrenocorticosteroids as, 385
 antidepressants as, 383-384
 antihistamines as, 384
 antiseizure medications as, 384
 β -adrenergic receptor blockers as, 384
 calcium channel blockers as, 384
 5-HT receptor blockers as, 382-383
 indomethacin as, 384-385
 SSRIs as, 383
 tricyclic antidepressants as, 383
 for prophylactic treatment, 382-385
 ergot derivatives and, 379-380
 5-hydroxytryptamine and, 379
 stratified approach to treatment of, 382, 382b
 treatment of, clinical, 382, 382b
- Milk of magnesia, for irritable bowel syndrome, 535
- Milrinone
 for congestive heart failure, 419-420
 for emergency use, 846t, 849
- Minamata disease, 821
- Mineral oil, as laxative, 532
- Mineralocorticoids, 549
- Minimal inhibitory concentration, of antibiotics, 590
- Minimum alveolar concentration, definition of, 267
- Minocycline, 624. *See also* Tetracycline(s).
 adverse reactions to, 625-626
- Minoxidil
 for hypertension, 444, 453
 side effects of, 56t
 structural formula of, 452f
- Miotics, for glaucoma treatment, 125, 125t
- Mirex
 structural formula of, 828f
 toxicity of, 828
- Mirtazapine, 165, 177-178
 adverse effects of, 176t
 as sleep adjuvant, 383-384
 structural formula of, 178f
- Misoprostol, for peptic ulcer disease, 529
- Mitochondria, anesthetic action and, 270
- Mitomycin, for cancer, 686t-692t, 698
- Mitotane, for cancer, 686t-692t, 698
- Mitoxantrone, for cancer, 686t-692t, 697
- Mivacurium, pharmacologic properties of, 142t
- Modafinil, toxic extension of therapeutic effect of, 55t
- Moduretic, components of, 434t
- Molecular influences, on pain, 304
- Molecular mechanisms, of anesthesia, 268-270
- Molecular size, simple diffusion and, 17-18
- Molindone
 autonomic effects of, 170
 pharmacologic effects of, 168
 side effects of, 171t
 structure and activity relationships of, 166-167
 structure of, 167f
- Monoamine oxidase (MAO)
 in catecholamine metabolism, 98-99
 drug inactivation and, 23-24
 norepinephrine breakdown and, 85
- Monoamine oxidase (MAO) inhibitors, 177
 absorption, fate, and excretion of, 177
 adverse effects of, 113t, 176t, 177
 characteristics of, 165, 174
 in dentistry, 115, 182
 for depression, 165
 forms of, 165
 local anesthetics with, 258
 meperidine interactions with, 293
 in neuroprotection in Parkinson's disease, 234-235
 pharmacologic effects of, 177
 therapeutic uses of, 114, 182
 type B, for Parkinson's disease, 239
 side effects of, in dental practice, 243
- Monoamines
 as central nervous system transmitters, 155, 156t
 in depression, 165
- Monobactams, 615b
 characteristics of, 618
- Monoclonal antibody(ies)
 for cancer, 705t, 706-708
 chimeric, 674
 complementarity-defining region-grafted (humanized), 674
 names of, 675t
 uses of, 674, 675t
- Monocyte chemoattractive protein-1,
 in inflammatory process, 328
- Monocyte/macrophage colony-stimulating factor (M-CSF)
 in hematopoiesis, 482
 therapeutic uses of, 678
- Monocytes/macrophages, interleukin-1 effects on, 679t
- Monogenic phenotypes, polygenic phenotypes versus, 71-72
- Montelukast, for asthma, 517
- Mood stabilizers, 166
- Moonflower plant seeds, poisoning from, 134
- Moricizine
 actions of, 400t
 for arrhythmias, 404
 pharmacokinetic properties of, 401t
 structural formula of, 404f
- Morphine
 absorption, fate, and excretion of, 314-315
 abuse of, history of, 799
 acute intoxication with, 313
 analgesia produced by, 312
 dependence on, 314
 dose, duration, and administration of, 315t
 for emergency use, 846t, 849
 for intravenous anesthesia, 292-293, 293t
 for intravenous sedation, 767
 pharmacologic effects of
 central, 311-312
 peripheral, 312-313
 for premedication in anesthesia, 295t
 side effects of, 56t
 sites and mechanisms of action of, 310
 structural formula of, 311, 311f
 therapeutic uses of, 315
 tolerance of, 313-314
- Morpholino compounds, in plaque prevention/control, 738
 in oral products, agent and proprietary name of, 739t
- Mortality
 from cocaine abuse, 806-807
 hypertension and, 444, 444f
 from respiratory arrest, neuromuscular blocking drugs and, 144
 sedation/anesthesia and, 762
 Morton, William T.G., 266-267
- Mosby's Dental Drug Reference*, 67
- Mosby's Drug Reference for Health Professions*, 66
- Motion sickness
 antihistamines for, 366-367
 scopolamine for, 132-133
 treatment of, 531
- Motor blockade, vs. sensory blockade, local anesthetic action and, 253
- Motor endplate receptor
 desensitization of, 141
 neuromuscular blocking drug effects on, 141-142
- Motor function, neural control of, 231-232
- Mouth. *See also* under Oral.
 anticonvulsant effects on, 227
 complications of cancer therapy involving, 782-798, 783b
- Mouth rinses
 early, 734
 fluoride-containing, 727
 herbal ingredients in, 873, 874t
 for plaque prevention/control, bis-biguanide-containing, 735-736
 stannous fluoride-containing, in plaque prevention/control, 737-738
- Movement disorders
 drugs affecting, names of, 243b
 drugs used for, 241-242
- Movements, involuntary, abnormal, in Parkinson's disease, levodopa and, 237
- Mucolytics, 522
 names of, 522b-523b
- Mucosa
 damage to, from cancer chemotherapy, 782
 gastric, enterochromaffin-like cells in, 359-360
 infections of, in immunosuppressed patients, 786-789
 nasal, drug absorption by, 26
 oral, drug absorption by, 24
 rectal, drug absorption by, 24
 surface area of, drug absorption and, 22
- Mucositis, oral
 in cancer chemotherapy, 782-785
 clinical presentation of, 783-784, 783f
 epidemiology of, 782
 management of, 784, 784t
 morbidity from, 783
 pain control in, 784-785
 pathogenesis of, 783-784
 in hematopoietic cell transplantation for cancer, 790
 oral hygiene maintenance for, 785
 radiation-induced, 792
 clinical appearance of, 792
 epidemiology of, 792
 management of, 792
 morbidity of, 792
 pathogenesis of, 792
 therapeutic interventions for, 785
- Mucous membranes, topical drug application to, 26
- Multidrug efflux pumps, in antibiotic resistance, 584-585
- Multidrug resistance-associated protein (MRP) transporters, 19
- Multidrug resistance-associated protein (MRP) type 2, in biliary and renal excretion, 40
- Multidrug resistant protein-1, distributional tolerance and, 53
- Multiple antibiotic allergy syndrome, 612-613
- Multiple drug resistance, tetracyclines and, 588
- Multiple lipoprotein-type hyperlipidemia, characteristics of, 461t
- Multistate model, of drug action, 13-15
- μ receptor, 309
 characterization of, 309t
- Mupirocin, topical, 634
- Muromonab-CD3, proprietary names of and indications for, 675t
- Muscarine
 pharmacologic effects of, peripheral, 119-120
 poisoning with, 120-121
 structure of, 118f
- Muscarinic agonists, 117
 anticholinesterases vs., 123
 in patients taking digoxin, 420

- Muscarinic effects, of anticholinesterases, 123, 124b
- Muscarinic receptor-blocking drugs. *See* Antimuscarinic drugs.
- Muscarinic receptor(s), 82, 86
antimuscarinic drug action and, 129-130
blockade of, 163t
proteins of, 118
stimulation of, 118-119, 119f
subtypes of, 130
- Muscle(s)
drug binding in, 29-30
skeletal
 alcoholism and, 716, 716t
 focal necrosis in, from local anesthetics, 257
 inhalation anesthetic effects on, 277-278
 smooth. *See* Smooth muscle.
- Muscle contraction
cardiac
 heart failure and, 410-411
 rate of, effects of digoxin on, 415
 serotonin receptors and, 377
- Muscle relaxants
centrally acting, 203-206
 adverse effects of, 205-206
 in dentistry, 209, 210b
 drug interactions with, 206
 for musculoskeletal pain, 385-386
 names of, 391t
 therapeutic uses of, 194
 vs. sedative-hypnotics, anti-anxiety drugs, and antihistamines, 205t
 names of, 210b
- Muscle relaxation, definition of, 267
- Musculoskeletal pain, drugs for, 385-386
- Mushrooms
 muscarine in, 117
 poisoning by, 120-121, 133
- Mutations, genetic, in carcinogenesis, 58
- Myasthenia gravis, 120-121
- Myasthenic crisis, 126
- Mycobacterium tuberculosis*, infection with, 635-636
- Mycophenolate, in immunotherapy, 678
- Mycoses, 640
- Mydriasis
 adrenergic agonists for, 100
 atropine and scopolamine use for, 132
- Mydriatic agents, names of, 103b-104b
- Myeloid cells, interleukin-1 effects on, 679t
- Myeloid factors, cytokines in, functional relationships of, 663t
- Myeloid growth factors
 physiologic characteristics of, 482-483
 therapeutic use of, 483
- Myeloid stem cells, in immune system, 660, 661f
- Myeloproliferative disorders, antibiotic prophylaxis for dental patients with, 778
- Myocardial effects, of local anesthetics, 254
- Myocardial infarction
 β blockers for, 112
 prevention of, 429
- Myoclonic seizures, 212, 213t
- Myofascial pain disorders, from cancer chemotherapy, 785
- Myopathy, glucocorticoid therapy and, 553
- Myxedema, 541
- Myxedematous coma, 542-543
- N**
- N-Acetyl-benzoquinoneimine, structural formula of, 346f
- N-Methyl-D-aspartate (NMDA) receptor(s)
 anesthetic action and, 269
 antagonists of
 in anticonvulsant therapy, 226
 for chronic pain treatment, 388-389
 names of, 391t
 ethanol and, 711
 in trigeminal nociceptive mechanisms, 303
- N/OFG receptor, 308
- Na⁺, K⁺-ATPase, in cardiac contractility, 414, 415f
- Nabumetone
 for inflammatory conditions, 342
 structural formula of, 340f
- Nadolol. *See also* Adrenergic receptor antagonists, β .
 for Parkinson's disease, 241
 pharmacologic effects of, 110t
 side effects of, 56t
 structural formula of, 111f, 449f
- NADPH-cytochrome P-450 reductase, 31
- Nafcillin, 605-607, 606t-607t
- Naftifine, for fungal infections, 646
- Nalarabine, for cancer, 686t-692t
- Nalbuphine
 dose, duration, and administration of, 315t
 for intravenous anesthesia, 293t, 294
 for intravenous sedation, 767
 pharmacologic effects of, 320
- Nalidixic acid
 structural formula of, 626f
 as urinary antiseptic, 635
- Nalmefene, pharmacologic effects of, 319
- Naloxone
 for acute opioid intoxication, 313
 for emergency use, 849
 for opioid toxicity, 802
 pharmacologic effects of, 319
 for reversal of opioid analgesics, 768
 structural formula of, 319f
 uses of, 318
- Naltrexone
 pharmacologic effects of, 319
 uses of, 318
- Naphthalene, phase I reactions in, 35t-36t
- Naphthalene oxide, phase II metabolic reactions in, 37t
- Naproxen
 characteristics of, 338-339
 for chronic orofacial pain, 755
 COX inhibitory activity of, 331f
 dosages of, 346t
 for pain, dosage of, 346t
 structural formula of, 338f
- Naratriptan
 dosage forms and T_{max} of, 380t
 for migraine, 380-381
- Narcolepsy, adrenergic agonists for, 100-101
- Narcotic Drugs Import and Export Act (1922), 799
- Nasal allergies, H₁ antihistamines for, 366
- Nasal decongestants, 521-522
 adrenergic agonists as, 99
 names of, 103b-104b, 522b-523b
 overdose of, 99
- Nasal mucosa, drug absorption by, 26
- Nasal polyps, aspirin intolerance and, 336
- NAT2, genetic polymorphisms in, 72
- Nateglinide, for diabetes, 562. *See also* Meglitinides, for diabetes.
- National Center for Complementary and Alternative Medicine (NCCAM), 852, 869
- National Cholesterol Education Program, guidelines of, for hyperlipidemia treatment, 462
- National Committee for Clinical Laboratory Standards, MIC breakpoints of, 589
- National Formulary (NF), 65-66
- National Formulary of Unofficial Preparations, 862
- Natriuretics, 431. *See also* Diuretics.
- Natural killer (NK) cells, 660, 661f
 interleukin-1 effects on, 679t
 interleukin-2 effects on, 679
- Natural medicine. *See* Alternative medicine.
- Natural products
 availability of, 867
 for cancer, 686t-692t
- Nausea and vomiting. *See also* Antiemetics.
 antihistamines for, 366-367
 cancer chemotherapy-induced, 531, 789-790
 dronabinol for, 809
 digoxin administration and, 417
 morphine-induced, 312
- Neck space infections, deep, microbiology of, 603
- Necrosis, focal, in skeletal muscle, from local anesthetics, 257
- Necrotizing fasciitis, microbiology of, 603
- Necrotizing ulcerative gingivitis, acute, microbiology of, 602
- Nedocromil, for asthma prophylaxis, 518
- Nefazodone, 177-178
 adverse effects of, 176t
 for headache, 383
 structural formula of, 178f
- Nelfinavir, for human immunodeficiency virus infection, 656
- Neoendorphins, 307-308
- Neomycin
 digoxin interactions with, 419
 topical, 634
- Neonates. *See also* Infants.
 antibiotic dosing and, 592
 drug effects and, 49
- Neostigmine
 for paralytic ileus, 126-127
 structural formula of, 121f-122f
- Nephron, sites of diuretic action along, 431, 432f
- Nephropathy, analgesic-associated, 335
- Nephrotoxicity, 819
 of aminoglycosides, 629
- Nerve(s)
 cholinergic, 82, 83f
 neurotransmission in, 85-86
 cranial, pain transmission in orofacial region and, 300
 facial, in pain transmission, 300
 glossopharyngeal, in pain transmission, 300
 injury to, from local anesthetics, 257
 peripheral
 analgesic control mechanisms of, 302
 organization of, local anesthetic action and, 253
 trigeminal, in pain transmission, 300
 vagus
 in pain transmission, 300
 pulse generators in, for seizure prevention, 226
- Nerve block. *See* Block, nerve.
- Nerve fibers
 critical length of, susceptibility to nerve block and, 252
 low-threshold sensory, pain sensations by, 301-302
 nociceptive afferent
 C, 299-300, 300f
 activation of, 301
 sensitization of, 389-390
 A δ , 299-300, 300f
 activation of, 301
 sensory vs. motor, local anesthetic action and, 253
- Nerve gases, historical background of, 121
- Nerve terminal, neurotransmitter release at, 157-158
- Nervous system
 alcoholism and, 716t, 717, 717f
 autonomic. *See* Autonomic nervous system.
 parasympathetic, 78-79, 80f, 81t
 neurotransmitters of, 80-82
 transmission in, ganglionic blocking drugs and, 136, 139t
 sympathetic, 78, 80f. *See also* Sympathetic nervous system.
 neurotransmission in, ganglionic blocking drug action and, 136, 139t
- Nesiritide, for congestive heart failure, 419
- Netilmicin. *See also* Aminoglycosides.
 development of, 628
- Neuralgia
 traumatic, diagnostic criteria for, 387b
 trigeminal
 diagnostic criteria for, 387b
 topical agents for, 389-390
- Neurokin-1 receptor, in afferent endings in nucleus caudalis, 303
- Neuroleptanalgesia, for deep sedation, 767

- Neuroleptic drugs, 162. *See also* Antipsychotic drugs.
for migraine, 381-382
- Neuroleptic malignant syndrome, antipsychotic drugs and, 172
- Neurologic manifestations, in vitamin B₁₂ deficiency, 477
- Neuroma, corticosteroids for, 385
- Neuromuscular blocking drugs
drug interactions with, 145t
names of, 147b
- Neuromuscular junction, neuromuscular blocking drug effects on, 142
- Neuromuscular junction blockers, 140-146
absorption, fate, and excretion of, 143-144
adverse effects of, 144
applications of, in dentistry, 145-146
depolarizing
action and structural formula of, 141-142, 141f
structural formula of, 141f
drug interactions with, 144-145
duration of action of, 142t, 143
nondepolarizing
action and structural formula of, 140-141, 141f
neuromuscular blocking drugs and, 145
onset of action of, 142t, 143
pharmacologic effects of, 142-143
therapeutic uses of, 144
- Neuromuscular transmission
drugs affecting, 140-147
other agents affecting, 146-147
physiologic events in, 140
- Neuron(s). *See also* Neurotransmission; Neurotransmitter(s).
analog communication between, in central nervous system, 152
digital communication between, in central nervous system, 152
endomorphin-containing, 308
enkephalin-containing, 308
nociceptive, 303
of parasympathetic nervous system, 78-79, 80f
serotonin, 375
structural features of, 152-153
susceptibility of, to local anesthetics, 252
of sympathetic and parasympathetic nervous systems, 78, 80f
types of, in pain perception, 301
- Neuropathic pain
characteristics of, 752
drugs for, 386-390
names of, 391t
orofacial. *See* Orofacial pain syndromes, neuropathic.
- Neuropathy
anticonvulsants for, 226
orofacial, topical agents for, 389-390
peripheral, organophosphate poisoning and, 124
- Neuropeptides
function of, in central nervous system, 157
synaptic release of, in pain perception, 301
- Neurophysiologic theories, of anesthetic action, 270-272, 271f
- Neurosteroids, for seizures, 224
- Neurotransmission
adrenergic, 82-85
cholinergic, 85-86
- Neurotransmitter(s), 80-82
adrenergic, biosynthesis of, 85f
adrenergic and cholinergic junctions of, 82
in autonomic nervous system, 80-82
in central nervous system, 155-157, 156t
co-release of, peptide transmission and, 88-89, 88f
diffusion of, 159
effect of, termination of, 158-159
enzymatic degradation of, 158-159
in nociceptive signaling, 303
- Neurotransmitter(s) (*Continued*)
in psychotic behavior, 163-164
release of, 157-158
inhibition of, in opioid analgesia, 311
mechanism of, 82
serotonin receptors and, 377
reuptake of, 158
in schizophrenia, 166
- Neutrophils
with inflammatory potential, 328b
interleukin-1 effects on, 679t
lysosomal products of, in inflammatory process, 328
- Nevirapine
for human immunodeficiency virus infection, 655
structural formula of, 655f
- New Drug Application, 64
- Niacin (nicotinic acid), for hyperlipidemia, 463-464
- Nicardipine, for hypertension, 447-448
- Nicotinamide adenine dinucleotide phosphate (NADPH), 31
- Nicotine, 117
chemical structure of, 138f
as ganglionic stimulating drug, 136-138
in smoking deterrents, 137, 137t
- Nicotinic acid (niacin)
for hyperlipidemia, 463-464
properties of, 463t
- Nicotinic effects
of anticholinesterases, 123-124, 124b
of cholinomimetic drugs, peripheral, 120
- Nicotinic receptor(s), 3, 3f, 82, 85-86
agents affecting, names of, 147b
anesthetic action and, 269
drugs affecting, 136-148
in ganglionic transmission of autonomic impulses, 136, 137f
in neuromuscular transmission, 140
nicotine depolarizing, 136-137
on nociceptive neurons, 301
stimulation and blockade of, 118, 137
- Nifedipine
cardiovascular effects of, 427, 428t
for hypertension, 447-448
structural formula of, 427f
- Nilotinib, for cancer, 705t, 706
- Nilutamide
as androgen receptor blocker, 574
for cancer, 686t-692t, 699
- Nimodipine
cardiovascular effects of, 428t
for hypertension, 447-448
- Nisoldipine, for hypertension, 447-448
- Nitrates/nitrites
absorption, fate, and excretion of, 425
adverse effects of, 425-426
for angina, 422, 424-426
sites of action of, 423f
chemistry of, 424
for congestive heart failure, 413
long-acting preparations of, 425
mechanism of action of, 425f
names of, 429t-430t
pharmacologic effects of, 424
structural formulas for, 424f
- Nitrazepam, 223
for seizures, 223
- Nitrendipine, for hypertension, 447-448
- Nitric oxide, 5
as central nervous system transmitter, 156t, 157
in inflammatory process, 330
nitrovasodilators and, 424
- Nitrites, organic, abuse of, 810
- Nitrofurantoin, as urinary antiseptic, 634
- Nitrogen balance, negative, glucocorticoid therapy and, 554
- Nitrogen mustards, for cancer, 686t-692t
- Nitrogen oxides, toxic effects of, 825-826
- Nitroglycerin. *See also* Nitrates/nitrites.
for angina, 424
for congestive heart failure, 420
for emergency use, 844t, 845, 846t, 849
for hypertension, 452-453
- Nitroglycerin (*Continued*)
structural formula of, 424f
transdermal patch of, 425
transmucosal preparation of, 425
- Nitrophenolic compounds, toxicity of, 829
- Nitroprusside
for congestive heart failure, 420
for emergency use, 846t
for hypertension, 452-453
structural formula of, 452f
- Nitrosoureas, for cancer, 686t-692t, 693
- Nitrous oxide, 281-284
abuse of, 810
adverse effects of, 278-279, 283
discovery of, and experiments with, 266
elimination of, 283
exposure to, 278-279
reducing, 279b
for inhalation sedation, 763-764
advantages of, 763
clinical application of, 764
disadvantages of, 763-764
properties of, 275t, 282f, 282t
anesthetic, 281-283
pharmacologic, 284t
physical and chemical, 281
therapeutic uses of, 283-284
vitamin B₁₂ and, 479
- Nitrovasodilators, 424
for angina. *See also* Nitrates/nitrites.
- Nizatidine
other H₂ antihistamines vs., 527t
for peptic ulcer disease, 527
structural formula of, 368f
- Nociceptive pain, characteristics of, 752
- Nociceptive signaling, neurotransmitters involved in, 303
- Nociceptor(s)
A δ
blockade of, 302
physiology of, 299, 300f
- C
blockade of, 302
physiology of, 299, 300f
- Nocistatin, 308-309
- Noncompliance, drug effects and, 48
- Nonionic bisphenols, in plaque prevention/control, 736-737
in oral products, agent and proprietary name of, 739t
- Nonsteroidal anti-inflammatory drugs (NSAIDs), 330-345
actions of, 302
adverse gastrointestinal reactions to, 535
antihypertensive drug interactions with, 455
antineoplastic drug interactions with, 708
chronic use of, 330
contraindications to, 345
COX inhibitory activity of, vs.
acetaminophen, 330, 331f, 332t
in dentistry, 305, 345, 346t
diflunisal as, 336-337
diuretic use and, 439-440
fenemates as, 342
herbal product interactions with, 872t
indole and indene derivatives as, 340-341, 340f. *See also* Indole and indene derivatives, for inflammatory conditions.
for musculoskeletal pain, 386
nabumetone as, 342
opioid analgesics combined with, 348-349, 349t, 756-757
other than aspirin, 337-343
oxicams as, 342
for pain control, 305, 754-755
peptic ulcer disease and, 529
pretreatment with, 302, 305
propionic acid derivatives as, 337-340.
See also Propionic acid derivatives.
proprietary names of, 346t
pyrazolones as, 342-343
pyrrole derivatives as, 340f, 341-342.
See also Pyrrole derivatives, for inflammatory conditions.
salicylates as, 330-337. *See also* Aspirin; Salicylates.

- Nonsteroidal anti-inflammatory drugs (NSAIDs) (*Continued*)
 selective cyclooxygenase-2 inhibitors as, 343-345. *See also* Cyclooxygenase-2-selective inhibitors.
 therapeutic use of, 330
 toxicity risk with, in elderly, 837, 837t
- Norepinephrine, 80-82. *See also* Catecholamines.
 adenosine triphosphate and, co-release of, 88-89, 88f
 antidepressant action and, 165, 173-174
 binding of, to β_2 -adrenergic receptors, 6-7, 6f
 biotransformation and excretion of, 98, 98f
 as central nervous system transmitter, 155, 156t
 for emergency use, 846t, 848-849
 endogenous
 administration of, effects of, 93-95, 94f
 cardiac effects of, 94
 in local anesthetics, tissue necrosis from, 257
 phase II metabolic reactions in, 37t
 release of, 82-83
 mechanism of, 82, 84f
 reuptake of, blocking of, 163t
 by antidepressants, 173
 structural formula of, 92f
 structure-activity relationships of, 92t
 synthesis of, 82, 84f-85f
- Norethindrone
 indications for and dose of, 570t
 structural formula of, 570f
- Norfloracin, for traveler's diarrhea, 534
- Norgestimate, structural formula of, 570f
- Norgestrel
 indications for and dose of, 570t
 structural formula of, 570f
- Normochromic anemias, 470
- Normocytic anemias, 470, 471t
- Normocytic erythrocytes, 470
- Nortriptyline, 175
 adverse effects of, 176t
- Noscapine, for cough suppression, 521
- Nosocomial infections, 579
- Notice of Claimed Investigational Exemption for a New Drug*, 64
- NSAIDs. *See* Nonsteroidal anti-inflammatory drugs (NSAIDs).
- Nuclear factor- κ B, in T-cell differentiation, 669
- Nucleated erythrocytes, description of, 471b
- Nucleic acid(s)
 receptors and, 2
 synthesis of, inhibition of, by antibiotics, 582f, 582t, 583
- Nucleus, of brain and brainstem, in anesthetic action, 271, 271f
- Nucleus caudalis, in pain perception, 300-301, 303
- Nucleus raphe magnus, SPA and, 374
- Nucleus raphe magnus (NRM), serotonin neurons in, 375
- Nutraceuticals, 869
- Nutrition
 disturbances in
 in cancer chemotherapy, 789-790
 postirradiation, 795
 iron deficiency anemia and, 470-473
- Nystatin, 642
 for candidiasis in cancer patients, 787
 mechanism of action and clinical uses of, 641t
 structural formula of, 641f
- Nystatin oral pastilles/rinses, for oral candidiasis, 646
- O**
- O-benzyl-p-chlorophenol, with o-phenylphenol as disinfectant, 747-748
- O-phenylphenol, with o-benzyl-p-chlorophenol as disinfectant, 747-748
- Obesity, centripetal, 550-551
- Obsessive-compulsive behavior, SSRIs for, 383
- Occupation theory
 in dose-response relationships, 9f
 limitations of, 10-11
- Occupational safety, in dentistry, 820
- Occupational Safety and Health
 Administration, regulations of
 on hazardous materials, 820
 on mercury exposure, 821-822
- Ocular effects. *See also* Eye(s).
 of antimuscarinic drugs, 131-132
 of β blockers, 112
 of cholinergic drugs, 119
 of decongestants, 100
 of ganglionic blocking drugs, 139
 of glucocorticoid therapy, 554
 of nitrous oxide, 283
- Odontalgia, atypical
 diagnostic criteria for, 387b
 treatment of, 389
- Ofloxacin, for traveler's diarrhea, 534
- Olanzapine
 antipsychotic effects of, 168
 autonomic effects of, 170
 for mania, 185
 metabolism of, 172t
 relative potency of receptor antagonist affinities in, 166t
 side effects of, 171t
 structure-activity relationships of, 167
 structure of, 167f
- Olfactory cortex, nuclei of, in anesthetic action, 271, 271f
- Oligodendroglia, 153
- Omalizumab, for asthma, 518-519
- Omega-3 polyunsaturated fatty acids, in fish oil, for hyperlipidemia, 466
- Omeprazole, as proton pump inhibitors, 525-526
- Oncogenes, in chemical carcinogenesis, 58
- Ondansetron, as antiemetic, 531-532
- Ophthalmic agents
 adrenergic agonists as, 100
 botulinum toxin as, 146
 names of, 103b-104b
- Opioid(s)
 actions of, in CNS, 150t
 for deep sedation, with benzodiazepines, 767-768
 in dentistry, 321
 for diarrhea, 534
 herbal product interactions with, 872t
 for intravenous anesthesia, 292-294, 293t
 for intravenous sedation, 766-767
 for oral sedation, 766
 for premedication in anesthesia, 295-296, 295t
 sites and mechanisms of action of, 150t
- Opioid agonists. *See also* Morphine.
 central effects of, 303-304
 for pain, 320-321
 sites and mechanisms of action of, 310-311
- Opioid agonists-antagonists
 for anesthesia and sedation, 294
 mixed, 318-320
 for pain control, 320-321
 names of, 321b-322b
- Opioid analgesics, 307-318. *See also* Opioid(s).
 abuse of, 801-803
 characteristics of, 801-802
 action of
 physiologic functions and, 310
 sites and mechanism of, 310-311
 addiction to, 756, 802
 withdrawal from, clonidine and, 96-97
 adverse gastrointestinal reaction to, 535
 codeine as, 315-316
 combined with nonopioid analgesics, 348-349, 349t
 comparison of, 315t
 for cough suppression, 521
 in dentistry, side effects of, 350
 dependence on, 314, 315t, 801
- Opioid analgesics (*Continued*)
 dihydrocodeine as, 316
 fear of, 314, 321
 fentanyl as, 317-318
 historical background of, 307
 hydrocodone as, 316
 mechanism of action of, 307-311
 meperidine as, 316-317
 morphine as, 311-315. *See also* Morphine.
 names of, 321b-322b
 nonopioid analgesics vs., 754
 oral administration of, 756
 for oral mucositis, 785
 oxycodone as, 316
 for pain control, 755-757
 pharmacologic effects of, 801
 propoxyphene as, 317
 reversal agents for, 768
 for severe chronic pain, 757
 tolerance to, 801
 toxicity of, 313, 802-803
 in elderly, 837t
- Opioid antagonists, names of, 321b-322b
- Opioid peptides, endogenous
 for analgesia, 302
 central effects of opioids and, 303-304
 derivation and function of, 307-308, 308f
 physiologic functions of, 310
- Opioid receptor antagonists, 318-320
 nalmeferone as, 319
 naloxone as, 319, 319f
 naltrexone as, 319
- Opioid receptor(s), 308-309
 characterization of, 309t
 G protein coupled to, 308
 genetic polymorphisms in, 70
 opioid drug action and, 303-304
 role in blocking nociceptive impulses, 302
 sites and mechanisms of action of, 303-304, 310-311
- Opium, as drug of abuse, history of, 799
- Oprelvekin
 for cancer, 686t-692t, 703
 therapeutic use of, 483
- Oral antihyperglycemic agents, 561-564
 analogue of amylin as, 564
 biguanides as, 563
 incretin-related drugs as, 563-564
 meglitinides as, 562-563
 sulfonylureas as, 561-562. *See also* Sulfonylureas.
 thiazolidinediones as, 563
- Oral cavity
 drug absorption in, 733
 drug clearance from, 733
 drug distribution in, 733
 drug metabolism of, 733
 pharmacokinetics of, 733-734, 734f
- Oral complications
 of cancer chemotherapy, 782-798, 783b
 of cancer radiation therapy, 790-795, 792b
 late, 793-795
 postirradiation, acute, 791-793, 792b
- Oral contraceptives, 571-572
 adverse effects of, 573-574
 antibiotics and, 574, 594
 vitamin K absorption and, 504
- Oral hairy leukoplakia, 656-657
- EBV-related, in immunosuppressed patients, 787-788
- Oral hemorrhage, in cancer patients, 789
- Oral hygiene
 bacterial endocarditis and, 775
 products for, herbal ingredients in, 874t
- Oral infection(s). *See also* Orofacial infections.
 antibiotics for, 610t-611t
 hematopoietic cell transplantation and, 790, 791t
 in immunosuppressed patients, 786-789
 postirradiation, 792
- Oral ingestion, of drugs, 21-24, 21f
- Oral mucosal lesions, antiviral therapy for, 656-657
- Oral mucositis. *See also* Mucositis, oral.
- Oral osteomyelitis, pathogens causing, 602

- Oral sedation
 advantages of, 764
 clinical application of, 764-765
 disadvantages of, 764
 drugs for, 763t, 765-766
 doses of, 763t
 inhalation and intravenous sedation
 compared with, 763t
- Oral ulcerations, glucocorticoids for, 553
Orange Book, 854
- Organ transplants, antibiotic prophylaxis for
 dental patients with, 778
- Organic solvents
 structural formula of, 826f
 toxic effects of, 826
- Organochlorine insecticides
 structural formula of, 828f
 toxicity of, 827-828
- Organophosphate insecticides
 absorption and metabolism of, 123
 adverse effects of, 123, 124b
 treatment of, 124
 historical background of, 121
 neuromuscular blocking drug action and,
 144
 structural formula of, 827f
 toxicity of, 827-828
- ORL-1 receptor, 308
- Orofacial infections, 600-604. *See also* Oral
 infection(s).
 acute necrotizing ulcerative gingivitis as,
 602
 cervicofacial actinomycosis as, 603
 culture and sensitivity testing for, 589
 deep neck space, 603
 Ludwig's angina and, 603
 mediastinal, 603
 necrotizing fasciitis as, 603
 oral microbial pathogens causing, 600-603,
 601t
 microbial resistance in, 603-604
 osteomyelitis as, 602
 pericoronitis as, 602
 periimplantitis as, 602
 periodontal abscess as, 601-602
 pulpal and periapical pathogens causing,
 601, 602b
- Orofacial motor impairment, in Parkinson's
 disease, in dental practice, 242
- Orofacial pain
 neuropathic, drugs for, names of, 391t
 pathways of, 299-301
- Orofacial pain syndromes
 drugs for, 373-391
 implications of, for dentistry, 391
 migraine as. *See also* Migraine.
 neuropathic
 diagnostic criteria for, 387b
 topical agents for, 389-390
 treatment of, 386-390
 sympathetically independent, diagnostic
 criteria for, 387b
 sympathetically maintained, treatment of,
 389
 sympathetically mediated, diagnostic criteria
 for, 387b
- Orosomucoid, 29
- Orphan Drug laws, 65, 863
- Orphanin FQ, 308
- Orphenadrine, structural formula of, 204f
- Orthostatic hypotension
 antihypertensive drug use and, 456
 antipsychotic drug action and, 170,
 171t
 herbal product use and, 873
 levodopa-induced, in dental practice,
 242
- Oseltamivir, for influenza, 647-649, 648t
- Osmotic cathartics, 532-533, 532f
 for irritable bowel syndrome, 535
- Osmotic diuretics, 438. *See also* Diuretic(s),
 osmotic.
- Osteoarthritis, meloxicam for, 342
- Osteomalacia, phenytoin and, 218
- Osteomyelitis, oral, pathogens causing,
 602
- Osteonecrosis
 glucocorticoid therapy and, 554
 of jaws, bisphosphonate therapy and, 786,
 786f
 postradiation, 795
- Osteoporosis
 estrogen deficiency and, 576
 glucocorticoid therapy and, 554
 postmenopausal, prevention of, estrogens
 for, 572, 573t
- Osteoradionecrosis, 795
- Osteosarcoma, fluoridated water supplies and,
 722-723
- OTC drugs, 851
- Ototoxicity
 of aminoglycosides, 629-630
 of loop diuretics, 437-438
 of macrolides, 620
- Ovarian hormones, as antidepressants, 181
- Overpressurization, in anesthesia, 274
- Oxacillin, 605-607, 606t-607t
- Oxaliplatin, for cancer, 686t-692t, 700
- Oxandrolone
 indications for and dose of, 569t
 structural formula of, 568f
- Oxapropin
 characteristics of, 339
 structural formula of, 338f
- Oxazolidinones, 631
- Oxazepam
 absorption, metabolism, and excretion of,
 192-193, 193t
 abuse of, 803
 for anxiety, dose and administration of, 197t
 in dentistry, 208
 structural formula of, 190t
- Oxazolinediones, mechanisms of action and
 therapeutic uses of, 216t
- Oxcarbazepine
 adverse reactions to, 219t
 mechanisms of action and therapeutic uses
 of, 216t
 structural formula of, 217f
 for trigeminal neuralgia, 388
- Oxicams
 for inflammatory conditions, 342
 structural formulas of, 340f
- Oxiconazole, for fungal infections, 644
- Oxidation
 genetic polymorphisms in, 72-73
 microsomal
 competitive inhibition of, 38
 in drug metabolism, 31-33, 34f, 35t-36t
 intermediary substances in, toxicity of,
 39
 nonmicrosomal
 in drug metabolism, 34
 of drugs, 35t-36t
- Oxidizing agents, antimicrobial activity of,
 745t
- Oxidizing compounds
 as antiseptics, 748
 names of, 749b
- Oxybarbiturates, 199, 199t
- Oxycodone
 abuse of, recent trends in, 800
 in combination analgesics, 350
 dose, duration, and administration of, 315t
 structure and effects of, 316
- Oxygen
 for emergency use, 844, 844t
 in inhalation sedation administration,
 763-764
 inspired concentrations of, with different
 delivery systems, 845b
 myocardial demand for, angina pectoris and,
 422, 423f
- Oxygenating agents, in plaque prevention/
 control, 738
 in oral products, agents and proprietary
 names of, 739t
- Oxymetazoline
 for nasal decongestion, 522
 pharmacologic effects of, 97
- Oxymorphone, dose, duration, and
 administration of, 315t
- Oxypurinol, for gout, 353-354
- Oxytetracycline, 624. *See also* Tetracycline(s).
- Oxytocin, 538
- Ozone, toxic effects of, 825
- P**
- p53 gene, 58
- P-glycoprotein
 active transport of drugs and, 19-20, 20f
 in biliary and renal excretion, 40
 drug absorption delayed by, 23
 in drug metabolism, 38-39
 placental transfer and, 27-28
- P-selectin, hemostatic, functions of, 490
- Paclitaxel
 for cancer, 686t-692t, 700
 structural formula of, 701f
- PAF (platelet-activating factor),
 in inflammatory process, 329
- Pain
 in acute intermittent porphyria, 474
 analgesics for, 752-758. *See also*
 Analgesics.
 anxiety and, 752, 759
 aspirin for. *See also* Aspirin.
 assessment of, 752-753, 753f
 characteristics of, 752
 chronic
 anticonvulsant therapy for, 226-227
 drugs for, 382-385
 mechanisms of, 389b
 management of, 299
 pharmacology and, 373
 tricyclic antidepressants for, 181, 383
 classification of, 752
 control of
 antinociceptive drugs for, 305
 drug abuse and, 811-812
 opioid agonists and mixed agonists-
 antagonists in, 320-321
- dental
 analgesics for
 acetaminophen for, 347
 nonopioid, 346t
 opioid, 321
 management of, 305
 prevention of, 304-305
- epigastric, erythromycin use and, 620
- facial. *See also* Orofacial pain; Orofacial pain
 syndromes.
 atypical, antidepressant use and, 183
 hydroxytryptamine and, 374
 inflammatory, 302
- intensity of
 anticipated, in analgesic selection, 754
 scales for, 752-753, 753f
- migraine
 acute treatment of, 379-382
 prophylactic treatment of, 382-385
 names of, 391t
 misconceptions about, 753
 musculoskeletal, drugs for, 385-386
- neuropathic
 characteristics of, 752
 drugs for, 386-390
 names of, 391t
- nociceptive, characteristics of, 752
- opioid drugs for. *See* Opioid analgesics;
 Opioid(s).
- orofacial. *See* Orofacial pain.
- patient response to, history of, in analgesic
 selection, 754
- perception of, 299
 neurotransmitter signaling in, 303
 nociceptors active in, 302
- processing of
 brainstem modulation of, 300-301
 central mechanisms in, 303-304
 descending pathways of, 310, 311f
 endogenous opioid peptides and, 310
 molecular-genetic influences on, 304
 opioid sites and mechanisms of action
 and, 308-309, 311f
 transduction and peripheral transmission
 of, 299-300, 300f
 prostaglandin action and, 332

- Pain (*Continued*)
 response to, motivational-affective component of, 310
 morphine analgesia and, 312
 salicylates for, 332, 332f
 undertreatment of, 752
- Paint thinner abuse, 810
- Palifermin, for cancer, 686t-692t, 703-704
- Paliperidone, antipsychotic effects of, 168
- Palivizumab
 proprietary names of and indications for, 675t
 for RSV infections, 653
- Pamidronate, 544. *See also* Bisphosphonates.
- Pancreas
 endocrine, 558-559
 insulin regulation by, 558
- Pancreatitis, macrolide use and, 620
- Pancuronium
 action and structural formula of, 140, 141f
 adverse effects of, 144
 pharmacologic properties of, 142t
- Pancytopenia, in hematopoietic insufficiency, 480
- Panitumumab, for cancer, 705t, 708
- Pantoprazole, as proton pump inhibitors, 525-526
- Paracellular transport, drug transport by, 19
- Parachlorometaxylenol (PCMX), as antiseptic, 747
- Paralytic ileus, cholinergic drugs for, 126-127
- Paraoxon
 structural formula of, 827f
 toxicity of, 827-828
- Paraquat
 in neuropathology of Parkinson's disease, 231
 structural formula of, 829f
 toxicity of, 829-830
- Parasympathetic nervous system, 78-79, 80f, 81t
 neurotransmitters of, 80-82
 transmission in, ganglionic blocking drug action and, 136, 139t
- Parasympathomimetic agonists, 117
- Parasympathomimetic responses, to cholinergic drugs, 118
- Parathion
 structural formula of, 122f, 827f
 toxicity of, 827-828
- Parathyroid hormone, 543
 effects of, 544t
- Parecoxib
 for inflammatory conditions, 345
 structural formula of, 343f
- Parenteral injection, 24-25
- Paresthesias, in vitamin B₁₂ deficiency, 477
- Pargyline, 114
- Parkinson's disease
 brain function changes in, 231-232
 classification of, 230
 in dental practice, 242-243
 drug therapy for, 230-245, 236t
 anticholinergic drugs for, 133
 dentistry and, 242-243
 dopamine replacement in, 234-235
 names of, 243b
 inheritance of, 231t
 neurobiology of, 230-234
 neuroprotective strategies for, 232-234
 pathophysiology of, 230-234
 progression of, 230
 rating scale for, 233-234
 surgical therapy for, 241
 symptoms and signs of, 230
 tomographic imaging in, 233, 234t
- Paroxetine
 adverse effects of, 176t
 structural formula of, 179f
- Partial estrogen receptor agonists, 574-575
 chemical structures of, 575f
- Partial thromboplastin time (PTT), in heparin activity monitoring, 502
- Partition coefficient
 in general anesthesia, 273, 273f
 of inhalation anesthetics, 275t
- Passive diffusion, passage of drugs across membranes by, 17-19
- Passive immunization, 673
 agents use for, names of, 681b
- Pathogens. *See* Microorganisms.
- Pathology, drug metabolism and, 39
- Patient compliance/noncompliance
 drug effects and, 54
 in elderly, medication errors and, 837
 prescriptions and, 858
- Patient position, adrenergic blocking drug use and, 115
- PBPs (penicillin-sensitive enzymes), 607-608
- PCMX (parachlorometaxylenol), as antiseptic, 747
- PCP
 abuse of, 808
 structural formula of, 808f
- Pegaspargase, for cancer, 699
- Pegfilgrastim, 482
 therapeutic use of, 483
- Pegylated megakaryocyte growth and development factor, 482
- Pemetrexed disodium, for cancer, 686t-692t, 694-695
- Penciclovir
 for herpes viral infections, 652
 for viral infections, 648t
- Penicillamine
 for heavy metal poisoning, 823-824, 824t
 immunosuppressive action of, 678
 for lead poisoning, 823
 for mercury poisoning, 824
 for rheumatoid arthritis, 351
 structural formula of, 824f
 for Wilson's disease, 242
- Penicillin(s), 605-614
 absorption, fate, and excretion of, 608-609
 allergic reactions to, 612
 antigenic determinants of, 612, 613f
 antibacterial spectrum of, 607-608
 bacterial resistance to, 608
 biosynthesis and hydrolysis of, 605, 605f
 chemistry and classification of, 605-607, 606t-607t
 contraindications to, 613-614
 cross-allergy of, with cephalosporins, 617
 diseases responsive to, 608b
 dosage of, 614, 614t
 drug interactions with, 613
 extended-spectrum, 606t-607t, 607
 plus β -lactamase inhibitors, 606t-607t
 herbal product interactions with, 872t
 for infective endocarditis prophylaxis, risk/benefit ratio for, 775
 isolation of, 580
 β -lactamase resistant, 606t-607t
 mechanisms of action of, 607-608
 microorganisms sensitive to, 608, 608b, 610t-611t
 nonallergic reactions to, 613
 for oral infections, 610t-611t
 pharmacokinetics of, 609t
 in plaque prevention/control, 738
 prophylactic, allergic reactions to, 775
 structure and characteristics of, 606t-607t
 uses of, in dentistry, 610
- Penicillin-binding proteins (PBPs), 581
- Penicillin derivatives. *See* Penicillin(s).
- Penicillin G, 606t-607t, 608
 in dentistry, 610
 diseases responsive to, 608b
 microorganisms sensitive to, 608b
 pharmacokinetics of, 609t
 in renal failure, dosage adjustments needed in, 51t
- Penicillin-sensitive enzymes, 581, 607-608
- Penicillin V, 605-608, 606t-607t
 in dentistry, 610
 diseases responsive to, 608b
 microorganisms sensitive to, 608b
 pharmacokinetics of, 608, 609t
 recommended dosages of, 614t
- Penile implants, antibiotic prophylaxis for dental patients with, 777
- Pentagastrin, therapeutic uses of, 362
- Pentazocine
 in combination analgesics, 350
 dose, duration, and administration of, 315t
 for intravenous anesthesia or sedation, 293t, 294
 for intravenous sedation, 767
 pharmacologic effects of, 319
 structural formula of, 319f
- Pentobarbital
 abuse of, 803
 duration of action of, 200t
 for intravenous sedation, 766
 in renal failure, dosage adjustments needed in, 51t
 for seizures in sedative-hypnotic withdrawal, 804
 structural formula of, 199t
- Pentostatin, for cancer, 686t-692t, 695
- Peptic ulcer disease (PUD), 525
 glucocorticoid therapy and, 554
 treatment of, drugs used for, 525-530
- Peptic ulcer(s)
 H₂ antihistamines for, 369-370
 salicylate therapy and, 335
- Peptide antibiotics, 597
- Peptide hormones, 576
- Peptide transmission, and co-release of neurotransmitters, 88-89
- Peptides
 cationic antimicrobial, 597
 opioid, endogenous
 for analgesia, 302
 central effects of opioids and, 303-304
 derivation and function of, 307-308, 308f
- Peptidyl dipeptidase, 445
- Perchlorate, for hyperthyroidism, 542
- Perchloroethylene
 structural formula of, 826f
 toxicity of, 826
- Perflubron, names of, 485t
- Pergolide
 for Parkinson's disease, 236t, 239
 structural formula of, 237f
 for Tourette's syndrome, 241-242
- Periaqueductal gray, pain perception and, 374
- Pericoronitis, pathogens causing, 602
- Periimplantitis, pathogens causing, 602
- Periochip, for local oral drug delivery, 739
- Periodicals, drug information in, 66-67
- Periodontal abscesses, 601-602
- Periodontal disease
 in cancer chemotherapy patients, 788-789
 dental plaque and, 732
 in drug-abusing patients, 811
- Periodontitis, tetracycline for, 625
- Periodontium
 sex steroid hormones and, 576
 structure of, 732, 733f
- Peripheral nervous system
 antimuscarinic drug effects on, 131-132
 local anesthetic action and, 253
- Peripheral vasculature, local anesthetic action and, 254-255
- Permethrin
 structural formula of, 828f
 toxicity of, 828
- Pernicious anemia, 479
 vitamin B₁₂ deficiency and, 477
- Perphenazine, side effects of, 171t
- Pesticides
 for control of predatory animals, 830
 government regulations for, 827
 toxic effects of, 827-830
- Peyer's patches, 672
- pH
 in drug absorption, 21-24, 21f
 in drug distribution, 26-27
 of local anesthetics, 246-248
 membrane penetration by drugs and, 17
 urinary, in renal drug excretion, 40
- Pharmacokinetics, genetic differences in, 70
- Pharmacies
 Internet, 857
 mail order, 857
- Pharmacodynamic differences, in drug effects, 48

- Pharmacodynamic sensitization, 53
 Pharmacodynamic tolerance, 13
 Pharmacodynamics, 2-16
 drug responsiveness and, 69
 in elderly, 839
 genetic differences in, 70, 71f
 Pharmacogenetics, 69-76, 816
 definition of, 69
 of drug metabolism, 72-73
 ethnic differences in, 72
 implications of, for dentistry, 74
 Pharmacogenomics, 69-76, 816
 definition of, 69
 implications of, for dentistry, 74
 Pharmacokinetic differences, in drug effects, 48
 Pharmacokinetic tolerance, 38-39
 Pharmacokinetics, 17-47
 of absorption and elimination, 41
 absorption in, 21-26. *See also* Drug(s),
 absorption of.
 distribution in, 26-31. *See also* Drug
 distribution.
 in elderly, 838-839
 excretion in, 39-41. *See also* Drug(s),
 excretion of.
 metabolism in, 31-39. *See also* Drug
 metabolism.
 of oral cavity, 733-734, 734f
 passage of drugs across membranes in, 17-21
 pharmacodynamic modeling with, 46
 time course of drug action in, 41-44
 Pharmacology, geriatric, 834-841. *See also*
 Elderly patients.
 Pharmacotherapeutics, 48-68
 Pharmacotherapy, for sickle cell anemia, 476
 Phasic block, by local anesthetics, 250
 Phenacetin
 phase I reactions in, 35t-36t
 structural formula of, 346f
 Phencyclidine
 abuse of, 808
 psychosis induced by, 163-164
 structural formula of, 808f
 Phendimetrazine, structural formula of, 804f
 Phenelzine
 adverse effects of, 176t
 side effects of, 56t
 Phenformin, for diabetes, 563. *See also*
 Biguanides, for diabetes.
 Phenindamine tartrate, structural formula and
 dosages of, 363t-364t
 Phenobarbital
 abuse of, 803
 adverse reactions to, 219t
 as anticonvulsant, 218
 dicumarol and, 38-39
 duration of action of, 200t
 induction of, in metabolism, 38
 introduction of, 214
 mechanisms of action and therapeutic uses
 of, 216t
 for muscle relaxation, doses of, 205t
 in renal failure, dosage adjustments needed
 in, 51t
 for sedative-hypnotic abuse, 804
 side effects of, 56t
 Phenolic compounds
 for plaque prevention/control, 737
 in plaque prevention/control, in oral
 products, agents and proprietary names
 of, 739t
 Phenolphthalein, as laxative, 532
 Phenols
 antimicrobial activity of, 745t
 as disinfectants and antiseptics, 746-748
 names of, 749b
 Phenothiazines
 as antiemetics, 531
 autonomic effects of, 170
 in dental practice, 173, 242-243
 derivatives of, for migraine, 381-382
 dosages of, 363t-364t
 pharmacologic effects of, 168
 side effects of, 171t
 structural formula of, 165f, 363t-364t
 structure and activity relationships of, 166
 Phenotype(s)
 determination of, 70-71
 monogenic versus polygenic, 71-72
 Phenoxybenzamine, 108-109
 adverse effects of, 109
 uses of, 109
 Phensuximide
 as anticonvulsant, 221
 mechanisms of action and therapeutic uses
 of, 216t
 Phentolamine, 106, 108
 for orofacial pain syndromes, 389
 Phenylalanine, biosynthesis of, 84f
 Phenylbutazone
 for analgesia, 342-343
 COX inhibitory activity of, vs.
 acetaminophen, 332t
 Phenylephrine
 for emergency use, 848-849
 in local anesthetic formulations, 255
 for nasal decongestion, 522
 pharmacologic effect of, 96
 structure-activity relationships of, 92t
 Phenytoin
 absorption, fate, and excretion of, 218
 adverse effects of, 218, 219f, 219t
 for arrhythmias, 402
 gingival hyperplasia from, 218, 219f, 227,
 535
 mechanisms of action and therapeutic uses
 of, 216t
 neuromuscular blocking drug action with,
 145t
 pharmacologic effects of, 217-218
 for seizures, 217, 219t
 side effects of, 56t
 useful, 56t
 structural formula of, 217f
 for trigeminal neuralgia, 388
 variation in effects of and response to, 48, 49f
 Pheochromocytoma, β blockers for, 113
 Phobia, definition of, 759
 Phocomelia, 59
 Phosphate, parathyroid hormone secretion and,
 543
 Phospholipase A
 histamine action and, 361
 histamine release triggered by, 360
 Phospholipase A₂, in prostaglandin synthesis,
 302
 Phospholipase C, activation of, by serotonin
 receptors, 377-378
 Photoallergy, antibiotic-induced, 595
 Photodisinfection, in plaque prevention/
 control, 738
 Photosensitivity
 antibiotic-induced, 595
 in porphyria cutanea tarda, 475
 Phototoxicity, antibiotic-induced, 595
 Phthalazinones, structural formulas and
 dosages of, 363t-364t
 Physical dependence, definition of, 314
 Physically active agents, 15-16
 Physicians' Desk Reference (PDR), 66
 Physostigmine
 absorption of, 123
 for atropine poisoning, 126, 134
 historical background of, 121
 structural formula of, 121f
 Phytonadione, structural formula of, 503f
 Pilocarpine
 absorption of, 120
 adverse reactions to, 120
 for glaucoma treatment, 125, 125t
 for salivary gland stimulation, 793
 structure of, 117, 118f
 for xerostomia, 125-126
 Pimozide
 metabolism of, 172t
 pharmacologic effects of, 168
 side effects of, 171t
 structure and activity relationships of, 167
 Pindolol. *See also* Adrenergic receptor
 antagonists, β .
 pharmacologic effects of, 109, 110t
 structural formula of, 111f, 449f
 Pioglitazone
 for diabetes, 563. *See also*
 Thiazolidinediones.
 structural formula of, 563f
 Piperacillin, 606t-607t, 607
 adverse reactions to, 613
 plus tazobactam, 606t-607t, 609
 Piperazines
 side effects of, 171t
 structural formula and dosages of, 363t-364t
 Piperidines
 side effects of, 171t
 structural formulas and dosages of,
 363t-364t
 Pirbuterol, pharmacologic effects of, 97
 Pirenzepine
 antimuscarinic action of, 130
 for peptic ulcer disease, 529
 Piroxicam
 for inflammatory conditions, 342
 structural formula of, 340f
 Pituitary-adrenal function, glucocorticoid
 therapy and, 554
 Pituitary drugs, names of, 546b-547b
 Pituitary hormones, 538
 anterior, 538-540, 539t
 release of, dopamine and, 95-96
 posterior, 538
 Placebo effects, 53-54
 Placental transfer, of drugs, 27-28
 Plaque
 atheromatous, 458
 dental. *See also* Biofilm, dental.
 agents active against, 732-743. *See also*
 Antiplatelet/antigingivitis agents.
 in cancer chemotherapy, 788
 gingivitis and, 732
 Plasma cholinesterase, genetic polymorphisms
 in, 73
 Plasma concentration
 in pharmacokinetics, 46
 in repeated doses, 43-44, 44f
 in single doses, 43, 43f
 Plasma extenders
 names of, 485t
 synthetic, 484
 Plasma mediators, of inflammation, 325t,
 329-330
 Plasma membrane
 anesthetic action and, 269-270
 structure of, 17, 18f
 Plasma protein binding
 antibiotic dosage and, 592
 drug metabolism and, 37-38
 drug storage and, 29
 in renal drug excretion, 40
 volume of distribution and, 28
 Plasma proteins
 anesthetic action and, 269-270
 drug binding and, 29
 Plasmids, in antibiotic resistance, 585
 Plasmin, in fibrinolysis, 498-499, 499f
 Plasminogen activator inhibitor-1, in
 fibrinolysis, 488, 488f, 499-500, 499f
 Plasminogen activator inhibitor-2, in
 fibrinolysis, 488-489, 499-500, 499f
 Platelet-activating factor (PAF), in
 inflammatory process, 329
 Platelet factor 4, heparin activity and, 501-502
 Platelets
 activation of, 487-489, 488f
 adhesion of, 487, 488f
 aggregation of, 488f, 489-490
 aspirin prophylaxis against, 333-334,
 334t
 heparin-induced, 501
 α and δ granules of, 490-492
 in clot retraction, 490
 disorders of, bleeding with, 495
 inhibitors of, 505-506
 names of, 509t
 Platinum complexes, for cancer, 686t-692t,
 699-700
 Pleuromutlins, topical, development of, 634
 Pleuronic lecithin organogel, for topical agents,
 389

- Plicamycin, for cancer, 686t-692t
- Plumbism, 822
- Pluripotent stem cells, in immune system, 469, 660, 661f
- Podophyllotoxins, for cancer, 700
- Poikilocytosis, description of, 471b
- Poisoning. *See also* Toxic effects; Toxicity.
 - arsenic, chelator treatment for, 824t
 - atropine, 126, 134
 - cadmium, chelator treatment for, 824t
 - copper, chelator treatment for, 824t
 - cyanide, 830, 830f
 - drug, 59
 - first aid for, 819b
 - fluoride, 728-729
 - Inocybe lateraria* mushroom, 120-121, 133
 - iron, 473, 823
 - chelator treatment for, 824t
 - lead, 822-823
 - mercury, treatment of, 824
 - methanol, 718
 - mushroom, 120-121, 133
 - prevention and management of, 819-820
 - therapy for, 819-820
- Polychromasia, description of, 471b
- Polyclonal antibody preparations, in immunotherapy, 673
- Polycythemia vera, 469
- Polydrug abuse, 810
- Polyene antifungal drugs, 640-642
- Polyethylene glycol (PEG), as laxative, 533
- Polygenic hypercholesterolemia, characteristics of, 461t
- Polygenic phenotypes, monogenic phenotypes versus, 71-72
- Polyhemoglobin products, 483-484
- Polymixin B
 - mechanism of action of, 581
 - topical, 634
- Polymorphism(s)
 - acetylation, 72
 - definition of, 71-72
 - dihydropyrimidine dehydrogenase, 73
 - drug transporter, 73
 - oxidation, 72-73
 - plasma cholinesterase, 73
 - thiopurine S-methyltransferase, 73
 - uridine diphosphate glucuronosyltransferase, 73
- Polypharmacy, in elderly, adverse reactiuis abd, 837
- Polyps, nasal, aspirin intolerance and, 336
- Polythiazide, pharmacokinetic data on, 434t
- Polyuria
 - in diabetes insipidus, thiazide diuretics for, 435
 - lithium use and, 184
- Pons, serotonin concentrations in, 375
- Porfimer, for cancer, 686t-692t
- Porphyria, 474-475
 - acute intermittent, 474
 - management of, 475
 - safe and unsafe drugs in, 474-475, 475b
 - classification of, 474, 474t
 - variegate, safe and unsafe drugs in, 474-475, 475b
- Porphyria cutanea tarda, 475
- Porphyrin synthesis, barbiturates and, 201
- Posaconazole
 - for fungal infections, 644
 - structural formula of, 643f
- Posology, 859-861
- Postoperative sequelae, glucocorticoids for, 553
- Potassium, plasma, digitalis therapy and, 419
- Potassium channels
 - blockade of, local anesthetic selectivity and, 253
 - closure of, by serotonin receptors, 377-378
 - opening of, by serotonin receptors, 376
- Potassium conduction
 - in cardiac electrophysiology, 393-394, 395f
 - defects in, arrhythmias from, 396
 - in opioid analgesia, 311
- Potassium iodide, as expectorant, 522
- Potassium-sparing diuretics, 431-433. *See also* Diuretic(s), potassium-sparing.
- Pralidoxime
 - for organophosphate poisoning, 124
 - structural formula of, 124f
- Prampixole
 - for Parkinson's disease, 236t, 239-240
 - structural formula of, 240f
- Pramlintide, for diabetes, 564
- Prasugrel, for platelet inhibition, 506
- Pravastatin
 - for hyperlipidemia, 464-465
 - structural formula of, 465f
- Prazepam
 - absorption, metabolism, and excretion of, 192-193, 193t
 - for anxiety, dose and administration of, 197t
 - metabolism of, 193f
 - structural formula of, 190t
- Prazosin, 107-108
 - absorption, fate, and excretion of, 107
 - adverse effects of, 107-108, 450
 - for hypertension, 449-450
 - structural formula of, 107f, 449f
 - therapeutic uses of, 107
- Predicides, toxicity of, 830
- Prednisolone
 - for cancer, 686t-692t
 - dose, administration, and preparations of, 556t
 - potency of, 550t
 - side effects of, 56t
 - structural formula of, 555f
- Prednisone
 - for cancer, 686t-692t, 703
 - dose, administration, and preparations of, 556t
 - for herpes zoster infection, 385
 - in renal failure, dosage adjustments needed in, 51t
- Pregabalin
 - mechanism of action and therapeutic uses of, 216t
 - for seizures, 224
 - for trigeminal neuralgia, 388
- Pregnancy
 - antibiotic dosing and, 592
 - anticonvulsant use in, 218
 - aspirin use in, 336
 - benzodiazepine use in, 194-195
 - doxylamine in, 367
 - drug effects and, 50
 - drug teratogenicity and, 59, 60t, 218
 - FDA risk categories of, 60t
 - gingival disease in, 576
 - lithium salts teratogenicity and, 184
 - local anesthetic use in, 258
 - sedative-hypnotics in, 198
- Pregnane, 569-570
 - structural formula of, 550f
 - structure of, 568f
- Pregnane X receptor, 38
- Preinfarction angina, 422
- Prekallikrein, 329
- Premedication, drugs used for, 133, 295-296, 295t
- Prescription(s), 851-862
 - component parts of, 855-857
 - dental, federal laws regulating, 853t
 - drug dosage calculations for, 859-861
 - format and pad forms for, 858-859, 859f-860f
 - Internet, 857
 - linked database prescribing system and, 855, 855f
 - patient compliance and, 858
 - single-entity vs. combination, 852-854
 - sources of drug information for, 855
 - writing of, 851-866
 - errors in, 851
 - steps in, 851, 852f
- Prescription Drug User Fee Act, 863
- Priestley, Joseph, 266
- Prilocaine
 - activity of, physicochemical correlates of, 247t
 - for dental anesthesia, 260
 - parenteral application of, preparations and dosages of, 261
 - side effects of, 56t
 - structural formula of, 247f
 - surface application of, preparations and dosages of, 262
- Primidone
 - as anticonvulsant, 218
 - mechanisms of action and therapeutic uses of, 216t
- Proadifen, drug metabolism inhibition and, 38
- Probenecid
 - for gout, 353
 - structural formula of, 353f
 - in renal drug excretion, 40
 - side effects of, useful, 56t
- Probulcol, properties of, 463t
- Procaainamide
 - absorption, fate, and excretion of, 401
 - actions of, 400t
 - adverse effects of, 408t
 - for arrhythmias, 401-402
 - drug interactions with, 407
 - for emergency use, 846t-848t
 - indications for, 407t
 - pharmacokinetic properties of, 401t
 - pharmacologic effects of, 401
 - structural formula of, 401f
- Procaine
 - activity of, physicochemical correlates of, 247t
 - structural formula of, 247f
- Procaine penicillin G, 606t-607t
 - pharmacokinetics of, 608-609
 - plus benzathine penicillin G, 606t-607t
- Procarbazine
 - for cancer, 686t-692t, 701
 - drug interactions with, 709
- Prochlorperazine
 - as antiemetic, 531
 - for migraine, 381-382
 - side effects of, 171t
 - structure-activity relationships of, 166
- Procoagulant agents
 - for bleeding disorders, 493-498, 496t
 - topical, names of, 509t
- Procyclidine, for Parkinson's disease, 236t
- Prodynorphin, 307-308
- Proenkephalin, 307
- Progabide, for seizures, 224
- Progesterone
 - as antidepressant, 181
 - structural formula of, 570f
- Progestins
 - administration of, 570
 - adverse effects of, 573
 - antagonists of, 575t, 576
 - for cancer, 686t-692t
 - drug interactions with, 574
 - indications for and dosages of, 570t
 - names of, 570t, 577b
 - in oral contraceptives, 571t, 572-573
 - structural formulas of, 570f
 - structure and functions of, 569-570
 - therapeutic uses of, 572-573
- Proinsulin, structure of, 558, 559f
- Prolactin, 539, 539t
 - release of, drugs prohibiting, names of, 546b-547b
- Prolonged QT syndrome. *See* Long QT interval syndrome.
- Promethazine, 202
 - as antiemetic, 531
 - for migraine, 381-382
 - for oral sedation, 765-766
 - for premedication in anesthesia, 295t
 - for sedation, 294
 - structural formula and dosages of, 363t-364t
- Promoters, in chemical carcinogenesis, 58

- Propafenone
absorption, fate, and excretion of, 403
actions of, 400t
adverse effects of, 403-404
for arrhythmias, 403-404
drug interactions with, 407
indications for, 407t
pharmacokinetic properties of, 401t
pharmacologic effects of, 403
structural formula of, 403f
- Propanediol and glycerol derivatives, 194
- Propranolol
absorption, fate, and excretion of, 404
actions of, 400t
adverse effects of, 109-111, 404, 408t
for anxiety, 206
for emergency use, 848
history of, 106
for hypertension, 448-449
for Parkinson's disease, 241
pharmacokinetic properties of, 401t
pharmacologic effects of, 109-111, 110t, 404
in renal failure, dosage adjustments needed in, 51t
side effects of, 56t
structural formula of, 111f, 449f
- Propylene glycol, 719
- Propylhexedrine, for nasal decongestion, 522
- Propylthiouracil
for hyperthyroidism, 542
structural formula of, 542f
toxic effects of, 818
- Prostacyclin, for hypertension, 453
- Prostaglandin(s)
in arachidonic acid metabolism, 325-327, 326f
biologic effects of, 327
as central nervous system transmitters, 156t, 157
inflammatory pain and, analgesic drugs blocking, 302
in inflammatory process, 327-328
inhibition of
adverse effects of, 335
by glucocorticoids, 551
by salicylates, 330-332
for peptic ulcer disease, 529
structure and derivation of, 325
synthesis of, 326f, 327
- Prostaglandin endoperoxide synthetase, in arachidonic acid metabolism, 325
- Prostaglandin endoperoxides, in platelet aggregation, 489-490
- Prostanoids, as central nervous system transmitters, 156t
- Prosthetic joints, antibiotic prophylaxis for dental patients with, 777
- Protamine, for heparin neutralization, 502
- Protease-activated receptors, 490
- Protease inhibitors
for HIV infections, 655-656
amprenavir as, 656
atazanavir as, 656
darunavir as, 656
fosaprenavir as, 656
indinavir as, 656
iopinavir as, 656
nelfinavir as, 656
ritonavir as, 656
saquinavir as, 655-656
tipranavir as, 656
for viral infections, 648t
- Proteasome inhibitors, for cancer, 705t, 706
- Proteasomes, antigen processing in, 665
- Protectants, for cancer, 686t-692t
- Protection neurons, in pain perception, 301
- Protein(s)
chromatin remodeling, in asthma, corticosteroid effects on, 512
drug responsiveness and, 69
metabolism of, insulin actions on, 560t
plasma
anesthetic action and, 269-270
drug binding and, 29
R, in cobalamin transport, 477-478
ras, in chemical carcinogenesis, 58
- Protein binding, plasma. *See* Plasma protein binding.
- Protein C/protein S system, in clotting regulation, 492
- Protein kinases, in histamine release, 359
- Protein metabolism, glucocorticoid effects on, 550
- Prothrombin time, INR value of, 506-507, 507f
- Proto-oncogenes, in chemical carcinogenesis, 58
- Proton pump inhibitors
comparison of, 527t
in dentistry, 529-530
drug interactions with, 526
names of, 536b
for peptic ulcer disease, 525-526
- Protriptyline, 175
adverse effects of, 176t
- Pruritus, eczematous, H₁ antihistamines for, 366
- Pseudoallergic drug reactions, 58
- Pseudobipolar cells, 152-153
- Pseudomembranous colitis
antibiotic-associated, 595-596
clindamycin and, 622
- Pshcyedelics, 807
- Psilocin
abuse of, 807
structural formula of f, 807f
- Psilocybin, abuse of, 807
- Psychedelic hallucinogens, 800-801
- Psychiatric disorders, major, 162-166
- Psychological dependence, on drugs, 314
- Psychomimetics, 807
- Psychopharmacology, 162-187
- Psychosocial factors, in elderly, adverse drug effects and, 837-838
- Psychotic disorders, 162
drug therapy for, 166-173. *See also* Antipsychotic drugs.
- Psyllium, as laxative, 533
- PubMed, 67
- PUD. *See* Peptic ulcer disease (PUD).
- Pulmonary drug excretion, 41
- Pulmonary edema
loop diuretics for, 437
morphine administration for, 313
- Pulpal hypersensitivity, glucocorticoids for, 553
- Pulpal infections, in cancer chemotherapy, 788
- Pulpal pathogens, in oral infections, 601, 602b
- Pulse generators, vagus nerve, for seizure prevention, 226
- Pupillary reaction, morphine-induced, 312
- Pure Food and Drug Act, 799, 862
- Purine analogues, for cancer, 686t-692t, 695
- Purinergic transmission, 88, 88f
- Purines, as central nervous system neurotransmitters, 157
- Purkinje fibers, ion channels in, 393, 395f
- Pyrazinamide, for tuberculosis, 636
- Pyrazolones, for analgesia, 342-343
- Pyrethroid insecticides
structural formulas of, 828f
toxicity of, 828
- Pyridines, in neuropathology of Parkinson's disease, 231
- Pyridoxine, levodopa-induced interactions with, in dental practice, 242-243
- Pyrimidine maleate, structural formula and dosages of, 363t-364t
- Pyrimidine analogues, for cancer, 686t-692t, 696
- Pyrrole derivatives
for inflammatory conditions, 340f, 341-342
diclofenac as, 341-342
ketorolac as, 341
tolmetin as, 341
structural formulas of, 340f
- Q**
- Quarternary ammonium compounds. *See also* Antimuscarinic drugs.
as disinfectants, 748
names of, 749b
for plaque prevention/control, 737
in plaque prevention/control
in oral products, agents and proprietary names of, 739t
- Quazepam
absorption, metabolism, and excretion of, 193t
mechanism of action of, 191-192
metabolism of, 193f
structural formula of, 190t
- Queen Victoria, 267
- Quetiapine
antipsychotic effects of, 168
metabolism of, 172t
relative potency of receptor antagonist affinities in, 166t
side effects of, 171t
structure-activity relationships of, 167
structure of, 167f
- Quil-A, as vaccine adjuvant, 673
- Quinethazone, pharmacokinetic data on, 434t
- Quinidine
absorption, fate, and excretion of, 399
actions of, 400t
adverse effects of, 399, 408t
digoxin and, 419
drug interactions with, 407
indications for, 407t
pharmacokinetic properties of, 401t
pharmacologic effects of, 399
side effects of, useful, 56t
structural formula of, 401f
- Quinolones, 626. *See also* Fluoroquinolones.
classification of, 626-627, 626b
- Quinupristin, 630
- Quorum sensing, 597
- R**
- R proteins, in cobalamin transport, 477-478
- Rabeprazole, as proton pump inhibitors, 525-526
- Radiation therapy, for cancer, oral complications of, 790-795, 792b
acute, 791-793, 792b
late, 793-795
- Radioactive iodine, for hyperthyroidism, 541-542
- Raloxifene
for cancer, 686t-692t
as estrogen receptor partial agonist, 575-576
structural formula of, 575f
- Ramelteon, for sleep disturbances, 198
- Ranexa (ranolazine), for angina, 428
- Ranitidine
history of, 368
other H₂ antihistamines vs., 527t
for peptic ulcer disease, 527
for premedication in anesthesia, 295t

- Ranitidine (*Continued*)
 in renal failure, dosage adjustments needed in, 51t
 structural formula of, 368f
- Ranolazine, for angina, 423-424, 428
- Rapamycin, 677
- Ras proteins, in chemical carcinogenesis, 58
- Rasagiline
 adverse effects of, 239
 for Parkinson's disease, 236t, 239
- Reboxetine, 180
- Receptor(s)
 acetylcholine, antibody for, in myasthenia gravis, 126
- adrenergic, 82
 in antidepressant action, 174
 classification of, 91
 selectivity of adrenergic agonists for, 93t
- α -adrenergic, 83-85
 drugs acting at
 names of, 391t
 for neuropathic orofacial pain, 389
- α_1 -adrenergic, anesthetic action of, 272
- α_2 -adrenergic, 270
- AMPA, 303
 anesthetic action and, 269
- androstane, constitutive, 38
 for antipsychotic drugs, 165, 166t
- benzodiazepine, types of, 191-192
- β -adrenergic, 83-85
 antagonists of
 cardiovascular effects of, 111
 pharmacologic activity of, 109-112, 110t
- β_2 -adrenergic, norepinephrine binding to, 6-7, 6f
- bound by common antipsychotic and antidepressant drugs, 163, 163t
- characteristics of, 2
 cholinergic, 82, 85-86
 classification of, 2-5
 clonally distributed antigen-specific, in specific immunity, 662
- definition of, 2
 diversity of, 13
- dopamine. *See* Dopamine receptor(s).
- drug actions independent of, 15-16
- drug binding to, 5-6, 5f
 consequences of, 7-8
- and drugs, interactions between, 2-8
- enzyme-linked, 3f, 4
- G protein-linked, 3-4, 3f, 86, 87f, 118
 in opioid tolerance, 313-314
- γ -aminobutyric acid_A, 192
 allosteric binding domains on, 191f
- anesthetic action and, 269
- barbiturate action and, 199
- benzodiazepine action and, 189-192, 190f
- ethanol and
 in neurologic control of Parkinson's disease, 231-232
- structural model of, 191f
- valproic acid and, 221
- genetic polymorphisms in, 73-74
 drug responsiveness and, 70, 71f
- for glucocorticoids, 549
- glycine, anesthetic action and, 269
- histamine, 361
 antagonists of, 362-370. *See also* Antihistamines.
- 5-HT_{1B/1D}, in migraine, 379
- insulin, interactions with, 558-559, 559f
- for insulin-like growth factors, 558
- interleukin-1, in cytokine therapy, 679
- intracellular, 3f, 4-5
- ion channel-linked, 2-3, 3f, 86-87, 87f
- ionotropic, 86, 158
- membrane
 characteristics of, 2
 classification of, 2-5, 3f
- metabotropic, 3-4, 158
 in trigeminal nociceptive mechanisms, 303
- motor endplate
 desensitization of, 141
 neuromuscular blocking drug effects on, 141-142
- Receptor(s) (*Continued*)
 with multiple ligand-binding sites, 13
- muscarinic, 82, 86. *See also* Muscarinic receptor(s).
- N-methyl-D-aspartate. *See* N-Methyl-D-aspartate (NMDA) receptor(s).
- N/OFG, 308
- nicotinic, 3, 3f, 82, 85-86, 301. *See also* Nicotinic receptor(s).
- for nociceptive neurons, 301
- nonclonally distributed antigen binding in specific immunity, 662
- opioid, 308-309. *See also* Opioid receptor(s).
 characterization of, 309t
 δ , characterization of, 309t
 G protein-linked, 308
 κ , characterization of, 309t
 μ , 309
 characterization of, 309t
- opioid-receptor-like (ORL-1), 308
- for platelet adhesion, 487
- pregnane X, 38
- protease-activated, 490
- purinergic, 88, 88f
- serotonin. *See also* Serotonin, receptors of.
 pain and, 376-378
 subtypes of, antimigraine medications and, 377t
- serotonergic, pain and, 301
- for sex steroid hormones, structure of, 571
- T cell, in specific immune response, 667
- thrombin, 490
- Receptor-transmitter complex, postsynaptic internalization of, 159
- Recombinant factor VIII products, for bleeding disorders, 497
- Recombinant factor IX products, 498
- Recombinant human tetramers of hemoglobin, 484
- Recovery
 from anesthesia, definition of, 267
 from general anesthesia, 274f, 276
- Rectal administration of drugs, 24
- Red blood cell indices, 470
- Red blood cells (RBCs), 469. *See also* Erythrocytes.
- Red yeast rice, pharmacologic profile of, 870t-871t
- Redistribution, 30
- Reduction
 microsomal, of drugs, 33, 35t-36t
 nonmicrosomal, of drugs, 35t-36t
- Reentry, in cardiac arrhythmias, 395-396, 396f
- Reflex seizures, 212
- Remifentanyl
 for intravenous anesthesia, 293t, 294
 structure and analgesic effects of, 317-318
- Remoxipride, antipsychotic activity of, 167-168
- Renal disease, drug effects and, 51, 51t
- Renal effects. *See* Kidney(s).
- Renal excretion, 40
- Renal failure
 chronic, epoetin alfa for, 481-482
 dosage adjustments needed in, 51t, 592
 loop diuretics for, 437
- Renin-angiotensin system
 in blood pressure control, 443
 in hypertension, 445
- Renin inhibitors, for hypertension, 447
- Repaglinide
 for diabetes, 562. *See also* Meglitinides, for diabetes.
 structural formula of, 563f
- Reproduction
 abnormalities of, nitrous oxide effects and, 283
 steroid hormones of, 567-578. *See also* Steroid hormones.
- Reserpine
 adverse effects of, 113t, 451
 for hypertension, 450-451
 pharmacologic effects of, 450
- Resistance, microbial, antibiotic prophylaxis and, 775, 779
- Resistance genes
 in antibiotic resistance, 585
 species transfer of, 595
 microbial resistance patterns and, 604
 sulfonamide use and, 632
 of tetracyclines, 624-625
- Respiration, drugs stimulating or supporting, 511-524
- Respiratory arrest, neuromuscular blocking drugs and, 144
- Respiratory depression, antipsychotic drug action and, 170
- Respiratory stimulants, emergency use of, 845t, 846
- Respiratory syncytial virus, drugs active against, 653
- Respiratory syncytial virus infections, antiviral agent for, 648t
- Respiratory system
 anticholinesterase overdose effects on, 123
 antimuscarinic drug effects on, 131-133
 barbiturate effects on, 200
 benzodiazepine effects on, 192
 depression of, morphine-induced, 312
 diseases of. *See also* Asthma; Chronic obstructive pulmonary disease (COPD).
 dentistry and, 520-521
 mild, drugs for, 521-522
 drugs acting on, 511-524
 ganglionic blocking drug effects on, 139
 halothane effects on, 285
 inhalation anesthetic effects on, 277
 isoflurane effects on, 286
 ketamine effects on, 290
 morphine effects on, 293
 nitrous oxide effects on, 282-283
 propofol effects on, 289-290
 thiopental effects on, 289
 as toxic target, 818
- Restless leg syndrome (RLS), pramipexole and ropinirole for, 239-240
- Retapamulin, topical, 634
- Reteplase, for myocardial thrombosis, 500
- Reticular activating system (RAS), in
 anesthetic action, 271, 271f
- Reticular formation, barbiturate action and, 199-200
- Retinoids, for cancer, 702-703
- Reverse cholesterol transport, 460
- Reverse transcriptase inhibitors, for viral infections, 648t
- Reverse transcription inhibitors, for HIV infections, 654-655
 abacavir as, 655
 delavirdine as, 655
 didanosine as, 654-655
 efavirenz as, 655
 emtricitabine as, 655
 etravirine as, 655
 lamivudine as, 655
 nevirapine as, 655
 stavudine as, 655
 zalcitabine as, 655
 zidovudine as, 654
- Reye's syndrome, aspirin and, 335
- Rh disease, 673
- Rheumatic diseases, autoimmune, drugs used for, immunosuppressive actions of, 678
- Rheumatic fever, aspirin for, 332-333
- Rheumatoid arthritis
 corticosteroids for, 552
 drugs used for, 335
 names of, 354b
 glucocorticoid therapy for, peptic ulcer disease and, 554
 piroxicam for, 342
 salicylates for, 333
- Rheumatoid factor, 333
- Rho(D) immunoglobulins, uses of, 673
- Ribavirin
 for RSV infections, 653
 structural formula of, 650f
 for viral infections, 648t
- Ribosomal protein synthesis, inhibition of, by antibiotics, 581-583, 582f, 582t

- Rice, red yeast, pharmacologic profile of, 870t-871t
- Rickets, phenytoin and, 218
- Rifabutin, for tuberculosis, 635
- Rifampin
 - drug interactions of, with benzodiazepines, 195, 195t
 - side effects of, 56t
 - for tuberculosis, 635
- Rifapentene, for tuberculosis, 636
- Rifaximin, for traveler's diarrhea, 534
- Riggs, John, 266
- Riluzole, Parkinson's disease and, 240
- Rimantadine
 - structural formula of, 647f
 - for viral infections, 647, 648t
- Risedronate, 544. *See also* Bisphosphonates.
- Risk, definition of, 815b
- Risperidone
 - antipsychotic effects of, 168
 - metabolism of, 172t
 - relative potency of receptor antagonist affinities in, 166t
 - side effects of, 171t
 - structure-activity relationships of, 167
- Ristocetin cofactor assay, for von Willebrand's disease, 497
- Ritodrine
 - pharmacologic effects of, 97
 - structure-activity relationships of, 92t
- Ritonavir, for human immunodeficiency virus infection, 656
- Rituximab
 - for cancer, 705t, 706
 - proprietary names of and indications for, 675t
 - for rheumatoid arthritis, 352
- Rizatriptan
 - dosage forms and T_{max} of, 380t
 - for migraine, 381
- Rocuronium, pharmacologic properties of, 142t
- Rodenticides
 - structural formula of, 831f
 - toxicity of, 830
- Rofecoxib
 - COX inhibitory activity of, 331f
 - for inflammatory conditions, 344-345
 - structural formula of, 343f
- Ropinrole
 - for Parkinson's disease, 236t, 239-240
 - structural formula of, 240f
- Ropivacaine
 - activity of, physicochemical correlates of, 247t
 - preparations and dosage of, 262
- Rosiglitazone, for diabetes, 563. *See also* Thiazolidinediones.
- Rostrovventral medulla (RVM)
 - serotonin neurons in, 375
 - SPA and, 374
- Rosuvastatin, for hyperlipidemia, 464-465
- Rotenone, in neuropathology of Parkinson's disease, 231
- Rotigotine, for Parkinson's disease, 236t, 239-240
- Roxecoxib, dosages of, 346t
- RxList, 67
- S**
- SA nodal cell, ion channels in, 393-394, 395f
- Safety
 - definition of, 815b
 - occupational, in dentistry, 820
 - of sedation/anesthesia, 762
- St. John's wort
 - as antidepressant, 180-181
 - availability of, 863
 - for depression, 165
 - drug interactions with, 873
 - pharmacologic profile of, 870t-871t
- Salicylates, 330-337. *See also* Aspirin.
 - absorption, fate, and excretion of, 334-335
 - adverse effects of, 335-336
 - diflunisal as, 336-337
 - historical development of, 330
- Salicylates (*Continued*)
 - mechanism of action of, 330-332
 - for pain, 332
 - proprietary names of, 346t
 - therapeutic effects of, 332-334
- Salicylic acid, phase II metabolic reactions in, 37t
- Salicylism, 335
- Saline cathartics, as laxatives, 532-533, 532f
- Saliva
 - control of, in dental procedures, 530
 - drug distribution in, 29t
 - measurement of
 - in anticonvulsant drugs, 227
 - in lithium, 184-185
 - flow of
 - drug clearance and, 733
 - drug substantivity and, 734
 - functions of, 125
 - redistribution of drugs into, 30-31
- Salivary glands
 - antimuscarinic drug effects on, 131, 133
 - dysfunction of
 - in cancer chemotherapy, 785
 - postradiation, 792-794
 - endogenous catecholamine-induced effects on, 95
 - ganglionic blocking drug effects on, 139
- Salmeterol
 - for asthma, 515
 - duration of action of, 513
 - pharmacologic effects of, 97
 - structural formula of, 514f
- Salsalate, structural formula of, 331f
- Salt-restricted diet, lithium use and, 184
- Saquinavir, for human immunodeficiency virus infection, 655-656, 655f
- Sarcoplasmic reticulum
 - calcium from, in cardiac contractility, 410
 - calcium in, in malignant hyperthermia, 147
- Sargramostim, 482
 - for cancer, 686t-692t, 703
 - therapeutic use of, 483
- Saw palmetto, pharmacologic profile of, 870t-871t
- Schistocytes, description of, 471b
- Schizophrenia, 162-164
 - anatomic changes in, 164
 - antipsychotic drugs for, 172-173
 - dopamine hypothesis for, 163
 - drug target genetic polymorphisms and, 74
 - etiology of, 162-163
 - genetic predisposition to, 164
 - symptoms of, 162
- Schools, fluoridated water supplies of, 724
- Scopolamine. *See also* Antimuscarinic drugs.
 - antimuscarinic effects of, atropine vs., 130-131, 130t
 - effects of
 - on central nervous system, 132
 - on peripheral nervous system, 131
 - for motion sickness, 132-133, 531
 - for preanesthetic medication, 133, 295-296, 295t
 - for sedation, 295
- Scramblase, 490
- Screening tests, for sources of new drugs, 61
- Secobarbital
 - abuse of, 803
 - duration of action of, 200t
- Second messengers
 - in autonomic nervous system, 86-87
 - signal transduction and, 86-87
 - synthesis of, by insulin, 559
- Secretory glands, cholinergic drug effects on, 120
- Secretory immunoglobulin A, antibodies of, vaccination systems and, 672
- Secretory potential, 157
- Sedation
 - from antihistamines, 365, 367
 - conscious, agents used for. *See also* Anesthesia, general, drugs used for. deep, 767-768. *See also* Deep sedation. definition of, 267
 - herbal product use and, 873
- Sedation (*Continued*)
 - intravenous, 766-767. *See also* Intravenous sedation.
 - minimal
 - characteristics of, 761
 - drugs and doses used for, 763t
 - inhalation, 763-764, 763t. *See also* Inhalation sedation.
 - intravenous, 766-767. *See also* Intravenous sedation.
 - moderate and deep sedation compared with, 762t
 - oral, 764-766. *See also* Oral sedation. pharmacologic approaches to, 761
 - routes of administration of, 762-763
 - vs. moderate and deep sedation and general anesthesia, 762t
- moderate
 - characteristics of, 761
 - drugs and doses for, 763t
 - inhalation. *See also* Inhalation anesthesia.
 - intravenous, 766-767. *See also* Intravenous sedation.
 - oral, 764-766. *See also* Oral sedation. pharmacologic approaches to, 761
 - routes of administration of, 762-763, 763t
 - vs. minimal and deep sedation and general anesthesia, 762t
- Sedative actions, of antipsychotic drugs, 168-169
- Sedative-hypnotics
 - abuse of, 803-804
 - characteristics of, 803-804
 - recent trends in, 800
 - benzodiazepine-like, 198
 - in dentistry, 207-209, 209b-210b
 - drug interactions with, 195, 195t
 - names of, 209b-210b
 - pharmacologic effects of, 803
 - preparations and doses of, 203t
 - therapeutic uses of, 202-203
 - toxicity of, 804
 - vs. centrally acting muscle relaxants, antianxiety drugs, and antihistamines, 205t
- Sedatives, 188. *See also* Sedative-hypnotics.
 - analgesic combinations with, 349
 - choice of, in peptic ulcer patients, 530
 - H_1 antihistamines as, 366
 - half-lives of, 42t
 - proprietary names for, 296b
- Seizures. *See also* Epilepsy.
 - absence, 212, 213t. *See also* Absence seizures.
 - drugs exacerbating, 214-215
 - valproic acid for, 220-221
- anticonvulsant drugs for, 212-229. *See also* Anticonvulsants.
 - anticonvulsant drugs promoting, 215
 - antipsychotic drugs and, 169-170
 - atonic, 212, 213t
 - catamenial, 212
 - classification of, 212-213, 213t
 - clonic, 213t
 - definition of, 212
 - in dental practice, prevention and management of, 226-227
 - emergency treatment of, 846
 - experimental drugs for, 225-226
 - febrile, in children, 226
 - generalized, 212-213, 213t
 - local anesthetic-induced, 256-257
 - benzodiazepine therapy for, 197-198
 - prevention and management of, 226
 - myoclonic, 212, 213t
 - partial, 213, 213t
 - pathophysiology of, 213-214
 - reflex, 212
 - secondary, 213
 - sedative-hypnotic withdrawal and, 803-804
 - tonic, 213t
 - tonic-clonic, 212, 213t
 - uncontrolled, hazards of, 226
- Selective amine inhibitors, 180
- Selective estrogen receptor modulators (SERMs), 574-575, 576t

- Selective serotonin reuptake inhibitors (SSRIs), 179-180
 absorption, fate, and excretion of, 180
 adverse effects of, 176t
 characteristics of, 174
 for chronic pain syndromes, 383
 in dentistry, 183
 development of, 165
 drug interactions with, 180
 for Parkinson's disease, 236t
 pharmacologic effects of, 179
 propionic acid derivative interactions with, 339-340
 serotonergic pathways in, 174t
 side effects of, 180b
 structural formulas of, 179f
 therapeutic uses of, 182
- Selegiline
 adverse effects of, 239
 in dental practice, 243
 for Parkinson's disease, 236t, 239, 241
- Senile dementia, treatment of, 121
- Senna, as laxative, 532
- Sensitization, pharmacodynamic, 53
- Sensory blockade, vs. motor blockade, local anesthetic action and, 253
- Septic shock, treatment of, 99-100
- Serine residues, of proteins, 4
- Serotonin, 373-379
 anatomic distribution of, 374-375
 behavior of, 378-379
 biosynthesis and metabolism of, 374f
 brain concentrations of, 375
 drugs affecting, 373, 378-379, 378f
 historical aspects of, 373-374
 metabolism of, 376
 migraine and, 379
 pain and, 374
 physiologic function of, 378-379
 receptors of
 blockade of, for migraine prophylaxis, 382-383
 G protein-linked, in signal transduction pathways, 378
 pain and, 301, 376-378
 signal transduction pathways linked to, 378
 subtypes of, antimigraine medications and, 377t
 reuptake of, and transport across body membranes, 376
 storage and release of, 376
 synthesis of, 375-376
- Serotonin syndrome, 177
- Sertraline
 adverse effects of, 176t, 180
 structural formula of, 179f
- Sevoflurane, 287-288
 chemical properties of, 276
 properties of, 275t, 282t
 pharmacologic, 284t
 structural formula of, 282f
- Sex, drug effects and, 50
- Sex hormone-binding globulin, 567
- Sexual function
 antidepressant action and, 175
 ethanol and, 713
- Shock
 histamine, 362
 treatment of, adrenergic agonists for, 99-100
- Shutdown, of immune response, 670
- Sialagogues
 in dentistry, 526t
 for salivary gland stimulation after radiation therapy, 793-794
- Sickle cell anemia, 476
- Sickle cell trait, 476
- Sickling
 description of, 471b
 in sickle cell anemia, 476
- Side effects, of drugs, 55, 56t
 useful, 56t
- Signal conduction pathways, 5-HT receptor-linked, 378
- Signal transducers and activators of transcription (STAT) proteins, 680
- Signal transduction
 in autonomic nervous system, 86-87
 receptor binding and, 158
 second messengers and, 86-87
- Sildenafil
 for hypertension, 454
 intracellular receptor action and, 5
- Silent carrier, of thalassemia, 475
- Silo filler's disease, 825-826
- Silver compounds, as disinfectants, 748
- Simethicone, for peptic ulcer disease, 529
- Simpson, James Young, 267
- Simvastatin
 for hyperlipidemia, 464-465
 structural formula of, 465f
- Single nucleotide polymorphism (SNP), map of, 69
- Sinus tachycardia, electrocardiographic appearance of, 396-397, 397f
- Sirolimus, in immunotherapy, 677
- Sitagliptin, for diabetes, 563-564
- Skeletal growth, cancer chemotherapy effects on, 785
- Skeletal muscle
 alcoholism and, 716, 716t
 focal necrosis in, from local anesthetics, 257
 inhalation anesthetic effects on, 277-278
- Skin
 antibiotic-induced reactions of, 595
 drug absorption resistance of, 25
 Skin reactive factor, in inflammatory process, 328
- Skin testing, for allergic reactions to penicillin, 612
- SLC transporters. *See* Solute carrier (SLC) transporters.
- Sleep, REM
 barbiturate action and, 199
 benzodiazepine action and, 197
- Sleep disorders, 188
 benzodiazepine-induced, 194
 benzodiazepine therapy for, 197
 melatonin receptor agonists for, 198
- Slow-reacting substance of anaphylaxis (SRS-A), 328
- Slow-reacting substance (SRS), 328
- SLUD response, 120
- Small intestine, drug absorption in, 21-22
- Smell dysfunction, postradiation, late, 795
- Smoking
 cessation of, nicotine preparations for, 137
 cocaine abuse with, 806
 COPD from, 512
 lung toxicity from, 818
 marijuana abuse with, 808-809
 methamphetamine abuse with, 805
 nicotine effects and, 137
 PCP abuse with, 808
- Smooth muscle
 airway, β blocker effects on, 111, 114
 bronchial
 cholinergic drug effects on, 120
 isoproterenol effects on, 97
 gastrointestinal, cholinergic drug effects on, 120
 nonvascular
 endogenous catecholamine effects on, 94-95
 histamine effects on, 362
 opioid effects on, 312-313
 vascular
 cholinergic drug effects on, 119-120
 relaxation of, by nitrovasodilators, 424
- SNAP-25, in nerve stimulation, 158
- SNARE complex, in nerve stimulation, 158
- SNP (single nucleotide polymorphism), map of, 69
- Sodium
 diuretic action and, 431-432, 433f
 local anesthetic action and, 248
- Sodium bicarbonate
 for emergency use, 846t, 849
 for peptic ulcer disease, 528
- Sodium biphosphate, as laxative, 532-533
- Sodium-calcium exchange, in cardiac contractility, 410, 414, 415f
- Sodium carrier (SLC) transporters, in renal excretion of drugs, 40
- Sodium channel(s)
 blockade of, by β blockers, 109-111
 in cardiac electrophysiology, 393-394, 395f
 in cardiac electrophysiology, defects in, arrhythmias from, 396
 functional structure of, 249, 250f
 local anesthetic action and, 249
 in nerve stimulation, 157
 phenytoin action and, 217
 receptors linked to, 2
- Sodium cyanide, as pesticide, 830
- Sodium fluoride, in fluoride dentifrices, 727-728, 728t
- Sodium hyaluronate, for orofacial pain, 390
- Sodium hypochlorite
 characteristics of, 15
 as disinfectant, 746
- Sodium ion, volume of distribution of, 28t
- Sodium monofluorophosphate
 in fluoride dentifrices, 727, 728t
 structural formula of, 727f
- Sodium nitroprusside
 for emergency use, 849
 for hypertension, 452-453
 structural formula of, 452f
- Sodium phosphate, as laxative, 532-533
- Sodium-potassium exchange, 435
- Sodium salicylate, structural formula of, 331f
- Soft tissue necrosis, postradiation therapy, 794-795
- Solute carrier (SLC) transporters, 19-20
 inhibition of, 39
 in renal drug excretion, 40
- Solvents
 chlorinated, toxic effects of, 826
 toxic effects of, 826
 volatile, abuse of, 810
- Soma, 152
- Somatodendritic autoreceptor, function of, 376
- Somatotropin, 538-539. *See also* Growth hormone (somatotropin).
 names of, 546b-547b
- Sorafenib, for cancer, 705t, 706
- Sotalol
 actions of, 400t
 for arrhythmias, 404-405
 pharmacokinetic properties of, 401t
- Spasmodic torticollis, management of, 242
- Spasticity. *See also* Muscle relaxants.
 gastrointestinal, antimuscarinic drug use for, 133
 relief of, dantrolene for, 146
- Specific responses, 661
- Spherocytes, description of, 471b
- Spinal anesthesia, with local anesthetics, 259
- Spinal cord
 in anesthetic action, 272
 drug action in, 151
- Spinothalamic tract, in pain perception, 300f, 301
- Spironolactone
 as androgen receptor antagonist, 574
 for congestive heart failure, 411-413
 digoxin interactions with, 419
 structural formula of, 433f
 urinary effects and mechanisms of action of, 432t
- Spiroside, components of, 434t
- Spleen, in sickle cell anemia, 476
- Splenectomy, antibiotic prophylaxis for dental patients after, 778
- SRS (slow-reacting substance), 328
- Stalked cell, in pain perception, 301
- Stannous fluoride
 in fluoride dentifrices, 727, 728t
 for plaque prevention/control, 737-738, 739t
- Staphylococcus*, methicillin-resistant, 586
- Starling's law of heart, 410, 411f
- Statins, for hyperlipidemia, 464-465
- Status epilepticus, 212-213
 in dentist's office, 226
 drugs used for, 197-198

- Stavudine, for human immunodeficiency virus infection, 655
- Stem cell factor (SCF), 482
therapeutic use of, 483
- Stem cell(s)
fetal, in treatment of Parkinson's disease, 236t
in immune system, 660, 661f
pluripotent/multipotent, 469, 660, 661f
stem cell factor and, 482
- Sterilization, definition of, 744
- Steroid hormones, 567-578
calcium-regulating, 543-544. *See also* Vitamin D.
corticosteroid, 549-557. *See also* Corticosteroids.
- sex
adverse effects of, 573-574
antagonists of, 575t
in dentistry, 576
drug interactions with, 574
mechanism of action of, 570-571
names of, 577b
peptide, 576
receptors of, structure of, 571
structural formulas of, 568f
structure and functions of, 567-570
therapeutic uses of, 571-573
- Steroid responsive element, 571
- Stevens-Johnson syndrome, macrolide use and, 620
- Stimulants, of gastrointestinal tract, 535
as laxatives, 532, 532f
names of, 536b
- Stimulation-produced analgesia, 374
- Stimulus-response coupling, 11-13, 12f
in dose-response relationships, 11-13, 12f
- Stomach
acid in. *See* Gastric acid.
drug absorption in, 21-22
- Stomatitis, vs. oral mucositis, 782
- Stool softeners, 532
- Streptococcus mutans*, caries and, 732
gingival swabbing antigen against, 672
immunotherapeutic mouth rinses against, 674
vaccines against, 672
- Streptococcus pneumoniae*, antibiotic resistance of, 586-587
- Streptococcus pyogenes*, erythromycin resistance of, 587
- Streptococcus sobrinus*, caries and, vaccines against, 672
- Streptococcus* species
oral, 603-604
viridans group, antibiotic resistance of, 603-604
- Streptogramins, 630-631
- Streptokinase
for emergency use, 846t, 849
for myocardial infarction, 500
- Streptomycin. *See also* Aminoglycosides.
isolation of, 628
structural formula of, 629f
for tuberculosis, 635
- Streptozocin, for cancer, 686t-692t, 693
- Stress, in dental procedures, for cardiac patients, 420
- Styptics
for bleeding control, 495
names of, 509t
- Subarachnoid administration, of drugs, 25
- Subcutaneous administration, of drugs, 25
- Sublingual administration, of drugs, 24
- Substance P
in afferent endings in nucleus caudalis, 303
in neurogenic inflammation, 302
- Substantia gelatinosa, in pain perception, 303
- Substantia nigra par compacta, in neural control of Parkinson's disease, 232, 233f
- Substantivity, drug, in oral cavity, 733-734
- Succimer
for heavy metal poisoning, 823-824, 824t
for lead poisoning, 823
for mercury poisoning, 824
structural formula of, 824f
- Succinimides, 221-222
mechanisms of action and therapeutic uses of, 216t
- Succinylcholine
actions and structural formula of, 141, 141f
adverse effects of, 144
digoxin interactions with, 419
drug target polymorphisms and, 73
for emergency use, 849
malignant hyperthermia from, 142, 147
neuromuscular blocking drug action with, 145t
pharmacologic properties of, 142t
- Sucralfate, for peptic ulcer disease, 529
- Sufentanil
dose, duration, and administration of, 315t
for intravenous anesthesia, 293t, 294
structural formula of, 318f
structure and analgesic effects of, 317-318
- Sugammadex, neuromuscular blocking drugs and, 145
- Suicide, antidepressant use and, 180
- Sulbactam, characteristics of, 609
- Sulfadiazine, side effects of, 56t
- Sulfamethoxazole, herbal product interactions with, 872t
- Sulfanilamide, phase II metabolic reactions in, 37t
- Sulfasalazine
digoxin interactions with, 419
immunosuppressive actions of, 678
for rheumatoid arthritis, 351
- Sulfites, in local anesthetic preparations, allergic reactions to, 257-258
- Sulfonamides, 631-633
absorption, fate, and excretion of, 632
adverse effects of, 632
antibacterial spectrum of, 631-632
bacterial resistance to, 632
chemistry of, 631
classification of, 633t
contraindications to, 633
drug interactions with, 633
mechanism of action of, 583, 631-632
names of, 633t
structural formula of, 632f
therapeutic uses of, 632, 633t
- Sulfones, for leprosy, 636
- Sulfonylureas
adverse effects of, 562
contraindications to, 562
for diabetes mellitus, 561-562
drug interactions with, 562, 562b
mechanism of action of, 561
names of, 562t
pharmacokinetics of, 561, 562t
structural formulas of, 561f
therapeutic uses of, 562
- Sulpyrazone, for gout, 353
structural formula of, 353f
- Sulfur dioxide, toxic effects of, 825
- Sulindac
for inflammatory conditions, 341
structural formula of, 340f
- Sulpride, antipsychotic activity of, 167-168
- Sumatriptan
dosage forms and T_{max} of, 380t
for migraine, 380
- Sunitinib, for cancer, 705t, 706
- Superinfection, antibiotic-induced, 595
- Suppression, in immune response regulation, 670
- Surface-active agents
antimicrobial activity of, 745t
as disinfectants, 748
names of, 749b
- Surface area, in drug dosage calculations for children, 861, 861f
- Surgical anesthesia, definition of, 267
- Surgical procedures
dental, in cancer chemotherapy patients, 788, 789t
glucocorticoid therapy and, 555
neuromuscular blocking drugs in, 144
for Parkinson's disease, 236t
- Sustained-release preparations, drug absorption and, 23
- Sweat glands, ganglionic blocking drug effects on, 139
- Sympathetic nervous system, 78, 80f
in blood pressure control, 442-443
antihypertensives targeting, 448-454
drugs used for, 448-454
function of, 79-80, 81t
neurotransmission in, 80-82
neurotransmission in. *See also* Neurotransmission; Neurotransmitter(s).
ganglionic blocking drug action and, 137f
pain maintained by, treatment of, 389
pain mediated by, diagnostic criteria for, 387b
transmission in, ganglionic blocking drug action and, 138-139
- Sympatholytic drugs, 106. *See also* Adrenergic receptor antagonists.
- Sympathomimetic amines
digoxin and, 419
foods containing, MAO inhibitor use and, 177
- Sympathomimetic drugs, 91. *See also* Adrenergic agonists.
neuromuscular blocking drugs and, 145
toxic effects of, 103
- Synapses
forms of, 154-155
organizational features of, 155
- Synaptic cleft, presynaptic reuptake of 5-HT from, 376
- Synaptic communication, in central nervous system, 153, 154f
- Synaptic organization, of central nervous system, 153-155
- Synaptic transmission, in anesthetic action, 270
- Synaptic vesicles, 149
- Synaptobrevin, in nerve stimulation, 158
- Syntaxin, in nerve stimulation, 158
- Synucleinopathy, 231
- Systemic lupus erythematosus, antibiotic prophylaxis for dental patients with, 778
- T**
- T cell(s)
CD8+, suppression mechanism of, 670
differentiation of, in specific immune response, 668f, 669
factors stimulating, cytokines in, functional relationships of, 663t
functional maturation of, in specific immune response, 667
in immune system, 660, 661f
interleukin-1 effects on, 679t
proliferation of, in specific immune response, 667
activation of, in specific immune response, 666f
- Tachycardia, antipsychotic drug action and, 170
- Tachyphylaxis, 52-53
indirect-acting adrenergic agonists and, 98
neuromuscular blocking drug action and, 142
- Tacrine, for Alzheimer's disease, 127
- Tacrolimus
in immunotherapy, 677
structural formula of, 676f
- Tamoxifen
as antiestrogen, 575-576
behavior of, 11
for cancer, 686t-692t, 698
structural formula of, 575f
- Tamsulosin
action of, 108
chemical structure of, 110t
- Tapentadol, for acute pain, 320
- Tardive dyskinesia
antipsychotic drug action and, 169-170
in dentistry, 173
- Targeted antineoplastic therapy, 704-708, 705t
- Targeting, description of, 471b

- Taste dysfunction
in cancer chemotherapy, 785
postradiation, 793
late, 795
- Taxoids, for cancer, 700-701
- Tazobactam, characteristics of, 609
- Tegaserod, for irritable bowel syndrome, 535
- Telangiectasia, hemorrhagic, hereditary,
antibiotic prophylaxis for dental patients
with, 778
- Telenzepine, for peptic ulcer disease, 529
- Telithromycin, 621
- Telodendria, 151-152
- Temazepam
absorption, metabolism, and excretion of,
192, 193t
structural formula of, 190t
- Temozolomide, for cancer, 686t-692t, 693
- Temperature, body
antimuscarinic drug action in, 132
in malignant hyperthermia. *See* Malignant
hyperthermia.
- Temporomandibular joint (TMJ)
dysfunction of
cancer chemotherapy and, 785
glucocorticoids for, 553
postradiation, 795
inflammation of, corticosteroids for, 385
- Tendinitis, fluoroquinolones and, 628
- Teniposide
for cancer, 686t-692t, 700
structural formula of, 700f
- Teratogenic effects
of drugs, 59, 60t
of lithium, 184
of phenytoin, 218
- Teratology, antibiotic, 594
- Terazosin
absorption, fate, and excretion of, 450
for hypertension, 449-450
metabolism of, 107
structural formula of, 449f
therapeutic uses of, 107
- Terbinafine
for fungal infections, 646
mechanism of action and clinical uses of,
641t
- Terbutaline
for asthma, 515
for emergency use, 845
pharmacologic effects of, 97
structure-activity relationships of, 92t
- Terconazole, for fungal infections, 644
- Terfenadine
adverse effects of, 367
cardiotoxicity of, 817
- Terminal autoreceptor, 373
function of, 376
- Testolactone, for cancer, 686t-692t
- Testosterone
side effects of, 56t
structural formula of, 568f
structure of, 567
- Testosterone propionate
indications for and dose of, 569t
structural formula of, 568f
- Tetanus, neuromuscular blocking drugs in, 144
- Tetrabenazine, for Huntington's disease, 241
- Tetracaine
activity of, physicochemical correlates of,
247t
structural formula of, 247f
- Tetracaine hydrochloride, preparations and
dosages of, 262
- 2,3,7,8-Tetrachlorodibenzo-*p*-dioxin, toxicity
of, 817
- Tetrachloroethylene, toxicity of, 826
- Tetracycline(s), 624-626
absorption, fate, and excretion of, 625
adverse effects of, 625-626
antibacterial spectrum of, 624, 624b
chemistry of, 624
commercially available preparations of, 625b
contraindications to, 602
digoxin interactions with, 419-420
drug interactions with, 626
- Tetracycline(s) (*Continued*)
herbal product interactions with, 872t
mechanism of action of, 581-583, 624
microbial resistance to, 588, 624-625
multidrug antibiotics efflux pumps in,
584-585
in renal failure, dosage adjustments needed
in, 51t
side effects of, 56t
structural formula of, 624f
therapeutic uses of, 625
in dentistry, 625
volume of distribution of, 28t
- Δ -9-Tetrahydrocannabinol (THC)
abuse of, 808-809
structural formula of, 808f
- Tetraethylammonium, ganglionic blocking
action of, 138
- Tetrazine derivative, for cancer, 686t-692t
- Tetrodotoxin, neuromuscular transmission and,
146
- TH1 and TH2 cytokines, therapeutic uses of,
680
- Thalamocortical-corticothalamic loop, in
anesthetic action, 271, 271f
- Thalamus
nuclei of, in anesthetic action, 271, 271f
surgical ablation or stimulation of, for
Parkinson's disease, 241
- Thalassemias, 475-476
- Thalidomide
for cancer, 686t-692t, 701-702
in immunotherapy, 677
structural formula of, 701f
teratogenicity of, 59
- THC (Δ -9-tetrahydrocannabinol)
abuse of, 808-809
structural formula of, 808f
- Theophylline
for asthma, 516-517
drug interactions with, 517b
side effects of, 56t
- Therapeutic index
definition of, 62-63
limitations of, 62f, 63
- Thermal hypersensitivity, of teeth, cancer
chemotherapy and, 785
- Thiazide diuretics, 433-436. *See also*
Diuretic(s), thiazide.
- Thiazolidinediones
adverse effects of, 563
for diabetes, 563
mechanism of action of, 563
drug interactions with, 563
pharmacokinetics of, 563
- Thienobenzodiazepines
side effects of, 171t
structure-activity relationships of, 167
- Thienopyridine drugs, for platelet inhibition,
506
- Thioamides, for hyperthyroidism, 542
- Thiobarbiturates, 199, 199t
- Thiocyanate, for hyperthyroidism, 542
- Thioguanine, for cancer, 686t-692t, 695
- Thiopental
alcohol with, 200-201
duration of action of, 200t
for intravenous anesthesia, 288-289
redistribution of, 30, 30f
structural formula of, 199t, 282f
- Thiopurine-S-methyltransferase, genetic
polymorphisms in, 73
- Thioridazine
metabolism of, 172t
side effects of, 56t, 171t
structure-activity relationships of, 166
- Thiotepa, for cancer, 686t-692t, 693
- Thiothixene, side effects of, 171t
- Thioxanthenes
pharmacologic effects of, 168
side effects of, 171t
structural formula of, 165f
structure and activity relationships of, 166
- Thirst, lithium use and, 184
- Threonine residues, of proteins, 4
- Threshold concentration, of drug, 8
- Thrombin
antithrombotic mechanisms of, 492
in blood clotting, 490
direct inhibitors of, 502
in fibrinolysis, 498-499, 499f
generation of, platelet-assisted, 489-490
inactivation of, by heparin, 501
topical, 494
- Thrombin receptors, 490
- Thrombocytopenia, heparin-induced, 501
- Thrombopoietin (TPO), in hematopoiesis, 482
- Thrombolytic agents, 502
for emergency use, 846t, 849
names of, 509t
- Thrombospondin, in clotting regulation, 492
- Thrombospondin, in platelet adhesion, 487
- Thromboxane A₂
aspirin inhibition of, in platelet aggregation
prophylaxis, 333
generation of, in platelet aggregation,
489-490
physiological effects of, 327
- Thrombus formation, 487-488
- Thymectomy, for myasthenia gravis, 126
- Thymic extracts, for cell-mediated immunity
stimulation, 673
- Thymidine, structural formula of, 650f
- Thymol, in plaque prevention/control, 737,
739t
- Thyroid-active substances, for hyperlipidemia,
466
- Thyroid disorders, 541
- Thyroid hormones, 540-541
actions of, 541
as antidepressants, 181
names of, 546b-547b
pharmacokinetics of, 541
secretion of, control of, 540
structure of, 540f
synthesis of, 540, 540f
- Thyroid problems, lithium use and, 184
- Thyroid-stimulating hormones (TSH),
539-540, 539t
preparations of, names of, 546b-547b
in thyroid hormone secretion, 540
- Thyroiditis, Hashimoto's, 541
- Thyrotoxicosis, 541
in dental practice, 543
oral complications of, 543
- Thyrotropin, 539-540
- Thyrotropin-releasing hormone, 539t
- Thyroxine
as antidepressant, 181
structural formula of, 540f
- Tiagabine
adverse reactions to, 219t
mechanisms of action and therapeutic uses
of, 216t
for seizures, 224
structural formula of, 223f
for trigeminal neuralgia, 388
- Tic douloureux, 386
- Ticarcillin, 606t-607t, 607
adverse reactions to, 613
plus clavulanate, 606t-607t
- Ticlopidine
for myocardial infarction prevention, 429
for platelet inhibition, 506
- Tifluridine, for viral infections, 648t
- Tigicycline, 626
- Tiludronate, 544. *See also* Bisphosphonates.
- Timolol. *See also* Adrenergic receptor
antagonists, β .
pharmacologic effects of, 110t
structural formula of, 111f, 449f
- Tin, as disinfectant, 748-749
- Tiotropium, for asthma, 517
- Tipranavir, for human immunodeficiency virus
infection, 656
- Tirofiban
for myocardial infarction prevention, 429
for platelet inhibition, 506
- Tissue binding, of drugs, 29-30
- Tissue factor
in blood clotting, 490
in prothrombin time INR value, 506-507

- Tissue factor pathway inhibitor, in clotting regulation, 493
- Tissue injury
in histamine release, 360
from local anesthetics, 257
- Tissue mediators, of inflammation, 324-329, 325t
- Tissue necrosis, postradiation therapy, 794-795
- Tissue plasminogen activator
in fibrinolysis, 498-499, 499f
for myocardial thrombosis, 500
- Titration, of intravenous administration, 24
- Tizanidine
for muscle relaxation, 206
for musculoskeletal pain, 385-386
neuromuscular transmission and, 146
- Tizantine, for orofacial pain syndromes, 389
- Tobacco. *See also* Smoking.
cessation of, nicotine preparations for, 137
- Tobramycin. *See also* Aminoglycosides.
development of, 628
- Tocainide
actions of, 400t
for arrhythmias, 402-403
pharmacokinetic properties of, 401t
structural formula of, 403f
- Tocopherol, for Parkinson's disease, 241
- Tolazamide, pharmacokinetics of, 562t
- Tolazoline, 450
- Tolbutamide, pharmacokinetics of, 562t
- Tolcapone
for Parkinson's disease, 236t, 238-239
structural formula of, 238f
- Tolerance
to amphetamines, 805
to anticonvulsants, 226
to benzodiazepines, 194
to bronchodilator actions, of β_2 agonists, 514
cellular, drug effects and, 52
to CNS drugs, 160
to cocaine, 806
definition of, 800
drug, 52-53
to indirect-acting adrenergic agonists, 98
to long-acting nitrovasodilators, 425
to marijuana, 809
to mixed opioid agonists-antagonists, 318-319
to morphine, 313-314
to muscle relaxants, 205-206
to opioid agonists, 801
to opioid analgesics, 756
pharmacodynamic, 13
pharmacokinetic, 38-39
to sedative-hypnotics, 804
- Tolmetin
for inflammatory conditions, 341
structural formula of, 340f
- Tolnaftate, for fungal infections, 646
- Tonic-clonic seizures, 212, 213t
- Tonic seizures, 213t
- Tooth (teeth)
brushing of, topical fluoride and, 726t, 727-728
development of, cancer chemotherapy effects on, 785
extraction of, in cancer chemotherapy patients, 788, 789t
tetracycline staining, 626
thermal hypersensitivity of, cancer chemotherapy and, 785
- Toothbrushing, topical fluoride and, caries and, 726t, 727-728
- Toothpaste. *See* Dentifrices.
- Topical application
of agents for orofacial neuropathic pain, 389-390
of antibiotics, 634
of clotting factors, 494-495
drug absorption and, 25-26
of local anesthetics, 259
of nasal decongestants, 522
- Topiramate
adverse reactions to, 219t
for mania, 185
- Topiramate (*Continued*)
mechanisms of action and therapeutic uses of, 216t
for seizures, 225
structural formula of, 223f
for trigeminal neuralgia, 388
- Topotecan, for cancer, 686t-692t, 700
- Toremifene
as antiestrogen, 575-576
for cancer, 686t-692t, 698
- Torsades de pointes, 396
antidepressant use and, 182
antipsychotic drug action and, 170
electrocardiographic pattern of, 397, 397f
- Torsemide, absorption, fate, and excretion of, 437
- Torsion dystonia, management of, 242
- Torticollis, spasmodic, management of, 242
- Tositumomab
for cancer, 705t, 707
proprietary names of and indications for, 675t
- Total iron-binding capacity, 472
- Tourette's syndrome, drugs used for, 241-242
- Toxic chemicals
epidermal absorption of, 25-26
target organs of, 817-819
- Toxic effects
of gases, 824-826
of liquids and vapors, 826-827
of local anesthetics, prevention of, 256-257
of metals, 820-824
of pesticides, 827-830
- Toxic nodular goiter, 541
- Toxicants
carbon monoxide as, 824-825
fumigants as, 829
gases as, 824-826
herbicides as, 829-830
lead as, 822-823
liquid, 826-827
mercury as, 820-821
metals as, 820-824
nitrogen oxides as, 825-826
ozone as, 825
pesticides as, 827-830
predicides as, 830
rodenticides as, 830
solvents as, 826
specific, 820-830
sulfur dioxide as, 825
vapors as, 826-827
- Toxicity. *See also subheading* toxicity of *under specific agents/drugs*.
acute vs. chronic, 816-817
definition of, 815b
drug metabolism and, 817
of ethanol, 715-717
of ethylene glycol, 719
fluoride, 728-729
acute, 728-729
chronic, 729
hazard vs., 814
of isopropyl alcohol, 718-719
local vs. systemic, 817
- Toxicology, 814-833
causal relationships in, 815b
dose-response relationships in, 814-816, 815f
factors changing, 816
general principles of, 814-819, 815b
risk in, evaluation of, 814
- Toxin, botulinum, 134
neuromuscular transmission and, 146
type A, for dystonic syndromes, 242
type A and B, 390-391
- Tramadol
dose, duration, and administration of, 315t
herbal product interactions with, 872t
pharmacologic effects of, 320
- Transactivation, in steroid effect on inflammation, 512
- Transcobalamin II, in cobalamin transport, 477-478
- Transcortin, 551
- Transcytosis, 20-21
- Transdermal therapeutic system, for percutaneous drug absorption, 26
- Transduction, in antibiotic resistance, 585
- Transferrin
in iron absorption, 472
tests for, 472
- Transient receptor potential (TRP) channels, on nociceptive neurons, 301
- Transitional block, by local anesthetics, 250
- Transmembrane channels, passive diffusion and, 19
- Transmitter-receptor complex, postsynaptic internalization of, 159
- Transplantation, bone marrow, for sickle cell anemia, 476
- Transport systems, in renal drug excretion, 40
- Transporters, in drug metabolism inhibition and induction, 39
- Transposable elements, in antibiotic resistance, 585
- Transposons, in antibiotic resistance, 585
- Tranlycypromine, adverse effects of, 176t
- Trastuzumab
for cancer, 705t, 706-707
proprietary names of and indications for, 675t
- Traumatic neuralgia, diagnostic criteria for, 387b
- Traveler's diarrhea, prevention and treatment of, 534-535
- Trazodone, 177-178
adverse effects of, 176t
for chronic pain syndromes, 383
structural formula of, 178f
- Tremor(s)
antimuscarinic drug action on, 132
in Parkinson's disease, 232
surgical brain stimulation for, 241
- Trench mouth, 602
- Tretinoin, for cancer, 686t-692t, 702
- Triamcinolone
intranasal, for rhinitis, 522
potency of, 550t
structural formula of, 556t
for TMJ inflammation, 385
- Triamterene
structural formula of, 433f
urinary effects and mechanisms of action of, 432t
- Triazene derivative, for cancer, 686t-692t
- Triazine herbicides, toxicity of, 829
- Triazolam
absorption, metabolism, and excretion of, 193-194, 193t
adverse effects of, 194
for anxiety, dose and administration of, 197t
in dentistry, 208
for intravenous anesthesia, 292
metabolism of, 193f, 195
for oral sedation, 765
for premedication in anesthesia, 295t
structural formula of, 189f
- Triazole antifungal drugs, 642-644, 643f
- Trichlormethiazide, pharmacokinetic data on, 434t
- 2,4,5-Trichlorophenoxyacetic acid, toxicity of, 817
- Trichloroethanol
phase I reactions in, 35t-36t
structural formula of, 201f
- Trichloroethylene, chemical properties of, 276
- Trichlorofluoromethane, abuse of, 810
- Triclosan
as antiseptic, 747
for plaque prevention/control, 736-737
structural formula of, 736f, 739t
- Tricyclic antidepressants, 175-177
absorption, fate, and excretion of, 176
as adjuncts in analgesia, 311
adverse effects of, 176-177, 176t
characteristics of, 174
chemistry and structure-activity relationships of, 175
for chronic orofacial pain, 183, 383

- Tricyclic antidepressants (*Continued*)
 in dentistry, 182
 development and use of, 165
 inhibition of reuptake of 5-HT by, 376
 for migraine prophylaxis, 383
 for Parkinson's disease, 236t
 pharmacologic effects of, 175-176
 therapeutic uses of, 181
- Trifluoperazine, side effects of, 171t
- Triflupromazine, side effects of, 171t
- Trifluridine, for herpes virus infections, 651
- Trigeminal nerve, in pain transmission, 300
- Trigeminal neuralgia, 386
 diagnostic criteria for, 387b
 topical agents for, 389-390
- Trigeminothalamic tract, in pain perception, 300f, 301, 303
- Triglycerides, in lipoprotein metabolism, 459-460
- Trihexyphenidyl, for Parkinson's disease, 236t, 240
- Triiodothyronine, structural formula of, 540f
- Trimeprazine tartrate, structural formula and dosages of, 363t-364t
- Trimetazidine, for angina, mechanism of action of, 423-424
- Trimethadione
 as anticonvulsant, 221
 mechanisms of action and therapeutic uses of, 216t
- Trimethaphan
 structural formula of, 138f
 uses of, 139-140
- Trimethobenzamide
 as antiemetic, 531
 for migraine, 381-382
- Trimethoprim. *See also* Sulfonamides.
 herbal product interactions with, 872t
 mechanism of action of, 583
 synergism of, with sulfonamides, 631
 therapeutic uses of, 632, 633t
- Trimethoprim-sulfamethoxazole, for traveler's diarrhea prevention, 535
- Trimipramine, adverse effects of, 176t
- Tripelennamine citrate, structural formula and dosages of, 363t-364t
- Tripolidine hydrochloride, structural formula and dosages of, 363t-364t
- Triptans
 adverse reactions to, 381b
 contraindications to, 381, 381b
 for migraine, 380-381, 380t
 names of, 391t
- Trizivir, for human immunodeficiency virus infection, 655
- Troleandomycin, 618. *See also* Macrolide antibiotics.
- Trophoblasts, placental transfer of drugs and, 27-28
- Tropicamide, for mydriasis and cycloplegia, 132
- Tropomyosin, in cardiac muscle contraction, 410
- Troponin, in cardiac muscle contraction, 410
- TRP (transient receptor potential) channels, on nociceptive neurons, 301
- Tryptamine derivatives, abuse of, 807-808
- Tryptophan, antidepressant action and, 173
- Tryptophan hydroxylase, in serotonin synthesis, 374f, 375
- Tuberculosis, drugs used for, 615
 names of, 636b-637b
- Tubocurarine, 136
 action and structural formula of, 140, 141f
 historical use of, 141
 pharmacologic properties of, 142t
- Tubular reabsorption, in renal excretion of drugs, 40
- Tumor killing, cytokines in, functional relationships of, 663t
- Tumor resistance, chemotherapeutic approaches to, 708
- Tumor suppressor genes, in chemical carcinogenesis, 58
- Tyramine
 monoamine oxidase inhibitors and, 114-115, 177
 structure-activity relationships of, 92t
 tachyphylaxis and, 52-53
- Tyrosine
 biosynthesis of, 85f
 enzyme-linked receptor action and, 4
- Tyrosine hydroxylase, in catecholamine synthesis, 82
- Tyrosine kinase inhibitors, for cancer, 704-706, 704f, 705t
- U**
- Ubiquitin, in antigen processing, 665
- Ulcer(s)
 oral, glucocorticoids for, 553
 peptic. *See also* Peptic ulcer disease (PUD).
 treatment of, 525-530
- Ulcerative gingivitis, acute recrotizing, microbiology of, 602
- Unconsciousness, definition of, 267
- Unified Parkinson's Disease Rating Scale (UPDRS), 233-234
 scores on, effects of anti-Parkinson drugs on, 235t
- United States Pharmacopeia* (USP), 65-66, 862
- Unresponsiveness, definition of, 267
- Uracil, structural formula of, 694f
- Urea, volume of distribution of, 28t
- Ureidopenicillins, 606t-607t
- Uric acid, in gout, 352
- Uridine diphosphate glucuronosyltransferase polymorphism, 73
- Urinary antiseptics, 634-635
- Urinary bladder, endogenous catecholamine effects on, 94-95
- Urinary tract
 antimuscarinic drug effects on, 132-133
 cholinergic drug effects on, 120
 ganglionic blocking drug effects on, 139
- Urine
 alkalization of, for toxicity treatment, 40
 mercury concentrations in, 821, 821f
 pH of, in renal excretion, 40
- Urofollitropin, 576
- Urokinase, for emergency use, 849
- Urokinase plasminogen activator, in fibrinolysis, 498-500, 499f
- Urticaria, H₁ antihistamines for, 366
- Use-dependent block, by local anesthetics, 250-252
- USP Dispensing Information*, drug information in, 66
- Uterus
 endogenous catecholamine effects on, 94-95
 relaxation of, adrenergic agonists for, 100
- V**
- Vaccination, 671
- Vaccine(s)
 caries, 672
 herpes zoster, 652-653
 human immunodeficiency virus, 656
 human papillomavirus, 648t
 influenza, 648t, 649
 subunit, 663
- Vagus nerve
 in pain transmission, 300
- Valacyclovir
 for herpes virus infections, 648t, 651-652
 for oral HSVs, 787
- Valdecoxib
 COX inhibitory activity of, 331f
 for inflammatory conditions, 345
 structural formula of, 343f
- Valerian, pharmacologic profile of, 870t-871t
- Valganciclovir, for CMV infections, 652
- Valproic acid, 220-221
 absorption, fate, and excretion of, 221
 adverse effects of, 219t, 221
 discovery of, 214-215
 drug interactions with, 227
 interactions of, with barbiturates, 195t
 for mania, 185
- Valproic acid (*Continued*)
 mechanisms of action and therapeutic uses of, 216t
 pharmacologic effects of, 221
 side effects of, 56t
 structural formula of, 217f
 for trigeminal neuralgia, 387-388
- Valsartan, for chronic heart failure, 413
- Van der Waals forces, in drug-receptor interactions, 5f, 6
- Vancomycin, 630
 adverse effects of, 630
 antibacterial spectrum of, 630
 for *C. difficile* diarrhea, 596
 drug interactions with, 630
 mechanism of action of, 630
 microbial resistance to, 586-587, 630
 therapeutic uses of, 630
- Vanilloid receptor channels, on nociceptive neurons, 301
- Vapor, elemental mercury, 821
- Vaporizer, temperature-compensated, variable-bypass, for inhalation anesthetics, 278, 278f
- Variant angina, 422
- Varicella-zoster virus, drugs active against, 652-653
 famciclovir as, 652
 herpes zoster vaccine as, 652-653
- Varicella-zoster virus infection, in cancer patients, 787
- Varnish, fluoride, 726
- Vascular effects
 of anticholinesterases, 123
 of endogenous catecholamines, 93-94
 of isoproterenol, 97
- Vascular smooth muscle
 cholinergic drug effects on, 119-120
 relaxation of, by nitrovasodilators, 424
- Vasculature
 peripheral, local anesthetic action and, 255
 systemic, digoxin administration and, 416
- Vasoconstriction
 endogenous catecholamine-induced, 93-94
 in hemostasis, 487
 histamine effects on, 361
- Vasoconstrictor(s)
 adrenergic, 99
 for bleeding control, 495
 in dentistry, 101-103, 101t
 names of, 103b-104b
 for emergency use, 849
 ergotamine as, 379
 in local anesthetics
 drug interactions with, 258, 455-456
 effects of, 255-256
 local tissue responses to, 257
 names of, 103b-104b, 509t
- Vasodilation
 calcium channel blockers and, 427
 cerebral, morphine administration and, 313
 histamine effects on, 361-362
 muscarinic receptor stimulation and, 118, 119f
 nitrites/nitrites in, 424
- Vasodilator(s)
 direct
 for hypertension, 452-454
 names of, 456b-457b
 directly acting, for congestive heart failure, 420
 for emergency use, 846t, 849
- Vasopressin, 431, 538. *See also* Antidiuretic hormone (ADH).
 for emergency use, 846t-848t, 848-849
- Vasopressors, for emergency use, 849
- Vectors, for breaching blood-brain barrier, 27
- Vecuronium
 pharmacologic properties of, 142t
 toxic extension of therapeutic effect of, 55t
- Venable, James, 266
- Venlafaxine, 180
 adverse effects of, 176t
 for chronic pain syndromes, 383
 structural formula of, 178f

- Ventilation
 mechanical, neuromuscular blocking drugs
 in, 144
 pulmonary, for acute opioid intoxication,
 313
- Ventricular fibrillation, electrocardiographic
 appearance of, 396-397, 397f
- Ventricular tachycardia, electrocardiographic
 appearance of, 396-397, 397f
- Verapamil
 actions of, 400t
 benzodiazepine interactions with, 195
 cardiovascular effects of, 427, 428t
 for cluster headache, 384
 digoxin and, 419
 for emergency use, 846t-848t, 848
 for hypertension, 447-448
 indications for, 407t
 pharmacokinetic properties of, 401t
 structural formula of, 427f
- Vertigo, H₁ antihistamines for, 366-367
- Vesicles, synaptic, in nerve stimulation, 149
- Vestibular function, antimuscarinic drug
 effects on, 132
- Vidarabine
 for herpes virus infections, 648t, 650-651
 mechanism of action of, 650f
 structural formula of, 650f
- Vigabatrin
 adverse reactions to, 219t
 clinical toxicology of, 215
 mechanisms of action and therapeutic uses
 of, 216t
 for seizures, 223-224
 structural formula of, 223f
- Vildagliptin, for diabetes, 563-564
- Vinblastine
 for cancer, 686t-692t, 698
 structural formula of, 698f
- Vinca alkaloids, for cancer, 686t-692t, 698
- Vincent's infection, microbiology of, 602
- Vincristine
 for cancer, 686t-692t, 698
 structural formula of, 698f
- Vinorelbine, for cancer, 686t-692t, 698
- Viral hepatitis, in drug-abusing patient, 811
- Virulence, microbial, factors affecting, 594
- Virus(es)
 inactivation of, in therapeutic blood
 products, 497
 infections due to
 antibiotics for, 610t-611t
 antiviral agents for, 647-656, 648t
 names of, 657b
 oral, in immunosuppressed patients,
 787-788
 transmission of, in hemophiliacs, 508
- Vitamin B₁₂, 477-479
 deficiency of
 megaloblastic anemia from, 476-477
 pathophysiologic characteristics of,
 478-479
 dietary sources of, 477
 metabolic pathways of, 481f
 physiologic characteristics of, 477-478
 preparations of, names of, 485t
- Vitamin D, 543-544
 effects of, 544t
 on bone, gastrointestinal tract, and kidney,
 544t
 preparations of, names of, 546b-547b
 structural formula of, 544f
- Vitamin K
 coumarin-indandione action and, 502, 504
 deficiency of, hemorrhage and, 503
- Vitamin K-dependent clotting factors, 490
- Vitamin K epoxide reductase, inhibition of, by
 coumarin-indandiones, 502, 503f
- Volatile solvents, abuse of, 810
- Voltage-gated ion channels, 2
 anesthetic action and, 270
- Volume depletion
 loop diuretics and, 437
 thiazide diuretic action and, 435
- Volume of distribution
 of drugs, 28, 28f, 28t
 in renal drug excretion, 40
 of various agents, 28t
- Vomiting. *See also* Antiemetics.
 antihistamines for, 366-367
 cancer chemotherapy-induced, 531, 789-790
 digoxin administration and, 417
 morphine-induced, 312
- von Willebrand factor, in platelet adhesion,
 487, 488f
- von Willebrand's disease, 496-497
 treatment of, 497-498
- Voriconazole
 for fungal infections, 644
 introduction of, 596
 structural formula of, 643f
- Vorinostat, for cancer, 705t
- W**
- Warfarin
 chloral hydrate with, 202
 drug interactions with, 504
 interactions of
 with barbiturates, 190t
 with chloral hydrate, 190t
 for myocardial infarction prevention, 429
 structural formula of, 503f, 831f
 toxicity of, 830
- Warren, John C., 267
- Water
 body, glucocorticoid effects on, 551
 renal reabsorption of, 431-432
 supplies of, fluoridated, 721-724, 722f
 safety of, 722-724
 of schools, 724
- Water solubility, of drugs
 drug access to central nervous system and,
 27
 membrane penetration and, 17
 placental transfer and, 27-28
 volume of distribution and, 28, 28f
- Waxman-Hatch Act, 863
- Wedensky inhibition, by local anesthetics,
 250
- Weight, body
 drug effects and, 49
 gain of, with antipsychotic drugs, 170-172,
 171t
 loss of, sympathomimetic anorexic drugs for,
 101
- Weights and measures, for drugs, 861-862,
 862t
- Wells, Horace, 266
- Wetting agents, as laxatives, 532, 532f
- Wilson's disease, drugs used for, 242
- Withdrawal
 from alcohol, benzodiazepine therapy for,
 197-198
 amphetamine, 805
 of antihypertensive drugs, 455
 from benzodiazepines, 194, 197
 from cocaine, 806
 from marijuana, 809
 from opioid analgesics, 801-802
 from sedative-hypnotics, 803-804
- Withdrawal syndrome, definition of, 800
- Women, iron stores in, 472
- World Health Organization, regulations of, for
 occupational mercury exposure, 821-822
- Wound healing, phenytoin for, 227
- X**
- Xanthines, for asthma, names of, 522b-523b
- Xenogeneic antibodies, oral administration of,
 674
- Xerostomia
 adrenergic agonists and, 115
 antidepressant use and, 183
 antihypertensive use and, 456
 antimuscarinic drugs and, 134-135
 from cancer radiation therapy, 793
 palliation of, 794
 caries and, 794
 causes and characteristics of, 125-126
 dental practice and, 173
 in drug-abusing patients, 811
 in elderly, 837
 in Parkinson's disease, 242
- xPharm, 67
- Xylitol, for salivary gland stimulation, 793
- Y**
- Young's rule, for drug dosage calculations,
 861
- Z**
- Zafirlukast, for asthma, 517
- Zalcitabine
 for human immunodeficiency virus infection,
 655
 structural formula of, 650f
- Zaleplon, 198
 for oral sedation, 765
- Zanamivir, for influenza, 647-649, 648t
- Zero-order kinetics, of absorption and
 elimination, 41
- Zidovudine
 for HIV and AIDS, 654
 side effects of, 56t
 structural formula of, 650f
- Zileuton, for asthma, 517-518
- Zinc phosphide, toxicity of, 829
- Zinc supplements, for taste dysfunction in
 cancer radiation therapy, 793
- Ziprasidone
 antipsychotic activity of, 167
 metabolism of, 172t
 relative potency of receptor antagonist
 affinities in, 166t
 side effects of, 171t
- Zoledronic acid, 544. *See also* Bisphosphonates.
- Zollinger-Ellison syndrome, H₂ antihistamines
 for, 369
- Zolmitriptan
 dosage forms and T_{max} of, 380t
 for migraine, 381
- Zolpidem, 198, 198f
 in dentistry, 207
 for oral sedation, 765
 toxic extension of therapeutic effect of, 55t
- Zona fasciculata, hormones produced by, 549,
 550f
- Zona glomerulosa, hormones produced by,
 549, 550f
- Zona reticularis, hormones produced by, 549,
 550f
- Zonisamide
 adverse reactions to, 219t
 mechanisms of action and therapeutic uses
 of, 216t
 for seizures, 225
 structural formula of, 223f
- Zopiclone, 198