

# **Removable Orthodontic Appliances**



**K Vijayalakshmi**

**JAYPEE**

*Removable  
Orthodontic  
Appliances*



# *Removable Orthodontic Appliances*

**K Vijayalakshmi** MDS

Principal

Indira Gandhi Institute of  
Dental Science, Pillaiyarkuppam  
Cuddalore, Puducherry  
India



**JAYPEE BROTHERS MEDICAL PUBLISHERS (P) LTD**

---

Chennai • St Louis (USA) • Panama City (Panama) • New Delhi • Ahmedabad  
Bengaluru • Hyderabad • Kochi • Kolkata • Lucknow • Mumbai • Nagpur

*Published by*

Jitendar P Vij

**Jaypee Brothers Medical Publishers (P) Ltd**

**Corporate Office**

4838/24 Ansari Road, Daryaganj, **New Delhi** - 110002, India,

Phone: +91-11-43574357, Fax: +91-11-43574314

**Registered Office**

B-3 EMCA House, 23/23B Ansari Road, Daryaganj, **New Delhi** - 110 002, India

Phones: +91-11-23272143, +91-11-23272703, +91-11-23282021

+91-11-23245672, Rel: +91-11-32558559, Fax: +91-11-23276490,

+91-11-23245683, e-mail: jaypee@jaypeebrothers.com,

Website: www.jaypeebrothers.com

**Offices in India**

- **Ahmedabad**, Phone: Rel: +91-79-32988717, e-mail: ahmedabad@jaypeebrothers.com
- **Bengaluru**, Phone: Rel: +91-80-32714073, e-mail: bangalore@jaypeebrothers.com
- **Chennai**, Phone: Rel: +91-44-32972089, e-mail: chennai@jaypeebrothers.com
- **Hyderabad**, Phone: Rel:+91-40-32940929, e-mail: hyderabad@jaypeebrothers.com
- **Kochi**, Phone: +91-484-2395740, e-mail: kochi@jaypeebrothers.com
- **Kolkata**, Phone: +91-33-22276415, e-mail: kolkata@jaypeebrothers.com
- **Lucknow**, Phone: +91-522-3040554, e-mail: lucknow@jaypeebrothers.com
- **Mumbai**, Phone: Rel: +91-22-32926896, e-mail: mumbai@jaypeebrothers.com
- **Nagpur**, Phone: Rel: +91-712-3245220, e-mail: nagpur@jaypeebrothers.com

**Overseas Offices**

- **North America Office, USA**, Ph: 001-636-6279734, e-mail: jaypee@jaypeebrothers.com, anjulav@jaypeebrothers.com
- **Central America Office, Panama City, Panama**, Ph: 001-507-317-0160, e-mail: cservice@jphmedical.com, Website: www.jphmedical.com

**Removable Orthodontic Appliances**

© 2010, Jaypee Brothers Medical Publishers (P) Ltd.

All rights reserved. No part of this publication should be reproduced, stored in a retrieval system, or transmitted in any form or by any means: electronic, mechanical, photocopying, recording, or otherwise, without the prior written permission of the author and the publisher.

This book has been published in good faith that the material provided by author is original. Every effort is made to ensure accuracy of material, but the publisher, printer and author will not be held responsible for any inadvertent error (s). In case of any dispute, all legal matters are to be settled under Delhi jurisdiction only.

*First Edition: 2010*

ISBN 978-81-8448-839-5

*Typeset at JPBMP typesetting unit*

*Printed at Ajanta Offset*

**Dedicated to**

My parents SR Kuppuswamy and  
K Krishnaveny

My husband G Ravindran

My children Arun Jai Kumar and  
Pradeep Kumar



## PREFACE

---

Removable appliances are fabricated in the laboratory rather than directly in the patient's mouth, reducing the dentist chair time and they can be made almost invisible if fabricated from clear plastic materials. This makes them more acceptable to especially adult patients. These advantages for both the patient and the dentist have ensured a continuing interest in removable appliance. With a few limitations, removable appliances are most useful for the first 2 phases of treatment and contemporary comprehensive treatment is dominated by fixed appliance. However, removable appliances remain to stay as retention appliance.

Major part of malocclusion need either removable appliances or with combination of semi-fixed removable appliance. Moreover, the most of simple removable appliances are delivered by general clinicians than orthodontic specialists. One, who is handling with an understanding of how appliances function, is able to rationally design, select and use orthodontic appliances in an efficient manner for the patient.

In view of this, I present this book useful for the undergraduates and clinicians in designing and construction of the removable appliances. I have listed the various designs and modifications of components of appliances.

**K Vijayalakshmi**





# CONTENTS

---

1. Introduction .....	1
2. Labial Wire .....	7
3. Clasp .....	23
4. Springs .....	47
5. Bite Planes .....	65
6. Expansion Appliance .....	73
7. Clinical Adjustments .....	87
<i>Index</i> .....	93

# 1

## *Introduction*

---

---

### **DEFINITION**

---

**Lischer** defined an orthodontic appliance as a mechanism for the application of force to the teeth and their supporting tissues, to produce changes in their relations and to control the growth and development of this structure.

**Grabner** defined as a device through which an optimal orthodontic force is delivered to a tooth or a group of teeth in a predetermined direction.

### **Mechanical Appliances**

It may be defined as device through which an optimal orthodontic force is delivered to the alveolar bone via teeth in a predetermined direction by means of screws, elastics and springs.

### **Attributes**

Appliance should possess the following qualities. They are divided into four categories.

1. Biologic
2. Mechanical
3. Aesthetics
4. Hygienic

### **Biologic**

1. It must not impede normal development of teeth.
2. It must be free from inherent qualities which may be harmful to oral tissues and should not be damaged by oral secretions.

## **2 Removable Orthodontic Appliances**

---

3. It should interfere as little as possible with movements of lips, cheeks and tongue.
4. It must not produce movement of teeth already correctly aligned. It must not cause damage to tooth, bone or soft tissue structures.

### **Mechanical**

1. Less bulky, comfortable to wear.
2. Adequate retention for fixation in proper position.
3. It should be capable of exerting the correct sufficient force in correct direction and offer sufficient anchorage resistance to induce the necessary bone changes for orthodontic tooth movement.
4. Pressure exerted must be positive and under proper control and operate for as long as possible between adjustments. It should be stable in the mouth so less interference with the functions of oral cavity.
5. It should be easy to construct and repair.
6. It should be easy to remove and wear.
7. It should be light and inconspicuous but sufficiently strong to withstand the stresses of mastication and general wear and tear.

### **Aesthetic**

1. Base plate used for appliance should have color matching with individual's mucosa.
2. For functional appliances, since they are bulky with many wire parts, transparent resin is used and aesthetically look good.
3. It should be well trimmed, finished and polished.

### **Hygienic**

1. It is easy to clean daily.
2. Avoid depositions of food and calculus.
3. Discoloration due to some habit is possible so get it changed.

## **CLASSIFICATION OF APPLIANCE**

---

It is classified into

- Mechanical appliance

- Removable
- Fixed
- Combination of removable and fixed
- Functional appliance .  
(In this text, I concentrate only on removable mechanical appliance.)

## **Advantages and Disadvantages of Removable Appliances**

### *Advantages*

Removable orthodontic appliances have many advantages like:

1. Majority of cases will require only simple tipping of teeth.
2. It can incorporate bite platforms to eliminate occlusal interferences and displacement.
3. Simple to fabricate and easy to maintain
4. Adjustments are possible by an educated patient.
5. Inexpensive and any dentist can deal with appliance.
6. Less visible and easy repair.

These advantages for both the patient and the dentist have ensured a continuing interest in removable appliances. There are also obvious disadvantages.

### *Disadvantages*

- The response to treatment is heavily depended on patient compliance.
- Bodily movement and multiple rotations are not possible to correct.
- In extraction cases, uprighting of roots of canine and 2nd premolar is not possible.
- It is not indicated in certain skeletal cases.
- The amount of activation is minimal which in turn affect the tooth movement

Because of these limitations, removable appliances are most useful for the first of two phases of treatment and contemporary comprehensive treatment is dominated by fixed but not by the removable appliances.

### **Development of Removable Appliance**

In the United States, Victor Hugo Jackson was the Chief proponent of removable appliances among the pioneer orthodontists of the early twentieth century. At that time, neither the modern plastics for base plate materials nor stainless steel wires for clasps and springs were available and the appliances were rather clumsy combinations of vulcanite bases and previous metal or nickel-silver wires.

In the early 1900s, George Crozat developed a removable appliance fabricated entirely of precious metal that is still used occasionally. The appliance consisted of an effective clasp for first molar teeth modified from Jackson's designs, heavy gold wires as a framework, and lighter gold finger springs to produce the desired tooth movement. At that time the Crozat appliance was developed, a typical fixed appliance consisted of bands only on first molars, with wire ligatures tied to a heavy labial or lingual arch wire to align malposed teeth by expanding the dental arch. The Crozat appliance was a removable but more flexible version of the same device. Its metal framework and improved clasps made it greatly superior to alternative removable of that time. The clasping was good enough to allow the use of light interarch elastics, and Class II elastics were employed with Crozat appliances to treat Class II malocclusions.

The Crozat appliance attracted a small but devoted following, primarily in the area around New Orleans. It is still used by some practitioners, but had little impact on the main stream by American orthodontic thought and practice. From the beginning, the emphasis in American Orthodontics has been on fixed appliances and the steady progression of fixed appliance techniques in the US was described.

For a variety of reasons, development of removable appliances continued in Europe despite their neglect in the US. There were three major reasons for this trend:

1. Angle's dogmatic approach to occlusion, with its emphasis on precise positioning of each tooth, had less impact in Europe than in the US
2. Social welfare systems developed much more rapidly in Europe, which meant that the emphasis tended to be on limited

orthodontic treatment for large numbers of people, often delivered by general practitioners rather than orthodontic specialist;

3. Precious metal for fixed appliances was less available in Europe, both as a consequence of the social systems and because the use of precious metal in dentistry was banned in Nazi Germany, forcing German orthodontists to emphasize removable appliances that could be made with available materials (Precision steel attachments were not available until long after World War II; fixed appliances required precious metal).

The interesting result was that in the 1925 to 1965 era, American orthodontics was based almost exclusively on the use of fixed appliances, while fixed appliances were essentially unknown in Europe and all the treatment was done with removable, not only for growth guidance but also for tooth movement of all types.

A major part of European removable orthodontic appliance was functional appliances for guidance of growth.

Within the past 20 years, the dichotomy between European and American orthodontics has largely disappeared. European style removable appliances, particularly for growth modifications during first stage mixed dentition treatment have become widely used in the United States while fixed appliances have largely replaced by removable for comprehensive treatment in Europe and elsewhere throughout the World. At present, removable appliances are indicated primarily for three major uses:

1. Growth modification during mixed dentition.
2. Limited tooth movements, especially for arch expansion or correction of individual tooth position.
3. Retention after comprehensive.

The design, fabrication and clinical use of removable mechanical appliance alone in mixed dentition treatment and retention appliance are covered in this text.

The use of a removable appliance is to retract flared incisors. The labial bow with loops for greater flexibility and adjustment is normally used. The classic labial bow with loops in the canine regions bilaterally was designed by Charles Hawley in the 1920s and a removable appliance incorporating it is still often called a Hawley appliance or since it is frequently used as a retainer after compre-

## 6 *Removable Orthodontic Appliances*

---

hensive treatment, a Hawley retainer. A wire labial bow is usually included in removable appliances even if there is no desire to reposition the anterior teeth, because it provides some anterior stabilization for the appliance and helps control the position of incisor teeth that are not meant to be moved.

### **Components of Removable Appliance**

It consists of:

1. Active components – Bows/springs/elastics/screws
2. Retentive components – Clasps
3. Base plates – It provides framework to hold clasps and springs in position and also anchorage.



# 2

## *Labial Wire*

---

---

The labial wire is comprised of the following elements:

1. The incisor segment
2. The vertical loops
3. The occlusal crossover section
4. The retentive ends.

As a rule, a labial wire is provided with vertical loops in the canine areas. The incisor segment of the wire, depending upon the case, either contacts or stands slightly away from the middle third of the crowns of the incisors and ends with a right angle bend at the distal third of the lateral incisors or the mesial third of the canines. If the canines are to be actively influenced by the labial wire, the right angle bend of the vertical loop is placed in the canine area. The vertical loop consists of parallel vertical legs joined by a smooth curve. The height of the loops is 12 mm, usually extending 2 to 3 mm above the gingival margin level. The loop is positioned 1.0 to 1.5 mm away from the tissue.

The loops allow for adjustment to constantly changing occlusal situations arising during treatment. Constricting the loops shortens the wire; opening the loops lengthens it. These loop adjustments cause a vertical deflection of the incisor section of the wire, necessitating a compensatory bend at the distal leg of the loop or at the point where the end of the wire enters the acrylic. Repeated bending in this area can weaken the wire, leading to breakage.

The distal leg of the vertical loop approximates the embrasure between the canine and first premolar. The wire then crosses over the occlusal surface to its retention in the palatal or lingual acrylic. The occlusal crossover in maxillary appliances should be kept as

close to the mesial surface of the first premolar as possible, in order to minimize any occlusal interference. The end of the wire is bent back toward the gingival surface for retention in the acrylic. The incisor segment of a labial wire does not usually contact all incisors uniformly. Contact occurs on the most labially positioned incisor(s).

The vertical height of the incisor segment of the labial wire is directly related to type of movement desired. The tipping potential increase as the incisor segment approaches the incisal edges of the teeth, because the center of rotation is directly related to the point of coronal contact. The height of the incisor segment of the labial wire is adjusted upon initial insertion of the appliance and during subsequent visits.

Labial bows are used for following purposes:

1. To limit the labial movement of incisors.
2. To reinforce the anchorage.
3. Media through which pressure exerted in a lingual direction.
4. To carry an auxiliary springs and soldered attachments.
5. For retention purposes.
6. It carries modification of labial bow.

### TYPES

---

#### Short Labial Bow

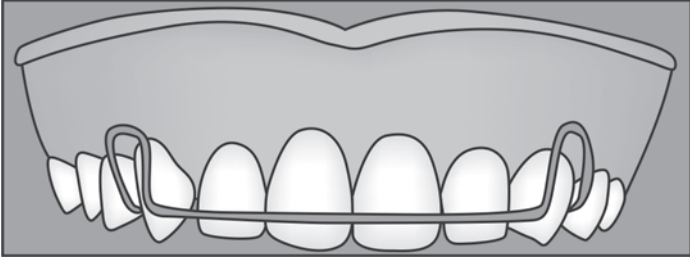
It is made from 0.7 mm wire. It carries a vertical loop which passes over the interdental contact points distal to canine. Both loops should be identical. The height of vertical loop is determined by the clinical crown height. The upper part of loop is located just 3 mm above the cervical line. The distance between the two arms of loop is again determined by mesiodistal dimensions of canine.

For small size of canine—bend started for loop near distal half of lateral incisors.

For bigger size—started at mesial angle of canine.

It is placed at the junction of incisal and middle third of crown—it is activated by compressing the each loop by 0.5 mm. It is indicated where there is minor tooth movement, for the purpose of retention

and for attachment of whip spring to correct single tooth rotation (Fig. 2.1).



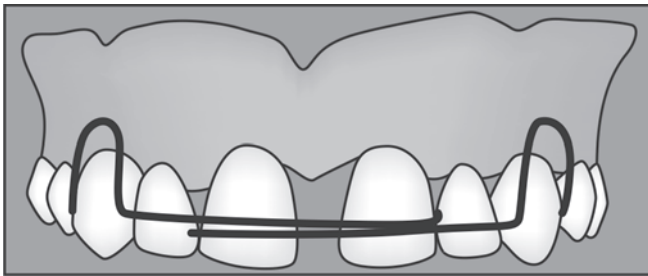
**Figure 2.1:** Short labial bow

### Long Labial Bow

It is similar to short labial bow except that it covers 1st premolar also. It is mainly used to close the space between canine and premolar and to control the canine position.

### Split Labial Bow

A short labial bow is split into halves. Each loop embraces the incisor of opposite side to close the mild midline diastema and minor rotation (Fig. 2.2).



**Figure 2.2:** Split labial bow

### Mills' Retractor

It is made up to 0.7 mm. It is used to correct severe protrusion of upper teeth. It is activated by compressing the horizontal loops. Minor alignment of tooth irregularities can be corrected (Fig. 2.3).

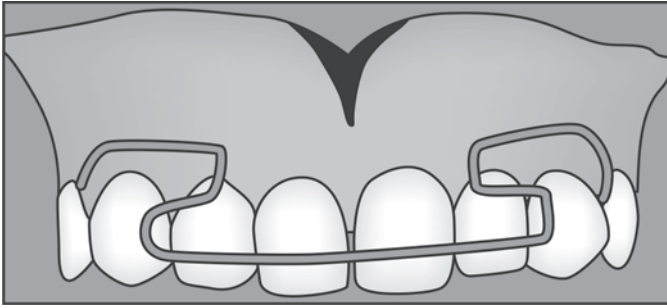


Figure 2.3: Mills' retractor

### Robert's Retractor

It is made up of 0.5 m. It is used for correction of severe proclination of upper teeth. It is activated by closing the coil. It is modified by adding tubing in the distal part of the coil in order to strengthen the wire while activating. This retractor is not like short and long labial bow but the loops carry coil and it is shaped like '^' shaped (Fig. 2.4).

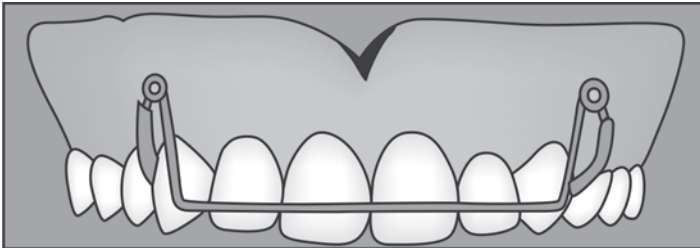


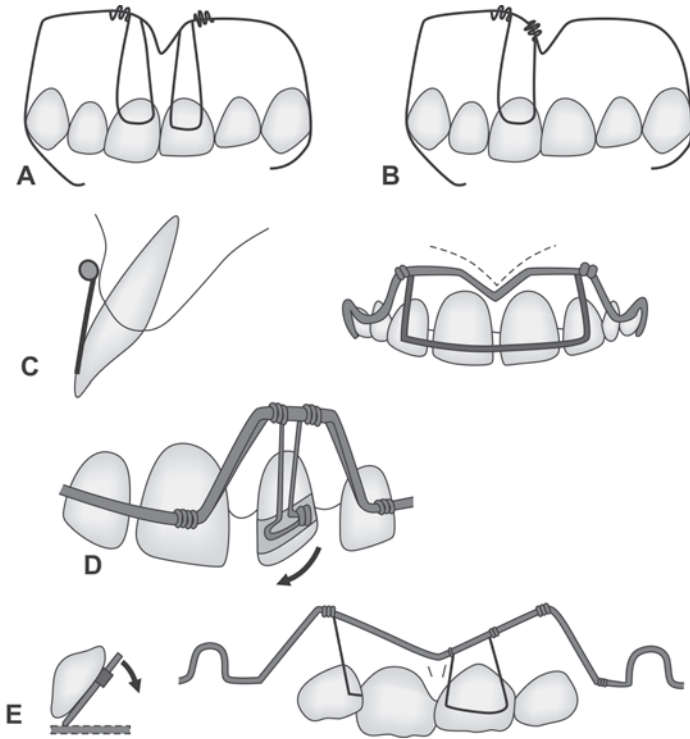
Figure 2.4: Robert's retractor

### Reverse Loop Labial Bow

It is made up of 0.7 mm. The loop is reversed passing in between first premolar and canine. The loop is activated by opening the loop.

### High Labial Bow

High labial bow acts as a base so, it is made up of thick wire 0.9 or 1 mm. The high labial bow is constructed by extending till the vestibular sulcus and giving relief for frenum. The wire is passed



**Figures 2.5A to E:** High labial bow with different designs of apron springs

between canine and premolar. In cases where there is abnormal frenula attachment, the high labial bow can be split in the midline and the free ends can be circled.

The apron spring is made by winding one end of 0.4 mm wire on to the base wire tightly and free end is soldered. It is formed as apron for one or two groups of teeth. The other end of apron is wound in the opposite direction and the free end is soldered. The design is shown in the Figures 2.5A to E.

### Fitted Labial Bow

It is made up of 0.7 mm and it is similar to short labial bow except that horizontal bow part is closely adapted onto the labial surface of the teeth. It is mainly used to control the corrected teeth as retentive device (Fig. 2.6).

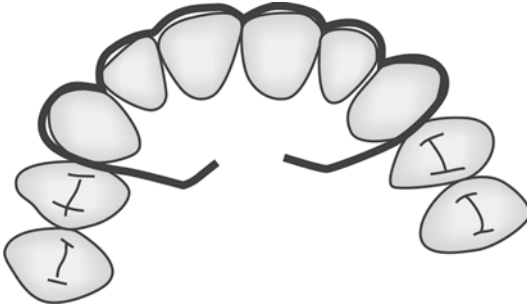


Figure 2.6: Fitted labial bow

### Soldered Labial Bow

The distal arm of the loop is not passed in between canine and premolar but it is extended posteriorly and the free end is soldered onto bridge of the Adams' clasp. It is indicated for retention of teeth after the active treatment is completed. The loop can be either passive or active. The loops can be activated if the extracted spaces get opened up (Fig. 2.7).

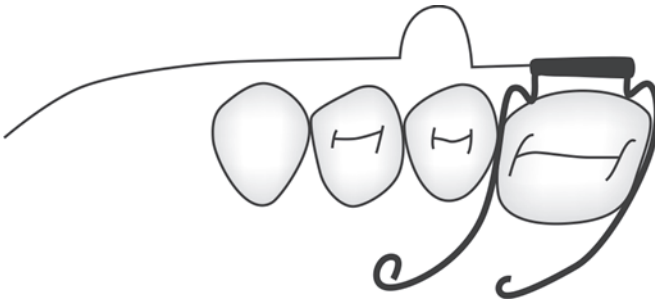
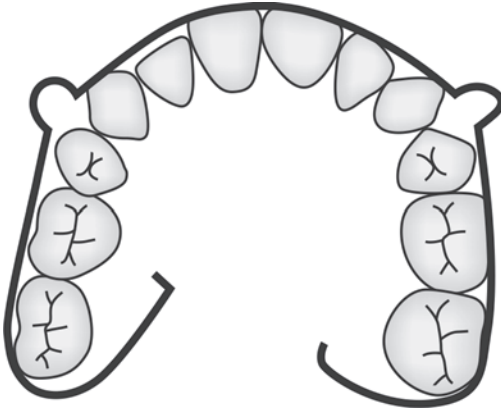


Figure 2.7: Labial wire is soldered to the bridge of Adams' clasp

### Begg's Retainer

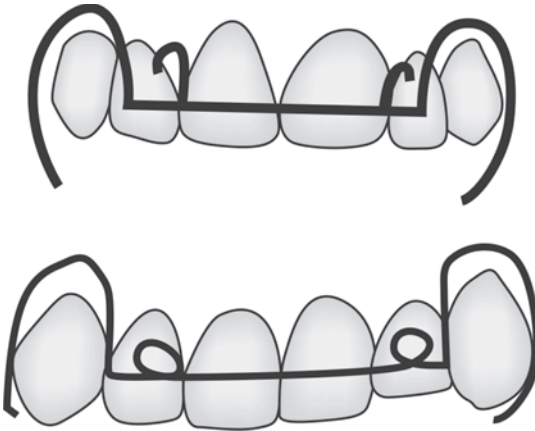
The labial bow which is used as retentive device, here is not like short or other labial bow. A single piece by wire is constructed with the loop at the extraction site and is extended on to the molar as clasp (Fig. 2.8).



**Figure 2.8:** Begg's retainer

### Labial Bow for 'J' Hook Attachment

Eyelets or hooks can be soldered onto the labial bow near the spot by distal part of the lateral incisors, for engaging the 'J' hooks of extra oral traction (Figs 2.9A and B).



**Figures 2.9A and B:** A. Short labial bow with 'J' hook for high pull head gear  
B. Short labial bow with eyelet hook for face bow

### Labial Bow with Small Hook

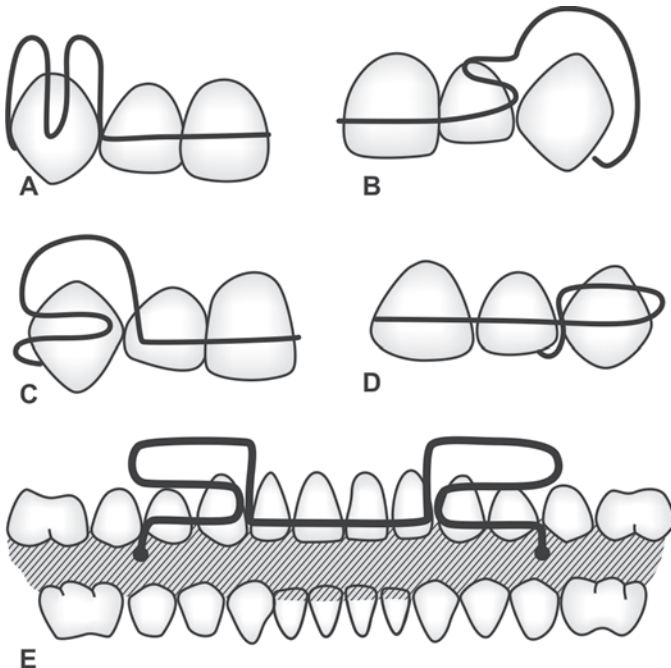
Labial bow with small hook on to the extruded single anterior tooth can be used for intrusion of tooth.

**Asymmetrical Labial Bow**

(One side loop on the canine and other side on the 1st Premolar). It is indicated where one side canine is either rotated or any space present distal to canine.

**LABIAL BOW VARIATIONS**

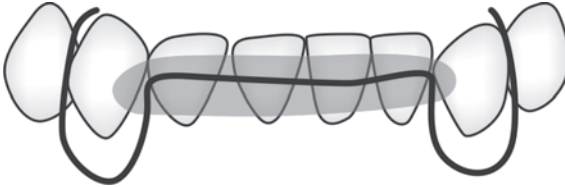
1. Loop position can be modified by combining the vertical loop of the labial wire with other loops and springs: The labial wire with a double loop as in Figure 2.10A offers the possibility of moving the crown palatally. Canine rotation is also possible by moving the center section of the loop to the mesial or distal surface. This type of loop is also useful where a large degree of tooth movement is anticipated. The increased amount of wire in this M-shaped loop offers great adaptation possibilities.
2. Other horizontal loops instead of M-shaped loop on canine is also possible to control the canine (Figs 2.10B to E).



**Figures 2.10A to E:** Other types of labial bow. **A.** Labial wire with vertical M-loops; **B.** Hooks for elastic bands can be either on mesial or distal leg; **C.** Vertical loop combined with horizontal loop for canine control; **D.** Modified loop at the canine. The horizontal segment is stabilized by the cross over; **E.** A canine loop design (Eschler 1971) can also be altered to move the lateral incisor



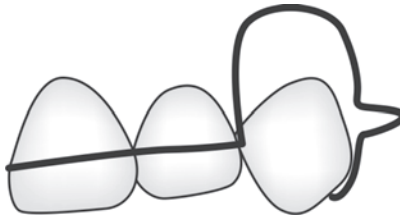
3. When a labial wire is covered with acrylic, the incisor section should be bent in a curvilinear fashion for retentive purposes. The acrylic covering is approximately 2 mm wide and should not touch the incisal edges. If the mandibular labial wire is constructed in this manner, occlusal interference must be avoided (Fig. 2.11).



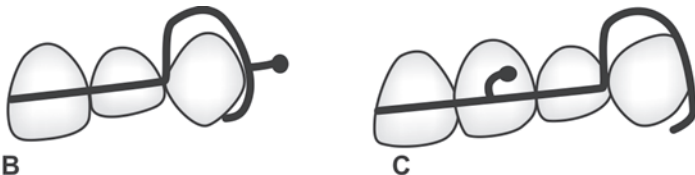
**Figure 2.11:** Labial wire sheathed in acrylic

4. The labial wire can also act as anchorage for elastic bands, which are used to move incisors or canines. Loops are bent into the labial wire or hooks are soldered to it to engage the elastic bands.

If additional loops are bent into a labial wire for anchorage of elastic bands, the resultant force vector should be as horizontal as possible. The point of force origin and the point of force application should be close to the occlusal plane (Figs 2.10A to 2.12C).



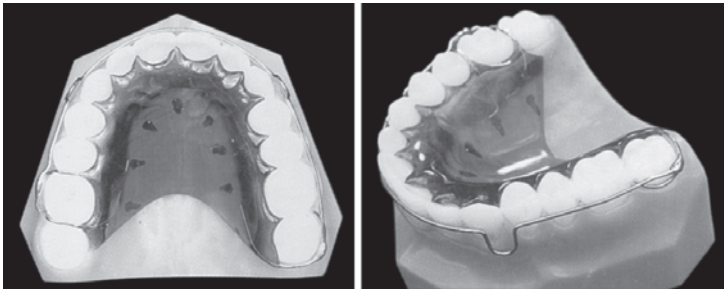
**Figure 2.12A:** Labial bow with distal leg on the loop for anterior elastic



**Figures 2.12B and C:** B. Labial bow with distal hook for elastic bands  
C. Hooks may be soldered in the horizontal section

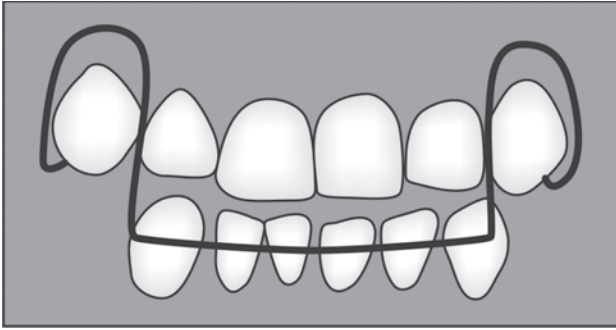
The use of Intermaxillary elastic bands on removable appliances is not new. It was described by Jackson (1904) at the beginning of this century. The application of Intermaxillary elastic bands to removable plates is greatly enhanced by the introduction of arrow head clasps and Adam's clasp with their superior retention ability. Intermaxillary elastic band traction can be applied to position the mandible anteriorly in CI II cases (CI-II elastic bands), as well as for posterior-directed section on the mandible in CI-III elastic bands) (Figs 2.12 A and B). Hooks or loops for elastic bands can be formed on the distal leg or mesial leg of the labial wire adjustment loops.

5. Maxillary retainer with minimal clasps to avoid occlusal interferences is fabricated. In this retainer, the labial wire extends distally to form small adjustment loops and terminates soldered to the bridge of Adams' clasp (Fig. 2.7).
6. When an appliance is made without clasps, a continuous labial wire is brought around the last molar to aid in retention. (Fig. 2.13).

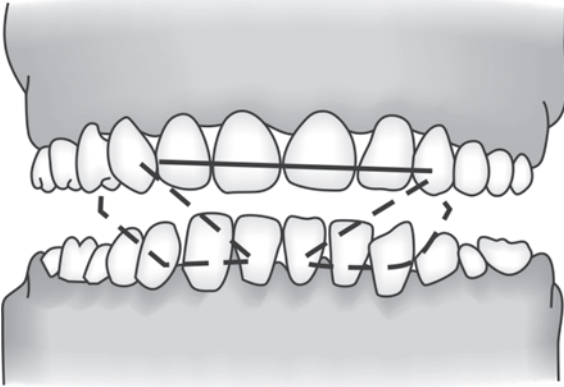


**Figure 2.13:** Wraparound or circumferential design: The labial loop can be either passive or active form. This design is given as retainer after orthodontic treatment

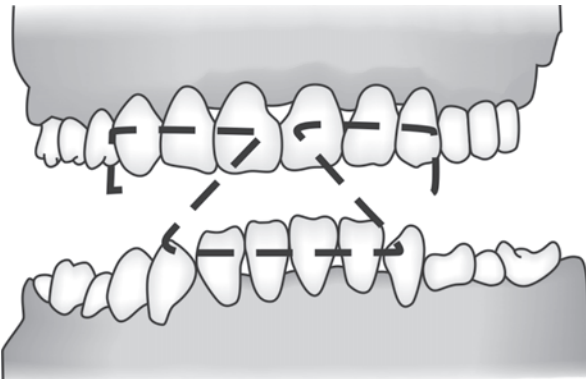
7. *Extended labial wire:* Although the labial wire is usually placed in a single arch, in certain cases, it can be extended to the opposite arch. Extended labial wires can be seen in the Figure 2.14A. This type of wire is formed from 0.9 mm. The large vertical loops can be provided with a helix to reduce stiffness of the wire. This labial wire inhibits forward mandibular movement and can tip the mandibular anteriors lingually (Figs 2.14A to D).



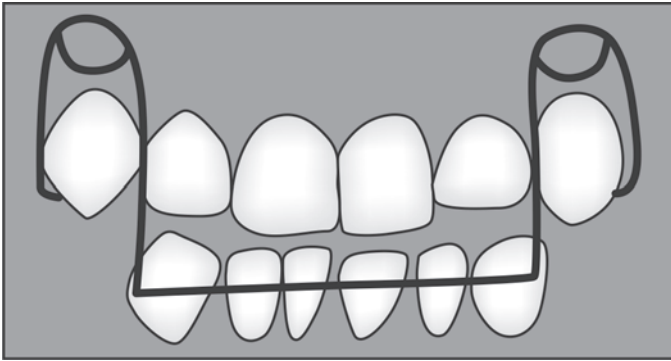
**Figure 2.14A:** Extended labial wire



**Figure 2.14B:** The positive segment contacts the maxillary incisors. The negative segment resides in the mandibular labial vestibule

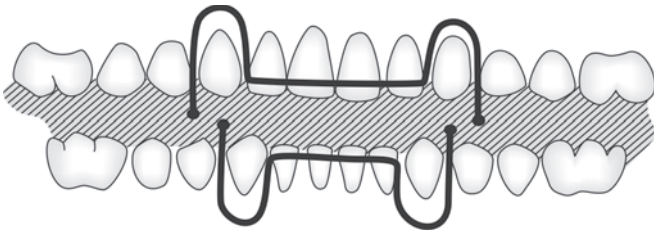


**Figure 2.14C:** Eschler labial wire: The positive segment contacts the mandibular incisors. The negative segment is in the maxillary vestibule



**Figure 2.14D:** Extended labial bow with helices in the loop

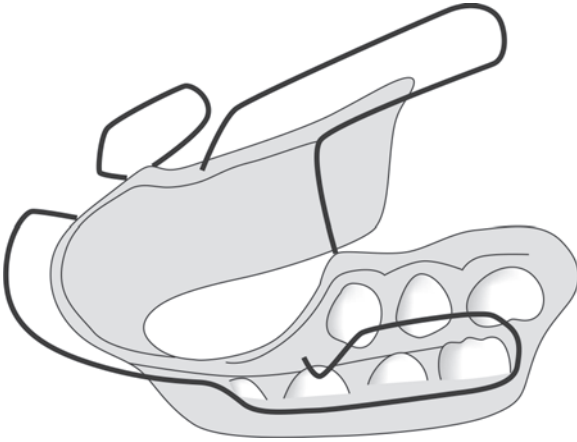
8. *Labial bow in activator:* It should be made in 0.9 mm and the distal leg of the loop of the labial bow is longer than the mesial leg and it is not adapted closely to the embrasure between the upper canines and the upper premolars (Fig. 2.15).



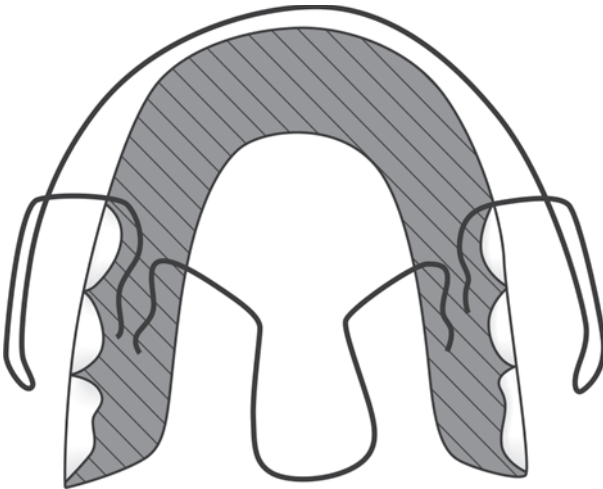
**Figure 2.15:** Maxillary and mandibular labial wires in activator. Note the distal arm of loop passes in the center of wax bite block to avoid damage of the wire during trimming of activator

9. *Labial bow in bionator* (Fig. 2.16).

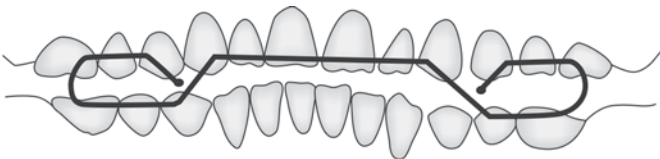
- a. Labial wire with buccinator extensions for the basic bionator (Figs 2.17A and B).
- b. Labial wire with buccinator extension for the tongue screening bionator (Figs 2.18A and B).
- c. Labial wire with buccinator extensions for the CI III bionator (Figs 2.19A to C).



**Figure 2.16:** Labial bow in bionator



**Figure 2.17A:** Basic bionator with palatal wire and labial bow



**Figure 2.17B:** Labial wire with buccinator extensions for the basic bionator

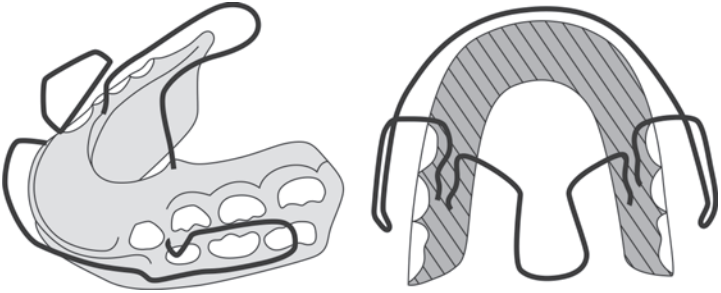


Figure 2.18A: Tongue screening bionator with palatal wire and labial bow

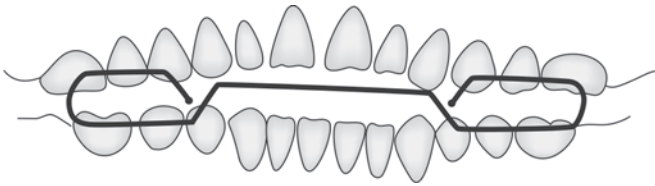


Figure 2.18B: Labial wire with buccinator extensions for the tongue screening bionator

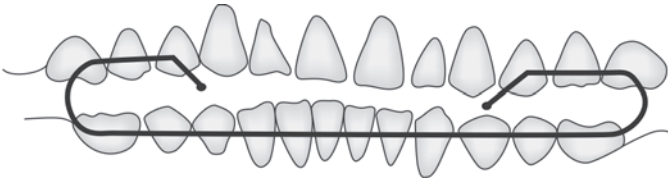
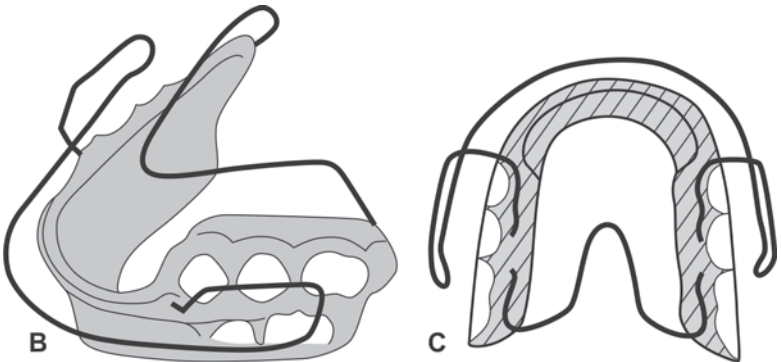


Figure 2.19A: Labial wire with buccinator extensions for the CI III bionator



Figures 2.19B and C: CI III bionator with palatal wire reversed and labial bow

10. Labial bow and lingual bow as in Frankel appliance (Fig. 2.20A).
11. Labial bow can be modified with loop facing incisally for high canine (Fig. 2.20B).
12. Labial wire is modified for impacted teeth (Fig. 2.20C).

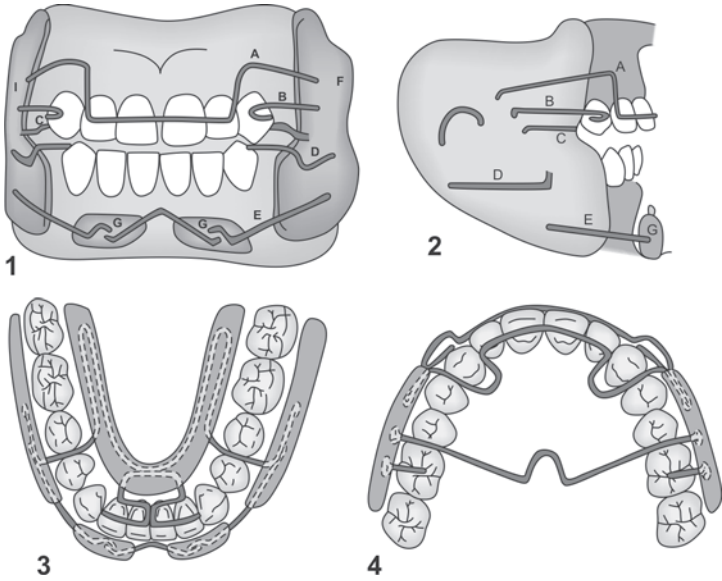


Figure 2.20A: Frankel II appliance: (A) Labial bow

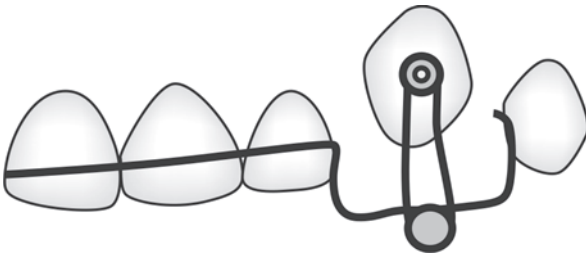
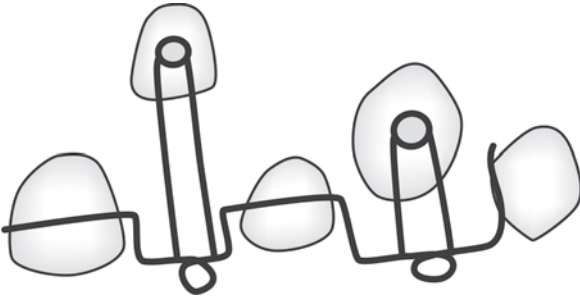


Figure 2.20B: Labial bow can be modified with loop facing incisally for high canines. Labial bow is made is 19 gauge wire



**Figure 2.20C:** Labial wire is modified for impacted teeth. Labial bow is made in 19 gauge wire



# 3

## *Clasp*

---

---

### **DEFINITION**

---

Clasp literally means to fasten or grasp. It is an attachment or a device used for fixation, stabilization or retention of an appliance.

Lawson and Blazuki define it as a part of an appliance that partially encircles the abutment teeth and aids in retention and stabilization.

Originally the term CRIB was used to loosely denote a clasp. Crib is metal frame work enclosure.

### **SIGNIFICANCE OF USING A CLASP**

---

1. It maintains mechanical efficiency of the appliance by ensuring that springs are continuously held in accurate position.
2. It helps in patient adaptation to the appliance by providing a firm fit. Habits, movements and initial difficulty with speech and eating are minimized.
3. Extraoral traction may be added without any risk of displacement.
4. Contribution by base plate is maximized by preventing forward sliding of acrylic plate down the curvature of the palate.

### **REQUISITES OF A CLASP**

---

1. It should provide adequate retention for the appliance.
2. It should not cause irritation to the buccal and gingival mucosa.
3. It should be devoid of occlusal interferences. Occlusal interferences can be eliminated by proper occlusal crossover, straight across the occlusal embrasure. Or it can be directed to fit into the occlusal embrasure.

4. Wedging or separation of teeth by clasps is undesirable.
5. It should engage either undercut or embrasure area.
6. Retentive arm should be 1 to 1.5 mm away from the represented tissue surface on the cast.
7. Clasps should be bio-compatible.
8. Wire should be gently contoured into the desired form. Sharp bends and overworking render it prone to breakage. They should not be overworked or stressed.
9. Since clasps are used in removable appliances, they should spring over the maximum contour of the teeth.
10. Solder joints should be avoided since they are potential sources of weakness. Such joints lead to corrosion and breakages. If solders have to be advocated they have to be polished well.
11. Clasps should be passive unless otherwise indicated. If activated, they cause tooth movement and distortion and breakage.
12. They should be strong enough to withstand masticatory forces.

### **MATERIALS USED**

---

Metal alloys can be used in fabrication of clasps and should possess the following properties.

1. Resistance to chemical action of fluids in the mouth.
2. Strength to withstand force imposed on it.
3. Ease of manipulation.
4. Resilience/springiness should be possessed so that it springs over the maximum contour of the tooth.
5. Easy to handle and solder.
6. Should be commercially produced.

Ideally platinised gold fulfills the aforementioned requirements and also retains its properties after heat treatment (platinum increases hardness and elasticity and lightens the color of gold). Stainless steel has all the properties but loses them on heating. It is economical with satisfactory results so it is widely used.

Resiliency of stainless steel is categorized as hard and springy.

Modulus of elasticity for hard wire is between  $14.5 \times 10^4$  to  $16 \times 10^4 \text{ N/mm}^2$ .

Modulus of elasticity for springy wire is between  $18.5 \times 10^4$  to  $20.5 \times 10^4 \text{ N/mm}^2$ .

Higher the modulus of elasticity greater is the elasticity and lesser the deformation under unanticipated forces. So, a wire with high modulus of elasticity, i.e. springy wire or spring tempered wire seems to be most suited, but its disadvantages are that it is difficult to bend and there is the danger of breakage.

With correct and slow manipulation avoiding nicks and scratches and use of smooth beaked pliers even hard wire can be rendered springy.

### **Patient Instructions**

Repeated workload, placement and replacement stiffen the wire which eventually breaks. So, patient should be trained to handle the appliance. Children are mostly in adapt to the above habit and the clasp wire distorts or breaks.

Clasps can be bent anywhere between 19 to 23 gauge wire. Wires of less diameter like 22 gauge wires are used to form narrow loops and can be used in anterior teeth and partially erupted teeth.

### **SELECTION AND DESIGN OF CLASP**

The selection and design of clasp depends on the case being treated. Since each is different, it is essential to visualize the condition. Design of a clasp is directed by

1. Amount of retention to be provided or factors tending to displace the appliance.
2. Condition of abutment teeth:
  - a. Partially erupted
  - b. Fully erupted
  - c. Presence of gingival recession.

In case of partially erupted teeth, the gingival tissue represented on the cast is carved to follow the contour of the future tooth.

In case of gingival recession, cemento-enamel junction is not engaged where maximum undercut is present. If engaged, clasp does not spring out.

1. Contact area
2. Occlusal and gingival embrasures
3. Undercut area
4. Morphology of the tooth—cervical ridge or curvatures which are invariably present on most teeth.

## **CLASSIFICATION OF CLASPS**

---

1. Based on number of retentive arms:
  - i. Single armed clasps.  
*Examples*
    - a. Ball end clasp
    - b. Lingual extension clasp
    - c. Triangular clasp
    - d. Eyelet clasp
    - e. Groth clasp
  - ii. Double armed clasps.  
*Examples*
    - a. Jackson's clasp
    - b. Crozats' clasp
    - c. Southend clasp
    - d. Adams' clasp
    - e. Arrowhead clasp
2. Based on the presence or absence of arrowheads.
  - i. Arrowhead clasps.  
*Examples*
    - a. Adams' clasp
    - b. Schwartz arrowhead clasp
    - c. Single arrowhead clasps
  - ii. Non-arrowhead clasps  
*Examples*
    - a. Lingual extension clasp
    - b. Ball end clasp

## **DESCRIPTION OF INDIVIDUAL CLASPS WITH THEIR MODIFICATIONS AND APPLICATIONS**

---

### **Evolution of Clasp**

The forerunner of clasps is thought to be a plain loop of wire fitted over the buccal gum margin of the tooth and is arched over the

contact points. It is activated or sprung towards the base plate causing the clasp to pinch the tooth against the baseplate. The clasp thus fits the buccal undercuts and the baseplate against the lingual undercuts of the teeth holding the baseplate in position.

### **Circumferential Clasp (C clasp or $\frac{3}{4}$ clasp)**

It is known as  $\frac{3}{4}$  clasp because it engages three surfaces the mesial, the buccal undercut and the distal surfaces of the teeth. Mainly used for 1st and 2nd molars and occasionally for canines. Easier to keep out of occlusal contact, than Adams' clasp. It is a supportive element rather than retentive. It has a single arm embedded into acrylic.

The clasp size can be individualized according to the morphology of the teeth so as to achieve the best fit and thereby the best retention for the plate. During treatment, the clasps can be adjusted (narrowed or widened without difficulty). The clasps can be active or passive. The other name for 'C' clasp is  $\frac{3}{4}$  th clasp and circumferential clasp. It is highly recommended in the case of mixed dentition period so that it will not interfere with the eruption of underlying permanent tooth (Fig. 3.1).

1. "C" clasp combined with an eyelet or small loop bend vertically or horizontally (Figs 3.2A and B).
2. "C" clasp with occlusal rest either mesially or distally placed to prevent supraeruption of molar or helps in intruding the molar by activating the occlusal rest (Fig. 3.3A).
3. "C" clasp with spur from the center of "C" curve to control molar rotation or push it slightly to palatal direction (Figs 3.3B and C).
4. Soldered 'C'-clasp: It is used for securing either upper or lower appliances when posterior clasp is not practical (Fig. 3.3 D)
5. High labial bow with 'C' clasp modification: A piece of wire can be soldered at the tip of 'C' clasp acting as ball end clasp for extra retention. Eyelet in the center of 'C' clasp is used for mild intrusion of molar by engaging the elastic band to the spur in the high labial bow (Fig. 3.3E).
6. Mesial "C" clasp in case of mild crowding of anteriors. The interdental arm is passed mesially between molar and premolar and it acts as a wedge to prevent mesial molar migration (Fig. 3.4A).

7. Distal "C" clasp in case of mild spacing in the anterior region. It is passed distally inbetween 1st molar and 2nd molar. It can be activated to close spaces anterior to 1st molar (Fig. 3.4B).

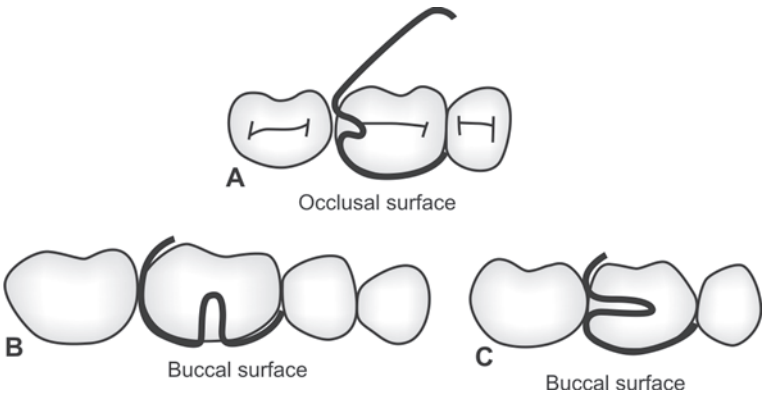
In difficult situations, the C-clasp retention can be increased with an auxiliary attachment such as a molar tube or by bonding a plastic ledge to serve as an undercut.



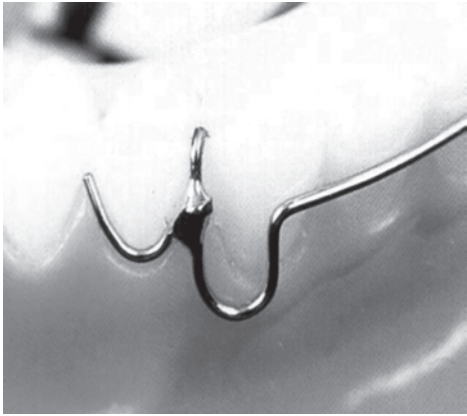
Figure 3.1: Circumferential clasp



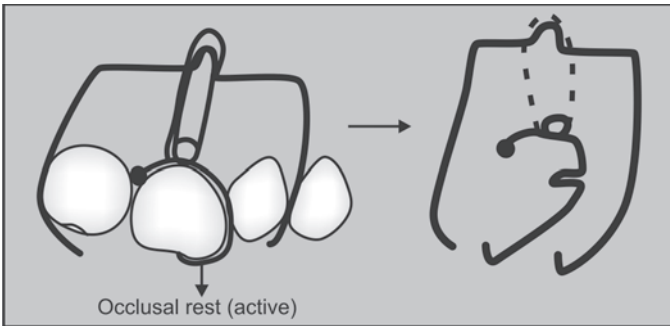
Figures 3.2A and B: A. 'C' clasp with vertical end loop; B. 'C' clasp with horizontal end loop



Figures 3.3A to C: Another 'C' clasp modification



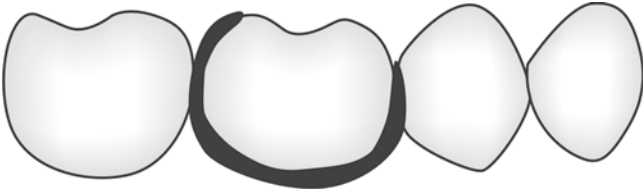
**Figure 3.3D:** Soldered 'C' clasp



**Figure 3.3E:** High labial bow with 'C' clasp modification



**Figure 3.4A:** Mesial 'C' clasp in case of crowding (Anterior)



**Figure 3.4B:** Distal 'C' clasp in case of spacing (Anterior)

### **Jackson's Clasp**

It is squared mesially and distally so that it makes contact with the mesial and distal undercuts (Fig. 3.5).



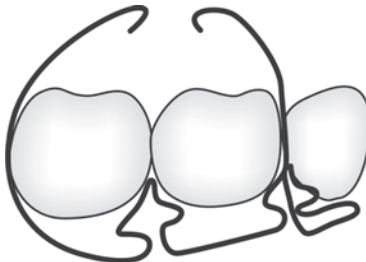
**Figure 3.5:** Jackson's clasp

### **Crozat's Clasp**

Crozat's clasp also makes use of mesial and distal undercuts. To an ordinary orthodontic loop an additional piece of wire is welded or soldered which runs into the mesial and distal undercuts.

### **Arrowhead Clasp (AM Schwarz -1935)**

It is a retentive element which finds wide application in primary, mixed and permanent dentition. It is fabricated with specially designed pliers a combination of two pliers (Fig. 3.6A).

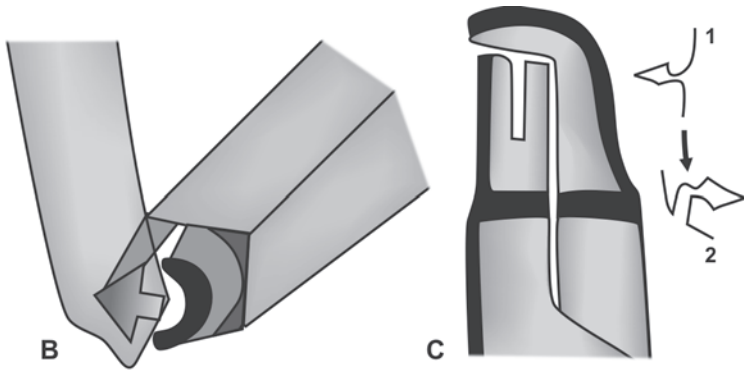


**Figure 3.6A:** Arrowhead clasp



For superior results in individual cases as embrasure area is different between any set of given two adjacent teeth, manual fabrication with flat beaked plier is preferred. To make an arrowhead clasp a 23 gauge wire is used.

Arrowhead must be bent in a horizontal plane perpendicular to the long axis of the tooth. For optimal retention arrowhead is adapted to the anatomic contour. Small tapered arrowheads are not preferred since they lie too deep into the interdental space where papillae are traumatized (Figs 3.6A to C).



**Figures 3.6B and C:** B. Forming an arrowhead clasp with special clasp forming pliers; C. Special arrowhead clasp for bending the tip of the arrowhead

Clasp arm should make a sweeping curve from the base of the arrowhead to its insertion as pointed out by Sthal-1958. In doing so the length of the wire is increased for adjustments, by the operator.

If short, it becomes stiff and exerts more force on interdental papillae and dislodges the plate. Arrowheads are continuous, 2 between 3 teeth or 3 between 4 teeth.

### *Use*

Incorporated into a removable appliance which is to be used for extraoral anchorage to provide high quality retention.

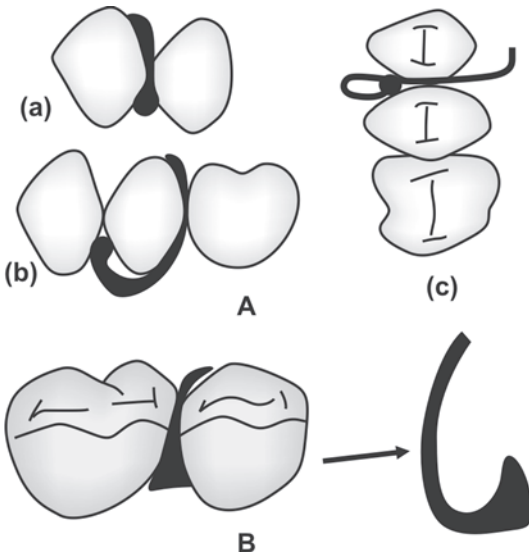
### *Disadvantage*

It causes separation of teeth.

**Ball End Clasp**

It uses the mesial and the distal undercuts of the teeth and can be fabricated using commercially available ball end wires or by adding a drop of solder at the end of the wire.

The wire is sprung into the angular undercuts as shown. Ball clasps formed with a short arm has less potential for adjustments. There before bent at 45° toward the interdental space. Ball end also finds application as a C-clasp. A 21 gauge wire is used (Figs 3.7A and B).



**Figures 3.7A and B:** **A.** (a) Ball clasp;. (b) Ball clasp bent as a 'C' form; (c) Ball clasp with extended arm; **B.** The arrow pin clasp, it is a solid arrow bent to penetrate into the interdental space. It provides very firm grip on the teeth

*Advantage*

It is easy to fabricate.

*Disadvantages*

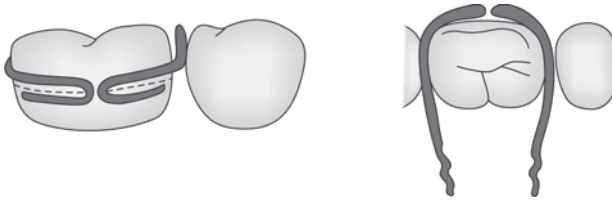
- It has a short span and so it is stiff
- Undercuts are not deeply engaged
- Only limited demands can be placed on them.

### *The Arrow Pin Clasp*

It is a solid arrow bent to penetrate into the interdental space. It provides very firm grip on the teeth (Fig. 3.7B).

### **Duyzing's Clasp**

Two stainless steel wires are bent over the maximum contour of the tooth from the mesial and distal aspect and then curved back below the maximum contour and ends are sprung. A 21gauge wire is used (Fig. 3.8).



**Figure 3.8:** The Duyzing's clasp. (From Duyzing's, JAC: Orthodontic appliances. Leiden, Stafleu and Tholen, 1969)

### **Lingual Extention Clasp**

It is designed to prevent occlusal interferences (idealistic). Theoretically such clasp is feasible by extending a spring element (of 25 or 26 gauge wire) into the gingival embrasure area from the palatal aspect between the upper 2nd premolar and 1st molar. This clasp provides enough retention for maxillary retainer.

#### *Advantage*

No occlusal interferences.

#### *Disadvantages*

- Impossible to adjust
- Prone to breakages
- Tissue irritation
- Tooth separation.

### Triangular Clasp (Zimmer-1949)

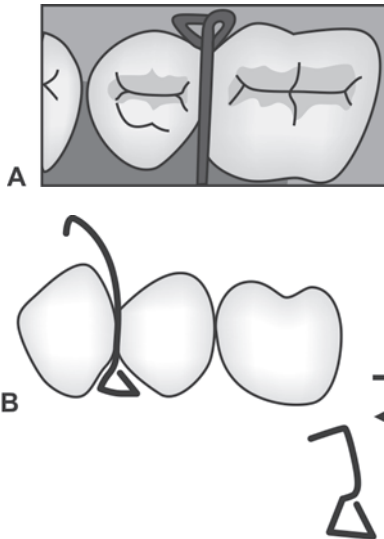
Uses interdental space gingival to the contact point or embrasure area. It is larger than ball end. Occlusally project 1.5-2 mm before being bent back into the gingival embrasure and this extension is used for adjustments.

The base of the triangle should be parallel to the occlusal plane. Angling them offers no retentive advantage. The apex of the triangle should fit snugly into the interdental space. The size of the triangular clasp depends on the embrasure (Fig. 3.9A).

The Zimmer (1949) triangular clasp is formed with its open end toward the teeth. Adjustment of this modification is especially easy. The longer clasp arm is also an advantage. The area of transition from the clasp arm into the first bend of the triangle increases its retentive capability (Fig. 3.9B).

### Zimmer's-Triangular Clasp (Fig. 3.9B)

Used between premolar areas because morphology presents adequate embrasure space for retention a 21gauge wire is used. Elastics can be engaged.



Figures 3.9A and B: A: Triangular clasp; B: Zimmer's triangular clasp

### Eyelet Clasp

It can be single or continuous and uses the interdental space gingival to contact. Its length is increased because occlusal part of the clasp arm projects 1.5 to 2 mm buccally before being bent back toward the gingival aspect.

Eyelet fits perpendicular to the long axis of the tooth into the interdental space.

A 21 gauge wire is used. When extraoral traction is applied retention is increased by multiple eyelets, between the posterior teeth (Fig. 3.10).

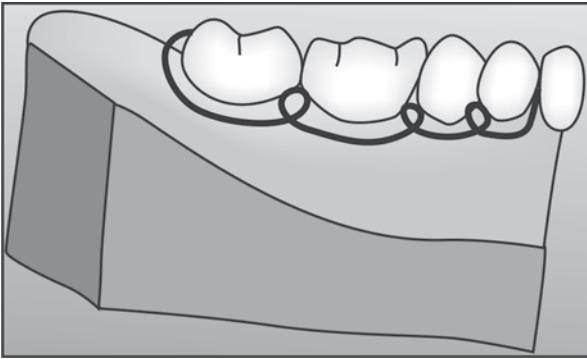


Figure 3.10: Eyelet clasp

### Groth Clasp

It has a small inverted 'V' reaching deep into the interdental space for anchorage. A long bow shaped arm is present on the buccal aspect for adjustments. Ideal for securing plates in primary dentition. A 21 gauge wire is used (Fig. 3.11).

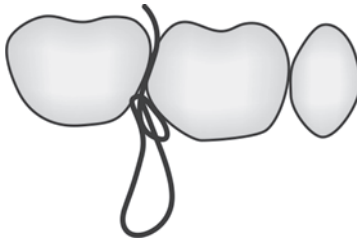
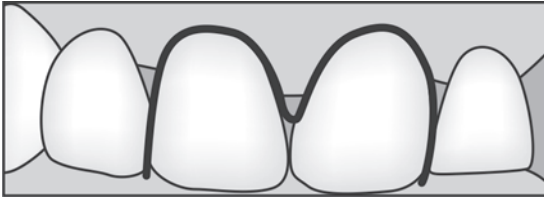


Figure 3.11: Groth clasp

### **Southend Clasp**

It is designed by Di Biase and Leavis. It is described by Stephans in 1979. It is fabricated on central incisors for retention with 19/21 gauge wire.

Follows the contour of gingiva but interdentially bent towards the gingival embrasure area, forming a kind of arrowhead. Engages the undercut in gingival 3rd. Has two arms which go into acrylic plate. Prepared for stability of removable appliances in the absence of lateral incisors. Tightened by pushing it at interdental crest (Fig. 3.12).



**Figure 3.12:** Southend clasp

### *Uses*

- Habit breaking appliance
- Space maintainer
- Retainer.

### **Adams' Clasp**

It is introduced by CP Adams in 1949. It is a modification of Schwarz arrowhead clasp. Most popular retentive device without which removable appliance therapy would be less successful. It is also known as the Liverpool clasp (universal clasp) or Modified arrowhead clasp. Contains bridge, arrowhead and retentive arms. It engage mesiobuccal and distobuccal undercuts of the tooth rather than the embrasure area. Thus, it does not separate the teeth.

Prior to fabrication of clasp, the cast for the tooth position, eruption and undercut is studied. The Adams' universal plier and 21 gauge wire is used. A piece of wire approximately 12 cm is straightened. The width of the bridge is said to be 2/3rd the maximum mesiodistal width of the tooth.

Ideally maximum width of the tooth is in its middle 3rd where it contacts the adjacent teeth but if 2/3rd of this width is used, the arrowheads will lie in the embrasure area rather than the undercut areas, which is not the requirement of an Adams' clasp.

The posterior teeth are somewhat spheroidal in their buccal and lingual views. They taper from the point of contact, both occlusally and (more) gingivally so that 2/3rd of the mesiodistal width of the occlusal surface, corresponds to the undercut area. We need to engage and is adequate (and not the cemento-enamel junction).

After estimating the width of the bridge, two right angled bends are given and then made acute so as to overlap.

Arrowhead bend is made such that bridge will lie in the middle 3rd of the tooth. To make an arrowhead first, a sharp bend is made parallel to the bridge.

The bridge of the clasp is laid against the back of the plier and the tip of the plier engages the first arm of the arrowhead to bend the arrowhead outside the beak of the plier. Similarly, the second arrowhead is made.

The arrowheads are squeezed and adjusted but while doing so outward pressure is exerted so that the arms of the arrowhead remain parallel and then checked on the tooth. Arrowheads are bent 45° toothward, to align them with the contour at the undercut. Also a downward and toothward thrust is laid for the same reason. The clasp is tried on the tooth for fit.

A bend is given on the retentive arm such that the length of the second arm of the arrowhead is half of the first arm. After laying the bridge across the beak and grasping the arrowhead at the suitable level, a bend is given in a direction parallel to the bridge (Fig. 3.13).

### *Essential Features of Adams' Clasp*

- Bridge should be straight
- Bridge is halfway between the occlusal surface of the tooth and the gum margin
- Bridge stands away from the tooth surface -2 mm
- Bridge should be parallel to the buccal segment and not the buccal-surface of the tooth

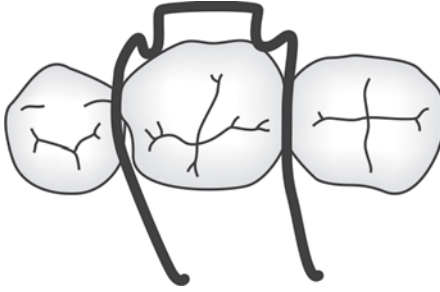


Figure 3.13: Adams' clasp

- Arrowheads are parallel
- Arrowheads should contact the tooth only at the extreme ends
- Uniform space is left between the tags and the represented tissue surface of the cast
- Excessive sharp bends weaken the wire and so are avoided
- Arrowhead should be sufficiently long
  - 0.6 mm for canine (22 gauge)
  - 0.7 mm for molar (21 gauge).

#### *Precautions*

Erupting teeth, recession of gingiva.

#### *Clinical Adjustments*

The clinical adjustments can be carried out at the following:

- At first occlusal bend (CP Adams)
- At the second occlusal bend or point of attachment
- By directing arrowhead points toothward
- Bridge is bent towards or away from the tooth surface.

#### *Advantages of Adams' Clasp*

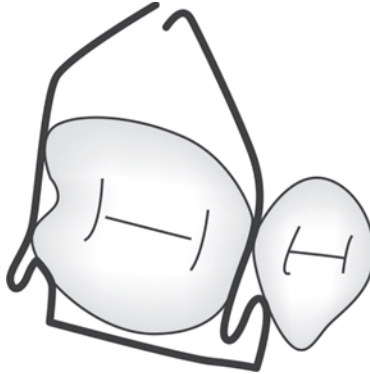
- Makes use of undercuts mesiobuccal and distobuccal and not embrasure area and so can be used in isolated teeth
- Small, neat, unobtrusive. Occupies minimum space in buccal sulcus and base plates
- Universally applicable any tooth deciduous, permanent and semi-erupted teeth
- Strong firm, resists distorting and masticatory forces



- No special pliers are required
- Can be easily repaired
- Can be modified to suit the needs.

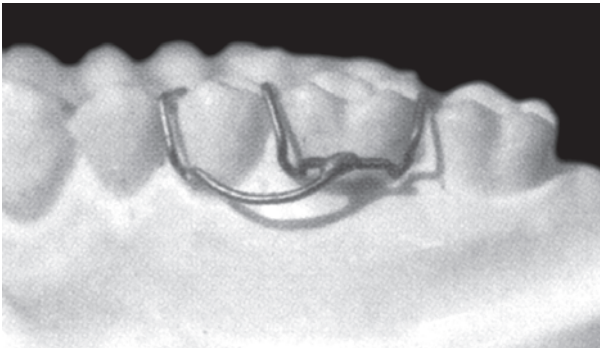
### *Modifications of Adams' Clasp*

1. Horizontal bent loops that extend directly into the interdental space (Fig. 3.14).



**Figure 3.14:** Adams' clasp with horizontal loop

2. Vertical loops may be used in cases where molars positioned loops contact the proximal surfaces of the tooth.
3. It can also be made with only one vertical "C" clasp (Fig. 3.15). It is indicated when an adverse gingival condition is present in one proximal area, for example, on the distal aspect of a partially erupted molar.



**Figure 3.15:** Clasp with single arrowhead

- 4. A clasp similar to the Adams' clasp is the universal adjustment (Fig. 3.16).

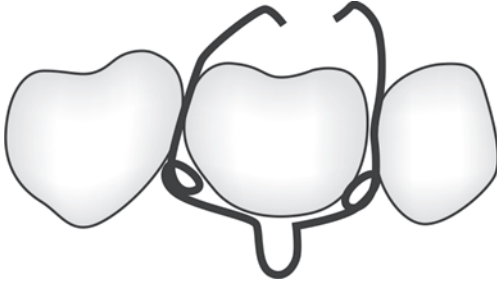


Figure 3.16: Universal clasp with loop

- 5. Adams' clasp with a triangle inbetween molar and premolar as in the case of multiple Adams' clasp (Fig. 3.17).



Figure 3.17: Adams' clasp with a triangular clasp

- 6. Adams' clasp with an arrowhead instead of triangular clasp (Figs 3.18A and B).

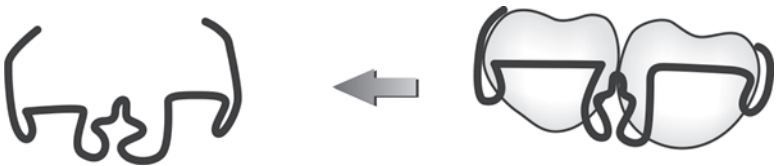
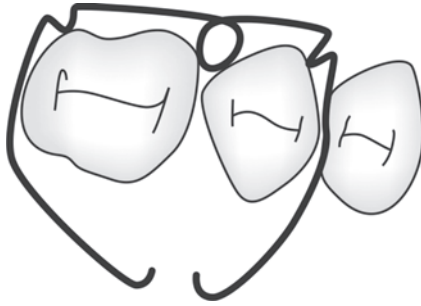
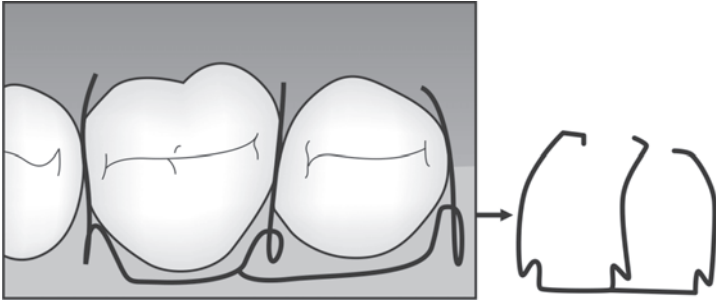


Figure 3.18A: Adams' clasp with arrowhead clasp



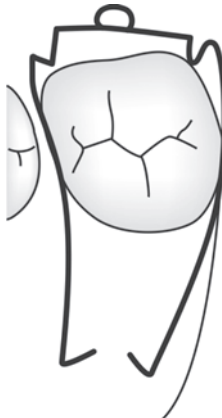
**Figure 3.18B:** Adams' clasp with eyelet facing embrasure

7. Multiple Adams' clasp covering more than one tooth (Fig. 3.19).



**Figure 3.19:** Multiple Adams' clasp

8. Inverted question mark hook or eyelet is attached on the bridge of Adams' (Figs 3.20A and B).

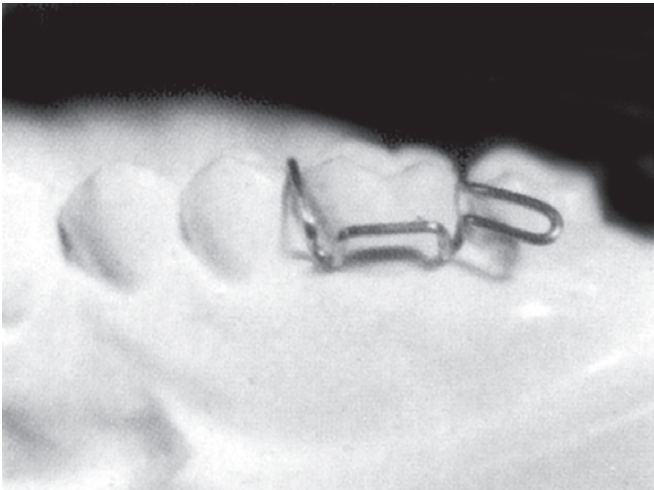


**Figure 3.20A:** Adams' clasp with eyelet on the bridge



**Figure 3.20B:** Adams' clasp with inverted question mark soldered on to the bridge

- 9. Adams' clasp with traction hook which engages elastics (Fig. 3.21).



**Figure 3.21:** Clasp with spur

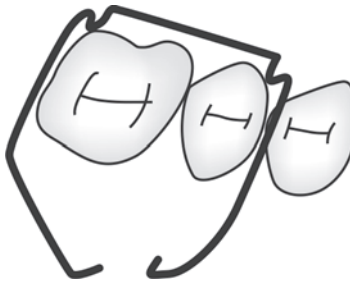
- 10. Auxiliary / Accessory clasp with Adams' clasp (Fig. 3.15).
- 11. Adams' clasp for extraoral traction: To prevent anchor teeth

from moving mesially when upper anterior teeth are being retracted. Extraoral traction at night are given via face bow engaged in molar tube of Adams' clasp. Rest of the appliance is worn throughout.

12. Adams' clasp on incisors is called double Adams' clasp (Figs 3.22A and B).



**Figure 3.22A:** Double Adams' clasp on two central incisors



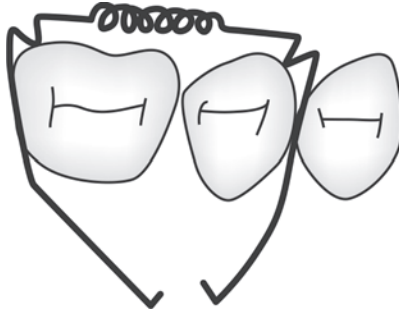
**Figure 3.22B:** Adams' clasp covering two buccal teeth

13. Adams' clasp with soldered tube (Fig. 3.23).



**Figure 3.23:** Adams' with soldered tube: Buccal tube can be attached on the bridge of Adams' clasp

14. Adams' clasp with helical spring coils to incorporate in the bridge for face bow (Fig. 3.24).



**Figure 3.24:** Double Adams' clasp carrying coils fabricated on the bridge for insertion by inner face bow

15. Adams' clasp in combination;
- a. With triangular clasp (Fig. 3.17).
  - b. With arrowhead clasp (Fig. 3.18A).
  - c. With eyelet clasp (Fig. 3.18B).

To prevent anchor teeth from moving mesially when upper anterior teeth are being retracted. Extraoral traction at night given via face bow engaged in molar tube of Adams. Rest of the appliance is worn throughout.

*Limitations of Adams' Clasp:* According to CP Adams temptation to use Adams' clasp on anterior teeth should be resisted and so should over-extending on many teeth because its clasping efficiency is best when used on single tooth. Proclined incisors Adams' clasp is unsatisfactory. When retentive arrowhead required in groups of two, i.e. both teeth need to be clasped, accessory clasp is used but solder joint is a potential source of weakness.

16. **The Resta clasp** is a modified version of the Adam's clasp. It uses the arrowhead retentive point from the Adam's clasp and the ball from a ball clasp to engage two undercut areas on the buccal surface of the anchor tooth. The clasp wire passes over the occlusal surface of the clasped tooth either on its mesial or on its distal side. The clasp is useful when interocclusal clearance or space is available on only the mesial

or distal side of the tooth to be clasped. Although not as retentive as Adam's clasp, the Resta clasp has the ability to perform well in retainers. The making of a Resta clasp is easier and quicker than the forming of an Adam's clasp. The Resta clasp is formed from preformed stainless steel ball clasp wires having diameters of 28 mil for premolars and 30 or 32 mil for molars.

### **Single Arrowhead Clasp**

It is indicated in a situation as above. Single arrowhead clasp 0.8 mm straight wire. Mesiobuccal corner of the upper 2nd premolar. Thicker gauge so stronger. Avoidance of solder has less chances of breakage.

### **Incisor Clasp**

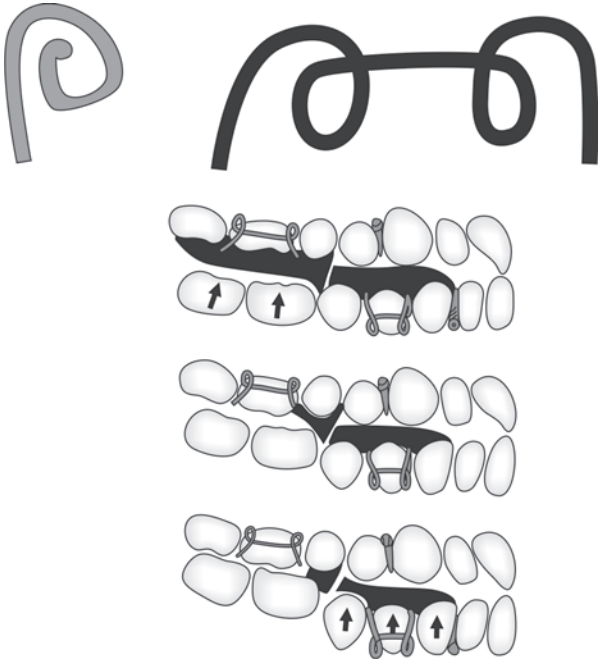
Adams' not suitable for anterior teeth and thus alternative clasps can be used.

### **Universal Clasp**

It is similar to Adams' clasp. Instead of arrowhead, helix incorporated in the undercut. Here, it is in combination with buccal adjustment loop (Fig. 3.16).

### **Delta Clasp**

- Designed by WJ Clark of Scotland
- A 0.8 mm wire, i.e 20 gauge wire
- Provides excellent retention for lower premolar. Requires minimal adjustments
- Used in twin block functional orthopedic appliance (Fig. 3.25).



**Figure 3.25:** Delta clasp

### **AUXILIARY METHODS OF INCREASING RETENTION**

- By cutting grooves in the enamel of a tooth. Undercut was created to accept a clasp arm
- A bend with artificial undercut such as a buccal tube provides undercut
- Bonded plastic (composite resins) to create horizontal ledge
- Direct bonded buttons and brackets from fixed armamentarium.



# 4

## *Springs*

---

---

In designing springs to move a tooth facially, lingually, or mesio-distally within the arch, two important principles must be kept in mind:

1. The design must ensure adequate springiness and range while retaining acceptable strength. This usually means using recurved or looped wires for additional length and
2. The spring must be guided so that its action is exerted only in the appropriate direction.

In general, it is better to use a larger wire for its greater strength, and then gain springiness and range by increasing the length of the spring, than to use a smaller wire initially. Examples of the springs are:

1. Helical spring for distal tipping of molar
2. Paddle spring for labial movement of an incisor and
3. Buccal loop spring to tip a canine lingually.

The major problem with long flexible springs is that the spring can deflect three-dimensionally even though tooth movement in only one direction is usually desired. For instance, if a spring is placed against a lingually positioned incisor, it will be ineffective as it distorts vertically, sliding down the lingual surface toward the incisal edge. This is a problem with any spring against any tooth surface: unless the spring remains in its planned position, its action will be unpredictable.

This difficulty can be overcome in three ways:

1. Place the spring in an undercut area of the tooth, so that it cannot slip toward the occlusal surface for example, the end of this helical spring to tip the first premolar posteriorly is held in position because it engages the mesial undercut of the premolar.

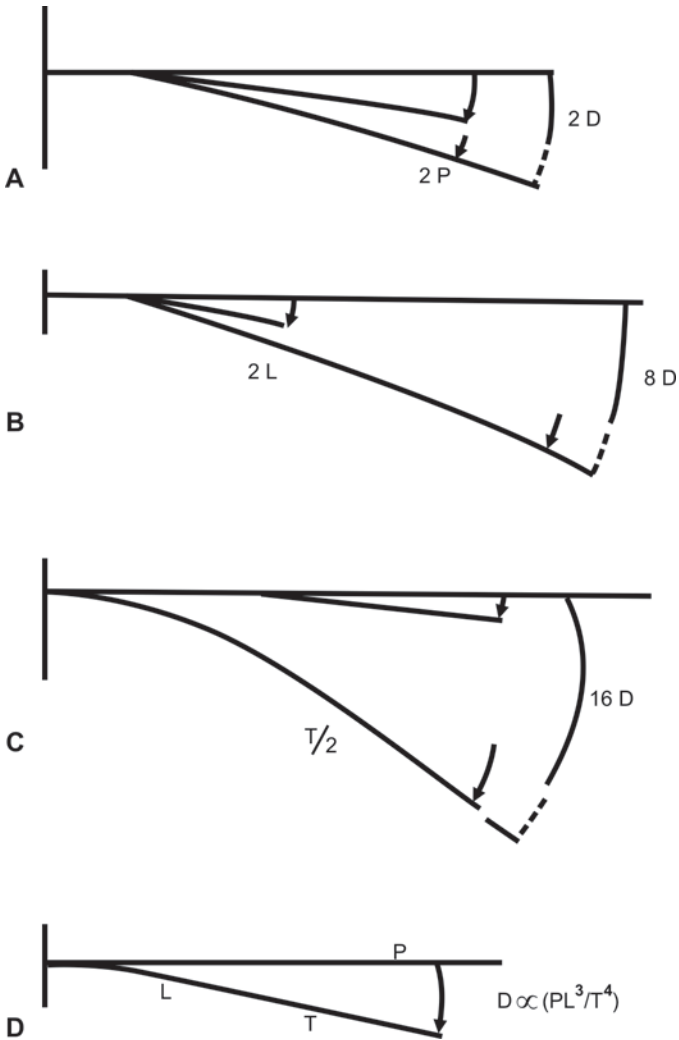
2. Use a guide to hold the spring in its proper position. This approach is often necessary with active springs to move the canine and incisors labially, because no undercuts are available on the lingual surfaces. The guide can be called as guided spring or the spring can be boxed with acrylic material.
3. Bond an attachment to the tooth surface to provide a point of positive attachment for the spring.

The most generally useful spring for removable appliance is the cantilever spring. In scientific terms, the connection between the length, thickness and amount of deflection of a cantilever spring of round section is expressed by the formula.

$D \propto PL^3/T^4$  where D is the amount of deflection, P the amount of pressure, L the length of the spring and T the thickness (Figs 4.1A to D).

This means that for a given cantilever spring' deflection will be double when pressure is doubled, deflection will increase by eight times if the length of the spring is doubles and 16 times if the thickness of the wire is halved (Fig. 4.1A). When designing a spring for a particular tooth movement, the requirements are to ensure that the spring will act over the distance and in the direction needed to move the tooth that is being treated, that the spring will exert a suitable pressure to produce tooth movement and that the spring will at the same time be mechanically strong enough to withstand the interferences that occur in the mouth in eating and speaking and during cleaning after meals.

Planning the design and layout of a spring entails selecting a point of attachment so that the free end sweeps along the intended line of movement of the tooth; further details are to ensure an optimum combination of length, number of coils, thickness, shape of the spring and provision for guarding and guiding the spring over its range of activity. If these features are well conceived, the resulting appliance will be comfortable to wear, sure in action, trouble-free and easy for the patient to insert, remove and keep clean. To conclude, longer the wire, thinner the wire will give long range of action (Table 4.1).



**Figures 4.1A to D:** A cantilever spring is fixed at one end and free to move at the other which deflects under pressure and delivers a gradually diminishing pressure in returning to its original form **A**. The degree of pressure is proportional to the amount of deflection produced; **B**. If the length of the spring is doubled, the degree of deflection becomes eight times as great for the same amount of pressure; **C**. If the thickness of the spring is reduced to one-half, the amount of deflection becomes 16 times as great for the same amount of pressure; **D**. Deflection, pressure length and thickness are related by the formula at the right of the illustration

**Table 4.1:** Pressures of springs

<i>Spring type</i>	<i>Length (mm)</i>	<i>Thickness (mm)</i>	<i>No. of coils</i>	<i>Inner diameter of coils (mm)</i>	<i>Deflection for 20 g pressure (mm)</i>
Apron	12	0.3	4	1.0	9.0
Finger	18	0.5	1	2.5	3.0
Self supporting	10 15	0.7 0.7	1	3.5	0.6

In designing springs to move a tooth facially, lingually or mesio-distally within the arch, a few important principles must be kept in mind. Ideal qualities of orthodontic wires to form a spring are (i) flexibility, (ii) spring back action, (iii) formability (The wire should be bent at any configuration).

**PHYSICAL PROPERTIES OF WIRE**

1. Rigidity
2. Resistance to distortion
3. Susceptibility to fracture. The flexibility of wire depends on the length by wire and its diameter. The effective length is increased by incorporating a coil at least 3 mm in diameter. If a thin wire is used, deflection will be doubled.

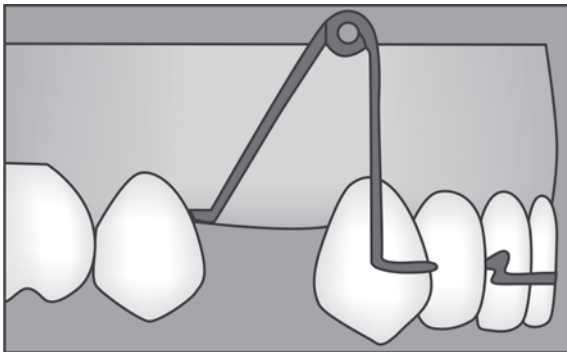
**CLASSIFICATION OF SPRINGS**

- I. Based on the direction of tooth movement brought about by the springs, they can be classified as:
  - a. Springs used for mesiodistal tooth movement
  - b. Springs used for labial movement
  - c. Springs used for lingual movement expansion of arches
  - d. Springs used for expansion of arches.
- II. Based on the nature of support required for its action, orthodontic springs can be broadly classified as:
  - a. Self supporting spring
    - i. Buccal canine retractor
    - ii. Helical canine retractor
    - iii. Palatal canine retractor
    - iv. Reverse loop buccal retractor
    - v. 'U' loop canine retractor.
  - b. Guided spring
    - i. Finger spring
    - ii. Cantilever spring

- c. *Auxiliary spring*: High labial bow with apron spring for any retractor, there are active arm and passive arm. Self supporting spring.
- III. According to placement
  1. Buccal/labial
  2. Palatal/lingual
- IV. Number of arms in a spring
  1. *Single cantilever*: The spring has only one arm and one coil.
  2. *Double cantilever*: The spring has two arms and two coils when two teeth are moved in the same direction.
- V. According to coil
  1. Spring with coil
  2. Spring without coil.

### *Buccal Canine Retractor*

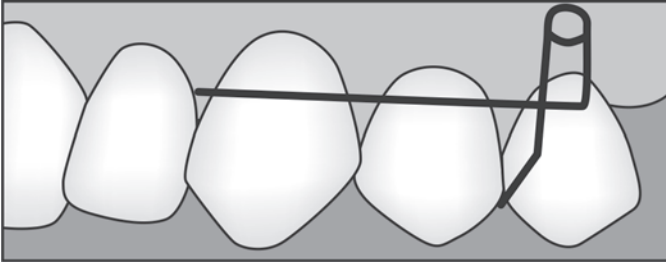
It is indicated where a buccally placed canine is to be moved distally as well as palatally. It is not popular because liable to cause discomfort for the patient. It is difficult to adjust and unstable in the vertical direction. However, it can be adjusted with the precautions: the free end should be adapted in such a way, so that it encircles the canine at the cervical third. After every activation, the free end is cut and readapted. The activation is by closing the coil by 1 mm. Since the 0.7 mm wire is used, deflection is small and hence frequent adjustments are necessary. The retractor carries a helix which lies at the extraction site and the free end passes through mesial aspect 2nd premolar. Tubing should be done to support the passive arm of retractor (Fig. 4.2).



**Figure 4.2:** Buccal self-supported canine retractor

*Helical Canine Retractor*

It is made up of 0.5 mm. The active arm lies below and it carries a  $1\frac{1}{2}$  coil helix and the passive arm lies over the active arm and passes through the mesial aspect of 2nd premolars. The both arms of the helix should be parallel. The activation is by opening the coil and the arms of the loop unparallel after activation. The free end is cut by 1 mm after every activation. The free end should engage the canine at the embrasure and should be readapted every time. It is indicated where the canine lies in the occlusal plane (Fig. 4.3).



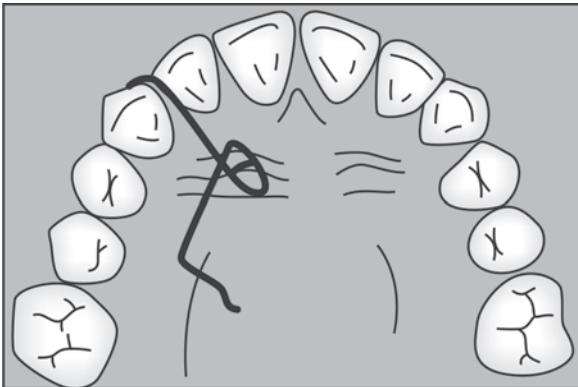
**Figure 4.3:** Helical canine retractor

*Reverse Loop Canine Retractor*

It is same as helical canine retractor but it is given for lower teeth.

*Palatal Canine Retractor*

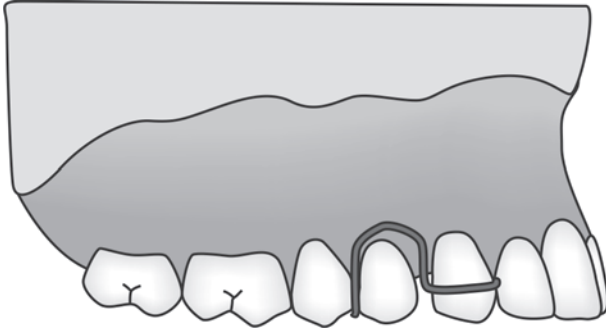
Helical canine retractor is given on the side but palatal canine retractor is given on the palate (Fig. 4.4).



**Figure 4.4:** Palatal canine retractor

### 'U' Loop Canine Retractor

It is made up of 0.7 mm and activation is by compressing the loop. The other features of the retractor remain the same as other retractor. It is given on the buccal side (Fig. 4.5).



**Figure 4.5:** 'U' loop canine retractor

### Guided Spring

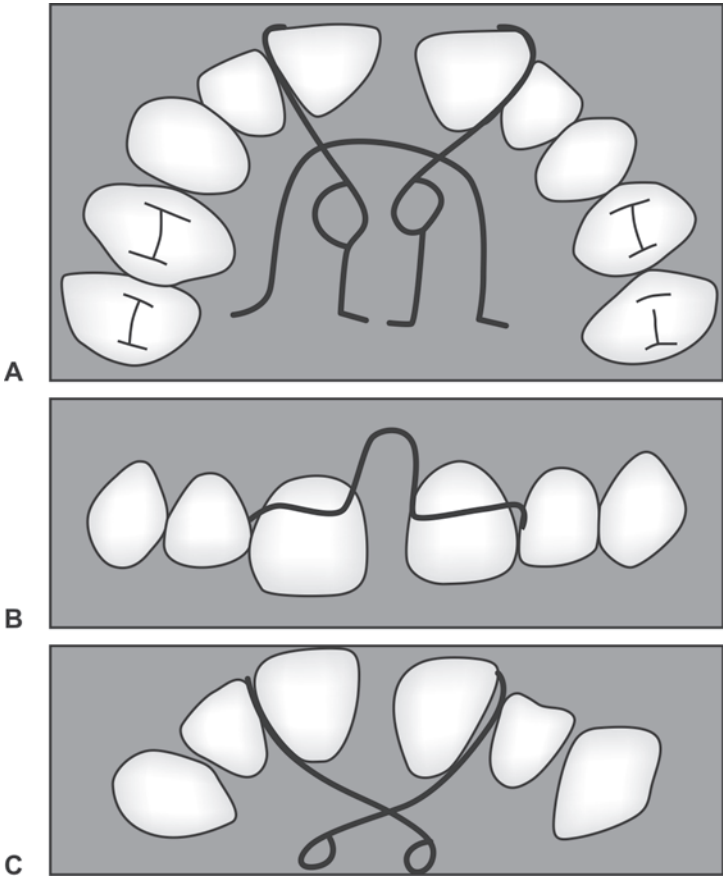
The use of thinner wire gets distorted by the tongue forces. Hence, the spring has to be guided.

### Finger Spring

This spring is used to bring about mesial or distal movements of teeth. For example, midline diastema. The active arm of spring lies close to the tissue and carry one and half turn coil. The coil is positioned midway between the initial and final position of the tooth. The coil should be on the opposite side of the direction of tooth movement. The activation is by opening the coil and the free end is readapted (Figs 4.6A to C).

### Cantilever Spring

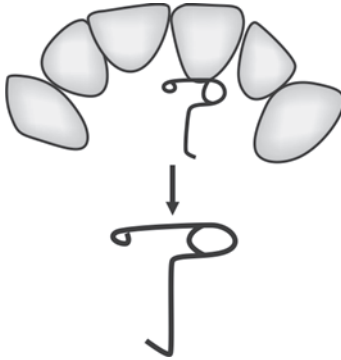
1. Single cantilever spring
2. Double cantilever spring
3. Cranked spring
4. 'Z' spring without coil.



**Figures 4.6A to C:** Midline diastema correction. **A.** Finger spring; **B.** Closed proximal spring with adjustment loop; **C.** Crossed retention arms of closed proximal spring

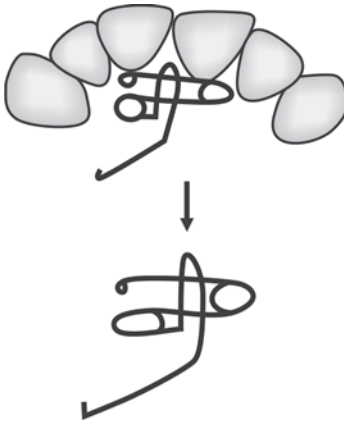
*Single cantilever spring:* It is made out by 0.5 mm and active arm should be parallel to the occlusal plane or at right angle to the long axis of the tooth. The active arm lies below and carry one and half coil. It is indicated for correction of labial movement by single tooth, e.g. anterior cross bite or lingually placed anterior tooth. It is activated by opening the coil. While activating, it is ensured that the active arm lies always at right angle to the tooth which is to be corrected (Fig. 4.7).





**Figure 4.7:** Single cantilever spring

*Double cantilever spring:* It is similar to single cantilever spring except it carries double helices. The passive arm of the first coil, becomes active arm of the 2nd coil. The activation is done on both coils. It is indicated in anterior arms bite, e.g. two teeth involvement (Figs 4.8 and 4.9A to D).



**Figure 4.8:** Double cantilever spring

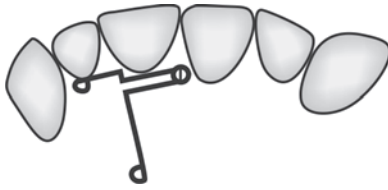


Figure 4.9A: Cranked spring

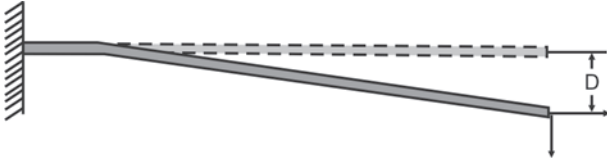


Figure 4.9B: It is fixed at one end and free at the other end

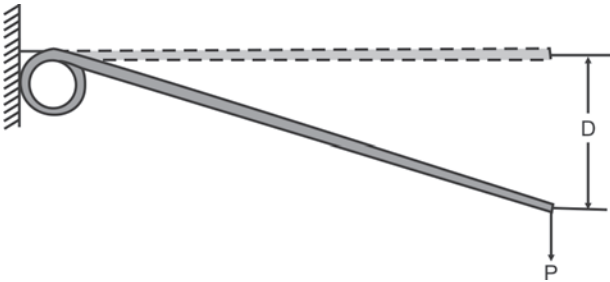


Figure 4.9C: Cantilever spring with coil at the point of attachment to the base plate or support

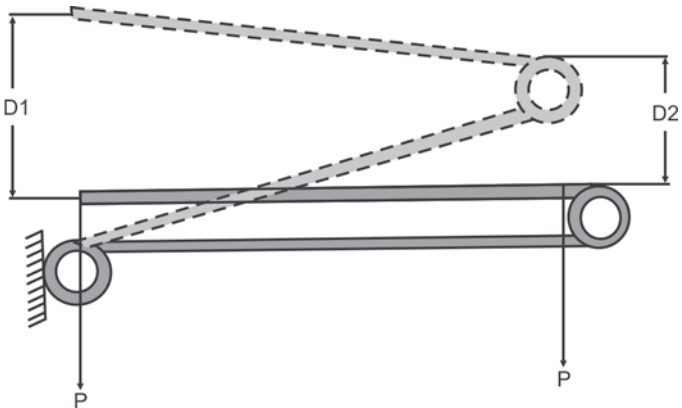
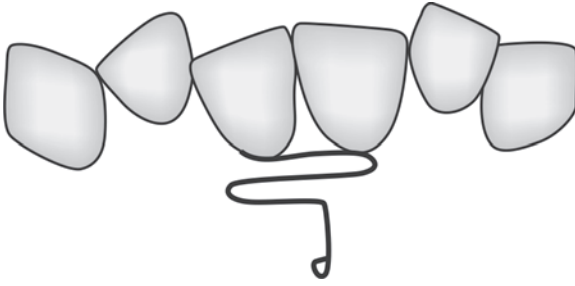


Figure 4.9D: A double cantilever spring which will move two, three or four teeth an equal amount in the same direction. Pressure  $P$ -produces deflections  $D$ ,  $D1$  and  $D2$



**Figure 4.10:** 'Z' spring without coil

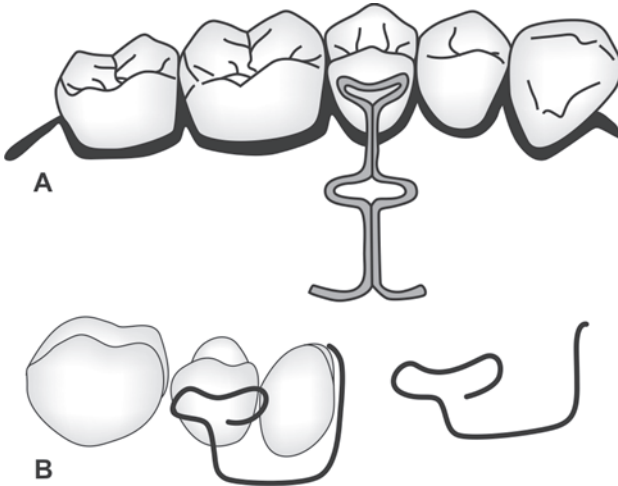
*Cranked spring:* A longer active arm is made and an offset is placed so that the active arm of the spring can be precisely adapted to the tooth (Figs 4.9A to D).

*Z spring:* Without coil it can also be designed. The activation is at the loop by opening it (Fig. 4.10).

### Auxiliary Spring

It is discussed already in the Chapter 3 – Labial Wire (high labial bow with apron spring).

It is indicated in premolar or molar cross bite. It is made up of 0.5 mm and kept on the palatal side to move palatobuccal direction.

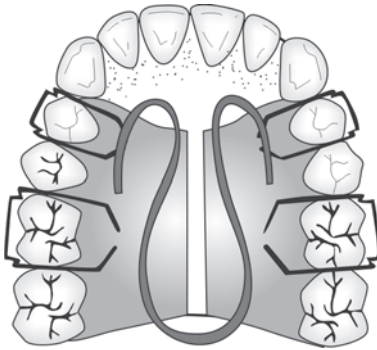


**Figures 4.11A and B:** A. T spring and B. Buccal push spring

It is adjusted with additional loops incorporated, so, that spring can be elongated as the tooth moves. It is adjusted by straightening the loop. Buccal push spring is used to push buccally placed premolar palatally (Fig. 4.11A and B).

### **Coffin Spring**

Coffin in 1881, introduced the spring and hence it is named after his name. It is fabricated with the wire of 1.25 or 1 mm. It is indicated in bilateral and unilateral cross bite for lateral expansion (Fig. 4.12).



**Figure 4.12:** Coffin spring

### **Protrusion Springs**

Open spring or closed protrusion springs are employed mainly to move anterior teeth labially. The active part of the spring is bent in one plane and should, if possible, contact the tooth at right angle to its long axis. These springs can also be used to move posterior teeth in a buccal direction. There are two types of springs namely:

1. Open protrusion springs
2. Closed protrusion springs.

#### *Open Protrusion Spring*

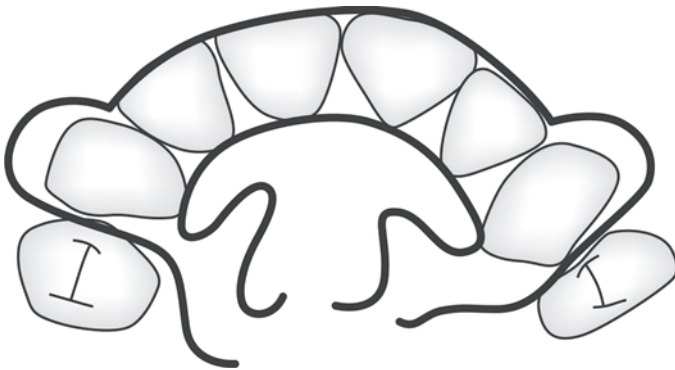
An open protrusion spring is S-shaped and as wide as the tooth to which it is applied. The wire is bent in two hairpin curves so that a flattened “S” with three parallel arms is formed. The activation of a protrusion spring is illustrated in the Figures 4.13A and B.

If the first curve is pressed between the beaks of a flat, pointed plier, the free end of the spring will move forward. The same manipulation applied to the second curve will bring the free end parallel to its original position but in a more anterior location. When the plate is inserted into the mouth, the spring will be compressed, that is activated. An easier activation method consists of elongating the spring by stretching more than 1 mm.

When a tooth is to be protruded and rotated simultaneously, the free end of the spring is positioned on the side of the tooth where more force has to be exerted. An open protrusion spring with its free end bent around the mesial or distal sides of a tooth, not only prevents lateral shifting but can, through activation, move the tooth mesially or distally. The appliance in the Figure 4.13A shows two open protrusion springs for the central incisors.

### *Closed Protrusion Spring*

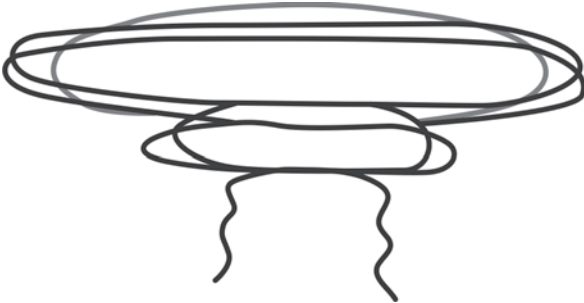
Both ends of the closed protrusion spring wire are anchored in the acrylic, it is therefore, less elastic than an open protrusion spring and it can be formed with one or two loops. When protruding all anterior teeth simultaneously, a closed protrusion spring with auxiliary "U" loops can be employed. This type of loop delivers a uniform force action. It can also be used effectively when combined with a labial wire for support.



**Figure 4.13A:** Closed protrusion spring with activating loops

Activation of the closed spring produces a typical alteration in its shape. Figure 4.13B shows changes undergone by a spring

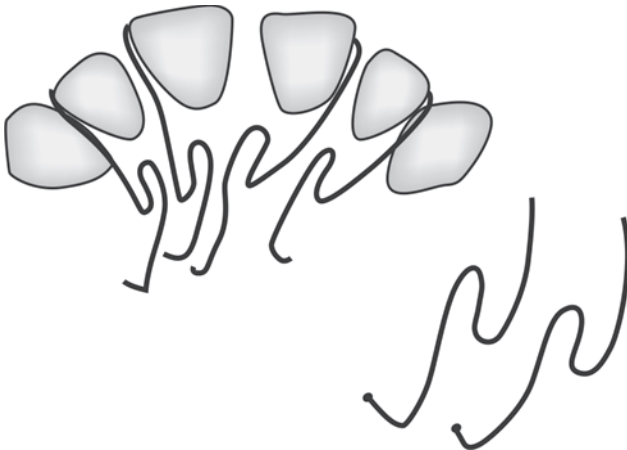
through the activation of its loops. Activation of a single loop protrusion spring produces a pronounced curvature in the wire, reducing its contact with the teeth and decreasing its effectiveness. This type of spring should therefore be made slightly wider than the teeth upon which it acts so that an adequate contact area remains following activation.



**Figure 4.13B:** Changes in the activation of a closed protrusion springs in relation to the point of adjustment

### **Proximal Springs**

Proximal springs or interdental springs are used to move anterior or posterior teeth in a mesial or distal direction. Depending on the



**Figure 4.14:** Proximal springs with 'S' shaped loops for mesial movement of incisors

individual case, they can also be called mesial or a distal spring, 0.5 mm is used for incisors where as 0.6 mm is used for canines and premolars.

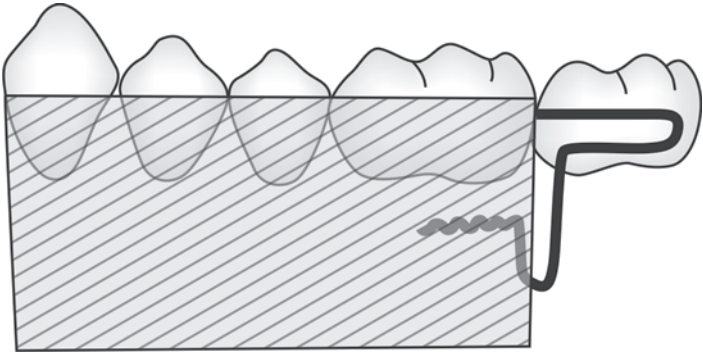
It contains a hairpin like bend that grasps the proximal surface of the tooth extending slightly onto the facial surface. The section of the spring that contacts the tooth lies roughly parallel to the occlusal plane. On anteriors, the spring extends several millimeters onto the labial surface. The palatal part of the spring can be straight, bent into a helix or double looped in an "S" configuration (Fig. 4.14).

Activation of the proximal spring is correctly performed when the place of insertion in the acrylic is ahead of the point of force application on the tooth, that is, during activation the spring arm should be displaced toward the proximal contact area on the tooth. Figure 4.14 shows the activation of a spring with a double loop. When preparing proximal springs, care has to be taken to place the wire approximately 1 mm away from the mucosa. The point of application of a spring on a tooth (toward the incisal or gingival aspect) depends on what type of tooth movement is desired.

A closed type of proximal spring with an adjusting loop on the labial surface is illustrated in Figure 4.14. It should be noted that in an appliance, where an anterior proximal spring is combined with a screw for transverse expansion, the insertion point of the spring wire in the acrylic moves laterally. If such a spring is applied to the distal surface of a central incisor, to move it mesially, for example, its effect will be reduced. This problem can be resolved either by readjusting the spring or by designing "crossed" proximal springs. With the spring for the right central incisor anchored in the left half of the appliance and vice versa, expansion of the plate will automatically activate the springs to move the central incisor anchored in the left half of the appliance and vice versa, expansion of the plate will automatically activate the springs to move the central incisors mesially.

## Lingual Springs

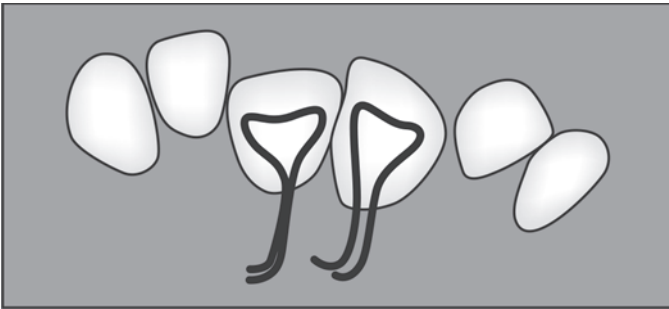
The lingual spring is useful for uprighting lingually tipped mandibular molars, where sufficient space is available. For the terminal tooth, the open loop lingual spring is bent out of 0.7 mm. Where the wire exists the acrylic, a vertical loop is formed for the optimal effect, this spring should contact the tooth above the height of contour (Fig. 4.15).



**Figure 4.15:** Lingual spring on the terminal molar

### **Paddle Spring**

It can also be included in the closed protrusion spring group. They can be applied in the anterior area but are used mainly in the posterior segment mainly on premolars. When the lingual surface of an anterior is unfavorable for the placement of a regular protrusion spring, a paddle spring can prove useful (Fig. 4.16).

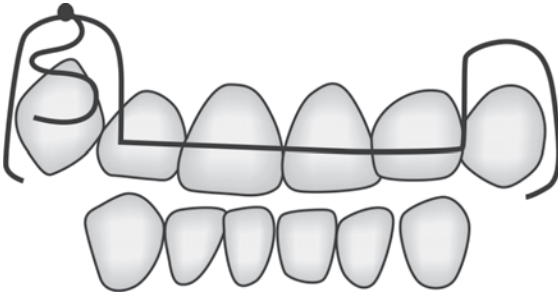


**Figure 4.16:** Paddle springs for incisors

### **Springs on the Labial Wire**

Various springs can be welded or soldered on a labial wire. These springs approach the teeth from the labial side to move them in a mesial, distal or lingual direction. It is advantageous for such springs to be soldered to the vertical loop of the labial wire (Fig. 4.17).

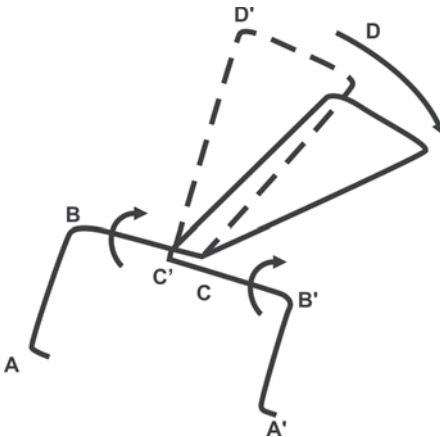




**Figure 4.17:** Spring soldered to the vertical loops for lingual movement of the canines

### Torque Spring

It is a special kind of finger spring where flexibility is given to a rather short and stiff active arm by means of transverse torque limbs which derive flexibility by the twisting of two sections of wire. This spring is particularly useful where a very precise action is required on the lingual aspect of upper anteriors which have to be rotated. Figure 4.18 shows diagrammatically the layout of a torque spring. The spring is symmetrical and the section A-B and A'-B' are fixed in the baseplate of the appliance. The sections B-C and B'-C' are torque bars and section C-D and C'-D', make up an apron spring.



**Figure 4.18:** Torque-spring: The ends AB and A' B' are embedded in the base plate. The lengths BC and B' C' twist when the apron CD and C' D' is deflected

## **BOXING**

---

The two ways of fixing the flexible springs like cantilever and finger spring to avoid distortion of the wire are (i) to give guide (ii) and to box the springs.

### **Fabrication of Boxing**

1. First the spring is fixed and a layer of wax is placed on the spring to act as spacer.
2. The acrylic can be built up over the spacer as flat from which act as bite plane in case of deep bite.

The main disadvantage of boxing is the accumulating of food particles and difficulty in cleaning. The second disadvantage is the difficulty in activating the coil.

If the boxing method is adopted there is no need to have a guide.

# 5

## *Bite Planes*

---

---

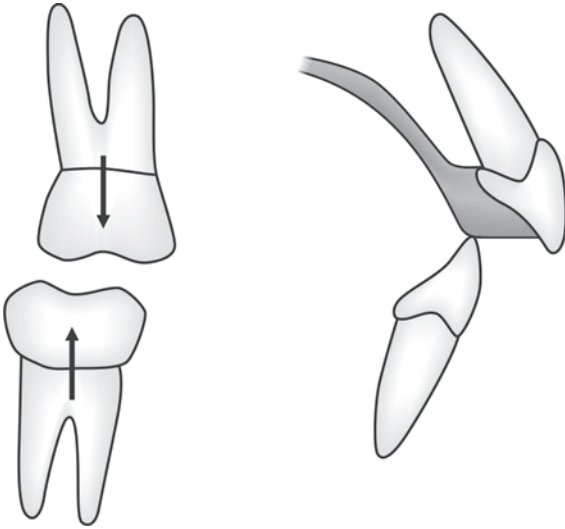
Bite planes may be divided into those planes which are inclined at an angle to the occlusal plane and lie parallel to it.

Anterior bite planes lying parallel to the occlusal plane (sometimes called horizontal bite planes) are designed to produce mainly axial stresses on the teeth. Such planes are intended either to protect the bite temporarily to facilitate certain teeth movements or to cause certain adjustments of the vertical relationships of the teeth.

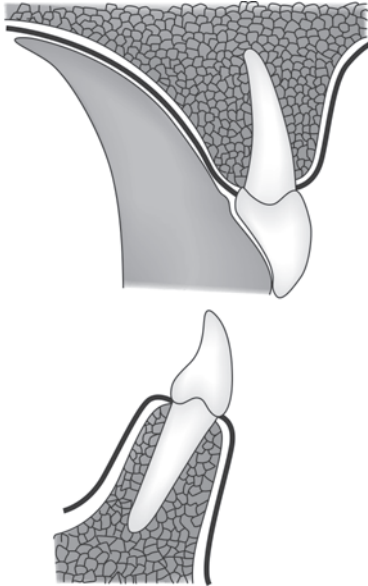
### **CLINICAL MANAGEMENT**

---

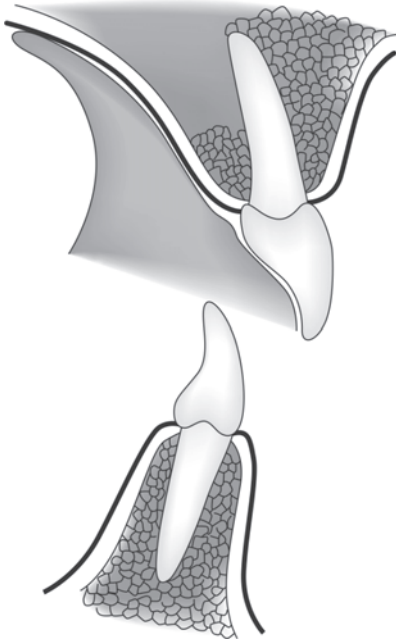
Appliance with anterior bite plane is indicated in the case of deep bite. When the appliance is worn in the mouth, the posteriors are disengaged so that they will supraerupt. Once the supra eruption is complete, the anteriorly deep bite is opened. This is called opening the bite. Initially the labial bows should not be activated and once the bite is opened, then only labial bow should be activated. Otherwise, the anteriors should be loose within the socket due to the pressure from the labial bow anteriorly and on the palatal side the anterior part of anterior bite plane, restricts the tooth movement palatally. As the labial bow is activated, the anterior part of the anterior bite plane is trimmed 2 mm everytime. While trimming, the care should be taken to maintain the semicircle shape of acrylic anteriorly. The thickness of the acrylic should be sufficient to disengage the posteriors about 2 to 3 mm (Figs 5.1 and 5.2 A to D).



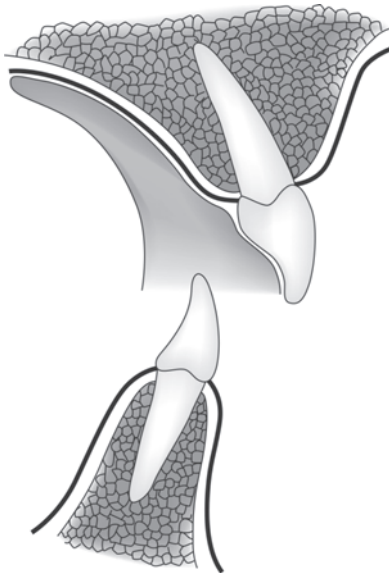
**Figure 5.1:** A clearance of 1.5 to 2 mm should exist between the upper and lower posterior teeth



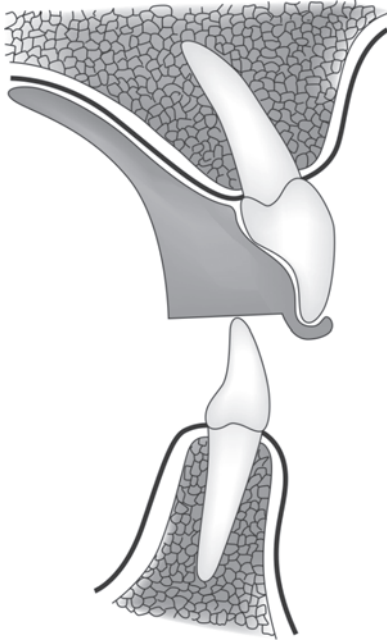
**Figure 5.2A:** A correctly executed flat bite plane



**Figure 5.2B:** Incorrectly executed flat bite plane



**Figure 5.2C:** Bite plane with groove for mandibular incisors  
(for mandibular orientation)



**Figure 5.2D:** Anterior bite plane with capped maxillary incisor to give an additional anchorage to the maxillary plate

### **USES OF ANTERIOR BITE PLANE**

---

1. To reduce the deep bite
2. To treat the pairs associated with the TMJ. The anterior bite plane is designed to free the existing occlusal contacts which often are abnormal due to the loss of the teeth and tilting of the remaining teeth and the presence of high spots on the occlusal plane due to faulty orthodontic treatment.

### **PROBLEMS WITH ANTERIOR BITE PLANE**

---

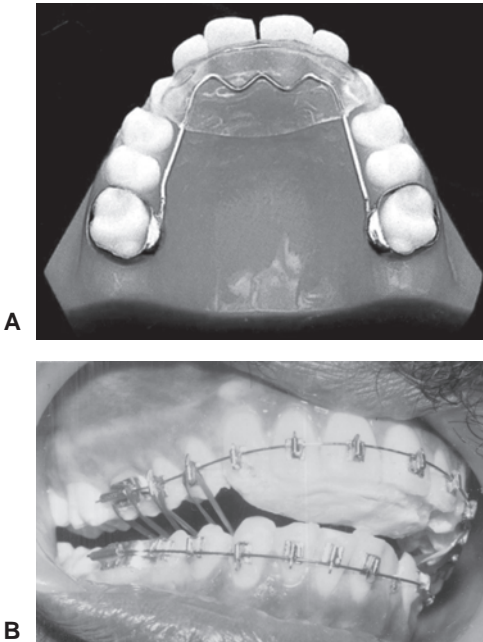
1. If the lower incisors are severely proclined or retroclined, unwanted changes in their position may occur. If it arises, the inclined bite plane is given so that the surface is perpendicular to the long axis of lower anteriors (Anterior bite plane).
2. If it is worn for longer period, a sinking of the appliance takes place anteriorly causing upper anteriors proclined. If the bite plane

sinks the labial bow moves forward with it and cannot restrain the upper incisors.

An anterior bite plane transmits the pressure axially to the upper incisors. Any forward component is restricted because the anterior bite plane prevents tipping labially of the upper incisors.

## FIXED ANTERIOR BITE PLANES

1. It can be built with glass ionomer cement. A palatal arch is soldered on the lingual aspect of upper molar band on the anterior part of the palatal arch, a mesh wire is soldered over which it carries glass ionomer anterior bite plane.
2. The second method is like the first method except glass ionomer bite plane. Instead of glass ionomer bite plane acrylic bite plane is added with short labial bow attached on the acrylic (Figs 5.3A and B).

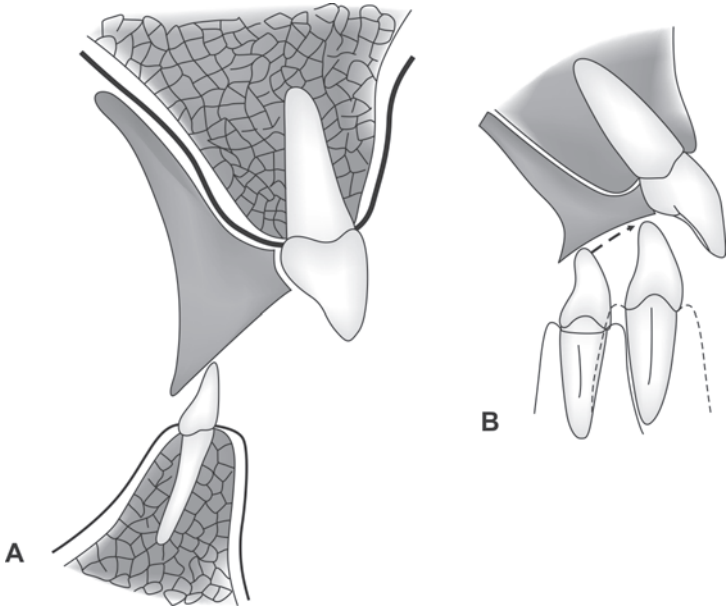


**Figures 5.3A and B:** **A.** Fixed bite plane—this versatile appliance can be used for bite opening. Or, with an angle added to the acrylic, the appliance serves as an anterior repositioning fixed splint; **B.** A short labial bow can be attached to the fixed bite plane for correction of deep bite. After the bite opening, the anterior part of the acrylic is trimmed for clearance and the short labial bow is activated

### **ANTERIOR INCLINED BITE PLANE**

Instead of being flat, the bite plane is inclined it faces downwards and forwards at an angle of  $60^\circ$  to the occlusal plane and engages the lower incisors and canines when the jaws are approximated guiding the mandible forward.

The inclined bite plane reinforces the anchorage and proclines the lower anterior teeth in addition to the correction of anterior deep bite (Figs 5.4A and B).



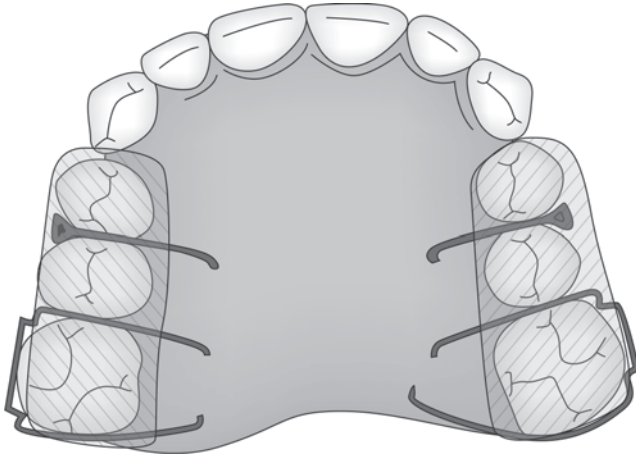
**Figures 5.4A and B:** **A.** Schematic drawing of a guide plane. When the mandible is brought into centric occlusion, the lower incisor is slid over the guide plane to bring the mandible forward. This may be act as mandibular repositioning splint; **B.** Upper anterior inclined plane

### **POSTERIOR BITE PLANES**

The posterior bite planes can be given either bilaterally or unilaterally. The unilateral posterior bite plane is indicated for correction of unilateral cross bite of simple or two or group of posterior teeth. The expansion appliance is given with unilateral posterior bite plane.



Bilateral posterior bite plane is given where there is mature anterior cross bite. The base is carried on to the occlusal surface of posterior till the buccal cusps of all the posteriors. The thickness of the bite plane should be sufficient to disengage the anterior which is cross bite. The posterior bite plane should not be too bulky. Otherwise the patient cannot close the mouth, causing inconvenient to the patient. While constructing the posterior bite plane, the care should be taken not to increase the same thickness of acrylic at the posterior end. Otherwise, excess acrylic trimming may be necessary to maintain the sufficient disengagement (Fig. 5.5).



**Figure 5.5:** Posterior bite plane

### **FIXED POSTERIOR BITE PLANE**

The fixed posterior bite plane can be used on the lower molar occlusal surfaces with glass ionomer filling materials. This is indicated along with fixed appliances.

Once the cross bite correction is over the posterior bite plane, it should be trimmed completely and keep the base plate alone.

Fixed bilateral or unilateral bite plane can be processed with glass ionomer cement on the occlusal surface of lower posterior.

**Base Plates**

The functions of the base plates are:

1. To carry all the wire components.
2. To anchor the appliance.
3. To carry anterior bite plane, posterior bite plane and other acrylic extensions.
4. To extend the acrylic over the finger spring and cantilever spring as boxing.
5. It carries the expansion screw.
6. It acts as Nance button to hold the arch (Nance holding arch-combination of fixed and acrylic).
7. In case of molar distalization, acrylic button on the slope of palate is processed (combination of fixed and acrylic plate).

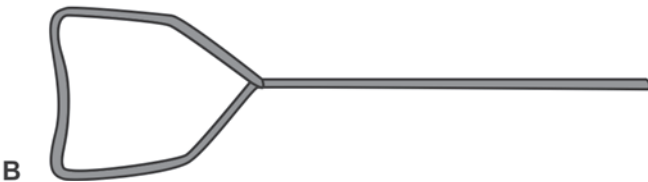
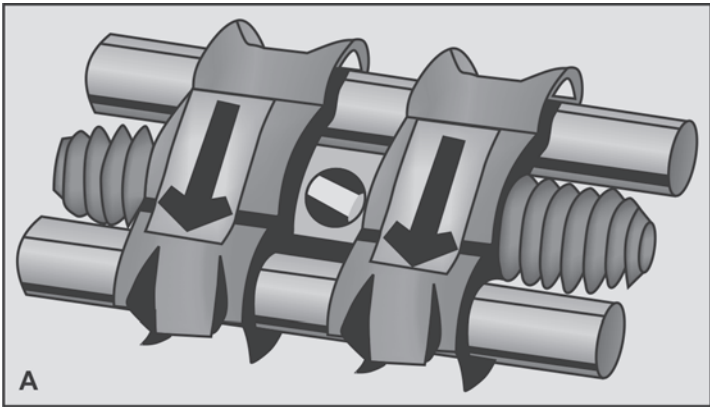
# 6

## *Expansion Appliance*

---

---

It is a mechanical appliance through which the orthodontic forces are transmitted by a screw called an expansion appliance. It may be classified into slow expansion appliance and rapid palatal expansion appliance. Likewise, the expansion screws are available to move either individual tooth or a group of teeth in anterior direction, lateral direction and anterolateral (three dimensional) and distal-medial direction (Figs 6.1A and B).

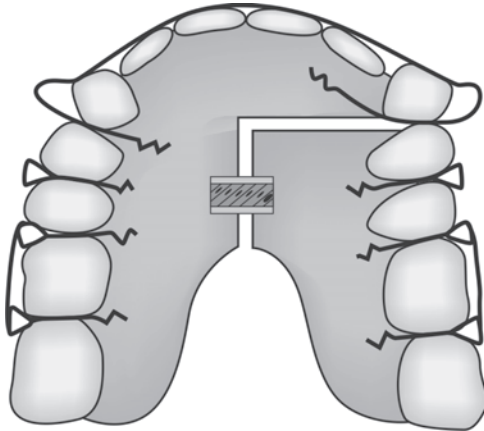


**Figures 6.1A and B:** A. Expansion screw; B. Expansion screw: Key

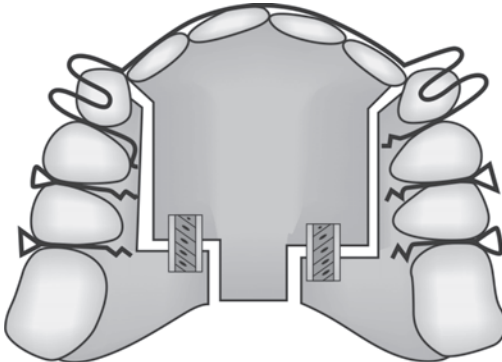
**INDICATIONS**

---

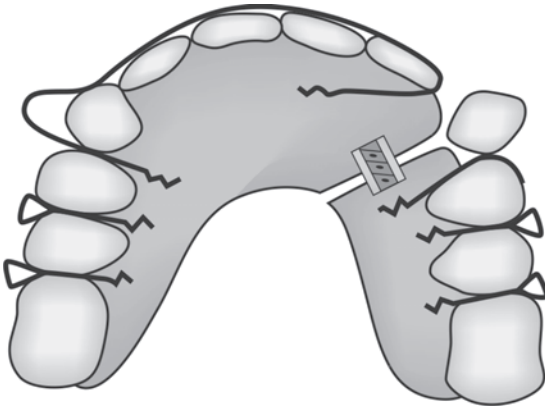
- Cleft palate.
- Syndromes associated with cleft palate.
- CI III malocclusion where there is a defect in the maxilla-bilateral and unilateral crossbite (Figs 6.2 and 6.3A and B).



**Figure 6.2:** Plate for unilateral crossbite. The larger part of the plate forms a block to serve as anchorage for the movement of the smaller part. The anchorage may be reinforced by the baseplate covering the palatal aspects of the buccal teeth on the side of the correct occlusion. The plate is thin on the side to be moved. Bite blocks may also support the correction

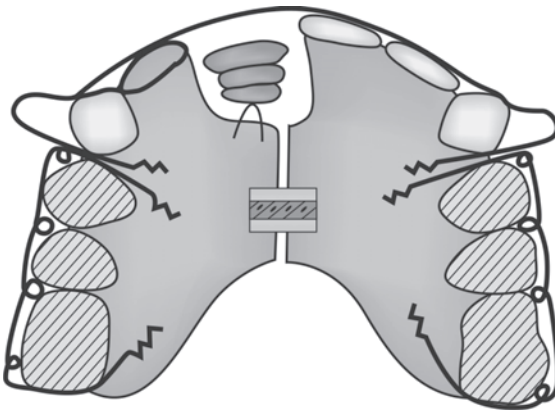


**Figure 6.3A:** A very effective variation of the Y plate. Insertion of the labial wire into the lateral parts is combined with coverage of the largest possible part of the palate by the anterior pan of the plate. U loops of the labial wire exert a slight pressure on the canines and are simultaneously activated by the turning of the screws. Anchorage with all Y plates may be reinforced by turning the screws on one side only alternately each week

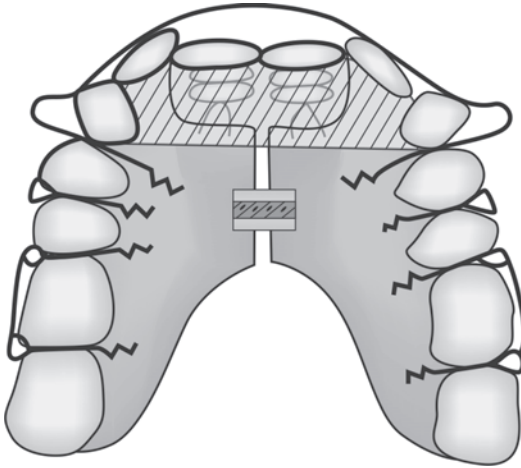


**Figure 6.3B:** Y plate for the movement of teeth on one side only

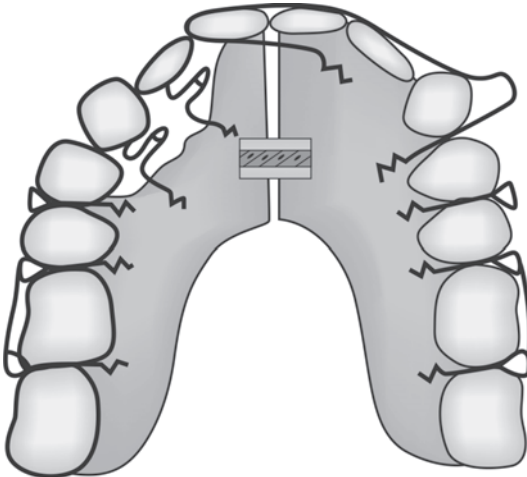
- To help activator therapy-Norwegian screws are attached in the center of activator where there is severe constriction of upper arch.
- Real and relative maxillary deficiencies.
- Cases of inadequate nasal capacity exhibiting chronic nasal respiratory problems.
- In a clinical condition where there is bilateral buccal crossbite and single tooth and double teeth anterior crossbite (Figs 6.4A to C).



**Figure 6.4A:** Slightly crowded upper central incisor locked in lingual occlusion is tipped forward by a double loop spring after space is provided by moderate expansion. Lateral bite blocks are used. The plate is held in place by continuous eyelet clasps

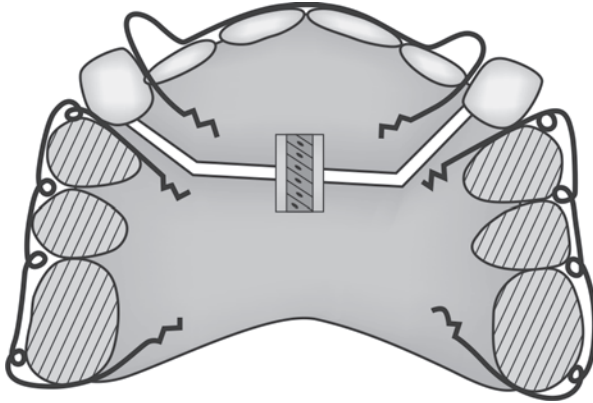


**Figure 6.4B:** Expansion of the maxillary arch and subsequent labial tipping of slightly crowded upper central incisors in Class II, Division 2 malocclusion. The double loop springs can be adapted sagittally and mesially to remain in proper contact with the teeth moved. The closed bite is to be opened by a bite plate. The springs may be boxed. Such plates are recommended for preliminary treatment before the insertion of functional appliances such as the bionator



**Figure 6.4C:** Expansion plate for the alignment of crowded upper right canine and lateral incisor. The right central incisor has moved over the midline and is brought back by the labial arch fastened with both ends inserted in the left side of the plate. Small helical springs exert pressure on canine and lateral incisors. The wire used for the springs is either 0.5 mm or double 0.4 mm. The double wire enhances resistance to dislocation without loss of elasticity

- In a clinical condition where there is anterior crossbite involving six teeth (Figure 6.5).



**Figure 6.5:** Plate for labial movement of all incisors. Lateral bite blocks are added for increased anchorage or for incisors in lingual occlusion

## WAYS FOR EXPANSION

Expansion of the arch can be achieved in number of ways:

- By using screws of different type
- By using Coffin's spring
- By using Portar appliance –modified form of Coffin's spring
- By using 'W' arch appliance
- Quad helix appliance
- Memory screw appliance
- Niti palatal expander
- Transpalatal arch
- RME (Rapid Maxillary Expansion).

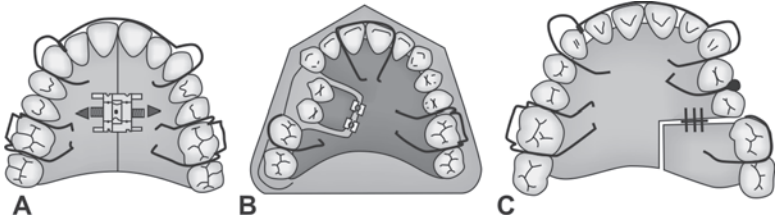
## TYPES OF EXPANSION SCREW

It can be of two different types (1) slow and (2) rapid.

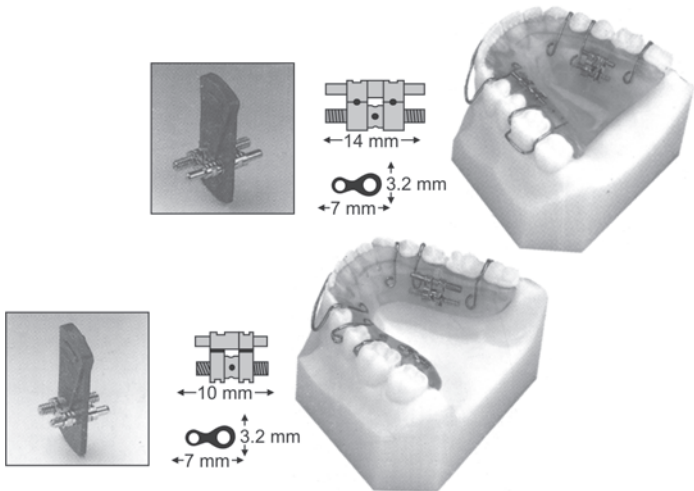
### Slow Type

- Skeleton type – Maximum - 7 mm expansion  
– Minimum - 3-4 mm expansion  
– Medium - 5 mm expansion

- Three dimension screws - to correct total crossbite
- Fan type expansion screw for anterior movement of maxilla
- Mandibular bow screw (lateral and sagittal anterior expansion of the mandible)
- Telescopic screws are to move a tooth or group of teeth and lateral expansion of upper lower jaw
- Spring loaded screws
- Norwegian plate screw - in CI III malocclusion.
- Standard expansion screws – lateral expansion of the maxilla.
- Sectional screws – for distal movements in upper and lower jaw (Figs 6.6 to 6.8)
- Magnet expansion screw
- Traction screws (Fig. 6.9).
- Fan type expansion screw (Fig. 6.10).

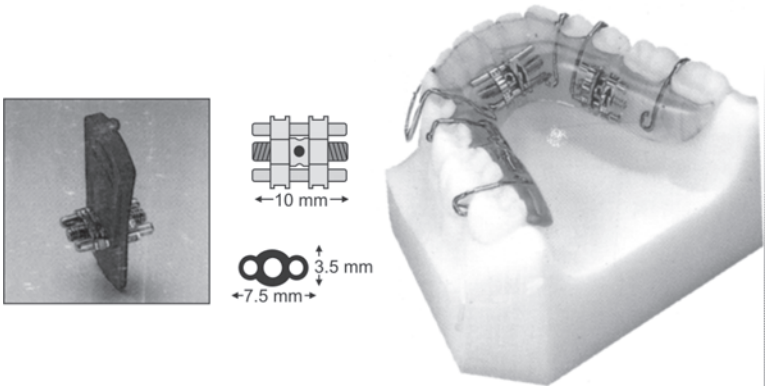


**Figures 6.6A to C:** Removable appliances incorporating screws **A.** Appliance for arch expansion; **B.** Appliance for buccal movement of a group of teeth; **C.** Appliance for distal movement of teeth

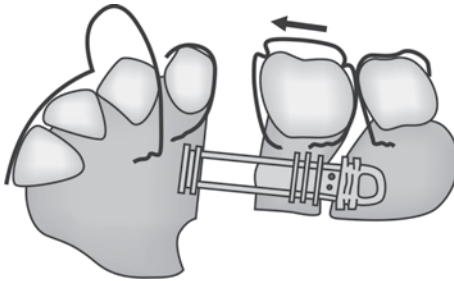


**Figure 6.7:** Medium skeleton-type for distal movements in the maxilla and mandible. Expansion in mm (7 mm)

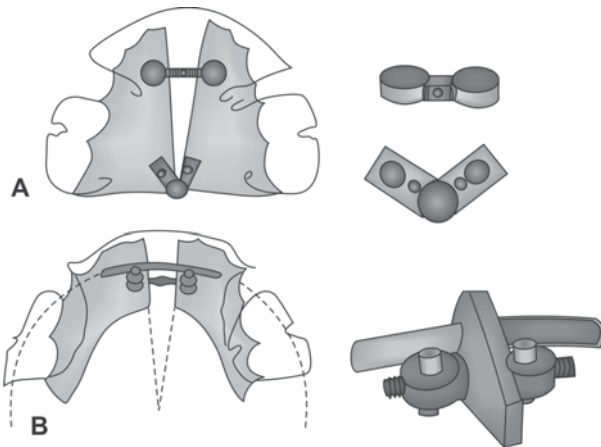




**Figure 6.8:** Medium skeleton-type for mandible-lateral expansion and distal movements. Expansion in mm (3 mm)



**Figure 6.9:** Plate with a Heller: A combined traction-pressure screw that can be used for movement of single teeth is the Heller screw



**Figures 6.10A and B:** Eccentric screws. **A.** For fanwise maxillary expansion; **B.** For eccentric mandibular expansion (Courtesy: Dentaurem Co.)

**Rapid Type**

- *Hyrax*: This appliance works quickly and is easy to keep clean and hygienically acceptable that is why it is called hyrax. It gives 7-11 mm expansion, which can be achieved in 21 days of total treatment.
- *Maximum*: It is sturdy encased screw, which gives 11 mm expansion.
- *Glenross*: 11 mm expansion and a larger than average keyhole which facilitates insertion of the key for turning (Table 6.1).

**Table 6.1:** Difference between slow and rapid expand

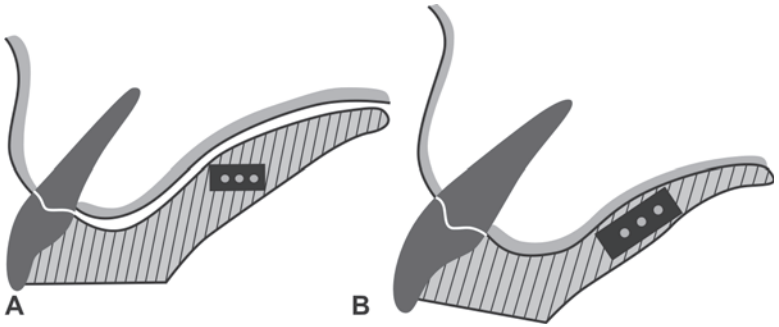
1. Slow in action in few weeks	1. Rapid in action in few days (21 days)
2. A weekly single quarter turn produces 0.25 mm of tooth movement	2. On turn in the morning, and another turn in the evening on the first day followed by one activation every day
3. Expansion is 1 mm per month	3. 7 to 11 mm expansion in 21 days
4. No pain and physiological	4. But it is painful and pathological
5. Orthodontic force	5. Orthopedic force

Over the years, since Schwarz first introduced these in his plates, an abundance of screws has come into being. It is safe to say that 200 screws of different types are still available.

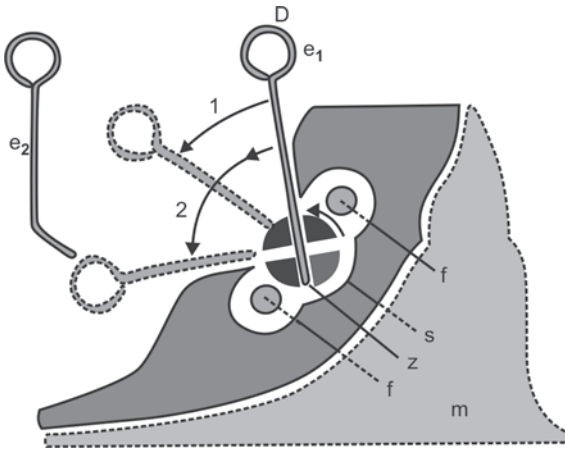
Figures 6.11 A and B depict the correct placement of expansion screws and Figure 6.12 shows the placement of key and mechanism of key rotation.

**Anterior Expansion of Maxillary Incisors**

One of the simplest use of an active plate for expansion is to correct a maxillary anterior crossbite when there is room to accommodate the teeth in their appropriate positions within the arch. If this is done in an adult, usually it is necessary to bring the base plate material up over the occlusal surface of the posteriors, to separate the teeth vertically and allow clearance for the upper incisors to move out of crossbite (Figs 6.6A to C).



**Figures 6.11A and B:** A. Incorrect placement of expansion screw;  
B. Correct placement of expansion screw



**Figure 6.12:** Schematic sagittal section through the anterior part of an upper expansion plate on the model (S, the screw with the two holes for the key; f, the guiding rods; e<sub>1</sub> the key put in one hole, which is situated near the anterior border of the slot, z, shown in the figure), arrow 1 shows a turn of 45°, which is called a "half turn", arrow 2 indicates a turn of 90°, until the key is stopped by the posterior borders of the slot, called a "whole turn". With this movement the next of the four holes appears at the anterior part of the slot. The patient or the parents must be explicitly instructed in the use of the screw. If the screw is placed at the side of the plate, the bent key, e<sub>2</sub>, is used. (From Schwarz, AM and Gratzinger M: Removable Orthodontic Appliances. Philadelphia, WB Saunders Co., 1966).

### **Transverse Expansion**

The most common circumstance in which arch expansion is needed is a constricted maxillary arch with a tendency toward crossbite.

An active plate split in the midline will expand the arch almost totally by tipping the posterior teeth buccally, not by opening the midpalatal suture and widening the maxilla itself for this reason, removable plates are not indicated for skeletal crossbites or for dental expansion of more than 4 to 5 mm. Excellent clasping is required to prevent displacement of the plate.

Lateral expansion of the mandibular arch with a removable appliance is much more difficult than maxillary expansion, because the screw must be placed more anteriorly. Expanding the mandibular intercanine distance with an anteriorly positioned screw in a removable appliance is not recommended, because the force is concentrated against the incisor and canine so that excessive forces easily can be produced and because mandibular intercanine expansion is notoriously unstable.

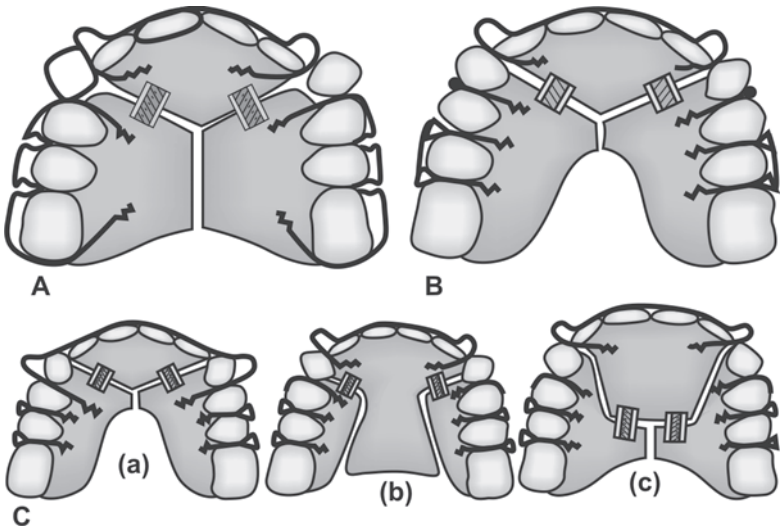
## **SIMULTANEOUS ANTERIOR AND POSTERIOR EXPANSION**

### **The Sagittal Appliance**

An early forerunner of the sagittal appliance was referred to as the Y-plate because of the shape of the cuts on the base plate separating the plate into its component parts. Most of the early model Y-plates or lateral expansion active plates of that era had a labial bow and one which is constructed that way today, still bear the name of "SCHWARZ PLATE" after the man who brought their use to such high level of proficiency. ( Figs 6.13 A to D).

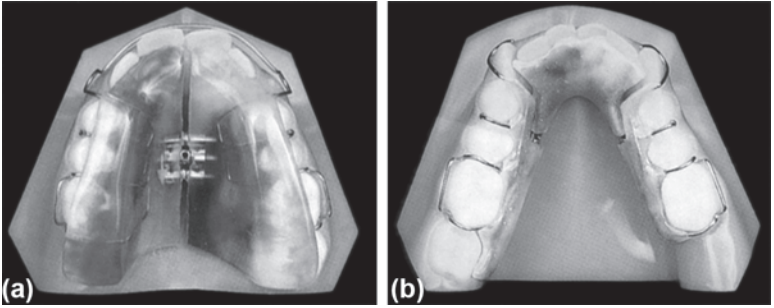
The word sagittal is derived from the original latin root sagitta which means "Arrow ". It must be remembered that like an arrow, the appliance is designed primarily for front to back expansion of the dental arch in a linear directions. This implies that if it is used to correct a narrow, short arch of crowded teeth, the end result will be narrow, longer arch of uncrowded teeth.

If the 2nd molar is intact, the primary direction of the development of the arch will be in an anterior direction. This is especially useful in the development and expansion of a crowded or retruded



**Figures 6.13A to C:** Y plates. The original Y plate of AM Schwarz used for the alignment of crowded canines by sagittal and lateral expansion. Lateral expansion is less if the screws are directed more sagittally. **A.** Y plates, The modernized Y plate. A large part of the palate is left uncovered. Triangular clasps are used in place of the Schwarz arrow clasp. Small clasps anterior to the first premolars are necessary to make these teeth participate in the movement; **B.** Y plate. The insertion of the tags of the labial wire into the lateral parts of the plate exerts a slight pressure in a posterior direction on the anterior part of the plate when the screws are turned. This serves to stabilize the anterior portion of the plate. The loops of the labial wire are small, permitting contact of the labial wire with canines to guide them into the space provided by the expansion. Full palatal coverage may enhance stability; **C.** The two designs stabilize the anterior part of the plate by extending it over a large part of the palate. The screws act nearly entirely in a posterior direction. This will produce only a minimum of lateral expansion to compensate for the movement of teeth into a wider diameter of the dental arch

premaxilla as in a CI II div 2 cases. However, if the 2nd molars are removed, the primary direction of the movement of the teeth will be of the posterior segments in a distal direction. This is exceptionally useful in cases of severe anterior crowding. Of course, the appliance itself expands in both directions at once. It is just that with the second molars in, the expansion is about 80% anteriorly and with the second molars out, the expansion is about 80% posteriorly.



**Figure 6.13D:** (a) Transverse expansion is accomplished with the Schwarz appliance. One or two screws can be used, depending on the size of the arch and stability required. Occlusal acrylic coverage and labial bow are optional. (b) Upper or lower arch length development can be accomplished using the sagittal appliance. A unilateral screw or bilateral screws can be utilized. Occlusal acrylic coverage and labial bow are optional

### *Sagittal I*

The sagittal I appliance is designed to distalize one or both posterior segments to varying degrees as necessary to relieve anterior crowding, which usually expresses itself in the form of blocked out cuspids in CI I crowded cases and it also may be used for the same purpose in CI II div 1 cases.

### *Sagittal II*

All but identical in appearance to the sagittal I, the sagittal II appliance is used for expansion of the arch in the completely opposite direction. Instead of distalizing teeth posteriorly, it develops them anteriorly using 2<sup>nd</sup> molars as anchorage and by means of the appropriate adjustments, the sagittal II can be used to apply labial crown torque to the anterior teeth.

### *Sagittal III*

The anterior bite plane should extend slightly forward of the upper incisors, so as to contact the lower incisors in bite occlusion. This is an excellent appliance for pseudo CI III cases with a reversed overbite.

### *To Conclude*

1. It is used to move the teeth in both permanent and mixed dentitions.
2. They may be used to develop immature premaxilla, the only true orthopedic aspect of the appliance and can torque to retroclined maxillary and mandibular incisors labially.
3. They may be used to distalize posterior segments, relieve crowding and regain lost 2nd deciduous molar space in the mixed dentition.
4. In cases of severe TMJ and muscle pain, they can even act as palliative by serving as an intraoral splint to open the vertical and decompress the compromised joint.

### *Clinical Tips*

- Arrow mark near the opening of the screw indicates the direction in which to turn.
- A turn of 45° which is called a half turn whenever 90° turn is called whole turn or full turn the screw, when turned 90°, will drive the parts of the plate apart 0.2 mm. This will result the narrowing of the periodontal membrane 0.1 mm on each side.

### **W-arch Expander**

This appliance will move both primary and permanent teeth and may accelerate the rate of normal expansion of the midpalatal suture, particularly in a young child. Therefore, correction may result from a combination of skeletal and dental change even if only dental change is required.

It is activated simply by opening the apices of the w and is easily adjusted to provide more anterior than posterior expansion or vice versa. If this is desired, bending the anterior palatal portion of the wire bilaterally near the solder joint at the molar bands increases the anterior arch width. The appliance delivers proper force levels when opened 3 to 4 mm wider than the passive width and should be adjusted to this dimension before being inserted.

Expansion should continue at the rate of 2 mm per month (1 mm tooth movement on each side) until the crossbite is slightly overcorrected. Intraoral appliance adjustment is possible but may lead

to unexpected changes. For this reason, removal and recementation are recommended at each active treatment visit. Most posterior cross-bites, require 2 to 3 months of active treatment and 3 months of retention (during which the w-arch is left passively in place) for stability.

### **Single Tooth Posterior Crossbite Correction by Semifixed or Removable Appliance**

- Through the bite elastics
- Upper Hawley's appliance with T spring with unilateral removable bite plane or fixed bite plane on the normal side
- By using universal expansion screw.

### **Memory Transverse Expansion Screw**

The new memory transversal expansion screw offers more patient comfort with a fewer adjustments and less patient cooperation. This has an invisible incorporated super flexible spring. A constant force of approximately 500 g is applied to the tooth by a spring range of 0.8 mm via 1.5 turn of the spindle. Readjustment is necessary only if the spring is fully extended. It gives 5 mm expansion. An elastic biomechanical force is exerted constantly over the teeth via a memory spring and this makes for substantially shorter treatment times approximately six weeks.

Visits are spaced at week intervals. A weekly activation of 1 spindle turn is particularly effective. It is processed into the cold cure acrylic appliance in the same way as any other transverse expansion screw. The use of heat cure acrylic is not recommended. With MTES, both orthodontic and orthopedic changes can be achieved particularly in late deciduous and early mixed dentition period with span of six weeks. After correction, the appliance can be inactivated as retainer.



# 7

## *Clinical Adjustments*

---

---

The fit of any removable appliance depends on the stability of its framework or baseplate. For this reason, maxillary removable appliances tend to be both better tolerated by patients and more successful than mandibular appliances.

The horseshoe-shaped mandibular appliances are inevitably somewhat flexible, making them less stable and less comfortable. This often is made worse by the presence of lingual undercuts in the mandibular molar region, so that an appliance must be extensively trimmed to make insertion possible. But it is important to adjust the appliance so that the patient can place and remove it without great difficulty.

As treatment proceeds, three adjustments are necessary when an active removable appliance is being used appropriately: tightening of clasps when they become loose, activation of the spring or springs and removal of material from the baseplate. Adam's clasps usually require a minor adjustment at each appointment, bending them as described previously.

Activation of the springs of a removable appliance must be done carefully and not more than approximately 1 mm at a time. The more the spring is activated, the more difficult it becomes to keep it in the proper position. Too much activation usually displaces either the spring or the whole appliance.

Often it is necessary to trim away acrylic material to complete the activation of a spring. Acrylic material must not be removed near a clasp, since this would allow that anchor tooth to move and retention of the appliance would be lost. On the other hand, acrylic must be removed from the path of a tooth that is to be moved, which means that the baseplate near a spring is a common error.

A patient who is wearing an active removable appliance should be seen at 4-6 week intervals. Springs should be adjusted to produce approximately 1 mm of tooth movement and acrylic should be relieved to provide a similar amount of clearance. At the next appointment, the spring is reactivated and the acrylic is again relieved by a similar amount. Trimming the acrylic only the amount that a tooth can move in one appointment interval preserves the fit of the appliance and provides a fail-safe feature if the patient does not return for the next appointment at the expected time. An active spring, with nothing to check its action, could produce an excessive response.

Preventing an excessive response by limiting the relief of the acrylic baseplate is possible only when a tooth is being moved lingually, not labially. The same fail-safe effect, however can be achieved by a placing a labial or buccal restraining wire. Split-plate appliances cannot be made fail-safe in this way, but since it is necessary for the patient to activate a screw and because the rate of activation is quite slow, these appliances have less danger of an excessive response.

### **Delivery of Removable Appliance**

When the appliance is to be delivered, certain points should be checked.

1. Prior to placing the appliance, clinician should check for any minute pimples due to blow holes in the cast that could irritate the mucosa and the free edges should be rounded and smooth.
2. The base plate, if necessary, need to be trimmed while fitting the appliance in the mouth.
3. Check for the position of the active and retentive components. The wire components should not irritate or impinge on any soft tissues. Clasps should fit the teeth accurately.
4. The patient should be taught the path of insertion and removable appliance.
5. The patient should be called for a recall visit every 2 weeks.

### **Instructions to the Patient**

The success of any removable appliance is certain if the patient follows the instructions carefully.

1. The patient should be instructed not to disturb or distort the wire components.
2. The patient should be instructed to wear the appliance for 24 hours a day and to remove the appliance only while brushing, eating and also during contact sports and swimming.
3. The patient should be instructed to clean the appliance by brushing it with soap and water.
4. In case of pain or any damage or loose fitting, patient must report to the dentist.
5. The patient should be instructed to keep the appliance in the container with the water whenever the appliance is not being worn.

### **PRESSURE ADJUSTMENT WITH REMOVABLE ORTHODONTIC APPLIANCES**

---

The aim of orthodontic treatment is to produce physiological tooth movement that is movement with normal process of resorption and deposition of bone. For producing tooth movement, the amount of pressure exerted on a tooth has to be considered as the pressure being applied per unit of root area and its supporting tissue like periodontal ligament. A pressure of 20 grams per square centimeter of root area is suitable for producing tooth movement.

Factors determining amount of pressure and how the pressure exerted for tooth movement are:

- The amount of pressure to determine whether the tooth has to move in a bodily manner or to incline.
- The size, number and surface area of root.
- The configuration of lamina dura of the tooth socket.
- Thickness of periodontal ligament.

When high pressure is applied to tooth, hyalinization of periodontal ligaments occurs. In hyalinized periodontal membrane blood vessel and cells have disappeared and the tissues looks structureless and glossy. Hyalinization delays bone resorption and tooth movement. when this high pressure is maintained, in due course of time, secondary bone resorption takes place and it relieves pressure on the hyalinized tissue permitting tooth movement.

If low pressure is used for tooth movement, lamina dura may produce spot areas where periodontal ligament get compressed again causing hyalinization and delayed tooth movement.

## **THE MODE OF FORCE APPLICATION**

---

Force may be exerted on a tooth continuously, intermittently or in an interrupted manner.

### **Interrupted Force**

Interrupted force is exerted continuously until tooth movement is complete, as in multiband appliances where movement is effected quite quickly over a short distance and a resting period ensues until a further adjustment is made. Example is the rigid screw type of removable appliance. Interrupted force will produce hyalinization but the resting period between adjustments will allow secondary bone resorption and remodeling to take place.

### **Intermittent Force**

An intermittent force is one that is applied and relaxed over the period between adjustments, as occurs with removable appliance which uses a flexible and easily adjusted spring and is taken out from time to time by patients. Example is functional appliances. An intermittent force with flexible spring action will produce semi-hyalinization on the pressure side and osteoclasts are formed below the hyalinized tissue so that bone resorption is less disturbed. In this way it is possible to produce a smooth and uniform movement if a small force is exerted and the appliance is worn wrongly.

### **Continuous Force**

A continuous force in orthodontic appliance is a fixed appliance with a really flexible spring attached to it and acting over the full distance of the proposed tooth movement as in the now unused labiolingual appliance.

The patient's reaction to pressure on the teeth must be watched carefully. Patients vary in their reactions to pressure in the sense

that pressure, especially in the initial stages, produces discomfort and pain and complain accordingly. Excessive pressure can be immediately and intolerably painful. A pressure that is slightly too high, if maintained, can become very painful and the affected tooth sensitive to the lightest touch. Such a situation should not be allowed to develop as, apart from warning signal that such pain might be, discomfort is a strong disincentive to cooperation in treatment. Orthodontic treatment should be carried out without discomfort to the patient and this can be achieved by proper adjustment of the appliance.

# Index

## A

- Adams' clasp 26, 36
  - advantages 38
  - clinical adjustments 38
  - essential features 37
  - limitations 44
  - modifications 39
  - precautions 38
- Arrow pin clasp 33
- Arrowhead clasp 30
  - disadvantage 31
  - use 31
- Auxiliary methods of increasing retention 46

## B

- Ball end clasp 32
  - advantage 32
  - disadvantages 32
- Bite planes 65
  - anterior bite plane 68
    - fixed 69
    - problems 68
  - anterior inclined bite plane 70
  - clinical management 65
    - uses 68
  - fixed posterior bite plane 71
    - base plates 72
  - posterior bite planes 70
- Boxing 64
  - fabrication of boxing 64

## C

- Circumferential clasp 27
- Clasp 23
  - classification 26

- based on number of retentive arms 26
  - based on the presence or absence of arrowheads 26
- materials used 24
  - patient instructions 25
- requisites 23
- selection and design 25
- significance 23
- Clinical adjustments 87
  - delivery of removable appliance 88
  - instructions to the patient 88
  - mandibular appliances 87
  - removable appliance 87
- Cranked spring 57
- Crozat appliance 4
- Crozat's clasp 26,30

## D

- Delta clasp 45
- Double cantilever spring 55
- Duyzing's clasp 33

## E

- Evolution of clasp 26
- Expansion appliance 73
  - anterior expansion of maxillary incisors 80
  - indications 74
  - simultaneous anterior and posterior expansion 82
  - sagittal appliance 82
  - w-arch expander 85
  - transverse expansion 82
  - types of expansion screw 77
    - rapid type 80
    - slow type 77
  - ways for expansion 77

Extended labial wire 16  
Eyelet clasp 35

**G**

Groth clasp 35

**H**

Hawley appliance 5

**I**

Incisor clasp 45

**J**

Jackson's clasp 26,30  
Jackson's designs 4

**L**

Labial bow and lingual bow 21  
Labial bow in activator 18  
Labial bow in bionator 18  
Labial bow variations 14  
Labial bows 8, 21  
  types 8  
    asymmetrical labial bow 14  
    Begg's retainer 12  
    fitted labial bow 11  
    high labial bow 10  
    labial bow for 'j' hook  
      attachment 13  
    labial bow with small hook 13  
    long labial bow 9  
    Mills' retractor 9  
    reverse loop labial bow 10  
    Robert's retractor 10  
    short labial bow 8  
    soldered labial bow 12  
    split labial bow 9

Labial wire 7  
  incisor segment 7  
  occlusal crossover section 7  
  retentive ends 7  
  vertical loops 7  
Lingual extension clasp 33  
  advantage 33  
  disadvantages 33

**M**

Memory transverse expansion  
  screw 86  
Mode of force application 90  
  continuous force 90  
  intermittent force 90  
  interrupted force 90

**O**

Orthodontic appliance 1  
  attributes 1  
    aesthetic 2  
    biologic 1  
    hygienic 2  
    mechanical 2  
  classification 2  
    functional appliance 3  
    mechanical appliance 2  
  development of removable  
    appliance 4  
    components 6  
  removable appliances 3  
    advantages 3  
    disadvantages 3

**P**

Pressure adjustment with removable  
orthodontic appliances 89

**R**

Removable mechanical appliance 5

**S**

Schwartz arrowhead clasp 26  
Single arrowhead clasp 45  
Single cantilever spring 54  
Southend clasp 36  
Springs 47  
    classification 50  
    auxiliary spring 57  
    buccal canine retractor 51  
    cantilever spring 53  
    coffin spring 58  
    finger spring 53  
    guided spring 53  
    helical canine retractor 52  
    lingual springs 61  
    paddle spring 62

palatal canine retractor 52  
protrusion springs 58  
proximal springs 60  
reverse loop canine retractor 52  
springs on the labial wire 62  
torque spring 63  
u loop canine retractor 53

**T**

Triangular clasp 34

**U**

Universal clasp 45

**Z**

Z spring 57  
Zimmer's-triangular clasp 34