

# BIMarabia

English Edition

3D 4D 5D 6D

March 2017 - The second issue

**Introduction  
to BIM**

**4D specialist**

**Facility  
Management**

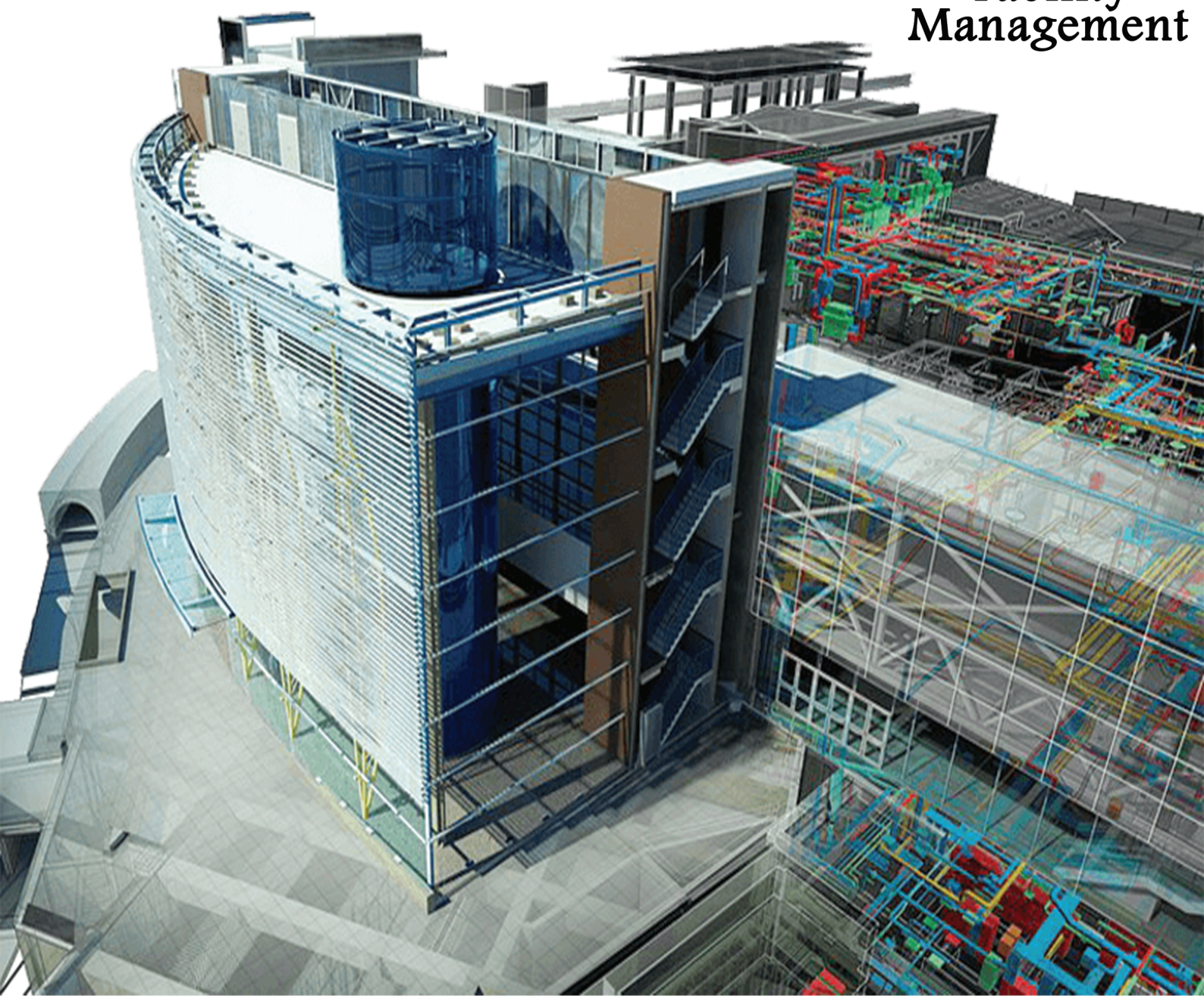



## Introduction

BIMarabia is the first E-magazine intended to spread awareness of BIM tools and workflows across Arabic region. BIMarabia is written and edited by users, targeted to be beneficial to practitioners and researchers in the field. For more information, please go to <http://bimarabia.com/>.

This is the second edition from BIMarabia magazine English version, the growth in the construction industry in Arab World especially in Building Information Modeling (BIM) applications pushing us to develop this magazine to satisfy the needs of the market. When the Arabic version was published, many readers asked for translation into English or any other language, Thus, we decided to translate it into English. If anyone is interested in translating into any other language or join our team, please don't hesitate to contact us:

[BIMARABIA@gmail.com](mailto:BIMARABIA@gmail.com)

Nothing is wiser than what Abdul Rahim Bin Ali said “ I've never seen a writer wrote a book without saying in the next day : If this was changed it'd be better, If this was increased it'd be advisable, If this was moved forward it would have been better and If this was let as it was it'd be better, This is the greatest lesson and an evidence of the size of shortage among humans.

Finally, after modicum progress in this broad knowledge hopes to obtain admission and receive plaudits.

Editor

[Omar Selim](#)

## CONTENTS

Introduction To BIM	4
BIM, is it a new science? Alternatively, is it an ancient one?	8
4D specialist (responsible for building 4D model)	17
Fifth Dimension (5D) in BIM	22
Level of Details (LoD)	25
Introduction to Facility Management Filed	31
Implementing BIM technology between acceptance and rejection	35
Quotes about BIM	37
Qatar BIM User Day	40

### Editorial Team:

[Omar Selim](#)

Engineer : [Hamza Faisal Moshrif](#)

Engineer : [Sonia Ahmed](#), CTU in Prague, Faculty of Civil  
Engineering, Department of Construction Management and Economics



## Virtual Building.

One of the important issues is that, BIM is not limited to buildings only, it could be an air plane, submarine, artificial body parts, etc...

BIM is the abbreviation of Building Information Building and here is the question: Is BUILDING a name, or a verb?

Does it mean already existing buildings or the construction process? BIM is interested in BOTH construction process and existing buildings, we use it during construction where the big benefit appears after the construction ends through the building management, monitoring and controlling.

Is it intended for architectural or structural purposes?.the answer is: all involved disciplines in construction process like: arch. , structural , electro-mechanical....

What is the benefit of BIM?

My teacher engineer Maaz Al-Najjar answers in an interview.

In short, the benefits of BIM for both:

### Architectural:

- Focus on designing rather than drawing
- Taking correct and direct readings from the spaces and dividing them between the model
- Effective management of the project according to the fact that the architect is the author of the idea of the project and he is responsible for it in front of the companies' management in a healthy work environment.

### Construction (Civil):

- Taking the model correctly (constructional elements required only, without diving in the eternal thinking to understand the model and re-work on it to become the form they wish)
- The possibility of analyzing the model within its program which he works on comfortably and then re-form it with the modifications of the basic project on the BIM Server to follow-up working on it later with an alert to changes taking place to the other engineering complementary, specialties and multiple staff.
- A direct calculation of the quantity related to space and sizes (and in some scenarios, calculating lengths and diameters of reinforcing bars) and extracting quantity tables directly from the model without returning to the previous drawings like : architectural , plumbing , electrical and mechanical ones.

### Mechanical Electrical and Plumbing (MEP):

Majority of work scenarios, MEP engineers have a prior experience of building needs to diameters of wires and their access as the case of push and pull circuits volumes used in air conditioning, refrigeration and so on for piping fresh water circuit and salt water... etc. But what needed is the knowledge of extension of these circuits, cables and pipes which would interfere or clash a non-structural or structural elements, such

as ceilings and others that will be installed in the building later MEP specialists benefit in knowing the sizes for heating and cooling

- Extension to show the place of trays, which cables will be extended on.
- Full representation of the central air-conditioning circuits Air Ducts with the work called Collision Detection to indicate if there is any objection with the structural elements that is currently installed
- A review of the project as a whole after the installation of all systems. This allows us to inspect the integrity of the original design and its lifetime.
- The possibility of transferring the model to other software which the engineering staff works on for further analysis and matching specifications

### The benefits of BIM for the contractor: (Contractor)

- Knowing the specifications required for implementation in the field.
- True and accurate knowledge of the necessary building materials and other accessories (Scaffolding and tower cranes to what else of toolkits) for the completion of the construction and overall site logistics.
- An estimated initial a true report for labor fees and required staff.
- True inventory of warehouses and what necessary for the construction project.
- Simulation of the time schedule (4D analysis) and giving the best reports for engineers' feedback about the proper functioning of the site.
- Setting up safety and evacuation plans.

### The benefits of BIM for workers in real estate (Real Estate Brokers and agents):

the environment , the nature of the client and the property as well in addition to the site. But most real estate workers share some specific characteristics which , BIM could contribute to such as:

- BIM helps in providing a true age of the property and its specifications which positively motivate the client to buy it.
- Full data on the location, size, and volumes if necessary.
- The possibility of providing the ready scheme to the client who wants to know everything about the property which he wants to buy.
- The possibility of expanding the data included in BIM system in order to contain the real estate data associated with the property, owners, transfer of ownership and its problems data, if existing.
- - Real-time reporting of leased area data of a facility (7D Simulation)

### The benefits of BIM for Facility Management (FM):

Usually, firms associated with facility management work with the owners according to maintenance annual contracts for everything related to this property.

BIM system is very essential according to the nature of the facility management. Some BIM software take the full model information, then add information about workers in facility management to connect them with time. ArchiFM, for instance, is one of the most common software in Britain, which works directly with the internet. It takes the property number after obtaining its model from Archicad software, then schedules the consumed items (they are often covered by the maintenance contract) within timetables in order to allow the maintenance department to follow it directly for repairing on a regular basis. This scheduling is based according to specific work hours or recording the damage when a problem occurs in the record to see what has been altered during a period, which is currently done by the accountant! Which unfortunately does not have any engineering experience of those pieces functions.

### [Benefits of BIM for manufacturers:](#)

BIM Object in the library has become an alternative to the image that we used to see in catalogs during the eighties and before. Within BIM software, we are working on providing ready-element by the manufacturer (furniture pieces, for example) that allows the designer to choose the right characterization of this element rather than the popular way in which the designer puts a general Block for any piece of furniture and then the problems come. When it turns out that the piece which was for beautiful decoration, on the ground, there will be other dimensions for the customer piece that will be chosen by the customer (later unfortunately)... Practically the manufacturer puts all models which are manufactured in the form of BIM Objects within its own site or it will be sent by any available way like: nowadays DropBox, Email to engineer, who will put on his turn the elements as they are (dimensions, price, manufacturer's name, date of manufacturing, shipping cost...) and so forth of information which the engineer must know and consequently preparing answers to the client and never leave that to the last moment.



## BIM, is it a new science? Alternatively, is it an ancient one?

Ahmad Lutfi

I could not find any earlier documentary speaking of BIM concept as we know it today better than what mentioned in the research “*augmenting human intellect a conceptual framework*” Quoted below.

“Ignoring the representation on the display, the architect next begins to enter a series of specifications and data--a six-inch slab floor, twelve-inch concrete walls eight feet high within the excavation, and so on. When he has finished, the revised scene appears on the screen. A structure is taking shape. He examines it, adjusts it, pauses long enough to ask for handbook or catalog information from the clerk at various points, and readjusts accordingly. He often recalls from the “clerk” his working lists of specifications and considerations to refer to them, modify them, or add to them. These lists grow into an ever more-detailed, interlinked structure, which represents the maturing thought behind the actual design. “ That was October 1962 By Douglas C. Engelbart

That was the concept of integrating disciplines, not segregating them which was the driver of many disciplines to specialize, this segregation appears in the recent common practice of many fields not only in the Building or construction industry.



Dr. Engelpert research was mainly about the interacting relation between the man and the computer as a machine, and to make in use “to make the world a better place” as he used to say. Not about BIM precisely and it is helpful to mention here that Dr. Engelpert is the official inventor of the computer mouse! Which used today by Billions as the main tool to interact with the computers, which enable us to use computers more effeminacy and of course gives BIM a big push ahead,

That was 1962, but I still believe that the concept of BIM is mainly was found a long time back, and 1962 was not the first time that somebody thought of integrating many disciplines in a central mode for more coordination and collaboration.

What about all those ancient landmarks which we still –as 21<sup>st</sup> century engineers- receive them with astonishment?

Wondering, how in earth have they been constructed? what are the criteria that were followed to build those tremendous structures?

Prof. G.R.H. Wright, in his book “Ancient Building in South Syria and Palestine”:  
Volume 1

“The first real evidence of the architectural drawings and manual shop drawings was discovered in the Middle East, specifically in Mesopotamia and in Egypt, and has sacrificed the facades details based on projections directly into a single drawing, which was a good way to maintain compatibility and consistency between the elevations and facades.”

If we assume that what we have today of ideas regarding the concept of integrating data in a a one interactive skeleton is the peak of development , it could be concluded that separating them according to sub-specializes is a bad one.

Well, there some people who may think of that. To assure that, we firstly have to speculate about the origin of construction industry and its development along ages (before turning into a multi - discipline science with different sub-specializes). Since engineering sciences have expanded, humans were forced to be specialized to so as to accumulate tremendous and accelerated to do their jobs and constitute groups of workers in this field which, includes enormous number of people. Since that, the engineer has become less creative despite different specializations.

To prove that , let's have a look on one of the ancient monuments ; Giza Pyramids which still , standing steadfast till today as an architectural masterpiece.

This landmark, which was - probably - beyond the design and implementation only one person, this man was the artist and designer and architect and project manager and representative of the owner and the structural engineer and mechanical interior designer and landscape designer, and even Consultant sustainability or green building,Really?

Is it possible??? Can one man combine those different branches of sciences at once even if we call them today ( primary or basic sciences)

Yes, this was possible indeed, and those sciences were not fundamental, they -in fact

-mature sciences and they were adopted by the modern world to make us what we are today! & they still in use in schools until today, but somewhere lost

Professor Robert Garland says in his book “The Other Side of History, daily life in the ancient world- lecture for being Egyptian about what ancient nations believes;

“ The Gods established your world for all eternity, so its best, to leave things as they are, just do what your fathers & your forefathers have always done, that is the best way to guarantee your future ! “

So a craft or a discipline- let’s say- in ancient Egypt, was reserved for some families, and this is the case in almost all regions of the ancient world, for example, a Builder will teach his sons this craft which he got with its skills & secrets (tricks and tips) as we call it today - who got it from his forefathers with all the secrets and so on and so forth..., Finlay you’ll find a builder with a summary of ten generations of experience, that’s almost 330 years old!

Moreover, we can recall the life and achievements of the ancient scientists from vast civilizations; Greek, Romanian, Persian, Islamic and others who had the knowledge of different disciplines at the same time, so they invented a new sciences were not in their ancestors. These discoveries and new science was the result of the integration multi disciplines with its presence in the heart or the brain of one man.

So we can say that behind the designing and construction management of each land mark of the ancient world stands one person who was thinking processing all issues together, like he has an interactive storage space (record, read and modify), in his head or his heart where he keeps a central model filled with information, revealing contradictions and errors, immediate sections and elevations, quantities, time span & cost of implementation in addition, with material and design specification in one model sits there without any problems!

It is the same “BIM “principle? Isn’t it?

To integrate data into one centralized model for easy access of record & recall.

What if I told you that as per many references, that most of the ancient architecture landmarks used to be built in small scale as a model for pleasing the king or ruler as a presentation, exactly like what we do today as the “mockup.” and due the missing of light and easy forming material such as plastic and cardboard we use, the models were built using the same material that will be used in real.

Therefore, there mockup was –more or less- a project simulation, which mean that they could have been rocked to simulate a seismic study, or exposing the model to airflow in a “wind tunnel” to simulate wind loads and project wind resistance !

And now that you know all that do you still think that the “BIM” or the methodology of construction facilities using integrated information model for ease of record, recall, comparison and retrieval processing is to build a novelty work flow of construction?

This method- indeed- was the original workflow for projects design and implementation,

and the methodology we have today ,which was used throughout last ten decades is an outsider methodology.

Nevertheless, with such progress of science and the availability of high and unlimited efficiency tools of software and hardware, that humanity will return to the same correct methodology and we shall soon see – if not started - creative innovations in the architectural ,construction, planning ,roads and infrastructure fields be ready.

## References

- AUGMENTING HUMAN INTELLECT: A CONCEPTUAL FRAMEWORK (Doglas research)  
Ancient Building in South Syria and Palestine: Y G.R.H. Wright BOOK1 /The Other Side of History: Daily Life in the Ancient World.BOOK 2



## “Roles and Responsibilities of a BIM Working Team”

MOHAMAD MOHSEN KAMEL When revolutions occur, traditional means of operation are no longer effective. Traditional cultures become unstable and new practices are explored to address the instability. Some social units will succeed and become successful, while others will not adapt and fade away.” Chuck Eastman

Chuck Eastman is the author of” BIM Handbook: A Guide to *Building Information Modeling* for Owners, Managers, Designers, Engineers and Contractors” who highlighted the importance of changing traditional methods of thinking in a construction of new projects where implementing new technologies in classical ways hinder the optimal utilization the capabilities of tools or knowledge that we have.

BIM is considered as a revolution in the fields of Architectural, Engineering and construction (AEC) Industry. Thus, traditional and well-rooted methodologies utilized in operating engineering projects are no longer suitable to compete for this revolution. Therefore, it is essential to discover and set new roles and responsibilities for BIM working team.

Definition of roles and responsibilities is considered as one of the preliminary steps to implement BIM in a certain project that needs to be clarified from the beginning. Therefore, it’s essential to appoint people to new roles and responsibility to achieve maximum optimization and the highest possible quality. The roles and responsibilities in BIM are divided into three main levels, which are listed as:

- (1) BIM steering committee
- (2) Project steering committee
- (3) BIM support committee

## 1- BIM steering committee

A group of people located in a high level of administration or ownership (owners, partners, managers, department heads ... etc) who have the right to make decisions over the firm. This committee clearly defines the strategic goals to upgrade the firm to a higher level of efficiency. Thus, the committee recruited BIM specialists or advisors to clarify the recent innovation in the BIM field and how to be applied strategically without involvement in technical details. Decisions are made for implementation by cognizance the available resources, which identify the need to increase these resources to achieve the goals set.

Therefore, some responsibilities that were not previously known is is arisen like BIM Manager. A BIM managing director is the person who study and plan the implementation of BIM over the firm. He is a member of the BIM steering committee. Some of his roles and responsibilities including but not limited to:

- 1- Formulates the overall context of BIM implementation over the firm.
- 2- Communication with the top management to check that BIM implementation aligned with strategic goals.
- 3- Established the needed plans to adopt BIM and follow up its implementation according to strategies.
- 4- Dividing targets and establishing a suitable timetable to achieve these targets.
- 5- Providing reports that clarify the maturity level of the firm regarding BIM implementation by following the particular plan and timetable.
- 6- Identifying required resources and materials for BIM implementation within the firm.
- 7- Determine the appropriate assessment standard that should be followed for BIM implementation.
- 8- Explain the latest update in practical policy related to BIM technology.
- 9- Presenting the engineering community capabilities and the quality level of the products, which is provided to clients by using BIM

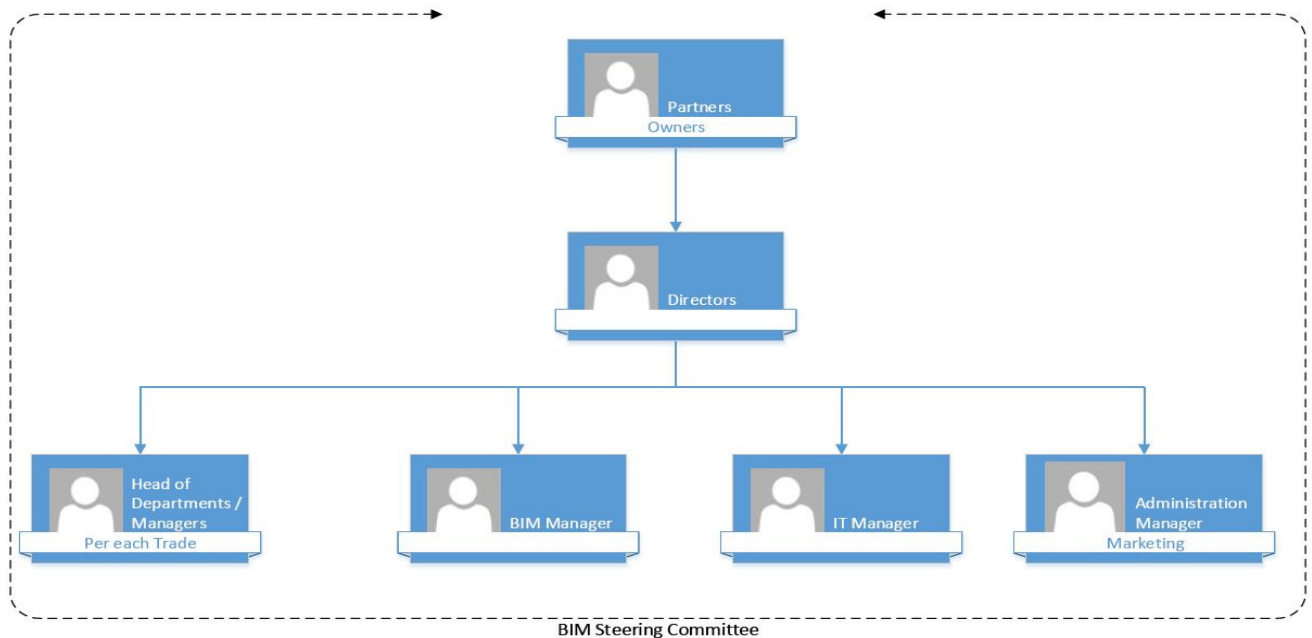

## 2-Project steering committee

A group of individuals responsible for BIM implementation in the project. They follow the strategy that developed by the BIM steering committee. They assigned a person to be a BIM coordinator in the project who responsible for all departments. Some of BIM coordinator roles and responsibilities are:

- 1- Defining goals of BIM implementation in the project.
- 2- Identifying the suitable assessment standard to be followed in the project.
- 3- Developing the BIM Execution Plan (BEP).
- 4- Ensuring that the project is implemented as required according to the planned efficiency.
- 5- Monitoring quality of the project and checking audit continuously.
- 6- Coordination between all specialties and clash detection among them.
- 7- Presenting the quality level of the project.

Sometimes, BIM manager is assigned to a specific project where the firm contract to implement BIM, but it does not have strategic goals to implement BIM. Therefore, the BIM manager has the same roles and responsibilities as a BIM coordinator.

A model coordinator / model manager is a member who is appointed to apply BIM in his department (architectural - structural – electrical – mechanical ...etc). His roles and responsibilities as follow:

- (1) Execution of assigned goals which are set in his sector.
- (2) Revising the project quality according to specific standards.
- (3) Providing solutions for technical problems in his department.

#### (4) Contribution in coordination and clash detections among departments.

The rest of the project members who build the model and follow the model coordinator instructions are called BIM modelers.

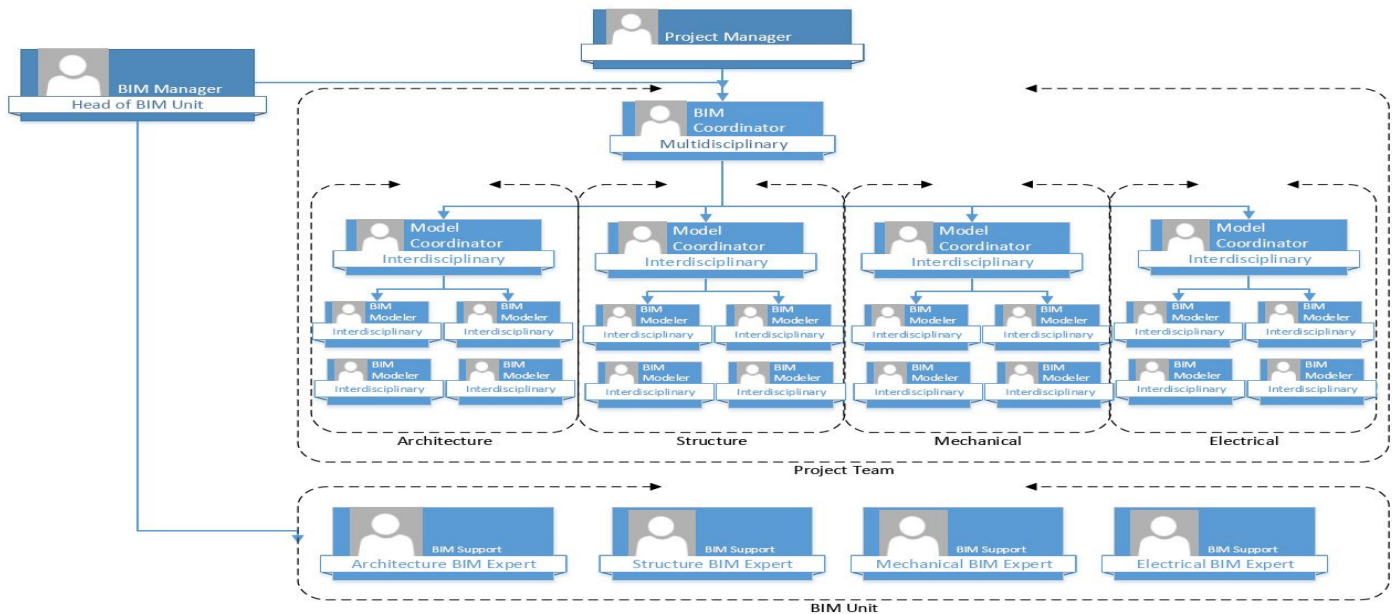

### 3- BIM support unit

In most companies, some of the mentioned members are devoted to doing one or some of the unit roles. While in other large companies, responsibilities and roles are separated. Specific persons are recruited in these branches without intrusion in BIM application in the company or in projects. They do their jobs through scientific researches, studying practical application and laying standards to be used by BIM steering committee and Project Steering Committee as their reference and doing the technical support to implement BIM in the projects. This process is called Research and Developing Tracks. The persons who do that is called BIM project support unit. Those members have the following technical descriptions:

- (1) BIM researcher: the expert who works in universities, institutions, and organizations. He develops and coordinates researches about BIM.
- (2) BIM analyst: the person taking charge of analysis and simulation of BIM models.
- (3) BIM application developer: the one responsible for development and customization programs to support integration and add-ins to make it easy for BIM users.
- (4) BIM facilitator / BIM support: the person who is in charge of training and helping new BIM users.
- (5) BIM technician: the one who helps the working team to do frequent tasks that is based on repeating, without the necessity of interference of experts.

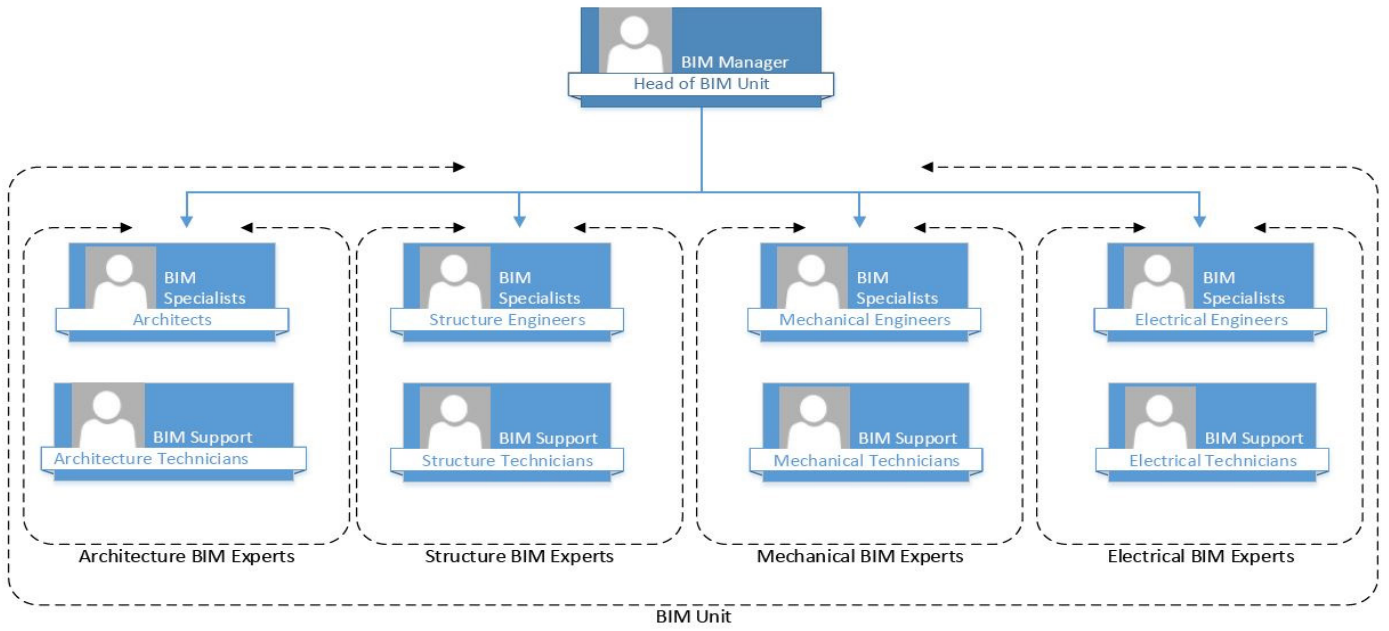

Translated by: Ehab Khirt





## 4D specialist (responsible for building 4D

4D Specialist must be (BIM coordinator + Planning Engineer + 3D modeler + Graphic Designer)

Tamer Elgohari

When someone talks about how easy creating simulation model (4D model) by linking each element of the project model (3D model) with its related timetable. The discussion always turns to be about 4D BIM Dilemma.

Did I say Dilemma? Yes, it is a dilemma connected with skills and knowledge of a 4D specialist. In order to become competent to build the 4D model in the correct way besides his responsibilities and duties.

After working and searching in this field, we can say that 4D specialist must be characterized by five separated different skills at the same time. When we think about these five skills, we find that they are:

- 1- Ability to build a 4D modeling: creating, developing, monitoring, and reviewing the 4D Simulation.
- 2- Ability to management and coordination: to be a joint point to accomplish smooth cooperation between the modeling and the planning team.
- 3- Planning Engineer: having the ability to create and modify schedules, reports by having a good knowledge about safety and general site planning.
- 4- 3D modeler / VDC: to have a complete knowledge about 3D CAD applications and building a virtual model.
- 5- Graphic Designer: having the ability to create animation, to merge audio and video files and to make a final presentation.

Do you still think that creating a simulation model (4D model) depends on linking each element of the project model (3D model) with its related task in the timetable?

So, how these five different skills interact to get the 4D model? and where must each skill take its part during the stages of building 4D model?

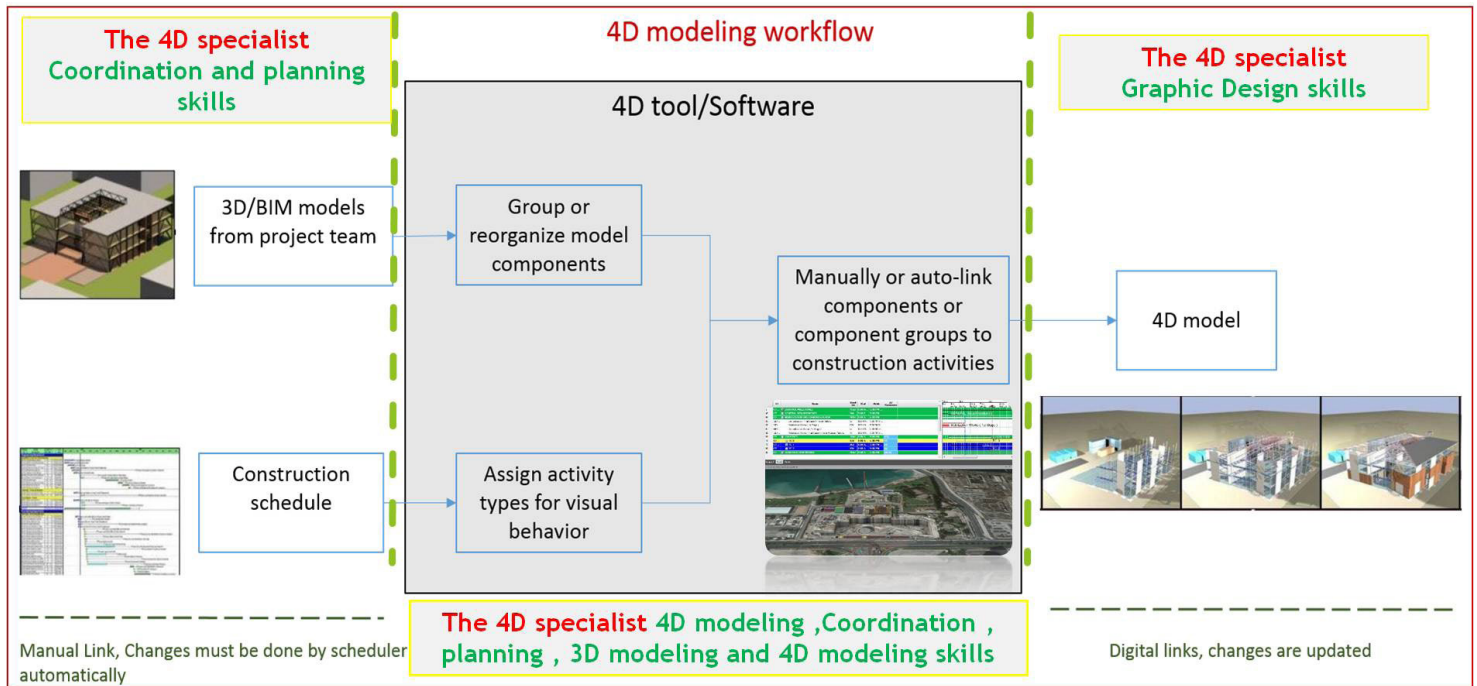

## Stages of Creating 4D Model

As the figure explains, creating 4D model is divided into 3 essential stages:

1. Building a virtual model of the project and creating a timetable.

In this stage, the 4D specialist represents the link between modeling team and planning team to make sure that the division method of the project model matches exactly the division method of the timetable in terms of details level, and matches zoning plan with WBS Schedule in terms of divisions. These steps are done to make sure that every element in the project model has an activity represents it in the timetable. At this stage the competency of 4D specialist in coordination between the different teams, the competency of imagining the method of building a simulation model, and the competency of analyzing the timetable is shown and how to connect it before creating simulation model.

2. Building simulation model stage:

In this stage, the simulation model is built by connecting every element of the project model with an activity in the timetable. This connection process is done through:

1- Classifying each element in the project model according to its nature and place in the project to match the timetable division. For example:

1-1-1 Ground slab Zone, 1-1-1 B0 1 columns Zone, 1-1-1 Raft Foundation Zone

2- Classifying every activity of the timetable according to its work and give it a distinctive color or a different movement of each other to make simulation easier and clearer. For example, drilling activity with a yellow color and hiding the element movement in the model, column pouring activity with a blue color and a vertical movement for the element in the model, roof pouring activity with a green color with horizontal movement for the element in the model, finishing activities in red color with showing the movement of the element in the model.

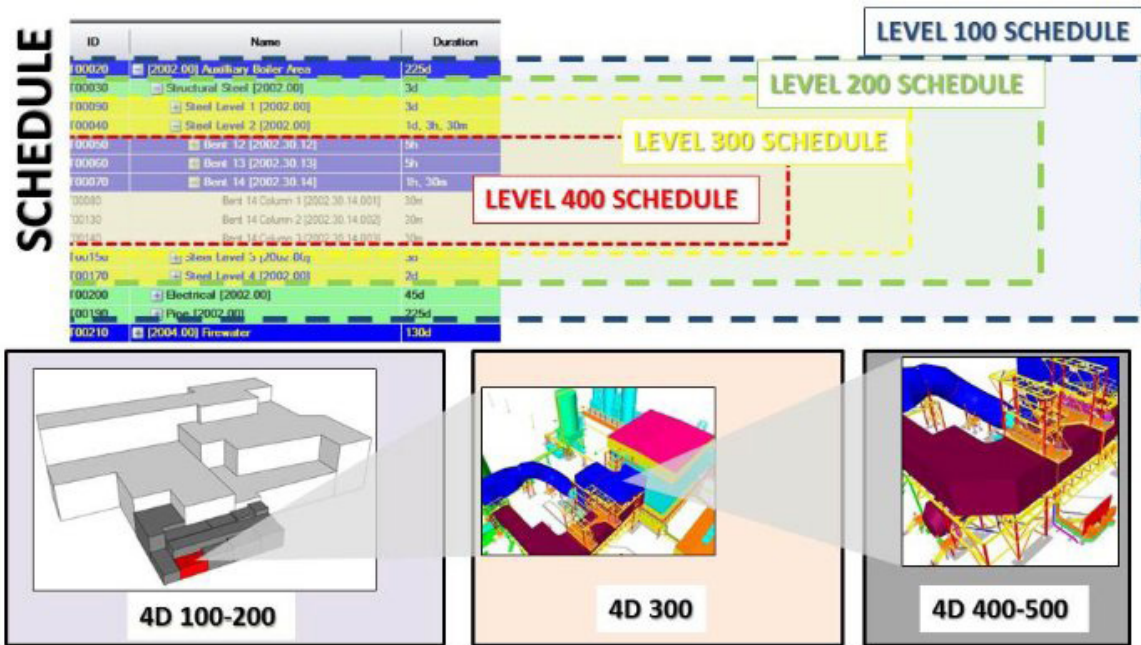

3- In the most of the times, there are some important activities which must be shown in simulation but nothing can represent it in the project model so 4D specialist must create these elements and add them to the project model. For example: Soil that is being drilled, ordinary concrete layer under the bases, the isolation layers.

In the same way, some elements are in the project model and don't exist in the timetable where 4D specialist should make more division to all activities in the timetable to match the element opposite to it in the project model. For example: some activity for columns and roof on every floor, but 4D specialist wants to divide columns activity from roof activity in every floor to make it clearer and more realistic because the columns activity is different from roof activity.

4- After ending these steps the 4D specialist connects every element of the project model with the opposite activity in the timetable, the connection step is done either by hand for each element or automatically by coding system to identify each element with its opposite activity.

At this stage, the 4D specialist ability to create 3D model, the ability of planning and updating the timetable, and the ability of connecting and creating 4D model is shown.

### 3. Graphic designer stage:

It is considered to be the last stage to create a simulation video, at this stage the imaging angle is determined, the light direction or any visual effects like shadows. At this stage, it is advised to export the videos in small parts for example a section of 10 minutes, and to gather them later on another program to merge video sections, in order to make video export easier and to save time. In addition, in case of reviewing the small sections sometimes a mistake in simulation process is discovered so we modify this mistake, and we export this section only instead of exporting the whole video. A video of 2 to 4 minutes needs 5 hours to export, so dividing it into small sections

is a perfect solution to save time. Besides, collecting the video on graphic designer gives the ability to add photos or to write next to the video so this will make it easy for the 4D specialist to add any engineering data next to the simulation video and this will add engineering value and make it clearer to the viewer; where all the information is being clear and result reached through the simulation model for example the delayed activity in the project or the proposed result solution and alternatives

At this stage the ability of 4D specialist in planning and analyzing simulation results and graphic designing is shown

### General view and advices

It is clear that as a result of interventions between the different sectors which is explained, we will find ourselves in a bigger dilemma, which is who is responsible of creating, management, development and owning a 4D model?

For example, is the raft foundation will be in one stage or in many stages? Who will determine the level of details which the timetable will be built to match the project model?

### References:

<https://synchrold.com/>

<http://www.epicbim.com/>



### 3D Model Based Scheduling

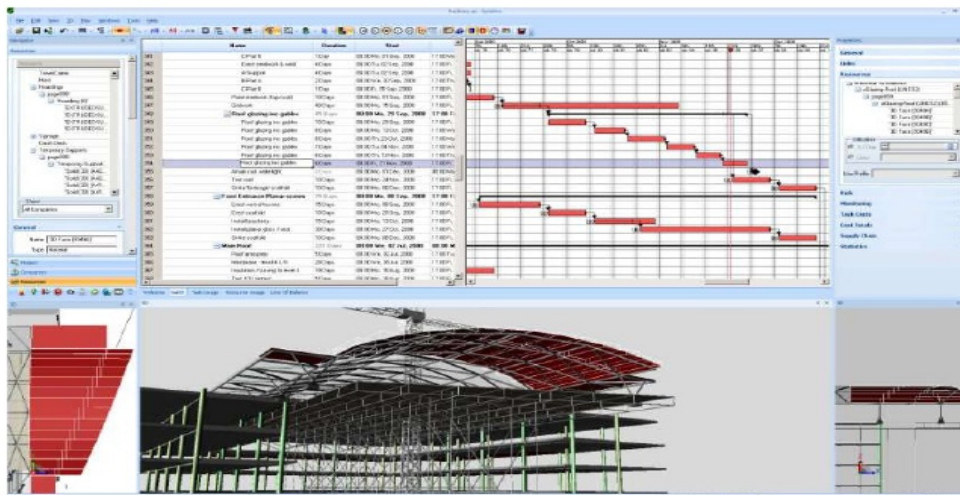

Synchro



# list o BIM software

## Architecture

Autodesk Revit Architecture  
Graphisoft ArchiCAD  
Nemetschek Allplan Architecture  
Gehry Technologies – Digital Project Designer  
Nemetschek Vectorworks Architect  
Bentley Architecture  
(4MSA IDEA Architectural Design (IntelliCAD  
CADSoft Envisioneer  
Softtech Spirit  
(RhinoBIM (BETA

## Structures

Autodesk Revit Structure  
Bentley Structural Modeler  
Bentley RAM, STAAD and ProSteel  
Tekla Structures  
CypeCAD  
Graytec Advance Design  
StructureSoft Metal Wood Framer  
Nemetschek Scia  
4MSA Strad and Steel  
Autodesk Robot Structural Analysis

## MEP

Autodesk Revit MEP  
Bentley Hevacomp Mechanical Designer  
4MSA FineHVAC + FineLIFT + FineELEC +  
FineSANI  
Gehry Technologies – Digital Project MEP Systems  
Routing  
(CADMEP (CADduct / CADmech

## Construction (Simulation, Estimating and Const. (Analysis

Autodesk Navisworks  
Solibri Model Checker  
Vico Office Suite  
Vela Field BIM  
Bentley ConstrucSim  
Tekla BIM Sight  
(Glue (by Horizontal Systems  
Synchro Professional  
Innovaya

## Sustainability

Autodesk Ecotect Analysis

Autodesk Green Building Studio  
Graphisoft EcoDesigner  
IES Solutions Virtual Environment VE-Pro  
Bentley Tas Simulator  
Bentley Hevacomp  
DesignBuilder

## estimating

Cost Estimate Autodesk QTO  
Innovaya  
Vico  
Timberline or equal

## ENERGY ANALYSIS

Energy Analysis Autodesk Green Building Studio  
IES  
Hevacomp  
TAS  
equal

## Facility Managment

Bentley Facilities  
FM:Systems FM:Interact  
(Vintocon ArchiFM (For ArchiCAD  
Onuma System  
EcoDomus

## INFRASTRUCURE

InfraWorks 360  
CityEngine

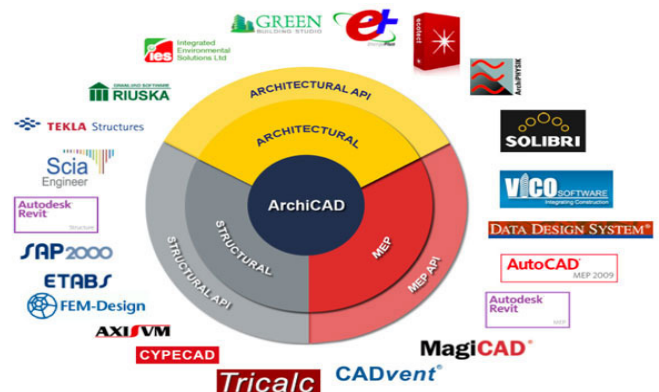

# FIFTH DIMENSION (5D) IN BIM

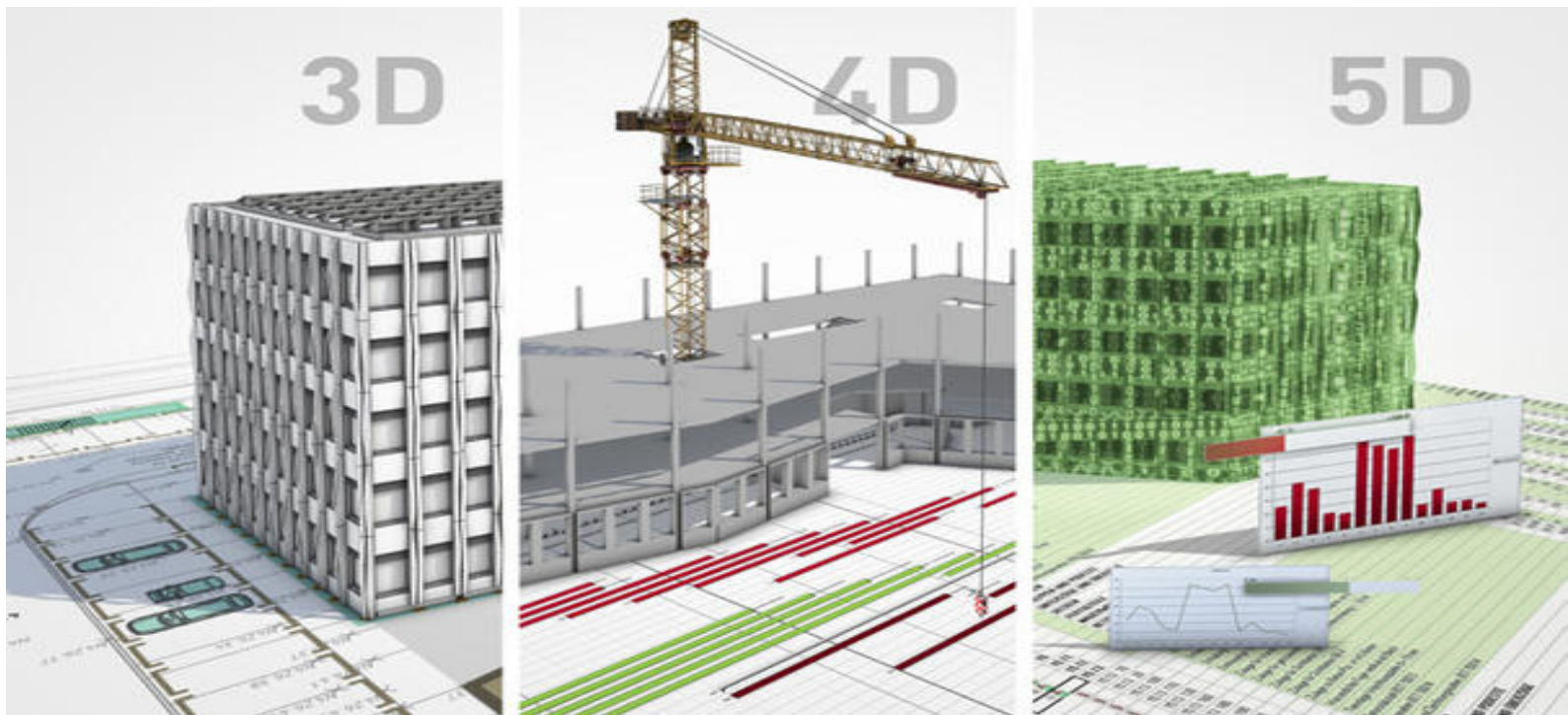

a Cost estimate is about predicting the potential cost of resources required to start and complete project works. Cost estimating is taking place at the beginning of the project where feasibility studies and the selection of the optimal alternative regarding continuity or cancellation. It is worth mentioning that there are many projects have not been completed due to poor cost estimation.

Cost estimating is the fifth dimension in Building Information Modelling (BIM).

To simplify the idea of dimensions: In the beginning, there was only one dimension, where a man pointing a spear towards a prey (X),

Then there became two dimensions (X and Y) when he moved to agriculture. Then there became a third dimension (X, Y, and Z) when he started in constructed high buildings.

Then there became a fourth dimension (time) fifth, sixth, BIMnD Today, we will talk about the fifth dimension in BIM that is a cost estimating.

The transforming from a narrow information in CAD system to wider space in BIM worth to take serious steps in adopting new technology due to accurate information about inventory and pricing of construction cost.



Omar Selim

BIM stimulates a paradigm shift in inventory

- 1) Inventory time has been shrunken to few minutes where you can get the Bill of Quantity (BoQ) on the same day of completing the design. When you finish the work in some BIM software, if you press inventory button, you will find a table contains the inventory of all elements of the project
- 2) You can set determinants or factors to determine the combination cost with great accuracy. For example, 1 door will cost 10 screws and hinges and it will take half an hour for installation and the worker salary is 10\$ per hour. You will have the door cost and the amount of material.

A study conducted by Stanford University Centre for Integrated Facilities Engineering (CIFE) on 32 huge projects found that: accuracy in cost calculating reached 97% and saving 10% of the cost.

- 3) You can know accurately when you will need the material so you can organize supply chain. This has a significant impact on the construction firms where they do not purchase materials and store them for a long time before they need them.
- 4) The inventory information coincides with the information in the model, so you will not do the inventory again. In the past, we were forced to redo inventory after any substantial modifications in the project (where the project files separate CAD from the inventory of EXCEL files) repeating time loss while in BIM tables are modified automatically.
- 5) Inventory in the old way was not accurate. For example, in pipes surveying we calculate the lengths of the horizontal pipes while vertical ones appear as a point in the drawings, by using BIM programs the calculations are accurate
- 6) You can determine the cost at every stage and the effect of any change in the design of cost.
- 7) Make more informed decisions by comparing multiple costs estimating with the target cost of the project.

### When did we start the inventory?

The inventory started when we did the preliminary designs and before the start of the construction. Before entering the tender, we make a model and inventory components to know the project cost

The most important software of 5D

Autodesk software provided quantity take off and then in 2014 was retired and has added a few tools such as; Navisworks – Innovaya – Vico - CostX - Timberline or equal.

To reinforce my argument, I quote from my dialogue with my teacher, Architect Hani Salah Omar

Omar Selim

I understand from your words that the feedback on BIM investment is large

Hany Salah Omar

Absolutely, one of the case studies I have encountered is a project in which 2.5 million cubic meters of concrete. In this huge project, the manager proposed to adopt BIM only for inventory quantities

They saved about seven million pounds where it was a quantum leap for them and they have earned the project. Since then the company uses BIM only because they have identified one of the BIM benefits.

Omar Selim

Is this all saving from inventory?

Hany Salah Omar

Yes, the project was nearly 500 million pounds

Restrictions on the 5D BIM programs

So far, this software cannot analyze the cash flow because they did not calculate the delay payments and overdrafts.



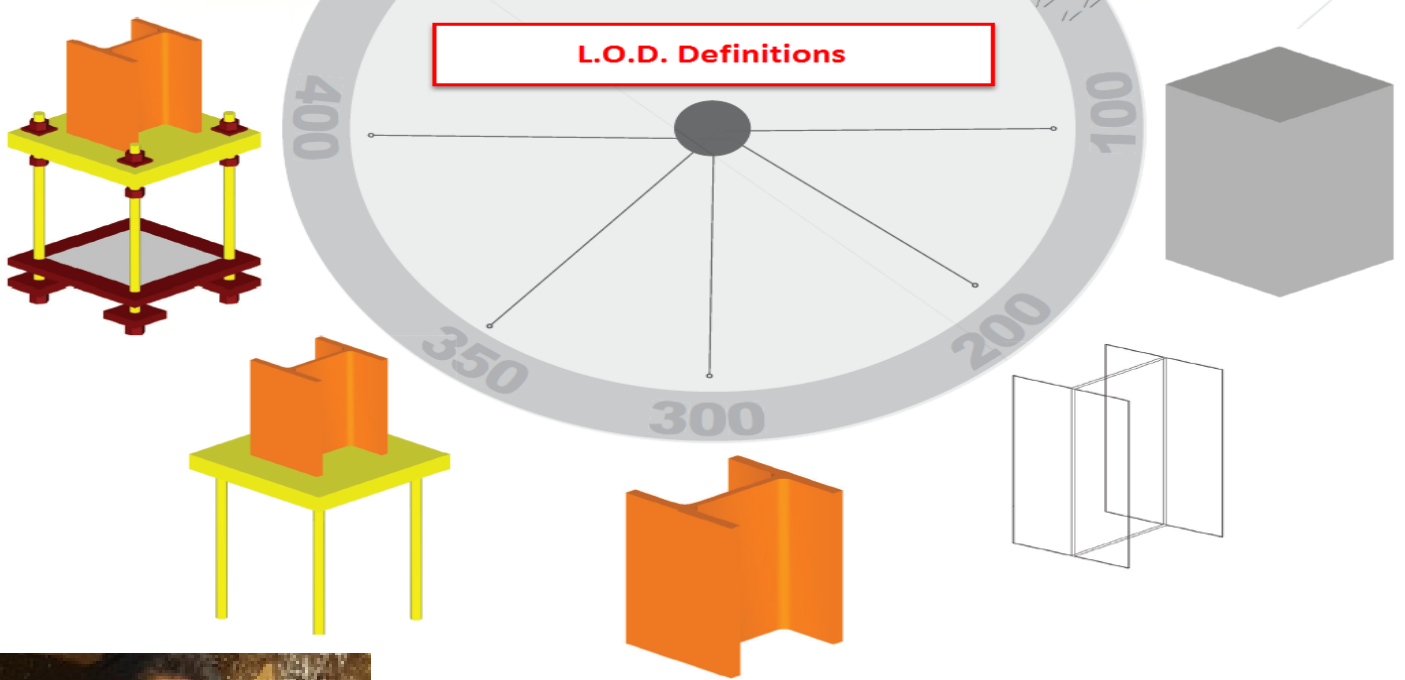

Moamed Hammad

## Level of Details (LoD)

Clarifying elements methods in terms of how much information or details according to the stages of a project at different rates from the design inception, implementation to the AS-Built stage; for the purpose of exchanging information to understand the element among all participants in the project, of architects, civil engineers, MEP engineers, owner and implementation engineers.

### When has LOD been started?

According to the American code AIA, document E202-2008

### Which is the first software program has applied LOD?

Vico Software with adding the cost to each stage in the project

Development stages advantages of LOD element

Determining the project cost for BIM.

1. Determining the time for each stage of the project.
2. Assisting the owner to know the components which are used in BIM in accordance with the agreed contract among the owner, consultant and contractor.

The LOD specifications (Architectural LOD)

### 1-LOD 100

Representing the mass object (shape) to clarify its purpose and its place in the general site and it can be designed according to the building area or the mass by approximate proportions, and the price of the item can be added to do a feasibility study.

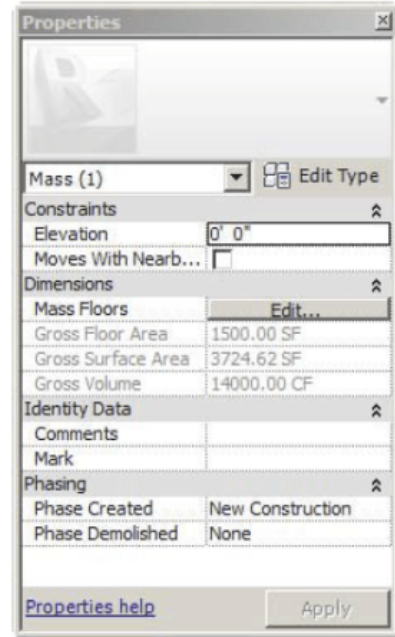
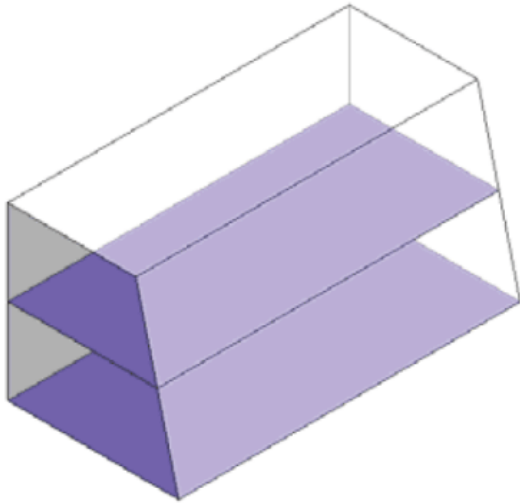

## 2- LOD 200

Representing the model as a mass according to the shape, height, location and orientation, size, wall thickness, floors and openings in the walls can be added, shafts and roofs but approximately and determining the elements which will be used.

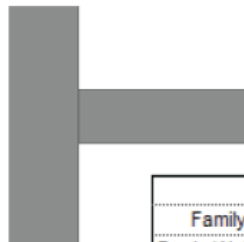
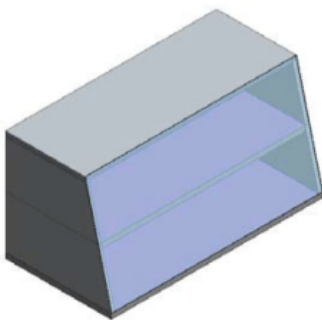

Wall Schedule (LoD-2)					
Family	Type	Width	Length	Area	Volume
Basic Wall	Generic - 8"	0' - 8"	39' - 0"	656 SF	437.51 CF
Basic Wall	Generic - 12"	1' - 0"	39' - 4"	759 SF	759.22 CF

## 3- LOD 300

Representing the model as a mass according to the size, quantity, location and orientation of the building in a very accurate way of adding layers of walls, floors and all aspects regarding the performance of element, and showing the details about the individual components away from the details relating to installation method.

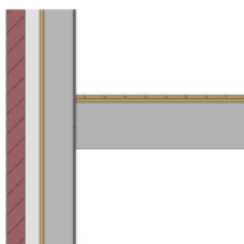
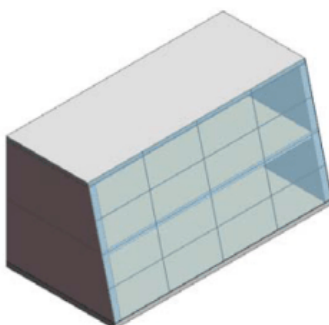

Wall Material Takeoff (LoD-3)	
Material: Name	Material: Volume
Gypsum Wall Board	58.66 CF
Masonry - Brick	425.26 CF
Metal - Stud Layer	703.87 CF
Misc. Air Layers - Air Space	351.94 CF
Wood - Sheathing - plywood	87.98 CF

#### 4- LOD 400

Representing the shape, size and location with adding the shop drawings, fabrication and manufacturing (HVAC) which contains an accurate cost information and 2D designs and the small details to develop it from the stage LOD 300.

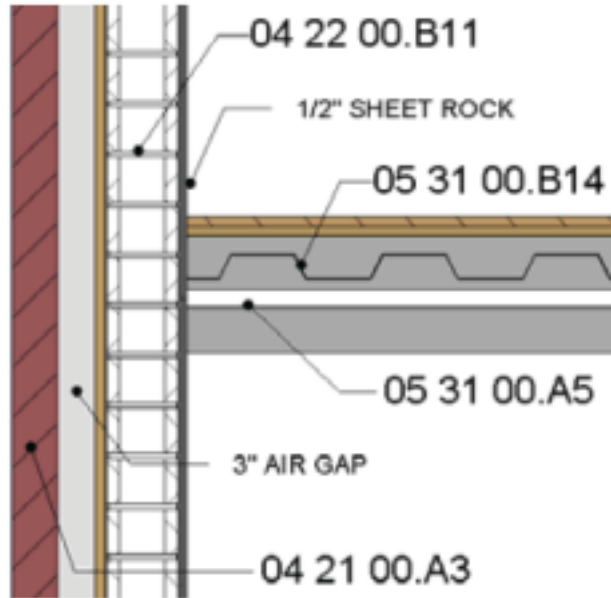

#### 5- LOD 500

The implemented drawings are taken from the site after the execution, measuring them, studying specifications, taking As-Built exactly and making updating with BIM, operation and maintenance and Facilities management.

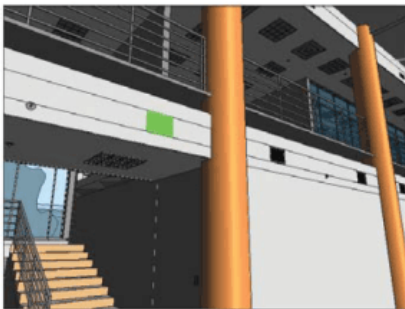

element_ID	revit_ID	last_inspected	next_inspection_due_date	priority	condition
132457383	659832	6/2/2008	9/11/2011	medium	good
132426790	679334	6/2/2008	9/11/2011	medium	good
132447782	650023	6/2/2008	9/11/2011	medium	good
131276003	672363	4/20/2006	1/24/2011	high	fair
132786522	650933	6/2/2008	9/11/2011	medium	good
131028862	667681	6/2/2008	9/11/2011	medium	good
132290073	679911	6/2/2008	9/11/2011	medium	excellent
131189520	640087	6/2/2008	9/11/2011	medium	good

What is the difference between Level of Development (LOD) and Level of Detail (LoD)?

LOD: it is a link between the detailed level and developmental level, and it doesn't focus on the shape or dimensions but it help the contractor to know the element's number and its manufacturer.

LoD: an amount of details and dimensions accurately in order to avoid the variation between the contract and modeling in the program or the extracted information from the program.

LOD aspects

1. LOA-Level of accuracy: the stage of beginning the design, such as HVAC with various sizes and specific percentages 100mm
2. LOI-level of information: this feature allows to use 4D and helps the projects management department as it contains information about cost and product's stores.
3. LOC- Level of Coordination: it's part of LOD but it relies on the element that is required to be implemented and its link with other surrounded elements, such as, the openings of doors with the structural walls.

## LOD schedule

After we talked about the levels of development in the element, it is necessary to do a schedule in the matrix to illustrate each element at every stage from design to handover.

The purpose of the matrix is to determine the outputs or desired results, so the elements should be emphasized with the existed amendment level, in order to avoid any disagreements between the parties within the contract and the required delivery.

Model Element by CSI UniFormat <sup>®</sup> classification			Notes							
			LOD		MEA		LOD		MEA	
<b>A SUBSTRUCTURE</b>										
A10 Foundations	A1010 Standard foundations									
	A1020 Special foundations									
	A1030 Slab on grade									
A20 Basement construction	A2010 Basement excavation									
	A2020 Basement walls									
<b>B SHELL</b>										
B10 Superstructure	B1010 Floor construction									
	B1020 Roof construction									

Source: NATSPEC BIM Paper NBP 001: BIM and LOO – Building Information Modelling and Level of development. First published 2013

1. The elements: setting the names of available departments which are participating in the project, such as, architecture, civil and MEP.
2. LOD: setting stages (LOD100-LOD200-LOD300-LOD400-LOD500) according to the existing contract.
3. The name of the department which is responsible for manufacturing of the element.
4. Clarifying the levels the project from design stage to development design stage in implementation drawings.
5. Any note or comment.

## Stages of LOD design

From the previous schedule, there is a life-cycle between LOD and project's design levels. For example, using walls without layers and then the element will be developed to add layers according to the crossing -off and orientation levels.

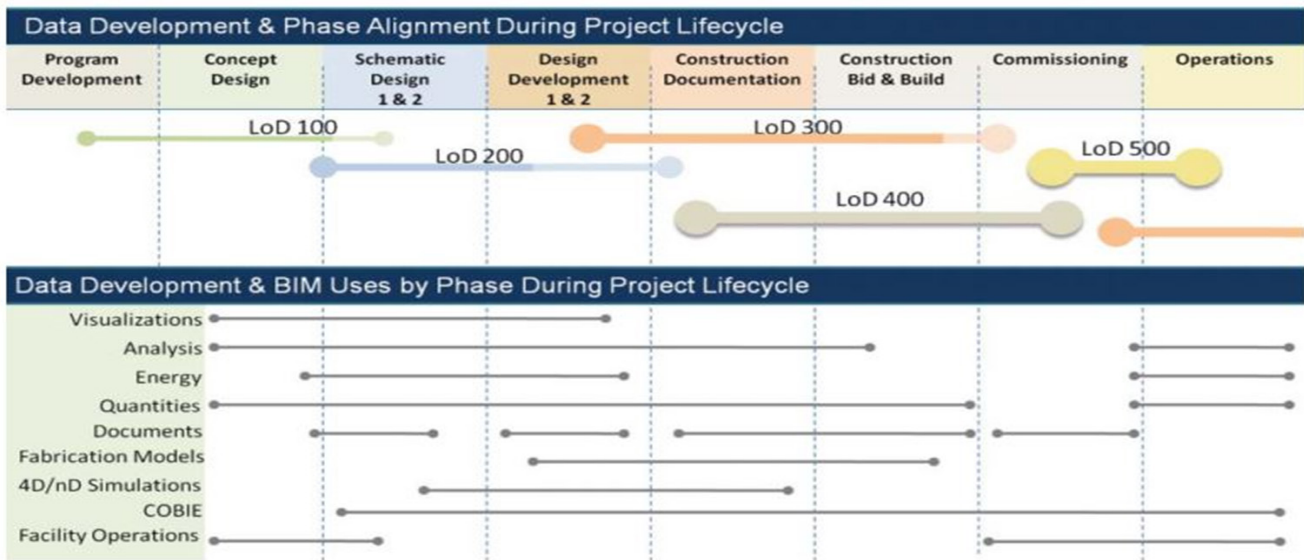

### Case Study:

It shows the levels of information producing development according to the mutual fields in architecture and structure of BIM model. This analysis aims to illustrate the gained benefits by exchanging BIM model with the structural team and vice versa. The green area shows the increased details between the two departments.

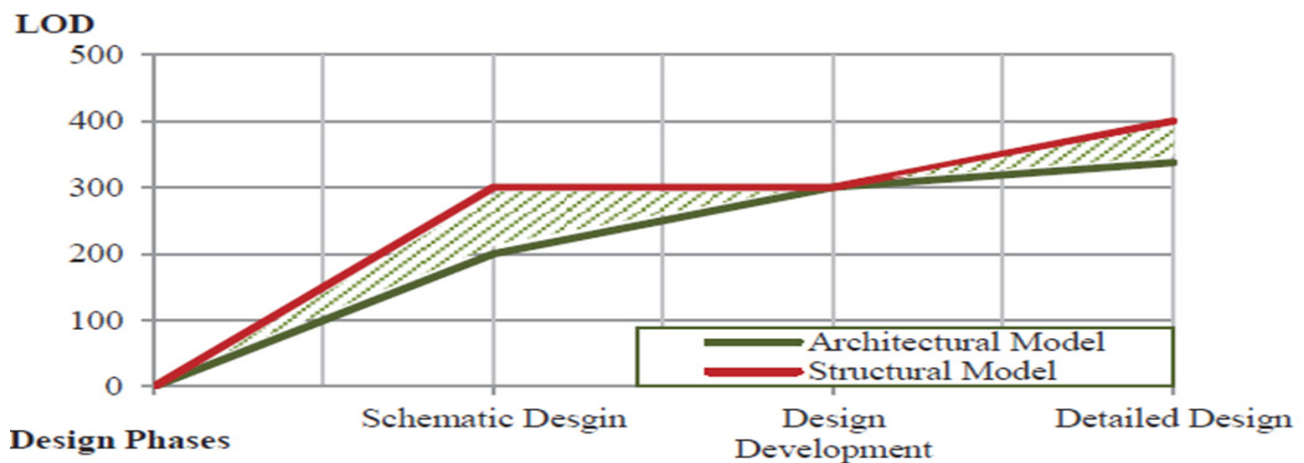

LOD evolution

### Glossary

-AIA: American Institute of Architects.

4D: A 3D model linked to time or scheduling data. Model objects and elements with this data -attached.

can be used for construction scheduling analysis and management. It can also be used to create animations of project construction processes.

### Model Element

Facility Management (FM) :The process of managing and maintaining the efficient operation of facilities including buildings, properties and infrastructure. The term is also applied to the discipline concerned with this process.

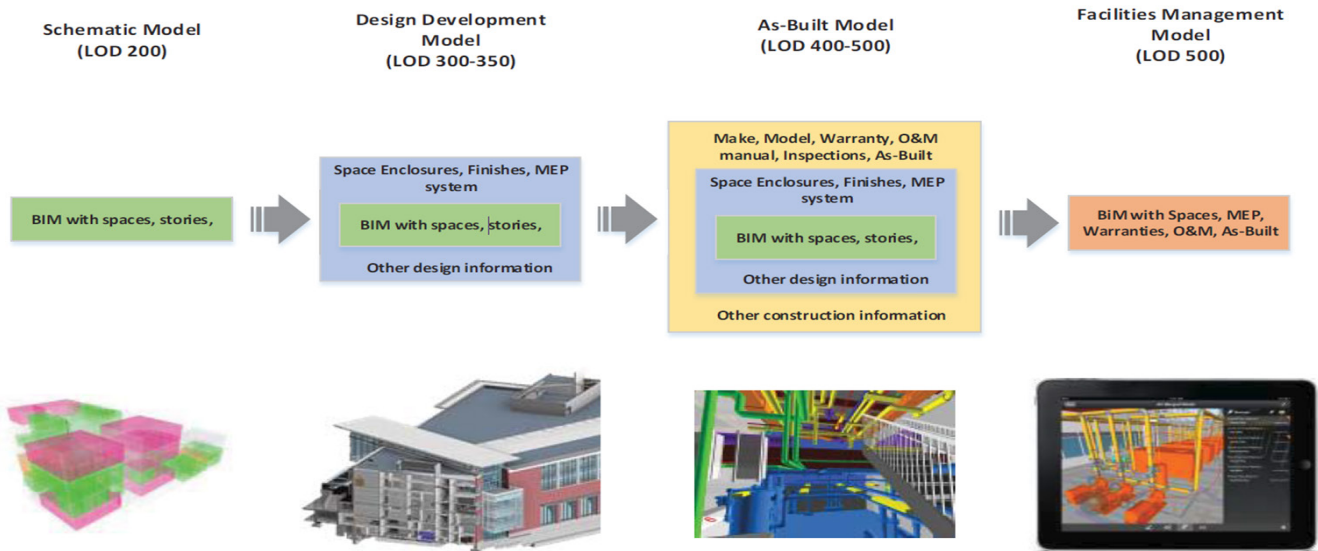

Reference:

BIM Content Development -

ACIF\_2015\_\_Building\_and\_Construction\_Procurement\_Guide\_\_PTI\_and\_BIM -

The Post Authority of NY and NJ\_BIM Standard Manual\_September2012-

Bruno Emanuel Araújo Caires BIM as a tool to support the collaborative project between the Structural -

Engineer and the Architect

Appendix

[LOD Matrix - Office of Physical Plant](#)

[Click here to download a copy of the 2015 LOD Specification](#)

Translated by : Dunya A. Aldhafer

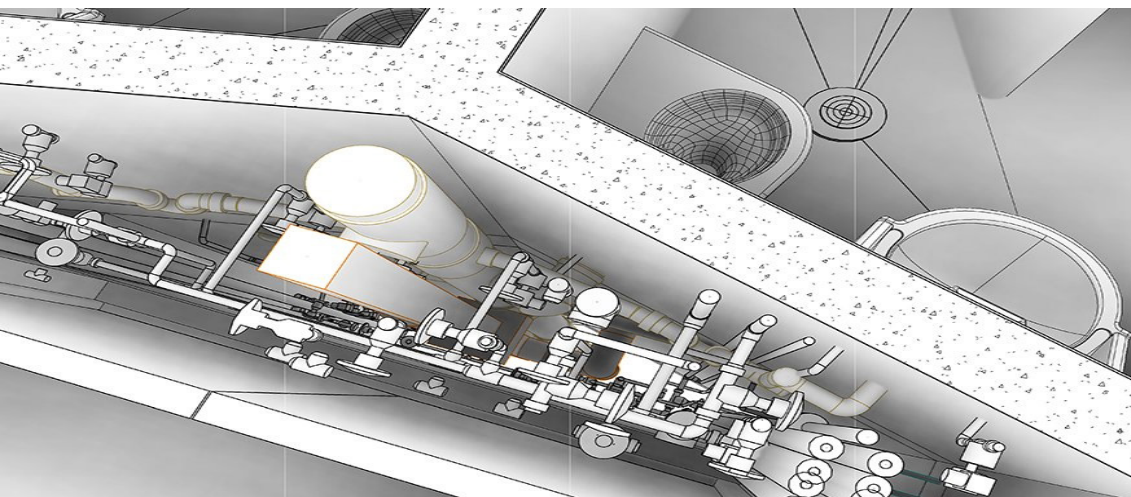

**Khalid Maher**

## The relation between Facility Management and BIM

So far, there is a disagreement in practice codes about Facility Management; while some talk about it as 6D other refer to it as 7D. Digital modeling researches related to FM have proven great benefits in digitizing design documents and maintenance manuals. Many facilities do not have a digital model where there is an opportunity to implement digital modeling by using standardized *Building Information Modeling* to support facility management.

Owners of facilities realize significant benefits by implementing BIM, where facility is delivered with higher quality and better performing. BIM facilitates the collaboration between project participants that result in reducing errors, increasing the efficient and reliable delivery process, reducing construction time and cost. There are many potential areas for BIM contributions where owners can use the virtual model to:

1. Increasing building performance through energy analysis and simulation to improve overall building performance.
2. Reducing the financial risk associated with the project in order by obtaining earlier reliable cost estimates.
3. Shortening the project duration from the design of the project to completion of construction by using BIM to facilitate coordination between project parties.
4. Obtaining reliable and accurate cost estimates through automated quantity surveying from the building model, providing feedback earlier when decisions will have the greatest impact on the project
5. Assuring program compliance according to owner requirements and local code through continuous analysis of the building model.
6. Optimizing facility operation and maintenance by embedded relevant data (as-built) to manage the facility.

Although these benefits are available to all types of projects, owners didn't notice all the benefits associated with BIM.

## Why Should Owners Care About BIM?

Lean processes and digital modeling have revolutionized the manufacturing and aerospace industries. Early adopters, such as Toyota and Boeing, have achieved manufacturing efficiencies and commercial successes (Laurenzo 2005). Late adopters were forced to catch up in order to compete; although they did not face technical obstacles experienced by early adopters, they still face significant challenges related to their work processes. AEC sector is facing a similar revolution requiring a paradigm shift from 2D-based documentation and staged delivery processes to a digital prototype and collaborative workflow.

In general, these tools and processes improve the ability to connect designing information with the commercial process like quantity surveying, sell expectation and different processes. Moreover, these tools support the collaboration instead of fragmented approach. This collaboration builds trust and common goals that serve the owner rather than competitive relationships where each team member strives to maximize their individual goals.

In contrast, with model-based processes, analyses must be done independently of the building design information. This analysis often requiring a duplicate, tedious, and error prone data entry resulting in loss of information value across phases, more errors and omissions, and increased effort to produce accurate project information, as the conceptual diagram in [Figure1](#) shown. Consequently, this analyses can be out of sync with design information and lead to errors.

With BIM-based processes, the owner can realize a greater return on investment as a result of the improved integrated design process that increases the value of project information in each phase and allows greater efficiency for the project team. Simultaneously, owners can reap dividends in project quality, cost, and future operation of the facility. The new Integrated Project Delivery (IPD) is considered an innovative approach to implementing construction projects and aims to achieve close collaboration among all members of a project team.



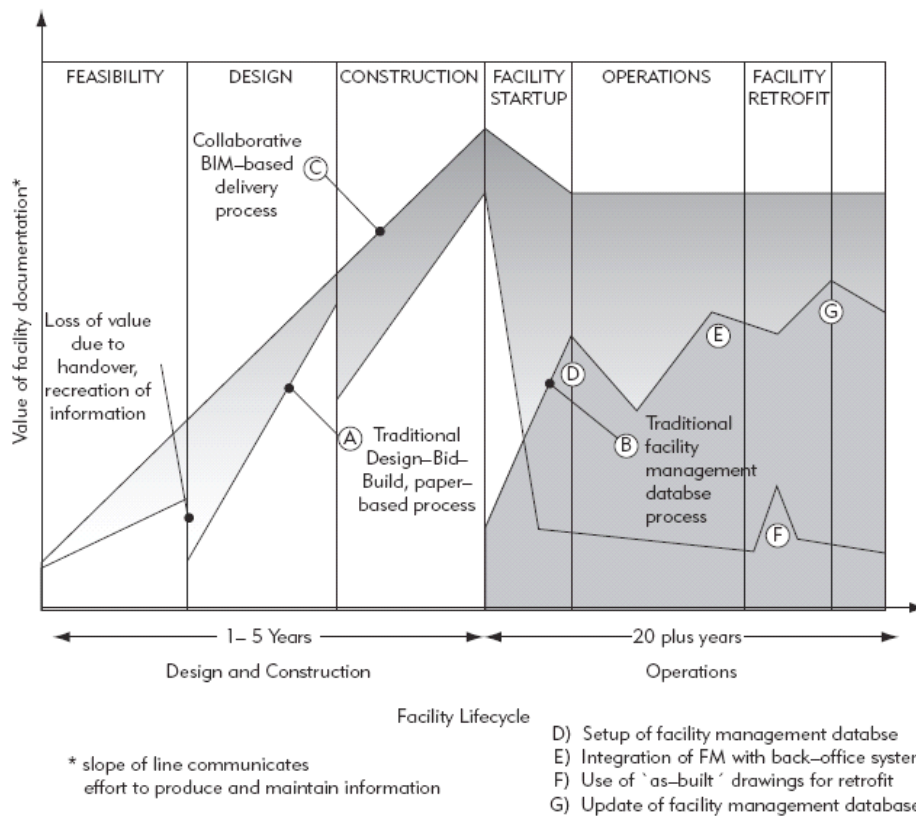

**FIGURE 1**  
 (A) Traditional single-stage drawing-based deliverables, (B) traditional facility management database system, (C) BIM-based deliverables throughout the project delivery and operation process, (D) setup of facility management (FM) database, (E) integration of FM with back-office systems, (F) use of "as-built" drawings for retrofit, and (G) update of FM database.

Figure 1

## BIM APPLICATION AREAS FOR OWNERS

Traditionally, owners have not been supportive of change within the construction industry. They have long been resigned of typical construction project problems, such as cost overruns, timetable delays, and quality issues (Jackson 2002). Many owners view construction as a relatively small capital expenditure compared to the lifecycle costs or other operational costs that accrue over time. Changing marketplace conditions, however, are forcing owners to rethink their views and place greater emphasis on the building delivery process and its impact on their business (Geertsema et al. 2003; Gaddie 2003). The firms that provide services to owners (AEC professionals) often point to the short-sightedness of owners and the frequent owner-requested changes that ultimately impact design quality, construction cost, and timetable.

Due to the potential impact of BIM on these problems, the owner is in the position to benefit most from its use. Thus, it is critical that owners understand how BIM applications can enable competitive advantages and allow their firms to better respond to market demands and yield a better return on their capital investments. In those instances in which service providers (AEC professionals) are leading the BIM implementation through education institutes, educated owners can lead better both designing and implementing team. In the following article, we provide an overview of drivers that is motivating all types of owners to adopt BIM technologies, and we describe the different types of BIM applications available today. These drivers are:

- Early design assessment
- Complexity of facilities
- Time to market

- Cost reliability and management
- Product quality, in terms of leakages, malfunctions, unwarranted
- Sustainability
- Asset management

Table 1 summarizes the BIM applications reviewed from the owner’s perspective and the respective benefits associated with those.

Specific BIM Application Areas for Owner	Market Driver	Benefits to All Owners	Relevant Case Study (CS) or Reference
Space planning and program compliance	Cost management; marketplace complexity	Ensure project requirements are met	Helsinki Music Hall
Energy (environmental) analysis	Sustainability	Improve sustainability and energy efficiencies	Marriott Hotel Renovation Helsinki Music Hall
Design configuration/ scenario planning	Cost management; complexity of building infrastructure	Design quality communication	Aviva Stadium Coast Guard Facility Planning
Building system analysis/simulation	Sustainability	Building performance and quality	Marriott Hotel Renovation Helsinki Music Hall 100 11th Ave., New York City
Design communication/ review	Marketplace complexity and language barriers	Communication	All case studies
Quantity takeoff and cost estimation	Cost management	More reliable and earlier estimates during the design process	<a href="#">Hillwood</a> Commercial Project, Dallas Sutter Medical Center
Design coordination (clash detection)	Cost management and infrastructure complexity	Reduce field errors and reduce construction costs	Sutter Medical Center One Island East Office Tower, Hong Kong
Schedule simulation/4D	Time to market, labor shortages, and language barriers	Communicate schedule visually	One Island East Office Tower <a href="#">Crusell</a> Bridge, Finland
Project controls	Time to market	Track project activities	Sutter Medical Center
Prefabrication	Time to market	Reduce onsite labor and improve design quality	Sutter Medical Center 100 11th Ave., New York City Aviva Stadium, Dublin <a href="#">Crusell</a> Bridge, Finland
Pro forma analysis	Cost management	Improve cost reliability	<a href="#">Hillwood</a> Commercial Project, Dallas
Operation simulation	Sustainability/Cost management	Building performance and maintainability	Sutter Medical Center Helsinki Music Hall
Commissioning and asset management	Asset management	Facility and asset management	Coast Guard Facility Planning, various locations <a href="#">Maryland</a> General Hospital, Philadelphia

We will explain in the next articles, each of those means that has motivated owners facilities to adapt BIM technology.

Please note that part of this article was quoted from BIM Handbook

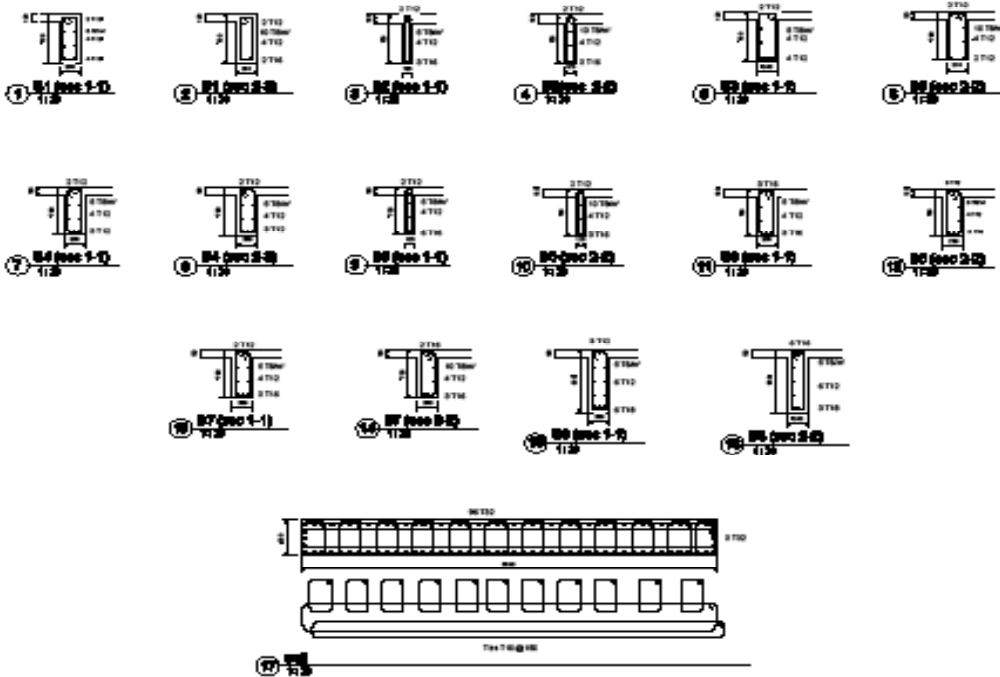

Notes:  
 All dimensions are in millimeters unless otherwise specified.  
 All reinforcement is to be provided in accordance with the Egyptian Code of Practice for Reinforced Concrete Structures (E.C.P. 2010) unless otherwise specified.  
 All reinforcement is to be provided in accordance with the Egyptian Code of Practice for Reinforced Concrete Structures (E.C.P. 2010) unless otherwise specified.  
 All reinforcement is to be provided in accordance with the Egyptian Code of Practice for Reinforced Concrete Structures (E.C.P. 2010) unless otherwise specified.  
 All reinforcement is to be provided in accordance with the Egyptian Code of Practice for Reinforced Concrete Structures (E.C.P. 2010) unless otherwise specified.

Prepared by :  
 Hossam Tareq  
 Ahmed Yehia Ali  
 Islam Mamdouh  
 Ahmed Fathi  
 Ahmed Soliman  
 Reem Mahmoud  
 Kirolos  
 Mohamed Rifaat

EDG  
**CLIFE Hospital**

**Beams Sections**

Project number:	1
Date:	01/06/2015
Drawn by:	Ahmed Fathi
Checked by:	Hossam Tareq
	<b>2</b>
Scale:	1 : 20

## Implementing BIM technology between acceptance and rejection

To continue our last discussion about the implementing BIM technology between acceptance and rejection – we find that many firms accept the new thinking and this technology but a rejection faced them from engineers who working inside these firms. Resists change is a nature of human. Thus, many engineers refuse to change the software they are working on for many years instead of learning a new one.

Due to the management pressing to try this new technology, we find a hard resistance. In the beginning, design a new project by using new technology consume double time and effort than before where a confrontation between the top-management and the engineers begins. However, were these engineers working with such efficiency and speed at the beginning of their learning on the old software? – No

Nevertheless, it is the resistance to change embedded in human psyche where top-management must insist on coping this desire, and planting the value of this new technology until it gains the trust of engineers who work on it.

One of the successful stories I was honored to work in is a training program from the university that qualifies students to immediate work within firms. This training program is one of the best ways to diffuse this technology anywhere. Learning is easy for students where he/she is looking for a new thing until he gets a good opportunity to work in the large engineering firm. Thus, it is easy to disseminate this technology in the new generation.

This training is provided to students in final year of Engineering Faculty where they proficient using this new software, besides hiring those young engineers after graduation will make a great compete between those who want comfort and new thinking.



**Kamal Shawky**

# Examples of the construction slab of final year students of the Engineering Faculty in University training to work UTW

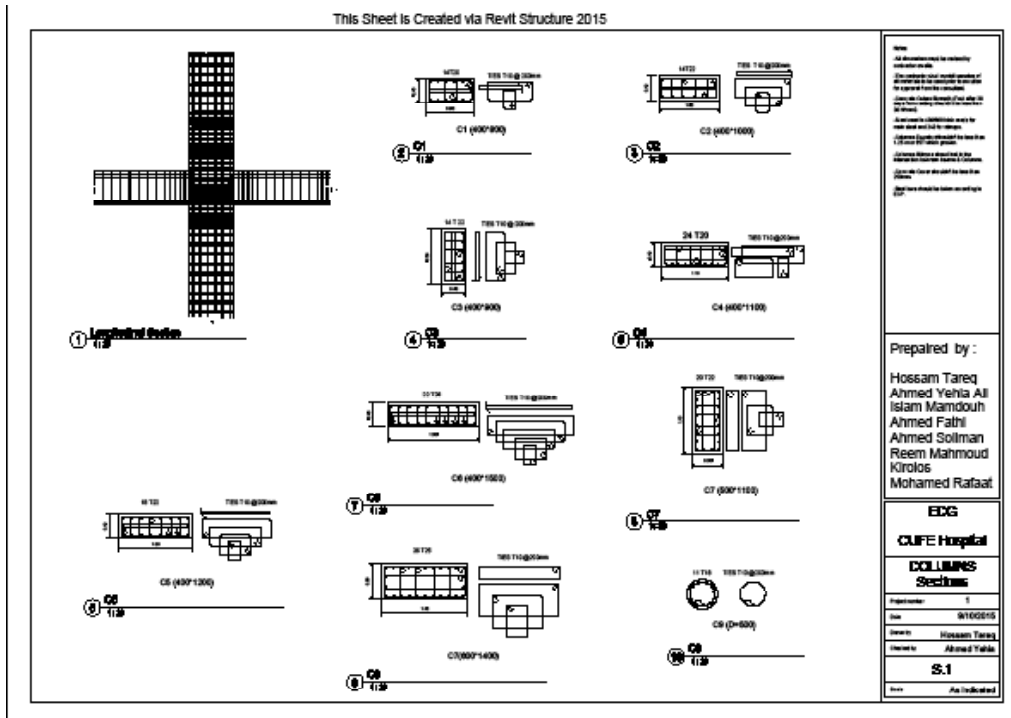
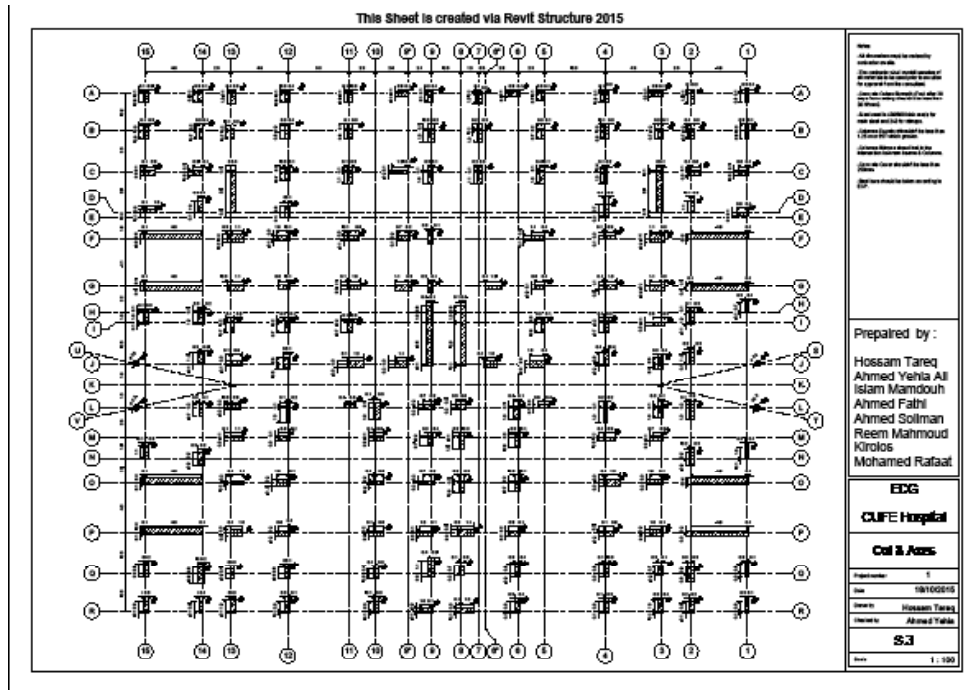

## Quotes about BIM

Evolutions such as BIM have the potential to facilitate—or  
.further complicate—integrated work  
Julie Gabrielli and Amy E. Gardner

Evolution of BIM implementation came in parallel with willingness  
to collaborate and share project information, the move toward  
.integrated practice that is much talked about in the industry  
- Phillip G. Bernstein

The biggest thing about BIM is that it's moving us back to  
interdisciplinary work

Kathleen Liston

Most firms begin their exploration of BIM doing comfortable 3D  
visualization and move systematically through more complex  
uses; the most advanced users integrate their project approach  
using BIM throughout the supply chain. Almost by definition,  
more advanced usage – such as analysis and production –  
.requires collaboration throughout more of the project team

Phillip G. Bernstein



**Waleed Elewa**

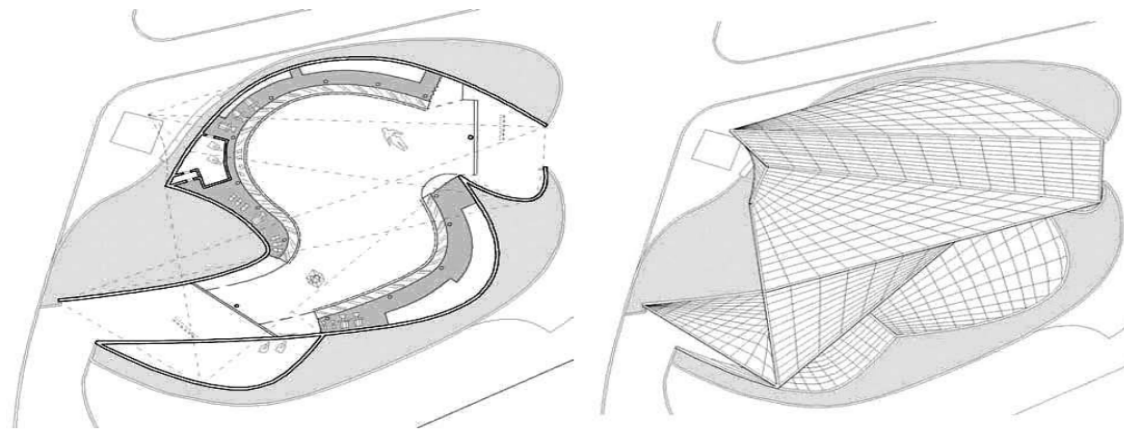

## Minutes of October 2015 meeting

The monthly meeting of the Group, which includes experts and volunteers in advanced research areas in BIM field held. Mr. Paul Oakly from British Research Establishment (BRE), which provides advanced areas of research in the British Standards area of BIM – He had addressed in his lecture the following points.

Comprehensive coverage of UK research and in different parts of the world and what we have reached, goals and achievements.

The British system and the different areas of BIM standard and how we end up to ISO.

BIM Support and counseling for projects from British system viewpoint.

Reducing designing risk and how to provide information and managing it from BIM viewpoint as an informational vision; not only to create a form as most associates in this field has thought.

How to change the world's view from zero level of BIM to Level 1 to Level 2 BIM , which has been applied in the British government projects and in many regions of the world in mid-2016

Informational level within the form, not only mass level - The most associates in BIM see it through the model and not a model Information form linking the building components of users through clever design and open non-conflicting information

The various levels of BIM from 0 to 2 and I Rora was defined accurately with British standard, which deals with the model formation, managing the origin and exchanging information.

Review CDE and how to manage information in the Model safely.

Customer requirements, the institution requirements, building management and how to form the required paperwork in project designing contract.

Presentation about the seven stages of designing even the access to already existing building; and its management through data types - loaded to three-dimensional elements and non-loaded ones.

Presentation the relationship between Cobie & IFC and developing each of them across different versions.

The difference between the American and British definitions in this field

**Figure 2 – The information delivery cycle**

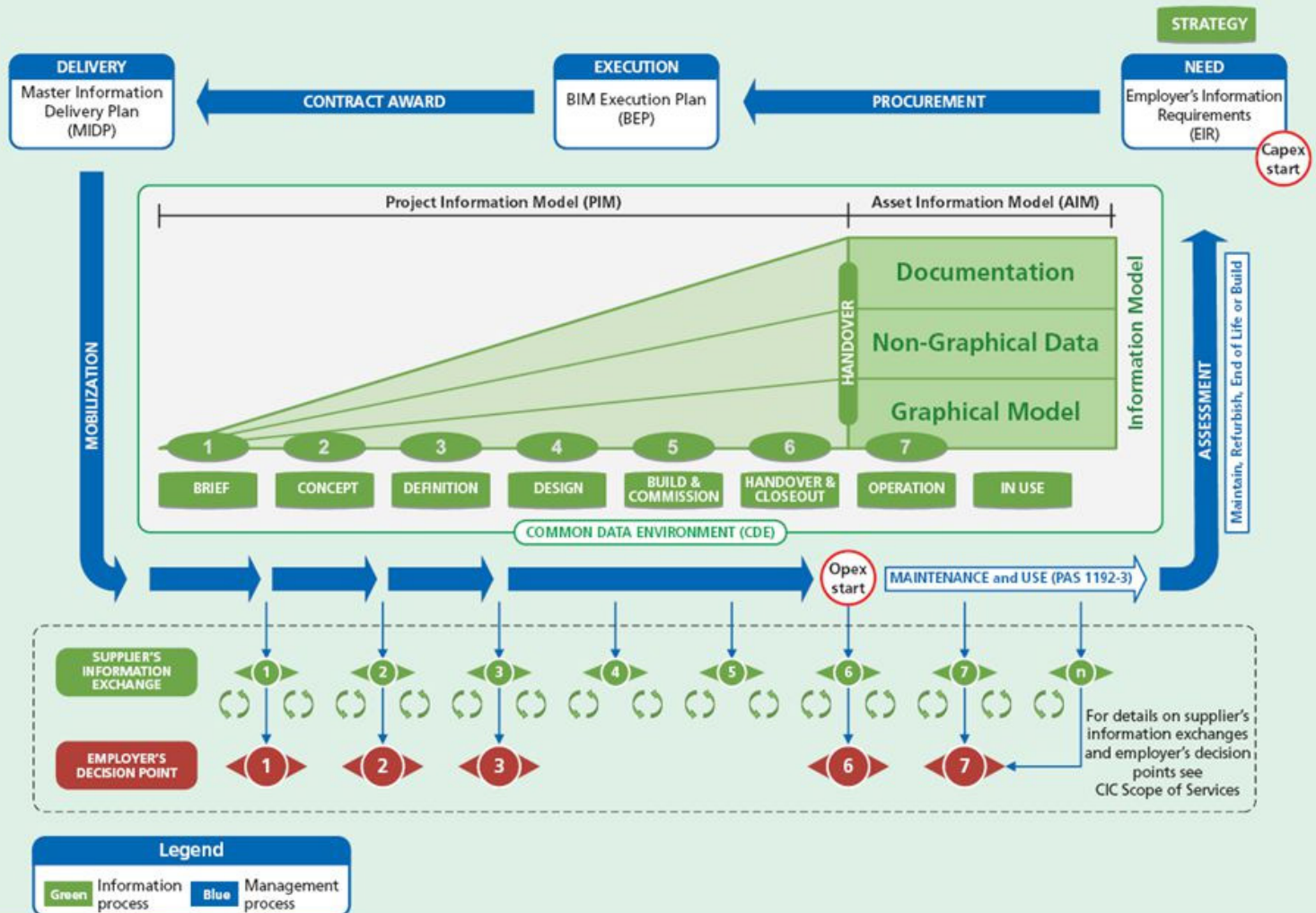



Thursday, 5<sup>th</sup> November, 2015, it was BIM User Day conference in Qatar University.

The main title of the conference was “BIM Implementation and management,” How to create, establish and manage BIM?

It was divided into four sections:

**The process:** It determines the basic processes for BIM management and the plan which we will work on. BIM execution plan and BIM process maps

**Technology:** What tools, software, and hardware should we use, work sharing environment (WSE). How are we going to share information if we are working in more than one country, BIM in the Cloud myth or reality?

**People:** They are the key element and their abilities will determine the interest rate which they will gain from BIM, they must be trained and directed

**Policy:** Without policy, clear standards and technical specifications BIM cannot be applied, goals and specifications must be specified accurately from the beginning.

These four sections need BIM manager to direct them and to achieve harmony among them.

Thank God that all what have been discussed in the conference is existed in the points which will be raised in the future issues of the magazine Conference site [www.bimuserday.com](http://www.bimuserday.com)

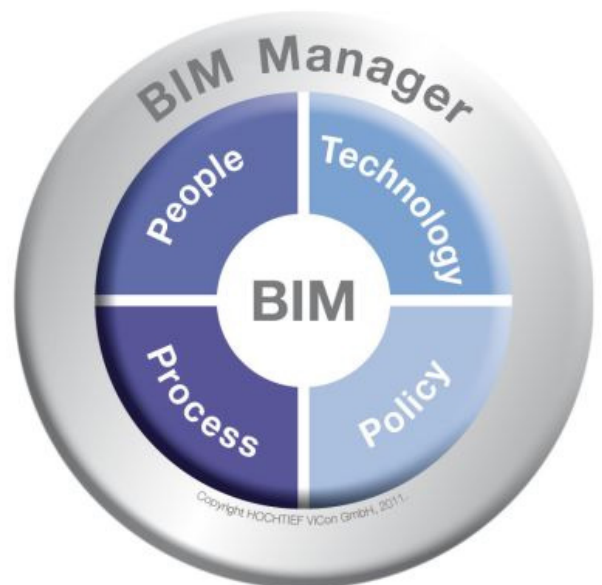



# BIMarabia

