

BIMarabia

English Edition

3D 4D 5D 6D

February 2017 - The first issue



INTERVIEW
WITH BIM

Interview with
Dr. Bilal Succar

BIM and
Eighth Dimension

Contracts
issues and BIM



Introduction

BIMarabia is the first E-magazine intended to spread awareness of BIM tools and workflows across Arabic region. BIMarabia is written and edited by users, targeted to be beneficial to practitioners and researchers in the field. For more information, please go to <http://bimarabia.com/>.

This is an English version of BIMarabia magazine, which is specialized in *Building Information Modeling* (BIM). We found that the construction industry need it. When we published the Arabic version, many readers ask us to translate it to English. Or any other language, Thus, we decided to translate it to English language. If anyone wants to translate it to any other language or to join our team, please don't hesitate to contact us :

BIMARABIA@gmail.com

Finally, i apologize for any mistakes, and thanks for Wonderful BIMarabia team, I'm honor to be one of them.

Editor

Omar Selim

CONTENTS

INTERVIEW WITH BIM	4
BIM between the acceptance & rejection	8
Interview with Dr. Bilal Succar	11
BIM implementation in infrastructure projects	14
BIM Execution Plan	17
Fourth dimension of BIM	21
Open source solutions available for parametric design	25
Quotes about BIM	31
BIM and Eighth Dimension	33
Contracts issues for BIM	35
Design technology	41
Case study	46

Editor

Omar selim

Editorial Team:

Engineer : Sonia Ahmed

Engineer :Ahmad Lutfi

INTERVIEW WITH BIM



Omar Selim

I am honored to have my first interview for first issue of BIM Arabia magazine with Mr.BIM:

Omar Selim: Would you introduce yourself, please?

BIM: My name is BIM, which BIM that stands for *Building Information Modeling*. Building is for buildings such as schools, factories, homes, towers, streets and cities. Information is for the availability of information which is useful for the building process and not only a model or a structure.

Modeling is any Visual representation of information as if you see framework (3D model) in front of you, not a plain AutoCAD drawing.

However, I'm not just like 3D Max. I'm informative as each element shall has its needed information. For example doors shall include information about material type, painting and fire resistance.

Omar Selim: Are you a new theory in the construction industry ?

BIM: No, theoretically, I have existed since 1970, however, the extensive use of hardware was the reason of not being spread previously, as the hardware back then was weak, ancient and could not represent the characteristics of the building in digital form. I was firstly executed under the concept of virtual construction via ArchiCAD Software for GRAPHISOFT Company, beginning FROM 1987.

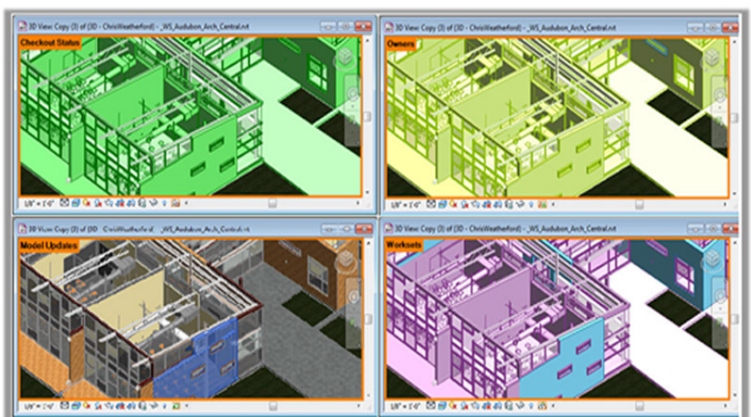

Omar Selim: What are the reasons for the recent attention?

BIM: For many reasons including availability of hardware that can formulate a digital model integrating necessary information about the building, as well as the current trend

to build a lot of unique buildings that were not designed before, as if you repeated the same building as in Residential complexes, you will return the same design without problems.

However, building a complex building (such as Tower Khalifa or the Kingdom or Tower Al-Arab) with unique properties, The model should be created to know whether it will handle it or not, how much will it cost, Would there be a problem in regards to energy consumption?

Using CAD technology caused some problems that discovered during the construction stage. As long as I am being applied in place and correctly; I prove myself and gets attention. Therefore, there are a lot of Masters and Doctorate degrees (PHDs) about me. Many countries made me mandatory. Also, there are Presidents who have talked about me like USA-President Barack Obama.

Omar Selim: Why There are many rumors about you these days?

BIM: because people heard about me but not from me.

Most of these rumors claims that I am only a software where some Talk Shows refer to me as Revit. I'm not a software – I'm a set of technologies and working process, any Software fulfills this methodology is a BIM Software.

If a Software such as MS Word or Paint could draw a building model which has all the required information and could resolve conflicts and obtain inventory data in seconds, then it is a BIM.

If the most complicated Software in the world couldn't do this, then it isn't a BIM.

Let's take AutoCAD as an example, when I add tools to draw walls and doors it become AutoCAD ARCH which is one of BIM Softwares.

I emphasize that no Software is called BIM, I am a technique, a method of work.

Another rumor is that I am a 3D Software and the only difference between me and the CAD is only a count. Not a brag, I'm a 3D, 4D, 6D to infinite nD.

When you enter all the valid data, no limit to what you can get, for example:

4D is the time dimension,

It will allow you to observe all construction stages based on your entered data, so you may see firstly, an empty plot, then the drilling , the foundation then the ground floor and the first floor will start to emerge and so on and so forth.

5D Costs: Not just the cost of an item such as a door but the cost of the door including the worker wage and the price of the screws and if there is a subcontractor.

I'm also useful when it comes to safety and project management. Also in Facility operation and management after handing it over to the client...

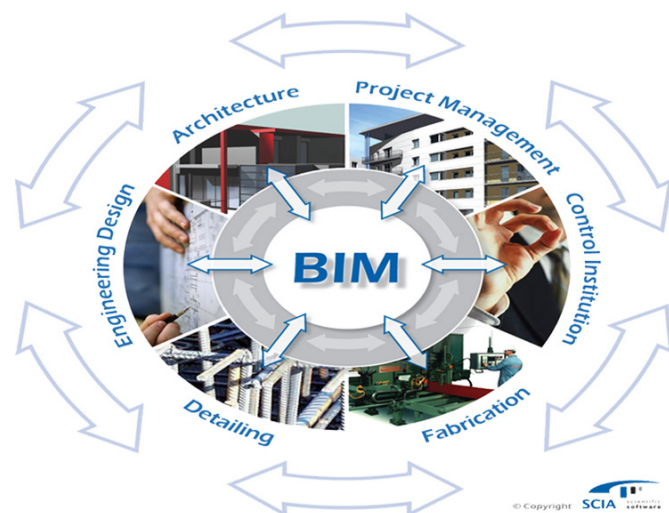

Omar Selim : There's a rumor about conflict between you and the CAD ?

BIM: It is a false rumor. The CAD would still be accessible but greater reliance will be on me. My existence was to solve the problem that CAD could not settle. The CAD Non-specialty is considered as an advantage and disadvantage at the same time. It can be used to design clothing or greeting cards, it's like drawing on a paper. On the other hand, I am specialized in buildings as appears from my name (i.e. MS Excel doesn't eliminate the presence of MS Word.) Away from work, we are friends and stay together.

Omar Selim: Who is benefiting from you?

BIM: Almost everyone can benefit from me; Engineers who shares information at the same time with others, rather than waiting for them to finish and restore work or design. Architect gets sections and elevations instantly, and doesn't have to amend in every sheet. Amendments occurs automatically, Structural design simulates the building structurally, MEP finds inventory ready, the contractor knows the accurate cost before tendering, government provides waste potential. Future generations will find building elements available, and the greatest beneficiary is the owner, the biggest benefit is in the period of the building operation, as I give immediate and complete information about where any mistake occurs at the same moment, even if it was a simple mistake; it can be fixed directly or send a worker to fix it, an entire hotel can be managed via mobile phone.

Omar Selim: Is there books wrote about you?

BIM: Hundreds of books but the most important are:

1-**BIM Handbook:** A Guide to *Building Information Modeling* for Owners, Managers, Designers, Engineers and Contractors. Written by Chuck Eastman, Paul Teicholz, Rafael Sacks and Kathleen, which gives deep understanding of technology and its associated processes. It highlights strong projects.

2-**The Impact of Building Information Modeling:** Transforming Construction. Written by Ray Crotty who lives in United Kingdom which is the reason behind finding interest in European Softwares such as Archicad. A beautiful book with a lot of updated information.

3-**Green BIM:** Successful Sustainable Design with *Building Information Modeling*. It concentrates on sustainability and its relation to BIM and how they grow together. Also, energy efficiency which is currently one of the top most criteria for the evaluation of building proposed design, in which comes the role of BIM.

4-**Building Information Modeling:** Planning and Managing Construction Projects with 4D CAD and Simulations.

Omar Selim: How BIM can improve processes such as construction management and construction documentation?

BIM: There are a whole section of the book which is devoted to the study of models of existing companies

In regards to a book in Arabic, there is "way to bim" BIM Manual for individuals and companies, the book is good for Arabic speakers and you can download it for free.

<https://draftsman.wordpress.com/2014/04/04/waytobim/>

Omar Selim: What is your favorite color?

BIM: My favorite color is green where you find me very helpful for green BUILDING and how to achieve the best energy efficient design

Omar Selim: Is there a documented study on the benefits of implementing BIM?

BIM: The Stanford University Centre of the Integrated Facilities Engineering's (CIFE) conducted a study on 32 huge projects and found that:

- You can avoid 40% of surprises during execution.
- Accuracy in cost estimation reached 97%.
- Saved 80% of the time needed to calculate cost.
- 10% cost savings.
- Reducing 7% of project period.

McGraw Hill Foundation conducted a questionnaire recently which showed that ((three quarters of BIM users in Western Europe have confirmed tangible positive results on their investment on those models, compared with 63% of BIM users in North America)).

Omar Selim: What are the largest projects that worked by BIM?

BIM: Almost all unique large-scale projects, for example:

- Build London Live 2012
- Build Qatar Live 2012
- D.C. Riverside Office Building
- Ellicott Heights
- Arboleda Open BIM Project

Translated by Radwa Hassan & Zidan Fahmy



BIM BETWEEN THE ACCEPTANCE & REJECTION



Kamal Shawqi



Before discussing details about this technology, let's recap what are the basic steps in a project. The basic steps are idea, design, drawings estimation, defined the action plan, and then implementation process, all the way to the operation and maintenance.

These are the basic steps of any engineering project, whether it is electrical, mechanical, structural or architectural. For any type of engineering project, it requires cooperation between engineers from various departments during each phase of the project. However, the main problem is the weakness of cooperation or misunderstanding, which might occur between engineers of different departments. Furthermore, this may generate significant errors during the project design stage and then during the implementation phase, not to mention waste of time and money.

Firstly engineers always have suffered from methods of software-based which depend on simulation for the building works (e.g. the adoption of structural analysis on the Analytical Modeling programs). Although these software has formed a qualitative bound in the field of design still can cause some design problems, especially if the software has been used non-professionally (especially by students and junior engineers). Secondly, it helps engineers with the production of various detailed charts, estimations and time schedules, that are output automatically after the completion of modeling and it runs the software per the BIM. After we learned about the definition of BIM technology, let's see another article that will move us forward to the next question, an author listed some advantages of a new technology that addresses some of the deficiencies current method.



[Http://bit.ly/BIMepisode24](http://bit.ly/BIMepisode24)

Most of the *Building Information Modeling* experts are passionately supporting others to master the use of this technology and encourage early collaboration between the designer and the contractor to build the best facilities and to develop the construction industry in a broader perspective. But we are also aware of the excessive difficulties of this approach, which is that is the weakness of marketing and involves technique for Clients, design and contractors - and construction firms. It is also typical for human beings to resist changes and this technique requires major changes. It will change corporate culture committed to the standards imposed by the adoption of this revolutionary process. The success of the marketing and the fulfillment of the changes that are required for the success of the BIM implementation is more important than the technical development itself.

We humans always want to see clearly around us, but on the other hand, we do not wish to share this ability with others. In other words, we are always trying to hide details that are not up to the level of acceptable standards instead of we show the details that we are proud of. Since the BIM technology cannot hide a lot, so we believe that time is necessary to accept it and get used to it.

BIM technology requires more cooperation and it forces us to deal with colleagues differently. Thus, so it is from psychological point of view is a healthy development and the transition is not easy, the need for cooperation will lead to dependence the development of team spirit and makes its members more comfortable for mutual assistance among themselves and sharing responsibility for the product outcome. The team members will respect the points you share information with them but always keep it as a subject to disagreement, the use of this technology will also enhance the culture of collaboration, rather than the culture of competition and everyone will be proud of the results of the joint work.

The BIM technology used in:

- Facilitation of the design and drawing process, and construction.
- Estimating, the study of the project expenses.
- Verification of the integrity of the building, the discovery of errors and reduces risks.
- Study the building environment; how it is reflected on the health and social life.
- Saving time and effort.
- Coordination and greater cooperation with the various engineering departments.
- Increasing customers and public confidence.
- Increasing employees' productivity.

With all the features mentioned above there are barriers preventing them from switching to a new technology. They are not ready to switch and adapt the process.

Barriers prevents the transition to the technology of BIM software:

- Work flow fears that obtains by beginners.
- Company size and specialization.
- Skill level of the current users and extent of their willingness to develop.

- The cost of training.
- Lack of mental readiness to accept the idea of switching to the new technology.
- Unwillingness to invest the time and money required to move to a new platform.
- The cost of new computer hardware, different features from current to suit the new software.

This is what makes AutoCAD an interesting option for many coming years.

Transition to technology of BIM software requires a change in the nature of the prevailing thinking about projects modeling and construction, and needs to develop management processes. Transition to the technology of BIM software meant to reduce the number of employees, and for that to happen it needs to move to the development of the current Career Level, this may be hard on people who are accustomed to AutoCAD and adapted to it. However, you must think about the benefits and advantages derived from transition to the technology of BIM software, and everyone who truly knows the technology of BIM software astonished by its performance, and its ability to improve the building, vision and documentation performance, with the benefits of maintaining the safety and durability. All this sums up the reality that the AutoCAD and technology BIM software are great products, and it is a precise decision to move to the BIM technology software.

AutoCAD or Revit?

I always say, two software are essential and are the most important two-dimension software in the world, and it operates its own style and technology. The Revit is the most important software in the modern era that uses BIM technology, so it is preferable for the user to have sufficient knowledge of both software, beginner AutoCAD and advanced Revit. Therefore, I do not encourage leaving AutoCAD completely and move on to Revit, but instead develop our knowledge, experience and proficiency by learning Revit along with AutoCAD, when the world dispenses AutoCAD completely, at that time I will tell you to forget AutoCAD.

Translated By: Mohammad Abdo.

INTERVIEW WITH DR. BILAL SUCCAR



DR. Bilal Succar

POINTS within clouds

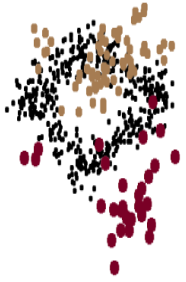

as generated through
LIDAR technologies
or similar

LINES and curves



as generated through
vector-based drafting tools
similar to AutoCAD LT®

SURFACES and meshes

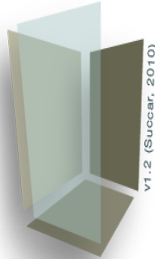

as generated through
surface-modelling tools
similar to SketchUp®

SOLIDS non-parametric

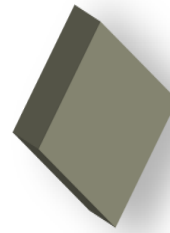

as generated through
solid-modelling tools
similar to 3ds Max®

Omar Selim: Could you please introduce yourself?

Dr. Succar: My name is Billal Succar, I am working on BIM performance assessment. I have studied Interior Design, after that I studied “Architecture Management”. Then I got PhD degree in BIM in the field of performance evaluation. I have started my career in the field since 2003, I worked as a BIM Manager for five years and then I became a counselor in my own company.

Since 2009 I became specialized in the evaluation of BIM performance, I have established my own website to assess the performance of the companies and employees.

Omar Selim: What is the definition of BIM?

Dr. Succar: If you ask five people about BIM definition you will get six different answers, the definition which I have followed and developed by researches, is a set of techniques and methods of work.

Omar Selim: How much did BIM spread?

Dr. Succar: It differs from country to another, Australia is not as UK, and an overview of BIM it has become common since the beginning of the third millennium, but the technique and style was known in the 60s, but at that time it was not called BIM, and it was not successful because the technology was not advanced, the computers were weak and costly. Nowadays it is accepted technically as it became well-known in the late of 90s and the first of the third millennium. The main reason for this change is Auto desk as it developed Revit and merged it with their programs, which makes people aware more about BIM Concept, but BIM Concept is earlier than Revit and AutoCAD.

Omar Selim: The Benefits of BIM in design stages Is it real or is it subject of discussion?

Dr. Succar: BIM is no longer a subject of discussion, and varies from country to another. For example, Australia, USA and UK recognized the benefits and it is no longer a subject of discussion, BIM has benefits at all stages of the lifetime of the project from beginning, before design and operation phase. The most benefits of BIM is not only the design, but in all the following phases of

the project FACILITY MANAGEMENT OPERATION.

Omar Selim: How is BIM related to the project management?

Dr. Succar: There are two answers. The first one is: the project manager is the weak point to adopt BIM. The designers and project owner are forerunners, the Project Manager must take advantage of BIM, so that they can develop the project management manner by visualized way before the PHYSICAL.

The second answer is, the BIM supports project management by encouraging the cooperation and the exchange of data, in order to get good results.

Omar Selim: an advice to the project manager, how can he/she take advantage of the BIM?

Dr. Succar: Project Manager is the biggest beneficiary of BIM if he decides to take the advantage of it, because of the integration of BIM for design or Construction, it gives the transparency to detect errors at the early phases, they also could take advantage and reduce risks.

Omar Selim: What is the relationship between BIM with laws and regulations and model contract? For example, who owns the model? Because the courts do not know CAD, so it can't judge about BIM.

Dr. Succar: The model consists of numbers of elements (doors, windows ..etc) and not one element, so we must differentiate between the owner of the model and who built it. This follows the contract which is called BIM EXECUTION PLAN.

Omar Selim: How do the countries and companies evaluate BIM?

Dr. Succar: For example, Australia for ten years, small numbers of engineering companies used BIM technology and it used for them. In the past four or five years, contractors and owners used BIM and in the UK. We can measure BIM maturity in any country by accreditation ratio of BIM, the maturity of a country, and we compare between USA and UK, UAE and Qatar according to the following factors:

- Number of companies using BIM
- Do the Universities teach special topics in BIM technology
- Protocol – specially of BIM and elements.

Thus, a number of possible factors which can be measured in each country, according to this basis we can measure maturity of the BIM technology.

Omar Selim: what is better BIM to be imposed or to be optional?

Dr. Succar: There is no easy answer, depends on your country's culture. What was the country's initial system before the BIM implementation, a good example of this type of country that won't impose is the USA and Australia. Because it rejects possible governmental intervention and it may create a backfire, therefore these countries do not impose.

But the industry in other the countries considers what exactly do you do,

for example, countries like Singapore and the Gulf, as well as part of the UK if the government did not obligate engineering firms to apply BIM they would never implement it, For example; Singapore's reliance on the state regulation is obligatory.

Omar Selim: Is it better to have standard criteria in each country?

Dr. Succar: Of course, it is better to have the unified standard, but it must contains maturity and it must go through certain period where there are larger number of the guidelines and the standards. Then it reaches the mature period in the future where there must be one. The answer is obvious, but there will be people who will not be convinced in the beginning.

Omar Selim: Is each company trying to work out something special?

Dr. Succar: The government in general does not mandate to have details or to identify the small elements but it determines the outcome, and what should be delivered "performance matrix". It never interferes how the model design or its details.

After that the organizations develop manuals to guide companies within the members. Moreover, each company is required to follow the protocol and not the standard, so every person within the company can make the model in the same way.

Guide subject has 3 parts:

- The government has a role.
- Organizations have a role.
- And the company has a role.

Omar Selim: If the government imposes restriction such as it would receive BIM projects only, then what criteria you would tell the government about BIM?

Dr. Succar: The government, the owner or any other person who will benefit from BIM, must have knowledge about BIM, If the owner has no knowledge so he will consider anything colorful 3D handed to him by the designer is the BIM. The only way we guarantee that this is BIM and it is designed accurately with enough data, is to educate the owner and the project manager. And to develop the requirement chain by those who determines BIM for them. And they should have members who have experience in assessments of what is delivered.

If these requirements do not exist and those people are not in the government or with the owner, then anything will be delivered to them is the same.

Translated By: Mohammad Abdo.

BIM IMPLEMENTATION IN INFRASTRUCTURE PROJECTS

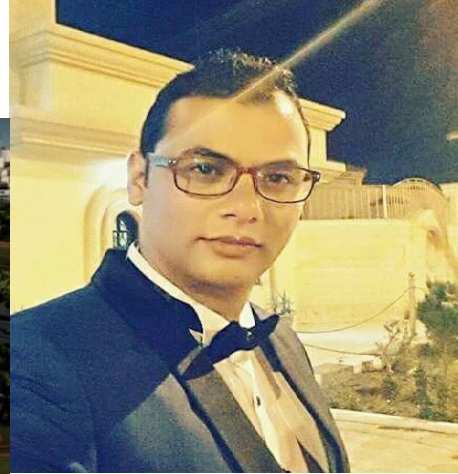

Ayman Kandeel

Introduction:

Currently, BIM implementation is an essential for each firm seeks to reach lower cost, reduce time and present projects in high quality before the actual construction.

Execution Stages of road projects:

1. Planning stage.
2. Schematic Design stage.
3. Detailed Design stage.
4. Presentation and direction stage.

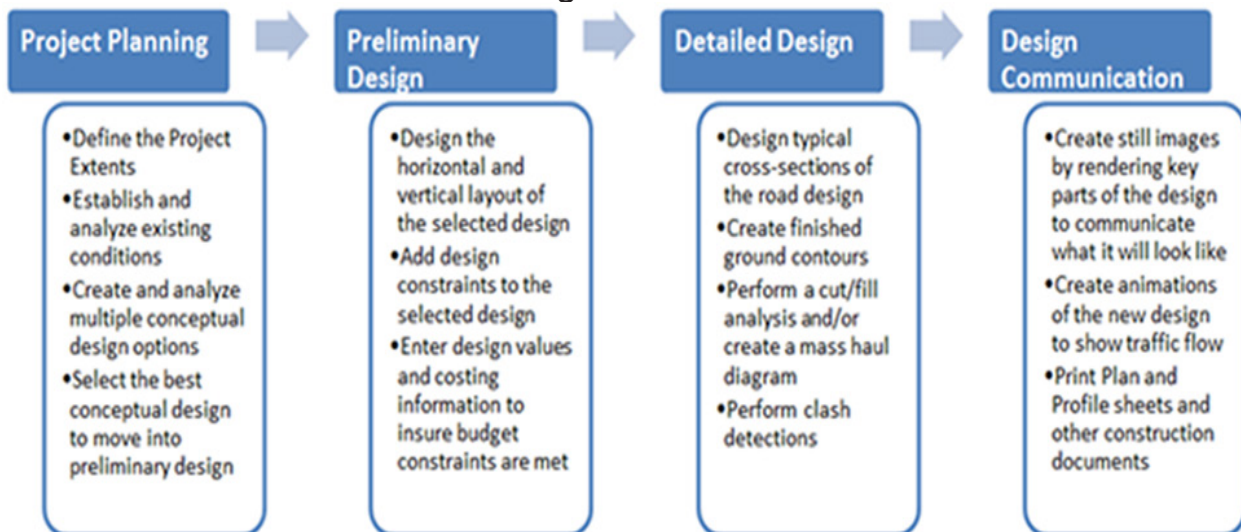

Planning Stage:

We work with a set of design proposals , in which we study each proposal separately according to the design determination and obstacles facing the project. IN the en the best proposal comparing with others shall be implemented.

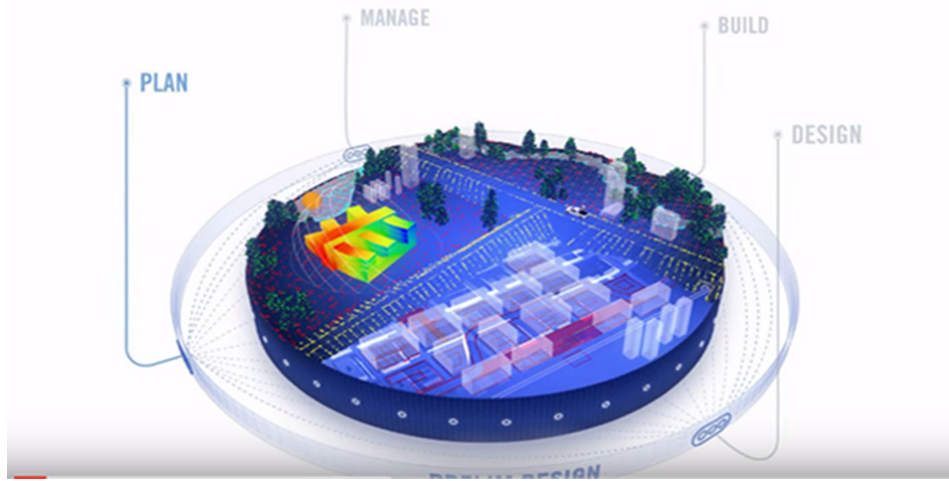

Schematic design stage:

We convert the proposal which we agreed on to designing proposal where we insert designing criteria such as designing speed, distance vision, analyzing quantities and prices of the proposal.



Detailed design Stage:

Conversion the proposal from INFRAWORKS program work environment to CIVIL 3D program work environment, which completing the design process, quantities, cross sections down to bring out (directed) sheets then export the entire project into NAVISWORK program to locate the conflicts between project elements as bridges, roads, water lines or exchange.

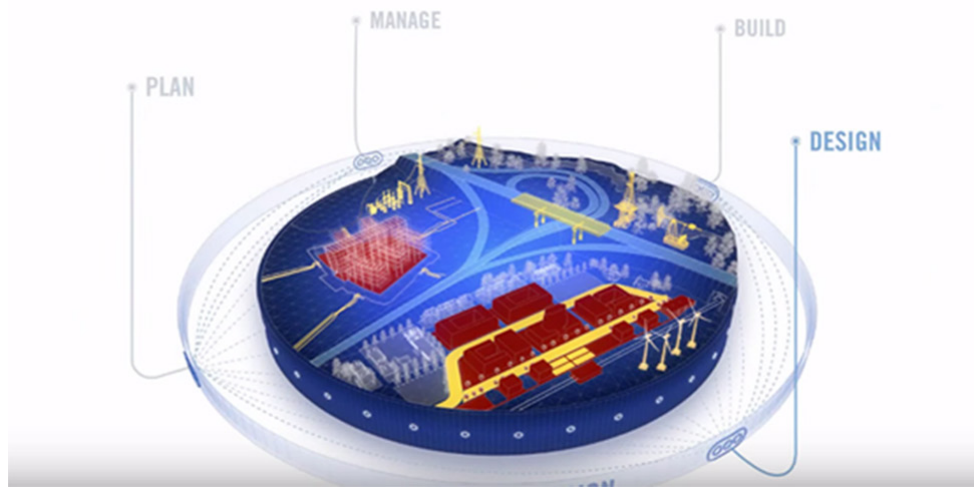

Direction stage:

The direction is by using detailed plates, quantities tables, roads coordinates for implementation, and the project can be directed professionally and present it as a video of INFRAWORKS program or send it to 3D MAX and make a video with movement characteristic to give a realism spirit to the model to make its displaying easy for the client.

You can follow-up on the Special Session link with theoretical application BIM in roads and infrastructure projects on the link:

https://web.facebook.com/groups/bimdiploma/?_rdr

Linkedin: ayman kandeel

/http://eng-ayman-kandeel.blogspot.com

email : eng.ayman_kandeel@yahoo.com

youtube : ayman kandeel

Translated by: Heba Yahya Khader

BIM EXECUTION PLAN

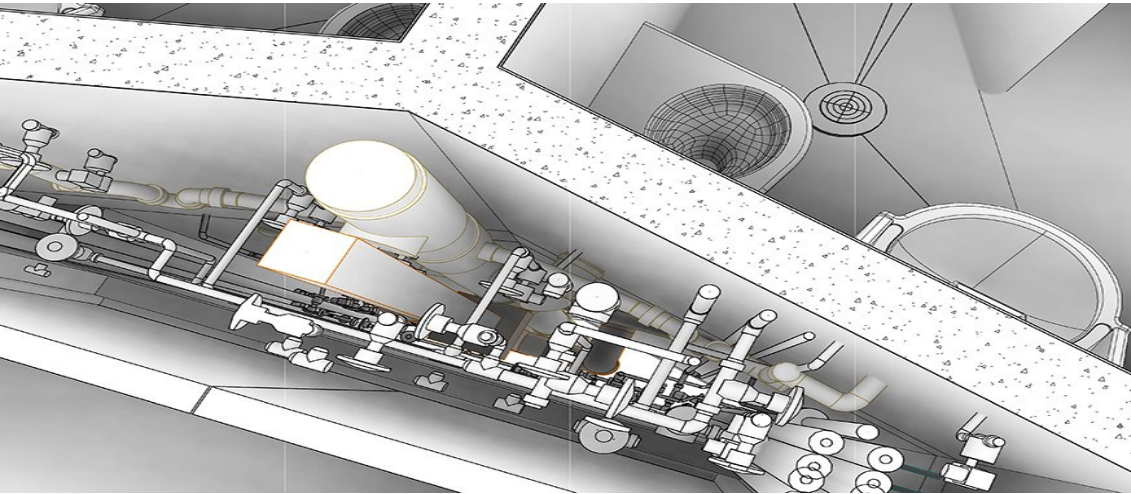

Mohammed Hammad

BIM Execution Plan includes a detailed plan for the project based on the modeling of buildings (BIM) and to clarifying the continuous business responsibility for the project to achieve goals and high efficiency of work strategy, and stimulate the time needed to complete work and illustrate the digital data exchanged between the parties involved in the project.

And it can be placed in one map

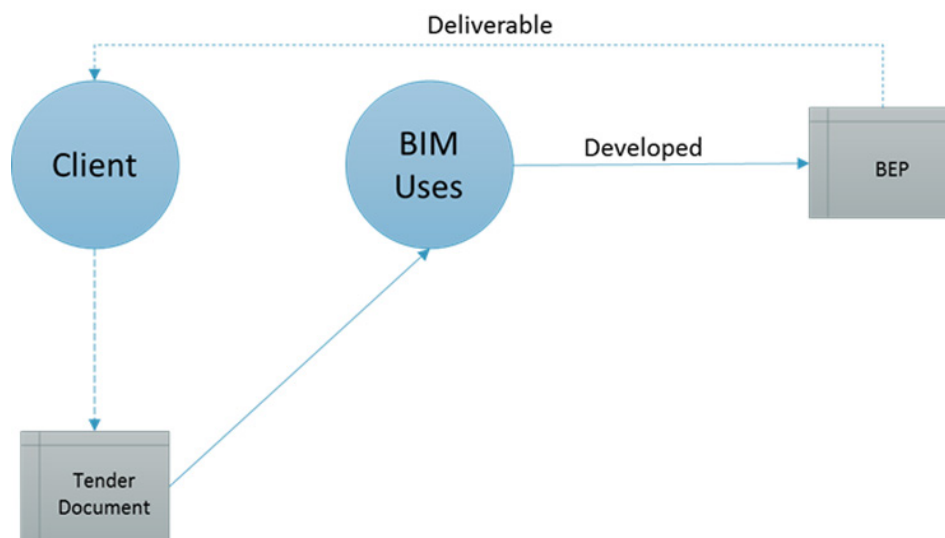

Illustrative map for the idea of (BIM planning exaction)

The general idea of BEP goal

- Illustration the input and output data of the project.
- Steps of working and designing.
- Setting a framework for the designing stages and implementation regulations.
- How to send a project reports.
- Determining the types of actions to put the basics for designing and implementation stages.

- Adding the required information of contractors, subcontractors and consultant.
- First steps to write a contract.

First: Project information

At the beginning of any project in the field of modeling consultant is required to extract a document approved by the owner, which should have a value for the team and a value currently and in the future. It contains project elements such as the title area of the project, contract number and nature of the project.

Client	
Project Name	
Contract Type	
Project Location	
Project Area	

Second: Key Project Contact

The schedule contains the electronics names and addresses for Individuals involved and who have effective in the project

And we can put them all in one map.

Contract	Company	Mails
Client		
Project Manager		
BIM Manager		
BIM coordinator		

Third: Project Goals /BIM User

The objectives and goals of using molding technology, it should be done in a table because it determines goals and importance degree for the project. This depends upon the owner contract and clarifying each goal.

Owner contract:

It is the contract which the owner sends to the designing company or the contractor. Also it includes all the projects conditions

Priority	Goals Description	BIM Uses
Height	Coordination	3D Coordinator
Medium	Effect Of Stakeholder	4D Modeling

BIM use:

A true (√) mark is signed on all the uses which will be applied in the building modeling. It differs from one project to another according to different designing stages.

Contact	Company	Mails
Client		
Project Manager		
BIM Manager		
BIM Coordinator		

Fourth: Organizational, rolls staffing:

It's the section of specifying existing tasks for each employee in the company, specially tasks related to BIM coordinator

Fifth: Collaboration Meeting:

Registering and commitments to the meetings dates for the required departments.

It's either dates determined through the time of the project or other meetings determined according to urgency and emergency

MEETING TYPE	PROJECT STAGE	FREQUENCY	PARTICIPANTS	LOCATION
BIM REQUIREMENTS KICK-OFF	PROGRAMMING	ONCE	OWNER,ARCHITECT	TBD
DESIGN REVIEW	PROGRAMMING DESIGN	MONTHLY	OWNER,ARCHITECT	

Sixth: Technical infrastructure

It's a table that contains the features of the machines all used programs

File name structure: it's one of the most important divisions and it's considered one of the BIM criteria that explains each file for each division and the file names used in the project.

Seventh: Model Delivery Schedule

It is one of the most important schedules to take full precautions for recommended deliveries in the owner contract and the method of delivering of the required folders.

BIM SUBMITTAL ITEM	STAGE	APPROXIMATE DUE DATE	FORMAT
Programming report	Programming	TBD	PDF
Energy Model	Design Development		GBXML

Eighth: Quality Control Checks

It consists of documents or reviews for project elements. It is not required but it is important for the person assigned to modeling in order to make it clear for the owner that Modeling is highly and specifically designed. It lists the best measurements to make the most benefit of the final form and it makes a list for each specialized department (Architectural, Civil, Mechanical, Planning)

For example:

1. To have no intersection between walls
2. To have no intersection between Architecture and Civil
3. Space details are same as the owner's copy of the contract and there are no

differences between them.

Ninth: Model Accuracy and Tolerance:

To put mistakes' percent in figures or in millimeter

Tenth: Level of Development (LOD):

It is one of the most important specification that determines the strength and the level of the production. Because it determines the cost of the time and the details. If you were a consultant, you would be required to request from the owner to specify the level of Modeling because it relies on the time calculation and it changes the cost of the project. Great care must be taken as it is extremely vital and requires reviewing each article and for consultants, they must know the level. If you were a contractor then a contractor you would make (LOD 400-500)

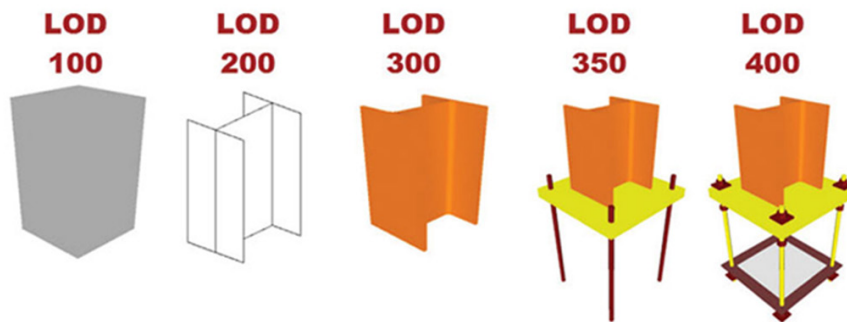

Workflow

An explanatory structure is made for project paths or the phases that will be covered from all sides, this reveals in structural phases. Method of exchanging information among all parties contracted or in action among the owner, the consultant contractor and the Subcontractor and it is very important for determination the paths of movement and the whole project structure.

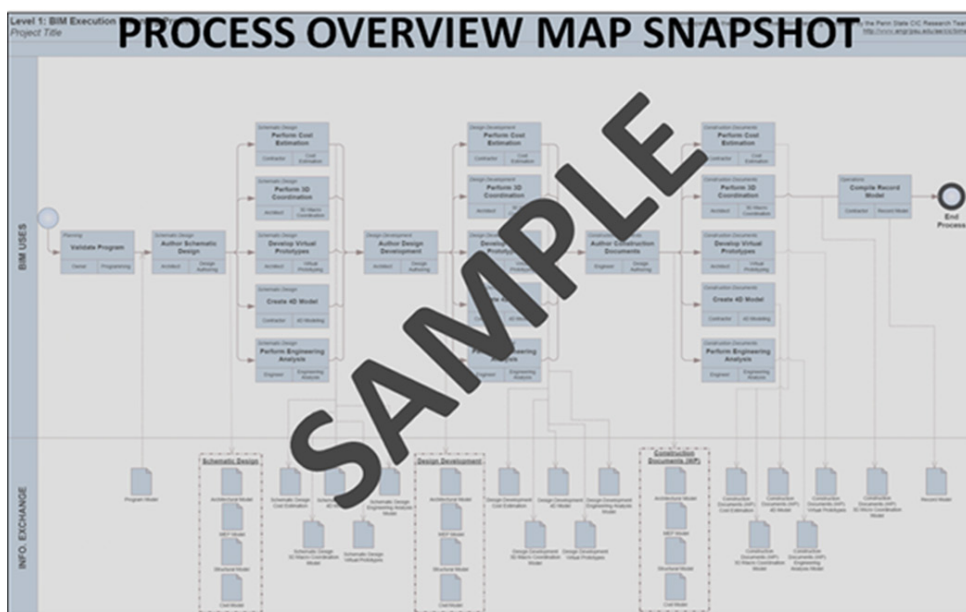

FOURTH DIMENSION OF BIM

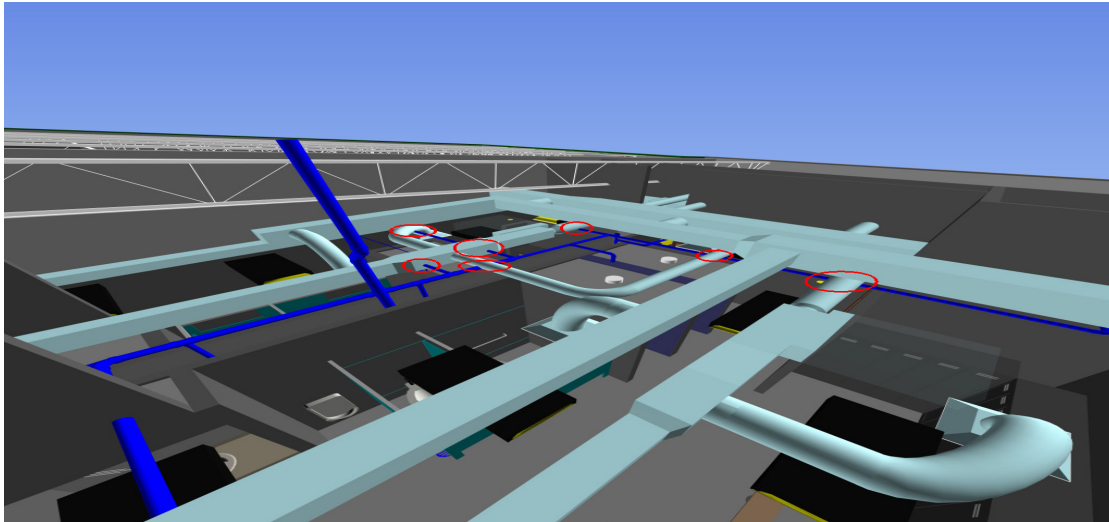

Tamer Elgohari

Firstly: The history of fourth dimension of *Building Information Modeling*

“Plan your work, work your plan” **Vince Lombardi**

This quote applies on building and construction industry more widely, where the success of the project is influenced by the plan process at the end, we find in the history of the building and construction industrial that the project team always makes a very big effort to implement the project during a specific time for delivery, in addition, the building project currently becomes more complex, and it is associated with a big number of implementation teams, that makes the effective planning requirements and improvement of communication between different branches of construction is essential, and affecting widely on the project's implementation time .

Although of applied techniques, and scientific researches in planning field, a very small number of construction projects has been implemented in a specific time, this is why it is necessary to find a new way which saves the time in planning and controlling the project.

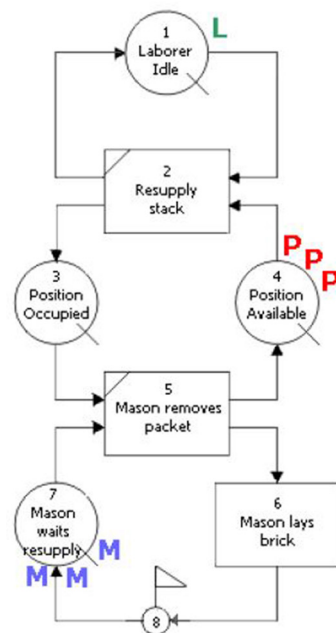

A model of according simulation to CYCLONE method

The concept of construction works 's simulation didn't get a lot of attention until the late of 1960, at that time, the process of linking between engineering drawing and implementation of project plan started, but in a very simple way .

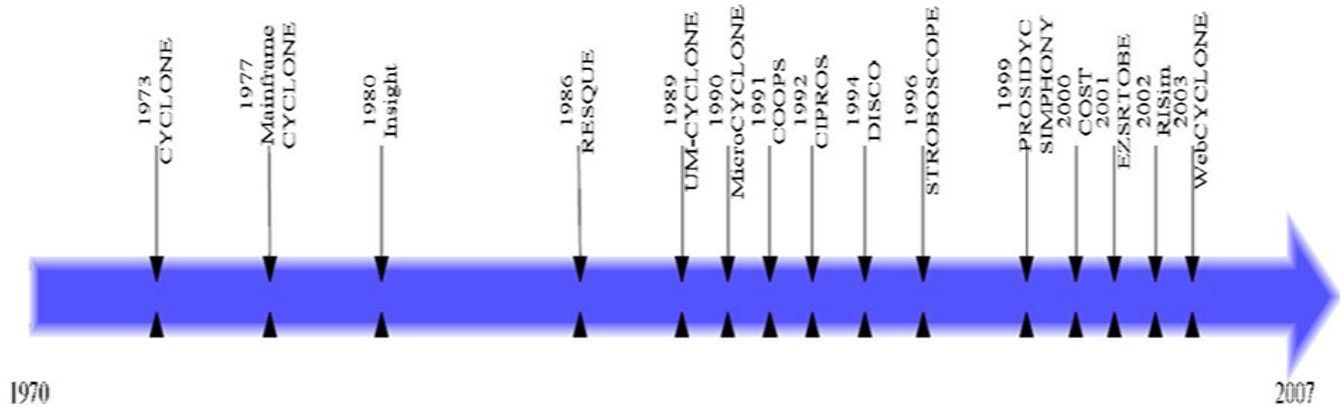

It was obvious that, although every construction project is different by itself, but there is a lot of repeated engineering process in every projects as (ground-leveling work, digging works, installation of glass over high buildings ...), from here, the idea of simulation these repeated works, and controlling its implementation rates to achieve the optimal utilization of resources and reducing the project's time. By that, the simulation's techniques started in construction projects by inserting new concepts, the first concept is called "simple networks", and this is considered, the first step to study the simulation of construction process models.

Then, the first practical application of these techniques is called "Link node" which was implemented by engineer "Teicholz" in 1963, then engineer Halpin in 1973 improved the concept of "CYCLONE format" which became essential for numbers of simulation systems in the future. CYCLONE has simplified the process of modeling and simulation and made it easy to access by construction workers who used to have limited simulation background.

The work continued to develop and to enter new concepts until 1990, where Halpin Developed "macroCYCLE", and it was the first simulation program based on the models developed through "CYCLONE format"



A simulation model according to the way of macroCYCLIC

After that, a lot of simulation programs which based on the models of CYCLONE were developed, for example: STROBO / PROSODIC / DISCO / SIMPHONY

WEB CYCLONE/ SCOPE. Improving simulation programs continued in order to become as we see it in current time.

Development of building models simulation from 1970 to 2007

Secondly: “an Overview at the simulation at simulation of building models “4D modeling” .

What does it mean by “BIM 4D modeling” or” BIM 4D simulation”?

It is a simulation for the required sequence of building activities implementation to finish the project, or simply it is a simulation of project’s timetable, also it helps in making connection between project teams and increasing the ability of understanding the timetable and building plans .

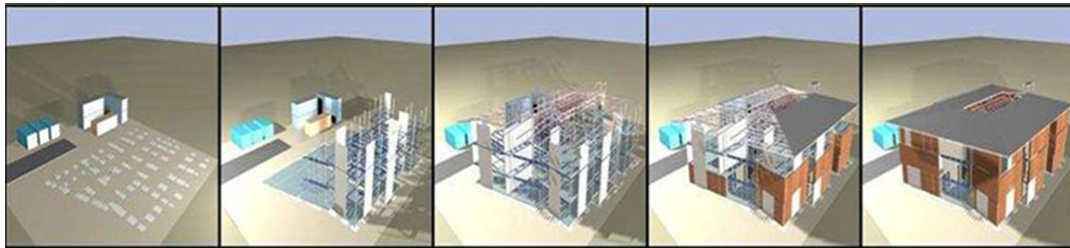

The map of workflow to build a simulation building model

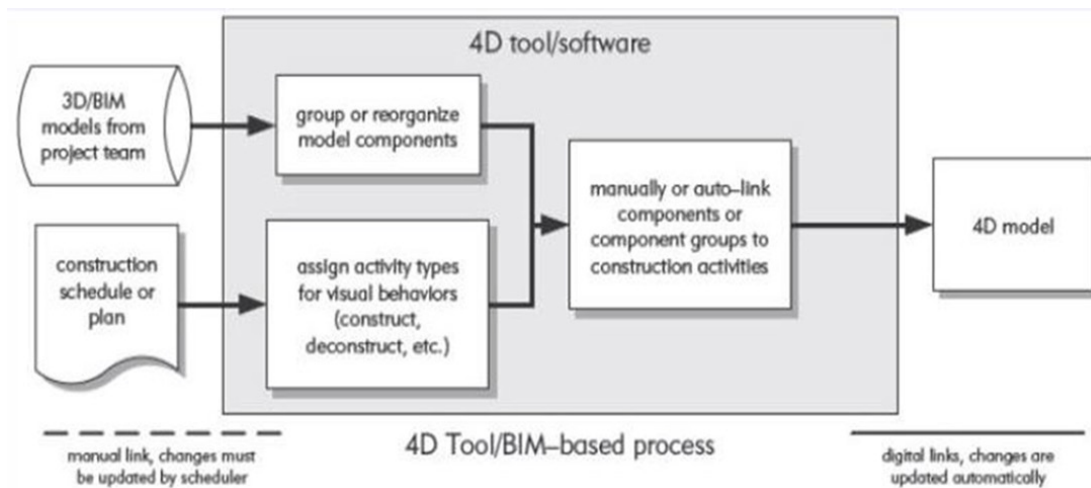

1) Getting 3D model from design team, and getting timetable from planning team.

2) Re Classifying and dividing every item of the 3D model, where it can comply with the opposite activity to it in the timetable, and reclassifying every activity in the timetable according to activity work type (digging activity, building activity or temporary activity).

3) Linking every element in 3D model with the opposite activity to it according to the timetable. Linking can be manually for every element or automatically by making shared coding system between planning team and design team.

4) Making sure that simulation process is working correctly, and every model in 3D model was linked correctly with the opposite activity.

Benefits of BIM 4D modeling:

The benefits of building simulation models is considered unlimited, because it

can be used differently according to the project's nature, where the simulation's engineer should achieve project requirements and implementation team's requirements "4D deliverables ". Through this, the simulation is used as it is required. In addition, the benefits of simulation are different according to implementation level in the project and there are some public benefits:

- 1) Increasing building timetable efficiency of the project, and checking the sequences of activities and implementation ways and "visual clash detection" to the project's model.
- 2) The ability of analyzing activities' implementation according to the timetable, and comparing between more than one timetables accurately, and it is considered a strong tool in the case of "disputes analysis".
- 3) Helping in taking decision and evaluating it in the case of finding more than alternatives to implement activities or to determine the required duration for the activity in the case of not being able to determine specific duration.
- 4) Improving the use of areas in the site in general (engineers offices places, materials storing sites, workshops sites, ...) and helping in determining the general shape of the site during implementation project's levels "site layout planning ".
- 5) Improving the communication between all involved parties in implementation of the project in general, by finding common simulation model which gathers all project's parties at the same time.

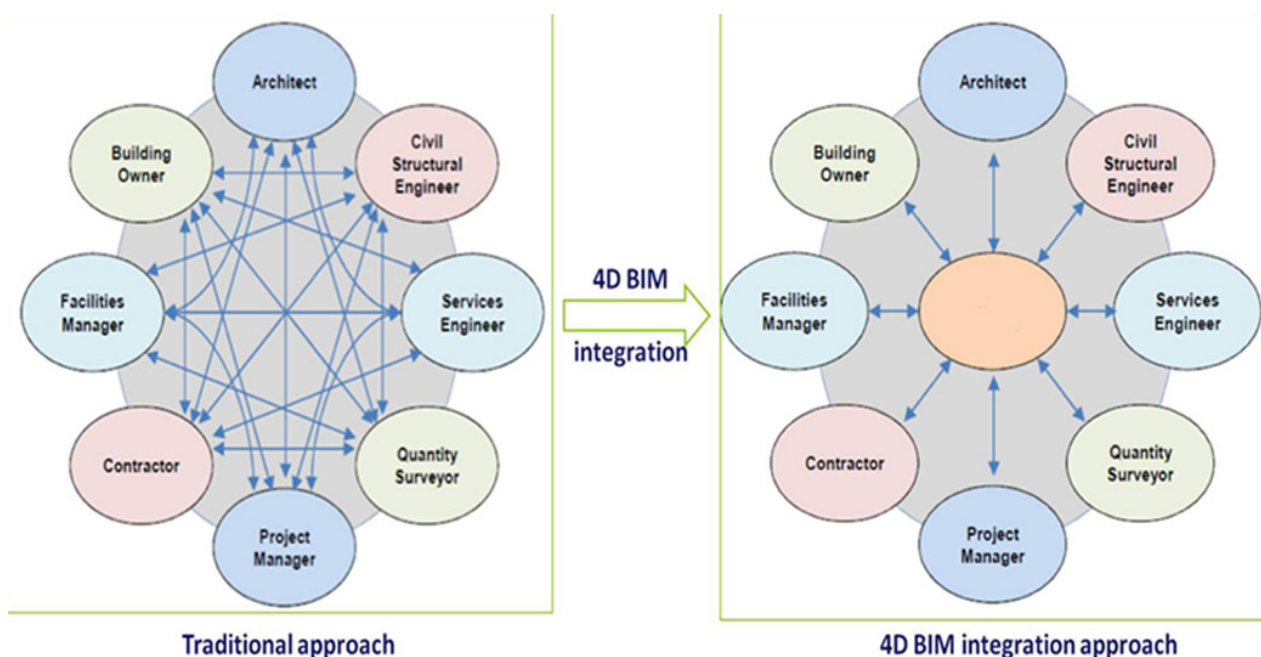

Translated By: RADWA HASSAN

OPEN SOURCE SOLUTIONS AVAILABLE FOR PARAMETRIC DESIGN

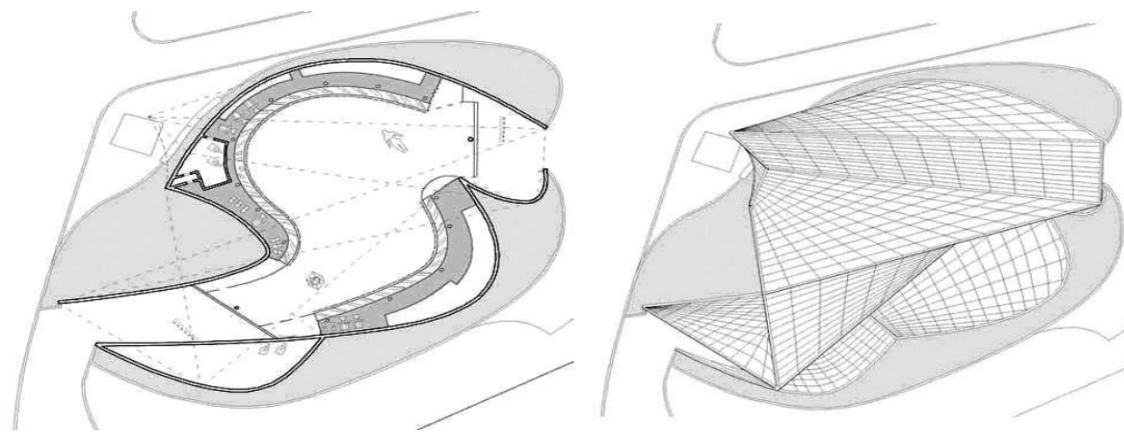

Muaz Alnajjar

Parametric design

Parametric design is one of the latest trends that appeared in the architectural design science particularly, and in engineering science generally. Modern technology has highly affected the architecture field.

The use of (Parametric design) term coincides with unprecedented spread of advanced technologies associated with the digital representation of complex engineering projects. However, this term is not clearly defined. If you read the software that represent these projects, we find that this software lacks a definition of the term, while it discusses methods of modeling and processes that underlie this software. This increases the term mystery and it creates at the same time, new dimensions may carry right and wrong to define it clearly.

The term “Parametric design” adopts the idea of linking the parameters (media) with design process, for example the idea of chemical Catalyst which are used to speed up certain interactions. This matches some how the use of parameters in this kind of design. Parametric symbolizes the idea of data that influences in shaping the design of most (if not all) construction projects are subject to the terms, conditions and external factors. But if we look around us to mathematical relationships that can describe construction as golden ratios and theories of complex curves, we find that parameters or media is still playing a key role in the design. Often this term is to denote a combination of factors contribute generally in building formation, whether these factors are quantitative or digital without neglecting the fact that all these factors are subject to measurement and associated with variable standard, in order the design will not be random and out of all common engineering systems.



Philip Pavilion

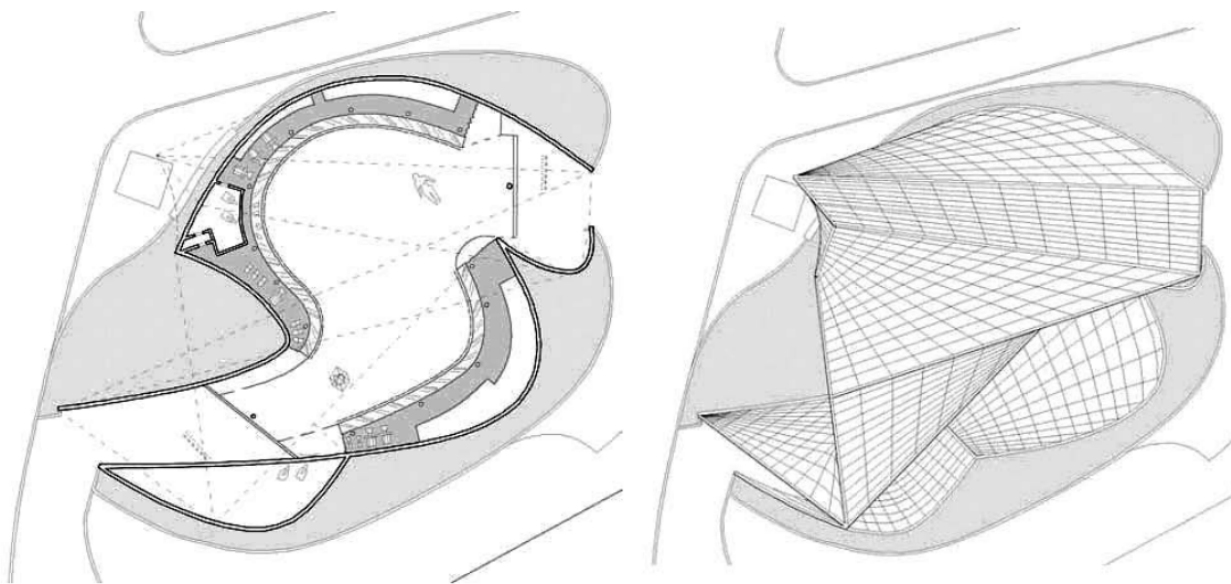

Philip Pavilion

Persisting in understanding the term and before discussing its most software appearance, we have to generate simple ideas which give the reader more comprehensive and accurate idea of what parametric design is. Perhaps this will be a reference for him and for others to understand this subject more accurately.

A practical example to design a facility by using the Parametric design

Let's assume that we have a project of apartments building within metropolitan downtown environment (Metropolitan Downtown). We want to build it in order to replace some building which it is time to end it because its assumption lifetime ends according to existing construction plan, In design process, we have many factors we should be aware of, such as neighboring markets (Existing Plaza) and the path of buses (Bus Route) and not to obscure the neighbor buildings and to leave enough space for exposure to sun (Solar Exposure). As shown in the following figure:

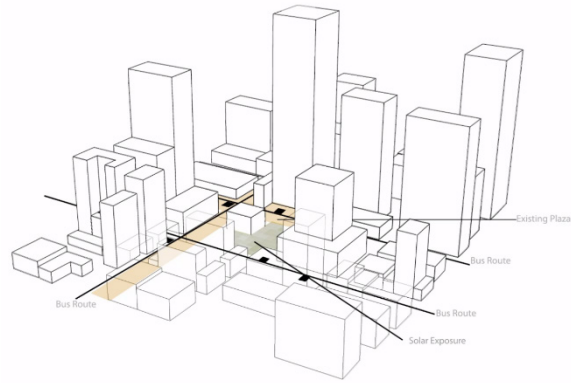

If we consider the factors mentioned above are key factors, so proposed design should follow within certain numerical ratios (for example: Area that is exposed to the sun should not be less than 35% of the total area of the land that is the property). By focusing in this factor imposed by the municipality (the capital secretariat), we find that it needs several steps of thinking and accurate calculation to make a design complies with these standards.

These steps collectively must gather in design which is compromise between those standards and it must follow aesthetic so the eye cannot reject or the mind misses it. Therefore, first you must convert these required factors to mathematical relationships and then to the numbers as we can see in the following figure

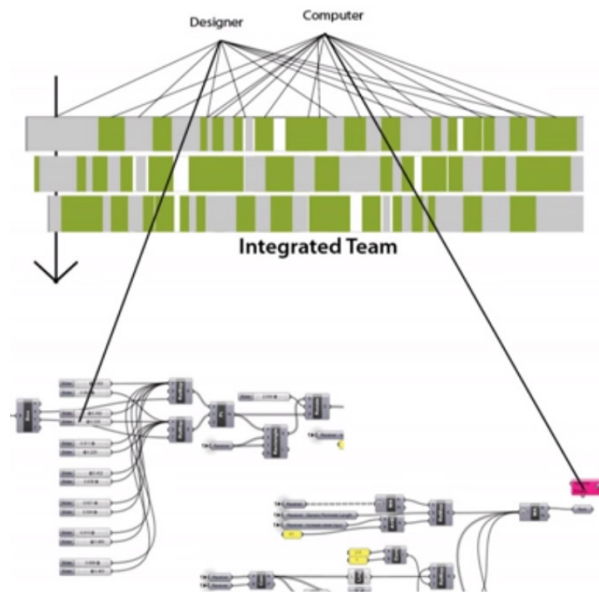

This figure shows the way in which we can translate the factors that contributes to the formation of the design, that we propose to reach via some relations (up to this moment at least). Then this will be translated into possibilities and experiences, the computer can do this until it reaches a close relatively set of solutions, we can directly select out of them, instead of wasting time doing this trails by opposite way (which is starting design and then study its compatibility with our standards then trail again to get convincing thing as is in the case of traditional design way, The following figure shows us how it's done within one parametric design software.



The red box shows us the required area for the building while the software calculates the factors which should be achieved in the space within the building footprint, after completion of calculations the program submits the required proposal regards to the alleged ground of the building, Then the process repeated again iteratively so that repetition of matching the same conditions for other levels to the top of the building, then other set of factors is put to suggest analyzing and distribution of interior parts of the building and the rooms, taking into consideration the areas that should not be compromised such as structural elements spaces and service elements space (elevators and mechanical services, etc.). This can be seen in the following.



Then if we take one of the apartments and we want to examine the distribution of spaces inside it, we find the following.

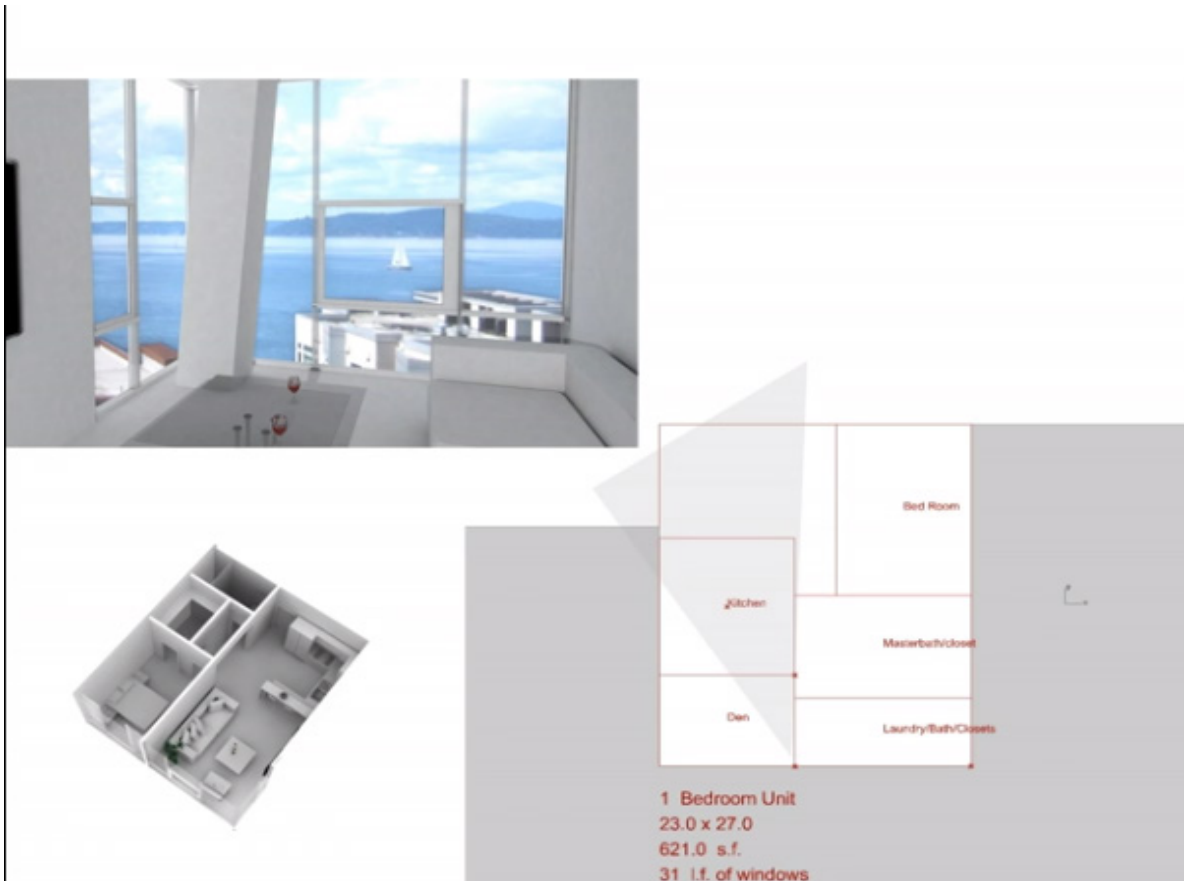

- Here, following questions appears directly?
- Is the era of aesthetic design ended?
- Is there any reason for the existence of the engineer?
- Will you accept to live in the facility has been designed by using computer?

These questions and its examples of scientific obsessing questions, considers computer who has offered the most accurate details of the building by using just numbers and relationships between these numbers, through correct questions, because we grew up in an environment where the engineer is considered the master of engineering work from the initiation until the conclusion, I see here that the work has not been done by a computer at all, but it is a synonymous to the architect who saves effort and enriched the quality of work. This is good for health calculation which does not affect the course of action, but at least make it a unique and distinctive.

But the question that comes to mind after exploring this information on the latest trends of design is that, which softwares can do such task or work? Do they achieve such prevalence or they still in their infancy and how much the engineer must accept their solutions to other questions, which the reader mind think of and he/she accepts science updates and realizes it or remains as it is accustomed.

Parametric Design Software

Most of the existing and trading programs in the labor market is considered a specialized software in third-dimension design (such as AutoCAD, TurboCAD, Sketch up, Rhinoceros and many others) and this software is not a direct subject to parametric design requirements but through Extras (Add-ons or Plug-ins) which are added later to do what is required of it as mentioned earlier. Grasshopper extension was marked soon, which was added to the Rhinoceros program to activate the properties of the

parametric design, and it has achieved good success as the relations that have been added touches the heart of the design work in most respects (interfaces, spaces, pre-programmed mathematical relationships)s.

While at the same time a group of programmers headed to develop an open source platform to create a special program valid for all as a basic nucleus which we can add to it or develop it. It is a program, or dynamo extension, as it includes mathematical relationships focusing on elevations and design of structural elements but at the same time it is able to evolve rapidly to complete many existing software used in engineering work companies.

The giant Autodesk company, recently added Dynamo to software list that it made (without buying it of course, because it is not primarily owned by a particular body and inserted it to replace the Vasari which is a program existed before, to be the starting point for the parametric design in the system of Autodesk. Dynamo are not designed primarily to be part of the Autodesk group, but the company has built its own interface and made it a program which can simulate the rest software provided by the company of the same specialization which called it the Dynamo Studio, where you can start designing on it or part of the design can be transferred to it from other software to process the incision by adding parameters and process it, then return it to the program, which will present the design and output plans.

What is the next step?

After I have provide what has been said about parametric design and its importance and effectiveness, I would advise strongly to follow the development news of this software and to start training on them as it poses services that benefit the designer especially, and engineer generally in saving time and clarifying many obstacles that could have been resolved but they requires the guidance to explain where it is and where it lies.

Translated by : Zidan Fahmy

QUOTES ABOUT BIM

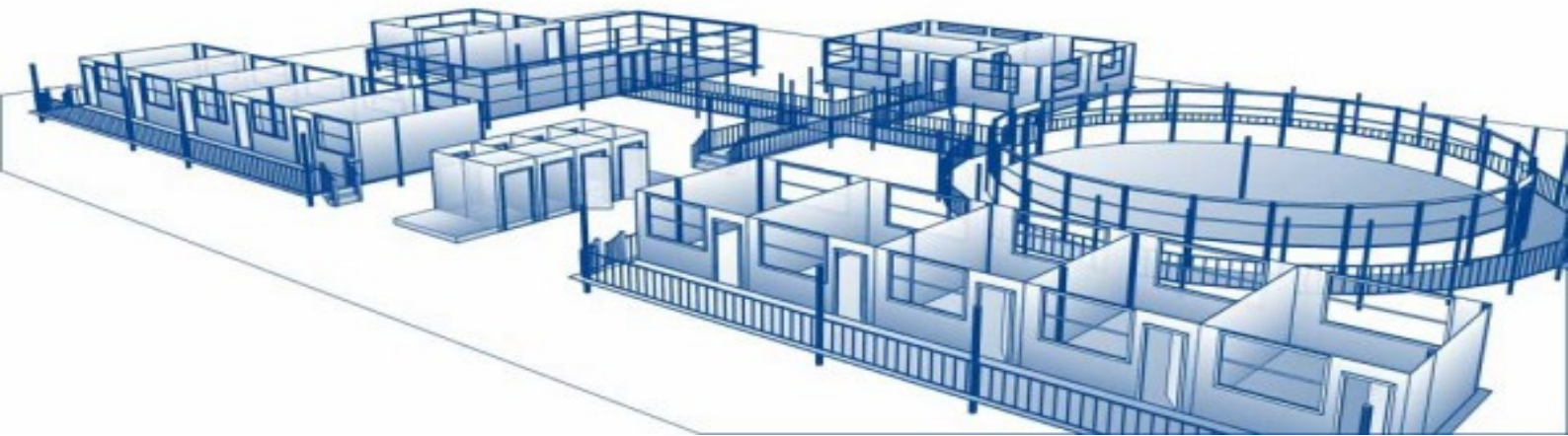

“BIM is not a philosophy that radically changes the whole construction process, it is rather an incremental approach of innovation that brings efficiencies to the way we collaborate digitally in the construction environment.”

Peter K Foster

“If only one book were to be written about BIM, it might be “DON’T PANIC” printed in large uppercase letters on the front cover.”

Pete Zyskowski

“BIM is not about one profession, it’s about everyone working in a collaborative way”

Richard Waterhouse, CEO of RIBA Enterprises

“...The lower limit [of projects where BIM will be mandatory]... but I think that is probably worth £5million. A lot, not less than 50 [million]”

Paul Morrell, Government’s Chief Construction Advisor

“...There was a debate between the services installer and the services consultant about a pipe through a wall and across a room... So I suggested to make a quick model of it”

Robert Klaschka, Director, Studio Klaschka

“About 50% of our basic staff are trained and are actually using BIM platforms and this is increasing month-by-month”

Alistair Kell, Director Information & Technology, BDP

“[We use BIM] where we think the BIM will add value, and that is not just our decision but the team design and a client decision”

Nigel Clark, Technical Director, Hilson Moran

“I think most businesses will have an implementation plan in place and they are trying to understand when to jump in and what they will get of this investment”

Sam Collard, Engineering Leader, Laing O’Rourke

“The important thing to understand is that it is a way of working so that we can work together, with others in other disciplines, work together through the supply chain. And the important thing is that we’re not just talking about geometry, we’re talking about every parameter that you can talk about with respect to a building, or a space, or a system, or a product.”

Anne King, Membership and Marketing Director, BSRIA

“The most important thing, with respect to master specification systems, is that they aren’t just words on paper or words in a word processor. The specification has got to be built around related objects so that you can query it... information you can work with digitally.”

Stephen Hamil, Head of BIM, NBS

“BIM is about 10% technology and 90% sociology.”

Charles Hardy, director of the General Services Administration’s (GSA)

“BIM is created to solve CAD problems, and using it as using CAD principal; increasing the problems not solving it. It seems like using computer monitor as a paper when we draw, or put a boiler on the cooker to make coffee. “

OMAR SELIM



BIM AND EIGHTH DIMENSION

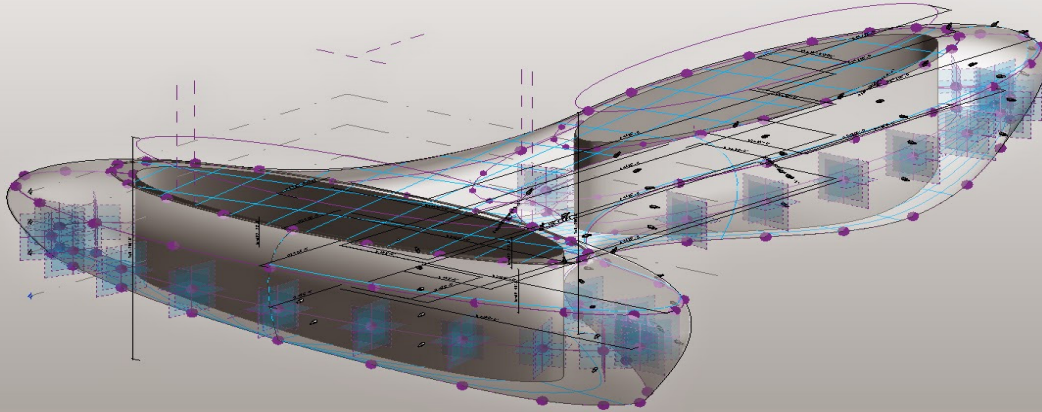

DR Samer El Sayary

We can consider that the real turning point in the Architecture happened when architects changed the traditional drawing tools and began to use computers in the nineties of the last century . During this time, the conflict between conservatives and moderns began and the arguments began, **can an Architect leave freehand sketching or not? Will it affect work or not?**

This article is not a place to discuss this argument, but rather to review the second turning point, which I think, it is much greater after computers has invaded architecture offices, universities and all those who work in the construction industry.

The rapid development of information technology allowed evolution of Architecture in the last 25 years and changed its features. As long as Architecture is in deep link with building materials, many concepts has risen up and required more development.

With great momentum and rapid development we needed a new technology to help us, *Building Information Technology* (BIM) classified as the best technology has reached to seven dimensions at the same time.

- Second-dimension : BIM can draw sections, horizontal plans, sectors and elevations efficiently higher than CAD programs. Whereas the architectural elements are defined as smart objects have specifications, not just simple lines as in the traditional engineering drawing CAD programs.
- Third-dimension: At the same time: when engineer draws the horizontal plan of the building, the whole project is built three-dimensions .
- Fourth-dimension: Timetable planning which means special needs for implementation process later when actual construction process begins and for the first time in the history of engineering, we find a technology respects the timetable planning considerations from the initial design process .
- Fifth-dimension: Bill Of Quantities which is a complex and difficult dimensional especially meanwhile the intense competition in the architectural creativity which produces complex forms may find it difficult to confine its sections.
- Sixth-dimension: Facility management for maintenance management works even the life cycle of the building ends, and even later when making changes or revisions.
- Seventh-dimension: It is the sustainability dimension and developing this dimension is continuous for making a full simulation of energy and the effect of the sun and the wind on the building, both externally and internally.

Many engineers began learning BIM to benefit from the above, but there are many in BIM which will be discovered next few days.

Perhaps some consider the most important new technique as the eighth dimension is Parametric design and this technique can be summarized in the use of computers in design forms that are difficult for the human mind to produce.

As a fact, this is not a new technology, it has appeared from nearly 8 years and the most famous application is GrassHopper.

These applications use mathematical equations and physical phenomena to make masses and different architectural forms and evolves with it in sequence techniques of digital fabrication. Although this field is considered new, but it is spreads widely and the implementation of many buildings which have used this technique in their design, is started.

Architects did not wait too much to merge between this technique and BIM even Autodesk surprised us once when it developed its famous program Revit by adding DYNAMO, a program that works within Revit same way GRASSHOPPER to announce a new era merges the previous seventh-dimensions with the new eighth dimension which will change the face of the industry. Then the buildings appearance in the coming period and it will provide a greater opportunity for architects to create without fearing drawing difficulty or bill of quantities or timetable planning etc.

Translated by : Doaa Mohammed



Ahmad Lutfi

- **Prosecution lawyer:** “Mr. President, honorable consultants...”.

This man had moved the {Model} from its place without permission which caused significant engineering mistakes of connecting the building with the services networks, We demand to apply the maximum penalties against him.

- **Defense lawyer:** “objection Mr. President, that “Model” is not a property of the plaintiff to prevent my client from modifying it, the Model can be considered as a son of my client as he is the one who made it from the beginning!

- **Judge:** Court decided to hold the model to question him about his relationship with the defendant; the case is postponed to another date ...

This example might be exaggerated, but it is possible, indeed!

It is well known that BIM is to use a digital platform to integrate the work of all design and construction teams and to generate 2d & 3d models, plans, and reports

Cost and schedule for the creation Can be added as a fourth and fifth dimensions in the one model or more.

It simply makes the design and implementation of a centralized collective effort and not an individual for this BIM will make new legal issues that did not exist earlier.

The project is called “BIM project” When a group of engineers of different specializations and affiliations contractual allowed to work on a single digital model which is the »model».

Well, this is just the theory, and by application, the validity of the theory is known.

But before we start, computer and technology criteria internationally agreed on must be put because both are the base of »BIM». Finding definitions for all the elements and practical components, and this is actually what specialists from several countries - trying while you are reading this article now - are racing for, according to recent updates it seems that the complete compatibility for engineering computer models of digital design professionals will become possible soon!

If we look at the workflow of »BIM» away from technology and computers it will appear completely as making soup by more than a cooker, each one puts his/her special ingredients, here, in this case, we ask who will be responsible for the soup succeeded

or failed?

The USA contracting law, for instance (which is based on British common law as both countries are leading in BIM subject) we rely on looking at this issue in a world of black and white; colors or other shades does not exist, it consider (as an assumption) the presence of quite a mistaken party and another entirely right one. Then each part tries to prove the contrary. Therefore, the result depends on the showing clear winner and a clear loser in each case.

Then an evaluation issue of economic losses for the project incurred by the losing party, the economic damage issues depend on the using revealing mistake principle by comparison and returning to the principles agreed on as well as to those who have decided to apply the work style of »BIM« adoption a formal contract between them determines or evaluates responsibility and risk in a correct and clean terms between them according to the following three types of the model which will follow:

As I mentioned earlier, in the beginning, all parties must agree on using BIM technology. Then, they have to agree on how they intend to achieve it!

They can either agree on specific technical steps for each part or simply agree on using reasonable efforts to coordinate their special Models or data. Then sorting details after signing the contract.

BIM Model Types:

Type A1: Complete integration and coordination in each design models created by all design professionals that (architect, civil engineer, and mechanical engineer, etc.) as well as design models that are created by the contractor and subcontractors, equipment and suppliers materials. In one design element is the «model» then coordinating all design elements and resolve contradictions. This integrated and coordinated approach allows the »BIM« to achieve all its advantages. But it raises the most difficult legal issues that will be discussed after.

Type A2: using BIM as a central storage place for data contains all of the separated and independent design models to be accessible, but not merged into one model. This separated methodology and non-uniform among all, raise the minimum number of legal issues that will be discussed after but doesn't allow BIM to achieve its complete advantages.

Type A3: using many mixed methodologies. For example, the parties can decide a complete merger only in certain and / or separation of certain models disciplines, or a particular size of special elements, or set of a discipline on a basis of agreed risk assessment (the data related to the elements of a certain size, as pipe 1 inch diameter, for instance, which can coordinated at site)

Model management

The model usually created and used by the project team, in every team, there must be an administrator. Accordingly, both main parties may wish to appoint one of them and to consider it responsible for the model management. The Model Manager is considered as »gatekeeper« he/she decides who can access the model with complete or partial authority regarding reading and writing, and closely follow the data entered to the Model. Overall he should ensure that all data are entered correctly.

The contracts documents of BIM

«Contract documents» are documents that together constitute the agreement between the owner and the contractor. They are the sub-agreements, general conditions, original drawings, specifications and any additions /orders that can deviate the origin contract. They are -therefore- must adhere by the contractor to perform the work according to the set of terms and conditions. Submissions and shop drawings are- usually- not considered parts of the contract documents, so if they deviate from original plans and specifications, the contractor will be responsible.

To consider the »model« as one of the contract documents is a very important decision. If so, it will oblige the contractor to perform the work accordingly, this will make the »model« very important (case A1 and A3) Moreover, the »model« develops during work progress accordingly, parties need a basis which determines the sequence of the contract documents importance in case contradiction which is a possible situation during the development of the »Model«. The sequence of documents is one of the important documents, but if the »model« did not have a contract documents, the contractor would be bound to perform the work according to the plans and specifications strictly (other contract documents)- and not for »model«, which would make the »model« just a collecting comfortable place for data with limited benefit and without any legal effect (case A2) therefore, to apply »BIM« with its complete actual advantages, the »model« should be included clearly as one of the contract documents.

Registration documents and license

Career services regulations that applicable for construction are usually designed as separated parallel procedures, where the contractor gets his Building Permit and conduct it according to consultant supervision the consultant is already licensed by the same end that issues the Building permit, so the Authority engineers as the architect will approve & stamp architectural plans and structural engineer will approve and stamp structural drawings, and electrical diagrams will be stamped ... The permit issue also will keeps architectural/structural and electrical copy ... etc. (The same versions which are stamped by his engineers) for the final comparison when the building handing over, keeping them separated from each other ... It is a licensing system does not fit the BIM

So the »BIM« required a higher level of d licensing procedures and to audit & develop the traditional procedures.

As the parties agreed whether the »model« would be one of the contract documents, as well as they must decide whether the »Model« or any of its components will be included in the building permit documents and records .or it is going to be internally only to implement the project, but The building permit and registration are going to be made in traditional manner.

In case the BIM model was adopted as one of the building permit documents within the license approved system, originally, this would require more efforts and details from contract parties to obtain the approval from the Authority engineers, because the engineers, who will review the submitted Model, will require more data than what they usually would ask to decide on things which definitely will not appear in the cases of traditional license

Responsibility for data

A large number of designers participating in the »Model« mainly will rely on dimensional accuracy and the data entered into this »model« by each other, and the »model« manager has to ensure the accuracy of the information provided by all parties. One mistake in one-dimension from one party can cause double effect damages across the entire »model«. This point might make the use of »BIM« a dangerous game. Thus, the contract parties must provide guarantees about the accuracy of their entered data; the guarantees must be acceptable and supported.

However, the potential problems associated with providing data will exceed inevitably dimensional accuracy. Responsibility for data must be extended to contain potential technological issues associated with transferring and corruption of data and software defect or at least one party computer non-compatible with the others, this may negatively affect the overall model and on others, of course.

This point has been overcome by hosting the Model on a digital cloud by management software company itself «Autodesk, for example,» rather than using local network and it bears (the hosting company) these responsibilities, but this solution may be considered relatively expensive for some as the company for sure will require the use of its original programs only with its expensive price for each device to add fees associated with duration of time and the overall space to host the »model« and finally will require a high-speed Internet which may be fanciful to some geographic areas!

Legal responsibility for mistakes

In A1 and A3 model, A subcontractors will object -for instance- on penalties that applied on it for a fail in the central »Model« because these penalties might exceed his wages as a contractor ! because the error might affect all participants. So this kind of penalty must be clear to all parties in the contract, and the contract should contain how it will prevent such errors from happening and how to customize, limit or share responsibility in case it happened from the beginning!

In type A2; all parties: owners, architects, subcontractors, consultants of separate management companies... etc. Should realize that the law defines the professional responsibility of the architect or designer in the case of a professional error occurs as an engineering mistake occurred due to human error (forgetting or neglecting). So engineers who caused the error in «model« of the «BIM« due to forgetting or omissions their mistakes will be automatically covered by the project insurance once defined in the contract, but this insurance will not cover mistakes that may occur due to a fault/failure of the program or computer or because of a security breaching for computers «Hacker« for example, so this have to be specified in the contract and contained it in the insurance policy, This will be added to the insurance of the »model« and its inputs and outputs only after it is considered one of the contract documents.

As we discussed before. The insurance company may refuse this procedure in case of absence the staff who are aware of BIM, or it may accept as exchange a large sum of money, then all parties will return again to the software company example hosting the model as mentioned above.

Intellectual property and copyrights

The collective and cooperative work in the design and data entry in one «model» inevitably will raise intellectual property issues between the parties

After we had discussed the responsible of the »model« in its different types, we will discuss here who is the owner of the Model, Design, specifications & merged information (case A 1 & A3)?

And do the Parties who works on it have the right to move, copy, sell, or possess this » Model »?

This will make security breach point of the project according to some parties or even to people how will use/operate the building

In the traditional contract the design, specifications, and drawings are usually considered intellectual property which is not allowed to be copied and sold. This will give the contractor according to the contract a limited license to work on the drawings and specifications, and may exclude specifications sometimes when the specification are a standard extracted from the official building codes, in this case, it is out of intellectual property.

By Going back to the business model of »BIM«, the intellectual property law -on one hand -must be applied to the information entered by each party and on the shared »model« on the other hand, so each party takes the responsibility for what he worked on, or rather the responsibility of what he has, also the impact of what he has done to others.

So, each party participates in entering data into the «model» of the »BIM«, which represents a set of orders. Each party has intellectual ownership of «copyright» and to have a valid license to access the data that is contributed to »Model». Otherwise, Parties may violate by intention or spontaneously third party rights by copying, using, or deleting its data.

The next step is to answer the question: who will own all the information and the »model« itself after the work accomplished?

For the intellectual property of entered data from various parties of the contract, the Rights will be similar in the exclusive way of sharing to data possession in traditional contracts. Where a subcontractor or a consultant, for instance, is given the intellectual property for the data entered by him/her. Or may all parties share with each other?

Well, It is allowed to sell the copyright or to give a limited or unlimited time license to be used.

As for the »Model« itself. Let's start with Type A2 mentioned above; it will not be treated in much different from the traditional contract because it would be considered as no more than a central storage of data to all parties

But in case A1 or A3, The issue is entirely different; there will be complicated issues on the property in these case which is related to the »model« complexity and overlaps terms of reference. After all parties ends of inserting their data &the data will not remain the same as in the input form. Because it is a subject for amendment and development given the overlap with other disciplines not to mention that it may change completely into a new version.

So there is no correct answer nor wrong for the question above, the topic is a subject for negotiation and agreement in the contract stage!

In the case of forming an independent legal entity for integrated project delivery (example A1)the project joint between all the basic team members of the project, this entity (and parties represents it) a possible candidate to acquire the intellectual property rights from the top down to subcontractors.

Perhaps they may agree on joint property between all parties, which is satisfied proposal to all, but in any case if one engineer possesses the »Model« in any way after the implementation completes, it will inevitably be the architect who represents the owner, because the owner owns the project, so he own the »model«. Besides, it is an architectural design with equipment and other services.

Another reason is that the owner is the biggest candidate to own the model. Moreover, he needs it for the building management or maintenance operations or adjustments, after that in the case of renting the building and at the request of tenants to modify or extend certain spaces.

Confidentiality

Some of the data entered into the »model« especially data submitted by contractors, manufacturers, and suppliers.- If -a cost model and the timetable been provided - a private data of the contractor will not- certainly - disclosed, the cost which is not exposed to all parties, according to this, the contract may need to allow certain parties to submit or view limited data only to the extent that necessary to meet the needs of the project. Otherwise, the contract may need that informed parties have to preserve the confidentiality of information and never disclose it to other parties.

Translated by: Najwa Salama

DESIGN TECHNOLOGY

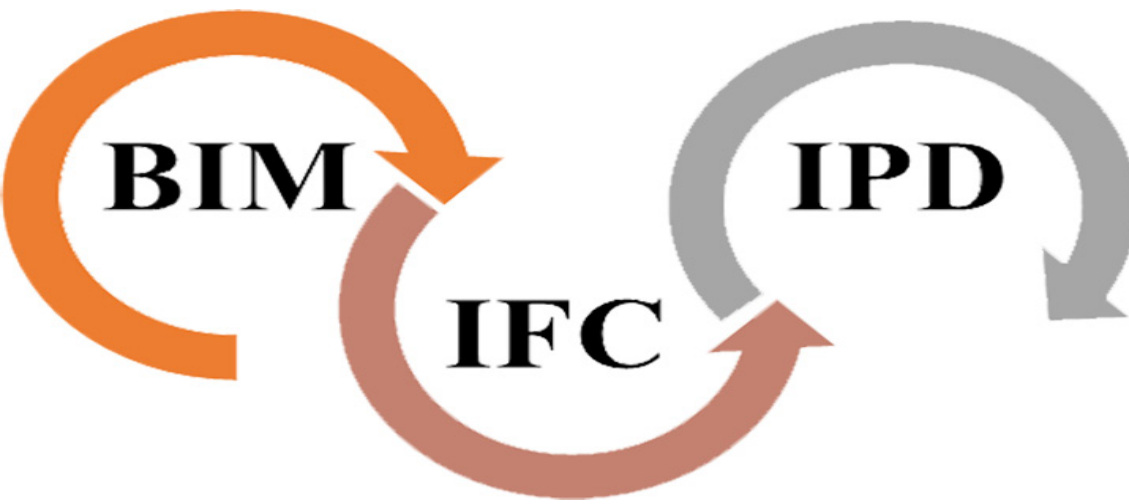

Hamza Faisal Moshrif

This technology is connected with creation, development, uses, support and management of computer-based information. This technology is used to improve communication between parties involved, strengthening product perception, support the computerization of information, consolidate simulations for various interactions, as well as improving the processes associated with the product. The goal of using this technology is to achieve success through design, construction, operation and management facilities. Sometimes definitions of information technology and design technology are confused. While information technology focuses primarily on the efficiency of network, hardware and software to meet the requirements. Design technology focuses in particular on the interaction between the designer and the technology used, taking into account the user interface, user experience, and usability.

Design technology applications in Industry

Design Technology works closely with IT to provide technological and human efficiency for the most effective use for these applications and tools. In building and construction design industry (AEC), the product is the building and the role of design technology is connected to the process of relevant information during the different phases of the project. This definition includes the related technology, such as Computer Aided Design (CAD), *Building Information Modeling* (BIM), design and imaginary construction (VDC), and other technology that supports operations and outputs of architectural and engineering design. The output of this technology appears during the design phase in the initial drafts, detailed drawings, illustrations binoculars, miniature replicas, imaginative models simulate the final product.

History of design technology

Despite the fame of computer aided design (CAD) to create and display information, the results related to improved design in this industry was limited. One of the problems, for example, was the failure of creative thinking to support architects by turning their ideas into Visual configurations enables others to recognize their destination. Also.

The incompetence of supplementation of drawings based on the lines as a Visual representation of the elements of building or technical documents based on manual input, not least, the lack of cooperation between interdisciplinary because of relying on a separate database for each allocate. This shortcoming caused a lot of problems later: reducing the productivity of the designer in the initial stages of the project, the emergence of conflicts between different disciplines, and lacking of access to knowledge from previous experience.

Building Information Modeling

The emergence of *building information modeling* as an innovative technology at the end of the twentieth century contributed later in stimulating innovation in processes and products. This technology arises depending on where element containing all data that identifies the summarized by containing the element of data which identifies the values and potential interactions. The effects of using this technology is the emergence of innovative services for design firms were quickly completed the design while maintaining a reasonable price and high quality too. This technology has supported the emergence of sustainable design in buildings as innovative products without compromising the functional efficiency. Although this technology contributes to bridge a technical gaps, but on the human side failed to support innovation. One aspect of limited cooperation between different disciplines is due to different software used design and refusing the change.

Architectural creativity and technology

Although of the effectiveness of this technology in the engineering design phase, architectural design phase received limited support. One of the reasons, it was and still is, the common ability of the programs to keep up creative formation to humans. The effectiveness of traditional design programs is clear in simple buildings or based on philosophy (form follows function), while the advantages of formed buildings nature were narrow. To overcome this problem generative design (G, D) technology, which is designed on algorithms standard, is used. This kind of technological development has helped to solve problems quickly and to reach critical decisions at this stage of the project. In addition, this technology enhanced to analyze the interactions of the building early as the impact of earthquakes, wind loads, the movement of users and vehicles.

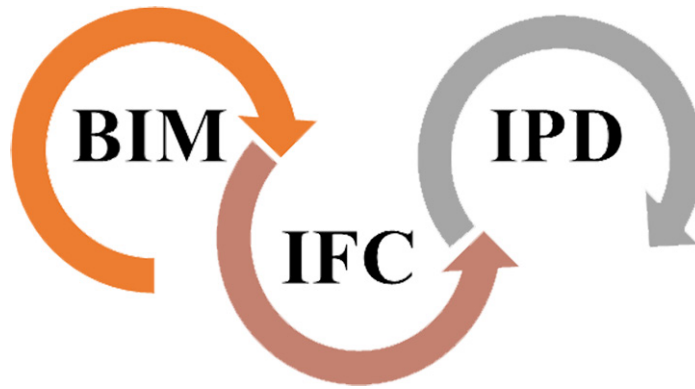

The use of technology starts from ongoing dynamics process to overcome the shortage

Technology to support cooperation

Technically, we have overcome cooperation obstacle between the various platforms through the establishment (IFC) formula to support the harmonic operation. This formula is constantly being updated to support the diverse disciplines, it even becomes the standard for documenting program efficiency in exchanging of information. In spite of the lack of support for border design programs to deal with the standard (IFC), but other methods have been devised to overcome this flaw. On the human side, it has been relying on contractual agreement - such as Design-Build(DB) - to enhance cooperation between the owner, architect, engineers and even contractors in the early stages of the project. Sharing of information contributes to the exchange knowledge and discovery of innovative ideas which is reflected on the processes and outputs of the design. These changes created new standards for the work at the project level, organizations, industries, and even national level.

Technology role integration of information

To apply these changes, we need to develop new criteria for work at the project level, organizations, and even industry. Integrated design means totalitarian process to merge information from stakeholders through setting decisions protocols, responsibilities, property rights, rewards and risks since the beginning of the project. In the integrated project delivery (IPD) all information collected during the various stages of building and of people, systems and practices are merged in creative process with the aim of improving the value for participants. Employer's information requirements (EIR) is one example of this integration and related information about technical capabilities, and operational management. Therefore, integration of industry (AEC) with universities, Government and other industries is imperative to increase the individual competency by formulating an innovative education to support cooperation between individuals, as well as encouraging companies to adopt innovative technology.

The benefits of BIM implementation

The output from BIM implementation are varied based in the project varies depending on method of using (modeling, collaboration, or integration), according to the target level (individuals, project, organization, industry). While using identical platforms (Closed BIM) helps to overcome the horizontal fragmentation between design members, (IFC) removes vertical fragmentation between the various phases of the project. In addition, the advantage of (BIM) is solving some of long fragmentation problems presented by using information from one project to another. From a commercial aspect related to companies, (BIM) paved as an innovation subversive - the way of emergence new markets based on the best performance through using technology to access information.

Also, the use of (BIM) prepared the way for exchange of knowledge between design team. Finally, it enabled the re-use of information across projects.

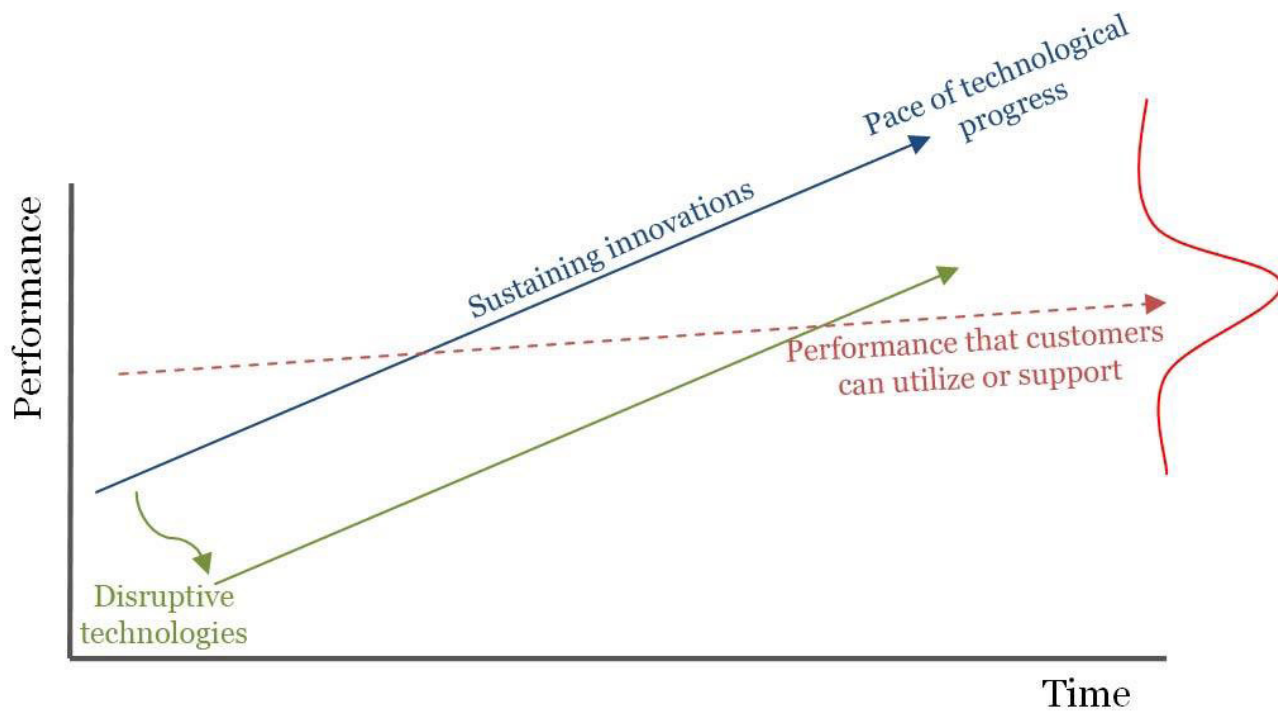

Realism about the results of using technology

Despite the growing acceptance of using BIM for AEC industry in a variety of geographic locations, a lot of researchers and practitioners were not convinced of the benefits of this use. This refusal appears in the architectural design phase and to a lesser extent when writing the technical requirements and specifications. Uncertainty about the benefits of the technology due to the unrealistic propaganda that is sometimes repeated by these technological software suppliers. A disputed allegations around, for example, revolves around the ability of these programs to generate the quantities and specifications of the graphics tables by itself without the aid of human intervention. This hype about the benefits due to the dynamic nature of the spread of technology. The hype about the benefits of innovative technology is manifested in the spread of

innovation curve, which usually rejected by the majority of those interested until its benefits become sure.

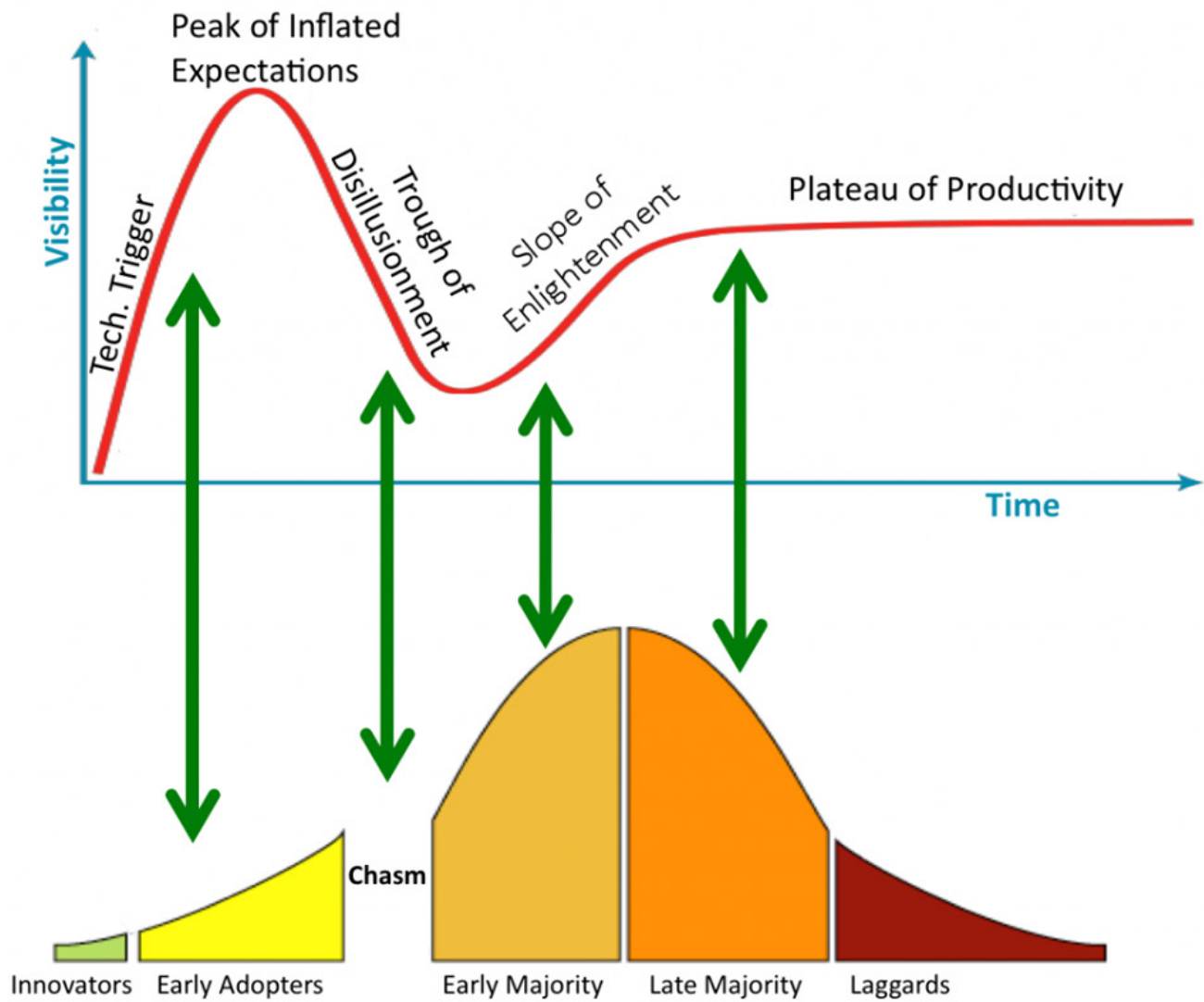

TRANSLATED BY TAMER IBRAHIM

CASE STUDY



Salah Omar Omran

In 2007 Summer, I remember that I Search about (BIM) term, then I found what I wished to learn and spent years in scientific search in University until I finished my master's degree.

At that Time I looked forward to apply everything i read and heard about (BIM), and I worked in a global company in (BIM), all projects at that time in (LOD 300) this means only a design stage.

In time, contracting for a large project a (Hospital) was done in a gulf country which its cost was 600 Million \$ in 69500m² area.

Contracting between the Owner & Contractor mean that the design has not finished yet, so there will be modification during project life-cycle which was not short, i found out that all projects in gulf area needed (BIM) but, because of the short time and poor contractor technical ability to go in mysterious filed for him, so he leaves that term aside.

The contracting company have a good vision, starting with actual applying (BIM) to get a model that can be constructed, then the contractor can save the technical office cost, especially the design office will send the model in design level which is totally different from implementation design. Our specific mission is to raise the BIM model and coordination between disciplines and production of implemented drawing in LOD 400

We comfort a big challenges, like who begins before us and failed, and unfortunately the idea spreads in the markets that (BIM)is not useful for contractors, but how do I advise it.

I started in raising up the level of project until the problems appeared to me and we solved them.

For example, we use Autodesk Revit it's a famous tool in (BIM), someone refuse it and prefer anther tools, but remember that level we need is higher than (LOD 400)

The new technology is the best than traditional methods in any stage of project but we should know than in first we found problems and we solve it gradually .

Sample problems

Problems	Solve
Contractor employs do not have experience in (BIM)	They should be Trained at the beginning of project
Employs need to back to CAD	Don't let that happened but mix between them
Shop drawing	Useful for Arc and MEP, but not for civil. It needs some training
Modifications	It is easy in Revit but should be constrain (When and who)
Ready Engineering	Should fit his academic learning
Hardware	Its cost is high, but we should know what we need to save our money
Time	Its against contractor, then we should found anther methods

Translated by: Amr Boghdady Omar



BIMarabia

