



Arab Republic of Egypt
Ministry of Education
& Technical Education
Central Administration
of Book Affairs

Search and Learn

Science

For Primary Stage

Year 4

First Term

Prepared by

Dr: Reda Al Sayed Hegazy

Mrs: Karima Ahmed Said

Mr: Hassan Al Sayed Moharam

Mrs: Nour El hoda Aly Hassan

Mr: Mahmoud Omer Khtab.

Science consultant

Youssry Fouad Saweris

2019/2020

غير مصرح بتداول هذا الكتاب خارج وزارة التربية والتعليم والتعليم الفني

مقدمة

عزيزى التلميذ/ التلميذة

يسعدنا ونحن نقدم هذا المنهج لأبنائنا تلاميذ الصف الرابع الابتدائى أن نؤكد على أن تعلم العلوم متعة وبهجة. متعة فى القيام ببعض الأنشطة العلمية البسيطة. وبهجة فيما يمكن الوصول إليه من نتائج. فتعلم العلوم يعتمد على الملاحظة والتفكير والتجربة واستخلاص النتائج. وقد تم اختيار عنوان لهذا المنهج يعكس فلسفته: وهو «ابحث وتعلم».

وقد شارك فى إعداد هذا المنهج مجموعة من المتخصصين فى المناهج وطرق تدريس العلوم والخبراء والموجهين والمعلمين. كما تمت فيه تجربة الاستعانة بمجموعة من تلاميذ المرحلة المستهدفة تأكيداً لفلسفة المنهج من حيث مراعاة طبيعة المرحلة العمرية وطبيعة المعرفة والمجتمع.

ويهدف هذا الكتاب إلى مساعدة التلميذ على إدراك العلاقة بين العلم والتكنولوجيا ورؤية العلم من منظور شخصى ومجتمعى وفهم تاريخ وطبيعة العلم وتنمية مهارات التفكير العليا وامتلاك المفاهيم العلمية الأساسية. ولتحقيق هذه الأهداف تم استخدام أسلوب علمى تقدم فيه المفاهيم فى شكل وحدات دراسية فى ترابط منطقى مع بعضها بعضاً وتكامل مع المواد الدراسية الأخرى. كما أن الموضوعات المتضمنة فى هذا المنهج تتناول المفاهيم الرئيسية فى مجالات الكائنات الحية والمادة والطاقة والفلك مما يساعد على تشجيع البحث والاستقصاء العلمى.

ويتضمن الفصل الدراسى الأول وحدتين لكل منهما عنوان يدل على محتواها. فقد جاءت الوحدة الأولى بعنوان المادة والوحدة الثانية بعنوان الكون. وتشمل كل وحدة مجموعة دروس مترابطة ومتكاملة.

ويعتمد المنهج على إثارة رغبة التلاميذ والتلميذات فى المعرفة والتعلم. والاستفادة من الخبرات المحيطة بهم من كل جانب وذلك من خلال الاعتماد على الأنشطة والتدريبات المتنوعة. كما يعتمد المنهج على استراتيجيات التعلم النشط فى تنفيذ دروسه. ولذلك تم تزويد الدروس بمصادر المعرفة ووسائل التكنولوجيا الحديثة بما يشجع مهارات البحث والتعلم الذاتى وتنمية مهارات التفكير الناقد ومساعدة التلميذ على التأمل والتقييم الذاتى فيما يدرسه ويتعلمه. بما يتفق وفلسفة التقويم الشامل.

ونحن إذ نقدم هذا الكتاب نرجوا الله أن يحقق الفائدة منه.

والله ولى التوفيق

المؤلفون

Contents

Unit One



Matter

1- Measuring tools	7
2- States of matter and their changes	18
3- Elements around us	28
4- Physical and chemical changes	41
• General exercise on unit (1)	50

Unit Two



Universe

1- Stars and planets	56
2- Movement of the Sun and the Earth	66
• General exercise on unit (2)	76

A circular logo with a green border and a white background containing the text 'Unit One' in green.

Unit One

Matter

- Matter states and its changes
- Types of Elements
- Changes of matter

Unit lessons

- 1- Measuring tools.
- 2- Matter states and changes.
- 3- Elements around us.
- 4- Physical and Chemical changes.

Matter surrounds us. It can be observed, described and measured.

Objectives

By the end of this unit, a student will be able to:

1. Use the length and mass measuring tools.
2. Calculate the volume of solid objects.
3. Examine the shape of a set of solid materials.
4. Perform activities to conclude the properties of metals and nonmetals.
5. Classify the materials into metals and nonmetals.
6. Compare metals to non-metals.
7. Record his daily observations on some of the changes occurred in the matter.
8. Participate his classmates in performing the activities of the unit.



1 LESSON ONE

Measuring Tools

Lesson Objectives

By the end of the lesson, a student will be able to:

1. Recognize the length and mass measuring tools.
2. Name the length and mass measuring units .
3. Measure the length of different objects.
4. Find the mass of different quantities of matter.
5. Calculate the volume of regular shape solid object.
6. Find the volume of an irregular shaped solid object that does not dissolve in water.
7. Highlight the importance of measuring tools in our life.



Lesson Items

- Length and Mass
- Volumes of solid objects.
- Masses of different matter volume.



Life Issues

- Rationalizing consumption.

Measuring Tools

We are surrounded by a countless number of things which are different in shape, size and mass. All these things are made up of "Matter". As you know matter is "every thing that has a mass and occupies a space".



When you buy some of those things such as cloth, the vendor measures the length. When you buy vegetables, fruits or meat, he estimates the mass and when you buy a quantity of oil, you ask for volume of a litre, more or less

Mass: Is the amount of matter in an object.

Volume: Is the space occupied by a matter.

Activity (1): Measuring Tools

Here are, some photographs for measuring tools of length, masse and volume. Try to identify them then complete the following table:



Sensitive balance



Common balance



Measuring tape



Measuring ruler



(Graduated cylinder)

Measuring tool \ Quantity	length	Mass	Volume
1- Common balance (two pans)		✓	
2-			
3-			
4-			
5-			

We use:

- 1- A measuring tape and a ruler in measuring lengths.
- 2- Common balance and sensitive balance in measuring masses.
- 3- Graduated cylinder in measuring volumes.

Measuring Units

There are large and small measuring units. For example, when estimating the dimensions of the classroom, we use the "metre" while in estimating the length of a pencil, we use the "centimeter". But when you buy fruits, we use the "kilogram" or a part of it while using the "gram" or a part of it in estimating the mass of gold. To learn more, try to perform this activity.

Activity (2): Objects and measuring units:

Here is a set of objects, identify the best units for measuring length and mass in the following table:



	the object	unit of measuring the length	unit of measuring the mass
1-	Table		
2-	Pencil		
3-	Science book		

- Length measuring units are: meter - centimeter.
- 1 meter = 100 centimeter.
- Mass measuring units are: gram - Kilogram.
- 1 kilogram = 1000 gram.

Exercise:

What is the benefit of measuring tools when purchasing things according to your point of view?

.....
.....



Read and learn

There are large units for measuring length and mass:

Kilometer = 1000 meter
Ton = 1000 kilogram

Estimating volumes of solid objects:

Solid objects may be regular or irregular in shape.

Activity (3): Calculating the volume of a regular shaped solid object

On calculating the volume of solid objects like a regular box or a brick, we measure the value of length, width and height. The product of multiplying these values gives the volume of the space occupied by the box or the brick.

With your classmates, use the measuring ruler to measure the dimensions of this box, then calculate its volume.

Length = centimeter

Width = centimeter

Height = centimeter

Volume of cuboid = Height \times Width \times Length

Volume of the box = cm^3

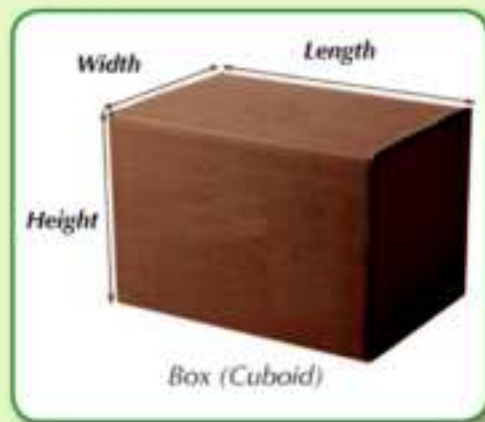

Activity (4): Estimating Volumes of irregular shaped solid objects

Get a graduated cylinder containing a quantity of water.

Record the reading of the level of water in the cylinder. Then gently place a small piece of marble into the cylinder and keep adding a number of marble pieces. Record the level of water in the cylinder each time you place a marble piece in the following table.



What do you observe?

.....

Conclusion:

.....

If an object is submerged in a measuring cylinder containing water, water rises up by a volume equals the volume of the object

Number of marble pieces	Reading of the measuring cylinder
None cm^3
1 cm^3
2 cm^3
3 cm^3

- **Liquid volume measuring units are : liter or milliliter**
Liter = 1000 milliliter or = 1000 cm^3
- **Solid volume measuring units are : the Cubic meter (m^3) or the cubic centimeter (cm^3).**

Exercise:

- The correct reading of the water volume in the given measuring cylinder is (38cm^3 - 36cm^3 - 37cm^3)
- To determine the correct reading of the water volume in the measuring cylinder, you have to take the position: (A - B - C).

Attention!

on reading the measuring cylinder, your eye must be in a horizontal line with the bottom point of water level.



Read and learn

You can use oil instead of water in measuring the volume of a solid that is dissolved in water

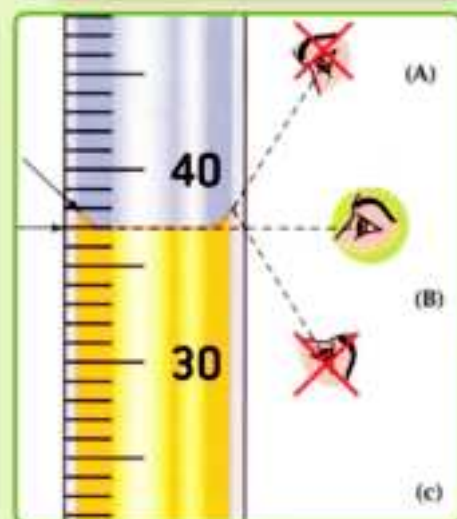

Exercise:

Get four similar graduated cylinders containing the same amount of water. Place a different number of iron pieces that are equal in volume to each cylinder as shown in the figure:

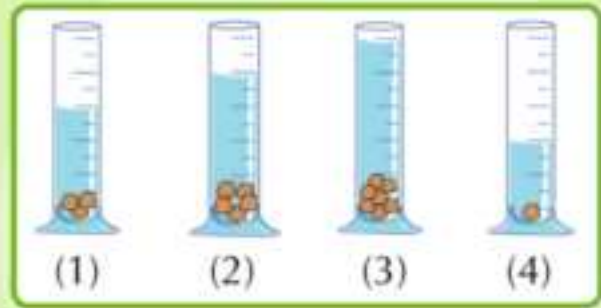

The reading of water volume in each cylinder is recorded and represented graphically as follows:

Put the number of the suitable cylinder under each column of the four graphical columns

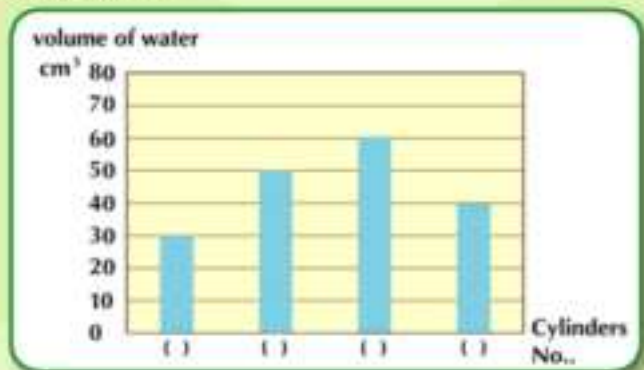

Optional activities

Choose one of the following activities and perform it.

- Prepare an album for modern and old different measuring tools.
- Write short notes about the importance of measuring tools in our life.
- Discuss with your classmates the importance of accuracy in measurement in our society.



Summary

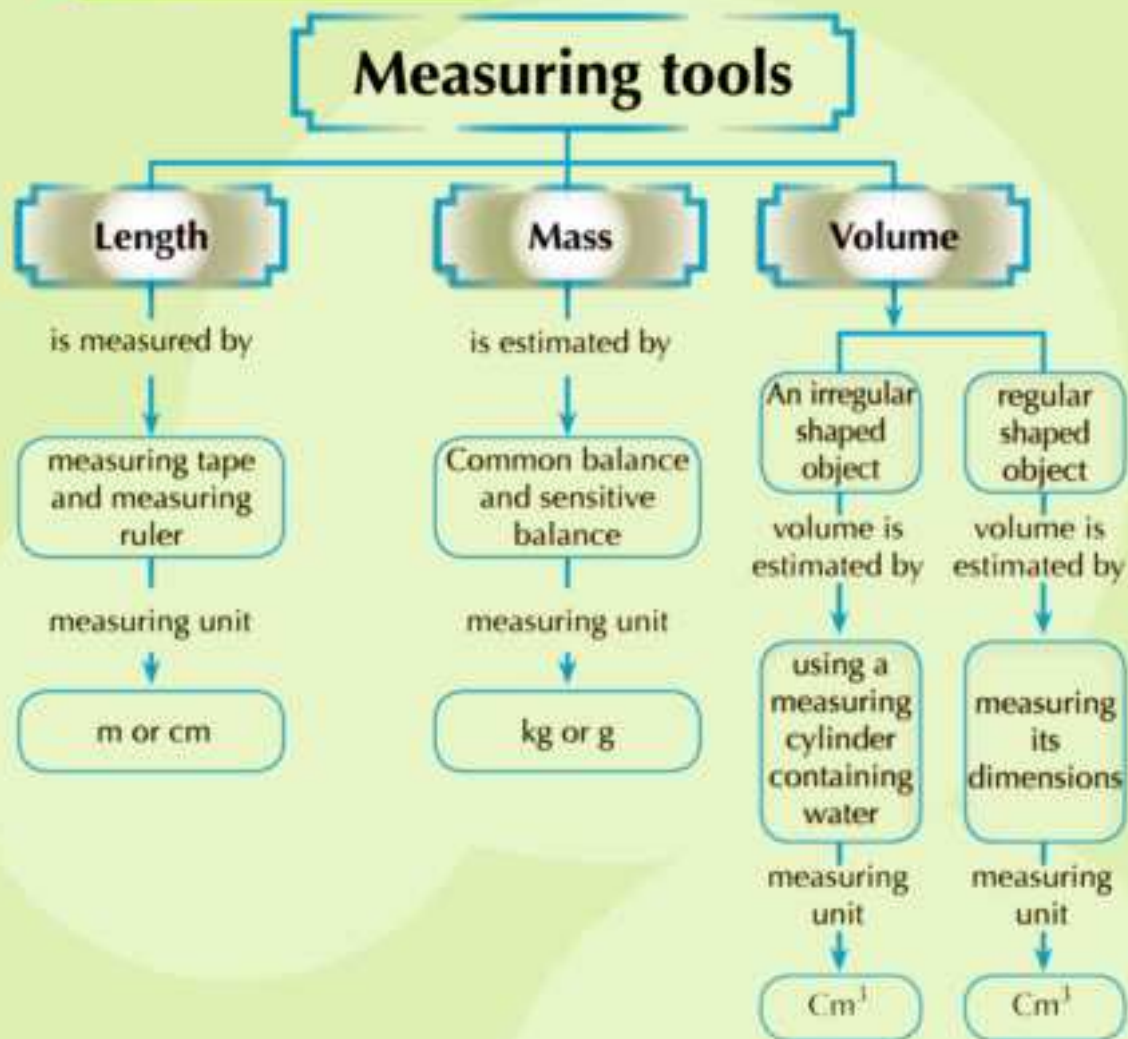

Exercises and activities

Question (1): Complete the following Sentences

- 1- Matter has
- 2- The Kilogram is the unit of measuring
- 3- The Meter is the unit of measuring
- 4- The Measuring tape is used for measuring
- 5- The Common balance is used for measuring
- 6- The ruler is used for measuring

Question (2) Choose the correct answer:

- 1- A stone is put in a jar containing 30 cm^3 of water, water level rises in the jar up to 50 cm^3 . So, the volume of the stone equals
A- 20 cm^3 **B-** 30 cm^3 **C-** 50 cm^3 **D-** 80 cm^3
- 2- Your Classmate placed a piece of iron into a 50 cm^3 beaker filled completely with water, so that a quantity of water of volume 20 cm^3 is poured out the beaker. The volume of this piece equals
A- 20 cm^3 **B-** 30 cm^3 **C-** 50 cm^3 **D-** 70 cm^3

3- The volume of a solid object is measured in :

- A- cm B- cm^2 C- cm^3 D- meter

4- We can determine the volume of irregular shaped small stone that does not dissolve in water by using

- A- a glass beaker B- a measuring cylinder
C- a common balance D- a graduated ruler

5- A pupil placed four marbles of equal volume in a 100 cm^3 graduated cylinder containing water. The water level raised up to 120 cm^3 , what is the volume of each marble?

- A- 30 cm^3 B- 25 cm^3 C- 20 cm^3 D- 5 cm^3

Question (3) You have a measuring cylinder and water. How can you use these materials to estimate the volume of a medal?

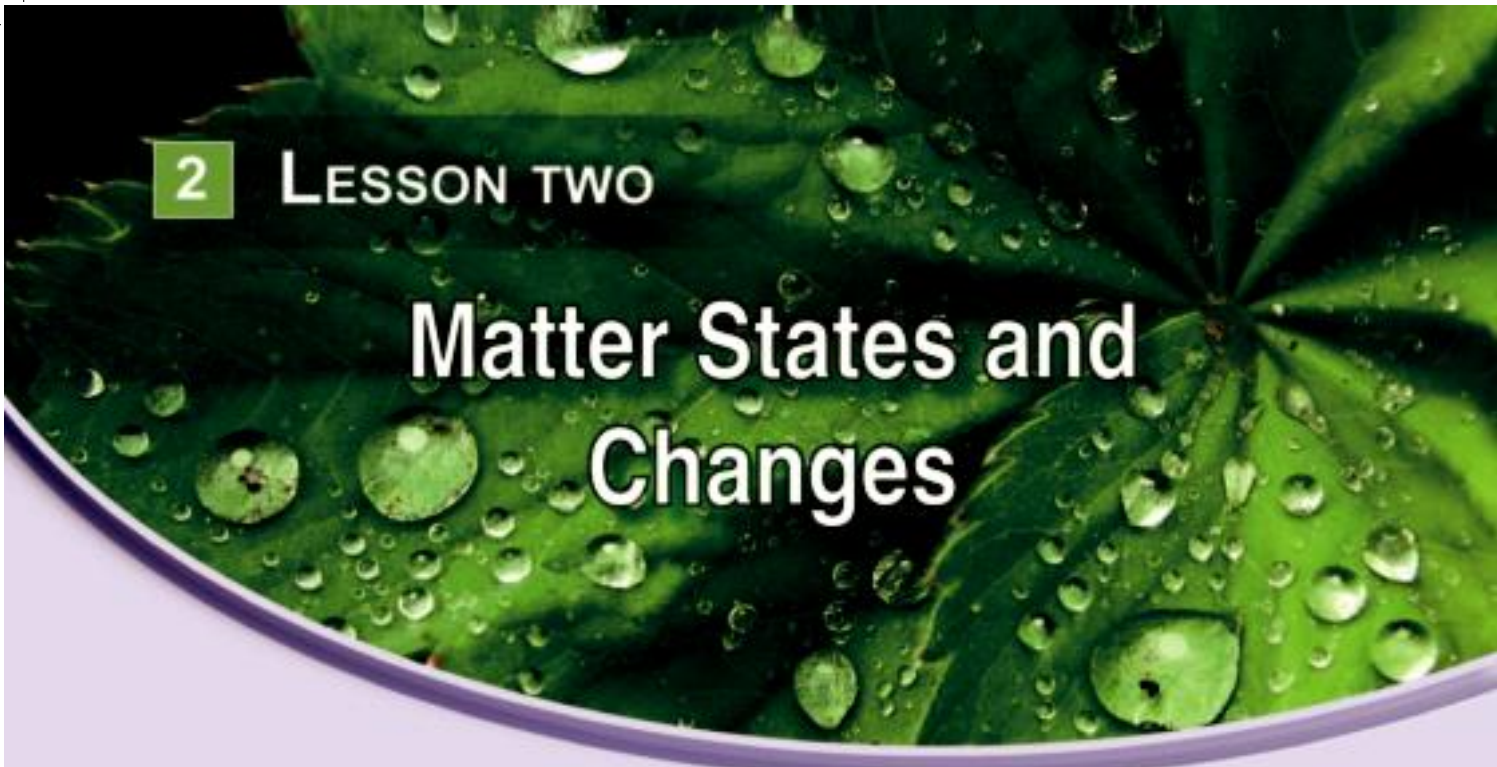

2 LESSON TWO

Matter States and Changes

Lesson Objectives

By the end of the lesson, a student will be able to:

1. State the three states of matter.
2. Determine the properties of the different states of matter.
3. Classify different materials according to their states.
4. Conclude the similarities and differences between the states of matter.
5. Identify the ways of changing the matter from one state to another .
6. Conclude the effect of temperature change on the states of matter.
7. Compare among melting, evaporation, condensation and freezing



Lesson Items

- The three states of matter
- Properties of matter.
- Matter changes



Life Issues

- Resources best usage and development.

A plenty of materials are surrounding us such as iron, water and air. They differ from each other in many properties. A matter is found in one state or more and can be changed such as the



change of ice into water and water into water vapor. Each state has its physical properties that are different from those of other states.

Activity (1): Identifying states of matter

Look at the materials in the shown pictures then classify them into three groups according to their properties, in the following table:



Pot with water



Glass of water



Air balloon



A bottle of oil



Pen



Ruler

Group (1)	Group (2)	Group (3)
Pen	Water	Air Balloon

What is the common property of the materials in each group?

There are three states of matter: **Solid**, **liquid** and **gas**

Exercise:

Look at this picture and try to give an example representing the states of matter.

- State is represented by
- State is represented by
- State is represented by

Rubber membrane



Properties of the three states of matter:

Activity (2): Solids shape and volume

Place each object of the shown objects into a water jar.

Compare between the volume of each object in the jar and its real volume.

Compare between the shape of each object in the jar and its real shape.

What do you observe?

Conclusion:

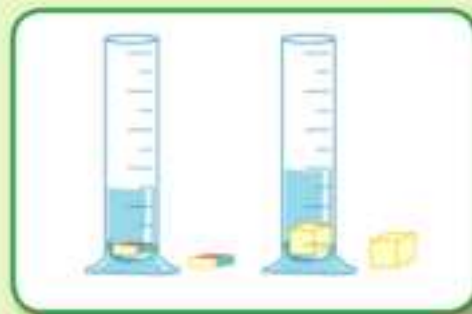

Solids have definite shape and definite volume

Activity (3): Liquids shape and volume

Place 100 cm³ of water in each of the shown pots:

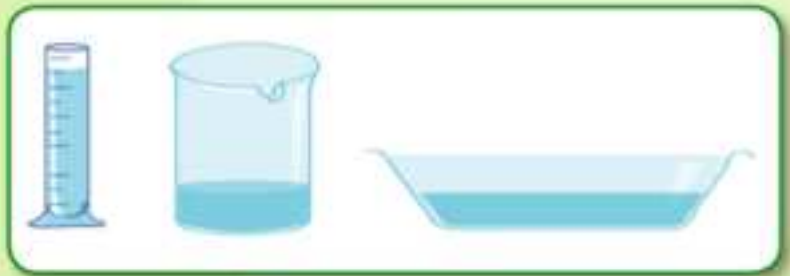

1- Does the volume of water change in the three pots?

2- Does the shape of water change in the three pots?

Repeat with other pots

Conclusion:

Liquids have definite volume but their shape change according to the container.

Activity (4): The shape and volume of gaseous materials

Blow a balloon, tie it with a thread as Shown in figure (A) then squeeze it by your hand as shown in figure (B) and observe the following:

• Is the balloon volume changed ?
.....

• Is the balloon shape changed?
.....

• Repeat with other balloons

Conclusion:



Read and learn

One of the practical applications based on that the shape and volume of gases can be changed. We can compress a large quantity of gas into gas cylinders.

Gases: their shapes and volumes are changing according to the container.

Changes of Matter

You have learned that matter has more than one state and it can be changed from one state to another.



Activity (5): Melting

Get a plastic cup containing some pieces of ice then leave it outside the refrigerator for a period of time

What do you observe?.....

Conclusion:

Melting: It is the change in a matter state from solid to liquid by heating

Activity (6): Evaporation

During preparation of tea, write your observations about the state of water in the pot on heating.



What do you observe?.....

Conclusion:

The amount of water keeps decreasing as long as you are heating because it changes into vapour.

Evaporation: It is the change of matter from liquid to gas by heating

Activity (7): Condensation

On your way to school early in the morning, notice the presence of drops of water on leaves or on cars.



Have you ever asked yourself the reason for the presence of these drops?

Why can it be only observed in the morning?.....

Conclusion: water vapour which is assembled in the air condenses on the cold surfaces like cars and leaves in winter, or when humidity increases in summer then condenses into drops of water because of temperature drop.

Condensation: It is the change of matter from the gaseous state into the liquid state by cooling

Activity (8): Freezing

When a bottle containing a quantity of water is kept in the freezer for one day, observe the change in the water state after and before placing the bottle in the freezer.

Conclusion:

Water is changed into ice in the bottle on cooling.

Freezing: It is the change of a matter from liquid into solid by cooling.



Attention!

It is preferred not to fill a bottle of water to an end when it is put in the freezer in order not to explode



Optional Activities

Choose one of the following activities then carry it out.

- Make an album for photos of solid, liquid and gaseous materials in your environment then mention their uses.
- Imagine that you are a solid material such as iron ore. What would you say to your classmates representing liquid and gaseous materials?
- Try to use the internet to search for pictures indicating the changes of matter and write a simple description to them .
- Write about some life applications that depend on changes of matter.



Summary

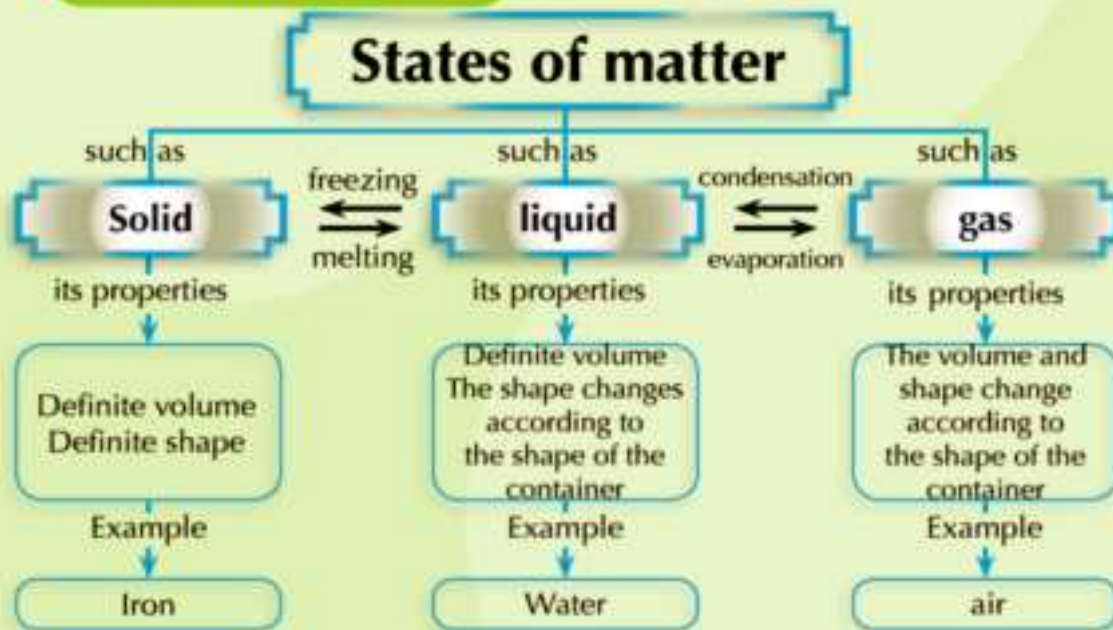

- **Melting:** it is the change of matter from a solid into a liquid state by heating
- **Condensation:** it is the change of matter from a gaseous state into a liquid by cooling.
- **Freezing:** it is the change of matter from a liquid state into a Solid one by Cooling
- **Evaporation:** it is the change of matter from a liquid state into a gaseous one by heating

Exercies and activities

Question (1): Put (✓) to the materials that have a definite shape:

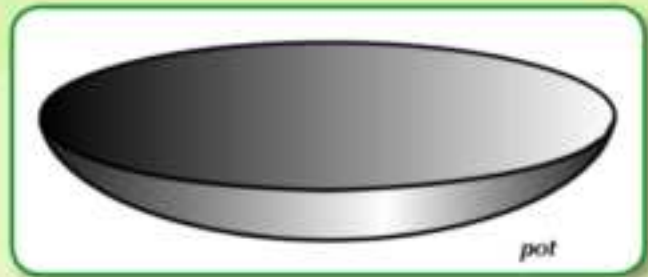
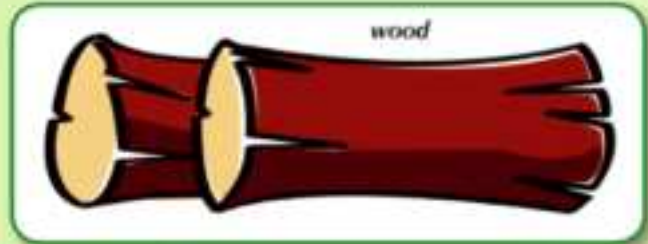
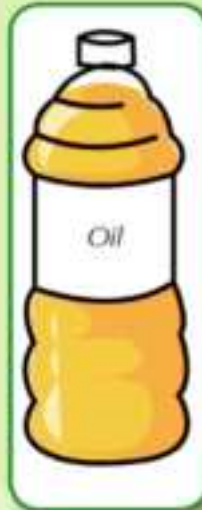

Question (2): Complete the following statements:

- 1- States of matter are, and
- 2- There are a definite shape and a definite volume in the state.
- 3- Matter can be pressed in case of its state
- 4- Matter that takes the shape of its container and its volume can not be changed is
- 5- On transferring water from one pot to another, it

Question (3): Give a reason: On putting a mixture of gravels and water in a refinery with minute holes, water passes while gravels remain in the refinery.

Question (4): Choose from the column (b) that is suitable for column (a)

(A)	(b)
<ul style="list-style-type: none">• The change of matter from the liquid state into the gaseous state• The change of matter from the solid state into the liquid state• The change of matter from the liquid state into the Solid state• The change of matter from the gaseous state into the liquid state.	<ol style="list-style-type: none">1. Melting2. Freezing3. Condensation4. Evaporation

Question (5) Choose the correct answer:

- 1- The change of water from the liquid state into ice is accompanied with:
- A- an increase in mass B- evaporation
C- an increase in temperature D- a decrease in temperature
- 2- The change of matter from the liquid state into the gaseous state is called:
- A- Condensation B- evaporation
C- Melting D- Freezing
- 3- Cooling is accompanied with process
- A- Melting B- Condensation
C- evaporation D- (a) and (b) together
- 4- Gold industries need process
- A- Melting then cooling . B- Condensation then cooling .
C- evaporation then cooling . D- Cooling then melting .



3

LESSON THREE

Elements around us

Lesson Objectives

By the end of the lesson, a student will be able to:

1. Examine the shape of a group of substances.
2. Conclude the properties of elements .
3. Perform an activity to show the characteristics of the elements.
4. Design an activity classifying elements into metals and non-metals.
5. Determine the uses of metals and nonmetals according to their properties.
6. Conclude the properties of metals and nonmetals.
7. Identify the metal and non-metal through their characteristics.
8. Join his classmates to search for more information about metals and nonmetals.
9. Compare between metals and nonmetals.



Lesson Items

- The apparent shape of elements
- Classification of elements.
- The economical importance of elements



Life Issues

- Developing the environmental resources

In our daily life we use cooking pots, metal cans for food and juices, also we use cars that move over the bridges also we use electric wires and other various materials.

Let us know these materials



Activity (1): Material Components

In the following picture, a group of solid objects. Try to identify their apparent shape then fill in the following table:



No	The Solid object	Its material
1	A nail	
2	A spoon	
3	An electric wire	
4	A piece of coal	
5	A piece of sulphur	

The objects identified in this activity are consisted of materials known as elements



Read and learn

- The number of elements found in nature is 92 and this number reached 118 after the synthesis of a number of elements
- The element consists of smaller particles known as molecules and molecules are **composed of atoms**
- An element contains one type of atoms which are different from the atoms of other elements.

The Element: is the simplest form of matter that can not be decomposed into two substances or more.

The use of the previous elements in order to manufacture different products depending on studying the properties of these elements

Activity (2): Elements and luster:

Materials differ from each other in luster

■ **Materials** Examine the following elements and classify them according to their luster:

- A shiny iron nail
- A copper lock
- An aluminium spoon
- A piece of coal

■ **The Procedures**

Examine the following elements and classify them according to their luster then fill in the following table:



Nails



A piece of coal



A copper lock



spoon

No	The object	The element	has luster	has not luster
1	Nails	Iron	✓	
2	Lock	copper		
3	Spoon	Aluminium		
4	Coal	Carbon		

Conclusion:

Some elements have luster such as iron, copper and aluminium where as some don't such as sulphur and carbon.

Exercise:

Name two elements that have luster and you use them in your life.

Activity (3): Elements and electrical conductivity:

Electrical conductivity is one of the important properties of elements and a lot of industries depend on this property .

Perform the following activity to identify the conductors and insulators elements for electricity.

■ Materials:

Electric wires - a battery
- a small lamp - different objects such as (a fork - aluminium paper - a coin - a pencil - a sulphur column)



■ Procedures

Set up an electric circuit as shown in the figure.

The pencil is replaced with one of the previous objects, and notice the light of the lamp.

Have your classmates in the group use other objects and observe the light of the lamp in each case.

Record your observations in the following table:

No	Object	element	the lamp will light	the lamp not light
1	Tip of Pencil	Carbon (graphite)		
2	Fork	Iron		
3	Coin	Copper		
4	Foil paper	Aluminium		
5	Sulphur column	Sulphur		

What do you observe?

Conclusion:

The Tip of the pencil is made up of graphite which is a form of carbon.

Some elements are good conductors of electricity and others are bad conductors of electricity

Exercise: Write using one of the sources of knowledge such as (CDs - Internet - Books) about the elements that can be used in manufacturing electric wires and their importance.

Activity (4): Elements and heat conductivity:

■ **Materials:** Bars of (iron -copper - aluminium) - stand - a flame- a piece of wax.

■ **Procedures:** you have a group of elements, replace each of them instead of the iron bar in the opposite figure.

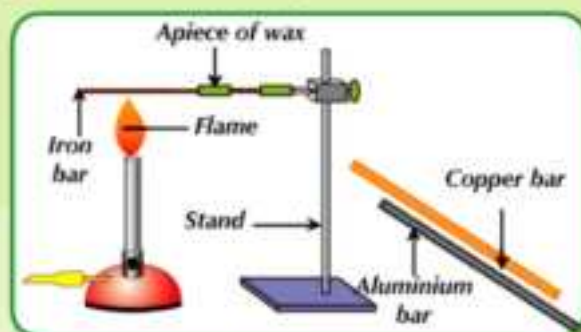

Ask your classmate to record the time taken for melting the piece of wax in case of each element, then fill in the following table :

No	element	time
1	Iron	
2	Aluminium	
3	Copper	

What do you observe?

Conclusion

Attention!

Don't try to touch the bar with your hand.

Explanation: Elements of iron, copper and aluminium conduct heat by different degrees, but there are other elements that are bad conductors of heat such as sulphur and carbon.

Some elements are good conductors of heat where as some of them are bad conductors of it.

Exercise: The time taken by wax to melt is recorded for each of the following elements (S, V, F, K) then is graphically represented as shown in the figure.

Arrange the elements (S, V, F, K) in an ascending order according to their heat conductivity.

Arrangement	element
The first
The second
The third
The fourth

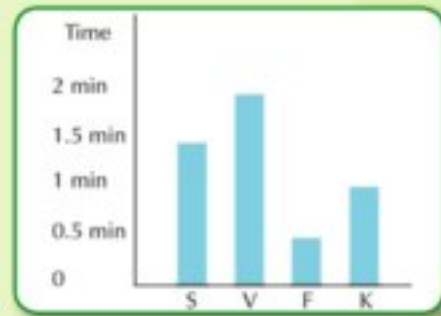

Activity (5): Elements and melting

You have studied that melting is the change of matter from the solid state to the liquid state and it is one of the important properties of elements, for studying that, Perform the following activity:

Materials:

- A flame
- a stand for the flame
- a crucible
- an iron nail
- a piece of sulphur
- a piece of lead
- a copper wire

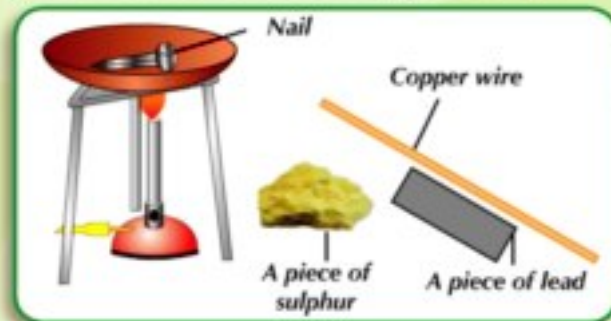

- Procedures:**
- Put the iron nail in the crucible.
 - put the crucible on the flame.
 - Have your classmates in the group heat the other elements.

What do you observe?

Conclusion :

Elements differ in their melting points.

Exercise: Use the Knowledge Egyptian Bank (KEB) Write a list of a group of elements and their melting points.

Activity (6): Elements and Malleability

We use aluminium foil in cooking and packaging food and we see the iron smith forming the doors and windows from iron and we see the jewells that are made up of gold and silver. How are these things made? to know the answer, perform the following activity:

Materials:

An iron nail - a copper wire - An aluminium wire - a piece of coal - a piece of sulphur - a hammer



Procedures:

Cooperate with your classmates in bending and hammering the elements existing in front of you.

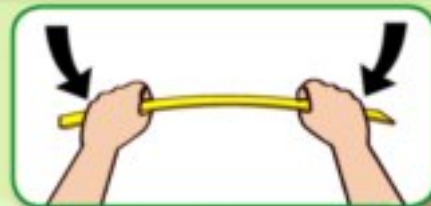

Record your observation in the following table:

Elements that are malleable and ductile	Elements that are not malleable or ductile
.....
.....
.....
.....
.....



Read and learn

- Gold is a flexible element so that copper is added to it in order to reshape it into jewelry and it can be added to silver and platinum as well.
- Silvery paper which is used in covering chocolate shows that aluminium can be hammered and bent.

Conclusion

Some elements are malleable and ductile where as some are not malleable or even ductile.

Activity (7): Classification of elements

According to your studying for the properties of elements, describe the common characteristics of elements in each group in the two figures (a) and (b). Then record them in the following table.



Group (a)	Its properties	Group (b)	Its properties
.....
.....
.....

What do you observe?

Conclusion

Elements can be classified into two groups:

1- A group of metals such as iron, copper and aluminium, and they have the following properties:

- Have luster
- Good conductors electricity
- High melting point
- Good conductors heat
- Malleable and ductile

2- A group of non -metals such as sulphur and carbon, and they have the following properties:

- Not having luster
- Bad conductor electricity except "carbon"
- Not malleable or ductile
- Bad conductors heat
- Low melting point

Metals: Solid elements in ordinary temperature except (mercury which is a liquid) have high melting and boiling points. have the ability to conduct electricity, can be hammered, pulled and bent, have a luster (if they are pure).

Non-metals: Elements that have low melting and boiling points- bad conductors electricity (except carbon)- can't be hammered, pulled or bent- have not luster For example, solid elements such as (carbon, sulphur and phosphorus), a liquid element (Bromine) and most of them are gases.

Exercise: Classify the following elements into metals and non metals.



Uses of metals and non-metals

Scientists studied the properties of elements to use them in different life applications for a better life

Activity (8): Life applications for elements

Here are some elements and their life applications. You are asked to determine the property that the application depended on.



Read and learn

- Ancient Egyptians used gold, silver and copper since 3000 B.C.
- Some metals have magnetic properties such as iron, cobalt and nickel.
- Aluminium is a good Conductor of electricity so, cables of electricity are made up of it
- All metals are solids except mercury which is a liquid and used in thermometers manufacture.

Element	The important applications	properties
Copper	electric wires
Iron	Bridges
Gold	Jewelry
Aluminium	Cooking pots
Graphite (carbon)	Poles of carbon in electric cells



From the previous, we conclude that there are many uses for metals and non-metals such as:

1. Iron is used in manufacturing car frames, bridges, doors and lamp-posts.
2. Aluminium is used in manufacturing cooking pots and foil paper .
3. Copper is used in manufacturing statues, coins and electric wires.
4. Gold is used in manufacturing jewels.
5. Carbon (graphite) is used in manufacturing positive poles of dry cells (batteries).



Read and learn

- From our arabic scientists "Jaber Ibn Hyan" who was the first one entered he experimental researches to chemistry and discovered acids and alkalis.
- From the foreign scientists "Brothelios" who was discovered many elements such as silicon.

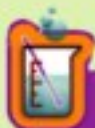

Optional activities

Choose one of the following activities then Perform it :

1. Make an album of photos showing the uses of metals and non-metals with sharing of your classmates.
2. Share your classmates and teacher in visiting one of factories that depends on metals or non-metals manufacturing and write a report of this visit.
3. Write a brief on one of the elements using (transparents - video -CDs - Internet- books or encyclopedias)
4. Discuss with your classmate mixing precious metals (gold – silver) with other metals. Why should be an announcement of the mixing ratios?



Summary

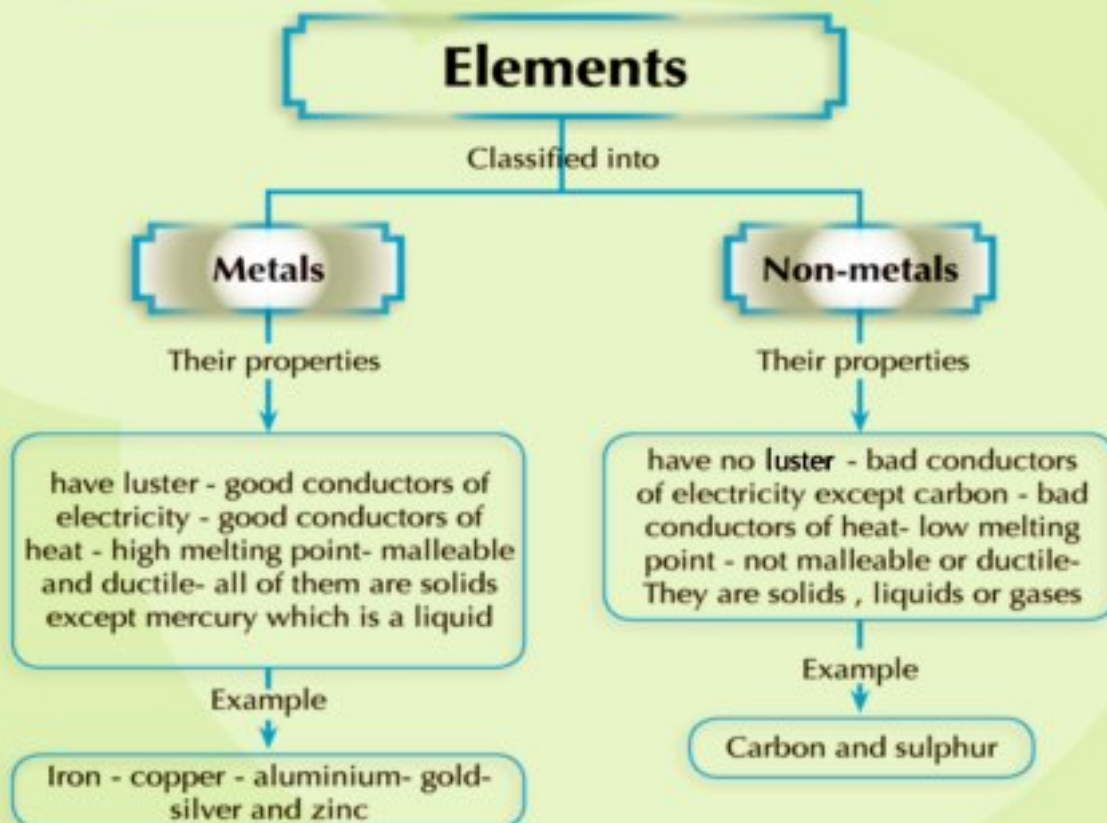

Exercises and activities

Question (1): Complete the following sentences by these words metals - Iron- elements - Non-metals - gold - carbon.

- 1- We use in manufacturing jewels .
- 2- We use in manufacturing bridges.
- 3- Poles of electric cells are made up of
- 4- All the materials you see in your environment are made up of
- 5- The group of elements that have luster is known as
- 6- The group of elements that doesn't have luster is known as

Question (2): Choose the correct answer from the following:

- 1- Electric wires are made up of
A- Sulphur B- Carbon C- Copper
- 2- Cooking pots are made of
A- Aluminium B- Iron C- Sulphur
- 3- Gold and silver are used in manufacturing
A- Bridges B- planes C- jewels
- 4- Statues are made up of
A- Copper B- Sulphur C- Carbon

Question (3):

One of the researchers has been studying the market and monitoring consumption rates and elements usage in the specified period. They have been placed in a graph. Study the graph and determine the most and least element used, then select the uses of each element.

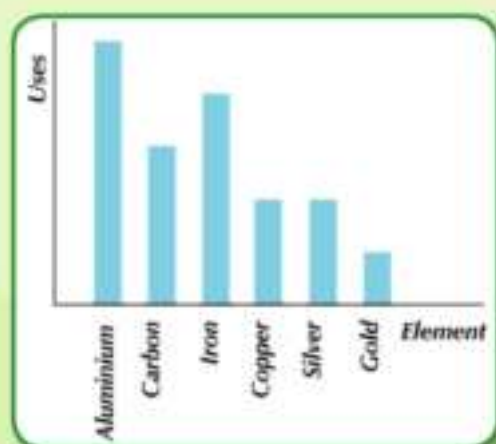

Question (4): Write the scientific term:

- 1- It is the simplest form of matter that can not be decomposed into two substances or more.
 - 2- A group of elements having luster , good conductors of electricity and heat- high melting point - malleable and ductile, and all of them are solids except mercury which is a liquid.
 - 3- A group of elements that doesn't have luster- bad conductors of heat and electricity except carbon , low melting point - and neither malleable nor ductile.
-

4 LESSON FOUR

Physical and chemical changes

Lesson Objectives

By the end of the lesson, a student will be able to:

1. Determine the physical changes of matter in our daily life.
2. Prove by an experiment the chemical changes of matter.
3. Explain the concept of physical changes and chemical changes.
4. Give examples for the different changes in the environment.
5. Compare between the physical change and the chemical change of matter.

Lesson Items

- Physical changes of matter
- Chemical changes of matter

Life Issues

- Good resources usages and development.

From our daily observation, we find that there are changes in the matter such as its change from one state to another and this is known as a "physical change". There are other changes affecting



the matter and known as "chemical changes". To identify these changes, try to perform the following activities:

First: Physical changes

Activity (1): Ice cycle

- **Materials:** a glass beaker - a glass surface - a flame- a stand - pieces of ice - Container .
- **Procedures:** - Put the pieces of ice in the beaker then put the beaker over the flame as shown in figure (A).

What do you observe?

- Continue heating as shown in figure (B).

What do you observe?

.....

- Put the cold glass surface facing the produced water vapour as shown in figure (C)

What do you observe?

.....

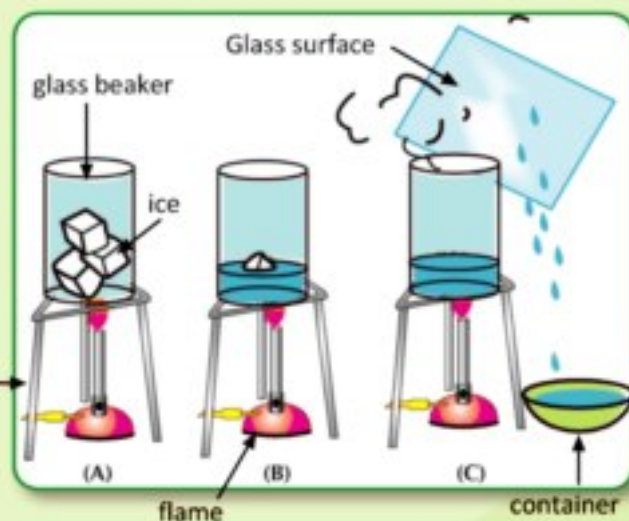

- Put the assembled substance in the other beaker (figure C) in a freezer for a period of time.

What do you observe?

Conclusion

Ice changes into water by heating (melting), and by continuous heating water boils and water vapour is released then, condenses on the cold surface to form water drops (condensation) that freezes by putting it in freezer (Freezing) to return back to its primary state which is ice.

Activity (2): Melting of wax

■ **Materials:** a watch glass - a match stick - a candle.

■ **Procedures:** -By cooperation with your classmates:

- Fix the candle on the watch glass.
- Wait a little bit and see what happens



What do you observe?

Conclusion:

Some wax melts, falling on the watch glass and freezes



Read and carry out

Activity: Collect the falling wax from melting candle and try to form a small candle from it then compare between the mass of the collected wax and the mass of the candle.

Activity (3): Grinding of sugar

■ **Materials:**

A Crucible - a mortar - a cube of sugar.

■ **Procedures:**

- Put the cube of sugar in a clean mortar.
- Ask your classmate to use the handle of the mortar in grinding



- Let your classmate taste the grinding sugar.

What do you observe?

Conclusion:

The sweet taste of sugar doesn't change and sugar still keeps its properties

Activity (4): Dissolving of table salt in water

■ **Materials:** a glass beaker of 50cm³ - a stirring rod - a crucible - a small plastic spoon - a flame - table salt.

■ **Procedures:** -By cooperation with your classmates:

- Put a little of water in the beaker.
- Add a spoon of table salt to water in the beaker.
- Use the stirring rod and stir the table salt in water until it completely dissolves.
- Pour the contents of the beaker in the crucible.
- Put the crucible on the flame.
- Wait until water is evaporated then remove it from the flame.
- Observe the remaining substance in the crucible.

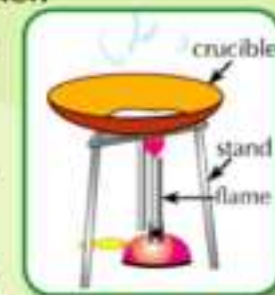

What do you observe?

Conclusion :

Table salt remains keeping its properties without change.

Based on activities 1, 2, 3 and 4 we conclude that the change happened to ice, candle, sugar, table salt does not even change their properties and does not change their chemical structures as well, this is known as the " Physical change".

The physical change of matter: it is a change in the appearance of matter without a change in its structure.

Second: The chemical changes

There is another kind of change leads to a change in the chemical structure of matter. To indicate that, carry out the following activities:

Activity (5): Burning of sugar

■ **Materials:** a crucible - a small spoon - a flame - a little amount of sugar.

■ **Procedures:** - Put a spoon of sugar in the crucible.
- Ask your classmate to put the crucible on the flame and record his observations

Conclusion:

Sugar changes into brown color and loses its sweet taste, In addition, it can't be returned back to its sweet form, white sugar.



Activity (6): iron rust

■ **Materials:** An iron wire which is used in cleaning dishes, - scissors, crucibles - magnifying lens.

■ **Procedures:** By the aid of your teacher
- Cut a piece of the iron wire then put it in the crucible.
- leave it in the wet air.
- Examine it by the magnifying lens.

What do you observe?.....

A brittle brown layer is formed on the wire that is called "the rust"

What do you conclude?

From activities 5, 6, 7 we conclude

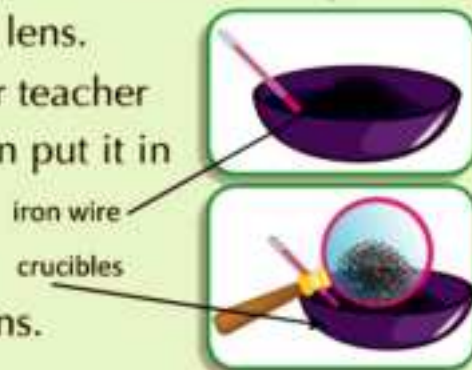

Attention !

Do not try to cut the iron wire by your hand to avoid the wound of your fingers.

that burning of sugar, paper and iron rust produced new substances that are different in their structure from the original ones and this is called "chemical change".

The chemical change: It is the change in the structure of a substance producing a new substance with different properties.

Exercise: The following table shows changes that happen to substances, determine the kind of change (Physical or chemical) then give the reason.

No	The change that is happened to the substance	kind of change		the reason
		physical	chemical	
1	Breaking of chalk			
2	Burning of wood			
3	Copper malleability into wires			
4	Melting of iron			
5	Dissolving of sugar in water			



Optional activities

Choose one of the following activities then perform it:

Activity (1): Sodium bicarbonate and blowing of balloon:

Discuss your classmates the kind of change in this activity.

- **Materials:** A bottle with narrow opening - a balloon - a small spoon of sodium bicarbonate- vinegar.



Read and learn

Iron smelting doesn't change its structure. any "physical change" or adding some elements to molten iron such as carbon and manganese give iron other properties. Making it more solid and more resistant to rust. Produced iron is known as iron alloy. The same happens when adding of copper to gold.



Activity (2): Colour change of some fruits

Discuss your classmates how to keep the colour of some slides of fruits from changing .

- **Materials:** Lemon juice - an apple or an eggplant - a dish



summary

Substances are exposed to two kinds of changes:

(A) physical change: It is a change in the appearance of a matter without a change in its structure. Examples

- Change of a matter from one state into another (solid - liquid - gas)
- Dissolving of sugar
- Dissolving of table salt.
- Malleability, ductility and bending elements
- Melting of substances

(B) Chemical change: It is the change in the structure of a substance producing a new substance with different properties. Examples

- - Burning of substances (paper - wood - candle - fuel - sugar)
- - Iron rust.

Exercises and activities

Question (1): Complete the following sentences:

- 1- Burning of wood is considered as a change .
- 2- Melting of ice is considered as a change
- 3- Boiling of water and its vapour release is considered as achange
- 4- Chemical change is a change in
- 5- Rotten of fruits and their fermentation is considered as achange.
- 6- The group of elements that doesn't have lustre is known as

Question (2): choose the correct answer:

- 1- Adding table salt to water with stirring produces ...
A- a new substance B- a physical change C- a chemical change
 - 2- Is an example of the physical changes.
A- Burning of a candle B- Iron rust
C- Dissolving of sugar in water
 - 3- Putting a bottle of water in the freezer of a refrigerator for a period of 24 hours causes a to water
A- physical change B- change in structure C- chemical change
 - 4- Adding yeast in baking is considered as a
A- physical change B- chemical change
C- change in appearance
 - 5- All of the following are chemical changes, except
- A- exploding of fire works B- burning of coal
C- formation of a salty solution

Question (3): compare

- 1- Melting of wax and burning of wax
- 2- Dissolving of sugar and burning of sugar

Question (4): Which of the following is a chemical change and which is a physical change and give reasons:

- 1- Paper recycling.
- 2- Melting of chocolate 3- Production of yoghurt from milk.

Question (5): According to your study of the changes that happen to a substance- classify the following sentences into two groups and name each of them.

- 1- Ending in the same substance that we started with.
- 2- New properties appear.
- 3- A new formed substance differs from the original one .
- 4- A change in the appearance of a substance .
- 5- A change in the structure of a substance .
- 6- No formation of a new substance.

Question (6): Moisten a nail by water then expose it to the air for several days then record your observations.....

General exercise on unit (1)

Question (1): choose the correct answer:

- 1- The volume of the box shown in the figure = cm^3
(20 - 25 - 30)

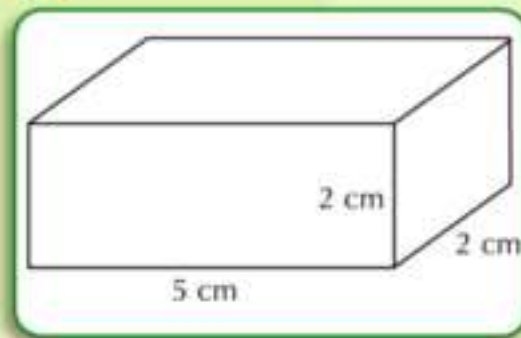

- 2- On boiling water ,it changes from.....
A- a solid state into a liquid one.
B- a liquid state into a gaseous one
C- a gaseous state into a solid one
- 3- On decreasing the temperature of water vapour, it
A- freezes. B- condenses. C- melts.
- 4- The carbon is characterized with:
A- good conductor of heat
B- good conductor of electricity
C- malleable and ductile.
- 5- Papers used in wrapping chocolate up show the property of.....
A- electric conductivity B- the ability of melting
C- Malleability and ductility

6- which of the following is considered as a physical change?

A- Burning of fuel

B- melting of a candle

C- Iron rust

7- The change produced as a result of ductility of copper into wires is the same change produced from

A- making bread

B- melting of iron

C- burning of coal

Question (2): complete the following statements:

1- changing of ice into water is considered as a process.

2- Increasing the temperature of water to the boiling point produces

3- The continuity of decreasing water temperature changes it from the state to the state.

4- The substance that can't be decomposed into two substances or more is known as

5- Elements are classified into and

6- The group of has luster while the group of doesn't have.

7- Graphite is a form of and it is a good conductor of

8-Ductility of copper into wires is considered as a..... change, while iron rust is considered as a..... change.

9- Melting of wax is a change, while burning of wax is achange.

10- Burning of wood is considered as a..... change.

11- Fuel of cars is and its burning for the purpose of cars movement is considered as a change.

Question (3): What happen when and give reason:

1- Putting a bottle of water in the freezer ?

2- Boiling of water and exposing the product to a cold surface?

3- Putting a piece of wet iron in a jar filled with a dry oxygen?

4- Increasing the temperature and melting the ice of the two poles?

5- leaving a dish containing salty water in the air for a period of time?

6- Putting a little sugar in a beaker over a flame?

Question (4): In the following figure:

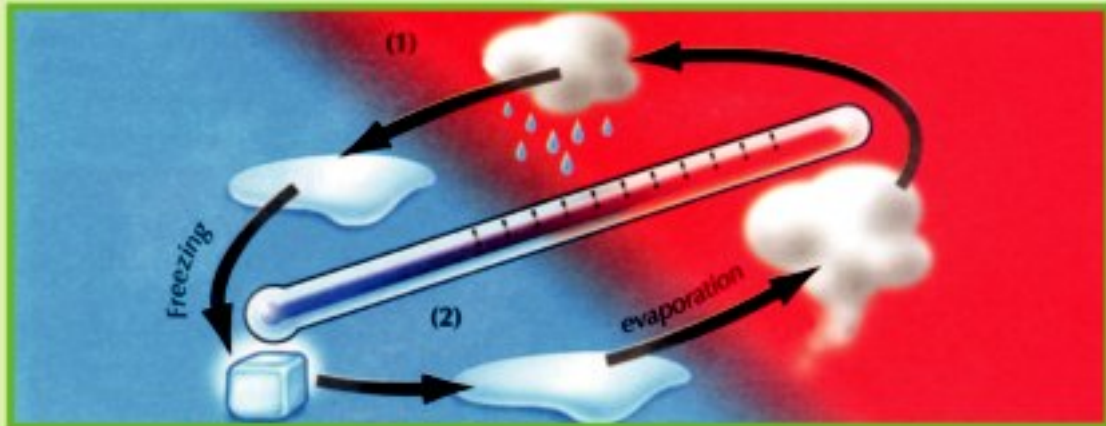

- 1- Number (1) is the change of matter from the..... state to the one.
- 2- Number (2) is the change of matter from the state to the one.
- 3- Mention the type of change happening in this figure?

Question (5): complete the following figure:



Question (6): Tamer has left a piece of iron wire which is used in cleaning cooking pots in water and after a period of time, he recorded his observations:

- What did Tamer observe?
- Mention the type of change happens.



Universe

Space, Motion of celestial bodies, and weather

Unit lessons

- 1- Stars and planets
- 2- Movement of the sun and the earth

Sun, earth and moon are apart of a system known as the solar system

Objectives

By the end of this unit, the student will be able to:

1. Identify the universe.
2. Explain the appearance of stars as small shining spots.
3. Identify the components of the solar system.
4. Infer that the sun is a star.
5. Compare between star, planet and the moon.
6. Explain the natural phenomena resulting from the motion of the celestial bodies.
7. Make a model indicating the sequence of day and night.
8. Appreciate the grandeur of Allah for the accurate organization of the universe.

1 LESSON ONE

Stars and Planets

Lesson Objectives

By the end of the lesson, a student will be able to:

1. Explain the meaning of a star.
2. Explain the appearance of the stars in the sky as small shining spots.
3. Recognize the components of the solar system.
4. Infer that the sun is a star.
5. Recognize the number of planets and their names.
6. Compare the size of solar system planets.
7. Arrange the planets according to their distance from the sun and according to their size.
8. Compare between the stars, planets and the moon.
9. Participate his classmates to design a model of the solar system.

Lesson Items

- Stars.
- Solar system

Life Issues

- Globalization.

Stars and planets

Once you live in one of your governorate districts, you've to know that you think it is the biggest thing for you, but your governorate is a part of Egypt, and Egypt is a country of hundreds of countries



of the globe as well. The globe represents the surface of an enormous sphere called the Earth. The Earth is floating in an immense space.

Stars

Activity (1): Stars in the sky

If you and your classmates look at the sky on a clear cloudless night, you can see some bodies spread out in the sky, these bodies have some characteristics.

Look at the following table, Put (✓) in front of the characteristics of these bodies you see in the table.

• Shining ()	• Not Shining ()
• Seems very small ()	• Seems huge ()
• Equal in size ()	• Different in size ()

The bodies which we see in the sky at night are known as "Stars" They are glowing bodies with different shapes in the vast vacuum which known as space.



Activity (2): The size of a distant objects

Look at these two pictures and compare the apparent size of the plane in each one :



.....
.....

Conclusion:

.....
.....



Bodies seem small when they are distant from us.



Activity (3): Sizes of the stars.

This picture shows a group of stars we can see in the sky at night.



- What do you observe about the sizes of the stars?

.....

Conclusion:

.....

The stars seems very small because they locate far apart from us.

Solar System

Activity (4): Description of the sun

Look at the sun during daytime with a sunglasses then answer these questions:

- Is the sun a star? why?

.....

- Why does the sun seem very large in comparing with other stars that we see in the sky at night?

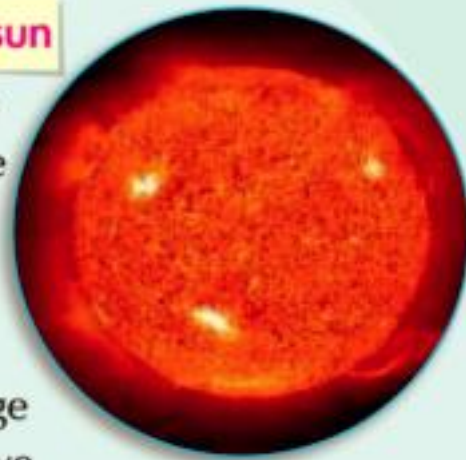

The sun is a shining star radiates light and heat, it is the nearest star to us.

Activity (5): Description of planets.

Look at the opposite figure it is indicating the solar system then, answer the following questions.

1- Write the names of planets arranged from the nearest to the farthest to the sun.



2- the number of planets which revolve around the sun equal:.....

3- The nearest planet to the sun is

4- the farthest planet to the sun is

5- The biggest planet is

6- The smallest planet is

Activity (6): Rotation of the planets

■ Materials:

- White paper - a large plastic ball,
- 8 plastic balls of different sizes - an aluminum wire - clay.

■ Procedures:

- Colour the balls in different colours
- Fix the largest ball in the middle of the paper
- Using the aluminum wire to make circles, each wire passes through one of the balls.
- Fix the circles by using the clay
- Move the balls through the wire around the large ball.
- Describe the movement of the balls

.....

.....

- The conclusion:

.....

The balls rotation around the large one looks like the rotation of the planets around the sun.



Read and learn

On Thursday 24, August 2006 the International astronomical union hold a general board meeting in Czech where 2500 astronomer attended by the end of the conference meeting .They decide that pluto planet is excluded from the solar system because of its small size whereas its size is less than one fifth of earth's size.



Planets are dark bodies revolve around the sun in fixed orbits
There are eight planets, these planets are arranged from the nearest to the farthest from the sun as following: Mercury, Venus, Earth, Mars, Jupiter, Saturn, Uranus and Neptune.

Identify the planets of the solar system:

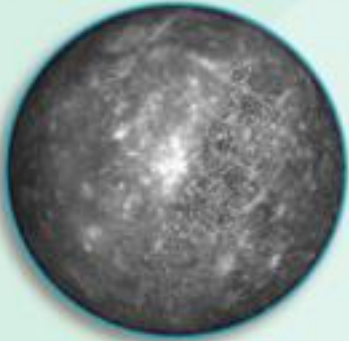

Mercury
The nearest planet to the sun



Venus
The most beautiful planet



The earth
The planet where we live
Earth planet is a Water planet
That occupies most of the water



Mars
Known as the red planet
to the presence of iron metal in its rocks



Jupiter
The biggest planet
giant



Saturn
A big number of colored rings which rotate around it



Uranus
The cold planet

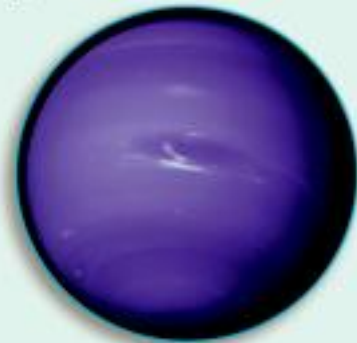

Neptune
known as The blue planet

Activity (7): The moon

If you look at the sky at night in the middle of the lunar month, you might see a shiny body

- Describe this body.
.....
- Why do you see this shining body?
.....
- To answer the previous questions you can do this activity:



Activity (8): we see the moon shining

■ Materials:

- A small plastic ball - foil paper
- A Torch.

■ Procedure:

- Cover the ball with the foil paper (representing the moon)
- Darken the class.
- can you see the ball in the dark?.....
- Using the pocket torch (representing the sun) towards the ball.
- What do you watch?.....
- Conclusion:.....

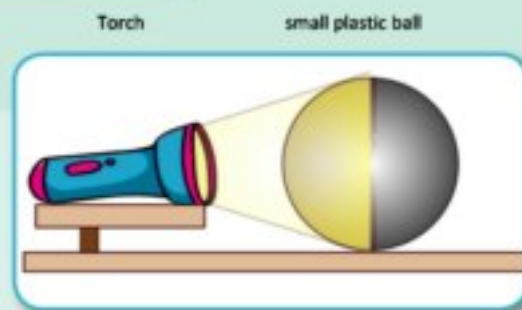

The moon: is a dark body revolves around the earth, it reflects the light of the sun, thus it seems shiny.

The solar system is consisted of:

- 1- **The sun:** is the center of the solar system.
- 2- **Planets:** dark bodies, they are eight planets which revolve around the sun in fixed orbits,.
- 3- **Moons:** followers to the planets revolving around some planets
- 4- **celestial bodies:**asteroids, comets, meteors and meteoroids.

Exercise:

- 1- Compare among the star, planet and the moon.
- 2- Make an album containing the solar system planets photoes and comment on every picture.



Read and learn

The number of the moons which revolving around the planets (from NASA web site):

1- Mercury	no moons
2- Venus	no moons
3- Earth	One
4- Mars	Two
5- Jupiter	62
6- Saturn	60
7- Uranus	27
8- Neptune	13



Summary

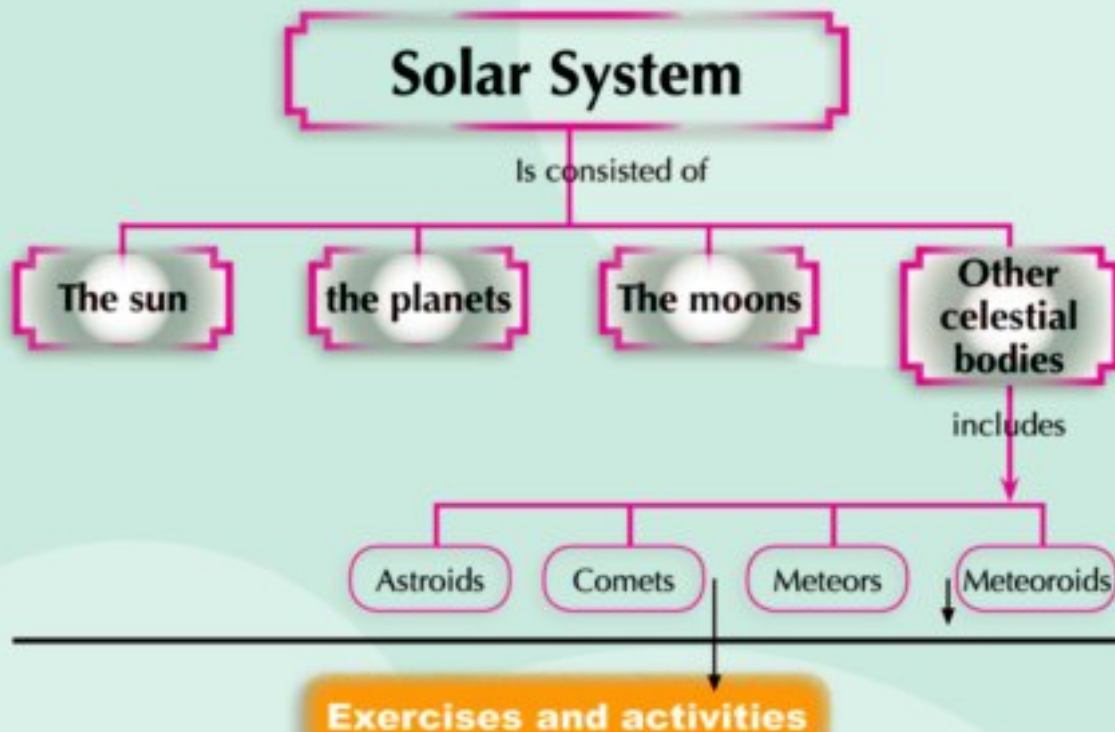

Question (1):

- 1- The nearest planet to the sun is.....
A- The earth B- Mercury C- Neptune D- Jupiter
- 2- The biggest planet is.....
A- The earth B- Mercury C- Neptune D- Jupiter
- 3- The sun is a star because it.....
A- absorbs light B- reflects light
C- radiates light D- let light pass through
- 4- We see the moon shinning because it
A- absorbs light B- reflects light
C- radiates light D- lets light pass through it light pass.

Question (2): complete the following:

- 1- The..... is located in the center of the solar system and there are..... revolving around it in definite orbitals.
- 2- The earth is located between and
- 3- The..... is the smallest planet while..... is the farthest planet from the sun.
- 4- Mars is known as, while Neptune is the

Question (3): Give reasons:

- 1- The sun is a star while the earth is a planet.
- 2- The stars seem very small in size.
- 3- The moon is dark body but we see it shining.

Question (4): compare the planet to the star.

Question (5): Draw the solar system, then colour the following planets:

- 1- The largest planet in green.
 - 2- The smallest planet in yellow.
 - 3- The planet which we live on, (in blue).
-



2

LESSON TWO

Movement of the sun and the earth

Lesson Objectives

By the end of the lesson, a student will be able to:

1. Recognize the rotation of sun and earth.
2. Design an experiment showing the day and night sequence .
3. Design an experiment showing the sequence of seasons.
4. Explain the sequence of day and night.
5. Explain the sequence of seasons.



Lesson Items

- Rotation of the sun.
- Rotation of the earth.
- Day and night sequence.
- Sequence of seasons of the year.



Life issues

- Man and the space

Stars, planets and moons are traveling in the space, all of them are in a continuous rotation and known as celestial bodies. we can see millions of stars in the sky, the sun is one of these stars, it seems larger than all other stars because it is the nearest one to us. the sun is in continuous rotation.

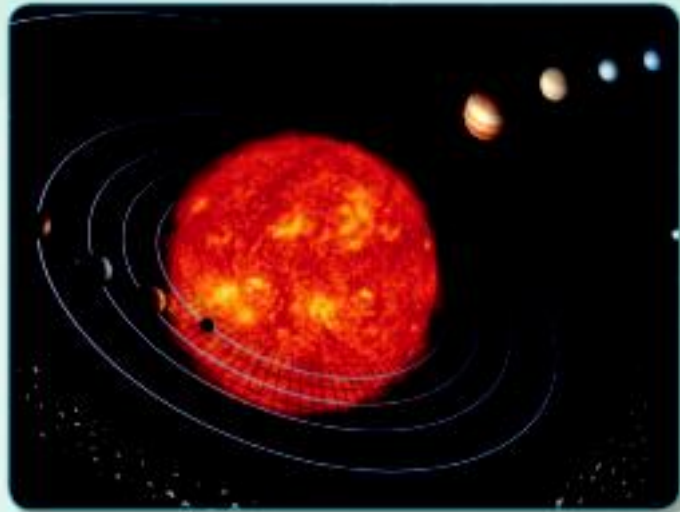

The rotation of the Earth:

We live on earth, we get up in the morning doing our works, at night we sleep, how can we explain the day and night sequence?



Activity (3): The day and night sequence:

■ Materials:

- A plastic ball - a pencil or a large needle a torch - a pin

■ Procedures:

- pass the needle or the pencil through the center of the ball. The ball represents the earth while the pencil or the needle represents the axis of the rotation of the earth.



Read and learn

Axis of the earth:

It is unreal straight line passes through the center of the earth.

- Fix the pin in specific place on the ball surface .
- Ask your classmate to help you fix the axis of the ball in a vertical position (Figure 1).
- Darken the room.
- Switch on the torch (represents the sun) towards the fixed side of the pin found.
- Have your friend let the ball rotate around itself.

What do you observe?

Conclusion:

Repeat the steps with inclined axis and rotate the ball around itself again as in figure (b).

What do you observe?.....

Conclusion:.....

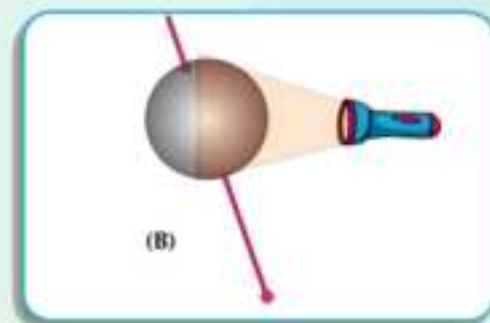
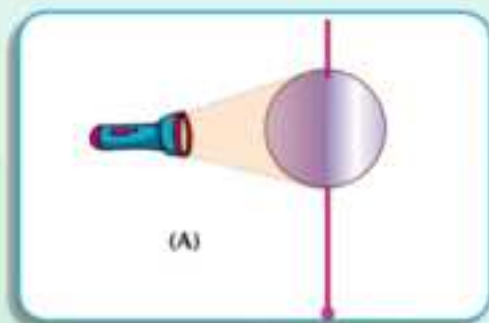

- In both cases, the pin will be located inside light area at one time. In this case, it represents the day time. And at the other case will be located in the shadow area representing the night.
- When the axis is vertical, the hours of day time are equal to the hours of night time, but in the case of inclined pin the hours of day time is different than the hours of night time.

Now, do you think the axis of the earth is vertical or inclined?.....

The earth rotates around its axis once every 24 hours causing day and night. The hours of day is not equal to the hours of night because the axis of the earth is inclined

Activity (4): A model of the earth and seasons of the year.

■ **Materials:**

A model of the earth - an electric bulb, a wire or a rope.

■ **Procedures:**

- Put the model of the earth on the Table (the north half of the model is inclined to the bulb) as in Figure (A)

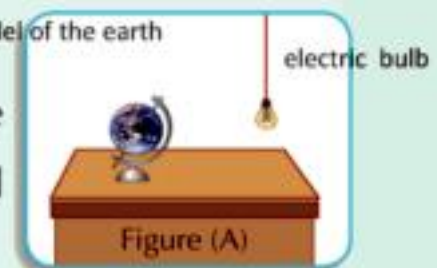

- Do the people who live in the north part of the earth have a longer day than night?

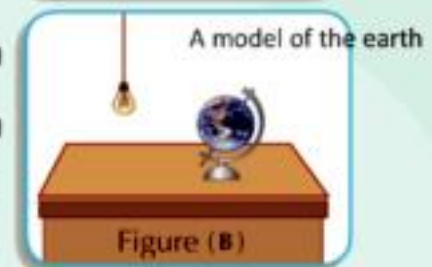

- which season of the year do they live in?

Record your observations

Conclusion:

- Move the model of the earth around the bulb and the southern half of the earth is inclined towards the bulb as in Figure (B)

- Do the people who live in the northern half of the earth having a longer day than night?

- Which season of the year do the people who live in the northern of the earth live?

Record your observations:.....

Conclusion:.....



Read and learn

As the Southern pole is inclined Towards the sun so it is always day for six months, at the same time it is night at the northern pole, that is because it is far away from the sun and vice - versa after six months.

- **The earth revolves around the sun once every 365 and quarter a day causing the sequence of the seasons.**
- **The earth rotates around its axis causing the sequence of day and night.**

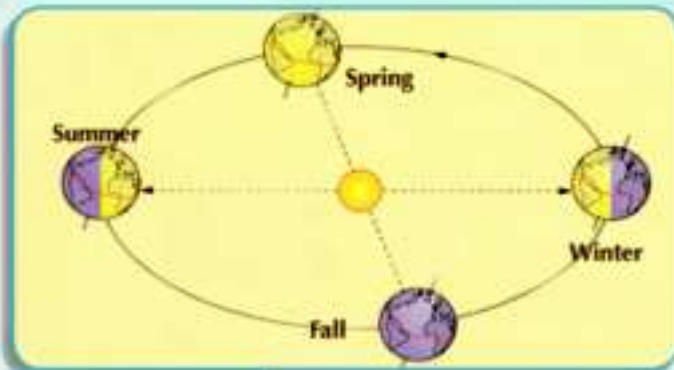

Exercise: Here are 4 figures indicating the day and night during 24 hours, write the suitable seasons under each one.

	(4)	(3)	(2)	(1)
night				
day				
	_____	_____	_____	_____
	_____	_____	_____	_____



Optional activities

Choose one of the following activities, carry it out:

- The following drawing shows the location of the pyramids on the surface of the earth.
 - Draw the location of the pyramids on the earth after 12 hours.

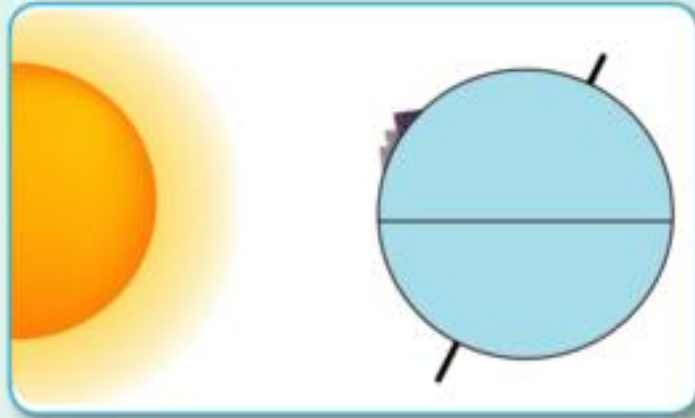

- Draw a model showing the sequence of day and night.



Summary

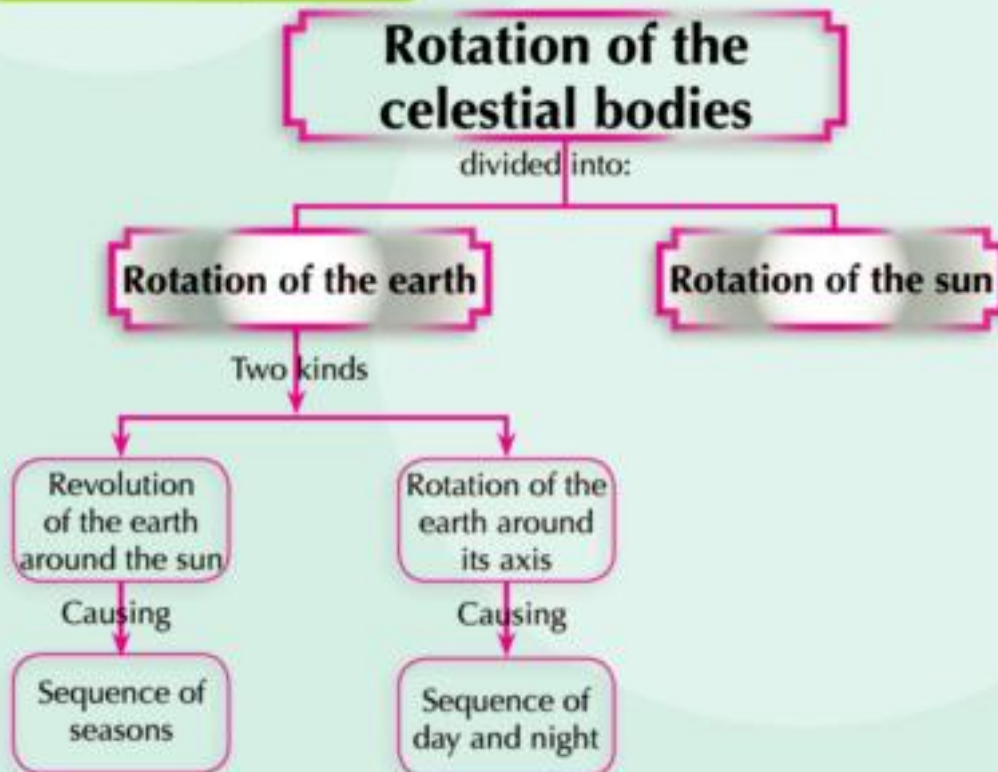

Exercises and activities

Question 1: choose the correct answer:

- 1- The sequence of day and night is occurred due to
 - A- revolution of the earth around the sun.
 - B- rotation of the earth around its axis.
 - C- rotation of the sun around its axis.

- 2- The sequence of the seasons of the year is occurred due to:
 - A- revolution of the earth around the sun.
 - B- rotation of the earth around its axis.
 - C- rotation of the sun around its axis.

Question 2: Make a model shows the consequence of the seasons of the year.

General exercises on Unit two

Question (1): choose the suitable word:

- 1- Stars are (shinning - dark) bodies with (equal - different) sizes. while the planets are (shining - dark) bodies.
- 2- The number of the planets in the solar system is (6 - 8) revolves around (the moon - the sun) in definite orbits.
- 3- The nearest planet to the sun is (Jupiter - Mercury) and the farthest planet is (Uranus - Nepton) while the biggest planet is (Jupiter - Venus).
- 4- Day and night happen because of the rotation of the (sun - earth) around its axis while the seasons of the year happen because of the rotation of the (earth - moon) around the sun.

Question (2): Write the scientific term:

- 1- Dark objects revolve around the sun in fixed orbits.
- 2- Dark objects revolve around the earth and reflect the sun rays falling on them.

Question (3): What is type of the phenomena resulted from:

- 1- Rotation of the earth around its axis.
- 2- Rotation of the earth around the sun.









Question (4): Compare between:











- 1- Star - planet.

Question (5): Share your friends in making an activity shows:

- 1- Day and night.
- 2- Solar system.

Links Of EKB

Code	Link Content	Lesson	Unit
	Physical Changes	Physical and chemical changes	One
	Chemical Changes		
	Chemical Changes		
	Characteristics of stars	Stars and planets	Two : Universe
	What are satars?		
	The planet		
	Day Time and Night	Movoment of the sun and Earth	
	Morement of Earth in space		

Code	Link Content	Lesson	Unit
	Why do we measure?	Measurement Tools	One
	Measuring matter		
	How To measure volume		
	States Of matter	States of Matter and its changes	
	States Of matter		
	Exploring solids, liquids and gases		
	States Of matter		
	Pure materials		
	Elements	Elements around us	
	Metals and non metals		

المواصفات الفنية:

مقاس الكتاب:	$\frac{1}{8}$ (٨٢ × ٥٧) سم
طبوع المتن:	٤ ألوان
طبوع الغلاف:	٤ ألوان
ورق المتن:	لا يقل عن ٧٠ جرام
ورق الغلاف:	لا يقل عن ١٨٠ جرام
عدد الصفحات بالغلاف:	٨٠ صفحة
رقم الكتاب:	١٥٠٨/٢٠/١٥/١١/٤/٣٤

<http://elearning.moe.gov.eg>

