

تم تحميل هذا الملف من موقع المناهج السعودية



موقع المناهج السعودي

* للحصول على أوراق عمل لجميع الصفوف وجميع المواد اضغط هنا

<https://www.almanahj.com/sa>

* للحصول على أوراق عمل لجميع مواد الصف الأول اضغط هنا

<https://almanahj.com/sa/1>

* للحصول على جميع أوراق الصف الأول في مادة لغة عربية ولجميع الفصول, اضغط هنا

<https://almanahj.com/sa/1arabic>

* للحصول على أوراق عمل لجميع مواد الصف الأول في مادة لغة عربية الخاصة بـ الفصل الأول اضغط هنا

<https://www.almanahj.com/sa/1arabic1>

* لتحميل كتب جميع المواد في جميع الفصول للـ الصف الأول اضغط هنا

<https://www.almanahj.com/sa/grade1>

للحصول على جميع روابط الصفوف على تلغرام وفيسبوك من قنوات وصفحات: اضغط هنا

<https://t.me/sacourse>



حُرُوفِي مَعَ الْفَتْحَةِ

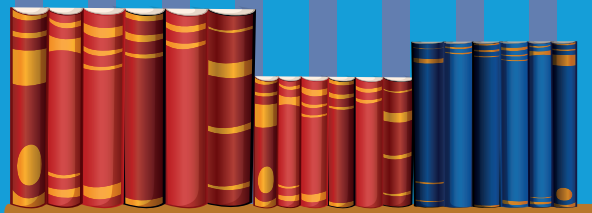

حَرْفُ الْأَيْفِ مَعَ الْفَتْحَةِ



حُرُوفِي مَعَ الْفَتْحَةِ

20

/ /

التَّارِيخُ:

العُمْرُ:

الاسْمُ:

2 لَوْنٌ بِالْأَلْوَانِ الْجَمِيلَةِ

1 مَرِّرِ الْقَلَمَ بِاتِّجَاهِ السَّهْمِ

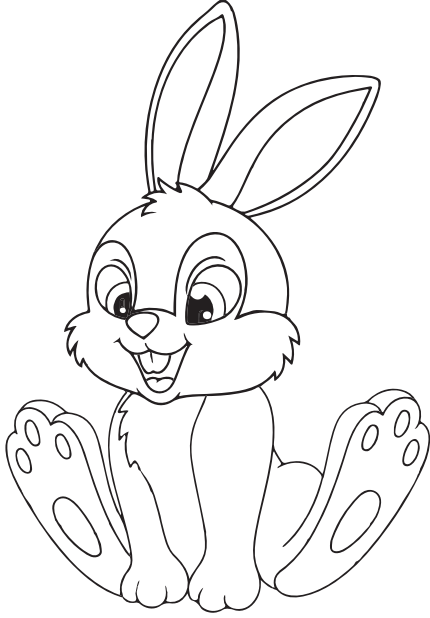

أَرْبَبٌ

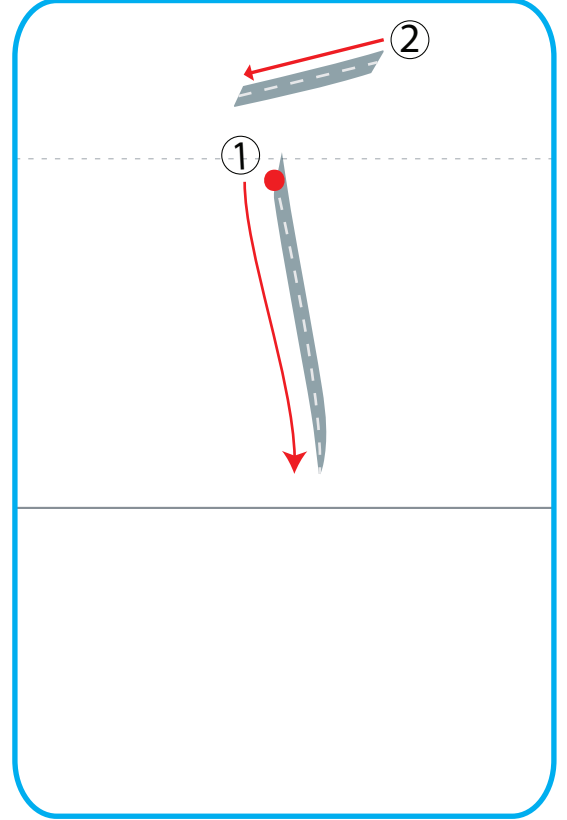

3 أَكْتُبِ الْحَرْفَ بِالشَّكْلِ الصَّحِيحِ

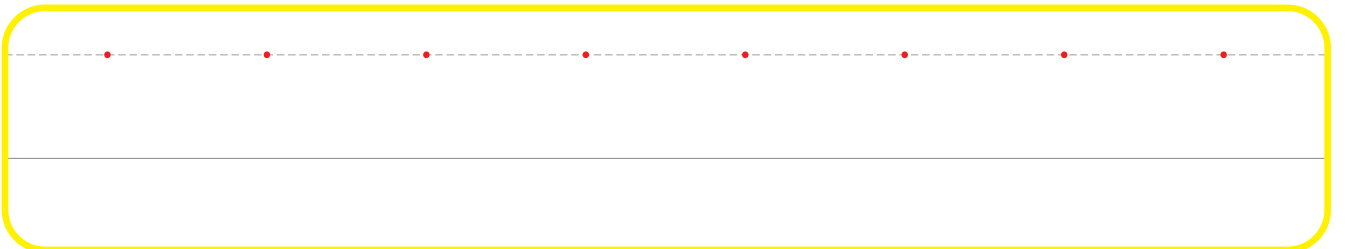
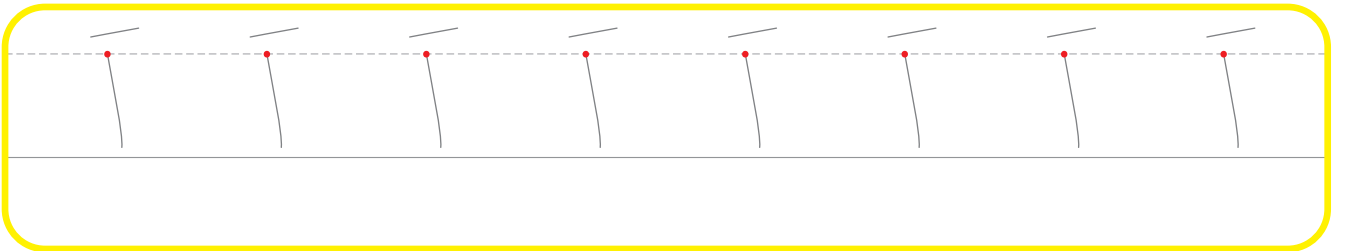
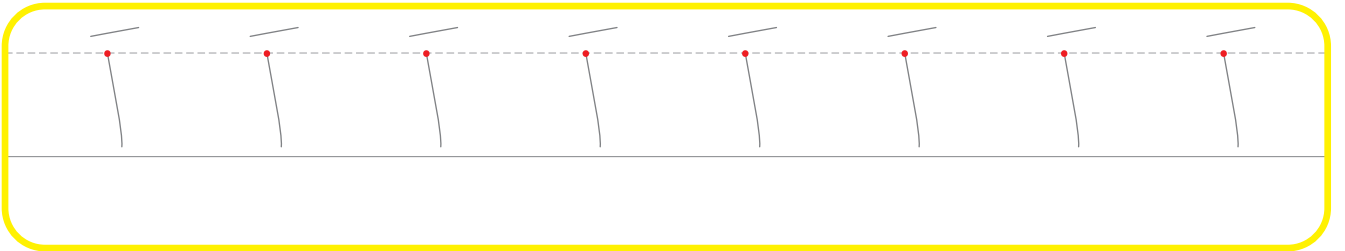



20

التَّارِيخُ:

العُمْرُ:

الاسْمُ:

2 لَوْنٌ بِالْأَلْوَانِ الْجَمِيلَةِ

1 مَرِّرِ الْقَلَمَ بِاتِّجَاهِ السَّهْمِ



بَيْتٌ

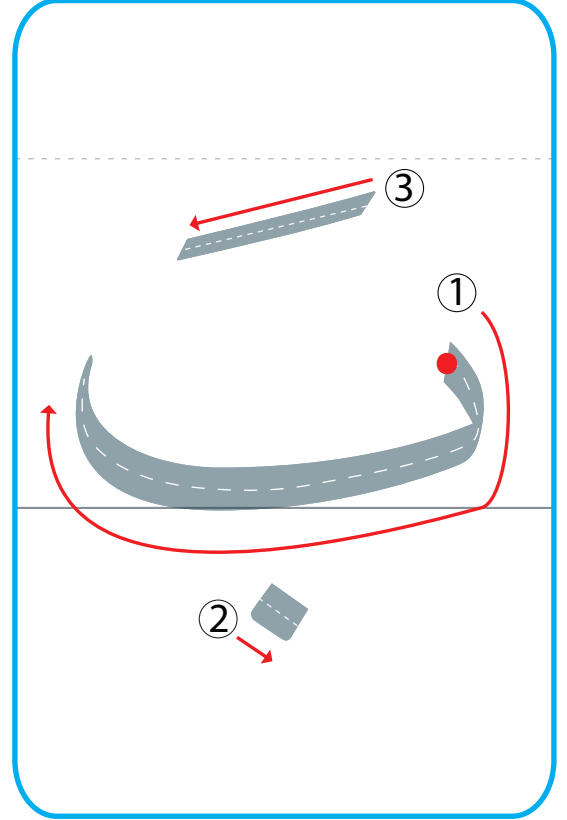

3 أَكْتُبِ الْحَرْفَ بِالشَّكْلِ الصَّحِيحِ

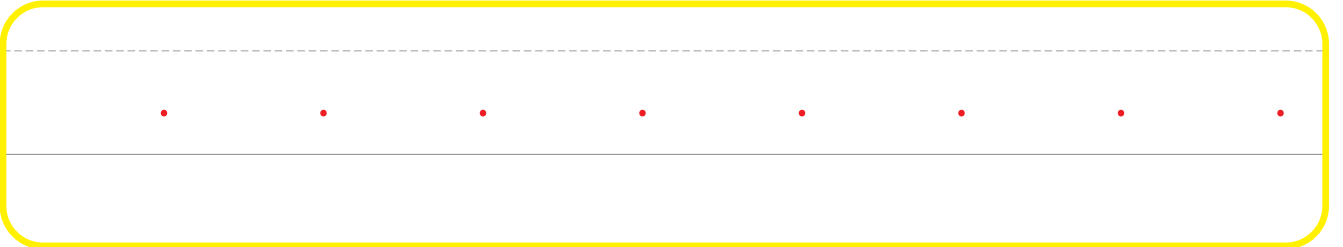
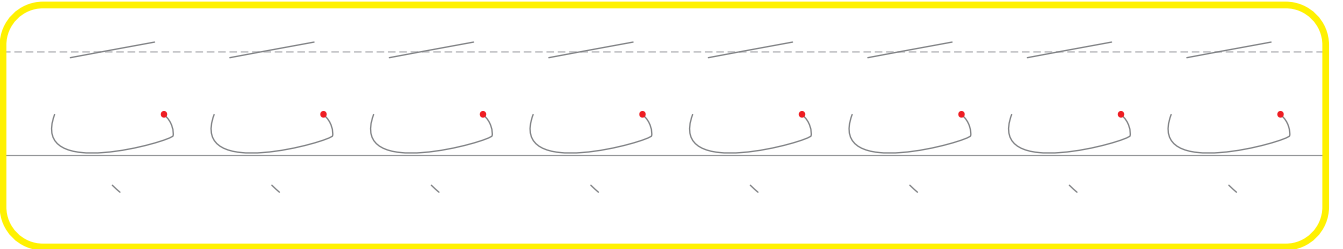
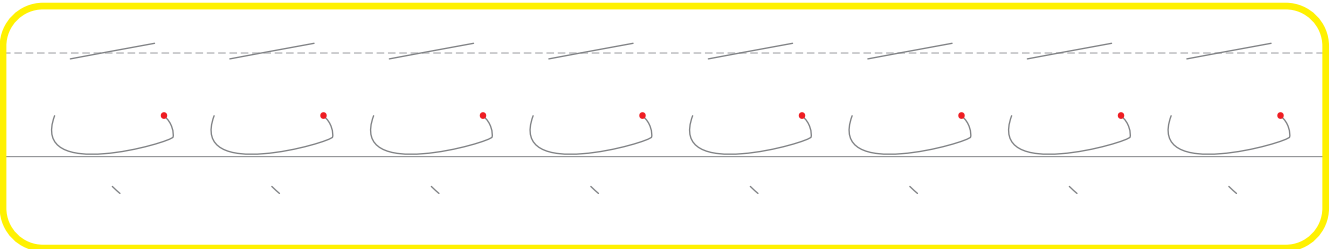



20

التَّارِيخُ:

العُمْرُ:

الاسْمُ:

2 لَوْنٌ بِالْأَلْوَانِ الْجَمِيلَةِ

1 مَرِّرِ الْقَلَمَ بِاتِّجَاهِ السَّهْمِ

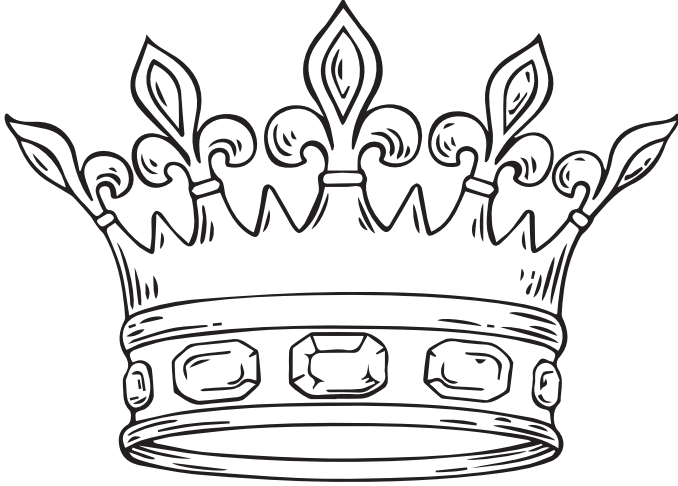

تَاج

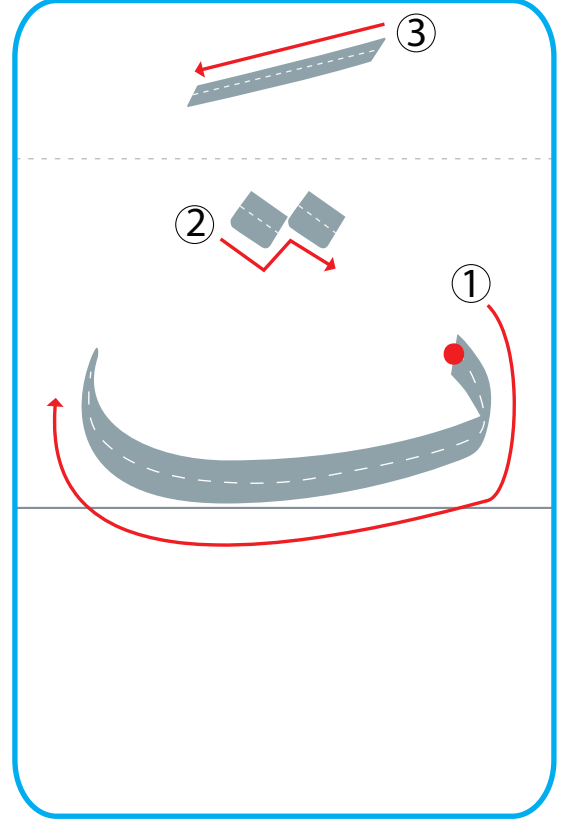

3 أَكْتُبِ الْحَرْفَ بِالشَّكْلِ الصَّحِيحِ

ت ت ت ت ت ت ت

ت ت ت ت ت ت ت

• • • • • • • •



20

التَّارِيخُ:

العُمْرُ:

الاسْمُ:

2 لَوْنٌ بِالْأَلْوَانِ الْجَمِيلَةِ

1 مَرِّرِ الْقَلَمَ بِاتِّجَاهِ السَّهْمِ



تَعَلَّبَ

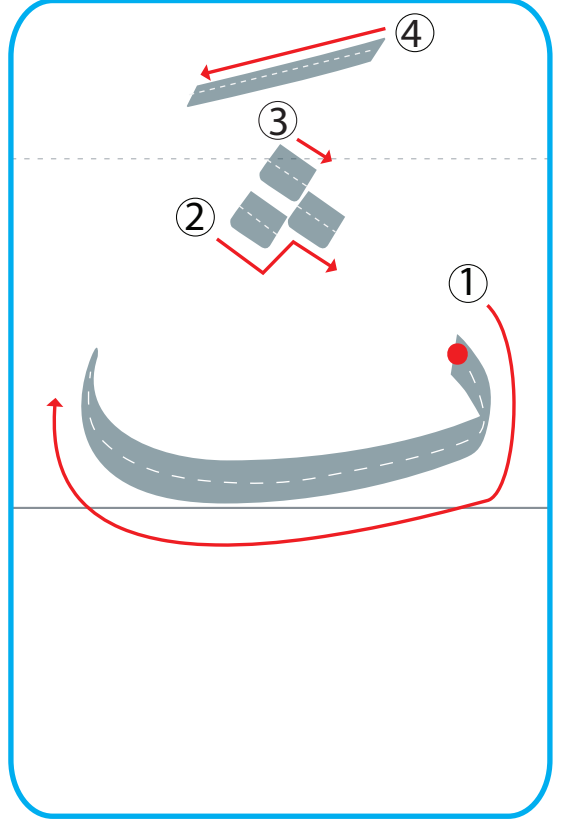

3 أَكْتُبِ الْحَرْفَ بِالشَّكْلِ الصَّحِيحِ

ت ت ت ت ت ت ت

ت ت ت ت ت ت ت

• • • • • • • •

حَرْفُ الْجِيمِ مَعَ الْفَتْحَةِ



حُرُوفِي مَعَ الْفَتْحَةِ

20

/ / التَّارِيخُ:

العُمْرُ:

الاسْمُ:

2 لَوْنٌ بِالْأَلْوَانِ الْجَمِيلَةِ

1 مَرِّرِ الْقَلَمَ بِاتِّجَاهِ السَّهْمِ

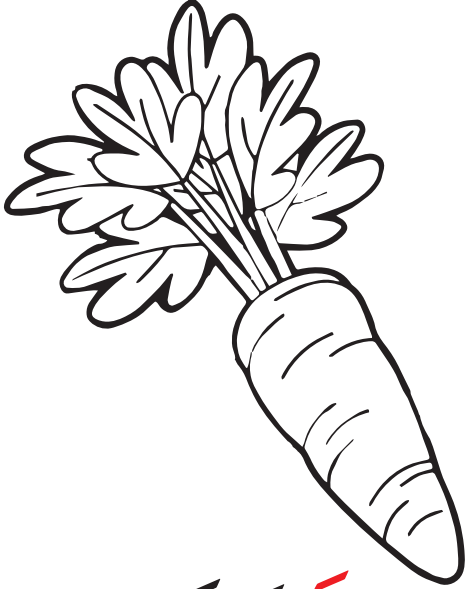

جَزَرَةٌ

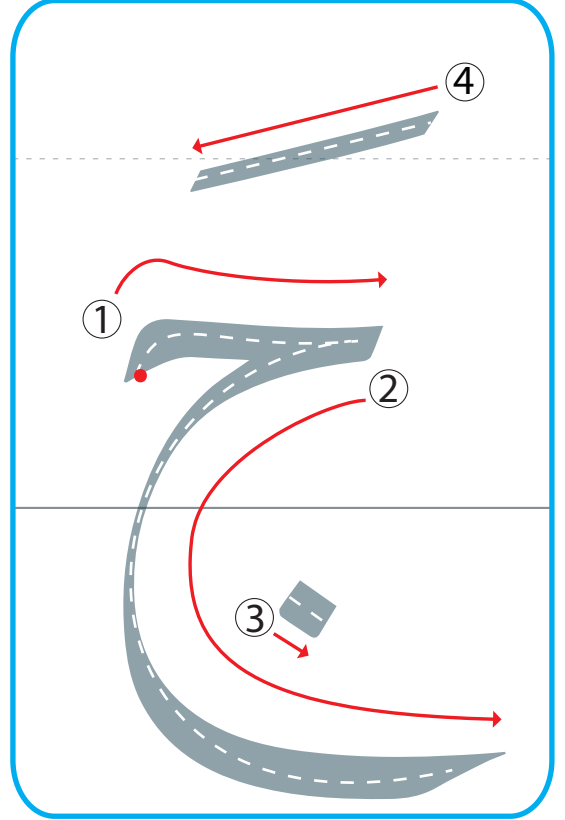

3 أَكْتُبِ الْحَرْفَ بِالشَّكْلِ الصَّحِيحِ

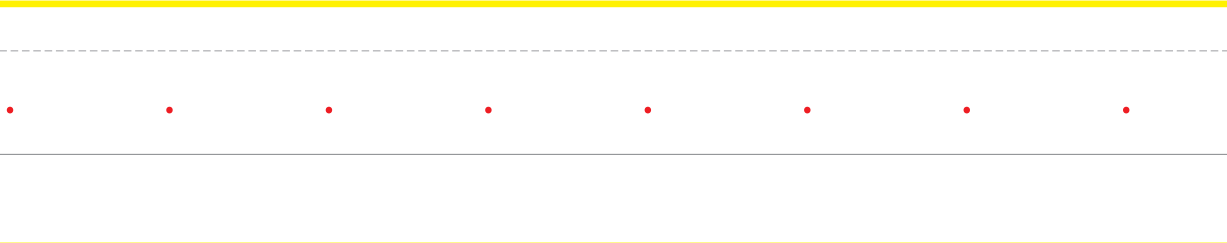
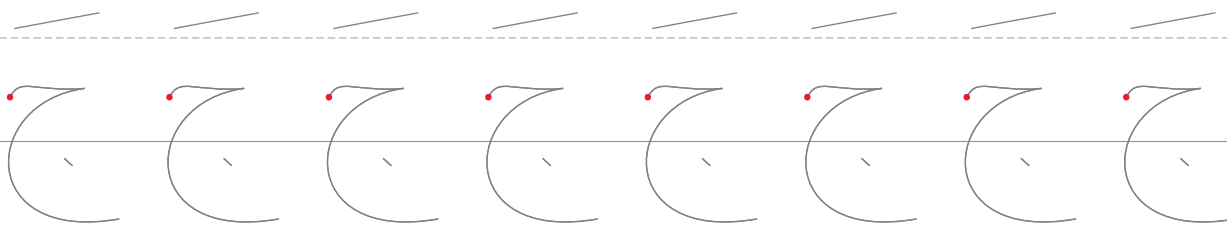
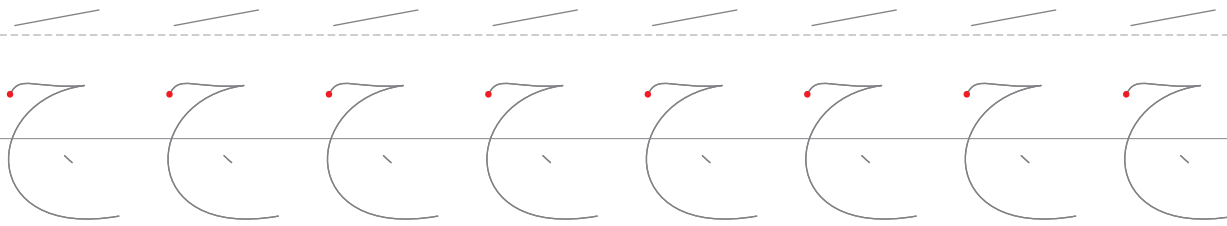



20

/ / التَّارِيخُ:

العُمْرُ:

الاسْمُ:

2 لَوْنٌ بِالألْوَانِ الجَمِيلَةِ

1 مَرَّرِ القَلَمَ بِاتِّجَاهِ السَّهْمِ

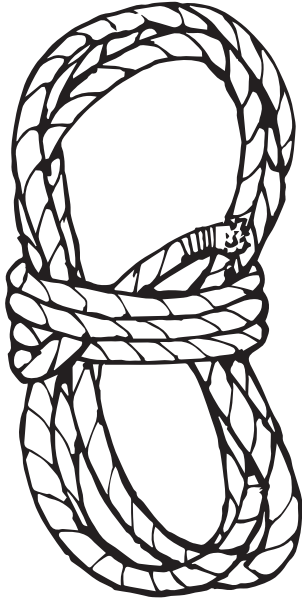

حَبْلٌ

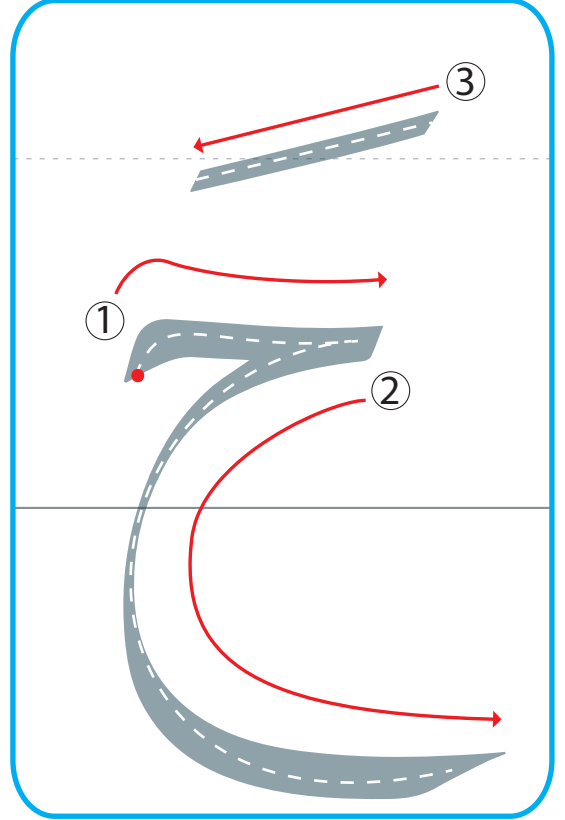

3 أَكْتُبِ الحَرْفَ بِالشَّكْلِ الصَّحِيحِ

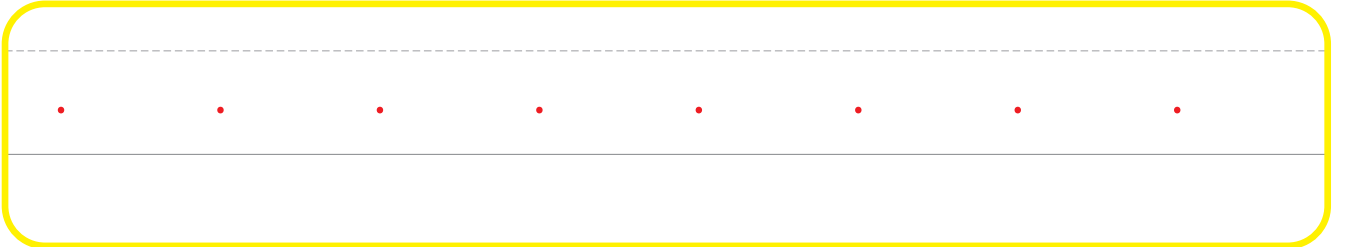
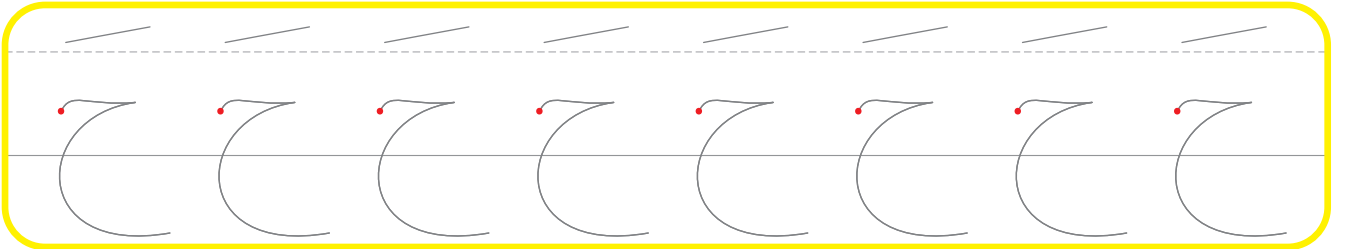
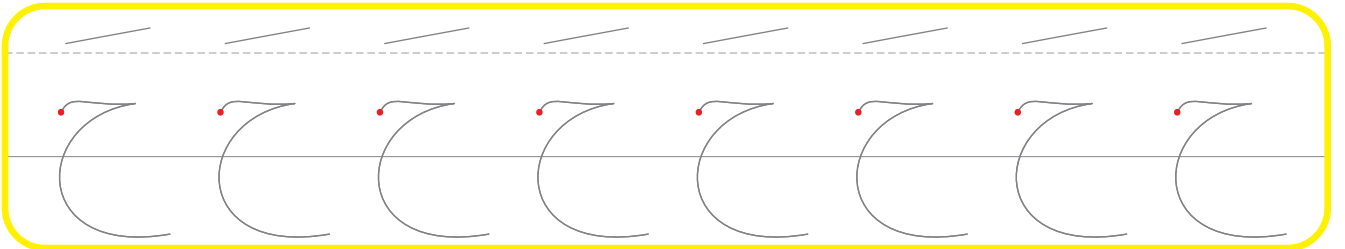



20

التَّارِيخُ:

العُمْرُ:

الاسْمُ:

2 لَوْنٌ بِالألوانِ الجَمِيلَةِ

1 مَرِّرِ القَلَمَ بِاتِّجَاهِ السَّهْمِ

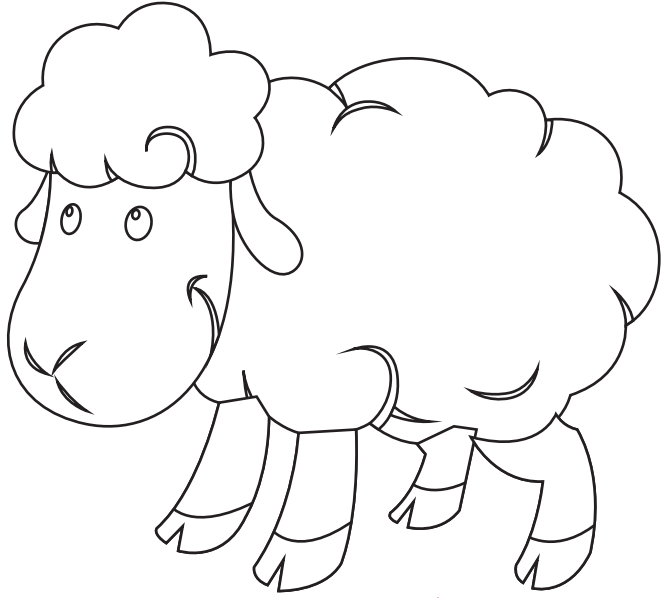

حُرُوف

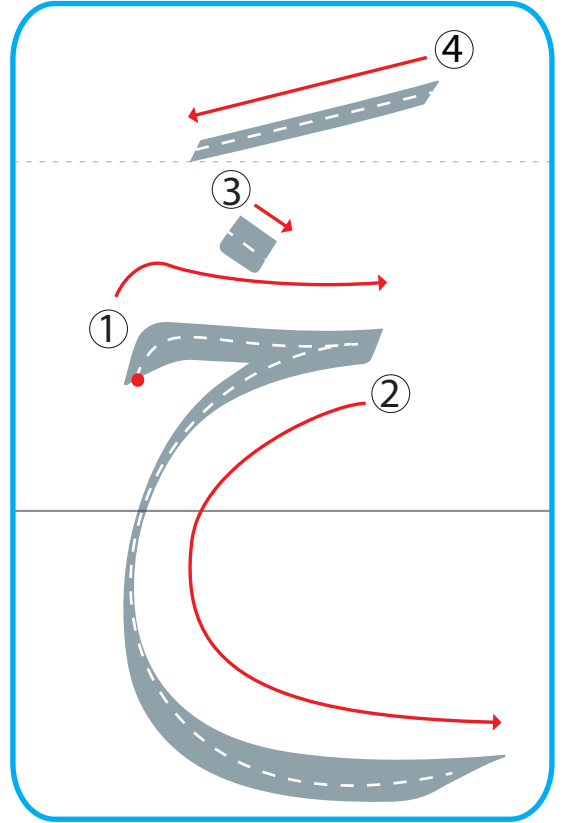

3 أَكْتُبِ الحَرْفَ بِالشَّكْلِ الصَّحِيحِ

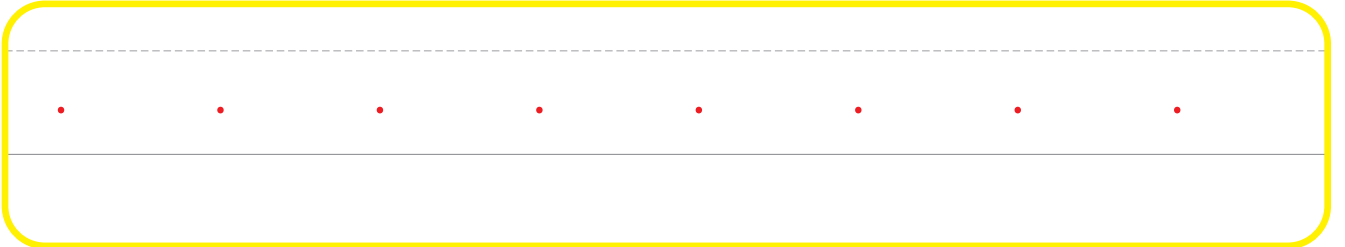
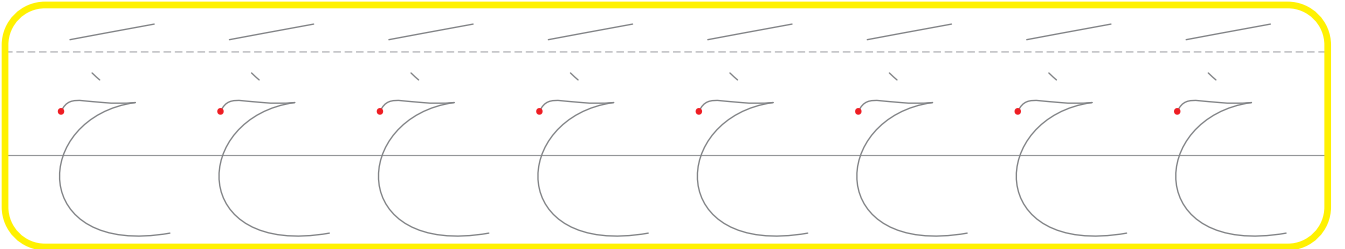
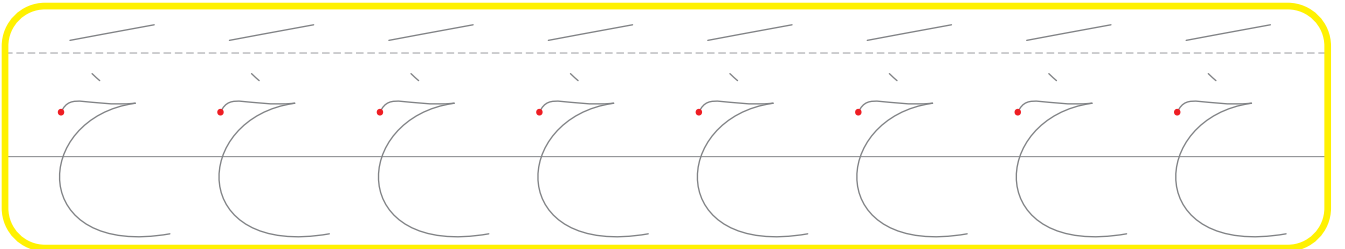



20

/ /

التَّارِيخُ:

العُمْرُ:

الاسْمُ:

2 لَوْنٌ بِالْأَلْوَانِ الْجَمِيلَةِ

1 مَرَّرِ الْقَلَمَ بِاتِّجَاهِ السَّهْمِ

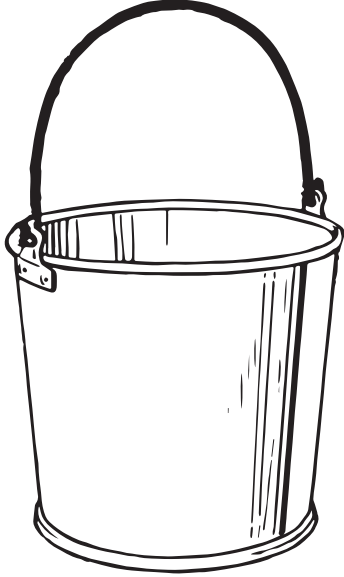

دَلُو

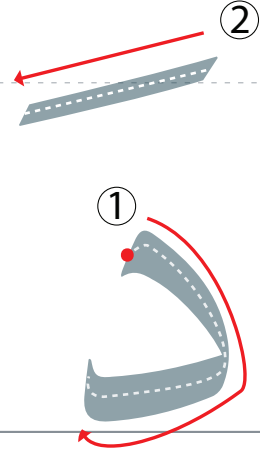

3 أَكْتُبِ الْحَرْفَ بِالشَّكْلِ الصَّحِيحِ

د د د د د د د د

د د د د د د د د

• • • • • • • •



20

/ /

التَّارِيخُ:

العُمْرُ:

الاسْمُ:

2 لَوْنٌ بِالْأَلْوَانِ الْجَمِيلَةِ

1 مَرِّرِ الْقَلَمَ بِاتِّجَاهِ السَّهْمِ

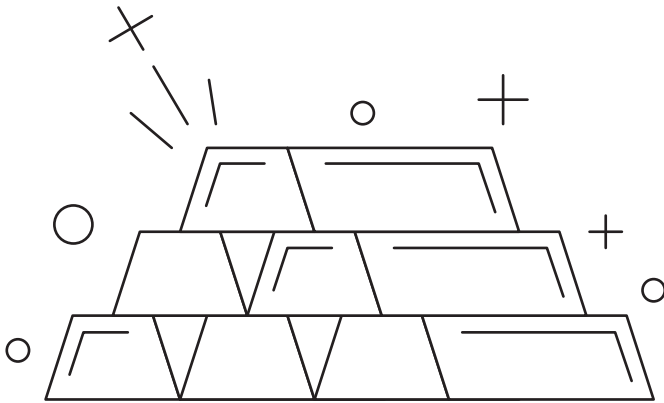

ذَهَبٌ

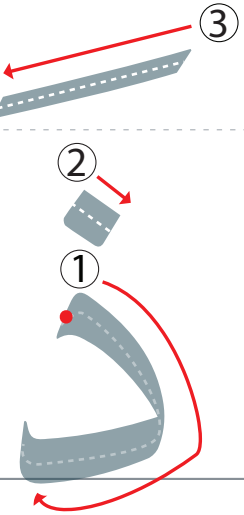

3 أَكْتُبِ الْحَرْفَ بِالشَّكْلِ الصَّحِيحِ

ذ ذ ذ ذ ذ ذ ذ ذ

ذ ذ ذ ذ ذ ذ ذ ذ

• • • • • • • •

حَرْفُ الرَّامَعِ الْفَتْحَةِ



حُرُوفِي مَعَ الْفَتْحَةِ

20

/

/

التَّارِيخُ:

العُمْرُ:

الاسْمُ:

2 لَوْنٌ بِالْأَلْوَانِ الْجَمِيلَةِ

1 مَرَّرِ الْقَلَمَ بِاتِّجَاهِ السَّهْمِ



رَجُلٌ

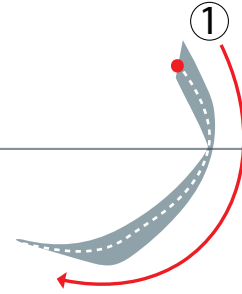
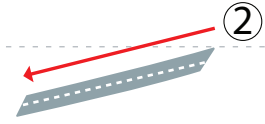

3 أَكْتُبِ الْحَرْفَ بِالشَّكْلِ الصَّحِيحِ

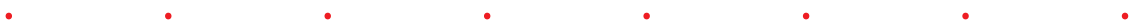
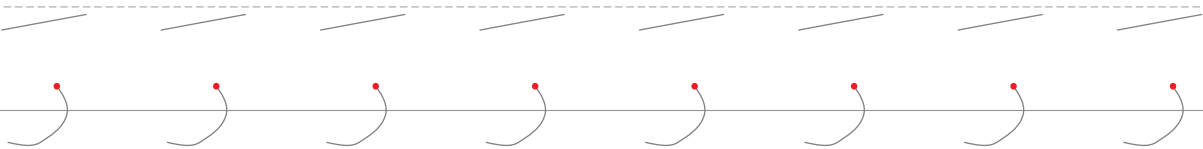
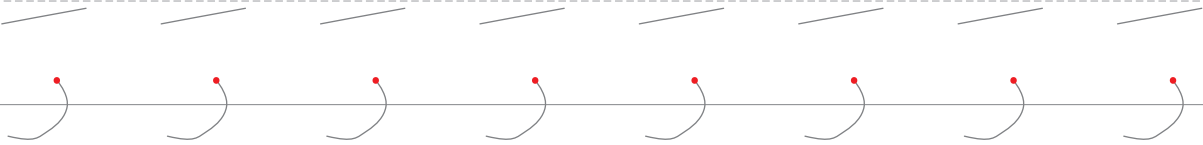

حَرْفُ الزَّامِعِ الْفَتْحَةِ



حُرُوفِي مَعَ الْفَتْحَةِ

20

/ /

التَّارِيخُ:

العُمْرُ:

الاسْمُ:

2 لَوْنٌ بِالْأَلْوَانِ الْجَمِيلَةِ

1 مَرِّرِ الْقَلَمَ بِاتِّجَاهِ السَّهْمِ

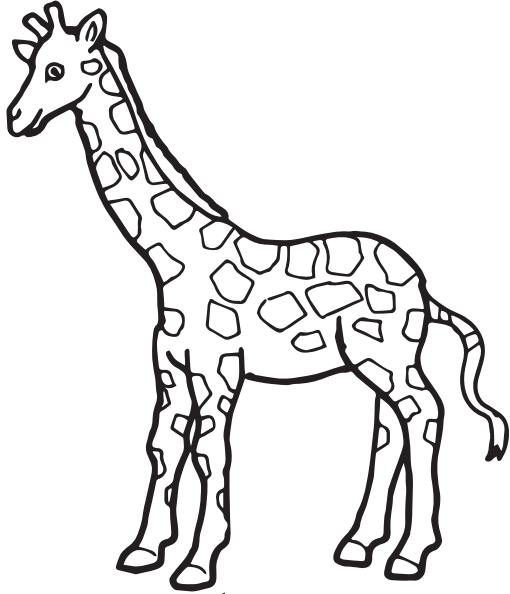

زِرَافَةٌ

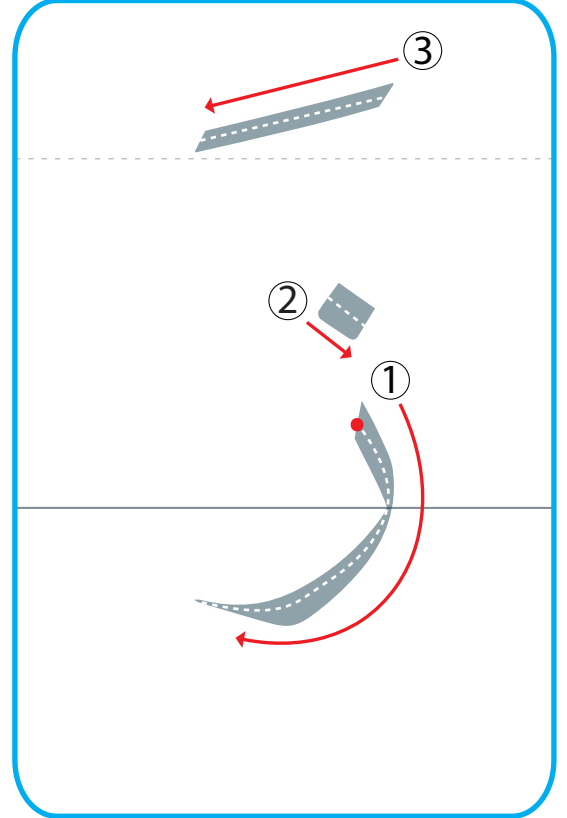

3 أَكْتُبِ الْحَرْفَ بِالشَّكْلِ الصَّحِيحِ

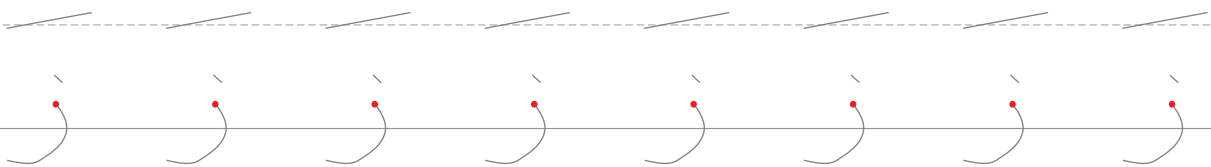
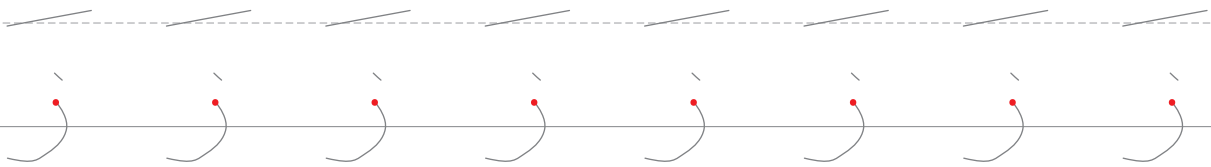



20

/ /

التَّارِيخُ:

العُمْرُ:

الاسْمُ:

2 لَوْنٌ بِالْأَلْوَانِ الْجَمِيلَةِ

1 مَرِّرِ الْقَلَمَ بِاتِّجَاهِ السَّهْمِ

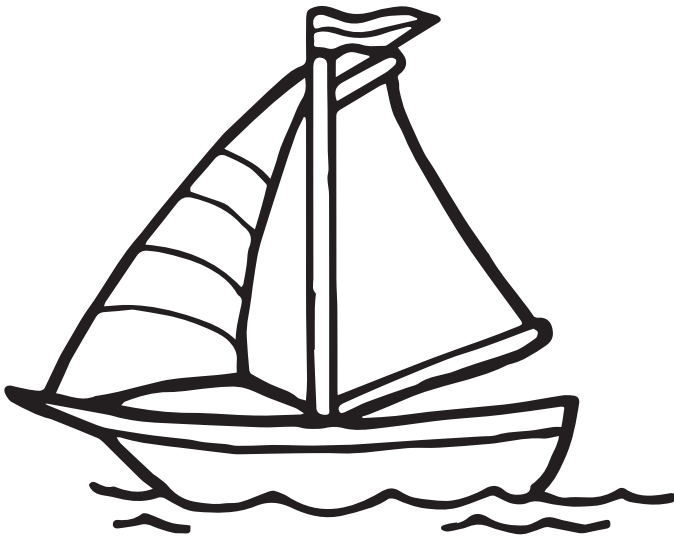

سَفِينَةٌ

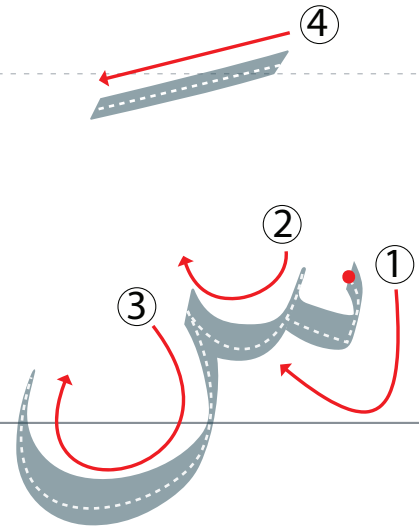

3 أَكْتُبِ الْحَرْفَ بِالشَّكْلِ الصَّحِيحِ

س س س س س س س س

س س س س س س س س

• • • • • • • •



20 / /

التَّارِيخُ:

العُمْرُ:

الاسْمُ:

2 لَوْنٌ بِالْأَلْوَانِ الْجَمِيلَةِ

1 مَرَّرِ الْقَلَمَ بِاتِّجَاهِ السَّهْمِ



شَمْعَةٌ

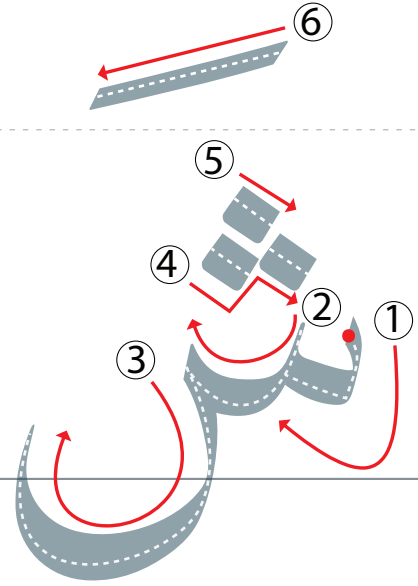

3 أَكْتُبِ الْحَرْفَ بِالشَّكْلِ الصَّحِيحِ

ش ش ش ش ش ش ش ش

ش ش ش ش ش ش ش ش

• • • • • • • • •



20

/ / التَّارِيخُ:

العُمْرُ:

الاسْمُ:

2 لَوْنٌ بِالْأَلْوَانِ الْجَمِيلَةِ

1 مَرَّرِ الْقَلَمَ بِاتِّجَاهِ السَّهْمِ

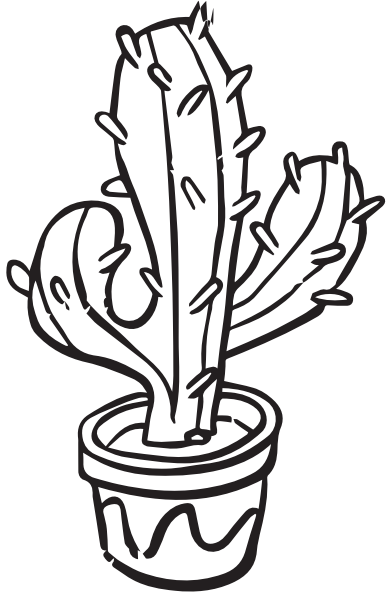

صَبَّار

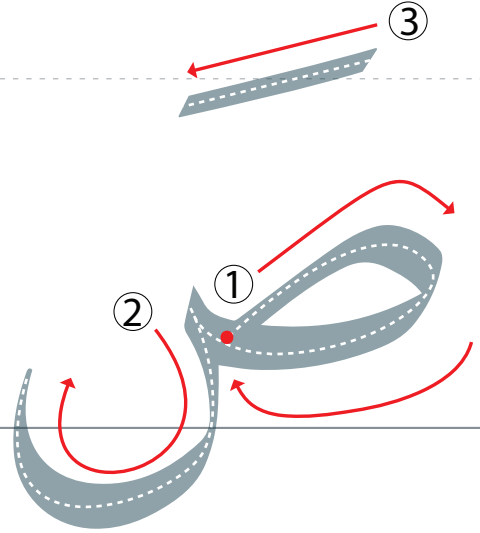

3 أَكْتُبِ الْحَرْفَ بِالشَّكْلِ الصَّحِيحِ

ص ص ص ص ص ص ص ص

ص ص ص ص ص ص ص ص

• • • • • • • •



20

التَّارِيخُ:

العُمْرُ:

الاسْمُ:

2 لَوْنٌ بِالْأَلْوَانِ الْجَمِيلَةِ

1 مَرَّرِ الْقَلَمَ بِاتِّجَاهِ السَّهْمِ

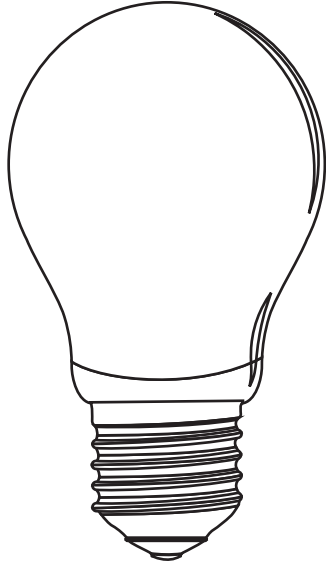

ضوء

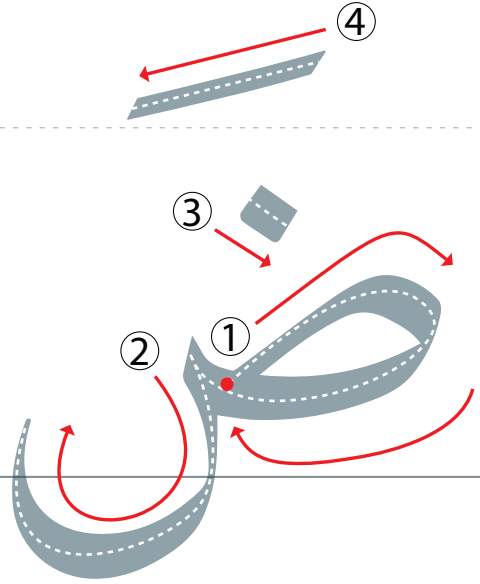

3 أَكْتُبِ الْحَرْفَ بِالشَّكْلِ الصَّحِيحِ

ض ض ض ض ض ض ض ض

ض ض ض ض ض ض ض ض

• • • • • • • •



20

التَّارِيخُ:

العُمْرُ:

الاسْمُ:

2 لَوْنٌ بِالْأَلْوَانِ الْجَمِيلَةِ

1 مَرَّرِ الْقَلَمَ بِاتِّجَاهِ السَّهْمِ

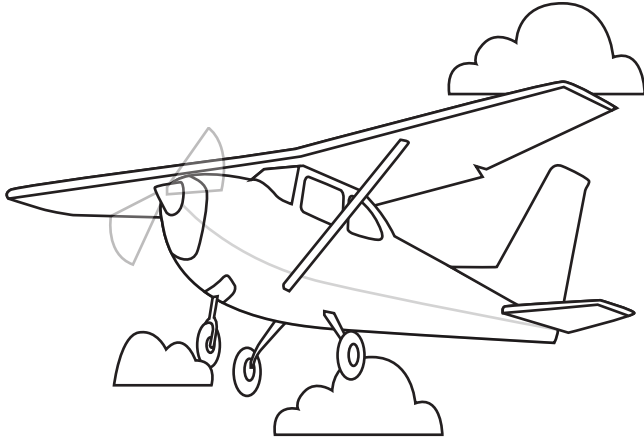

طَائِرَةٌ

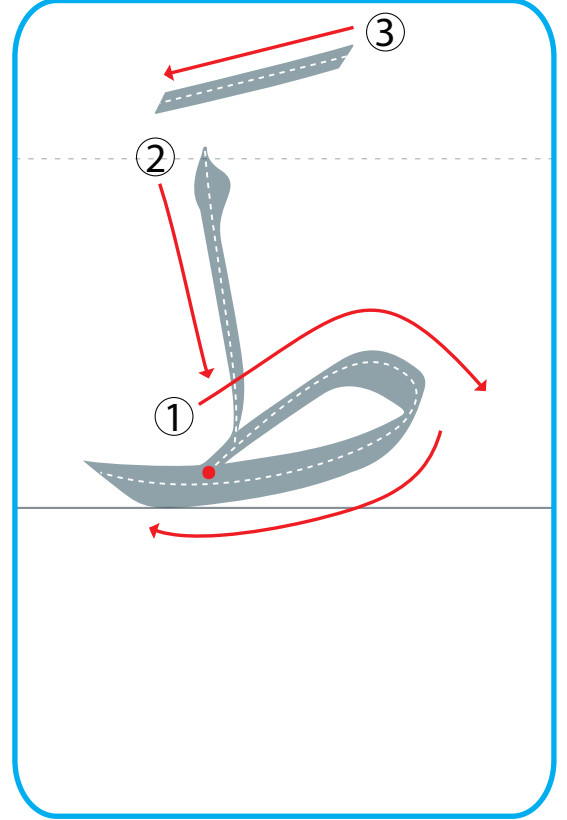

3 أَكْتُبِ الْحَرْفَ بِالشَّكْلِ الصَّحِيحِ

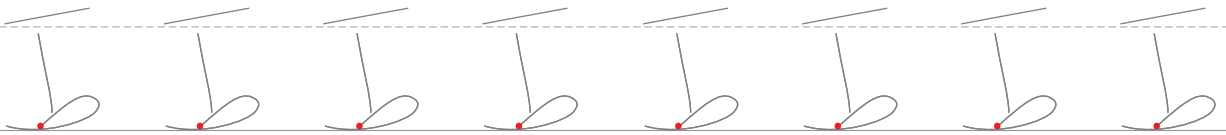
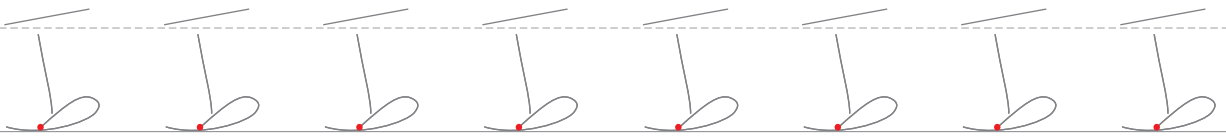



20

التَّارِيخُ:

العُمْرُ:

الاسْمُ:

2 لَوْنٌ بِالْأَلْوَانِ الْجَمِيلَةِ

1 مَرَّرِ الْقَلَمَ بِاتِّجَاهِ السَّهْمِ

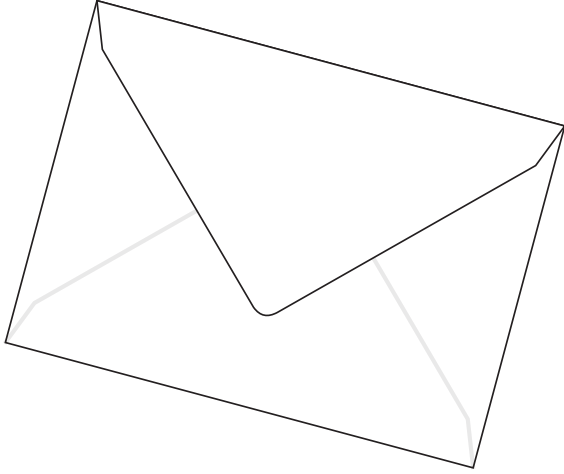

ظَرْفٌ

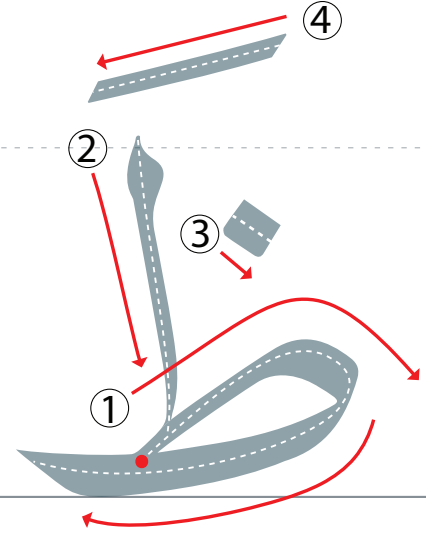

3 أَكْتُبِ الْحَرْفَ بِالشَّكْلِ الصَّحِيحِ

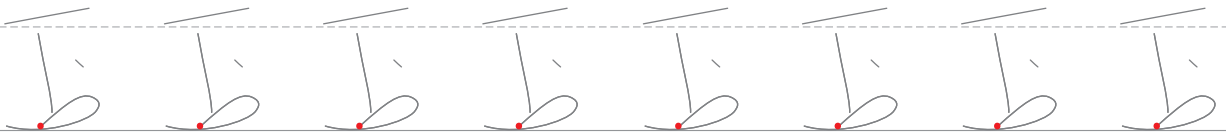
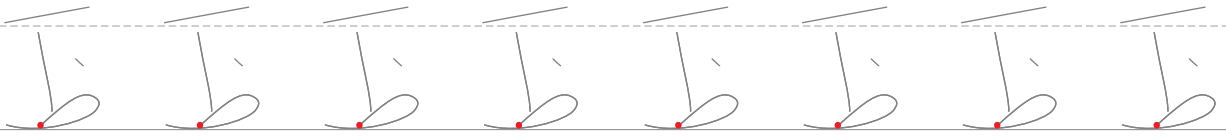



20

التَّارِيخُ:

العُمْرُ:

الاسْمُ:

2 لَوْنٌ بِالْأَلْوَانِ الْجَمِيلَةِ

1 مَرَّرِ الْقَلَمَ بِاتِّجَاهِ السَّهْمِ



عَسَلٌ

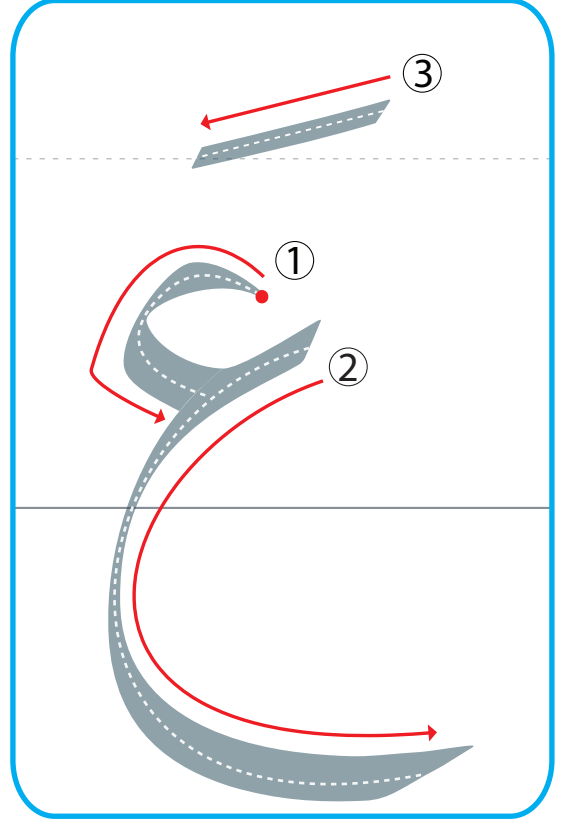

3 أَكْتُبِ الْحَرْفَ بِالشَّكْلِ الصَّحِيحِ

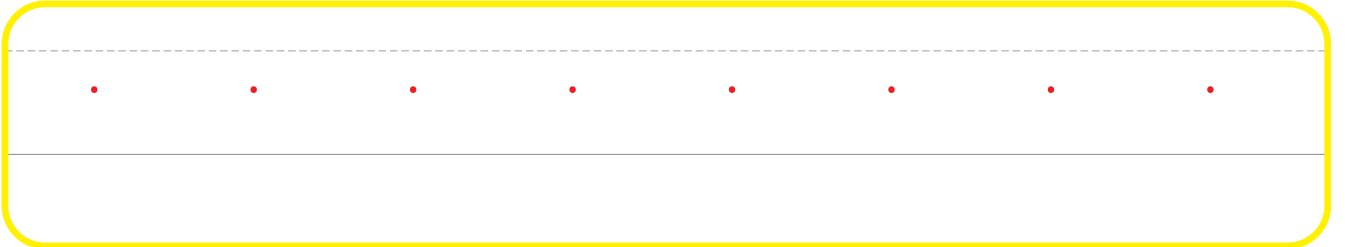
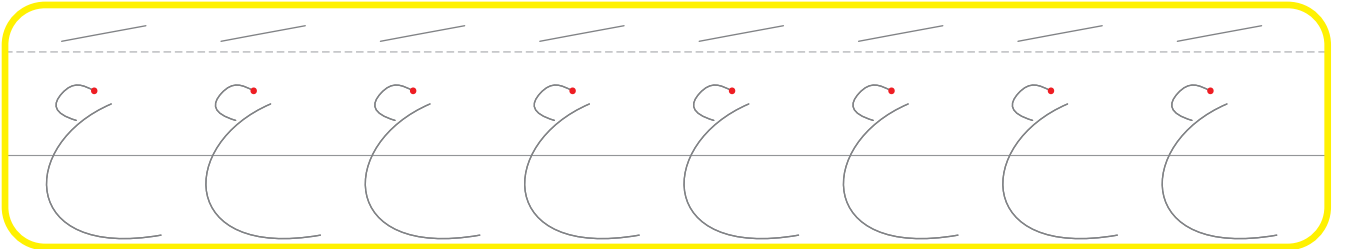
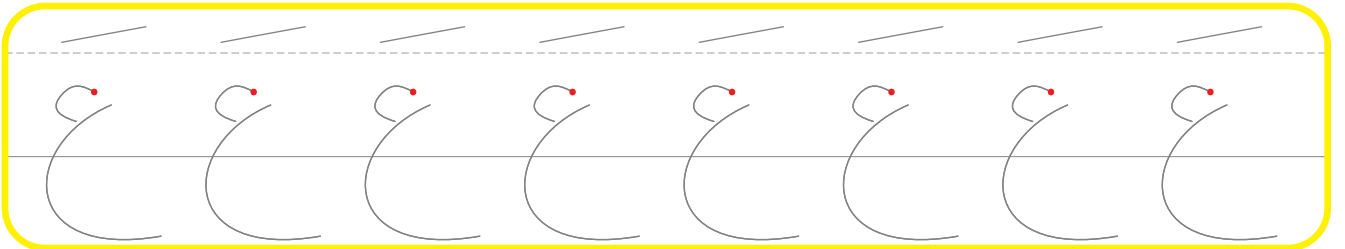

حَرْفُ الْغَيْنِ مَعَ الْفَتْحَةِ



حُرُوفِي مَعَ الْفَتْحَةِ

20

التَّارِيخُ:

العُمْرُ:

الاسْمُ:

2 لَوْنٌ بِالْأَلْوَانِ الْجَمِيلَةِ

1 مَرِّرِ الْقَلَمَ بِاتِّجَاهِ السَّهْمِ

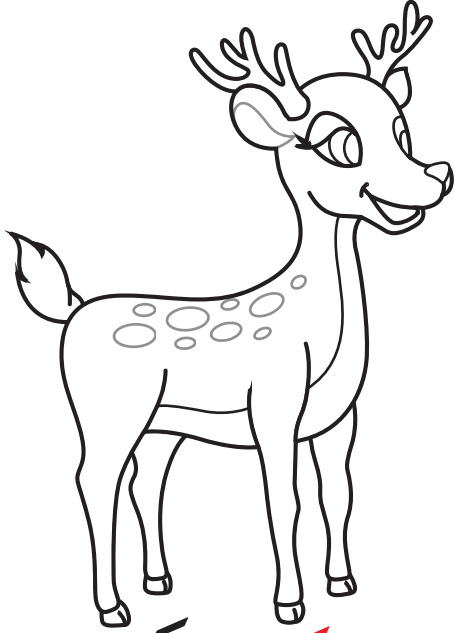

غَزَالَةٌ

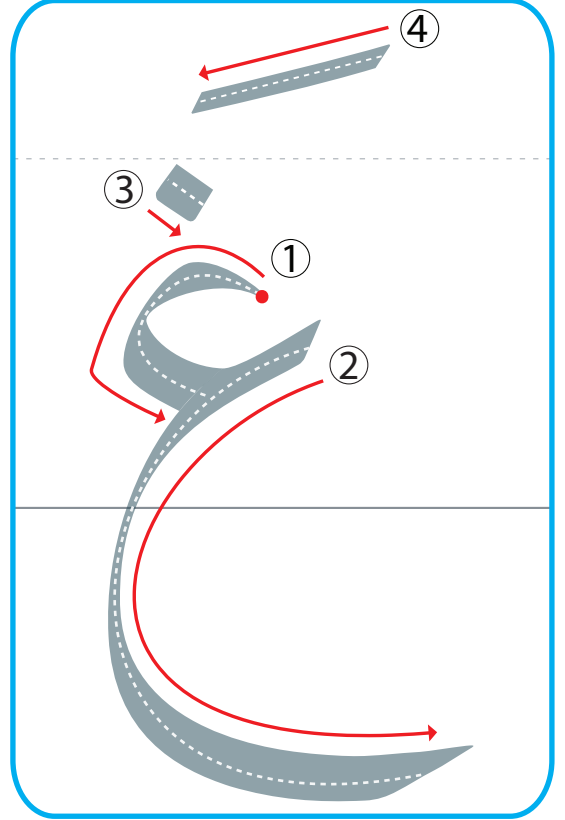

3 أَكْتُبِ الْحَرْفَ بِالشَّكْلِ الصَّحِيحِ

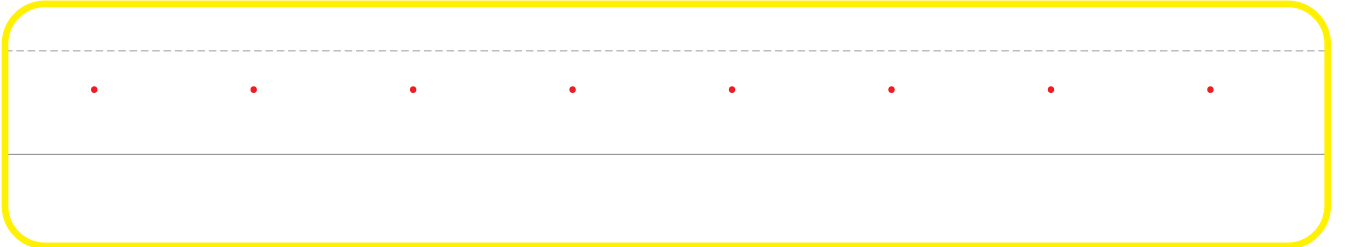
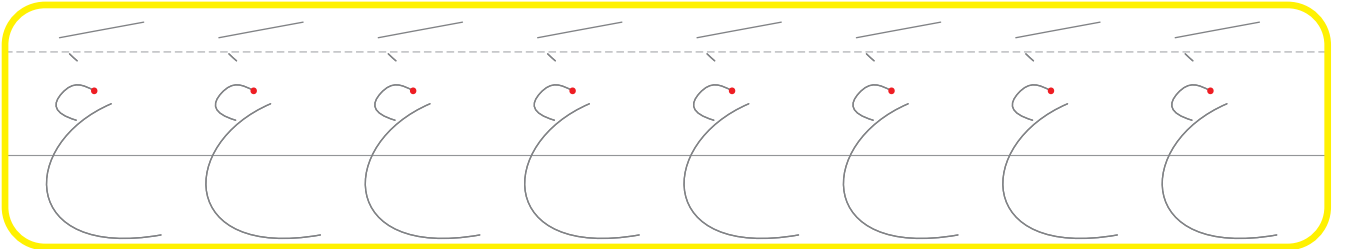
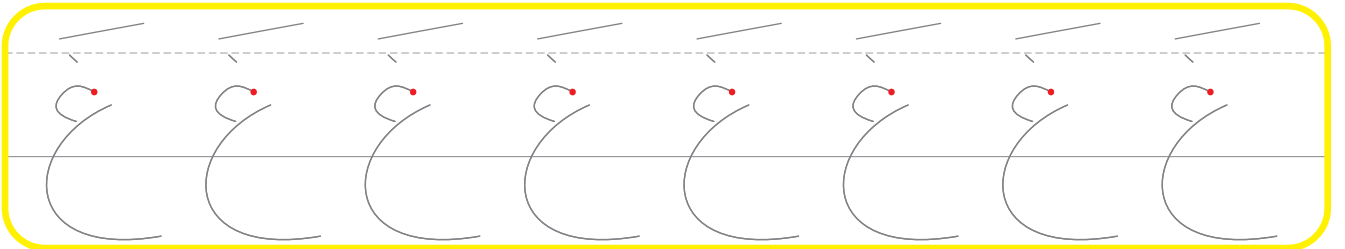



20

/ /

التَّارِيخُ:

العُمْرُ:

الاسْمُ:

2 لَوْنٌ بِالْأَلْوَانِ الْجَمِيلَةِ

1 مَرِّرِ الْقَلَمَ بِاتِّجَاهِ السَّهْمِ

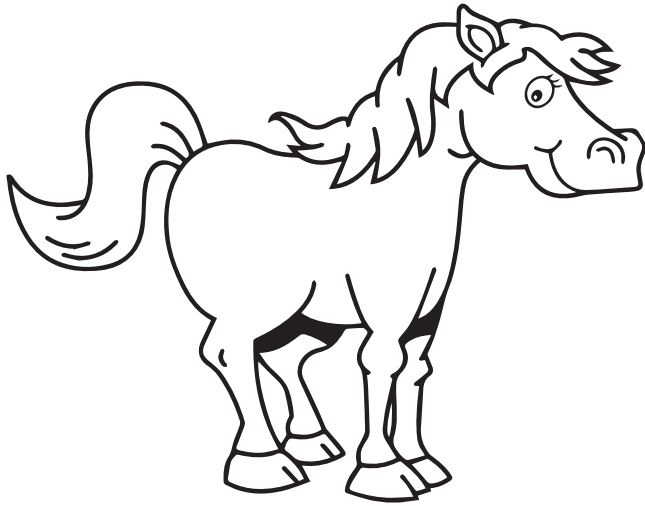

فَرَسٌ

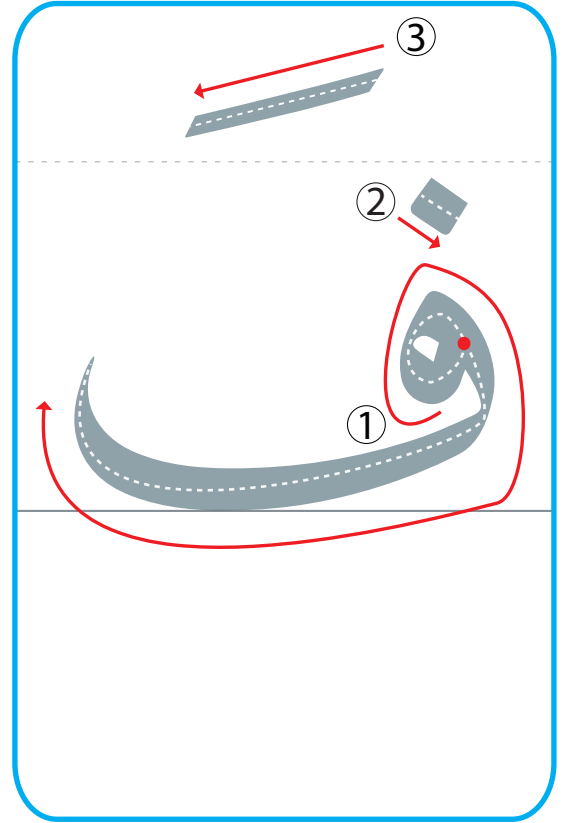

3 أَكْتُبِ الْحَرْفَ بِالشَّكْلِ الصَّحِيحِ

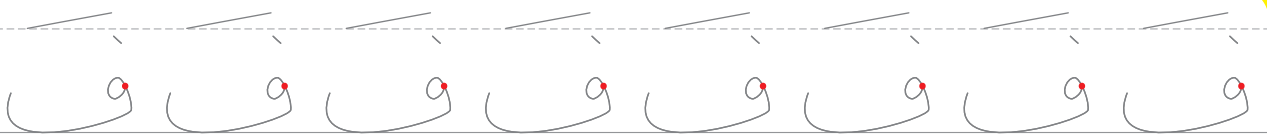
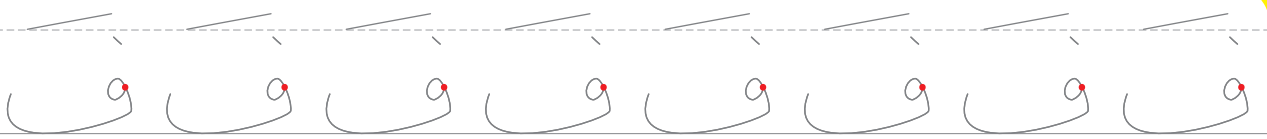



20

التَّارِيخُ:

العُمْرُ:

الاسْمُ:

2 لَوْنٌ بِالْأَلْوَانِ الْجَمِيلَةِ

1 مَرَّرِ الْقَلَمَ بِاتِّجَاهِ السَّهْمِ

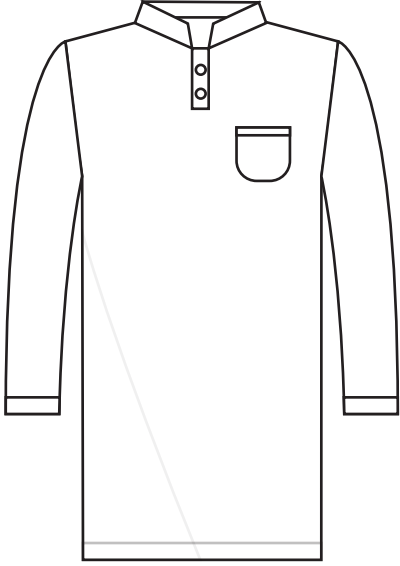

قميص

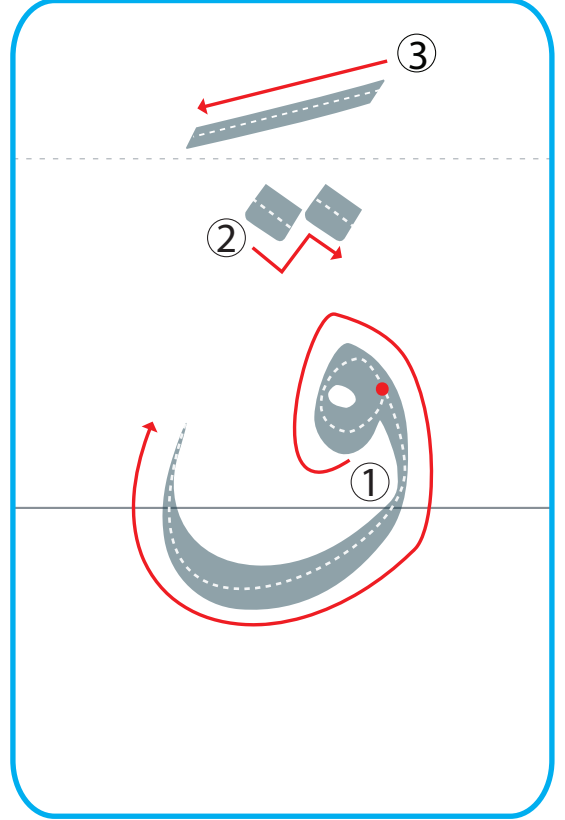

3 أَكْتُبِ الْحَرْفَ بِالشَّكْلِ الصَّحِيحِ

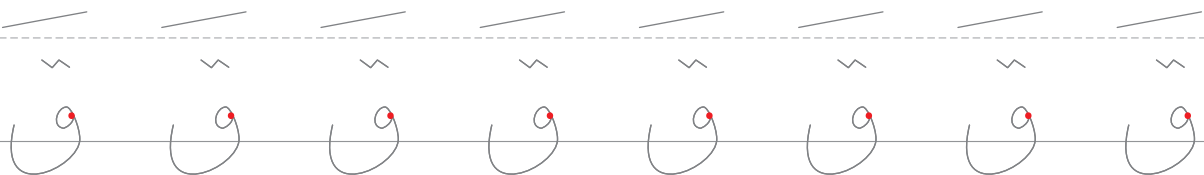
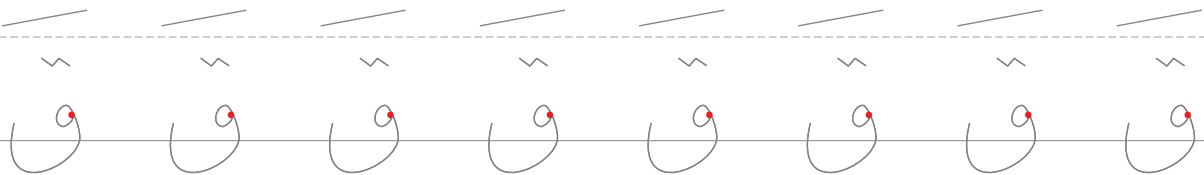



20

التَّارِيخُ:

العُمْرُ:

الاسْمُ:

2 لَوْنٌ بِالْأَلْوَانِ الْجَمِيلَةِ

1 مَرَّرِ الْقَلَمَ بِاتِّجَاهِ السَّهْمِ

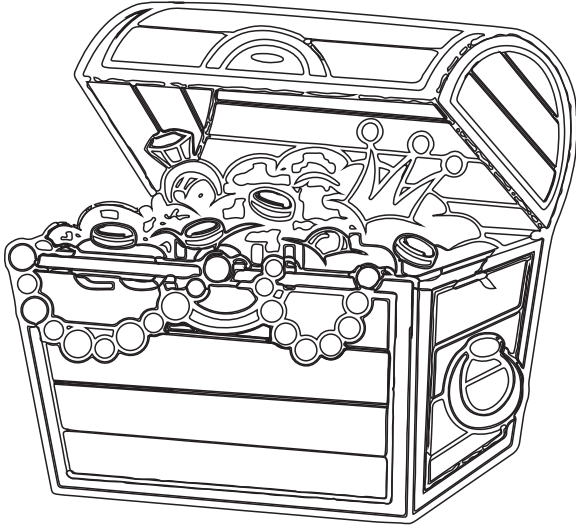

كَنْزٌ

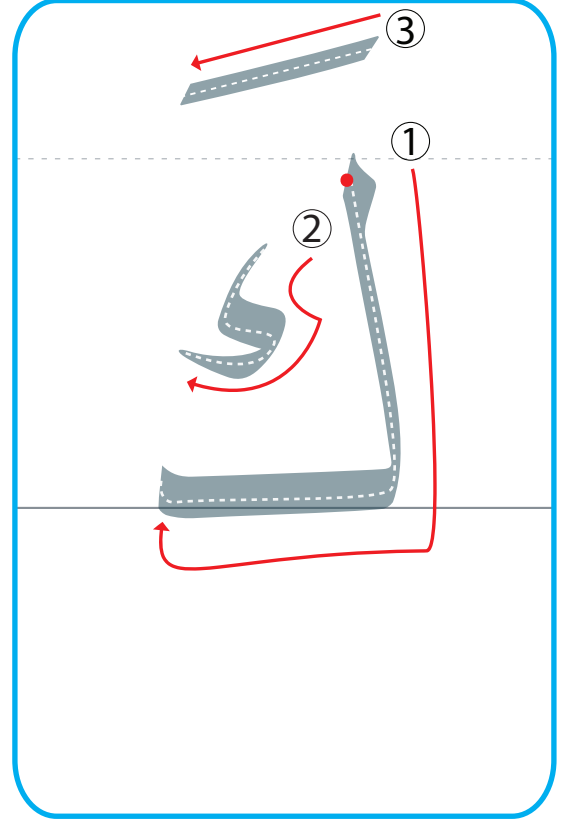

3 أَكْتُبِ الْحَرْفَ بِالشَّكْلِ الصَّحِيحِ

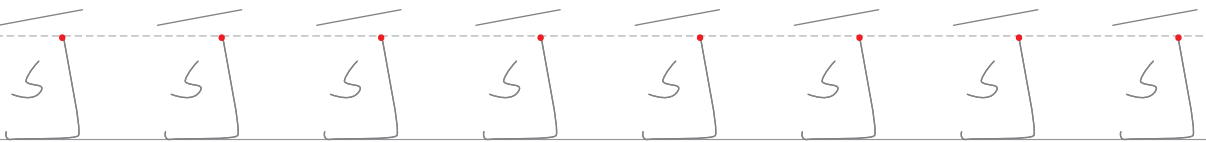
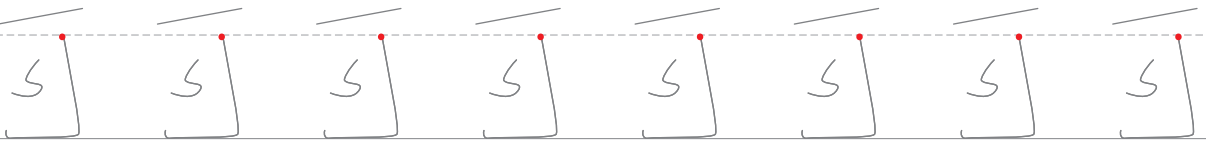



20

التَّارِيخُ:

العُمْرُ:

الاسْمُ:

2 لَوْنٌ بِالْأَلْوَانِ الْجَمِيلَةِ

1 مَرَّرِ الْقَلَمَ بِاتِّجَاهِ السَّهْمِ

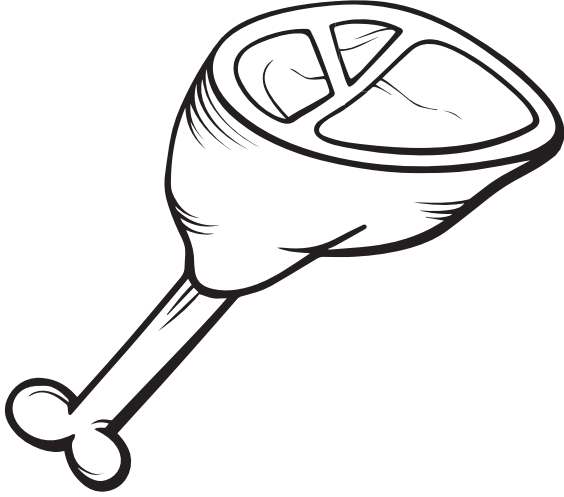

لَحْمٌ

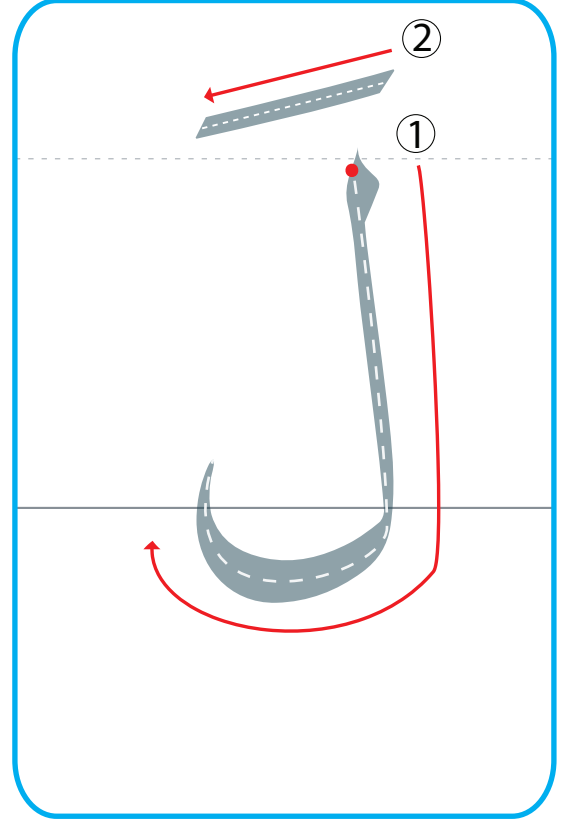

3 أَكْتُبِ الْحَرْفَ بِالشَّكْلِ الصَّحِيحِ

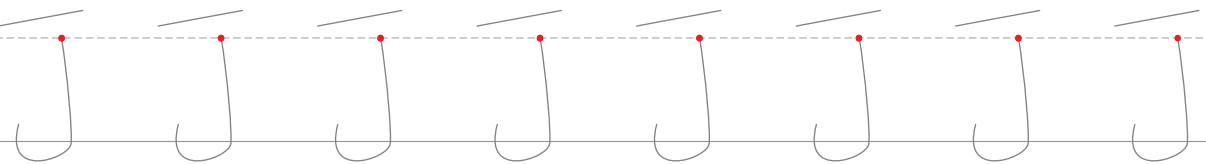
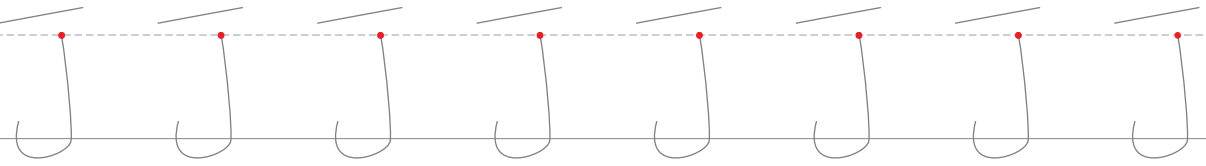

حَرْفُ المِيمِ مَعَ الفَتْحَةِ



حُرُوفِي مَعَ الفَتْحَةِ

20

/ /

التَّارِيخُ:

العُمْرُ:

الاسْمُ:

2 لَوْنٌ بِالألوانِ الجَمِيلَةِ

1 مَرِّرِ القَلَمَ بِاتِّجَاهِ السَّهْمِ

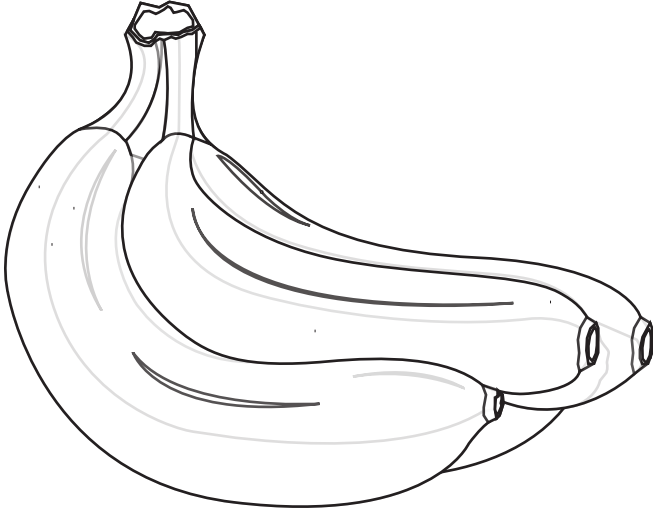

مَوْز

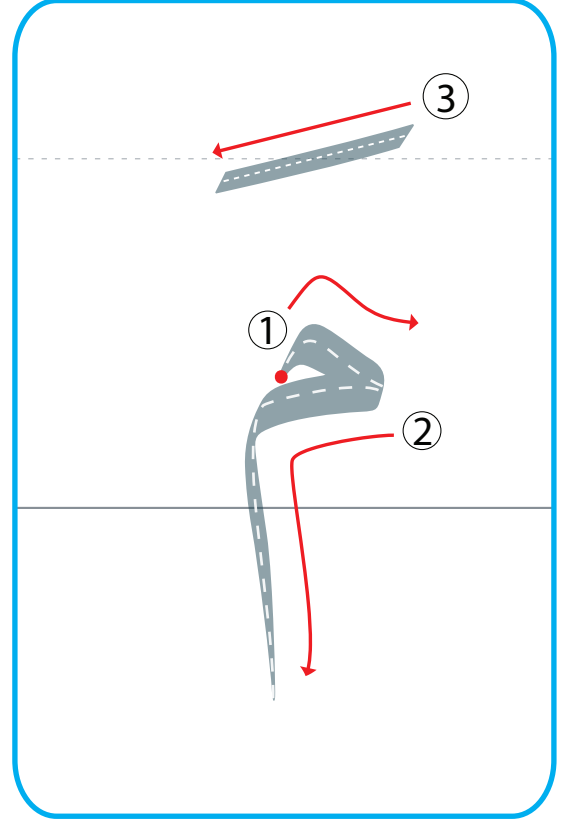

3 أَكْتُبِ الحَرْفَ بِالشَّكْلِ الصَّحِيحِ

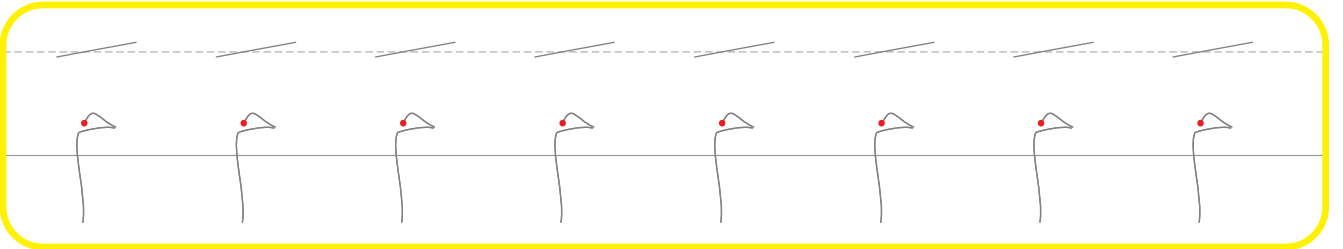
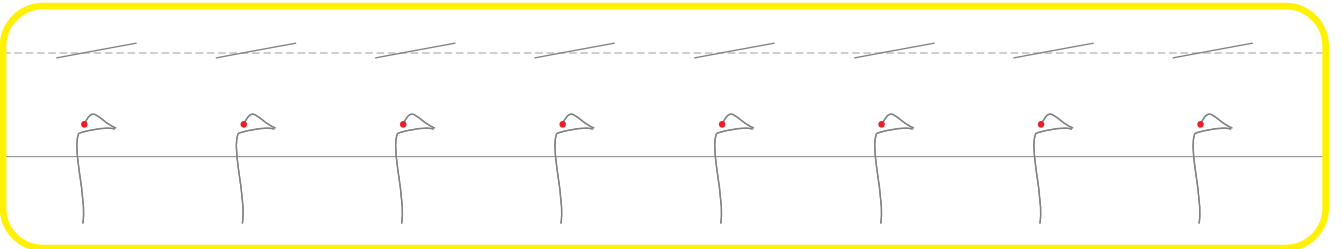



20

/ / التَّارِيخُ:

العُمْرُ:

الاسْمُ:

2 لَوْنٌ بِالْأَلْوَانِ الْجَمِيلَةِ

1 مَرَّرِ الْقَلَمَ بِاتِّجَاهِ السَّهْمِ

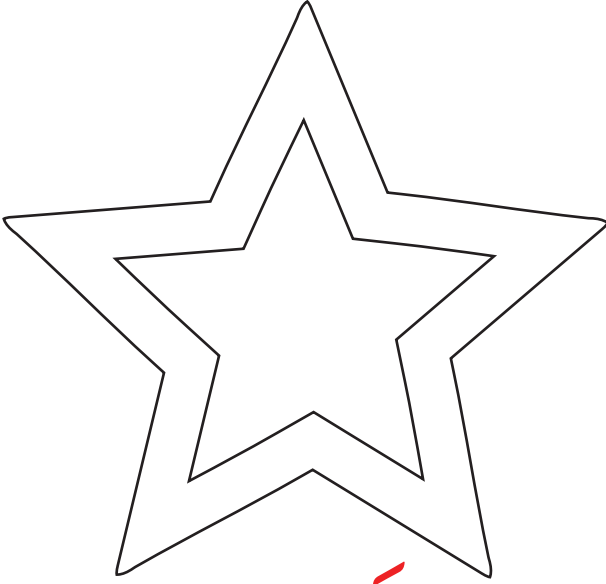

نَجْمَةٌ

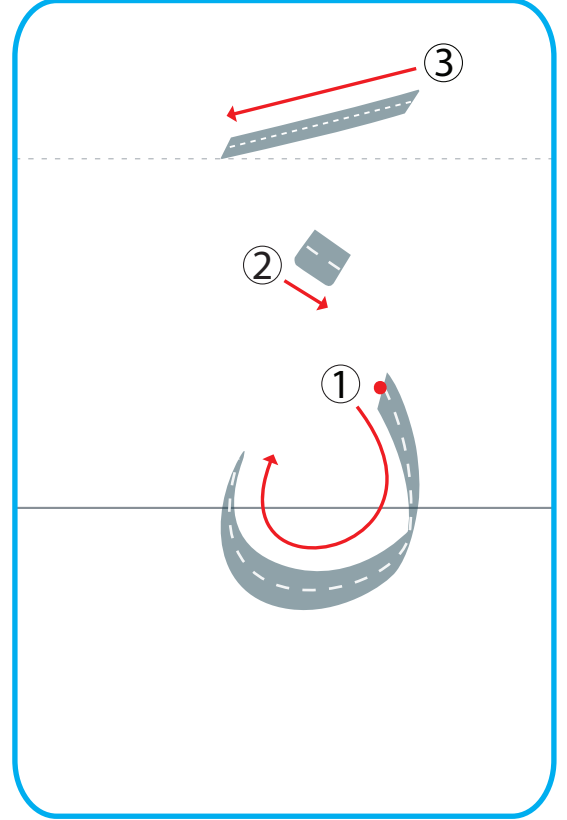

3 أَكْتُبِ الْحَرْفَ بِالشَّكْلِ الصَّحِيحِ

ن ن ن ن ن ن ن ن

ن ن ن ن ن ن ن ن

• • • • • • • •

حَرْفُ الْهَاءِ مَعَ الْفَتْحَةِ



حُرُوفِي مَعَ الْفَتْحَةِ

20

التَّارِيخُ:

العُمْرُ:

الاسْمُ:

2 لَوْنٌ بِالْأَلْوَانِ الْجَمِيلَةِ

1 مَرِّرِ الْقَلَمَ بِاتِّجَاهِ السَّهْمِ

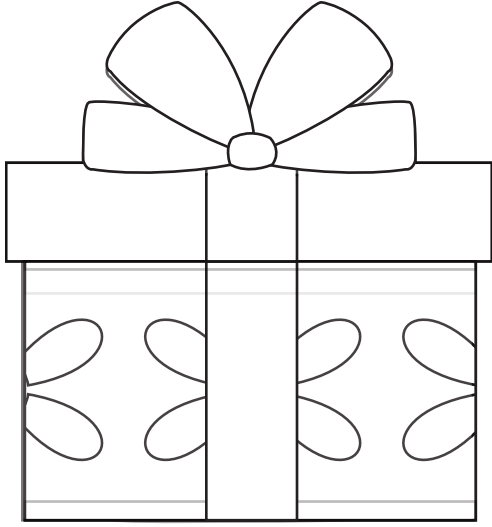

هَدِيَّةٌ

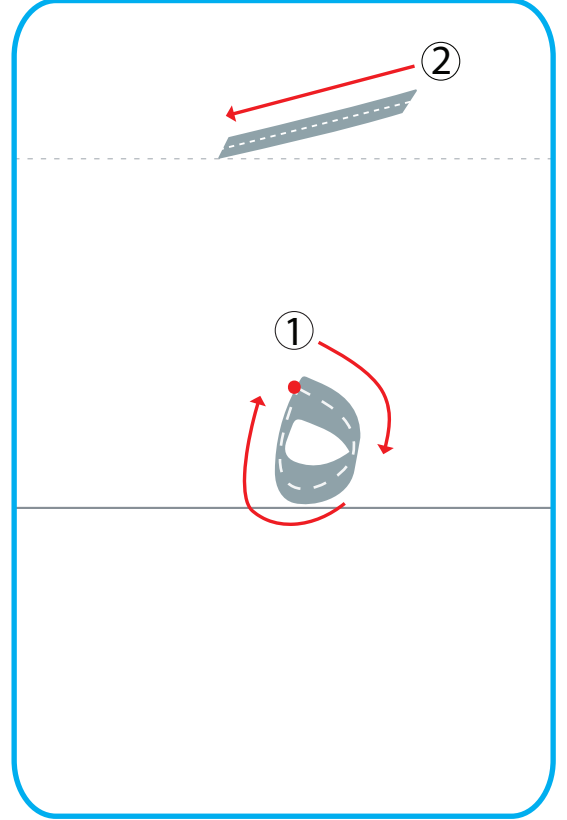

3 أَكْتُبِ الْحَرْفَ بِالشَّكْلِ الصَّحِيحِ

ه ه ه ه ه ه ه ه ه

ه ه ه ه ه ه ه ه ه

.



20

/ / التَّارِيخُ:

العُمْرُ:

الاسْمُ:

2 لَوْنٌ بِالْأَلْوَانِ الْجَمِيلَةِ

1 مَرَّرِ الْقَلَمَ بِاتِّجَاهِ السَّهْمِ

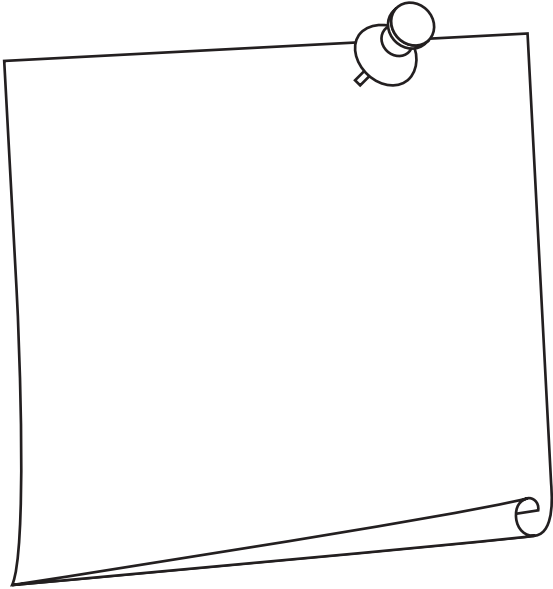

وَرَقَةٌ

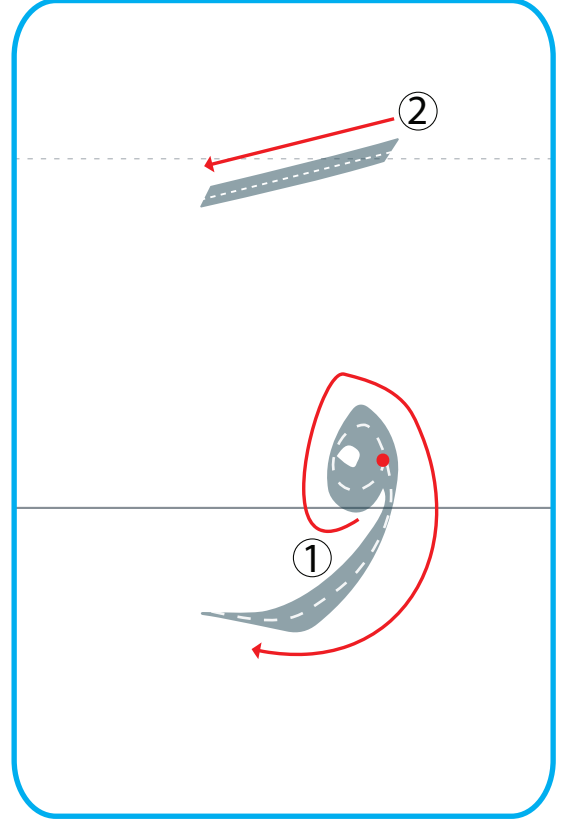

3 أَكْتُبِ الْحَرْفَ بِالشَّكْلِ الصَّحِيحِ

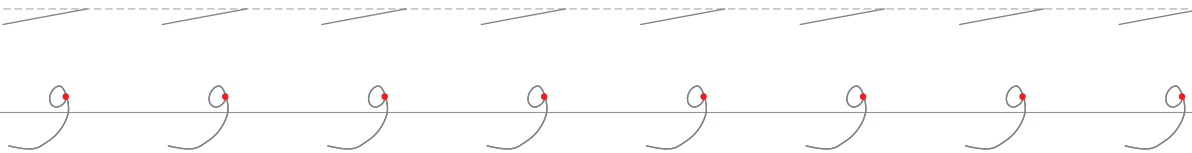
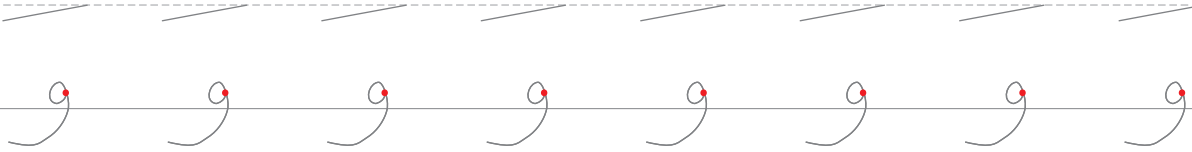



20

التَّارِيخُ:

العُمْرُ:

الاسْمُ:

2 لَوْنٌ بِالْأَلْوَانِ الْجَمِيلَةِ

1 مَرَّرِ الْقَلَمَ بِاتِّجَاهِ السَّهْمِ

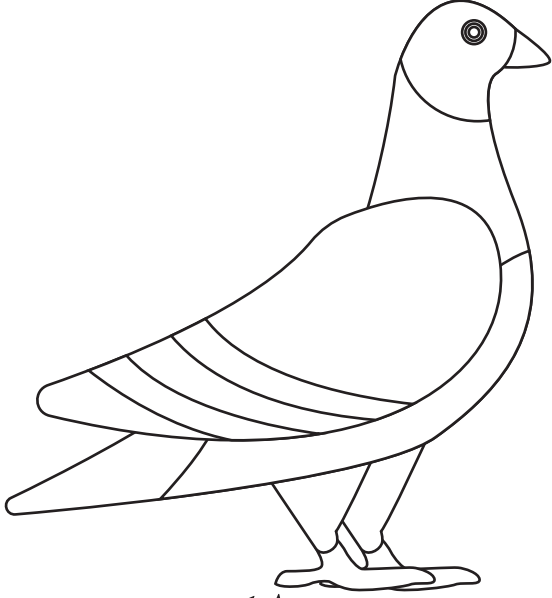

يَمَامَةٌ

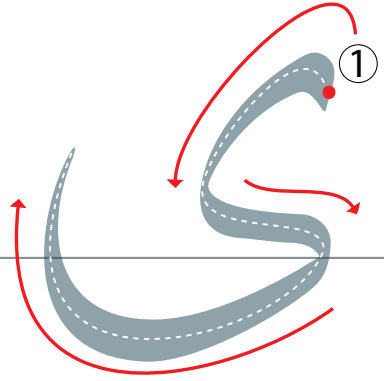
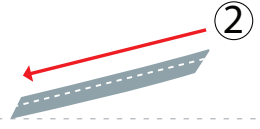

3 أَكْتُبِ الْحَرْفَ بِالشَّكْلِ الصَّحِيحِ

ي ي ي ي ي ي ي ي

ي ي ي ي ي ي ي ي

• • • • • • • •