

Light Metals 2011

**ALUMINUM REDUCTION
TECHNOLOGY**

Cells Process Modeling

SESSION CHAIR

Marc Dupuis

GéniSim Inc.

Jonquière, Canada

DEVELOPMENT AND APPLICATION OF AN ANSYS BASED THERMO-ELECTRO-MECHANICAL COLLECTOR BAR SLOT DESIGN TOOL

Marc Dupuis

GéniSim Inc.

3111 Alger St., Jonquière, Québec, Canada, G7S 2M9

marc.dupuis@genisim.com

Abstract

After the successful development and application of an ANSYS based thermo-electro-mechanical anode stub hole design tool [1], an ANSYS based thermo-electro-mechanical collector bar slot design tool has been developed. Since the average contact resistance at the cast iron/cathode block interface is higher than the contact resistance at the cast iron/anode carbon interface, the potential for mV savings is even greater.

A demonstration model has been developed and used to study different collector bar slot configurations. The results obtained are presented.

Introduction

Contrary to the anode stub hole cast iron/carbon contact resistance problem, issues related to the cathode collector bar slot cast iron/carbon contact resistance have not been the subject of numerous publications in recent years.

It is a bit strange in a way because since the introduction of 100% graphitized cathode blocks, the voltage drop due to the contact resistance represents more in percentage of the total cathode lining drop than the voltage drop due to the contact resistance represents in the total anode voltage drop. There should be room for further reduction of that lining voltage drop like it is the case for the anode voltage drop by using the thermo-electro-mechanical (TEM) collector bar design tool to optimize the cathode slot design.

Unfortunately, again contrary to the anode case [2], it is not so easy to instrument the cathode lining in order to measure the contact resistance between the cast iron and the cathode carbon in the collector bar slot. Boivin [3] did instrument a collector bar (see Figure 1 and 2 of his 1985 TMS paper) and indirectly measured $6.6 \mu\Omega\text{m}^2$ assuming a uniform contact resistance value on all three contact interfaces.

Yet as argued by Sorlie [4], since contact resistance is very dependent upon applied pressure, one has to assume that most of the current passes through the vertical cast iron-to-carbon contact interfaces but there are no references on experimental measurements that will confirm that.

This is the reason why over the last 20 years, per lack of measurements to confirm what is the true situation, when developing a thermo-electric cathode lining model, the author kind of arbitrarily assumed that the contact resistance on the top horizontal interface was twice the value of the contact resistance of the two vertical interfaces.

Of course, the development of the TEM eliminates the need to make this kind of arbitrary assumption by calculating the contact pressure and then the corresponding contact resistance value based on some temperature and pressure dependant relationship [5].

ANSYS® version 12.0 based TEM cathode collector bar slot model development

As for the TEM anode stub hole design tool developed and presented last year [1], the TEM cathode collector bar slot model is based on the usage of ANSYS® SOLID226 3D thermo-electro-mechanical second order element together with CONTA174 and TARGE170 thermo-electro-mechanical contact pair elements. CONTA174 element supports the setup of a pressure and temperature TCC (thermal contact conductance) and ECC (electrical contact conductance) values through the %table% option.

Essentially, the only difference between the TEM anode stub model and the TEM cathode collector bar slot model is the topology which is quite easy to build and when needed to modify using ANSYS® parametric design language (APDL).

One particularity of both TEM models that was not described in last year paper [1] is the selection of the thermal expansion reference temperatures. Contrary to Richard [5] who is creating a model geometry that corresponds to the room temperature geometry and hence is incorporating an air gap between the cast iron and the carbon (anode carbon in his case), the model geometry in the present work was constructed without incorporating an air gap between the cast iron and the carbon corresponding to the geometry when the cast iron has solidified.

In order to do that and still be able to accurately calculate the contact pressure of the unit (either anode or cathode) in operation, the material reference temperatures to calculate the thermal expansion must be set differently than in Richard's model. In that model incorporating a room temperature air gap, the reference temperature of all materials is the room temperature while in the present model that does not incorporate a room temperature air gap, the reference temperature of the cast iron is its solidification temperature (T_s in Equation 2 of [6]). The reference temperature of the other materials (stub and anode carbon or collector bar and cathode carbon block) is the average temperature of those materials when the cast iron solidified (like T_a in Equation 1 of [6]; notice that Equations 1 and 2 in [6] assume that the effective anode carbon temperature at cast iron solidification is T_0 the ambient temperature which is a simplification not made in the present work).

Base case model

Figure 1 is showing the geometry of the base case model. It is a quarter cathode block model of a “single slot per block” design type. Actually, there are two collector bars per block because the block is 3.67 m long and the two bars are 2.175 m long each leaving a section without bar in the middle of the block. Those two collector bars have a square cross-section of 160 mm x 160 mm. The cathode block has also a square cross-section of 48 cm x 48 cm. The size of the collector bar slot is 176 mm of height leaving room for 16 mm of cast iron above the bar and on average 200 mm of width leaving 20 mm of cast iron on each side of the bar. Yet, because of the typical “V” shape of the vertical faces of the slot, the cast iron thickness actually varies from a minimum of 15 mm to a maximum of 25 mm. It is assumed that there is 28 such cathode blocks in a cell running at 300 kA, so the current in each bar is $300/28/2 = 5.36$ kA for a maximum current density in each collector bar of $5360/16/16 = 20.92$ A/cm².

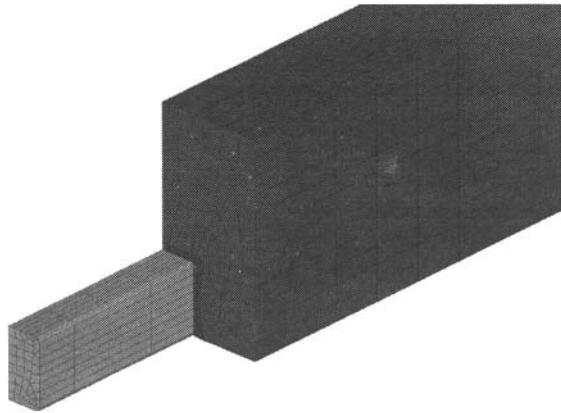

Figure 1: Mesh of the base case model

In a typical TE cathode side slice model [2], the collector bar and the slot are not represented in that much details but the full lining and potshell are also represented (see Figure 2). This is required in order to be able to accurately calculate the cathode heat loss. That calculation is not a requirement of the TEM cathode model, yet computation of the temperature is still required. Fortunately, it is possible to compute that temperature without having to represent the full lining by using appropriate boundary conditions (see Figure 3).

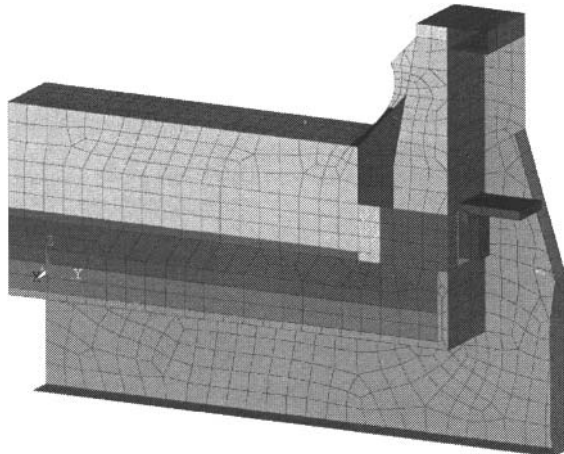

Figure 2: Mesh of a standard TE cathode side slice model

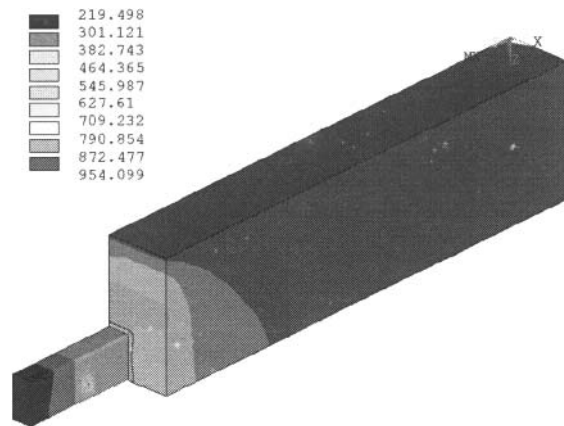

Figure 3: Temperature solution of the base case model

As a first step, the cathode voltage drop is calculated using constant user defined contact resistance values as in the TE model. Typical values of $4 \mu\Omega\text{m}^2$ for the vertical interface and $8 \mu\Omega\text{m}^2$ for the horizontal interface were selected (still using that arbitrarily factor of 2 between vertical and horizontal contact resistances). As presented in Figure 4, for setup, the model predicts a cathode lining drop of 212 mV.

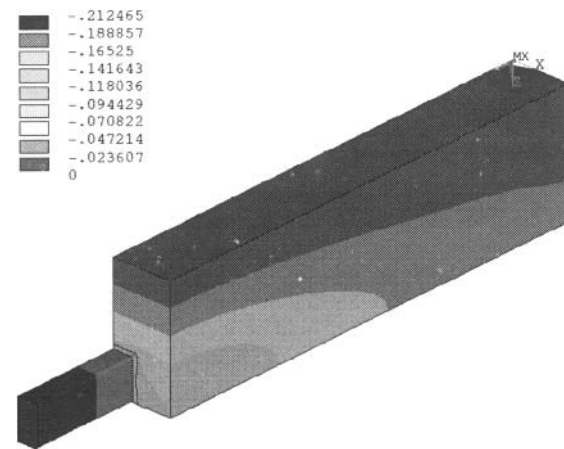

Figure 4: Voltage solution with constant contact resistance values

Figure 5 is presenting the resulting current density at the edge of the cathode block. Some current is travelling vertically straight down from the top of the slot into the top section of the cast iron. This may or may not be real, no measurement being available to confirm or disprove that. The only thing that is known is that this would be the current density, if the value of the horizontal contact resistance would be twice the value of the vertical contact resistance.

Assuming that the 4 and $8 \mu\Omega\text{m}^2$ were selected to match measured cathode lining drop, the next step is to activate the temperature- and pressure-dependent contact resistance property in the model and calibrate the model so that it can predict close to 212 mV of cathode lining drop. Many parameters could be used to do that calibration. The one selected in the present work is T_a the effective collector bar temperature at cast iron solidification: a value of 750 °C was required to get the results presented in Figure 6.

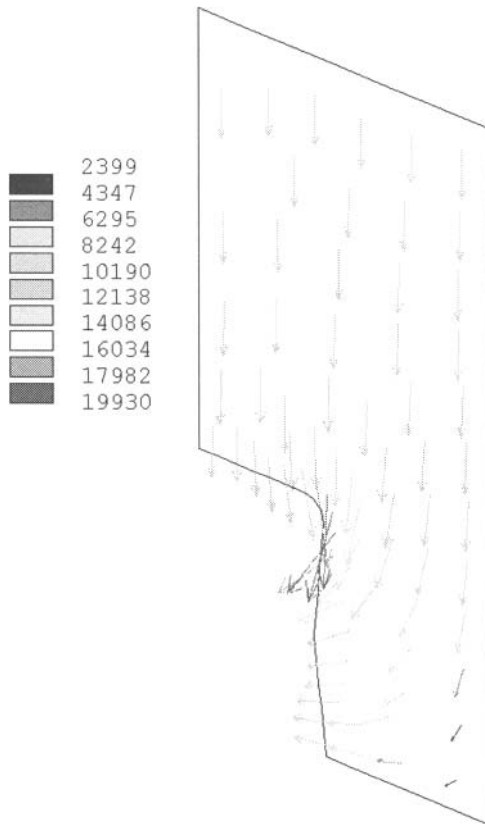

Figure 5: Current density with constant contact resistance values

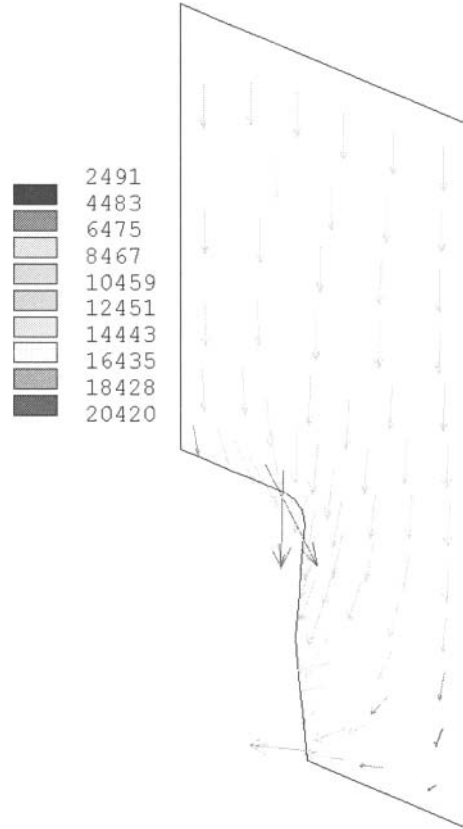

Figure 7: Current density with variable contact resistance values

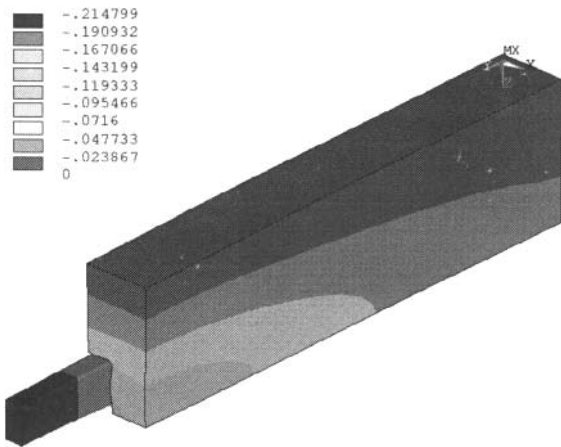

Figure 6: Voltage solution with variable contact resistance values

So after calibration, the total cathode voltage drop prediction is close of being equal. But is the current density in the cathode block edge very different now? In order to answer that question, one only has to compare Figure 5 with Figure 7 presenting the current density solution obtained while using the temperature and pressure contact resistance property in the model.

It is clear that far less current enters from the top horizontal interface section. Now at least that tool can be used to investigate how to improve the situation.

Base case model, finer mesh

At this point, the model can be considered as validated since after calibration it is reproducing “measured” data. Yet, before starting to use the model as a design tool, it is also a good idea to test the model mesh sensitivity. The initial model is using a mesh that is much finer than the one of a standard TE cathode side slice model. But is the mesh fine enough to well represent the contact behavior?

To answer that question, a second mesh was developed. The initial mesh has 2592 3D solid elements and 1065 2D contact elements. It took only 566 seconds to solve on a 64 bits dual core Intel Centrino T 9300 Cell Precision M6300 portable computer running ANSYS® 12.0 version. The refined mesh has 10924 3D solid elements and 2760 2D contact elements. Solving the same problem with that refined mesh took 5225 seconds, so about ten times more than solving for the initial mesh.

The predicted cathode lining voltage drop is identical; so as far as the accuracy of the solution is concerned the initial mesh is clearly good enough. But the current density vectors presented in Figure 8 indicate that the finer mesh is helping a lot in the interpretation of the results. In Figure 8, the current is concentrating itself in three points where the contact pressure is concentrated.

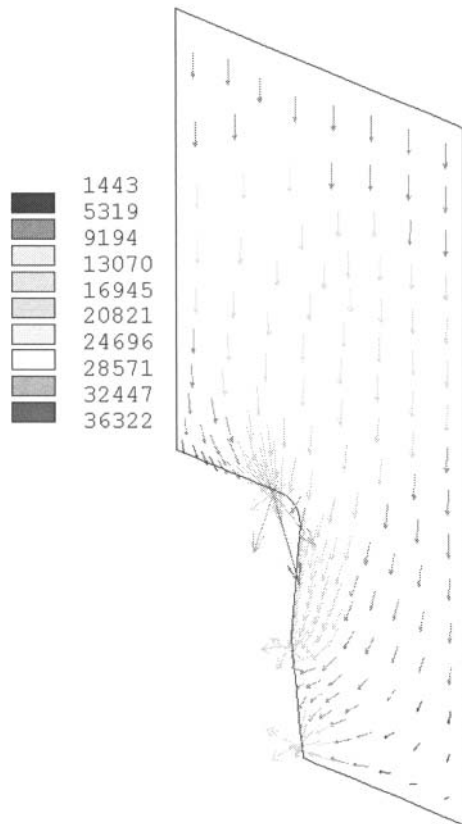

Figure 8: Current density with variable contact resistance values finer mesh version

Same slot, higher collector bar

As it is not clear at this point if having any cast iron on top of the bar is useful, the aim of the first design change run is to test that. In this run, the 160 mm wide x 160 mm high collector bar is replaced by a 160 mm wide x 174 mm high collector bar leaving only 2 mm of cast iron above the bar (completely eliminating the cast iron above the bar would require a new model topology). The new model geometry is presented in Figure 9.

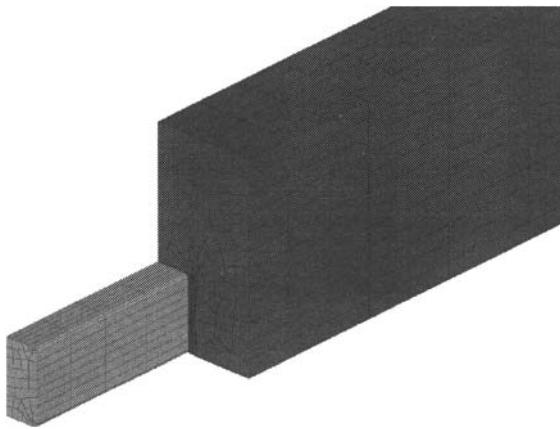

Figure 9: Mesh of the same slot, higher collector bar case

The model predicts 206 mV using the constant contact resistance setup and 197 mV while using the temperature- and pressure-dependent contact resistance setup. So a saving of about 6 mV came from the fact that there is less voltage drop in the collector bar section outside the cathode block. Then, according to the TEM model, an additional reduction of about 9 mV can be expected due to the improved contact in the top horizontal interface section that resulted from the decrease of the cast iron thickness and hence the increase of the contact pressure.

Since it is not expected that a direct steel collector bar/cathode carbon block interface contact would behave any differently than a cast iron/cathode carbon block contact, this run is really testing the option of not putting any cast iron above the bar. Figure 10 shows the corresponding current density in the cathode block edge.

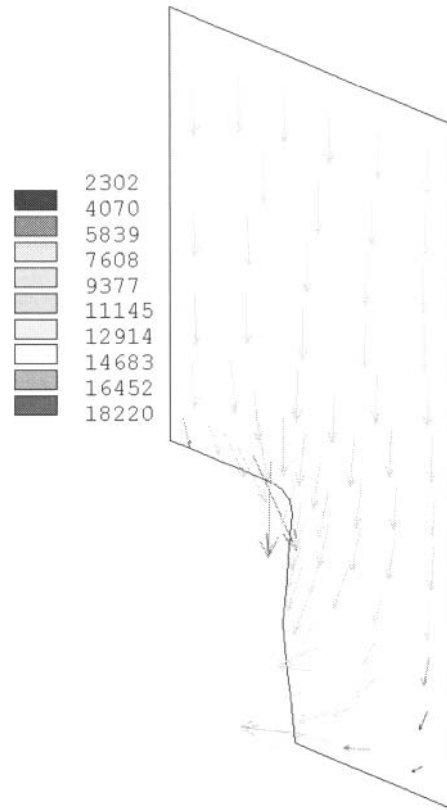

Figure 10: Current density with variable contact resistance values for the same slot, higher collector bar case

Same slot, higher and wider collector bar

It is clear that the maximum vertical interface contact pressure will be achieved using the minimum cast iron thickness possible. This reduction must be done by increasing the collector bar section, not by decreasing the collector bar slot width because, inside the block, the effective collector bar section is the slot section as the current travels in the cast iron too. So this second design change run is testing a 174 mm wide x 174 mm high collector bar using the same collector bar slot leaving on average only 13 mm of cast iron. Figure 11 is presenting the corresponding model geometry.

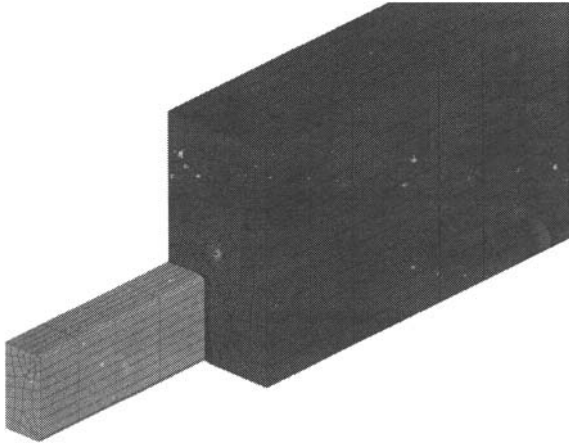

Figure 11: Mesh of the same slot, higher and wider collector bar case

The model predicts 199 mV using the constant contact resistance setup and 195 mV while using the temperature- and pressure-dependent contact resistance setup. So a saving of about 13 mV came from the fact that there is less voltage drop in the collector bar section outside the cathode block. Then, according to the TEM model, an additional reduction of about 4 mV can be expected due to the improved contact, which is less than the previous case.

New slot design, higher and wider collector bar

Next, the most difficult thing is to come up with a collector bar slot design change that improves the contact and hence decreases the cathode lining drop. As a simple example, it is possible to study the impact of changing the position of the minimum thickness area of the slot. In this third design change run, that position is moved up from the mid point position to the top quarter point position still keeping the bigger 174 mm x 174 mm collector bar and still keeping the same average 13 mm cast iron thickness on the two side sections (see Figure 12).

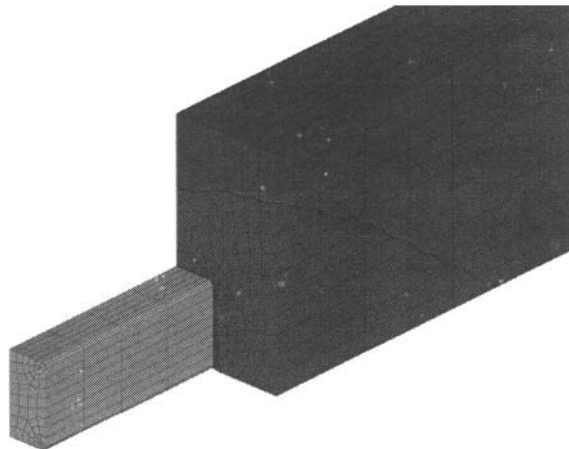

Figure 12: Mesh of the new slot design, higher and wider collector bar case

The model obviously still predicts 199 mV using the constant contact resistance setup but now predicts 192 mV while using the temperature- and pressure-dependent contact resistance setup. So this is an additional decrease of 3 mV for a total of 7 mV decrease

due to the improved contact, in addition of the 13 mV reduction due to the increase of the collector bar section: hence a grand total of 20 mV reduction over the base case value for a reduction of 9.4% while still keeping the same collector bar slot aspect ratio and cross-section.

New collector bar aspect ratio

This of course is only the beginning of a multitude of new collector bar slot configurations that can now be tested using this new TEM collector bar slot design tool, like testing if a “W” profile would provide a better contact than the standard “V” shape profile. Yet, testing a “W” profile would require a little change in the model topology while there are still many new cases that can be analyzed using the current model topology.

Per example, it is well known that a rectangular collector bar cross-section is more efficient than a square collector bar cross-section. But it would be interesting to see if the TEM collector bar slot model confirms this. In this forth design change, the 174 mm x 174 mm collector bar is replaced by a 144 mm wide x 210 mm high collector bar keeping about the same cross-section by significantly changing the aspect ratio. Figure 13 is presenting the resulting model geometry still keeping 13 mm of average cast iron thickness on the sides and the minimum thickness area at the upper quarter point.

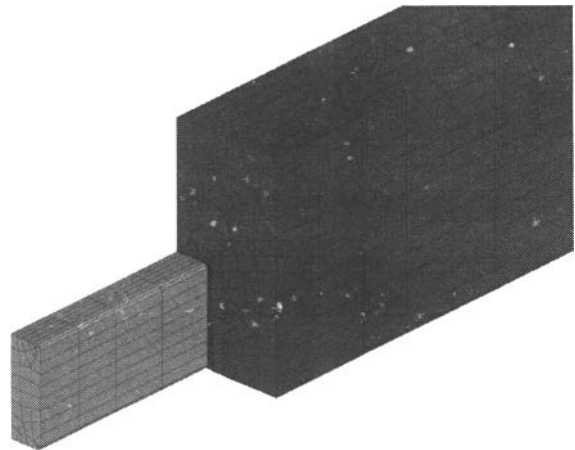

Figure 13: Mesh of the new collector bar aspect ratio case

The model predicts 192 mV using the constant contact resistance setup and 187 mV while using the temperature- and pressure-dependent contact resistance setup. It is fair to compare those results with the ones of the previous case as only the collector bar aspect ratio has been changed. It is also fair to compare the two constant contact resistance results and the two variable contact resistance results between themselves.

According to the constant contact resistance model setup with an arbitrarily ratio of 2 between the horizontal and the vertical contact resistance, that change of aspect ratio should reduce the cathode voltage drop by 7 mV. According to the variable contact resistance model setup, that change of aspect ratio should reduce the cathode voltage drop by 5 mV. So there is no strong disagreement between the two versions of the model which is a good thing for the user of the standard TE cathode side slice model. Of course, changing the collector bar aspect ratio will also affect the lining life so maybe in that context this design change is not an improvement!

Two collector bar slots per block

It is also well known that it is better to use two collector bar slots per block instead of one. So for this fifth design change, the single 174 mm x 174 mm square collector bar has been replaced by two 87 mm wide x 174 mm high rectangular collector bars. The average cast iron thickness on the two sides of the two collector bars has been decreased to 11.5 mm which adds up to 46 mm of cast iron as opposed to a total of 26 mm in the single collector bar slot per block design. Figure 13 is presenting the resulting model geometry. That it is still the same model topology but this time the model represents 1/8 of a full cathode block instead of 1/4 as in all the previous cases. Typically, the two collector bar slots are located a bit closer to the block centerline than the two block quarter points in order to have thicker carbon wings, but it is not possible to test this case using the current model topology of course.

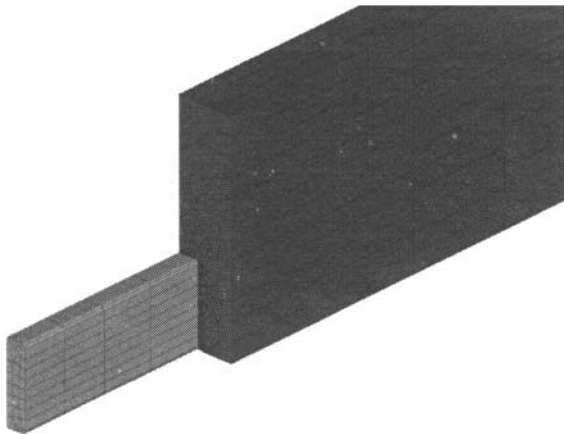

Figure 14: Mesh of the two collector bar slots per block case

The model predicts 178 mV using the constant contact resistance setup and 172 mV while using the temperature- and pressure-dependent contact resistance setup.

So as far as the constant contact resistance version of the model is concerned, replacing a single 174 mm x 174 mm collector bar by two 87 mm x 174 mm should result in a reduction of 21 mV while the variable contact resistance version of the model is predicting a reduction of 20 mV. So the two versions of the models are in fairly good agreement.

Conclusions

An ANSYS® version 12.0 based fully coupled TEM collector bar slot design tool has been successfully developed and is now available to the whole aluminium industry through GeniSim Inc.

The ANSYS® based APDL model is parametric, which means that for a given model topology, it is possible almost instantaneously to edit the APDL model input file to change the model geometry and submit another run.

The finer mesh quarter block model presented here solves in only around 5200 CPU seconds on a 64 bits dual core Intel Centrino T 9300 Cell Precision M6300 portable computer running ANSYS® 12.0 version. So this parametric ANSYS® based TEM collector bar slot model is a very efficient tool to study alternative collector bar and collector bar slot design.

A very quick design optimization study has revealed that it is possible to reduce the cathode lining drop of a typical single collector bar slot per block design having a square collector bar section of 160 mm x 160 mm by 40 mV or about 19%. This is done by keeping the same amount of carbon above the collector bar by shifting to a double collector bar slots per block design. This design is obtained by removing the cast iron above the bars with an increase of the bar height while keeping the same collector bar slot height and also reducing the cast iron thickness on the bar sides by increasing the bar width while keeping the same slot width.

It was also demonstrated that changing the collector bar slot profile design had some influence on the cathode lining drop. Performing a true collector bar slot profile optimization study would have required the development of a multitude of alternative model topologies which was not done in the present study.

References

1. M. Dupuis, "Development and Application of an ANSYS® Based Thermo-Electro-Mechanical Anode Stub Hole Design Tool", in *Proceedings of TMS Light Metals*, (2010), 433-438.
2. M. Dupuis and C. Fradet, "Using ANSYS® Based Aluminum Reduction Cell Energy Balance Models to Assist Efforts to Increase Lauralco's Smelter Productivity", *Proceeding of the ANSYS® 8th International Conference*, volume 2, 2.233-2.240, (1998).
3. R. F. Boivin, P. Desclaux and J. P. Huni, "Cathode Collector Bar Temperature and Current Pickup:", in *Proceedings of TMS Light Metals*, (1985), 625-635.
4. M. Sorlie and H. Gran, "Cathode Collector Bar-to-Carbon Contact Resistance", in *Proceedings of TMS Light Metals*, (1992), 779-787.
5. D. Richard, "Conception des tourillons d'anode en usage dans une cuve de Hall-Héroult à l'aide de la méthode des éléments finis", *M.Sc. Thesis, Université Laval, Québec, Canada*, (2000).
6. D. Richard, P. Goulet, O. Trempe, M. Dupuis and M. Fafard, "Challenges in Stub Hole Optimization of cast iron rodded anodes", in *Proceedings of TMS Light Metals*, (2009), 1067-1072.