

HEAT RECOVERY FROM ALUMINIUM REDUCTION CELLS

Yves Ladam¹, Asbjørn Solheim², Martin Segatz³, and Odd-Arne Lorentsen⁴

¹ SINTEF Energy; P.O. Box 4761 Sluppen, NO-7465 Trondheim, Norway

² SINTEF Materials and Chemistry; P.O. Box 4760 Sluppen, NO-7465 Trondheim, Norway

³ Hydro Primary Metal Technology; Koblenzer Str. 122, D-41468 Neuss, Germany

⁴ Hydro Primary Metal Technology; P.O. Box 1128, NO-3905 Porsgrunn, Norway

Key words: Heat recovery; Electricity Production; Energy Consumption; Productivity

Abstract

About half of the energy spent in aluminium electrolysis is lost as heat. A preliminary study concerning the possibilities of recovering part of that heat was carried out, primarily focusing on electrical power production. The three main heat sources (cathode sides, anode yokes, and gas) were combined in different ways, using different types of power cycles. The potential for electric power production is significant (up to 9 percent of the total consumption). The two most promising families of power cycles appear to be 1) distributed open Brayton cycle based on a turbo charger and 2) centralised power production with a Rankine cycle. The temperature and amount of heat available in the anode match well with the heat from the sides, while the potential of integrating the flue gas is limited. The main aims in energy recovery may be increased productivity or reduced energy consumption, which gives different strategies for heat collection.

Introduction

Since the invention of the Hall-Héroult process in 1886, there have been steady and long-lasting trends towards larger electrolysis cells, increased current efficiency, and lower specific energy consumption. Although the main principles in the process remain unchanged, it is fair to say that the difference between the first commercial cells in the 1890s and today's standard is comparable to the development of automobiles in the same period. However, during the last few decades, the trends towards higher current- and energy efficiencies have been gradually replaced by a trend towards higher productivity; in particular, by amperage increase in existing potlines (capacity creep). Besides reflecting the economical benefits by capacity creep, this also illustrates the increasing challenges in further reduction of the specific energy consumption. However, there is no reason to believe that the energy costs will become lower in the following decades. Therefore, it will become increasingly attractive to reduce the net amount of energy used for aluminium production by utilising the waste heat for electricity production or other purposes.

In any new cell designs, as well as when introducing modifications in existing electrolysis cells, the energy balance is of primary concern. This involves maintaining the protective layer of frozen bath at the sideling. Increasing amperage inevitably leads to more ohmic heating, and sooner or later, one will face the scenario that the only way of achieving increased amperage is to

get rid of the heat by active cooling of the cell. On the other hand, lowering the energy consumption requires lower heat loss. This requires a better insulated cell which gives higher temperatures in the lining, and active cooling may be necessary to protect vital components. As will be substantiated in the present paper, heat recovery and utilisation of heat may be instrumental in enabling reduced energy consumption as well as further capacity creep.

Even though there is no tradition for heat recovery and utilisation of heat from aluminium electrolysis cells, some patents have been filed. Newer patents comprise cooling by placing heat exchangers in the cell wall^[1,2] as well as active cooling of the anode yokes^[3]. The application of a heat exchanger in the dusty and contaminated raw gas from the cell has also been addressed^[4]. Moreover, systems for driving the thermal medium through the heat exchanger^[5] and utilisation of the heat^[6] have been patented. However, a large amount of development work is required to realise a cell with significant heat recovery.

Although all systems for heat recovery and utilisation will have some flexibility, the system must be designed to fulfil a primary purpose. The present work is based on a preliminary study where two extreme cases were considered; either aiming for maximum production, or aiming for minimum energy consumption. We focus on principles, challenges, and possibilities in heat collection from the cells, as well as utilisation of the recovered heat. Estimates concerning necessary infrastructure and cost are not part of the present work.

Methods and Equipment for Heat Utilisation

Thermodynamic Cycles

Thermodynamic cycles can be used to convert heat into work. The cycle always comprises compression, heating (internally or externally), expansion, and heat rejection. This can take place in three or more steps. A thermodynamic cycle is categorised according to how the different steps are performed (adiabatic, isobaric, *etc.*), and usually named after its inventor.

The most relevant cycles for utilisation of heat from aluminium cells are the Brayton cycle and the Rankine cycle. Principal sketches of these cycles are shown in Figure 1.

The Brayton cycle is a single phase gas cycle that is commonly used for high temperature applications (above 300-400 °C), like a gas turbine.

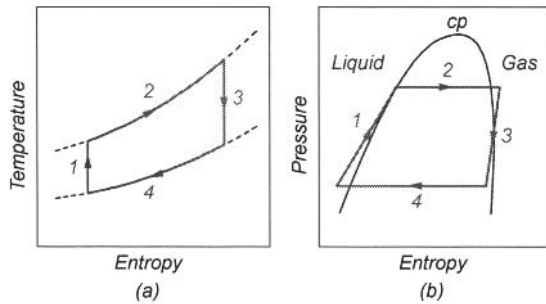

Figure 1. Schematic representation of two thermal cycles. a) – the basic Brayton cycle (dotted lines are isobars, cycle comprises gas only), b) – the basic Rankine cycle. 1 – compression, 2 – heating, 3 – expansion, 4 – heat rejection, cp – critical point.

The Rankine cycle implies a phase change. The dominating working fluid is water. However, for low temperature heat sources (below 300-400 °C), or for small installations (less than 3MWe) other media better adapted to the heat source can be used^[7]. There is an intense research activity in this field, particularly on the choice of working fluid^[8].

Heat Recovery Strategies

Depending on the heat source (amount of heat, temperature), several strategies for heat recovery can be considered, as illustrated in Figure 2.

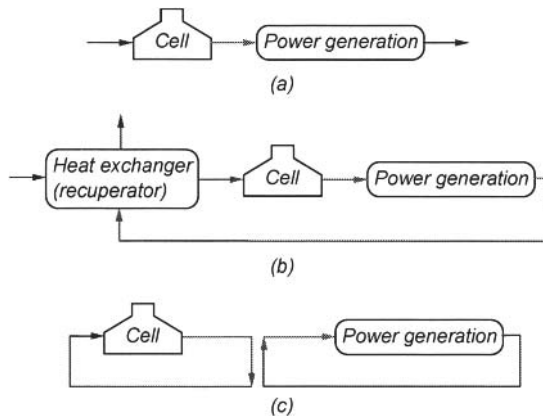

Figure 2. Some strategies for heat recovery. a – open loop, b – open loop with recuperator, c – closed loop.

In a simple open loop arrangement (Figure 2a), the working fluid is heated in the cell, expanded to produce power, and released to the atmosphere. Basically, only air can be used in this cycle, since production of steam from water as well as the use of flammable gases will be considered too risky in an aluminium plant. The temperature after the power generation is high, and it may be possible to apply a second power cycle to recover the waste heat (dual cycle).

In the open loop arrangement with recuperation (Figure 2b), the working fluid at the outlet from the power generator exchanges

heat with the incoming cold working fluid. In this mode, the working fluid can attain higher temperature in the cell (constant mass flow), or the mass flow can be increased at constant outlet temperature from the cell. Both solutions give higher efficiency, as compared to a simple open loop configuration.

The closed loop arrangement is illustrated in Figure 2c. In this case, the working fluid is not in contact with the cell. An intermediate closed loop recovers heat from the cell, and in this way, many working fluids can be considered. In this arrangement, the power cycle does not need to cool down the heat transfer fluid as much as possible, since the non-recovered heat is brought back to the cell. This allows for a better fit between the heat source and the power cycle. If the heat is to be transported a long distance, it may make sense to have an additional closed loop between the heat recovering loop (inert gas) and the working fluid. This intermediate loop can be based on thermal oil, which has high volumetric heat capacity, leading to small dimension piping and easy application of thermal insulation.

In general, the efficiency of electricity production by a thermal cycle increases with increasing temperature of the heat source. Still, high temperature operation is not always the most economical solution, since operation at high temperature requires expensive heat media, or it may lead to degradation of the medium.

Location of Power Cycle

Distributed Plant. Each cell or group of cells can have their own small power plant. The advantage is short distance between the heat source and the turbine, which gives small heat losses. The main drawbacks are higher cost and operating complexity of the plant. Assuming that there is 200 kW heat available from each cell at a temperature of 600 °C, the best power cycles will have efficiencies in the range 35-40 percent, corresponding to a potential production of up to 80 kWe per cell. Finding efficient equipment at a reasonable price will be challenging for such a small size class, even if heat from a few cells is combined.

Centralised Plant. At the other extreme, the heat from all the cells could be collected to serve a centralised power plant. Typical plants are organised in such a way that the flue gas from, e.g., 100 cells is treated in one dry scrubber, and the collection of heat could function in a similar manner. The potential power production is in the order of 10 MWe, and efficient components can be found for this size. The downside of this solution could be the cost and heat loss from the long pipes necessary for transporting the heat medium.

Assumptions for Power Cycle Calculations

Power cycle calculation and optimisation were performed using both *ProII* and *Excel*. For *ProII*, the equation of state was used with access to steam tables. For the *Excel* model, calculations were linked to the thermodynamic property calculator *REFPROP_8*. The following assumptions were made,

- 80 percent turbine efficiency (typical literature value^[9]).
- 70 percent pump efficiency (typical literature value^[9]).
- 10 °C minimum temperature difference in the heat exchangers.
- 5 °C minimum temperature difference in internal heat exchangers (recuperators).
- The lowest achievable condensation temperature is 20 °C.

- In calculations concerning heat recovery from the flue gas it was assumed that the lowest permissible temperature is 50 °C, due to the risk of surpassing the sulphuric acid dew point.
- Pressure drop in and heat loss from the piping were not accounted for.

Heat Collection. Implications in the Electrolysis Cells

A spreadsheet-based model was used to predict the implications of heat recovery on the electrolysis process itself. Although simplified, the model takes into consideration all known couplings in the aluminium electrolysis process, and the model also comprises an integrated model of the cell superstructure, gas ducts, dry scrubber, and fans. Earlier tests have proved that the predictions in the model generally are in line with measurements as well as with Hydro's other models.

All calculations shown in the present paper relate to a hypothetical modern 300 kA cell with 30 prebaked anodes. In the "base case", the cell voltage was assumed to be 4.15 V and the current efficiency was 94 percent, which gives a specific energy consumption of 13.16 kWh/kg Al.

Calculations were also made for two additional cases, aiming at minimising the specific energy consumption and aiming for increased production, respectively. In the former case, the outlet from the heat exchangers should have high temperature in order to ensure high power cycle efficiency. Not too much heat should be extracted from the cells however, since reduction of the specific energy consumption will be accompanied by reduced heat loss from the cells (unless the amperage is increased at the same time). On the other hand, when aiming for increased production, the main reason for having heat exchangers is to remove as much heat as possible from the interior of the cells, but the utilisation of the heat in a power cycle or for other applications may be less important.

It was assumed that measures were taken to decrease the electrical resistance in the cell, allowing either decreased cell voltage or increased amperage. The main data for the three cases is given in Table I, and the reasoning behind the differences will be discussed in the following.

Heat Collection from the Cathode

The cathode sides, including the cathode current collector bars, represent about 40 percent of the heat loss from an aluminium cell. The available temperature may be quite high; this can be exemplified by the potshell temperature, which is above 300 °C and sometimes close to 400 °C.

Minimum Energy Consumption. Cell operation relies on having a sufficiently thick layer of frozen electrolyte at the inner lining (sideledge). In order to reduce the heat flow, the cell must be operated at low superheat. In a modified cell with heat exchangers, the best technical solution seems to be a "hot" heat exchanger placed inside the cell close to the sideledge. By placing thermal insulation materials between the heat exchanger and the potshell, more heat will be collected. Moreover, the potshell will be protected against too high temperature. By having low superheat (difference between bath temperature and liquidus temperature) and a "hot" internal heat exchanger, it will still be possible to have a relatively small heat flux through the sideledge.

The main challenges with this concept will probably be related to the choice of materials. Ceramics can probably stand up to the

Table I. Energy balance for three cases. In the "minimum energy" and "maximum production" cases, the cell resistance was assumed to be lower than in the base case.

	Base case	Minimum energy	Maximum production
Amperage [kA]	300	300	340.5
Cell voltage [V]	4.150	3.794	4.150
Current efficiency [%]	94	94	94
EC, cell only [kWh/kgAl]	13.16	12.03	13.16
Air draught [Nm ² h ⁻¹]	6000	2000	2000
Effect in fans [kW/cell]	23.4	1.2	1.2
EC, including fans [kWh/kgAl] *)	13.41	12.04	13.17
Heat collected from the yoke [kW]	-	90	165
Heat collected from the cathode [kW]	195	140	290
Flue gas temperature [°C]	140.3	162.8	168.2
Yoke temperature [°C]	296	440	146
Cathode heat exchanger temperature	600	600	300

*) Neglected pressure drop in heat exchanger

temperature and chemical conditions, but they are permeable to sodium and fluorine-containing gases. Furthermore, ceramics are brittle, and the thermal shock resistance may be too low. On the other hand, it may prove difficult to find a metallic material that is chemically stable in such a harsh environment.

Maximum Production. When aiming for maximum production, the purpose with heat collection from the cathode is to obtain the highest possible heat flow through the side. This means that the sideledge should be thin (due to its relatively low thermal conductivity) and that the superheat should be high, leading to high heat flow through the ledge. A thin sideledge is also beneficial when introducing longer anodes for further amperage increase. In practice, however, it might be difficult to operate the cell with thinner sideledge than 5-10 cm, due to the trench formed at the metal-bath interface^[10].

High heat flow and a correspondingly steep temperature gradient in the sideledge may imply that the temperature at the heat exchanger will be low. This makes it difficult to utilise the heat efficiently. On the other hand, it will be easier to overcome the material challenges. By keeping the temperature low, it is possible that the vapour pressure of fluorides (NaAlF₄) will be acceptable low close to the heat exchanger. However, it has been found that the metallic potshell in aluminium cells may corrode due to the presence of fluorides^[11], and it appears that systematic studies concerning the corrosion behaviour of different metals in atmospheres containing NaAlF₄ have not been carried out.

The temperature difference across the sidelining is quite small, due to the high thermal conductivity of Si₃N₄-bonded SiC. Therefore, it is possible that almost the same amount of heat can be collected by placing the heat exchanger directly at the outside of the potshell, as compared with location inside the lining. The temperature will be limited by the permitted maximum temperature of the potshell, however. This is not necessarily a problem when the goal is increased production. By having the heat exchangers at the outside of the potshell, they will be available for inspection and repair or replacement during normal operation, which is impossible with heat exchangers on the inside.

To summarise; aiming for minimum specific energy consumption requires that the heat is collected at high temperature, in order to utilise it efficiently for power production. The heat flow out from

the cell should be limited, and it is necessary to operate the cell at low superheat. When aiming for maximum production, the most important issue is to get rid of the extra heat, which requires high superheat and thin sideledge, and the temperature in the heat exchanger will be lower. The difference between these extreme cases is illustrated in Figure 3. Clearly, one cannot obtain the best of both worlds at the same time.

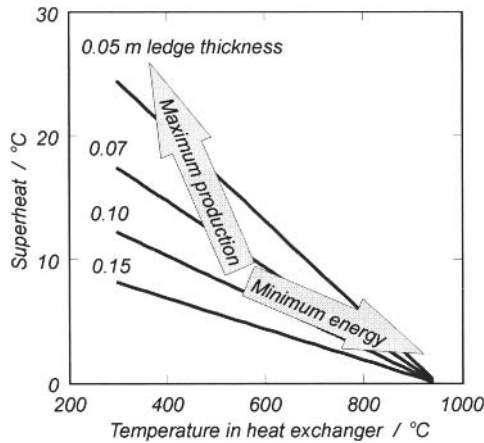

Figure 3. Relationship between superheat, sideledge thickness, and temperature in the heat exchanger. Thermal conductivity of ledge: $1.5 \text{ Wm}^{-1}\text{K}^{-1}$, bath-ledge heat transfer coefficient: $800 \text{ Wm}^{-2}\text{K}^{-1}$, ledge surface temperature: $950 \text{ }^\circ\text{C}$. The figure is based on the simplistic assumption of one-dimensional heat flux.

Heat Collection from the Anode

Tests with an air-cooled anode yoke was reported earlier [12]. The testing was performed with different pressure of compressed air and different air flow. The temperature of the air at the outlet from the yoke and the amount of heat removed were measured. It was found that by placing thermal insulation at the yoke/stubs and above part of the anode cover material, relatively large amounts of heat could be collected from the yoke at a reasonable high temperature (e.g., 4.3 kW per yoke at $320 \text{ }^\circ\text{C}$). A simple heat flux model for the anode was made, based on the measurements. This model was used in the construction of Figure 4, which shows the heat flux from the bath through the anode and the yoke temperature as a function of the amount of heat removed from the yoke.

The main challenges in cooling the anode yoke, at least when the collected heat is utilised, are related to connection and disconnection of the anodes during anode change, avoiding leakage of the heat medium, and making constructions at the anode stem that survive through the rodding shop without substantial repair and maintenance.

Minimum Energy Consumption. Although the thickness of the sideledge, and thereby the heat flux through the sides in principle can be varied, it seems likely that low energy operation also will be based on reducing the heat loss from the anode. This can be obtained by increasing the thermal insulation on top of the anode, e.g., by increasing the thickness of the anode cover material. This may give problems related to too high temperature at the bimetal

(or trimetal) plate between the anode rod and the yoke. However, by combining increased thermal insulation with cooling of the yoke, it is possible to achieve lower heat loss as well as acceptable low yoke temperature (“cooling for protection”); see Figure 4a.

In the “minimum energy” column in Table I, it was assumed that totally 90 kW is collected from the yokes at a temperature of approximately $440 \text{ }^\circ\text{C}$.

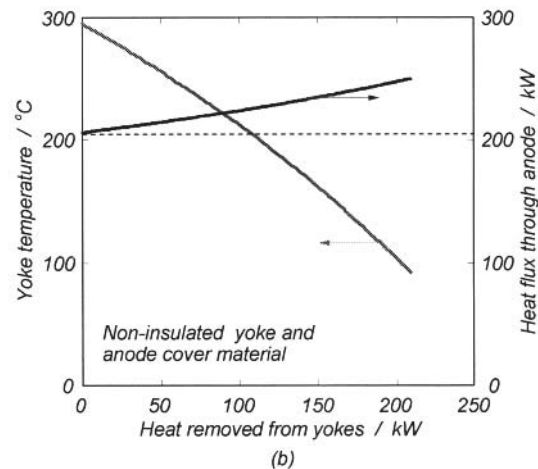
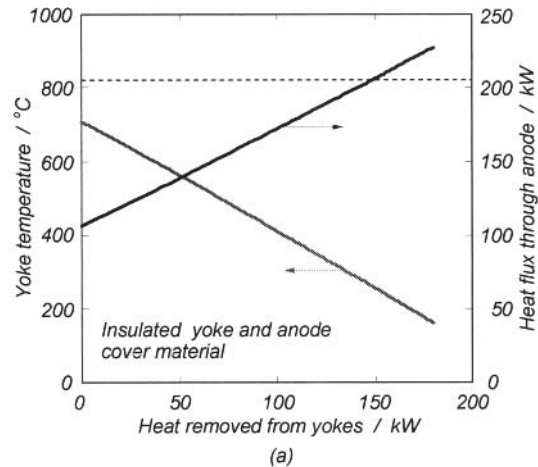

Figure 4. Yoke temperature and heat flux from the bath through the anode as a function of the amount of heat removed from the anode yokes (cell with 30 anodes). a – insulated anode yokes and anode cover material (in the test, the yoke and most of the anode were covered by 50 mm rock wool mats [12]), b – non-insulated anode yokes and anode cover material, The dotted line represents the heat flux in the normal situation without heat collection from the yokes.

Maximum Production. The heat loss from the anode can be increased by reducing the thickness of the anode cover. This may be risky however, since increased anode airburn may occur. It is known to be difficult to apply the anode cover material uniformly, especially at neighbouring anodes with very different age, i.e., different height.

The heat flow through the anode can also be increased by cooling the anode yoke, provided that the yoke and stubs are not thermally insulated, as shown in Figure 4b. As can be observed, although much heat can be collected from the yoke, the yoke temperature may become too low to utilise the heat. In the “maximum production” column in Table I, it was assumed that 165 kW is removed from the yokes, producing a yoke temperature of 146 °C.

The largest potential of cooling the anode might well be the possible reduction of the voltage drop by introducing new materials in the yoke. The current conducting parts of the yoke can be made of copper (even aluminium could be considered). The bimetal plate can be placed between the yokes and the stubs. The stubs can be made much shorter, and it might be possible to have a copper core in the stubs.

If the heat taken out from the yokes is not utilised for production of electricity, removal of heat by using a thermosiphon^[13] may be possible. This device can move heat from the yoke to the top of the anode stem by circulation of CO₂ in a closed circuit (flow driven by temperature-induced density difference, *i.e.*, no moving parts). It may also be possible to get rid of the heat by conducting it into the anode beam (which needs to be cooled to retain its structural strength and protect electronics and pneumatics in the superstructure). In this way, the previously mentioned problem with connecting and disconnecting the anode from an external cooling circuit will be eliminated.

Heat Collection from the Flue Gas

The flue gas (process gas and excess air) represents the far largest mass flow in the aluminium production, up to 100 tons of gas per ton aluminium. Typically, the gas temperature is in the range 120-160 °C. Heat collection from the flue gas is probably the energy recovery concept that has come closest to industrial implementation. There is only a weak coupling between the gas temperature above the crust and the heat loss from the top of the cell, and therefore, heat collection from the flue gas does not influence much on the cell performance or the choice of heat collection equipment. However, it is important to remember that heat collection from the anode gives less radiation from the anode yokes and stems, and thereby, less heat in the flue gas.

Figure 5 illustrates the relationship between gas draught, temperature, and amount of heat available for collection. As can be derived from the figure, collection of 180 kW from the anodes gives only about 100 kW reduction in the heat available in the flue gas. It should also be noted that, for the purpose of heat recovery, it will be beneficial to increase the gas temperature by reducing the draught. Reduced draught also leads to reduced fan power. It may also enable future CO₂ capture, since the gas will contain more CO₂ than the present 1 percent.

To enable lower draught, Distributed Pot Suction (DPS) is being developed by Hydro^[14]. This can be described as spot extracts placed above the feeder holes, and the devices allow reduction of the draught without compromising the hooding efficiency. The benefits are,

- A more concentrated gas suited for future CO₂ capture.
- Higher flue gas temperature; easier utilisation of the heat for power production or for CO₂ capture.
- Substantial savings in the fan power consumption.

The effect of reduced draught is shown in Figure 6. The fan power is proportional to the draught raised to a power of approximately 3. The main challenges with the application of DPS seem to be related to the high temperature. It may, therefore, be necessary to take measures for thermal protection of DPS units themselves as well as other equipment at the superstructure, such as electronics and pneumatics. It should be mentioned here that during an experiment at the Reference Centre in Årdal, 3-4 percent CO₂ was reached for a short period^[14]. Recent experiments have demonstrated that cells equipped with DPS can be operated with 1.5-2 percent CO₂ in the flue gas for weeks without encountering problems, which illustrates that this is a promising technology.

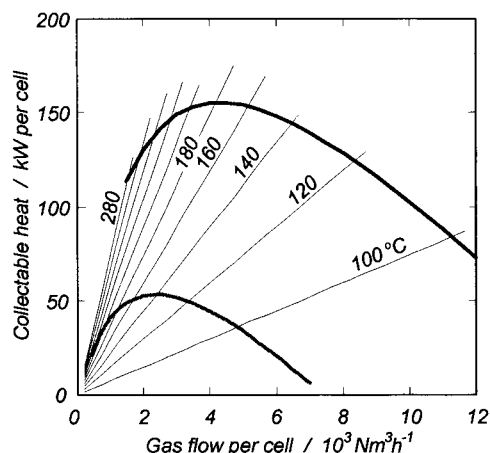

Figure 5. Generalised figure showing the amount of heat that can be collected from the flue gas as a function of the gas flow per cell by cooling from the flue gas temperatures given in the figure (straight lines) and down to 80 °C. Upper curve – standard operation, lower curve – 180 kW removed from the anode yokes.

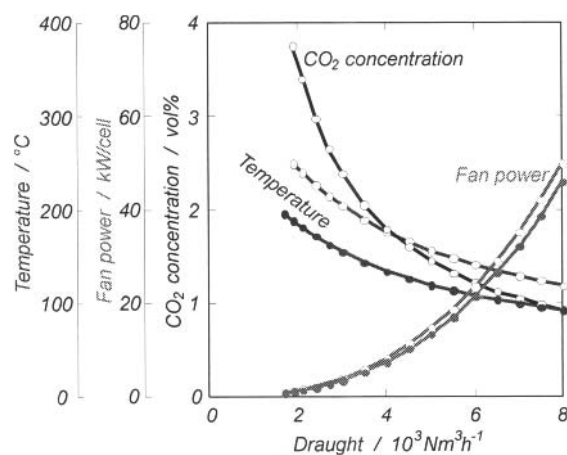

Figure 6. Temperature above the crust, fan power, and CO₂ concentration in the flue gas as a function of the draught from each cell. Open symbols – standard operation, filled symbols – 120 kW removed by cooling of the anodes.

Power Production from Recovered Heat

The performance of a large number of thermal cycles, layouts, and combinations of heat sources were studied, but only some of the most promising candidates will be mentioned here.

The cathode (cell sides and ends) is the heat source with the largest potential. Two families of power cycles appeared to be particularly interesting,

- Distributed open Brayton cycle, based on a turbo charger.
- Closed loop heat recovery and centralised power production with a Rankine cycle. For high temperature application (e.g., 600 °C), a steam cycle with recuperation is the natural choice. For medium temperatures (e.g., 300 °C), a steam cycle with a condensation turbine may be interesting. However, good results can also be obtained with an organic Rankine cycle (ORC) based on toluene with a butane bottoming cycle (the condensation heat of toluene is recovered in a butane power cycle, which increases the total power production).

No great potential was found by integration of heat from the cathode and heat from the flue gas. It is probably better to utilise the flue gas heat in a separate plant. On the other hand, heat from the anodes and heat from the cathodes could probably be integrated easily in some cases; it is always easier to integrate heat sources that are comparable in amount of heat and temperature.

For the flue gas, it seems most reasonable to collect the heat in front of the dry scrubber. Power production should be based on an ORC cycle.

A summary of the calculations made for the cases described in Table I is shown in Table II. As can be observed, the potential is up to about 9 percent of the total DC power consumption. Maybe surprising, the potential for power production from the flue gas (0.04-0.1 kWh/kgAl) is smaller than the savings in fan power following a draught reduction from 6000 Nm³ to 2000 Nm³ (0.24 kWh/kgAl). In addition, the higher gas temperature achieved with reduced draught opens for higher power cycle efficiency. The use of distributed pot suction may therefore have a great potential, also when CO₂ capture is not the primary focus.

Table II. Upper part of table: Summary of possible power cycles and potential for energy utilisation in kWh/kgAl for the three cases described in Table I. R – Rankine cycle, B – Brayton cycle, o – open loop heat recovery, c – closed loop heat recovery, M – medium temperature, H – high temperature. Lower part of table: Specific energy consumption in kWh/kgAl.

Heat source	Cycle	Base case	Minimum energy	Maximum production
Flue gas	RcM	0.10	0.04	0.04
Cathode	RcM	0.45	0.33	0.47
	RcH	0.77	0.55	-
	BoH	0.17	0.12	-
Cathode + anode	RcM	-	0.77	-
	RcH+RcM	-	0.86	-
	BoH	-	0.19	-
Specific energy consumption		Base case	Minimum energy	Maximum production
Including fans, no heat utilisation		13.47	12.04	13.17
Best case, max. heat utilisation		12.60	11.15	12.66

Concluding Remarks

A heat recovery system for an aluminium plant will only be built when it is considered economically viable with a minimum of process disturbance. The complexity and the cost of a heat transporting system (infrastructure) must be carefully evaluated. The economical attractiveness could be increased by introducing other ways of utilising the heat besides electric power production, such as production of cold, drying, and desalination. Customers for the recovered heat need to be on the spot.

Acknowledgement

The present work was mainly financed by Hydro Primary Metal Technology and partly through the project CREATIV, financed by the Research Council of Norway and Norwegian industry. Permission to publish the results is gratefully acknowledged.

References

1. O.-J. Siljan, "Electrolysis Cell and Structural Elements to be Used Therein", WO/2004/083489.
2. J.A. Aune, K. Johansen, and P.O. Nos, "Electrolytic Cell for the Production of Aluminium and a Method for Maintaining a Crust on a Sidewall and Recovering Electricity", WO/2001/94667.
3. B.P. Moxnes and A. Solheim, "Method and Means for Control of Heat Balance", WO/2006/088375.
4. E. Næss, T. Slungaard, O. Sønju, and B.P. Moxnes, "A Method and Equipment for Heat Recovery", WO/2006/009459.
5. H.K. Holmen and S. Gjørven, "A Method and a System for Energy Recovery and/or Cooling", WO/2006/031123.
6. J.A. Aune and P.O. Nos, "Method for Controlling the Temperature of Components in High Temperature Reactors", WO/2002/39043.
7. A.W. Crook, "Profiting from Low Grade Heat", IEE Energy Series 7, ISBN 0 85296 8355.
8. U. Drescher and D. Brüggemann, "Fluid Selection for the Organic Rankine Cycle (ORC) in Biomass Power and Heat Plants", *Applied Thermal Engineering* **27** (2007), pp. 223/28.
9. Y. Chen, P. Lundqvist, A. Johansson, and P. Platell, "A Comparative Study of the Carbon Dioxide Transcritical Power Cycle Compared with an Organic Rankine Cycle with R123 as Working Fluid in Waste Heat Recovery", *Applied Thermal Engineering* **26** (17-18) (2007), pp. 2142/47.
10. A. Solheim, H. Gudbrandsen, and S. Rolseth, "Sideledge in Aluminium Cells: The Trench at the Metal-Bath Boundary", *Light Metals 2009*, pp. 411/16.
11. V. V. Sharapova, "Study of the Interconnection of Aluminium Electrolyzer Life with Corrosion of its Casing" Translated from *Novye Ogneupory*, No. 1, pp. 39/42, January 2009, <http://www.springerlink.com/content/nx838151v1360721/>
12. A. Solheim, B. P. Moxnes, K. Vamraak, and E. Haugland, "Energy Recovery and Amperage Increase in Aluminium Cells by Active Cooling of the Anode Yokes", *Light Metals 2009*, pp. 1091/96.
13. S. Gjørven, Y. Ladam, B.P. Moxnes, P. Nekså, and A. Solheim, "Method and Means for Extracting Heat from Aluminium Electrolysis Cells", WO/2010/050823.
14. O.-A. Lorentsen, A. Dyrøy, and M. Karlsen, "Handling CO₂eq from an Aluminum Electrolysis Cell", *Light Metals 2009*, pp. 263/68.