

Chapter 9

Project Management Techniques: Engineering

9.1. Engineer and engineering

9.1.1. *The engineer*

The organization and completion of a project are the business of a man or more precisely of a team managed by a leader, the engineer [DAL 06].

The engineer is a person who applies scientific principles and theories to solve the practical problems economically. Most often, his job is to establish a link between scientific discovery and the creation of products, plants, industrial artifacts, and industrial facilities.

The engineer was one of the main architects of the fantastic progress, which in two centuries, shaped the Earth's surface, changed society profoundly, and transformed our lifestyles, and gave access to space. The engineer as to our current understanding is the culmination of a long history. He makes, embodies the field of scientific knowledge from "learning" to "art" in any facility type, means of production, transportation, communication, and objects produced in series. He cannot do it alone; he has to have a *team* with the most of varied skills. He needs an organization and resources which he must use properly. The field of engineering will be considered below.

France can boast of being the birthplace of the first engineering school, in the sense that it is currently understood, the Ecole des Ponts et Chaussées established in 1747 by Jean-Rodolphe Perronet (1708–1794) and Daniel Charles Trudaine (1703–1769). Perronet, a royal's engineer, bridge builder, including that of Neuilly in Paris, systematized the use of mathematics and physics to build structures: like bridges, canals, and water facilities.



The whole world recognizes the Eiffel Tower. This tower was built in only 26 months from 1887 to 1889, to celebrate the first centenary of the French Revolution during the 1889 Exhibition and today it is the symbol of Paris. Gustave Eiffel was an outstanding organizer, a creative genius, and a leader of men who knew how to select his employees.

A graduate of Ecole Centrale, at the age of 26 he was managing the construction of Bordeaux bridge, then the Garabit viaduct and many other achievements: bridges, viaducts, civil and religious buildings, the bridge over the Douro in Porto, not forgetting the framework of the Statue of Liberty in New York. Focusing on steel and cast iron instead of stone, he was a pioneer of prefabricated structures that he built in his workshops in Levallois-Perret close to Paris. He was also a shrewd manager who negotiated a contract with the government for operating the tower that bears his name. Being a hard worker throughout his life, he can be considered as the father of aerodynamics. He built the first wind tunnel at the age of 70 and contributed to the advancement of aviation and the emerging wireless technologies. He can also be credited with the introduction of scientific meteorology. In 1917, at the age of 85, he received a patent for a fighter monoplane and at the age of 88 he published a new treaty on propellers. Eiffel embodies the engineer of the 19th Century, which is renowned as the “century of the engineer”.

Box 9.1. *Gustave Eiffel (1832–1923)*

One is always struck by the “creativity” of the French revolutionary period which, in the middle of the tumult, gave birth, along with other schools, to the

prestigious Ecole Polytechnique: the familiarly nicknamed “X” founded by Gaspard Monge (1746–1818). The “X” served as a model for certain US engineering schools of the era including the famous *United States Military Academy* at West Point, founded in 1802, where education was imparted in French during the early years ...

In the USA the *engineer* is both a graduate (*civil, electrical, mechanical, and chemical engineer*) as well as the one who makes the *engine* work, that is to say a simple mechanic (*locomotive engineer*).

Gustave Eiffel in France symbolizes the engineer at the end of the Industrial Revolution [CAR 02, MAR 89]. Eiffel, the immortal builder of the tower that symbolizes Paris, was the inventor of innovative techniques (see Box 9.1).

9.1.2. Engineering

Engineering encompasses all those activities which aim to make an investment, that is to say, to transform financial resources into a facility or a piece of equipment, be it a bridge, a factory, a dam, a plane, which are so many projects for an engineer...

Engineering work typically includes several stages. Let us recollect and define more precisely the stages that were described in Chapter 6, “The industrialization process: preliminary projects”.

Preliminary studies are aimed at determining the merits of the proposed investment and demonstrating its *industrial feasibility*. *Profitability* is a major feature of these studies. At this stage let us say that engineering work includes:

- support for collaborative design usually with the client, or research centers or architectural firms;
- preparation of diagrams, plans, and specifications that are necessary for the construction;
- preparation of tenders for pieces of equipment and services that are required to carry out the work;
- cost estimates and evaluation of the amount of investment, with a determined accuracy (e.g. $\pm 10\%$);
- coordination and control of the construction.

NOTE.– The client may decide to entrust the complete or partial execution to a different company from the one who made the study: and give the jobs to a company more specialized in construction work;

– start-up assistance, staff training, and operating procedures.

NOTE.– The client may keep this activity in-house in whole or in part, because it is often very closely related to his expertise.

GENERAL NOTE.– Engineering jobs in the process industries are perceived differently by commercial and engineering companies themselves. The problem lies in the boundary between the *design process* (early engineering studies for corporations) and the *design of the facility* (beginning of engineering studies for engineering companies).

9.2. Project organization

9.2.1. Project concept

Projects have existed ever since humans started making tools and controlling fire. Who has not marveled at the pyramids of Egypt, Notre-Dame in Paris or the Millau viaduct!

The type of projects is very diverse and the projects vary in size, and their cost may range from tens of thousands of dollars to billions of dollars, depending on the scope of the project, the technologies involved or the location of the facility.

The construction of an oil refinery, a bridge, a vaccine unit, a fine chemicals plant uses very different resources and technologies but the management techniques used are very similar in most cases.

The project has to produce a unique product, a change: it has a beginning and an end. This is a temporary activity [LEB 00a]: *a project is born, lives, and dies*.

It is an action limited in time and involves a team, the project team, which, after completion and the beginning of the project will be scattered or assigned to other activities. This team will go through times, which are sometimes exhilarating, sometimes depressing, with happy or unhappy consequences for the individuals and the company.

The Bhopal disaster in India on the night of December 2–3 in 1984 resulted in the disappearance of Union Carbide, a company over 100 years old, and has painfully affected the lives of people involved in the construction of this plant, not to mention the thousands of victims of methyl isocyanate.

A project consists of interactive tasks performed in a logical order.

To build a house, one digs foundations, and then raises walls and places the roof on top of the walls.

These tasks involve skilled workers: the mason builds the walls, followed by the roofer who places the tiles on the roof.

Tasks, as well as the procurement of raw materials, must be planned along with the means to implement them with the adequate financial resources.

Project management was conceptualized and organized in the United States, during the 1960s by the major state agencies (*Department of Defense, NASA*), who developed methods of management planning, such as PERT system used in the development of Polaris missiles.

The Apollo project, which sent man to the Moon, involved about 400,000 people.

A project is owned by the *client* who entrusts the *contractor* with its implementation. *The client, person or entity, decides on the project, and thereby incurs liability and money.*

A company can be its own contractor for projects that are under its jurisdiction provided it has the means to deal with them through its engineering and design department. In this case, it must at least have the required resources, at the time needed so that it can supervise those subcontractors to whom it is forced to subcontract parts of its project.

Chemical companies do not always have at their disposal the means necessary to carry out civil engineering, electrical engineering, and other streams of work both from a design point of view and in terms of achievement. These are not their *core competencies*.

For “big jobs”, the company mostly deals with engineering and design departments or engineering companies.

The Company’s executive committee may appoint a project manager, who reports to the committee for projects which are categorized as *corporate projects* and whose aim is to rethink, reshape, or modify its operation. This can be an IT project, which will distribute skills and require large investments in training. In this case, a member of senior management is well qualified to perform this type of activity in addition to his normal work. He will be supported by a project team.

In the case of a major capital investment such as building a new plant, the executive committee may assign a project manager to the job who will take charge of it if he considers that the success of such an undertaking is crucial for the future of company. The project manager will justify the use of resources that he has been granted for achieving the results, with the hope that the results meet expectations.

Project-based management is increasingly becoming a leadership style. It is indispensable for this type of achievement.

For a contractor, managing a project means carrying out all the necessary actions to be carried out to offer the client the work he has ordered, on time, in accordance with the quality and cost determined by the contract.

Few organizations may, like King Louis XIV, undo what after realization, does not please them and have it rebuilt anew [TIB 02]! However the SUN King can be praised for the construction of the palace of Versailles, the largest construction site of the 17th Century which involved 40,000 men for up to 53 years, and marked a breakthrough in construction and organization methods.

Innovation has played a major role, with contributions from the French Academy of Science. The Marly machine which pumped water from the Seine to feed the fountains and ponds in the park via the aqueduct of Louveciennes was one of the largest engineering feats of the 17th Century.

9.2.2. Organization of an engineering project – client/project manager interface

For more information, it is useful to refer to the articles in Techniques de l'ingénieur [AUR 99, CHA 01, LEB 00a, LEB 00b, LEB 00c].

The company, after the validation stage which follows the development process stage (see Chapter 6), may decide to launch the *Process Engineering* stage. As the company does not have all the resources for performing this step, it seeks the help of another company, generally an engineering company.

This is even more necessary for the company during the *Basic Engineering* phase and *a fortiori* for the construction phase, given the diversity of jobs, the number of tasks to be performed and their volumes. *The volume is expressed in hours for which the cost will vary depending on the qualifications of the contractor's personnel/staff assigned to the job.*

Figure 9.1 shows an organization where relationships between the key players in the project are as follows:

- the representative of the client who communicates with the contractor, and sometimes the future manufacturer;
- the contractor, who appoints a project manager.

The project manager representing the contractor is responsible:

- for defining, implementing, and managing the project team (*Project Management*);

– for using Project Management techniques (*Project Control*) and all tools required to respond to the contractual terms, which include cost, schedule, and quality;

– for implementing all the corrective actions that are necessary to achieve the project objectives.

The client must establish a *steering committee* whose role is to monitor the development of the project, inform the executive committee about its progress, and act as a moderator between players when problems or crises arise whose origin may be rooted in the change of the socio-economic environment, social conflict, bankruptcies of suppliers, procurement difficulties, the tightening of regulations, an overrun of budget, delays in equipment procurement, and so on. The list is long! This will be discussed further.

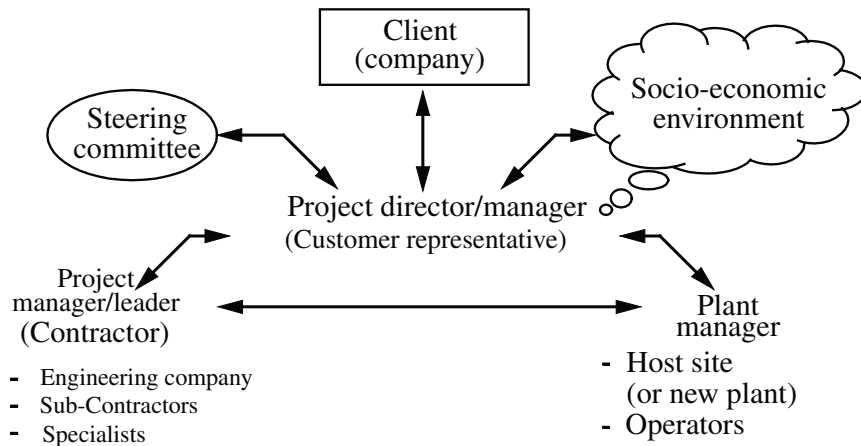

Figure 9.1. *Simplified organization of an investment project (realization stage)*

This type of organization is valid for large projects, to be specific, between 10 and 20 million dollars, which cannot be undertaken by the company's personnel such as the person in charge of contractors, due to time constraints. Here, one finds the operational/entrepreneurial conflict described in Chapter 2.

Small projects cannot afford a structure manned by many experts, and incur the risk of generating unbearable supervision costs, *although all the functions of the small projects are the same as those of the large projects!* Assigning a project manager is an expensive operation which most often requires finding a replacement. This is also true for the plant manager. So, there is a major problem in human resource management which was highlighted in the Chapter 2 on operational/entrepreneurial conflict. Small projects therefore require a different style of

management compared with that of the major projects, and have to be led by versatile performers in the field.

9.3. Management tools for industrial projects

Project management tools have been developed since the 1960s. The *Project Management Institute* (PMI) has distributed these tools throughout the world. PMI was founded in 1969 and is a Philadelphia-based not for-profit organization with half a million members in 185 countries.

Paris-based *AFITEP* (French Association for Project Management) has the same objectives: it ensures the publication of the “Dictionary for Project Management”. The AFITEP is part of the *IPMA* (*International Project Management Association*).

AFNOR has standardized practices relating to project management.

This book does not describe *all* project management techniques; we will focus on some of them which are very important from the management point of view. This book does not aim to make the reader an expert, what is important is to know that methods exist! Any reader who wants or feels the need to deepen their knowledge may consult the specialist reference books; there are lots of them!

9.3.1. WBS (*work breakdown structure*)

9.3.1.1. *Concept of WBS*

WBS divides the project into autonomous units, which are consistent and interrelated. With the help of a simplified diagram, one can quickly view the contents of the project to examine the essential characteristics, and establish the “identity card” to see where its major difficulties lie, the significant costs, the elements that require the longest time for procurement, installation, start-up, and so on. WBS makes it possible to organize the project into consistent parts to better perform studies, undertake construction work, and better control the project cost and schedule.

9.3.1.2. *WBS analysis of a project of a latex plant in China*

The project considered by us involves setting up a plant in China where the technology is transferred from France. The capacity planned for the plant in China represents about three times the capacity of the French unit.

Figure 9.2 describes in a simplified manner the process involved in latex production. Latex is an emulsion of microparticles in water, obtained by the

copolymerization in a suspension of styrene and butadiene monomers in water. The latex considered is used in paper coating and the formulation of paints.

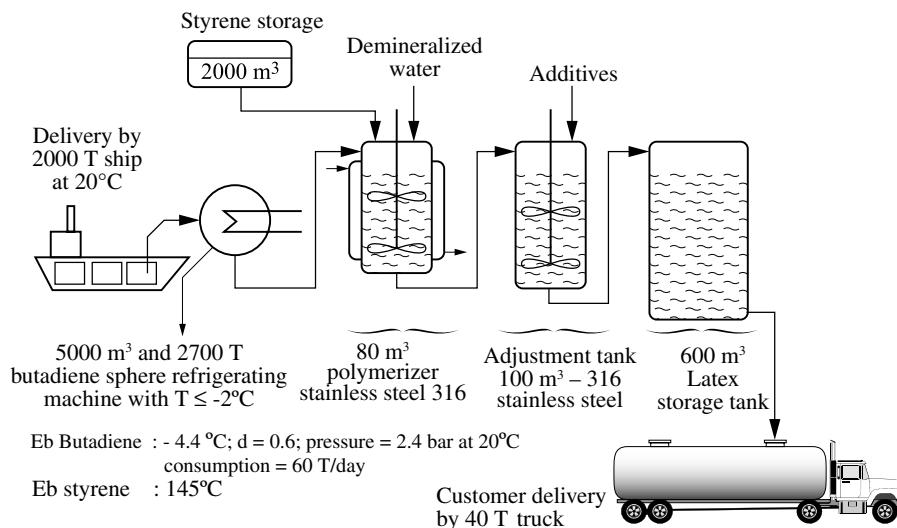

Figure 9.2. Simplified diagram of a latex plant

Styrene is a liquid that boils at 140°C. It can easily be stored in steel tanks. Butadiene can be assimilated as a liquefied gas and is usually stored in pressure-resistant and cooled spheres or “cigars” to prevent its polymerization.

The polymerization reactor is an agitated and cooled device and has a complex design. The agitation system of which will depend on the particle size, is a key element to ensure the value of use of the finished product. The introduction of reagents, as the mixing of reactants, is a key design factor. The tank must be perfectly polished to avoid the build up of films that could create unwanted lumps and disrupt thermal exchanges. As the polymerization reaction is exothermic, the reactor must be cooled. It is usually cooled by a jacket with cooling water. This is also part of the *design* problems.

The process is intermittent; each batch is subject to a devolatilization process to remove the traces of monomers at the end of a reaction. Each batch is provided with a number of additives which will give the finished product its commercial characteristics.

Latex, the finished product, is a non-hazardous product stored in carbon steel tanks. It is generally shipped by truck, tank cars, or containers; and it is a major consumer product.

The WBS of the plant, shown diagrammatically in Figure 9.2, highlights the following five elements and technical systems:

- storage of butadiene, unloading the ship and supply of polymerizer;
- storage of styrene and supply of polymerizer;
- polymerization reactor and its annexes;
- latex adjustment tank and addition of additives;
- latex storage tanks and shipping.

The WBS considered does not *deliberately* include the utilities system, fire protection, the administrative building, laboratory, maintenance plant, WWTU, and so on. At this stage it is judged that they are not key items in the analysis of the system because they do not present major technical difficulties or simply because the process unit considered is being integrated into an existing plant where these means are available.

The WBS analysis of the latex project in China highlights the essential characteristics of the project and the points that will require special attention:

- *safety of the system*: it mainly depends on the flammable butadiene product;
- from the *technical point of view*: the polymerizer is the biggest technical challenge because its size is very large compared with that of the existing polymerizer. One must reconsider the key functions such as agitation, heat exchange, and devolatilization. Protection of the know-how should be taken into account;
- what can one infer from WBS research? There are two essential criteria, namely system safety and design of the polymerizer, which should also be taken into account;
- *safety*: this plant should be located away from habitation by a distance that will depend on the design of the storage of butadiene, which can be aerial, buried, or semi-buried. Handling this product should be the main objective of an extensive safety study and will require training the operators;
- *polymerizer*: scaling up, by a factor of 3, creates some problems of design and construction. It is decided that the polymerizer will be manufactured in France. Transport and customs issues should be taken into account from the beginning of the project. This unit is probably on the critical path. It is therefore an essential element which will determine the deadline for the completion of the plant.

The other components of the WBS system have no specific difficulties. In China, one could easily find supplies of liquefied gas storage system of 5,000 m³ or more. It is enough to investigate and find good suppliers. The tank used for additives, like other storage tanks, does not pose any problem.

9.3.2. Value analysis (VA) [AFN 97, DAL 03, LED 91]

9.3.2.1. History of VA

Value analysis (VA) is an essential management tool, which has its place in the tool set and methods that the company must use to improve its operation and ensure its sustainability. *This is a major managerial revolution of the 20th Century!*

During World War II after the attack on Pearl Harbor on December 7 1941, Japan had virtually occupied all of Southeast Asia. Singapore, the impregnable fortress, collapsed on February 15 1942. America was cut off from many sources of raw material procurement such as rubber, copper, and tin.

Similar to other companies, *General Electric* was forced to use substitutes, and this encouraged Harry Erlich, Vice President of *General Electric* who was in charge of purchasing and transportation, to research methods to improve quality and lower costs. He placed Lawrence (Larry) D. Miles in charge to develop methods to create a *change*. Miles had a flash: he realized that a product is made to perform one or more *functions* (such as a vacuum cleaner is designed to *remove dust*, by *drawing air*).

To create a change, it is not the parts that make up the product which must be examined, it is the function or functions that the product is supposed to ensure. Miles developed his value analysis methodology between 1947 and 1952, and in 1956 he published *Techniques of Value Engineering Analysis*, a highly acclaimed book.

Miles created a specific department which was responsible for cost reduction. It achieved spectacular results. Reconsidering the manufacturing process sometimes led to better products and cheaper costs than before the war. He refined his method, which aimed to prioritize the functions, determine the cost and eliminate unnecessary functions.

The VA concept took hold in the American industry and in the powerful military-industrial complex during the 1960s under the leadership of Robert McNamara, US Minister of Defense at that time. The *Society of American Value Engineers* was created in 1959. The VA concept then spread slowly around the world.

VA has several names: *value analysis, value management, value engineering, value control, and value insurance.*

Value analysis has a broad meaning. *Value engineering* is applied to the products under development. *Value management* concerns with the company's processes and its management structures.

Value management (VM) is the subject of European standard NFEN 12,973, June 2000 (NF X50 -154). VM tends to encompass all the VA techniques.

The VA concept has been developing in *France* since the 1960s. It has a very strong base in the automotive, aerospace, weapons, household appliance, and electronics sectors. The *AFAV* (French Association for the Analysis of Value) was founded in 1978 and is headquartered in Paris. *AFNOR* has been strongly focusing on VA from the 1980s and had published the initial standards in 1985 (NF X50-150 and NF X50-153).

9.3.2.2. *VA: product and service*

Although the basic principle remains the same, the definition of VA has changed, which is normal in a period of over 50 years.

A commonly accepted definition nowadays is: *VA is a method for designing new products or improving existing products to meet the need(s) of the customer(s) at minimum cost.* It is a method of innovation.

Let us eliminate ambiguity upfront: VA is seen in a different way by the supplier and the customer. The supplier of the product or service looks for the lowest procurement cost; he wants to minimize the resources used. Resources mean raw materials, energy, wages, and costs associated with the manufacture and distribution of the product. The VA perceived by the supplier can be written:

$$\text{VA (supplier)} = \frac{\text{customer satisfaction}}{\text{manufacture and distribution cost}} \quad [9.1]$$

The customer is not concerned by the production cost. He is interested in the product quality, a term which will be discussed widely, and the purchase price. The VA perceived by the customer can have the common meaning as follows:

$$\text{VA (customer)} = \frac{\text{quality}}{\text{purchase price}} \quad [9.2]$$

Analyzing a product, or a service according to this aspect involves asking questions like: How much profit does this offer? Is it useful? How can it be made? Can it be made? What does it cost? Can it be done at a reduced cost? Do we know how to make it?

9.3.2.3. *Functional analysis (FA) is the keystone of VA*

A word function to which we will return in detail corresponds to the service(s) that this product is supposed to provide. The VA concept applies to the design of

new products, improving existing products, the analysis of administrative processes, manufacturing processes, and so on. It is an approach that formalizes the problem in terms of *purpose* and not in terms of solutions. It considers the costs associated with each function [TAS 95].

Figure 9.3 shows the generally accepted phases for the development of a product.

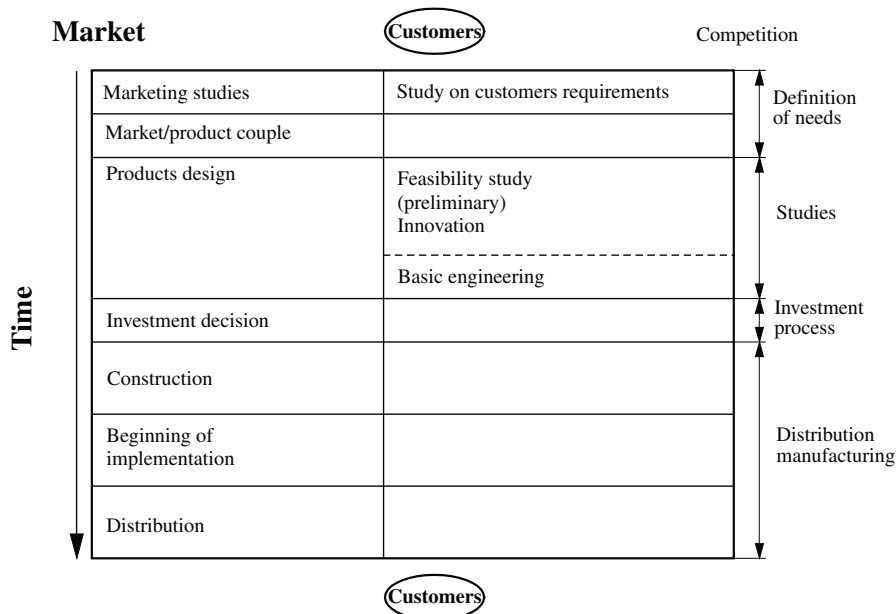

Resources: human, intellectual, financial, physical tools (plants, process units and all means of production), working methods (know-how, feedback).

Figure 9.3. Developmental stages of a new product

Table 9.1 briefly describes as a reference the steps related to an implementation of VA [BAL 02] and the players involved.

A typical process involves the decision-making person who heads the project and a multidisciplinary team which may include the product manager, sales manager, an expert in VA and line management that is to say those who make it possible to achieve the product. *VA is performed by a team!*

Group work techniques apply particularly in steps 3 and 4 of creativity and innovation.

	Action	Resources involved
Step 1	Define the project	Marketing/sales and R&D
Step 2	Functional analysis-FS* preliminary	Decision maker and VA team
Step 3	Look for alternative ideas Determination of TF** Cost analysis	Decision maker Team VA + line management
Step 4	Evaluation of ideas Definitive analysis of functional costs Establishment of definitive FS	Decision maker VA Team + line management May involve laboratory test, prototype tests, test campaigns
Step 5	Decision to invest	Person authorized by the society
Step 6	Product realization	Decision maker Operational teams (VA teams if needed)
Step 7	Product distribution Project tracking	Society officials VA team

*FS: functional specification (see section 9.3.4)

** TF: technical function

Table 9.1. *Developmental stages of a new product*

9.3.2.4. *VA and cost management*

Two methods have been developed in the United States to control costs at the design stage of a product.

9.3.2.5. *Design to cost (DTC) objective*

The DTC method [DEL 91] is a VA method which stipulates that the cost of the finished product remains below a value fixed in advance. This method was incorporated by the US Ministry of Defense into its contracts for weapons procurement in order to control the cost, in the late 1960s, under the *design to cost* policy. This policy came into existence after military projects incurred excessive costs, mostly due to the change in definition during the project (*project scope*¹). In this method, the unit cost of the product (aircraft, cannon) is assimilated into its performance, like the range or shooting accuracy. The industry in which we impose a DTC must review the contents of the project, its working methods, and its ceiling price. It has more freedom in design of the finished product. Expenditure control in all phases of design and construction, is critical.

¹ *Project scope* has a very strong connotation. It is used in all projects to define the content. General Foch was in the habit of asking his generals: "Gentlemen, what is it?" This is a good definition of *scope*.

The *design to cost* policy leads to a radical change of old habits, where VA is a key element to its success.

9.3.2.6. *Lifecycle cost (LCC)*

This method was also developed in the United States as the *Design to Lifecycle Cost (DTLCC)*. The total cost, or *Lifecycle Cost (LCC)*, is the cost of the product throughout its life: the purchase price, operating costs, maintenance costs, and possible destruction or recovery costs [DEL 91].

For a car, it will be the purchase price, fuel and oil consumption, maintenance, scrapping, insurance, and so on. Do not forget the mileage that one is entitled to expect. The LCC is an extension of the DTC.

9.3.2.7. *VA in the management of the company. Value management (VM)*

Any system can be improved, everything can be done differently but it is not always easy to accept ... and to make some one accept it!

The value management (VM) concept is applied to business processes in order to improve performance, motivate people, and implement strategic plans, so that its partners and *stakeholders* are satisfied.

Value Management (VM) is part of the process that the Americans called *re-engineering*. The company asks questions about its operation and often its mission! Which are the markets that the company needs to focus, and with what products? Does it make or buy? How? This process is difficult, sometimes brutal, and always requires coaching by facilitators from outside the company.

This will be further discussed in Chapter 13, “Change Management” on techniques such as:

- *benchmarking*: that is comparing with the competition to identify strengths and weaknesses;
- PARETO type analysis (cause/effect), which makes it possible to focus the efforts on the most important points for which the gains are achieved in the shortest time;
- taking into account the *human aspects*, which cannot be eliminated.

We have emphasized that the VA concept must bring together multidisciplinary teams, where these teams are asked to participate in creating a common impulse. VA has to depend on all the team work techniques:

- *management by project*, which targets setting the scope, cost analysis, planning methods, and defining the tasks are the essential features;

– *creativity techniques*, heuristic techniques (techniques of research and invention), where the *brainstorming* techniques were invented by Alex Osborn in the United States in 1935, and are the most commonly known and most widely used;

– *communication*.

9.3.3. Functional analysis (FA)

9.3.3.1. Concept of function

Functional analysis (FA) is based on the concept of function which the French standard NF X50-151 defines as “the action of a product or one of its constituents expressed exclusively in terms of purpose”.

A function is expressed by a verb followed by a complement. Miles recommends the use of a verb in the infinitive. A function does not advocate any solution for realization. Any product can have many uses that are unexpected, to say the least.

A hair dryer serves *to dry hair*: it does not say how! By blowing hot air? With what energy source? The electricity network? A battery? However, it is often used to dry laboratory equipment, and to heat certain products very gently. A hair dryer can be fixed, portable, and so on.

The functions of a product are described with respect to meeting the expectations and *needs* of a customer. The customer needs are generally difficult to identify. The head of a company used to say: “*A customer knows what he wants; he does not know what he needs*”. A need can be either objective or subjective. It may vary over time by having the object or using the service, for better or for worse. The test of time is a formidable test.

To cope up with this complexity, in functional analysis, a product is considered as a collection of functions and not as an assembly of parts. The classification of functions varies according to the authors. Simplicity is what will be focused on.

9.3.3.2. Ranking functions

9.3.3.2.1. Service functions (SF)

Service functions directly affect the user. To satisfy a need, a product must often have several SF. The main SF and secondary SF will be discussed. The SF can be broken down into functions of use (FU) and estimating functions (EF) can also be called “aesthetic” functions. The FU meet the *objective* needs, whereas the EF meet *subjective* needs.

A cabinet may be old (Louis XIV style, for example) or modern. Its FU is always to provide a storage space. It is clear that the customer attaches a completely different value to two products and is willing to pay a different price for each type of furniture.

The EF must meet the emotional part that almost always accompanies the purchase. The presentation aspect is very important, even for highly technical products. Will a piece of high fashion women's clothing serve to protect the body against external attacks, covering the body, or the contrary?

9.3.3.2.2. Technical functions (TF)

Technical functions or internal functions of the product, link the different components among them. Technical functions are required to achieve the SF.

For example, the motor of the hair dryer must be supplied with power. Its fan is powered by a motor which, in turn, is powered by electricity, along with a switch that closes or opens the circuit. The customer operates the on/off switch, and he is not concerned with the functioning of the parts of the fan or motor.

The TF are generally ignored by the user except sometimes in the case of failure!

9.3.3.2.3. Constraint functions (CF)

Any product design, any project, any action is normally limited by the constraints. The list is long:

- regulatory constraints (codes, standards, etc.);
- physical constraints;
- product incompatibility with other products;
- current voltage;
- limited availability of building materials;
- time constraints (*Time is money*): spending a lot of time in design can lead to putting a product on the market after the competition. A new car should be ready to be exhibited at a well-known car show;
- patents;
- feasibility constraints (one does not know how to do it, one does not have the financial resources to do it and so on);
- dependability (RAMS).

This final constraint is unavoidable in our overly mediatized society and society accepts fewer risks associated with the products and their means of production. This will be further discussed in Chapter 13.

9.3.3.2.4. Useless, harmful functions

This category consists of functions which are considered to be unnecessary by the customer (some radios have many nice silver buttons: are they all useful or placed there by the supplier to add questionable value?). The functions that are clearly harmful have to be eliminated as far as possible. Let us talk about noise, vibration, toxicity, all of which pose a usage risk. The VA involves hunting for unnecessary and harmful functions.

9.3.3.2.5. Environmental protection

Respecting the environment throughout the lifecycle of the product is now a necessity. In particular, the recovery or destruction of the product at the end of its life will assume more and more importance. Let us consider scrapyards.

9.3.3.3. *Characterization and flexibility of a function*

A function must be characterized by criteria and if possible by measurable levels. Functions related to an automobile may be the speed (criterion) expressed in kilometers per hour (level), the time taken to travel a kilometer, standing start (seconds), the consumption of fuel per 100 kilometers (L/100 km), and so on.

The measurement of value functions (VF) is inherently difficult; the evaluation can be carried out by a panel of consumers. But to formalize the dialog that must be established between the customer and supplier, the FA characterizes the level of performance by its flexibility.

The *flexibility of a function* expresses the degree of negotiability or imperativity set by the client. It is expressed by:

– an acceptance limit: let us consider the case of a car. The car considered should not consume more than 9 liters of gasoline per 100 km (standard conditions). It is clear that the supplier who does not meet this requirement is eliminated;

– an exchange rate: the appreciation or depreciation assigned to the product between the level of performance offered by the supplier and the level desired by the customer. For the car with a maximum limit of acceptance of 9 liters per 100 km, the desired level is 8 liters per 100 km. The customer is ready to accept a 5% increase in cost if consumption is 7.5 liters per 100 km and requires a 5% decrease if the consumption is 8.5 liters per 100 km. An exchange rate can thus be defined as the cost/benefit ratio.

The flexibility class specifies the degree of imperativeness or negotiability. The flexibility can range from zero (the level is imperative) to very high (level is negotiable). The flexibility often represents the “ignorance” of the customer who

wants to know what it would cost him if he changed the nature of a material with a material that is more noble, or if he wants a lower noise level ... It is often a method to push the supplier to its limits.

9.3.3.4. *Functional costs*

The assumed functional cost single-handedly represents the set of expenditures necessary for obtaining it. The determination cost of the forms part of cost accounting of the company. It was discussed in Chapter 2.

Let us consider, for example, a hybrid car, that is to say a car where the engine of the car is powered by a fossil fuel and electric batteries. The “moving in electric mode” function leads to an additional purchase cost which can be made profitable by gains in fuel that has lower CO₂ emissions.

9.3.3.5. *The methods of functional analysis (FA)*

The supplier, from a preliminary FPS (functional specification), must express the need under the form of functional services (FS) and technical functions (TF). The TF will “materialize” the device by components and define their interaction. It is from this phase that the supplier will calculate the cost of each function, since each function will result in the presence of certain parts, where some of them are entirely devoted to a specific function.

There are many FA methods of which some are owned by consulting firms. It is surprising the number of features included in the most ordinary objects! There were about 20 functions for a pair of sunglasses! As an illustration, we will give some information about the “intuitive” type of method and the FAST method.

9.3.3.6. *The intuitive method [TAS 95]*

This is a method used at the beginning of the study. It lends itself well to *brainstorming* techniques. Its objective is to identify the functions. A small team, generally limited to 6 or 7 people, review the product and interface with the user, environment, lifecycle aspects, movement, and distribution of the product.

Let us apply this method to the list of functions of a lamp used for underwater diving. The “bubbles” around the lamp (Figure 9.4) represent potential interactions. Several essential functions can be listed. The main service function (SF) is to illuminate the marine environment. The criteria may be the length of the beam, its width, and the possibility of adjusting it.

Among the other service functions, can be mentioned:

- lighting life: number of hours;

- handling: taking with one hand connected to the diver by a cord;
- reliability: it must be total as the life of the diver may depend on it;
- whether or not to double certain functions.

The constraint functions are as follows:

- resistance to water pressure at 100 m deep (no flexibility);
- corrosion resistance to sea water.

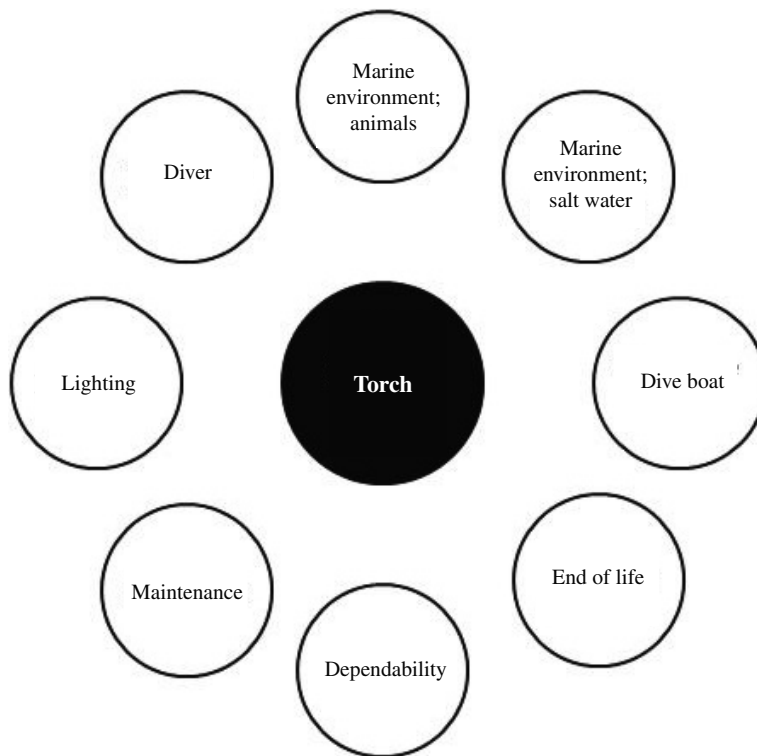

Figure 9.4. Functions analysis of a torch for diving (very simplified)

Value functions related to reliability functions are typical of equipment used in scuba diving.

For a torch that is used during scuba diving, a draft of the functional specifications is given as an example (Table 9.2).

Function	Nature	Criterion	Level	Flexibility		
				Limit	Class	Exchange rate
FS1	Illuminate the space	m	10	8 mini		
FS2	Rechargeable battery Autonomy	hours	3	2 mini	Negotiable	Non-rechargeable battery: price = -20%
FS3	Manageable with one hand					
FC1	Resistant to pressure	m	100	100	Imperative	
FC2	Resistant to sea water corrosion				Imperative	
FC3	Total reliability	On/off	1,000 tests	800 tests	Imperative	
FE	Give the impression of robustness, reliability					

Table 9.2. Outline of the FS (function specification) of a torch (for example)

9.3.3.7. The FAST method [TAS 95]

FAST stands for *Function Analysis System Technique* (Figure 9.5). It is used to represent and organize the functions on a diagram, to show dependency functions. It allows only a comprehensive and visual method in the sense of visual management, that is the project team “is” immediately in the project.

Let us apply this method to the list of functions of an electric hair dryer. Whoever is in charge of the dryer fan knows its function, knows how it is operated. The functions are classified from right to left of the question: why? The functions that appear at the same time are arranged on the same vertical. In a very simplified example of Figure 9.7, the hair is dried with a stream of hot air produced by a fan driven by an electric motor. The dryer is connected to the electricity network. The power is put into the motor and heater simultaneously.

The diagram from the 220 V electrical plug leads to the function of the main service: drying hair. One can imagine that the hair dryer has a recyclable battery and requires only the power supply for recharging, so that its life can be enhanced.

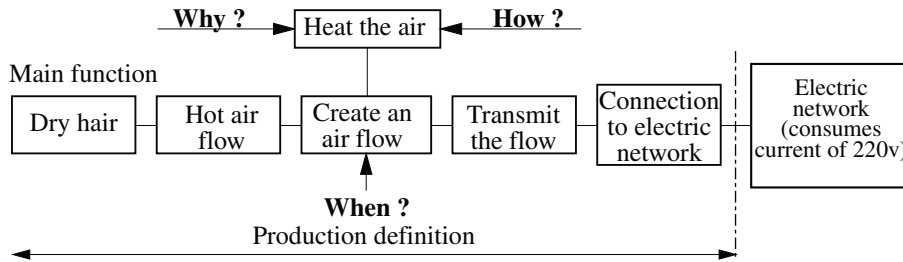

Figure 9.5. The FAST method applied to the analysis of the value of a hair dryer

9.3.4. The project scope (PS)

9.3.4.1. Objectives of the PS

The PS is the subject of the AFNOR X50-151 standard [ZAN 97]. It accompanies all the phases of design or redesign of the product. The PS is the result of a *dialog* between the customer and the supplier. Initially, the customer expresses his needs as he perceives it. A VA expert who is from an external firm or is an employee of the supplier, will condition this dialog.

The PS is designed to:

- list the functions as we have described them without identifying any solutions;
- prioritize them according to their importance (main SF and secondary SF);
- specify the levels of performance, flexibility, and acceptance limits.

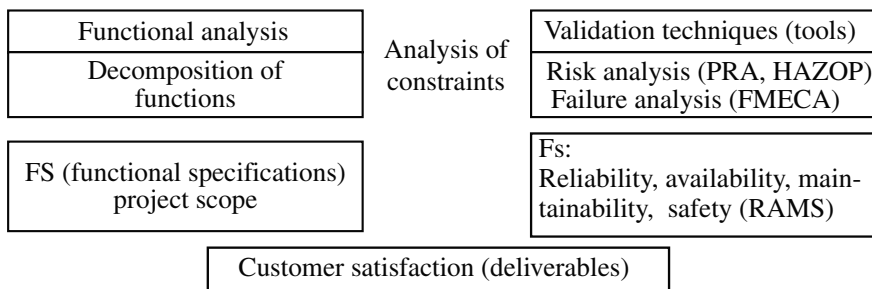

Figure 9.6. Development of functional specifications, or FPS

At this point, the FA allows the supplier to know what the customer wants. The preliminary PS is a document that can be contractual and which will therefore enable the supplier to work on solid ground by using his internal resources in research, design, and trades of various kinds.

NOTE.– The HSE aspects in accordance with the ethics of the society and its local regulations must always be addressed.

9.3.4.2. Case study: latex process unit described in section 9.3.1.2

The VA is applied to the whole system and to each major component of the WBS, itself divided into subsets.

In the first analysis, the butadiene sphere, as shown in the diagram, has at least three SF: unload the boat, store butadiene, and feed the polymerizer, hence the following questions can be raised:

- is the butadiene sphere necessary?
- can one use the boat as storage and then eliminate the sphere?
- can the addition of additive be made in the polymerizer?
- can one finally eliminate an expensive device at first, even if one has to install it later when sales will have increased in power?

The VA based on the FA can challenge, innovate, create new solutions, find the best compromise [DEL 91].

9.3.5. Planning

A project consists of a series of tasks related to each of the previous and the next by a necessity of succession. For example, in the construction of a building, one can only raise the walls after constructing the foundations, which can be achieved only after completing the excavation. The minimum duration of a project is equal to the cumulative duration of *critical path* tasks. It follows that one can reduce the time of execution of a work by reducing the length of one or more critical path tasks.

Various techniques, some of which are very sophisticated, are made readily usable by IT, and help to view tasks and their sequence.

Keeping a schedule is an essential project management tool. It makes it possible to view at any time the degree of progress of the work, to take corrective action to catch up as far as possible, and to involve different trades wisely. Two widely used methods, namely GANTT and PERT, will be simply described.

9.3.5.1. Gantt chart or bar chart

Henry L. Gantt (1861–1919) was an associate of Frederick Taylor. He developed numerous methods including a graphical diagram which bears his name.

It is a simple method which applies well to a small project where the number of tasks does not exceed 30 [KER 89]. Its weakness mainly lies in the fact that the interdependence of tasks is not taken into account.

In Figure 9.7, we have considered the example of planning related to the latex plant in China as mentioned above.

A simple reading of the diagram which is based on the WBS analysis of the project shows that:

- the plant can be built in 20 months after the credit agreement in the first month;
- the polymerizer and butadiene sphere, which are the two essential parts of the project, must be ordered in the fourth month.

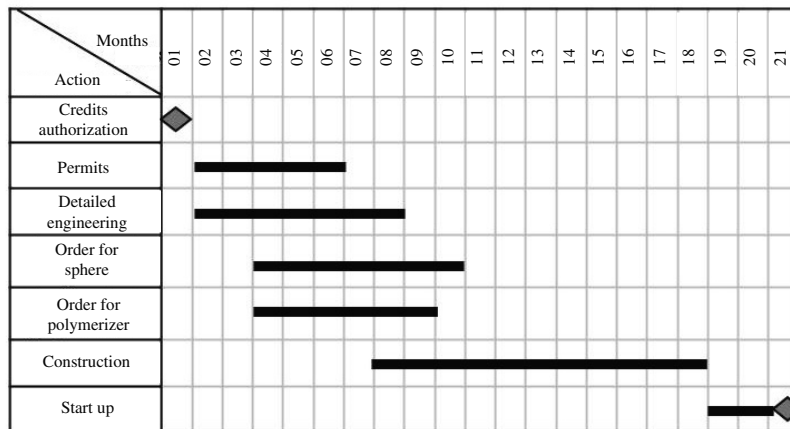

Figure 9.7. Example of a Gantt chart for a construction project for a latex plant in China

NOTE.— The announced schedule assumes that the funds are authorized before August of year *N*, the construction must start before March of year *N + 1* due to the monsoon that will make it impracticable in June/July.

9.3.5.2. The PERT (Program Evaluation & Review Technique) method [KER 89]

The PERT method was developed by the US Navy in 1958 for the construction of Polaris missiles which could be fired from submerged nuclear submarines.

It is used to plan the best use of resources for very large-scale projects through the use of IT. It assesses the impact of the delay of a task throughout the project.

This is an interactive method. The PERT method determines the project's critical path, which is the longest duration in the sequence of tasks, at any time in the project: this is the time required to complete the project.

Figure 9.8 illustrates the use of the method in a silica compaction project in Asia.

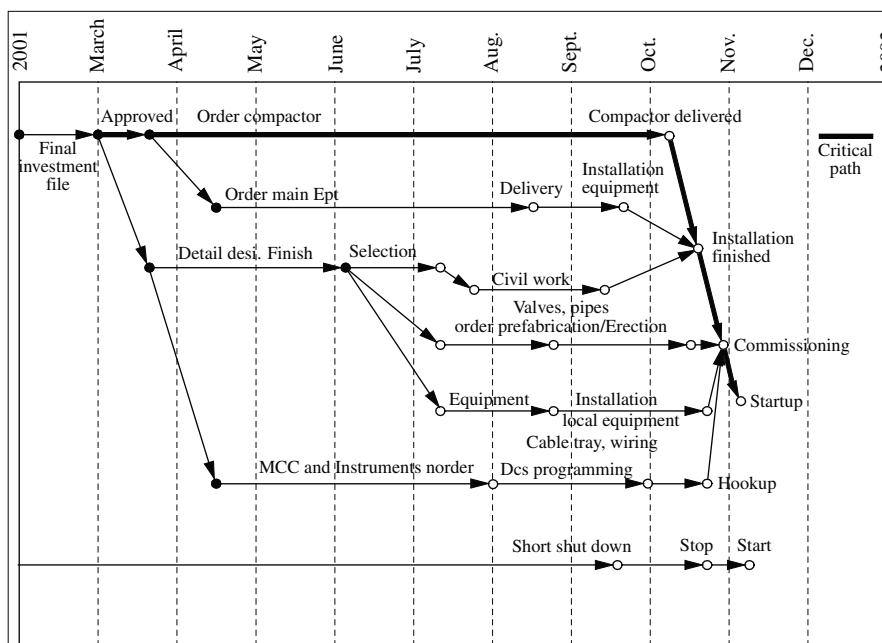

Figure 9.8. PERT method applied to a silica compaction project in Asia

9.4. The engineering project: from *Process Engineering* to the start of the facility

9.4.1. *Process Engineering*

Process Engineering follows the feasibility studies. It assumes different names according to the company; the term *preliminary study* is widely used.

This is the design phase of the process and is generally carried out by the client, in collaboration with research or testing centers, or with architectural firms and often with the support of an engineering firm.

It includes the establishment of material and utilities balances, design of major equipment, the establishment of a process flow chart, and a general layout.

It is during this phase that one must implement the above methods of functional analysis, value analysis, and risk analysis.

This step must demonstrate the industrial feasibility of the project taking into account the technical aspects, HSE, cost and time delivery, and profitability.

In many companies, the accuracy of the cost estimate is $\pm 25\%$ of the PFC (probable final cost) as described in Chapter 6. It is clear that for a project whose PFC is estimated at 100 million dollars, one performs the tasks needed to ensure that the forecast cost of investment has a high probability of being between 75 and 125 million dollars.

This is an important step in decision-making! This is usually the step when after validation it is decided to launch the basic engineering step.

9.4.1.1. Basic engineering

The step called “basic engineering” aims to develop the specifications of the system, which will be subjected to execution engineers, and to write the operating manual to be used in the “detailed engineering” step. It also aims to determine the probable final cost of investment, with an accuracy of about $\pm 10\%$ in general.

It is a “highly” expensive step, and its cost can range from 3% to 7% of the PFC, for example, 5 million dollars for a plant valued at 100 million dollars!

It should be only launched if it is believed that detailed engineering will be performed.

9.4.1.2. Detailed engineering: tools and goals

The main objective of *detailed engineering* is to handover the construction plans to the companies that are responsible for construction. Detailed engineering is expensive and since it is very labor-consuming, it is essential that the file “basic engineering” is explicit and comprehensive to avoid misunderstandings and subsequent amendments.

It carries out different trades including methods, projects, general studies, setting up, lay out, vessel design, mechanical engineering, civil engineering, electrical engineering, instrumentation, cost and time, fire protection, and so on.

The piping, in chemical and petrochemical industries, plays one of the most significant roles in set up cost, about 20% of the PFC; it is necessary to make their drawings (isometric) exact, position them in space, define the components’s support, and so on.

Information technology has profoundly changed the manner in which engineering companies function. A multitude of software packages helps the prime contractor to design, plan, control, and manage all aspects of the project.

Calculation software helps to carry out, in few minutes, certain calculations which took hours, days, or weeks a few decades ago: calculations of heat transfer coefficients, fluid mechanics, structures, and so on. They have allowed us to make simulations, that is to say, to model a system and analyze its reactions when some of the parameters vary. The peculiarity of IT is also to create documents, store them, and transmit them in the form of emails.

CAD (computer-aided design) aims to integrate the “trade” software (structural calculations, fitting, etc.) and the studies belonging to detailed engineering, such as those relating to the design of the pipes.

CAD unites the various skills in a single location to create a 3D virtual model which can be visited by climbing the stairs, and by “walking” on the floors. The detailed engineering requires the use of standards and procedures: codes will be selected for the system to be installed. The procedures define the methods to be used to run the project, thereby ensuring overall coordination.

9.4.1.3. *Schematic*

The schematic can be defined as the graphical representation which is composed of diagrams, plot plans, necessary for defining the design of the facility and the definition of the main equipment; drawings are needed to define networks associated with utilities (steam, power, nitrogen etc.) waste disposal. It is also used to describe the project organization in the form of organizational charts, thereby characterizing the sequences of tasks and monitoring progress on the site.

NOTE.— The figures in this section are from the article “Réalisation de projets dans une société d’ingénierie [Realization of projects in an engineering firm]” [CHA 01] courtesy of *Techniques de l’ingénieur*.

Figure 9.9 illustrates the general organization of a project.

Figure 9.10 describes the tasks and project schedule up to construction, where the sequence of tasks is included.

Figure 9.11 shows the typical organization of the team responsible for the construction of the facility. The different trades can be noted: mechanical, piping, rotating machinery, electricity, and so on.

Figure 9.12 shows the process flow diagram of a gasoline stripper with instrumentation, flow, temperature, and pressure for each stream.

The attached tables specify:

- the nature of materials of construction (MOC) for the various elements;
- temperature design data, pressure required to calculate the plate thickness;
- the conditions of hydraulic tests.

Figure 9.13 is a typical specification sheet. The stripper is defined with its dimensions, the positioning of fractionation trays, the nozzles, and manholes to allow inspection during shutdown.

Figure 9.14 is a PID (*Process and Instrumentation Diagram*). The evolution from the process flow diagram to the PID can be seen. The PID includes the size, item number and specifications of the pipes, and the details of the instrumentation. There is a shift from basic engineering to detailed engineering.

Figure 9.15 shows the layers of a pipe. Appropriate software programs are available to ensure that the pipes do not intersect!

Figure 9.16 shows the plant in 3D view. It will be useful to have an overview of the facility.

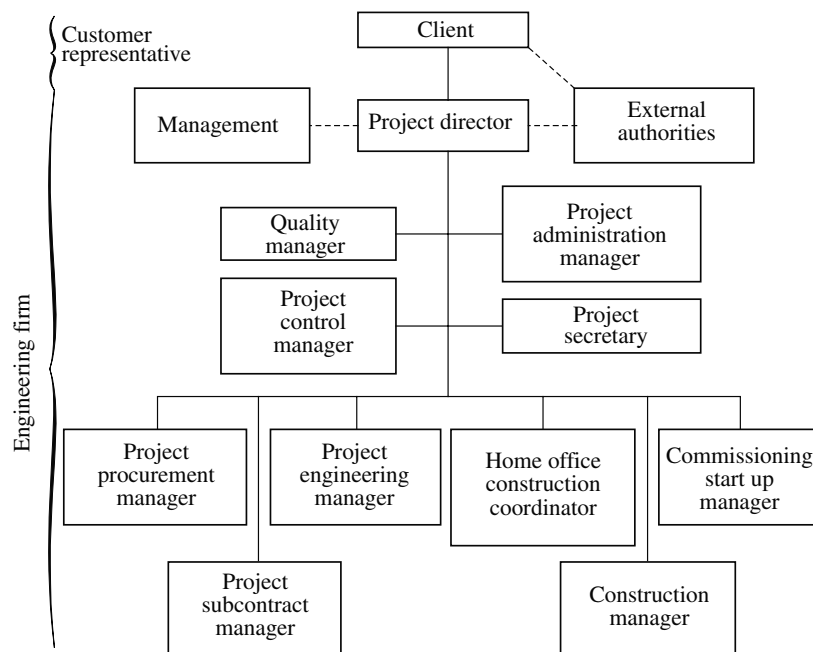

Figure 9.9. General organization of a project realization phase

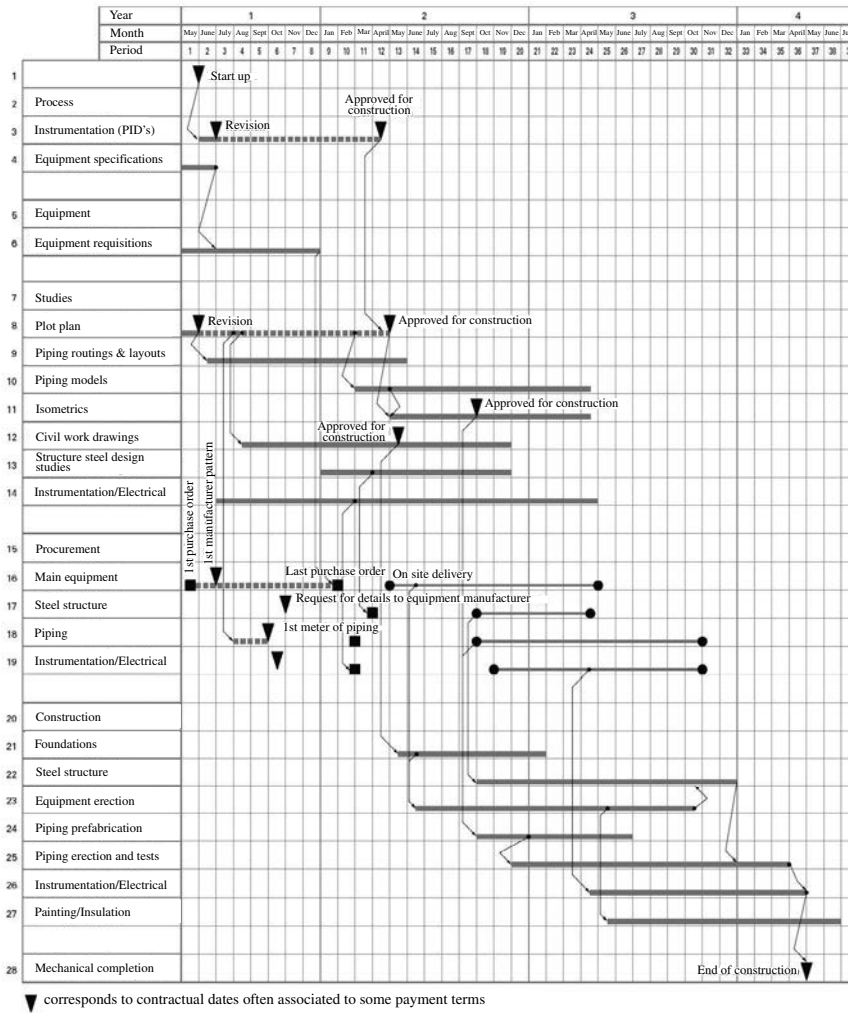

Figure 9.10. Typical chart related to the construction of a refining unit

9.4.1.4. Construction

This step may take several months for small projects and several years for large projects; it is the realization of what was initially a vision.

Construction sometimes occurs in difficult conditions due to severe climates, remoteness, which require an appropriate organization and dedicated management techniques especially for raising funds, and human resource supply.

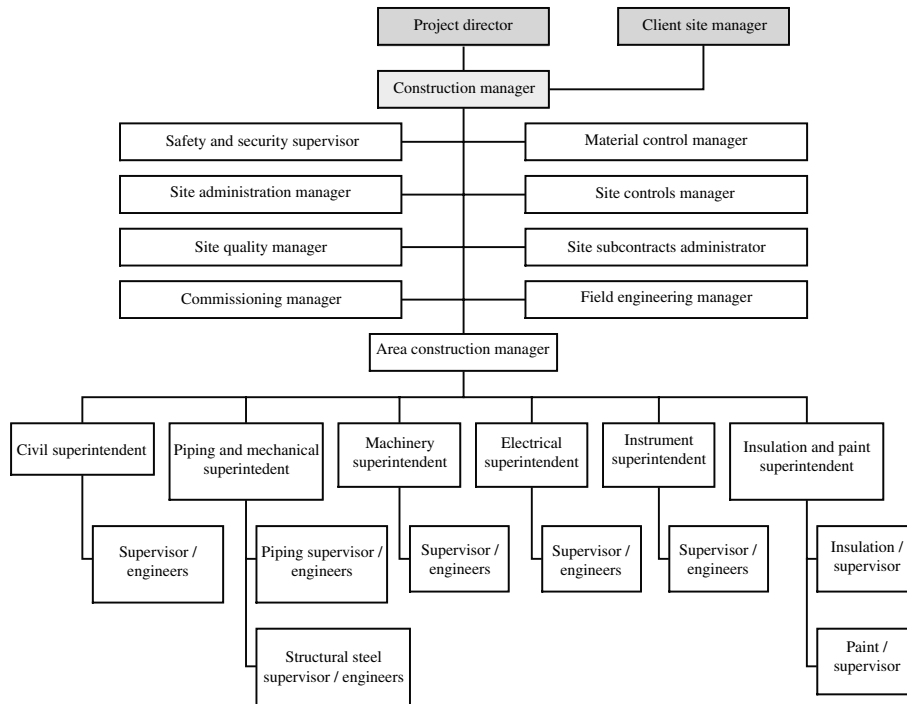

Figure 9.11. Typical organization of team in charge of the construction

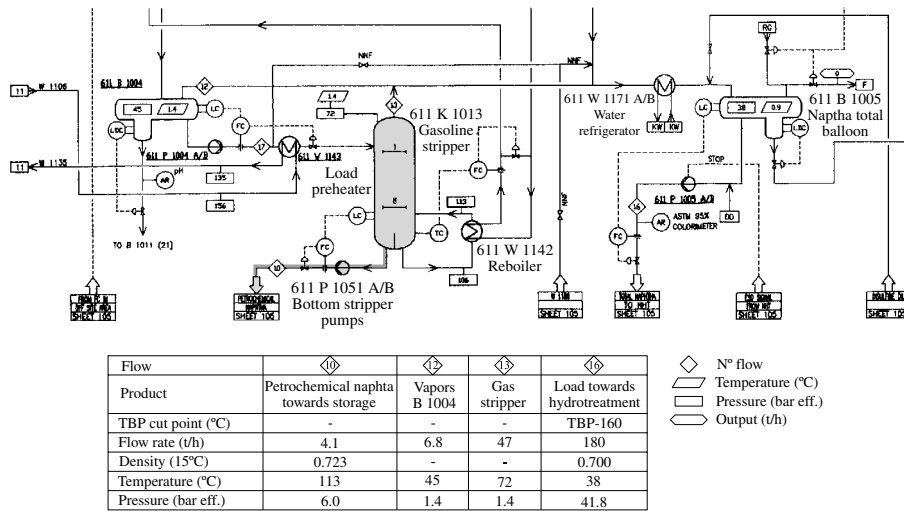

Figure 9.12. Process flow diagram – gasoline stripper

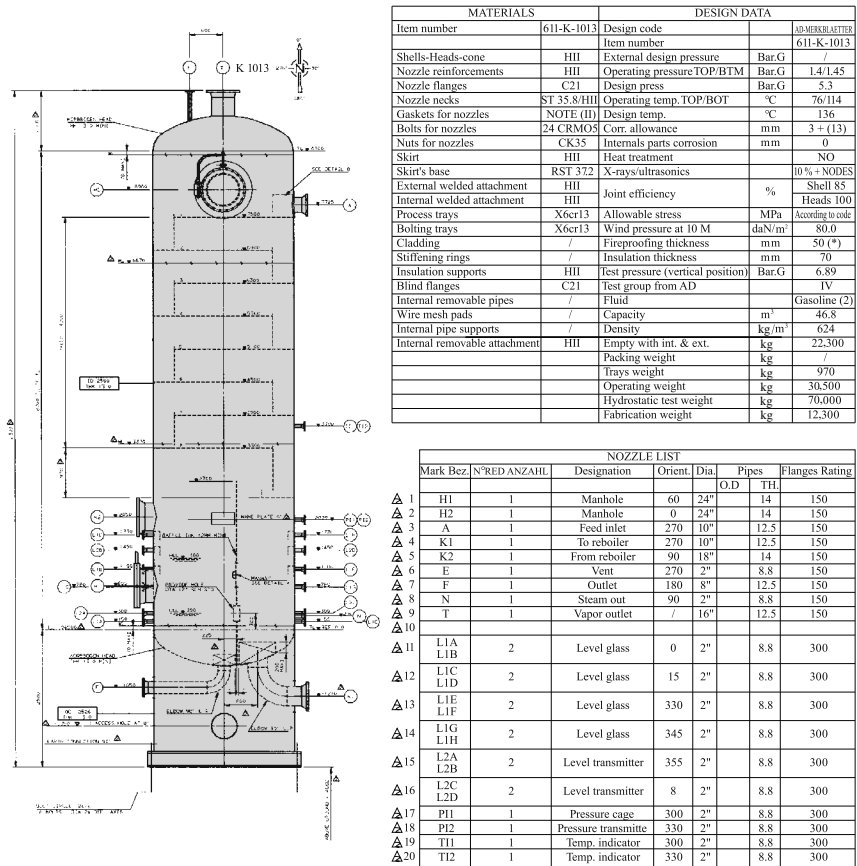

Figure 9.13. Engineering specifications – gasoline stripper

A significant portion of the project team moves, sometimes for months, on to the site during construction. A light habitation structure is located at the headquarters where it facilitates interaction between stakeholders and implements “sovereign” functions, such as expenditure tracking, contract compliance, and so on.

9.4.1.5. Contracts/insurance

The contracts will define the respective responsibilities of different stakeholders. *The most important one is the one which binds the client to the contractor.* Contracts are critical and must be written by engineering professionals and approved by lawyers who must have understood the nature of the project to ensure adequate preparation. Contracts should reflect, in good faith, what each party expects from the other and under what conditions; see [JOL 89a] for more information.

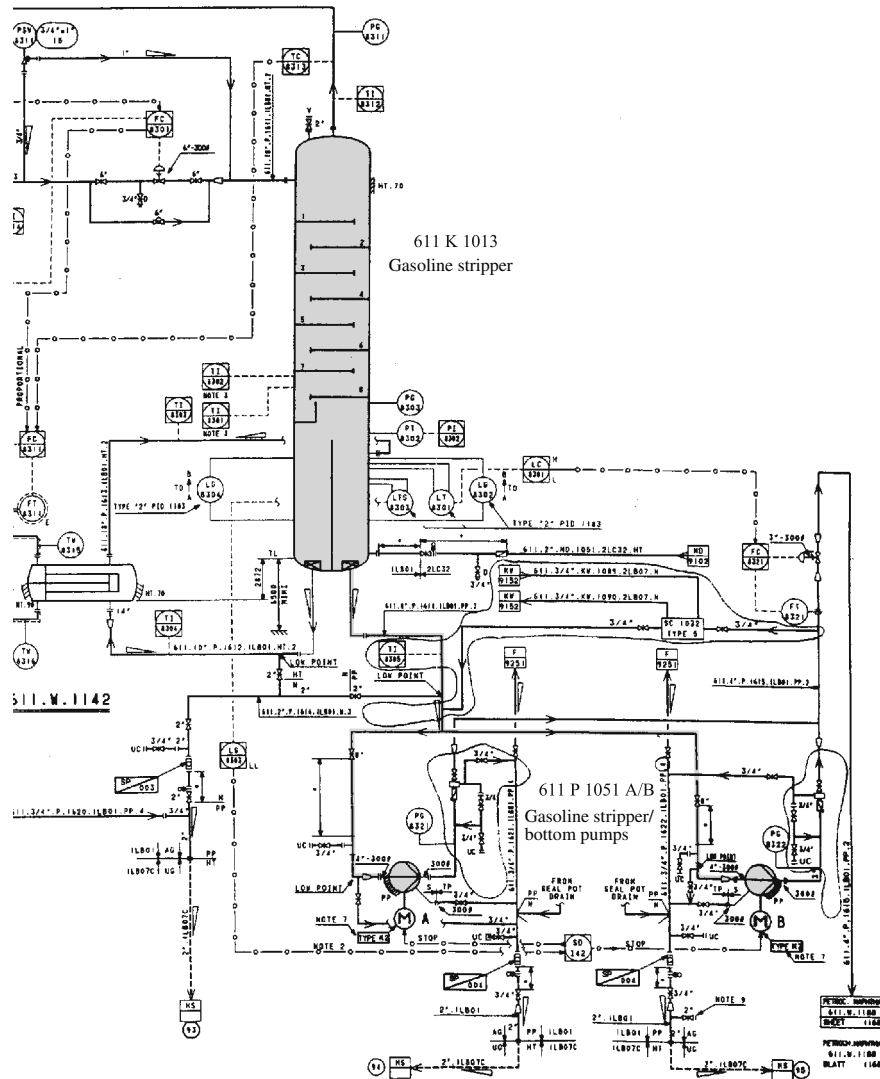

Figure 9.14. Process and instrument diagram (PID) – gasoline stripper

A client in possession of basic engineering may decide to consult various companies for what is commonly called an EPC (M), that is, “*Engineering Procurement and Construction (Management)*” contract. *Engineering* refers to detailed studies, *procurement* to the supply of equipment, whereas *construction management* is self explanatory.

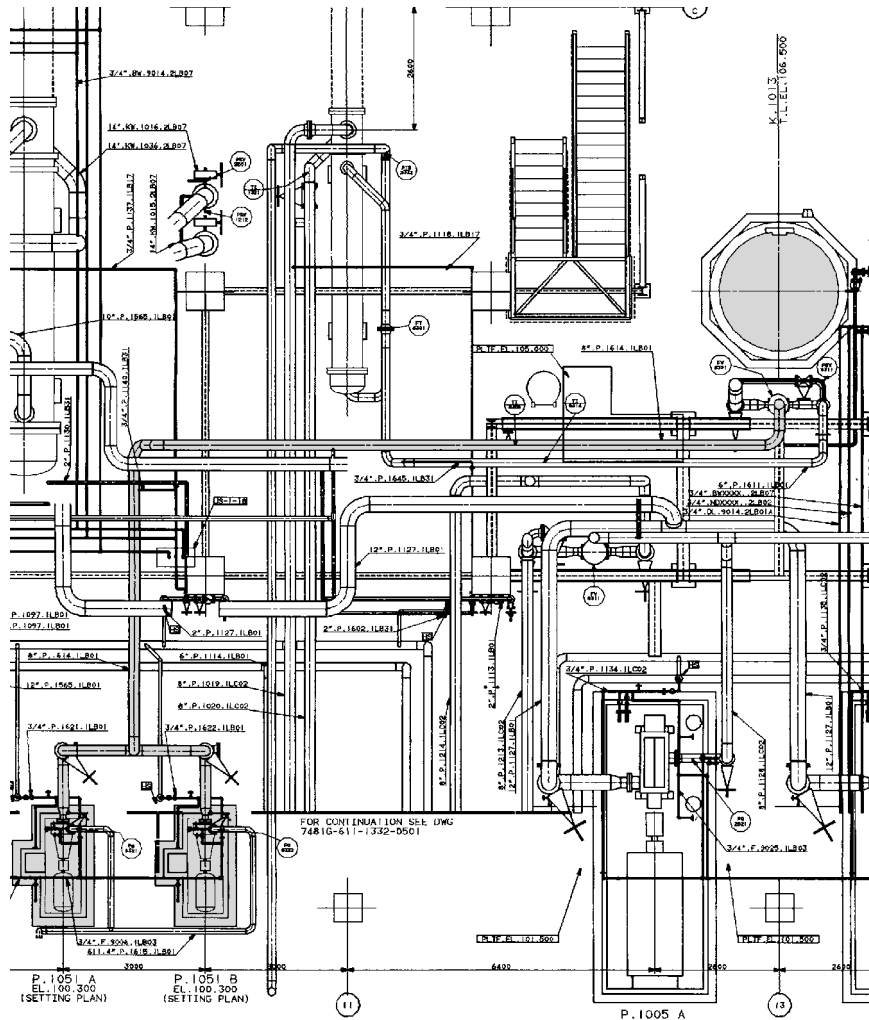

Figure 9.15. Piping layout – gasoline stripper

Obviously, the company that carried out the basic engineering has an advantage over competing companies, due to the fact that it has a team that knows the file which was created by it.

Let us retain two types of contracts among the most common ones:

- *turnkey*: the prime contractor gives the client a plant that is ready to start. The client has “nothing to do” during construction but wait. He has the opportunity to train operating personnel;

– the “*cost + fee*” contract means the client pays the prime contractor for the *actual* work performed which usually concerns the studies and construction to which he adds a *fee*. The *fee* is the profit of the contractor. It can be fixed or variable depending on the work performed. The *cost + fee* has alternatives.

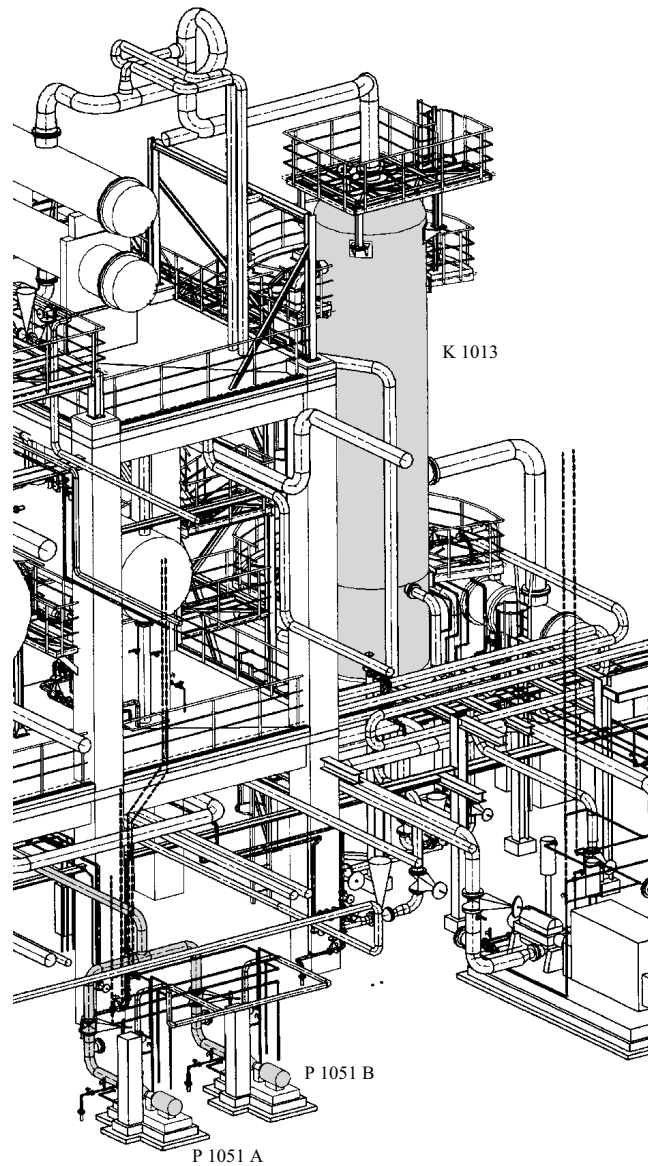

Figure 9.16. 3D model – gasoline stripper

In this type of contract, it is strongly advised that orders for material prepared by the contractor have to be signed by the client; this allows the client to control the project.

The precision of defining the project will influence the nature of the contract. A turnkey contract requires that the project be clearly defined and strongly involves the responsibility of the contractor. The client can rest peacefully, knowing how much he has to pay. *On the contrary*, a cost + fee contract is more appropriate when the project may be subject to hardly apprehensible random factors such as construction abroad when the quality of subcontractors is poorly understood.

Normally any contract is subject to penalties, in contrast, bonuses induce the contractor or the company to shorten the completion time, for example. The absolutely necessary insurances represent a particular type of contract, and they aim to protect all stakeholders in the project.

By the convention of January 8, 1887 between the State, the City of Paris and Gustave Eiffel, the City provided Eiffel with a grant of 1.5 million francs and enjoyment of operations for 20 years. The cost of the tower amounted to 7.4 million francs; due to revenue generated by the visitors, the operation was almost balanced in the first year [MAR 89].

9.4.1.6. *Selection of companies, staff*

The selection of engineering firms, contractors, and subcontractors is of paramount importance. It is worth checking references by onsite visits, and appropriate surveys of plants of the same type; this is essential before choosing a particular firm. It is the work of commercial representatives to promote them: its not them who does the work.

Good practice is to select project staff at the same time according to their ability and experience. Examining the CV (*resume*), surveys, interviews, and so on, is useful and avoids many disappointments.

9.4.1.7. *Procurement, inspection*

Buying is a job! The term procurement includes processes other than the purchasing function itself. It is a question of preparing the tenders specifying the material and associated contractual terms, choosing suppliers, inspecting during construction, ensuring the recovery, equipment transportation to the site, receiving it, carrying out payments, and so on.

This is an important function because the “itemized” and “bulk” material cost in a plant represents 40% of the total investment.

The “itemized” material is the material with an item number on the PIDs (heat exchangers, pumps, distillation columns, etc.). Equipment such as pipes, bolts and nuts, are classified as “bulk”.

9.4.2. Construction management – monitoring the progress of the project – cost and time

9.4.2.1. Site management

A building site where hundreds or thousands of people will bustle around clearly needs organization for special monitoring. Safety, protection of goods and people are of particular importance. A building site has its own disciplines: secretarial, administrative, social, and regulatory. A site has many interfaces: administration, customs, community, roads, police, electricity providers, water providers, and so on. Almost every day, the project director faces many problems.

Managing a project in the construction phase is to control costs, deadlines, and quality. The key is to identify the deviations to correct them in time, as far as possible. The objective of planning is to be proactive, that is to say to establish corrective actions in the case of deviations. A schedule is a living thing! It must anticipate events and not be limited to delays.

The project director must track expenditures (commitments and payments) based on the *degree of progress*, which is the percentage between the actual work achieved and the work necessary to complete the work (Figure 9.17). It can be measured by tonnes of steel structures installed, meters of piping, and so on; see [JOL 89b] for more details.

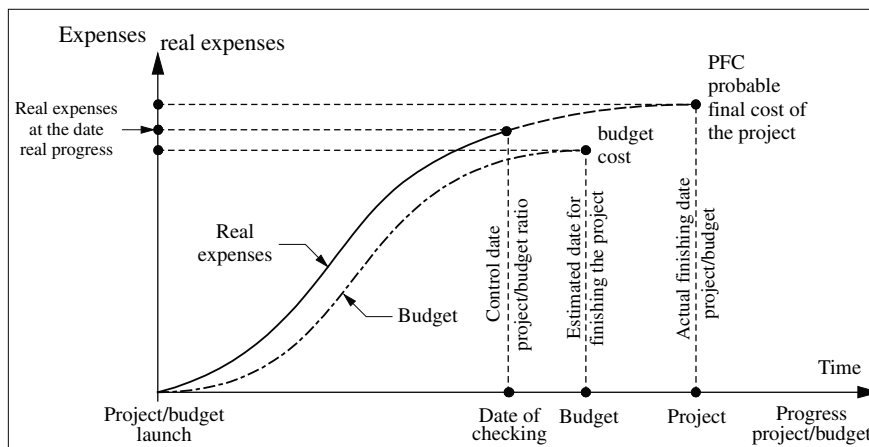

Figure 9.17. Project management: monitoring of expenditure versus budget depending on the degree of progress

What the customer wants to know is the date of delivery of the facility and the estimated cost! Adequacy of reporting, to create trust between all stakeholders in the project, is essential for the success of the project. It includes a *balanced scorecard* which reflects the situation of the project, its stage of completion, actual expenditures based on budgeted expenditures, the analysis of accidents if unfortunately there was any, *procurement*, and so on. *Reporting* refers to “hard points”, problems, how to overcome them; it is a projection into the future. It must meet the recurring questions: date of delivery of the facility and at what cost.

9.4.2.2. *Start-up*

The onsite operator, since the beginning of the construction, will have to be involved in hiring and training the staff, writing the operating manual that contains instructions, procedures and all that is required to understand the plant and its operation.

The maintenance manager must receive process plans regarding devices, “as built” drawings, and operating manuals to set up a maintenance plan in due time.

It is essential that operators are involved in detailed engineering, and to make it short “own it”.

9.4.2.3. *Commissioning*

The delivery of the work by the contractor to the client is a delicate phase of the project both on the technical aspects (the client wants a tool that meets his needs for a long period) and on the contractual aspects.

Definition of responsibilities at each stage is essential, along with *contradictory* findings, which help to clarify the responsibilities of each party rather than creating suspicion.

It is always difficult to “tie up loose ends” such as painting, insulation, cleaning, remediation of soil, and so on. It is not easy to obtain all drawings, and all specifications of equipment essential to the maintenance department. The engineering contract must include deductions, which are the only way to force contractors to meet their commitments.

One must simply note the following terms (the engineering contract should specify them in detail) that are not always understood in the same way by everyone:

- *mechanical acceptance*: the works are almost completed and in accordance with drawings and specifications (*as built*);
- *pre-commissioning*: water tests, dynamics tests, commissioning utilities, and so on;
- *start-up*: actual plant start-up using the specific raw materials;

– *commissioning*: contract data verification of the product and performance of the plant;

– receiving the plant after a test run by the client, who is apparently eager to take possession, is an important contractual phase. An indiscriminate reception will identify the responsibility of the contractor whose interest is obviously to leave quickly.

The transfer of ownership takes place during mechanical reception and modifies the respective roles of the contractor and the client. After this step, the contractor must request permission from the client to intervene in the plant.

Final acceptance of the plant does not relieve the contractor of obligations related to long-term guarantees. This is the case, for instance, with rotating machines which can work perfectly for a few months and present unacceptable defects in future.

9.4.3. Management of change orders

During the detailed engineering, assembly, and testing at reception, change requests will be made to accommodate the vagaries and *wishes* of operators. These *change orders* will create additional costs and delays. They are often an opportunity for engineering companies to charge overtime not provided in the contract, at full price.

The management of these changes lies with the project manager representing the client to evaluate its basis and decide the action. *It is a disease to be avoided.*

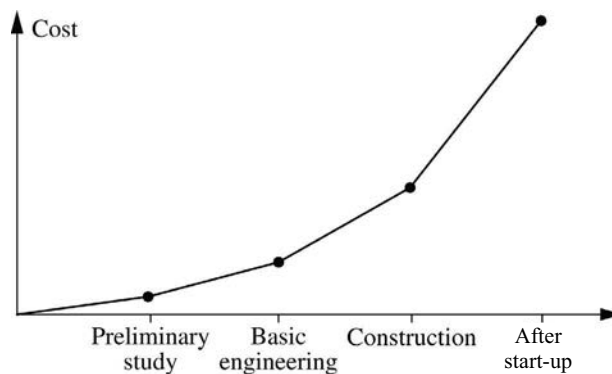

Figure 9.18. Impact of a change order to the probable final cost (PFC) with time

A *change order* will cost more if it is taken at a later stage. This is illustrated in Figure 9.18. If the *change order* is taken at the preliminary stage it changes only on “paper”. If done during construction it may lead to changes in location of structures, connections, and so on!

9.4.3.1. *Real life cases*

In the framework of a fine chemicals project in Texas, it is expected to reuse a stainless steel distillation column from an existing plant. During the development of the process of corrosion tests, it was shown that the stainless steel should be replaced with graphite and that the separation considered required 26 theoretical plates! It was necessary to specify this column, a marvel of technology, supply, install, and connect it. The executive community approves this significant *change order*, and the additional cost does not lead the project's profitability to be at risk. This is not always the case!

9.4.3.2. *Risks and uncertainties of projects*

For more information please see [BAR 00, DES 08].

Every project is subject to some hazards, whose origin can be traced to technical causes of administrative problems, personal conflicts, social conflicts, failures of suppliers, construction accidents, bad weather, negligence, order modification, and so on. Let us make a short list:

- *risks associated with people in the organization*: lack of skills, lack of ethics, lack of team spirit, poor organization, instability, turnover, lack of loyalty to the employer;

- *risks associated with partners, shareholders*: financial problems, lack of ethics, and so on;

- *technical risks associated with the process and the needs expressed by sales people*:

- poor definition of the process: the basic engineering or even the construction are launched too quickly, the assumptions are false (see the real life case above),

- the product must be further purified, or put into a different form (real life case: a drilling tower must be erected. The customer does not accept a dusty product; he wants a *free flowing* product);

- *administrative and contractual risks*:

- permits to build, produce, release into the environment when expected are not granted, there are delays or additional constraints,

- partners in a JV make changes to the contract;

- *risks associated with engineering, suppliers and subcontractors*:

- underestimation of the costs of engineering, equipment, and construction,

- strikes, bankruptcies, late delivery, transport problems, customs clearance, all that comes under the administration of various authorizations (*permitting*),

- defects: the material provided does not meet specifications, and does not have the expected performance (case study: welds for pressure storage in Asia must be 100% X-rayed. The work is poorly done, it must be repeated, and it becomes

compulsory to use an organization from Europe to control, repeat the X-rays and, repeat some of the welds);

– *risks associated with socio-economic, political, cultural aspects:*

- political unrest, economic turmoil, inflation, exchange rates, and market fluctuations,

- problems associated with religious practices, organized crime, and so on. (Case study: in 1997 in Asia, the Thai currency – the Baht was devalued by 90%, followed by the Indonesian Rupiah and the Korean Won in the following month! Economies collapse in a few weeks!);

– *market risks:*

- sales does not conform to forecasts either in volume or in price,

- competition makes an equivalent product cheaper, puts a better quality product onto the market,

- the competition has a “*breakthrough*” technology, a new process has an innovative technique that reduces production costs significantly;

– *miscellaneous:*

- natural hazards, floods, earthquakes, tornadoes, and so on,

- piracy, terrorism, and in general all that relates to the loss of know-how. These risks are exacerbated when setting up abroad in countries where the “protection of intellectual property” is not guaranteed, in countries at risk.

Let us note that there is a positive risk! Case study: projects conducted in China and Brazil on the skill of the players and especially their willingness to move forward for their sake and that of their country. Business is conducted in record time, and in an excellent atmosphere. One is far from the gloom of some aging countries. The countries of the BRIC group (Brazil, Russia, India, and China) and the Dragons of Southeast Asia attract investors; this is where there are projects!

Project risks are managed as technological risks. The different scenarios are classified based on the Consequence X probability couple [OF 08]. Kiviat and Farmer diagrams help to define the *criticality* of the risk about which the decision(s) is (are) wisely taken.

9.5. The amount of investment

The amount of investment is the figure that will retain the “non-technicians “of the company, those who move at headquarter level. This figure will be recorded in the files, reports of the planners, of the finance People. It is always difficult for the Industrial Director to change a figure by usually a larger one!!

This is extremely important for major projects, that is to say, for projects that involve the future of the company; this is in the case of strategic projects whose profitability is sometimes uncertain. What follows will deal with physical investments (factories or plants).

From the preliminary feasibility stage, it is necessary to get an idea of the amount of investment. It is a key parameter of profitability calculations as discussed below. It is also an amount that the CEO wants to know as soon as possible to find adequate funding. *Few companies can pay for themselves, one must resort to banks.*

The amount of capital investment includes:

- the cost of studies (preliminary study, basic engineering, detailed engineering);
- the cost of equipment and materials;
- the cost of construction (work contracts, supervision, administration of the site, etc.);
- start-up costs (cost of staff, products, miscellaneous);
- taxes, insurance, customs duties and transport, contingencies, and so on.

NOTE.– *The client usually separates these costs and the cost of research and development, which can be considerable. The development of a drug may require 8–10 years at a cost of around 1 billion dollars!*

To clarify, the cost of a large organic chemistry plant in France is as follows:

- equipment (itemized equipment) from 15% to 20%;
- piping: from 15% to 20%;
- instrumentation: from 15% to 20%;
- electricity: from 5% to 10%;
- civil/structural engineering: from 20% to 25%;
- insulation/painting/other: 5%;
- engineering: from 15% to 20%;
- total: 100%.

The cost of a plant having the same capacity in a given product will vary widely depending on its location, the degree of instrumentation, its overall design, climatic constraints, the organization of work, taking into account the HSE constraints and its mode of construction! This book does not deal with such a complex subject in detail, only some guidance and advice is given.

For further information the reader can refer to [VAN 96].

EXAMPLE 9.1.– The coordinator of this book led a major biotechnology project in the American midwest. Looking for a source of carbohydrate, he was able to visit a dozen plants which were very similar for corn processing, from the Great Lakes to the Carolinas, thus in extreme climatic regions. As an example, the cost of the plants ranged from 100 million to 150 million dollars. This huge variation was due to the conditions of design, engineering, closed or open structures, organization of work: a single control room or several scattered throughout the plant ...

Estimating is an art. One must have some flair and experience in the field!

Engineering companies of significant size have cost statistics related to:

- the projects achieved with their history;
- the “main equipment” such as heat exchangers depending on the type, material, and design conditions. The same goes for tanks, distillation columns, filters, and so on;
- the “units of work” such as the cost per cubic meter of earthwork...

One must distinguish between the expenditure in the limit of the production unit (*ISBL, inside battery limits*), that is to say everything concerning the means of production itself, and expenditures excluding the manufacturing unit (*OSBL; outside battery limits*).

The OSBL expenses include, unless limited to land, the production of utilities (water, steam, electricity, etc.), the WWTU, storage facilities, offices, shops, and laboratories. *The border between ISBL and OSBL is not always well defined; the key is to know what is included and not forget anything!*

The following methods are within the reach of small engineering offices or companies:

– *estimation by the type of activity or analytical estimation*: the process industries assemble “blocks”, and “unit operations” (reaction, distillation, crystallization, storage, etc.). Knowing the price of each block, the overall cost amounts to an addition;

– *similar method*: this is very valuable for the estimation of plants manufacturing the same product under similar conditions. Only the capacity is different. The following equation gives good results:

$$C_1/C_2 = (P_1/P_2)^e \quad [9.3]$$

where C_1 and C_2 represent the cost of two units of capacity P_1 and P_2 for the same finished product. The value of e is close to 0.6 for organic chemistry plants.

Let us note that this method works well for calculating the cost of basic equipment.

Let us consider the example of two exchangers of the same type. In this case, P_1 and P_2 are replaced by an equipment surface expressed in square meters. In the analytical method, one knows the cost of a “block” for a given capacity. The similar method allows us to calculate *a priori* the cost of the “block” for another capacity, where the problem is apparently to find parameter e .

Preliminary estimates mostly provoke passions; Business Unit Managers find it too high. They have their own idea, and ask the amounts to be reviewed. One tries to understand, to eliminate! The fact that they are given provisionally is forgotten and it is not considered whether they are given with some accuracy.

The estimates will succeed as the project progresses. It is necessary to follow their evolution. Figures that are too high are likely to “kill” the project. Low figures will sometimes make “*Heroes of the day*”. The moment of truth will arrive!

Estimating is a professional matter. It requires common sense, experience, and intuition.

Some traditional sources of common errors include:

- lack of general definition;
- forgetting a piece of equipment: an impurity that “appears during the development of the process” may require an additional distillation to be estimated;
- error in the construction materials (stainless steel which has to be replaced with a Hastelloy);
- design error: building designed “open” at the beginning and ends in a closed structure to improve the comfort of operators. The air of this structure must then be renewed in the case of emission of toxic products which results in the addition of ventilation systems;
- type of contract with engineering, lack of definition, unsuitable contract;
- subcontracting; underestimation of costs.

The most common mistake is forgetting a particular “item”. *It is important to list all items even with imprecision which is usually the case at the beginning of the job.*

The estimate of *revamping* poses particular problems, where one denotes by *revamping* the act of altering an existing plant in use. Modifying equipment of which conditions are not known, and working on plants that operate and require

stringent precautions will pose great difficulties. This will be discussed in Chapter 13.

9.6. Profitability on investment [DOR 81, MIK 10]

9.6.1. Principle of calculation of cash flows

Physical investment (plant, facility) is made in the hope of gain. It is a “sacrifice of resources”, a desired risk, carried out with the hope of obtaining after certain time, usually years, a higher profit in terms of incurred expenses. An investment is part of the strategy of the society; it is a *capital asset* which is contained in the balance sheet.

In what follows, we will focus on physical investments knowing that any investment of this nature can lead to research costs, additional needs for working capital from operations, advertising, hiring, training staff, travel expenses, transfer, reclassification, expatriation, and so on. What follows is not complete!

Calculating the profitability of an investment is like comparing cash flow as shown in Figure 9.19.

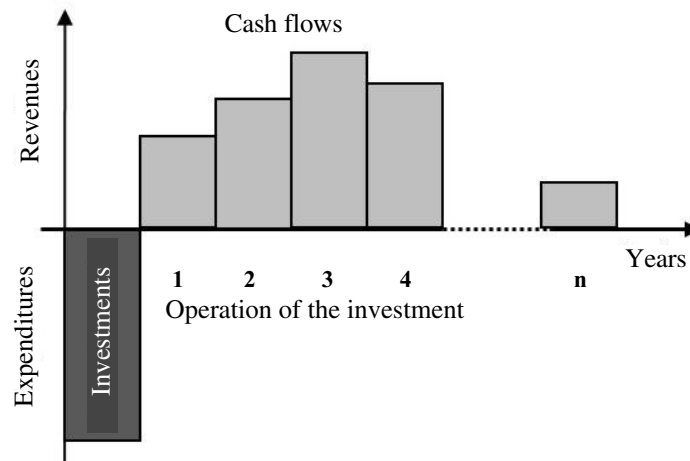

Figure 9.19. Cash flow

The first cash flow normally corresponds to the capital investment within a short period of time. The second is positioned at intervals of time. It corresponds to the excess amount that leaves the sales revenue net of expenses which they have created

including the purchase of raw materials, manufacturing costs, taxes, financing costs related to loans, management fees, and so on.

9.6.2. Depreciation and amortization

This is not a simple concept! Let us take the main idea. Any equipment wears out and loses its value (That is the case of an automobile!). Land does not wear out, it is not depreciable.

The legislature accepts and requires that a percentage of the amount of the property be brought into the operating costs column which diminishes the margin, thereby reducing taxes. Depreciation is charged to the cost of returns of the production [CON 01].

Depreciation is not an expense; it does not cause cash outflow, it is a *resource*. *Depreciation is expected to finance the renewal of the means of production.*

The *net accounting value* of an asset is its *gross value* (of purchase) subtracted from depreciation.

Depreciation may be *linear*; it is estimated that the wear is linear in time. It may be *declining*, the depreciation is very high in the first year.

9.6.3. Concept of discount [MAR 79]

Currently, 1 dollar will be worth $(1 + i)$ dollars after one year, i is the *interest rate*, $1 + i$ is the *discount factor* [CON 01]. If i is assumed to be constant then today's dollar will be worth $(1 + i)^n$ in n years. This is the formula of simple interest, only the capital generates interest. If the interest is reinvested, then it is called the *compound interest*.

This leads to the concept of *capitalization*, a capital of C dollars in recent days will be worth $C(1 + i)^n$ dollars in n years.

Inversely, the *update* of C dollars in n years is equivalent to $C/(1 + i)^n$ dollars today.

The *net present value (NPV)* is the excess of cumulated cash flow (CCF) relating to the operation of the investment calculated on its lifetime and deducted from the amount of it, I [MAR 79]. It is worth:

$$NPV = \Sigma(\text{CCF}) - I \quad [9.4]$$

For a project to be profitable, the NPV must be positive.

An investment may have a residual value at the end of its life. Some pieces of equipment can be sold, the land also *but* this is not always the case.

9.6.4. Concept of internal rate of return (IRR)

Some companies use the term IRR. *The IRR is the rate for which NPV is zero with the same definitions as before.* One must make calculations with different rates of i to achieve a zero NPV.

The higher the discount rate or rate of return of IRR, the more profitable the investment. The CCF is “crushed” when the amount of investment I is constant.

NPV and IRR are assessment tools which make it possible to choose between different projects.

9.6.5. Rapid methods: the calculations of the grocer (examples)

An industrial manager, a plant manager, and a financier very often have to decide quickly or simply give their opinion on the merits of small investment, particularly on investment maintenance or capital maintenance. These are investments that are aimed at maintaining the production equipment in the same state, improve productivity, and generate efficiencies in raw material usage. Let us note that small investments can be considered as very significant investment by small companies.

One simply divides the amount of investment by the expected gain; the result expressed in years is often called *Pay-Back* or ROI (*Return on Investment*).

Let us consider a simple example.

A plant examines an investment that aims for a gain of raw material (RM). The expected gain of 0.1 kg of RM/kg of finished product, or for a production of 10,000 tonnes of finished product/year, a gain of 1,000 tonnes of RM/year. If the cost of the raw material is 3,000 dollars/ton, then the expected annual gain is 3 million dollars/year.

One also considers that the approximate capital investment, research costs, and technical start-up costs correspond to 1.5 million dollars.

Such an investment would have a *pay-back* of six months! Studies can be launched immediately. If the investment is 9 million dollars and therefore the payback is 3 years it has to be thought about! In many companies, a *pay-back* of 3 years is the upper limit of acceptance of the investments.

9.7. Conclusion

Investment is a major act for the company; its future depends on it at least for major projects, called strategic projects, for which it keeps in most cases the “know-how”. Know-how that originates most often in its research and development laboratories.

Industrialization and implementation require close cooperation between the client and the contractor. The former knows the process; the latter has the know-how, the skills of project management procurement, construction management.

The client will never know how to provide all the details of the process in a process file as complete as it is, and an engineering firm despite all its skills, will not know how to “invent” these details. One must plan meeting points (PID reviews, project reviews, verification of specifications of critical devices, etc.), so that one can ensure that the engineering firm has understood and assimilated all *know-how* that “the designer” owner of the technology wanted to convey and implement in devices of all kinds.

The project team faces this task!

9.8. Bibliography

- [AFN 97] AFNOR GESTION, *Qualité en conception – La rencontre besoin-produit-ressources*, Saint-Denis, 1997.
- [AUR 99] AUROY M., *Processus d’Industrialisation – Schémas en industrie de process*, Techniques de l’Ingénieur, Paris, 1999.
- [BAL 02] BALLIEU J., BOULET C., *Analyse de la valeur, A savoir – AFNOR*, Saint-Denis, 2002.
- [BAR 00] BARTHELEMY B., QUIBEL J., *Gestion des risques de l’entreprise*, Techniques de l’Ingénieur, Paris, 2000.
- [CAR 02] CARMONA M., *Eiffel*, Fayard, Paris, 2002.
- [CHA 01] CHARRIER C., *Réalisation de projets dans une société d’ingénierie*, Techniques de l’Ingénieur, Paris, 2001.
- [CON 01] CONSO P., HEMICI F., *L’entreprise en 20 leçons*, Dunod, Paris, 2001.
- [DAL 03] DAL PONT J.-P., *L’entreprise industrielle – Analyse de la valeur – Analyse fonctionnelle*, Clartés, Dijon, 2003 (available for reference exclusively at the BnF).
- [DAL 06] DAL PONT J.-P., *L’Ingénierie*, Clartés, Dijon, 2006 (available for reference exclusively at the BnF).
- [DEL 91] DELAFOLLIE G., *Analyse de la valeur*, Hachette Technique, Paris, 1991.
- [DES 08] DESROCHES A., *Gestion des risques d’un projet*, Techniques de l’Ingénieur, Paris, 2008.

- [DOR 81] DORVAL C., *Choix des investissements*, Techniques de l'Ingénieur, Paris, 1981.
- [JOL 89a] JOLY M., *Organisation générale du projet*, Techniques de l'Ingénieur, Paris, 1989.
- [JOL 89b] JOLY M., *Contrôle des coûts et délais*, Techniques de l'Ingénieur, Paris, 1989.
- [KER 89] KERZNER H., *Project Management: A Systems Approach to Planning Scheduling & Controlling*, Van Nostrand Reinhold, New York, 1989.
- [LEB 00a] LE BISSONNAIS J., *Management de Projet – Les processus (d'après ISO 10006)*, Techniques de l'Ingénieur, Paris, 2000.
- [LEB 00b] LE BISSONNAIS J., *Management de Projet – Cas d'une coopérative agricole*, Techniques de l'Ingénieur, Paris, 2000.
- [LEB 00c] LE BISSONNAIS J., *Management de Projet – Cas d'un projet en joint-venture*, Techniques de l'Ingénieur, Paris, 2000.
- [MAR 79] MARGERIN J., AUSSET G., *Choix des investissements*, Sedifor, Paris, 1979.
- [MAR 89] MARREY B., *Gustave Eiffel – Une entreprise exemplaire*, Institute, La Charité-sur-Loire, 1989.
- [MIK 10] MIKOL A., *Gestion comptable et financière*, Que sais-je?, PUF, Paris, 2010.
- [PET 97] PETITDEMANGE C., *Le management par projet – 80 démarches opérationnelles*, EFE, Paris, 1997.
- [TAS 95] TASSINARI R., *L'analyse fonctionnelle*, A savoir – AFNOR, Saint-Denis, 1995.
- [TIB 02] TIBERGHIE F., *Versailles: le chantier de Louis XIV (1662–1715)*, Perrin, Paris, 2002.
- [VAN 96] VANDAMME M.-N., *Coûts des investissements – Méthodes d'estimation*, Techniques de l'Ingénieur, Paris, 1996.
- [ZAN 97] ZANY J.-P., *Cahier des charges fonctionnelles*, Techniques de l'Ingénieur, Paris, 1997.