

لجنة سنافر البوليتكنك - بسواعدنا نبيها

الاتجاه الاسلامي - البوليتكنك

حلول المادة

Calculus 101

By Anton , Bivens and davis
10Th Edition



نبيها
بسواعدنا

تواصل معنا



BESOWA3EDNA.NABNEHA



/snafermuslimengineer.weebly.com



/groups/Smurfs.On.The.Way



Muslimengineerpage

CALCULUS

ANTON BIVENS DAVIS

**INSTRUCTOR
SOLUTIONS
MANUAL**

EARLY TRANSCENDENTALS 10TH EDITION



WILEY

Contents

Chapter 0.	Before Calculus	1
Chapter 1.	Limits and Continuity	39
Chapter 2.	The Derivative	71
Chapter 3.	Topics in Differentiation	109
Chapter 4.	The Derivative in Graphing and Applications	153
Chapter 5.	Integration	243
Chapter 6.	Applications of the Definite Integral in Geometry, Science, and Engineering...	305
Chapter 7.	Principals of Integral Evaluation	363
Chapter 8.	Mathematical Modeling with Differential Equations	413
Chapter 9.	Infinite Series	437
Chapter 10.	Parametric and Polar Curves; Conic Sections	485
Chapter 11.	Three-Dimensional Space; Vectors	545
Chapter 12.	Vector-Valued Functions	589
Chapter 13.	Partial Derivatives	627
Chapter 14.	Multiple Integrals	675
Chapter 15.	Topics in Vector Calculus	713
Appendix A.	Graphing Functions Using Calculators and Computer Algebra Systems	745
Appendix B.	Trigonometry Review	753
Appendix C.	Solving Polynomial Equations	759

Before Calculus

Exercise Set 0.1

1. (a) $-2.9, -2.0, 2.35, 2.9$ (b) None (c) $y = 0$ (d) $-1.75 \leq x \leq 2.15, x = -3, x = 3$
(e) $y_{\max} = 2.8$ at $x = -2.6$; $y_{\min} = -2.2$ at $x = 1.2$
2. (a) $x = -1, 4$ (b) None (c) $y = -1$ (d) $x = 0, 3, 5$
(e) $y_{\max} = 9$ at $x = 6$; $y_{\min} = -2$ at $x = 0$
3. (a) Yes (b) Yes (c) No (vertical line test fails) (d) No (vertical line test fails)
4. (a) The natural domain of f is $x \neq -1$, and for g it is the set of all x . $f(x) = g(x)$ on the intersection of their domains.
(b) The domain of f is the set of all $x \geq 0$; the domain of g is the same, and $f(x) = g(x)$.
5. (a) 1999, \$47,700 (b) 1993, \$41,600
(c) The slope between 2000 and 2001 is steeper than the slope between 2001 and 2002, so the median income was declining more rapidly during the first year of the 2-year period.
6. (a) In thousands, approximately $\frac{47.7 - 41.6}{6} = \frac{6.1}{6}$ per yr, or \$1017/yr.
(b) From 1993 to 1996 the median income increased from \$41.6K to \$44K (K for 'kilodollars'; all figures approximate); the average rate of increase during this time was $(44 - 41.6)/3$ K/yr = $2.4/3$ K/yr = \$800/year. From 1996 to 1999 the average rate of increase was $(47.7 - 44)/3$ K/yr = $3.7/3$ K/yr \approx \$1233/year. The increase was larger during the last 3 years of the period.
(c) 1994 and 2005.
7. (a) $f(0) = 3(0)^2 - 2 = -2$; $f(2) = 3(2)^2 - 2 = 10$; $f(-2) = 3(-2)^2 - 2 = 10$; $f(3) = 3(3)^2 - 2 = 25$; $f(\sqrt{2}) = 3(\sqrt{2})^2 - 2 = 4$; $f(3t) = 3(3t)^2 - 2 = 27t^2 - 2$.
(b) $f(0) = 2(0) = 0$; $f(2) = 2(2) = 4$; $f(-2) = 2(-2) = -4$; $f(3) = 2(3) = 6$; $f(\sqrt{2}) = 2\sqrt{2}$; $f(3t) = 1/(3t)$ for $t > 1$ and $f(3t) = 6t$ for $t \leq 1$.
8. (a) $g(3) = \frac{3+1}{3-1} = 2$; $g(-1) = \frac{-1+1}{-1-1} = 0$; $g(\pi) = \frac{\pi+1}{\pi-1}$; $g(-1.1) = \frac{-1.1+1}{-1.1-1} = \frac{-0.1}{-2.1} = \frac{1}{21}$; $g(t^2 - 1) = \frac{t^2 - 1 + 1}{t^2 - 1 - 1} = \frac{t^2}{t^2 - 2}$.
(b) $g(3) = \sqrt{3+1} = 2$; $g(-1) = 3$; $g(\pi) = \sqrt{\pi+1}$; $g(-1.1) = 3$; $g(t^2 - 1) = 3$ if $t^2 < 2$ and $g(t^2 - 1) = \sqrt{t^2 - 1 + 1} = |t|$ if $t^2 \geq 2$.

9. (a) Natural domain: $x \neq 3$. Range: $y \neq 0$. (b) Natural domain: $x \neq 0$. Range: $\{1, -1\}$.
- (c) Natural domain: $x \leq -\sqrt{3}$ or $x \geq \sqrt{3}$. Range: $y \geq 0$.
- (d) $x^2 - 2x + 5 = (x - 1)^2 + 4 \geq 4$. So $G(x)$ is defined for all x , and is $\geq \sqrt{4} = 2$. Natural domain: all x . Range: $y \geq 2$.
- (e) Natural domain: $\sin x \neq 1$, so $x \neq (2n + \frac{1}{2})\pi$, $n = 0, \pm 1, \pm 2, \dots$. For such x , $-1 \leq \sin x < 1$, so $0 < 1 - \sin x \leq 2$, and $\frac{1}{1 - \sin x} \geq \frac{1}{2}$. Range: $y \geq \frac{1}{2}$.
- (f) Division by 0 occurs for $x = 2$. For all other x , $\frac{x^2 - 4}{x - 2} = x + 2$, which is nonnegative for $x \geq -2$. Natural domain: $[-2, 2) \cup (2, +\infty)$. The range of $\sqrt{x + 2}$ is $[0, +\infty)$. But we must exclude $x = 2$, for which $\sqrt{x + 2} = 2$. Range: $[0, 2) \cup (2, +\infty)$.
10. (a) Natural domain: $x \leq 3$. Range: $y \geq 0$. (b) Natural domain: $-2 \leq x \leq 2$. Range: $0 \leq y \leq 2$.
- (c) Natural domain: $x \geq 0$. Range: $y \geq 3$. (d) Natural domain: all x . Range: all y .
- (e) Natural domain: all x . Range: $-3 \leq y \leq 3$.
- (f) For \sqrt{x} to exist, we must have $x \geq 0$. For $H(x)$ to exist, we must also have $\sin \sqrt{x} \neq 0$, which is equivalent to $\sqrt{x} \neq \pi n$ for $n = 0, 1, 2, \dots$. Natural domain: $x > 0$, $x \neq (\pi n)^2$ for $n = 1, 2, \dots$. For such x , $0 < |\sin \sqrt{x}| \leq 1$, so $0 < (\sin \sqrt{x})^2 \leq 1$ and $H(x) \geq 1$. Range: $y \geq 1$.
11. (a) The curve is broken whenever someone is born or someone dies.
- (b) C decreases for eight hours, increases rapidly (but continuously), and then repeats.
12. (a) Yes. The temperature may change quickly under some conditions, but not instantaneously.
- (b) No; the number is always an integer, so the changes are in movements (jumps) of at least one unit.

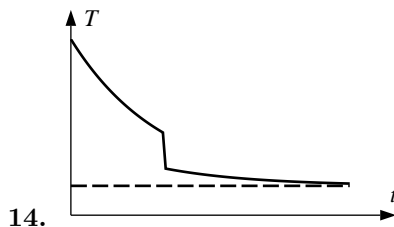
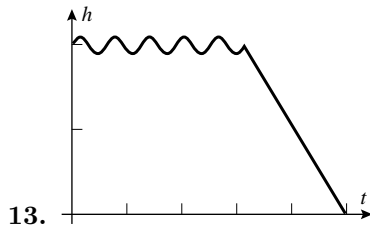

15. Yes. $y = \sqrt{25 - x^2}$.

16. Yes. $y = -\sqrt{25 - x^2}$.

17. Yes. $y = \begin{cases} \sqrt{25 - x^2}, & -5 \leq x \leq 0 \\ -\sqrt{25 - x^2}, & 0 < x \leq 5 \end{cases}$

18. No; the vertical line $x = 0$ meets the graph twice.
19. False. E.g. the graph of $x^2 - 1$ crosses the x -axis at $x = 1$ and $x = -1$.
20. True. This is Definition 0.1.5.
21. False. The range also includes 0.
22. False. The domain of g only includes those x for which $f(x) > 0$.
23. (a) $x = 2, 4$ (b) None (c) $x \leq 2; 4 \leq x$ (d) $y_{\min} = -1$; no maximum value.
24. (a) $x = 9$ (b) None (c) $x \geq 25$ (d) $y_{\min} = 1$; no maximum value.
25. The cosine of θ is $(L - h)/L$ (side adjacent over hypotenuse), so $h = L(1 - \cos \theta)$.
26. The sine of $\theta/2$ is $(L/2)/10$ (side opposite over hypotenuse), so $L = 20 \sin(\theta/2)$.

27. (a) If $x < 0$, then $|x| = -x$ so $f(x) = -x + 3x + 1 = 2x + 1$. If $x \geq 0$, then $|x| = x$ so $f(x) = x + 3x + 1 = 4x + 1$;

$$f(x) = \begin{cases} 2x + 1, & x < 0 \\ 4x + 1, & x \geq 0 \end{cases}$$

(b) If $x < 0$, then $|x| = -x$ and $|x - 1| = 1 - x$ so $g(x) = -x + (1 - x) = 1 - 2x$. If $0 \leq x < 1$, then $|x| = x$ and $|x - 1| = 1 - x$ so $g(x) = x + (1 - x) = 1$. If $x \geq 1$, then $|x| = x$ and $|x - 1| = x - 1$ so $g(x) = x + (x - 1) = 2x - 1$;

$$g(x) = \begin{cases} 1 - 2x, & x < 0 \\ 1, & 0 \leq x < 1 \\ 2x - 1, & x \geq 1 \end{cases}$$

28. (a) If $x < 5/2$, then $|2x - 5| = 5 - 2x$ so $f(x) = 3 + (5 - 2x) = 8 - 2x$. If $x \geq 5/2$, then $|2x - 5| = 2x - 5$ so $f(x) = 3 + (2x - 5) = 2x - 2$;

$$f(x) = \begin{cases} 8 - 2x, & x < 5/2 \\ 2x - 2, & x \geq 5/2 \end{cases}$$

(b) If $x < -1$, then $|x - 2| = 2 - x$ and $|x + 1| = -x - 1$ so $g(x) = 3(2 - x) - (-x - 1) = 7 - 2x$. If $-1 \leq x < 2$, then $|x - 2| = 2 - x$ and $|x + 1| = x + 1$ so $g(x) = 3(2 - x) - (x + 1) = 5 - 4x$. If $x \geq 2$, then $|x - 2| = x - 2$ and $|x + 1| = x + 1$ so $g(x) = 3(x - 2) - (x + 1) = 2x - 7$;

$$g(x) = \begin{cases} 7 - 2x, & x < -1 \\ 5 - 4x, & -1 \leq x < 2 \\ 2x - 7, & x \geq 2 \end{cases}$$

29. (a) $V = (8 - 2x)(15 - 2x)x$ (b) $0 < x < 4$

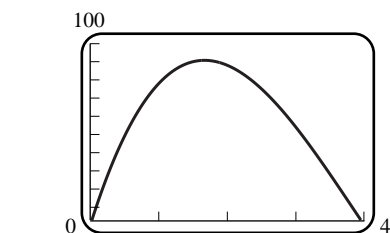

(c) $0 < V \leq 91$, approximately

(d) As x increases, V increases and then decreases; the maximum value occurs when x is about 1.7.

30. (a) $V = (6 - 2x)^2x$ (b) $0 < x < 3$

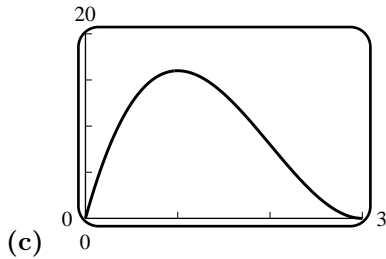

(c) $0 < V \leq 16$, approximately

(d) As x increases, V increases and then decreases; the maximum value occurs when x is about 1.

31. (a) The side adjacent to the building has length x , so $L = x + 2y$. (b) $A = xy = 1000$, so $L = x + 2000/x$.

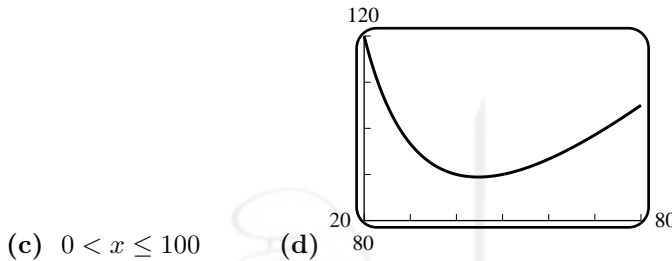

(c) $0 < x \leq 100$

(d)

$x \approx 44.72$ ft, $y \approx 22.36$ ft

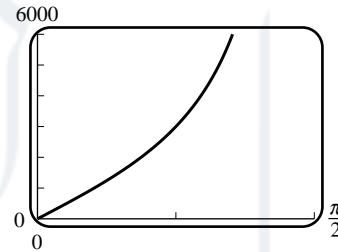

32. (a) $x = 3000 \tan \theta$ (b) $0 \leq \theta < \pi/2$ (c) 3000 ft

33. (a) $V = 500 = \pi r^2 h$, so $h = \frac{500}{\pi r^2}$. Then $C = (0.02)(2)\pi r^2 + (0.01)2\pi r h = 0.04\pi r^2 + 0.02\pi r \frac{500}{\pi r^2} = 0.04\pi r^2 + \frac{10}{r}$; $C_{\min} \approx 4.39$ cents at $r \approx 3.4$ cm, $h \approx 13.7$ cm.

(b) $C = (0.02)(2)(2r)^2 + (0.01)2\pi r h = 0.16r^2 + \frac{10}{r}$. Since $0.04\pi < 0.16$, the top and bottom now get more weight. Since they cost more, we diminish their sizes in the solution, and the cans become taller.

(c) $r \approx 3.1$ cm, $h \approx 16.0$ cm, $C \approx 4.76$ cents.

34. (a) The length of a track with straightaways of length L and semicircles of radius r is $P = (2)L + (2)(\pi r)$ ft. Let $L = 360$ and $r = 80$ to get $P = 720 + 160\pi \approx 1222.65$ ft. Since this is less than 1320 ft (a quarter-mile), a solution is possible.

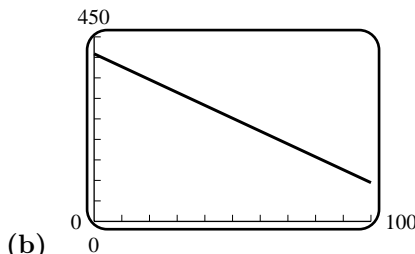

(b) $P = 2L + 2\pi r = 1320$ and $2r = 2x + 160$, so $L = (1320 - 2\pi r)/2 = (1320 - 2\pi(80 + x))/2 = 660 - 80\pi - \pi x$.

(c) The shortest straightaway is $L = 360$, so we solve the equation $360 = 660 - 80\pi - \pi x$ to obtain $x = \frac{300}{\pi} - 80 \approx 15.49$ ft.

(d) The longest straightaway occurs when $x = 0$, so $L = 660 - 80\pi \approx 408.67$ ft.

35. (i) $x = 1, -2$ causes division by zero. (ii) $g(x) = x + 1$, all x .

36. (i) $x = 0$ causes division by zero. (ii) $g(x) = |x| + 1$, all x .

37. (a) 25°F (b) 13°F (c) 5°F

38. If $v = 48$ then $-60 = \text{WCT} \approx 1.4157T - 30.6763$; thus $T \approx -21^\circ\text{F}$ when $\text{WCT} = -60$.

39. If $v = 48$ then $-60 = \text{WCT} \approx 1.4157T - 30.6763$; thus $T \approx 15^\circ\text{F}$ when $\text{WCT} = -10$.

40. The WCT is given by two formulae, but the first doesn't work with the data. Hence $5 = \text{WCT} = -27.2v^{0.16} + 48.17$ and $v \approx 18\text{mi/h}$.

Exercise Set 0.2

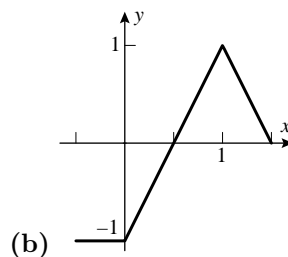
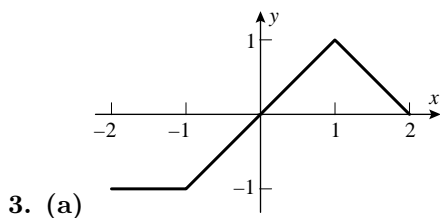
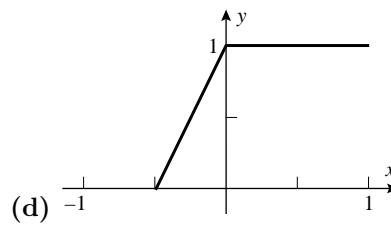
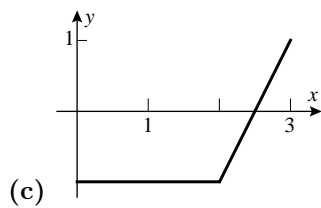
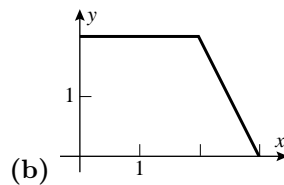
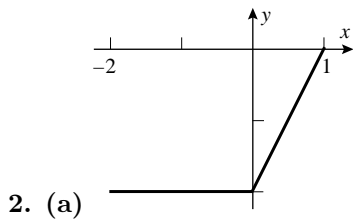
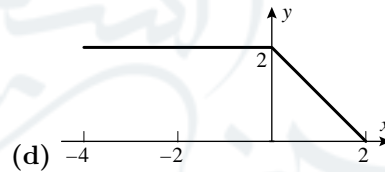
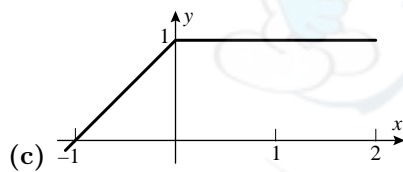
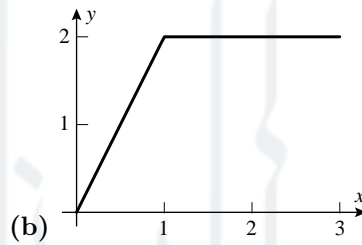
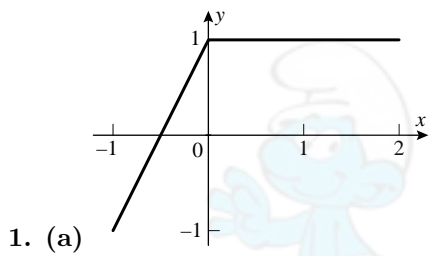

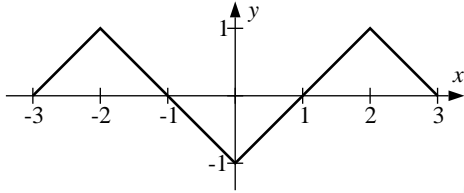
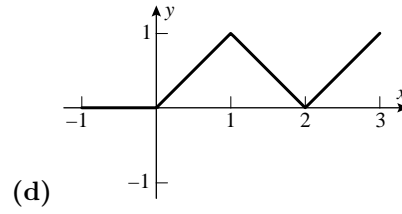
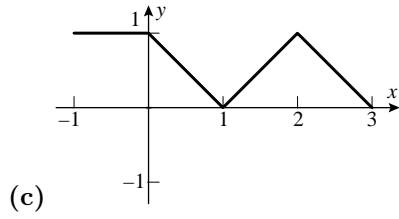

4.

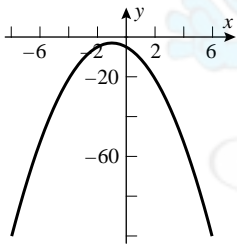
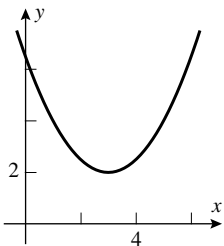
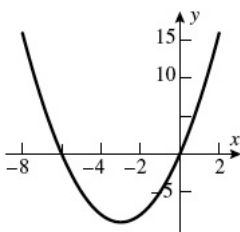
5. Translate left 1 unit, stretch vertically by a factor of 2, reflect over x -axis, translate down 3 units.6. Translate right 3 units, compress vertically by a factor of $\frac{1}{2}$, and translate up 2 units.7. $y = (x + 3)^2 - 9$; translate left 3 units and down 9 units.

8. $y = \frac{1}{2}[(x - 1)^2 + 2]$; translate right 1 unit and up 2 units, compress vertically by a factor of $\frac{1}{2}$

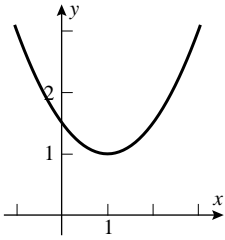

9. Translate left 1 unit, reflect over x -axis, translate up 3 units.

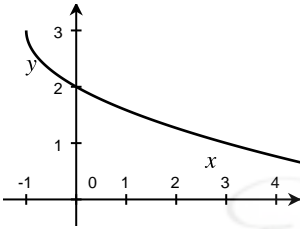

10. Translate right 4 units and up 1 unit.

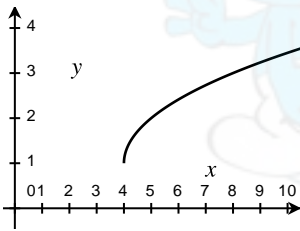

11. Compress vertically by a factor of $\frac{1}{2}$, translate up 1 unit.

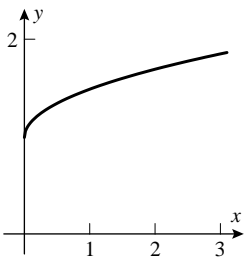

12. Stretch vertically by a factor of $\sqrt{3}$ and reflect over x -axis.

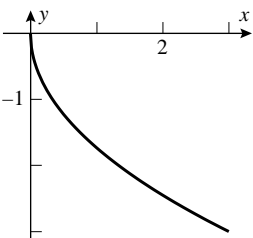

13. Translate right 3 units.

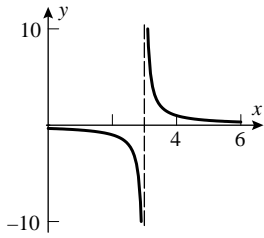

14. Translate right 1 unit and reflect over x -axis.

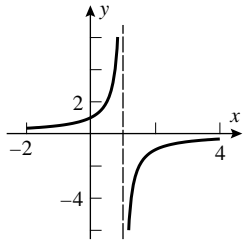

15. Translate left 1 unit, reflect over x -axis, translate up 2 units.

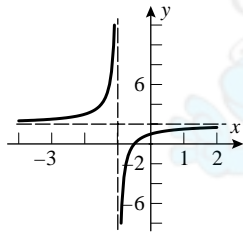

16. $y = 1 - 1/x$; reflect over x -axis, translate up 1 unit.

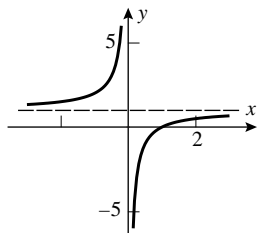

17. Translate left 2 units and down 2 units.

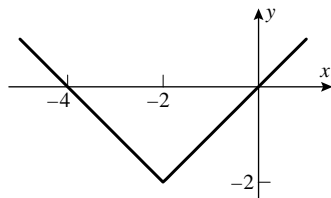

18. Translate right 3 units, reflect over x -axis, translate up 1 unit.

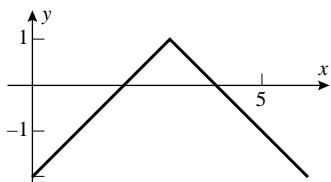

19. Stretch vertically by a factor of 2, translate right $1/2$ unit and up 1 unit.

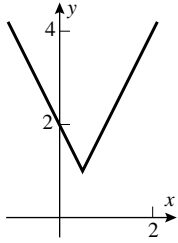

20. $y = |x - 2|$; translate right 2 units.

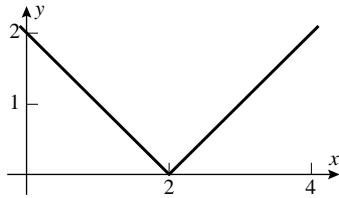

21. Stretch vertically by a factor of 2, reflect over x -axis, translate up 1 unit.

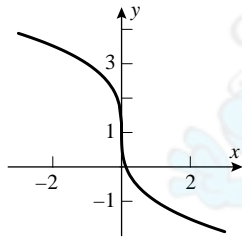

22. Translate right 2 units and down 3 units.

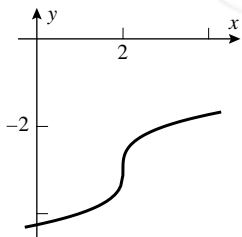

23. Translate left 1 unit and up 2 units.

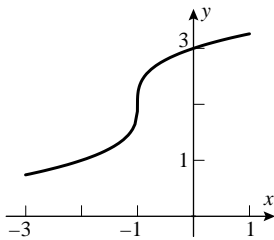

24. Translate right 2 units, reflect over x -axis.

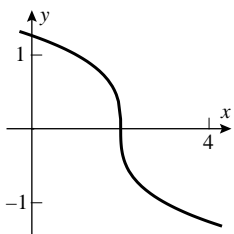

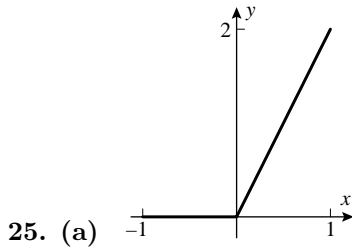

(b) $y = \begin{cases} 0 & \text{if } x \leq 0 \\ 2x & \text{if } 0 < x \end{cases}$

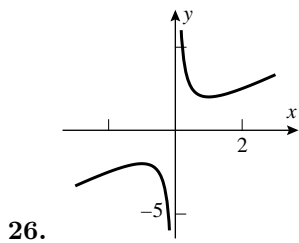

27. $(f + g)(x) = 3\sqrt{x-1}$, $x \geq 1$; $(f - g)(x) = \sqrt{x-1}$, $x \geq 1$; $(fg)(x) = 2x - 2$, $x \geq 1$; $(f/g)(x) = 2$, $x > 1$

28. $(f + g)(x) = (2x^2 + 1)/[x(x^2 + 1)]$, all $x \neq 0$; $(f - g)(x) = -1/[x(x^2 + 1)]$, all $x \neq 0$; $(fg)(x) = 1/(x^2 + 1)$, all $x \neq 0$; $(f/g)(x) = x^2/(x^2 + 1)$, all $x \neq 0$

29. (a) 3 (b) 9 (c) 2 (d) 2 (e) $\sqrt{2+h}$ (f) $(3+h)^3 + 1$

30. (a) $\sqrt{5s+2}$ (b) $\sqrt{\sqrt{x}+2}$ (c) $3\sqrt{5x}$ (d) $1/\sqrt{x}$ (e) $\sqrt[4]{x}$ (f) $0, x \geq 0$
 (g) $1/\sqrt[4]{x}$ (h) $|x-1|$ (i) $\sqrt{x+h}$

31. $(f \circ g)(x) = 1 - x$, $x \leq 1$; $(g \circ f)(x) = \sqrt{1-x^2}$, $|x| \leq 1$.

32. $(f \circ g)(x) = \sqrt{\sqrt{x^2+3}-3}$, $|x| \geq \sqrt{6}$; $(g \circ f)(x) = \sqrt{x}$, $x \geq 3$.

33. $(f \circ g)(x) = \frac{1}{1-2x}$, $x \neq \frac{1}{2}, 1$; $(g \circ f)(x) = -\frac{1}{2x} - \frac{1}{2}$, $x \neq 0, 1$.

34. $(f \circ g)(x) = \frac{x}{x^2+1}$, $x \neq 0$; $(g \circ f)(x) = \frac{1}{x} + x$, $x \neq 0$.

35. $(f \circ g \circ h)(x) = x^{-6} + 1$.

36. $(f \circ g \circ h)(x) = \frac{x}{1+x}$.

37. (a) $g(x) = \sqrt{x}$, $h(x) = x + 2$ (b) $g(x) = |x|$, $h(x) = x^2 - 3x + 5$

38. (a) $g(x) = x + 1$, $h(x) = x^2$ (b) $g(x) = 1/x$, $h(x) = x - 3$

39. (a) $g(x) = x^2$, $h(x) = \sin x$ (b) $g(x) = 3/x$, $h(x) = 5 + \cos x$

40. (a) $g(x) = 3 \sin x$, $h(x) = x^2$ (b) $g(x) = 3x^2 + 4x$, $h(x) = \sin x$

41. (a) $g(x) = (1+x)^3$, $h(x) = \sin(x^2)$ (b) $g(x) = \sqrt{1-x}$, $h(x) = \sqrt[3]{x}$

42. (a) $g(x) = \frac{1}{1-x}$, $h(x) = x^2$ (b) $g(x) = |5+x|$, $h(x) = 2x$

43. True, by Definition 0.2.1.

44. False. The domain consists of all x in the domain of g such that $g(x)$ is in the domain of f .

45. True, by Theorem 0.2.3(a).

46. False. The graph of $y = f(x + 2) + 3$ is obtained by translating the graph of $y = f(x)$ left 2 units and up 3 units.

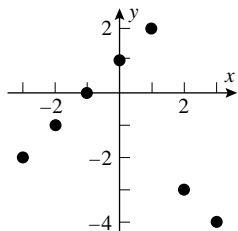

47.

48. $\{-2, -1, 0, 1, 2, 3\}$

49. Note that $f(g(-x)) = f(-g(x)) = f(g(x))$, so $f(g(x))$ is even.

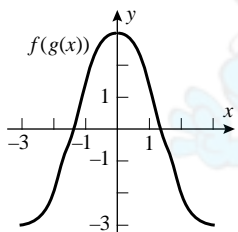

50. Note that $g(f(-x)) = g(f(x))$, so $g(f(x))$ is even.

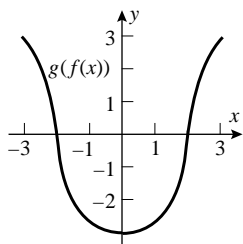

51. $f(g(x)) = 0$ when $g(x) = \pm 2$, so $x \approx \pm 1.5$; $g(f(x)) = 0$ when $f(x) = 0$, so $x = \pm 2$.

52. $f(g(x)) = 0$ at $x = -1$ and $g(f(x)) = 0$ at $x = -1$.

$$53. \frac{3(x+h)^2 - 5 - (3x^2 - 5)}{h} = \frac{6xh + 3h^2}{h} = 6x + 3h; \frac{3w^2 - 5 - (3x^2 - 5)}{w-x} = \frac{3(w-x)(w+x)}{w-x} = 3w + 3x.$$

$$54. \frac{(x+h)^2 + 6(x+h) - (x^2 + 6x)}{h} = \frac{2xh + h^2 + 6h}{h} = 2x + h + 6; \frac{w^2 + 6w - (x^2 + 6x)}{w-x} = w + x + 6.$$

$$55. \frac{1/(x+h) - 1/x}{h} = \frac{x - (x+h)}{xh(x+h)} = \frac{-1}{x(x+h)}; \frac{1/w - 1/x}{w-x} = \frac{x-w}{wx(w-x)} = -\frac{1}{xw}.$$

$$56. \frac{1/(x+h)^2 - 1/x^2}{h} = \frac{x^2 - (x+h)^2}{x^2h(x+h)^2} = -\frac{2x+h}{x^2(x+h)^2}; \frac{1/w^2 - 1/x^2}{w-x} = \frac{x^2 - w^2}{x^2w^2(w-x)} = -\frac{x+w}{x^2w^2}.$$

57. Neither; odd; even.

58. (a)

x	-3	-2	-1	0	1	2	3
$f(x)$	1	-5	-1	0	-1	-5	1

(b)

x	-3	-2	-1	0	1	2	3
$f(x)$	1	5	-1	0	1	-5	-1

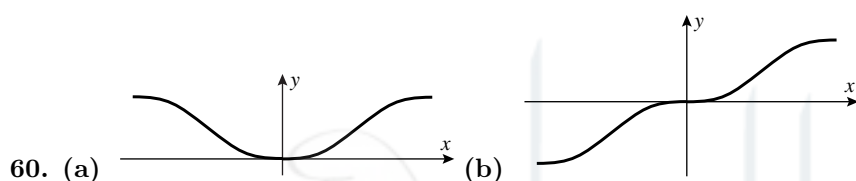
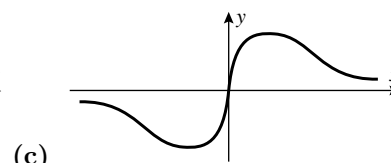
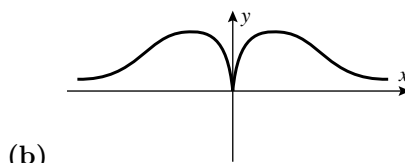
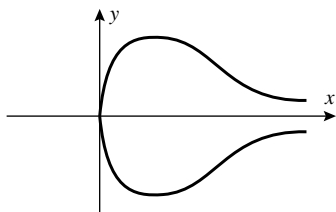

61. (a) Even. (b) Odd.

62. (a) Odd. (b) Neither.

63. (a) $f(-x) = (-x)^2 = x^2 = f(x)$, even. (b) $f(-x) = (-x)^3 = -x^3 = -f(x)$, odd.

(c) $f(-x) = |-x| = |x| = f(x)$, even. (d) $f(-x) = -x + 1$, neither.

(e) $f(-x) = \frac{(-x)^5 - (-x)}{1 + (-x)^2} = -\frac{x^5 - x}{1 + x^2} = -f(x)$, odd. (f) $f(-x) = 2 = f(x)$, even.

64. (a) $g(-x) = \frac{f(-x) + f(x)}{2} = \frac{f(x) + f(-x)}{2} = g(x)$, so g is even.

(b) $h(-x) = \frac{f(-x) - f(x)}{2} = -\frac{f(x) - f(-x)}{2} = -h(x)$, so h is odd.

65. In Exercise 64 it was shown that g is an even function, and h is odd. Moreover by inspection $f(x) = g(x) + h(x)$ for all x , so f is the sum of an even function and an odd function.

66. (a) x -axis, because $x = 5(-y)^2 + 9$ gives $x = 5y^2 + 9$.

(b) x -axis, y -axis, and origin, because $x^2 - 2(-y)^2 = 3$, $(-x)^2 - 2y^2 = 3$, and $(-x)^2 - 2(-y)^2 = 3$ all give $x^2 - 2y^2 = 3$.

(c) Origin, because $(-x)(-y) = 5$ gives $xy = 5$.

67. (a) y -axis, because $(-x)^4 = 2y^3 + y$ gives $x^4 = 2y^3 + y$.

(b) Origin, because $(-y) = \frac{(-x)}{3 + (-x)^2}$ gives $y = \frac{x}{3 + x^2}$.

(c) x -axis, y -axis, and origin because $(-y)^2 = |x| - 5$, $y^2 = |-x| - 5$, and $(-y)^2 = |-x| - 5$ all give $y^2 = |x| - 5$.

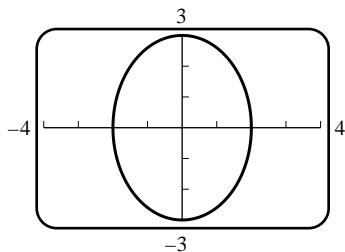

68.

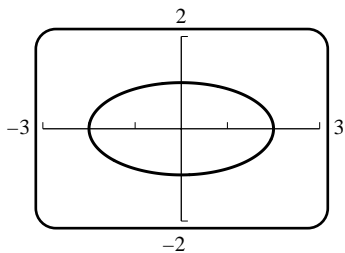

69.

70. (a) Whether we replace x with $-x$, y with $-y$, or both, we obtain the same equation, so by Theorem 0.2.3 the graph is symmetric about the x -axis, the y -axis and the origin.

(b) $y = (1 - x^{2/3})^{3/2}$.

(c) For quadrant II, the same; for III and IV use $y = -(1 - x^{2/3})^{3/2}$.

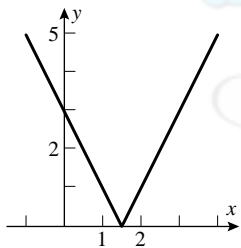

71.

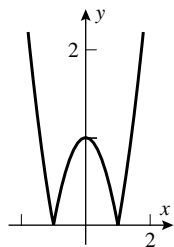

72.

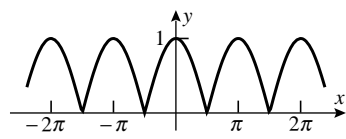

73. (a)

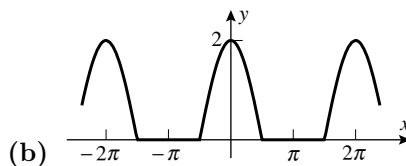

(b)

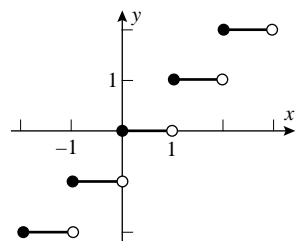

74. (a)

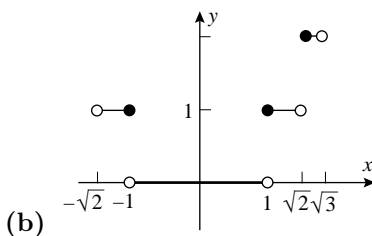

(b)

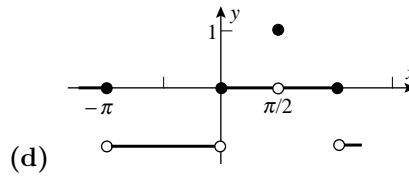
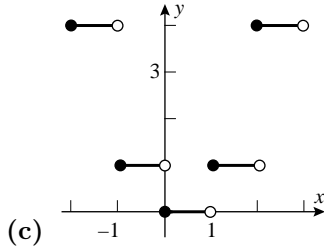

75. Yes, e.g. $f(x) = x^k$ and $g(x) = x^n$ where k and n are integers.

Exercise Set 0.3

1. (a) $y = 3x + b$ (b) $y = 3x + 6$

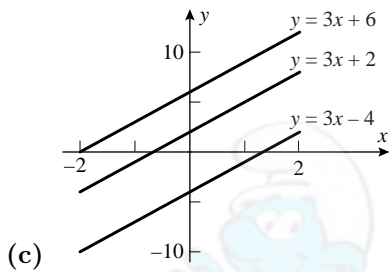

2. Since the slopes are negative reciprocals, $y = -\frac{1}{3}x + b$.

3. (a) $y = mx + 2$ (b) $m = \tan \phi = \tan 135^\circ = -1$, so $y = -x + 2$

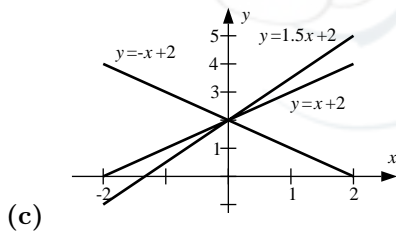

4. (a) $y = mx$ (b) $y = m(x - 1)$ (c) $y = -2 + m(x - 1)$ (d) $2x + 4y = C$

5. Let the line be tangent to the circle at the point (x_0, y_0) where $x_0^2 + y_0^2 = 9$. The slope of the tangent line is the negative reciprocal of y_0/x_0 (why?), so $m = -x_0/y_0$ and $y = -(x_0/y_0)x + b$. Substituting the point (x_0, y_0) as well as $y_0 = \pm\sqrt{9 - x_0^2}$ we get $y = \pm \frac{9 - x_0x}{\sqrt{9 - x_0^2}}$.

6. Solve the simultaneous equations to get the point $(-2, 1/3)$ of intersection. Then $y = \frac{1}{3} + m(x + 2)$.

7. The x -intercept is $x = 10$ so that with depreciation at 10% per year the final value is always zero, and hence $y = m(x - 10)$. The y -intercept is the original value.

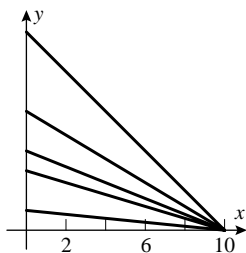

8. A line through $(6, -1)$ has the form $y + 1 = m(x - 6)$. The intercepts are $x = 6 + 1/m$ and $y = -6m - 1$. Set $-(6 + 1/m)(6m + 1) = 3$, or $36m^2 + 15m + 1 = (12m + 1)(3m + 1) = 0$ with roots $m = -1/12, -1/3$; thus $y + 1 = -(1/3)(x - 6)$ and $y + 1 = -(1/12)(x - 6)$.

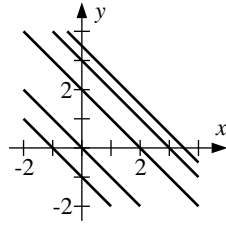

9. (a) The slope is -1 .

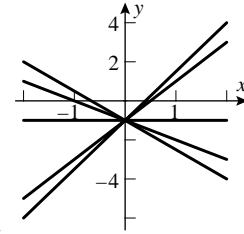

(b) The y -intercept is $y = -1$.

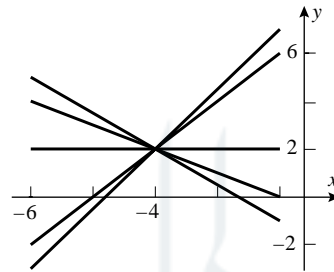

(c) They pass through the point $(-4, 2)$.

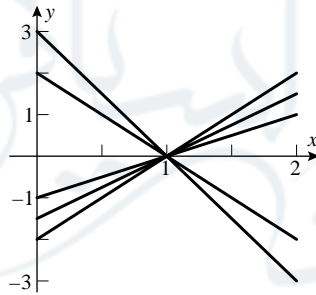

(d) The x -intercept is $x = 1$.

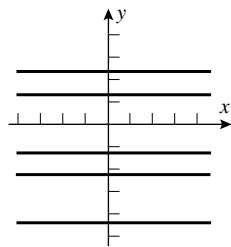

10. (a) Horizontal lines.

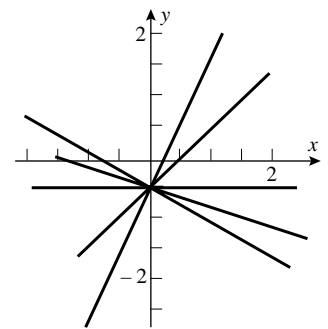

(b) The y -intercept is $y = -1/2$.

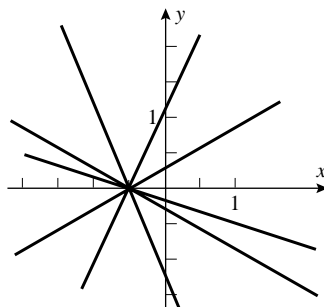

(c) The x -intercept is $x = -1/2$.

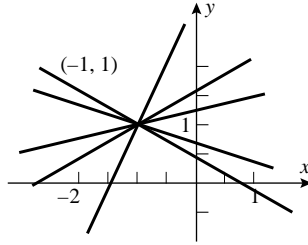

(d) They pass through $(-1, 1)$.

11. (a) VI (b) IV (c) III (d) V (e) I (f) II

12. In all cases k must be positive, or negative values would appear in the chart. Only kx^{-3} decreases, so that must be $f(x)$. Next, kx^2 grows faster than $kx^{3/2}$, so that would be $g(x)$, which grows faster than $h(x)$ (to see this, consider ratios of successive values of the functions). Finally, experimentation (a spreadsheet is handy) for values of k yields (approximately) $f(x) = 10x^{-3}$, $g(x) = x^2/2$, $h(x) = 2x^{1.5}$.

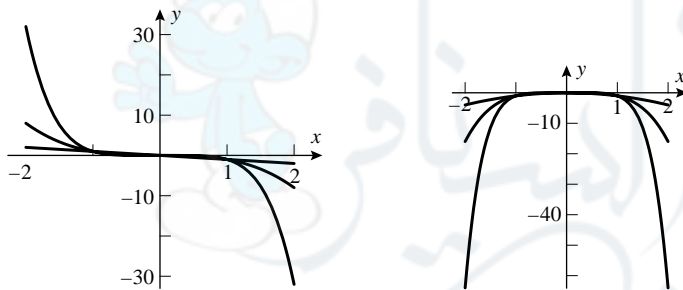

13. (a)

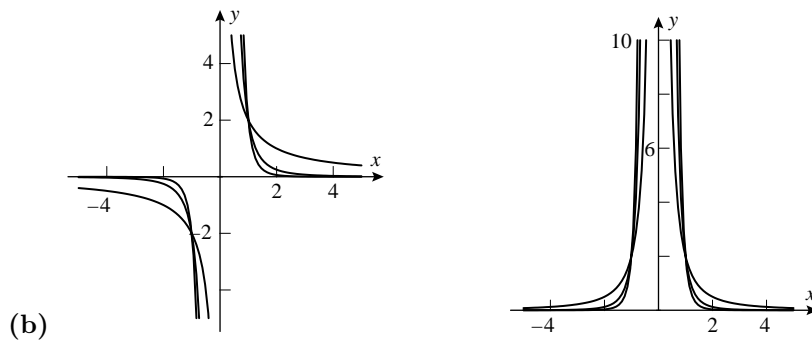

(b)

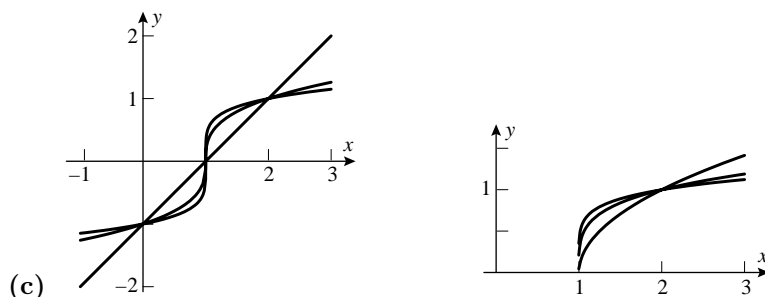

(c)

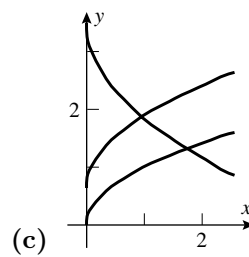
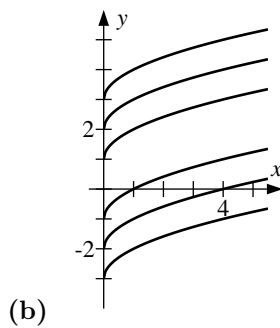
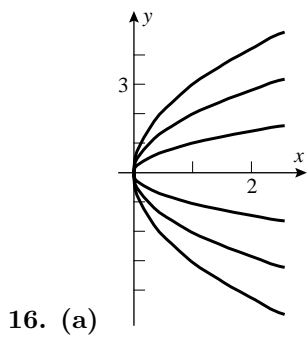
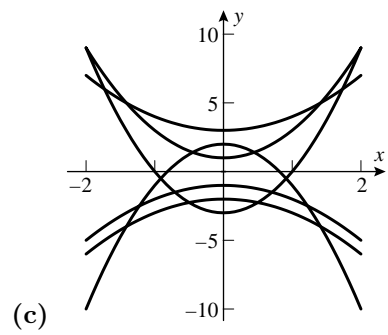
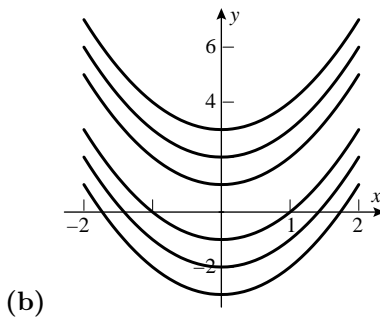
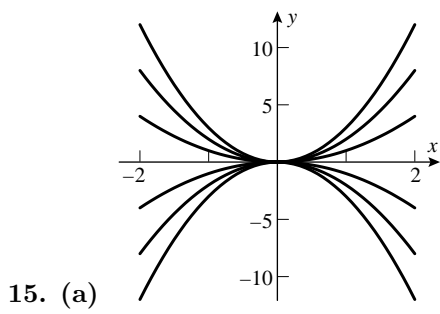
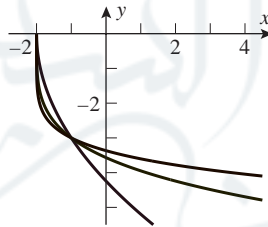
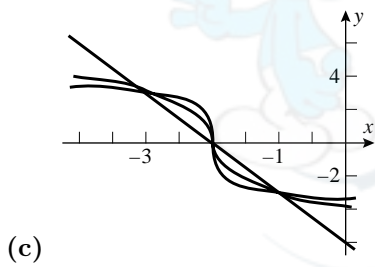
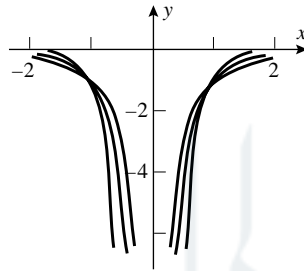
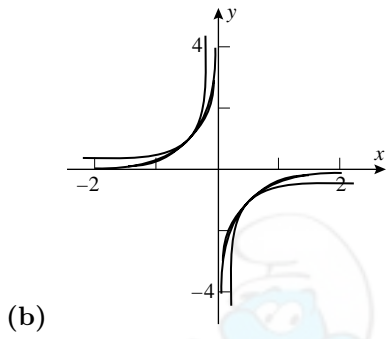
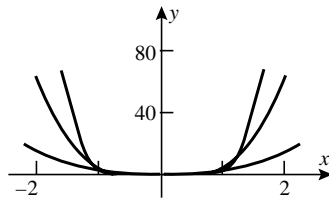
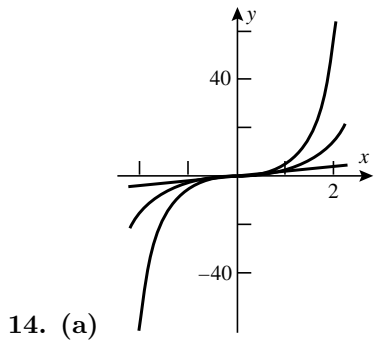

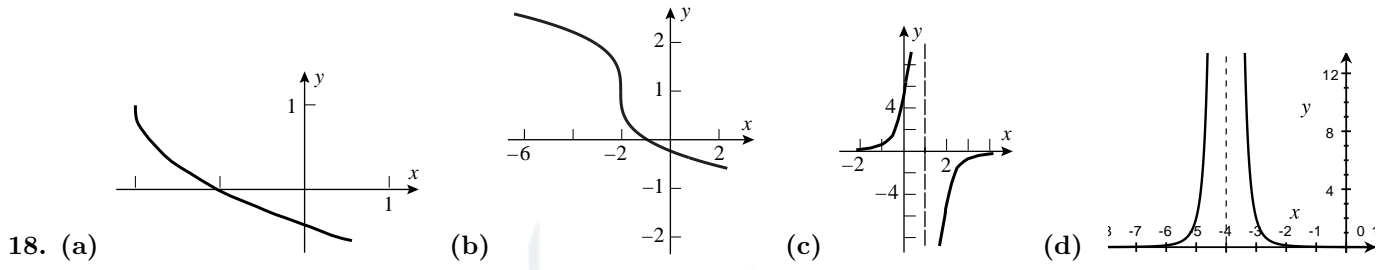
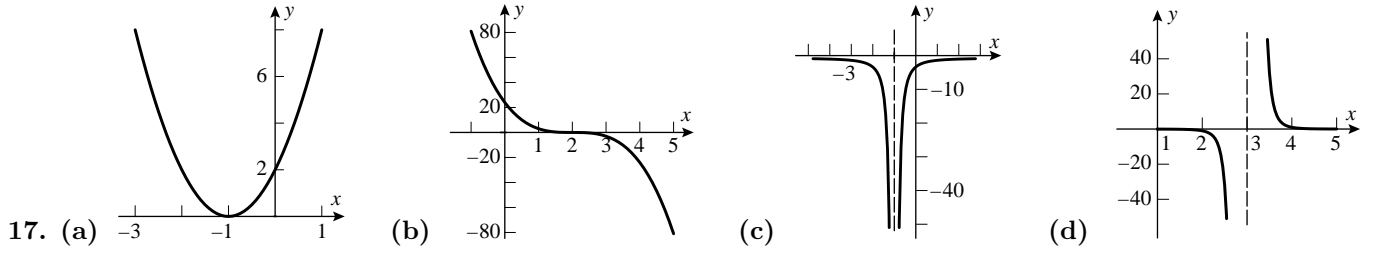

19. $y = x^2 + 2x = (x + 1)^2 - 1.$

20. (a) The part of the graph of $y = \sqrt{|x|}$ with $x \geq 0$ is the same as the graph of $y = \sqrt{x}$. The part with $x \leq 0$ is the reflection of the graph of $y = \sqrt{x}$ across the y -axis.

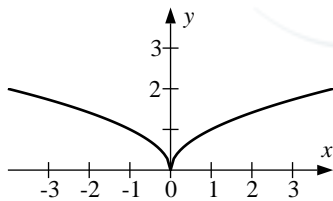

(b) The part of the graph of $y = \sqrt[3]{|x|}$ with $x \geq 0$ is the same as the part of the graph of $y = \sqrt[3]{x}$ with $x \geq 0$. The part with $x \leq 0$ is the reflection of the graph of $y = \sqrt[3]{x}$ with $x \geq 0$ across the y -axis.

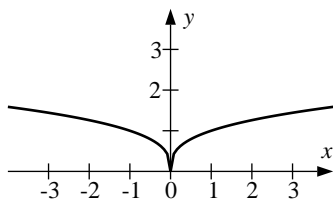

21. (a) $N \cdot m$ (b) $k = 20 \text{ N} \cdot m$

(c)

$V(L)$	0.25	0.5	1.0	1.5	2.0
$P (N/m^2)$	80×10^3	40×10^3	20×10^3	13.3×10^3	10×10^3

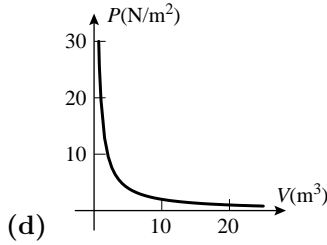

22. If the side of the square base is x and the height of the container is y then $V = x^2y = 100$; minimize $A = 2x^2 + 4xy = 2x^2 + 400/x$. A graphing utility with a zoom feature suggests that the solution is a cube of side $100^{1/3}$ cm.

23. (a) $F = k/x^2$ so $0.0005 = k/(0.3)^2$ and $k = 0.000045 \text{ N}\cdot\text{m}^2$. (b) $F = 0.000005 \text{ N}$.

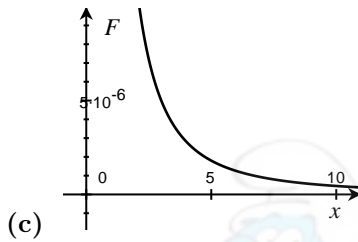

(d) When they approach one another, the force increases without bound; when they get far apart it tends to zero.

24. (a) $2000 = C/(4000)^2$, so $C = 3.2 \times 10^{10} \text{ lb}\cdot\text{mi}^2$. (b) $W = C/5000^2 = (3.2 \times 10^{10})/(25 \times 10^6) = 1280 \text{ lb}$.

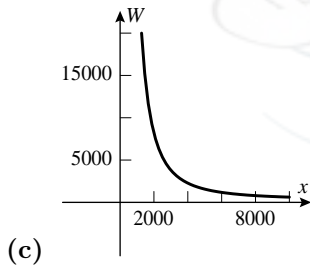

(d) No, but W is very small when x is large.

25. True. The graph of $y = 2x + b$ is obtained by translating the graph of $y = 2x$ up b units (or down $-b$ units if $b < 0$).

26. True. $x^2 + bx + c = \left(x + \frac{b}{2}\right)^2 + \left(c - \frac{b^2}{4}\right)$, so the graph of $y = x^2 + bx + c$ is obtained by translating the graph of $y = x^2$ left $\frac{b}{2}$ units (or right $-\frac{b}{2}$ units if $b < 0$) and up $c - \frac{b^2}{4}$ units (or down $-(c - \frac{b^2}{4})$ units if $c - \frac{b^2}{4} < 0$).

27. False. The curve's equation is $y = 12/x$, so the constant of proportionality is 12.

28. True. As discussed before Example 2, the amplitude is $|-5| = 5$ and the period is $\frac{2\pi}{|A\pi|} = \frac{2}{|A|}$.

29. (a) II; $y = 1, x = -1, 2$ (b) I; $y = 0, x = -2, 3$ (c) IV; $y = 2$ (d) III; $y = 0, x = -2$

30. The denominator has roots $x = \pm 1$, so $x^2 - 1$ is the denominator. To determine k use the point $(0, -1)$ to get $k = 1, y = 1/(x^2 - 1)$.

31. (a) $y = 3 \sin(x/2)$ (b) $y = 4 \cos 2x$ (c) $y = -5 \sin 4x$
 32. (a) $y = 1 + \cos \pi x$ (b) $y = 1 + 2 \sin x$ (c) $y = -5 \cos 4x$
 33. (a) $y = \sin(x + \pi/2)$ (b) $y = 3 + 3 \sin(2x/9)$ (c) $y = 1 + 2 \sin(2x - \pi/2)$
 34. $V = 120\sqrt{2} \sin(120\pi t)$.

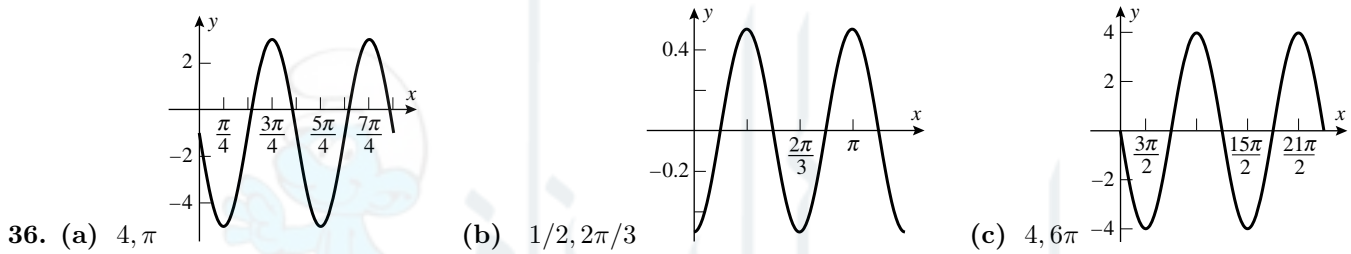
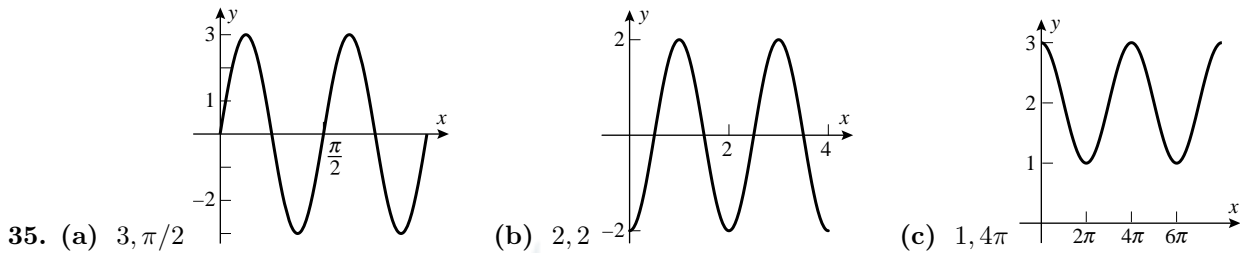

37. Let $\omega = 2\pi$. Then $A \sin(\omega t + \theta) = A(\cos \theta \sin 2\pi t + \sin \theta \cos 2\pi t) = (A \cos \theta) \sin 2\pi t + (A \sin \theta) \cos 2\pi t$, so for the two equations for x to be equivalent, we need $A \cos \theta = 5\sqrt{3}$ and $A \sin \theta = 5/2$. These imply that $A^2 = (A \cos \theta)^2 + (A \sin \theta)^2 = 325/4$ and $\tan \theta = \frac{A \sin \theta}{A \cos \theta} = \frac{1}{2\sqrt{3}}$. So let $A = \sqrt{\frac{325}{4}} = \frac{5\sqrt{13}}{2}$ and $\theta = \tan^{-1} \frac{1}{2\sqrt{3}}$. Then (verify) $\cos \theta = \frac{2\sqrt{3}}{\sqrt{13}}$ and $\sin \theta = \frac{1}{\sqrt{13}}$, so $A \cos \theta = 5\sqrt{3}$ and $A \sin \theta = 5/2$, as required. Hence $x = \frac{5\sqrt{13}}{2} \sin \left(2\pi t + \tan^{-1} \frac{1}{2\sqrt{3}} \right)$.

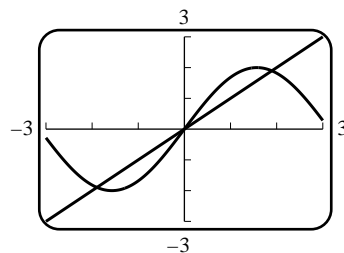
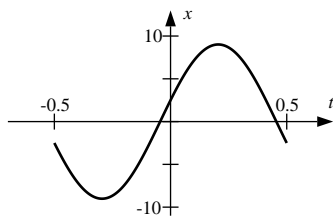

38. Three; $x = 0$, $x \approx \pm 1.8955$.

Exercise Set 0.4

1. (a) $f(g(x)) = 4(x/4) = x$, $g(f(x)) = (4x)/4 = x$, f and g are inverse functions.

(b) $f(g(x)) = 3(3x - 1) + 1 = 9x - 2 \neq x$ so f and g are not inverse functions.

(c) $f(g(x)) = \sqrt[3]{(x^3 + 2) - 2} = x$, $g(f(x)) = (x - 2) + 2 = x$, f and g are inverse functions.

(d) $f(g(x)) = (x^{1/4})^4 = x$, $g(f(x)) = (x^4)^{1/4} = |x| \neq x$, f and g are not inverse functions.

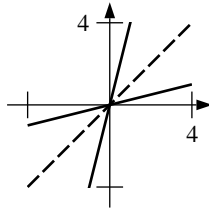

2. (a) They are inverse functions.

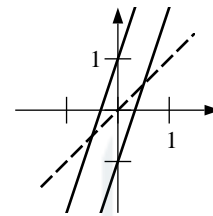

(b) The graphs are not reflections of each other about the line $y = x$.

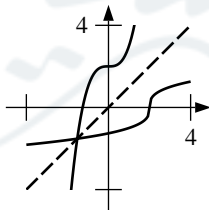

(c) They are inverse functions.

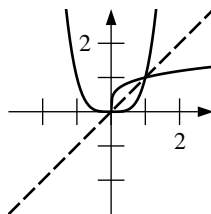

(d) They are not inverse functions.

3. (a) yes (b) yes (c) no (d) yes (e) no (f) no

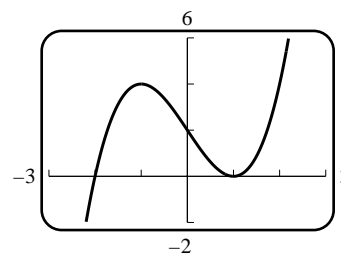

4. (a) The horizontal line test shows the function is not one-to-one.

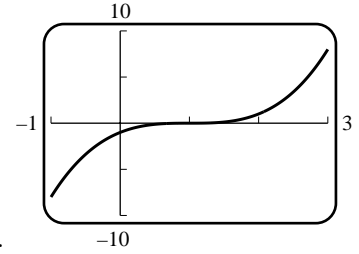

(b) Yes: $f(x) = (x - 1)^3$ so if $f(x) = f(y)$ then $x = \sqrt[3]{f(x)} + 1 = \sqrt[3]{f(y)} + 1 = y$.

5. (a) Yes; all outputs (the elements of row two) are distinct.

(b) No; $f(1) = f(6)$.

6. (a) Since the point $(0, 0)$ lies on the graph, no other point on the line $x = 0$ can lie on the graph, by the vertical line test. Thus the hour hand cannot point straight up or straight down, so noon, midnight, 6AM and 6PM are impossible. To show that other times are possible, suppose the tip of the hour hand stopped at (a, b) with $a \neq 0$. Then the function $y = bx/a$ passes through $(0, 0)$ and (a, b) .

(b) If f is invertible then, since $(0, 0)$ lies on the graph, no other point on the line $y = 0$ can lie on the graph, by the horizontal line test. So, in addition to the times mentioned in (a), 3AM, 3PM, 9AM, and 9PM are also impossible.

(c) In the generic case, the minute hand cannot point to 6 or 12, so times of the form 1:00, 1:30, 2:00, 2:30, ..., 12:30 are impossible. In case f is invertible, the minute hand cannot point to 3 or 9, so all hours :15 and :45 are also impossible.

7. (a) f has an inverse because the graph passes the horizontal line test. To compute $f^{-1}(2)$ start at 2 on the y -axis and go to the curve and then down, so $f^{-1}(2) = 8$; similarly, $f^{-1}(-1) = -1$ and $f^{-1}(0) = 0$.

(b) Domain of f^{-1} is $[-2, 2]$, range is $[-8, 8]$.

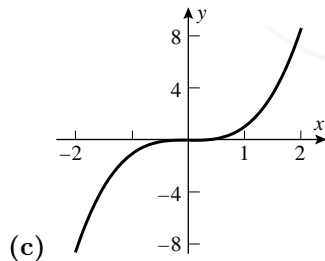

8. (a) The horizontal line test shows this. (b) $-3 \leq x \leq -1$; $-1 \leq x \leq 2$; and $2 \leq x \leq 4$.

9. $y = f^{-1}(x)$, $x = f(y) = 7y - 6$, $y = \frac{1}{7}(x + 6) = f^{-1}(x)$.

10. $y = f^{-1}(x)$, $x = f(y) = \frac{y+1}{y-1}$, $xy - x = y + 1$, $(x-1)y = x + 1$, $y = \frac{x+1}{x-1} = f^{-1}(x)$.

11. $y = f^{-1}(x)$, $x = f(y) = 3y^3 - 5$, $y = \sqrt[3]{(x+5)/3} = f^{-1}(x)$.

12. $y = f^{-1}(x)$, $x = f(y) = \sqrt[5]{4y+2}$, $y = \frac{1}{4}(x^5 - 2) = f^{-1}(x)$.

13. $y = f^{-1}(x)$, $x = f(y) = 3/y^2$, $y = -\sqrt{3/x} = f^{-1}(x)$.

14. $y = f^{-1}(x)$, $x = f(y) = \frac{5}{y^2 + 1}$, $y = \sqrt{\frac{5-x}{x}} = f^{-1}(x)$.

15. $y = f^{-1}(x), x = f(y) = \begin{cases} 5/2 - y, & y < 2 \\ 1/y, & y \geq 2 \end{cases}, y = f^{-1}(x) = \begin{cases} 5/2 - x, & x > 1/2 \\ 1/x, & 0 < x \leq 1/2 \end{cases}.$

16. $y = f^{-1}(x), x = f(y) = \begin{cases} 2y, & y \leq 0 \\ y^2, & y > 0 \end{cases}, y = f^{-1}(x) = \begin{cases} x/2, & x \leq 0 \\ \sqrt{x}, & x > 0 \end{cases}.$

17. $y = f^{-1}(x), x = f(y) = (y + 2)^4$ for $y \geq 0, y = f^{-1}(x) = x^{1/4} - 2$ for $x \geq 16$.

18. $y = f^{-1}(x), x = f(y) = \sqrt{y+3}$ for $y \geq -3, y = f^{-1}(x) = x^2 - 3$ for $x \geq 0$.

19. $y = f^{-1}(x), x = f(y) = -\sqrt{3-2y}$ for $y \leq 3/2, y = f^{-1}(x) = (3-x^2)/2$ for $x \leq 0$.

20. $y = f^{-1}(x), x = f(y) = y - 5y^2$ for $y \geq 1, y = f^{-1}(x) = (1 + \sqrt{1-20x})/10$ for $x \leq -4$.

21. $y = f^{-1}(x), x = f(y) = ay^2 + by + c, ay^2 + by + c - x = 0$, use the quadratic formula to get $y = \frac{-b \pm \sqrt{b^2 - 4a(c-x)}}{2a};$

(a) $f^{-1}(x) = \frac{-b + \sqrt{b^2 - 4a(c-x)}}{2a}$

(b) $f^{-1}(x) = \frac{-b - \sqrt{b^2 - 4a(c-x)}}{2a}$

22. (a) $C = \frac{5}{9}(F - 32).$

(b) How many degrees Celsius given the Fahrenheit temperature.

(c) $C = -273.15^\circ \text{C}$ is equivalent to $F = -459.67^\circ \text{F}$, so the domain is $F \geq -459.67$, the range is $C \geq -273.15$.

23. (a) $y = f(x) = \frac{10^4}{6.214}x.$ (b) $x = f^{-1}(y) = (6.214 \times 10^{-4})y.$

(c) How many miles in y meters.

24. (a) $f(g(x)) = f(\sqrt{x}) = (\sqrt{x})^2 = x, x > 1; g(f(x)) = g(x^2) = \sqrt{x^2} = x, x > 1.$

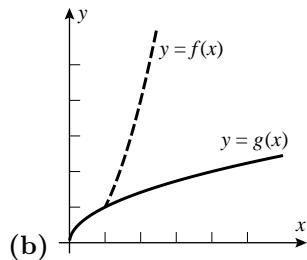

(c) No, because it is not true that $f(g(x)) = x$ for every x in the domain of g (the domain of g is $x \geq 0$).

25. (a) $f(f(x)) = \frac{3 - \frac{3-x}{1-x}}{1 - \frac{3-x}{1-x}} = \frac{3 - 3x - 3 + x}{1 - x - 3 + x} = x$ so $f = f^{-1}.$

(b) It is symmetric about the line $y = x$.

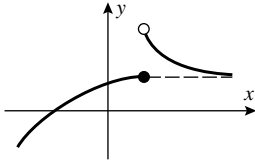

26.

27. If $f^{-1}(x) = 1$, then $x = f(1) = 2(1)^3 + 5(1) + 3 = 10$.

28. If $f^{-1}(x) = 2$, then $x = f(2) = (2)^3 / [(2)^2 + 1] = 8/5$.

29. $f(f(x)) = x$ thus $f = f^{-1}$ so the graph is symmetric about $y = x$.

30. (a) Suppose $x_1 \neq x_2$ where x_1 and x_2 are in the domain of g and $g(x_1), g(x_2)$ are in the domain of f then $g(x_1) \neq g(x_2)$ because g is one-to-one so $f(g(x_1)) \neq f(g(x_2))$ because f is one-to-one thus $f \circ g$ is one-to-one because $(f \circ g)(x_1) \neq (f \circ g)(x_2)$ if $x_1 \neq x_2$.

(b) f, g , and $f \circ g$ all have inverses because they are all one-to-one. Let $h = (f \circ g)^{-1}$ then $(f \circ g)(h(x)) = f[g(h(x))] = x$, apply f^{-1} to both sides to get $g(h(x)) = f^{-1}(x)$, then apply g^{-1} to get $h(x) = g^{-1}(f^{-1}(x)) = (g^{-1} \circ f^{-1})(x)$, so $h = g^{-1} \circ f^{-1}$.

31. False. $f^{-1}(2) = f^{-1}(f(2)) = 2$.

32. False. For example, the inverse of $f(x) = 1 + 1/x$ is $g(x) = 1/(x - 1)$. The domain of f consists of all x except $x = 0$; the domain of g consists of all x except $x = 1$.

33. True. Both terms have the same definition; see the paragraph before Theorem 0.4.3.

34. False. $\pi/2$ and $-\pi/2$ are not in the range of \tan^{-1} .

35. $\tan \theta = 4/3, 0 < \theta < \pi/2$; use the triangle shown to get $\sin \theta = 4/5, \cos \theta = 3/5, \cot \theta = 3/4, \sec \theta = 5/3, \csc \theta = 5/4$.

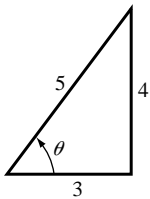

36. $\sec \theta = 2.6, 0 < \theta < \pi/2$; use the triangle shown to get $\sin \theta = 2.4/2.6 = 12/13, \cos \theta = 1/2.6 = 5/13, \tan \theta = 2.4 = 12/5, \cot \theta = 5/12, \csc \theta = 13/12$.

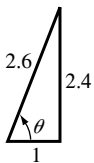

37. (a) $0 \leq x \leq \pi$ (b) $-1 \leq x \leq 1$ (c) $-\pi/2 < x < \pi/2$ (d) $-\infty < x < +\infty$

38. Let $\theta = \sin^{-1}(-3/4)$; then $\sin \theta = -3/4, -\pi/2 < \theta < 0$ and (see figure) $\sec \theta = 4/\sqrt{7}$.

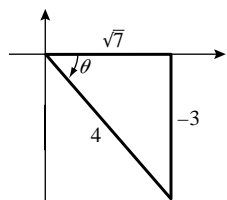

39. Let $\theta = \cos^{-1}(3/5)$; $\sin 2\theta = 2 \sin \theta \cos \theta = 2(4/5)(3/5) = 24/25$.

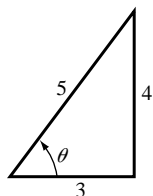

40. (a) $\sin(\cos^{-1} x) = \sqrt{1 - x^2}$

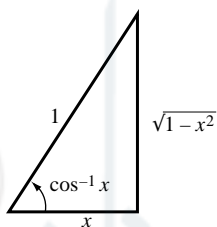

(b) $\tan(\cos^{-1} x) = \frac{\sqrt{1 - x^2}}{x}$

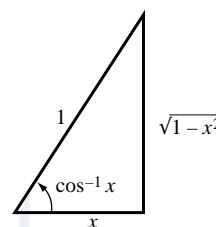

(c) $\csc(\tan^{-1} x) = \frac{\sqrt{1 + x^2}}{x}$

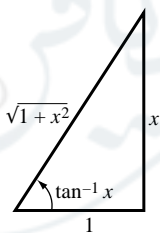

(d) $\sin(\tan^{-1} x) = \frac{x}{\sqrt{1 + x^2}}$

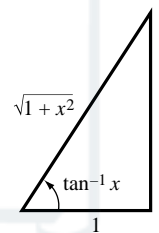

41. (a) $\cos(\tan^{-1} x) = \frac{1}{\sqrt{1 + x^2}}$

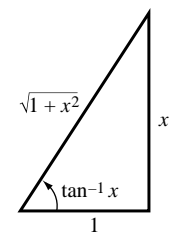

(b) $\tan(\cos^{-1} x) = \frac{\sqrt{1 - x^2}}{x}$

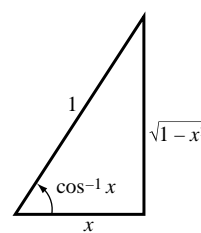

(c) $\sin(\sec^{-1} x) = \frac{\sqrt{x^2 - 1}}{x}$

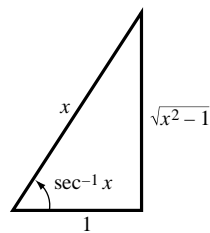

(d) $\cot(\sec^{-1} x) = \frac{1}{\sqrt{x^2 - 1}}$

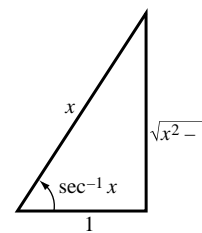

42. (a)

x	-1.00	-0.80	-0.60	-0.40	-0.20	0.00	0.20	0.40	0.60	0.80	1.00
$\sin^{-1} x$	-1.57	-0.93	-0.64	-0.41	-0.20	0.00	0.20	0.41	0.64	0.93	1.57
$\cos^{-1} x$	3.14	2.50	2.21	1.98	1.77	1.57	1.37	1.16	0.93	0.64	0.00

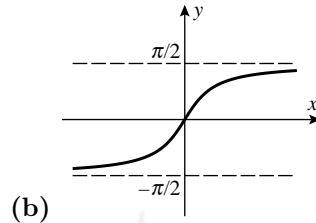
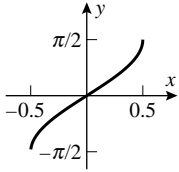
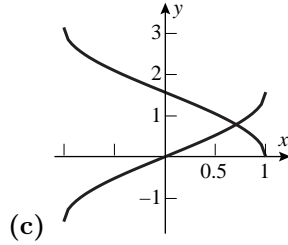
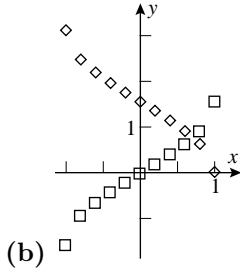

43. (a)

(b)

44. $4^2 = 2^2 + 3^2 - 2(2)(3) \cos \theta$, $\cos \theta = -1/4$, $\theta = \cos^{-1}(-1/4) \approx 104^\circ$.

45. (a) $x = \pi - \sin^{-1}(0.37) \approx 2.7626$ rad (b) $\theta = 180^\circ + \sin^{-1}(0.61) \approx 217.6^\circ$.

46. (a) $x = \pi + \cos^{-1}(0.85) \approx 3.6964$ rad (b) $\theta = -\cos^{-1}(0.23) \approx -76.7^\circ$.

47. (a) $\sin^{-1}(\sin^{-1} 0.25) \approx \sin^{-1} 0.25268 \approx 0.25545$; $\sin^{-1} 0.9 > 1$, so it is not in the domain of $\sin^{-1} x$.

(b) $-1 \leq \sin^{-1} x \leq 1$ is necessary, or $-0.841471 \leq x \leq 0.841471$.

48. $\sin 2\theta = gR/v^2 = (9.8)(18)/(14)^2 = 0.9$, $2\theta = \sin^{-1}(0.9)$ or $2\theta = 180^\circ - \sin^{-1}(0.9)$ so $\theta = \frac{1}{2} \sin^{-1}(0.9) \approx 32^\circ$ or $\theta = 90^\circ - \frac{1}{2} \sin^{-1}(0.9) \approx 58^\circ$. The ball will have a lower parabolic trajectory for $\theta = 32^\circ$ and hence will result in the shorter time of flight.

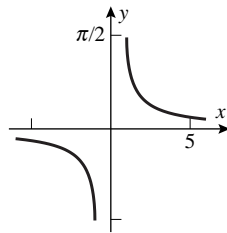
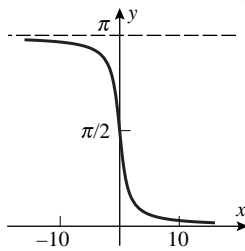

49. (a)

(b) The domain of $\cot^{-1} x$ is $(-\infty, +\infty)$, the range is $(0, \pi)$; the domain of $\csc^{-1} x$ is $(-\infty, -1] \cup [1, +\infty)$, the range is $[-\pi/2, 0) \cup (0, \pi/2]$.

50. (a) $y = \cot^{-1} x$; if $x > 0$ then $0 < y < \pi/2$ and $x = \cot y$, $\tan y = 1/x$, $y = \tan^{-1}(1/x)$; if $x < 0$ then $\pi/2 < y < \pi$ and $x = \cot y = \cot(y - \pi)$, $\tan(y - \pi) = 1/x$, $y = \pi + \tan^{-1} \frac{1}{x}$.

(b) $y = \sec^{-1} x$, $x = \sec y$, $\cos y = 1/x$, $y = \cos^{-1}(1/x)$.

(c) $y = \csc^{-1} x$, $x = \csc y$, $\sin y = 1/x$, $y = \sin^{-1}(1/x)$.

51. (a) 55.0° (b) 33.6° (c) 25.8°

52. (b) $\theta = \sin^{-1} \frac{R}{R+h} = \sin^{-1} \frac{6378}{16,378} \approx 23^\circ$.

53. (a) If $\gamma = 90^\circ$, then $\sin \gamma = 1$, $\sqrt{1 - \sin^2 \phi \sin^2 \gamma} = \sqrt{1 - \sin^2 \phi} = \cos \phi$, $D = \tan \phi \tan \lambda = (\tan 23.45^\circ)(\tan 65^\circ) \approx 0.93023374$ so $h \approx 21.1$ hours.

(b) If $\gamma = 270^\circ$, then $\sin \gamma = -1$, $D = -\tan \phi \tan \lambda \approx -0.93023374$ so $h \approx 2.9$ hours.

54. $\theta = \alpha - \beta$, $\cot \alpha = \frac{x}{a+b}$ and $\cot \beta = \frac{x}{b}$ so $\theta = \cot^{-1} \frac{x}{a+b} - \cot^{-1} \left(\frac{x}{b} \right)$.

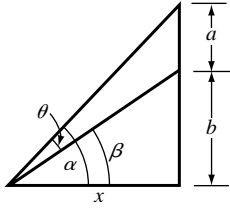

55. $y = 0$ when $x^2 = 6000v^2/g$, $x = 10v\sqrt{60/g} = 1000\sqrt{30}$ for $v = 400$ and $g = 32$; $\tan \theta = 3000/x = 3/\sqrt{30}$, $\theta = \tan^{-1}(3/\sqrt{30}) \approx 29^\circ$.

56. (a) Let $\theta = \sin^{-1}(-x)$ then $\sin \theta = -x$, $-\pi/2 \leq \theta \leq \pi/2$. But $\sin(-\theta) = -\sin \theta$ and $-\pi/2 \leq -\theta \leq \pi/2$ so $\sin(-\theta) = -(-x) = x$, $-\theta = \sin^{-1} x$, $\theta = -\sin^{-1} x$.

(b) Proof is similar to that in part (a).

57. (a) Let $\theta = \cos^{-1}(-x)$ then $\cos \theta = -x$, $0 \leq \theta \leq \pi$. But $\cos(\pi - \theta) = -\cos \theta$ and $0 \leq \pi - \theta \leq \pi$ so $\cos(\pi - \theta) = x$, $\pi - \theta = \cos^{-1} x$, $\theta = \pi - \cos^{-1} x$.

(b) Let $\theta = \sec^{-1}(-x)$ for $x \geq 1$; then $\sec \theta = -x$ and $\pi/2 < \theta \leq \pi$. So $0 \leq \pi - \theta < \pi/2$ and $\pi - \theta = \sec^{-1} \sec(\pi - \theta) = \sec^{-1}(-\sec \theta) = \sec^{-1} x$, or $\sec^{-1}(-x) = \pi - \sec^{-1} x$.

58. (a) $\sin^{-1} x = \tan^{-1} \frac{x}{\sqrt{1-x^2}}$ (see figure).

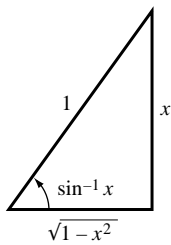

(b) $\sin^{-1} x + \cos^{-1} x = \pi/2$; $\cos^{-1} x = \pi/2 - \sin^{-1} x = \pi/2 - \tan^{-1} \frac{x}{\sqrt{1-x^2}}$.

59. $\tan(\alpha + \beta) = \frac{\tan \alpha + \tan \beta}{1 - \tan \alpha \tan \beta}$,

$$\tan(\tan^{-1} x + \tan^{-1} y) = \frac{\tan(\tan^{-1} x) + \tan(\tan^{-1} y)}{1 - \tan(\tan^{-1} x) \tan(\tan^{-1} y)} = \frac{x + y}{1 - xy}$$

$$\text{so } \tan^{-1} x + \tan^{-1} y = \tan^{-1} \frac{x + y}{1 - xy}.$$

60. (a) $\tan^{-1} \frac{1}{2} + \tan^{-1} \frac{1}{3} = \tan^{-1} \frac{1/2 + 1/3}{1 - (1/2)(1/3)} = \tan^{-1} 1 = \pi/4$.

(b) $2 \tan^{-1} \frac{1}{3} = \tan^{-1} \frac{1}{3} + \tan^{-1} \frac{1}{3} = \tan^{-1} \frac{1/3 + 1/3}{1 - (1/3)(1/3)} = \tan^{-1} \frac{2}{3}$.

$$2 \tan^{-1} \frac{1}{3} + \tan^{-1} \frac{1}{7} = \tan^{-1} \frac{3}{4} + \tan^{-1} \frac{1}{7} = \tan^{-1} \frac{3/4 + 1/7}{1 - (3/4)(1/7)} = \tan^{-1} 1 = \pi/4.$$

$$61. \sin(\sec^{-1} x) = \sin(\cos^{-1}(1/x)) = \sqrt{1 - \left(\frac{1}{x}\right)^2} = \frac{\sqrt{x^2 - 1}}{|x|}.$$

62. Suppose that g and h are both inverses of f . Then $f(g(x)) = x$, $h[f(g(x))] = h(x)$; but $h[f(g(x))] = g(x)$ because h is an inverse of f so $g(x) = h(x)$.

Exercise Set 0.5

1. (a) -4 (b) 4 (c) $1/4$
2. (a) $1/16$ (b) 8 (c) $1/3$
3. (a) 2.9691 (b) 0.0341
4. (a) 1.8882 (b) 0.9381
5. (a) $\log_2 16 = \log_2(2^4) = 4$ (b) $\log_2 \left(\frac{1}{32}\right) = \log_2(2^{-5}) = -5$ (c) $\log_4 4 = 1$ (d) $\log_9 3 = \log_9(9^{1/2}) = 1/2$
6. (a) $\log_{10}(0.001) = \log_{10}(10^{-3}) = -3$ (b) $\log_{10}(10^4) = 4$ (c) $\ln(e^3) = 3$ (d) $\ln(\sqrt{e}) = \ln(e^{1/2}) = 1/2$
7. (a) 1.3655 (b) -0.3011
8. (a) -0.5229 (b) 1.1447
9. (a) $2 \ln a + \frac{1}{2} \ln b + \frac{1}{2} \ln c = 2r + s/2 + t/2$ (b) $\ln b - 3 \ln a - \ln c = s - 3r - t$
10. (a) $\frac{1}{3} \ln c - \ln a - \ln b = t/3 - r - s$ (b) $\frac{1}{2}(\ln a + 3 \ln b - 2 \ln c) = r/2 + 3s/2 - t$
11. (a) $1 + \log x + \frac{1}{2} \log(x-3)$ (b) $2 \ln |x| + 3 \ln(\sin x) - \frac{1}{2} \ln(x^2 + 1)$
12. (a) $\frac{1}{3} \log |x+2| - \log |\cos 5x|$ when $x < -2$ and $\cos 5x < 0$ or when $x > -2$ and $\cos 5x > 0$.
 (b) $\frac{1}{2} \ln(x^2 + 1) - \frac{1}{2} \ln(x^3 + 5)$
13. $\log \frac{2^4(16)}{3} = \log(256/3)$
14. $\log \sqrt{x} - \log(\sin^3 2x) + \log 100 = \log \frac{100\sqrt{x}}{\sin^3 2x}$
15. $\ln \frac{\sqrt[3]{x}(x+1)^2}{\cos x}$
16. $1 + x = 10^3 = 1000$, $x = 999$
17. $\sqrt{x} = 10^{-1} = 0.1$, $x = 0.01$

18. $x^2 = e^4, x = \pm e^2$

19. $1/x = e^{-2}, x = e^2$

20. $x = 7$

21. $2x = 8, x = 4$

22. $\ln 4x - \ln x^6 = \ln 2, \ln \frac{4}{x^5} = \ln 2, \frac{4}{x^5} = 2, x^5 = 2, x = \sqrt[5]{2}$

23. $\ln 2x^2 = \ln 3, 2x^2 = 3, x^2 = 3/2, x = \sqrt{3/2}$ (we discard $-\sqrt{3/2}$ because it does not satisfy the original equation).

24. $\ln 3^x = \ln 2, x \ln 3 = \ln 2, x = \frac{\ln 2}{\ln 3}$

25. $\ln 5^{-2x} = \ln 3, -2x \ln 5 = \ln 3, x = -\frac{\ln 3}{2 \ln 5}$

26. $e^{-2x} = 5/3, -2x = \ln(5/3), x = -\frac{1}{2} \ln(5/3)$

27. $e^{3x} = 7/2, 3x = \ln(7/2), x = \frac{1}{3} \ln(7/2)$

28. $e^x(1 - 2x) = 0$ so $e^x = 0$ (impossible) or $1 - 2x = 0, x = 1/2$

29. $e^{-x}(x + 2) = 0$ so $e^{-x} = 0$ (impossible) or $x + 2 = 0, x = -2$

30. With $u = e^{-x}$, the equation becomes $u^2 - 3u = -2$, so $(u - 1)(u - 2) = u^2 - 3u + 2 = 0$, and $u = 1$ or 2 . Hence $x = -\ln(u)$ gives $x = 0$ or $x = -\ln 2$.

31. (a) Domain: all x ; range: $y > -1$.

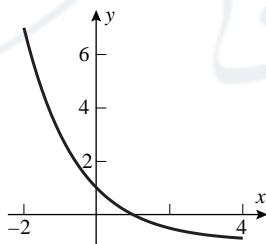

(b) Domain: $x \neq 0$; range: all y .

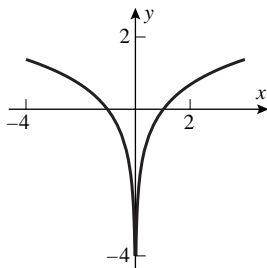

32. (a) Domain: $x > 2$; range: all y .

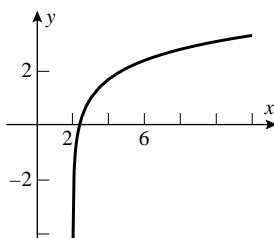

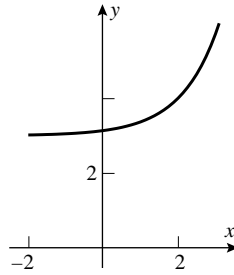

(b) Domain: all x ; range: $y > 0$.

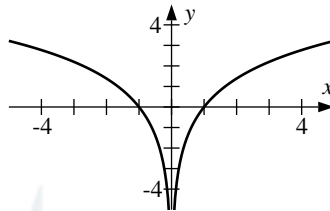

33. (a) Domain: $x \neq 0$; range: all y .

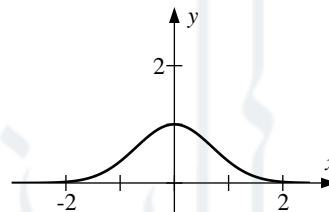

(b) Domain: all x ; range: $0 < y \leq 1$.

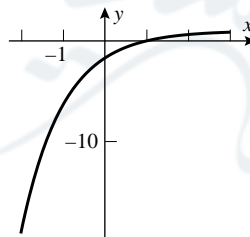

34. (a) Domain: all x ; range: $y < 1$.

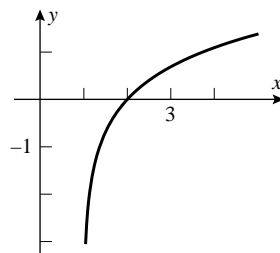

(b) Domain: $x > 1$; range: all y .

35. False. The graph of an exponential function passes through $(0, 1)$, but the graph of $y = x^3$ does not.

36. True. For any $b > 0$, $b^0 = 1$.

37. True, by definition.

38. False. The domain is the interval $x > 0$.

39. $\log_2 7.35 = (\log 7.35)/(\log 2) = (\ln 7.35)/(\ln 2) \approx 2.8777$; $\log_5 0.6 = (\log 0.6)/(\log 5) = (\ln 0.6)/(\ln 5) \approx -0.3174$.

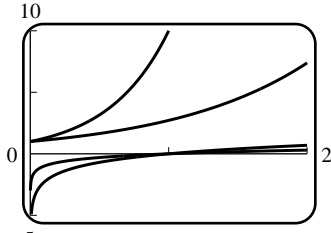

40. -5

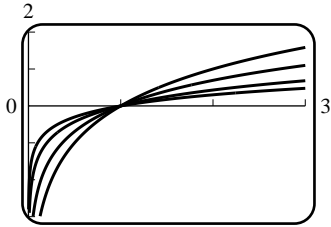

41. -3

42. (a) Let $X = \log_b x$ and $Y = \log_a x$. Then $b^X = x$ and $a^Y = x$ so $a^Y = b^X$, or $a^{Y/X} = b$, which means $\log_a b = Y/X$. Substituting for Y and X yields $\frac{\log_a x}{\log_b x} = \log_a b, \log_b x = \frac{\log_a x}{\log_a b}$.

(b) Let $x = a$ to get $\log_b a = (\log_a a)/(\log_a b) = 1/(\log_a b)$ so $(\log_a b)(\log_b a) = 1$. Now $(\log_2 81)(\log_3 32) = (\log_2 [3^4])(\log_3 [2^5]) = (4 \log_2 3)(5 \log_3 2) = 20(\log_2 3)(\log_3 2) = 20$.

43. $x \approx 1.47099$ and $x \approx 7.85707$.

44. $x \approx \pm 0.836382$

45. (a) No, the curve passes through the origin. (b) $y = (\sqrt[4]{2})^x$ (c) $y = 2^{-x} = (1/2)^x$ (d) $y = (\sqrt{5})^x$

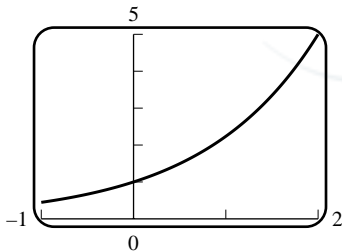

46. (a) As $x \rightarrow +\infty$ the function grows very slowly, but it is always increasing and tends to $+\infty$. As $x \rightarrow 1^+$ the function tends to $-\infty$.

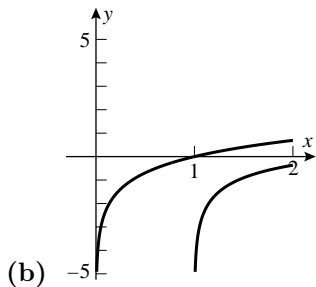

(b)

47. $\log(1/2) < 0$ so $3 \log(1/2) < 2 \log(1/2)$.

48. Let $x = \log_b a$ and $y = \log_b c$, so $a = b^x$ and $c = b^y$.

First, $ac = b^x b^y = b^{x+y}$ or equivalently, $\log_b(ac) = x + y = \log_b a + \log_b c$.

Second, $a/c = b^x/b^y = b^{x-y}$ or equivalently, $\log_b(a/c) = x - y = \log_b a - \log_b c$.

Next, $a^r = (b^x)^r = b^{rx}$ or equivalently, $\log_b a^r = rx = r \log_b a$.

Finally, $1/c = 1/b^y = b^{-y}$ or equivalently, $\log_b(1/c) = -y = -\log_b c$.

49. $75e^{-t/125} = 15, t = -125 \ln(1/5) = 125 \ln 5 \approx 201$ days.

50. (a) If $t = 0$, then $Q = 12$ grams.

(b) $Q = 12e^{-0.055(4)} = 12e^{-0.22} \approx 9.63$ grams.

(c) $12e^{-0.055t} = 6, e^{-0.055t} = 0.5, t = -(\ln 0.5)/(0.055) \approx 12.6$ hours.

51. (a) 7.4; basic (b) 4.2; acidic (c) 6.4; acidic (d) 5.9; acidic

52. (a) $\log[H^+] = -2.44, [H^+] = 10^{-2.44} \approx 3.6 \times 10^{-3}$ mol/L

(b) $\log[H^+] = -8.06, [H^+] = 10^{-8.06} \approx 8.7 \times 10^{-9}$ mol/L

53. (a) 140 dB; damage (b) 120 dB; damage (c) 80 dB; no damage (d) 75 dB; no damage

54. Suppose that $I_1 = 3I_2$ and $\beta_1 = 10 \log_{10} I_1/I_0, \beta_2 = 10 \log_{10} I_2/I_0$. Then $I_1/I_0 = 3I_2/I_0, \log_{10} I_1/I_0 = \log_{10} 3I_2/I_0 = \log_{10} 3 + \log_{10} I_2/I_0, \beta_1 = 10 \log_{10} 3 + \beta_2, \beta_1 - \beta_2 = 10 \log_{10} 3 \approx 4.8$ decibels.

55. Let I_A and I_B be the intensities of the automobile and blender, respectively. Then $\log_{10} I_A/I_0 = 7$ and $\log_{10} I_B/I_0 = 9.3, I_A = 10^7 I_0$ and $I_B = 10^{9.3} I_0$, so $I_B/I_A = 10^{2.3} \approx 200$.

56. First we solve $120 = 10 \log(I/I_0)$ to find the intensity of the original sound: $I = 10^{120/10} I_0 = 10^{12} \cdot 10^{-12} = 1 \text{ W/m}^2$. Hence the intensity of the n 'th echo is $(2/3)^n \text{ W/m}^2$ and its decibel level is $10 \log\left(\frac{(2/3)^n}{10^{-12}}\right) = 10(n \log(2/3) + 12)$. Setting this equal to 10 gives $n = -\frac{11}{\log(2/3)} \approx 62.5$. So the first 62 echoes can be heard.

57. (a) $\log E = 4.4 + 1.5(8.2) = 16.7, E = 10^{16.7} \approx 5 \times 10^{16} \text{ J}$

(b) Let M_1 and M_2 be the magnitudes of earthquakes with energies of E and $10E$, respectively. Then $1.5(M_2 - M_1) = \log(10E) - \log E = \log 10 = 1, M_2 - M_1 = 1/1.5 = 2/3 \approx 0.67$.

58. Let E_1 and E_2 be the energies of earthquakes with magnitudes M and $M + 1$, respectively. Then $\log E_2 - \log E_1 = \log(E_2/E_1) = 1.5, E_2/E_1 = 10^{1.5} \approx 31.6$.

Chapter 0 Review Exercises

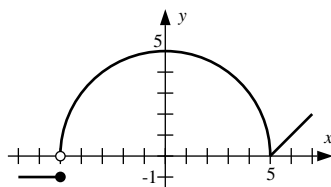

1.

2. (a) $f(-2) = 2, g(3) = 2$ (b) $x = -3, 3$ (c) $x < -2, x > 3$

(d) The domain is $-5 \leq x \leq 5$ and the range is $-5 \leq y \leq 4$.

(e) The domain is $-4 \leq x \leq 4.1$, the range is $-3 \leq y \leq 5$.

(f) $f(x) = 0$ at $x = -3, 5$; $g(x) = 0$ at $x = -3, 2$

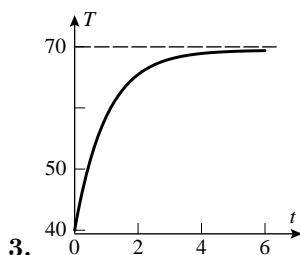

4. Assume that the paint is applied in a thin veneer of uniform thickness, so that the quantity of paint to be used is proportional to the area covered. If P is the amount of paint to be used, $P = k\pi r^2$. The constant k depends on physical factors, such as the thickness of the paint, absorption of the wood, etc.

5. (a) If the side has length x and height h , then $V = 8 = x^2h$, so $h = 8/x^2$. Then the cost $C = 5x^2 + 2(4)(xh) = 5x^2 + 64/x$.

(b) The domain of C is $(0, +\infty)$ because x can be very large (just take h very small).

6. (a) Suppose the radius of the uncoated ball is r and that of the coated ball is $r + h$. Then the plastic has volume equal to the difference of the volumes, i.e. $V = \frac{4}{3}\pi(r+h)^3 - \frac{4}{3}\pi r^3 = \frac{4}{3}\pi h[3r^2 + 3rh + h^2]$ in³. But $r = 3$ and hence $V = \frac{4}{3}\pi h[27 + 9h + h^2]$.

(b) $0 < h < \infty$

7. (a) The base has sides $(10 - 2x)/2$ and $6 - 2x$, and the height is x , so $V = (6 - 2x)(5 - x)x$ ft³.

(b) From the picture we see that $x < 5$ and $2x < 6$, so $0 < x < 3$.

(c) 3.57 ft \times 3.79 ft \times 1.21 ft

8. (a) $d = \sqrt{(x-1)^2 + 1/x^2}$ (b) $0 < x < +\infty$ (c) $d \approx 0.82$ at $x \approx 1.38$

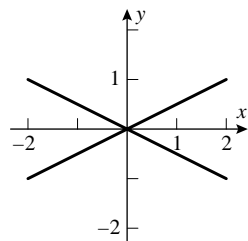
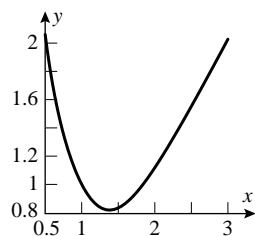

10. On the interval $[-20, 30]$ the curve seems tame, but seen close up on the interval $[-1.2, .4]$ we see that there is

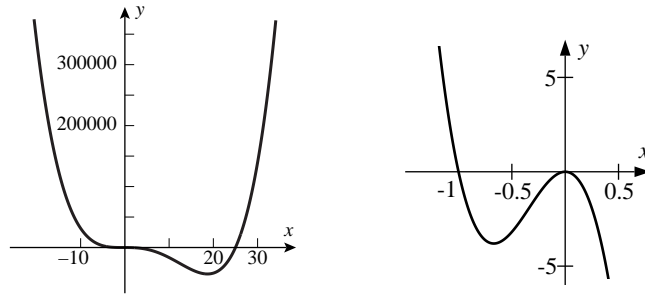

some wiggling near the origin.

11.

x	-4	-3	-2	-1	0	1	2	3	4
$f(x)$	0	-1	2	1	3	-2	-3	4	-4
$g(x)$	3	2	1	-3	-1	-4	4	-2	0
$(f \circ g)(x)$	4	-3	-2	-1	1	0	-4	2	3
$(g \circ f)(x)$	-1	-3	4	-4	-2	1	2	0	3

12. $(f \circ g)(x) = -1/x$ with domain $x > 0$, and $(g \circ f)(x)$ is nowhere defined, with domain \emptyset .

13. $f(g(x)) = (3x + 2)^2 + 1$, $g(f(x)) = 3(x^2 + 1) + 2$, so $9x^2 + 12x + 5 = 3x^2 + 5$, $6x^2 + 12x = 0$, $x = 0, -2$.

14. (a) $(3 - x)/x$

(b) No; the definition of $f(g(x))$ requires $g(x)$ to be defined, so $x \neq 1$, and $f(g(x))$ requires $g(x) \neq -1$, so we must have $g(x) \neq -1$, i.e. $x \neq 0$; whereas $h(x)$ only requires $x \neq 0$.

15. For $g(h(x))$ to be defined, we require $h(x) \neq 0$, i.e. $x \neq \pm 1$. For $f(g(h(x)))$ to be defined, we also require $g(h(x)) \neq 1$, i.e. $x \neq \pm\sqrt{2}$. So the domain of $f \circ g \circ h$ consists of all x except ± 1 and $\pm\sqrt{2}$. For all x in the domain, $(f \circ g \circ h)(x) = 1/(2 - x^2)$.

16. $g(x) = x^2 + 2x$

17. (a) even \times odd = odd (b) odd \times odd = even (c) even + odd is neither (d) odd \times odd = even

18. (a) $y = |x - 1|$, $y = |(-x) - 1| = |x + 1|$, $y = 2|x + 1|$, $y = 2|x + 1| - 3$, $y = -2|x + 1| + 3$

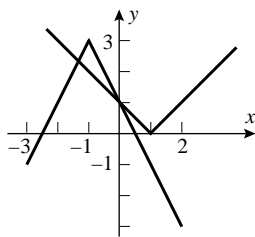

(b)

19. (a) The circle of radius 1 centered at (a, a^2) ; therefore, the family of all circles of radius 1 with centers on the parabola $y = x^2$.

(b) All translates of the parabola $y = x^2$ with vertex on the line $y = x/2$.

20. Let $y = ax^2 + bx + c$. Then $4a + 2b + c = 0$, $64a + 8b + c = 18$, $64a - 8b + c = 18$, from which $b = 0$ and $60a = 18$, or finally $y = \frac{3}{10}x^2 - \frac{6}{5}$.

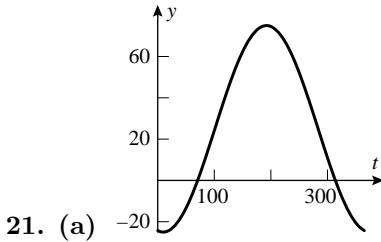

21. (a) $y = 20 \sin(\pi t / 100) - 10$
- (b) When $\frac{2\pi}{365}(t - 101) = \frac{3\pi}{2}$, or $t = 374.75$, which is the same date as $t = 9.75$, so during the night of January 10th-11th.
- (c) From $t = 0$ to $t = 70.58$ and from $t = 313.92$ to $t = 365$ (the same date as $t = 0$), for a total of about 122 days.

22. Let $y = A + B \sin(at + b)$. Since the maximum and minimum values of y are 35 and 5, $A + B = 35$ and $A - B = 5$, $A = 20$, $B = 15$. The period is 12 hours, so $12a = 2\pi$ and $a = \pi/6$. The maximum occurs at $t = 1$, so $1 = \sin(a + b) = \sin(\pi/6 + b)$, $\pi/6 + b = \pi/2$, $b = \pi/2 - \pi/6 = \pi/3$ and $y = 20 + 15 \sin(\pi t/6 + \pi/3)$.

23. When $x = 0$ the value of the green curve is higher than that of the blue curve, therefore the blue curve is given by $y = 1 + 2 \sin x$.

The points A, B, C, D are the points of intersection of the two curves, i.e. where $1 + 2 \sin x = 2 \sin(x/2) + 2 \cos(x/2)$. Let $\sin(x/2) = p, \cos(x/2) = q$. Then $2 \sin x = 4 \sin(x/2) \cos(x/2)$ (basic trigonometric identity), so the equation which yields the points of intersection becomes $1 + 4pq = 2p + 2q, 4pq - 2p - 2q + 1 = 0, (2p - 1)(2q - 1) = 0$; thus whenever either $\sin(x/2) = 1/2$ or $\cos(x/2) = 1/2$, i.e. when $x/2 = \pi/6, 5\pi/6, \pm\pi/3$. Thus A has coordinates $(-2\pi/3, 1 - \sqrt{3})$, B has coordinates $(\pi/3, 1 + \sqrt{3})$, C has coordinates $(2\pi/3, 1 + \sqrt{3})$, and D has coordinates $(5\pi/3, 1 - \sqrt{3})$.

24. (a) $R = R_0$ is the R -intercept, $R_0 k$ is the slope, and $T = -1/k$ is the T -intercept.

(b) $-1/k = -273$, or $k = 1/273$.

(c) $1.1 = R_0(1 + 20/273)$, or $R_0 = 1.025$.

(d) $T = 126.55^\circ\text{C}$.

25. (a) $f(g(x)) = x$ for all x in the domain of g , and $g(f(x)) = x$ for all x in the domain of f .

(b) They are reflections of each other through the line $y = x$.

(c) The domain of one is the range of the other and vice versa.

(d) The equation $y = f(x)$ can always be solved for x as a function of y . Functions with no inverses include $y = x^2, y = \sin x$.

26. (a) For $\sin x, -\pi/2 \leq x \leq \pi/2$; for $\cos x, 0 \leq x \leq \pi$; for $\tan x, -\pi/2 < x < \pi/2$; for $\sec x, 0 \leq x < \pi/2$ or $\pi/2 < x \leq \pi$.

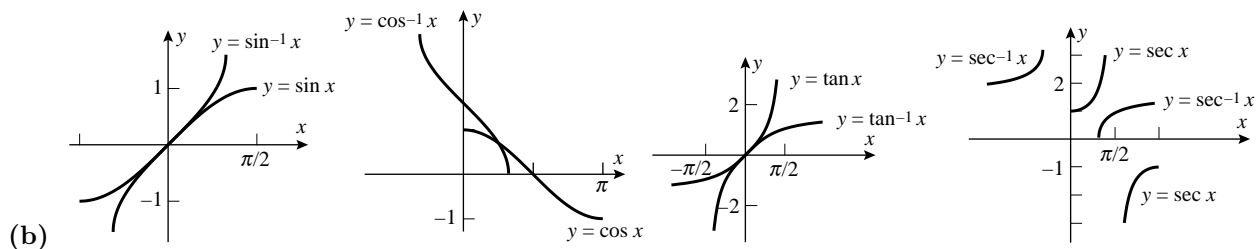

27. (a) $x = f(y) = 8y^3 - 1$; $f^{-1}(x) = y = \left(\frac{x+1}{8}\right)^{1/3} = \frac{1}{2}(x+1)^{1/3}$.

(b) $f(x) = (x-1)^2$; f does not have an inverse because f is not one-to-one, for example $f(0) = f(2) = 1$.

(c) $x = f(y) = (e^y)^2 + 1$; $f^{-1}(x) = y = \ln \sqrt{x-1} = \frac{1}{2} \ln(x-1)$.

(d) $x = f(y) = \frac{y+2}{y-1}$; $f^{-1}(x) = y = \frac{x+2}{x-1}$.

(e) $x = f(y) = \sin\left(\frac{1-2y}{y}\right)$; $f^{-1}(x) = y = \frac{1}{2 + \sin^{-1} x}$.

(f) $x = \frac{1}{1 + 3 \tan^{-1} y}$; $y = \tan\left(\frac{1-x}{3x}\right)$. The range of f consists of all $x < \frac{-2}{3\pi-2}$ or $x > \frac{2}{3\pi+2}$, so this is also the domain of f^{-1} . Hence $f^{-1}(x) = \tan\left(\frac{1-x}{3x}\right)$, $x < \frac{-2}{3\pi-2}$ or $x > \frac{2}{3\pi+2}$.

28. It is necessary and sufficient that the graph of f pass the horizontal line test. Suppose to the contrary that $\frac{ah+b}{ch+d} = \frac{ak+b}{ck+d}$ for $h \neq k$. Then $achk + bck + adh + bd = achk + adk + bch + bd$, $bc(h-k) = ad(h-k)$. It follows from $h \neq k$ that $ad - bc = 0$. These steps are reversible, hence f^{-1} exists if and only if $ad - bc \neq 0$, and if so, then $x = \frac{ay+b}{cy+d}$, $xcy + xd = ay + b$, $y(cx-a) = b - xd$, $y = \frac{b-xd}{cx-a} = f^{-1}(x)$.

29. Draw right triangles of sides 5, 12, 13, and 3, 4, 5. Then $\sin[\cos^{-1}(4/5)] = 3/5$, $\sin[\cos^{-1}(5/13)] = 12/13$, $\cos[\sin^{-1}(4/5)] = 3/5$, and $\cos[\sin^{-1}(5/13)] = 12/13$.

(a) $\cos[\cos^{-1}(4/5) + \sin^{-1}(5/13)] = \cos(\cos^{-1}(4/5)) \cos(\sin^{-1}(5/13)) - \sin(\cos^{-1}(4/5)) \sin(\sin^{-1}(5/13)) = \frac{4}{5} \frac{12}{13} - \frac{3}{5} \frac{5}{13} = \frac{33}{65}$.

(b) $\sin[\sin^{-1}(4/5) + \cos^{-1}(5/13)] = \sin(\sin^{-1}(4/5)) \cos(\cos^{-1}(5/13)) + \cos(\sin^{-1}(4/5)) \sin(\cos^{-1}(5/13)) = \frac{4}{5} \frac{5}{13} + \frac{3}{5} \frac{12}{13} = \frac{56}{65}$.

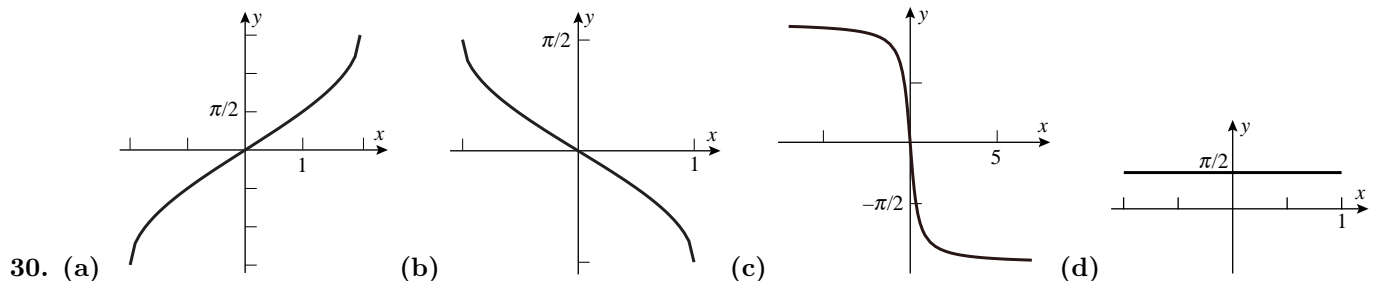

31. $y = 5$ ft = 60 in, so $60 = \log x$, $x = 10^{60}$ in $\approx 1.58 \times 10^{55}$ mi.

32. $y = 100$ mi = $12 \times 5280 \times 100$ in, so $x = \log y = \log 12 + \log 5280 + \log 100 \approx 6.8018$ in.

33. $3 \ln(e^{2x}(e^x)^3) + 2 \exp(\ln 1) = 3 \ln e^{2x} + 3 \ln(e^x)^3 + 2 \cdot 1 = 3(2x) + (3 \cdot 3)x + 2 = 15x + 2$.

34. $Y = \ln(Ce^{kt}) = \ln C + \ln e^{kt} = \ln C + kt$, a line with slope k and Y -intercept $\ln C$.

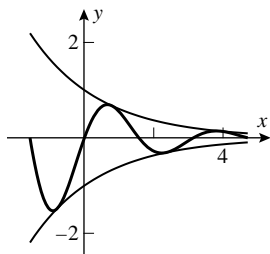

35. (a)

(b) The curve $y = e^{-x/2} \sin 2x$ has x -intercepts at $x = -\pi/2, 0, \pi/2, \pi, 3\pi/2$. It intersects the curve $y = e^{-x/2}$ at $x = \pi/4, 5\pi/4$ and it intersects the curve $y = -e^{-x/2}$ at $x = -\pi/4, 3\pi/4$.

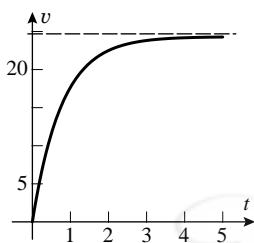

36. (a)

(b) As t gets larger, the velocity v grows towards 24.61 ft/s.

(c) For large t the velocity approaches $c = 24.61$.

(d) No; but it comes very close (arbitrarily close).

(e) 3.009 s.

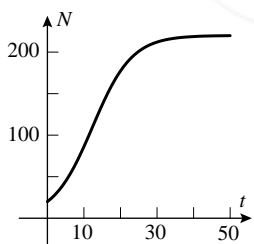

37. (a)

(b) $N = 80$ when $t = 9.35$ yrs.

(c) 220 sheep.

38. (a) The potato is done in the interval $27.65 < t < 32.71$.

(b) The oven temperature is always 400° F, so the difference between the oven temperature and the potato temperature is $D = 400 - T$. Initially $D = 325$, so solve $D = 75 + 325/2 = 237.5$ for t , so $t \approx 22.76$ min.

39. (a) The function $\ln x - x^{0.2}$ is negative at $x = 1$ and positive at $x = 4$, so it is reasonable to expect it to be zero somewhere in between. (This will be established later in this book.)

(b) $x = 3.654$ and 3.32105×10^5 .

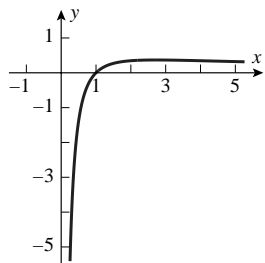

40. (a)

If $x^k = e^x$ then $k \ln x = x$, or $\frac{\ln x}{x} = \frac{1}{k}$. The steps are reversible.

(b) By zooming it is seen that the maximum value of y is approximately 0.368 (actually, $1/e$), so there are two distinct solutions of $x^k = e^x$ whenever $k > 1/0.368 \approx 2.717$.

(c) $x \approx 1.155, 26.093$.

41. (a) The functions x^2 and $\tan x$ are positive and increasing on the indicated interval, so their product $x^2 \tan x$ is also increasing there. So is $\ln x$; hence the sum $f(x) = x^2 \tan x + \ln x$ is increasing, and it has an inverse.

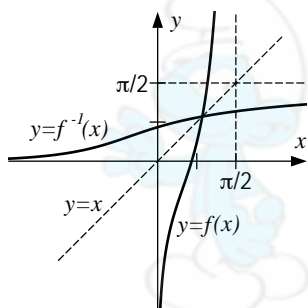

(b)

The asymptotes for $f(x)$ are $x = 0, x = \pi/2$. The asymptotes for $f^{-1}(x)$ are $y = 0, y = \pi/2$.

Limits and Continuity

Exercise Set 1.1

1. (a) 3 (b) 3 (c) 3 (d) 3
2. (a) 0 (b) 0 (c) 0 (d) 0
3. (a) -1 (b) 3 (c) does not exist (d) 1
4. (a) 2 (b) 0 (c) does not exist (d) 2
5. (a) 0 (b) 0 (c) 0 (d) 3
6. (a) 1 (b) 1 (c) 1 (d) 0
7. (a) $-\infty$ (b) $-\infty$ (c) $-\infty$ (d) 1
8. (a) $+\infty$ (b) $+\infty$ (c) $+\infty$ (d) can not be found from graph
9. (a) $+\infty$ (b) $+\infty$ (c) 2 (d) 2 (e) $-\infty$ (f) $x = -2, x = 0, x = 2$
10. (a) does not exist (b) $-\infty$ (c) 0 (d) -1 (e) $+\infty$ (f) 3 (g) $x = -2, x = 2$

11. (i)

-0.01	-0.001	-0.0001	0.0001	0.001	0.01
0.9950166	0.9995002	0.9999500	1.0000500	1.0005002	1.0050167

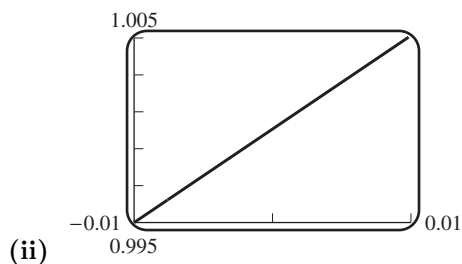

The limit appears to be 1.

12. (i)

-0.1	-0.01	-0.001	0.001	0.01	0.1
2.0135792	2.0001334	2.0000013	2.0000013	2.0001334	2.0135792

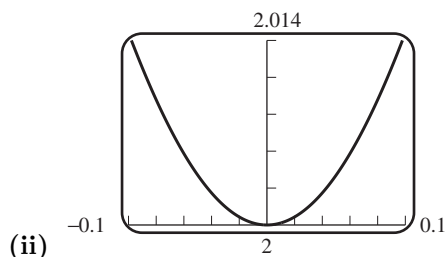

The limit appears to be 2.

13. (a)

2	1.5	1.1	1.01	1.001	0	0.5	0.9	0.99	0.999
0.1429	0.2105	0.3021	0.3300	0.3330	1.0000	0.5714	0.3690	0.3367	0.3337

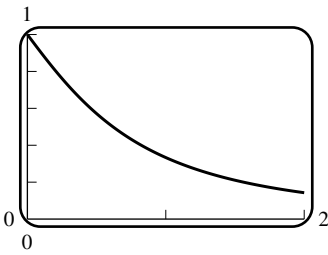

The limit is $1/3$.

(b)

2	1.5	1.1	1.01	1.001	1.0001
0.4286	1.0526	6.344	66.33	666.3	6666.3

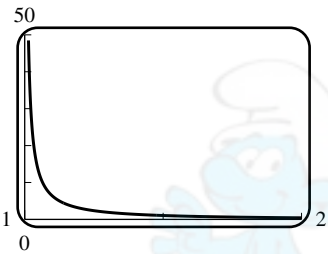

The limit is $+\infty$.

(c)

0	0.5	0.9	0.99	0.999	0.9999
-1	-1.7143	-7.0111	-67.001	-667.0	-6667.0

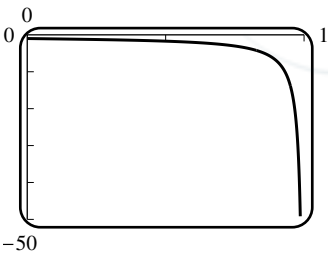

The limit is $-\infty$.

14. (a)

-0.25	-0.1	-0.001	-0.0001	0.0001	0.001	0.1	0.25
0.5359	0.5132	0.5001	0.5000	0.5000	0.4999	0.4881	0.4721

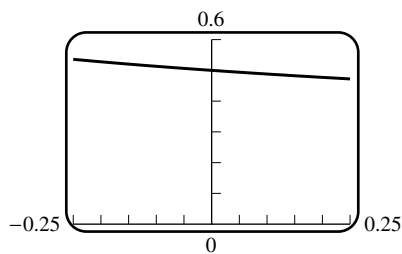

The limit is $1/2$.

(b)

0.25	0.1	0.001	0.0001
8.4721	20.488	2000.5	20001

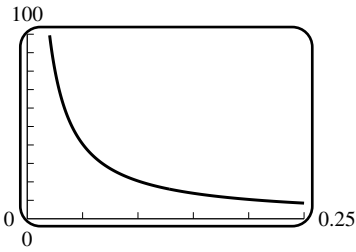

The limit is $+\infty$.

(c)

-0.25	-0.1	-0.001	-0.0001
-7.4641	-19.487	-1999.5	-20000

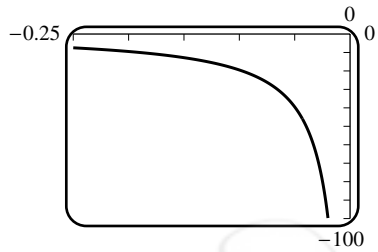

The limit is $-\infty$.

15. (a)

-0.25	-0.1	-0.001	-0.0001	0.0001	0.001	0.1	0.25
2.7266	2.9552	3.0000	3.0000	3.0000	3.0000	2.9552	2.7266

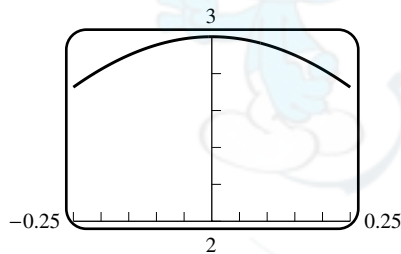

The limit is 3.

(b)

0	-0.5	-0.9	-0.99	-0.999	-1.5	-1.1	-1.01	-1.001
1	1.7552	6.2161	54.87	541.1	-0.1415	-4.536	-53.19	-539.5

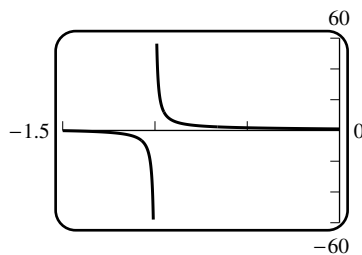

The limit does not exist.

16. (a)

0	-0.5	-0.9	-0.99	-0.999	-1.5	-1.1	-1.01	-1.001
1.5574	1.0926	1.0033	1.0000	1.0000	1.0926	1.0033	1.0000	1.0000

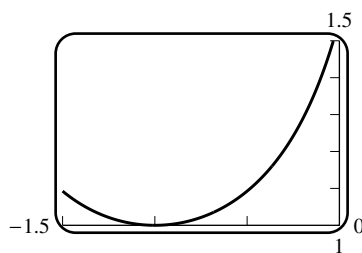

The limit is 1.

(b)	-0.25	-0.1	-0.001	-0.0001	0.0001	0.001	0.1	0.25
	1.9794	2.4132	2.5000	2.5000	2.5000	2.5000	2.4132	1.9794

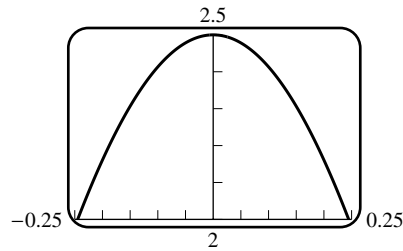

The limit is $5/2$.

17. False; define $f(x) = x$ for $x \neq a$ and $f(a) = a + 1$. Then $\lim_{x \rightarrow a} f(x) = a \neq f(a) = a + 1$.

18. True; by 1.1.3.

19. False; define $f(x) = 0$ for $x < 0$ and $f(x) = x + 1$ for $x \geq 0$. Then the left and right limits exist but are unequal.

20. False; define $f(x) = 1/x$ for $x > 0$ and $f(0) = 2$.

27. $m_{\text{sec}} = \frac{x^2 - 1}{x + 1} = x - 1$ which gets close to -2 as x gets close to -1 , thus $y - 1 = -2(x + 1)$ or $y = -2x - 1$.

28. $m_{\text{sec}} = \frac{x^2}{x} = x$ which gets close to 0 as x gets close to 0 , thus $y = 0$.

29. $m_{\text{sec}} = \frac{x^4 - 1}{x - 1} = x^3 + x^2 + x + 1$ which gets close to 4 as x gets close to 1 , thus $y - 1 = 4(x - 1)$ or $y = 4x - 3$.

30. $m_{\text{sec}} = \frac{x^4 - 1}{x + 1} = x^3 - x^2 + x - 1$ which gets close to -4 as x gets close to -1 , thus $y - 1 = -4(x + 1)$ or $y = -4x - 3$.

31. (a) The length of the rod while at rest.

(b) The limit is zero. The length of the rod approaches zero as its speed approaches c .

32. (a) The mass of the object while at rest.

(b) The limiting mass as the velocity approaches the speed of light; the mass is unbounded.

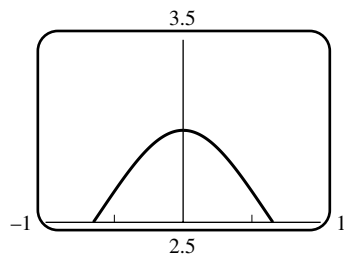

33. (a)

The limit appears to be 3.

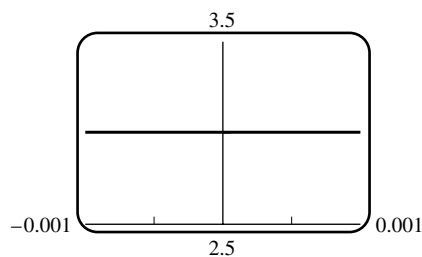

(b)

The limit appears to be 3.

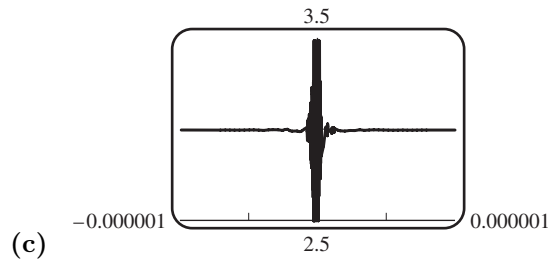

The limit does not exist.

Exercise Set 1.2

1. (a) By Theorem 1.2.2, this limit is $2 + 2 \cdot (-4) = -6$.
 (b) By Theorem 1.2.2, this limit is $0 - 3 \cdot (-4) + 1 = 13$.
 (c) By Theorem 1.2.2, this limit is $2 \cdot (-4) = -8$.
 (d) By Theorem 1.2.2, this limit is $(-4)^2 = 16$.
 (e) By Theorem 1.2.2, this limit is $\sqrt[3]{6+2} = 2$.
 (f) By Theorem 1.2.2, this limit is $\frac{2}{(-4)} = -\frac{1}{2}$.
2. (a) By Theorem 1.2.2, this limit is $0 + 0 = 0$.
 (b) The limit doesn't exist because $\lim f$ doesn't exist and $\lim g$ does.
 (c) By Theorem 1.2.2, this limit is $-2 + 2 = 0$.
 (d) By Theorem 1.2.2, this limit is $1 + 2 = 3$.
 (e) By Theorem 1.2.2, this limit is $0/(1+0) = 0$.
 (f) The limit doesn't exist because the denominator tends to zero but the numerator doesn't.
 (g) The limit doesn't exist because $\sqrt{f(x)}$ is not defined for $0 < x < 2$.
 (h) By Theorem 1.2.2, this limit is $\sqrt{1} = 1$.
3. By Theorem 1.2.3, this limit is $2 \cdot 1 \cdot 3 = 6$.
4. By Theorem 1.2.3, this limit is $3^3 - 3 \cdot 3^2 + 9 \cdot 3 = 27$.
5. By Theorem 1.2.4, this limit is $(3^2 - 2 \cdot 3)/(3 + 1) = 3/4$.
6. By Theorem 1.2.4, this limit is $(6 \cdot 0 - 9)/(0^3 - 12 \cdot 0 + 3) = -3$.
7. After simplification, $\frac{x^4 - 1}{x - 1} = x^3 + x^2 + x + 1$, and the limit is $1^3 + 1^2 + 1 + 1 = 4$.
8. After simplification, $\frac{t^3 + 8}{t + 2} = t^2 - 2t + 4$, and the limit is $(-2)^2 - 2 \cdot (-2) + 4 = 12$.
9. After simplification, $\frac{x^2 + 6x + 5}{x^2 - 3x - 4} = \frac{x + 5}{x - 4}$, and the limit is $(-1 + 5)/(-1 - 4) = -4/5$.

10. After simplification, $\frac{x^2 - 4x + 4}{x^2 + x - 6} = \frac{x - 2}{x + 3}$, and the limit is $(2 - 2)/(2 + 3) = 0$.
11. After simplification, $\frac{2x^2 + x - 1}{x + 1} = 2x - 1$, and the limit is $2 \cdot (-1) - 1 = -3$.
12. After simplification, $\frac{3x^2 - x - 2}{2x^2 + x - 3} = \frac{3x + 2}{2x + 3}$, and the limit is $(3 \cdot 1 + 2)/(2 \cdot 1 + 3) = 1$.
13. After simplification, $\frac{t^3 + 3t^2 - 12t + 4}{t^3 - 4t} = \frac{t^2 + 5t - 2}{t^2 + 2t}$, and the limit is $(2^2 + 5 \cdot 2 - 2)/(2^2 + 2 \cdot 2) = 3/2$.
14. After simplification, $\frac{t^3 + t^2 - 5t + 3}{t^3 - 3t + 2} = \frac{t + 3}{t + 2}$, and the limit is $(1 + 3)/(1 + 2) = 4/3$.
15. The limit is $+\infty$.
16. The limit is $-\infty$.
17. The limit does not exist.
18. The limit is $+\infty$.
19. The limit is $-\infty$.
20. The limit does not exist.
21. The limit is $+\infty$.
22. The limit is $-\infty$.
23. The limit does not exist.
24. The limit is $-\infty$.
25. The limit is $+\infty$.
26. The limit does not exist.
27. The limit is $+\infty$.
28. The limit is $+\infty$.
29. After simplification, $\frac{x - 9}{\sqrt{x} - 3} = \sqrt{x} + 3$, and the limit is $\sqrt{9} + 3 = 6$.
30. After simplification, $\frac{4 - y}{2 - \sqrt{y}} = 2 + \sqrt{y}$, and the limit is $2 + \sqrt{4} = 4$.
31. (a) 2 (b) 2 (c) 2
32. (a) does not exist (b) 1 (c) 4
33. True, by Theorem 1.2.2.
34. False; e.g. $\lim_{x \rightarrow 0} \frac{x^2}{x} = 0$.

35. False; e.g. $f(x) = 2x$, $g(x) = x$, so $\lim_{x \rightarrow 0} f(x) = \lim_{x \rightarrow 0} g(x) = 0$, but $\lim_{x \rightarrow 0} f(x)/g(x) = 2$.

36. True, by Theorem 1.2.4.

37. After simplification, $\frac{\sqrt{x+4}-2}{x} = \frac{1}{\sqrt{x+4}+2}$, and the limit is $1/4$.

38. After simplification, $\frac{\sqrt{x^2+4}-2}{x} = \frac{x}{\sqrt{x^2+4}+2}$, and the limit is 0.

39. (a) After simplification, $\frac{x^3-1}{x-1} = x^2+x+1$, and the limit is 3.

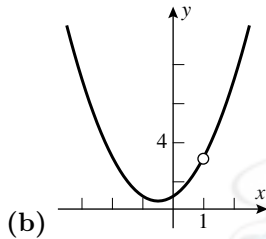

40. (a) After simplification, $\frac{x^2-9}{x+3} = x-3$, and the limit is -6 , so we need that $k = -6$.

(b) On its domain (all real numbers), $f(x) = x - 3$.

41. (a) Theorem 1.2.2 doesn't apply; moreover one cannot subtract infinities.

(b) $\lim_{x \rightarrow 0^+} \left(\frac{1}{x} - \frac{1}{x^2} \right) = \lim_{x \rightarrow 0^+} \left(\frac{x-1}{x^2} \right) = -\infty$.

42. (a) Theorem 1.2.2 assumes that L_1 and L_2 are real numbers, not infinities. It is in general not true that " $\infty \cdot 0 = 0$ ".

(b) $\frac{1}{x} - \frac{2}{x^2+2x} = \frac{x^2}{x(x^2+2x)} = \frac{1}{x+2}$ for $x \neq 0$, so that $\lim_{x \rightarrow 0} \left(\frac{1}{x} - \frac{2}{x^2+2x} \right) = \frac{1}{2}$.

43. For $x \neq 1$, $\frac{1}{x-1} - \frac{a}{x^2-1} = \frac{x+1-a}{x^2-1}$ and for this to have a limit it is necessary that $\lim_{x \rightarrow 1} (x+1-a) = 0$, i.e. $a = 2$. For this value, $\frac{1}{x-1} - \frac{2}{x^2-1} = \frac{x+1-2}{x^2-1} = \frac{x-1}{x^2-1} = \frac{1}{x+1}$ and $\lim_{x \rightarrow 1} \frac{1}{x+1} = \frac{1}{2}$.

44. (a) For small x , $1/x^2$ is much bigger than $\pm 1/x$.

(b) $\frac{1}{x} + \frac{1}{x^2} = \frac{x+1}{x^2}$. Since the numerator has limit 1 and x^2 tends to zero from the right, the limit is $+\infty$.

45. The left and/or right limits could be plus or minus infinity; or the limit could exist, or equal any preassigned real number. For example, let $q(x) = x - x_0$ and let $p(x) = a(x - x_0)^n$ where n takes on the values 0, 1, 2.

46. If on the contrary $\lim_{x \rightarrow a} g(x)$ did exist then by Theorem 1.2.2 so would $\lim_{x \rightarrow a} [f(x) + g(x)]$, and that would be a contradiction.

47. Clearly, $g(x) = [f(x) + g(x)] - f(x)$. By Theorem 1.2.2, $\lim_{x \rightarrow a} [f(x) + g(x)] - \lim_{x \rightarrow a} f(x) = \lim_{x \rightarrow a} [f(x) + g(x) - f(x)] = \lim_{x \rightarrow a} g(x)$.

48. By Theorem 1.2.2, $\lim_{x \rightarrow a} f(x) = \left(\lim_{x \rightarrow a} \frac{f(x)}{g(x)} \right) \lim_{x \rightarrow a} g(x) = \left(\lim_{x \rightarrow a} \frac{f(x)}{g(x)} \right) \cdot 0 = 0$, since $\lim_{x \rightarrow a} \frac{f(x)}{g(x)}$ exists.

Exercise Set 1.3

1. (a) $-\infty$ (b) $+\infty$

2. (a) 2 (b) 0

3. (a) 0 (b) -1

4. (a) does not exist (b) 0

5. (a) $3 + 3 \cdot (-5) = -12$ (b) $0 - 4 \cdot (-5) + 1 = 21$ (c) $3 \cdot (-5) = -15$ (d) $(-5)^2 = 25$

(e) $\sqrt[3]{5+3} = 2$ (f) $3/(-5) = -3/5$ (g) 0

(h) The limit doesn't exist because the denominator tends to zero but the numerator doesn't.

6. (a) $2 \cdot 7 - (-6) = 20$ (b) $6 \cdot 7 + 7 \cdot (-6) = 0$ (c) $+\infty$ (d) $-\infty$ (e) $\sqrt[3]{-42}$

(f) $-6/7$ (g) 7 (h) $-7/12$

7. (a)

x	0.1	0.01	0.001	0.0001	0.00001	0.000001
$f(x)$	1.471128	1.560797	1.569796	1.570696	1.570786	1.570795

The limit appears to be $\approx 1.57079\dots$

(b) The limit is $\pi/2$.

8.

x	10	100	1000	10000	100000	1000000
$f(x)$	1.258925	1.047129	1.006932	1.000921	1.000115	1.000014

The limit appears to be 1.

9. The limit is $-\infty$, by the highest degree term.

10. The limit is $+\infty$, by the highest degree term.

11. The limit is $+\infty$.

12. The limit is $+\infty$.

13. The limit is $3/2$, by the highest degree terms.

14. The limit is $5/2$, by the highest degree terms.

15. The limit is 0, by the highest degree terms.

16. The limit is 0, by the highest degree terms.

17. The limit is 0, by the highest degree terms.

18. The limit is $5/3$, by the highest degree terms.

19. The limit is $-\infty$, by the highest degree terms.

20. The limit is $+\infty$, by the highest degree terms.

21. The limit is $-1/7$, by the highest degree terms.

22. The limit is $4/7$, by the highest degree terms.

23. The limit is $\sqrt[3]{-5/8} = -\sqrt[3]{5}/2$, by the highest degree terms.

24. The limit is $\sqrt[3]{3/2}$, by the highest degree terms.

25. $\frac{\sqrt{5x^2-2}}{x+3} = \frac{\sqrt{5-\frac{2}{x^2}}}{-1-\frac{3}{x}}$ when $x < 0$. The limit is $-\sqrt{5}$.

26. $\frac{\sqrt{5x^2-2}}{x+3} = \frac{\sqrt{5-\frac{2}{x^2}}}{1+\frac{3}{x}}$ when $x > 0$. The limit is $\sqrt{5}$.

27. $\frac{2-y}{\sqrt{7+6y^2}} = \frac{-\frac{2}{y}+1}{\sqrt{\frac{7}{y^2}+6}}$ when $y < 0$. The limit is $1/\sqrt{6}$.

28. $\frac{2-y}{\sqrt{7+6y^2}} = \frac{\frac{2}{y}-1}{\sqrt{\frac{7}{y^2}+6}}$ when $y > 0$. The limit is $-1/\sqrt{6}$.

29. $\frac{\sqrt{3x^4+x}}{x^2-8} = \frac{\sqrt{3+\frac{1}{x^3}}}{1-\frac{8}{x^2}}$ when $x < 0$. The limit is $\sqrt{3}$.

30. $\frac{\sqrt{3x^4+x}}{x^2-8} = \frac{\sqrt{3+\frac{1}{x^3}}}{1-\frac{8}{x^2}}$ when $x > 0$. The limit is $\sqrt{3}$.

31. $\lim_{x \rightarrow +\infty} (\sqrt{x^2+3} - x) \frac{\sqrt{x^2+3} + x}{\sqrt{x^2+3} + x} = \lim_{x \rightarrow +\infty} \frac{3}{\sqrt{x^2+3} + x} = 0$, by the highest degree terms.

32. $\lim_{x \rightarrow +\infty} (\sqrt{x^2-3x} - x) \frac{\sqrt{x^2-3x} + x}{\sqrt{x^2-3x} + x} = \lim_{x \rightarrow +\infty} \frac{-3x}{\sqrt{x^2-3x} + x} = -3/2$, by the highest degree terms.

33. $\lim_{x \rightarrow -\infty} \frac{1-e^x}{1+e^x} = \frac{1-0}{1+0} = 1$.

34. Divide the numerator and denominator by e^x : $\lim_{x \rightarrow +\infty} \frac{1-e^x}{1+e^x} = \lim_{x \rightarrow +\infty} \frac{e^{-x}-1}{e^{-x}+1} = \frac{0-1}{0+1} = -1$.

35. Divide the numerator and denominator by e^x : $\lim_{x \rightarrow +\infty} \frac{1+e^{-2x}}{1-e^{-2x}} = \frac{1+0}{1-0} = 1$.

36. Divide the numerator and denominator by e^{-x} : $\lim_{x \rightarrow -\infty} \frac{e^{2x}+1}{e^{2x}-1} = \frac{0+1}{0-1} = -1$.

37. The limit is $-\infty$.

38. The limit is $+\infty$.

39. $\frac{x+1}{x} = 1 + \frac{1}{x}$, so $\lim_{x \rightarrow +\infty} \frac{(x+1)^x}{x^x} = e$ from Figure 1.3.4.

40. $\left(1 + \frac{1}{x}\right)^{-x} = \frac{1}{\left(1 + \frac{1}{x}\right)^x}$, so the limit is e^{-1} .

41. False: $\lim_{x \rightarrow +\infty} \left(1 + \frac{1}{x}\right)^{2x} = \left[\lim_{x \rightarrow +\infty} \left(1 + \frac{1}{x}\right)^x\right]^2 = e^2$.

42. False; $y = 0$ is a horizontal asymptote for the curve $y = e^x$ yet $\lim_{x \rightarrow +\infty} e^x$ does not exist.

43. True: for example $f(x) = \sin x/x$ crosses the x -axis infinitely many times at $x = n\pi, n = 1, 2, \dots$

44. False: if the asymptote is $y = 0$, then $\lim_{x \rightarrow \pm\infty} p(x)/q(x) = 0$, and clearly the degree of $p(x)$ is strictly less than the degree of $q(x)$. If the asymptote is $y = L \neq 0$, then $\lim_{x \rightarrow \pm\infty} p(x)/q(x) = L$ and the degrees must be equal.
45. It appears that $\lim_{t \rightarrow +\infty} n(t) = +\infty$, and $\lim_{t \rightarrow +\infty} e(t) = c$.
46. (a) It is the initial temperature of the potato (400° F).
 (b) It is the ambient temperature, i.e. the temperature of the room.
47. (a) $+\infty$ (b) -5
48. (a) 0 (b) -6
49. $\lim_{x \rightarrow -\infty} p(x) = +\infty$. When n is even, $\lim_{x \rightarrow +\infty} p(x) = +\infty$; when n is odd, $\lim_{x \rightarrow +\infty} p(x) = -\infty$.
50. (a) $p(x) = q(x) = x$. (b) $p(x) = x, q(x) = x^2$. (c) $p(x) = x^2, q(x) = x$. (d) $p(x) = x + 3, q(x) = x$.
51. (a) No. (b) Yes, $\tan x$ and $\sec x$ at $x = n\pi + \pi/2$ and $\cot x$ and $\csc x$ at $x = n\pi, n = 0, \pm 1, \pm 2, \dots$
52. If $m > n$ the limit is zero. If $m = n$ the limit is c_n/d_n . If $n > m$ the limit is $+\infty$ if $c_n d_m > 0$ and $-\infty$ if $c_n d_m < 0$.
53. (a) Every value taken by e^{x^2} is also taken by e^t : choose $t = x^2$. As x and t increase without bound, so does $e^t = e^{x^2}$. Thus $\lim_{x \rightarrow +\infty} e^{x^2} = \lim_{t \rightarrow +\infty} e^t = +\infty$.
 (b) If $f(t) \rightarrow +\infty$ (resp. $f(t) \rightarrow -\infty$) then $f(t)$ can be made arbitrarily large (resp. small) by taking t large enough. But by considering the values $g(x)$ where $g(x) > t$, we see that $f(g(x))$ has the limit $+\infty$ too (resp. limit $-\infty$). If $f(t)$ has the limit L as $t \rightarrow +\infty$ the values $f(t)$ can be made arbitrarily close to L by taking t large enough. But if x is large enough then $g(x) > t$ and hence $f(g(x))$ is also arbitrarily close to L .
 (c) For $\lim_{x \rightarrow -\infty}$ the same argument holds with the substitution "x decreases without bound" instead of "x increases without bound". For $\lim_{x \rightarrow c^-}$ substitute "x close enough to c, $x < c$ ", etc.
54. (a) Every value taken by e^{-x^2} is also taken by e^t : choose $t = -x^2$. As x increases without bound and t decreases without bound, the quantity $e^t = e^{-x^2}$ tends to 0. Thus $\lim_{x \rightarrow +\infty} e^{-x^2} = \lim_{t \rightarrow -\infty} e^t = 0$.
 (b) If $f(t) \rightarrow +\infty$ (resp. $f(t) \rightarrow -\infty$) then $f(t)$ can be made arbitrarily large (resp. small) by taking t small enough. But by considering the values $g(x)$ where $g(x) < t$, we see that $f(g(x))$ has the limit $+\infty$ too (resp. limit $-\infty$). If $f(t)$ has the limit L as $t \rightarrow -\infty$ the values $f(t)$ can be made arbitrarily close to L by taking t small enough. But if x is large enough then $g(x) < t$ and hence $f(g(x))$ is also arbitrarily close to L .
 (c) For $\lim_{x \rightarrow -\infty}$ the same argument holds with the substitution "x decreases without bound" instead of "x increases without bound". For $\lim_{x \rightarrow c^-}$ substitute "x close enough to c, $x < c$ ", etc.
55. $t = 1/x, \lim_{t \rightarrow +\infty} f(t) = +\infty$.
56. $t = 1/x, \lim_{t \rightarrow -\infty} f(t) = 0$.
57. $t = \csc x, \lim_{t \rightarrow +\infty} f(t) = +\infty$.
58. $t = \csc x, \lim_{t \rightarrow -\infty} f(t) = 0$.
59. Let $t = \ln x$. Then t also tends to $+\infty$, and $\frac{\ln 2x}{\ln 3x} = \frac{t + \ln 2}{t + \ln 3}$, so the limit is 1.
60. With $t = x - 1, [\ln(x^2 - 1) - \ln(x + 1)] = \ln(x + 1) + \ln(x - 1) - \ln(x + 1) = \ln t$, so the limit is $+\infty$.

61. Set $t = -x$, then get $\lim_{t \rightarrow -\infty} \left(1 + \frac{1}{t}\right)^t = e$ by Figure 1.3.4.

62. With $t = x/2$, $\lim_{x \rightarrow +\infty} \left(1 + \frac{2}{x}\right)^x = \left(\lim_{t \rightarrow +\infty} [1 + 1/t]^t\right)^2 = e^2$

63. From the hint, $\lim_{x \rightarrow +\infty} b^x = \lim_{x \rightarrow +\infty} e^{(\ln b)x} = \begin{cases} 0 & \text{if } b < 1, \\ 1 & \text{if } b = 1, \\ +\infty & \text{if } b > 1. \end{cases}$

64. It suffices by Theorem 1.1.3 to show that the left and right limits at zero are equal to e .

(a) $\lim_{x \rightarrow +\infty} (1+x)^{1/x} = \lim_{t \rightarrow 0^+} (1+1/t)^t = e.$

(b) $\lim_{x \rightarrow -\infty} (1+x)^{1/x} = \lim_{t \rightarrow 0^-} (1+1/t)^t = e.$

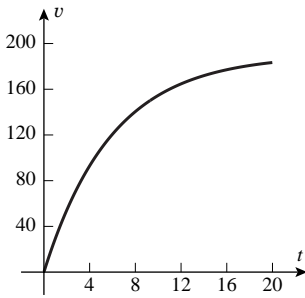

65. (a)

(b) $\lim_{t \rightarrow \infty} v = 190 \left(1 - \lim_{t \rightarrow \infty} e^{-0.168t}\right) = 190$, so the asymptote is $v = c = 190$ ft/sec.

(c) Due to air resistance (and other factors) this is the maximum speed that a sky diver can attain.

66. (a) $p(1990) = 525/(1 + 1.1) = 250$ (million).

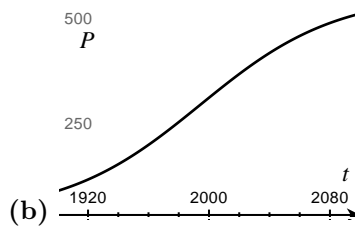

(c) $\lim_{t \rightarrow \infty} p(t) = \frac{525}{1 + 1.1 \lim_{t \rightarrow \infty} e^{-0.02225(t-1990)}} = 525$ (million).

(d) The population becomes stable at this number.

67. (a)

n	2	3	4	5	6	7
$1 + 10^{-n}$	1.01	1.001	1.0001	1.00001	1.000001	1.0000001
$1 + 10^n$	101	1001	10001	100001	1000001	10000001
$(1 + 10^{-n})^{1+10^n}$	2.7319	2.7196	2.7184	2.7183	2.71828	2.718282

The limit appears to be e .

(b) This is evident from the lower left term in the chart in part (a).

(c) The exponents are being multiplied by a , so the result is e^a .

68. (a) $f(-x) = \left(1 - \frac{1}{x}\right)^{-x} = \left(\frac{x-1}{x}\right)^{-x} = \left(\frac{x}{x-1}\right)^x$, $f(x-1) = \left(\frac{x}{x-1}\right)^{x-1} = \left(\frac{x-1}{x}\right) f(-x)$.

(b) $\lim_{x \rightarrow -\infty} \left(1 + \frac{1}{x}\right)^x = \lim_{x \rightarrow +\infty} f(-x) = \left[\lim_{x \rightarrow +\infty} \frac{x}{x-1} \right] \lim_{x \rightarrow +\infty} f(x-1) = \lim_{x \rightarrow +\infty} f(x-1) = e$.

69. After a long division, $f(x) = x + 2 + \frac{2}{x-2}$, so $\lim_{x \rightarrow \pm\infty} (f(x) - (x+2)) = 0$ and $f(x)$ is asymptotic to $y = x + 2$. The only vertical asymptote is at $x = 2$.

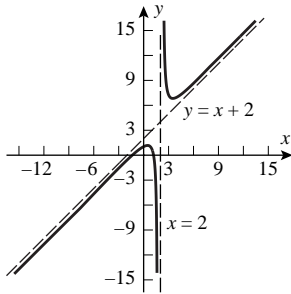

70. After a simplification, $f(x) = x^2 - 1 + \frac{3}{x}$, so $\lim_{x \rightarrow \pm\infty} (f(x) - (x^2 - 1)) = 0$ and $f(x)$ is asymptotic to $y = x^2 - 1$. The only vertical asymptote is at $x = 0$.

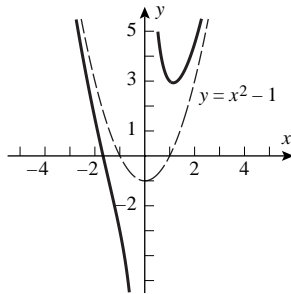

71. After a long division, $f(x) = -x^2 + 1 + \frac{2}{x-3}$, so $\lim_{x \rightarrow \pm\infty} (f(x) - (-x^2 + 1)) = 0$ and $f(x)$ is asymptotic to $y = -x^2 + 1$. The only vertical asymptote is at $x = 3$.

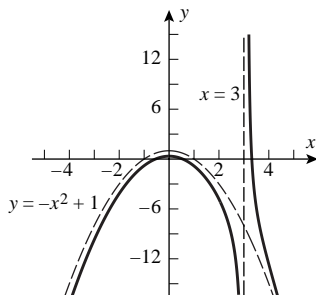

72. After a long division, $f(x) = x^3 + \frac{3}{2(x-1)} - \frac{3}{2(x+1)}$, so $\lim_{x \rightarrow \pm\infty} (f(x) - x^3) = 0$ and $f(x)$ is asymptotic to $y = x^3$. The vertical asymptotes are at $x = \pm 1$.

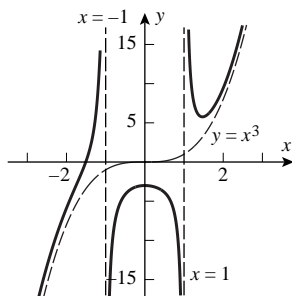

73. $\lim_{x \rightarrow \pm\infty} (f(x) - \sin x) = 0$ so $f(x)$ is asymptotic to $y = \sin x$. The only vertical asymptote is at $x = 1$.

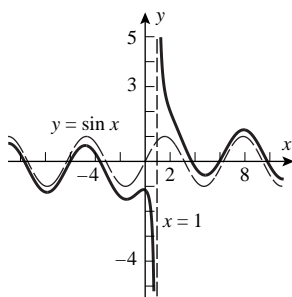

Exercise Set 1.4

- (a) $|f(x) - f(0)| = |x + 2 - 2| = |x| < 0.1$ if and only if $|x| < 0.1$.

(b) $|f(x) - f(3)| = |(4x - 5) - 7| = 4|x - 3| < 0.1$ if and only if $|x - 3| < (0.1)/4 = 0.025$.

(c) $|f(x) - f(4)| = |x^2 - 16| < \epsilon$ if $|x - 4| < \delta$. We get $f(x) = 16 + \epsilon = 16.001$ at $x = 4.000124998$, which corresponds to $\delta = 0.000124998$; and $f(x) = 16 - \epsilon = 15.999$ at $x = 3.999874998$, for which $\delta = 0.000125002$. Use the smaller δ : thus $|f(x) - 16| < \epsilon$ provided $|x - 4| < 0.000125$ (to six decimals).
- (a) $|f(x) - f(0)| = |2x + 3 - 3| = 2|x| < 0.1$ if and only if $|x| < 0.05$.

(b) $|f(x) - f(0)| = |2x + 3 - 3| = 2|x| < 0.01$ if and only if $|x| < 0.005$.

(c) $|f(x) - f(0)| = |2x + 3 - 3| = 2|x| < 0.0012$ if and only if $|x| < 0.0006$.
- (a) $x_0 = (1.95)^2 = 3.8025, x_1 = (2.05)^2 = 4.2025$.

(b) $\delta = \min(|4 - 3.8025|, |4 - 4.2025|) = 0.1975$.
- (a) $x_0 = 1/(1.1) = 0.909090\dots, x_1 = 1/(0.9) = 1.111111\dots$

(b) $\delta = \min(|1 - 0.909090|, |1 - 1.111111|) = 0.090909\dots$
- $|(x^3 - 4x + 5) - 2| < 0.05$ is equivalent to $-0.05 < (x^3 - 4x + 5) - 2 < 0.05$, which means $1.95 < x^3 - 4x + 5 < 2.05$. Now $x^3 - 4x + 5 = 1.95$ at $x = 1.0616$, and $x^3 - 4x + 5 = 2.05$ at $x = 0.9558$. So $\delta = \min(1.0616 - 1, 1 - 0.9558) = 0.0442$.

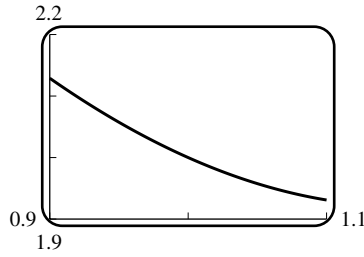

6. $\sqrt{5x+1} = 3.5$ at $x = 2.25$, $\sqrt{5x+1} = 4.5$ at $x = 3.85$, so $\delta = \min(3 - 2.25, 3.85 - 3) = 0.75$.

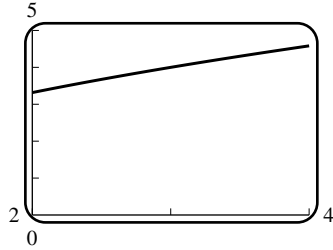

7. With the TRACE feature of a calculator we discover that (to five decimal places) (0.87000, 1.80274) and (1.13000, 2.19301) belong to the graph. Set $x_0 = 0.87$ and $x_1 = 1.13$. Since the graph of $f(x)$ rises from left to right, we see that if $x_0 < x < x_1$ then $1.80274 < f(x) < 2.19301$, and therefore $1.8 < f(x) < 2.2$. So we can take $\delta = 0.13$.
8. From a calculator plot we conjecture that $\lim_{x \rightarrow 0} f(x) = 2$. Using the TRACE feature we see that the points $(\pm 0.2, 1.94709)$ belong to the graph. Thus if $-0.2 < x < 0.2$, then $1.95 < f(x) \leq 2$ and hence $|f(x) - L| < 0.05 < 0.1 = \epsilon$.
9. $|2x - 8| = 2|x - 4| < 0.1$ when $|x - 4| < 0.1/2 = 0.05 = \delta$.
10. $|(5x - 2) - 13| = 5|x - 3| < 0.01$ when $|x - 3| < 0.01/5 = 0.002 = \delta$.
11. If $x \neq 3$, then $\left| \frac{x^2 - 9}{x - 3} - 6 \right| = \left| \frac{x^2 - 9 - 6x + 18}{x - 3} \right| = \left| \frac{x^2 - 6x + 9}{x - 3} \right| = |x - 3| < 0.05$ when $|x - 3| < 0.05 = \delta$.
12. If $x \neq -1/2$, then $\left| \frac{4x^2 - 1}{2x + 1} - (-2) \right| = \left| \frac{4x^2 - 1 + 4x + 2}{2x + 1} \right| = \left| \frac{4x^2 + 4x + 1}{2x + 1} \right| = |2x + 1| = 2|x - (-1/2)| < 0.05$ when $|x - (-1/2)| < 0.025 = \delta$.
13. Assume $\delta \leq 1$. Then $-1 < x - 2 < 1$ means $1 < x < 3$ and then $|x^3 - 8| = |(x - 2)(x^2 + 2x + 4)| < 19|x - 2|$, so we can choose $\delta = 0.001/19$.
14. Assume $\delta \leq 1$. Then $-1 < x - 4 < 1$ means $3 < x < 5$ and then $|\sqrt{x} - 2| = \left| \frac{x - 4}{\sqrt{x} + 2} \right| < \frac{|x - 4|}{\sqrt{3} + 2}$, so we can choose $\delta = 0.001 \cdot (\sqrt{3} + 2)$.
15. Assume $\delta \leq 1$. Then $-1 < x - 5 < 1$ means $4 < x < 6$ and then $\left| \frac{1}{x} - \frac{1}{5} \right| = \left| \frac{x - 5}{5x} \right| < \frac{|x - 5|}{20}$, so we can choose $\delta = 0.05 \cdot 20 = 1$.
16. $||x| - 0| = |x| < 0.05$ when $|x - 0| < 0.05 = \delta$.
17. Let $\epsilon > 0$ be given. Then $|f(x) - 3| = |3 - 3| = 0 < \epsilon$ regardless of x , and hence any $\delta > 0$ will work.
18. Let $\epsilon > 0$ be given. Then $|(x + 2) - 6| = |x - 4| < \epsilon$ provided $\delta = \epsilon$ (although any smaller δ would work).

19. $|3x - 15| = 3|x - 5| < \epsilon$ if $|x - 5| < \epsilon/3$, $\delta = \epsilon/3$.
20. $|7x + 5 + 2| = 7|x + 1| < \epsilon$ if $|x + 1| < \epsilon/7$, $\delta = \epsilon/7$.
21. $\left| \frac{2x^2 + x}{x} - 1 \right| = |2x| < \epsilon$ if $|x| < \epsilon/2$, $\delta = \epsilon/2$.
22. $\left| \frac{x^2 - 9}{x + 3} - (-6) \right| = |x + 3| < \epsilon$ if $|x + 3| < \epsilon$, $\delta = \epsilon$.
23. $|f(x) - 3| = |x + 2 - 3| = |x - 1| < \epsilon$ if $0 < |x - 1| < \epsilon$, $\delta = \epsilon$.
24. $|9 - 2x - 5| = 2|x - 2| < \epsilon$ if $0 < |x - 2| < \epsilon/2$, $\delta = \epsilon/2$.
25. If $\epsilon > 0$ is given, then take $\delta = \epsilon$; if $|x - 0| = |x| < \delta$, then $|x - 0| = |x| < \epsilon$.
26. If $x < 2$ then $|f(x) - 5| = |9 - 2x - 5| = 2|x - 2| < \epsilon$ if $|x - 2| < \epsilon/2$, $\delta_1 = \epsilon/2$. If $x > 2$ then $|f(x) - 5| = |3x - 1 - 5| = 3|x - 2| < \epsilon$ if $|x - 2| < \epsilon/3$, $\delta_2 = \epsilon/3$. Now let $\delta = \min(\delta_1, \delta_2)$ then for any x with $|x - 2| < \delta$, $|f(x) - 5| < \epsilon$.
27. For the first part, let $\epsilon > 0$. Then there exists $\delta > 0$ such that if $a < x < a + \delta$ then $|f(x) - L| < \epsilon$. For the left limit replace $a < x < a + \delta$ with $a - \delta < x < a$.
28. (a) Given $\epsilon > 0$ there exists $\delta > 0$ such that if $0 < |x - a| < \delta$ then $||f(x) - L| - 0| < \epsilon$, or $|f(x) - L| < \epsilon$.
- (b) From part (a) it follows that $|f(x) - L| < \epsilon$ is the defining condition for each of the two limits, so the two limit statements are equivalent.
29. (a) $|(3x^2 + 2x - 20 - 300)| = |3x^2 + 2x - 320| = |(3x + 32)(x - 10)| = |3x + 32| \cdot |x - 10|$.
- (b) If $|x - 10| < 1$ then $|3x + 32| < 65$, since clearly $x < 11$.
- (c) $\delta = \min(1, \epsilon/65)$; $|3x + 32| \cdot |x - 10| < 65 \cdot |x - 10| < 65 \cdot \epsilon/65 = \epsilon$.
30. (a) $\left| \frac{28}{3x + 1} - 4 \right| = \left| \frac{28 - 12x - 4}{3x + 1} \right| = \left| \frac{-12x + 24}{3x + 1} \right| = \left| \frac{12}{3x + 1} \right| \cdot |x - 2|$.
- (b) If $|x - 2| < 4$ then $-2 < x < 6$, so x can be very close to $-1/3$, hence $\left| \frac{12}{3x + 1} \right|$ is not bounded.
- (c) If $|x - 2| < 1$ then $1 < x < 3$ and $3x + 1 > 4$, so $\left| \frac{12}{3x + 1} \right| < \frac{12}{4} = 3$.
- (d) $\delta = \min(1, \epsilon/3)$; $\left| \frac{12}{3x + 1} \right| \cdot |x - 2| < 3 \cdot |x - 2| < 3 \cdot \epsilon/3 = \epsilon$.
31. If $\delta < 1$ then $|2x^2 - 2| = 2|x - 1||x + 1| < 6|x - 1| < \epsilon$ if $|x - 1| < \epsilon/6$, so $\delta = \min(1, \epsilon/6)$.
32. If $\delta < 1$ then $|x^2 + x - 12| = |x + 4| \cdot |x - 3| < 5|x - 3| < \epsilon$ if $|x - 3| < \epsilon/5$, so $\delta = \min(1, \epsilon/5)$.
33. If $\delta < 1/2$ and $|x - (-2)| < \delta$ then $-5/2 < x < -3/2$, $x + 1 < -1/2$, $|x + 1| > 1/2$; then $\left| \frac{1}{x + 1} - (-1) \right| = \frac{|x + 2|}{|x + 1|} < 2|x + 2| < \epsilon$ if $|x + 2| < \epsilon/2$, so $\delta = \min(1/2, \epsilon/2)$.
34. If $\delta < 1/4$ and $|x - (1/2)| < \delta$ then $\left| \frac{2x + 3}{x} - 8 \right| = \frac{|6x - 3|}{|x|} < \frac{6|x - (1/2)|}{1/4} = 24|x - (1/2)| < \epsilon$ if $|x - (1/2)| < \epsilon/24$, so $\delta = \min(1/4, \epsilon/24)$.

35. $|\sqrt{x} - 2| = \left| (\sqrt{x} - 2) \frac{\sqrt{x} + 2}{\sqrt{x} + 2} \right| = \left| \frac{x - 4}{\sqrt{x} + 2} \right| < \frac{1}{2} |x - 4| < \epsilon$ if $|x - 4| < 2\epsilon$, so $\delta = \min(2\epsilon, 4)$.
36. If $\delta < 1$ and $|x - 2| < \delta$ then $|x| < 3$ and $x^2 + 2x + 4 < 9 + 6 + 4 = 19$, so $|x^3 - 8| = |x - 2| \cdot |x^2 + 2x + 4| < 19\delta < \epsilon$ if $\delta = \min(\epsilon/19, 1)$.
37. Let $\epsilon > 0$ be given and take $\delta = \epsilon$. If $|x| < \delta$, then $|f(x) - 0| = 0 < \epsilon$ if x is rational, and $|f(x) - 0| = |x| < \delta = \epsilon$ if x is irrational.
38. If the limit did exist, then for $\epsilon = 1/2$ there would exist $\delta > 0$ such that if $|x| < \delta$ then $|f(x) - L| < 1/2$. Some of the x -values are rational, for which $|L| < 1/2$; some are irrational, for which $|1 - L| < 1/2$. But $1 = |1| = L + (1 - L) < 1/2 + 1/2$, or $1 < 1$, a contradiction. Hence the limit cannot exist.
39. (a) We have to solve the equation $1/N^2 = 0.1$ here, so $N = \sqrt{10}$.
- (b) This will happen when $N/(N + 1) = 0.99$, so $N = 99$.
- (c) Because the function $1/x^3$ approaches 0 from below when $x \rightarrow -\infty$, we have to solve the equation $1/N^3 = -0.001$, and $N = -10$.
- (d) The function $x/(x + 1)$ approaches 1 from above when $x \rightarrow -\infty$, so we have to solve the equation $N/(N + 1) = 1.01$. We obtain $N = -101$.
40. (a) $N = \sqrt[3]{10}$ (b) $N = \sqrt[3]{100}$ (c) $N = \sqrt[3]{1000} = 10$
41. (a) $\frac{x_1^2}{1 + x_1^2} = 1 - \epsilon$, $x_1 = -\sqrt{\frac{1 - \epsilon}{\epsilon}}$; $\frac{x_2^2}{1 + x_2^2} = 1 - \epsilon$, $x_2 = \sqrt{\frac{1 - \epsilon}{\epsilon}}$
- (b) $N = \sqrt{\frac{1 - \epsilon}{\epsilon}}$ (c) $N = -\sqrt{\frac{1 - \epsilon}{\epsilon}}$
42. (a) $x_1 = -1/\epsilon^3$; $x_2 = 1/\epsilon^3$ (b) $N = 1/\epsilon^3$ (c) $N = -1/\epsilon^3$
43. $\frac{1}{x^2} < 0.01$ if $|x| > 10$, $N = 10$.
44. $\frac{1}{x + 2} < 0.005$ if $|x + 2| > 200$, $x > 198$, $N = 198$.
45. $\left| \frac{x}{x + 1} - 1 \right| = \left| \frac{1}{x + 1} \right| < 0.001$ if $|x + 1| > 1000$, $x > 999$, $N = 999$.
46. $\left| \frac{4x - 1}{2x + 5} - 2 \right| = \left| \frac{11}{2x + 5} \right| < 0.1$ if $|2x + 5| > 110$, $2x > 105$, $N = 52.5$.
47. $\left| \frac{1}{x + 2} - 0 \right| < 0.005$ if $|x + 2| > 200$, $-x - 2 > 200$, $x < -202$, $N = -202$.
48. $\left| \frac{1}{x^2} \right| < 0.01$ if $|x| > 10$, $-x > 10$, $x < -10$, $N = -10$.
49. $\left| \frac{4x - 1}{2x + 5} - 2 \right| = \left| \frac{11}{2x + 5} \right| < 0.1$ if $|2x + 5| > 110$, $-2x - 5 > 110$, $2x < -115$, $x < -57.5$, $N = -57.5$.
50. $\left| \frac{x}{x + 1} - 1 \right| = \left| \frac{1}{x + 1} \right| < 0.001$ if $|x + 1| > 1000$, $-x - 1 > 1000$, $x < -1001$, $N = -1001$.

51. $\left| \frac{1}{x^2} \right| < \epsilon$ if $|x| > \frac{1}{\sqrt{\epsilon}}$, so $N = \frac{1}{\sqrt{\epsilon}}$.

52. $\left| \frac{1}{x+2} \right| < \epsilon$ if $|x+2| > \frac{1}{\epsilon}$, i.e. when $x+2 > \frac{1}{\epsilon}$, or $x > \frac{1}{\epsilon} - 2$, so $N = \frac{1}{\epsilon} - 2$.

53. $\left| \frac{4x-1}{2x+5} - 2 \right| = \left| \frac{11}{2x+5} \right| < \epsilon$ if $|2x+5| > \frac{11}{\epsilon}$, i.e. when $-2x-5 > \frac{11}{\epsilon}$, which means $2x < -\frac{11}{\epsilon} - 5$, or $x < -\frac{11}{2\epsilon} - \frac{5}{2}$,
so $N = -\frac{5}{2} - \frac{11}{2\epsilon}$.

54. $\left| \frac{x}{x+1} - 1 \right| = \left| \frac{1}{x+1} \right| < \epsilon$ if $|x+1| > \frac{1}{\epsilon}$, i.e. when $-x-1 > \frac{1}{\epsilon}$, or $x < -1 - \frac{1}{\epsilon}$, so $N = -1 - \frac{1}{\epsilon}$.

55. $\left| \frac{2\sqrt{x}}{\sqrt{x}-1} - 2 \right| = \left| \frac{2}{\sqrt{x}-1} \right| < \epsilon$ if $\sqrt{x}-1 > \frac{2}{\epsilon}$, i.e. when $\sqrt{x} > 1 + \frac{2}{\epsilon}$, or $x > \left(1 + \frac{2}{\epsilon}\right)^2$, so $N = \left(1 + \frac{2}{\epsilon}\right)^2$.

56. $2^x < \epsilon$ if $x < \log_2 \epsilon$, so $N = \log_2 \epsilon$.

57. (a) $\frac{1}{x^2} > 100$ if $|x| < \frac{1}{10}$ (b) $\frac{1}{|x-1|} > 1000$ if $|x-1| < \frac{1}{1000}$

(c) $\frac{-1}{(x-3)^2} < -1000$ if $|x-3| < \frac{1}{10\sqrt{10}}$ (d) $-\frac{1}{x^4} < -10000$ if $x^4 < \frac{1}{10000}$, $|x| < \frac{1}{10}$

58. (a) $\frac{1}{(x-1)^2} > 10$ if and only if $|x-1| < \frac{1}{\sqrt{10}}$

(b) $\frac{1}{(x-1)^2} > 1000$ if and only if $|x-1| < \frac{1}{10\sqrt{10}}$

(c) $\frac{1}{(x-1)^2} > 100000$ if and only if $|x-1| < \frac{1}{100\sqrt{10}}$

59. If $M > 0$ then $\frac{1}{(x-3)^2} > M$ when $0 < (x-3)^2 < \frac{1}{M}$, or $0 < |x-3| < \frac{1}{\sqrt{M}}$, so $\delta = \frac{1}{\sqrt{M}}$.

60. If $M < 0$ then $\frac{-1}{(x-3)^2} < M$ when $0 < (x-3)^2 < -\frac{1}{M}$, or $0 < |x-3| < \frac{1}{\sqrt{-M}}$, so $\delta = \frac{1}{\sqrt{-M}}$.

61. If $M > 0$ then $\frac{1}{|x|} > M$ when $0 < |x| < \frac{1}{M}$, so $\delta = \frac{1}{M}$.

62. If $M > 0$ then $\frac{1}{|x-1|} > M$ when $0 < |x-1| < \frac{1}{M}$, so $\delta = \frac{1}{M}$.

63. If $M < 0$ then $-\frac{1}{x^4} < M$ when $0 < x^4 < -\frac{1}{M}$, or $|x| < \frac{1}{(-M)^{1/4}}$, so $\delta = \frac{1}{(-M)^{1/4}}$.

64. If $M > 0$ then $\frac{1}{x^4} > M$ when $0 < x^4 < \frac{1}{M}$, or $x < \frac{1}{M^{1/4}}$, so $\delta = \frac{1}{M^{1/4}}$.

65. If $x > 2$ then $|x+1-3| = |x-2| = x-2 < \epsilon$ if $2 < x < 2 + \epsilon$, so $\delta = \epsilon$.

66. If $x < 1$ then $|3x+2-5| = |3x-3| = 3|x-1| = 3(1-x) < \epsilon$ if $1-x < \epsilon/3$, or $1 - \epsilon/3 < x < 1$, so $\delta = \epsilon/3$.

67. If $x > 4$ then $\sqrt{x-4} < \epsilon$ if $x-4 < \epsilon^2$, or $4 < x < 4 + \epsilon^2$, so $\delta = \epsilon^2$.
68. If $x < 0$ then $\sqrt{-x} < \epsilon$ if $-x < \epsilon^2$, or $-\epsilon^2 < x < 0$, so $\delta = \epsilon^2$.
69. If $x > 2$ then $|f(x) - 2| = |x - 2| = x - 2 < \epsilon$ if $2 < x < 2 + \epsilon$, so $\delta = \epsilon$.
70. If $x < 2$ then $|f(x) - 6| = |3x - 6| = 3|x - 2| = 3(2 - x) < \epsilon$ if $2 - x < \epsilon/3$, or $2 - \epsilon/3 < x < 2$, so $\delta = \epsilon/3$.
71. (a) Definition: For every $M < 0$ there corresponds a $\delta > 0$ such that if $1 < x < 1 + \delta$ then $f(x) < M$. In our case we want $\frac{1}{1-x} < M$, i.e. $1-x > \frac{1}{M}$, or $x < 1 - \frac{1}{M}$, so we can choose $\delta = -\frac{1}{M}$.
- (b) Definition: For every $M > 0$ there corresponds a $\delta > 0$ such that if $1 - \delta < x < 1$ then $f(x) > M$. In our case we want $\frac{1}{1-x} > M$, i.e. $1-x < \frac{1}{M}$, or $x > 1 - \frac{1}{M}$, so we can choose $\delta = \frac{1}{M}$.
72. (a) Definition: For every $M > 0$ there corresponds a $\delta > 0$ such that if $0 < x < \delta$ then $f(x) > M$. In our case we want $\frac{1}{x} > M$, i.e. $x < \frac{1}{M}$, so take $\delta = \frac{1}{M}$.
- (b) Definition: For every $M < 0$ there corresponds a $\delta > 0$ such that if $-\delta < x < 0$ then $f(x) < M$. In our case we want $\frac{1}{x} < M$, i.e. $x > \frac{1}{M}$, so take $\delta = -\frac{1}{M}$.
73. (a) Given any $M > 0$, there corresponds an $N > 0$ such that if $x > N$ then $f(x) > M$, i.e. $x + 1 > M$, or $x > M - 1$, so $N = M - 1$.
- (b) Given any $M < 0$, there corresponds an $N < 0$ such that if $x < N$ then $f(x) < M$, i.e. $x + 1 < M$, or $x < M - 1$, so $N = M - 1$.
74. (a) Given any $M > 0$, there corresponds an $N > 0$ such that if $x > N$ then $f(x) > M$, i.e. $x^2 - 3 > M$, or $x > \sqrt{M+3}$, so $N = \sqrt{M+3}$.
- (b) Given any $M < 0$, there corresponds an $N < 0$ such that if $x < N$ then $f(x) < M$, i.e. $x^3 + 5 < M$, or $x < (M-5)^{1/3}$, so $N = (M-5)^{1/3}$.
75. (a) $\frac{3.0}{7.5} = 0.4$ (amperes) (b) $[0.3947, 0.4054]$ (c) $\left[\frac{3}{7.5 + \delta}, \frac{3}{7.5 - \delta} \right]$ (d) 0.0187
- (e) It approaches infinity.

Exercise Set 1.5

1. (a) No: $\lim_{x \rightarrow 2} f(x)$ does not exist. (b) No: $\lim_{x \rightarrow 2} f(x)$ does not exist. (c) No: $\lim_{x \rightarrow 2^-} f(x) \neq f(2)$.
- (d) Yes. (e) Yes. (f) Yes.
2. (a) No: $\lim_{x \rightarrow 2} f(x) \neq f(2)$. (b) No: $\lim_{x \rightarrow 2} f(x) \neq f(2)$. (c) No: $\lim_{x \rightarrow 2^-} f(x) \neq f(2)$.
- (d) Yes. (e) No: $\lim_{x \rightarrow 2^+} f(x) \neq f(2)$. (f) Yes.
3. (a) No: $f(1)$ and $f(3)$ are not defined. (b) Yes. (c) No: $f(1)$ is not defined.
- (d) Yes. (e) No: $f(3)$ is not defined. (f) Yes.

4. (a) No: $f(3)$ is not defined. (b) Yes. (c) Yes.
 (d) Yes. (e) No: $f(3)$ is not defined. (f) Yes.
5. (a) No. (b) No. (c) No. (d) Yes. (e) Yes. (f) No. (g) Yes.
6. (a) No. (b) No. (c) No. (d) No. (e) Yes. (f) Yes. (g) Yes.

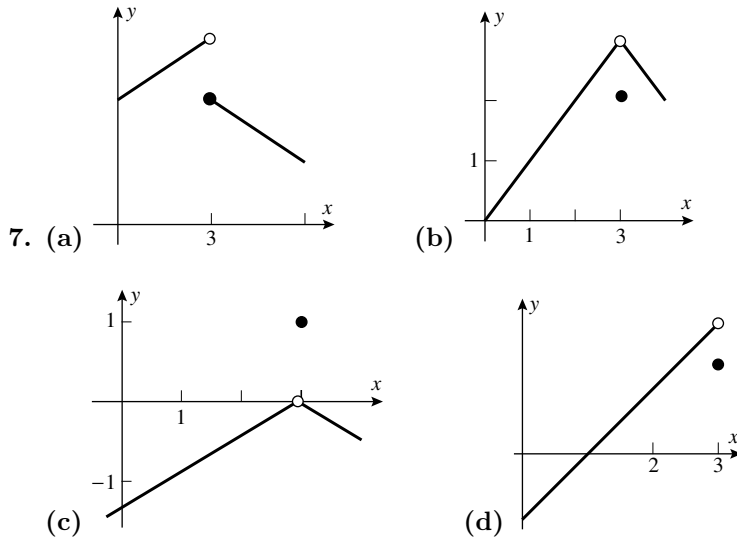

8. The discontinuities probably correspond to the times when the patient takes the medication. We see a jump in the concentration values here, which are followed by continuously decreasing concentration values as the medication is being absorbed.

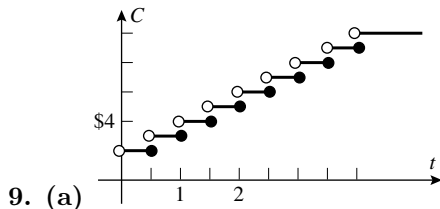

- (b) One second could cost you one dollar.
10. (a) Not continuous, since the values are integers.
 (b) Continuous.
 (c) Not continuous, again, the values are integers (if we measure them in cents).
 (d) Continuous.
11. None, this is a continuous function on the real numbers.
12. None, this is a continuous function on the real numbers.
13. None, this is a continuous function on the real numbers.
14. The function is not continuous at $x = 2$ and $x = -2$.
15. The function is not continuous at $x = -1/2$ and $x = 0$.

16. None, this is a continuous function on the real numbers.
17. The function is not continuous at $x = 0$, $x = 1$ and $x = -1$.
18. The function is not continuous at $x = 0$ and $x = -4$.
19. None, this is a continuous function on the real numbers.
20. The function is not continuous at $x = 0$ and $x = -1$.
21. None, this is a continuous function on the real numbers. $f(x) = 2x + 3$ is continuous on $x < 4$ and $f(x) = 7 + \frac{16}{x}$ is continuous on $4 < x$; $\lim_{x \rightarrow 4^-} f(x) = \lim_{x \rightarrow 4^+} f(x) = f(4) = 11$ so f is continuous at $x = 4$.
22. The function is not continuous at $x = 1$, as $\lim_{x \rightarrow 1} f(x)$ does not exist.
23. True; by Theorem 1.5.5.
24. False; e.g. $f(x) = 1$ if $x \neq 3$, $f(3) = -1$.
25. False; e.g. $f(x) = g(x) = 2$ if $x \neq 3$, $f(3) = 1$, $g(3) = 3$.
26. False; e.g. $f(x) = g(x) = 2$ if $x \neq 3$, $f(3) = 1$, $g(3) = 4$.
27. True; use Theorem 1.5.3 with $g(x) = \sqrt{f(x)}$.
28. Generally, this statement is false because $\sqrt{f(x)}$ might not even be defined. If we suppose that $f(c)$ is nonnegative, and $f(x)$ is also nonnegative on some interval $(c - \alpha, c + \alpha)$, then the statement is true. If $f(c) = 0$ then given $\epsilon > 0$ there exists $\delta > 0$ such that whenever $|x - c| < \delta$, $0 \leq f(x) < \epsilon^2$. Then $|\sqrt{f(x)}| < \epsilon$ and \sqrt{f} is continuous at $x = c$. If $f(c) \neq 0$ then given $\epsilon > 0$ there corresponds $\delta > 0$ such that whenever $|x - c| < \delta$, $|f(x) - f(c)| < \epsilon\sqrt{f(c)}$. Then $|\sqrt{f(x)} - \sqrt{f(c)}| = \frac{|f(x) - f(c)|}{|\sqrt{f(x)} + \sqrt{f(c)}|} \leq \frac{|f(x) - f(c)|}{\sqrt{f(c)}} < \epsilon$.
29. (a) f is continuous for $x < 1$, and for $x > 1$; $\lim_{x \rightarrow 1^-} f(x) = 5$, $\lim_{x \rightarrow 1^+} f(x) = k$, so if $k = 5$ then f is continuous for all x .
- (b) f is continuous for $x < 2$, and for $x > 2$; $\lim_{x \rightarrow 2^-} f(x) = 4k$, $\lim_{x \rightarrow 2^+} f(x) = 4 + k$, so if $4k = 4 + k$, $k = 4/3$ then f is continuous for all x .
30. (a) f is continuous for $x < 3$, and for $x > 3$; $\lim_{x \rightarrow 3^-} f(x) = k/9$, $\lim_{x \rightarrow 3^+} f(x) = 0$, so if $k = 0$ then f is continuous for all x .
- (b) f is continuous for $x < 0$, and for $x > 0$; $\lim_{x \rightarrow 0^-} f(x)$ doesn't exist unless $k = 0$, and if so then $\lim_{x \rightarrow 0^-} f(x) = 0$; $\lim_{x \rightarrow 0^+} f(x) = 9$, so there is no k value which makes the function continuous everywhere.
31. f is continuous for $x < -1$, $-1 < x < 2$ and $x > 2$; $\lim_{x \rightarrow -1^-} f(x) = 4$, $\lim_{x \rightarrow -1^+} f(x) = k$, so $k = 4$ is required. Next, $\lim_{x \rightarrow 2^-} f(x) = 3m + k = 3m + 4$, $\lim_{x \rightarrow 2^+} f(x) = 9$, so $3m + 4 = 9$, $m = 5/3$ and f is continuous everywhere if $k = 4$ and $m = 5/3$.
32. (a) No, f is not defined at $x = 2$. (b) No, f is not defined for $x \leq 2$. (c) Yes. (d) No, see (b).

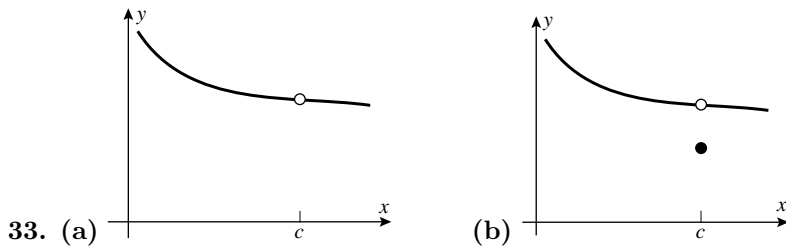

34. (a) $f(c) = \lim_{x \rightarrow c} f(x)$

(b) $\lim_{x \rightarrow 1} f(x) = 2, \lim_{x \rightarrow 1} g(x) = 1.$

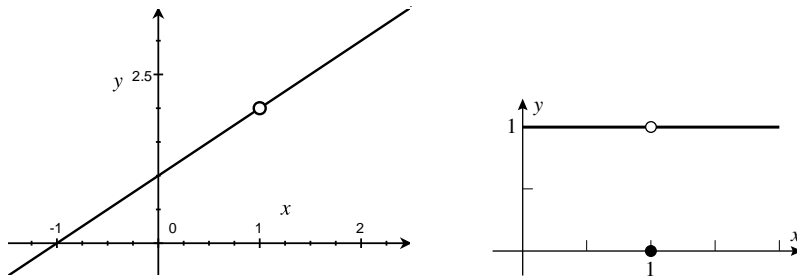

(c) Define $f(1) = 2$ and redefine $g(1) = 1$.

35. (a) $x = 0, \lim_{x \rightarrow 0^-} f(x) = -1 \neq +1 = \lim_{x \rightarrow 0^+} f(x)$ so the discontinuity is not removable.

(b) $x = -3$; define $f(-3) = -3 = \lim_{x \rightarrow -3} f(x)$, then the discontinuity is removable.

(c) f is undefined at $x = \pm 2$; at $x = 2, \lim_{x \rightarrow 2} f(x) = 1$, so define $f(2) = 1$ and f becomes continuous there; at $x = -2, \lim_{x \rightarrow -2} f(x)$ does not exist, so the discontinuity is not removable.

36. (a) f is not defined at $x = 2$; $\lim_{x \rightarrow 2} f(x) = \lim_{x \rightarrow 2} \frac{x+2}{x^2+2x+4} = \frac{1}{3}$, so define $f(2) = \frac{1}{3}$ and f becomes continuous there.

(b) $\lim_{x \rightarrow 2^-} f(x) = 1 \neq 4 = \lim_{x \rightarrow 2^+} f(x)$, so f has a nonremovable discontinuity at $x = 2$.

(c) $\lim_{x \rightarrow 1} f(x) = 8 \neq f(1)$, so f has a removable discontinuity at $x = 1$.

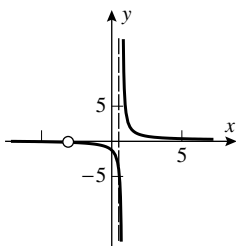

37. (a) Discontinuity at $x = 1/2$, not removable; at $x = -3$, removable.

(b) $2x^2 + 5x - 3 = (2x - 1)(x + 3)$

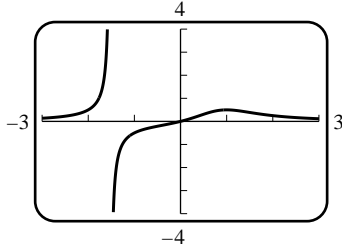

38. (a)

There appears to be one discontinuity near $x = -1.52$.(b) One discontinuity at $x \approx -1.52$.

39. Write $f(x) = x^{3/5} = (x^3)^{1/5}$ as the composition (Theorem 1.5.6) of the two continuous functions $g(x) = x^3$ and $h(x) = x^{1/5}$; it is thus continuous.

40. $x^4 + 7x^2 + 1 \geq 1 > 0$, thus $f(x)$ is the composition of the polynomial $x^4 + 7x^2 + 1$, the square root \sqrt{x} , and the function $1/x$ and is therefore continuous by Theorem 1.5.6.

41. Since f and g are continuous at $x = c$ we know that $\lim_{x \rightarrow c} f(x) = f(c)$ and $\lim_{x \rightarrow c} g(x) = g(c)$. In the following we use Theorem 1.2.2.

(a) $f(c) + g(c) = \lim_{x \rightarrow c} f(x) + \lim_{x \rightarrow c} g(x) = \lim_{x \rightarrow c} (f(x) + g(x))$ so $f + g$ is continuous at $x = c$.

(b) Same as (a) except the $+$ sign becomes a $-$ sign.

(c) $f(c)g(c) = \lim_{x \rightarrow c} f(x) \lim_{x \rightarrow c} g(x) = \lim_{x \rightarrow c} f(x)g(x)$ so fg is continuous at $x = c$.

42. A rational function is the quotient $f(x)/g(x)$ of two polynomials $f(x)$ and $g(x)$. By Theorem 1.5.2 f and g are continuous everywhere; by Theorem 1.5.3 f/g is continuous except when $g(x) = 0$.

43. (a) Let $h = x - c, x = h + c$. Then by Theorem 1.5.5, $\lim_{h \rightarrow 0} f(h + c) = f(\lim_{h \rightarrow 0} (h + c)) = f(c)$.

(b) With $g(h) = f(c + h)$, $\lim_{h \rightarrow 0} g(h) = \lim_{h \rightarrow 0} f(c + h) = f(c) = g(0)$, so $g(h)$ is continuous at $h = 0$. That is, $f(c + h)$ is continuous at $h = 0$, so f is continuous at $x = c$.

44. The function $h(x) = f(x) - g(x)$ is continuous on the interval $[a, b]$, and satisfies $h(a) > 0, h(b) < 0$. The Intermediate Value Theorem or Theorem 1.5.8 tells us that there is at least one solution of the equation on this interval $h(x) = 0$, i.e. $f(x) = g(x)$.

45. Of course such a function must be discontinuous. Let $f(x) = 1$ on $0 \leq x < 1$, and $f(x) = -1$ on $1 \leq x \leq 2$.

46. (a) (i) No. (ii) Yes. (b) (i) No. (ii) No. (c) (i) No. (ii) No.

47. If $f(x) = x^3 + x^2 - 2x - 1$, then $f(-1) = 1, f(1) = -1$. The Intermediate Value Theorem gives us the result.

48. Since $\lim_{x \rightarrow -\infty} p(x) = -\infty$ and $\lim_{x \rightarrow +\infty} p(x) = +\infty$ (or vice versa, if the leading coefficient of p is negative), it follows that for $M = -1$ there corresponds $N_1 < 0$, and for $M = 1$ there is $N_2 > 0$, such that $p(x) < -1$ for $x < N_1$ and $p(x) > 1$ for $x > N_2$. We choose $x_1 < N_1$ and $x_2 > N_2$ and use Theorem 1.5.8 on the interval $[x_1, x_2]$ to show the existence of a solution of $p(x) = 0$.

49. For the negative root, use intervals on the x -axis as follows: $[-2, -1]$; since $f(-1.3) < 0$ and $f(-1.2) > 0$, the midpoint $x = -1.25$ of $[-1.3, -1.2]$ is the required approximation of the root. For the positive root use the interval $[0, 1]$; since $f(0.7) < 0$ and $f(0.8) > 0$, the midpoint $x = 0.75$ of $[0.7, 0.8]$ is the required approximation.

50. For the negative root, use intervals on the x -axis as follows: $[-2, -1]$; since $f(-1.7) < 0$ and $f(-1.6) > 0$, use the interval $[-1.7, -1.6]$. Since $f(-1.61) < 0$ and $f(-1.60) > 0$ the midpoint $x = -1.605$ of $[-1.61, -1.60]$ is the

required approximation of the root. For the positive root use the interval $[1, 2]$; since $f(1.3) > 0$ and $f(1.4) < 0$, use the interval $[1.3, 1.4]$. Since $f(1.37) > 0$ and $f(1.38) < 0$, the midpoint $x = 1.375$ of $[1.37, 1.38]$ is the required approximation.

51. For the positive root, use intervals on the x -axis as follows: $[2, 3]$; since $f(2.2) < 0$ and $f(2.3) > 0$, use the interval $[2.2, 2.3]$. Since $f(2.23) < 0$ and $f(2.24) > 0$ the midpoint $x = 2.235$ of $[2.23, 2.24]$ is the required approximation of the root.
52. Assume the locations along the track are numbered with increasing $x \geq 0$. Let $T_S(x)$ denote the time during the sprint when the runner is located at point $x, 0 \leq x \leq 100$. Let $T_J(x)$ denote the time when the runner is at the point x on the return jog, measured so that $T_J(100) = 0$. Then $T_S(0) = 0, T_S(100) > 0, T_J(100) = 0, T_J(0) > 0$, so that Exercise 44 applies and there exists an x_0 such that $T_S(x_0) = T_J(x_0)$.
53. Consider the function $f(\theta) = T(\theta + \pi) - T(\theta)$. Note that T has period 2π , $T(\theta + 2\pi) = T(\theta)$, so that $f(\theta + \pi) = T(\theta + 2\pi) - T(\theta + \pi) = -(T(\theta + \pi) - T(\theta)) = -f(\theta)$. Now if $f(\theta) \equiv 0$, then the statement follows. Otherwise, there exists θ such that $f(\theta) \neq 0$ and then $f(\theta + \pi)$ has an opposite sign, and thus there is a t_0 between θ and $\theta + \pi$ such that $f(t_0) = 0$ and the statement follows.
54. Let the ellipse be contained between the horizontal lines $y = a$ and $y = b$, where $a < b$. The expression $|f(z_1) - f(z_2)|$ expresses the area of the ellipse that lies between the vertical lines $x = z_1$ and $x = z_2$, and thus $|f(z_1) - f(z_2)| \leq (b - a)|z_1 - z_2|$. Thus for a given $\epsilon > 0$ there corresponds $\delta = \epsilon/(b - a)$, such that if $|z_1 - z_2| < \delta$, then $|f(z_1) - f(z_2)| \leq (b - a)|z_1 - z_2| < (b - a)\delta = \epsilon$ which proves that f is a continuous function.
55. Since R and L are arbitrary, we can introduce coordinates so that L is the x -axis. Let $f(z)$ be as in Exercise 54. Then for large z , $f(z) = \text{area of ellipse}$, and for small z , $f(z) = 0$. By the Intermediate Value Theorem there is a z_1 such that $f(z_1) = \text{half of the area of the ellipse}$.

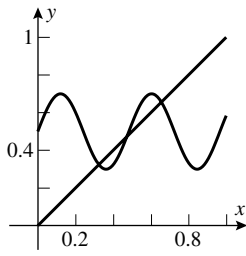

56. (a)

(b) Let $g(x) = x - f(x)$. Then $g(x)$ is continuous, $g(1) \geq 0$ and $g(0) \leq 0$; by the Intermediate Value Theorem there is a solution c in $[0, 1]$ of $g(c) = 0$, which means $f(c) = c$.

Exercise Set 1.6

1. This is a composition of continuous functions, so it is continuous everywhere.
2. Discontinuity at $x = \pi$.
3. Discontinuities at $x = n\pi, n = 0, \pm 1, \pm 2, \dots$
4. Discontinuities at $x = \frac{\pi}{2} + n\pi, n = 0, \pm 1, \pm 2, \dots$
5. Discontinuities at $x = n\pi, n = 0, \pm 1, \pm 2, \dots$
6. Continuous everywhere.
7. Discontinuities at $x = \frac{\pi}{6} + 2n\pi$, and $x = \frac{5\pi}{6} + 2n\pi, n = 0, \pm 1, \pm 2, \dots$

8. Discontinuities at $x = \frac{\pi}{2} + n\pi$, $n = 0, \pm 1, \pm 2, \dots$
9. $\sin^{-1} u$ is continuous for $-1 \leq u \leq 1$, so $-1 \leq 2x \leq 1$, or $-1/2 \leq x \leq 1/2$.
10. $\cos^{-1} u$ is defined and continuous for $-1 \leq u \leq 1$ which means $-1 \leq \ln x \leq 1$, or $1/e \leq x \leq e$.
11. $(0, 3) \cup (3, \infty)$.
12. $(-\infty, 0) \cup (0, +\infty)$.
13. $(-\infty, -1] \cup [1, \infty)$.
14. $(-3, 0) \cup (0, \infty)$.
15. (a) $f(x) = \sin x$, $g(x) = x^3 + 7x + 1$. (b) $f(x) = |x|$, $g(x) = \sin x$. (c) $f(x) = x^3$, $g(x) = \cos(x + 1)$.
16. (a) $f(x) = |x|$, $g(x) = 3 + \sin 2x$. (b) $f(x) = \sin x$, $g(x) = \sin x$. (c) $f(x) = x^5 - 2x^3 + 1$,
 $g(x) = \cos x$.
17. $\lim_{x \rightarrow +\infty} \cos\left(\frac{1}{x}\right) = \cos\left(\lim_{x \rightarrow +\infty} \frac{1}{x}\right) = \cos 0 = 1$.
18. $\lim_{x \rightarrow +\infty} \sin\left(\frac{\pi x}{2 - 3x}\right) = \sin\left(\lim_{x \rightarrow +\infty} \frac{\pi x}{2 - 3x}\right) = \sin\left(-\frac{\pi}{3}\right) = -\frac{\sqrt{3}}{2}$.
19. $\lim_{x \rightarrow +\infty} \sin^{-1}\left(\frac{x}{1 - 2x}\right) = \sin^{-1}\left(\lim_{x \rightarrow +\infty} \frac{x}{1 - 2x}\right) = \sin^{-1}\left(-\frac{1}{2}\right) = -\frac{\pi}{6}$.
20. $\lim_{x \rightarrow +\infty} \ln\left(\frac{x+1}{x}\right) = \ln\left(\lim_{x \rightarrow +\infty} \frac{x+1}{x}\right) = \ln(1) = 0$.
21. $\lim_{x \rightarrow 0} e^{\sin x} = e^{\left(\lim_{x \rightarrow 0} \sin x\right)} = e^0 = 1$.
22. $\lim_{x \rightarrow +\infty} \cos(2 \tan^{-1} x) = \cos\left(\lim_{x \rightarrow +\infty} 2 \tan^{-1} x\right) = \cos(2(\pi/2)) = -1$.
23. $\lim_{\theta \rightarrow 0} \frac{\sin 3\theta}{\theta} = 3 \lim_{\theta \rightarrow 0} \frac{\sin 3\theta}{3\theta} = 3$.
24. $\lim_{h \rightarrow 0} \frac{\sin h}{2h} = \frac{1}{2} \lim_{h \rightarrow 0} \frac{\sin h}{h} = \frac{1}{2}$.
25. $\lim_{\theta \rightarrow 0^+} \frac{\sin \theta}{\theta^2} = \left(\lim_{\theta \rightarrow 0^+} \frac{1}{\theta}\right) \lim_{\theta \rightarrow 0^+} \frac{\sin \theta}{\theta} = +\infty$.
26. $\lim_{\theta \rightarrow 0^+} \frac{\sin^2 \theta}{\theta} = \left(\lim_{\theta \rightarrow 0} \sin \theta\right) \lim_{\theta \rightarrow 0} \frac{\sin \theta}{\theta} = 0$.
27. $\frac{\tan 7x}{\sin 3x} = \frac{7}{3 \cos 7x} \cdot \frac{\sin 7x}{7x} \cdot \frac{3x}{\sin 3x}$, so $\lim_{x \rightarrow 0} \frac{\tan 7x}{\sin 3x} = \frac{7}{3 \cdot 1} \cdot 1 \cdot 1 = \frac{7}{3}$.
28. $\frac{\sin 6x}{\sin 8x} = \frac{6}{8} \cdot \frac{\sin 6x}{6x} \cdot \frac{8x}{\sin 8x}$, so $\lim_{x \rightarrow 0} \frac{\sin 6x}{\sin 8x} = \frac{6}{8} \cdot 1 \cdot 1 = \frac{3}{4}$.

29. $\lim_{x \rightarrow 0^+} \frac{\sin x}{5\sqrt{x}} = \frac{1}{5} \lim_{x \rightarrow 0^+} \sqrt{x} \lim_{x \rightarrow 0^+} \frac{\sin x}{x} = 0.$

30. $\lim_{x \rightarrow 0} \frac{\sin^2 x}{3x^2} = \frac{1}{3} \left(\lim_{x \rightarrow 0} \frac{\sin x}{x} \right)^2 = \frac{1}{3}.$

31. $\lim_{x \rightarrow 0} \frac{\sin x^2}{x} = \left(\lim_{x \rightarrow 0} x \right) \left(\lim_{x \rightarrow 0} \frac{\sin x^2}{x^2} \right) = 0.$

32. $\frac{\sin h}{1 - \cos h} = \frac{\sin h}{1 - \cos h} \cdot \frac{1 + \cos h}{1 + \cos h} = \frac{\sin h(1 + \cos h)}{1 - \cos^2 h} = \frac{1 + \cos h}{\sin h}$; this implies that $\lim_{h \rightarrow 0^+}$ is $+\infty$, and $\lim_{h \rightarrow 0^-}$ is $-\infty$, therefore the limit does not exist.

33. $\frac{t^2}{1 - \cos^2 t} = \left(\frac{t}{\sin t} \right)^2$, so $\lim_{t \rightarrow 0} \frac{t^2}{1 - \cos^2 t} = 1.$

34. $\cos(\frac{1}{2}\pi - x) = \cos(\frac{1}{2}\pi) \cos x + \sin(\frac{1}{2}\pi) \sin x = \sin x$, so $\lim_{x \rightarrow 0} \frac{x}{\cos(\frac{1}{2}\pi - x)} = 1.$

35. $\frac{\theta^2}{1 - \cos \theta} \cdot \frac{1 + \cos \theta}{1 + \cos \theta} = \frac{\theta^2(1 + \cos \theta)}{1 - \cos^2 \theta} = \left(\frac{\theta}{\sin \theta} \right)^2 (1 + \cos \theta)$, so $\lim_{\theta \rightarrow 0} \frac{\theta^2}{1 - \cos \theta} = (1)^2 \cdot 2 = 2.$

36. $\frac{1 - \cos 3h}{\cos^2 5h - 1} \cdot \frac{1 + \cos 3h}{1 + \cos 3h} = \frac{\sin^2 3h}{-\sin^2 5h} \cdot \frac{1}{1 + \cos 3h}$, so (using the result of problem 28)

$$\lim_{x \rightarrow 0} \frac{1 - \cos 3h}{\cos^2 5h - 1} = \lim_{x \rightarrow 0} \frac{\sin^2 3h}{-\sin^2 5h} \cdot \frac{1}{1 + \cos 3h} = - \left(\frac{3}{5} \right)^2 \cdot \frac{1}{2} = -\frac{9}{50}$$

37. $\lim_{x \rightarrow 0^+} \sin \left(\frac{1}{x} \right) = \lim_{t \rightarrow +\infty} \sin t$, so the limit does not exist.

38. $\lim_{x \rightarrow 0} \frac{x^2 - 3 \sin x}{x} = \lim_{x \rightarrow 0} x - 3 \lim_{x \rightarrow 0} \frac{\sin x}{x} = -3.$

39. $\frac{2 - \cos 3x - \cos 4x}{x} = \frac{1 - \cos 3x}{x} + \frac{1 - \cos 4x}{x}$. Note that $\frac{1 - \cos 3x}{x} = \frac{1 - \cos 3x}{x} \cdot \frac{1 + \cos 3x}{1 + \cos 3x} = \frac{\sin^2 3x}{x(1 + \cos 3x)} = \frac{\sin 3x}{x} \cdot \frac{\sin 3x}{1 + \cos 3x}$. Thus

$$\lim_{x \rightarrow 0} \frac{2 - \cos 3x - \cos 4x}{x} = \lim_{x \rightarrow 0} \frac{\sin 3x}{x} \cdot \frac{\sin 3x}{1 + \cos 3x} + \lim_{x \rightarrow 0} \frac{\sin 4x}{x} \cdot \frac{\sin 4x}{1 + \cos 4x} = 3 \cdot 0 + 4 \cdot 0 = 0.$$

40. $\frac{\tan 3x^2 + \sin^2 5x}{x^2} = \frac{3}{\cos 3x^2} \cdot \frac{\sin 3x^2}{3x^2} + 25 \cdot \frac{\sin^2 5x}{(5x)^2}$, so

$$\lim_{x \rightarrow 0} \frac{\tan 3x^2 + \sin^2 5x}{x^2} = \lim_{x \rightarrow 0} \frac{3}{\cos 3x^2} \lim_{x \rightarrow 0} \frac{\sin 3x^2}{3x^2} + 25 \lim_{x \rightarrow 0} \left(\frac{\sin 5x}{5x} \right)^2 = 3 + 25 = 28.$$

41. (a)

4	4.5	4.9	5.1	5.5	6
0.093497	0.100932	0.100842	0.098845	0.091319	0.076497

The limit appears to be 0.1.

(b) Let $t = x - 5$. Then $t \rightarrow 0$ as $x \rightarrow 5$ and $\lim_{x \rightarrow 5} \frac{\sin(x - 5)}{x^2 - 25} = \lim_{x \rightarrow 5} \frac{1}{x + 5} \lim_{t \rightarrow 0} \frac{\sin t}{t} = \frac{1}{10} \cdot 1 = \frac{1}{10}.$

42. (a)

-2.1	-2.01	-2.001	-1.999	-1.99	-1.9
-1.09778	-1.00998	-1.00100	-0.99900	-0.98998	-0.89879

The limit appears to be -1 .

(b) Let $t = (x+2)(x+1)$. Then $t \rightarrow 0$ as $x \rightarrow -2$, and $\lim_{x \rightarrow -2} \frac{\sin[(x+2)(x+1)]}{x+2} = \lim_{x \rightarrow -2} (x+1) \lim_{t \rightarrow 0} \frac{\sin t}{t} = -1 \cdot 1 = -1$ by the Substitution Principle (Exercise 1.3.53).

43. True: let $\epsilon > 0$ and $\delta = \epsilon$. Then if $|x - (-1)| = |x + 1| < \delta$ then $|f(x) + 5| < \epsilon$.

44. True; from the proof of Theorem 1.6.5 we have $\tan x \geq x \geq \sin x$ for $0 < x < \pi/2$, and the desired inequalities follow immediately.

45. False; consider $f(x) = \tan^{-1} x$.

46. True; by the Squeezing Theorem 1.6.4 $|\lim_{x \rightarrow 0} xf(x)| \leq M \lim_{x \rightarrow 0} |x| = 0$ and $\left| \lim_{x \rightarrow +\infty} \frac{f(x)}{x} \right| \leq M \lim_{x \rightarrow +\infty} \frac{1}{x} = 0$.

47. (a) The student calculated x in degrees rather than radians.

(b) $\sin x^\circ = \sin t$ where x° is measured in degrees, t is measured in radians and $t = \frac{\pi x^\circ}{180}$. Thus $\lim_{x^\circ \rightarrow 0} \frac{\sin x^\circ}{x^\circ} = \lim_{t \rightarrow 0} \frac{\sin t}{(180t/\pi)} = \frac{\pi}{180}$.

48. Denote θ by x in accordance with Figure 1.6.4. Let P have coordinates $(\cos x, \sin x)$ and Q coordinates $(1, 0)$ so that $c^2(x) = (1 - \cos x)^2 + \sin^2 x = 2(1 - \cos x)$. Since $s = r\theta = 1 \cdot x = x$ we have $\lim_{x \rightarrow 0^+} \frac{c^2(x)}{s^2(x)} = \lim_{x \rightarrow 0^+} 2 \frac{1 - \cos x}{x^2} = \lim_{x \rightarrow 0^+} 2 \frac{1 - \cos x}{x^2} \cdot \frac{1 + \cos x}{1 + \cos x} = \lim_{x \rightarrow 0^+} \left(\frac{\sin x}{x} \right)^2 \frac{2}{1 + \cos x} = 1$.

49. $\lim_{x \rightarrow 0^-} f(x) = k \lim_{x \rightarrow 0} \frac{\sin kx}{kx \cos kx} = k$, $\lim_{x \rightarrow 0^+} f(x) = 2k^2$, so $k = 2k^2$, and the nonzero solution is $k = \frac{1}{2}$.

50. No; $\sin x/|x|$ has unequal one-sided limits ($+1$ and -1).

51. (a) $\lim_{t \rightarrow 0^+} \frac{\sin t}{t} = 1$.

(b) $\lim_{t \rightarrow 0^-} \frac{1 - \cos t}{t} = 0$ (Theorem 1.6.3).

(c) $\sin(\pi - t) = \sin t$, so $\lim_{x \rightarrow \pi} \frac{\pi - x}{\sin x} = \lim_{t \rightarrow 0} \frac{t}{\sin t} = 1$.

52. Let $t = \frac{\pi}{2} - \frac{\pi}{x}$. Then $\cos\left(\frac{\pi}{2} - t\right) = \sin t$, so $\lim_{x \rightarrow 2} \frac{\cos(\pi/x)}{x-2} = \lim_{t \rightarrow 0} \frac{(\pi - 2t) \sin t}{4t} = \lim_{t \rightarrow 0} \frac{\pi - 2t}{4} \lim_{t \rightarrow 0} \frac{\sin t}{t} = \frac{\pi}{4}$.

53. $t = x - 1$; $\sin(\pi x) = \sin(\pi t + \pi) = -\sin \pi t$; and $\lim_{x \rightarrow 1} \frac{\sin(\pi x)}{x-1} = -\lim_{t \rightarrow 0} \frac{\sin \pi t}{t} = -\pi$.

54. $t = x - \pi/4$; $\tan x - 1 = \frac{2 \sin t}{\cos t - \sin t}$; $\lim_{x \rightarrow \pi/4} \frac{\tan x - 1}{x - \pi/4} = \lim_{t \rightarrow 0} \frac{2 \sin t}{t(\cos t - \sin t)} = 2$.

55. $t = x - \pi/4$, $\cos(t + \pi/4) = (\sqrt{2}/2)(\cos t - \sin t)$, $\sin(t + \pi/4) = (\sqrt{2}/2)(\sin t + \cos t)$, so $\frac{\cos x - \sin x}{x - \pi/4} = -\frac{\sqrt{2} \sin t}{t}$; $\lim_{x \rightarrow \pi/4} \frac{\cos x - \sin x}{x - \pi/4} = -\sqrt{2} \lim_{t \rightarrow 0} \frac{\sin t}{t} = -\sqrt{2}$.

56. Let $g(x) = f^{-1}(x)$ and $h(x) = f(x)/x$ when $x \neq 0$ and $h(0) = L$. Then $\lim_{x \rightarrow 0} h(x) = L = h(0)$, so h is continuous at $x = 0$. Apply Theorem 1.5.5 to $h \circ g$ to obtain that on the one hand $h(g(0)) = L$, and on the other $h(g(x)) = \frac{f(g(x))}{g(x)}$, $x \neq 0$, and $\lim_{x \rightarrow 0} h(g(x)) = h(g(0))$. Since $f(g(x)) = x$ and $g = f^{-1}$ this shows that $\lim_{x \rightarrow 0} \frac{x}{f^{-1}(x)} = L$.

57. $\lim_{x \rightarrow 0} \frac{x}{\sin^{-1} x} = \lim_{x \rightarrow 0} \frac{\sin x}{x} = 1$.

58. $\tan(\tan^{-1} x) = x$, so $\lim_{x \rightarrow 0} \frac{\tan^{-1} x}{x} = \lim_{x \rightarrow 0} \frac{x}{\tan x} = (\lim_{x \rightarrow 0} \cos x) \lim_{x \rightarrow 0} \frac{x}{\sin x} = 1$.

59. $5 \lim_{x \rightarrow 0} \frac{\sin^{-1} 5x}{5x} = 5 \lim_{x \rightarrow 0} \frac{5x}{\sin 5x} = 5$.

60. $\lim_{x \rightarrow 1} \frac{1}{x+1} \lim_{x \rightarrow 1} \frac{\sin^{-1}(x-1)}{x-1} = \frac{1}{2} \lim_{x \rightarrow 1} \frac{x-1}{\sin(x-1)} = \frac{1}{2}$.

61. $-|x| \leq x \cos\left(\frac{50\pi}{x}\right) \leq |x|$, which gives the desired result.

62. $-x^2 \leq x^2 \sin\left(\frac{50\pi}{\sqrt[3]{x}}\right) \leq x^2$, which gives the desired result.

63. Since $\lim_{x \rightarrow 0} \sin(1/x)$ does not exist, no conclusions can be drawn.

64. $\lim_{x \rightarrow 0} f(x) = 1$ by the Squeezing Theorem.

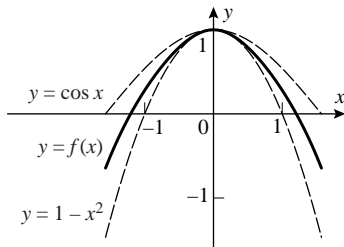

65. $\lim_{x \rightarrow +\infty} f(x) = 0$ by the Squeezing Theorem.

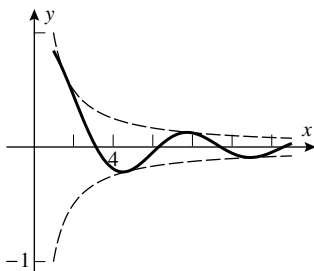

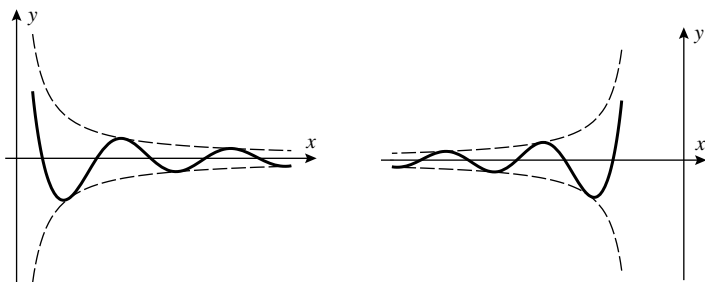

66.

67. (a) Let $f(x) = x - \cos x$; $f(0) = -1$, $f(\pi/2) = \pi/2$. By the IVT there must be a solution of $f(x) = 0$.

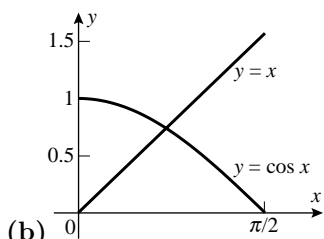

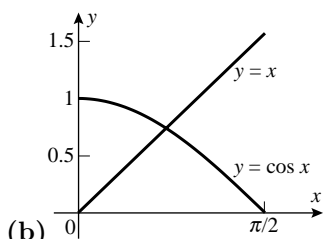
(b)  (c) 0.739

68. (a) $f(x) = x + \sin x - 1$; $f(0) = -1$, $f(\pi/6) = \pi/6 - 1/2 > 0$. By the IVT there must be a solution of $f(x) = 0$ in the interval.

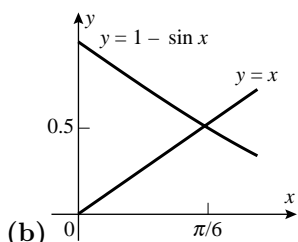

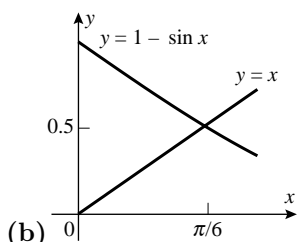
(b)  (c) 0.511

69. (a) Gravity is strongest at the poles and weakest at the equator.

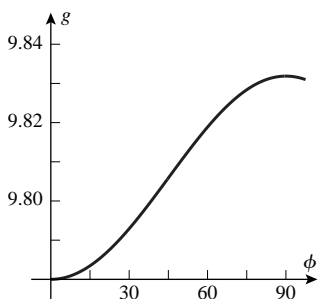

(b) Let $g(\phi)$ be the given function. Then $g(38) < 9.8$ and $g(39) > 9.8$, so by the Intermediate Value Theorem there is a value c between 38 and 39 for which $g(c) = 9.8$ exactly.

Chapter 1 Review Exercises

1. (a) 1 (b) Does not exist. (c) Does not exist. (d) 1 (e) 3 (f) 0 (g) 0
 (h) 2 (i) 1/2

2. (a)

x	2.00001	2.0001	2.001	2.01	2.1	2.5
$f(x)$	0.250	0.250	0.250	0.249	0.244	0.222

For $x \neq 2$, $f(x) = \frac{1}{x+2}$, so the limit is $1/4$.

(b)	x	-0.01	-0.001	-0.0001	0.0001	0.001	0.01
	$f(x)$	4.0021347	4.0000213	4.0000002	4.0000002	4.0000213	4.0021347

Use $\frac{\tan 4x}{x} = \frac{\sin 4x}{x \cos 4x} = \frac{4}{\cos 4x} \cdot \frac{\sin 4x}{4x}$; the limit is 4.

3. (a)	x	-0.01	-0.001	-0.0001	0.0001	0.001	0.01
	$f(x)$	0.402	0.405	0.405	0.406	0.406	0.409

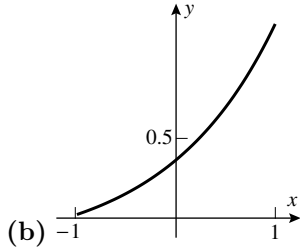

4.	x	2.9	2.99	2.999	3.001	3.01	3.1
	$f(x)$	5.357	5.526	5.543	5.547	5.564	5.742

5. The limit is $\frac{(-1)^3 - (-1)^2}{-1 - 1} = 1$.

6. For $x \neq 1$, $\frac{x^3 - x^2}{x - 1} = x^2$, so $\lim_{x \rightarrow 1} \frac{x^3 - x^2}{x - 1} = 1$.

7. If $x \neq -3$ then $\frac{3x + 9}{x^2 + 4x + 3} = \frac{3}{x + 1}$ with limit $-\frac{3}{2}$.

8. The limit is $-\infty$.

9. By the highest degree terms, the limit is $\frac{2^5}{3} = \frac{32}{3}$.

10. $\frac{\sqrt{x^2 + 4} - 2}{x^2} \cdot \frac{\sqrt{x^2 + 4} + 2}{\sqrt{x^2 + 4} + 2} = \frac{x^2}{x^2(\sqrt{x^2 + 4} + 2)} = \frac{1}{\sqrt{x^2 + 4} + 2}$, so $\lim_{x \rightarrow 0} \frac{\sqrt{x^2 + 4} - 2}{x^2} = \lim_{x \rightarrow 0} \frac{1}{\sqrt{x^2 + 4} + 2} = \frac{1}{4}$.

11. (a) $y = 0$. (b) None. (c) $y = 2$.

12. (a) $\sqrt{5}$, no limit, $\sqrt{10}$, $\sqrt{10}$, no limit, $+\infty$, no limit.

(b) $-1, +1, -1, -1$, no limit, $-1, +1$

13. If $x \neq 0$, then $\frac{\sin 3x}{\tan 3x} = \cos 3x$, and the limit is 1.

14. If $x \neq 0$, then $\frac{x \sin x}{1 - \cos x} \cdot \frac{1 + \cos x}{1 + \cos x} = \frac{x}{\sin x}(1 + \cos x)$, so the limit is 2.

15. If $x \neq 0$, then $\frac{3x - \sin(kx)}{x} = 3 - k \frac{\sin(kx)}{kx}$, so the limit is $3 - k$.

16. $\lim_{\theta \rightarrow 0} \tan\left(\frac{1 - \cos \theta}{\theta}\right) = \tan\left(\lim_{\theta \rightarrow 0} \frac{1 - \cos \theta}{\theta}\right) = \tan\left(\lim_{\theta \rightarrow 0} \frac{1 - \cos^2 \theta}{\theta(1 + \cos \theta)}\right) = \tan\left(\lim_{\theta \rightarrow 0} \frac{\sin \theta}{\theta} \cdot \frac{\sin \theta}{(1 + \cos \theta)}\right) = 0$.

17. As $t \rightarrow \pi/2^+$, $\tan t \rightarrow -\infty$, so the limit in question is 0.

18. $\ln(2 \sin \theta \cos \theta) - \ln \tan \theta = \ln 2 + 2 \ln \cos \theta$, so the limit is $\ln 2$.

19. $\left(1 + \frac{3}{x}\right)^{-x} = \left[\left(1 + \frac{3}{x}\right)^{x/3}\right]^{(-3)}$, so the limit is e^{-3} .

20. $\left(1 + \frac{a}{x}\right)^{bx} = \left[\left(1 + \frac{a}{x}\right)^{x/a}\right]^{(ab)}$, so the limit is e^{ab} .

21. \$2,001.60, \$2,009.66, \$2,013.62, \$2013.75.

23. (a) $f(x) = 2x/(x-1)$.

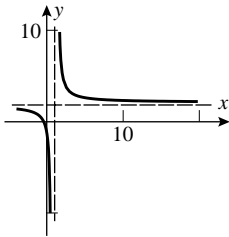

(b)

24. Given any window of height 2ϵ centered at the point $x = a, y = L$ there exists a width 2δ such that the window of width 2δ and height 2ϵ contains all points of the graph of the function for x in that interval.

25. (a) $\lim_{x \rightarrow 2} f(x) = 5$.

(b) $\delta = (3/4) \cdot (0.048/8) = 0.0045$.

26. $\delta \approx 0.07747$ (use a graphing utility).

27. (a) $|4x - 7 - 1| < 0.01$ means $4|x - 2| < 0.01$, or $|x - 2| < 0.0025$, so $\delta = 0.0025$.

(b) $\left|\frac{4x^2 - 9}{2x - 3} - 6\right| < 0.05$ means $|2x + 3 - 6| < 0.05$, or $|x - 1.5| < 0.025$, so $\delta = 0.025$.

(c) $|x^2 - 16| < 0.001$; if $\delta < 1$ then $|x + 4| < 9$ if $|x - 4| < 1$; then $|x^2 - 16| = |x - 4||x + 4| \leq 9|x - 4| < 0.001$ provided $|x - 4| < 0.001/9 = 1/9000$, take $\delta = 1/9000$, then $|x^2 - 16| < 9|x - 4| < 9(1/9000) = 1/1000 = 0.001$.

28. (a) Given $\epsilon > 0$ then $|4x - 7 - 1| < \epsilon$ provided $|x - 2| < \epsilon/4$, take $\delta = \epsilon/4$.

(b) Given $\epsilon > 0$ the inequality $\left|\frac{4x^2 - 9}{2x - 3} - 6\right| < \epsilon$ holds if $|2x + 3 - 6| < \epsilon$, or $|x - 1.5| < \epsilon/2$, take $\delta = \epsilon/2$.

29. Let $\epsilon = f(x_0)/2 > 0$; then there corresponds a $\delta > 0$ such that if $|x - x_0| < \delta$ then $|f(x) - f(x_0)| < \epsilon$, $-\epsilon < f(x) - f(x_0) < \epsilon$, $f(x) > f(x_0) - \epsilon = f(x_0)/2 > 0$, for $x_0 - \delta < x < x_0 + \delta$.

30. (a)

x	1.1	1.01	1.001	1.0001	1.00001	1.000001
$f(x)$	0.49	0.54	0.540	0.5403	0.54030	0.54030

(b) $\cos 1$

31. (a) f is not defined at $x = \pm 1$, continuous elsewhere.
 (b) None; continuous everywhere.
 (c) f is not defined at $x = 0$ and $x = -3$, continuous elsewhere.
32. (a) Continuous everywhere except $x = \pm 3$.
 (b) Defined and continuous for $x \leq -1, x \geq 1$.
 (c) Defined and continuous for $x > 0$.
33. For $x < 2$ f is a polynomial and is continuous; for $x > 2$ f is a polynomial and is continuous. At $x = 2$, $f(2) = -13 \neq 13 = \lim_{x \rightarrow 2^+} f(x)$, so f is not continuous there.
35. $f(x) = -1$ for $a \leq x < \frac{a+b}{2}$ and $f(x) = 1$ for $\frac{a+b}{2} \leq x \leq b$; f does not take the value 0.
36. If, on the contrary, $f(x_0) < 0$ for some x_0 in $[0, 1]$, then by the Intermediate Value Theorem we would have a solution of $f(x) = 0$ in $[0, x_0]$, contrary to the hypothesis.
37. $f(-6) = 185, f(0) = -1, f(2) = 65$; apply Theorem 1.5.8 twice, once on $[-6, 0]$ and once on $[0, 2]$.

Chapter 1 Making Connections

1. Let $P(x, x^2)$ be an arbitrary point on the curve, let $Q(-x, x^2)$ be its reflection through the y -axis, let $O(0, 0)$ be the origin. The perpendicular bisector of the line which connects P with O meets the y -axis at a point $C(0, \lambda(x))$, whose ordinate is as yet unknown. A segment of the bisector is also the altitude of the triangle $\triangle OPC$ which is isosceles, so that $CP = CO$.

Using the symmetrically opposing point Q in the second quadrant, we see that $\overline{OP} = \overline{OQ}$ too, and thus C is equidistant from the three points O, P, Q and is thus the center of the unique circle that passes through the three points.

2. Let R be the midpoint of the line segment connecting P and O , so that $R(x/2, x^2/2)$. We start with the Pythagorean Theorem $\overline{OC}^2 = \overline{OR}^2 + \overline{CR}^2$, or $\lambda^2 = (x/2)^2 + (x^2/2)^2 + (x/2)^2 + (\lambda - x^2/2)^2$. Solving for λ we obtain $\lambda x^2 = (x^2 + x^4)/2, \lambda = 1/2 + x^2/2$.

3. Replace the parabola with the general curve $y = f(x)$ which passes through $P(x, f(x))$ and $S(0, f(0))$. Let the perpendicular bisector of the line through S and P meet the y -axis at $C(0, \lambda)$, and let $R(x/2, (f(x) - \lambda)/2)$ be the midpoint of P and S . By the Pythagorean Theorem, $\overline{CS}^2 = \overline{RS}^2 + \overline{CR}^2$, or $(\lambda - f(0))^2 = x^2/4 + \left[\frac{f(x) + f(0)}{2} - f(0) \right]^2 + x^2/4 + \left[\frac{f(x) + f(0)}{2} - \lambda \right]^2$,
 which yields $\lambda = \frac{1}{2} \left[f(0) + f(x) + \frac{x^2}{f(x) - f(0)} \right]$.

4. (a) $f(0) = 0, C(x) = \frac{1}{8} + 2x^2, x^2 + (y - \frac{1}{8})^2 = (\frac{1}{8})^2$.
 (b) $f(0) = 0, C(x) = \frac{1}{2}(\sec x + x^2), x^2 + (y - \frac{1}{2})^2 = (\frac{1}{2})^2$.
 (c) $f(0) = 0, C(x) = \frac{1}{2} \frac{x^2 + |x|^2}{|x|}, x^2 + y^2 = 0$ (not a circle).
 (d) $f(0) = 0, C(x) = \frac{1}{2} \frac{x(1 + \sin^2 x)}{\sin x}, x^2 + \left(y - \frac{1}{2} \right)^2 = \left(\frac{1}{2} \right)^2$.

(e) $f(0) = 1, C(x) = \frac{1}{2} \frac{x^2 - \sin^2 x}{\cos x - 1}, x^2 + y^2 = 1.$

(f) $f(0) = 0, C(x) = \frac{1}{2g(x)} + \frac{x^2 g(x)}{2}, x^2 + \left(y - \frac{1}{2g(0)}\right)^2 = \left(\frac{1}{2g(0)}\right)^2.$

(g) $f(0) = 0, C(x) = \frac{1}{2} \frac{1 + x^6}{x^2},$ limit does not exist, osculating circle does not exist.

The Derivative

Exercise Set 2.1

1. (a) $m_{\text{tan}} = (50 - 10)/(15 - 5) = 40/10 = 4 \text{ m/s}$.

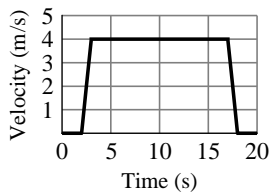

(b)

2. At $t = 4 \text{ s}$, $m_{\text{tan}} \approx (90 - 0)/(10 - 2) = 90/8 = 11.25 \text{ m/s}$. At $t = 8 \text{ s}$, $m_{\text{tan}} \approx (140 - 0)/(10 - 4) = 140/6 \approx 23.33 \text{ m/s}$.

3. (a) $(10 - 10)/(3 - 0) = 0 \text{ cm/s}$.

(b) $t = 0, t = 2, t = 4.2$, and $t = 8$ (horizontal tangent line).

(c) maximum: $t = 1$ (slope > 0), minimum: $t = 3$ (slope < 0).

(d) $(3 - 18)/(4 - 2) = -7.5 \text{ cm/s}$ (slope of estimated tangent line to curve at $t = 3$).

4. (a) decreasing (slope of tangent line decreases with increasing time)

(b) increasing (slope of tangent line increases with increasing time)

(c) increasing (slope of tangent line increases with increasing time)

(d) decreasing (slope of tangent line decreases with increasing time)

5. It is a straight line with slope equal to the velocity.

6. The velocity increases from time 0 to time t_0 , so the slope of the curve increases during that time. From time t_0 to time t_1 , the velocity, and the slope, decrease. At time t_1 , the velocity, and hence the slope, instantaneously drop to zero, so there is a sharp bend in the curve at that point.

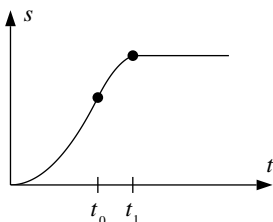

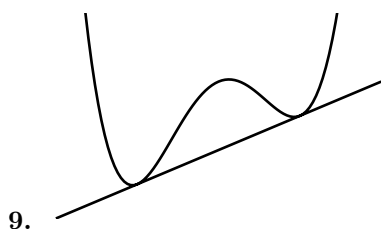
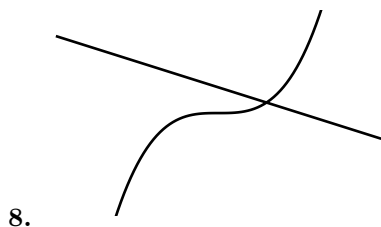
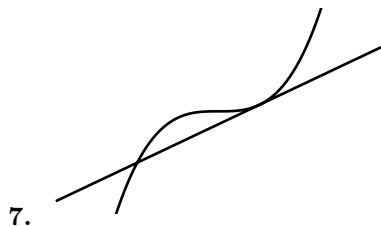

11. (a) $m_{\text{sec}} = \frac{f(1) - f(0)}{1 - 0} = \frac{2}{1} = 2$

(b) $m_{\text{tan}} = \lim_{x_1 \rightarrow 0} \frac{f(x_1) - f(0)}{x_1 - 0} = \lim_{x_1 \rightarrow 0} \frac{2x_1^2 - 0}{x_1 - 0} = \lim_{x_1 \rightarrow 0} 2x_1 = 0$

(c) $m_{\text{tan}} = \lim_{x_1 \rightarrow x_0} \frac{f(x_1) - f(x_0)}{x_1 - x_0} = \lim_{x_1 \rightarrow x_0} \frac{2x_1^2 - 2x_0^2}{x_1 - x_0} = \lim_{x_1 \rightarrow x_0} (2x_1 + 2x_0) = 4x_0$

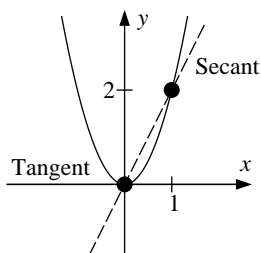

(d) The tangent line is the x -axis.

12. (a) $m_{\text{sec}} = \frac{f(2) - f(1)}{2 - 1} = \frac{2^3 - 1^3}{1} = 7$

(b) $m_{\text{tan}} = \lim_{x_1 \rightarrow 1} \frac{f(x_1) - f(1)}{x_1 - 1} = \lim_{x_1 \rightarrow 1} \frac{x_1^3 - 1}{x_1 - 1} = \lim_{x_1 \rightarrow 1} \frac{(x_1 - 1)(x_1^2 + x_1 + 1)}{x_1 - 1} = \lim_{x_1 \rightarrow 1} (x_1^2 + x_1 + 1) = 3$

$$(c) m_{\tan} = \lim_{x_1 \rightarrow x_0} \frac{f(x_1) - f(x_0)}{x_1 - x_0} = \lim_{x_1 \rightarrow x_0} \frac{x_1^3 - x_0^3}{x_1 - x_0} = \lim_{x_1 \rightarrow x_0} (x_1^2 + x_1x_0 + x_0^2) = 3x_0^2$$

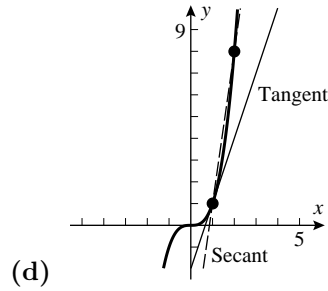

$$13. (a) m_{\sec} = \frac{f(3) - f(2)}{3 - 2} = \frac{1/3 - 1/2}{1} = -\frac{1}{6}$$

$$(b) m_{\tan} = \lim_{x_1 \rightarrow 2} \frac{f(x_1) - f(2)}{x_1 - 2} = \lim_{x_1 \rightarrow 2} \frac{1/x_1 - 1/2}{x_1 - 2} = \lim_{x_1 \rightarrow 2} \frac{2 - x_1}{2x_1(x_1 - 2)} = \lim_{x_1 \rightarrow 2} \frac{-1}{2x_1} = -\frac{1}{4}$$

$$(c) m_{\tan} = \lim_{x_1 \rightarrow x_0} \frac{f(x_1) - f(x_0)}{x_1 - x_0} = \lim_{x_1 \rightarrow x_0} \frac{1/x_1 - 1/x_0}{x_1 - x_0} = \lim_{x_1 \rightarrow x_0} \frac{x_0 - x_1}{x_0x_1(x_1 - x_0)} = \lim_{x_1 \rightarrow x_0} \frac{-1}{x_0x_1} = -\frac{1}{x_0^2}$$

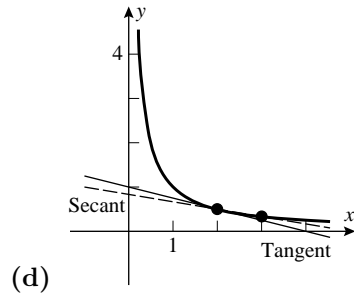

$$14. (a) m_{\sec} = \frac{f(2) - f(1)}{2 - 1} = \frac{1/4 - 1}{1} = -\frac{3}{4}$$

$$(b) m_{\tan} = \lim_{x_1 \rightarrow 1} \frac{f(x_1) - f(1)}{x_1 - 1} = \lim_{x_1 \rightarrow 1} \frac{1/x_1^2 - 1}{x_1 - 1} = \lim_{x_1 \rightarrow 1} \frac{1 - x_1^2}{x_1^2(x_1 - 1)} = \lim_{x_1 \rightarrow 1} \frac{-(x_1 + 1)}{x_1^2} = -2$$

$$(c) m_{\tan} = \lim_{x_1 \rightarrow x_0} \frac{f(x_1) - f(x_0)}{x_1 - x_0} = \lim_{x_1 \rightarrow x_0} \frac{1/x_1^2 - 1/x_0^2}{x_1 - x_0} = \lim_{x_1 \rightarrow x_0} \frac{x_0^2 - x_1^2}{x_0^2x_1^2(x_1 - x_0)} = \lim_{x_1 \rightarrow x_0} \frac{-(x_1 + x_0)}{x_0^2x_1^2} = -\frac{2}{x_0^3}$$

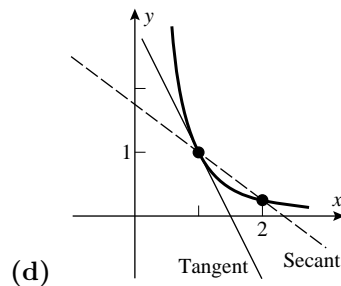

$$15. (a) m_{\tan} = \lim_{x_1 \rightarrow x_0} \frac{f(x_1) - f(x_0)}{x_1 - x_0} = \lim_{x_1 \rightarrow x_0} \frac{(x_1^2 - 1) - (x_0^2 - 1)}{x_1 - x_0} = \lim_{x_1 \rightarrow x_0} \frac{(x_1^2 - x_0^2)}{x_1 - x_0} = \lim_{x_1 \rightarrow x_0} (x_1 + x_0) = 2x_0$$

$$(b) m_{\tan} = 2(-1) = -2$$

$$16. \text{ (a) } m_{\tan} = \lim_{x_1 \rightarrow x_0} \frac{f(x_1) - f(x_0)}{x_1 - x_0} = \lim_{x_1 \rightarrow x_0} \frac{(x_1^2 + 3x_1 + 2) - (x_0^2 + 3x_0 + 2)}{x_1 - x_0} = \lim_{x_1 \rightarrow x_0} \frac{(x_1^2 - x_0^2) + 3(x_1 - x_0)}{x_1 - x_0} =$$

$$= \lim_{x_1 \rightarrow x_0} (x_1 + x_0 + 3) = 2x_0 + 3$$

$$\text{(b) } m_{\tan} = 2(2) + 3 = 7$$

$$17. \text{ (a) } m_{\tan} = \lim_{x_1 \rightarrow x_0} \frac{f(x_1) - f(x_0)}{x_1 - x_0} = \lim_{x_1 \rightarrow x_0} \frac{(x_1 + \sqrt{x_1}) - (x_0 + \sqrt{x_0})}{x_1 - x_0} = \lim_{x_1 \rightarrow x_0} \left(1 + \frac{1}{\sqrt{x_1} + \sqrt{x_0}} \right) = 1 + \frac{1}{2\sqrt{x_0}}$$

$$\text{(b) } m_{\tan} = 1 + \frac{1}{2\sqrt{1}} = \frac{3}{2}$$

$$18. \text{ (a) } m_{\tan} = \lim_{x_1 \rightarrow x_0} \frac{f(x_1) - f(x_0)}{x_1 - x_0} = \lim_{x_1 \rightarrow x_0} \frac{1/\sqrt{x_1} - 1/\sqrt{x_0}}{x_1 - x_0} = \lim_{x_1 \rightarrow x_0} \frac{\sqrt{x_0} - \sqrt{x_1}}{\sqrt{x_0} \sqrt{x_1} (x_1 - x_0)} =$$

$$= \lim_{x_1 \rightarrow x_0} \frac{-1}{\sqrt{x_0} \sqrt{x_1} (\sqrt{x_1} + \sqrt{x_0})} = -\frac{1}{2x_0^{3/2}}$$

$$\text{(b) } m_{\tan} = -\frac{1}{2(4)^{3/2}} = -\frac{1}{16}$$

19. True. Let $x = 1 + h$.

20. False. A secant line meets the curve in at least two places, but a tangent line might meet it only once.

21. False. Velocity represents the rate at which position changes.

22. True. The units of the rate of change are obtained by dividing the units of $f(x)$ (inches) by the units of x (tons).

23. (a) 72°F at about 4:30 P.M. (b) About $(67 - 43)/6 = 4^\circ\text{F/h}$.

(c) Decreasing most rapidly at about 9 P.M.; rate of change of temperature is about -7°F/h (slope of estimated tangent line to curve at 9 P.M.).

24. For $V = 10$ the slope of the tangent line is about $(0 - 5)/(20 - 0) = -0.25$ atm/L, for $V = 25$ the slope is about $(1 - 2)/(25 - 0) = -0.04$ atm/L.

25. (a) During the first year after birth.

(b) About 6 cm/year (slope of estimated tangent line at age 5).

(c) The growth rate is greatest at about age 14; about 10 cm/year.

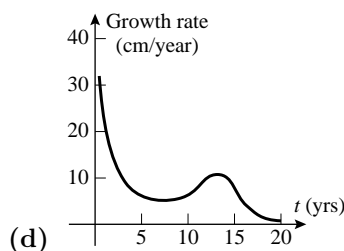

26. (a) The object falls until $s = 0$. This happens when $1250 - 16t^2 = 0$, so $t = \sqrt{1250/16} = \sqrt{78.125} > \sqrt{25} = 5$; hence the object is still falling at $t = 5$ sec.

$$\text{(b) } \frac{f(6) - f(5)}{6 - 5} = \frac{674 - 850}{1} = -176. \text{ The average velocity is } -176 \text{ ft/s.}$$

$$(c) \quad v_{\text{inst}} = \lim_{h \rightarrow 0} \frac{f(5+h) - f(5)}{h} = \lim_{h \rightarrow 0} \frac{[1250 - 16(5+h)^2] - 850}{h} = \lim_{h \rightarrow 0} \frac{-160h - 16h^2}{h} = \lim_{h \rightarrow 0} (-160 - 16h) = -160 \text{ ft/s.}$$

$$27. (a) \quad 0.3 \cdot 40^3 = 19,200 \text{ ft} \quad (b) \quad v_{\text{ave}} = 19,200/40 = 480 \text{ ft/s}$$

$$(c) \quad \text{Solve } s = 0.3t^3 = 1000; t \approx 14.938 \text{ so } v_{\text{ave}} \approx 1000/14.938 \approx 66.943 \text{ ft/s.}$$

$$(d) \quad v_{\text{inst}} = \lim_{h \rightarrow 0} \frac{0.3(40+h)^3 - 0.3 \cdot 40^3}{h} = \lim_{h \rightarrow 0} \frac{0.3(4800h + 120h^2 + h^3)}{h} = \lim_{h \rightarrow 0} 0.3(4800 + 120h + h^2) = 1440 \text{ ft/s}$$

$$28. (a) \quad v_{\text{ave}} = \frac{4.5(12)^2 - 4.5(0)^2}{12 - 0} = 54 \text{ ft/s}$$

$$(b) \quad v_{\text{inst}} = \lim_{t_1 \rightarrow 6} \frac{4.5t_1^2 - 4.5(6)^2}{t_1 - 6} = \lim_{t_1 \rightarrow 6} \frac{4.5(t_1^2 - 36)}{t_1 - 6} = \lim_{t_1 \rightarrow 6} \frac{4.5(t_1 + 6)(t_1 - 6)}{t_1 - 6} = \lim_{t_1 \rightarrow 6} 4.5(t_1 + 6) = 54 \text{ ft/s}$$

$$29. (a) \quad v_{\text{ave}} = \frac{6(4)^4 - 6(2)^4}{4 - 2} = 720 \text{ ft/min}$$

$$(b) \quad v_{\text{inst}} = \lim_{t_1 \rightarrow 2} \frac{6t_1^4 - 6(2)^4}{t_1 - 2} = \lim_{t_1 \rightarrow 2} \frac{6(t_1^4 - 16)}{t_1 - 2} = \lim_{t_1 \rightarrow 2} \frac{6(t_1^2 + 4)(t_1^2 - 4)}{t_1 - 2} = \lim_{t_1 \rightarrow 2} 6(t_1^2 + 4)(t_1 + 2) = 192 \text{ ft/min}$$

30. See the discussion before Definition 2.1.1.

31. The instantaneous velocity at $t = 1$ equals the limit as $h \rightarrow 0$ of the average velocity during the interval between $t = 1$ and $t = 1 + h$.

Exercise Set 2.2

$$1. \quad f'(1) = 2.5, \quad f'(3) = 0, \quad f'(5) = -2.5, \quad f'(6) = -1.$$

$$2. \quad f'(4) < f'(0) < f'(2) < 0 < f'(-3).$$

$$3. (a) \quad f'(a) \text{ is the slope of the tangent line.} \quad (b) \quad f'(2) = m = 3 \quad (c) \quad \text{The same, } f'(2) = 3.$$

$$4. \quad f'(1) = \frac{2 - (-1)}{1 - (-1)} = \frac{3}{2}$$

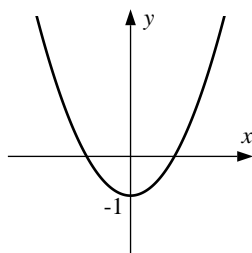

5.

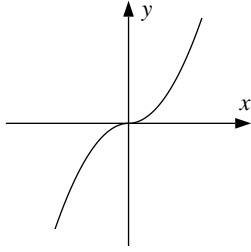

6.

7. $y - (-1) = 5(x - 3), y = 5x - 16$

8. $y - 3 = -4(x + 2), y = -4x - 5$

9. $f'(x) = \lim_{h \rightarrow 0} \frac{f(x+h) - f(x)}{h} = \lim_{h \rightarrow 0} \frac{2(x+h)^2 - 2x^2}{h} = \lim_{h \rightarrow 0} \frac{4xh + 2h^2}{h} = 4x; f'(1) = 4$ so the tangent line is given by $y - 2 = 4(x - 1), y = 4x - 2$.

10. $f'(x) = \lim_{h \rightarrow 0} \frac{f(x+h) - f(x)}{h} = \lim_{h \rightarrow 0} \frac{1/(x+h)^2 - 1/x^2}{h} = \lim_{h \rightarrow 0} \frac{x^2 - (x+h)^2}{hx^2(x+h)^2} = \lim_{h \rightarrow 0} \frac{-2xh - h^2}{hx^2(x+h)^2} = \lim_{h \rightarrow 0} \frac{-2x - h}{x^2(x+h)^2} = -\frac{2}{x^3}; f'(-1) = 2$ so the tangent line is given by $y - 1 = 2(x + 1), y = 2x + 3$.

11. $f'(x) = \lim_{h \rightarrow 0} \frac{f(x+h) - f(x)}{h} = \lim_{h \rightarrow 0} \frac{(x+h)^3 - x^3}{h} = \lim_{h \rightarrow 0} (3x^2 + 3xh + h^2) = 3x^2; f'(0) = 0$ so the tangent line is given by $y - 0 = 0(x - 0), y = 0$.

12. $f'(x) = \lim_{h \rightarrow 0} \frac{f(x+h) - f(x)}{h} = \lim_{h \rightarrow 0} \frac{[2(x+h)^3 + 1] - [2x^3 + 1]}{h} = \lim_{h \rightarrow 0} (6x^2 + 6xh + 2h^2) = 6x^2; f(-1) = 2(-1)^3 + 1 = -1$ and $f'(-1) = 6$ so the tangent line is given by $y + 1 = 6(x + 1), y = 6x + 5$.

13. $f'(x) = \lim_{h \rightarrow 0} \frac{f(x+h) - f(x)}{h} = \lim_{h \rightarrow 0} \frac{\sqrt{x+1+h} - \sqrt{x+1}}{h} = \lim_{h \rightarrow 0} \frac{\sqrt{x+1+h} - \sqrt{x+1}}{h} \cdot \frac{\sqrt{x+1+h} + \sqrt{x+1}}{\sqrt{x+1+h} + \sqrt{x+1}} = \lim_{h \rightarrow 0} \frac{h}{h(\sqrt{x+1+h} + \sqrt{x+1})} = \frac{1}{2\sqrt{x+1}}; f(8) = \sqrt{8+1} = 3$ and $f'(8) = \frac{1}{6}$ so the tangent line is given by $y - 3 = \frac{1}{6}(x - 8), y = \frac{1}{6}x + \frac{5}{3}$.

14. $f'(x) = \lim_{h \rightarrow 0} \frac{f(x+h) - f(x)}{h} = \lim_{h \rightarrow 0} \frac{\sqrt{2x+2h+1} - \sqrt{2x+1}}{h} \cdot \frac{\sqrt{2x+2h+1} + \sqrt{2x+1}}{\sqrt{2x+2h+1} + \sqrt{2x+1}} = \lim_{h \rightarrow 0} \frac{2h}{h(\sqrt{2x+2h+1} + \sqrt{2x+1})} = \lim_{h \rightarrow 0} \frac{2}{\sqrt{2x+2h+1} + \sqrt{2x+1}} = \frac{1}{\sqrt{2x+1}}; f(4) = \sqrt{2 \cdot 4 + 1} = \sqrt{9} = 3$ and $f'(4) = 1/3$ so the tangent line is given by $y - 3 = \frac{1}{3}(x - 4), y = \frac{1}{3}x + \frac{5}{3}$.

15. $f'(x) = \lim_{\Delta x \rightarrow 0} \frac{\frac{1}{x+\Delta x} - \frac{1}{x}}{\Delta x} = \lim_{\Delta x \rightarrow 0} \frac{\frac{x - (x+\Delta x)}{x(x+\Delta x)}}{\Delta x} = \lim_{\Delta x \rightarrow 0} \frac{-\Delta x}{x\Delta x(x+\Delta x)} = \lim_{\Delta x \rightarrow 0} -\frac{1}{x(x+\Delta x)} = -\frac{1}{x^2}$.

16. $f'(x) = \lim_{\Delta x \rightarrow 0} \frac{\frac{1}{(x+\Delta x)+1} - \frac{1}{x+1}}{\Delta x} = \lim_{\Delta x \rightarrow 0} \frac{\frac{(x+1) - (x+\Delta x+1)}{(x+1)(x+\Delta x+1)}}{\Delta x} = \lim_{\Delta x \rightarrow 0} \frac{x+1 - x - \Delta x - 1}{\Delta x(x+1)(x+\Delta x+1)} = \lim_{\Delta x \rightarrow 0} \frac{-\Delta x}{\Delta x(x+1)(x+\Delta x+1)} = \lim_{\Delta x \rightarrow 0} \frac{-1}{(x+1)(x+\Delta x+1)} = -\frac{1}{(x+1)^2}$.

17. $f'(x) = \lim_{\Delta x \rightarrow 0} \frac{(x+\Delta x)^2 - (x+\Delta x) - (x^2 - x)}{\Delta x} = \lim_{\Delta x \rightarrow 0} \frac{2x\Delta x + (\Delta x)^2 - \Delta x}{\Delta x} = \lim_{\Delta x \rightarrow 0} (2x - 1 + \Delta x) = 2x - 1$.

$$18. f'(x) = \lim_{\Delta x \rightarrow 0} \frac{(x + \Delta x)^4 - x^4}{\Delta x} = \lim_{\Delta x \rightarrow 0} \frac{4x^3 \Delta x + 6x^2(\Delta x)^2 + 4x(\Delta x)^3 + (\Delta x)^4}{\Delta x} =$$

$$= \lim_{\Delta x \rightarrow 0} (4x^3 + 6x^2 \Delta x + 4x(\Delta x)^2 + (\Delta x)^3) = 4x^3.$$

$$19. f'(x) = \lim_{\Delta x \rightarrow 0} \frac{\frac{1}{\sqrt{x + \Delta x}} - \frac{1}{\sqrt{x}}}{\Delta x} = \lim_{\Delta x \rightarrow 0} \frac{\sqrt{x} - \sqrt{x + \Delta x}}{\Delta x \sqrt{x} \sqrt{x + \Delta x}} = \lim_{\Delta x \rightarrow 0} \frac{x - (x + \Delta x)}{\Delta x \sqrt{x} \sqrt{x + \Delta x} (\sqrt{x} + \sqrt{x + \Delta x})} =$$

$$= \lim_{\Delta x \rightarrow 0} \frac{-1}{\sqrt{x} \sqrt{x + \Delta x} (\sqrt{x} + \sqrt{x + \Delta x})} = -\frac{1}{2x^{3/2}}.$$

$$20. f'(x) = \lim_{\Delta x \rightarrow 0} \frac{\frac{1}{\sqrt{x + \Delta x - 1}} - \frac{1}{\sqrt{x - 1}}}{\Delta x} = \lim_{\Delta x \rightarrow 0} \frac{\sqrt{x - 1} - \sqrt{x + \Delta x - 1}}{\Delta x \sqrt{x - 1} \sqrt{x + \Delta x - 1}} \frac{\sqrt{x - 1} + \sqrt{x + \Delta x - 1}}{\sqrt{x - 1} + \sqrt{x + \Delta x - 1}} =$$

$$= \lim_{\Delta x \rightarrow 0} \frac{-\Delta x}{\Delta x \sqrt{x - 1} \sqrt{x + \Delta x - 1} (\sqrt{x - 1} + \sqrt{x + \Delta x - 1})} = \lim_{\Delta x \rightarrow 0} \frac{-1}{\sqrt{x - 1} \sqrt{x + \Delta x - 1} (\sqrt{x - 1} + \sqrt{x + \Delta x - 1})} =$$

$$-\frac{1}{2(x - 1)^{3/2}}.$$

$$21. f'(t) = \lim_{h \rightarrow 0} \frac{f(t + h) - f(t)}{h} = \lim_{h \rightarrow 0} \frac{[4(t + h)^2 + (t + h)] - [4t^2 + t]}{h} = \lim_{h \rightarrow 0} \frac{4t^2 + 8th + 4h^2 + t + h - 4t^2 - t}{h} =$$

$$\lim_{h \rightarrow 0} \frac{8th + 4h^2 + h}{h} = \lim_{h \rightarrow 0} (8t + 4h + 1) = 8t + 1.$$

$$22. \frac{dV}{dr} = \lim_{h \rightarrow 0} \frac{\frac{4}{3}\pi(r + h)^3 - \frac{4}{3}\pi r^3}{h} = \lim_{h \rightarrow 0} \frac{\frac{4}{3}\pi(r^3 + 3r^2h + 3rh^2 + h^3 - r^3)}{h} = \lim_{h \rightarrow 0} \frac{4}{3}\pi(3r^2 + 3rh + h^2) = 4\pi r^2.$$

23. (a) D (b) F (c) B (d) C (e) A (f) E

24. $f'(\sqrt{2}/2)$ is the slope of the tangent line to the unit circle at $(\sqrt{2}/2, \sqrt{2}/2)$. This line is perpendicular to the line $y = x$, so its slope is -1.

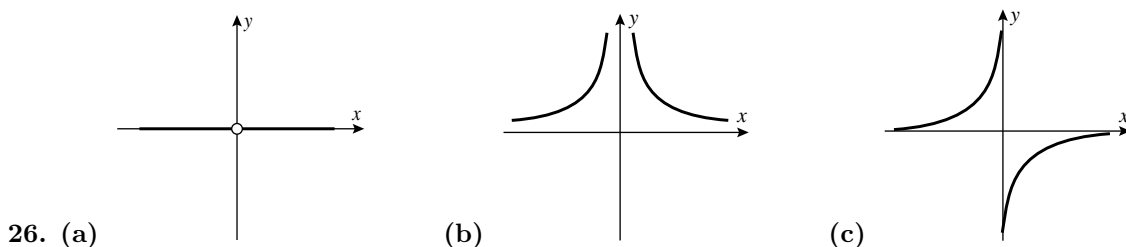
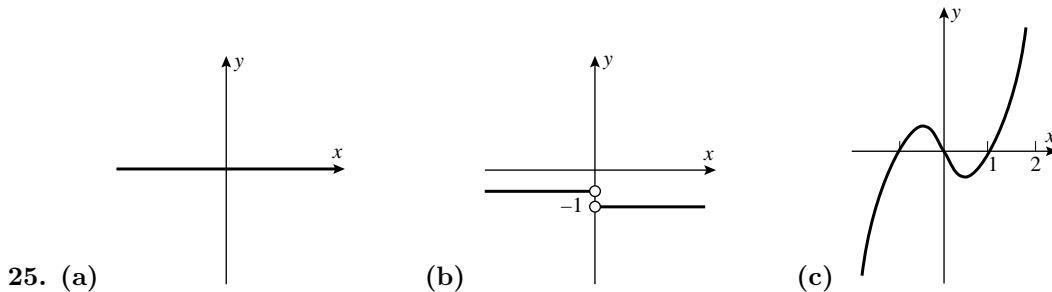
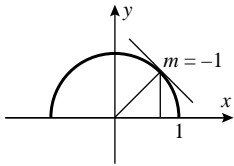

27. False. If the tangent line is horizontal then $f'(a) = 0$.
28. True. $f'(-2)$ equals the slope of the tangent line.
29. False. E.g. $|x|$ is continuous but not differentiable at $x = 0$.
30. True. See Theorem 2.2.3.
31. (a) $f(x) = \sqrt{x}$ and $a = 1$ (b) $f(x) = x^2$ and $a = 3$
32. (a) $f(x) = \cos x$ and $a = \pi$ (b) $f(x) = x^7$ and $a = 1$

$$33. \frac{dy}{dx} = \lim_{h \rightarrow 0} \frac{(1 - (x+h)^2) - (1 - x^2)}{h} = \lim_{h \rightarrow 0} \frac{-2xh - h^2}{h} = \lim_{h \rightarrow 0} (-2x - h) = -2x, \text{ and } \left. \frac{dy}{dx} \right|_{x=1} = -2.$$

$$34. \frac{dy}{dx} = \lim_{h \rightarrow 0} \frac{\frac{x+2+h}{x+h} - \frac{x+2}{x}}{h} = \lim_{h \rightarrow 0} \frac{x(x+2+h) - (x+2)(x+h)}{hx(x+h)} = \lim_{h \rightarrow 0} \frac{-2}{x(x+h)} = \frac{-2}{x^2}, \text{ and } \left. \frac{dy}{dx} \right|_{x=-2} = -\frac{1}{2}.$$

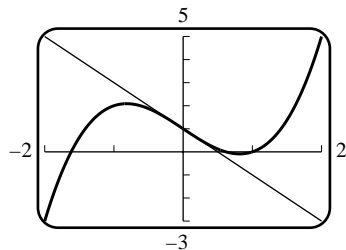

35. $y = -2x + 1$

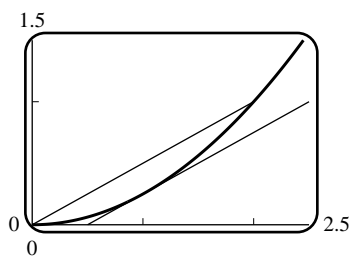

36. 0

37. (b)

w	1.5	1.1	1.01	1.001	1.0001	1.00001
$\frac{f(w) - f(1)}{w - 1}$	1.6569	1.4355	1.3911	1.3868	1.3863	1.3863
w	0.5	0.9	0.99	0.999	0.9999	0.99999
$\frac{f(w) - f(1)}{w - 1}$	1.1716	1.3393	1.3815	1.3858	1.3863	1.3863

38. (b)

w	$\frac{\pi}{4} + 0.5$	$\frac{\pi}{4} + 0.1$	$\frac{\pi}{4} + 0.01$	$\frac{\pi}{4} + 0.001$	$\frac{\pi}{4} + 0.0001$	$\frac{\pi}{4} + 0.00001$
$\frac{f(w) - f(\pi/4)}{w - \pi/4}$	0.50489	0.67060	0.70356	0.70675	0.70707	0.70710
w	$\frac{\pi}{4} - 0.5$	$\frac{\pi}{4} - 0.1$	$\frac{\pi}{4} - 0.01$	$\frac{\pi}{4} - 0.001$	$\frac{\pi}{4} - 0.0001$	$\frac{\pi}{4} - 0.00001$
$\frac{f(w) - f(\pi/4)}{w - \pi/4}$	0.85114	0.74126	0.71063	0.70746	0.70714	0.70711

39. (a) $\frac{f(3) - f(1)}{3 - 1} = \frac{2.2 - 2.12}{2} = 0.04$; $\frac{f(2) - f(1)}{2 - 1} = \frac{2.34 - 2.12}{1} = 0.22$; $\frac{f(2) - f(0)}{2 - 0} = \frac{2.34 - 0.58}{2} = 0.88$.

(b) The tangent line at $x = 1$ appears to have slope about 0.8, so $\frac{f(2) - f(0)}{2 - 0}$ gives the best approximation and $\frac{f(3) - f(1)}{3 - 1}$ gives the worst.

40. (a) $f'(0.5) \approx \frac{f(1) - f(0)}{1 - 0} = \frac{2.12 - 0.58}{1} = 1.54$.

(b) $f'(2.5) \approx \frac{f(3) - f(2)}{3 - 2} = \frac{2.2 - 2.34}{1} = -0.14$.

41. (a) dollars/ft

(b) $f'(x)$ is roughly the price per additional foot.

(c) If each additional foot costs extra money (this is to be expected) then $f'(x)$ remains positive.

(d) From the approximation $1000 = f'(300) \approx \frac{f(301) - f(300)}{301 - 300}$ we see that $f(301) \approx f(300) + 1000$, so the extra foot will cost around \$1000.

42. (a) $\frac{\text{gallons}}{\text{dollars/gallon}} = \text{gallons}^2/\text{dollar}$

(b) The increase in the amount of paint that would be sold for one extra dollar per gallon.

(c) It should be negative since an increase in the price of paint would decrease the amount of paint sold.

(d) From $-100 = f'(10) \approx \frac{f(11) - f(10)}{11 - 10}$ we see that $f(11) \approx f(10) - 100$, so an increase of one dollar per gallon would decrease the amount of paint sold by around 100 gallons.

43. (a) $F \approx 200$ lb, $dF/d\theta \approx 50$ (b) $\mu = (dF/d\theta)/F \approx 50/200 = 0.25$

44. The derivative at time $t = 100$ of the velocity with respect to time is equal to the slope of the tangent line, which is approximately $m \approx \frac{12500 - 0}{140 - 40} = 125$ ft/s². Thus the mass is approximately $M(100) \approx \frac{T}{dv/dt} = \frac{7680982 \text{ lb}}{125 \text{ ft/s}^2} \approx 61000$ slugs.

45. (a) $T \approx 115^\circ\text{F}$, $dT/dt \approx -3.35^\circ\text{F}/\text{min}$ (b) $k = (dT/dt)/(T - T_0) \approx (-3.35)/(115 - 75) = -0.084$

46. (a) $\lim_{x \rightarrow 0} f(x) = \lim_{x \rightarrow 0} \sqrt[3]{x} = 0 = f(0)$, so f is continuous at $x = 0$. $\lim_{h \rightarrow 0} \frac{f(0+h) - f(0)}{h} = \lim_{h \rightarrow 0} \frac{\sqrt[3]{h} - 0}{h} = \lim_{h \rightarrow 0} \frac{1}{h^{2/3}} = +\infty$, so $f'(0)$ does not exist.

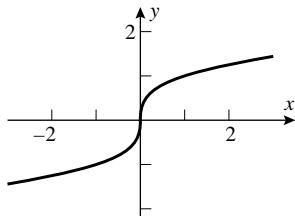

(b) $\lim_{x \rightarrow 2} f(x) = \lim_{x \rightarrow 2} (x-2)^{2/3} = 0 = f(2)$ so f is continuous at $x = 2$. $\lim_{h \rightarrow 0} \frac{f(2+h) - f(2)}{h} = \lim_{h \rightarrow 0} \frac{h^{2/3} - 0}{h} = \lim_{h \rightarrow 0} \frac{1}{h^{1/3}}$ which does not exist so $f'(2)$ does not exist.

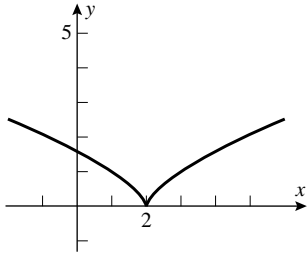

47. $\lim_{x \rightarrow 1^-} f(x) = \lim_{x \rightarrow 1^+} f(x) = f(1)$, so f is continuous at $x = 1$. $\lim_{h \rightarrow 0^-} \frac{f(1+h) - f(1)}{h} = \lim_{h \rightarrow 0^-} \frac{[(1+h)^2 + 1] - 2}{h} = \lim_{h \rightarrow 0^-} (2+h) = 2$; $\lim_{h \rightarrow 0^+} \frac{f(1+h) - f(1)}{h} = \lim_{h \rightarrow 0^+} \frac{2(1+h) - 2}{h} = \lim_{h \rightarrow 0^+} 2 = 2$, so $f'(1) = 2$.

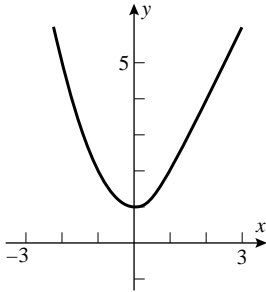

48. $\lim_{x \rightarrow 1^-} f(x) = \lim_{x \rightarrow 1^+} f(x) = f(1)$ so f is continuous at $x = 1$. $\lim_{h \rightarrow 0^-} \frac{f(1+h) - f(1)}{h} = \lim_{h \rightarrow 0^-} \frac{[(1+h)^2 + 2] - 3}{h} = \lim_{h \rightarrow 0^-} (2+h) = 2$; $\lim_{h \rightarrow 0^+} \frac{f(1+h) - f(1)}{h} = \lim_{h \rightarrow 0^+} \frac{[(1+h) + 2] - 3}{h} = \lim_{h \rightarrow 0^+} 1 = 1$, so $f'(1)$ does not exist.

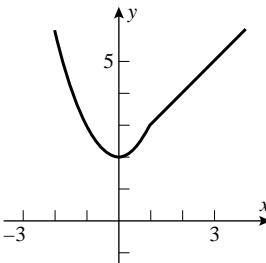

49. Since $-|x| \leq x \sin(1/x) \leq |x|$ it follows by the Squeezing Theorem (Theorem 1.6.4) that $\lim_{x \rightarrow 0} x \sin(1/x) = 0$. The derivative cannot exist: consider $\frac{f(x) - f(0)}{x} = \sin(1/x)$. This function oscillates between -1 and $+1$ and does not tend to any number as x tends to zero.

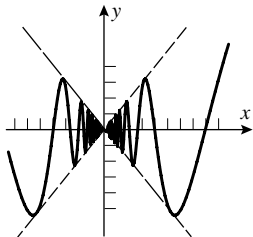

50. For continuity, compare with $\pm x^2$ to establish that the limit is zero. The difference quotient is $x \sin(1/x)$ and (see Exercise 49) this has a limit of zero at the origin.

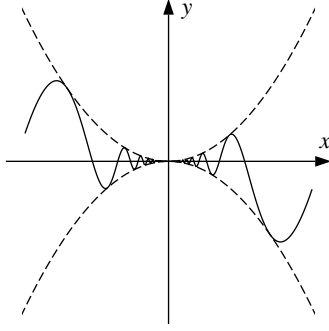

51. Let $\epsilon = |f'(x_0)/2|$. Then there exists $\delta > 0$ such that if $0 < |x - x_0| < \delta$, then $\left| \frac{f(x) - f(x_0)}{x - x_0} - f'(x_0) \right| < \epsilon$. Since $f'(x_0) > 0$ and $\epsilon = f'(x_0)/2$ it follows that $\frac{f(x) - f(x_0)}{x - x_0} > \epsilon > 0$. If $x = x_1 < x_0$ then $f(x_1) < f(x_0)$ and if $x = x_2 > x_0$ then $f(x_2) > f(x_0)$.

52.
$$g'(x_1) = \lim_{h \rightarrow 0} \frac{g(x_1 + h) - g(x_1)}{h} = \lim_{h \rightarrow 0} \frac{f(m(x_1 + h) + b) - f(mx_1 + b)}{h} = m \lim_{h \rightarrow 0} \frac{f(x_0 + mh) - f(x_0)}{mh} = mf'(x_0).$$

53. (a) Let $\epsilon = |m|/2$. Since $m \neq 0$, $\epsilon > 0$. Since $f(0) = f'(0) = 0$ we know there exists $\delta > 0$ such that $\left| \frac{f(0 + h) - f(0)}{h} \right| < \epsilon$ whenever $0 < |h| < \delta$. It follows that $|f(h)| < \frac{1}{2}|hm|$ for $0 < |h| < \delta$. Replace h with x to get the result.

(b) For $0 < |x| < \delta$, $|f(x)| < \frac{1}{2}|mx|$. Moreover $|mx| = |mx - f(x) + f(x)| \leq |f(x) - mx| + |f(x)|$, which yields $|f(x) - mx| \geq |mx| - |f(x)| > \frac{1}{2}|mx| > |f(x)|$, i.e. $|f(x) - mx| > |f(x)|$.

(c) If any straight line $y = mx + b$ is to approximate the curve $y = f(x)$ for small values of x , then $b = 0$ since $f(0) = 0$. The inequality $|f(x) - mx| > |f(x)|$ can also be interpreted as $|f(x) - mx| > |f(x) - 0|$, i.e. the line $y = 0$ is a better approximation than is $y = mx$.

54. Let $g(x) = f(x) - [f(x_0) + f'(x_0)(x - x_0)]$ and $h(x) = f(x) - [f(x_0) + m(x - x_0)]$; note that $h(x) - g(x) = (f'(x_0) - m)(x - x_0)$. If $m \neq f'(x_0)$ then there exists $\delta > 0$ such that if $0 < |x - x_0| < \delta$ then $\left| \frac{f(x) - f(x_0)}{x - x_0} - f'(x_0) \right| < \frac{1}{2}|f'(x_0) - m|$. Multiplying by $|x - x_0|$ gives $|g(x)| < \frac{1}{2}|h(x) - g(x)|$. Hence $2|g(x)| < |h(x) + (-g(x))| \leq |h(x)| + |g(x)|$, so $|g(x)| < |h(x)|$. In words, $f(x)$ is closer to $f(x_0) + f'(x_0)(x - x_0)$ than it is to $f(x_0) + m(x - x_0)$. So the tangent line gives a better approximation to $f(x)$ than any other line through $(x_0, f(x_0))$. Clearly any line not passing through that point gives an even worse approximation for x near x_0 , so the tangent line gives the best linear approximation.

55. See discussion around Definition 2.2.2.

56. See Theorem 2.2.3.

Exercise Set 2.3

1. $28x^6$, by Theorems 2.3.2 and 2.3.4.
2. $-36x^{11}$, by Theorems 2.3.2 and 2.3.4.
3. $24x^7 + 2$, by Theorems 2.3.1, 2.3.2, 2.3.4, and 2.3.5.
4. $2x^3$, by Theorems 2.3.1, 2.3.2, 2.3.4, and 2.3.5.

5. 0, by Theorem 2.3.1.
6. $\sqrt{2}$, by Theorems 2.3.1, 2.3.2, 2.3.4, and 2.3.5.
7. $-\frac{1}{3}(7x^6 + 2)$, by Theorems 2.3.1, 2.3.2, 2.3.4, and 2.3.5.
8. $\frac{2}{5}x$, by Theorems 2.3.1, 2.3.2, 2.3.4, and 2.3.5.
9. $-3x^{-4} - 7x^{-8}$, by Theorems 2.3.3 and 2.3.5.
10. $\frac{1}{2\sqrt{x}} - \frac{1}{x^2}$, by Theorems 2.3.3 and 2.3.5.
11. $24x^{-9} + 1/\sqrt{x}$, by Theorems 2.3.3, 2.3.4, and 2.3.5.
12. $-42x^{-7} - \frac{5}{2\sqrt{x}}$, by Theorems 2.3.3, 2.3.4, and 2.3.5.
13. $f'(x) = ex^{e-1} - \sqrt{10}x^{-1-\sqrt{10}}$, by Theorems 2.3.3 and 2.3.5.
14. $f'(x) = -\frac{2}{3}x^{-4/3}$, by Theorems 2.3.3 and 2.3.4.
15. $(3x^2 + 1)^2 = 9x^4 + 6x^2 + 1$, so $f'(x) = 36x^3 + 12x$, by Theorems 2.3.1, 2.3.2, 2.3.4, and 2.3.5.
16. $3ax^2 + 2bx + c$, by Theorems 2.3.1, 2.3.2, 2.3.4, and 2.3.5.
17. $y' = 10x - 3$, $y'(1) = 7$.
18. $y' = \frac{1}{2\sqrt{x}} - \frac{2}{x^2}$, $y'(1) = -3/2$.
19. $2t - 1$, by Theorems 2.3.2 and 2.3.5.
20. $\frac{1}{3} - \frac{1}{3t^2}$, by Theorems 2.3.3, 2.3.4, and 2.3.5.
21. $dy/dx = 1 + 2x + 3x^2 + 4x^3 + 5x^4$, $dy/dx|_{x=1} = 15$.
22. $\frac{dy}{dx} = \frac{-3}{x^4} - \frac{2}{x^3} - \frac{1}{x^2} + 1 + 2x + 3x^2$, $\frac{dy}{dx}|_{x=1} = 0$.
23. $y = (1 - x^2)(1 + x^2)(1 + x^4) = (1 - x^4)(1 + x^4) = 1 - x^8$, $\frac{dy}{dx} = -8x^7$, $dy/dx|_{x=1} = -8$.
24. $dy/dx = 24x^{23} + 24x^{11} + 24x^7 + 24x^5$, $dy/dx|_{x=1} = 96$.
25. $f'(1) \approx \frac{f(1.01) - f(1)}{0.01} = \frac{-0.999699 - (-1)}{0.01} = 0.0301$, and by differentiation, $f'(1) = 3(1)^2 - 3 = 0$.
26. $f'(1) \approx \frac{f(1.01) - f(1)}{0.01} \approx \frac{0.980296 - 1}{0.01} \approx -1.9704$, and by differentiation, $f'(1) = -2/1^3 = -2$.
27. The estimate will depend on your graphing utility and on how far you zoom in. Since $f'(x) = 1 - \frac{1}{x^2}$, the exact value is $f'(1) = 0$.

28. The estimate will depend on your graphing utility and on how far you zoom in. Since $f'(x) = \frac{1}{2\sqrt{x}} + 2$, the exact value is $f'(1) = 5/2$.
29. $32t$, by Theorems 2.3.2 and 2.3.4.
30. 2π , by Theorems 2.3.2 and 2.3.4.
31. $3\pi r^2$, by Theorems 2.3.2 and 2.3.4.
32. $-2\alpha^{-2} + 1$, by Theorems 2.3.2, 2.3.4, and 2.3.5.
33. True. By Theorems 2.3.4 and 2.3.5, $\frac{d}{dx}[f(x) - 8g(x)] = f'(x) - 8g'(x)$; substitute $x = 2$ to get the result.
34. True. $\frac{d}{dx}[ax^3 + bx^2 + cx + d] = 3ax^2 + 2bx + c$.
35. False. $\left. \frac{d}{dx}[4f(x) + x^3] \right|_{x=2} = (4f'(x) + 3x^2)|_{x=2} = 4f'(2) + 3 \cdot 2^2 = 32$
36. False. $f(x) = x^6 - x^3$ so $f'(x) = 6x^5 - 3x^2$ and $f''(x) = 30x^4 - 6x$, which is not equal to $2x(4x^3 - 1) = 8x^4 - 2x$.
37. (a) $\frac{dV}{dr} = 4\pi r^2$ (b) $\left. \frac{dV}{dr} \right|_{r=5} = 4\pi(5)^2 = 100\pi$
38. $\frac{d}{d\lambda} \left[\frac{\lambda\lambda_0 + \lambda^6}{2 - \lambda_0} \right] = \frac{1}{2 - \lambda_0} \frac{d}{d\lambda}(\lambda\lambda_0 + \lambda^6) = \frac{1}{2 - \lambda_0}(\lambda_0 + 6\lambda^5) = \frac{\lambda_0 + 6\lambda^5}{2 - \lambda_0}$.
39. $y - 2 = 5(x + 3)$, $y = 5x + 17$.
40. $y + 2 = -(x - 2)$, $y = -x$.
41. (a) $dy/dx = 21x^2 - 10x + 1$, $d^2y/dx^2 = 42x - 10$ (b) $dy/dx = 24x - 2$, $d^2y/dx^2 = 24$
 (c) $dy/dx = -1/x^2$, $d^2y/dx^2 = 2/x^3$ (d) $dy/dx = 175x^4 - 48x^2 - 3$, $d^2y/dx^2 = 700x^3 - 96x$
42. (a) $y' = 28x^6 - 15x^2 + 2$, $y'' = 168x^5 - 30x$ (b) $y' = 3$, $y'' = 0$
 (c) $y' = \frac{2}{5x^2}$, $y'' = -\frac{4}{5x^3}$ (d) $y' = 8x^3 + 9x^2 - 10$, $y'' = 24x^2 + 18x$
43. (a) $y' = -5x^{-6} + 5x^4$, $y'' = 30x^{-7} + 20x^3$, $y''' = -210x^{-8} + 60x^2$
 (b) $y = x^{-1}$, $y' = -x^{-2}$, $y'' = 2x^{-3}$, $y''' = -6x^{-4}$
 (c) $y' = 3ax^2 + b$, $y'' = 6ax$, $y''' = 6a$
44. (a) $dy/dx = 10x - 4$, $d^2y/dx^2 = 10$, $d^3y/dx^3 = 0$
 (b) $dy/dx = -6x^{-3} - 4x^{-2} + 1$, $d^2y/dx^2 = 18x^{-4} + 8x^{-3}$, $d^3y/dx^3 = -72x^{-5} - 24x^{-4}$
 (c) $dy/dx = 4ax^3 + 2bx$, $d^2y/dx^2 = 12ax^2 + 2b$, $d^3y/dx^3 = 24ax$
45. (a) $f'(x) = 6x$, $f''(x) = 6$, $f'''(x) = 0$, $f'''(2) = 0$

$$(b) \frac{dy}{dx} = 30x^4 - 8x, \frac{d^2y}{dx^2} = 120x^3 - 8, \left. \frac{d^2y}{dx^2} \right|_{x=1} = 112$$

$$(c) \frac{d}{dx} [x^{-3}] = -3x^{-4}, \frac{d^2}{dx^2} [x^{-3}] = 12x^{-5}, \frac{d^3}{dx^3} [x^{-3}] = -60x^{-6}, \frac{d^4}{dx^4} [x^{-3}] = 360x^{-7}, \left. \frac{d^4}{dx^4} [x^{-3}] \right|_{x=1} = 360$$

$$46. (a) y' = 16x^3 + 6x^2, y'' = 48x^2 + 12x, y''' = 96x + 12, y'''(0) = 12$$

$$(b) y = 6x^{-4}, \frac{dy}{dx} = -24x^{-5}, \frac{d^2y}{dx^2} = 120x^{-6}, \frac{d^3y}{dx^3} = -720x^{-7}, \frac{d^4y}{dx^4} = 5040x^{-8}, \left. \frac{d^4y}{dx^4} \right|_{x=1} = 5040$$

$$47. y' = 3x^2 + 3, y'' = 6x, \text{ and } y''' = 6 \text{ so } y''' + xy'' - 2y' = 6 + x(6x) - 2(3x^2 + 3) = 6 + 6x^2 - 6x^2 - 6 = 0.$$

$$48. y = x^{-1}, y' = -x^{-2}, y'' = 2x^{-3} \text{ so } x^3y'' + x^2y' - xy = x^3(2x^{-3}) + x^2(-x^{-2}) - x(x^{-1}) = 2 - 1 - 1 = 0.$$

49. The graph has a horizontal tangent at points where $\frac{dy}{dx} = 0$, but $\frac{dy}{dx} = x^2 - 3x + 2 = (x-1)(x-2) = 0$ if $x = 1, 2$. The corresponding values of y are $5/6$ and $2/3$ so the tangent line is horizontal at $(1, 5/6)$ and $(2, 2/3)$.

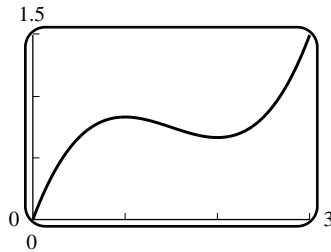

50. Find where $f'(x) = 0$: $f'(x) = 1 - 9/x^2 = 0$, $x^2 = 9$, $x = \pm 3$. The tangent line is horizontal at $(3, 6)$ and $(-3, -6)$.

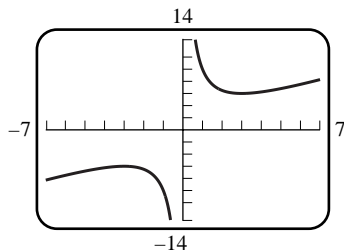

51. The y -intercept is -2 so the point $(0, -2)$ is on the graph; $-2 = a(0)^2 + b(0) + c$, $c = -2$. The x -intercept is 1 so the point $(1, 0)$ is on the graph; $0 = a + b - 2$. The slope is $dy/dx = 2ax + b$; at $x = 0$ the slope is b so $b = -1$, thus $a = 3$. The function is $y = 3x^2 - x - 2$.

52. Let $P(x_0, y_0)$ be the point where $y = x^2 + k$ is tangent to $y = 2x$. The slope of the curve is $\frac{dy}{dx} = 2x$ and the slope of the line is 2 thus at P , $2x_0 = 2$ so $x_0 = 1$. But P is on the line, so $y_0 = 2x_0 = 2$. Because P is also on the curve we get $y_0 = x_0^2 + k$ so $k = y_0 - x_0^2 = 2 - (1)^2 = 1$.

53. The points $(-1, 1)$ and $(2, 4)$ are on the secant line so its slope is $(4 - 1)/(2 + 1) = 1$. The slope of the tangent line to $y = x^2$ is $y' = 2x$ so $2x = 1$, $x = 1/2$.

54. The points $(1, 1)$ and $(4, 2)$ are on the secant line so its slope is $1/3$. The slope of the tangent line to $y = \sqrt{x}$ is $y' = 1/(2\sqrt{x})$ so $1/(2\sqrt{x}) = 1/3$, $2\sqrt{x} = 3$, $x = 9/4$.

55. $y' = -2x$, so at any point (x_0, y_0) on $y = 1 - x^2$ the tangent line is $y - y_0 = -2x_0(x - x_0)$, or $y = -2x_0x + x_0^2 + 1$. The point $(2, 0)$ is to be on the line, so $0 = -4x_0 + x_0^2 + 1$, $x_0^2 - 4x_0 + 1 = 0$. Use the quadratic formula to get $x_0 = \frac{4 \pm \sqrt{16 - 4}}{2} = 2 \pm \sqrt{3}$. The points are $(2 + \sqrt{3}, -6 - 4\sqrt{3})$ and $(2 - \sqrt{3}, -6 + 4\sqrt{3})$.

56. Let $P_1(x_1, ax_1^2)$ and $P_2(x_2, ax_2^2)$ be the points of tangency. $y' = 2ax$ so the tangent lines at P_1 and P_2 are $y - ax_1^2 = 2ax_1(x - x_1)$ and $y - ax_2^2 = 2ax_2(x - x_2)$. Solve for x to get $x = \frac{1}{2}(x_1 + x_2)$ which is the x -coordinate of a point on the vertical line halfway between P_1 and P_2 .

57. $y' = 3ax^2 + b$; the tangent line at $x = x_0$ is $y - y_0 = (3ax_0^2 + b)(x - x_0)$ where $y_0 = ax_0^3 + bx_0$. Solve with $y = ax^3 + bx$ to get

$$\begin{aligned} (ax^3 + bx) - (ax_0^3 + bx_0) &= (3ax_0^2 + b)(x - x_0) \\ ax^3 + bx - ax_0^3 - bx_0 &= 3ax_0^2x - 3ax_0^3 + bx - bx_0 \\ x^3 - 3x_0^2x + 2x_0^3 &= 0 \\ (x - x_0)(x^2 + xx_0 - 2x_0^2) &= 0 \\ (x - x_0)^2(x + 2x_0) &= 0, \text{ so } x = -2x_0. \end{aligned}$$

58. Let (x_0, y_0) be the point of tangency. Note that $y_0 = 1/x_0$. Since $y' = -1/x^2$, the tangent line has the equation $y - y_0 = (-1/x_0^2)(x - x_0)$, or $y - \frac{1}{x_0} = -\frac{1}{x_0^2}x + \frac{1}{x_0}$ or $y = -\frac{1}{x_0^2}x + \frac{2}{x_0}$, with intercepts at $(0, \frac{2}{x_0}) = (0, 2y_0)$ and $(2x_0, 0)$. The distance from the y -intercept to the point of tangency is $\sqrt{(x_0 - 0)^2 + (y_0 - 2y_0)^2}$, and the distance from the x -intercept to the point of tangency is $\sqrt{(x_0 - 2x_0)^2 + (y_0 - 0)^2}$ so that they are equal (and equal the distance $\sqrt{x_0^2 + y_0^2}$ from the point of tangency to the origin).

59. $y' = -\frac{1}{x^2}$; the tangent line at $x = x_0$ is $y - y_0 = -\frac{1}{x_0^2}(x - x_0)$, or $y = -\frac{x}{x_0^2} + \frac{2}{x_0}$. The tangent line crosses the x -axis at $2x_0$, the y -axis at $2/x_0$, so that the area of the triangle is $\frac{1}{2}(2/x_0)(2x_0) = 2$.

60. $f'(x) = 3ax^2 + 2bx + c$; there is a horizontal tangent where $f'(x) = 0$. Use the quadratic formula on $3ax^2 + 2bx + c = 0$ to get $x = (-b \pm \sqrt{b^2 - 3ac})/(3a)$ which gives two real solutions, one real solution, or none if

- (a) $b^2 - 3ac > 0$ (b) $b^2 - 3ac = 0$ (c) $b^2 - 3ac < 0$

61. $F = GmMr^{-2}$, $\frac{dF}{dr} = -2GmMr^{-3} = -\frac{2GmM}{r^3}$

62. $dR/dT = 0.04124 - 3.558 \times 10^{-5}T$ which decreases as T increases from 0 to 700. When $T = 0$, $dR/dT = 0.04124 \Omega/^\circ\text{C}$; when $T = 700$, $dR/dT = 0.01633 \Omega/^\circ\text{C}$. The resistance is most sensitive to temperature changes at $T = 0^\circ\text{C}$, least sensitive at $T = 700^\circ\text{C}$.

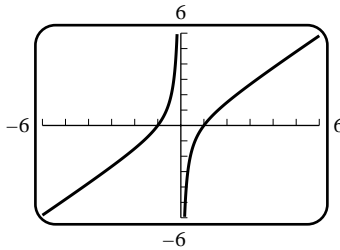

63. $f'(x) = 1 + 1/x^2 > 0$ for all $x \neq 0$

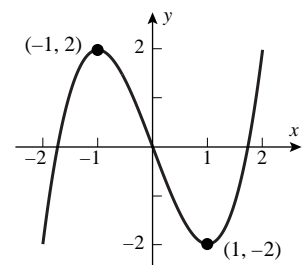

64. $f'(x) = 3x^2 - 3 = 0$ when $x = \pm 1$; $f'(x) > 0$ for $-\infty < x < -1$ and $1 < x < +\infty$

65. f is continuous at 1 because $\lim_{x \rightarrow 1^-} f(x) = \lim_{x \rightarrow 1^+} f(x) = f(1)$; also $\lim_{x \rightarrow 1^-} f'(x) = \lim_{x \rightarrow 1^-} (2x + 1) = 3$ and $\lim_{x \rightarrow 1^+} f'(x) = \lim_{x \rightarrow 1^+} 3 = 3$ so f is differentiable at 1, and the derivative equals 3.

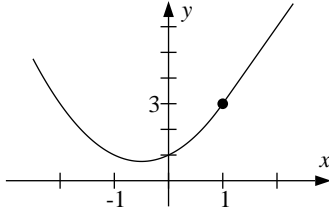

66. f is not continuous at $x = 9$ because $\lim_{x \rightarrow 9^-} f(x) = -63$ and $\lim_{x \rightarrow 9^+} f(x) = 3$. f cannot be differentiable at $x = 9$, for if it were, then f would also be continuous, which it is not.

67. f is continuous at 1 because $\lim_{x \rightarrow 1^-} f(x) = \lim_{x \rightarrow 1^+} f(x) = f(1)$. Also, $\lim_{x \rightarrow 1^-} \frac{f(x) - f(1)}{x - 1}$ equals the derivative of x^2 at $x = 1$, namely $2x|_{x=1} = 2$, while $\lim_{x \rightarrow 1^+} \frac{f(x) - f(1)}{x - 1}$ equals the derivative of \sqrt{x} at $x = 1$, namely $\frac{1}{2\sqrt{x}} \Big|_{x=1} = \frac{1}{2}$. Since these are not equal, f is not differentiable at $x = 1$.

68. f is continuous at $1/2$ because $\lim_{x \rightarrow 1/2^-} f(x) = \lim_{x \rightarrow 1/2^+} f(x) = f(1/2)$; also $\lim_{x \rightarrow 1/2^-} f'(x) = \lim_{x \rightarrow 1/2^-} 3x^2 = 3/4$ and $\lim_{x \rightarrow 1/2^+} f'(x) = \lim_{x \rightarrow 1/2^+} 3x/2 = 3/4$ so $f'(1/2) = 3/4$, and f is differentiable at $x = 1/2$.

69. (a) $f(x) = 3x - 2$ if $x \geq 2/3$, $f(x) = -3x + 2$ if $x < 2/3$ so f is differentiable everywhere except perhaps at $2/3$. f is continuous at $2/3$, also $\lim_{x \rightarrow 2/3^-} f'(x) = \lim_{x \rightarrow 2/3^-} (-3) = -3$ and $\lim_{x \rightarrow 2/3^+} f'(x) = \lim_{x \rightarrow 2/3^+} (3) = 3$ so f is not differentiable at $x = 2/3$.

(b) $f(x) = x^2 - 4$ if $|x| \geq 2$, $f(x) = -x^2 + 4$ if $|x| < 2$ so f is differentiable everywhere except perhaps at ± 2 . f is continuous at -2 and 2 , also $\lim_{x \rightarrow 2^-} f'(x) = \lim_{x \rightarrow 2^-} (-2x) = -4$ and $\lim_{x \rightarrow 2^+} f'(x) = \lim_{x \rightarrow 2^+} (2x) = 4$ so f is not differentiable at $x = 2$. Similarly, f is not differentiable at $x = -2$.

70. (a) $f'(x) = -(1)x^{-2}$, $f''(x) = (2 \cdot 1)x^{-3}$, $f'''(x) = -(3 \cdot 2 \cdot 1)x^{-4}$, $f^{(n)}(x) = (-1)^n \frac{n(n-1)(n-2) \cdots 1}{x^{n+1}}$

(b) $f'(x) = -2x^{-3}$, $f''(x) = (3 \cdot 2)x^{-4}$, $f'''(x) = -(4 \cdot 3 \cdot 2)x^{-5}$, $f^{(n)}(x) = (-1)^n \frac{(n+1)(n)(n-1) \cdots 2}{x^{n+2}}$

71. (a)

$$\frac{d^2}{dx^2}[cf(x)] = \frac{d}{dx} \left[\frac{d}{dx}[cf(x)] \right] = \frac{d}{dx} \left[c \frac{d}{dx}[f(x)] \right] = c \frac{d}{dx} \left[\frac{d}{dx}[f(x)] \right] = c \frac{d^2}{dx^2}[f(x)]$$

$$\frac{d^2}{dx^2}[f(x) + g(x)] = \frac{d}{dx} \left[\frac{d}{dx}[f(x) + g(x)] \right] = \frac{d}{dx} \left[\frac{d}{dx}[f(x)] + \frac{d}{dx}[g(x)] \right] = \frac{d^2}{dx^2}[f(x)] + \frac{d^2}{dx^2}[g(x)]$$

(b) Yes, by repeated application of the procedure illustrated in part (a).

72. $\lim_{w \rightarrow 2} \frac{f'(w) - f'(2)}{w - 2} = f''(2)$; $f'(x) = 8x^7 - 2$, $f''(x) = 56x^6$, so $f''(2) = 56(2^6) = 3584$.

73. (a) $f'(x) = nx^{n-1}$, $f''(x) = n(n-1)x^{n-2}$, $f'''(x) = n(n-1)(n-2)x^{n-3}$, ..., $f^{(n)}(x) = n(n-1)(n-2) \cdots 1$

(b) From part (a), $f^{(k)}(x) = k(k-1)(k-2) \cdots 1$ so $f^{(k+1)}(x) = 0$ thus $f^{(n)}(x) = 0$ if $n > k$.

(c) From parts (a) and (b), $f^{(n)}(x) = a_n n(n-1)(n-2) \cdots 1$.

74. (a) If a function is differentiable at a point then it is continuous at that point, thus f' is continuous on (a, b) and consequently so is f .

(b) f and all its derivatives up to $f^{(n-1)}(x)$ are continuous on (a, b) .

75. Let $g(x) = x^n, f(x) = (mx + b)^n$. Use Exercise 52 in Section 2.2, but with f and g permuted. If $x_0 = mx_1 + b$ then Exercise 52 says that f is differentiable at x_1 and $f'(x_1) = mg'(x_0)$. Since $g'(x_0) = nx_0^{n-1}$, the result follows.

76. $f(x) = 4x^2 + 12x + 9$ so $f'(x) = 8x + 12 = 2 \cdot 2(2x + 3)$, as predicted by Exercise 75.

77. $f(x) = 27x^3 - 27x^2 + 9x - 1$ so $f'(x) = 81x^2 - 54x + 9 = 3 \cdot 3(3x - 1)^2$, as predicted by Exercise 75.

78. $f(x) = (x - 1)^{-1}$ so $f'(x) = (-1) \cdot 1(x - 1)^{-2} = -1/(x - 1)^2$.

79. $f(x) = 3(2x + 1)^{-2}$ so $f'(x) = 3(-2)2(2x + 1)^{-3} = -12/(2x + 1)^3$.

80. $f(x) = \frac{x + 1 - 1}{x + 1} = 1 - (x + 1)^{-1}$, and $f'(x) = -(-1)(x + 1)^{-2} = 1/(x + 1)^2$.

81. $f(x) = \frac{2x^2 + 4x + 2 + 1}{(x + 1)^2} = 2 + (x + 1)^{-2}$, so $f'(x) = -2(x + 1)^{-3} = -2/(x + 1)^3$.

82. (a) If $n = 0$ then $f(x) = x^0 = 1$ so $f'(x) = 0$ by Theorem 2.3.1. This equals $0x^{0-1}$, so the Extended Power Rule holds in this case.

$$\begin{aligned} \text{(b)} \quad f'(x) &= \lim_{h \rightarrow 0} \frac{f(x+h) - f(x)}{h} = \lim_{h \rightarrow 0} \frac{1/(x+h)^m - 1/x^m}{h} = \lim_{h \rightarrow 0} \frac{x^m - (x+h)^m}{hx^m(x+h)^m} = \\ &= \lim_{h \rightarrow 0} \frac{(x+h)^m - x^m}{h} \cdot \lim_{h \rightarrow 0} \left(-\frac{1}{x^m(x+h)^m} \right) = \frac{d}{dx} (x^m) \cdot \left(-\frac{1}{x^{2m}} \right) = mx^{m-1} \cdot \left(-\frac{1}{x^{2m}} \right) = -mx^{-m-1} = nx^{n-1}. \end{aligned}$$

Exercise Set 2.4

1. (a) $f(x) = 2x^2 + x - 1, f'(x) = 4x + 1$ (b) $f'(x) = (x + 1) \cdot (2) + (2x - 1) \cdot (1) = 4x + 1$

2. (a) $f(x) = 3x^4 + 5x^2 - 2, f'(x) = 12x^3 + 10x$ (b) $f'(x) = (3x^2 - 1) \cdot (2x) + (x^2 + 2) \cdot (6x) = 12x^3 + 10x$

3. (a) $f(x) = x^4 - 1, f'(x) = 4x^3$ (b) $f'(x) = (x^2 + 1) \cdot (2x) + (x^2 - 1) \cdot (2x) = 4x^3$

4. (a) $f(x) = x^3 + 1, f'(x) = 3x^2$ (b) $f'(x) = (x + 1)(2x - 1) + (x^2 - x + 1) \cdot (1) = 3x^2$

5. $f'(x) = (3x^2 + 6) \frac{d}{dx} \left(2x - \frac{1}{4} \right) + \left(2x - \frac{1}{4} \right) \frac{d}{dx} (3x^2 + 6) = (3x^2 + 6)(2) + \left(2x - \frac{1}{4} \right) (6x) = 18x^2 - \frac{3}{2}x + 12$

6. $f'(x) = (2 - x - 3x^3) \frac{d}{dx} (7 + x^5) + (7 + x^5) \frac{d}{dx} (2 - x - 3x^3) = (2 - x - 3x^3)(5x^4) + (7 + x^5)(-1 - 9x^2) = -24x^7 - 6x^5 + 10x^4 - 63x^2 - 7$

7. $f'(x) = (x^3 + 7x^2 - 8) \frac{d}{dx} (2x^{-3} + x^{-4}) + (2x^{-3} + x^{-4}) \frac{d}{dx} (x^3 + 7x^2 - 8) = (x^3 + 7x^2 - 8)(-6x^{-4} - 4x^{-5}) + (2x^{-3} + x^{-4})(3x^2 + 14x) = -15x^{-2} - 14x^{-3} + 48x^{-4} + 32x^{-5}$

8. $f'(x) = (x^{-1} + x^{-2}) \frac{d}{dx} (3x^3 + 27) + (3x^3 + 27) \frac{d}{dx} (x^{-1} + x^{-2}) = (x^{-1} + x^{-2})(9x^2) + (3x^3 + 27)(-x^{-2} - 2x^{-3}) = 3 + 6x - 27x^{-2} - 54x^{-3}$

9. $f'(x) = 1 \cdot (x^2 + 2x + 4) + (x - 2) \cdot (2x + 2) = 3x^2$

$$10. f'(x) = (2x+1)(x^2-x) + (x^2+x)(2x-1) = 4x^3 - 2x$$

$$11. f'(x) = \frac{(x^2+1)\frac{d}{dx}(3x+4) - (3x+4)\frac{d}{dx}(x^2+1)}{(x^2+1)^2} = \frac{(x^2+1) \cdot 3 - (3x+4) \cdot 2x}{(x^2+1)^2} = \frac{-3x^2 - 8x + 3}{(x^2+1)^2}$$

$$12. f'(x) = \frac{(x^4+x+1)\frac{d}{dx}(x-2) - (x-2)\frac{d}{dx}(x^4+x+1)}{(x^4+x+1)^2} = \frac{(x^4+x+1) \cdot 1 - (x-2) \cdot (4x^3+1)}{(x^4+x+1)^2} = \frac{-3x^4 + 8x^3 + 3}{(x^4+x+1)^2}$$

$$13. f'(x) = \frac{(3x-4)\frac{d}{dx}(x^2) - x^2\frac{d}{dx}(3x-4)}{(3x-4)^2} = \frac{(3x-4) \cdot 2x - x^2 \cdot 3}{(3x-4)^2} = \frac{3x^2 - 8x}{(3x-4)^2}$$

$$14. f'(x) = \frac{(3x-4)\frac{d}{dx}(2x^2+5) - (2x^2+5)\frac{d}{dx}(3x-4)}{(3x-4)^2} = \frac{(3x-4) \cdot 4x - (2x^2+5) \cdot 3}{(3x-4)^2} = \frac{6x^2 - 16x - 15}{(3x-4)^2}$$

$$15. f(x) = \frac{2x^{3/2} + x - 2x^{1/2} - 1}{x+3}, \text{ so}$$

$$\begin{aligned} f'(x) &= \frac{(x+3)\frac{d}{dx}(2x^{3/2} + x - 2x^{1/2} - 1) - (2x^{3/2} + x - 2x^{1/2} - 1)\frac{d}{dx}(x+3)}{(x+3)^2} = \\ &= \frac{(x+3) \cdot (3x^{1/2} + 1 - x^{-1/2}) - (2x^{3/2} + x - 2x^{1/2} - 1) \cdot 1}{(x+3)^2} = \frac{x^{3/2} + 10x^{1/2} + 4 - 3x^{-1/2}}{(x+3)^2} \end{aligned}$$

$$16. f(x) = \frac{-2x^{3/2} - x + 4x^{1/2} + 2}{x^2 + 3x}, \text{ so}$$

$$\begin{aligned} f'(x) &= \frac{(x^2+3x)\frac{d}{dx}(-2x^{3/2} - x + 4x^{1/2} + 2) - (-2x^{3/2} - x + 4x^{1/2} + 2)\frac{d}{dx}(x^2+3x)}{(x^2+3x)^2} = \\ &= \frac{(x^2+3x) \cdot (-3x^{1/2} - 1 + 2x^{-1/2}) - (-2x^{3/2} - x + 4x^{1/2} + 2) \cdot (2x+3)}{(x^2+3x)^2} = \\ &= \frac{x^{5/2} + x^2 - 9x^{3/2} - 4x - 6x^{1/2} - 6}{(x^2+3x)^2} \end{aligned}$$

17. This could be computed by two applications of the product rule, but it's simpler to expand $f(x)$: $f(x) = 14x + 21 + 7x^{-1} + 2x^{-2} + 3x^{-3} + x^{-4}$, so $f'(x) = 14 - 7x^{-2} - 4x^{-3} - 9x^{-4} - 4x^{-5}$.

18. This could be computed by two applications of the product rule, but it's simpler to expand $f(x)$: $f(x) = -6x^7 - 4x^6 + 16x^5 - 3x^{-2} - 2x^{-3} + 8x^{-4}$, so $f'(x) = -42x^6 - 24x^5 + 80x^4 + 6x^{-3} + 6x^{-4} - 32x^{-5}$.

19. In general, $\frac{d}{dx}[g(x)^2] = 2g(x)g'(x)$ and $\frac{d}{dx}[g(x)^3] = \frac{d}{dx}[g(x)^2g(x)] = g(x)^2g'(x) + g(x)\frac{d}{dx}[g(x)^2] = g(x)^2g'(x) + g(x) \cdot 2g(x)g'(x) = 3g(x)^2g'(x)$.

Letting $g(x) = x^7 + 2x - 3$, we have $f'(x) = 3(x^7 + 2x - 3)^2(7x^6 + 2)$.

20. In general, $\frac{d}{dx}[g(x)^2] = 2g(x)g'(x)$, so $\frac{d}{dx}[g(x)^4] = \frac{d}{dx}[(g(x)^2)^2] = 2g(x)^2 \cdot \frac{d}{dx}[g(x)^2] = 2g(x)^2 \cdot 2g(x)g'(x) = 4g(x)^3g'(x)$

Letting $g(x) = x^2 + 1$, we have $f'(x) = 4(x^2 + 1)^3 \cdot 2x = 8x(x^2 + 1)^3$.

$$21. \frac{dy}{dx} = \frac{(x+3) \cdot 2 - (2x-1) \cdot 1}{(x+3)^2} = \frac{7}{(x+3)^2}, \text{ so } \left. \frac{dy}{dx} \right|_{x=1} = \frac{7}{16}.$$

$$22. \frac{dy}{dx} = \frac{(x^2-5) \cdot 4 - (4x+1) \cdot (2x)}{(x^2-5)^2} = \frac{-4x^2 - 2x - 20}{(x^2-5)^2}, \text{ so } \left. \frac{dy}{dx} \right|_{x=1} = -\frac{26}{16} = -\frac{13}{8}.$$

$$23. \frac{dy}{dx} = \left(\frac{3x+2}{x}\right) \frac{d}{dx} (x^{-5} + 1) + (x^{-5} + 1) \frac{d}{dx} \left(\frac{3x+2}{x}\right) = \left(\frac{3x+2}{x}\right) (-5x^{-6}) + (x^{-5} + 1) \left[\frac{x(3) - (3x+2)(1)}{x^2}\right] = \left(\frac{3x+2}{x}\right) (-5x^{-6}) + (x^{-5} + 1) \left(-\frac{2}{x^2}\right); \text{ so } \left.\frac{dy}{dx}\right|_{x=1} = 5(-5) + 2(-2) = -29.$$

$$24. \frac{dy}{dx} = (2x^7 - x^2) \frac{d}{dx} \left(\frac{x-1}{x+1}\right) + \left(\frac{x-1}{x+1}\right) \frac{d}{dx} (2x^7 - x^2) = (2x^7 - x^2) \left[\frac{(x+1)(1) - (x-1)(1)}{(x+1)^2}\right] + \left(\frac{x-1}{x+1}\right) (14x^6 - 2x) = (2x^7 - x^2) \cdot \frac{2}{(x+1)^2} + \left(\frac{x-1}{x+1}\right) (14x^6 - 2x); \text{ so } \left.\frac{dy}{dx}\right|_{x=1} = (2-1) \frac{2}{4} + 0(14-2) = \frac{1}{2}.$$

$$25. f'(x) = \frac{(x^2 + 1) \cdot 1 - x \cdot 2x}{(x^2 + 1)^2} = \frac{1 - x^2}{(x^2 + 1)^2}, \text{ so } f'(1) = 0.$$

$$26. f'(x) = \frac{(x^2 + 1) \cdot 2x - (x^2 - 1) \cdot 2x}{(x^2 + 1)^2} = \frac{4x}{(x^2 + 1)^2}, \text{ so } f'(1) = 1.$$

$$27. (a) g'(x) = \sqrt{x}f'(x) + \frac{1}{2\sqrt{x}}f(x), g'(4) = (2)(-5) + \frac{1}{4}(3) = -37/4.$$

$$(b) g'(x) = \frac{xf'(x) - f(x)}{x^2}, g'(4) = \frac{(4)(-5) - 3}{16} = -23/16.$$

$$28. (a) g'(x) = 6x - 5f'(x), g'(3) = 6(3) - 5(4) = -2.$$

$$(b) g'(x) = \frac{2f(x) - (2x+1)f'(x)}{f^2(x)}, g'(3) = \frac{2(-2) - 7(4)}{(-2)^2} = -8.$$

$$29. (a) F'(x) = 5f'(x) + 2g'(x), F'(2) = 5(4) + 2(-5) = 10.$$

$$(b) F'(x) = f'(x) - 3g'(x), F'(2) = 4 - 3(-5) = 19.$$

$$(c) F'(x) = f(x)g'(x) + g(x)f'(x), F'(2) = (-1)(-5) + (1)(4) = 9.$$

$$(d) F'(x) = [g(x)f'(x) - f(x)g'(x)]/g^2(x), F'(2) = [(1)(4) - (-1)(-5)]/(1)^2 = -1.$$

$$30. (a) F'(x) = 6f'(x) - 5g'(x), F'(\pi) = 6(-1) - 5(2) = -16.$$

$$(b) F'(x) = f(x) + g(x) + x(f'(x) + g'(x)), F'(\pi) = 10 - 3 + \pi(-1 + 2) = 7 + \pi.$$

$$(c) F'(x) = 2f(x)g'(x) + 2f'(x)g(x) = 2(20) + 2(3) = 46.$$

$$(d) F'(x) = \frac{(4+g(x))f'(x) - f(x)g'(x)}{(4+g(x))^2} = \frac{(4-3)(-1) - 10(2)}{(4-3)^2} = -21.$$

$$31. \frac{dy}{dx} = \frac{2x(x+2) - (x^2-1)}{(x+2)^2}, \frac{dy}{dx} = 0 \text{ if } x^2 + 4x + 1 = 0. \text{ By the quadratic formula, } x = \frac{-4 \pm \sqrt{16-4}}{2} = -2 \pm \sqrt{3}.$$

The tangent line is horizontal at $x = -2 \pm \sqrt{3}$.

$$32. \frac{dy}{dx} = \frac{2x(x-1) - (x^2+1)}{(x-1)^2} = \frac{x^2 - 2x - 1}{(x-1)^2}. \text{ The tangent line is horizontal when it has slope 0, i.e. } x^2 - 2x - 1 = 0$$

which, by the quadratic formula, has solutions $x = \frac{2 \pm \sqrt{4+4}}{2} = 1 \pm \sqrt{2}$, the tangent line is horizontal when $x = 1 \pm \sqrt{2}$.

33. The tangent line is parallel to the line $y = x$ when it has slope 1. $\frac{dy}{dx} = \frac{2x(x+1) - (x^2+1)}{(x+1)^2} = \frac{x^2+2x-1}{(x+1)^2} = 1$ if $x^2+2x-1 = (x+1)^2$, which reduces to $-1 = +1$, impossible. Thus the tangent line is never parallel to the line $y = x$.
34. The tangent line is perpendicular to the line $y = x$ when the tangent line has slope -1 . $y = \frac{x+2+1}{x+2} = 1 + \frac{1}{x+2}$, hence $\frac{dy}{dx} = -\frac{1}{(x+2)^2} = -1$ when $(x+2)^2 = 1$, $x^2+4x+3 = 0$, $(x+1)(x+3) = 0$, $x = -1, -3$. Thus the tangent line is perpendicular to the line $y = x$ at the points $(-1, 2), (-3, 0)$.
35. Fix x_0 . The slope of the tangent line to the curve $y = \frac{1}{x+4}$ at the point $(x_0, 1/(x_0+4))$ is given by $\frac{dy}{dx} = \frac{-1}{(x+4)^2} \Big|_{x=x_0} = \frac{-1}{(x_0+4)^2}$. The tangent line to the curve at (x_0, y_0) thus has the equation $y - y_0 = \frac{-(x-x_0)}{(x_0+4)^2}$, and this line passes through the origin if its constant term $y_0 - x_0 \frac{-1}{(x_0+4)^2}$ is zero. Then $\frac{1}{x_0+4} = \frac{-x_0}{(x_0+4)^2}$, so $x_0+4 = -x_0$, $x_0 = -2$.
36. $y = \frac{2x+5}{x+2} = \frac{2x+4+1}{x+2} = 2 + \frac{1}{x+2}$, and hence $\frac{dy}{dx} = \frac{-1}{(x+2)^2}$, thus the tangent line at the point (x_0, y_0) is given by $y - y_0 = \frac{-1}{(x_0+2)^2}(x - x_0)$, where $y_0 = 2 + \frac{1}{x_0+2}$. If this line is to pass through $(0, 2)$, then $2 - y_0 = \frac{-1}{(x_0+2)^2}(-x_0)$, $\frac{-1}{x_0+2} = \frac{x_0}{(x_0+2)^2}$, $-x_0 - 2 = x_0$, so $x_0 = -1$.
37. (a) Their tangent lines at the intersection point must be perpendicular.
- (b) They intersect when $\frac{1}{x} = \frac{1}{2-x}$, $x = 2 - x$, $x = 1$, $y = 1$. The first curve has derivative $y = -\frac{1}{x^2}$, so the slope when $x = 1$ is -1 . Second curve has derivative $y = \frac{1}{(2-x)^2}$ so the slope when $x = 1$ is 1 . Since the two slopes are negative reciprocals of each other, the tangent lines are perpendicular at the point $(1, 1)$.
38. The curves intersect when $a/(x-1) = x^2 - 2x + 1$, or $(x-1)^3 = a$, $x = 1 + a^{1/3}$. They are perpendicular when their slopes are negative reciprocals of each other, i.e. $\frac{-a}{(x-1)^2}(2x-2) = -1$, which has the solution $x = 2a + 1$. Solve $x = 1 + a^{1/3} = 2a + 1$, $2a^{2/3} = 1$, $a = 2^{-3/2}$. Thus the curves intersect and are perpendicular at the point $(2a + 1, 1/2)$ provided $a = 2^{-3/2}$.
39. $F'(x) = xf'(x) + f(x)$, $F''(x) = xf''(x) + f'(x) + f'(x) = xf''(x) + 2f'(x)$.
40. (a) $F'''(x) = xf'''(x) + 3f''(x)$.
- (b) Assume that $F^{(n)}(x) = xf^{(n)}(x) + nf^{(n-1)}(x)$ for some n (for instance $n = 3$, as in part (a)). Then $F^{(n+1)}(x) = xf^{(n+1)}(x) + (1+n)f^{(n)}(x) = xf^{(n+1)}(x) + (n+1)f^{(n)}(x)$, which is an inductive proof.
41. $R'(p) = p \cdot f'(p) + f(p) \cdot 1 = f(p) + pf'(p)$, so $R'(120) = 9000 + 120 \cdot (-60) = 1800$. Increasing the price by a small amount Δp dollars would increase the revenue by about $1800\Delta p$ dollars.
42. $R'(p) = p \cdot f'(p) + f(p) \cdot 1 = f(p) + pf'(p)$, so $R'(120) = 9000 + 120 \cdot (-80) = -600$. Increasing the price by a small amount Δp dollars would decrease the revenue by about $600\Delta p$ dollars.
43. $f(x) = \frac{1}{x^n}$ so $f'(x) = \frac{x^n \cdot (0) - 1 \cdot (nx^{n-1})}{x^{2n}} = -\frac{n}{x^{n+1}} = -nx^{-n-1}$.

Exercise Set 2.5

1. $f'(x) = -4 \sin x + 2 \cos x$
2. $f'(x) = \frac{-10}{x^3} + \cos x$
3. $f'(x) = 4x^2 \sin x - 8x \cos x$
4. $f'(x) = 4 \sin x \cos x$
5. $f'(x) = \frac{\sin x(5 + \sin x) - \cos x(5 - \cos x)}{(5 + \sin x)^2} = \frac{1 + 5(\sin x - \cos x)}{(5 + \sin x)^2}$
6. $f'(x) = \frac{(x^2 + \sin x) \cos x - \sin x(2x + \cos x)}{(x^2 + \sin x)^2} = \frac{x^2 \cos x - 2x \sin x}{(x^2 + \sin x)^2}$
7. $f'(x) = \sec x \tan x - \sqrt{2} \sec^2 x$
8. $f'(x) = (x^2 + 1) \sec x \tan x + (\sec x)(2x) = (x^2 + 1) \sec x \tan x + 2x \sec x$
9. $f'(x) = -4 \csc x \cot x + \csc^2 x$
10. $f'(x) = -\sin x - \csc x + x \csc x \cot x$
11. $f'(x) = \sec x(\sec^2 x) + (\tan x)(\sec x \tan x) = \sec^3 x + \sec x \tan^2 x$
12. $f'(x) = (\csc x)(-\csc^2 x) + (\cot x)(-\csc x \cot x) = -\csc^3 x - \csc x \cot^2 x$
13. $f'(x) = \frac{(1 + \csc x)(-\csc^2 x) - \cot x(0 - \csc x \cot x)}{(1 + \csc x)^2} = \frac{\csc x(-\csc x - \csc^2 x + \cot^2 x)}{(1 + \csc x)^2}$, but $1 + \cot^2 x = \csc^2 x$ (identity), thus $\cot^2 x - \csc^2 x = -1$, so $f'(x) = \frac{\csc x(-\csc x - 1)}{(1 + \csc x)^2} = -\frac{\csc x}{1 + \csc x}$.
14. $f'(x) = \frac{(1 + \tan x)(\sec x \tan x) - (\sec x)(\sec^2 x)}{(1 + \tan x)^2} = \frac{\sec x \tan x + \sec x \tan^2 x - \sec^3 x}{(1 + \tan x)^2} = \frac{\sec x(\tan x + \tan^2 x - \sec^2 x)}{(1 + \tan x)^2} = \frac{\sec x(\tan x - 1)}{(1 + \tan x)^2}$
15. $f(x) = \sin^2 x + \cos^2 x = 1$ (identity), so $f'(x) = 0$.
16. $f'(x) = 2 \sec x \tan x \sec x - 2 \tan x \sec^2 x = \frac{2 \sin x}{\cos^3 x} - 2 \frac{\sin x}{\cos^3 x} = 0$; also, $f(x) = \sec^2 x - \tan^2 x = 1$ (identity), so $f'(x) = 0$.
17. $f(x) = \frac{\tan x}{1 + x \tan x}$ (because $\sin x \sec x = (\sin x)(1/\cos x) = \tan x$), so $f'(x) = \frac{(1 + x \tan x)(\sec^2 x) - \tan x[x(\sec^2 x) + (\tan x)(1)]}{(1 + x \tan x)^2} = \frac{\sec^2 x - \tan^2 x}{(1 + x \tan x)^2} = \frac{1}{(1 + x \tan x)^2}$ (because $\sec^2 x - \tan^2 x = 1$).
18. $f(x) = \frac{(x^2 + 1) \cot x}{3 - \cot x}$ (because $\cos x \csc x = (\cos x)(1/\sin x) = \cot x$), so $f'(x) = \frac{(3 - \cot x)[2x \cot x - (x^2 + 1) \csc^2 x] - (x^2 + 1) \cot x \csc^2 x}{(3 - \cot x)^2} = \frac{6x \cot x - 2x \cot^2 x - 3(x^2 + 1) \csc^2 x}{(3 - \cot x)^2}$.

19. $dy/dx = -x \sin x + \cos x$, $d^2y/dx^2 = -x \cos x - \sin x - \sin x = -x \cos x - 2 \sin x$
20. $dy/dx = -\csc x \cot x$, $d^2y/dx^2 = -[(\csc x)(-\csc^2 x) + (\cot x)(-\csc x \cot x)] = \csc^3 x + \csc x \cot^2 x$
21. $dy/dx = x(\cos x) + (\sin x)(1) - 3(-\sin x) = x \cos x + 4 \sin x$,
 $d^2y/dx^2 = x(-\sin x) + (\cos x)(1) + 4 \cos x = -x \sin x + 5 \cos x$
22. $dy/dx = x^2(-\sin x) + (\cos x)(2x) + 4 \cos x = -x^2 \sin x + 2x \cos x + 4 \cos x$,
 $d^2y/dx^2 = -[x^2(\cos x) + (\sin x)(2x)] + 2[x(-\sin x) + \cos x] - 4 \sin x = (2 - x^2) \cos x - 4(x + 1) \sin x$
23. $dy/dx = (\sin x)(-\sin x) + (\cos x)(\cos x) = \cos^2 x - \sin^2 x$,
 $d^2y/dx^2 = (\cos x)(-\sin x) + (\cos x)(-\sin x) - [(\sin x)(\cos x) + (\sin x)(\cos x)] = -4 \sin x \cos x$
24. $dy/dx = \sec^2 x$, $d^2y/dx^2 = 2 \sec^2 x \tan x$
25. Let $f(x) = \tan x$, then $f'(x) = \sec^2 x$.
- (a) $f(0) = 0$ and $f'(0) = 1$, so $y - 0 = (1)(x - 0)$, $y = x$.
- (b) $f\left(\frac{\pi}{4}\right) = 1$ and $f'\left(\frac{\pi}{4}\right) = 2$, so $y - 1 = 2\left(x - \frac{\pi}{4}\right)$, $y = 2x - \frac{\pi}{2} + 1$.
- (c) $f\left(-\frac{\pi}{4}\right) = -1$ and $f'\left(-\frac{\pi}{4}\right) = 2$, so $y + 1 = 2\left(x + \frac{\pi}{4}\right)$, $y = 2x + \frac{\pi}{2} - 1$.
26. Let $f(x) = \sin x$, then $f'(x) = \cos x$.
- (a) $f(0) = 0$ and $f'(0) = 1$, so $y - 0 = (1)(x - 0)$, $y = x$.
- (b) $f(\pi) = 0$ and $f'(\pi) = -1$, so $y - 0 = (-1)(x - \pi)$, $y = -x + \pi$.
- (c) $f\left(\frac{\pi}{4}\right) = \frac{1}{\sqrt{2}}$ and $f'\left(\frac{\pi}{4}\right) = \frac{1}{\sqrt{2}}$, so $y - \frac{1}{\sqrt{2}} = \frac{1}{\sqrt{2}}\left(x - \frac{\pi}{4}\right)$, $y = \frac{1}{\sqrt{2}}x - \frac{\pi}{4\sqrt{2}} + \frac{1}{\sqrt{2}}$.
27. (a) If $y = x \sin x$ then $y' = \sin x + x \cos x$ and $y'' = 2 \cos x - x \sin x$ so $y'' + y = 2 \cos x$.
- (b) Differentiate the result of part (a) twice more to get $y^{(4)} + y'' = -2 \cos x$.
28. (a) If $y = \cos x$ then $y' = -\sin x$ and $y'' = -\cos x$, so $y'' + y = (-\cos x) + (\cos x) = 0$; if $y = \sin x$ then $y' = \cos x$ and $y'' = -\sin x$ so $y'' + y = (-\sin x) + (\sin x) = 0$.
- (b) $y' = A \cos x - B \sin x$, $y'' = -A \sin x - B \cos x$, so $y'' + y = (-A \sin x - B \cos x) + (A \sin x + B \cos x) = 0$.
29. (a) $f'(x) = \cos x = 0$ at $x = \pm\pi/2, \pm3\pi/2$.
- (b) $f'(x) = 1 - \sin x = 0$ at $x = -3\pi/2, \pi/2$.
- (c) $f'(x) = \sec^2 x \geq 1$ always, so no horizontal tangent line.
- (d) $f'(x) = \sec x \tan x = 0$ when $\sin x = 0$, $x = \pm2\pi, \pm\pi, 0$.

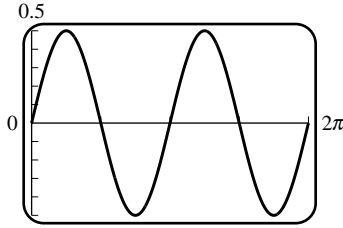

30. (a) -0.5

(b) $y = \sin x \cos x = (1/2) \sin 2x$ and $y' = \cos 2x$. So $y' = 0$ when $2x = (2n + 1)\pi/2$ for $n = 0, 1, 2, 3$ or $x = \pi/4, 3\pi/4, 5\pi/4, 7\pi/4$.

31. $x = 10 \sin \theta$, $dx/d\theta = 10 \cos \theta$; if $\theta = 60^\circ$, then $dx/d\theta = 10(1/2) = 5$ ft/rad = $\pi/36$ ft/deg ≈ 0.087 ft/deg.

32. $s = 3800 \csc \theta$, $ds/d\theta = -3800 \csc \theta \cot \theta$; if $\theta = 30^\circ$, then $ds/d\theta = -3800(2)(\sqrt{3}) = -7600\sqrt{3}$ ft/rad = $-380\sqrt{3}\pi/9$ ft/deg ≈ -230 ft/deg.

33. $D = 50 \tan \theta$, $dD/d\theta = 50 \sec^2 \theta$; if $\theta = 45^\circ$, then $dD/d\theta = 50(\sqrt{2})^2 = 100$ m/rad = $5\pi/9$ m/deg ≈ 1.75 m/deg.

34. (a) From the right triangle shown, $\sin \theta = r/(r + h)$ so $r + h = r \csc \theta$, $h = r(\csc \theta - 1)$.

(b) $dh/d\theta = -r \csc \theta \cot \theta$; if $\theta = 30^\circ$, then $dh/d\theta = -6378(2)(\sqrt{3}) \approx -22,094$ km/rad ≈ -386 km/deg.

35. False. $g'(x) = f(x) \cos x + f'(x) \sin x$

36. True, if $f(x)$ is continuous at $x = 0$, then $g'(0) = \lim_{h \rightarrow 0} \frac{g(h) - g(0)}{h} = \lim_{h \rightarrow 0} \frac{f(h) \sin h}{h} = \lim_{h \rightarrow 0} f(h) \cdot \lim_{h \rightarrow 0} \frac{\sin h}{h} = f(0) \cdot 1 = f(0)$.

37. True. $f(x) = \frac{\sin x}{\cos x} = \tan x$, so $f'(x) = \sec^2 x$.

38. False. $g'(x) = f(x) \cdot \frac{d}{dx}(\sec x) + f'(x) \sec x = f(x) \sec x \tan x + f'(x) \sec x$, so $g'(0) = f(0) \sec 0 \tan 0 + f'(0) \sec 0 = 8 \cdot 1 \cdot 0 + (-2) \cdot 1 = -2$. The second equality given in the problem is wrong: $\lim_{h \rightarrow 0} \frac{f(h) \sec h - f(0)}{h} = -2$ but $\lim_{h \rightarrow 0} \frac{8(\sec h - 1)}{h} = 0$.

39. $\frac{d^4}{dx^4} \sin x = \sin x$, so $\frac{d^{4k}}{dx^{4k}} \sin x = \sin x$; $\frac{d^{87}}{dx^{87}} \sin x = \frac{d^3}{dx^3} \frac{d^{4 \cdot 21}}{dx^{4 \cdot 21}} \sin x = \frac{d^3}{dx^3} \sin x = -\cos x$.

40. $\frac{d^{100}}{dx^{100}} \cos x = \frac{d^{4k}}{dx^{4k}} \cos x = \cos x$.

41. $f'(x) = -\sin x$, $f''(x) = -\cos x$, $f'''(x) = \sin x$, and $f^{(4)}(x) = \cos x$ with higher order derivatives repeating this pattern, so $f^{(n)}(x) = \sin x$ for $n = 3, 7, 11, \dots$

42. $f(x) = \sin x$, $f'(x) = \cos x$, $f''(x) = -\sin x$, $f'''(x) = -\cos x$, $f^{(4)}(x) = \sin x$, and the right-hand sides continue with a period of 4, so that $f^{(n)}(x) = \sin x$ when $n = 4k$ for some k .

43. (a) all x (b) all x (c) $x \neq \pi/2 + n\pi$, $n = 0, \pm 1, \pm 2, \dots$

(d) $x \neq n\pi$, $n = 0, \pm 1, \pm 2, \dots$ (e) $x \neq \pi/2 + n\pi$, $n = 0, \pm 1, \pm 2, \dots$ (f) $x \neq n\pi$, $n = 0, \pm 1, \pm 2, \dots$

(g) $x \neq (2n + 1)\pi$, $n = 0, \pm 1, \pm 2, \dots$ (h) $x \neq n\pi/2$, $n = 0, \pm 1, \pm 2, \dots$ (i) all x

$$44. \text{ (a) } \frac{d}{dx}[\cos x] = \lim_{h \rightarrow 0} \frac{\cos(x+h) - \cos x}{h} = \lim_{h \rightarrow 0} \frac{\cos x \cos h - \sin x \sin h - \cos x}{h} =$$

$$= \lim_{h \rightarrow 0} \left[\cos x \left(\frac{\cos h - 1}{h} \right) - \sin x \left(\frac{\sin h}{h} \right) \right] = (\cos x)(0) - (\sin x)(1) = -\sin x.$$

$$\text{ (b) } \frac{d}{dx}[\cot x] = \frac{d}{dx} \left[\frac{\cos x}{\sin x} \right] = \frac{\sin x(-\sin x) - \cos x(\cos x)}{\sin^2 x} = \frac{-\sin^2 x - \cos^2 x}{\sin^2 x} = \frac{-1}{\sin^2 x} = -\csc^2 x.$$

$$\text{ (c) } \frac{d}{dx}[\sec x] = \frac{d}{dx} \left[\frac{1}{\cos x} \right] = \frac{0 \cdot \cos x - (1)(-\sin x)}{\cos^2 x} = \frac{\sin x}{\cos^2 x} = \sec x \tan x.$$

$$\text{ (d) } \frac{d}{dx}[\csc x] = \frac{d}{dx} \left[\frac{1}{\sin x} \right] = \frac{(\sin x)(0) - (1)(\cos x)}{\sin^2 x} = -\frac{\cos x}{\sin^2 x} = -\csc x \cot x.$$

$$45. \frac{d}{dx} \sin x = \lim_{w \rightarrow x} \frac{\sin w - \sin x}{w - x} = \lim_{w \rightarrow x} \frac{2 \sin \frac{w-x}{2} \cos \frac{w+x}{2}}{w - x} = \lim_{w \rightarrow x} \frac{\sin \frac{w-x}{2}}{\frac{w-x}{2}} \cos \frac{w+x}{2} = 1 \cdot \cos x = \cos x.$$

$$46. \frac{d}{dx}[\cos x] = \lim_{w \rightarrow x} \frac{\cos w - \cos x}{w - x} = \lim_{w \rightarrow x} \frac{-2 \sin(\frac{w-x}{2}) \sin(\frac{w+x}{2})}{w - x} = -\lim_{w \rightarrow x} \sin \left(\frac{w+x}{2} \right) \lim_{w \rightarrow x} \frac{\sin(\frac{w-x}{2})}{\frac{w-x}{2}} = -\sin x.$$

$$47. \text{ (a) } \lim_{h \rightarrow 0} \frac{\tan h}{h} = \lim_{h \rightarrow 0} \frac{\left(\frac{\sin h}{\cos h} \right)}{h} = \lim_{h \rightarrow 0} \frac{\left(\frac{\sin h}{h} \right)}{\cos h} = \frac{1}{1} = 1.$$

$$\text{ (b) } \frac{d}{dx}[\tan x] = \lim_{h \rightarrow 0} \frac{\tan(x+h) - \tan x}{h} = \lim_{h \rightarrow 0} \frac{\frac{\tan x + \tan h}{1 - \tan x \tan h} - \tan x}{h} = \lim_{h \rightarrow 0} \frac{\tan x + \tan h - \tan x + \tan^2 x \tan h}{h(1 - \tan x \tan h)} =$$

$$\lim_{h \rightarrow 0} \frac{\tan h(1 + \tan^2 x)}{h(1 - \tan x \tan h)} = \lim_{h \rightarrow 0} \frac{\tan h \sec^2 x}{h(1 - \tan x \tan h)} = \sec^2 x \lim_{h \rightarrow 0} \frac{\frac{\tan h}{h}}{1 - \tan x \tan h} = \sec^2 x \frac{\lim_{h \rightarrow 0} \frac{\tan h}{h}}{\lim_{h \rightarrow 0} (1 - \tan x \tan h)} = \sec^2 x.$$

$$48. \lim_{x \rightarrow 0} \frac{\tan(x+y) - \tan y}{x} = \lim_{h \rightarrow 0} \frac{\tan(y+h) - \tan y}{h} = \frac{d}{dy}(\tan y) = \sec^2 y.$$

49. By Exercises 49 and 50 of Section 1.6, we have $\lim_{h \rightarrow 0} \frac{\sin h}{h} = \frac{\pi}{180}$ and $\lim_{h \rightarrow 0} \frac{\cos h - 1}{h} = 0$. Therefore:

$$\text{ (a) } \frac{d}{dx}[\sin x] = \lim_{h \rightarrow 0} \frac{\sin(x+h) - \sin x}{h} = \sin x \lim_{h \rightarrow 0} \frac{\cos h - 1}{h} + \cos x \lim_{h \rightarrow 0} \frac{\sin h}{h} = (\sin x)(0) + (\cos x)(\pi/180) = \frac{\pi}{180} \cos x.$$

$$\text{ (b) } \frac{d}{dx}[\cos x] = \lim_{h \rightarrow 0} \frac{\cos(x+h) - \cos x}{h} = \lim_{h \rightarrow 0} \frac{\cos x \cos h - \sin x \sin h - \cos x}{h} = \cos x \lim_{h \rightarrow 0} \frac{\cos h - 1}{h} - \sin x \lim_{h \rightarrow 0} \frac{\sin h}{h} =$$

$$0 \cdot \cos x - \frac{\pi}{180} \cdot \sin x = -\frac{\pi}{180} \sin x.$$

50. If f is periodic, then so is f' . Proof: Suppose $f(x+p) = f(x)$ for all x . Then $f'(x+p) = \lim_{h \rightarrow 0} \frac{f(x+p+h) - f(x+p)}{h} = \lim_{h \rightarrow 0} \frac{f(x+h) - f(x)}{h} = f'(x)$. However, f' may be periodic even if f is not. For example, $f(x) = x + \sin x$ is not periodic, but $f'(x) = 1 + \cos x$ has period 2π .

Exercise Set 2.6

1. $(f \circ g)'(x) = f'(g(x))g'(x)$, so $(f \circ g)'(0) = f'(g(0))g'(0) = f'(0)(3) = (2)(3) = 6$.

2. $(f \circ g)'(2) = f'(g(2))g'(2) = 5(-3) = -15$.
3. (a) $(f \circ g)(x) = f(g(x)) = (2x - 3)^5$ and $(f \circ g)'(x) = f'(g(x))g'(x) = 5(2x - 3)^4(2) = 10(2x - 3)^4$.
- (b) $(g \circ f)(x) = g(f(x)) = 2x^5 - 3$ and $(g \circ f)'(x) = g'(f(x))f'(x) = 2(5x^4) = 10x^4$.
4. (a) $(f \circ g)(x) = 5\sqrt{4 + \cos x}$ and $(f \circ g)'(x) = f'(g(x))g'(x) = \frac{5}{2\sqrt{4 + \cos x}}(-\sin x)$.
- (b) $(g \circ f)(x) = 4 + \cos(5\sqrt{x})$ and $(g \circ f)'(x) = g'(f(x))f'(x) = -\sin(5\sqrt{x})\frac{5}{2\sqrt{x}}$.
5. (a) $F'(x) = f'(g(x))g'(x)$, $F'(3) = f'(g(3))g'(3) = -1(7) = -7$.
- (b) $G'(x) = g'(f(x))f'(x)$, $G'(3) = g'(f(3))f'(3) = 4(-2) = -8$.
6. (a) $F'(x) = f'(g(x))g'(x)$, $F'(-1) = f'(g(-1))g'(-1) = f'(2)(-3) = (4)(-3) = -12$.
- (b) $G'(x) = g'(f(x))f'(x)$, $G'(-1) = g'(f(-1))f'(-1) = -5(3) = -15$.
7. $f'(x) = 37(x^3 + 2x)^{36} \frac{d}{dx}(x^3 + 2x) = 37(x^3 + 2x)^{36}(3x^2 + 2)$.
8. $f'(x) = 6(3x^2 + 2x - 1)^5 \frac{d}{dx}(3x^2 + 2x - 1) = 6(3x^2 + 2x - 1)^5(6x + 2) = 12(3x^2 + 2x - 1)^5(3x + 1)$.
9. $f'(x) = -2 \left(x^3 - \frac{7}{x}\right)^{-3} \frac{d}{dx} \left(x^3 - \frac{7}{x}\right) = -2 \left(x^3 - \frac{7}{x}\right)^{-3} \left(3x^2 + \frac{7}{x^2}\right)$.
10. $f(x) = (x^5 - x + 1)^{-9}$, $f'(x) = -9(x^5 - x + 1)^{-10} \frac{d}{dx}(x^5 - x + 1) = -9(x^5 - x + 1)^{-10}(5x^4 - 1) = \frac{-9(5x^4 - 1)}{(x^5 - x + 1)^{10}}$.
11. $f(x) = 4(3x^2 - 2x + 1)^{-3}$, $f'(x) = -12(3x^2 - 2x + 1)^{-4} \frac{d}{dx}(3x^2 - 2x + 1) = -12(3x^2 - 2x + 1)^{-4}(6x - 2) = \frac{24(1 - 3x)}{(3x^2 - 2x + 1)^4}$.
12. $f'(x) = \frac{1}{2\sqrt{x^3 - 2x + 5}} \frac{d}{dx}(x^3 - 2x + 5) = \frac{3x^2 - 2}{2\sqrt{x^3 - 2x + 5}}$.
13. $f'(x) = \frac{1}{2\sqrt{4 + \sqrt{3x}}} \frac{d}{dx}(4 + \sqrt{3x}) = \frac{\sqrt{3}}{4\sqrt{x}\sqrt{4 + \sqrt{3x}}}$.
14. $f'(x) = \frac{1}{3} (12 + \sqrt{x})^{-2/3} \cdot \frac{1}{2} \frac{1}{\sqrt{x}} = \frac{1}{6(12 + \sqrt{x})^{2/3}\sqrt{x}}$.
15. $f'(x) = \cos(1/x^2) \frac{d}{dx}(1/x^2) = -\frac{2}{x^3} \cos(1/x^2)$.
16. $f'(x) = (\sec^2 \sqrt{x}) \frac{d}{dx} \sqrt{x} = (\sec^2 \sqrt{x}) \frac{1}{2\sqrt{x}}$.
17. $f'(x) = 20 \cos^4 x \frac{d}{dx}(\cos x) = 20 \cos^4 x (-\sin x) = -20 \cos^4 x \sin x$.
18. $f'(x) = 4 + 20(\sin^3 x) \frac{d}{dx}(\sin x) = 4 + 20 \sin^3 x \cos x$.

$$19. f'(x) = 2 \cos(3\sqrt{x}) \frac{d}{dx} [\cos(3\sqrt{x})] = -2 \cos(3\sqrt{x}) \sin(3\sqrt{x}) \frac{d}{dx} (3\sqrt{x}) = -\frac{3 \cos(3\sqrt{x}) \sin(3\sqrt{x})}{\sqrt{x}}.$$

$$20. f'(x) = 4 \tan^3(x^3) \frac{d}{dx} [\tan(x^3)] = 4 \tan^3(x^3) \sec^2(x^3) \frac{d}{dx} (x^3) = 12x^2 \tan^3(x^3) \sec^2(x^3).$$

$$21. f'(x) = 4 \sec(x^7) \frac{d}{dx} [\sec(x^7)] = 4 \sec(x^7) \sec(x^7) \tan(x^7) \frac{d}{dx} (x^7) = 28x^6 \sec^2(x^7) \tan(x^7).$$

$$22. f'(x) = 3 \cos^2\left(\frac{x}{x+1}\right) \frac{d}{dx} \cos\left(\frac{x}{x+1}\right) = 3 \cos^2\left(\frac{x}{x+1}\right) \left[-\sin\left(\frac{x}{x+1}\right)\right] \frac{(x+1)(1) - x(1)}{(x+1)^2} = \\ = -\frac{3}{(x+1)^2} \cos^2\left(\frac{x}{x+1}\right) \sin\left(\frac{x}{x+1}\right).$$

$$23. f'(x) = \frac{1}{2\sqrt{\cos(5x)}} \frac{d}{dx} [\cos(5x)] = -\frac{5 \sin(5x)}{2\sqrt{\cos(5x)}}.$$

$$24. f'(x) = \frac{1}{2\sqrt{3x - \sin^2(4x)}} \frac{d}{dx} [3x - \sin^2(4x)] = \frac{3 - 8 \sin(4x) \cos(4x)}{2\sqrt{3x - \sin^2(4x)}}.$$

$$25. f'(x) = -3 [x + \csc(x^3 + 3)]^{-4} \frac{d}{dx} [x + \csc(x^3 + 3)] = \\ = -3 [x + \csc(x^3 + 3)]^{-4} \left[1 - \csc(x^3 + 3) \cot(x^3 + 3) \frac{d}{dx} (x^3 + 3)\right] = \\ = -3 [x + \csc(x^3 + 3)]^{-4} [1 - 3x^2 \csc(x^3 + 3) \cot(x^3 + 3)].$$

$$26. f'(x) = -4 [x^4 - \sec(4x^2 - 2)]^{-5} \frac{d}{dx} [x^4 - \sec(4x^2 - 2)] = \\ = -4 [x^4 - \sec(4x^2 - 2)]^{-5} \left[4x^3 - \sec(4x^2 - 2) \tan(4x^2 - 2) \frac{d}{dx} (4x^2 - 2)\right] = \\ = -16x [x^4 - \sec(4x^2 - 2)]^{-5} [x^2 - 2 \sec(4x^2 - 2) \tan(4x^2 - 2)].$$

$$27. \frac{dy}{dx} = x^3 (2 \sin 5x) \frac{d}{dx} (\sin 5x) + 3x^2 \sin^2 5x = 10x^3 \sin 5x \cos 5x + 3x^2 \sin^2 5x.$$

$$28. \frac{dy}{dx} = \sqrt{x} \left[3 \tan^2(\sqrt{x}) \sec^2(\sqrt{x}) \frac{1}{2\sqrt{x}}\right] + \frac{1}{2\sqrt{x}} \tan^3(\sqrt{x}) = \frac{3}{2} \tan^2(\sqrt{x}) \sec^2(\sqrt{x}) + \frac{1}{2\sqrt{x}} \tan^3(\sqrt{x}).$$

$$29. \frac{dy}{dx} = x^5 \sec\left(\frac{1}{x}\right) \tan\left(\frac{1}{x}\right) \frac{d}{dx} \left(\frac{1}{x}\right) + \sec\left(\frac{1}{x}\right) (5x^4) = x^5 \sec\left(\frac{1}{x}\right) \tan\left(\frac{1}{x}\right) \left(-\frac{1}{x^2}\right) + 5x^4 \sec\left(\frac{1}{x}\right) = \\ = -x^3 \sec\left(\frac{1}{x}\right) \tan\left(\frac{1}{x}\right) + 5x^4 \sec\left(\frac{1}{x}\right).$$

$$30. \frac{dy}{dx} = \frac{\sec(3x+1) \cos x - 3 \sin x \sec(3x+1) \tan(3x+1)}{\sec^2(3x+1)} = \cos x \cos(3x+1) - 3 \sin x \sin(3x+1).$$

$$31. \frac{dy}{dx} = -\sin(\cos x) \frac{d}{dx} (\cos x) = -\sin(\cos x) (-\sin x) = \sin(\cos x) \sin x.$$

$$32. \frac{dy}{dx} = \cos(\tan 3x) \frac{d}{dx} (\tan 3x) = 3 \sec^2 3x \cos(\tan 3x).$$

$$33. \frac{dy}{dx} = 3 \cos^2(\sin 2x) \frac{d}{dx} [\cos(\sin 2x)] = 3 \cos^2(\sin 2x) [-\sin(\sin 2x)] \frac{d}{dx} (\sin 2x) = -6 \cos^2(\sin 2x) \sin(\sin 2x) \cos 2x.$$

34. $\frac{dy}{dx} = \frac{(1 - \cot x^2)(-2x \csc x^2 \cot x^2) - (1 + \csc x^2)(2x \csc^2 x^2)}{(1 - \cot x^2)^2} = -2x \csc x^2 \frac{1 + \cot x^2 + \csc x^2}{(1 - \cot x^2)^2}$, since $\csc^2 x^2 = 1 + \cot^2 x^2$.
35. $\frac{dy}{dx} = (5x + 8)^7 \frac{d}{dx}(1 - \sqrt{x})^6 + (1 - \sqrt{x})^6 \frac{d}{dx}(5x + 8)^7 = 6(5x + 8)^7(1 - \sqrt{x})^5 \frac{-1}{2\sqrt{x}} + 7 \cdot 5(1 - \sqrt{x})^6(5x + 8)^6 = \frac{-3}{\sqrt{x}}(5x + 8)^7(1 - \sqrt{x})^5 + 35(1 - \sqrt{x})^6(5x + 8)^6$.
36. $\frac{dy}{dx} = (x^2 + x)^5 \frac{d}{dx} \sin^8 x + (\sin^8 x) \frac{d}{dx}(x^2 + x)^5 = 8(x^2 + x)^5 \sin^7 x \cos x + 5(\sin^8 x)(x^2 + x)^4(2x + 1)$.
37. $\frac{dy}{dx} = 3 \left[\frac{x-5}{2x+1} \right]^2 \frac{d}{dx} \left[\frac{x-5}{2x+1} \right] = 3 \left[\frac{x-5}{2x+1} \right]^2 \cdot \frac{11}{(2x+1)^2} = \frac{33(x-5)^2}{(2x+1)^4}$.
38. $\frac{dy}{dx} = 17 \left(\frac{1+x^2}{1-x^2} \right)^{16} \frac{d}{dx} \left(\frac{1+x^2}{1-x^2} \right) = 17 \left(\frac{1+x^2}{1-x^2} \right)^{16} \frac{(1-x^2)(2x) - (1+x^2)(-2x)}{(1-x^2)^2} = 17 \left(\frac{1+x^2}{1-x^2} \right)^{16} \frac{4x}{(1-x^2)^2} = \frac{68x(1+x^2)^{16}}{(1-x^2)^{18}}$.
39. $\frac{dy}{dx} = \frac{(4x^2 - 1)^8(3)(2x + 3)^2(2) - (2x + 3)^3(8)(4x^2 - 1)^7(8x)}{(4x^2 - 1)^{16}} = \frac{2(2x + 3)^2(4x^2 - 1)^7[3(4x^2 - 1) - 32x(2x + 3)]}{(4x^2 - 1)^{16}} = \frac{2(2x + 3)^2(52x^2 + 96x + 3)}{(4x^2 - 1)^9}$.
40. $\frac{dy}{dx} = 12[1 + \sin^3(x^5)]^{11} \frac{d}{dx}[1 + \sin^3(x^5)] = 12[1 + \sin^3(x^5)]^{11} 3 \sin^2(x^5) \frac{d}{dx} \sin(x^5) = 180x^4[1 + \sin^3(x^5)]^{11} \sin^2(x^5) \cos(x^5)$.
41. $\frac{dy}{dx} = 5 [x \sin 2x + \tan^4(x^7)]^4 \frac{d}{dx} [x \sin 2x \tan^4(x^7)] = 5 [x \sin 2x + \tan^4(x^7)]^4 \left[x \cos 2x \frac{d}{dx}(2x) + \sin 2x + 4 \tan^3(x^7) \frac{d}{dx} \tan(x^7) \right] = 5 [x \sin 2x + \tan^4(x^7)]^4 [2x \cos 2x + \sin 2x + 28x^6 \tan^3(x^7) \sec^2(x^7)]$.
42. $\frac{dy}{dx} = 4 \tan^3 \left(2 + \frac{(7-x)\sqrt{3x^2+5}}{x^3 + \sin x} \right) \sec^2 \left(2 + \frac{(7-x)\sqrt{3x^2+5}}{x^3 + \sin x} \right) \times \left(-\frac{\sqrt{3x^2+5}}{x^3 + \sin x} + 3 \frac{(7-x)x}{\sqrt{3x^2+5}(x^3 + \sin x)} - \frac{(7-x)\sqrt{3x^2+5}(3x^2 + \cos x)}{(x^3 + \sin x)^2} \right)$
43. $\frac{dy}{dx} = \cos 3x - 3x \sin 3x$; if $x = \pi$ then $\frac{dy}{dx} = -1$ and $y = -\pi$, so the equation of the tangent line is $y + \pi = -(x - \pi)$, or $y = -x$.
44. $\frac{dy}{dx} = 3x^2 \cos(1 + x^3)$; if $x = -3$ then $y = -\sin 26$, $\frac{dy}{dx} = 27 \cos 26$, so the equation of the tangent line is $y + \sin 26 = 27(\cos 26)(x + 3)$, or $y = 27(\cos 26)x + 81 \cos 26 - \sin 26$.
45. $\frac{dy}{dx} = -3 \sec^3(\pi/2 - x) \tan(\pi/2 - x)$; if $x = -\pi/2$ then $\frac{dy}{dx} = 0$, $y = -1$, so the equation of the tangent line is $y + 1 = 0$, or $y = -1$

46. $\frac{dy}{dx} = 3 \left(x - \frac{1}{x}\right)^2 \left(1 + \frac{1}{x^2}\right)$; if $x = 2$ then $y = \frac{27}{8}$, $\frac{dy}{dx} = 3 \frac{9 \cdot 5}{4 \cdot 4} = \frac{135}{16}$, so the equation of the tangent line is $y - 27/8 = (135/16)(x - 2)$, or $y = \frac{135}{16}x - \frac{27}{2}$.

47. $\frac{dy}{dx} = \sec^2(4x^2) \frac{d}{dx}(4x^2) = 8x \sec^2(4x^2)$, $\frac{dy}{dx} \Big|_{x=\sqrt{\pi}} = 8\sqrt{\pi} \sec^2(4\pi) = 8\sqrt{\pi}$. When $x = \sqrt{\pi}$, $y = \tan(4\pi) = 0$, so the equation of the tangent line is $y = 8\sqrt{\pi}(x - \sqrt{\pi}) = 8\sqrt{\pi}x - 8\pi$.

48. $\frac{dy}{dx} = 12 \cot^3 x \frac{d}{dx} \cot x = -12 \cot^3 x \csc^2 x$, $\frac{dy}{dx} \Big|_{x=\pi/4} = -24$. When $x = \pi/4$, $y = 3$, so the equation of the tangent line is $y - 3 = -24(x - \pi/4)$, or $y = -24x + 3 + 6\pi$.

49. $\frac{dy}{dx} = 2x\sqrt{5-x^2} + \frac{x^2}{2\sqrt{5-x^2}}(-2x)$, $\frac{dy}{dx} \Big|_{x=1} = 4 - 1/2 = 7/2$. When $x = 1$, $y = 2$, so the equation of the tangent line is $y - 2 = (7/2)(x - 1)$, or $y = \frac{7}{2}x - \frac{3}{2}$.

50. $\frac{dy}{dx} = \frac{1}{\sqrt{1-x^2}} - \frac{x}{2}(1-x^2)^{3/2}(-2x)$, $\frac{dy}{dx} \Big|_{x=0} = 1$. When $x = 0$, $y = 0$, so the equation of the tangent line is $y = x$.

51. $\frac{dy}{dx} = x(-\sin(5x)) \frac{d}{dx}(5x) + \cos(5x) - 2 \sin x \frac{d}{dx}(\sin x) = -5x \sin(5x) + \cos(5x) - 2 \sin x \cos x = -5x \sin(5x) + \cos(5x) - \sin(2x)$,
 $\frac{d^2y}{dx^2} = -5x \cos(5x) \frac{d}{dx}(5x) - 5 \sin(5x) - \sin(5x) \frac{d}{dx}(5x) - \cos(2x) \frac{d}{dx}(2x) = -25x \cos(5x) - 10 \sin(5x) - 2 \cos(2x)$.

52. $\frac{dy}{dx} = \cos(3x^2) \frac{d}{dx}(3x^2) = 6x \cos(3x^2)$, $\frac{d^2y}{dx^2} = 6x(-\sin(3x^2)) \frac{d}{dx}(3x^2) + 6 \cos(3x^2) = -36x^2 \sin(3x^2) + 6 \cos(3x^2)$.

53. $\frac{dy}{dx} = \frac{(1-x) + (1+x)}{(1-x)^2} = \frac{2}{(1-x)^2} = 2(1-x)^{-2}$ and $\frac{d^2y}{dx^2} = -2(2)(-1)(1-x)^{-3} = 4(1-x)^{-3}$.

54. $\frac{dy}{dx} = x \sec^2\left(\frac{1}{x}\right) \frac{d}{dx}\left(\frac{1}{x}\right) + \tan\left(\frac{1}{x}\right) = -\frac{1}{x} \sec^2\left(\frac{1}{x}\right) + \tan\left(\frac{1}{x}\right)$,
 $\frac{d^2y}{dx^2} = -\frac{2}{x} \sec\left(\frac{1}{x}\right) \frac{d}{dx} \sec\left(\frac{1}{x}\right) + \frac{1}{x^2} \sec^2\left(\frac{1}{x}\right) + \sec^2\left(\frac{1}{x}\right) \frac{d}{dx}\left(\frac{1}{x}\right) = \frac{2}{x^3} \sec^2\left(\frac{1}{x}\right) \tan\left(\frac{1}{x}\right)$.

55. $y = \cot^3(\pi - \theta) = -\cot^3 \theta$ so $dy/dx = 3 \cot^2 \theta \csc^2 \theta$.

56. $6 \left(\frac{au+b}{cu+d}\right)^5 \frac{ad-bc}{(cu+d)^2}$.

57. $\frac{d}{d\omega}[a \cos^2 \pi\omega + b \sin^2 \pi\omega] = -2\pi a \cos \pi\omega \sin \pi\omega + 2\pi b \sin \pi\omega \cos \pi\omega = \pi(b-a)(2 \sin \pi\omega \cos \pi\omega) = \pi(b-a) \sin 2\pi\omega$.

58. $2 \csc^2(\pi/3 - y) \cot(\pi/3 - y)$.

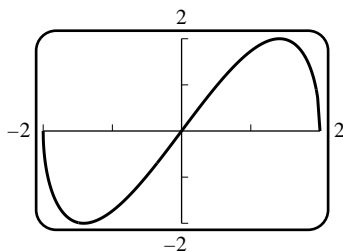

59. (a)

(c) $f'(x) = x \frac{-x}{\sqrt{4-x^2}} + \sqrt{4-x^2} = \frac{4-2x^2}{\sqrt{4-x^2}}$.

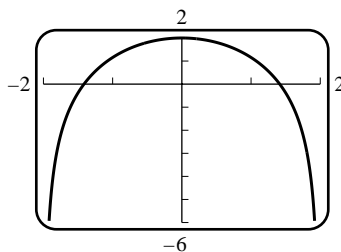

(d) $f(1) = \sqrt{3}$ and $f'(1) = \frac{2}{\sqrt{3}}$ so the tangent line has the equation $y - \sqrt{3} = \frac{2}{\sqrt{3}}(x - 1)$.

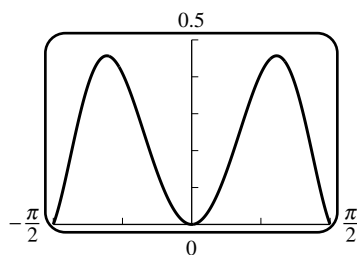
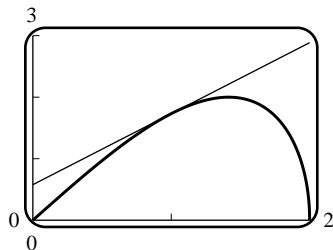

60. (a)

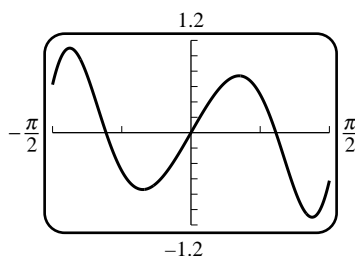

(c) $f'(x) = 2x \cos(x^2) \cos x - \sin x \sin(x^2)$.

(d) $f(1) = \sin 1 \cos 1$ and $f'(1) = 2 \cos^2 1 - \sin^2 1$, so the tangent line has the equation $y - \sin 1 \cos 1 = (2 \cos^2 1 - \sin^2 1)(x - 1)$.

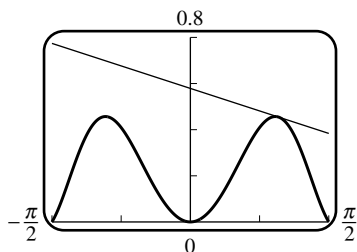

61. False. $\frac{d}{dx}[\sqrt{y}] = \frac{1}{2\sqrt{y}} \frac{dy}{dx} = \frac{f'(x)}{2\sqrt{f(x)}}$.

62. False. $dy/dx = f'(u)g'(x) = f'(g(x))g'(x)$.

63. False. $dy/dx = -\sin[g(x)]g'(x)$.

64. True. Let $u = 3x^3$ and $v = \sin u$, so $y = v^3$. Then $\frac{dy}{dx} = \frac{dy}{dv} \frac{dv}{du} \frac{du}{dx} = 3v^2 \cdot (\cos u) \cdot 9x^2 = 3 \sin^2(3x^3) \cdot \cos(3x^3) \cdot 9x^2 = 27x^2 \sin^2(3x^3) \cos(3x^3)$.

65. (a) $dy/dt = -A\omega \sin \omega t$, $d^2y/dt^2 = -A\omega^2 \cos \omega t = -\omega^2 y$

(b) One complete oscillation occurs when ωt increases over an interval of length 2π , or if t increases over an interval of length $2\pi/\omega$.

(c) $f = 1/T$

(d) Amplitude = 0.6 cm, $T = 2\pi/15$ s/oscillation, $f = 15/(2\pi)$ oscillations/s.

66. $dy/dt = 3A \cos 3t$, $d^2y/dt^2 = -9A \sin 3t$, so $-9A \sin 3t + 2A \sin 3t = 4 \sin 3t$, $-7A \sin 3t = 4 \sin 3t$, $-7A = 4$, and $A = -4/7$

67. By the chain rule, $\frac{d}{dx} [\sqrt{x+f(x)}] = \frac{1+f'(x)}{2\sqrt{x+f(x)}}$. From the graph, $f(x) = \frac{4}{3}x + 5$ for $x < 0$, so $f(-1) = \frac{11}{3}$, $f'(-1) = \frac{4}{3}$, and $\frac{d}{dx} [\sqrt{x+f(x)}] \Big|_{x=-1} = \frac{7/3}{2\sqrt{8/3}} = \frac{7\sqrt{6}}{24}$.

68. $2 \sin(\pi/6) = 1$, so we can assume $f(x) = -\frac{5}{2}x + 5$. Thus for sufficiently small values of $|x - \pi/6|$ we have $\frac{d}{dx} [f(2 \sin x)] \Big|_{x=\pi/6} = f'(2 \sin x) \frac{d}{dx} 2 \sin x \Big|_{x=\pi/6} = -\frac{5}{2} 2 \cos x \Big|_{x=\pi/6} = -\frac{5}{2} 2 \frac{\sqrt{3}}{2} = -\frac{5}{2} \sqrt{3}$.

69. (a) $p \approx 10$ lb/in², $dp/dh \approx -2$ lb/in²/mi. (b) $\frac{dp}{dt} = \frac{dp}{dh} \frac{dh}{dt} \approx (-2)(0.3) = -0.6$ lb/in²/s.

70. (a) $F = \frac{45}{\cos \theta + 0.3 \sin \theta}$, $\frac{dF}{d\theta} = -\frac{45(-\sin \theta + 0.3 \cos \theta)}{(\cos \theta + 0.3 \sin \theta)^2}$; if $\theta = 30^\circ$, then $dF/d\theta \approx 10.5$ lb/rad ≈ 0.18 lb/deg.

(b) $\frac{dF}{dt} = \frac{dF}{d\theta} \frac{d\theta}{dt} \approx (0.18)(-0.5) = -0.09$ lb/s.

71. With $u = \sin x$, $\frac{d}{dx} (|\sin x|) = \frac{d}{dx} (|u|) = \frac{d}{du} (|u|) \frac{du}{dx} = \frac{d}{du} (|u|) \cos x = \begin{cases} \cos x, & u > 0 \\ -\cos x, & u < 0 \end{cases} = \begin{cases} \cos x, & \sin x > 0 \\ -\cos x, & \sin x < 0 \end{cases}$
 $= \begin{cases} \cos x, & 0 < x < \pi \\ -\cos x, & -\pi < x < 0 \end{cases}$

72. $\frac{d}{dx} (\cos x) = \frac{d}{dx} [\sin(\pi/2 - x)] = -\cos(\pi/2 - x) = -\sin x$.

73. (a) For $x \neq 0$, $|f(x)| \leq |x|$, and $\lim_{x \rightarrow 0} |x| = 0$, so by the Squeezing Theorem, $\lim_{x \rightarrow 0} f(x) = 0$.

(b) If $f'(0)$ were to exist, then the limit (as x approaches 0) $\frac{f(x) - f(0)}{x - 0} = \sin(1/x)$ would have to exist, but it doesn't.

(c) For $x \neq 0$, $f'(x) = x \left(\cos \frac{1}{x} \right) \left(-\frac{1}{x^2} \right) + \sin \frac{1}{x} = -\frac{1}{x} \cos \frac{1}{x} + \sin \frac{1}{x}$.

(d) If $x = \frac{1}{2\pi n}$ for an integer $n \neq 0$, then $f'(x) = -2\pi n \cos(2\pi n) + \sin(2\pi n) = -2\pi n$. This approaches $+\infty$ as $n \rightarrow -\infty$, so there are points x arbitrarily close to 0 where $f'(x)$ becomes arbitrarily large. Hence $\lim_{x \rightarrow 0} f'(x)$ does not exist.

74. (a) $-x^2 \leq x^2 \sin(1/x) \leq x^2$, so by the Squeezing Theorem $\lim_{x \rightarrow 0} f(x) = 0$.

(b) $f'(0) = \lim_{x \rightarrow 0} \frac{f(x) - f(0)}{x - 0} = \lim_{x \rightarrow 0} x \sin(1/x) = 0$ by Exercise 73, part (a).

(c) For $x \neq 0$, $f'(x) = 2x \sin(1/x) + x^2 \cos(1/x)(-1/x^2) = 2x \sin(1/x) - \cos(1/x)$.

(d) If $f'(x)$ were continuous at $x = 0$ then so would $\cos(1/x) = 2x \sin(1/x) - f'(x)$ be, since $2x \sin(1/x)$ is continuous there. But $\cos(1/x)$ oscillates at $x = 0$.

75. (a) $g'(x) = 3[f(x)]^2 f'(x)$, $g'(2) = 3[f(2)]^2 f'(2) = 3(1)^2(7) = 21$.

(b) $h'(x) = f'(x^3)(3x^2)$, $h'(2) = f'(8)(12) = (-3)(12) = -36$.

76. $F'(x) = f'(g(x))g'(x) = \sqrt{3(x^2 - 1) + 4} \cdot 2x = 2x\sqrt{3x^2 + 1}$.

77. $F'(x) = f'(g(x))g'(x) = f'(\sqrt{3x - 1}) \frac{3}{2\sqrt{3x - 1}} = \frac{\sqrt{3x - 1}}{(3x - 1) + 1} \frac{3}{2\sqrt{3x - 1}} = \frac{1}{2x}$.

78. $\frac{d}{dx}[f(x^2)] = f'(x^2)(2x)$, thus $f'(x^2)(2x) = x^2$ so $f'(x^2) = x/2$ if $x \neq 0$.

79. $\frac{d}{dx}[f(3x)] = f'(3x) \frac{d}{dx}(3x) = 3f'(3x) = 6x$, so $f'(3x) = 2x$. Let $u = 3x$ to get $f'(u) = \frac{2}{3}u$; $\frac{d}{dx}[f(x)] = f'(x) = \frac{2}{3}x$.

80. (a) If $f(-x) = f(x)$, then $\frac{d}{dx}[f(-x)] = \frac{d}{dx}[f(x)]$, $f'(-x)(-1) = f'(x)$, $f'(-x) = -f'(x)$ so f' is odd.

(b) If $f(-x) = -f(x)$, then $\frac{d}{dx}[f(-x)] = -\frac{d}{dx}[f(x)]$, $f'(-x)(-1) = -f'(x)$, $f'(-x) = f'(x)$ so f' is even.

81. For an even function, the graph is symmetric about the y -axis; the slope of the tangent line at $(a, f(a))$ is the negative of the slope of the tangent line at $(-a, f(-a))$. For an odd function, the graph is symmetric about the origin; the slope of the tangent line at $(a, f(a))$ is the same as the slope of the tangent line at $(-a, f(-a))$.

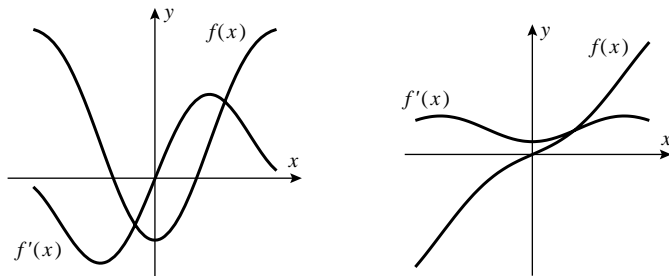

82. $\frac{dy}{dx} = \frac{dy}{du} \frac{du}{dv} \frac{dv}{dw} \frac{dw}{dx}$.

83. $\frac{d}{dx}[f(g(h(x)))] = \frac{d}{dx}[f(g(u))]$, $u = h(x)$, $\frac{d}{du}[f(g(u))] \frac{du}{dx} = f'(g(u))g'(u) \frac{du}{dx} = f'(g(h(x)))g'(h(x))h'(x)$.

84. $g'(x) = f'(\frac{\pi}{2} - x) \cdot \frac{d}{dx}(\frac{\pi}{2} - x) = -f'(\frac{\pi}{2} - x)$, so g' is the negative of the co-function of f' .

The derivatives of $\sin x$, $\tan x$, and $\sec x$ are $\cos x$, $\sec^2 x$, and $\sec x \tan x$, respectively. The negatives of the co-functions of these are $-\sin x$, $-\csc^2 x$, and $-\csc x \cot x$, which are the derivatives of $\cos x$, $\cot x$, and $\csc x$, respectively.

Chapter 2 Review Exercises

$$2. (a) m_{\text{sec}} = \frac{f(4) - f(3)}{4 - 3} = \frac{(4)^2/2 - (3)^2/2}{1} = \frac{7}{2}$$

$$(b) m_{\text{tan}} = \lim_{w \rightarrow 3} \frac{f(w) - f(3)}{w - 3} = \lim_{w \rightarrow 3} \frac{w^2/2 - 9/2}{w - 3} = \lim_{w \rightarrow 3} \frac{w^2 - 9}{2(w - 3)} = \lim_{w \rightarrow 3} \frac{(w + 3)(w - 3)}{2(w - 3)} = \lim_{w \rightarrow 3} \frac{w + 3}{2} = 3.$$

$$(c) m_{\text{tan}} = \lim_{w \rightarrow x} \frac{f(w) - f(x)}{w - x} = \lim_{w \rightarrow x} \frac{w^2/2 - x^2/2}{w - x} = \lim_{w \rightarrow x} \frac{w^2 - x^2}{2(w - x)} = \lim_{w \rightarrow x} \frac{w + x}{2} = x.$$

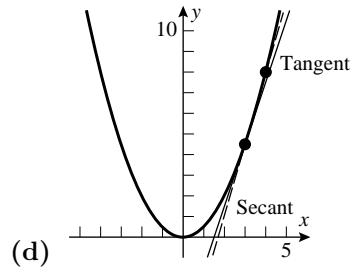

$$3. (a) m_{\text{tan}} = \lim_{w \rightarrow x} \frac{f(w) - f(x)}{w - x} = \lim_{w \rightarrow x} \frac{(w^2 + 1) - (x^2 + 1)}{w - x} = \lim_{w \rightarrow x} \frac{w^2 - x^2}{w - x} = \lim_{w \rightarrow x} (w + x) = 2x.$$

$$(b) m_{\text{tan}} = 2(2) = 4.$$

4. To average 60 mi/h one would have to complete the trip in two hours. At 50 mi/h, 100 miles are completed after two hours. Thus time is up, and the speed for the remaining 20 miles would have to be infinite.

$$5. v_{\text{inst}} = \lim_{h \rightarrow 0} \frac{3(h + 1)^{2.5} + 580h - 3}{10h} = 58 + \frac{1}{10} \left. \frac{d}{dx} 3x^{2.5} \right|_{x=1} = 58 + \frac{1}{10} (2.5)(3)(1)^{1.5} = 58.75 \text{ ft/s.}$$

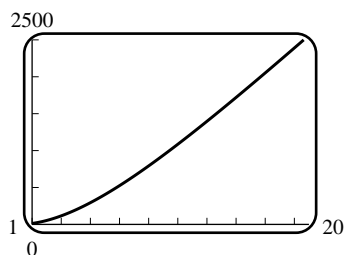

6. 164 ft/s

$$7. (a) v_{\text{ave}} = \frac{[3(3)^2 + 3] - [3(1)^2 + 1]}{3 - 1} = 13 \text{ mi/h.}$$

$$(b) v_{\text{inst}} = \lim_{t_1 \rightarrow 1} \frac{(3t_1^2 + t_1) - 4}{t_1 - 1} = \lim_{t_1 \rightarrow 1} \frac{(3t_1 + 4)(t_1 - 1)}{t_1 - 1} = \lim_{t_1 \rightarrow 1} (3t_1 + 4) = 7 \text{ mi/h.}$$

$$9. (a) \frac{dy}{dx} = \lim_{h \rightarrow 0} \frac{\sqrt{9 - 4(x + h)} - \sqrt{9 - 4x}}{h} = \lim_{h \rightarrow 0} \frac{9 - 4(x + h) - (9 - 4x)}{h(\sqrt{9 - 4(x + h)} + \sqrt{9 - 4x})} =$$

$$= \lim_{h \rightarrow 0} \frac{-4h}{h(\sqrt{9 - 4(x + h)} + \sqrt{9 - 4x})} = \frac{-4}{2\sqrt{9 - 4x}} = \frac{-2}{\sqrt{9 - 4x}}.$$

$$(b) \frac{dy}{dx} = \lim_{h \rightarrow 0} \frac{\frac{x + h}{x + h + 1} - \frac{x}{x + 1}}{h} = \lim_{h \rightarrow 0} \frac{(x + h)(x + 1) - x(x + h + 1)}{h(x + h + 1)(x + 1)} = \lim_{h \rightarrow 0} \frac{h}{h(x + h + 1)(x + 1)} = \frac{1}{(x + 1)^2}.$$

10. $f(x)$ is continuous and differentiable at any $x \neq 1$, so we consider $x = 1$.

(a) $\lim_{x \rightarrow 1^-} (x^2 - 1) = \lim_{x \rightarrow 1^+} k(x - 1) = 0 = f(1)$, so any value of k gives continuity at $x = 1$.

(b) $\lim_{x \rightarrow 1^-} f'(x) = \lim_{x \rightarrow 1^-} 2x = 2$, and $\lim_{x \rightarrow 1^+} f'(x) = \lim_{x \rightarrow 1^+} k = k$, so only if $k = 2$ is $f(x)$ differentiable at $x = 1$.

11. (a) $x = -2, -1, 1, 3$ (b) $(-\infty, -2), (-1, 1), (3, +\infty)$ (c) $(-2, -1), (1, 3)$

(d) $g''(x) = f''(x) \sin x + 2f'(x) \cos x - f(x) \sin x$; $g''(0) = 2f'(0) \cos 0 = 2(2)(1) = 4$

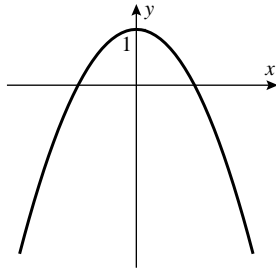

12.

13. (a) The slope of the tangent line $\approx \frac{10 - 2.2}{2050 - 1950} = 0.078$ billion, so in 2000 the world population was increasing at the rate of about 78 million per year.

(b) $\frac{dN/dt}{N} \approx \frac{0.078}{6} = 0.013 = 1.3 \text{ \%/year}$

14. When $x^4 - x - 1 > 0$, $f(x) = x^4 - 2x - 1$; when $x^4 - x - 1 < 0$, $f(x) = -x^4 + 1$, and f is differentiable in both cases. The roots of $x^4 - x - 1 = 0$ are $x_1 \approx -0.724492$, $x_2 \approx 1.220744$. So $x^4 - x - 1 > 0$ on $(-\infty, x_1)$ and $(x_2, +\infty)$, and $x^4 - x - 1 < 0$ on (x_1, x_2) . Then $\lim_{x \rightarrow x_1^-} f'(x) = \lim_{x \rightarrow x_1^-} (4x^3 - 2) = 4x_1^3 - 2$ and $\lim_{x \rightarrow x_1^+} f'(x) = \lim_{x \rightarrow x_1^+} -4x^3 = -4x_1^3$ which is not equal to $4x_1^3 - 2$, so f is not differentiable at $x = x_1$; similarly f is not differentiable at $x = x_2$.

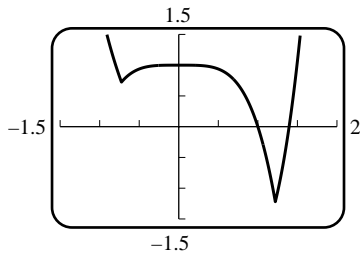

15. (a) $f'(x) = 2x \sin x + x^2 \cos x$ (c) $f''(x) = 4x \cos x + (2 - x^2) \sin x$

16. (a) $f'(x) = \frac{1 - 2\sqrt{x} \sin 2x}{2\sqrt{x}}$ (c) $f''(x) = \frac{-1 - 8x^{3/2} \cos 2x}{4x^{3/2}}$

17. (a) $f'(x) = \frac{6x^2 + 8x - 17}{(3x + 2)^2}$ (c) $f''(x) = \frac{118}{(3x + 2)^3}$

18. (a) $f'(x) = \frac{(1 + x^2) \sec^2 x - 2x \tan x}{(1 + x^2)^2}$

(c) $f''(x) = \frac{(2 + 4x^2 + 2x^4) \sec^2 x \tan x - (4x + 4x^3) \sec^2 x + (-2 + 6x^2) \tan x}{(1 + x^2)^3}$

19. (a) $\frac{dW}{dt} = 200(t - 15)$; at $t = 5$, $\frac{dW}{dt} = -2000$; the water is running out at the rate of 2000 gal/min.

(b) $\frac{W(5) - W(0)}{5 - 0} = \frac{10000 - 22500}{5} = -2500$; the average rate of flow out is 2500 gal/min.

20. (a) $\frac{4^3 - 2^3}{4 - 2} = \frac{56}{2} = 28$ (b) $(dV/d\ell)|_{\ell=5} = 3\ell^2|_{\ell=5} = 3(5)^2 = 75$

21. (a) $f'(x) = 2x$, $f'(1.8) = 3.6$ (b) $f'(x) = (x^2 - 4x)/(x - 2)^2$, $f'(3.5) = -7/9 \approx -0.777778$

22. (a) $f'(x) = 3x^2 - 2x$, $f'(2.3) = 11.27$ (b) $f'(x) = (1 - x^2)/(x^2 + 1)^2$, $f'(-0.5) = 0.48$

23. f is continuous at $x = 1$ because it is differentiable there, thus $\lim_{h \rightarrow 0} f(1 + h) = f(1)$ and so $f(1) = 0$ because $\lim_{h \rightarrow 0} \frac{f(1 + h)}{h}$ exists; $f'(1) = \lim_{h \rightarrow 0} \frac{f(1 + h) - f(1)}{h} = \lim_{h \rightarrow 0} \frac{f(1 + h)}{h} = 5$.

24. Multiply the given equation by $\lim_{x \rightarrow 2} (x - 2) = 0$ to get $0 = \lim_{x \rightarrow 2} (x^3 f(x) - 24)$. Since f is continuous at $x = 2$, this equals $2^3 f(2) - 24$, so $f(2) = 3$. Now let $g(x) = x^3 f(x)$. Then $g'(2) = \lim_{x \rightarrow 2} \frac{g(x) - g(2)}{x - 2} = \lim_{x \rightarrow 2} \frac{x^3 f(x) - 2^3 f(2)}{x - 2} = \lim_{x \rightarrow 2} \frac{x^3 f(x) - 24}{x - 2} = 28$. But $g'(x) = x^3 f'(x) + 3x^2 f(x)$, so $28 = g'(2) = 2^3 f'(2) + 3 \cdot 2^2 f(2) = 8f'(2) + 36$, and $f'(2) = -1$.

25. The equation of such a line has the form $y = mx$. The points (x_0, y_0) which lie on both the line and the parabola and for which the slopes of both curves are equal satisfy $y_0 = mx_0 = x_0^3 - 9x_0^2 - 16x_0$, so that $m = x_0^2 - 9x_0 - 16$. By differentiating, the slope is also given by $m = 3x_0^2 - 18x_0 - 16$. Equating, we have $x_0^2 - 9x_0 - 16 = 3x_0^2 - 18x_0 - 16$, or $2x_0^2 - 9x_0 = 0$. The root $x_0 = 0$ corresponds to $m = -16$, $y_0 = 0$ and the root $x_0 = 9/2$ corresponds to $m = -145/4$, $y_0 = -1305/8$. So the line $y = -16x$ is tangent to the curve at the point $(0, 0)$, and the line $y = -145x/4$ is tangent to the curve at the point $(9/2, -1305/8)$.

26. The slope of the line $x + 4y = 10$ is $m_1 = -1/4$, so we set the negative reciprocal $4 = m_2 = \frac{d}{dx}(2x^3 - x^2) = 6x^2 - 2x$ and obtain $6x^2 - 2x - 4 = 0$ with roots $x = \frac{1 \pm \sqrt{1 + 24}}{6} = 1, -2/3$.

27. The slope of the tangent line is the derivative $y' = 2x|_{x=\frac{1}{2}(a+b)} = a + b$. The slope of the secant is $\frac{a^2 - b^2}{a - b} = a + b$, so they are equal.

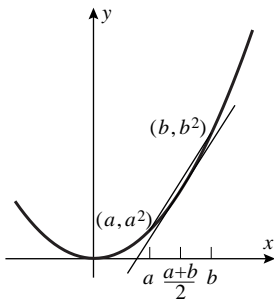

28. (a) $f'(1)g(1) + f(1)g'(1) = 3(-2) + 1(-1) = -7$ (b) $\frac{g(1)f'(1) - f(1)g'(1)}{g(1)^2} = \frac{-2(3) - 1(-1)}{(-2)^2} = -\frac{5}{4}$

(c) $\frac{1}{2\sqrt{f(1)}} f'(1) = \frac{1}{2\sqrt{1}}(3) = \frac{3}{2}$ (d) 0 (because $f(1)g'(1)$ is constant)

29. (a) $8x^7 - \frac{3}{2\sqrt{x}} - 15x^{-4}$ (b) $2 \cdot 101(2x+1)^{100}(5x^2-7) + 10x(2x+1)^{101} = (2x+1)^{100}(1030x^2 + 10x - 1414)$

30. (a) $\cos x - 6 \cos^2 x \sin x$ (b) $(1 + \sec x)(2x - \sec^2 x) + (x^2 - \tan x) \sec x \tan x$

31. (a) $2(x-1)\sqrt{3x+1} + \frac{3}{2\sqrt{3x+1}}(x-1)^2 = \frac{(x-1)(15x+1)}{2\sqrt{3x+1}}$

(b) $3 \left(\frac{3x+1}{x^2} \right)^2 \frac{x^2(3) - (3x+1)(2x)}{x^4} = -\frac{3(3x+1)^2(3x+2)}{x^7}$

32. (a) $-\csc^2 \left(\frac{\csc 2x}{x^3+5} \right) \frac{-2(x^3+5) \csc 2x \cot 2x - 3x^2 \csc 2x}{(x^3+5)^2}$ (b) $-\frac{2+3 \sin^2 x \cos x}{(2x+\sin^3 x)^2}$

33. Set $f'(x) = 0$: $f'(x) = 6(2)(2x+7)^5(x-2)^5 + 5(2x+7)^6(x-2)^4 = 0$, so $2x+7 = 0$ or $x-2 = 0$ or, factoring out $(2x+7)^5(x-2)^4$, $12(x-2) + 5(2x+7) = 0$. This reduces to $x = -7/2$, $x = 2$, or $22x+11 = 0$, so the tangent line is horizontal at $x = -7/2, 2, -1/2$.

34. Set $f'(x) = 0$: $f'(x) = \frac{4(x^2+2x)(x-3)^3 - (2x+2)(x-3)^4}{(x^2+2x)^2}$, and a fraction can equal zero only if its numerator equals zero. So either $x-3 = 0$ or, after factoring out $(x-3)^3$, $4(x^2+2x) - (2x+2)(x-3) = 0$, $2x^2+12x+6 = 0$, whose roots are (by the quadratic formula) $x = \frac{-6 \pm \sqrt{36-4 \cdot 3}}{2} = -3 \pm \sqrt{6}$. So the tangent line is horizontal at $x = 3, -3 \pm \sqrt{6}$.

35. Suppose the line is tangent to $y = x^2 + 1$ at (x_0, y_0) and tangent to $y = -x^2 - 1$ at (x_1, y_1) . Since it's tangent to $y = x^2 + 1$, its slope is $2x_0$; since it's tangent to $y = -x^2 - 1$, its slope is $-2x_1$. Hence $x_1 = -x_0$ and $y_1 = -y_0$. Since the line passes through both points, its slope is $\frac{y_1 - y_0}{x_1 - x_0} = \frac{-2y_0}{-2x_0} = \frac{y_0}{x_0} = \frac{x_0^2 + 1}{x_0}$. Thus $2x_0 = \frac{x_0^2 + 1}{x_0}$, so $2x_0^2 = x_0^2 + 1$, $x_0^2 = 1$, and $x_0 = \pm 1$. So there are two lines which are tangent to both graphs, namely $y = 2x$ and $y = -2x$.

36. (a) Suppose $y = mx + b$ is tangent to $y = x^n + n - 1$ at (x_0, y_0) and to $y = -x^n - n + 1$ at (x_1, y_1) . Then $m = nx_0^{n-1} = -nx_1^{n-1}$; since n is even this implies that $x_1 = -x_0$. Again since n is even, $y_1 = -x_1^n - n + 1 = -x_0^n - n + 1 = -(x_0^n + n - 1) = -y_0$. Thus the points (x_0, y_0) and (x_1, y_1) are symmetric with respect to the origin and both lie on the tangent line and thus $b = 0$. The slope m is given by $m = nx_0^{n-1}$ and by $m = y_0/x_0 = (x_0^n + n - 1)/x_0$, hence $nx_0^n = x_0^n + n - 1$, $(n-1)x_0^n = n - 1$, $x_0^n = 1$. Since n is even, $x_0 = \pm 1$. One easily checks that $y = nx$ is tangent to $y = x^n + n - 1$ at $(1, n)$ and to $y = -x^n - n + 1$ at $(-1, -n)$, while $y = -nx$ is tangent to $y = x^n + n - 1$ at $(-1, n)$ and to $y = -x^n - n + 1$ at $(1, -n)$.

(b) Suppose there is such a common tangent line with slope m . The function $y = x^n + n - 1$ is always increasing, so $m \geq 0$. Moreover the function $y = -x^n - n + 1$ is always decreasing, so $m \leq 0$. Thus the tangent line has slope 0, which only occurs on the curves for $x = 0$. This would require the common tangent line to pass through $(0, n - 1)$ and $(0, -n + 1)$ and do so with slope $m = 0$, which is impossible.

37. The line $y - x = 2$ has slope $m_1 = 1$ so we set $m_2 = \frac{d}{dx}(3x - \tan x) = 3 - \sec^2 x = 1$, or $\sec^2 x = 2$, $\sec x = \pm\sqrt{2}$ so $x = n\pi \pm \pi/4$ where $n = 0, \pm 1, \pm 2, \dots$

38. Solve $3x^2 - \cos x = 0$ to get $x = \pm 0.535428$.

39. $3 = f(\pi/4) = (M+N)\sqrt{2}/2$ and $1 = f'(\pi/4) = (M-N)\sqrt{2}/2$. Add these two equations to get $4 = \sqrt{2}M$, $M = 2^{3/2}$. Subtract to obtain $2 = \sqrt{2}N$, $N = \sqrt{2}$. Thus $f(x) = 2\sqrt{2} \sin x + \sqrt{2} \cos x$. $f' \left(\frac{3\pi}{4} \right) = -3$, so the tangent line is $y - 1 = -3 \left(x - \frac{3\pi}{4} \right)$.

40. $f(x) = M \tan x + N \sec x$, $f'(x) = M \sec^2 x + N \sec x \tan x$. At $x = \pi/4$, $2M + \sqrt{2}N, 0 = 2M + \sqrt{2}N$. Add to get $M = -2$, subtract to get $N = \sqrt{2} + M/\sqrt{2} = 2\sqrt{2}$, $f(x) = -2 \tan x + 2\sqrt{2} \sec x$. $f'(0) = -2$, so the tangent line is $y - 2\sqrt{2} = -2x$.

41. $f'(x) = 2xf(x)$, $f(2) = 5$

(a) $g(x) = f(\sec x)$, $g'(x) = f'(\sec x) \sec x \tan x = 2 \cdot 2f(2) \cdot 2 \cdot \sqrt{3} = 40\sqrt{3}$.

(b) $h'(x) = 4 \left[\frac{f(x)}{x-1} \right]^3 \frac{(x-1)f'(x) - f(x)}{(x-1)^2}$, $h'(2) = 4 \frac{5^3 f'(2) - f(2)}{1} = 4 \cdot 5^3 \frac{2 \cdot 2f(2) - f(2)}{1} = 4 \cdot 5^3 \cdot 3 \cdot 5 = 7500$

Chapter 2 Making Connections

1. (a) By property (ii), $f(0) = f(0+0) = f(0)f(0)$, so $f(0) = 0$ or 1. By property (iii), $f(0) \neq 0$, so $f(0) = 1$.

(b) By property (ii), $f(x) = f\left(\frac{x}{2} + \frac{x}{2}\right) = f\left(\frac{x}{2}\right)^2 \geq 0$. If $f(x) = 0$, then $1 = f(0) = f(x+(-x)) = f(x)f(-x) = 0 \cdot f(-x) = 0$, a contradiction. Hence $f(x) > 0$.

(c) $f'(x) = \lim_{h \rightarrow 0} \frac{f(x+h) - f(x)}{h} = \lim_{h \rightarrow 0} \frac{f(x)f(h) - f(x)}{h} = \lim_{h \rightarrow 0} f(x) \frac{f(h) - 1}{h} = f(x) \lim_{h \rightarrow 0} \frac{f(h) - f(0)}{h} = f(x)f'(0) = f(x)$

2. (a) By the chain rule and Exercise 1(c), $y' = f'(2x) \cdot \frac{d}{dx}(2x) = f'(2x) \cdot 2 = 2y$.

(b) By the chain rule and Exercise 1(c), $y' = f'(kx) \cdot \frac{d}{dx}(kx) = kf'(kx) = kf(kx)$.

(c) By the product rule and Exercise 1(c), $y' = f(x)g'(x) + g(x)f'(x) = f(x)g(x) + g(x)f(x) = 2f(x)g(x) = 2y$, so $k = 2$.

(d) By the quotient rule and Exercise 1(c), $h'(x) = \frac{g(x)f'(x) - f(x)g'(x)}{g(x)^2} = \frac{g(x)f(x) - f(x)g(x)}{g(x)^2} = 0$. As we will see in Theorem 4.1.2(c), this implies that $h(x)$ is a constant. Since $h(0) = f(0)/g(0) = 1/1 = 1$ by Exercise 1(a), $h(x) = 1$ for all x , so $f(x) = g(x)$.

3. (a) For brevity, we omit the “(x)” throughout.

$$(f \cdot g \cdot h)' = \frac{d}{dx}[(f \cdot g) \cdot h] = (f \cdot g) \cdot \frac{dh}{dx} + h \cdot \frac{d}{dx}(f \cdot g) = f \cdot g \cdot h' + h \cdot \left(f \cdot \frac{dg}{dx} + g \cdot \frac{df}{dx} \right)$$

$$= f' \cdot g \cdot h + f \cdot g' \cdot h + f \cdot g \cdot h'$$

(b) $(f \cdot g \cdot h \cdot k)' = \frac{d}{dx}[(f \cdot g \cdot h) \cdot k] = (f \cdot g \cdot h) \cdot \frac{dk}{dx} + k \cdot \frac{d}{dx}(f \cdot g \cdot h)$

$$= f \cdot g \cdot h \cdot k' + k \cdot (f' \cdot g \cdot h + f \cdot g' \cdot h + f \cdot g \cdot h') = f' \cdot g \cdot h \cdot k + f \cdot g' \cdot h \cdot k + f \cdot g \cdot h' \cdot k + f \cdot g \cdot h \cdot k'$$

(c) Theorem: If $n \geq 1$ and f_1, \dots, f_n are differentiable functions of x , then

$$(f_1 \cdot f_2 \cdot \dots \cdot f_n)' = \sum_{i=1}^n f_1 \cdot \dots \cdot f_{i-1} \cdot f'_i \cdot f_{i+1} \cdot \dots \cdot f_n$$

Proof: For $n = 1$ the statement is obviously true: $f'_1 = f'_1$. If the statement is true for $n - 1$, then

$$(f_1 \cdot f_2 \cdot \dots \cdot f_n)' = \frac{d}{dx}[(f_1 \cdot f_2 \cdot \dots \cdot f_{n-1}) \cdot f_n] = (f_1 \cdot f_2 \cdot \dots \cdot f_{n-1}) \cdot f'_n + f_n \cdot (f_1 \cdot f_2 \cdot \dots \cdot f_{n-1})'$$

$$= f_1 \cdot f_2 \cdot \dots \cdot f_{n-1} \cdot f'_n + f_n \cdot \sum_{i=1}^{n-1} f_1 \cdot \dots \cdot f_{i-1} \cdot f'_i \cdot f_{i+1} \cdot \dots \cdot f_{n-1} = \sum_{i=1}^n f_1 \cdot \dots \cdot f_{i-1} \cdot f'_i \cdot f_{i+1} \cdot \dots \cdot f_n$$

so the statement is true for n . By induction, it's true for all n .

$$4. (a) [(f/g)/h]' = \frac{h \cdot (f/g)' - (f/g) \cdot h'}{h^2} = \frac{h \cdot \frac{g \cdot f' - f \cdot g'}{g^2} - \frac{f \cdot h'}{g}}{h^2} = \frac{f' \cdot g \cdot h - f \cdot g' \cdot h - f \cdot g \cdot h'}{g^2 h^2}$$

$$(b) [(f/g)/h]' = [f/(g \cdot h)]' = \frac{(g \cdot h) \cdot f' - f \cdot (g \cdot h)'}{(g \cdot h)^2} = \frac{f' \cdot g \cdot h - f \cdot (g \cdot h' + h \cdot g')}{g^2 h^2} =$$

$$= \frac{f' \cdot g \cdot h - f \cdot g' \cdot h - f \cdot g \cdot h'}{g^2 h^2}$$

$$(c) [f/(g/h)]' = \frac{(g/h) \cdot f' - f \cdot (g/h)'}{(g/h)^2} = \frac{\frac{f' \cdot g}{h} - f \cdot \frac{h \cdot g' - g \cdot h'}{h^2}}{(g/h)^2} = \frac{f' \cdot g \cdot h - f \cdot g' \cdot h + f \cdot g \cdot h'}{g^2}$$

$$(d) [f/(g/h)]' = [(f \cdot h)/g]' = \frac{g \cdot (f \cdot h)' - (f \cdot h) \cdot g'}{g^2} = \frac{g \cdot (f \cdot h' + h \cdot f') - f \cdot g' \cdot h}{g^2} =$$

$$= \frac{f' \cdot g \cdot h - f \cdot g' \cdot h + f \cdot g \cdot h'}{g^2}$$

5. (a) By the chain rule, $\frac{d}{dx}([g(x)]^{-1}) = -[g(x)]^{-2}g'(x) = -\frac{g'(x)}{[g(x)]^2}$. By the product rule,

$$h'(x) = f(x) \cdot \frac{d}{dx}([g(x)]^{-1}) + [g(x)]^{-1} \cdot \frac{d}{dx}[f(x)] = -\frac{f(x)g'(x)}{[g(x)]^2} + \frac{f'(x)}{g(x)} = \frac{g(x)f'(x) - f(x)g'(x)}{[g(x)]^2}.$$

(b) By the product rule, $f'(x) = \frac{d}{dx}[h(x)g(x)] = h(x)g'(x) + g(x)h'(x)$. So

$$h'(x) = \frac{1}{g(x)}[f'(x) - h(x)g'(x)] = \frac{1}{g(x)} \left[f'(x) - \frac{f(x)}{g(x)}g'(x) \right] = \frac{g(x)f'(x) - f(x)g'(x)}{[g(x)]^2}.$$

Topics in Differentiation

Exercise Set 3.1

1. (a) $1 + y + x \frac{dy}{dx} - 6x^2 = 0$, $\frac{dy}{dx} = \frac{6x^2 - y - 1}{x}$.
(b) $y = \frac{2 + 2x^3 - x}{x} = \frac{2}{x} + 2x^2 - 1$, $\frac{dy}{dx} = -\frac{2}{x^2} + 4x$.
(c) From part (a), $\frac{dy}{dx} = 6x - \frac{1}{x} - \frac{1}{x}y = 6x - \frac{1}{x} - \frac{1}{x} \left(\frac{2}{x} + 2x^2 - 1 \right) = 4x - \frac{2}{x^2}$.
2. (a) $\frac{1}{2}y^{-1/2} \frac{dy}{dx} - \cos x = 0$ or $\frac{dy}{dx} = 2\sqrt{y} \cos x$.
(b) $y = (2 + \sin x)^2 = 4 + 4 \sin x + \sin^2 x$ so $\frac{dy}{dx} = 4 \cos x + 2 \sin x \cos x$.
(c) From part (a), $\frac{dy}{dx} = 2\sqrt{y} \cos x = 2 \cos x (2 + \sin x) = 4 \cos x + 2 \sin x \cos x$.
3. $2x + 2y \frac{dy}{dx} = 0$ so $\frac{dy}{dx} = -\frac{x}{y}$.
4. $3x^2 + 3y^2 \frac{dy}{dx} = 3y^2 + 6xy \frac{dy}{dx}$, $\frac{dy}{dx} = \frac{3y^2 - 3x^2}{3y^2 - 6xy} = \frac{y^2 - x^2}{y^2 - 2xy}$.
5. $x^2 \frac{dy}{dx} + 2xy + 3x(3y^2) \frac{dy}{dx} + 3y^3 - 1 = 0$, $(x^2 + 9xy^2) \frac{dy}{dx} = 1 - 2xy - 3y^3$, so $\frac{dy}{dx} = \frac{1 - 2xy - 3y^3}{x^2 + 9xy^2}$.
6. $x^3(2y) \frac{dy}{dx} + 3x^2y^2 - 5x^2 \frac{dy}{dx} - 10xy + 1 = 0$, $(2x^3y - 5x^2) \frac{dy}{dx} = 10xy - 3x^2y^2 - 1$, so $\frac{dy}{dx} = \frac{10xy - 3x^2y^2 - 1}{2x^3y - 5x^2}$.
7. $-\frac{1}{2x^{3/2}} - \frac{\frac{dy}{dx}}{2y^{3/2}} = 0$, so $\frac{dy}{dx} = -\frac{y^{3/2}}{x^{3/2}}$.
8. $2x = \frac{(x-y)(1 + dy/dx) - (x+y)(1 - dy/dx)}{(x-y)^2}$, $2x(x-y)^2 = -2y + 2x \frac{dy}{dx}$, so $\frac{dy}{dx} = \frac{x(x-y)^2 + y}{x}$.
9. $\cos(x^2y^2) \left[x^2(2y) \frac{dy}{dx} + 2xy^2 \right] = 1$, so $\frac{dy}{dx} = \frac{1 - 2xy^2 \cos(x^2y^2)}{2x^2y \cos(x^2y^2)}$.
10. $-\sin(xy^2) \left[y^2 + 2xy \frac{dy}{dx} \right] = \frac{dy}{dx}$, so $\frac{dy}{dx} = -\frac{y^2 \sin(xy^2)}{2xy \sin(xy^2) + 1}$.

11. $3 \tan^2(xy^2 + y) \sec^2(xy^2 + y) \left(2xy \frac{dy}{dx} + y^2 + \frac{dy}{dx} \right) = 1$, so $\frac{dy}{dx} = \frac{1 - 3y^2 \tan^2(xy^2 + y) \sec^2(xy^2 + y)}{3(2xy + 1) \tan^2(xy^2 + y) \sec^2(xy^2 + y)}$.
12. $\frac{(1 + \sec y)[3xy^2(dy/dx) + y^3] - xy^3(\sec y \tan y)(dy/dx)}{(1 + \sec y)^2} = 4y^3 \frac{dy}{dx}$, multiply through by $(1 + \sec y)^2$ and solve for $\frac{dy}{dx}$ to get $\frac{dy}{dx} = \frac{y(1 + \sec y)}{4y(1 + \sec y)^2 - 3x(1 + \sec y) + xy \sec y \tan y}$.
13. $4x - 6y \frac{dy}{dx} = 0$, $\frac{dy}{dx} = \frac{2x}{3y}$, $4 - 6 \left(\frac{dy}{dx} \right)^2 - 6y \frac{d^2y}{dx^2} = 0$, so $\frac{d^2y}{dx^2} = -\frac{3 \left(\frac{dy}{dx} \right)^2 - 2}{3y} = \frac{2(3y^2 - 2x^2)}{9y^3} = -\frac{8}{9y^3}$.
14. $\frac{dy}{dx} = -\frac{x^2}{y^2}$, $\frac{d^2y}{dx^2} = -\frac{y^2(2x) - x^2(2y dy/dx)}{y^4} = -\frac{2xy^2 - 2x^2y(-x^2/y^2)}{y^4} = -\frac{2x(y^3 + x^3)}{y^5}$, but $x^3 + y^3 = 1$, so $\frac{d^2y}{dx^2} = -\frac{2x}{y^5}$.
15. $\frac{dy}{dx} = -\frac{y}{x}$, $\frac{d^2y}{dx^2} = -\frac{x(dy/dx) - y(1)}{x^2} = -\frac{x(-y/x) - y}{x^2} = \frac{2y}{x^2}$.
16. $y + x \frac{dy}{dx} + 2y \frac{dy}{dx} = 0$, $\frac{dy}{dx} = -\frac{y}{x + 2y}$, $2 \frac{dy}{dx} + x \frac{d^2y}{dx^2} + 2 \left(\frac{dy}{dx} \right)^2 + 2y \frac{d^2y}{dx^2} = 0$, $\frac{d^2y}{dx^2} = \frac{2y(x + y)}{(x + 2y)^3}$.
17. $\frac{dy}{dx} = (1 + \cos y)^{-1}$, $\frac{d^2y}{dx^2} = -(1 + \cos y)^{-2}(-\sin y) \frac{dy}{dx} = \frac{\sin y}{(1 + \cos y)^3}$.
18. $\frac{dy}{dx} = \frac{\cos y}{1 + x \sin y}$, $\frac{d^2y}{dx^2} = \frac{(1 + x \sin y)(-\sin y)(dy/dx) - (\cos y)[(x \cos y)(dy/dx) + \sin y]}{(1 + x \sin y)^2} = -\frac{2 \sin y \cos y + (x \cos y)(2 \sin^2 y + \cos^2 y)}{(1 + x \sin y)^3}$, but $x \cos y = y$, $2 \sin y \cos y = \sin 2y$, and $\sin^2 y + \cos^2 y = 1$, so $\frac{d^2y}{dx^2} = -\frac{\sin 2y + y(\sin^2 y + 1)}{(1 + x \sin y)^3}$.
19. By implicit differentiation, $2x + 2y(dy/dx) = 0$, $\frac{dy}{dx} = -\frac{x}{y}$; at $(1/2, \sqrt{3}/2)$, $\frac{dy}{dx} = -\sqrt{3}/3$; at $(1/2, -\sqrt{3}/2)$, $\frac{dy}{dx} = +\sqrt{3}/3$. Directly, at the upper point $y = \sqrt{1 - x^2}$, $\frac{dy}{dx} = \frac{-x}{\sqrt{1 - x^2}} = -\frac{1/2}{\sqrt{3}/4} = -1/\sqrt{3}$ and at the lower point $y = -\sqrt{1 - x^2}$, $\frac{dy}{dx} = \frac{x}{\sqrt{1 - x^2}} = +1/\sqrt{3}$.
20. If $y^2 - x + 1 = 0$, then $y = \sqrt{x - 1}$ goes through the point $(10, 3)$ so $dy/dx = 1/(2\sqrt{x - 1})$. By implicit differentiation $dy/dx = 1/(2y)$. In both cases, $dy/dx|_{(10,3)} = 1/6$. Similarly $y = -\sqrt{x - 1}$ goes through $(10, -3)$ so $dy/dx = -1/(2\sqrt{x - 1}) = -1/6$ which yields $dy/dx = 1/(2y) = -1/6$.
21. False; $x = y^2$ defines two functions $y = \pm\sqrt{x}$. See Definition 3.1.1.
22. True.
23. False; the equation is equivalent to $x^2 = y^2$ which is satisfied by $y = |x|$.
24. True.
25. $4x^3 + 4y^3 \frac{dy}{dx} = 0$, so $\frac{dy}{dx} = -\frac{x^3}{y^3} = -\frac{1}{15^{3/4}} \approx -0.1312$.

26. $3y^2 \frac{dy}{dx} + x^2 \frac{dy}{dx} + 2xy + 2x - 6y \frac{dy}{dx} = 0$, so $\frac{dy}{dx} = -2x \frac{y+1}{3y^2 + x^2 - 6y} = 0$ at $x = 0$.
27. $4(x^2 + y^2) \left(2x + 2y \frac{dy}{dx}\right) = 25 \left(2x - 2y \frac{dy}{dx}\right)$, $\frac{dy}{dx} = \frac{x[25 - 4(x^2 + y^2)]}{y[25 + 4(x^2 + y^2)]}$; at $(3, 1)$ $\frac{dy}{dx} = -9/13$.
28. $\frac{2}{3} \left(x^{-1/3} + y^{-1/3} \frac{dy}{dx}\right) = 0$, $\frac{dy}{dx} = -\frac{y^{1/3}}{x^{1/3}} = \sqrt{3}$ at $(-1, 3\sqrt{3})$.
29. $4a^3 \frac{da}{dt} - 4t^3 = 6 \left(a^2 + 2at \frac{da}{dt}\right)$, solve for $\frac{da}{dt}$ to get $\frac{da}{dt} = \frac{2t^3 + 3a^2}{2a^3 - 6at}$.
30. $\frac{1}{2}u^{-1/2} \frac{du}{dv} + \frac{1}{2}v^{-1/2} = 0$, so $\frac{du}{dv} = -\frac{\sqrt{u}}{\sqrt{v}}$.
31. $2a^2\omega \frac{d\omega}{d\lambda} + 2b^2\lambda = 0$, so $\frac{d\omega}{d\lambda} = -\frac{b^2\lambda}{a^2\omega}$.
32. $1 = (\cos x) \frac{dx}{dy}$, so $\frac{dx}{dy} = \frac{1}{\cos x} = \sec x$.
33. $2x + x \frac{dy}{dx} + y + 2y \frac{dy}{dx} = 0$. Substitute $y = -2x$ to obtain $-3x \frac{dy}{dx} = 0$. Since $x = \pm 1$ at the indicated points, $\frac{dy}{dx} = 0$ there.
34. (a) The equation and the point $(1, 1)$ are both symmetric in x and y (if you interchange the two variables you get the same equation and the same point). Therefore the outcome "horizontal tangent at $(1, 1)$ " could be replaced by "vertical tangent at $(1, 1)$ ", and these cannot both be the case.
- (b) Implicit differentiation yields $\frac{dy}{dx} = \frac{2x - y}{x - 2y}$, which is zero only if $y = 2x$; coupled with the equation $x^2 - xy + y^2 = 1$ we obtain $x^2 - 2x^2 + 4x^2 = 1$, or $3x^2 = 1$, $x = (\sqrt{3}/3, 2\sqrt{3}/3)$ and $(-\sqrt{3}/3, -2\sqrt{3}/3)$.

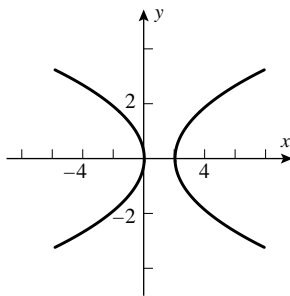

35. (a)
- (b) Implicit differentiation of the curve yields $(4y^3 + 2y) \frac{dy}{dx} = 2x - 1$, so $\frac{dy}{dx} = 0$ only if $x = 1/2$ but $y^4 + y^2 \geq 0$ so $x = 1/2$ is impossible.
- (c) $x^2 - x - (y^4 + y^2) = 0$, so by the Quadratic Formula, $x = \frac{-1 \pm \sqrt{(2y^2 + 1)^2}}{2} = 1 + y^2$ or $-y^2$, and we have the two parabolas $x = -y^2, x = 1 + y^2$.
36. By implicit differentiation, $2y(2y^2 + 1) \frac{dy}{dx} = 2x - 1$, $\frac{dx}{dy} = \frac{2y(2y^2 + 1)}{2x - 1} = 0$ only if $2y(2y^2 + 1) = 0$, which can only hold if $y = 0$. From $y^4 + y^2 = x(x - 1)$, if $y = 0$ then $x = 0$ or 1 , and so $(0, 0)$ and $(1, 0)$ are the two points where the tangent is vertical.

37. The point (1,1) is on the graph, so $1 + a = b$. The slope of the tangent line at (1,1) is $-4/3$; use implicit differentiation to get $\frac{dy}{dx} = -\frac{2xy}{x^2 + 2ay}$ so at (1,1), $-\frac{2}{1 + 2a} = -\frac{4}{3}$, $1 + 2a = 3/2$, $a = 1/4$ and hence $b = 1 + 1/4 = 5/4$.
38. The slope of the line $x + 2y - 2 = 0$ is $m_1 = -1/2$, so the line perpendicular has slope $m = 2$ (negative reciprocal). The slope of the curve $y^3 = 2x^2$ can be obtained by implicit differentiation: $3y^2 \frac{dy}{dx} = 4x$, $\frac{dy}{dx} = \frac{4x}{3y^2}$. Set $\frac{dy}{dx} = 2$; $\frac{4x}{3y^2} = 2$, $x = (3/2)y^2$. Use this in the equation of the curve: $y^3 = 2x^2 = 2((3/2)y^2)^2 = (9/2)y^4$, $y = 2/9$, $x = \frac{3}{2} \left(\frac{2}{9}\right)^2 = \frac{2}{27}$.
39. By implicit differentiation, $0 = \frac{1}{p} \frac{dp}{dt} + \frac{0.0046}{2.3 - 0.0046p} \frac{dp}{dt} - 2.3$, after solving for $\frac{dp}{dt}$ we get $\frac{dp}{dt} = 0.0046p(500 - p)$.
40. By implicit differentiation, $0 = \frac{1}{p} \frac{dp}{dt} + \frac{4.2381}{2225 - 4.2381p} \frac{dp}{dt} - 0.02225$, after solving for $\frac{dp}{dt}$ we obtain that $\frac{dp}{dt} = 10^{-5}p(2225 - 4.2381p)$.
41. We shall find when the curves intersect and check that the slopes are negative reciprocals. For the intersection solve the simultaneous equations $x^2 + (y - c)^2 = c^2$ and $(x - k)^2 + y^2 = k^2$ to obtain $cy = kx = \frac{1}{2}(x^2 + y^2)$. Thus $x^2 + y^2 = cy + kx$, or $y^2 - cy = -x^2 + kx$, and $\frac{y - c}{x} = -\frac{x - k}{y}$. Differentiating the two families yields (black) $\frac{dy}{dx} = -\frac{x}{y - c}$, and (gray) $\frac{dy}{dx} = -\frac{x - k}{y}$. But it was proven that these quantities are negative reciprocals of each other.
42. Differentiating, we get the equations (black) $x \frac{dy}{dx} + y = 0$ and (gray) $2x - 2y \frac{dy}{dx} = 0$. The first says the (black) slope is $-\frac{y}{x}$ and the second says the (gray) slope is $\frac{x}{y}$, and these are negative reciprocals of each other.

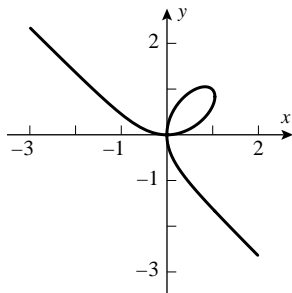

43. (a)

(b) $x \approx 0.84$

(c) Use implicit differentiation to get $dy/dx = (2y - 3x^2)/(3y^2 - 2x)$, so $dy/dx = 0$ if $y = (3/2)x^2$. Substitute this into $x^3 - 2xy + y^3 = 0$ to obtain $27x^6 - 16x^3 = 0$, $x^3 = 16/27$, $x = 2^{4/3}/3$ and hence $y = 2^{5/3}/3$.

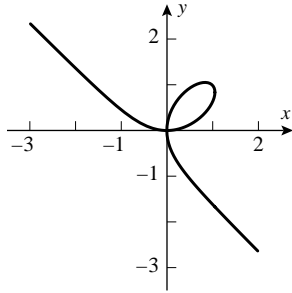

44. (a)

(b) Evidently (by symmetry) the tangent line at the point $x = 1, y = 1$ has slope -1 .

(c) Use implicit differentiation to get $dy/dx = (2y - 3x^2)/(3y^2 - 2x)$, so $dy/dx = -1$ if $2y - 3x^2 = -3y^2 + 2x$, $2(y - x) + 3(y - x)(y + x) = 0$. One solution is $y = x$; this together with $x^3 + y^3 = 2xy$ yields $x = y = 1$. For these values $dy/dx = -1$, so that $(1, 1)$ is a solution. To prove that there is no other solution, suppose $y \neq x$. From $dy/dx = -1$ it follows that $2(y - x) + 3(y - x)(y + x) = 0$. But $y \neq x$, so $x + y = -2/3$, which is not true for any point in the first quadrant.

45. By the chain rule, $\frac{dy}{dx} = \frac{dy}{dt} \frac{dt}{dx}$. Using implicit differentiation for $2y^3t + t^3y = 1$ we get $\frac{dy}{dt} = -\frac{2y^3 + 3t^2y}{6ty^2 + t^3}$, but $\frac{dt}{dx} = \frac{1}{\cos t}$, so $\frac{dy}{dx} = -\frac{2y^3 + 3t^2y}{(6ty^2 + t^3) \cos t}$.

46. Let $P(x_0, y_0)$ be a point where a line through the origin is tangent to the curve $2x^2 - 4x + y^2 + 1 = 0$. Implicit differentiation applied to the equation of the curve gives $dy/dx = (2 - 2x)/y$. At P the slope of the curve must equal the slope of the line so $(2 - 2x_0)/y_0 = y_0/x_0$, or $y_0^2 = 2x_0(1 - x_0)$. But $2x_0^2 - 4x_0 + y_0^2 + 1 = 0$ because (x_0, y_0) is on the curve, and elimination of y_0^2 in the latter two equations gives $2x_0 = 4x_0 - 1$, $x_0 = 1/2$ which when substituted into $y_0^2 = 2x_0(1 - x_0)$ yields $y_0^2 = 1/2$, so $y_0 = \pm\sqrt{2}/2$. The slopes of the lines are $(\pm\sqrt{2}/2)/(1/2) = \pm\sqrt{2}$ and their equations are $y = \sqrt{2}x$ and $y = -\sqrt{2}x$.

Exercise Set 3.2

1. $\frac{1}{5x}(5) = \frac{1}{x}$.

2. $\frac{1}{x/3} \frac{1}{3} = \frac{1}{x}$.

3. $\frac{1}{1+x}$.

4. $\frac{1}{2+\sqrt{x}} \left(\frac{1}{2\sqrt{x}} \right) = \frac{1}{2\sqrt{x}(2+\sqrt{x})}$.

5. $\frac{1}{x^2-1}(2x) = \frac{2x}{x^2-1}$.

6. $\frac{3x^2-14x}{x^3-7x^2-3}$.

7. $\frac{d}{dx} \ln x - \frac{d}{dx} \ln(1+x^2) = \frac{1}{x} - \frac{2x}{1+x^2} = \frac{1-x^2}{x(1+x^2)}$.

8. $\frac{d}{dx} (\ln|1+x| - \ln|1-x|) = \frac{1}{1+x} - \frac{-1}{1-x} = \frac{2}{1-x^2}$.

9. $\frac{d}{dx}(2 \ln x) = 2 \frac{d}{dx} \ln x = \frac{2}{x}$.
10. $3(\ln x)^2 \frac{1}{x}$.
11. $\frac{1}{2}(\ln x)^{-1/2} \left(\frac{1}{x}\right) = \frac{1}{2x\sqrt{\ln x}}$.
12. $\frac{d}{dx} \frac{1}{2} \ln x = \frac{1}{2x}$.
13. $\ln x + x \frac{1}{x} = 1 + \ln x$.
14. $x^3 \left(\frac{1}{x}\right) + (3x^2) \ln x = x^2(1 + 3 \ln x)$.
15. $2x \log_2(3 - 2x) + \frac{-2x^2}{(\ln 2)(3 - 2x)}$.
16. $[\log_2(x^2 - 2x)]^3 + 3x [\log_2(x^2 - 2x)]^2 \frac{2x - 2}{(x^2 - 2x) \ln 2}$.
17. $\frac{2x(1 + \log x) - x/(\ln 10)}{(1 + \log x)^2}$.
18. $1/[x(\ln 10)(1 + \log x)^2]$.
19. $\frac{1}{\ln x} \left(\frac{1}{x}\right) = \frac{1}{x \ln x}$.
20. $\frac{1}{\ln(\ln(x))} \frac{1}{\ln x} \frac{1}{x}$.
21. $\frac{1}{\tan x} (\sec^2 x) = \sec x \csc x$.
22. $\frac{1}{\cos x} (-\sin x) = -\tan x$.
23. $-\sin(\ln x) \frac{1}{x}$.
24. $2 \sin(\ln x) \cos(\ln x) \frac{1}{x} = \frac{\sin(2 \ln x)}{x} = \frac{\sin(\ln x^2)}{x}$.
25. $\frac{1}{\ln 10 \sin^2 x} (2 \sin x \cos x) = 2 \frac{\cot x}{\ln 10}$.
26. $\frac{1}{\ln 10} \frac{d}{dx} \ln \cos^2 x = \frac{1}{\ln 10} \frac{-2 \sin x \cos x}{\cos^2 x} = -\frac{2 \tan x}{\ln 10}$.
27. $\frac{d}{dx} [3 \ln(x - 1) + 4 \ln(x^2 + 1)] = \frac{3}{x - 1} + \frac{8x}{x^2 + 1} = \frac{11x^2 - 8x + 3}{(x - 1)(x^2 + 1)}$.
28. $\frac{d}{dx} [2 \ln \cos x + \frac{1}{2} \ln(1 + x^4)] = -2 \tan x + \frac{2x^3}{1 + x^4}$.

29. $\frac{d}{dx} \left[\ln \cos x - \frac{1}{2} \ln(4 - 3x^2) \right] = -\tan x + \frac{3x}{4 - 3x^2}$

30. $\frac{d}{dx} \left(\frac{1}{2} [\ln(x - 1) - \ln(x + 1)] \right) = \frac{1}{2} \left(\frac{1}{x - 1} - \frac{1}{x + 1} \right)$.

31. True, because $\frac{dy}{dx} = \frac{1}{x}$, so as $x = a \rightarrow 0^+$, the slope approaches infinity.

32. False, e.g. $f(x) = \sqrt{x}$.

33. True; if $x > 0$ then $\frac{d}{dx} \ln|x| = 1/x$; if $x < 0$ then $\frac{d}{dx} \ln|x| = 1/x$.

34. False; $\frac{d}{dx} (\ln x)^2 = 2 \frac{1}{x} \ln x \neq \frac{2}{x}$.

35. $\ln|y| = \ln|x| + \frac{1}{3} \ln|1 + x^2|$, so $\frac{dy}{dx} = x \sqrt[3]{1 + x^2} \left[\frac{1}{x} + \frac{2x}{3(1 + x^2)} \right]$.

36. $\ln|y| = \frac{1}{5} [\ln|x - 1| - \ln|x + 1|]$, so $\frac{dy}{dx} = \frac{1}{5} \sqrt[5]{\frac{x - 1}{x + 1}} \left[\frac{1}{x - 1} - \frac{1}{x + 1} \right]$.

37. $\ln|y| = \frac{1}{3} \ln|x^2 - 8| + \frac{1}{2} \ln|x^3 + 1| - \ln|x^6 - 7x + 5|$, so

$$\frac{dy}{dx} = \frac{(x^2 - 8)^{1/3} \sqrt{x^3 + 1}}{x^6 - 7x + 5} \left[\frac{2x}{3(x^2 - 8)} + \frac{3x^2}{2(x^3 + 1)} - \frac{6x^5 - 7}{x^6 - 7x + 5} \right]$$

38. $\ln|y| = \ln|\sin x| + \ln|\cos x| + 3 \ln|\tan x| - \frac{1}{2} \ln|x|$, so $\frac{dy}{dx} = \frac{\sin x \cos x \tan^3 x}{\sqrt{x}} \left[\cot x - \tan x + \frac{3 \sec^2 x}{\tan x} - \frac{1}{2x} \right]$

39. (a) $\log_x e = \frac{\ln e}{\ln x} = \frac{1}{\ln x}$, so $\frac{d}{dx} [\log_x e] = -\frac{1}{x(\ln x)^2}$.

(b) $\log_x 2 = \frac{\ln 2}{\ln x}$, so $\frac{d}{dx} [\log_x 2] = -\frac{\ln 2}{x(\ln x)^2}$.

40. (a) From $\log_a b = \frac{\ln b}{\ln a}$ for $a, b > 0$ it follows that $\log_{(1/x)} e = \frac{\ln e}{\ln(1/x)} = -\frac{1}{\ln x}$, so $\frac{d}{dx} [\log_{(1/x)} e] = \frac{1}{x(\ln x)^2}$.

(b) $\log_{(\ln x)} e = \frac{\ln e}{\ln(\ln x)} = \frac{1}{\ln(\ln x)}$, so $\frac{d}{dx} \log_{(\ln x)} e = -\frac{1}{(\ln(\ln x))^2} \frac{1}{x \ln x} = -\frac{1}{x(\ln x)(\ln(\ln x))^2}$.

41. $f'(x_0) = \frac{1}{x_0} = e$, $y - (-1) = e(x - x_0) = ex - 1$, $y = ex - 2$.

42. $y = \log x = \frac{\ln x}{\ln 10}$, $y' = \frac{1}{x \ln 10}$, $y_0 = \log 10 = 1$, $y - 1 = \frac{1}{10 \ln 10} (x - 10)$.

43. $f(x_0) = f(-e) = 1$, $f'(x)|_{x=-e} = -\frac{1}{e}$, $y - 1 = -\frac{1}{e}(x + e)$, $y = -\frac{1}{e}x$.

44. $y - \ln 2 = -\frac{1}{2}(x + 2)$, $y = -\frac{1}{2}x + \ln 2 - 1$.

45. (a) Let the equation of the tangent line be $y = mx + b$ and suppose that it meets the curve at (x_0, y_0) . Then $m = \frac{1}{x} \Big|_{x=x_0} = \frac{1}{x_0}$ and $y_0 = mx_0 + b = \ln x_0$. So $m = \frac{1}{x_0} = \frac{\ln x_0}{x_0}$ and $\ln x_0 = 1, x_0 = e, m = \frac{1}{e}$ and the equation of the tangent line is $y = \frac{1}{e}x$.

(b) Let $y = mx + b$ be a line tangent to the curve at (x_0, y_0) . Then b is the y -intercept and the slope of the tangent line is $m = \frac{1}{x_0}$. Moreover, at the point of tangency, $mx_0 + b = \ln x_0$ or $\frac{1}{x_0}x_0 + b = \ln x_0, b = \ln x_0 - 1$, as required.

46. Let $y(x) = u(x)v(x)$, then $\ln y = \ln u + \ln v$, so $y'/y = u'/u + v'/v$, or $y' = uv' + vu'$. Let $y = u/v$, then $\ln y = \ln u - \ln v$, so $y'/y = u'/u - v'/v$, or $y' = u'/v - uv'/v^2 = (u'v - uv')/v^2$. The logarithm of a product (quotient) is the sum (difference) of the logarithms.

47. The area of the triangle PQR is given by the formula $|PQ||QR|/2$. $|PQ| = w$, and, by Exercise 45 part (b), $|QR| = 1$, so the area is $w/2$.

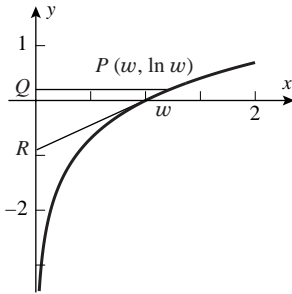

48. Since $y = 2 \ln x$, let $y = 2z$; then $z = \ln x$ and we apply the result of Exercise 45 to find that the area is, in the x - z plane, $w/2$. In the x - y plane, since $y = 2z$, the vertical dimension gets doubled, so the area is w .

49. If $x = 0$ then $y = \ln e = 1$, and $\frac{dy}{dx} = \frac{1}{x+e}$. But $e^y = x + e$, so $\frac{dy}{dx} = \frac{1}{e^y} = e^{-y}$.

50. If $x = 0$ then $y = -\ln e^2 = -2$, and $\frac{dy}{dx} = \frac{1}{e^2 - x}$. But $e^y = \frac{1}{e^2 - x}$, so $\frac{dy}{dx} = e^y$.

51. Let $y = \ln(x + a)$. Following Exercise 49 we get $\frac{dy}{dx} = \frac{1}{x+a} = e^{-y}$, and when $x = 0, y = \ln(a) = 0$ if $a = 1$, so let $a = 1$, then $y = \ln(x + 1)$.

52. Let $y = -\ln(a - x)$, then $\frac{dy}{dx} = \frac{1}{a-x}$. But $e^y = \frac{1}{a-x}$, so $\frac{dy}{dx} = e^y$. If $x = 0$ then $y = -\ln(a) = -\ln 2$ provided $a = 2$, so $y = -\ln(2 - x)$.

53. (a) Set $f(x) = \ln(1 + 3x)$. Then $f'(x) = \frac{3}{1+3x}$, $f'(0) = 3$. But $f'(0) = \lim_{x \rightarrow 0} \frac{f(x) - f(0)}{x} = \lim_{x \rightarrow 0} \frac{\ln(1+3x)}{x}$.

(b) Set $f(x) = \ln(1 - 5x)$. Then $f'(x) = \frac{-5}{1-5x}$, $f'(0) = -5$. But $f'(0) = \lim_{x \rightarrow 0} \frac{f(x) - f(0)}{x} = \lim_{x \rightarrow 0} \frac{\ln(1-5x)}{x}$.

54. (a) $f(x) = \ln x; f'(e^2) = \lim_{\Delta x \rightarrow 0} \frac{\ln(e^2 + \Delta x) - 2}{\Delta x} = \frac{d}{dx}(\ln x) \Big|_{x=e^2} = \frac{1}{x} \Big|_{x=e^2} = e^{-2}$.

(b) $f(w) = \ln w; f'(1) = \lim_{w \rightarrow 1} \frac{\ln w - \ln 1}{w - 1} = \lim_{w \rightarrow 1} \frac{\ln w}{w - 1} = \frac{1}{w} \Big|_{w=1} = 1$.

55. (a) Let $f(x) = \ln(\cos x)$, then $f(0) = \ln(\cos 0) = \ln 1 = 0$, so $f'(0) = \lim_{x \rightarrow 0} \frac{f(x) - f(0)}{x} = \lim_{x \rightarrow 0} \frac{\ln(\cos x)}{x}$, and $f'(0) = -\tan 0 = 0$.

(b) Let $f(x) = x^{\sqrt{2}}$, then $f(1) = 1$, so $f'(1) = \lim_{h \rightarrow 0} \frac{f(1+h) - f(1)}{h} = \lim_{h \rightarrow 0} \frac{(1+h)^{\sqrt{2}} - 1}{h}$, and $f'(x) = \sqrt{2}x^{\sqrt{2}-1}$, $f'(1) = \sqrt{2}$.

56. $\frac{d}{dx}[\log_b x] = \lim_{h \rightarrow 0} \frac{\log_b(x+h) - \log_b(x)}{h}$

$$= \lim_{h \rightarrow 0} \frac{1}{h} \log_b \left(\frac{x+h}{x} \right) \quad \text{Theorem 0.5.2(b)}$$

$$= \lim_{h \rightarrow 0} \frac{1}{h} \log_b \left(1 + \frac{h}{x} \right)$$

$$= \lim_{v \rightarrow 0} \frac{1}{vx} \log_b(1+v) \quad \text{Let } v = h/x \text{ and note that } v \rightarrow 0 \text{ as } h \rightarrow 0$$

$$= \frac{1}{x} \lim_{v \rightarrow 0} \frac{1}{v} \log_b(1+v) \quad \textit{h and v are variable, whereas x is constant}$$

$$= \frac{1}{x} \lim_{v \rightarrow 0} \log_b(1+v)^{1/v} \quad \text{Theorem 0.5.2.(c)}$$

$$= \frac{1}{x} \log_b \lim_{v \rightarrow 0} (1+v)^{1/v} \quad \text{Theorem 1.5.5}$$

$$= \frac{1}{x} \log_b e = \frac{1}{x} \cdot \frac{\ln e}{\ln b} = \frac{1}{x \ln b}. \quad \text{Formula 7 of Section 1.3}$$

Exercise Set 3.3

1. (a) $f(x) = 5x^4 + 3x^2 + 1 \geq 1$ so f is increasing and one-to-one on $-\infty < x < +\infty$.

(b) $f(1) = 3$ so $1 = f^{-1}(3)$; $\frac{d}{dx} f^{-1}(x) = \frac{1}{f'(f^{-1}(x))}$, $(f^{-1})'(3) = \frac{1}{f'(1)} = \frac{1}{9}$.

2. (a) $f(x) = 3x^2 + 2e^x$; $f'(x) > 0$ for all x (since $3x^2 \geq 0$ and $2e^x > 0$), so f is increasing and one-to-one on $-\infty < x < +\infty$.

(b) $f(0) = 2$ so $0 = f^{-1}(2)$; $\frac{d}{dx} f^{-1}(x) = \frac{1}{f'(f^{-1}(x))}$, $(f^{-1})'(2) = \frac{1}{f'(0)} = \frac{1}{2}$.

3. $f^{-1}(x) = \frac{2}{x} - 3$, so directly $\frac{d}{dx} f^{-1}(x) = -\frac{2}{x^2}$. Using Formula (2), $f'(x) = \frac{-2}{(x+3)^2}$, so $\frac{1}{f'(f^{-1}(x))} = -(1/2)(f^{-1}(x) + 3)^2$, and $\frac{d}{dx} f^{-1}(x) = -(1/2) \left(\frac{2}{x}\right)^2 = -\frac{2}{x^2}$.

4. $f^{-1}(x) = \frac{e^x - 1}{2}$, so directly, $\frac{d}{dx} f^{-1}(x) = \frac{e^x}{2}$. Next, $f'(x) = \frac{2}{2x+1}$, and using Formula (2), $\frac{d}{dx} f^{-1}(x) = \frac{2f^{-1}(x) + 1}{2} = \frac{e^x}{2}$.

5. (a) $f'(x) = 2x + 8$; $f' < 0$ on $(-\infty, -4)$ and $f' > 0$ on $(-4, +\infty)$; not enough information. By inspection, $f(1) = 10 = f(-9)$, so not one-to-one.

(b) $f'(x) = 10x^4 + 3x^2 + 3 \geq 3 > 0$; $f'(x)$ is positive for all x , so f is one-to-one.

(c) $f'(x) = 2 + \cos x \geq 1 > 0$ for all x , so f is one-to-one.

(d) $f'(x) = -(\ln 2) \left(\frac{1}{2}\right)^x < 0$ because $\ln 2 > 0$, so f is one-to-one for all x .

6. (a) $f'(x) = 3x^2 + 6x = x(3x + 6)$ changes sign at $x = -2, 0$, so not enough information; by observation (of the graph, and using some guesswork), $f(0) = -8 = f(-3)$, so f is not one-to-one.

(b) $f'(x) = 5x^4 + 24x^2 + 2 \geq 2 > 0$; f' is positive for all x , so f is one-to-one.

(c) $f'(x) = \frac{1}{(x+1)^2}$; f is one-to-one because:

if $x_1 < x_2 < -1$ then $f' > 0$ on $[x_1, x_2]$, so $f(x_1) \neq f(x_2)$

if $-1 < x_1 < x_2$ then $f' > 0$ on $[x_1, x_2]$, so $f(x_1) \neq f(x_2)$

if $x_1 < -1 < x_2$ then $f(x_1) > 1 > f(x_2)$ since $f(x) > 1$ on $(-\infty, -1)$ and $f(x) < 1$ on $(-1, +\infty)$

(d) Note that $f(x)$ is only defined for $x > 0$. $\frac{d}{dx} \log_b x = \frac{1}{x \ln b}$, which is always negative ($0 < b < 1$), so f is one-to-one.

7. $y = f^{-1}(x)$, $x = f(y) = 5y^3 + y - 7$, $\frac{dx}{dy} = 15y^2 + 1$, $\frac{dy}{dx} = \frac{1}{15y^2 + 1}$; check: $1 = 15y^2 \frac{dy}{dx} + \frac{dy}{dx}$, $\frac{dy}{dx} = \frac{1}{15y^2 + 1}$.

8. $y = f^{-1}(x)$, $x = f(y) = 1/y^2$, $\frac{dx}{dy} = -2y^{-3}$, $\frac{dy}{dx} = -y^3/2$; check: $1 = -2y^{-3} \frac{dy}{dx}$, $\frac{dy}{dx} = -y^3/2$.

9. $y = f^{-1}(x)$, $x = f(y) = 2y^5 + y^3 + 1$, $\frac{dx}{dy} = 10y^4 + 3y^2$, $\frac{dy}{dx} = \frac{1}{10y^4 + 3y^2}$; check: $1 = 10y^4 \frac{dy}{dx} + 3y^2 \frac{dy}{dx}$, $\frac{dy}{dx} = \frac{1}{10y^4 + 3y^2}$.

10. $y = f^{-1}(x)$, $x = f(y) = 5y - \sin 2y$, $\frac{dx}{dy} = 5 - 2 \cos 2y$, $\frac{dy}{dx} = \frac{1}{5 - 2 \cos 2y}$; check: $1 = (5 - 2 \cos 2y) \frac{dy}{dx}$, $\frac{dy}{dx} = \frac{1}{5 - 2 \cos 2y}$.

11. Let $P(a, b)$ be given, not on the line $y = x$. Let Q_1 be its reflection across the line $y = x$, yet to be determined. Let Q have coordinates (b, a) .

(a) Since P does not lie on $y = x$, we have $a \neq b$, i.e. $P \neq Q$ since they have different abscissas. The line \vec{PQ} has slope $(b - a)/(a - b) = -1$ which is the negative reciprocal of $m = 1$ and so the two lines are perpendicular.

(b) Let (c, d) be the midpoint of the segment PQ . Then $c = (a + b)/2$ and $d = (b + a)/2$ so $c = d$ and the midpoint is on $y = x$.

(c) Let $Q(c, d)$ be the reflection of P through $y = x$. By definition this means P and Q lie on a line perpendicular to the line $y = x$ and the midpoint of P and Q lies on $y = x$.

(d) Since the line through P and Q is perpendicular to the line $y = x$ it is parallel to the line through P and Q_1 ; since both pass through P they are the same line. Finally, since the midpoints of P and Q_1 and of P and Q both lie on $y = x$, they are the same point, and consequently $Q = Q_1$.

12. Let (a, b) and (A, B) be points on a line with slope m . Then $m = (B - b)/(A - a)$. Consider the associated points (B, A) and (b, a) . The line through these two points has slope $(A - a)/(B - b)$, which is the reciprocal of m . Thus (B, A) and (b, a) define the line with slope $1/m$.

13. If $x < y$ then $f(x) \leq f(y)$ and $g(x) \leq g(y)$; thus $f(x) + g(x) \leq f(y) + g(y)$. Moreover, $g(x) \leq g(y)$, so $f(g(x)) \leq f(g(y))$. Note that $f(x)g(x)$ need not be increasing, e.g. $f(x) = g(x) = x$, both increasing for all x , yet $f(x)g(x) = x^2$, not an increasing function.
14. On $[0, 1]$ let $f(x) = x - 2$, $g(x) = 2 - x$, then f and g are one-to-one but $f + g$ is not. If $f(x) = x + 1$, $g(x) = 1/(x + 1)$ then f and g are one-to-one but fg is not. Finally, if f and g are one-to-one and if $f(g(x)) = f(g(y))$ then, because f is one-to-one, $g(x) = g(y)$, and since g is one-to-one, $x = y$, so $f(g(x))$ is one-to-one.
15. $\frac{dy}{dx} = 7e^{7x}$.
16. $\frac{dy}{dx} = -10xe^{-5x^2}$.
17. $\frac{dy}{dx} = x^3e^x + 3x^2e^x = x^2e^x(x + 3)$.
18. $\frac{dy}{dx} = -\frac{1}{x^2}e^{1/x}$.
19. $\frac{dy}{dx} = \frac{(e^x + e^{-x})(e^x + e^{-x}) - (e^x - e^{-x})(e^x - e^{-x})}{(e^x + e^{-x})^2} = \frac{(e^{2x} + 2 + e^{-2x}) - (e^{2x} - 2 + e^{-2x})}{(e^x + e^{-x})^2} = 4/(e^x + e^{-x})^2$.
20. $\frac{dy}{dx} = e^x \cos(e^x)$.
21. $\frac{dy}{dx} = (x \sec^2 x + \tan x)e^{x \tan x}$.
22. $\frac{dy}{dx} = \frac{(\ln x)e^x - e^x(1/x)}{(\ln x)^2} = \frac{e^x(x \ln x - 1)}{x(\ln x)^2}$.
23. $\frac{dy}{dx} = (1 - 3e^{3x})e^{(x - e^{3x})}$.
24. $\frac{dy}{dx} = \frac{1}{2} \frac{1}{\sqrt{1 + 5x^3}} 15x^2 \exp(\sqrt{1 + 5x^3}) = \frac{15}{2} x^2 (1 + 5x^3)^{-1/2} \exp(\sqrt{1 + 5x^3})$.
25. $\frac{dy}{dx} = \frac{(x - 1)e^{-x}}{1 - xe^{-x}} = \frac{x - 1}{e^x - x}$.
26. $\frac{dy}{dx} = \frac{1}{\cos(e^x)} [-\sin(e^x)]e^x = -e^x \tan(e^x)$.
27. $f'(x) = 2^x \ln 2$; $y = 2^x$, $\ln y = x \ln 2$, $\frac{1}{y}y' = \ln 2$, $y' = y \ln 2 = 2^x \ln 2$.
28. $f'(x) = -3^{-x} \ln 3$; $y = 3^{-x}$, $\ln y = -x \ln 3$, $\frac{1}{y}y' = -\ln 3$, $y' = -y \ln 3 = -3^{-x} \ln 3$.
29. $f'(x) = \pi^{\sin x} (\ln \pi) \cos x$; $y = \pi^{\sin x}$, $\ln y = (\sin x) \ln \pi$, $\frac{1}{y}y' = (\ln \pi) \cos x$, $y' = \pi^{\sin x} (\ln \pi) \cos x$.
30. $f'(x) = \pi^{x \tan x} (\ln \pi) (x \sec^2 x + \tan x)$; $y = \pi^{x \tan x}$, $\ln y = (x \tan x) \ln \pi$, $\frac{1}{y}y' = (\ln \pi) (x \sec^2 x + \tan x)$, $y' = \pi^{x \tan x} (\ln \pi) (x \sec^2 x + \tan x)$.

$$31. \ln y = (\ln x) \ln(x^3 - 2x), \frac{1}{y} \frac{dy}{dx} = \frac{3x^2 - 2}{x^3 - 2x} \ln x + \frac{1}{x} \ln(x^3 - 2x), \frac{dy}{dx} = (x^3 - 2x)^{\ln x} \left[\frac{3x^2 - 2}{x^3 - 2x} \ln x + \frac{1}{x} \ln(x^3 - 2x) \right].$$

$$32. \ln y = (\sin x) \ln x, \frac{1}{y} \frac{dy}{dx} = \frac{\sin x}{x} + (\cos x) \ln x, \frac{dy}{dx} = x^{\sin x} \left[\frac{\sin x}{x} + (\cos x) \ln x \right].$$

$$33. \ln y = (\tan x) \ln(\ln x), \frac{1}{y} \frac{dy}{dx} = \frac{1}{x \ln x} \tan x + (\sec^2 x) \ln(\ln x), \frac{dy}{dx} = (\ln x)^{\tan x} \left[\frac{\tan x}{x \ln x} + (\sec^2 x) \ln(\ln x) \right].$$

$$34. \ln y = (\ln x) \ln(x^2 + 3), \frac{1}{y} \frac{dy}{dx} = \frac{2x}{x^2 + 3} \ln x + \frac{1}{x} \ln(x^2 + 3), \frac{dy}{dx} = (x^2 + 3)^{\ln x} \left[\frac{2x}{x^2 + 3} \ln x + \frac{1}{x} \ln(x^2 + 3) \right].$$

$$35. \ln y = (\ln x)(\ln(\ln x)), \frac{dy/dx}{y} = (1/x)(\ln(\ln x)) + (\ln x) \frac{1/x}{\ln x} = (1/x)(1 + \ln(\ln x)), dy/dx = \frac{1}{x} (\ln x)^{\ln x} (1 + \ln \ln x).$$

36. (a) Because x^x is not of the form a^x where a is constant.

$$(b) y = x^x, \ln y = x \ln x, \frac{1}{y} y' = 1 + \ln x, y' = x^x (1 + \ln x).$$

$$37. \frac{dy}{dx} = (3x^2 - 4x)e^x + (x^3 - 2x^2 + 1)e^x = (x^3 + x^2 - 4x + 1)e^x.$$

$$38. \frac{dy}{dx} = (4x - 2)e^{2x} + (2x^2 - 2x + 1)2e^{2x} = 4x^2 e^{2x}.$$

$$39. \frac{dy}{dx} = (2x + \frac{1}{2\sqrt{x}})3^x + (x^2 + \sqrt{x})3^x \ln 3.$$

$$40. \frac{dy}{dx} = (3x^2 + \frac{1}{3}x^{-2/3})5^x + (x^3 + \sqrt[3]{x})5^x \ln 5.$$

$$41. \frac{dy}{dx} = 4^{3 \sin x - e^x} \ln 4 (3 \cos x - e^x).$$

$$42. \frac{dy}{dx} = 2^{\cos x + \ln x} \ln 2 (-\sin x + \frac{1}{x}).$$

$$43. \frac{dy}{dx} = \frac{3}{\sqrt{1 - (3x)^2}} = \frac{3}{\sqrt{1 - 9x^2}}.$$

$$44. \frac{dy}{dx} = -\frac{1/2}{\sqrt{1 - (\frac{x+1}{2})^2}} = -\frac{1}{\sqrt{4 - (x+1)^2}}.$$

$$45. \frac{dy}{dx} = \frac{1}{\sqrt{1 - 1/x^2}} (-1/x^2) = -\frac{1}{|x|\sqrt{x^2 - 1}}.$$

$$46. \frac{dy}{dx} = \frac{\sin x}{\sqrt{1 - \cos^2 x}} = \frac{\sin x}{|\sin x|} = \begin{cases} 1, & \sin x > 0 \\ -1, & \sin x < 0 \end{cases}.$$

$$47. \frac{dy}{dx} = \frac{3x^2}{1 + (x^3)^2} = \frac{3x^2}{1 + x^6}.$$

$$48. \frac{dy}{dx} = \frac{5x^4}{|x^5|\sqrt{(x^5)^2 - 1}} = \frac{5}{|x|\sqrt{x^{10} - 1}}.$$

49. $y = 1/\tan x = \cot x$, $dy/dx = -\csc^2 x$.

50. $y = (\tan^{-1} x)^{-1}$, $dy/dx = -(\tan^{-1} x)^{-2} \left(\frac{1}{1+x^2} \right)$.

51. $\frac{dy}{dx} = \frac{e^x}{|x|\sqrt{x^2-1}} + e^x \sec^{-1} x$.

52. $\frac{dy}{dx} = -\frac{1}{(\cos^{-1} x)\sqrt{1-x^2}}$.

53. $\frac{dy}{dx} = 0$.

54. $\frac{dy}{dx} = \frac{3x^2(\sin^{-1} x)^2}{\sqrt{1-x^2}} + 2x(\sin^{-1} x)^3$.

55. $\frac{dy}{dx} = 0$.

56. $\frac{dy}{dx} = -1/\sqrt{e^{2x}-1}$.

57. $\frac{dy}{dx} = -\frac{1}{1+x} \left(\frac{1}{2} x^{-1/2} \right) = -\frac{1}{2(1+x)\sqrt{x}}$.

58. $\frac{dy}{dx} = -\frac{1}{2\sqrt{\cot^{-1} x}(1+x^2)}$.

59. False; $y = Ae^x$ also satisfies $\frac{dy}{dx} = y$.

60. False; $dy/dx = 1/x$ is rational, but $y = \ln x$ is not.

61. True; examine the cases $x > 0$ and $x < 0$ separately.

62. True; $\frac{d}{dx} \sin^{-1} x + \frac{d}{dx} \cos^{-1} x = 0$.

63. (a) Let $x = f(y) = \cot y$, $0 < y < \pi$, $-\infty < x < +\infty$. Then f is differentiable and one-to-one and $f'(f^{-1}(x)) = -\csc^2(\cot^{-1} x) = -x^2 - 1 \neq 0$, and $\left. \frac{d}{dx} [\cot^{-1} x] \right|_{x=0} = \lim_{x \rightarrow 0} \frac{1}{f'(f^{-1}(x))} = -\lim_{x \rightarrow 0} \frac{1}{x^2 + 1} = -1$.

(b) If $x \neq 0$ then, from Exercise 48(a) of Section 0.4, $\frac{d}{dx} \cot^{-1} x = \frac{d}{dx} \tan^{-1} \frac{1}{x} = -\frac{1}{x^2} \frac{1}{1+(1/x)^2} = -\frac{1}{x^2+1}$. For $x = 0$, part (a) shows the same; thus for $-\infty < x < +\infty$, $\frac{d}{dx} [\cot^{-1} x] = -\frac{1}{x^2+1}$.

(c) For $-\infty < u < +\infty$, by the chain rule it follows that $\frac{d}{dx} [\cot^{-1} u] = -\frac{1}{u^2+1} \frac{du}{dx}$.

64. (a) By the chain rule, $\frac{d}{dx} [\csc^{-1} x] = \frac{d}{dx} \sin^{-1} \frac{1}{x} = -\frac{1}{x^2} \frac{1}{\sqrt{1-(1/x)^2}} = \frac{-1}{|x|\sqrt{x^2-1}}$.

(b) By the chain rule, $\frac{d}{dx} [\csc^{-1} u] = \frac{du}{dx} \frac{d}{du} [\csc^{-1} u] = \frac{-1}{|u|\sqrt{u^2-1}} \frac{du}{dx}$.

(c) From Section 0.4 equation (11), $\sec^{-1} x + \csc^{-1} x = \pi/2$, so $\frac{d}{dx} \sec^{-1} x = -\frac{d}{dx} \csc^{-1} x = \frac{1}{|x|\sqrt{x^2-1}}$ by part (a).

(d) By the chain rule, $\frac{d}{dx} [\sec^{-1} u] = \frac{du}{dx} \frac{d}{du} [\sec^{-1} u] = \frac{1}{|u|\sqrt{u^2-1}} \frac{du}{dx}$.

65. $x^3 + x \tan^{-1} y = e^y$, $3x^2 + \frac{x}{1+y^2} y' + \tan^{-1} y = e^y y'$, $y' = \frac{(3x^2 + \tan^{-1} y)(1+y^2)}{(1+y^2)e^y - x}$.

66. $\sin^{-1}(xy) = \cos^{-1}(x-y)$, $\frac{1}{\sqrt{1-x^2y^2}}(xy' + y) = -\frac{1}{\sqrt{1-(x-y)^2}}(1-y')$, $y' = \frac{y\sqrt{1-(x-y)^2} + \sqrt{1-x^2y^2}}{\sqrt{1-x^2y^2} - x\sqrt{1-(x-y)^2}}$.

67. (a) $f(x) = x^3 - 3x^2 + 2x = x(x-1)(x-2)$ so $f(0) = f(1) = f(2) = 0$ thus f is not one-to-one.

(b) $f'(x) = 3x^2 - 6x + 2$, $f'(x) = 0$ when $x = \frac{6 \pm \sqrt{36-24}}{6} = 1 \pm \sqrt{3}/3$. $f'(x) > 0$ (f is increasing) if $x < 1 - \sqrt{3}/3$, $f'(x) < 0$ (f is decreasing) if $1 - \sqrt{3}/3 < x < 1 + \sqrt{3}/3$, so $f(x)$ takes on values less than $f(1 - \sqrt{3}/3)$ on both sides of $1 - \sqrt{3}/3$ thus $1 - \sqrt{3}/3$ is the largest value of k .

68. (a) $f(x) = x^3(x-2)$ so $f(0) = f(2) = 0$ thus f is not one-to-one.

(b) $f'(x) = 4x^3 - 6x^2 = 4x^2(x-3/2)$, $f'(x) = 0$ when $x = 0$ or $3/2$; f is decreasing on $(-\infty, 3/2]$ and increasing on $[3/2, +\infty)$ so $3/2$ is the smallest value of k .

69. (a) $f'(x) = 4x^3 + 3x^2 = (4x+3)x^2 = 0$ only at $x = 0$. But on $[0, 2]$, f' has no sign change, so f is one-to-one.

(b) $F'(x) = 2f'(2g(x))g'(x)$ so $F'(3) = 2f'(2g(3))g'(3)$. By inspection $f(1) = 3$, so $g(3) = f^{-1}(3) = 1$ and $g'(3) = (f^{-1})'(3) = 1/f'(f^{-1}(3)) = 1/f'(1) = 1/7$ because $f'(x) = 4x^3 + 3x^2$. Thus $F'(3) = 2f'(2)(1/7) = 2(44)(1/7) = 88/7$. $F(3) = f(2g(3)) = f(2 \cdot 1) = f(2) = 25$, so the line tangent to $F(x)$ at $(3, 25)$ has the equation $y - 25 = (88/7)(x - 3)$, $y = (88/7)x - 89/7$.

70. (a) $f'(x) = -e^{4-x^2} \left(2 + \frac{1}{x^2}\right) < 0$ for all $x > 0$, so f is one-to-one.

(b) By inspection, $f(2) = 1/2$, so $2 = f^{-1}(1/2) = g(1/2)$. By inspection, $f'(2) = -\left(2 + \frac{1}{4}\right) = -\frac{9}{4}$, and $F'(1/2) = f'([g(x)]^2) \frac{d}{dx} [g(x)^2] \Big|_{x=1/2} = f'([g(x)]^2) 2g(x)g'(x) \Big|_{x=1/2} = f'(2^2) 2 \cdot 2 \frac{1}{f'(g(x))} \Big|_{x=1/2} = 4 \frac{f'(4)}{f'(2)} = 4 \frac{e^{-12}(2 + \frac{1}{16})}{(2 + \frac{1}{4})} = \frac{33}{9e^{12}} = \frac{11}{3e^{12}}$.

71. $y = Ae^{kt}$, $dy/dt = kAe^{kt} = k(Ae^{kt}) = ky$.

72. $y = Ae^{2x} + Be^{-4x}$, $y' = 2Ae^{2x} - 4Be^{-4x}$, $y'' = 4Ae^{2x} + 16Be^{-4x}$ so $y'' + 2y' - 8y = (4Ae^{2x} + 16Be^{-4x}) + 2(2Ae^{2x} - 4Be^{-4x}) - 8(Ae^{2x} + Be^{-4x}) = 0$.

73. (a) $y' = -xe^{-x} + e^{-x} = e^{-x}(1-x)$, $xy' = xe^{-x}(1-x) = y(1-x)$.

(b) $y' = -x^2e^{-x^2/2} + e^{-x^2/2} = e^{-x^2/2}(1-x^2)$, $xy' = xe^{-x^2/2}(1-x^2) = y(1-x^2)$.

74. $\frac{dy}{dx} = 100(-0.2)e^{-0.2x} = -20e^{-0.2x} = -0.2y$, $k = -0.2$.

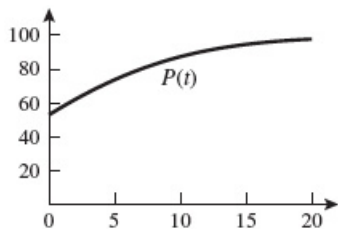

75. (a)

(b) The percentage converges to 100%, full coverage of broadband internet access. The limit of the expression in the denominator is clearly 53 as $t \rightarrow \infty$.

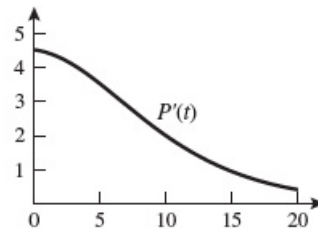

(c) The rate converges to 0 according to the graph.

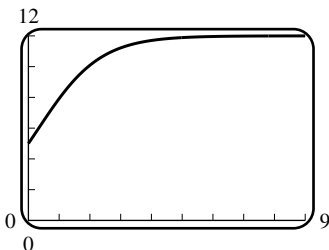

76. (a)

(b) P tends to 12 as t gets large; $\lim_{t \rightarrow +\infty} P(t) = \lim_{t \rightarrow +\infty} \frac{60}{5 + 7e^{-t}} = \frac{60}{5 + 7 \lim_{t \rightarrow +\infty} e^{-t}} = \frac{60}{5} = 12$.

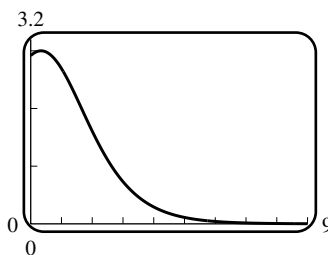

(c) The rate of population growth tends to zero.

77. $f(x) = e^{3x}, f'(0) = \lim_{x \rightarrow 0} \frac{f(x) - f(0)}{x - 0} = 3e^{3x} \Big|_{x=0} = 3$.

78. $f(x) = e^{x^2}, f'(0) = 2xe^{x^2} \Big|_{x=0} = 0$.

79. $\lim_{h \rightarrow 0} \frac{10^h - 1}{h} = \frac{d}{dx} 10^x \Big|_{x=0} = \frac{d}{dx} e^{x \ln 10} \Big|_{x=0} = \ln 10$.

80. $\lim_{h \rightarrow 0} \frac{\tan^{-1}(1+h) - \pi/4}{h} = \frac{d}{dx} \tan^{-1} x \Big|_{x=1} = \frac{1}{1+x^2} \Big|_{x=1} = \frac{1}{2}$.

81. $\lim_{\Delta x \rightarrow 0} \frac{9[\sin^{-1}(\frac{\sqrt{3}}{2} + \Delta x)]^2 - \pi^2}{\Delta x} = \frac{d}{dx} (3 \sin^{-1} x)^2 \Big|_{x=\frac{\sqrt{3}}{2}} = 2(3 \sin^{-1} x) \frac{3}{\sqrt{1-x^2}} \Big|_{x=\frac{\sqrt{3}}{2}} = 2(3 \frac{\pi}{3}) \frac{3}{\sqrt{1-(3/4)}} = 12\pi$.

$$82. \lim_{w \rightarrow 2} \frac{3 \sec^{-1} w - \pi}{w - 2} = \frac{d}{dx} 3 \sec^{-1} x \Big|_{x=2} = \frac{3}{|2| \sqrt{2^2 - 1}} = \frac{\sqrt{3}}{2}.$$

$$83. \lim_{k \rightarrow 0^+} 9.8 \frac{1 - e^{-kt}}{k} = 9.8 \lim_{k \rightarrow 0^+} \frac{1 - e^{-kt}}{k} = 9.8 \frac{d}{dk} (-e^{-kt}) \Big|_{k=0} = 9.8t, \text{ so if the fluid offers no resistance, then the speed will increase at a constant rate of } 9.8 \text{ m/s}^2.$$

Exercise Set 3.4

$$1. \frac{dy}{dt} = 3 \frac{dx}{dt}$$

$$(a) \frac{dy}{dt} = 3(2) = 6. \quad (b) -1 = 3 \frac{dx}{dt}, \frac{dx}{dt} = -\frac{1}{3}.$$

$$2. \frac{dx}{dt} + 4 \frac{dy}{dt} = 0$$

$$(a) 1 + 4 \frac{dy}{dt} = 0 \text{ so } \frac{dy}{dt} = -\frac{1}{4} \text{ when } x = 2. \quad (b) \frac{dx}{dt} + 4(4) = 0 \text{ so } \frac{dx}{dt} = -16 \text{ when } x = 3.$$

$$3. 8x \frac{dx}{dt} + 18y \frac{dy}{dt} = 0$$

$$(a) 8 \frac{1}{2\sqrt{2}} \cdot 3 + 18 \frac{1}{3\sqrt{2}} \frac{dy}{dt} = 0, \frac{dy}{dt} = -2. \quad (b) 8 \left(\frac{1}{3}\right) \frac{dx}{dt} - 18 \frac{\sqrt{5}}{9} \cdot 8 = 0, \frac{dx}{dt} = 6\sqrt{5}.$$

$$4. 2x \frac{dx}{dt} + 2y \frac{dy}{dt} = 2 \frac{dx}{dt} + 4 \frac{dy}{dt}$$

$$(a) 2 \cdot 3(-5) + 2 \cdot 1 \frac{dy}{dt} = 2(-5) + 4 \frac{dy}{dt}, \frac{dy}{dt} = -10.$$

$$(b) 2(1 + \sqrt{2}) \frac{dx}{dt} + 2(2 + \sqrt{3}) \cdot 6 = 2 \frac{dx}{dt} + 4 \cdot 6, \frac{dx}{dt} = -12 \frac{\sqrt{3}}{2\sqrt{2}} = -3\sqrt{3}\sqrt{2}.$$

$$5. (b) A = x^2.$$

$$(c) \frac{dA}{dt} = 2x \frac{dx}{dt}.$$

$$(d) \text{ Find } \frac{dA}{dt} \Big|_{x=3} \text{ given that } \frac{dx}{dt} \Big|_{x=3} = 2. \text{ From part (c), } \frac{dA}{dt} \Big|_{x=3} = 2(3)(2) = 12 \text{ ft}^2/\text{min}.$$

$$6. (b) A = \pi r^2.$$

$$(c) \frac{dA}{dt} = 2\pi r \frac{dr}{dt}.$$

$$(d) \text{ Find } \frac{dA}{dt} \Big|_{r=5} \text{ given that } \frac{dr}{dt} \Big|_{r=5} = 2. \text{ From part (c), } \frac{dA}{dt} \Big|_{r=5} = 2\pi(5)(2) = 20\pi \text{ cm}^2/\text{s}.$$

$$7. (a) V = \pi r^2 h, \text{ so } \frac{dV}{dt} = \pi \left(r^2 \frac{dh}{dt} + 2rh \frac{dr}{dt} \right).$$

$$(b) \text{ Find } \frac{dV}{dt} \Big|_{\substack{h=6, \\ r=10}} \text{ given that } \frac{dh}{dt} \Big|_{\substack{h=6, \\ r=10}} = 1 \text{ and } \frac{dr}{dt} \Big|_{\substack{h=6, \\ r=10}} = -1. \text{ From part (a), } \frac{dV}{dt} \Big|_{\substack{h=6, \\ r=10}} = \pi[10^2(1) + 2(10)(6)(-1)] = -20\pi \text{ in}^3/\text{s}; \text{ the volume is decreasing.}$$

8. (a) $\ell^2 = x^2 + y^2$, so $\frac{d\ell}{dt} = \frac{1}{\ell} \left(x \frac{dx}{dt} + y \frac{dy}{dt} \right)$.

(b) Find $\frac{d\ell}{dt} \Big|_{\substack{x=3, \\ y=4}}$, given that $\frac{dx}{dt} = \frac{1}{2}$ and $\frac{dy}{dt} = -\frac{1}{4}$. From part (a) and the fact that $\ell = 5$ when $x = 3$ and $y = 4$,
 $\frac{d\ell}{dt} \Big|_{\substack{x=3, \\ y=4}} = \frac{1}{5} \left[3 \left(\frac{1}{2} \right) + 4 \left(-\frac{1}{4} \right) \right] = \frac{1}{10}$ ft/s; the diagonal is increasing.

9. (a) $\tan \theta = \frac{y}{x}$, so $\sec^2 \theta \frac{d\theta}{dt} = \frac{x \frac{dy}{dt} - y \frac{dx}{dt}}{x^2}$, $\frac{d\theta}{dt} = \frac{\cos^2 \theta}{x^2} \left(x \frac{dy}{dt} - y \frac{dx}{dt} \right)$.

(b) Find $\frac{d\theta}{dt} \Big|_{\substack{x=2, \\ y=2}}$, given that $\frac{dx}{dt} \Big|_{\substack{x=2, \\ y=2}} = 1$ and $\frac{dy}{dt} \Big|_{\substack{x=2, \\ y=2}} = -\frac{1}{4}$. When $x = 2$ and $y = 2$, $\tan \theta = 2/2 = 1$ so $\theta = \frac{\pi}{4}$
 and $\cos \theta = \cos \frac{\pi}{4} = \frac{1}{\sqrt{2}}$. Thus from part (a), $\frac{d\theta}{dt} \Big|_{\substack{x=2, \\ y=2}} = \frac{(1/\sqrt{2})^2}{2^2} \left[2 \left(-\frac{1}{4} \right) - 2(1) \right] = -\frac{5}{16}$ rad/s; θ is decreasing.

10. Find $\frac{dz}{dt} \Big|_{\substack{x=1, \\ y=2}}$, given that $\frac{dx}{dt} \Big|_{\substack{x=1, \\ y=2}} = -2$ and $\frac{dy}{dt} \Big|_{\substack{x=1, \\ y=2}} = 3$. $\frac{dz}{dt} = 2x^3y \frac{dy}{dt} + 3x^2y^2 \frac{dx}{dt}$, $\frac{dz}{dt} \Big|_{\substack{x=1, \\ y=2}} = (4)(3) + (12)(-2) = -12$ units/s; z is decreasing.

11. Let A be the area swept out, and θ the angle through which the minute hand has rotated. Find $\frac{dA}{dt}$ given that $\frac{d\theta}{dt} = \frac{\pi}{30}$ rad/min; $A = \frac{1}{2}r^2\theta = 8\theta$, so $\frac{dA}{dt} = 8 \frac{d\theta}{dt} = \frac{4\pi}{15}$ in²/min.

12. Let r be the radius and A the area enclosed by the ripple. We want $\frac{dA}{dt} \Big|_{t=10}$ given that $\frac{dr}{dt} = 3$. We know that $A = \pi r^2$, so $\frac{dA}{dt} = 2\pi r \frac{dr}{dt}$. Because r is increasing at the constant rate of 3 ft/s, it follows that $r = 30$ ft after 10 seconds so $\frac{dA}{dt} \Big|_{t=10} = 2\pi(30)(3) = 180\pi$ ft²/s.

13. Find $\frac{dr}{dt} \Big|_{A=9}$ given that $\frac{dA}{dt} = 6$. From $A = \pi r^2$ we get $\frac{dA}{dt} = 2\pi r \frac{dr}{dt}$ so $\frac{dr}{dt} = \frac{1}{2\pi r} \frac{dA}{dt}$. If $A = 9$ then $\pi r^2 = 9$, $r = 3/\sqrt{\pi}$ so $\frac{dr}{dt} \Big|_{A=9} = \frac{1}{2\pi(3/\sqrt{\pi})} (6) = 1/\sqrt{\pi}$ mi/h.

14. The volume V of a sphere of radius r is given by $V = \frac{4}{3}\pi r^3$ or, because $r = \frac{D}{2}$ where D is the diameter,
 $V = \frac{4}{3}\pi \left(\frac{D}{2} \right)^3 = \frac{1}{6}\pi D^3$. We want $\frac{dD}{dt} \Big|_{r=1}$ given that $\frac{dV}{dt} = 3$. From $V = \frac{1}{6}\pi D^3$ we get $\frac{dV}{dt} = \frac{1}{2}\pi D^2 \frac{dD}{dt}$,
 $\frac{dD}{dt} = \frac{2}{\pi D^2} \frac{dV}{dt}$, so $\frac{dD}{dt} \Big|_{r=1} = \frac{2}{\pi(2)^2} (3) = \frac{3}{2\pi}$ ft/min.

15. Find $\frac{dV}{dt} \Big|_{r=9}$ given that $\frac{dr}{dt} = -15$. From $V = \frac{4}{3}\pi r^3$ we get $\frac{dV}{dt} = 4\pi r^2 \frac{dr}{dt}$ so $\frac{dV}{dt} \Big|_{r=9} = 4\pi(9)^2(-15) = -4860\pi$.
 Air must be removed at the rate of 4860π cm³/min.

16. Let x and y be the distances shown in the diagram. We want to find $\frac{dy}{dt} \Big|_{y=8}$ given that $\frac{dx}{dt} = 5$. From $x^2 + y^2 = 17^2$
 we get $2x \frac{dx}{dt} + 2y \frac{dy}{dt} = 0$, so $\frac{dy}{dt} = -\frac{x}{y} \frac{dx}{dt}$. When $y = 8$, $x^2 + 8^2 = 17^2$, $x^2 = 289 - 64 = 225$, $x = 15$ so

$\left. \frac{dy}{dt} \right|_{y=8} = -\frac{15}{8}(5) = -\frac{75}{8}$ ft/s; the top of the ladder is moving down the wall at a rate of 75/8 ft/s.

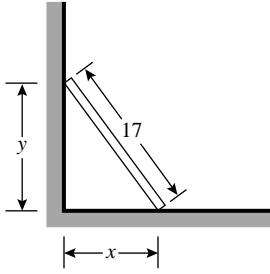

17. Find $\left. \frac{dx}{dt} \right|_{y=5}$ given that $\frac{dy}{dt} = -2$. From $x^2 + y^2 = 13^2$ we get $2x \frac{dx}{dt} + 2y \frac{dy}{dt} = 0$ so $\frac{dx}{dt} = -\frac{y}{x} \frac{dy}{dt}$. Use $x^2 + y^2 = 169$ to find that $x = 12$ when $y = 5$ so $\left. \frac{dx}{dt} \right|_{y=5} = -\frac{5}{12}(-2) = \frac{5}{6}$ ft/s.

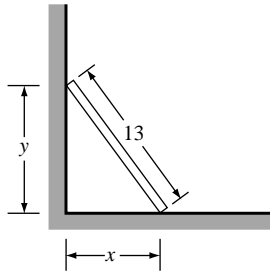

18. Let θ be the acute angle, and x the distance of the bottom of the plank from the wall. Find $\left. \frac{d\theta}{dt} \right|_{x=2}$ given that $\left. \frac{dx}{dt} \right|_{x=2} = -\frac{1}{2}$ ft/s. The variables θ and x are related by the equation $\cos \theta = \frac{x}{10}$ so $-\sin \theta \frac{d\theta}{dt} = \frac{1}{10} \frac{dx}{dt}$, $\frac{d\theta}{dt} = -\frac{1}{10 \sin \theta} \frac{dx}{dt}$. When $x = 2$, the top of the plank is $\sqrt{10^2 - 2^2} = \sqrt{96}$ ft above the ground so $\sin \theta = \sqrt{96}/10$ and $\left. \frac{d\theta}{dt} \right|_{x=2} = -\frac{1}{\sqrt{96}} \left(-\frac{1}{2}\right) = \frac{1}{2\sqrt{96}} \approx 0.051$ rad/s.

19. Let x denote the distance from first base and y the distance from home plate. Then $x^2 + 60^2 = y^2$ and $2x \frac{dx}{dt} = 2y \frac{dy}{dt}$. When $x = 50$ then $y = 10\sqrt{61}$ so $\frac{dy}{dt} = \frac{x}{y} \frac{dx}{dt} = \frac{50}{10\sqrt{61}}(25) = \frac{125}{\sqrt{61}}$ ft/s.

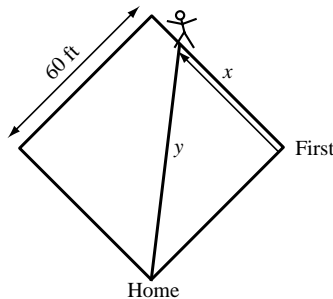

20. Find $\left. \frac{dx}{dt} \right|_{x=4}$ given that $\left. \frac{dy}{dt} \right|_{x=4} = 2000$. From $x^2 + 5^2 = y^2$ we get $2x \frac{dx}{dt} = 2y \frac{dy}{dt}$ so $\frac{dx}{dt} = \frac{y}{x} \frac{dy}{dt}$. Use $x^2 + 25 = y^2$ to find that $y = \sqrt{41}$ when $x = 4$ so $\left. \frac{dx}{dt} \right|_{x=4} = \frac{\sqrt{41}}{4}(2000) = 500\sqrt{41}$ mi/h.

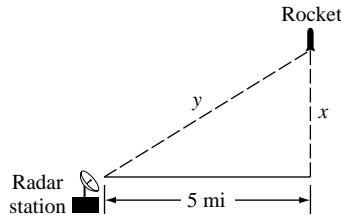

21. Find $\frac{dy}{dt}\Big|_{x=4000}$ given that $\frac{dx}{dt}\Big|_{x=4000} = 880$. From $y^2 = x^2 + 3000^2$ we get $2y\frac{dy}{dt} = 2x\frac{dx}{dt}$ so $\frac{dy}{dt} = \frac{x}{y}\frac{dx}{dt}$. If $x = 4000$, then $y = 5000$ so $\frac{dy}{dt}\Big|_{x=4000} = \frac{4000}{5000}(880) = 704$ ft/s.

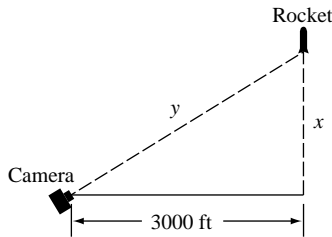

22. Find $\frac{dx}{dt}\Big|_{\phi=\pi/4}$ given that $\frac{d\phi}{dt}\Big|_{\phi=\pi/4} = 0.2$. But $x = 3000 \tan \phi$ so $\frac{dx}{dt} = 3000(\sec^2 \phi)\frac{d\phi}{dt}$, $\frac{dx}{dt}\Big|_{\phi=\pi/4} = 3000\left(\sec^2 \frac{\pi}{4}\right)(0.2) = 1200$ ft/s.

23. (a) If x denotes the altitude, then $r - x = 3960$, the radius of the Earth. $\theta = 0$ at perigee, so $r = 4995/1.12 \approx 4460$; the altitude is $x = 4460 - 3960 = 500$ miles. $\theta = \pi$ at apogee, so $r = 4995/0.88 \approx 5676$; the altitude is $x = 5676 - 3960 = 1716$ miles.

(b) If $\theta = 120^\circ$, then $r = 4995/0.94 \approx 5314$; the altitude is $5314 - 3960 = 1354$ miles. The rate of change of the altitude is given by $\frac{dx}{dt} = \frac{dr}{dt} = \frac{dr}{d\theta} \frac{d\theta}{dt} = \frac{4995(0.12 \sin \theta)}{(1 + 0.12 \cos \theta)^2} \frac{d\theta}{dt}$. Use $\theta = 120^\circ$ and $d\theta/dt = 2.7^\circ/\text{min} = (2.7)(\pi/180)$ rad/min to get $dr/dt \approx 27.7$ mi/min.

24. (a) Let x be the horizontal distance shown in the figure. Then $x = 4000 \cot \theta$ and $\frac{dx}{dt} = -4000 \csc^2 \theta \frac{d\theta}{dt}$, so $\frac{d\theta}{dt} = -\frac{\sin^2 \theta}{4000} \frac{dx}{dt}$. Use $\theta = 30^\circ$ and $dx/dt = 300$ mi/h $= 300(5280/3600)$ ft/s $= 440$ ft/s to get $d\theta/dt = -0.0275$ rad/s $\approx -1.6^\circ/\text{s}$; θ is decreasing at the rate of $1.6^\circ/\text{s}$.

(b) Let y be the distance between the observation point and the aircraft. Then $y = 4000 \csc \theta$ so $dy/dt = -4000(\csc \theta \cot \theta)(d\theta/dt)$. Use $\theta = 30^\circ$ and $d\theta/dt = -0.0275$ rad/s to get $dy/dt \approx 381$ ft/s.

25. Find $\frac{dh}{dt}\Big|_{h=16}$ given that $\frac{dV}{dt} = 20$. The volume of water in the tank at a depth h is $V = \frac{1}{3}\pi r^2 h$. Use similar triangles (see figure) to get $\frac{r}{h} = \frac{10}{24}$ so $r = \frac{5}{12}h$ thus $V = \frac{1}{3}\pi\left(\frac{5}{12}h\right)^2 h = \frac{25}{432}\pi h^3$, $\frac{dV}{dt} = \frac{25}{144}\pi h^2 \frac{dh}{dt}$; $\frac{dh}{dt} = \frac{144}{25\pi h^2} \frac{dV}{dt}$, $\frac{dh}{dt}\Big|_{h=16} = \frac{144}{25\pi(16)^2}(20) = \frac{9}{20\pi}$ ft/min.

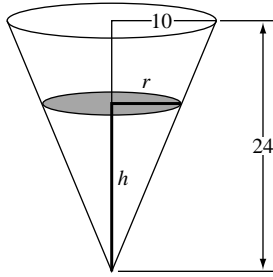

26. Find $\left. \frac{dh}{dt} \right|_{h=6}$ given that $\frac{dV}{dt} = 8$. $V = \frac{1}{3}\pi r^2 h$, but $r = \frac{1}{2}h$ so $V = \frac{1}{3}\pi \left(\frac{h}{2}\right)^2 h = \frac{1}{12}\pi h^3$, $\frac{dV}{dt} = \frac{1}{4}\pi h^2 \frac{dh}{dt}$,
 $\frac{dh}{dt} = \frac{4}{\pi h^2} \frac{dV}{dt}$, $\left. \frac{dh}{dt} \right|_{h=6} = \frac{4}{\pi(6)^2}(8) = \frac{8}{9\pi}$ ft/min.

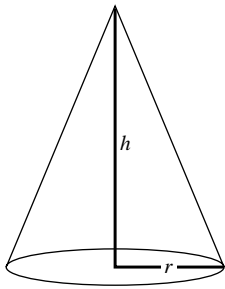

27. Find $\left. \frac{dV}{dt} \right|_{h=10}$ given that $\frac{dh}{dt} = 5$. $V = \frac{1}{3}\pi r^2 h$, but $r = \frac{1}{2}h$ so $V = \frac{1}{3}\pi \left(\frac{h}{2}\right)^2 h = \frac{1}{12}\pi h^3$, $\frac{dV}{dt} = \frac{1}{4}\pi h^2 \frac{dh}{dt}$, $\left. \frac{dV}{dt} \right|_{h=10} = \frac{1}{4}\pi(10)^2(5) = 125\pi$ ft³/min.

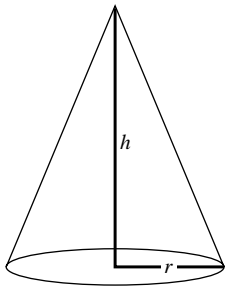

28. Let r and h be as shown in the figure. If C is the circumference of the base, then we want to find $\left. \frac{dC}{dt} \right|_{h=8}$ given that $\frac{dV}{dt} = 10$. It is given that $r = \frac{1}{2}h$, thus $C = 2\pi r = \pi h$ so $\frac{dC}{dt} = \pi \frac{dh}{dt}$. Use $V = \frac{1}{3}\pi r^2 h = \frac{1}{12}\pi h^3$ to get $\frac{dV}{dt} = \frac{1}{4}\pi h^2 \frac{dh}{dt}$, so $\frac{dh}{dt} = \frac{4}{\pi h^2} \frac{dV}{dt}$. Substitution of $\frac{dh}{dt}$ into $\frac{dC}{dt}$ gives $\frac{dC}{dt} = \frac{4}{h^2} \frac{dV}{dt}$ so $\left. \frac{dC}{dt} \right|_{h=8} = \frac{4}{64}(10) = \frac{5}{8}$ ft/min.

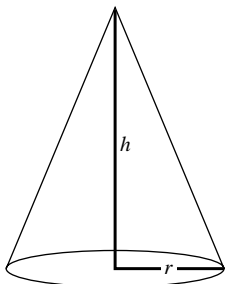

29. With s and h as shown in the figure, we want to find $\frac{dh}{dt}$ given that $\frac{ds}{dt} = 500$. From the figure, $h = s \sin 30^\circ = \frac{1}{2}s$ so $\frac{dh}{dt} = \frac{1}{2} \frac{ds}{dt} = \frac{1}{2}(500) = 250$ mi/h.

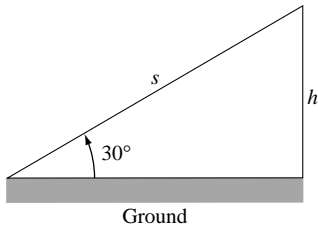

30. Find $\left. \frac{dx}{dt} \right|_{y=125}$ given that $\frac{dy}{dt} = -20$. From $x^2 + 10^2 = y^2$ we get $2x \frac{dx}{dt} = 2y \frac{dy}{dt}$ so $\frac{dx}{dt} = \frac{y}{x} \frac{dy}{dt}$. Use $x^2 + 100 = y^2$ to find that $x = \sqrt{15,525} = 15\sqrt{69}$ when $y = 125$ so $\left. \frac{dx}{dt} \right|_{y=125} = \frac{125}{15\sqrt{69}}(-20) = -\frac{500}{3\sqrt{69}}$. The boat is approaching the dock at the rate of $\frac{500}{3\sqrt{69}}$ ft/min.

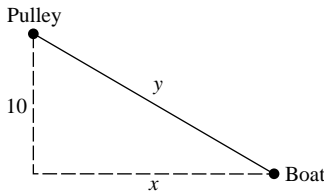

31. Find $\frac{dy}{dt}$ given that $\left. \frac{dx}{dt} \right|_{y=125} = -12$. From $x^2 + 10^2 = y^2$ we get $2x \frac{dx}{dt} = 2y \frac{dy}{dt}$ so $\frac{dy}{dt} = \frac{x}{y} \frac{dx}{dt}$. Use $x^2 + 100 = y^2$ to find that $x = \sqrt{15,525} = 15\sqrt{69}$ when $y = 125$ so $\frac{dy}{dt} = \frac{15\sqrt{69}}{125}(-12) = -\frac{36\sqrt{69}}{25}$. The rope must be pulled at the rate of $\frac{36\sqrt{69}}{25}$ ft/min.

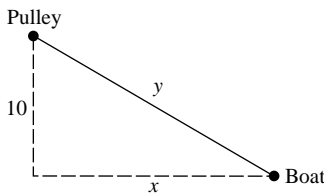

32. (a) Let x and y be as shown in the figure. It is required to find $\frac{dx}{dt}$, given that $\frac{dy}{dt} = -3$. By similar triangles, $\frac{x}{6} = \frac{x+y}{18}$, $18x = 6x + 6y$, $12x = 6y$, $x = \frac{1}{2}y$, so $\frac{dx}{dt} = \frac{1}{2} \frac{dy}{dt} = \frac{1}{2}(-3) = -\frac{3}{2}$ ft/s.

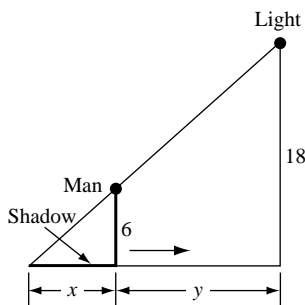

- (b) The tip of the shadow is $z = x + y$ feet from the street light, thus the rate at which it is moving is given by $\frac{dz}{dt} = \frac{dx}{dt} + \frac{dy}{dt}$. In part (a) we found that $\frac{dx}{dt} = -\frac{3}{2}$ when $\frac{dy}{dt} = -3$ so $\frac{dz}{dt} = (-3/2) + (-3) = -9/2$ ft/s; the tip

of the shadow is moving at the rate of 9/2 ft/s toward the street light.

33. Find $\left. \frac{dx}{dt} \right|_{\theta=\pi/4}$ given that $\frac{d\theta}{dt} = \frac{2\pi}{10} = \frac{\pi}{5}$ rad/s. Then $x = 4 \tan \theta$ (see figure) so $\frac{dx}{dt} = 4 \sec^2 \theta \frac{d\theta}{dt}$, $\left. \frac{dx}{dt} \right|_{\theta=\pi/4} = 4 \left(\sec^2 \frac{\pi}{4} \right) \left(\frac{\pi}{5} \right) = 8\pi/5$ km/s.

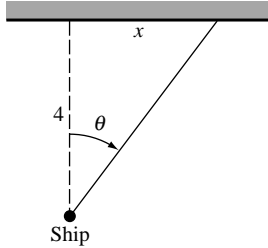

34. If x , y , and z are as shown in the figure, then we want $\left. \frac{dz}{dt} \right|_{\substack{x=2, \\ y=4}}$ given that $\frac{dx}{dt} = -600$ and $\left. \frac{dy}{dt} \right|_{\substack{x=2, \\ y=4}} = -1200$. But $z^2 = x^2 + y^2$ so $2z \frac{dz}{dt} = 2x \frac{dx}{dt} + 2y \frac{dy}{dt}$, $\frac{dz}{dt} = \frac{1}{z} \left(x \frac{dx}{dt} + y \frac{dy}{dt} \right)$. When $x = 2$ and $y = 4$, $z^2 = 2^2 + 4^2 = 20$, $z = \sqrt{20} = 2\sqrt{5}$ so $\left. \frac{dz}{dt} \right|_{\substack{x=2, \\ y=4}} = \frac{1}{2\sqrt{5}} [2(-600) + 4(-1200)] = -\frac{3000}{\sqrt{5}} = -600\sqrt{5}$ mi/h; the distance between missile and aircraft is decreasing at the rate of $600\sqrt{5}$ mi/h.

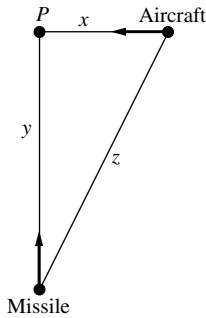

35. We wish to find $\left. \frac{dz}{dt} \right|_{\substack{x=2, \\ y=4}}$ given $\frac{dx}{dt} = -600$ and $\left. \frac{dy}{dt} \right|_{\substack{x=2, \\ y=4}} = -1200$ (see figure). From the law of cosines, $z^2 = x^2 + y^2 - 2xy \cos 120^\circ = x^2 + y^2 - 2xy(-1/2) = x^2 + y^2 + xy$, so $2z \frac{dz}{dt} = 2x \frac{dx}{dt} + 2y \frac{dy}{dt} + x \frac{dy}{dt} + y \frac{dx}{dt}$, $\frac{dz}{dt} = \frac{1}{2z} \left[(2x + y) \frac{dx}{dt} + (2y + x) \frac{dy}{dt} \right]$. When $x = 2$ and $y = 4$, $z^2 = 2^2 + 4^2 + (2)(4) = 28$, so $z = \sqrt{28} = 2\sqrt{7}$, thus $\left. \frac{dz}{dt} \right|_{\substack{x=2, \\ y=4}} = \frac{1}{2(2\sqrt{7})} [(2(2) + 4)(-600) + (2(4) + 2)(-1200)] = -\frac{4200}{\sqrt{7}} = -600\sqrt{7}$ mi/h; the distance between missile and aircraft is decreasing at the rate of $600\sqrt{7}$ mi/h.

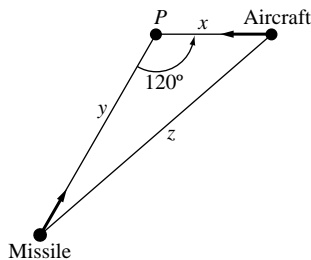

36. (a) Let P be the point on the helicopter's path that lies directly above the car's path. Let x , y , and z be the distances shown in the first figure. Find $\left. \frac{dz}{dt} \right|_{\substack{x=2, \\ y=0}}$ given that $\frac{dx}{dt} = -75$ and $\frac{dy}{dt} = 100$. In order to find an equation

relating x , y , and z , first draw the line segment that joins the point P to the car, as shown in the second figure. Because triangle OPC is a right triangle, it follows that PC has length $\sqrt{x^2 + (1/2)^2}$; but triangle HPC is also a right triangle so $z^2 = (\sqrt{x^2 + (1/2)^2})^2 + y^2 = x^2 + y^2 + 1/4$ and $2z \frac{dz}{dt} = 2x \frac{dx}{dt} + 2y \frac{dy}{dt} + 0$, $\frac{dz}{dt} = \frac{1}{z} \left(x \frac{dx}{dt} + y \frac{dy}{dt} \right)$. Now, when $x = 2$ and $y = 0$, $z^2 = (2)^2 + (0)^2 + 1/4 = 17/4$, $z = \sqrt{17}/2$ so $\frac{dz}{dt} \Big|_{\substack{x=2, \\ y=0}} = \frac{1}{(\sqrt{17}/2)} [2(-75) + 0(100)] = -300/\sqrt{17}$ mi/h.

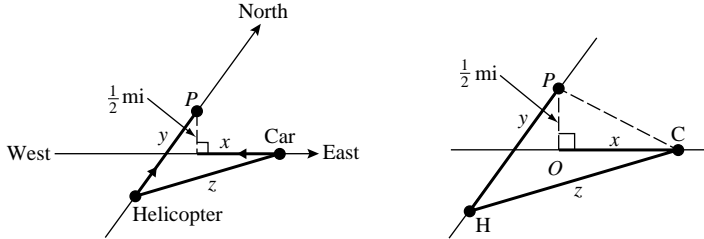

(b) Decreasing, because $\frac{dz}{dt} < 0$.

37. (a) We want $\frac{dy}{dt} \Big|_{\substack{x=1, \\ y=2}}$ given that $\frac{dx}{dt} \Big|_{\substack{x=1, \\ y=2}} = 6$. For convenience, first rewrite the equation as $xy^3 = \frac{8}{5} + \frac{8}{5}y^2$ then $3xy^2 \frac{dy}{dt} + y^3 \frac{dx}{dt} = \frac{16}{5}y \frac{dy}{dt}$, $\frac{dy}{dt} = \frac{16}{5} \frac{y^3}{y - 3xy^2} \frac{dx}{dt}$, so $\frac{dy}{dt} \Big|_{\substack{x=1, \\ y=2}} = \frac{2^3}{5(2) - 3(1)2^2} (6) = -60/7$ units/s.

(b) Falling, because $\frac{dy}{dt} < 0$.

38. Find $\frac{dx}{dt} \Big|_{(2,5)}$ given that $\frac{dy}{dt} \Big|_{(2,5)} = 2$. Square and rearrange to get $x^3 = y^2 - 17$, so $3x^2 \frac{dx}{dt} = 2y \frac{dy}{dt}$, $\frac{dx}{dt} = \frac{2y}{3x^2} \frac{dy}{dt}$, $\frac{dx}{dt} \Big|_{(2,5)} = \left(\frac{5}{6}\right) (2) = \frac{5}{3}$ units/s.

39. The coordinates of P are $(x, 2x)$, so the distance between P and the point $(3, 0)$ is $D = \sqrt{(x-3)^2 + (2x-0)^2} = \sqrt{5x^2 - 6x + 9}$. Find $\frac{dD}{dt} \Big|_{x=3}$ given that $\frac{dx}{dt} \Big|_{x=3} = -2$. $\frac{dD}{dt} = \frac{5x-3}{\sqrt{5x^2-6x+9}} \frac{dx}{dt}$, so $\frac{dD}{dt} \Big|_{x=3} = \frac{12}{\sqrt{36}} (-2) = -4$ units/s.

40. (a) Let D be the distance between P and $(2, 0)$. Find $\frac{dD}{dt} \Big|_{x=3}$ given that $\frac{dx}{dt} \Big|_{x=3} = 4$. $D = \sqrt{(x-2)^2 + y^2} = \sqrt{(x-2)^2 + x} = \sqrt{x^2 - 3x + 4}$, so $\frac{dD}{dt} = \frac{2x-3}{2\sqrt{x^2-3x+4}} \frac{dx}{dt}$; $\frac{dD}{dt} \Big|_{x=3} = \frac{3}{2\sqrt{4}} 4 = 3$ units/s.

(b) Let θ be the angle of inclination. Find $\frac{d\theta}{dt} \Big|_{x=3}$ given that $\frac{dx}{dt} \Big|_{x=3} = 4$. $\tan \theta = \frac{y}{x-2} = \frac{\sqrt{x}}{x-2}$, so $\sec^2 \theta \frac{d\theta}{dt} = -\frac{x+2}{2\sqrt{x}(x-2)^2} \frac{dx}{dt}$, $\frac{d\theta}{dt} = -\cos^2 \theta \frac{x+2}{2\sqrt{x}(x-2)^2} \frac{dx}{dt}$. When $x = 3$, $D = 2$ so $\cos \theta = \frac{1}{2}$ and $\frac{d\theta}{dt} \Big|_{x=3} = -\frac{1}{4} \frac{5}{2\sqrt{3}} (4) = -\frac{5}{2\sqrt{3}}$ rad/s.

41. Solve $\frac{dx}{dt} = 3 \frac{dy}{dt}$ given $y = x/(x^2+1)$. Then $y(x^2+1) = x$. Differentiating with respect to x , $(x^2+1) \frac{dy}{dx} + y(2x) = 1$. But $\frac{dy}{dx} = \frac{dy/dt}{dx/dt} = \frac{1}{3}$ so $(x^2+1) \frac{1}{3} + 2xy = 1$, $x^2+1+6xy = 3$, $x^2+1+6x^2/(x^2+1) = 3$, $(x^2+1)^2+6x^2-3x^2-3 =$

0, $x^4 + 5x^2 - 2 = 0$. By the quadratic formula applied to x^2 we obtain $x^2 = (-5 \pm \sqrt{25 + 8})/2$. The minus sign is spurious since x^2 cannot be negative, so $x^2 = (-5 + \sqrt{33})/2$, and $x = \pm\sqrt{(-5 + \sqrt{33})/2}$.

42. $32x \frac{dx}{dt} + 18y \frac{dy}{dt} = 0$; if $\frac{dy}{dt} = \frac{dx}{dt} \neq 0$, then $(32x + 18y) \frac{dx}{dt} = 0$, $32x + 18y = 0$, $y = -\frac{16}{9}x$, so $16x^2 + 9 \frac{256}{81}x^2 = 144$, $\frac{400}{9}x^2 = 144$, $x^2 = \frac{81}{25}$, $x = \pm\frac{9}{5}$. If $x = \frac{9}{5}$, then $y = -\frac{16 \cdot 9}{9 \cdot 5} = -\frac{16}{5}$. Similarly, if $x = -\frac{9}{5}$, then $y = \frac{16}{5}$. The points are $\left(\frac{9}{5}, -\frac{16}{5}\right)$ and $\left(-\frac{9}{5}, \frac{16}{5}\right)$.

43. Find $\left. \frac{dS}{dt} \right|_{s=10}$ given that $\left. \frac{ds}{dt} \right|_{s=10} = -2$. From $\frac{1}{s} + \frac{1}{S} = \frac{1}{6}$ we get $-\frac{1}{s^2} \frac{ds}{dt} - \frac{1}{S^2} \frac{dS}{dt} = 0$, so $\frac{dS}{dt} = -\frac{S^2}{s^2} \frac{ds}{dt}$. If $s = 10$, then $\frac{1}{10} + \frac{1}{S} = \frac{1}{6}$ which gives $S = 15$. So $\left. \frac{dS}{dt} \right|_{s=10} = -\frac{225}{100}(-2) = 4.5$ cm/s. The image is moving away from the lens.

44. Suppose that the reservoir has height H and that the radius at the top is R . At any instant of time let h and r be the corresponding dimensions of the cone of water (see figure). We want to show that $\frac{dh}{dt}$ is constant and independent of H and R , given that $\frac{dV}{dt} = -kA$ where V is the volume of water, A is the area of a circle of radius r , and k is a positive constant. The volume of a cone of radius r and height h is $V = \frac{1}{3}\pi r^2 h$. By similar triangles $\frac{r}{h} = \frac{R}{H}$, $r = \frac{R}{H}h$ thus $V = \frac{1}{3}\pi \left(\frac{R}{H}\right)^2 h^3$, so $\frac{dV}{dt} = \pi \left(\frac{R}{H}\right)^2 h^2 \frac{dh}{dt}$. But it is given that $\frac{dV}{dt} = -kA$ or, because $A = \pi r^2 = \pi \left(\frac{R}{H}\right)^2 h^2$, $\frac{dV}{dt} = -k\pi \left(\frac{R}{H}\right)^2 h^2$, which when substituted into the previous equation for $\frac{dV}{dt}$ gives $-k\pi \left(\frac{R}{H}\right)^2 h^2 = \pi \left(\frac{R}{H}\right)^2 h^2 \frac{dh}{dt}$, and $\frac{dh}{dt} = -k$.

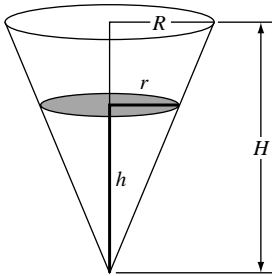

45. Let r be the radius, V the volume, and A the surface area of a sphere. Show that $\frac{dr}{dt}$ is a constant given that $\frac{dV}{dt} = -kA$, where k is a positive constant. Because $V = \frac{4}{3}\pi r^3$, $\frac{dV}{dt} = 4\pi r^2 \frac{dr}{dt}$. But it is given that $\frac{dV}{dt} = -kA$ or, because $A = 4\pi r^2$, $\frac{dV}{dt} = -4\pi r^2 k$ which when substituted into the previous equation for $\frac{dV}{dt}$ gives $-4\pi r^2 k = 4\pi r^2 \frac{dr}{dt}$, and $\frac{dr}{dt} = -k$.

46. Let x be the distance between the tips of the minute and hour hands, and α and β the angles shown in the figure. Because the minute hand makes one revolution in 60 minutes, $\frac{d\alpha}{dt} = \frac{2\pi}{60} = \pi/30$ rad/min; the hour hand makes one revolution in 12 hours (720 minutes), thus $\frac{d\beta}{dt} = \frac{2\pi}{720} = \pi/360$ rad/min. We want to find $\left. \frac{dx}{dt} \right|_{\substack{\alpha=2\pi \\ \beta=3\pi/2}}$ given that $\frac{d\alpha}{dt} = \pi/30$ and $\frac{d\beta}{dt} = \pi/360$. Using the law of cosines on the triangle shown in the

figure, $x^2 = 3^2 + 4^2 - 2(3)(4) \cos(\alpha - \beta) = 25 - 24 \cos(\alpha - \beta)$, so $2x \frac{dx}{dt} = 0 + 24 \sin(\alpha - \beta) \left(\frac{d\alpha}{dt} - \frac{d\beta}{dt} \right)$, $\frac{dx}{dt} = \frac{12}{x} \left(\frac{d\alpha}{dt} - \frac{d\beta}{dt} \right) \sin(\alpha - \beta)$. When $\alpha = 2\pi$ and $\beta = 3\pi/2$, $x^2 = 25 - 24 \cos(2\pi - 3\pi/2) = 25$, $x = 5$; so $\frac{dx}{dt} \Big|_{\substack{\alpha=2\pi, \\ \beta=3\pi/2}} = \frac{12}{5} (\pi/30 - \pi/360) \sin(2\pi - 3\pi/2) = \frac{11\pi}{150}$ in/min.

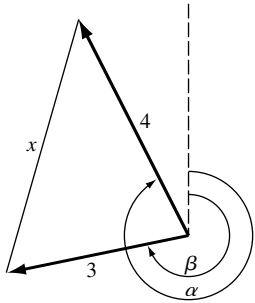

47. Extend sides of cup to complete the cone and let V_0 be the volume of the portion added, then (see figure) $V = \frac{1}{3}\pi r^2 h - V_0$ where $\frac{r}{h} = \frac{4}{12} = \frac{1}{3}$ so $r = \frac{1}{3}h$ and $V = \frac{1}{3}\pi \left(\frac{h}{3}\right)^2 h - V_0 = \frac{1}{27}\pi h^3 - V_0$, $\frac{dV}{dt} = \frac{1}{9}\pi h^2 \frac{dh}{dt}$, $\frac{dh}{dt} = \frac{9}{\pi h^2} \frac{dV}{dt}$, $\frac{dh}{dt} \Big|_{h=9} = \frac{9}{\pi(9)^2} (20) = \frac{20}{9\pi}$ cm/s.

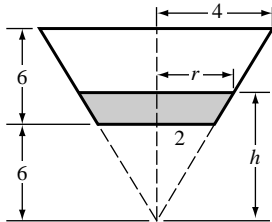

Exercise Set 3.5

1. (a) $f(x) \approx f(1) + f'(1)(x - 1) = 1 + 3(x - 1)$.
 (b) $f(1 + \Delta x) \approx f(1) + f'(1)\Delta x = 1 + 3\Delta x$.
 (c) From part (a), $(1.02)^3 \approx 1 + 3(0.02) = 1.06$. From part (b), $(1.02)^3 \approx 1 + 3(0.02) = 1.06$.
2. (a) $f(x) \approx f(2) + f'(2)(x - 2) = 1/2 + (-1/2^2)(x - 2) = (1/2) - (1/4)(x - 2)$.
 (b) $f(2 + \Delta x) \approx f(2) + f'(2)\Delta x = 1/2 - (1/4)\Delta x$.
 (c) From part (a), $1/2.05 \approx 0.5 - 0.25(0.05) = 0.4875$, and from part (b), $1/2.05 \approx 0.5 - 0.25(0.05) = 0.4875$.
3. (a) $f(x) \approx f(x_0) + f'(x_0)(x - x_0) = 1 + (1/(2\sqrt{1}))(x - 0) = 1 + (1/2)x$, so with $x_0 = 0$ and $x = -0.1$, we have $\sqrt{0.9} = f(-0.1) \approx 1 + (1/2)(-0.1) = 1 - 0.05 = 0.95$. With $x = 0.1$ we have $\sqrt{1.1} = f(0.1) \approx 1 + (1/2)(0.1) = 1.05$.

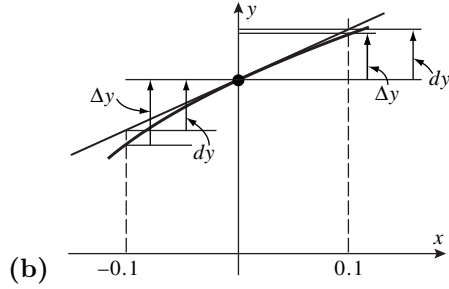

4. (b) The approximation is $\sqrt{x} \approx \sqrt{x_0} + \frac{1}{2\sqrt{x_0}}(x - x_0)$, so show that $\sqrt{x_0} + \frac{1}{2\sqrt{x_0}}(x - x_0) \geq \sqrt{x}$ which is equivalent to $g(x) = \sqrt{x} - \frac{x}{2\sqrt{x_0}} \leq \frac{\sqrt{x_0}}{2}$. But $g(x_0) = \frac{\sqrt{x_0}}{2}$, and $g'(x) = \frac{1}{2\sqrt{x}} - \frac{1}{2\sqrt{x_0}}$ which is negative for $x > x_0$ and positive for $x < x_0$. This shows that g has a maximum value at $x = x_0$, so the student's observation is correct.
5. $f(x) = (1 + x)^{15}$ and $x_0 = 0$. Thus $(1 + x)^{15} \approx f(x_0) + f'(x_0)(x - x_0) = 1 + 15(1)^{14}(x - 0) = 1 + 15x$.
6. $f(x) = \frac{1}{\sqrt{1-x}}$ and $x_0 = 0$, so $\frac{1}{\sqrt{1-x}} \approx f(x_0) + f'(x_0)(x - x_0) = 1 + \frac{1}{2(1-0)^{3/2}}(x - 0) = 1 + x/2$.
7. $\tan x \approx \tan(0) + \sec^2(0)(x - 0) = x$.
8. $\frac{1}{1+x} \approx 1 + \frac{-1}{(1+0)^2}(x - 0) = 1 - x$.
9. $x_0 = 0, f(x) = e^x, f'(x) = e^x, f'(x_0) = 1$, hence $e^x \approx 1 + 1 \cdot x = 1 + x$.
10. $x_0 = 0, f(x) = \ln(1 + x), f'(x) = 1/(1 + x), f'(x_0) = 1$, hence $\ln(1 + x) \approx 0 + 1 \cdot (x - 0) = x$.
11. $x^4 \approx (1)^4 + 4(1)^3(x - 1)$. Set $\Delta x = x - 1$; then $x = \Delta x + 1$ and $(1 + \Delta x)^4 = 1 + 4\Delta x$.
12. $\sqrt{x} \approx \sqrt{1} + \frac{1}{2\sqrt{1}}(x - 1)$, and $x = 1 + \Delta x$, so $\sqrt{1 + \Delta x} \approx 1 + \Delta x/2$.
13. $\frac{1}{2+x} \approx \frac{1}{2+1} - \frac{1}{(2+1)^2}(x - 1)$, and $2 + x = 3 + \Delta x$, so $\frac{1}{3 + \Delta x} \approx \frac{1}{3} - \frac{1}{9}\Delta x$.
14. $(4 + x)^3 \approx (4 + 1)^3 + 3(4 + 1)^2(x - 1)$ so, with $4 + x = 5 + \Delta x$ we get $(5 + \Delta x)^3 \approx 125 + 75\Delta x$.
15. Let $f(x) = \tan^{-1} x, f(1) = \pi/4, f'(1) = 1/2, \tan^{-1}(1 + \Delta x) \approx \frac{\pi}{4} + \frac{1}{2}\Delta x$.
16. $f(x) = \sin^{-1}\left(\frac{x}{2}\right), \sin^{-1}\left(\frac{1}{2}\right) = \frac{\pi}{6}, f'(x) = \frac{1/2}{\sqrt{1-x^2/4}}, f'(1) = 1/\sqrt{3}, \sin^{-1}\left(\frac{1}{2} + \frac{1}{2}\Delta x\right) \approx \frac{\pi}{6} + \frac{1}{\sqrt{3}}\Delta x$.
17. $f(x) = \sqrt{x+3}$ and $x_0 = 0$, so $\sqrt{x+3} \approx \sqrt{3} + \frac{1}{2\sqrt{3}}(x - 0) = \sqrt{3} + \frac{1}{2\sqrt{3}}x$, and $\left|f(x) - \left(\sqrt{3} + \frac{1}{2\sqrt{3}}x\right)\right| < 0.1$ if $|x| < 1.692$.

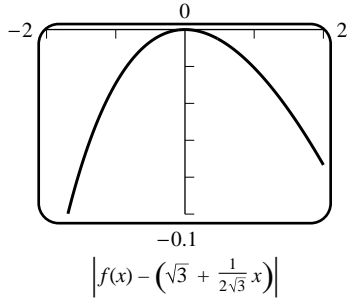

18. $f(x) = \frac{1}{\sqrt{9-x}}$ so $\frac{1}{\sqrt{9-x}} \approx \frac{1}{\sqrt{9}} + \frac{1}{2(9-0)^{3/2}}(x-0) = \frac{1}{3} + \frac{1}{54}x$, and $\left|f(x) - \left(\frac{1}{3} + \frac{1}{54}x\right)\right| < 0.1$ if $|x| < 5.5114$.

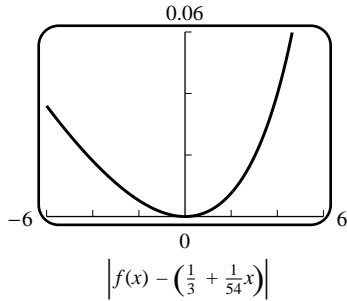

19. $\tan 2x \approx \tan 0 + (\sec^2 0)(2x - 0) = 2x$, and $|\tan 2x - 2x| < 0.1$ if $|x| < 0.3158$.

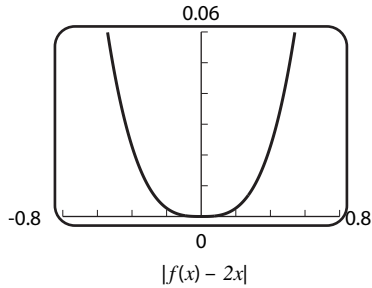

20. $\frac{1}{(1+2x)^5} \approx \frac{1}{(1+2 \cdot 0)^5} + \frac{-5(2)}{(1+2 \cdot 0)^6}(x-0) = 1 - 10x$, and $|f(x) - (1 - 10x)| < 0.1$.

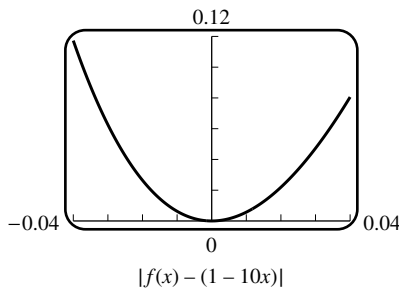

21. (a) The local linear approximation $\sin x \approx x$ gives $\sin 1^\circ = \sin(\pi/180) \approx \pi/180 = 0.0174533$ and a calculator gives $\sin 1^\circ = 0.0174524$. The relative error $|\sin(\pi/180) - (\pi/180)|/(\sin \pi/180) = 0.000051$ is very small, so for such a small value of x the approximation is very good.

(b) Use $x_0 = 45^\circ$ (this assumes you know, or can approximate, $\sqrt{2}/2$).

(c) $44^\circ = \frac{44\pi}{180}$ radians, and $45^\circ = \frac{45\pi}{180} = \frac{\pi}{4}$ radians. With $x = \frac{44\pi}{180}$ and $x_0 = \frac{\pi}{4}$ we obtain $\sin 44^\circ = \sin \frac{44\pi}{180} \approx \sin \frac{\pi}{4} + \left(\cos \frac{\pi}{4}\right) \left(\frac{44\pi}{180} - \frac{\pi}{4}\right) = \frac{\sqrt{2}}{2} + \frac{\sqrt{2}}{2} \left(\frac{-\pi}{180}\right) = 0.694765$. With a calculator, $\sin 44^\circ = 0.694658$.

22. (a) $\tan x \approx \tan 0 + \sec^2 0(x - 0) = x$, so $\tan 2^\circ = \tan(2\pi/180) \approx 2\pi/180 = 0.034907$, and with a calculator $\tan 2^\circ = 0.034921$.
- (b) Use $x_0 = \pi/3$ because we know $\tan 60^\circ = \tan(\pi/3) = \sqrt{3}$.
- (c) With $x_0 = \frac{\pi}{3} = \frac{60\pi}{180}$ and $x = \frac{61\pi}{180}$ we have $\tan 61^\circ = \tan \frac{61\pi}{180} \approx \tan \frac{\pi}{3} + \left(\sec^2 \frac{\pi}{3}\right) \left(\frac{61\pi}{180} - \frac{\pi}{3}\right) = \sqrt{3} + 4 \frac{\pi}{180} = 1.8019$, and with a calculator $\tan 61^\circ = 1.8040$.
23. $f(x) = x^4$, $f'(x) = 4x^3$, $x_0 = 3$, $\Delta x = 0.02$; $(3.02)^4 \approx 3^4 + (108)(0.02) = 81 + 2.16 = 83.16$.
24. $f(x) = x^3$, $f'(x) = 3x^2$, $x_0 = 2$, $\Delta x = -0.03$; $(1.97)^3 \approx 2^3 + (12)(-0.03) = 8 - 0.36 = 7.64$.
25. $f(x) = \sqrt{x}$, $f'(x) = \frac{1}{2\sqrt{x}}$, $x_0 = 64$, $\Delta x = 1$; $\sqrt{65} \approx \sqrt{64} + \frac{1}{16}(1) = 8 + \frac{1}{16} = 8.0625$.
26. $f(x) = \sqrt{x}$, $f'(x) = \frac{1}{2\sqrt{x}}$, $x_0 = 25$, $\Delta x = -1$; $\sqrt{24} \approx \sqrt{25} + \frac{1}{10}(-1) = 5 - 0.1 = 4.9$.
27. $f(x) = \sqrt{x}$, $f'(x) = \frac{1}{2\sqrt{x}}$, $x_0 = 81$, $\Delta x = -0.1$; $\sqrt{80.9} \approx \sqrt{81} + \frac{1}{18}(-0.1) \approx 8.9944$.
28. $f(x) = \sqrt{x}$, $f'(x) = \frac{1}{2\sqrt{x}}$, $x_0 = 36$, $\Delta x = 0.03$; $\sqrt{36.03} \approx \sqrt{36} + \frac{1}{12}(0.03) = 6 + 0.0025 = 6.0025$.
29. $f(x) = \sin x$, $f'(x) = \cos x$, $x_0 = 0$, $\Delta x = 0.1$; $\sin 0.1 \approx \sin 0 + (\cos 0)(0.1) = 0.1$.
30. $f(x) = \tan x$, $f'(x) = \sec^2 x$, $x_0 = 0$, $\Delta x = 0.2$; $\tan 0.2 \approx \tan 0 + (\sec^2 0)(0.2) = 0.2$.
31. $f(x) = \cos x$, $f'(x) = -\sin x$, $x_0 = \pi/6$, $\Delta x = \pi/180$; $\cos 31^\circ \approx \cos 30^\circ + \left(-\frac{1}{2}\right) \left(\frac{\pi}{180}\right) = \frac{\sqrt{3}}{2} - \frac{\pi}{360} \approx 0.8573$.
32. $f(x) = \ln x$, $x_0 = 1$, $\Delta x = 0.01$, $\ln x \approx \Delta x$, $\ln 1.01 \approx 0.01$.
33. $\tan^{-1}(1 + \Delta x) \approx \frac{\pi}{4} + \frac{1}{2}\Delta x$, $\Delta x = -0.01$, $\tan^{-1} 0.99 \approx \frac{\pi}{4} - 0.005 \approx 0.780398$.
34. (a) Let $f(x) = (1 + x)^k$ and $x_0 = 0$. Then $(1 + x)^k \approx 1^k + k(1)^{k-1}(x - 0) = 1 + kx$. Set $k = 37$ and $x = 0.001$ to obtain $(1.001)^{37} \approx 1.037$.
- (b) With a calculator $(1.001)^{37} = 1.03767$.
- (c) It is the linear term of the expansion.
35. $\sqrt[3]{8.24} = 8^{1/3} \sqrt[3]{1.03} \approx 2(1 + \frac{1}{3}0.03) \approx 2.02$, and $4.08^{3/2} = 4^{3/2} 1.02^{3/2} = 8(1 + 0.02(3/2)) = 8.24$.
36. $6^\circ = \pi/30$ radians; $h = 500 \tan(\pi/30) \approx 500[\tan 0 + (\sec^2 0) \frac{\pi}{30}] = 500\pi/30 \approx 52.36$ ft.
37. (a) $dy = (-1/x^2)dx = (-1)(-0.5) = 0.5$ and $\Delta y = 1/(x + \Delta x) - 1/x = 1/(1 - 0.5) - 1/1 = 2 - 1 = 1$.

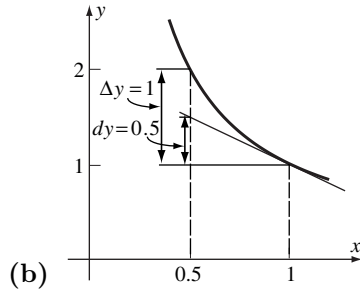

38. (a) $dy = (1/2\sqrt{x})dx = (1/(2 \cdot 3))(-1) = -1/6 \approx -0.167$ and $\Delta y = \sqrt{x + \Delta x} - \sqrt{x} = \sqrt{9 + (-1)} - \sqrt{9} = \sqrt{8} - 3 \approx -0.172$.

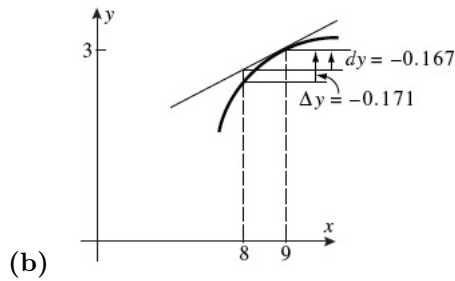

39. $dy = 3x^2 dx$; $\Delta y = (x + \Delta x)^3 - x^3 = x^3 + 3x^2 \Delta x + 3x(\Delta x)^2 + (\Delta x)^3 - x^3 = 3x^2 \Delta x + 3x(\Delta x)^2 + (\Delta x)^3$.

40. $dy = 8dx$; $\Delta y = [8(x + \Delta x) - 4] - [8x - 4] = 8\Delta x$.

41. $dy = (2x - 2)dx$; $\Delta y = [(x + \Delta x)^2 - 2(x + \Delta x) + 1] - [x^2 - 2x + 1] = x^2 + 2x \Delta x + (\Delta x)^2 - 2x - 2\Delta x + 1 - x^2 + 2x - 1 = 2x \Delta x + (\Delta x)^2 - 2\Delta x$.

42. $dy = \cos x dx$; $\Delta y = \sin(x + \Delta x) - \sin x$.

43. (a) $dy = (12x^2 - 14x)dx$.

(b) $dy = x d(\cos x) + \cos x dx = x(-\sin x)dx + \cos x dx = (-x \sin x + \cos x)dx$.

44. (a) $dy = (-1/x^2)dx$.

(b) $dy = 5 \sec^2 x dx$.

45. (a) $dy = \left(\sqrt{1-x} - \frac{x}{2\sqrt{1-x}} \right) dx = \frac{2-3x}{2\sqrt{1-x}} dx$.

(b) $dy = -17(1+x)^{-18} dx$.

46. (a) $dy = \frac{(x^3 - 1)d(1) - (1)d(x^3 - 1)}{(x^3 - 1)^2} = \frac{(x^3 - 1)(0) - (1)3x^2 dx}{(x^3 - 1)^2} = -\frac{3x^2}{(x^3 - 1)^2} dx$.

(b) $dy = \frac{(2-x)(-3x^2)dx - (1-x^3)(-1)dx}{(2-x)^2} = \frac{2x^3 - 6x^2 + 1}{(2-x)^2} dx$.

47. False; $dy = (dy/dx)dx$.

48. True.

49. False; they are equal whenever the function is linear.

50. False; if $f'(x_0) = 0$ then the approximation is constant.

$$51. dy = \frac{3}{2\sqrt{3x-2}} dx, x = 2, dx = 0.03; \Delta y \approx dy = \frac{3}{4}(0.03) = 0.0225.$$

$$52. dy = \frac{x}{\sqrt{x^2+8}} dx, x = 1, dx = -0.03; \Delta y \approx dy = (1/3)(-0.03) = -0.01.$$

$$53. dy = \frac{1-x^2}{(x^2+1)^2} dx, x = 2, dx = -0.04; \Delta y \approx dy = \left(-\frac{3}{25}\right)(-0.04) = 0.0048.$$

$$54. dy = \left(\frac{4x}{\sqrt{8x+1}} + \sqrt{8x+1}\right) dx, x = 3, dx = 0.05; \Delta y \approx dy = (37/5)(0.05) = 0.37.$$

55. (a) $A = x^2$ where x is the length of a side; $dA = 2x dx = 2(10)(\pm 0.1) = \pm 2 \text{ ft}^2$.

(b) Relative error in x is within $\frac{dx}{x} = \frac{\pm 0.1}{10} = \pm 0.01$ so percentage error in x is $\pm 1\%$; relative error in A is within $\frac{dA}{A} = \frac{2x dx}{x^2} = 2\frac{dx}{x} = 2(\pm 0.01) = \pm 0.02$ so percentage error in A is $\pm 2\%$.

56. (a) $V = x^3$ where x is the length of a side; $dV = 3x^2 dx = 3(25)^2(\pm 1) = \pm 1875 \text{ cm}^3$.

(b) Relative error in x is within $\frac{dx}{x} = \frac{\pm 1}{25} = \pm 0.04$ so percentage error in x is $\pm 4\%$; relative error in V is within $\frac{dV}{V} = \frac{3x^2 dx}{x^3} = 3\frac{dx}{x} = 3(\pm 0.04) = \pm 0.12$ so percentage error in V is $\pm 12\%$.

57. (a) $x = 10 \sin \theta$, $y = 10 \cos \theta$ (see figure), $dx = 10 \cos \theta d\theta = 10 \left(\cos \frac{\pi}{6}\right) \left(\pm \frac{\pi}{180}\right) = 10 \left(\frac{\sqrt{3}}{2}\right) \left(\pm \frac{\pi}{180}\right) \approx \pm 0.151 \text{ in}$, $dy = -10(\sin \theta)d\theta = -10 \left(\sin \frac{\pi}{6}\right) \left(\pm \frac{\pi}{180}\right) = -10 \left(\frac{1}{2}\right) \left(\pm \frac{\pi}{180}\right) \approx \pm 0.087 \text{ in}$.

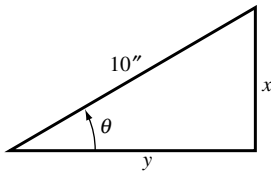

(b) Relative error in x is within $\frac{dx}{x} = (\cot \theta)d\theta = \left(\cot \frac{\pi}{6}\right) \left(\pm \frac{\pi}{180}\right) = \sqrt{3} \left(\pm \frac{\pi}{180}\right) \approx \pm 0.030$, so percentage error in x is $\approx \pm 3.0\%$; relative error in y is within $\frac{dy}{y} = -\tan \theta d\theta = -\left(\tan \frac{\pi}{6}\right) \left(\pm \frac{\pi}{180}\right) = -\frac{1}{\sqrt{3}} \left(\pm \frac{\pi}{180}\right) \approx \pm 0.010$, so percentage error in y is $\approx \pm 1.0\%$.

58. (a) $x = 25 \cot \theta$, $y = 25 \csc \theta$ (see figure); $dx = -25 \csc^2 \theta d\theta = -25 \left(\csc^2 \frac{\pi}{3}\right) \left(\pm \frac{\pi}{360}\right) = -25 \left(\frac{4}{3}\right) \left(\pm \frac{\pi}{360}\right) \approx \pm 0.291 \text{ cm}$, $dy = -25 \csc \theta \cot \theta d\theta = -25 \left(\csc \frac{\pi}{3}\right) \left(\cot \frac{\pi}{3}\right) \left(\pm \frac{\pi}{360}\right) = -25 \left(\frac{2}{\sqrt{3}}\right) \left(\frac{1}{\sqrt{3}}\right) \left(\pm \frac{\pi}{360}\right) \approx \pm 0.145 \text{ cm}$.

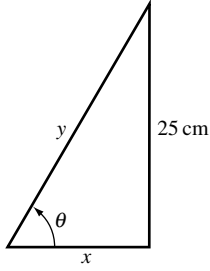

(b) Relative error in x is within $\frac{dx}{x} = -\frac{\csc^2 \theta}{\cot \theta} d\theta = -\frac{4/3}{1/\sqrt{3}} \left(\pm \frac{\pi}{360}\right) \approx \pm 0.020$, so percentage error in x is $\approx \pm 2.0\%$; relative error in y is within $\frac{dy}{y} = -\cot \theta d\theta = -\frac{1}{\sqrt{3}} \left(\pm \frac{\pi}{360}\right) \approx \pm 0.005$, so percentage error in y is $\approx \pm 0.5\%$.

59. $\frac{dR}{R} = \frac{(-2k/r^3)dr}{(k/r^2)} = -2\frac{dr}{r}$, but $\frac{dr}{r} = \pm 0.05$ so $\frac{dR}{R} = -2(\pm 0.05) = \pm 0.10$; percentage error in R is $\pm 10\%$.
60. $h = 12 \sin \theta$ thus $dh = 12 \cos \theta d\theta$ so, with $\theta = 60^\circ = \pi/3$ radians and $d\theta = -1^\circ = -\pi/180$ radians, $dh = 12 \cos(\pi/3)(-\pi/180) = -\pi/30 \approx -0.105$ ft.
61. $A = \frac{1}{4}(4)^2 \sin 2\theta = 4 \sin 2\theta$ thus $dA = 8 \cos 2\theta d\theta$ so, with $\theta = 30^\circ = \pi/6$ radians and $d\theta = \pm 15' = \pm 1/4^\circ = \pm \pi/720$ radians, $dA = 8 \cos(\pi/3)(\pm \pi/720) = \pm \pi/180 \approx \pm 0.017$ cm².
62. $A = x^2$ where x is the length of a side; $\frac{dA}{A} = \frac{2x dx}{x^2} = 2\frac{dx}{x}$, but $\frac{dx}{x} = \pm 0.01$, so $\frac{dA}{A} = 2(\pm 0.01) = \pm 0.02$; percentage error in A is $\pm 2\%$
63. $V = x^3$ where x is the length of a side; $\frac{dV}{V} = \frac{3x^2 dx}{x^3} = 3\frac{dx}{x}$, but $\frac{dx}{x} = \pm 0.02$, so $\frac{dV}{V} = 3(\pm 0.02) = \pm 0.06$; percentage error in V is $\pm 6\%$.
64. $\frac{dV}{V} = \frac{4\pi r^2 dr}{4\pi r^3/3} = 3\frac{dr}{r}$, but $\frac{dV}{V} = \pm 0.03$ so $3\frac{dr}{r} = \pm 0.03$, $\frac{dr}{r} = \pm 0.01$; maximum permissible percentage error in r is $\pm 1\%$.
65. $A = \frac{1}{4}\pi D^2$ where D is the diameter of the circle; $\frac{dA}{A} = \frac{(\pi D/2)dD}{\pi D^2/4} = 2\frac{dD}{D}$, but $\frac{dA}{A} = \pm 0.01$ so $2\frac{dD}{D} = \pm 0.01$, $\frac{dD}{D} = \pm 0.005$; maximum permissible percentage error in D is $\pm 0.5\%$.
66. $V = x^3$ where x is the length of a side; approximate ΔV by dV if $x = 1$ and $dx = \Delta x = 0.02$, $dV = 3x^2 dx = 3(1)^2(0.02) = 0.06$ in³.
67. $V =$ volume of cylindrical rod $= \pi r^2 h = \pi r^2(15) = 15\pi r^2$; approximate ΔV by dV if $r = 2.5$ and $dr = \Delta r = 0.1$. $dV = 30\pi r dr = 30\pi(2.5)(0.1) \approx 23.5619$ cm³.
68. $P = \frac{2\pi}{\sqrt{g}}\sqrt{L}$, $dP = \frac{2\pi}{\sqrt{g}}\frac{1}{2\sqrt{L}}dL = \frac{\pi}{\sqrt{g}\sqrt{L}}dL$, $\frac{dP}{P} = \frac{1}{2}\frac{dL}{L}$ so the relative error in $P \approx \frac{1}{2}$ the relative error in L .
Thus the percentage error in P is $\approx \frac{1}{2}$ the percentage error in L .
69. (a) $\alpha = \Delta L/(L\Delta T) = 0.006/(40 \times 10) = 1.5 \times 10^{-5}/^\circ\text{C}$.
- (b) $\Delta L = 2.3 \times 10^{-5}(180)(25) \approx 0.1$ cm, so the pole is about 180.1 cm long.

70. $\Delta V = 7.5 \times 10^{-4}(4000)(-20) = -60$ gallons; the truck delivers $4000 - 60 = 3940$ gallons.

Exercise Set 3.6

1. (a) $\lim_{x \rightarrow 2} \frac{x^2 - 4}{x^2 + 2x - 8} = \lim_{x \rightarrow 2} \frac{(x-2)(x+2)}{(x+4)(x-2)} = \lim_{x \rightarrow 2} \frac{x+2}{x+4} = \frac{2}{3}$ or, using L'Hôpital's rule,
 $\lim_{x \rightarrow 2} \frac{x^2 - 4}{x^2 + 2x - 8} = \lim_{x \rightarrow 2} \frac{2x}{2x + 2} = \frac{2}{3}$.
- (b) $\lim_{x \rightarrow +\infty} \frac{2x - 5}{3x + 7} = \frac{2 - \lim_{x \rightarrow +\infty} \frac{5}{x}}{3 + \lim_{x \rightarrow +\infty} \frac{7}{x}} = \frac{2}{3}$ or, using L'Hôpital's rule, $\lim_{x \rightarrow +\infty} \frac{2x - 5}{3x + 7} = \lim_{x \rightarrow +\infty} \frac{2}{3} = \frac{2}{3}$.
2. (a) $\frac{\sin x}{\tan x} = \cos x$ so $\lim_{x \rightarrow 0} \frac{\sin x}{\tan x} = \lim_{x \rightarrow 0} \cos x = 1$ or, using L'Hôpital's rule, $\lim_{x \rightarrow 0} \frac{\sin x}{\tan x} = \lim_{x \rightarrow 0} \frac{\cos x}{\sec^2 x} = 1$.
- (b) $\frac{x^2 - 1}{x^3 - 1} = \frac{(x-1)(x+1)}{(x-1)(x^2 + x + 1)} = \frac{x+1}{x^2 + x + 1}$ so $\lim_{x \rightarrow 1} \frac{x^2 - 1}{x^3 - 1} = \frac{2}{3}$ or, using L'Hôpital's rule,
 $\lim_{x \rightarrow 1} \frac{x^2 - 1}{x^3 - 1} = \lim_{x \rightarrow 1} \frac{2x}{3x^2} = \frac{2}{3}$.
3. True; $\ln x$ is not defined for negative x .
4. True; apply L'Hôpital's rule n times, where $n = \deg p(x)$.
5. False; apply L'Hôpital's rule n times.
6. True; the logarithm of the expression approaches $-\infty$.
7. $\lim_{x \rightarrow 0} \frac{e^x}{\cos x} = 1$.
8. $\lim_{x \rightarrow 0} \frac{2 \cos 2x}{5 \cos 5x} = \frac{2}{5}$.
9. $\lim_{\theta \rightarrow 0} \frac{\sec^2 \theta}{1} = 1$.
10. $\lim_{t \rightarrow 0} \frac{te^t + e^t}{-e^t} = -1$.
11. $\lim_{x \rightarrow \pi^+} \frac{\cos x}{1} = -1$.
12. $\lim_{x \rightarrow 0^+} \frac{\cos x}{2x} = +\infty$.
13. $\lim_{x \rightarrow +\infty} \frac{1/x}{1} = 0$.
14. $\lim_{x \rightarrow +\infty} \frac{3e^{3x}}{2x} = \lim_{x \rightarrow +\infty} \frac{9e^{3x}}{2} = +\infty$.
15. $\lim_{x \rightarrow 0^+} \frac{-\csc^2 x}{1/x} = \lim_{x \rightarrow 0^+} \frac{-x}{\sin^2 x} = \lim_{x \rightarrow 0^+} \frac{-1}{2 \sin x \cos x} = -\infty$.

$$16. \lim_{x \rightarrow 0^+} \frac{-1/x}{(-1/x^2)e^{1/x}} = \lim_{x \rightarrow 0^+} \frac{x}{e^{1/x}} = 0.$$

$$17. \lim_{x \rightarrow +\infty} \frac{100x^{99}}{e^x} = \lim_{x \rightarrow +\infty} \frac{(100)(99)x^{98}}{e^x} = \dots = \lim_{x \rightarrow +\infty} \frac{(100)(99)(98) \cdots (1)}{e^x} = 0.$$

$$18. \lim_{x \rightarrow 0^+} \frac{\cos x / \sin x}{\sec^2 x / \tan x} = \lim_{x \rightarrow 0^+} \cos^2 x = 1.$$

$$19. \lim_{x \rightarrow 0} \frac{2/\sqrt{1-4x^2}}{1} = 2.$$

$$20. \lim_{x \rightarrow 0} \frac{1 - \frac{1}{1+x^2}}{3x^2} = \lim_{x \rightarrow 0} \frac{1}{3(1+x^2)} = \frac{1}{3}.$$

$$21. \lim_{x \rightarrow +\infty} xe^{-x} = \lim_{x \rightarrow +\infty} \frac{x}{e^x} = \lim_{x \rightarrow +\infty} \frac{1}{e^x} = 0.$$

$$22. \lim_{x \rightarrow \pi} (x - \pi) \tan(x/2) = \lim_{x \rightarrow \pi} \frac{x - \pi}{\cot(x/2)} = \lim_{x \rightarrow \pi} \frac{1}{-(1/2) \csc^2(x/2)} = -2.$$

$$23. \lim_{x \rightarrow +\infty} x \sin(\pi/x) = \lim_{x \rightarrow +\infty} \frac{\sin(\pi/x)}{1/x} = \lim_{x \rightarrow +\infty} \frac{(-\pi/x^2) \cos(\pi/x)}{-1/x^2} = \lim_{x \rightarrow +\infty} \pi \cos(\pi/x) = \pi.$$

$$24. \lim_{x \rightarrow 0^+} \tan x \ln x = \lim_{x \rightarrow 0^+} \frac{\ln x}{\cot x} = \lim_{x \rightarrow 0^+} \frac{1/x}{-\csc^2 x} = \lim_{x \rightarrow 0^+} \frac{-\sin^2 x}{x} = \lim_{x \rightarrow 0^+} \frac{-2 \sin x \cos x}{1} = 0.$$

$$25. \lim_{x \rightarrow (\pi/2)^-} \sec 3x \cos 5x = \lim_{x \rightarrow (\pi/2)^-} \frac{\cos 5x}{\cos 3x} = \lim_{x \rightarrow (\pi/2)^-} \frac{-5 \sin 5x}{-3 \sin 3x} = \frac{-5(+1)}{(-3)(-1)} = -\frac{5}{3}.$$

$$26. \lim_{x \rightarrow \pi} (x - \pi) \cot x = \lim_{x \rightarrow \pi} \frac{x - \pi}{\tan x} = \lim_{x \rightarrow \pi} \frac{1}{\sec^2 x} = 1.$$

$$27. y = (1 - 3/x)^x, \lim_{x \rightarrow +\infty} \ln y = \lim_{x \rightarrow +\infty} \frac{\ln(1 - 3/x)}{1/x} = \lim_{x \rightarrow +\infty} \frac{-3}{1 - 3/x} = -3, \lim_{x \rightarrow +\infty} y = e^{-3}.$$

$$28. y = (1 + 2x)^{-3/x}, \lim_{x \rightarrow 0} \ln y = \lim_{x \rightarrow 0} -\frac{3 \ln(1 + 2x)}{x} = \lim_{x \rightarrow 0} -\frac{6}{1 + 2x} = -6, \lim_{x \rightarrow 0} y = e^{-6}.$$

$$29. y = (e^x + x)^{1/x}, \lim_{x \rightarrow 0} \ln y = \lim_{x \rightarrow 0} \frac{\ln(e^x + x)}{x} = \lim_{x \rightarrow 0} \frac{e^x + 1}{e^x + x} = 2, \lim_{x \rightarrow 0} y = e^2.$$

$$30. y = (1 + a/x)^{bx}, \lim_{x \rightarrow +\infty} \ln y = \lim_{x \rightarrow +\infty} \frac{b \ln(1 + a/x)}{1/x} = \lim_{x \rightarrow +\infty} \frac{ab}{1 + a/x} = ab, \lim_{x \rightarrow +\infty} y = e^{ab}.$$

$$31. y = (2 - x)^{\tan(\pi x/2)}, \lim_{x \rightarrow 1} \ln y = \lim_{x \rightarrow 1} \frac{\ln(2 - x)}{\cot(\pi x/2)} = \lim_{x \rightarrow 1} \frac{2 \sin^2(\pi x/2)}{\pi(2 - x)} = 2/\pi, \lim_{x \rightarrow 1} y = e^{2/\pi}.$$

$$32. y = [\cos(2/x)]^{x^2}, \lim_{x \rightarrow +\infty} \ln y = \lim_{x \rightarrow +\infty} \frac{\ln \cos(2/x)}{1/x^2} = \lim_{x \rightarrow +\infty} \frac{(-2/x^2)(-\tan(2/x))}{-2/x^3} = \lim_{x \rightarrow +\infty} \frac{-\tan(2/x)}{1/x} = \lim_{x \rightarrow +\infty} \frac{(2/x^2) \sec^2(2/x)}{-1/x^2} = -2, \lim_{x \rightarrow +\infty} y = e^{-2}.$$

$$33. \lim_{x \rightarrow 0} \left(\frac{1}{\sin x} - \frac{1}{x} \right) = \lim_{x \rightarrow 0} \frac{x - \sin x}{x \sin x} = \lim_{x \rightarrow 0} \frac{1 - \cos x}{x \cos x + \sin x} = \lim_{x \rightarrow 0} \frac{\sin x}{2 \cos x - x \sin x} = 0.$$

$$34. \lim_{x \rightarrow 0} \frac{1 - \cos 3x}{x^2} = \lim_{x \rightarrow 0} \frac{3 \sin 3x}{2x} = \lim_{x \rightarrow 0} \frac{9}{2} \cos 3x = \frac{9}{2}.$$

$$35. \lim_{x \rightarrow +\infty} \frac{(x^2 + x) - x^2}{\sqrt{x^2 + x} + x} = \lim_{x \rightarrow +\infty} \frac{x}{\sqrt{x^2 + x} + x} = \lim_{x \rightarrow +\infty} \frac{1}{\sqrt{1 + 1/x} + 1} = 1/2.$$

$$36. \lim_{x \rightarrow 0} \frac{e^x - 1 - x}{xe^x - x} = \lim_{x \rightarrow 0} \frac{e^x - 1}{xe^x + e^x - 1} = \lim_{x \rightarrow 0} \frac{e^x}{xe^x + 2e^x} = 1/2.$$

$$37. \lim_{x \rightarrow +\infty} [x - \ln(x^2 + 1)] = \lim_{x \rightarrow +\infty} [\ln e^x - \ln(x^2 + 1)] = \lim_{x \rightarrow +\infty} \ln \frac{e^x}{x^2 + 1}, \lim_{x \rightarrow +\infty} \frac{e^x}{x^2 + 1} = \lim_{x \rightarrow +\infty} \frac{e^x}{2x} = \lim_{x \rightarrow +\infty} \frac{e^x}{2} = +\infty, \\ \text{so } \lim_{x \rightarrow +\infty} [x - \ln(x^2 + 1)] = +\infty$$

$$38. \lim_{x \rightarrow +\infty} \ln \frac{x}{1+x} = \lim_{x \rightarrow +\infty} \ln \frac{1}{1/x + 1} = \ln(1) = 0.$$

$$39. y = x^{\sin x}, \ln y = \sin x \ln x, \lim_{x \rightarrow 0^+} \ln y = \lim_{x \rightarrow 0^+} \frac{\ln x}{\csc x} = \lim_{x \rightarrow 0^+} \frac{1/x}{-\csc x \cot x} = \lim_{x \rightarrow 0^+} \left(\frac{\sin x}{x} \right) (-\tan x) = 1(-0) = 0, \text{ so} \\ \lim_{x \rightarrow 0^+} x^{\sin x} = \lim_{x \rightarrow 0^+} y = e^0 = 1.$$

$$40. y = (e^{2x} - 1)^x, \ln y = x \ln(e^{2x} - 1), \lim_{x \rightarrow 0^+} \ln y = \lim_{x \rightarrow 0^+} \frac{\ln(e^{2x} - 1)}{1/x} = \lim_{x \rightarrow 0^+} \frac{2e^{2x}}{e^{2x} - 1} (-x^2) = \\ = \lim_{x \rightarrow 0^+} \frac{x}{e^{2x} - 1} \lim_{x \rightarrow 0^+} (-2xe^{2x}) = \lim_{x \rightarrow 0^+} \frac{1}{2e^{2x}} \lim_{x \rightarrow 0^+} (-2xe^{2x}) = \frac{1}{2} \cdot 0 = 0, \lim_{x \rightarrow 0^+} y = e^0 = 1.$$

$$41. y = \left[-\frac{1}{\ln x} \right]^x, \ln y = x \ln \left[-\frac{1}{\ln x} \right], \lim_{x \rightarrow 0^+} \ln y = \lim_{x \rightarrow 0^+} \frac{\ln \left[-\frac{1}{\ln x} \right]}{1/x} = \lim_{x \rightarrow 0^+} \left(-\frac{1}{x \ln x} \right) (-x^2) = - \lim_{x \rightarrow 0^+} \frac{x}{\ln x} = 0, \text{ so} \\ \lim_{x \rightarrow 0^+} y = e^0 = 1.$$

$$42. y = x^{1/x}, \ln y = \frac{\ln x}{x}, \lim_{x \rightarrow +\infty} \ln y = \lim_{x \rightarrow +\infty} \frac{\ln x}{x} = \lim_{x \rightarrow +\infty} \frac{1/x}{1} = 0, \text{ so } \lim_{x \rightarrow +\infty} y = e^0 = 1.$$

$$43. y = (\ln x)^{1/x}, \ln y = (1/x) \ln \ln x, \lim_{x \rightarrow +\infty} \ln y = \lim_{x \rightarrow +\infty} \frac{\ln \ln x}{x} = \lim_{x \rightarrow +\infty} \frac{1/(x \ln x)}{1} = 0, \text{ so } \lim_{x \rightarrow +\infty} y = 1.$$

$$44. y = (-\ln x)^x, \ln y = x \ln(-\ln x), \lim_{x \rightarrow 0^+} \ln y = \lim_{x \rightarrow 0^+} \ln(-\ln x)/(1/x) = \lim_{x \rightarrow 0^+} \frac{(1/(x \ln x))}{(-1/x^2)} = \lim_{x \rightarrow 0^+} \left(-\frac{x}{\ln x} \right) = 0, \text{ so} \\ \lim_{x \rightarrow 0^+} y = 1.$$

$$45. y = (\tan x)^{\pi/2 - x}, \ln y = (\pi/2 - x) \ln \tan x, \lim_{x \rightarrow (\pi/2)^-} \ln y = \lim_{x \rightarrow (\pi/2)^-} \frac{\ln \tan x}{1/(\pi/2 - x)} = \lim_{x \rightarrow (\pi/2)^-} \frac{(\sec^2 x / \tan x)}{1/(\pi/2 - x)^2} = \\ \lim_{x \rightarrow (\pi/2)^-} \frac{(\pi/2 - x)(\pi/2 - x)}{\cos x \sin x} = \lim_{x \rightarrow (\pi/2)^-} \frac{(\pi/2 - x)}{\cos x} \lim_{x \rightarrow (\pi/2)^-} \frac{(\pi/2 - x)}{\sin x} = 1 \cdot 0 = 0, \text{ so } \lim_{x \rightarrow (\pi/2)^-} y = 1.$$

$$46. \text{(a)} \lim_{x \rightarrow +\infty} \frac{\ln x}{x^n} = \lim_{x \rightarrow +\infty} \frac{1/x}{nx^{n-1}} = \lim_{x \rightarrow +\infty} \frac{1}{nx^n} = 0.$$

$$\text{(b)} \lim_{x \rightarrow +\infty} \frac{x^n}{\ln x} = \lim_{x \rightarrow +\infty} \frac{nx^{n-1}}{1/x} = \lim_{x \rightarrow +\infty} nx^n = +\infty.$$

$$47. \text{(a)} \text{ L'Hôpital's rule does not apply to the problem } \lim_{x \rightarrow 1} \frac{3x^2 - 2x + 1}{3x^2 - 2x} \text{ because it is not an indeterminate form.}$$

$$\text{(b)} \lim_{x \rightarrow 1} \frac{3x^2 - 2x + 1}{3x^2 - 2x} = 2.$$

48. (a) L'Hôpital's rule does not apply to the problem $\lim_{x \rightarrow 2} \frac{e^{3x^2-12x+12}}{x^4-16}$, because it is not an indeterminate form.

(b) $\lim_{x \rightarrow 2^-}$ and $\lim_{x \rightarrow 2^+}$ exist, with values $-\infty$ if x approaches 2 from the left and $+\infty$ if from the right. The general limit $\lim_{x \rightarrow 2}$ does not exist.

49. $\lim_{x \rightarrow +\infty} \frac{1/(x \ln x)}{1/(2\sqrt{x})} = \lim_{x \rightarrow +\infty} \frac{2}{\sqrt{x} \ln x} = 0.$

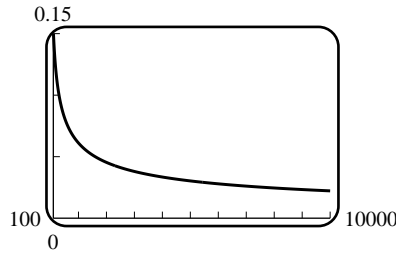

50. $y = x^x, \lim_{x \rightarrow 0^+} \ln y = \lim_{x \rightarrow 0^+} \frac{\ln x}{1/x} = \lim_{x \rightarrow 0^+} -x = 0, \lim_{x \rightarrow 0^+} y = 1.$

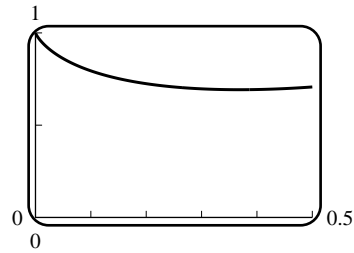

51. $y = (\sin x)^{3/\ln x}, \lim_{x \rightarrow 0^+} \ln y = \lim_{x \rightarrow 0^+} \frac{3 \ln \sin x}{\ln x} = \lim_{x \rightarrow 0^+} (3 \cos x) \frac{x}{\sin x} = 3, \lim_{x \rightarrow 0^+} y = e^3.$

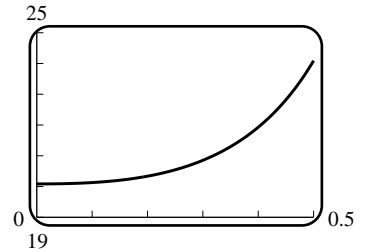

52. $\lim_{x \rightarrow \pi/2^-} \frac{4 \sec^2 x}{\sec x \tan x} = \lim_{x \rightarrow \pi/2^-} \frac{4}{\sin x} = 4.$

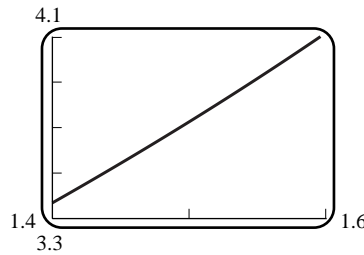

53. $\ln x - e^x = \ln x - \frac{1}{e^{-x}} = \frac{e^{-x} \ln x - 1}{e^{-x}}; \lim_{x \rightarrow +\infty} e^{-x} \ln x = \lim_{x \rightarrow +\infty} \frac{\ln x}{e^x} = \lim_{x \rightarrow +\infty} \frac{1/x}{e^x} = 0$ by L'Hôpital's rule, so $\lim_{x \rightarrow +\infty} [\ln x - e^x] = \lim_{x \rightarrow +\infty} \frac{e^{-x} \ln x - 1}{e^{-x}} = -\infty$; no horizontal asymptote.

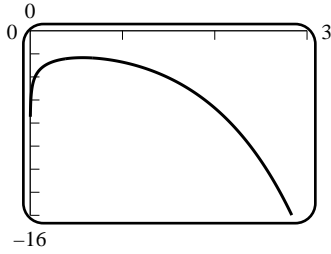

54. $\lim_{x \rightarrow +\infty} [\ln e^x - \ln(1 + 2e^x)] = \lim_{x \rightarrow +\infty} \ln \frac{e^x}{1 + 2e^x} = \lim_{x \rightarrow +\infty} \ln \frac{1}{e^{-x} + 2} = \ln \frac{1}{2}$; horizontal asymptote $y = -\ln 2$. Also,
 $\lim_{x \rightarrow -\infty} \ln \frac{e^x}{1 + 2e^x} = -\infty$.

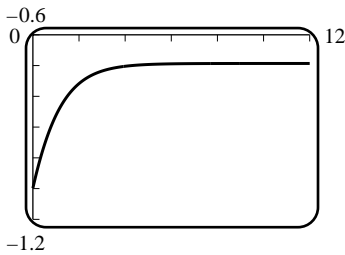

55. $y = (\ln x)^{1/x}$, $\lim_{x \rightarrow +\infty} \ln y = \lim_{x \rightarrow +\infty} \frac{\ln(\ln x)}{x} = \lim_{x \rightarrow +\infty} \frac{1}{x \ln x} = 0$; $\lim_{x \rightarrow +\infty} y = 1$, $y = 1$ is the horizontal asymptote.

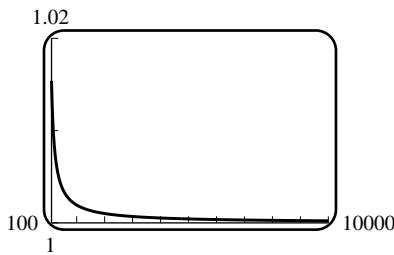

56. $y = \left(\frac{x+1}{x+2}\right)^x$, $\lim_{x \rightarrow \pm\infty} \ln y = \lim_{x \rightarrow \pm\infty} \frac{\ln \frac{x+1}{x+2}}{1/x} = \lim_{x \rightarrow \pm\infty} \frac{-x^2}{(x+1)(x+2)} = -1$; $\lim_{x \rightarrow \pm\infty} y = e^{-1}$ is the horizontal asymptote.

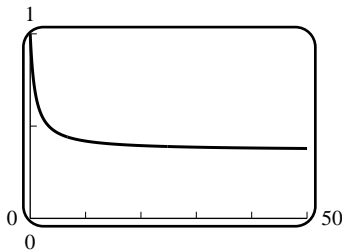

57. (a) 0 (b) $+\infty$ (c) 0 (d) $-\infty$ (e) $+\infty$ (f) $-\infty$

58. (a) Type 0^0 ; $y = x^{(\ln a)/(1+\ln x)}$; $\lim_{x \rightarrow 0^+} \ln y = \lim_{x \rightarrow 0^+} \frac{(\ln a) \ln x}{1 + \ln x} = \lim_{x \rightarrow 0^+} \frac{(\ln a)/x}{1/x} = \lim_{x \rightarrow 0^+} \ln a = \ln a$, so we obtain
that $\lim_{x \rightarrow 0^+} y = e^{\ln a} = a$.

- (b) Type ∞^0 ; same calculation as part (a) with $x \rightarrow +\infty$.

(c) Type 1^∞ ; $y = (x + 1)^{(\ln a)/x}$, $\lim_{x \rightarrow 0} \ln y = \lim_{x \rightarrow 0} \frac{(\ln a) \ln(x + 1)}{x} = \lim_{x \rightarrow 0} \frac{\ln a}{x + 1} = \ln a$, so $\lim_{x \rightarrow 0} y = e^{\ln a} = a$.

59. $\lim_{x \rightarrow +\infty} \frac{1 + 2 \cos 2x}{1}$ does not exist, nor is it $\pm\infty$; $\lim_{x \rightarrow +\infty} \frac{x + \sin 2x}{x} = \lim_{x \rightarrow +\infty} \left(1 + \frac{\sin 2x}{x}\right) = 1$.

60. $\lim_{x \rightarrow +\infty} \frac{2 - \cos x}{3 + \cos x}$ does not exist, nor is it $\pm\infty$; $\lim_{x \rightarrow +\infty} \frac{2x - \sin x}{3x + \sin x} = \lim_{x \rightarrow +\infty} \frac{2 - (\sin x)/x}{3 + (\sin x)/x} = \frac{2}{3}$.

61. $\lim_{x \rightarrow +\infty} (2 + x \cos 2x + \sin 2x)$ does not exist, nor is it $\pm\infty$; $\lim_{x \rightarrow +\infty} \frac{x(2 + \sin 2x)}{x + 1} = \lim_{x \rightarrow +\infty} \frac{2 + \sin 2x}{1 + 1/x}$, which does not exist because $\sin 2x$ oscillates between -1 and 1 as $x \rightarrow +\infty$.

62. $\lim_{x \rightarrow +\infty} \left(\frac{1}{x} + \frac{1}{2} \cos x + \frac{\sin x}{2x}\right)$ does not exist, nor is it $\pm\infty$; $\lim_{x \rightarrow +\infty} \frac{x(2 + \sin x)}{x^2 + 1} = \lim_{x \rightarrow +\infty} \frac{2 + \sin x}{x + 1/x} = 0$.

63. $\lim_{R \rightarrow 0^+} \frac{\frac{Vt}{L} e^{-Rt/L}}{1} = \frac{Vt}{L}$.

64. (a) $\lim_{x \rightarrow \pi/2} (\pi/2 - x) \tan x = \lim_{x \rightarrow \pi/2} \frac{\pi/2 - x}{\cot x} = \lim_{x \rightarrow \pi/2} \frac{-1}{x - \pi/2 - \csc^2 x} = \lim_{x \rightarrow \pi/2} \sin^2 x = 1$.

(b) $\lim_{x \rightarrow \pi/2} \left(\frac{1}{\pi/2 - x} - \tan x\right) = \lim_{x \rightarrow \pi/2} \left(\frac{1}{\pi/2 - x} - \frac{\sin x}{\cos x}\right) = \lim_{x \rightarrow \pi/2} \frac{\cos x - (\pi/2 - x) \sin x}{(\pi/2 - x) \cos x} =$
 $= \lim_{x \rightarrow \pi/2} \frac{-(\pi/2 - x) \cos x}{-(\pi/2 - x) \sin x - \cos x} = \lim_{x \rightarrow \pi/2} \frac{(\pi/2 - x) \sin x + \cos x}{-(\pi/2 - x) \cos x + 2 \sin x} = 0$ (by applying L'H's rule twice).

(c) $1/(\pi/2 - 1.57) \approx 1255.765534$, $\tan 1.57 \approx 1255.765592$; $1/(\pi/2 - 1.57) - \tan 1.57 \approx 0.000058$.

65. (b) $\lim_{x \rightarrow +\infty} x(k^{1/x} - 1) = \lim_{t \rightarrow 0^+} \frac{k^t - 1}{t} = \lim_{t \rightarrow 0^+} \frac{(\ln k)k^t}{1} = \ln k$.

(c) $\ln 0.3 = -1.20397$, $1024 \left({}^{1024}\sqrt{0.3} - 1\right) = -1.20327$; $\ln 2 = 0.69315$, $1024 \left({}^{1024}\sqrt{2} - 1\right) = 0.69338$.

66. If $k \neq -1$ then $\lim_{x \rightarrow 0} (k + \cos \ell x) = k + 1 \neq 0$, so $\lim_{x \rightarrow 0} \frac{k + \cos \ell x}{x^2} = \pm\infty$. Hence $k = -1$, and by the rule

$$\lim_{x \rightarrow 0} \frac{-1 + \cos \ell x}{x^2} = \lim_{x \rightarrow 0} \frac{-\ell \sin \ell x}{2x} = \lim_{x \rightarrow 0} \frac{-\ell^2 \cos \ell x}{2} = -\frac{\ell^2}{2} = -4 \text{ if } \ell = \pm 2\sqrt{2}.$$

67. (a) No; $\sin(1/x)$ oscillates as $x \rightarrow 0$.

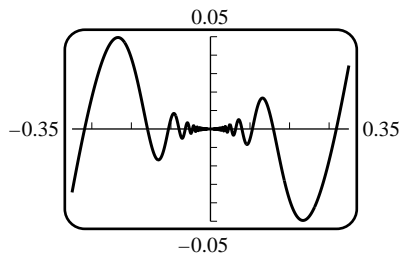

(b)

(c) For the limit as $x \rightarrow 0^+$ use the Squeezing Theorem together with the inequalities $-x^2 \leq x^2 \sin(1/x) \leq x^2$. For $x \rightarrow 0^-$ do the same; thus $\lim_{x \rightarrow 0} f(x) = 0$.

68. (a) Apply the rule to get $\lim_{x \rightarrow 0} \frac{-\cos(1/x) + 2x \sin(1/x)}{\cos x}$ which does not exist (nor is it $\pm\infty$).

(b) Rewrite as $\lim_{x \rightarrow 0} \left[\frac{x}{\sin x} \right] [x \sin(1/x)]$, but $\lim_{x \rightarrow 0} \frac{x}{\sin x} = \lim_{x \rightarrow 0} \frac{1}{\cos x} = 1$ and $\lim_{x \rightarrow 0} x \sin(1/x) = 0$, thus

$$\lim_{x \rightarrow 0} \left[\frac{x}{\sin x} \right] [x \sin(1/x)] = (1)(0) = 0.$$

69. $\lim_{x \rightarrow 0^+} \frac{\sin(1/x)}{(\sin x)/x}$, $\lim_{x \rightarrow 0^+} \frac{\sin x}{x} = 1$ but $\lim_{x \rightarrow 0^+} \sin(1/x)$ does not exist because $\sin(1/x)$ oscillates between -1 and 1 as $x \rightarrow +\infty$, so $\lim_{x \rightarrow 0^+} \frac{x \sin(1/x)}{\sin x}$ does not exist.

70. Since $f(a) = g(a) = 0$, then for $x \neq a$, $\frac{f(x)}{g(x)} = \frac{(f(x) - f(a))/(x - a)}{(g(x) - g(a))/(x - a)}$. Now take the limit: $\lim_{x \rightarrow a} \frac{f(x)}{g(x)} = \lim_{x \rightarrow a} \frac{(f(x) - f(a))/(x - a)}{(g(x) - g(a))/(x - a)} = \frac{f'(a)}{g'(a)}$.

Chapter 3 Review Exercises

1. (a) $3x^2 + x \frac{dy}{dx} + y - 2 = 0$, $\frac{dy}{dx} = \frac{2 - y - 3x^2}{x}$.

(b) $y = (1 + 2x - x^3)/x = 1/x + 2 - x^2$, $dy/dx = -1/x^2 - 2x$.

(c) $\frac{dy}{dx} = \frac{2 - (1/x + 2 - x^2) - 3x^2}{x} = -1/x^2 - 2x$.

2. (a) $xy = x - y$, $x \frac{dy}{dx} + y = 1 - \frac{dy}{dx}$, $\frac{dy}{dx} = \frac{1 - y}{x + 1}$.

(b) $y(x + 1) = x$, $y = \frac{x}{x + 1}$, $y' = \frac{1}{(x + 1)^2}$.

(c) $\frac{dy}{dx} = \frac{1 - y}{x + 1} = \frac{1 - \frac{x}{x + 1}}{1 + x} = \frac{1}{(x + 1)^2}$.

3. $-\frac{1}{y^2} \frac{dy}{dx} - \frac{1}{x^2} = 0$ so $\frac{dy}{dx} = -\frac{y^2}{x^2}$.

4. $3x^2 - 3y^2 \frac{dy}{dx} = 6(x \frac{dy}{dx} + y)$, $-(3y^2 + 6x) \frac{dy}{dx} = 6y - 3x^2$ so $\frac{dy}{dx} = \frac{x^2 - 2y}{y^2 + 2x}$.

5. $\left(x \frac{dy}{dx} + y \right) \sec(xy) \tan(xy) = \frac{dy}{dx}$, $\frac{dy}{dx} = \frac{y \sec(xy) \tan(xy)}{1 - x \sec(xy) \tan(xy)}$.

6. $2x = \frac{(1 + \csc y)(-\csc^2 y)(dy/dx) - (\cot y)(-\csc y \cot y)(dy/dx)}{(1 + \csc y)^2}$, $2x(1 + \csc y)^2 = -\csc y(\csc y + \csc^2 y - \cot^2 y) \frac{dy}{dx}$,
but $\csc^2 y - \cot^2 y = 1$, so $\frac{dy}{dx} = -\frac{2x(1 + \csc y)}{\csc y}$.

7. $\frac{dy}{dx} = \frac{3x}{4y}$, $\frac{d^2y}{dx^2} = \frac{(4y)(3) - (3x)(4dy/dx)}{16y^2} = \frac{12y - 12x(3x/(4y))}{16y^2} = \frac{12y^2 - 9x^2}{16y^3} = \frac{-3(3x^2 - 4y^2)}{16y^3}$, but $3x^2 - 4y^2 = 7$ so $\frac{d^2y}{dx^2} = \frac{-3(7)}{16y^3} = -\frac{21}{16y^3}$.

8. $\frac{dy}{dx} = \frac{y}{y-x}, \frac{d^2y}{dx^2} = \frac{(y-x)(dy/dx) - y(dy/dx - 1)}{(y-x)^2} = \frac{(y-x)\left(\frac{y}{y-x}\right) - y\left(\frac{y}{y-x} - 1\right)}{(y-x)^2} = \frac{y^2 - 2xy}{(y-x)^3}$, but $y^2 - 2xy = -3$, so $\frac{d^2y}{dx^2} = -\frac{3}{(y-x)^3}$.
9. $\frac{dy}{dx} = \tan(\pi y/2) + x(\pi/2)\frac{dy}{dx}\sec^2(\pi y/2), \frac{dy}{dx}\Big|_{y=1/2} = 1 + (\pi/4)\frac{dy}{dx}\Big|_{y=1/2} (2), \frac{dy}{dx}\Big|_{y=1/2} = \frac{2}{2-\pi}$.
10. Let $P(x_0, y_0)$ be the required point. The slope of the line $4x - 3y + 1 = 0$ is $4/3$ so the slope of the tangent to $y^2 = 2x^3$ at P must be $-3/4$. By implicit differentiation $dy/dx = 3x^2/y$, so at P , $3x_0^2/y_0 = -3/4$, or $y_0 = -4x_0^2$. But $y_0^2 = 2x_0^3$ because P is on the curve $y^2 = 2x^3$. Elimination of y_0 gives $16x_0^4 = 2x_0^3, x_0^3(8x_0 - 1) = 0$, so $x_0 = 0$ or $1/8$. From $y_0 = -4x_0^2$ it follows that $y_0 = 0$ when $x_0 = 0$, and $y_0 = -1/16$ when $x_0 = 1/8$. It does not follow, however, that $(0, 0)$ is a solution because $dy/dx = 3x^2/y$ (the slope of the curve as determined by implicit differentiation) is valid only if $y \neq 0$. Further analysis shows that the curve is tangent to the x -axis at $(0, 0)$, so the point $(1/8, -1/16)$ is the only solution.
11. Substitute $y = mx$ into $x^2 + xy + y^2 = 4$ to get $x^2 + mx^2 + m^2x^2 = 4$, which has distinct solutions $x = \pm 2/\sqrt{m^2 + m + 1}$. They are distinct because $m^2 + m + 1 = (m + 1/2)^2 + 3/4 \geq 3/4$, so $m^2 + m + 1$ is never zero. Note that the points of intersection occur in pairs (x_0, y_0) and $(-x_0, -y_0)$. By implicit differentiation, the slope of the tangent line to the ellipse is given by $dy/dx = -(2x + y)/(x + 2y)$. Since the slope is unchanged if we replace (x, y) with $(-x, -y)$, it follows that the slopes are equal at the two point of intersection. Finally we must examine the special case $x = 0$ which cannot be written in the form $y = mx$. If $x = 0$ then $y = \pm 2$, and the formula for dy/dx gives $dy/dx = -1/2$, so the slopes are equal.
12. By implicit differentiation, $3x^2 - y - xy' + 3y^2y' = 0$, so $y' = (3x^2 - y)/(x - 3y^2)$. This derivative is zero when $y = 3x^2$. Substituting this into the original equation $x^3 - xy + y^3 = 0$, one has $x^3 - 3x^3 + 27x^6 = 0, x^3(27x^3 - 2) = 0$. The unique solution in the first quadrant is $x = 2^{1/3}/3, y = 3x^2 = 2^{2/3}/3$.
13. By implicit differentiation, $3x^2 - y - xy' + 3y^2y' = 0$, so $y' = (3x^2 - y)/(x - 3y^2)$. This derivative exists except when $x = 3y^2$. Substituting this into the original equation $x^3 - xy + y^3 = 0$, one has $27y^6 - 3y^3 + y^3 = 0, y^3(27y^3 - 2) = 0$. The unique solution in the first quadrant is $y = 2^{1/3}/3, x = 3y^2 = 2^{2/3}/3$.
14. By implicit differentiation, $dy/dx = k/(2y)$ so the slope of the tangent to $y^2 = kx$ at (x_0, y_0) is $k/(2y_0)$ if $y_0 \neq 0$. The tangent line in this case is $y - y_0 = \frac{k}{2y_0}(x - x_0)$, or $2y_0y - 2y_0^2 = kx - kx_0$. But $y_0^2 = kx_0$ because (x_0, y_0) is on the curve $y^2 = kx$, so the equation of the tangent line becomes $2y_0y - 2kx_0 = kx - kx_0$ which gives $y_0y = k(x + x_0)/2$. If $y_0 = 0$, then $x_0 = 0$; the graph of $y^2 = kx$ has a vertical tangent at $(0, 0)$ so its equation is $x = 0$, but $y_0y = k(x + x_0)/2$ gives the same result when $x_0 = y_0 = 0$.
15. $y = \ln(x + 1) + 2\ln(x + 2) - 3\ln(x + 3) - 4\ln(x + 4), dy/dx = \frac{1}{x+1} + \frac{2}{x+2} - \frac{3}{x+3} - \frac{4}{x+4}$.
16. $y = \frac{1}{2}\ln x + \frac{1}{3}\ln(x + 1) - \ln \sin x + \ln \cos x$, so $\frac{dy}{dx} = \frac{1}{2x} + \frac{1}{3(x+1)} - \frac{\cos x}{\sin x} - \frac{\sin x}{\cos x} = \frac{5x+3}{6x(x+1)} - \cot x - \tan x$.
17. $\frac{dy}{dx} = \frac{1}{2x}(2) = 1/x$.
18. $\frac{dy}{dx} = 2(\ln x)\left(\frac{1}{x}\right) = \frac{2\ln x}{x}$.
19. $\frac{dy}{dx} = \frac{1}{3x(\ln x + 1)^{2/3}}$.
20. $y = \frac{1}{3}\ln(x + 1), y' = \frac{1}{3(x+1)}$.

$$21. \frac{dy}{dx} = \log_{10} \ln x = \frac{\ln \ln x}{\ln 10}, y' = \frac{1}{(\ln 10)(x \ln x)}.$$

$$22. y = \frac{1 + \ln x / \ln 10}{1 - \ln x / \ln 10} = \frac{\ln 10 + \ln x}{\ln 10 - \ln x}, y' = \frac{(\ln 10 - \ln x)/x + (\ln 10 + \ln x)/x}{(\ln 10 - \ln x)^2} = \frac{2 \ln 10}{x(\ln 10 - \ln x)^2}.$$

$$23. y = \frac{3}{2} \ln x + \frac{1}{2} \ln(1 + x^4), y' = \frac{3}{2x} + \frac{2x^3}{(1 + x^4)}.$$

$$24. y = \frac{1}{2} \ln x + \ln \cos x - \ln(1 + x^2), y' = \frac{1}{2x} - \frac{\sin x}{\cos x} - \frac{2x}{1 + x^2} = \frac{1 - 3x^2}{2x(1 + x^2)} - \tan x.$$

$$25. y = x^2 + 1 \text{ so } y' = 2x.$$

$$26. y = \ln \frac{(1 + e^x + e^{2x})}{(1 - e^x)(1 + e^x + e^{2x})} = -\ln(1 - e^x), \frac{dy}{dx} = \frac{e^x}{1 - e^x}.$$

$$27. y' = 2e^{\sqrt{x}} + 2xe^{\sqrt{x}} \frac{d}{dx} \sqrt{x} = 2e^{\sqrt{x}} + \sqrt{x}e^{\sqrt{x}}.$$

$$28. y' = \frac{abe^{-x}}{(1 + be^{-x})^2}.$$

$$29. y' = \frac{2}{\pi(1 + 4x^2)}.$$

$$30. y = e^{(\sin^{-1} x) \ln 2}, y' = \frac{\ln 2}{\sqrt{1 - x^2}} 2^{\sin^{-1} x}.$$

$$31. \ln y = e^x \ln x, \frac{y'}{y} = e^x \left(\frac{1}{x} + \ln x \right), \frac{dy}{dx} = x^{e^x} e^x \left(\frac{1}{x} + \ln x \right) = e^x \left[x^{e^x - 1} + x^{e^x} \ln x \right].$$

$$32. \ln y = \frac{\ln(1 + x)}{x}, \frac{y'}{y} = \frac{x/(1 + x) - \ln(1 + x)}{x^2} = \frac{1}{x(1 + x)} - \frac{\ln(1 + x)}{x^2}, \frac{dy}{dx} = \frac{1}{x}(1 + x)^{(1/x) - 1} - \frac{(1 + x)^{(1/x)}}{x^2} \ln(1 + x).$$

$$33. y' = \frac{2}{|2x + 1| \sqrt{(2x + 1)^2 - 1}}.$$

$$34. y' = \frac{1}{2\sqrt{\cos^{-1} x^2}} \frac{d}{dx} \cos^{-1} x^2 = -\frac{1}{\sqrt{\cos^{-1} x^2}} \frac{x}{\sqrt{1 - x^4}}.$$

$$35. \ln y = 3 \ln x - \frac{1}{2} \ln(x^2 + 1), y'/y = \frac{3}{x} - \frac{x}{x^2 + 1}, y' = \frac{3x^2}{\sqrt{x^2 + 1}} - \frac{x^4}{(x^2 + 1)^{3/2}}.$$

$$36. \ln y = \frac{1}{3}(\ln(x^2 - 1) - \ln(x^2 + 1)), \frac{y'}{y} = \frac{1}{3} \left(\frac{2x}{x^2 - 1} - \frac{2x}{x^2 + 1} \right) = \frac{4x}{3(x^4 - 1)} \text{ so } y' = \frac{4x}{3(x^4 - 1)} \sqrt[3]{\frac{x^2 - 1}{x^2 + 1}}.$$

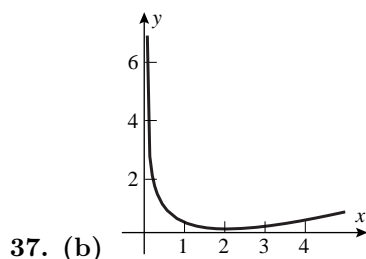

(c) $\frac{dy}{dx} = \frac{1}{2} - \frac{1}{x}$, so $\frac{dy}{dx} < 0$ at $x = 1$ and $\frac{dy}{dx} > 0$ at $x = e$.

(d) The slope is a continuous function which goes from a negative value to a positive value; therefore it must take the value zero between, by the Intermediate Value Theorem.

(e) $\frac{dy}{dx} = 0$ when $x = 2$.

38. $\beta = 10 \log I - 10 \log I_0$, $\frac{d\beta}{dI} = \frac{10}{I \ln 10}$.

(a) $\left. \frac{d\beta}{dI} \right|_{I=10I_0} = \frac{1}{I_0 \ln 10} \text{ dB}/(\text{W}/\text{m}^2)$.

(b) $\left. \frac{d\beta}{dI} \right|_{I=100I_0} = \frac{1}{10I_0 \ln 10} \text{ dB}/(\text{W}/\text{m}^2)$.

(c) $\left. \frac{d\beta}{dI} \right|_{I=1000I_0} = \frac{1}{1000I_0 \ln 10} \text{ dB}/(\text{W}/\text{m}^2)$.

39. Solve $\frac{dy}{dt} = 3 \frac{dx}{dt}$ given $y = x \ln x$. Then $\frac{dy}{dt} = \frac{dy}{dx} \frac{dx}{dt} = (1 + \ln x) \frac{dx}{dt}$, so $1 + \ln x = 3$, $\ln x = 2$, $x = e^2$.

40. $x = 2, y = 0; y' = -2x/(5 - x^2) = -4$ at $x = 2$, so $y - 0 = -4(x - 2)$ or $y = -4x + 8$.

41. Set $y = \log_b x$ and solve $y' = 1$: $y' = \frac{1}{x \ln b} = 1$ so $x = \frac{1}{\ln b}$. The curves intersect when (x, x) lies on the graph of $y = \log_b x$, so $x = \log_b x$. From Formula (8), Section 1.6, $\log_b x = \frac{\ln x}{\ln b}$ from which $\ln x = 1$, $x = e$, $\ln b = 1/e$, $b = e^{1/e} \approx 1.4447$.

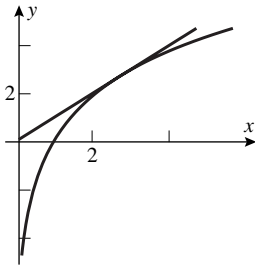

42. (a) Find the point of intersection: $f(x) = \sqrt{x} + k = \ln x$. The slopes are equal, so $m_1 = \frac{1}{\sqrt{x}} = m_2 = \frac{1}{2\sqrt{x}}$, $\sqrt{x} = 2$, $x = 4$. Then $\ln 4 = \sqrt{4} + k$, $k = \ln 4 - 2$.

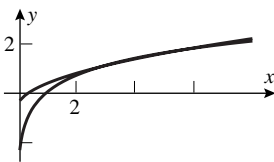

(b) Since the slopes are equal $m_1 = \frac{k}{2\sqrt{x}} = m_2 = \frac{1}{x}$, so $k\sqrt{x} = 2$. At the point of intersection $k\sqrt{x} = \ln x$, $2 = \ln x$, $x = e^2$, $k = 2/e$.

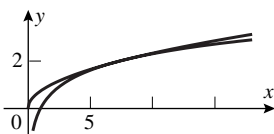

43. Yes, g must be differentiable (where $f' \neq 0$); this can be inferred from the graphs. Note that if $f' = 0$ at a point then g' cannot exist (infinite slope).

44. (a) $f'(x) = -3/(x+1)^2$. If $x = f(y) = 3/(y+1)$ then $y = f^{-1}(x) = (3/x) - 1$, so $\frac{d}{dx}f^{-1}(x) = -\frac{3}{x^2}$; and $\frac{1}{f'(f^{-1}(x))} = -\frac{(f^{-1}(x)+1)^2}{3} = -\frac{(3/x)^2}{3} = -\frac{3}{x^2}$.

(b) $f(x) = e^{x/2}$, $f'(x) = \frac{1}{2}e^{x/2}$. If $x = f(y) = e^{y/2}$ then $y = f^{-1}(x) = 2 \ln x$, so $\frac{d}{dx}f^{-1}(x) = \frac{2}{x}$; and $\frac{1}{f'(f^{-1}(x))} = 2e^{-f^{-1}(x)/2} = 2e^{-\ln x} = 2x^{-1} = \frac{2}{x}$.

45. Let $P(x_0, y_0)$ be a point on $y = e^{3x}$ then $y_0 = e^{3x_0}$. $dy/dx = 3e^{3x}$ so $m_{\text{tan}} = 3e^{3x_0}$ at P and an equation of the tangent line at P is $y - y_0 = 3e^{3x_0}(x - x_0)$, $y - e^{3x_0} = 3e^{3x_0}(x - x_0)$. If the line passes through the origin then $(0, 0)$ must satisfy the equation so $-e^{3x_0} = -3x_0e^{3x_0}$ which gives $x_0 = 1/3$ and thus $y_0 = e$. The point is $(1/3, e)$.

46. $\ln y = \ln 5000 + 1.07x$; $\frac{dy/dx}{y} = 1.07$, or $\frac{dy}{dx} = 1.07y$.

47. $\ln y = 2x \ln 3 + 7x \ln 5$; $\frac{dy/dx}{y} = 2 \ln 3 + 7 \ln 5$, or $\frac{dy}{dx} = (2 \ln 3 + 7 \ln 5)y$.

48. $\frac{dk}{dT} = k_0 \exp\left[-\frac{q(T-T_0)}{2T_0T}\right] \left(-\frac{q}{2T^2}\right) = -\frac{qk_0}{2T^2} \exp\left[-\frac{q(T-T_0)}{2T_0T}\right]$.

49. $y' = ae^{ax} \sin bx + be^{ax} \cos bx$, and $y'' = (a^2 - b^2)e^{ax} \sin bx + 2abe^{ax} \cos bx$, so $y'' - 2ay' + (a^2 + b^2)y = (a^2 - b^2)e^{ax} \sin bx + 2abe^{ax} \cos bx - 2a(ae^{ax} \sin bx + be^{ax} \cos bx) + (a^2 + b^2)e^{ax} \sin bx = 0$.

50. $\sin(\tan^{-1} x) = x/\sqrt{1+x^2}$ and $\cos(\tan^{-1} x) = 1/\sqrt{1+x^2}$, and $y' = \frac{1}{1+x^2}$, $y'' = \frac{-2x}{(1+x^2)^2}$, hence $y'' + 2 \sin y \cos^3 y = \frac{-2x}{(1+x^2)^2} + 2 \frac{x}{\sqrt{1+x^2}} \frac{1}{(1+x^2)^{3/2}} = 0$.

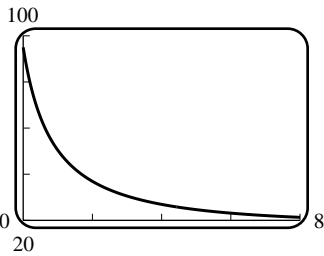

51. (a)

(b) As t tends to $+\infty$, the population tends to 19: $\lim_{t \rightarrow +\infty} P(t) = \lim_{t \rightarrow +\infty} \frac{95}{5 - 4e^{-t/4}} = \frac{95}{5 - 4 \lim_{t \rightarrow +\infty} e^{-t/4}} = \frac{95}{5} = 19$.

(c) The rate of population growth tends to zero.

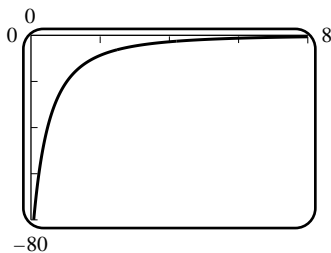

52. (a) $y = (1+x)^\pi$, $\lim_{h \rightarrow 0} \frac{(1+h)^\pi - 1}{h} = \frac{d}{dx}(1+x)^\pi \Big|_{x=0} = \pi(1+x)^{\pi-1} \Big|_{x=0} = \pi$.

(b) Let $y = \frac{1 - \ln x}{\ln x}$. Then $y(e) = 0$, and $\lim_{x \rightarrow e} \frac{1 - \ln x}{(x - e) \ln x} = \frac{dy}{dx} \Big|_{x=e} = -\frac{1/x}{(\ln x)^2} = -\frac{1}{e}$.

53. In the case $+\infty - (-\infty)$ the limit is $+\infty$; in the case $-\infty - (+\infty)$ the limit is $-\infty$, because large positive (negative) quantities are added to large positive (negative) quantities. The cases $+\infty - (+\infty)$ and $-\infty - (-\infty)$ are indeterminate; large numbers of opposite sign are subtracted, and more information about the sizes is needed.

54. (a) When the limit takes the form $0/0$ or ∞/∞ .

(b) Not necessarily; only if $\lim_{x \rightarrow a} f(x) = 0$. Consider $g(x) = x$; $\lim_{x \rightarrow 0} g(x) = 0$. Then $\lim_{x \rightarrow 0} \frac{\cos x}{x}$ is not indeterminate, whereas $\lim_{x \rightarrow 0} \frac{\sin x}{x}$ is indeterminate.

55. $\lim_{x \rightarrow +\infty} (e^x - x^2) = \lim_{x \rightarrow +\infty} x^2(e^x/x^2 - 1)$, but $\lim_{x \rightarrow +\infty} \frac{e^x}{x^2} = \lim_{x \rightarrow +\infty} \frac{e^x}{2x} = \lim_{x \rightarrow +\infty} \frac{e^x}{2} = +\infty$, so $\lim_{x \rightarrow +\infty} (e^x/x^2 - 1) = +\infty$ and thus $\lim_{x \rightarrow +\infty} x^2(e^x/x^2 - 1) = +\infty$.

56. $\lim_{x \rightarrow 1} \frac{\ln x}{x^4 - 1} = \lim_{x \rightarrow 1} \frac{1/x}{4x^3} = \frac{1}{4}$; $\lim_{x \rightarrow 1} \sqrt{\frac{\ln x}{x^4 - 1}} = \sqrt{\lim_{x \rightarrow 1} \frac{\ln x}{x^4 - 1}} = \frac{1}{2}$.

57. $\lim_{x \rightarrow 0} \frac{x^2 e^x}{\sin^2 3x} = \left[\lim_{x \rightarrow 0} \frac{3x}{\sin 3x} \right]^2 \left[\lim_{x \rightarrow 0} \frac{e^x}{9} \right] = \frac{1}{9}$.

58. $\lim_{x \rightarrow 0} a^x \ln a = \ln a$.

59. The boom is pulled in at the rate of 5 m/min, so the circumference $C = 2r\pi$ is changing at this rate, which means that $\frac{dr}{dt} = \frac{dC}{dt} \cdot \frac{1}{2\pi} = -5/(2\pi)$. $A = \pi r^2$ and $\frac{dA}{dt} = -5/(2\pi)$, so $\frac{dA}{dt} = \frac{dA}{dr} \frac{dr}{dt} = 2\pi r(-5/2\pi) = -250$, so the area is shrinking at a rate of 250 m²/min.

60. Find $\frac{d\theta}{dt} \Big|_{\substack{x=1 \\ y=1}}$ given $\frac{dz}{dt} = a$ and $\frac{dy}{dt} = -b$. From the figure $\sin \theta = y/z$; when $x = y = 1$, $z = \sqrt{2}$. So $\theta = \sin^{-1}(y/z)$ and $\frac{d\theta}{dt} = \frac{1}{\sqrt{1 - y^2/z^2}} \left(\frac{1}{z} \frac{dy}{dt} - \frac{y}{z^2} \frac{dz}{dt} \right) = -b - \frac{a}{\sqrt{2}}$ when $x = y = 1$.

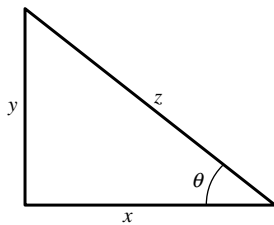

61. (a) $\Delta x = 1.5 - 2 = -0.5$; $dy = \frac{-1}{(x-1)^2} \Delta x = \frac{-1}{(2-1)^2}(-0.5) = 0.5$; and $\Delta y = \frac{1}{(1.5-1)} - \frac{1}{(2-1)} = 2 - 1 = 1$.

(b) $\Delta x = 0 - (-\pi/4) = \pi/4$; $dy = (\sec^2(-\pi/4))(\pi/4) = \pi/2$; and $\Delta y = \tan 0 - \tan(-\pi/4) = 1$.

(c) $\Delta x = 3 - 0 = 3$; $dy = \frac{-x}{\sqrt{25-x^2}} = \frac{-0}{\sqrt{25-(0)^2}}(3) = 0$; and $\Delta y = \sqrt{25-3^2} - \sqrt{25-0^2} = 4 - 5 = -1$.

62. $\cot 46^\circ = \cot \frac{46\pi}{180}$; let $x_0 = \frac{\pi}{4}$ and $x = \frac{46\pi}{180}$. Then

$$\cot 46^\circ = \cot x \approx \cot \frac{\pi}{4} - \left(\csc^2 \frac{\pi}{4} \right) \left(x - \frac{\pi}{4} \right) = 1 - 2 \left(\frac{46\pi}{180} - \frac{\pi}{4} \right) = 0.9651; \text{ with a calculator, } \cot 46^\circ = 0.9657.$$

63. (a) $h = 115 \tan \phi$, $dh = 115 \sec^2 \phi d\phi$; with $\phi = 51^\circ = \frac{51}{180}\pi$ radians and $d\phi = \pm 0.5^\circ = \pm 0.5 \left(\frac{\pi}{180} \right)$ radians, $h \pm dh = 115(1.2349) \pm 2.5340 = 142.0135 \pm 2.5340$, so the height lies between 139.48 m and 144.55 m.

(b) If $|dh| \leq 5$ then $|d\phi| \leq \frac{5}{115} \cos^2 \frac{51}{180}\pi \approx 0.017$ radian, or $|d\phi| \leq 0.98^\circ$.

Chapter 3 Making Connections

1. (a) If $t > 0$ then $A(-t)$ is the amount K there was t time-units ago in order that there be 1 unit now, i.e. $K \cdot A(t) = 1$, so $K = \frac{1}{A(t)}$. But, as said above, $K = A(-t)$. So $A(-t) = \frac{1}{A(t)}$.

(b) If s and t are positive, then the amount 1 becomes $A(s)$ after s seconds, and that in turn is $A(s)A(t)$ after another t seconds, i.e. 1 becomes $A(s)A(t)$ after $s + t$ seconds. But this amount is also $A(s + t)$, so $A(s)A(t) = A(s + t)$. Now if $0 \leq -s \leq t$ then $A(-s)A(s + t) = A(t)$. From the first case, we get $A(s + t) = A(s)A(t)$. If $0 \leq t \leq -s$ then $A(s + t) = \frac{1}{A(-s - t)} = \frac{1}{A(-s)A(-t)} = A(s)A(t)$ by the previous cases. If s and t are both negative then by the first case, $A(s + t) = \frac{1}{A(-s - t)} = \frac{1}{A(-s)A(-t)} = A(s)A(t)$.

(c) If $n > 0$ then $A\left(\frac{1}{n}\right) A\left(\frac{1}{n}\right) \dots A\left(\frac{1}{n}\right) = A\left(n \frac{1}{n}\right) = A(1)$, so $A\left(\frac{1}{n}\right) = A(1)^{1/n} = b^{1/n}$ from part (b). If $n < 0$ then by part (a), $A\left(\frac{1}{n}\right) = \frac{1}{A\left(-\frac{1}{n}\right)} = \frac{1}{A(1)^{-1/n}} = A(1)^{1/n} = b^{1/n}$.

(d) Let m, n be integers. Assume $n \neq 0$ and $m > 0$. Then $A\left(\frac{m}{n}\right) = A\left(\frac{1}{n}\right)^m = A(1)^{m/n} = b^{m/n}$.

(e) If f, g are continuous functions of t and f and g are equal on the rational numbers $\left\{ \frac{m}{n} : n \neq 0 \right\}$, then $f(t) = g(t)$ for all t . Because if x is irrational, then let t_n be a sequence of rational numbers which converges to x . Then for all $n > 0$, $f(t_n) = g(t_n)$ and thus $f(x) = \lim_{n \rightarrow +\infty} f(t_n) = \lim_{n \rightarrow +\infty} g(t_n) = g(x)$.

2. (a) From Figure 1.3.4 it is evident that $(1+h)^{1/h} < e < (1-h)^{-1/h}$ provided $h > 0$, and $(1-h)^{-1/h} < e < (1+h)^{1/h}$ for $h < 0$.

(b) Suppose $h > 0$. Then $(1+h)^{1/h} < e < (1-h)^{-1/h}$. Raise to the power h : $1+h < e^h < 1/(1-h)$; $h < e^h - 1 < h/(1-h)$; $1 < \frac{e^h - 1}{h} < 1/(1-h)$; use the Squeezing Theorem as $h \rightarrow 0^+$. Use a similar argument in the case $h < 0$.

(c) The quotient $\frac{e^h - 1}{h}$ is the slope of the secant line through $(0, 1)$ and (h, e^h) , and this secant line converges to the tangent line as $h \rightarrow 0$.

(d) $\frac{d}{dx} e^x = \lim_{h \rightarrow 0} \frac{e^{x+h} - e^x}{h} = e^x \lim_{h \rightarrow 0} \frac{e^h - 1}{h} = e^x$ from part (b).

The Derivative in Graphing and Applications

Exercise Set 4.1

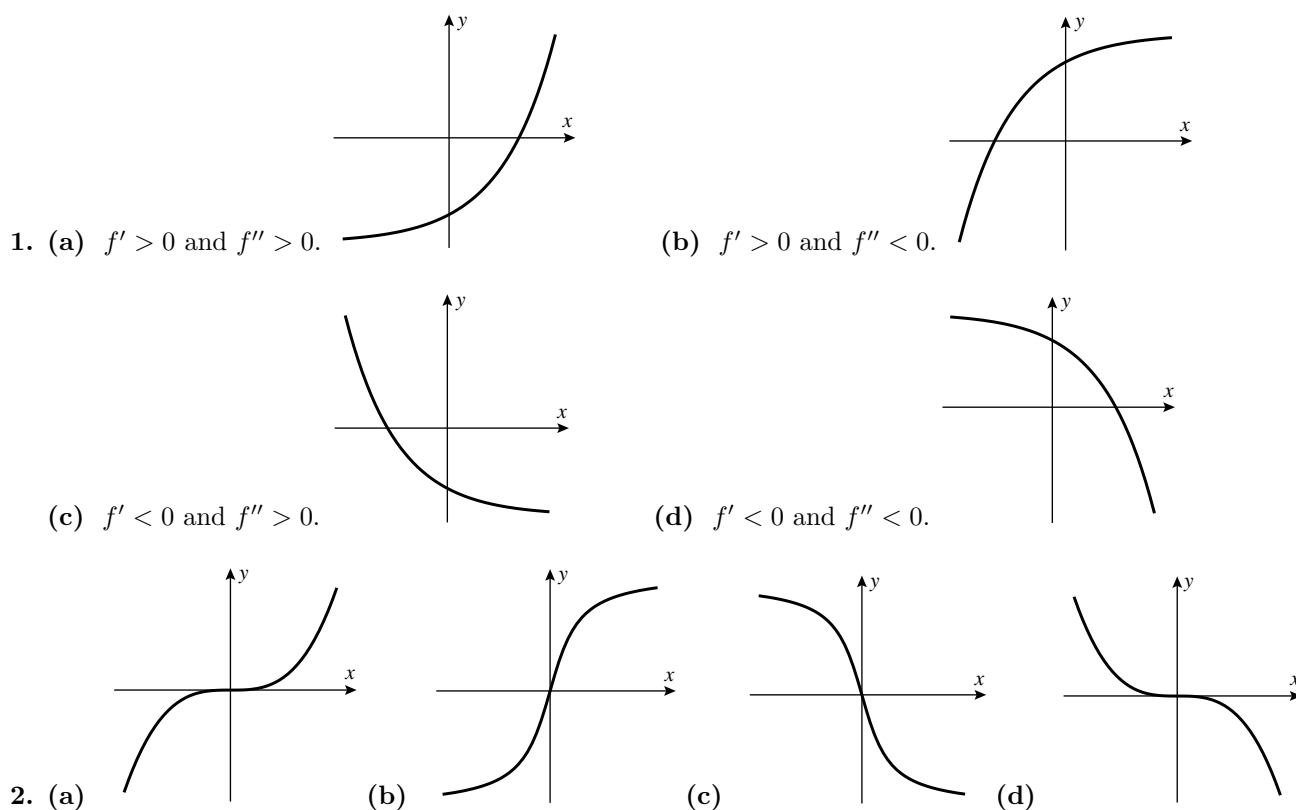

1. (a) $f' > 0$ and $f'' > 0$.

(b) $f' > 0$ and $f'' < 0$.

(c) $f' < 0$ and $f'' > 0$.

(d) $f' < 0$ and $f'' < 0$.

2. (a)

(b)

(c)

(d)

3. A: $dy/dx < 0$, $d^2y/dx^2 > 0$, B: $dy/dx > 0$, $d^2y/dx^2 < 0$, C: $dy/dx < 0$, $d^2y/dx^2 < 0$.

4. A: $dy/dx < 0$, $d^2y/dx^2 < 0$, B: $dy/dx < 0$, $d^2y/dx^2 > 0$, C: $dy/dx > 0$, $d^2y/dx^2 < 0$.

5. An inflection point occurs when f'' changes sign: at $x = -1, 0, 1$ and 2 .

6. (a) $f(0) < f(1)$ since $f' > 0$ on $(0, 1)$.

(b) $f(1) > f(2)$ since $f' < 0$ on $(1, 2)$.

(c) $f'(0) > 0$ by inspection.

(d) $f'(1) = 0$ by inspection.

(e) $f''(0) < 0$ since f' is decreasing there.

(f) $f''(2) = 0$ since f' has a minimum there.

7. (a) $[4, 6]$ (b) $[1, 4]$ and $[6, 7]$. (c) $(1, 2)$ and $(3, 5)$. (d) $(2, 3)$ and $(5, 7)$. (e) $x = 2, 3, 5$.

8.

	(1, 2)	(2, 3)	(3, 4)	(4, 5)	(5, 6)	(6, 7)
f'	-	-	-	+	+	-
f''	+	-	+	+	-	-

9. (a) f is increasing on $[1, 3]$.
 (b) f is decreasing on $(-\infty, 1], [3, +\infty)$.
 (c) f is concave up on $(-\infty, 2), (4, +\infty)$.
 (d) f is concave down on $(2, 4)$.
 (e) Points of inflection at $x = 2, 4$.
10. (a) f is increasing on $(-\infty, +\infty)$.
 (b) f is nowhere decreasing.
 (c) f is concave up on $(-\infty, 1), (3, +\infty)$.
 (d) f is concave down on $(1, 3)$.
 (e) f has points of inflection at $x = 1, 3$.
11. True, by Definition 4.1.1(b).
12. False. Let $f(x) = (2x - 1)^2$. Then $f'(x) = 4(2x - 1)$ so $f'(1) = 4 > 0$. But $f(0) = 1 > 0 = f(\frac{1}{2})$, so f is not increasing on $[0, 2]$.
13. False. Let $f(x) = (x - 1)^3$. Then f is increasing on $[0, 2]$, but $f'(1) = 0$.
14. True. Since f' is defined everywhere in $[0, 2]$, f is continuous on $(0, 2)$. Since f' is increasing on $(0, 1)$, f is concave up there. Since f' is decreasing on $(1, 2)$, f is concave down there. So f satisfies all the conditions of Definition 4.1.5, and has an inflection point at $x = 1$.
15. $f'(x) = 2(x - 3/2)$, $f''(x) = 2$.
 (a) $[3/2, +\infty)$ (b) $(-\infty, 3/2]$ (c) $(-\infty, +\infty)$ (d) nowhere (e) none
16. $f'(x) = -2(2 + x)$, $f''(x) = -2$.
 (a) $(-\infty, -2]$ (b) $[-2, +\infty)$ (c) nowhere (d) $(-\infty, +\infty)$ (e) none
17. $f'(x) = 6(2x + 1)^2$, $f''(x) = 24(2x + 1)$.
 (a) $(-\infty, +\infty)$ (b) nowhere (c) $(-1/2, +\infty)$ (d) $(-\infty, -1/2)$ (e) $-1/2$
18. $f'(x) = 3(4 - x^2)$, $f''(x) = -6x$.
 (a) $[-2, 2]$ (b) $(-\infty, -2], [2, +\infty)$ (c) $(-\infty, 0)$ (d) $(0, +\infty)$ (e) 0
19. $f'(x) = 12x^2(x - 1)$, $f''(x) = 36x(x - 2/3)$.
 (a) $[1, +\infty)$ (b) $(-\infty, 1]$ (c) $(-\infty, 0), (2/3, +\infty)$ (d) $(0, 2/3)$ (e) $0, 2/3$
20. $f'(x) = x(4x^2 - 15x + 18)$, $f''(x) = 6(x - 1)(2x - 3)$.
 (a) $[0, +\infty)$ (b) $(-\infty, 0]$ (c) $(-\infty, 1), (3/2, +\infty)$ (d) $(1, 3/2)$ (e) $1, 3/2$

$$21. f'(x) = -\frac{3(x^2 - 3x + 1)}{(x^2 - x + 1)^3}, f''(x) = \frac{6x(2x^2 - 8x + 5)}{(x^2 - x + 1)^4}.$$

$$(a) \left[\frac{3 - \sqrt{5}}{2}, \frac{3 + \sqrt{5}}{2} \right] \quad (b) \left(-\infty, \frac{3 - \sqrt{5}}{2} \right], \left[\frac{3 + \sqrt{5}}{2}, +\infty \right) \quad (c) \left(0, 2 - \frac{\sqrt{6}}{2} \right), \left(2 + \frac{\sqrt{6}}{2}, +\infty \right)$$

$$(d) (-\infty, 0), \left(2 - \frac{\sqrt{6}}{2}, 2 + \frac{\sqrt{6}}{2} \right) \quad (e) 0, 2 - \frac{\sqrt{6}}{2}, 2 + \frac{\sqrt{6}}{2}$$

$$22. f'(x) = \frac{2 - x^2}{(x^2 + 2)^2}, f''(x) = \frac{2x(x^2 - 6)}{(x^2 + 2)^3}.$$

$$(a) (-\sqrt{2}, \sqrt{2}) \quad (b) (-\infty, -\sqrt{2}), (\sqrt{2}, +\infty) \quad (c) (-\sqrt{6}, 0), (\sqrt{6}, +\infty) \quad (d) (-\infty, -\sqrt{6}), (0, \sqrt{6}) \quad (e) 0, \pm\sqrt{6}$$

$$23. f'(x) = \frac{2x + 1}{3(x^2 + x + 1)^{2/3}}, f''(x) = -\frac{2(x + 2)(x - 1)}{9(x^2 + x + 1)^{5/3}}.$$

$$(a) [-1/2, +\infty) \quad (b) (-\infty, -1/2] \quad (c) (-2, 1) \quad (d) (-\infty, -2), (1, +\infty) \quad (e) -2, 1$$

$$24. f'(x) = \frac{4(x - 1/4)}{3x^{2/3}}, f''(x) = \frac{4(x + 1/2)}{9x^{5/3}}.$$

$$(a) [1/4, +\infty) \quad (b) (-\infty, 1/4] \quad (c) (-\infty, -1/2), (0, +\infty) \quad (d) (-1/2, 0) \quad (e) -1/2, 0$$

$$25. f'(x) = \frac{4(x^{2/3} - 1)}{3x^{1/3}}, f''(x) = \frac{4(x^{5/3} + x)}{9x^{7/3}}.$$

$$(a) [-1, 0], [1, +\infty) \quad (b) (-\infty, -1], [0, 1] \quad (c) (-\infty, 0), (0, +\infty) \quad (d) \text{nowhere} \quad (e) \text{none}$$

$$26. f'(x) = \frac{2}{3}x^{-1/3} - 1, f''(x) = -\frac{2}{9}x^{-4/3}.$$

$$(a) [0, 8/27] \quad (b) (-\infty, 0], [8/27, +\infty) \quad (c) \text{nowhere} \quad (d) (-\infty, 0), (0, +\infty) \quad (e) \text{none}$$

$$27. f'(x) = -xe^{-x^2/2}, f''(x) = (-1 + x^2)e^{-x^2/2}.$$

$$(a) (-\infty, 0] \quad (b) [0, +\infty) \quad (c) (-\infty, -1), (1, +\infty) \quad (d) (-1, 1) \quad (e) -1, 1$$

$$28. f'(x) = (2x^2 + 1)e^{x^2}, f''(x) = 2x(2x^2 + 3)e^{x^2}.$$

$$(a) (-\infty, +\infty) \quad (b) \text{none} \quad (c) (0, +\infty) \quad (d) (-\infty, 0) \quad (e) 0$$

$$29. f'(x) = \frac{x}{x^2 + 4}, f''(x) = -\frac{x^2 - 4}{(x^2 + 4)^2}.$$

$$(a) [0, +\infty) \quad (b) (-\infty, 0] \quad (c) (-2, 2) \quad (d) (-\infty, -2), (2, +\infty) \quad (e) -2, 2$$

$$30. f'(x) = x^2(1 + 3 \ln x), f''(x) = x(5 + 6 \ln x).$$

$$(a) [e^{-1/3}, +\infty) \quad (b) (0, e^{-1/3}] \quad (c) (e^{-5/6}, +\infty) \quad (d) (0, e^{-5/6}) \quad (e) e^{-5/6}$$

$$31. f'(x) = \frac{2x}{1 + (x^2 - 1)^2}, f''(x) = -2 \frac{3x^4 - 2x^2 - 2}{[1 + (x^2 - 1)^2]^2}.$$

$$(a) [0, +\infty) \quad (b) (-\infty, 0] \quad (c) \left(-\frac{\sqrt{1 + \sqrt{7}}}{\sqrt{3}}, \frac{\sqrt{1 + \sqrt{7}}}{\sqrt{3}} \right) \quad (d) \left(-\infty, -\frac{\sqrt{1 + \sqrt{7}}}{\sqrt{3}} \right), \left(\frac{\sqrt{1 + \sqrt{7}}}{\sqrt{3}}, +\infty \right)$$

$$(e) \pm \frac{\sqrt{1 + \sqrt{7}}}{3}$$

$$32. f'(x) = \frac{2}{3x^{1/3}\sqrt{1-x^{4/3}}}, f''(x) = \frac{2(-1+3x^{4/3})}{9x^{4/3}(1-x^{4/3})^{3/2}}$$

(a) $[0, 1]$ (b) $[-1, 0]$ (c) $(-1, -3^{-3/4}), (3^{-3/4}, 1)$ (d) $(-3^{-3/4}, 0), (0, 3^{-3/4})$ (e) $\pm 3^{-3/4}$

33. $f'(x) = \cos x + \sin x$, $f''(x) = -\sin x + \cos x$, increasing: $[-\pi/4, 3\pi/4]$, decreasing: $(-\pi, -\pi/4], [3\pi/4, \pi)$, concave up: $(-3\pi/4, \pi/4)$, concave down: $(-\pi, -3\pi/4), (\pi/4, \pi)$, inflection points: $-3\pi/4, \pi/4$.

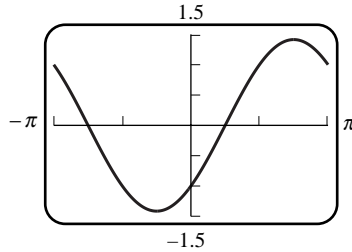

34. $f'(x) = (2 \tan^2 x + 1) \sec x$, $f''(x) = \sec x \tan x (6 \tan^2 x + 5)$, increasing: $(-\pi/2, \pi/2)$, decreasing: nowhere, concave up: $(0, \pi/2)$, concave down: $(-\pi/2, 0)$, inflection point: 0.

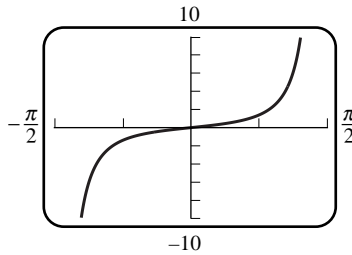

35. $f'(x) = -\frac{1}{2} \sec^2(x/2)$, $f''(x) = -\frac{1}{2} \tan(x/2) \sec^2(x/2)$, increasing: nowhere, decreasing: $(-\pi, \pi)$, concave up: $(-\pi, 0)$, concave down: $(0, \pi)$, inflection point: 0.

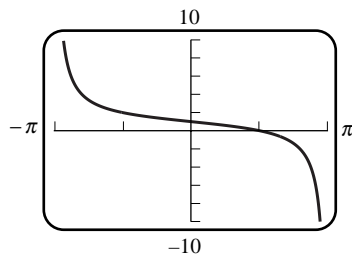

36. $f'(x) = 2 - \csc^2 x$, $f''(x) = 2 \csc^2 x \cot x = 2 \frac{\cos x}{\sin^3 x}$, increasing: $[\pi/4, 3\pi/4]$, decreasing: $(0, \pi/4], [3\pi/4, \pi)$, concave up: $(0, \pi/2)$, concave down: $(\pi/2, \pi)$, inflection point: $\pi/2$.

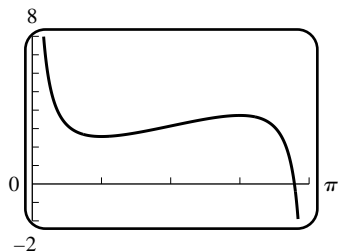

37. $f(x) = 1 + \sin 2x$, $f'(x) = 2 \cos 2x$, $f''(x) = -4 \sin 2x$, increasing: $[-\pi, -3\pi/4], [-\pi/4, \pi/4], [3\pi/4, \pi]$, decreasing: $[-3\pi/4, -\pi/4], [\pi/4, 3\pi/4]$, concave up: $(-\pi/2, 0), (\pi/2, \pi)$, concave down: $(-\pi, -\pi/2), (0, \pi/2)$, inflection points: $-\pi/2, 0, \pi/2$.

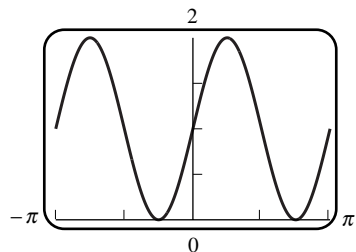

38. $f'(x) = 2 \sin 4x$, $f''(x) = 8 \cos 4x$, increasing: $(0, \pi/4]$, $[\pi/2, 3\pi/4]$, decreasing: $[\pi/4, \pi/2]$, $[3\pi/4, \pi]$, concave up: $(0, \pi/8)$, $(3\pi/8, 5\pi/8)$, $(7\pi/8, \pi)$, concave down: $(\pi/8, 3\pi/8)$, $(5\pi/8, 7\pi/8)$, inflection points: $\pi/8, 3\pi/8, 5\pi/8, 7\pi/8$.

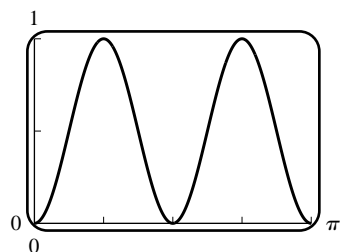

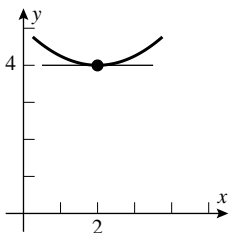
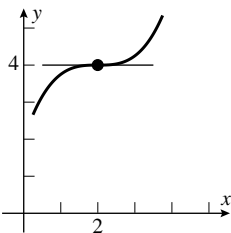
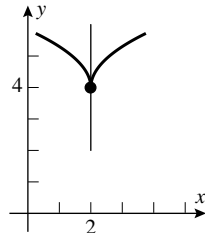
39. (a)  (b)  (c) 

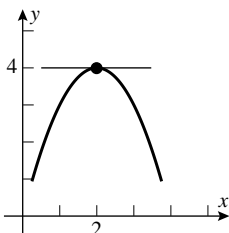
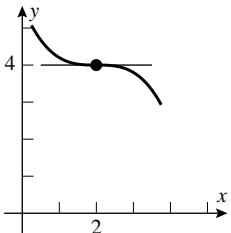
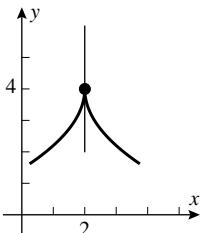
40. (a)  (b)  (c) 

41. $f'(x) = 1/3 - 1/[3(1+x)^{2/3}]$ so f is increasing on $[0, +\infty)$, thus if $x > 0$, then $f(x) > f(0) = 0$, $1+x/3 - \sqrt[3]{1+x} > 0$, $\sqrt[3]{1+x} < 1+x/3$.

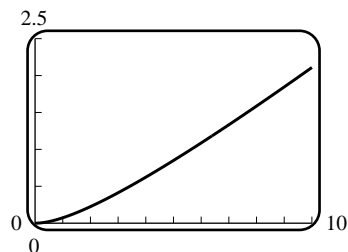

42. $f'(x) = \sec^2 x - 1$ so f is increasing on $[0, \pi/2)$, thus if $0 < x < \pi/2$, then $f(x) > f(0) = 0$, $\tan x - x > 0$, $x < \tan x$.

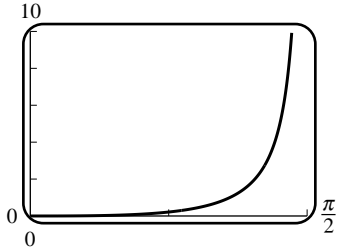

43. $x \geq \sin x$ on $[0, +\infty)$: let $f(x) = x - \sin x$. Then $f(0) = 0$ and $f'(x) = 1 - \cos x \geq 0$, so $f(x)$ is increasing on $[0, +\infty)$. ($f' = 0$ only at isolated points.)

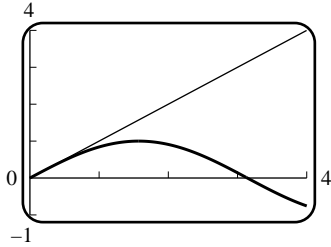

44. Let $f(x) = 1 - x^2/2 - \cos x$ for $x \geq 0$. Then $f(0) = 0$ and $f'(x) = -x + \sin x$. By Exercise 43, $f'(x) \leq 0$ for $x \geq 0$, so $f(x) \leq 0$ for all $x \geq 0$, that is, $\cos x \geq 1 - x^2/2$.
45. (a) Let $f(x) = x - \ln(x+1)$ for $x \geq 0$. Then $f(0) = 0$ and $f'(x) = 1 - 1/(x+1) > 0$ for $x > 0$, so f is increasing for $x \geq 0$ and thus $\ln(x+1) \leq x$ for $x \geq 0$.

- (b) Let $g(x) = x - \frac{1}{2}x^2 - \ln(x+1)$. Then $g(0) = 0$ and $g'(x) = 1 - x - 1/(x+1) < 0$ for $x > 0$ since $1 - x^2 \leq 1$. Thus g is decreasing and thus $\ln(x+1) \geq x - \frac{1}{2}x^2$ for $x \geq 0$.

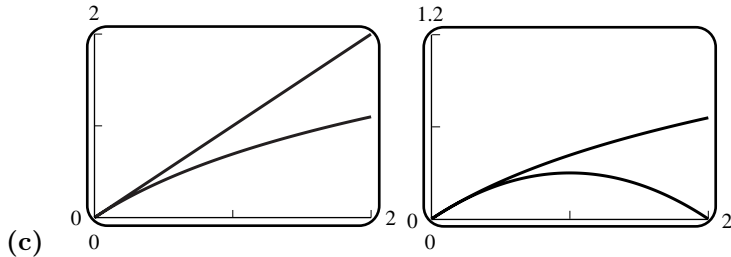

46. (a) Let $h(x) = e^x - 1 - x$ for $x \geq 0$. Then $h(0) = 0$ and $h'(x) = e^x - 1 > 0$ for $x > 0$, so $h(x)$ is increasing.
- (b) Let $h(x) = e^x - 1 - x - \frac{1}{2}x^2$. Then $h(0) = 0$ and $h'(x) = e^x - 1 - x$. By part (a), $e^x - 1 - x > 0$ for $x > 0$, so $h(x)$ is increasing.

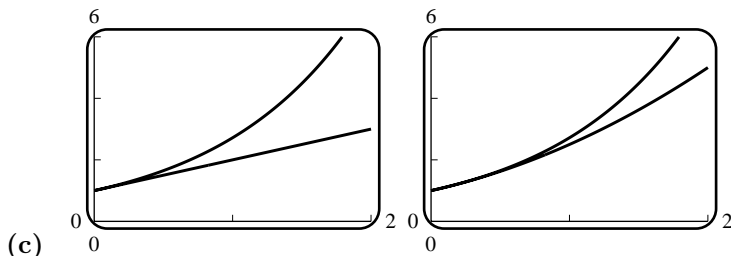

47. Points of inflection at $x = -2, +2$. Concave up on $(-5, -2)$ and $(2, 5)$; concave down on $(-2, 2)$. Increasing on $[-3.5829, 0.2513]$ and $[3.3316, 5]$, and decreasing on $[-5, -3.5829]$ and $[0.2513, 3.3316]$.

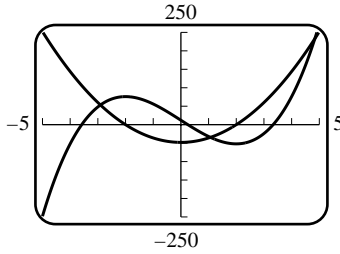

48. Points of inflection at $x = \pm 1/\sqrt{3}$. Concave up on $(-5, -1/\sqrt{3})$ and $(1/\sqrt{3}, 5)$, and concave down on $(-1/\sqrt{3}, 1/\sqrt{3})$. Increasing on $[-5, 0]$ and decreasing on $[0, 5]$.

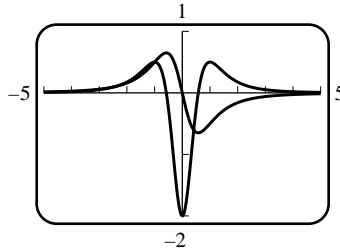

49. $f''(x) = 2 \frac{90x^3 - 81x^2 - 585x + 397}{(3x^2 - 5x + 8)^3}$. The denominator has complex roots, so is always positive; hence the x -coordinates of the points of inflection of $f(x)$ are the roots of the numerator (if it changes sign). A plot of the numerator over $[-5, 5]$ shows roots lying in $[-3, -2]$, $[0, 1]$, and $[2, 3]$. To six decimal places the roots are $x \approx -2.464202, 0.662597, 2.701605$.

50. $f''(x) = \frac{2x^5 + 5x^3 + 14x^2 + 30x - 7}{(x^2 + 1)^{5/2}}$. Points of inflection will occur when the numerator changes sign, since the denominator is always positive. A plot of $y = 2x^5 + 5x^3 + 14x^2 + 30x - 7$ shows that there is only one root and it lies in $[0, 1]$. To six decimal place the point of inflection is located at $x \approx 0.210970$.

51. $f(x_1) - f(x_2) = x_1^2 - x_2^2 = (x_1 + x_2)(x_1 - x_2) < 0$ if $x_1 < x_2$ for x_1, x_2 in $[0, +\infty)$, so $f(x_1) < f(x_2)$ and f is thus increasing.

52. $f(x_1) - f(x_2) = \frac{1}{x_1} - \frac{1}{x_2} = \frac{x_2 - x_1}{x_1 x_2} > 0$ if $x_1 < x_2$ for x_1, x_2 in $(0, +\infty)$, so $f(x_1) > f(x_2)$ and thus f is decreasing.

53. (a) True. If $x_1 < x_2$ where x_1 and x_2 are in I , then $f(x_1) < f(x_2)$ and $g(x_1) < g(x_2)$, so $f(x_1) + g(x_1) < f(x_2) + g(x_2)$, $(f + g)(x_1) < (f + g)(x_2)$. Thus $f + g$ is increasing on I .

(b) False. If $f(x) = g(x) = x$ then f and g are both increasing on $(-\infty, 0)$, but $(f \cdot g)(x) = x^2$ is decreasing there.

54. (a) True. f' and g' are increasing functions on the interval. By Exercise 53, $f' + g'$ is increasing.

(b) False. Let $f(x) = (x - 1)^2$ and $g(x) = (x + 1)^2$. Each is concave up on $(-\infty, +\infty)$, but their product, $(f \cdot g)(x) = (x^2 - 1)^2$ is not; $(f \cdot g)''(x) = 4(3x^2 - 1) < 0$ for $|x| < 1/\sqrt{3}$, so $f \cdot g$ is concave down in $(-1/\sqrt{3}, 1/\sqrt{3})$.

55. (a) $f(x) = x, g(x) = 2x$ (b) $f(x) = x, g(x) = x + 6$ (c) $f(x) = 2x, g(x) = x$

56. (a) $f(x) = e^x, g(x) = e^{2x}$ (b) $f(x) = g(x) = e^x$ (c) $f(x) = e^{2x}, g(x) = e^x$

57. (a) $f''(x) = 6ax + 2b = 6a \left(x + \frac{b}{3a}\right)$, $f''(x) = 0$ when $x = -\frac{b}{3a}$. f changes its direction of concavity at $x = -\frac{b}{3a}$ so $-\frac{b}{3a}$ is an inflection point.

(b) If $f(x) = ax^3 + bx^2 + cx + d$ has three x -intercepts, then it has three roots, say x_1, x_2 and x_3 , so we can write $f(x) = a(x - x_1)(x - x_2)(x - x_3) = ax^3 + bx^2 + cx + d$, from which it follows that $b = -a(x_1 + x_2 + x_3)$. Thus $-\frac{b}{3a} = \frac{1}{3}(x_1 + x_2 + x_3)$, which is the average.

(c) $f(x) = x(x^2 - 3x + 2) = x(x - 1)(x - 2)$ so the intercepts are 0, 1, and 2 and the average is 1. $f''(x) = 6x - 6 = 6(x - 1)$ changes sign at $x = 1$. The inflection point is at (1,0). f is concave up for $x > 1$, concave down for $x < 1$.

58. $f''(x) = 6x + 2b$, so the point of inflection is at $x = -\frac{b}{3}$. Thus an increase in b moves the point of inflection to the left.

59. (a) Let $x_1 < x_2$ belong to (a, b) . If both belong to $(a, c]$ or both belong to $[c, b)$ then we have $f(x_1) < f(x_2)$ by hypothesis. So assume $x_1 < c < x_2$. We know by hypothesis that $f(x_1) < f(c)$, and $f(c) < f(x_2)$. We conclude that $f(x_1) < f(x_2)$.

(b) Use the same argument as in part (a), but with inequalities reversed.

60. By Theorem 4.1.2, f is increasing on any interval $[(2n - 1)\pi, 2(n + 1)\pi]$ ($n = 0, \pm 1, \pm 2, \dots$), because $f'(x) = 1 + \cos x > 0$ on $((2n - 1)\pi, 2(n + 1)\pi)$. By Exercise 59 (a) we can piece these intervals together to show that $f(x)$ is increasing on $(-\infty, +\infty)$.

61. By Theorem 4.1.2, f is decreasing on any interval $[(2n\pi + \pi/2, 2(n + 1)\pi + \pi/2]$ ($n = 0, \pm 1, \pm 2, \dots$), because $f'(x) = -\sin x + 1 < 0$ on $(2n\pi + \pi/2, 2(n + 1)\pi + \pi/2)$. By Exercise 59 (b) we can piece these intervals together to show that $f(x)$ is decreasing on $(-\infty, +\infty)$.

62. By zooming in on the graph of $\frac{dy}{dx} = -\frac{2x}{(1 + x^2)^2}$, we find that the maximum increase is at $x \approx -0.577$ and the maximum decrease is at $x \approx 0.577$. Using methods introduced in Section 4.4, it can be shown that the maximum increase is at $x = -1/\sqrt{3}$ and the maximum decrease is at $x = 1/\sqrt{3}$.

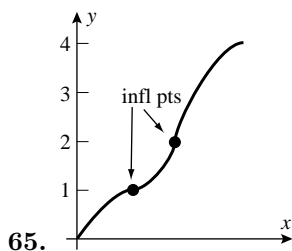
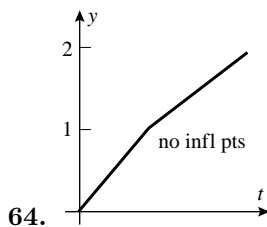
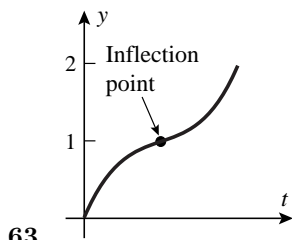

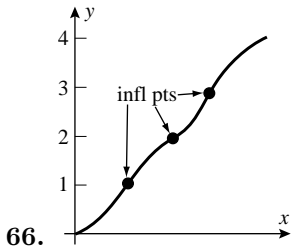

66.

67. (a) $y'(t) = \frac{LAke^{-kt}}{(1 + Ae^{-kt})^2}S$, so $y'(0) = \frac{LAk}{(1 + A)^2}$.

(b) The rate of growth increases to its maximum, which occurs when y is halfway between 0 and L , or when $t = \frac{1}{k} \ln A$; it then decreases back towards zero.

(c) From (2) one sees that $\frac{dy}{dt}$ is maximized when y lies half way between 0 and L , i.e. $y = L/2$. This follows since the right side of (2) is a parabola (with y as independent variable) with y -intercepts $y = 0, L$. The value $y = L/2$ corresponds to $t = \frac{1}{k} \ln A$, from (4).

68. Find t so that $N'(t)$ is maximum. The size of the population is increasing most rapidly when $t = 8.4$ years.

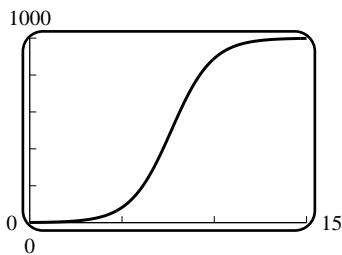

69. $t \approx 7.67$

70. Factor the left side of $ye^{kt} + Ay = Le^{kt}$ to get $(e^{kt} + A)y = Le^{kt}$. Differentiating with respect to t gives $(e^{kt} + A)\frac{dy}{dt} + ke^{kt}y = kLe^{kt}$, so $\frac{dy}{dt} = \frac{kLe^{kt} - ke^{kt}y}{e^{kt} + A} = \frac{ke^{kt}(L - y)}{Le^{kt}/y} = \frac{k}{L}y(L - y)$. Differentiating again, we get $\frac{d^2y}{dt^2} = \frac{k}{L} \left[y \left(-\frac{dy}{dt} \right) + (L - y)\frac{dy}{dt} \right] = \frac{k}{L}(L - 2y)\frac{dy}{dt} = \frac{k}{L}(L - 2y) \cdot \frac{k}{L}y(L - y) = \frac{k^2}{L^2}y(L - y)(L - 2y)$.

71. Since $0 < y < L$ the right-hand side of (5) of Example 9 can change sign only if the factor $L - 2y$ changes sign, which it does when $y = L/2$, at which point we have $\frac{L}{2} = \frac{L}{1 + Ae^{-kt}}$, $1 = Ae^{-kt}$, $t = \frac{1}{k} \ln A$.

72. “Either the rate at which the temperature is falling decreases for a while and then begins to increase, or it increases for a while and then begins to decrease”. If $T(t)$ is the temperature at time t , then the rate at which the temperature is falling is $-T'(t)$. If this is decreasing then $T'(t)$ is increasing, so $T(t)$ is concave up; if it’s increasing then $T'(t)$ is decreasing, so $T(t)$ is concave down. When $-T'(t)$ changes from decreasing to increasing or vice versa, the direction of concavity of $T(t)$ changes, so the graph of the temperature has an inflection point.

73. Sign analysis of $f'(x)$ tells us where the graph of $y = f(x)$ increases or decreases. Sign analysis of $f''(x)$ tells us where the graph of $y = f(x)$ is concave up or concave down.

Exercise Set 4.2

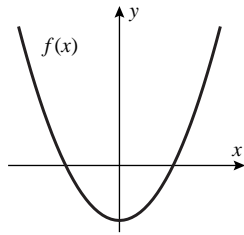

1. (a)

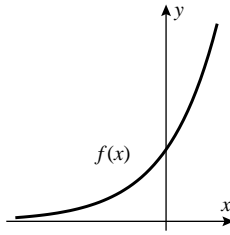

(b)

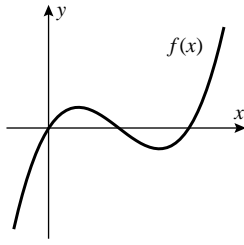

(c)

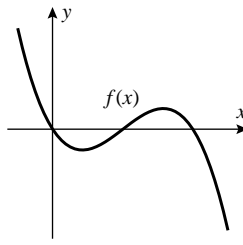

(d)

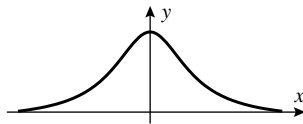

2. (a)

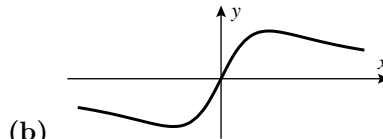

(b)

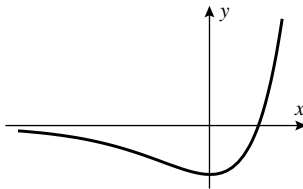

(c)

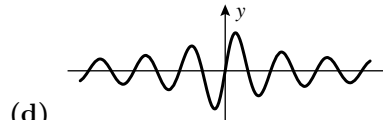

(d)

3. (a) $f'(x) = 6x - 6$ and $f''(x) = 6$, with $f'(1) = 0$. For the first derivative test, $f' < 0$ for $x < 1$ and $f' > 0$ for $x > 1$. For the second derivative test, $f''(1) > 0$.

(b) $f'(x) = 3x^2 - 3$ and $f''(x) = 6x$. $f'(x) = 0$ at $x = \pm 1$. First derivative test: $f' > 0$ for $x < -1$ and $x > 1$, and $f' < 0$ for $-1 < x < 1$, so there is a relative maximum at $x = -1$, and a relative minimum at $x = 1$. Second derivative test: $f'' < 0$ at $x = -1$, a relative maximum; and $f'' > 0$ at $x = 1$, a relative minimum.

4. (a) $f'(x) = 2 \sin x \cos x = \sin 2x$ (so $f'(0) = 0$) and $f''(x) = 2 \cos 2x$. First derivative test: if x is near 0 then $f' < 0$ for $x < 0$ and $f' > 0$ for $x > 0$, so a relative minimum at $x = 0$. Second derivative test: $f''(0) = 2 > 0$, so relative minimum at $x = 0$.

(b) $g'(x) = 2 \tan x \sec^2 x$ (so $g'(0) = 0$) and $g''(x) = 2 \sec^2 x (\sec^2 x + 2 \tan^2 x)$. First derivative test: if x is near 0, then $g' < 0$ for $x < 0$ and $g' > 0$ for $x > 0$, so a relative minimum at $x = 0$. Second derivative test: $g''(0) = 2 > 0$, relative minimum at $x = 0$.

(c) Both functions are squares of nonzero values when x is close to 0 but $x \neq 0$, and so are positive for values of x near zero; both functions are zero at $x = 0$, so that must be a relative minimum.

5. (a) $f'(x) = 4(x - 1)^3$, $g'(x) = 3x^2 - 6x + 3$ so $f'(1) = g'(1) = 0$.

(b) $f''(x) = 12(x - 1)^2$, $g''(x) = 6x - 6$, so $f''(1) = g''(1) = 0$, which yields no information.

(c) $f' < 0$ for $x < 1$ and $f' > 0$ for $x > 1$, so there is a relative minimum at $x = 1$; $g'(x) = 3(x - 1)^2 > 0$ on both sides of $x = 1$, so there is no relative extremum at $x = 1$.

6. (a) $f'(x) = -5x^4$, $g'(x) = 12x^3 - 24x^2$ so $f'(0) = g'(0) = 0$.

(b) $f''(x) = -20x^3$, $g''(x) = 36x^2 - 48x$, so $f''(0) = g''(0) = 0$, which yields no information.

(c) $f' < 0$ on both sides of $x = 0$, so there is no relative extremum there; $g'(x) = 12x^2(x - 2) < 0$ on both sides of $x = 0$ (for x near 0), so again there is no relative extremum there.

7. $f'(x) = 16x^3 - 32x = 16x(x^2 - 2)$, so $x = 0, \pm\sqrt{2}$ are stationary points.

8. $f'(x) = 12x^3 + 12 = 12(x + 1)(x^2 - x + 1)$, so $x = -1$ is the stationary point.

9. $f'(x) = \frac{-x^2 - 2x + 3}{(x^2 + 3)^2}$, so $x = -3, 1$ are the stationary points.

10. $f'(x) = -\frac{x(x^3 - 16)}{(x^3 + 8)^2}$, so stationary points at $x = 0, 2^{4/3}$.

11. $f'(x) = \frac{2x}{3(x^2 - 25)^{2/3}}$; so $x = 0$ is the stationary point; $x = \pm 5$ are critical points which are not stationary points.

12. $f'(x) = \frac{2x(4x - 3)}{3(x - 1)^{1/3}}$, so $x = 0, 3/4$ are the stationary points; $x = 1$ is a critical point which is not a stationary point.

13. $f(x) = |\sin x| = \begin{cases} \sin x, & \sin x \geq 0 \\ -\sin x, & \sin x < 0 \end{cases}$, so $f'(x) = \begin{cases} \cos x, & \sin x > 0 \\ -\cos x, & \sin x < 0 \end{cases}$ and $f'(x)$ does not exist when $x = n\pi$, $n = 0, \pm 1, \pm 2, \dots$ (the points where $\sin x = 0$) because $\lim_{x \rightarrow n\pi^-} f'(x) \neq \lim_{x \rightarrow n\pi^+} f'(x)$ (see Theorem preceding Exercise 65, Section 2.3); these are critical points which are not stationary points. Now $f'(x) = 0$ when $\pm \cos x = 0$ provided $\sin x \neq 0$ so $x = \pi/2 + n\pi$, $n = 0, \pm 1, \pm 2, \dots$ are stationary points.

14. When $x > 0$, $f'(x) = \cos x$, so $x = (n + \frac{1}{2})\pi$, $n = 0, 1, 2, \dots$ are stationary points.

When $x < 0$, $f'(x) = -\cos x$, so $x = (n + \frac{1}{2})\pi$, $n = -1, -2, -3, \dots$ are stationary points.

f is not differentiable at $x = 0$, so the latter is a critical point but not a stationary point.

15. False. Let $f(x) = (x - 1)^2(2x - 3)$. Then $f'(x) = 2(x - 1)(3x - 4)$; $f'(x)$ changes sign from + to - at $x = 1$, so f has a relative maximum at $x = 1$. But $f(2) = 1 > 0 = f(1)$.

16. True, by Theorem 4.2.2.

17. False. Let $f(x) = x + (x - 1)^2$. Then $f'(x) = 2x - 1$ and $f''(x) = 2$, so $f''(1) > 0$. But $f'(1) = 1 \neq 0$, so f does not have a relative extremum at $x = 1$.

18. True. By Theorem 4.2.5(c), the graph of $p'(x)$ crosses the x -axis at $x = 1$. By either case (a) or case (b) of Theorem 4.2.3, f has either a relative maximum or a relative minimum at $x = 1$.

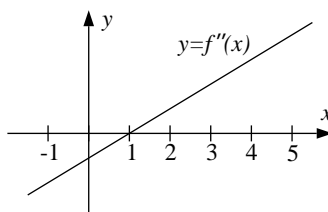
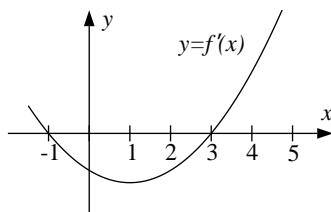

19.

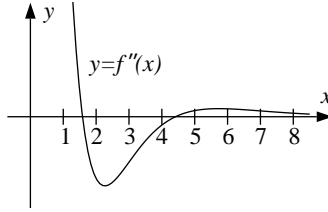
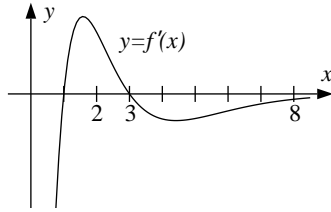

20.

21. (a) None.

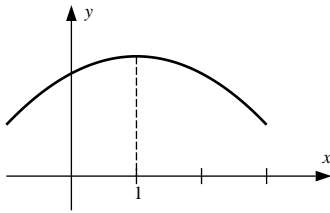
(b) $x = 1$ because f' changes sign from $+$ to $-$ there.(c) None, because $f'' = 0$ (never changes sign).

(d)

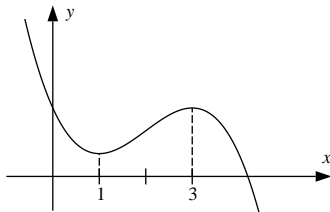
22. (a) $x = 1$ because $f'(x)$ changes sign from $-$ to $+$ there.(b) $x = 3$ because $f'(x)$ changes sign from $+$ to $-$ there.(c) $x = 2$ because $f''(x)$ changes sign there.

(d)

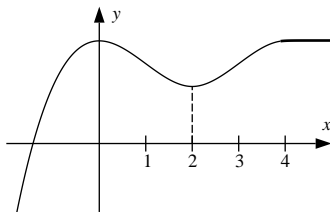
23. (a) $x = 2$ because $f'(x)$ changes sign from $-$ to $+$ there.(b) $x = 0$ because $f'(x)$ changes sign from $+$ to $-$ there.(c) $x = 1, 3$ because $f''(x)$ changes sign at these points.

(d)

24. (a) $x = 1$. (b) $x = 5$. (c) $x = -1, 0, 3$.

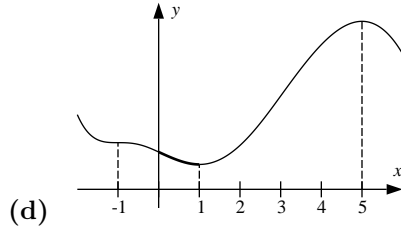

25. f' : $\frac{- - - 0 - - - 0 + + +}{0 \quad 5^{1/3}}$ Critical points: $x = 0, 5^{1/3}$; $x = 0$: neither, $x = 5^{1/3}$: relative minimum.

26. f' : $\frac{- - - 0 + + + 0 - - - 0 + + +}{-3/2 \quad 0 \quad 3/2}$ Critical points: $x = -3/2, 0, 3/2$; $x = -3/2$: relative minimum, $x = 0$: relative maximum, $x = 3/2$: relative minimum.

27. f' : $\frac{- - - \infty + + + 0 - - -}{-2 \quad 2/3}$ Critical points: $x = -2, 2/3$; $x = -2$: relative minimum, $x = 2/3$: relative maximum.

28. f' : $\frac{+ + + 0 - - - 0 + + +}{-\sqrt{7} \quad \sqrt{7}}$ Critical points: $x = \pm\sqrt{7}$; $x = -\sqrt{7}$: relative maximum, $x = \sqrt{7}$: relative minimum.

29. f' : $\frac{- - - 0 + + +}{0}$ Critical point: $x = 0$; $x = 0$: relative minimum.

30. f' : $\frac{- - - 0 - - - 0 + + +}{0 \quad \ln 3}$ Critical points: $x = 0, \ln 3$; $x = 0$: neither, $x = \ln 3$: relative minimum.

31. f' : $\frac{- - - 0 + + + 0 - - -}{-1 \quad 1}$ Critical points: $x = -1, 1$; $x = -1$: relative minimum, $x = 1$: relative maximum.

32. f' : $\frac{+ + + 0 - - - 0 + + +}{\ln 2 \quad \ln 3}$ Critical points: $x = \ln 2, \ln 3$; $x = \ln 2$: relative maximum, $x = \ln 3$: relative minimum.

33. $f'(x) = 8 - 6x$: critical point $x = 4/3$, $f''(4/3) = -6$: f has a relative maximum of $19/3$ at $x = 4/3$.

34. $f'(x) = 4x^3 - 36x^2$: critical points at $x = 0, 9$, $f''(0) = 0$: Theorem 4.2.5 with $m = 3$: f has an inflection point at $x = 0$, $f''(9) > 0$: f has a relative minimum of -2187 at $x = 9$.

35. $f'(x) = 2 \cos 2x$: critical points at $x = \pi/4, 3\pi/4$, $f''(\pi/4) = -4$: f has a relative maximum of 1 at $x = \pi/4$, $f''(3\pi/4) = 4$: f has a relative minimum of -1 at $x = 3\pi/4$.

36. $f'(x) = (x - 2)e^x$: critical point at $x = 2$, $f''(2) = e^2$: f has a relative minimum of $-e^2$ at $x = 2$.

37. $f'(x) = 4x^3 - 12x^2 + 8x$: $\frac{- - - 0 + + + 0 - - - 0 + + +}{0 \quad 1 \quad 2}$ Critical points at $x = 0, 1, 2$; relative minimum of 0 at $x = 0$, relative maximum of 1 at $x = 1$, relative minimum of 0 at $x = 2$.

38. $f'(x) = 4x^3 - 36x^2 + 96x - 64$; critical points at $x = 1, 4$, $f''(1) = 36$: f has a relative minimum of -27 at $x = 1$, $f''(4) = 0$: Theorem 4.2.5 with $m = 3$: f has an inflection point at $x = 4$.

39. $f'(x) = 5x^4 + 8x^3 + 3x^2$: critical points at $x = -3/5, -1, 0$, $f''(-3/5) = 18/25$: f has a relative minimum of $-108/3125$ at $x = -3/5$, $f''(-1) = -2$: f has a relative maximum of 0 at $x = -1$, $f''(0) = 0$: Theorem 4.2.5 with $m = 3$: f has an inflection point at $x = 0$.

40. $f'(x) = 5x^4 + 12x^3 + 9x^2 + 2x$: critical points at $x = -2/5, -1, 0, f''(-2/5) = -18/25$: f has a relative maximum of $108/3125$ at $x = -2/5, f''(-1) = 0$: Theorem 4.2.5 with $m = 3$: f has an inflection point at $x = -1, f''(0) = 2$: f has a relative minimum of 0 at $x = 0$.

41. $f'(x) = \frac{2(x^{1/3} + 1)}{x^{1/3}}$: critical point at $x = -1, 0, f''(-1) = -\frac{2}{3}$: f has a relative maximum of 1 at $x = -1, f'$ does not exist at $x = 0$. Using the First Derivative Test, it is a relative minimum of 0.

42. $f'(x) = \frac{2x^{2/3} + 1}{x^{2/3}}$: no critical point except $x = 0$; since f is an odd function, $x = 0$ is an inflection point for f .

43. $f'(x) = -\frac{5}{(x-2)^2}$; no extrema.

44. $f'(x) = -\frac{2x(x^4 - 16)}{(x^4 + 16)^2}$; critical points $x = -2, 0, 2, f''(-2) = -\frac{1}{8}$; f has a relative maximum of $\frac{1}{8}$ at $x = -2, f''(0) = \frac{1}{8}$; f has a relative minimum of 0 at $x = 0, f''(2) = -\frac{1}{8}$; f has a relative maximum of $\frac{1}{8}$ at $x = 2$.

45. $f'(x) = \frac{2x}{2+x^2}$; critical point at $x = 0, f''(0) = 1$; f has a relative minimum of $\ln 2$ at $x = 0$.

46. $f'(x) = \frac{3x^2}{2+x^2}$: $\begin{array}{ccccccc} & & - & - & 0 & + & + & + & + & + & + \\ & & & & - & \sqrt[3]{2} & & 0 & & & \end{array}$ Critical points at $x = 0, -2^{1/3}; f''(0) = 0$ inconclusive. Using the First Derivative Test, there is no relative extrema; f has no limit at $x = -2^{1/3}$.

47. $f'(x) = 2e^{2x} - e^x$; critical point $x = -\ln 2, f''(-\ln 2) = 1/2$; relative minimum of $-1/4$ at $x = -\ln 2$.

48. $f'(x) = 2x(1+x)e^{2x}$: critical point $x = -1, 0, f''(-1) = -2/e^2$; relative maximum of $1/e^2$ at $x = -1, f''(0) = 2$; relative minimum of 0 at $x = 0$.

49. $f'(x)$ is undefined at $x = 0, 3$, so these are critical points. Elsewhere, $f'(x) = \begin{cases} 2x - 3 & \text{if } x < 0 \text{ or } x > 3; \\ 3 - 2x & \text{if } 0 < x < 3. \end{cases}$
 $f'(x) = 0$ for $x = 3/2$, so this is also a critical point. $f''(3/2) = -2$, so relative maximum of $9/4$ at $x = 3/2$. By the first derivative test, relative minimum of 0 at $x = 0$ and $x = 3$.

50. On each of the intervals $(-\infty, -1), (-1, +\infty)$ the derivative is of the form $y = \pm \frac{1}{3x^{2/3}}$ hence it is clear that the only critical points are possibly -1 or 0 . Near $x = 0, x \neq 0, y' = \frac{1}{3x^{2/3}} > 0$ so y has an inflection point at $x = 0$. At $x = -1, y'$ changes sign, thus the only extremum is a relative minimum of 0 at $x = -1$.

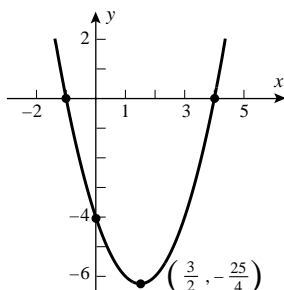

51.

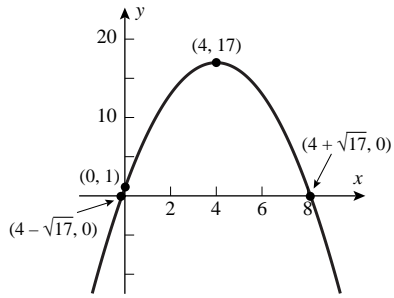

52.

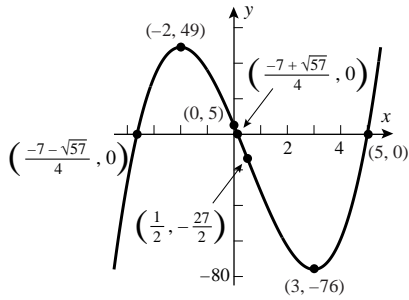

53.

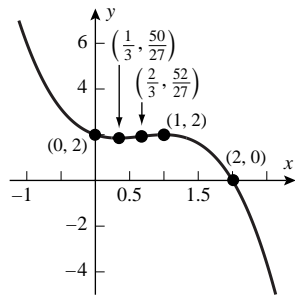

54.

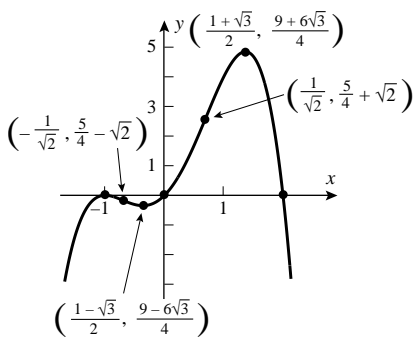

55.

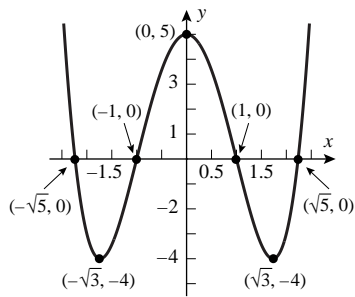

56.

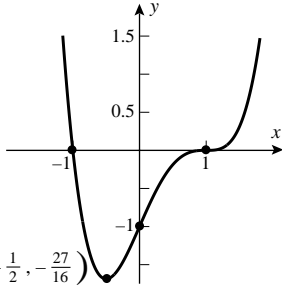

57.

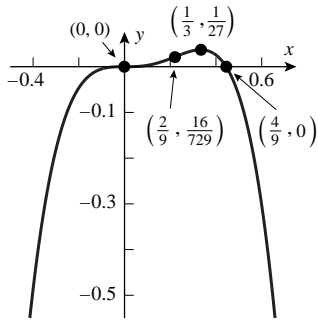

58.

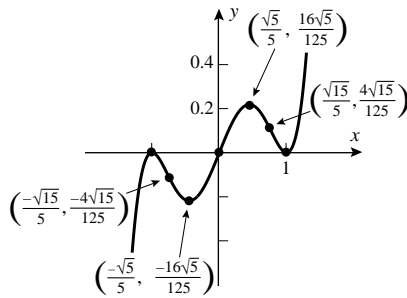

59.

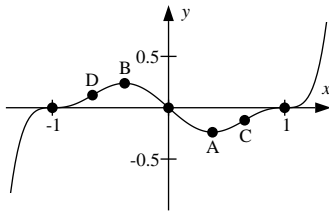

60.

Stationary points: $(\pm 1, 0)$, $A = \left(\frac{1}{\sqrt{7}}, \frac{-216}{343\sqrt{7}}\right)$, $B = \left(\frac{-1}{\sqrt{7}}, \frac{216}{343\sqrt{7}}\right)$. Inflection points: $(0, 0)$, $(\pm 1, 0)$, $C = \left(\frac{\sqrt{3}}{\sqrt{7}}, \frac{-64\sqrt{3}}{343\sqrt{7}}\right)$, $D = \left(\frac{-\sqrt{3}}{\sqrt{7}}, \frac{64\sqrt{3}}{343\sqrt{7}}\right)$.

61. (a) $\lim_{x \rightarrow -\infty} y = -\infty$, $\lim_{x \rightarrow +\infty} y = +\infty$; curve crosses x -axis at $x = 0, 1, -1$.

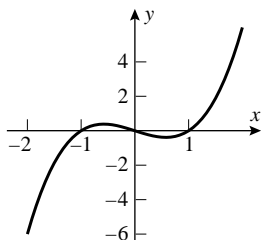

(b) $\lim_{x \rightarrow \pm\infty} y = +\infty$; curve never crosses x -axis.

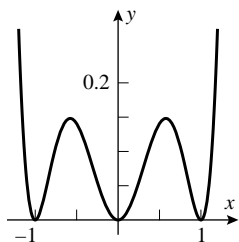

(c) $\lim_{x \rightarrow -\infty} y = -\infty$, $\lim_{x \rightarrow +\infty} y = +\infty$; curve crosses x -axis at $x = -1$

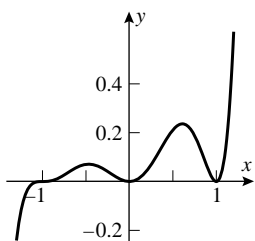

(d) $\lim_{x \rightarrow \pm\infty} y = +\infty$; curve crosses x -axis at $x = 0, 1$.

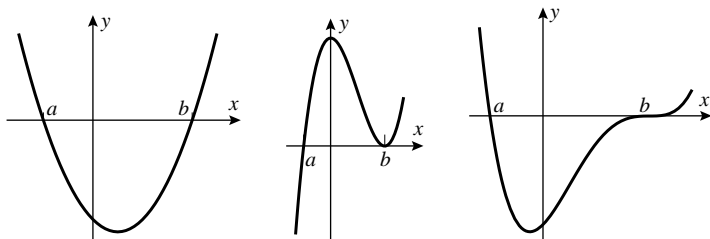
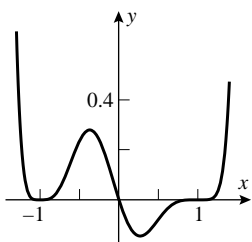

62. (a)

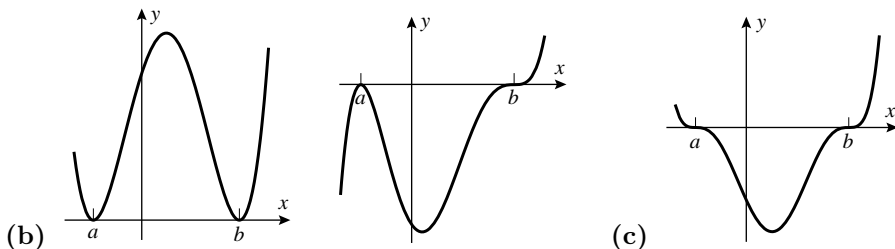

(b)

(c)

63. $f'(x) = 2 \cos 2x$ if $\sin 2x > 0$, $f'(x) = -2 \cos 2x$ if $\sin 2x < 0$, $f'(x)$ does not exist when $x = \pi/2, \pi, 3\pi/2$; critical numbers $x = \pi/4, 3\pi/4, 5\pi/4, 7\pi/4, \pi/2, \pi, 3\pi/2$, relative minimum of 0 at $x = \pi/2, \pi, 3\pi/2$; relative maximum of 1 at $x = \pi/4, 3\pi/4, 5\pi/4, 7\pi/4$.

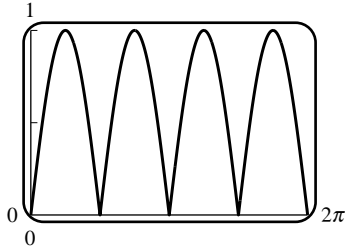

64. $f'(x) = \sqrt{3} + 2 \cos x$; critical numbers $x = 5\pi/6, 7\pi/6$, relative minimum of $7\sqrt{3}\pi/6 - 1$ at $x = 7\pi/6$; relative maximum of $5\sqrt{3}\pi/6 + 1$ at $x = 5\pi/6$.

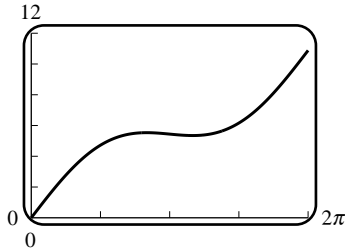

65. $f'(x) = -\sin 2x$; critical numbers $x = \pi/2, \pi, 3\pi/2$, relative minimum of 0 at $x = \pi/2, 3\pi/2$; relative maximum of 1 at $x = \pi$.

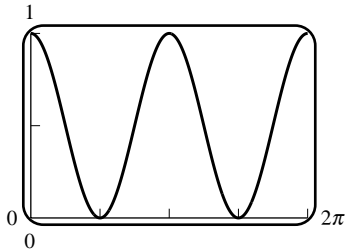

66. $f'(x) = (2 \cos x - 1)/(2 - \cos x)^2$; critical numbers $x = \pi/3, 5\pi/3$, relative maximum of $\sqrt{3}/3$ at $x = \pi/3$, relative minimum of $-\sqrt{3}/3$ at $x = 5\pi/3$.

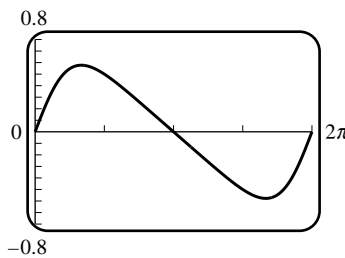

67. $f'(x) = \ln x + 1$, $f''(x) = 1/x$; $f'(1/e) = 0$, $f''(1/e) > 0$; relative minimum of $-1/e$ at $x = 1/e$.

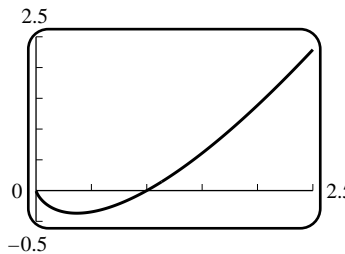

68. $f'(x) = -2 \frac{e^x - e^{-x}}{(e^x + e^{-x})^2} = 0$ when $x = 0$. By the first derivative test $f'(x) > 0$ for $x < 0$ and $f'(x) < 0$ for $x > 0$; relative maximum of 1 at $x = 0$.

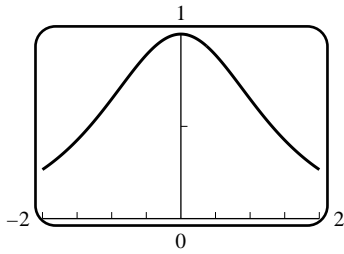

69. $f'(x) = 2x(1 - x)e^{-2x} = 0$ at $x = 0, 1$. $f''(x) = (4x^2 - 8x + 2)e^{-2x}$; $f''(0) > 0$ and $f''(1) < 0$, so a relative minimum of 0 at $x = 0$ and a relative maximum of $1/e^2$ at $x = 1$.

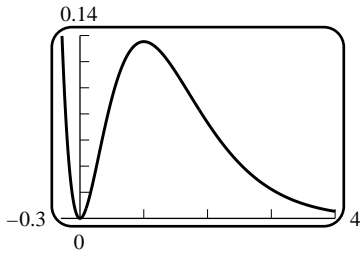

70. $f'(x) = 10/x - 1 = 0$ at $x = 10$; $f''(x) = -10/x^2 < 0$; relative maximum of $10(\ln(10) - 1) \approx 13.03$ at $x = 10$.

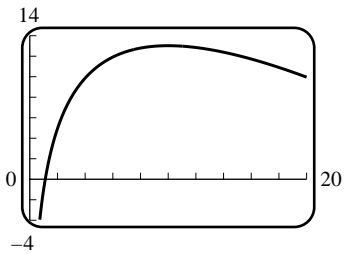

71. Relative minima at $x \approx -3.58, 3.33$; relative maximum at $x \approx 0.25$.

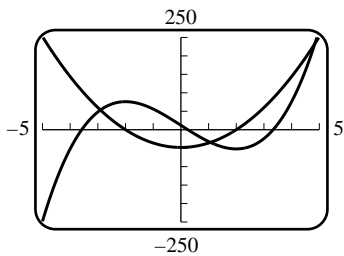

72. Relative minimum at $x \approx -0.84$; relative maximum at $x \approx 0.84$.

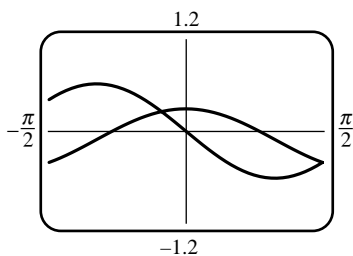

73. Relative maximum at $x \approx -0.272$, relative minimum at $x \approx 0.224$.

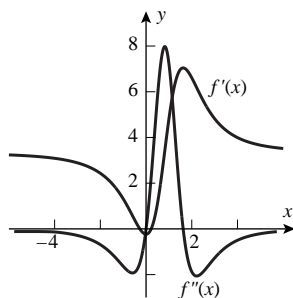

74. Relative maximum at $x \approx -1.111$, relative minimum at $x \approx 0.471$, relative maximum at $x \approx 2.036$.

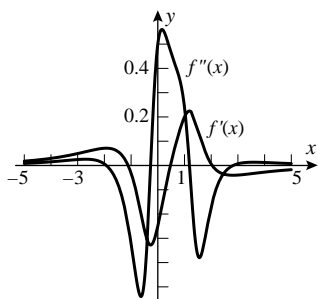

75. $f'(x) = \frac{4x^3 - \sin 2x}{2\sqrt{x^4 + \cos^2 x}}$, $f''(x) = \frac{6x^2 - \cos 2x}{\sqrt{x^4 + \cos^2 x}} - \frac{(4x^3 - \sin 2x)(4x^3 - \sin 2x)}{4(x^4 + \cos^2 x)^{3/2}}$. Relative minima at $x \approx \pm 0.618$, relative maximum at $x = 0$.

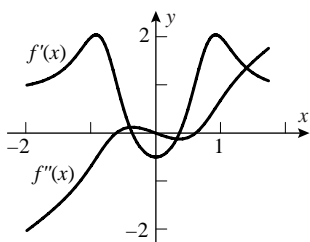

76. Point of inflection at $x = 0$, relative minimum at $x \approx -2.263$.

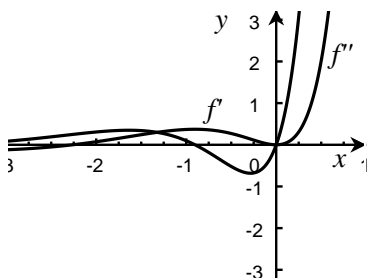

77. (a) Let $f(x) = x^2 + \frac{k}{x}$, then $f'(x) = 2x - \frac{k}{x^2} = \frac{2x^3 - k}{x^2}$. f has a relative extremum when $2x^3 - k = 0$, so $k = 2x^3 = 2(3)^3 = 54$.

- (b) Let $f(x) = \frac{x}{x^2 + k}$, then $f'(x) = \frac{k - x^2}{(x^2 + k)^2}$. f has a relative extremum when $k - x^2 = 0$, so $k = x^2 = 3^2 = 9$.

78. (a) Relative minima at $x \approx \pm 0.6436$, relative maximum at $x = 0$.

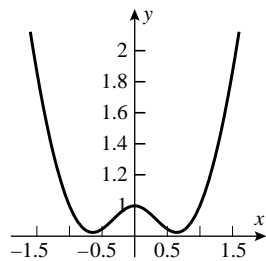

(b) $x = 0, \pm\sqrt{\sqrt{2}-1}$.

79. (a) $f'(x) = -xf(x)$. Since $f(x)$ is always positive, $f'(x) = 0$ at $x = 0$, $f'(x) > 0$ for $x < 0$ and $f'(x) < 0$ for $x > 0$, so $x = 0$ is a maximum.

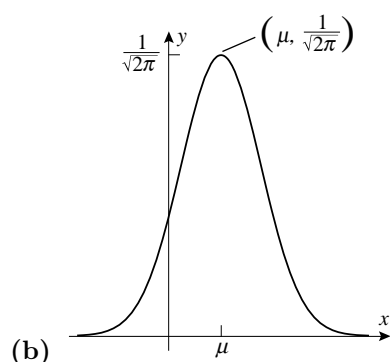

80. (a) One relative maximum, located at $x = n$.

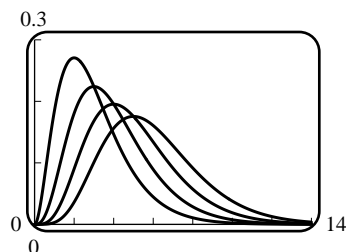

(b) $f'(x) = cx^{n-1}(-x+n)e^{-x} = 0$ at $x = n$. Since $f'(x) > 0$ for $x < n$ and $f'(x) < 0$ for $x > n$ it's a maximum.

81. (a) Because h and g have relative maxima at x_0 , $h(x) \leq h(x_0)$ for all x in I_1 and $g(x) \leq g(x_0)$ for all x in I_2 , where I_1 and I_2 are open intervals containing x_0 . If x is in both I_1 and I_2 then both inequalities are true and by addition so is $h(x) + g(x) \leq h(x_0) + g(x_0)$ which shows that $h + g$ has a relative maximum at x_0 .

(b) By counterexample; both $h(x) = -x^2$ and $g(x) = -2x^2$ have relative maxima at $x = 0$ but $h(x) - g(x) = x^2$ has a relative minimum at $x = 0$ so in general $h - g$ does not necessarily have a relative maximum at x_0 .

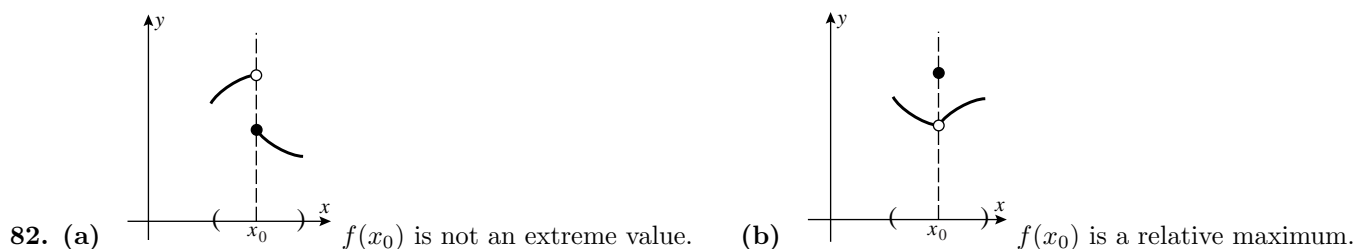

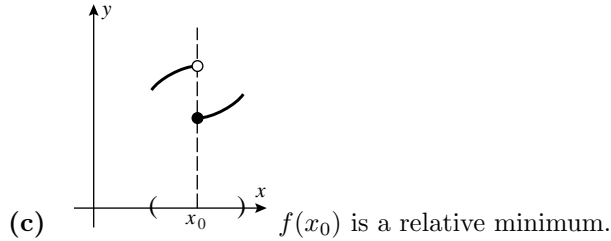

83. The first derivative test applies in many cases where the second derivative test does not. For example, it implies that $|x|$ has a relative minimum at $x = 0$, but the second derivative test does not, since $|x|$ is not differentiable there.

The second derivative test is often easier to apply, since we only need to compute $f'(x_0)$ and $f''(x_0)$, instead of analyzing $f'(x)$ at values of x near x_0 . For example, let $f(x) = 10x^3 + (1-x)e^x$. Then $f'(x) = 30x^2 - xe^x$ and $f''(x) = 60x - (x+1)e^x$. Since $f'(0) = 0$ and $f''(0) = -1$, the second derivative test tells us that f has a relative maximum at $x = 0$. To prove this using the first derivative test is slightly more difficult, since we need to determine the sign of $f'(x)$ for x near, but not equal to, 0.

84. The zeros of p tell us where the graph meets the x -axis. If the multiplicity of such a zero is odd then the graph crosses the x -axis; otherwise it does not.

The zeros of p' tell us where the graph of p is horizontal. If such a zero has odd multiplicity then p' changes sign there, and p has a relative extremum; otherwise it does not.

The zeros of p'' with odd multiplicity are the places where p'' changes sign, so they tell us where p has an inflection point. (Zeros of p'' with even multiplicity don't tell us much about the graph.)

Exercise Set 4.3

1. Vertical asymptote $x = 4$, horizontal asymptote $y = -2$.

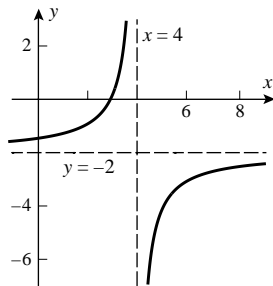

2. Vertical asymptotes $x = \pm 2$, horizontal asymptote $y = 0$.

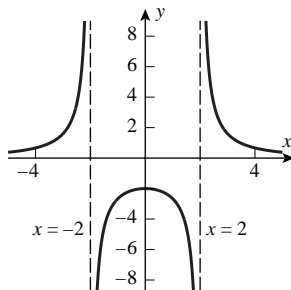

3. Vertical asymptotes $x = \pm 2$, horizontal asymptote $y = 0$.

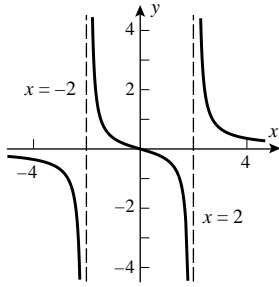

4. Vertical asymptotes $x = \pm 2$, horizontal asymptote $y = 1$.

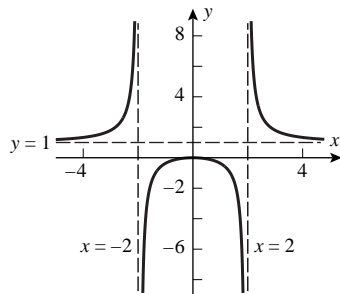

5. No vertical asymptotes, horizontal asymptote $y = 1$.

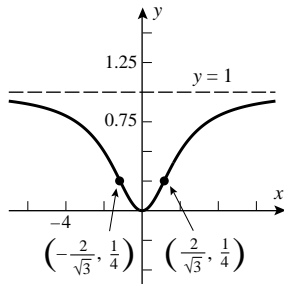

6. No vertical asymptotes, horizontal asymptote $y = 1$.

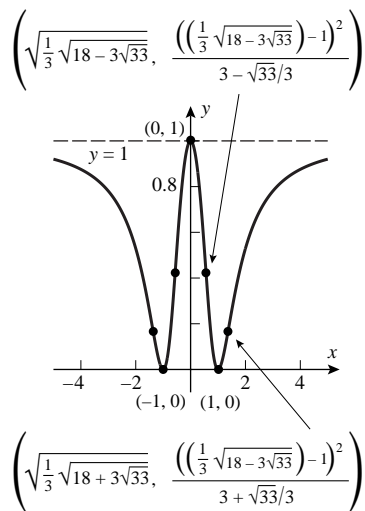

7. Vertical asymptote $x = 1$, horizontal asymptote $y = 1$.

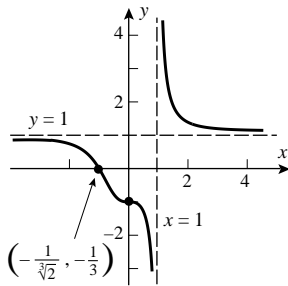

8. Vertical asymptote $x = 0, -3$, horizontal asymptote $y = 2$.

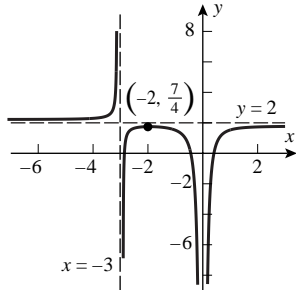

9. Vertical asymptote $x = 0$, horizontal asymptote $y = 3$.

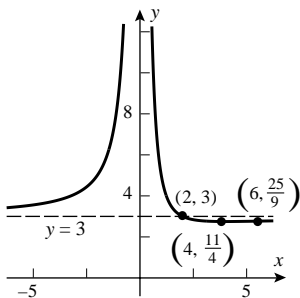

10. Vertical asymptote $x = 1$, horizontal asymptote $y = 3$.

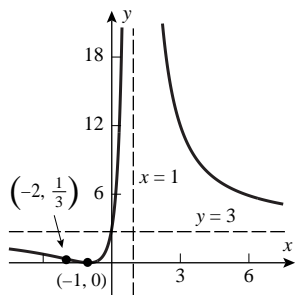

11. Vertical asymptote $x = 1$, horizontal asymptote $y = 9$.

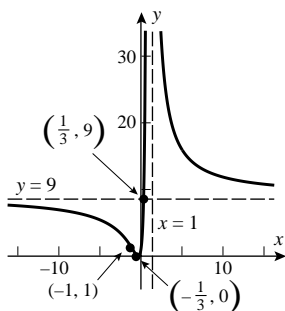

12. Vertical asymptote $x = 1$, horizontal asymptote $y = 3$.

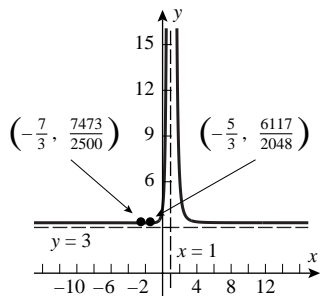

13. Vertical asymptote $x = 1$, horizontal asymptote $y = -1$.

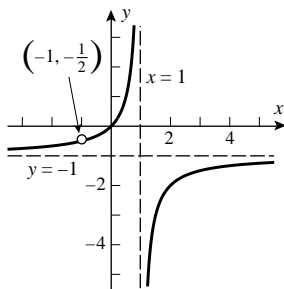

14. Vertical asymptote $x = 1$, horizontal asymptote $y = 0$.

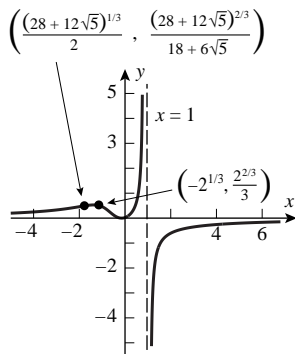

15. (a) Horizontal asymptote $y = 3$ as $x \rightarrow \pm\infty$, vertical asymptotes at $x = \pm 2$.

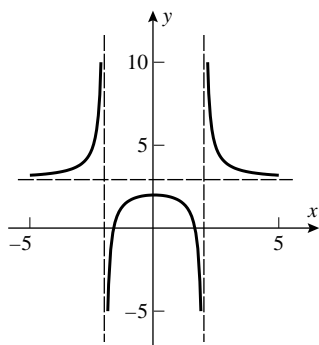

- (b) Horizontal asymptote of $y = 1$ as $x \rightarrow \pm\infty$, vertical asymptotes at $x = \pm 1$.

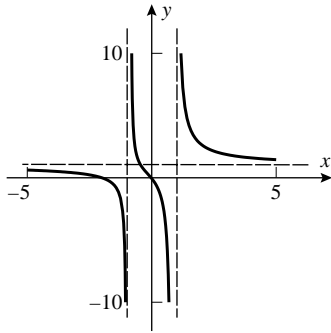

16. (a) Horizontal asymptote of $y = -1$ as $x \rightarrow \pm\infty$, vertical asymptotes at $x = -2, 1$.

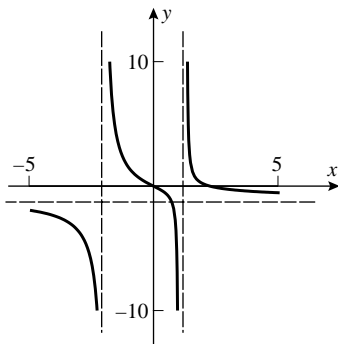

- (b) Horizontal asymptote of $y = 1$ as $x \rightarrow \pm\infty$, vertical asymptote at $x = -1, 2$.

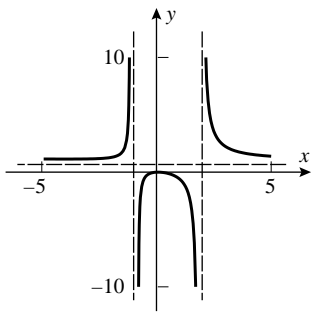

$$17. \lim_{x \rightarrow \pm\infty} \left| \frac{x^2}{x-3} - (x+3) \right| = \lim_{x \rightarrow \pm\infty} \left| \frac{9}{x-3} \right| = 0.$$

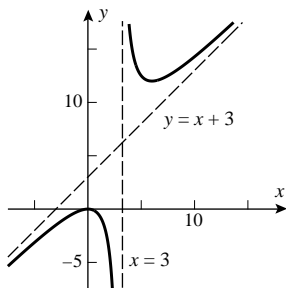

$$18. \frac{2+3x-x^3}{x} - (3-x^2) = \frac{2}{x} \rightarrow 0 \text{ as } x \rightarrow \pm\infty.$$

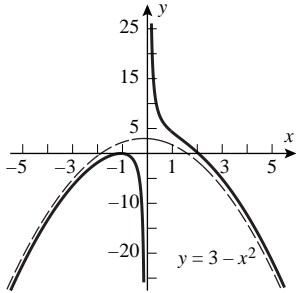

19. $y = x^2 - \frac{1}{x} = \frac{x^3 - 1}{x}$; y -axis is a vertical asymptote; $y' = \frac{2x^3 + 1}{x^2}$, $y' = 0$ when $x = -\sqrt[3]{\frac{1}{2}} \approx -0.8$; $y'' = \frac{2(x^3 - 1)}{x^3}$, curvilinear asymptote $y = x^2$.

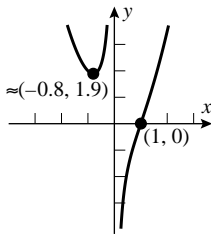

20. $y = \frac{x^2 - 2}{x} = x - \frac{2}{x}$ so y -axis is a vertical asymptote, $y = x$ is an oblique asymptote; $y' = \frac{x^2 + 2}{x^2}$, $y'' = -\frac{4}{x^3}$.

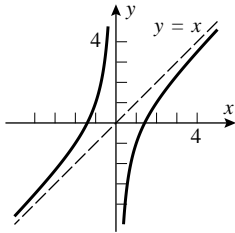

21. $y = \frac{(x - 2)^3}{x^2} = x - 6 + \frac{12x - 8}{x^2} = \frac{(x - 2)^2(x + 4)}{x^3}$, $y'' = \frac{24(x - 2)}{x^4}$. so y -axis is a vertical asymptote, $y = x - 6$ is an oblique asymptote; $y' =$

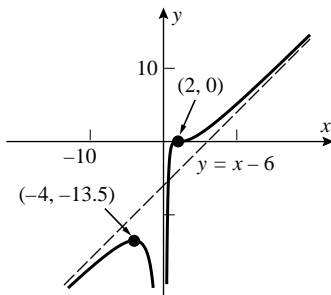

22. $y = x - \frac{1}{x} - \frac{1}{x^2} = x - \left(\frac{1}{x} + \frac{1}{x^2}\right)$ so y -axis is a vertical asymptote, $y = x$ is an oblique asymptote; $y' = 1 + \frac{1}{x^2} + \frac{2}{x^3} = \frac{(x + 1)(x^2 - x + 2)}{x^3}$, $y'' = -\frac{2}{x^3} - \frac{6}{x^4} = -\frac{2(x + 3)}{x^4}$.

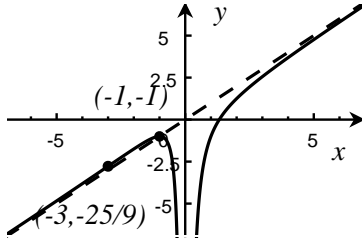

23. $y = \frac{x^3 - 4x - 8}{x + 2} = x^2 - 2x - \frac{8}{x + 2}$ so $x = -2$ is a vertical asymptote, $y = x^2 - 2x$ is a curvilinear asymptote as $x \rightarrow \pm\infty$.

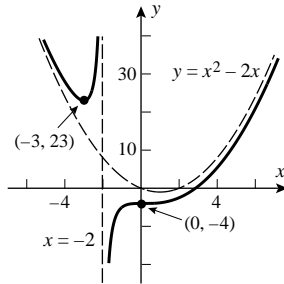

24. $y = \frac{x^5}{x^2 + 1} = x^3 - x + \frac{x}{x^2 + 1}$ so $y = x^3 - x$ is a curvilinear asymptote.

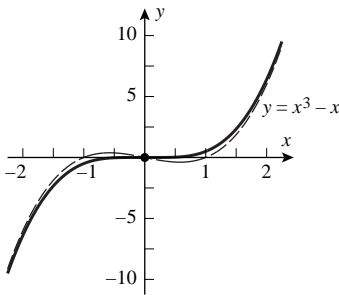

25. (a) VI (b) I (c) III (d) V (e) IV (f) II

26. (a) When n is even the function is defined only for $x \geq 0$; as n increases the graph approaches the line $y = 1$ for $x > 0$.

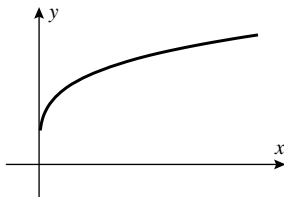

- (b) When n is odd the graph is symmetric with respect to the origin; as n increases the graph approaches the line $y = 1$ for $x > 0$ and the line $y = -1$ for $x < 0$.

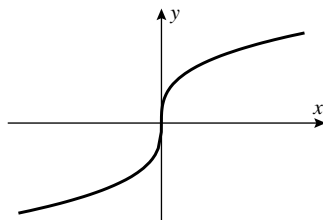

27. True. If the degree of P were larger than the degree of Q , then $\lim_{x \rightarrow \pm\infty} f(x)$ would be infinite and the graph would not have a horizontal asymptote. If the degree of P were less than the degree of Q , then $\lim_{x \rightarrow \pm\infty} f(x)$ would be zero, so the horizontal asymptote would be $y = 0$, not $y = 5$.

28. True. If f were continuous at $x = 1$ then $\lim_{x \rightarrow 1} f(x)$ would equal $f(1)$, not $\pm\infty$.

29. False. Let $f(x) = \sqrt[3]{x-1}$. Then f is continuous at $x = 1$, but $\lim_{x \rightarrow 1} f'(x) = \lim_{x \rightarrow 1} \frac{1}{3}(x-1)^{-2/3} = +\infty$, so f' has a vertical asymptote at $x = 1$.

30. True. Suppose that f has a cusp at $x = 1$. Then either

(1) $\lim_{x \rightarrow 1^+} f'(x) = -\infty$ and $\lim_{x \rightarrow 1^-} f'(x) = +\infty$, or

(2) $\lim_{x \rightarrow 1^+} f'(x) = +\infty$ and $\lim_{x \rightarrow 1^-} f'(x) = -\infty$.

If f also has an inflection point at $x = 1$, then there exist real numbers $a < 1 < b$ such that either

(A) f' is increasing on $[a, 1)$ and decreasing on $(1, b]$, or

(B) f' is decreasing on $[a, 1)$ and increasing on $(1, b]$.

We will show that each of the 4 combinations of these cases leads to a contradiction:

(1A) Since f' is decreasing on $(1, b]$, $f'(x) \geq f'(b)$ for all x in $(1, b]$. This contradicts the fact that $\lim_{x \rightarrow 1^+} f'(x) = -\infty$.

(1B) Since f' is decreasing on $[a, 1)$, $f'(x) \leq f'(a)$ for all x in $[a, 1)$. This contradicts the fact that $\lim_{x \rightarrow 1^-} f'(x) = +\infty$.

(2A) Since f' is increasing on $[a, 1)$, $f'(x) \geq f'(a)$ for all x in $[a, 1)$. This contradicts the fact that $\lim_{x \rightarrow 1^-} f'(x) = -\infty$.

(2B) Since f' is increasing on $(1, b]$, $f'(x) \leq f'(b)$ for all x in $(1, b]$. This contradicts the fact that $\lim_{x \rightarrow 1^+} f'(x) = +\infty$.

31. $y = \sqrt{4x^2 - 1}$, $y' = \frac{4x}{\sqrt{4x^2 - 1}}$, $y'' = -\frac{4}{(4x^2 - 1)^{3/2}}$ so extrema when $x = \pm \frac{1}{2}$, no inflection points.

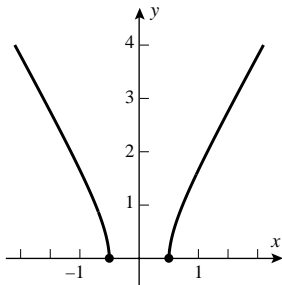

32. $y = \sqrt[3]{x^2 - 4}$; $y' = \frac{2x}{3(x^2 - 4)^{2/3}}$; $y'' = -\frac{2(3x^2 + 4)}{9(x^2 - 4)^{5/3}}$.

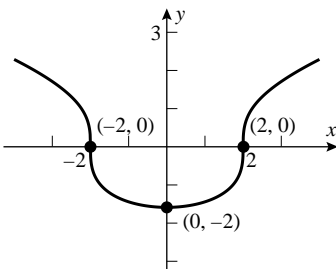

33. $y = 2x + 3x^{2/3}$; $y' = 2 + 2x^{-1/3}$; $y'' = -\frac{2}{3}x^{-4/3}$.

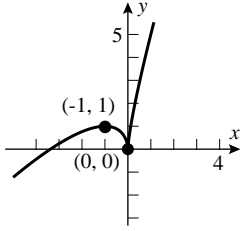

34. $y = 2x^2 - 3x^{4/3}$; $y' = 4x - 4x^{1/3}$; $y'' = 4 - \frac{4}{3}x^{-2/3}$.

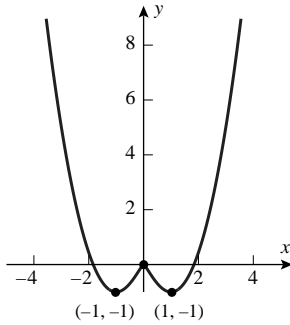

35. $y = x^{1/3}(4-x)$; $y' = \frac{4(1-x)}{3x^{2/3}}$; $y'' = -\frac{4(x+2)}{9x^{5/3}}$.

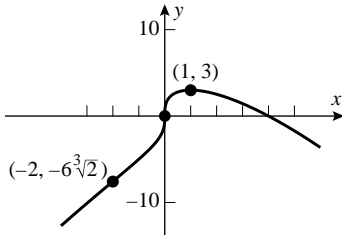

36. $y = 5x^{2/3} + x^{5/3}$; $y' = \frac{5(x+2)}{3x^{1/3}}$; $y'' = \frac{10(x-1)}{9x^{4/3}}$.

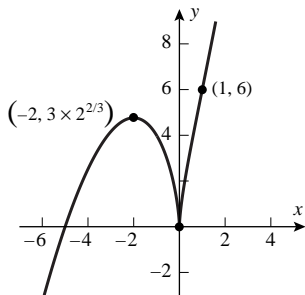

37. $y = x^{2/3} - 2x^{1/3} + 4$; $y' = \frac{2(x^{1/3} - 1)}{3x^{2/3}}$; $y'' = -\frac{2(x^{1/3} - 2)}{9x^{5/3}}$.

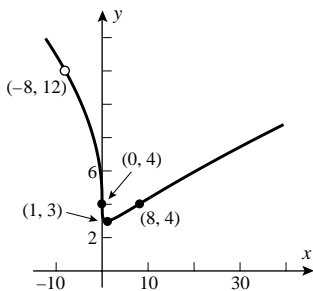

38. $y = \frac{8(\sqrt{x} - 1)}{x}$; $y' = \frac{4(2 - \sqrt{x})}{x^2}$; $y'' = \frac{2(3\sqrt{x} - 8)}{x^3}$.

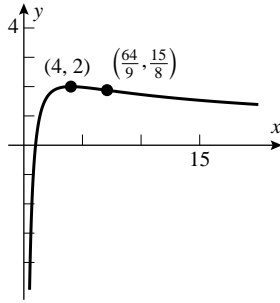

39. $y = x + \sin x$; $y' = 1 + \cos x$, $y' = 0$ when $x = \pi + 2n\pi$; $y'' = -\sin x$; $y'' = 0$ when $x = n\pi$, $n = 0, \pm 1, \pm 2, \dots$

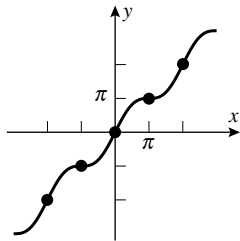

40. $y = x - \tan x$; $y' = 1 - \sec^2 x$; $y' = 0$ when $x = n\pi$; $y'' = -2\sec^2 x \tan x = 0$ when $x = n\pi$, $n = 0, \pm 1, \pm 2, \dots$

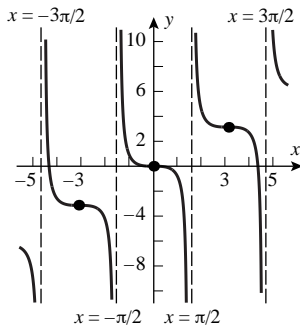

41. $y = \sqrt{3} \cos x + \sin x$; $y' = -\sqrt{3} \sin x + \cos x$; $y' = 0$ when $x = \pi/6 + n\pi$; $y'' = -\sqrt{3} \cos x - \sin x$; $y'' = 0$ when $x = 2\pi/3 + n\pi$.

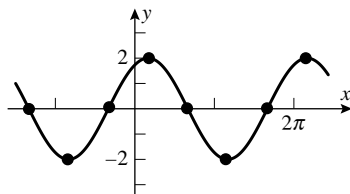

42. $y = \sin x + \cos x$; $y' = \cos x - \sin x$; $y' = 0$ when $x = \pi/4 + n\pi$; $y'' = -\sin x - \cos x$; $y'' = 0$ when $x = 3\pi/4 + n\pi$.

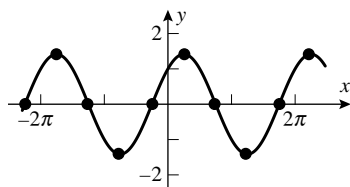

43. $y = \sin^2 x - \cos x$; $y' = \sin x(2 \cos x + 1)$; $y' = 0$ when $x = -\pi, 0, \pi, 2\pi, 3\pi$ and when $x = -\frac{2}{3}\pi, \frac{2}{3}\pi, \frac{4}{3}\pi, \frac{8}{3}\pi$; $y'' = 4 \cos^2 x + \cos x - 2$; $y'' = 0$ when $x \approx \pm 2.57, \pm 0.94, 3.71, 5.35, 7.22, 8.86$.

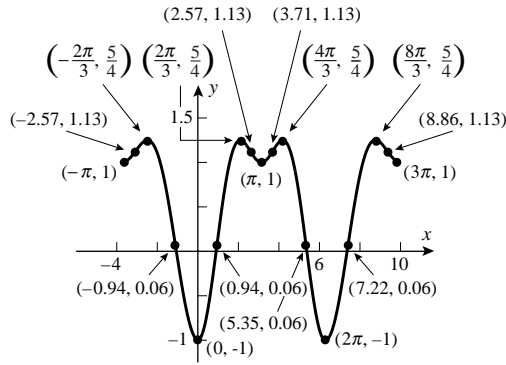

44. $y = \sqrt{\tan x}$; $y' = \frac{\sec^2 x}{2\sqrt{\tan x}}$; so $y' > 0$ always; $y'' = \sec^2 x \frac{3 \tan^2 x - 1}{4(\tan x)^{3/2}}$, $y'' = 0$ when $x = \frac{\pi}{6}$, $y = \frac{1}{\sqrt[4]{3}}$.

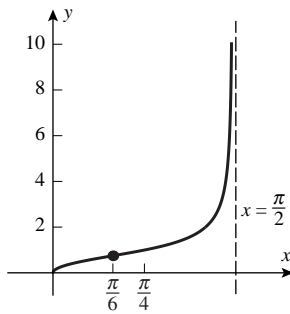

45. (a) $\lim_{x \rightarrow +\infty} xe^x = +\infty$, $\lim_{x \rightarrow -\infty} xe^x = 0$.

(b) $y = xe^x$; $y' = (x+1)e^x$; $y'' = (x+2)e^x$; relative minimum at $(-1, -e^{-1}) \approx (-1, -0.37)$, inflection point at $(-2, -2e^{-2}) \approx (-2, -0.27)$, horizontal asymptote $y = 0$ as $x \rightarrow -\infty$.

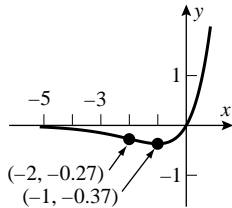

46. (a) $\lim_{x \rightarrow +\infty} f(x) = 0$, $\lim_{x \rightarrow -\infty} f(x) = -\infty$.

(b) $f'(x) = (1-x)e^{-x}$, $f''(x) = (x-2)e^{-x}$, critical point at $x = 1$; relative maximum at $x = 1$, point of inflection at $x = 2$, horizontal asymptote $y = 0$ as $x \rightarrow +\infty$.

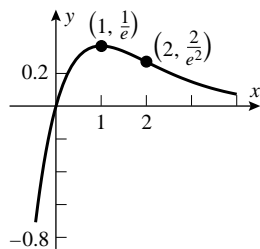

47. (a) $\lim_{x \rightarrow +\infty} \frac{x^2}{e^{2x}} = 0$, $\lim_{x \rightarrow -\infty} \frac{x^2}{e^{2x}} = +\infty$.

(b) $y = x^2/e^{2x} = x^2e^{-2x}$; $y' = 2x(1-x)e^{-2x}$; $y'' = 2(2x^2 - 4x + 1)e^{-2x}$; $y'' = 0$ if $2x^2 - 4x + 1 = 0$, when

$$x = \frac{4 \pm \sqrt{16-8}}{4} = 1 \pm \sqrt{2}/2 \approx 0.29, 1.71, \text{ horizontal asymptote } y = 0 \text{ as } x \rightarrow +\infty.$$

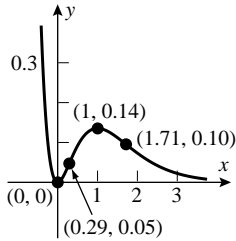

48. (a) $\lim_{x \rightarrow +\infty} x^2 e^{2x} = +\infty, \lim_{x \rightarrow -\infty} x^2 e^{2x} = 0.$

(b) $y = x^2 e^{2x}; y' = 2x(x+1)e^{2x}; y'' = 2(2x^2 + 4x + 1)e^{2x}; y'' = 0$ if $2x^2 + 4x + 1 = 0$, when $x = \frac{-4 \pm \sqrt{16-8}}{4} = -1 \pm \sqrt{2}/2 \approx -0.29, -1.71$, horizontal asymptote $y = 0$ as $x \rightarrow -\infty$.

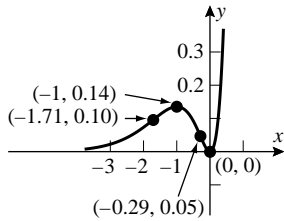

49. (a) $\lim_{x \rightarrow \pm\infty} x^2 e^{-x^2} = 0.$

(b) $y = x^2 e^{-x^2}; y' = 2x(1-x^2)e^{-x^2}; y' = 0$ if $x = 0, \pm 1; y'' = 2(1-5x^2+2x^4)e^{-x^2}; y'' = 0$ if $2x^4 - 5x^2 + 1 = 0$, $x^2 = \frac{5 \pm \sqrt{17}}{4}$, $x = \pm \frac{1}{2} \sqrt{5 + \sqrt{17}} \approx \pm 1.51$, $x = \pm \frac{1}{2} \sqrt{5 - \sqrt{17}} \approx \pm 0.47$, horizontal asymptote $y = 0$ as $x \rightarrow \pm\infty$.

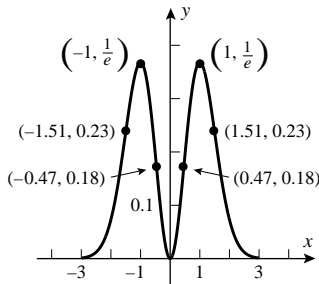

50. (a) $\lim_{x \rightarrow \pm\infty} f(x) = 1.$

(b) $f'(x) = 2x^{-3}e^{-1/x^2}$ so $f'(x) < 0$ for $x < 0$ and $f'(x) > 0$ for $x > 0$. Set $u = x^2$ and use the given result to find $\lim_{x \rightarrow 0} f'(x) = 0$, so (by the first derivative test) $f(x)$ has a minimum at $x = 0$. $f''(x) = (-6x^{-4} + 4x^{-6})e^{-1/x^2}$, so $f(x)$ has points of inflection at $x = \pm\sqrt{2/3}$. $y = 1$ is a horizontal asymptote as $x \rightarrow \pm\infty$.

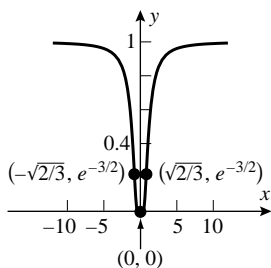

51. (a) $\lim_{x \rightarrow -\infty} f(x) = 0$, $\lim_{x \rightarrow +\infty} f(x) = -\infty$.

(b) $f'(x) = -\frac{e^x(x-2)}{(x-1)^2}$ so $f'(x) = 0$ when $x = 2$, $f''(x) = -\frac{e^x(x^2 - 4x + 5)}{(x-1)^3}$ so $f''(x) \neq 0$ always, relative maximum when $x = 2$, no point of inflection, vertical asymptote $x = 1$, horizontal asymptote $y = 0$ as $x \rightarrow -\infty$.

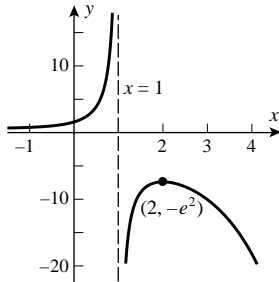

52. (a) $\lim_{x \rightarrow -\infty} f(x) = 0$, $\lim_{x \rightarrow +\infty} f(x) = +\infty$.

(b) $f'(x) = \frac{e^x(3x+2)}{3x^{1/3}}$ so $f'(x) = 0$ when $x = -\frac{2}{3}$, $f''(x) = \frac{e^x(9x^2 + 12x - 2)}{9x^{4/3}}$ so points of inflection when $f''(x) = 0$ at $x = -\frac{2-\sqrt{6}}{3}$, $-\frac{2+\sqrt{6}}{3}$, relative maximum at $\left(-\frac{2}{3}, e^{-2/3} \left(-\frac{2}{3}\right)^{2/3}\right)$, absolute minimum at $(0, 0)$, horizontal asymptote $y = 0$ as $x \rightarrow -\infty$.

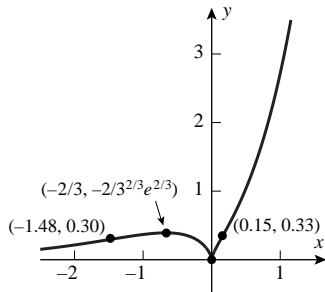

53. (a) $\lim_{x \rightarrow +\infty} f(x) = 0$, $\lim_{x \rightarrow -\infty} f(x) = +\infty$.

(b) $f'(x) = x(2-x)e^{1-x}$, $f''(x) = (x^2 - 4x + 2)e^{1-x}$, critical points at $x = 0, 2$; relative minimum at $x = 0$, relative maximum at $x = 2$, points of inflection at $x = 2 \pm \sqrt{2}$, horizontal asymptote $y = 0$ as $x \rightarrow +\infty$.

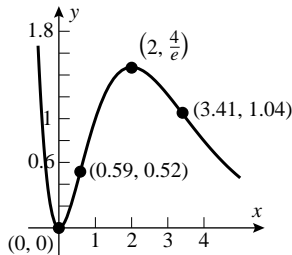

54. (a) $\lim_{x \rightarrow +\infty} f(x) = +\infty$, $\lim_{x \rightarrow -\infty} f(x) = 0$.

(b) $f'(x) = x^2(3+x)e^{x-1}$, $f''(x) = x(x^2 + 6x + 6)e^{x-1}$, critical points at $x = -3, 0$; relative minimum at $x = -3$, points of inflection at $x = 0, -3 \pm \sqrt{3} \approx 0, -4.7, -1.27$, horizontal asymptote $y = 0$ as $x \rightarrow -\infty$.

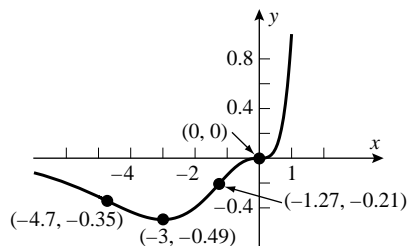

55. (a) $\lim_{x \rightarrow 0^+} y = \lim_{x \rightarrow 0^+} x \ln x = \lim_{x \rightarrow 0^+} \frac{\ln x}{1/x} = \lim_{x \rightarrow 0^+} \frac{1/x}{-1/x^2} = 0$; $\lim_{x \rightarrow +\infty} y = +\infty$.

(b) $y = x \ln x$, $y' = 1 + \ln x$, $y'' = 1/x$, $y' = 0$ when $x = e^{-1}$.

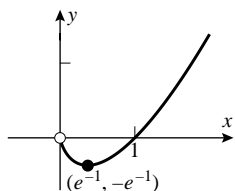

56. (a) $\lim_{x \rightarrow 0^+} y = \lim_{x \rightarrow 0^+} \frac{\ln x}{1/x^2} = \lim_{x \rightarrow 0^+} \frac{1/x}{-2/x^3} = 0$, $\lim_{x \rightarrow +\infty} y = +\infty$.

(b) $y = x^2 \ln x$, $y' = x(1 + 2 \ln x)$, $y'' = 3 + 2 \ln x$, $y' = 0$ if $x = e^{-1/2}$, $y'' = 0$ if $x = e^{-3/2}$, $\lim_{x \rightarrow 0^+} y' = 0$.

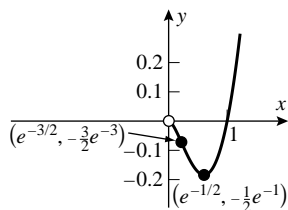

57. (a) $\lim_{x \rightarrow 0^+} x^2 \ln(2x) = \lim_{x \rightarrow 0^+} (x^2 \ln 2) + \lim_{x \rightarrow 0^+} (x^2 \ln x) = 0$ by the rule given, $\lim_{x \rightarrow +\infty} x^2 \ln x = +\infty$ by inspection.

(b) $y = x^2 \ln(2x)$, $y' = 2x \ln(2x) + x$, $y'' = 2 \ln(2x) + 3$, $y' = 0$ if $x = 1/(2\sqrt{e})$, $y'' = 0$ if $x = 1/(2e^{3/2})$.

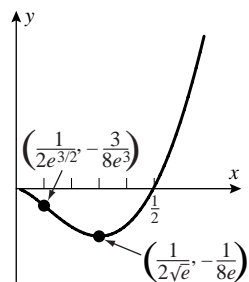

58. (a) $\lim_{x \rightarrow +\infty} f(x) = +\infty$; $\lim_{x \rightarrow 0} f(x) = 0$.

(b) $y = \ln(x^2 + 1)$, $y' = 2x/(x^2 + 1)$, $y'' = -2 \frac{x^2 - 1}{(x^2 + 1)^2}$, $y' = 0$ if $x = 0$, $y'' = 0$ if $x = \pm 1$.

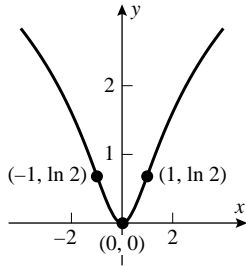

59. (a) $\lim_{x \rightarrow +\infty} f(x) = +\infty$, $\lim_{x \rightarrow 0^+} f(x) = 0$.

(b) $y = x^{2/3} \ln x$, $y' = \frac{2 \ln x + 3}{3x^{1/3}}$, $y' = 0$ when $\ln x = -\frac{3}{2}$, $x = e^{-3/2}$, $y'' = \frac{-3 + 2 \ln x}{9x^{4/3}}$, $y'' = 0$ when $\ln x = \frac{3}{2}$, $x = e^{3/2}$.

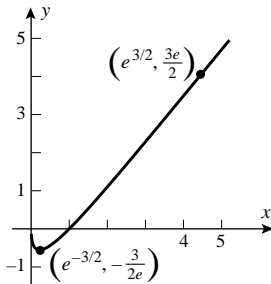

60. (a) $\lim_{x \rightarrow 0^+} f(x) = -\infty$, $\lim_{x \rightarrow +\infty} f(x) = 0$.

(b) $y = x^{-1/3} \ln x$, $y' = \frac{3 - \ln x}{3x^{4/3}}$, $y' = 0$ when $x = e^3$; $y'' = \frac{4 \ln x - 15}{9x^{7/3}}$, $y'' = 0$ when $x = e^{15/4}$.

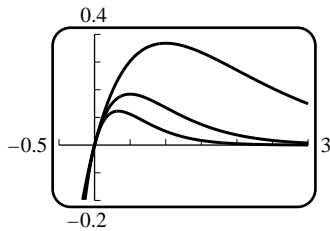
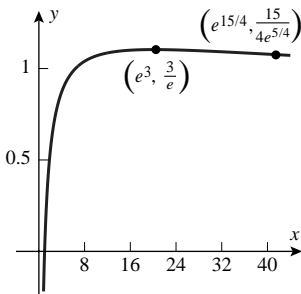

61. (a)

(b) $y' = (1 - bx)e^{-bx}$, $y'' = b^2(x - 2/b)e^{-bx}$; relative maximum at $x = 1/b$, $y = 1/(be)$; point of inflection at $x = 2/b$, $y = 2/(be^2)$. Increasing b moves the relative maximum and the point of inflection to the left and down, i.e. towards the origin.

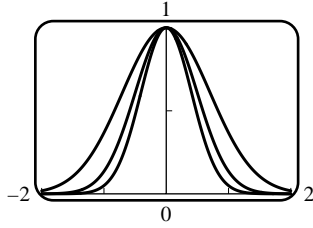

62. (a)

(b) $y' = -2bx e^{-bx^2}$, $y'' = 2b(-1 + 2bx^2)e^{-bx^2}$; relative maximum at $x = 0$, $y = 1$; points of inflection at $x = \pm\sqrt{1/2b}$, $y = 1/\sqrt{e}$. Increasing b moves the points of inflection towards the y -axis; the relative maximum doesn't move.

63. (a) The oscillations of $e^x \cos x$ about zero increase as $x \rightarrow +\infty$ so the limit does not exist, and $\lim_{x \rightarrow -\infty} e^x \cos x = 0$.

(b) $y = e^x$ and $y = e^x \cos x$ intersect for $x = 2\pi n$ for any integer n . $y = -e^x$ and $y = e^x \cos x$ intersect for $x = 2\pi n + \pi$ for any integer n . On the graph below, the intersections are at $(0, 1)$ and $(\pi, -e^\pi)$.

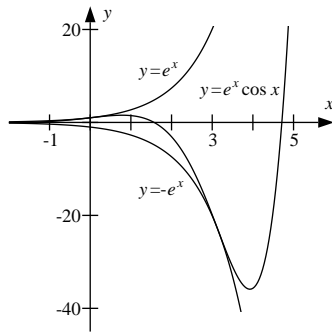

(c) The curve $y = e^{ax} \cos bx$ oscillates between $y = e^{ax}$ and $y = -e^{ax}$. The frequency of oscillation increases when b increases.

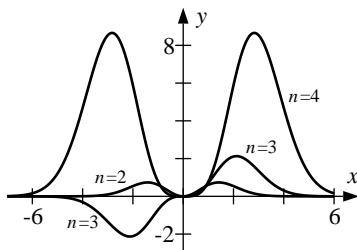
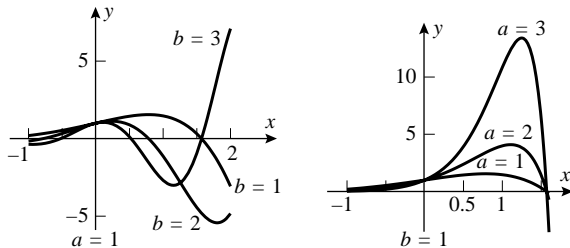

64. (a)

(b) $y' = \frac{n^2 - 2x^2}{n} x^{n-1} e^{-x^2/n}$, $y'' = \frac{n^4 - n^3 - 4x^2 n^2 - 2x^2 n + 4x^4}{n^2} x^{n-2} e^{-x^2/n}$. For n even, the curve has relative maxima at $x = \pm \frac{n}{\sqrt{2}}$ and a relative minimum at $x = 0$. For n odd, it has a relative maximum at $x = \frac{n}{\sqrt{2}}$ and a relative minimum at $x = -\frac{n}{\sqrt{2}}$. For every n , there are 4 inflection points, at $x = \pm \sqrt{\frac{n(2n+1 \pm \sqrt{8n+1})}{4}}$.

65. (a) $x = 1, 2.5, 4$ and $x = 3$, the latter being a cusp.

(b) $(-\infty, 1], [2.5, 3)$.

(c) Relative maxima for $x = 1, 3$; relative minima for $x = 2.5$.

(d) $x \approx 0.6, 1.9, 4$.

66. (a) $f'(x) = -2h(x) + (1 - 2x)h'(x)$, $f'(5) = -2h(5) - 9h'(5)$. But from the graph $h'(5) \approx -0.2$ and $f'(5) = 0$, so $h(5) = -(9/2)h'(5) \approx 0.9$.

(b) $f''(x) = -4h'(x) + (1 - 2x)h''(x)$, $f''(5) \approx 0.8 - 9h''(5)$ and since $h''(5)$ is clearly negative, $f''(5) > 0$ and thus f has a minimum at $x = 5$.

67. Let y be the length of the other side of the rectangle, then $L = 2x + 2y$ and $xy = 400$ so $y = 400/x$ and hence $L = 2x + 800/x$. $L = 2x$ is an oblique asymptote. $L = 2x + \frac{800}{x} = \frac{2(x^2 + 400)}{x}$, $L' = 2 - \frac{800}{x^2} = \frac{2(x^2 - 400)}{x^2}$, $L'' = \frac{1600}{x^3}$, $L' = 0$ when $x = 20$, $L = 80$.

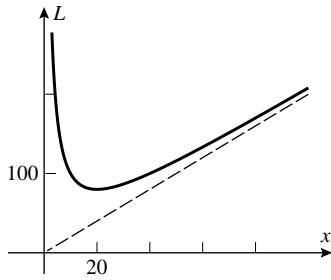

68. Let y be the height of the box, then $S = x^2 + 4xy$ and $x^2y = 500$ so $y = 500/x^2$ and hence $S = x^2 + 2000/x$. The graph approaches the curve $S = x^2$ asymptotically. $S = x^2 + \frac{2000}{x} = \frac{x^3 + 2000}{x}$, $S' = 2x - \frac{2000}{x^2} = \frac{2(x^3 - 1000)}{x^2}$, $S'' = 2 + \frac{4000}{x^3} = \frac{2(x^3 + 2000)}{x^3}$, $S' = 0$ when $x = 10$, $S = 300$.

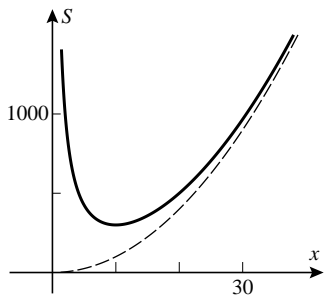

69. $y' = 0.1x^4(6x - 5)$; critical numbers: $x = 0$, $x = 5/6$; relative minimum at $x = 5/6$, $y \approx -6.7 \times 10^{-3}$.

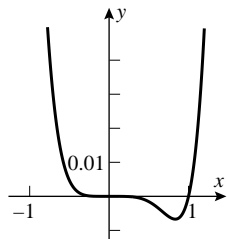

70. $y' = 0.1x^4(x + 1)(7x + 5)$; critical numbers: $x = 0$, $x = -1$, $x = -5/7$, relative maximum at $x = -1$, $y = 0$; relative minimum at $x = -5/7$, $y \approx -1.5 \times 10^{-3}$.

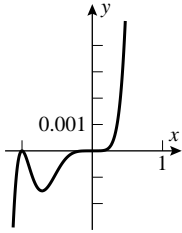

72. Calculus may tell us about details that are too small to show up in the graph, as in Exercise 70. It may also tell us about what the graph looks like outside of the viewing window.

Exercise Set 4.4

1. Relative maxima at $x = 2, 6$; absolute maximum at $x = 6$; relative minimum at $x = 4$; absolute minima at $x = 0, 4$.
2. Relative maximum at $x = 3$; absolute maximum at $x = 7$; relative minima at $x = 1, 5$; absolute minima at $x = 1, 5$.

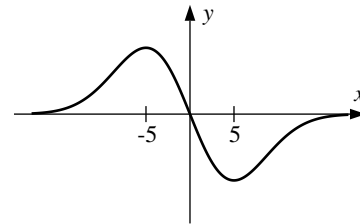
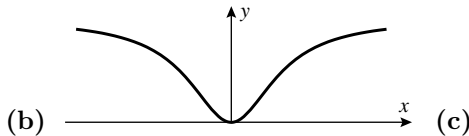
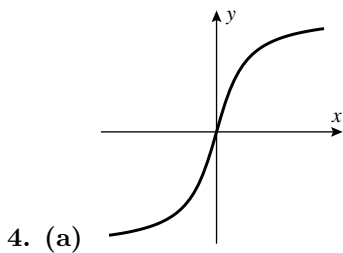
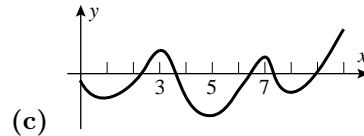
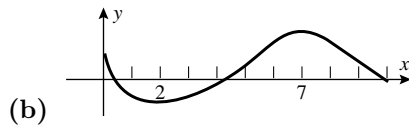
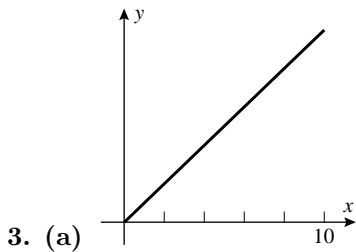

5. The minimum value is clearly 0; there is no maximum because $\lim_{x \rightarrow 1^-} f(x) = \infty$. $x = 1$ is a point of discontinuity of f .
6. There are no absolute extrema on $(0, 1)$, since there are no critical points there. Also, neither $x = 0$ nor $x = 1$ gives an absolute maximum or minimum, since $f(x)$ takes on values both larger and smaller than $f(0) = f(1) = 1/2$.
7. $f'(x) = 8x - 12$, $f'(x) = 0$ when $x = 3/2$; $f(1) = 2$, $f(3/2) = 1$, $f(2) = 2$ so the maximum value is 2 at $x = 1, 2$ and the minimum value is 1 at $x = 3/2$.
8. $f'(x) = 8 - 2x$, $f'(x) = 0$ when $x = 4$; $f(0) = 0$, $f(4) = 16$, $f(6) = 12$ so the maximum value is 16 at $x = 4$ and the minimum value is 0 at $x = 0$.
9. $f'(x) = 3(x - 2)^2$, $f'(x) = 0$ when $x = 2$; $f(1) = -1$, $f(2) = 0$, $f(4) = 8$ so the minimum is -1 at $x = 1$ and the maximum is 8 at $x = 4$.
10. $f'(x) = 6x^2 + 6x - 12$, $f'(x) = 0$ when $x = -2, 1$; $f(-3) = 9$, $f(-2) = 20$, $f(1) = -7$, $f(2) = 4$, so the minimum is -7 at $x = 1$ and the maximum is 20 at $x = -2$.
11. $f'(x) = 3/(4x^2 + 1)^{3/2}$, no critical points; $f(-1) = -3/\sqrt{5}$, $f(1) = 3/\sqrt{5}$ so the maximum value is $3/\sqrt{5}$ at $x = 1$ and the minimum value is $-3/\sqrt{5}$ at $x = -1$.

12. $f'(x) = \frac{2(2x+1)}{3(x^2+x)^{1/3}}$, $f'(x) = 0$ when $x = -1/2$ and $f'(x)$ does not exist when $x = -1, 0$; $f(-2) = 2^{2/3}$, $f(-1) = 0$, $f(-1/2) = 4^{-2/3}$, $f(0) = 0$, $f(3) = 12^{2/3}$ so the maximum value is $12^{2/3}$ at $x = 3$ and the minimum value is 0 at $x = -1, 0$.
13. $f'(x) = 1 - 2\cos x$, $f'(x) = 0$ when $x = \pi/3$; then $f(-\pi/4) = -\pi/4 + \sqrt{2}$; $f(\pi/3) = \pi/3 - \sqrt{3}$; $f(\pi/2) = \pi/2 - 2$, so f has a minimum of $\pi/3 - \sqrt{3}$ at $x = \pi/3$ and a maximum of $-\pi/4 + \sqrt{2}$ at $x = -\pi/4$.
14. $f'(x) = \cos x + \sin x$, $f'(x) = 0$ for x in $(0, \pi)$ when $x = 3\pi/4$; $f(0) = -1$, $f(3\pi/4) = \sqrt{2}$, $f(\pi) = 1$ so the maximum value is $\sqrt{2}$ at $x = 3\pi/4$ and the minimum value is -1 at $x = 0$.
15. $f(x) = 1 + |9 - x^2| = \begin{cases} 10 - x^2, & |x| \leq 3 \\ -8 + x^2, & |x| > 3 \end{cases}$, $f'(x) = \begin{cases} -2x, & |x| < 3 \\ 2x, & |x| > 3 \end{cases}$, thus $f'(x) = 0$ when $x = 0$, $f'(x)$ does not exist for x in $(-5, 1)$ when $x = -3$ because $\lim_{x \rightarrow -3^-} f'(x) \neq \lim_{x \rightarrow -3^+} f'(x)$ (see Theorem preceding Exercise 65, Section 2.3); $f(-5) = 17$, $f(-3) = 1$, $f(0) = 10$, $f(1) = 9$ so the maximum value is 17 at $x = -5$ and the minimum value is 1 at $x = -3$.
16. $f(x) = |6 - 4x| = \begin{cases} 6 - 4x, & x \leq 3/2 \\ -6 + 4x, & x > 3/2 \end{cases}$, $f'(x) = \begin{cases} -4, & x < 3/2 \\ 4, & x > 3/2 \end{cases}$, $f'(x)$ does not exist when $x = 3/2$ thus $3/2$ is the only critical point in $(-3, 3)$; $f(-3) = 18$, $f(3/2) = 0$, $f(3) = 6$ so the maximum value is 18 at $x = -3$ and the minimum value is 0 at $x = 3/2$.
17. True, by Theorem 4.4.2.
18. False. By Example 5, $f(x) = \frac{1}{x^2 - x}$ is continuous on $(0, 1)$ but has no absolute minimum there.
19. True, by Theorem 4.4.3.
20. True. The absolute maximum of f on $[a, b]$ exists, by Theorem 4.4.2. If it occurred in (a, b) , then it would also be a relative maximum. Since f has no relative maximum in (a, b) , the absolute maximum must occur at either $x = a$ or $x = b$.
21. $f'(x) = 2x - 1$, $f'(x) = 0$ when $x = 1/2$; $f(1/2) = -9/4$ and $\lim_{x \rightarrow \pm\infty} f(x) = +\infty$. Thus f has a minimum of $-9/4$ at $x = 1/2$ and no maximum.
22. $f'(x) = -4(x + 1)$; critical point $x = -1$. Maximum value $f(-1) = 5$, no minimum.
23. $f'(x) = 12x^2(1 - x)$; critical points $x = 0, 1$. Maximum value $f(1) = 1$, no minimum because $\lim_{x \rightarrow +\infty} f(x) = -\infty$.
24. $f'(x) = 4(x^3 + 1)$; critical point $x = -1$. Minimum value $f(-1) = -3$, no maximum.
25. No maximum or minimum because $\lim_{x \rightarrow +\infty} f(x) = +\infty$ and $\lim_{x \rightarrow -\infty} f(x) = -\infty$.
26. No maximum or minimum because $\lim_{x \rightarrow +\infty} f(x) = +\infty$ and $\lim_{x \rightarrow -\infty} f(x) = -\infty$.
27. $\lim_{x \rightarrow -1^-} f(x) = -\infty$, so there is no absolute minimum on the interval; $f'(x) = \frac{x^2 + 2x - 1}{(x + 1)^2} = 0$ at $x = -1 - \sqrt{2}$, for which $y = -2 - 2\sqrt{2} \approx -4.828$. Also $f(-5) = -13/2$, so the absolute maximum of f on the interval is $y = -2 - 2\sqrt{2}$, taken at $x = -1 - \sqrt{2}$.
28. $\lim_{x \rightarrow -1^+} f(x) = -\infty$, so there is no absolute minimum on the interval. $f'(x) = 3/(x + 1)^2 > 0$, so f is increasing on the interval $(-1, 5]$ and the maximum must occur at the endpoint $x = 5$ where $f(5) = 1/2$.

29. $\lim_{x \rightarrow \pm\infty} = +\infty$ so there is no absolute maximum. $f'(x) = 4x(x-2)(x-1)$, $f'(x) = 0$ when $x = 0, 1, 2$, and $f(0) = 0, f(1) = 1, f(2) = 0$ so f has an absolute minimum of 0 at $x = 0, 2$.

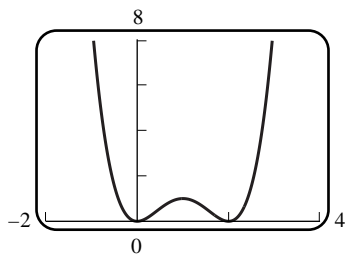

30. $(x-1)^2(x+2)^2$ can never be less than zero because it is the product of two squares; the minimum value is 0 for $x = 1$ or -2 , no maximum because $\lim_{x \rightarrow +\infty} f(x) = +\infty$.

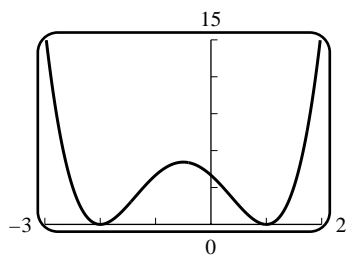

31. $f'(x) = \frac{5(8-x)}{3x^{1/3}}$, $f'(x) = 0$ when $x = 8$ and $f'(x)$ does not exist when $x = 0$; $f(-1) = 21, f(0) = 0, f(8) = 48, f(20) = 0$ so the maximum value is 48 at $x = 8$ and the minimum value is 0 at $x = 0, 20$.

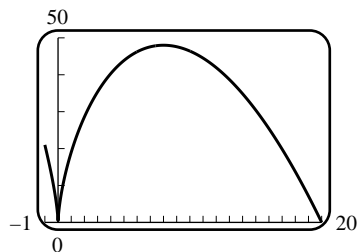

32. $f'(x) = (2-x^2)/(x^2+2)^2$, $f'(x) = 0$ for x in the interval $(-1, 4)$ when $x = \sqrt{2}$; $f(-1) = -1/3, f(\sqrt{2}) = \sqrt{2}/4, f(4) = 2/9$ so the maximum value is $\sqrt{2}/4$ at $x = \sqrt{2}$ and the minimum value is $-1/3$ at $x = -1$.

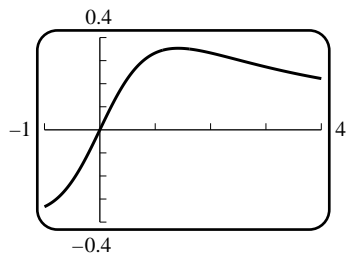

33. $f'(x) = -1/x^2$; no maximum or minimum because there are no critical points in $(0, +\infty)$.

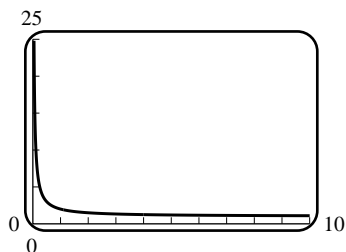

34. $f'(x) = -\frac{x(x-2)}{(x^2-2x+2)^2}$, and for $1 \leq x < +\infty$, $f'(x) = 0$ when $x = 2$. Also $\lim_{x \rightarrow +\infty} f(x) = 2$ and $f(2) = 5/2$ and $f(1) = 2$, hence f has an absolute minimum value of 2 at $x = 1$ and an absolute maximum value of $5/2$ at $x = 2$.

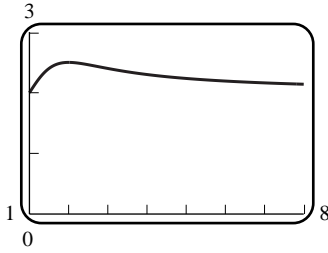

35. $f'(x) = \frac{1-2\cos x}{\sin^2 x}$; $f'(x) = 0$ on $[\pi/4, 3\pi/4]$ only when $x = \pi/3$. Then $f(\pi/4) = 2\sqrt{2} - 1$, $f(\pi/3) = \sqrt{3}$ and $f(3\pi/4) = 2\sqrt{2} + 1$, so f has an absolute maximum value of $2\sqrt{2} + 1$ at $x = 3\pi/4$ and an absolute minimum value of $\sqrt{3}$ at $x = \pi/3$.

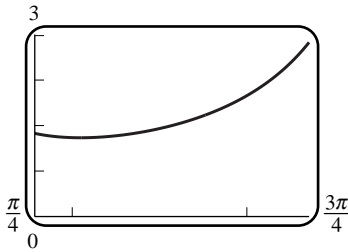

36. $f'(x) = 2\sin x \cos x - \sin x = \sin x(2\cos x - 1)$, $f'(x) = 0$ for x in $(-\pi, \pi)$ when $x = 0, \pm\pi/3$; $f(-\pi) = -1$, $f(-\pi/3) = 5/4$, $f(0) = 1$, $f(\pi/3) = 5/4$, $f(\pi) = -1$ so the maximum value is $5/4$ at $x = \pm\pi/3$ and the minimum value is -1 at $x = \pm\pi$.

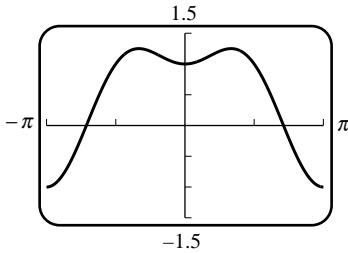

37. $f'(x) = x^2(3-2x)e^{-2x}$, $f'(x) = 0$ for x in $[1, 4]$ when $x = 3/2$; if $x = 1, 3/2, 4$, then $f(x) = e^{-2}, \frac{27}{8}e^{-3}, 64e^{-8}$; critical point at $x = 3/2$; absolute maximum of $\frac{27}{8}e^{-3}$ at $x = 3/2$, absolute minimum of $64e^{-8}$ at $x = 4$.

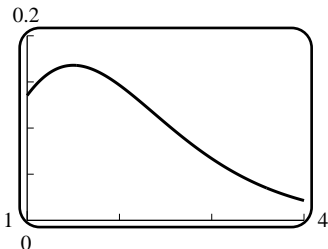

38. $f'(x) = (1 - \ln 2x)/x^2$, $f'(x) = 0$ on $[1, e]$ for $x = e/2$; if $x = 1, e/2, e$ then $f(x) = \ln 2, 2/e, (\ln 2 + 1)/e$; absolute minimum of $\frac{1 + \ln 2}{e}$ at $x = e$, absolute maximum of $2/e$ at $x = e/2$.

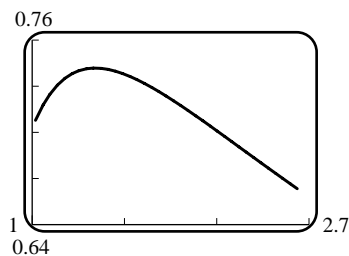

39. $f'(x) = -\frac{3x^2 - 10x + 3}{x^2 + 1}$, $f'(x) = 0$ when $x = \frac{1}{3}, 3$. $f(0) = 0$, $f\left(\frac{1}{3}\right) = 5 \ln\left(\frac{10}{9}\right) - 1$, $f(3) = 5 \ln 10 - 9$, $f(4) = 5 \ln 17 - 12$ and thus f has an absolute minimum of $5(\ln 10 - \ln 9) - 1$ at $x = 1/3$ and an absolute maximum of $5 \ln 10 - 9$ at $x = 3$.

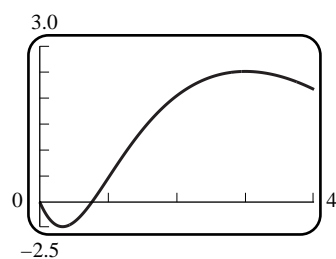

40. $f'(x) = (x^2 + 2x - 1)e^x$, $f'(x) = 0$ at $x = -1 + \sqrt{2}$ and $x = -1 - \sqrt{2}$ (discard), $f(-1 + \sqrt{2}) = (2 - 2\sqrt{2})e^{-1+\sqrt{2}} \approx -1.25$, $f(-2) = 3e^{-2} \approx 0.41$, $f(2) = 3e^2 \approx 22.17$. Absolute maximum is $3e^2$ at $x = 2$, absolute minimum is $(2 - 2\sqrt{2})e^{-1+\sqrt{2}}$ at $x = -1 + \sqrt{2}$.

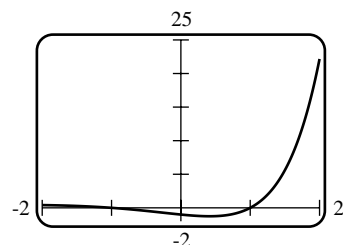

41. $f'(x) = -[\cos(\cos x)] \sin x$; $f'(x) = 0$ if $\sin x = 0$ or if $\cos(\cos x) = 0$. If $\sin x = 0$, then $x = \pi$ is the critical point in $(0, 2\pi)$; $\cos(\cos x) = 0$ has no solutions because $-1 \leq \cos x \leq 1$. Thus $f(0) = \sin(1)$, $f(\pi) = \sin(-1) = -\sin(1)$, and $f(2\pi) = \sin(1)$ so the maximum value is $\sin(1) \approx 0.84147$ and the minimum value is $-\sin(1) \approx -0.84147$.

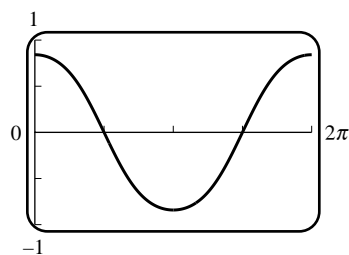

42. $f'(x) = -[\sin(\sin x)] \cos x$; $f'(x) = 0$ if $\cos x = 0$ or if $\sin(\sin x) = 0$. If $\cos x = 0$, then $x = \pi/2$ is the critical point in $(0, \pi)$; $\sin(\sin x) = 0$ if $\sin x = 0$, which gives no critical points in $(0, \pi)$. Thus $f(0) = 1$, $f(\pi/2) = \cos(1)$, and $f(\pi) = 1$ so the maximum value is 1 and the minimum value is $\cos(1) \approx 0.54030$.

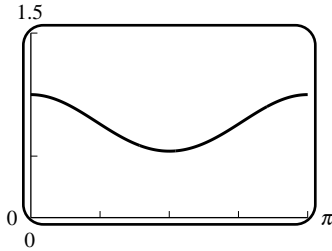

43. $f'(x) = \begin{cases} 4, & x < 1 \\ 2x - 5, & x > 1 \end{cases}$ so $f'(x) = 0$ when $x = 5/2$, and $f'(x)$ does not exist when $x = 1$ because $\lim_{x \rightarrow 1^-} f'(x) \neq \lim_{x \rightarrow 1^+} f'(x)$ (see Theorem preceding Exercise 65, Section 2.3); $f(1/2) = 0$, $f(1) = 2$, $f(5/2) = -1/4$, $f(7/2) = 3/4$ so the maximum value is 2 and the minimum value is $-1/4$.
44. $f'(x) = 2x + p$ which exists throughout the interval $(0, 2)$ for all values of p so $f'(1) = 0$ because $f(1)$ is an extreme value, thus $2 + p = 0$, $p = -2$. $f(1) = 3$ so $1^2 + (-2)(1) + q = 3$, $q = 4$ thus $f(x) = x^2 - 2x + 4$ and $f(0) = 4$, $f(2) = 4$ so $f(1)$ is the minimum value.
45. The period of $f(x)$ is 2π , so check $f(0) = 3$, $f(2\pi) = 3$ and the critical points. $f'(x) = -2\sin x - 2\sin 2x = -2\sin x(1 + 2\cos x) = 0$ on $[0, 2\pi]$ at $x = 0, \pi, 2\pi$ and $x = 2\pi/3, 4\pi/3$. Check $f(\pi) = -1$, $f(2\pi/3) = -3/2$, $f(4\pi/3) = -3/2$. Thus f has an absolute maximum on $(-\infty, +\infty)$ of 3 at $x = 2k\pi$, $k = 0, \pm 1, \pm 2, \dots$ and an absolute minimum of $-3/2$ at $x = 2k\pi \pm 2\pi/3$, $k = 0, \pm 1, \pm 2, \dots$
46. $\cos \frac{x}{3}$ has a period of 6π , and $\cos \frac{x}{2}$ a period of 4π , so $f(x)$ has a period of 12π . Consider the interval $[0, 12\pi]$. $f'(x) = -\sin \frac{x}{3} - \sin \frac{x}{2}$, $f'(x) = 0$ when $\sin \frac{x}{3} + \sin \frac{x}{2} = 0$ thus, by use of the trigonometric identity $\sin a + \sin b = 2\sin \frac{a+b}{2} \cos \frac{a-b}{2}$, $2\sin \left(\frac{5x}{12}\right) \cos \left(-\frac{x}{12}\right) = 0$ so $\sin \frac{5x}{12} = 0$ or $\cos \frac{x}{12} = 0$. Solve $\sin \frac{5x}{12} = 0$ to get $x = 12\pi/5, 24\pi/5, 36\pi/5, 48\pi/5$ and then solve $\cos \frac{x}{12} = 0$ to get $x = 6\pi$. The corresponding values of $f(x)$ are $-4.0450, 1.5450, 1.5450, -4.0450, 1, 5, 5$ so the maximum value is 5 and the minimum value is -4.0450 (approximately).
47. Let $f(x) = x - \sin x$, then $f'(x) = 1 - \cos x$ and so $f'(x) = 0$ when $\cos x = 1$ which has no solution for $0 < x < 2\pi$ thus the minimum value of f must occur at 0 or 2π . $f(0) = 0$, $f(2\pi) = 2\pi$ so 0 is the minimum value on $[0, 2\pi]$ thus $x - \sin x \geq 0$, $\sin x \leq x$ for all x in $[0, 2\pi]$.
48. Let $h(x) = \cos x - 1 + x^2/2$. Then $h(0) = 0$, and it is sufficient to show that $h'(x) \geq 0$ for $0 < x < 2\pi$. But $h'(x) = -\sin x + x \geq 0$ by Exercise 47.
49. Let $m =$ slope at x , then $m = f'(x) = 3x^2 - 6x + 5$, $dm/dx = 6x - 6$; critical point for m is $x = 1$, minimum value of m is $f'(1) = 2$.
50. (a) $\lim_{x \rightarrow 0^+} f(x) = +\infty$, $\lim_{x \rightarrow (\pi/2)^-} f(x) = +\infty$, so f has no maximum value on the interval. By Table 4.4.3 f must have a minimum value.
- (b) According to Table 4.4.3, there is an absolute minimum value of f on $(0, \pi/2)$. To find the absolute minimum value, we examine the critical points (Theorem 4.4.3). $f'(x) = \sec x \tan x - \csc x \cot x = 0$ at $x = \pi/4$, where $f(\pi/4) = 2\sqrt{2}$, which must be the absolute minimum value of f on the interval $(0, \pi/2)$.
51. $\lim_{x \rightarrow +\infty} f(x) = +\infty$, $\lim_{x \rightarrow 8^+} f(x) = +\infty$, so there is no absolute maximum value of f for $x > 8$. By Table 4.4.3 there must be a minimum. Since $f'(x) = \frac{2x(-520 + 192x - 24x^2 + x^3)}{(x-8)^3}$, we must solve a quartic equation to find the critical points. But it is easy to see that $x = 0$ and $x = 10$ are real roots, and the other two are complex. Since $x = 0$ is not in the interval in question, we must have an absolute minimum of f on $(8, +\infty)$ of 125 at $x = 10$.

52. (a) $\frac{dC}{dt} = \frac{K}{a-b} (ae^{-at} - be^{-bt})$ so $\frac{dC}{dt} = 0$ at $t = \frac{\ln(a/b)}{a-b}$. This is the only stationary point and $C(0) = 0$, $\lim_{t \rightarrow +\infty} C(t) = 0$, $C(t) > 0$ for $0 < t < +\infty$, so it is an absolute maximum.

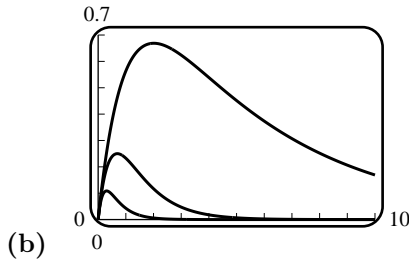

53. The absolute extrema of $y(t)$ can occur at the endpoints $t = 0, 12$ or when $dy/dt = 2 \sin t = 0$, i.e. $t = 0, 12, k\pi$, $k = 1, 2, 3$; the absolute maximum is $y = 4$ at $t = \pi, 3\pi$; the absolute minimum is $y = 0$ at $t = 0, 2\pi$.
54. (a) The absolute extrema of $y(t)$ can occur at the endpoints $t = 0, 2\pi$ or when $dy/dt = 2 \cos 2t - 4 \sin t \cos t = 2 \cos 2t - 2 \sin 2t = 0$, $t = 0, 2\pi, \pi/8, 5\pi/8, 9\pi/8, 13\pi/8$; the absolute maximum is $y \approx 3.4142$ at $t = \pi/8, 9\pi/8$; the absolute minimum is $y \approx 0.5858$ at $t = 5\pi/8, 13\pi/8$.

(b) The absolute extrema of $x(t)$ occur at the endpoints $t = 0, 2\pi$ or when $\frac{dx}{dt} = -\frac{2 \sin t + 1}{(2 + \sin t)^2} = 0$, $t = 7\pi/6, 11\pi/6$. The absolute maximum is $x \approx 0.5774$ at $t = 11\pi/6$ and the absolute minimum is $x \approx -0.5774$ at $t = 7\pi/6$.

55. $f'(x) = 2ax + b$; critical point is $x = -\frac{b}{2a}$. $f''(x) = 2a > 0$ so $f\left(-\frac{b}{2a}\right)$ is the minimum value of f , but $f\left(-\frac{b}{2a}\right) = a\left(-\frac{b}{2a}\right)^2 + b\left(-\frac{b}{2a}\right) + c = \frac{-b^2 + 4ac}{4a}$ thus $f(x) \geq 0$ if and only if $f\left(-\frac{b}{2a}\right) \geq 0$, $\frac{-b^2 + 4ac}{4a} \geq 0$, $-b^2 + 4ac \geq 0$, $b^2 - 4ac \leq 0$.

56. Use the proof given in the text, replacing “maximum” by “minimum” and “largest” by “smallest” and reversing the order of all inequality symbols.

57. If f has an absolute minimum, say at $x = a$, then, for all x , $f(x) \geq f(a) > 0$. But since $\lim_{x \rightarrow +\infty} f(x) = 0$, there is some x such that $f(x) < f(a)$. This contradiction shows that f cannot have an absolute minimum. On the other hand, let $f(x) = \frac{1}{(x^2 - 1)^2 + 1}$. Then $f(x) > 0$ for all x . Also, $\lim_{x \rightarrow +\infty} f(x) = 0$ so the x -axis is an asymptote, both as $x \rightarrow -\infty$ and as $x \rightarrow +\infty$. But since $f(0) = \frac{1}{2} < 1 = f(1) = f(-1)$, the absolute minimum of f on $[-1, 1]$ does not occur at $x = 1$ or $x = -1$, so it is a relative minimum. (In fact it occurs at $x = 0$.)

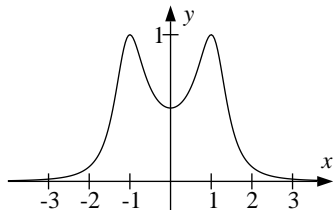

58. At an absolute maximum of a function on an interval, the value of the function is greater than or equal to the value at any other point of the interval. An absolute maximum may occur in the interior of the interval or at an endpoint.

At a relative maximum of a function on an interval, the value of the function is greater than or equal to the values at other nearby points, but not necessarily greater than or equal to the values at distant points in the interval. A relative maximum can only occur in the interior of the interval, not at an endpoint.

This function has a relative maximum at P which is not an absolute maximum, since the value of the function at Q is larger than at P:

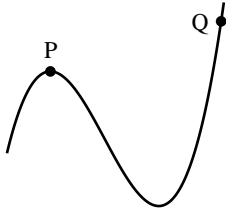

This function has an absolute maximum at P. It is not a relative maximum, since it occurs at an endpoint of the interval where the function is defined.

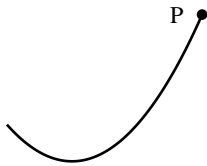

Exercise Set 4.5

- If $y = x + 1/x$ for $1/2 \leq x \leq 3/2$, then $dy/dx = 1 - 1/x^2 = (x^2 - 1)/x^2$, $dy/dx = 0$ when $x = 1$. If $x = 1/2, 1, 3/2$, then $y = 5/2, 2, 13/6$ so
 - y is as small as possible when $x = 1$.
 - y is as large as possible when $x = 1/2$.
- Let x and y be nonnegative numbers and z the sum of their squares, then $z = x^2 + y^2$. But $x + y = 1$, $y = 1 - x$ so $z = x^2 + (1 - x)^2 = 2x^2 - 2x + 1$ for $0 \leq x \leq 1$. $dz/dx = 4x - 2$, $dz/dx = 0$ when $x = 1/2$. If $x = 0, 1/2, 1$ then $z = 1, 1/2, 1$ so
 - z is as large as possible when one number is 0 and the other is 1.
 - z is as small as possible when both numbers are $1/2$.
- $A = xy$ where $x + 2y = 1000$ so $y = 500 - x/2$ and $A = 500x - x^2/2$ for x in $[0, 1000]$; $dA/dx = 500 - x$, $dA/dx = 0$ when $x = 500$. If $x = 0$ or 1000 then $A = 0$, if $x = 500$ then $A = 125,000$ so the area is maximum when $x = 500$ ft and $y = 500 - 500/2 = 250$ ft.

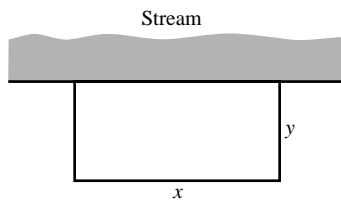

- Let the length of one fenced side be x feet. Then the other fenced side has length $1000 - x$ feet, and the area of the triangle is $A(x) = \frac{1}{2}x(1000 - x) = 500x - \frac{1}{2}x^2$ square feet. We wish to maximize this for x in the interval $[0, 1000]$. The derivative $A'(x) = 500 - x$ equals 0 when $x = 500$, so the maximum area occurs for either $x = 0$, $x = 500$, or $x = 1000$. Since $A(0) = A(1000) = 0$ and $A(500) = 125,000$, the maximum area occurs when both fenced sides are 500 feet long.

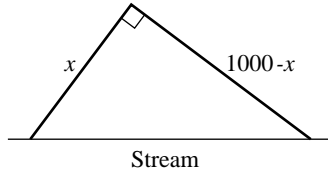

5. Let x and y be the dimensions shown in the figure and A the area, then $A = xy$ subject to the cost condition $3(2x) + 2(2y) = 6000$, or $y = 1500 - 3x/2$. Thus $A = x(1500 - 3x/2) = 1500x - 3x^2/2$ for x in $[0, 1000]$. $dA/dx = 1500 - 3x$, $dA/dx = 0$ when $x = 500$. If $x = 0$ or 1000 then $A = 0$, if $x = 500$ then $A = 375,000$ so the area is greatest when $x = 500$ ft and (from $y = 1500 - 3x/2$) when $y = 750$ ft.

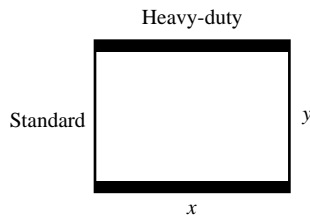

6. Let x and y be the dimensions shown in the figure and A the area of the rectangle, then $A = xy$ and, by similar triangles, $x/6 = (8 - y)/8$, $y = 8 - 4x/3$ so $A = x(8 - 4x/3) = 8x - 4x^2/3$ for x in $[0, 6]$. $dA/dx = 8 - 8x/3$, $dA/dx = 0$ when $x = 3$. If $x = 0, 3, 6$ then $A = 0, 12, 0$ so the area is greatest when $x = 3$ in and (from $y = 8 - 4x/3$) $y = 4$ in.

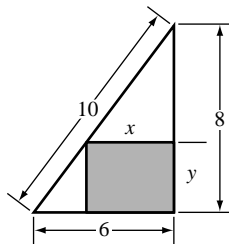

7. Let x, y , and z be as shown in the figure and A the area of the rectangle, then $A = xy$ and, by similar triangles, $z/10 = y/6$, $z = 5y/3$; also $x/10 = (8 - z)/8 = (8 - 5y/3)/8$ thus $y = 24/5 - 12x/25$ so $A = x(24/5 - 12x/25) = 24x/5 - 12x^2/25$ for x in $[0, 10]$. $dA/dx = 24/5 - 24x/25$, $dA/dx = 0$ when $x = 5$. If $x = 0, 5, 10$ then $A = 0, 12, 0$ so the area is greatest when $x = 5$ in and $y = 12/5$ in.

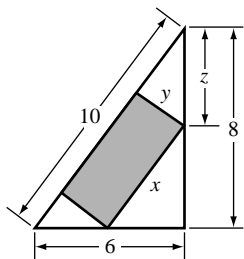

8. $A = (2x)y = 2xy$ where $y = 16 - x^2$ so $A = 32x - 2x^3$ for $0 \leq x \leq 4$; $dA/dx = 32 - 6x^2$, $dA/dx = 0$ when $x = 4/\sqrt{3}$. If $x = 0, 4/\sqrt{3}, 4$ then $A = 0, 256/(3\sqrt{3}), 0$ so the area is largest when $x = 4/\sqrt{3}$ and $y = 32/3$. The dimensions of the rectangle with largest area are $8/\sqrt{3}$ by $32/3$.

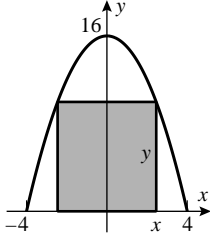

9. $A = xy$ where $x^2 + y^2 = 20^2 = 400$ so $y = \sqrt{400 - x^2}$ and $A = x\sqrt{400 - x^2}$ for $0 \leq x \leq 20$; $dA/dx = 2(200 - x^2)/\sqrt{400 - x^2}$, $dA/dx = 0$ when $x = \sqrt{200} = 10\sqrt{2}$. If $x = 0, 10\sqrt{2}, 20$ then $A = 0, 200, 0$ so the area is maximum when $x = 10\sqrt{2}$ and $y = \sqrt{400 - 200} = 10\sqrt{2}$.

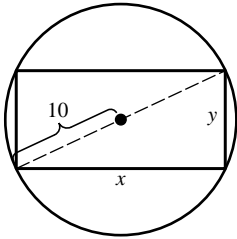

10. The perimeter is $f(x) = 2x + 2y = 2x + 2x^{-2}$; we must minimize this for x in $(0, +\infty)$. Since $\lim_{x \rightarrow 0^+} f(x) = +\infty$, the analysis in Table 4.4.3 implies that f has an absolute minimum on the interval $(0, +\infty)$. This minimum must occur at a critical point, so we compute $f'(x) = 2 - 4x^{-3}$. Solving $f'(x) = 0$ gives $x = \sqrt[3]{2}$. The point P for which the perimeter is smallest is $(\sqrt[3]{2}, \frac{1}{\sqrt[3]{4}})$.

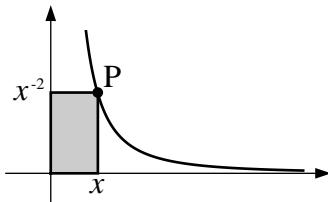

11. Let $x =$ length of each side that uses the \$1 per foot fencing, $y =$ length of each side that uses the \$2 per foot fencing. The cost is $C = (1)(2x) + (2)(2y) = 2x + 4y$, but $A = xy = 3200$ thus $y = 3200/x$ so $C = 2x + 12800/x$ for $x > 0$, $dC/dx = 2 - 12800/x^2$, $dC/dx = 0$ when $x = 80$, $d^2C/dx^2 > 0$ so C is least when $x = 80$, $y = 40$.
12. $A = xy$ where $2x + 2y = p$ so $y = p/2 - x$ and $A = px/2 - x^2$ for x in $[0, p/2]$; $dA/dx = p/2 - 2x$, $dA/dx = 0$ when $x = p/4$. If $x = 0$ or $p/2$ then $A = 0$, if $x = p/4$ then $A = p^2/16$ so the area is maximum when $x = p/4$ and $y = p/2 - p/4 = p/4$, which is a square.

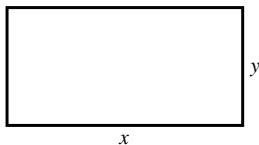

13. Let x and y be the dimensions of a rectangle; the perimeter is $p = 2x + 2y$. But $A = xy$ thus $y = A/x$ so $p = 2x + 2A/x$ for $x > 0$, $dp/dx = 2 - 2A/x^2 = 2(x^2 - A)/x^2$, $dp/dx = 0$ when $x = \sqrt{A}$, $d^2p/dx^2 = 4A/x^3 > 0$ if $x > 0$ so p is a minimum when $x = \sqrt{A}$ and $y = \sqrt{A}$ and thus the rectangle is a square.
14. With $x, y, r,$ and s as shown in the figure, the sum of the enclosed areas is $A = \pi r^2 + s^2$ where $r = \frac{x}{2\pi}$ and $s = \frac{y}{4}$ because x is the circumference of the circle and y is the perimeter of the square, thus $A = \frac{x^2}{4\pi} + \frac{y^2}{16}$. But

$x + y = 12$, so $y = 12 - x$ and $A = \frac{x^2}{4\pi} + \frac{(12 - x)^2}{16} = \frac{\pi + 4}{16\pi}x^2 - \frac{3}{2}x + 9$ for $0 \leq x \leq 12$. $\frac{dA}{dx} = \frac{\pi + 4}{8\pi}x - \frac{3}{2}$, $\frac{dA}{dx} = 0$ when $x = \frac{12\pi}{\pi + 4}$. If $x = 0, \frac{12\pi}{\pi + 4}, 12$ then $A = 9, \frac{36}{\pi + 4}, \frac{36}{\pi}$ so the sum of the enclosed areas is

(a) a maximum when $x = 12$ in (when all of the wire is used for the circle).

(b) a minimum when $x = 12\pi/(\pi + 4)$ in.

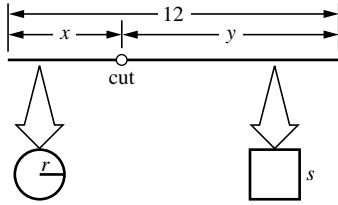

15. Suppose that the lower left corner of S is at $(x, -3x)$. From the figure it's clear that the maximum area of the intersection of R and S occurs for some x in $[-4, 4]$, and the area is $A(x) = (8 - x)(12 + 3x) = 96 + 12x - 3x^2$. Since $A'(x) = 12 - 6x = 6(2 - x)$ is positive for $x < 2$ and negative for $x > 2$, $A(x)$ is increasing for x in $[-4, 2]$ and decreasing for x in $[2, 4]$. So the maximum area is $A(2) = 108$.

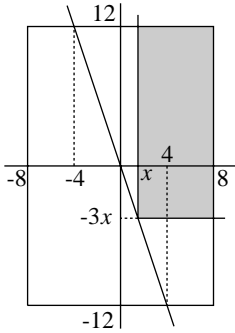

16. Suppose that the lower left corner of S is at $(x, -3x)$. As in Exercise 15, it's clear that the maximum intersection occurs for some x in $[-4, 4]$. If $-4 \leq x \leq \frac{4}{3}$, then the area is the same as in Exercise 15, $A(x) = (8 - x)(12 + 3x) = 96 + 12x - 3x^2$. But if $\frac{4}{3} \leq x \leq 4$, then the height of the intersection is only 16, so the area is $A(x) = 16(8 - x)$. For x in $(-4, \frac{4}{3})$, $A'(x) = 6(2 - x) > 0$, so $A(x)$ is increasing on $[-4, \frac{4}{3}]$. For x in $(\frac{4}{3}, 4)$, $A'(x) = -16$, so $A(x)$ is decreasing on $[\frac{4}{3}, 4]$. Hence the maximum area is $A(\frac{4}{3}) = \frac{320}{3}$.

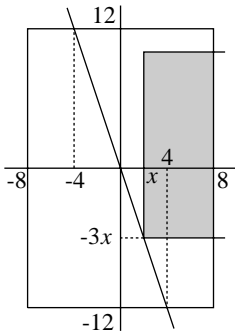

17. Suppose that the lower left corner of S is at $(x, -6x)$. From the figure it's clear that the maximum area of the intersection of R and S occurs for some x in $[-2, 2]$, and the area is $A(x) = (8 - x)(12 + 6x) = 96 + 36x - 6x^2$. Since $A'(x) = 36 - 12x = 12(3 - x)$ is positive for $x < 3$, $A(x)$ is increasing for x in $[-2, 2]$. So the maximum area is $A(2) = 144$.

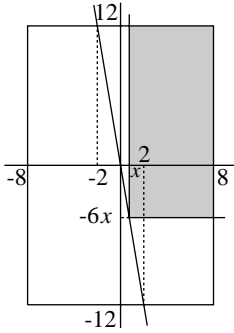

18. Suppose the printable area has width x inches; then its height is $\frac{42}{x}$ inches. The width of the paper is $x + 3$ inches and its height is $\frac{42}{x} + 2$ inches, so its area is $A(x) = (x + 3) \left(\frac{42}{x} + 2 \right) = 2x + 48 + \frac{126}{x}$ square inches. We must minimize this for x in $(0, +\infty)$. Since $A'(x) = 2 - \frac{126}{x^2} = \frac{2(x^2 - 63)}{x^2}$, $A(x)$ is decreasing on $(0, \sqrt{63})$ and increasing on $(\sqrt{63}, +\infty)$. So the minimum area occurs for $x = \sqrt{63} = 3\sqrt{7}$; the width of the paper is $3\sqrt{7} + 3$ inches and the height is $2\sqrt{7} + 2$ inches.

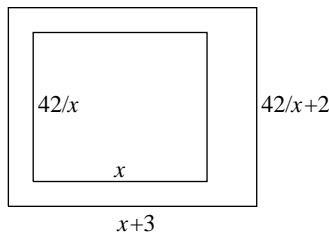

19. Let the box have dimensions x, x, y , with $y \geq x$. The constraint is $4x + y \leq 108$, and the volume $V = x^2y$. If we take $y = 108 - 4x$ then $V = x^2(108 - 4x)$ and $dV/dx = 12x(-x + 18)$ with roots $x = 0, 18$. The maximum value of V occurs at $x = 18, y = 36$ with $V = 11,664 \text{ in}^3$. The First Derivative Test shows this is indeed a maximum.
20. Let the box have dimensions x, x, y with $x \geq y$. The constraint is $x + 2(x + y) \leq 108$, and the volume $V = x^2y$. Take $x = (108 - 2y)/3 = 36 - 2y/3$, $V = y(36 - 2y/3)^2$, $dV/dy = (4/3)y^2 - 96y + 1296$ with roots $y = 18, 54$. Then $d^2V/dy^2 = (8/3)y - 96$ is negative for $y = 18$, so by the second derivative test, V has a maximum of $10,368 \text{ in}^3$ at $y = 18, x = 24$.
21. Let x be the length of each side of a square, then $V = x(3 - 2x)(8 - 2x) = 4x^3 - 22x^2 + 24x$ for $0 \leq x \leq 3/2$; $dV/dx = 12x^2 - 44x + 24 = 4(3x - 2)(x - 3)$, $dV/dx = 0$ when $x = 2/3$ for $0 < x < 3/2$. If $x = 0, 2/3, 3/2$ then $V = 0, 200/27, 0$ so the maximum volume is $200/27 \text{ ft}^3$.
22. Let $x =$ length of each edge of base, $y =$ height. The cost is $C = (\text{cost of top and bottom}) + (\text{cost of sides}) = (2)(2x^2) + (3)(4xy) = 4x^2 + 12xy$, but $V = x^2y = 2250$, thus $y = 2250/x^2$, so $C = 4x^2 + 27000/x$ for $x > 0$, $dC/dx = 8x - 27000/x^2$, $dC/dx = 0$ when $x = \sqrt[3]{3375} = 15$, $d^2C/dx^2 > 0$ so C is least when $x = 15, y = 10$.
23. Let $x =$ length of each edge of base, $y =$ height, $k =$ \$/cm² for the sides. The cost is $C = (2k)(2x^2) + (k)(4xy) = 4k(x^2 + xy)$, but $V = x^2y = 2000$ thus $y = 2000/x^2$ so $C = 4k(x^2 + 2000/x)$ for $x > 0$, $dC/dx = 4k(2x - 2000/x^2)$, $dC/dx = 0$ when $x = \sqrt[3]{1000} = 10$, $d^2C/dx^2 > 0$ so C is least when $x = 10, y = 20$.
24. Let x and y be the dimensions shown in the figure and V the volume, then $V = x^2y$. The amount of material is to be 1000 ft^2 , thus (area of base) + (area of sides) = 1000 , $x^2 + 4xy = 1000$, $y = \frac{1000 - x^2}{4x}$ so $V = x^2 \frac{1000 - x^2}{4x} =$

$\frac{1}{4}(1000x - x^3)$ for $0 < x \leq 10\sqrt{10}$. $\frac{dV}{dx} = \frac{1}{4}(1000 - 3x^2)$, $\frac{dV}{dx} = 0$ when $x = \sqrt{1000/3} = 10\sqrt{10/3}$. If $x = 0, 10\sqrt{10/3}, 10\sqrt{10}$ then $V = 0, \frac{5000}{3}\sqrt{10/3}, 0$; the volume is greatest for $x = 10\sqrt{10/3}$ ft and $y = 5\sqrt{10/3}$ ft.

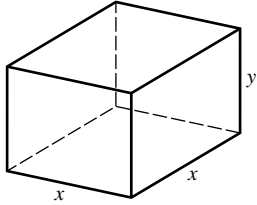

25. Let $x =$ height and width, $y =$ length. The surface area is $S = 2x^2 + 3xy$ where $x^2y = V$, so $y = V/x^2$ and $S = 2x^2 + 3V/x$ for $x > 0$; $dS/dx = 4x - 3V/x^2$, $dS/dx = 0$ when $x = \sqrt[3]{3V/4}$, $d^2S/dx^2 > 0$ so S is minimum when $x = \sqrt[3]{\frac{3V}{4}}$, $y = \frac{4}{3}\sqrt[3]{\frac{3V}{4}}$.

26. The area of the window is $A = 2rh + \pi r^2/2$, the perimeter is $p = 2r + 2h + \pi r$ thus $h = \frac{1}{2}[p - (2 + \pi)r]$ so $A = r[p - (2 + \pi)r] + \pi r^2/2 = pr - (2 + \pi/2)r^2$ for $0 \leq r \leq p/(2 + \pi)$, $dA/dr = p - (4 + \pi)r$, $dA/dr = 0$ when $r = p/(4 + \pi)$ and $d^2A/dr^2 < 0$, so A is maximum when $r = p/(4 + \pi)$.

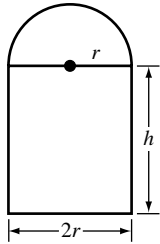

27. Let r and h be the dimensions shown in the figure, then the volume of the inscribed cylinder is $V = \pi r^2 h$. But $r^2 + \left(\frac{h}{2}\right)^2 = R^2$ so $r^2 = R^2 - \frac{h^2}{4}$. Hence $V = \pi \left(R^2 - \frac{h^2}{4}\right) h = \pi \left(R^2 h - \frac{h^3}{4}\right)$ for $0 \leq h \leq 2R$. $\frac{dV}{dh} = \pi \left(R^2 - \frac{3}{4}h^2\right)$, $\frac{dV}{dh} = 0$ when $h = 2R/\sqrt{3}$. If $h = 0, 2R/\sqrt{3}, 2R$ then $V = 0, \frac{4\pi}{3\sqrt{3}}R^3, 0$ so the volume is largest when $h = 2R/\sqrt{3}$ and $r = \sqrt{2/3}R$.

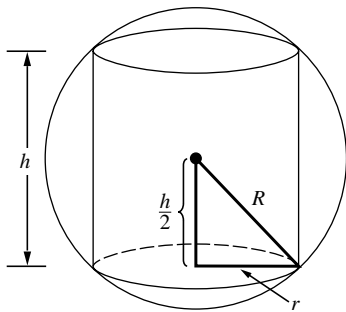

28. Let r and h be the dimensions shown in the figure, then the surface area is $S = 2\pi r h + 2\pi r^2$. But $r^2 + \left(\frac{h}{2}\right)^2 = R^2$ so $h = 2\sqrt{R^2 - r^2}$. Hence $S = 4\pi r\sqrt{R^2 - r^2} + 2\pi r^2$ for $0 \leq r \leq R$, $\frac{dS}{dr} = \frac{4\pi(R^2 - 2r^2)}{\sqrt{R^2 - r^2}} + 4\pi r$; $\frac{dS}{dr} = 0$ when $\frac{R^2 - 2r^2}{\sqrt{R^2 - r^2}} = -r$, $R^2 - 2r^2 = -r\sqrt{R^2 - r^2}$, $R^4 - 4R^2r^2 + 4r^4 = r^2(R^2 - r^2)$, $5r^4 - 5R^2r^2 + R^4 = 0$, and using the quadratic formula $r^2 = \frac{5R^2 \pm \sqrt{25R^4 - 20R^4}}{10} = \frac{5 \pm \sqrt{5}}{10}R^2$, $r = \sqrt{\frac{5 \pm \sqrt{5}}{10}}R$, of which only $r = \sqrt{\frac{5 + \sqrt{5}}{10}}R$

satisfies the original equation. If $r = 0, \sqrt{\frac{5 + \sqrt{5}}{10}}R, 0$ then $S = 0, (5 + \sqrt{5})\pi R^2, 2\pi R^2$ so the surface area is greatest when $r = \sqrt{\frac{5 + \sqrt{5}}{10}}R$ and, from $h = 2\sqrt{R^2 - r^2}, h = 2\sqrt{\frac{5 - \sqrt{5}}{10}}R$.

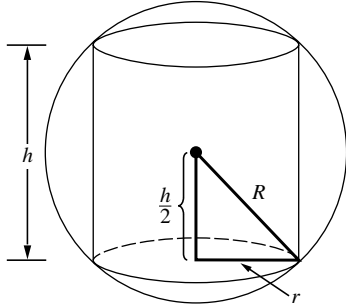

29. From (13), $S = 2\pi r^2 + 2\pi r h$. But $V = \pi r^2 h$ thus $h = V/(\pi r^2)$ and so $S = 2\pi r^2 + 2V/r$ for $r > 0$. $dS/dr = 4\pi r - 2V/r^2, dS/dr = 0$ if $r = \sqrt[3]{V/(2\pi)}$. Since $d^2S/dr^2 = 4\pi + 4V/r^3 > 0$, the minimum surface area is achieved when $r = \sqrt[3]{V/2\pi}$ and so $h = V/(\pi r^2) = [V/(\pi r^3)]r = 2r$.
30. $V = \pi r^2 h$ where $S = 2\pi r^2 + 2\pi r h$ so $h = \frac{S - 2\pi r^2}{2\pi r}, V = \frac{1}{2}(Sr - 2\pi r^3)$ for $r > 0$. $\frac{dV}{dr} = \frac{1}{2}(S - 6\pi r^2) = 0$ if $r = \sqrt{S/(6\pi)}, \frac{d^2V}{dr^2} = -6\pi r < 0$ so V is maximum when $r = \sqrt{S/(6\pi)}$ and $h = \frac{S - 2\pi r^2}{2\pi r} = \frac{S - 2\pi r^2}{2\pi r} = \frac{S - S/3}{S/3}r = 2r$, thus the height is equal to the diameter of the base.
31. The surface area is $S = \pi r^2 + 2\pi r h$ where $V = \pi r^2 h = 500$ so $h = 500/(\pi r^2)$ and $S = \pi r^2 + 1000/r$ for $r > 0$; $dS/dr = 2\pi r - 1000/r^2 = (2\pi r^3 - 1000)/r^2, dS/dr = 0$ when $r = \sqrt[3]{500/\pi}, d^2S/dr^2 > 0$ for $r > 0$ so S is minimum when $r = \sqrt[3]{500/\pi}$ cm and $h = \frac{500}{\pi r^2} = \frac{500}{\pi} \left(\frac{\pi}{500}\right)^{2/3} = \sqrt[3]{500/\pi}$ cm.

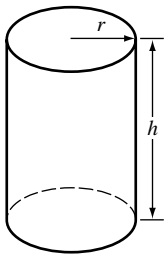

32. The total area of material used is $A = A_{\text{top}} + A_{\text{bottom}} + A_{\text{side}} = (2r)^2 + (2r)^2 + 2\pi r h = 8r^2 + 2\pi r h$. The volume is $V = \pi r^2 h$ thus $h = V/(\pi r^2)$ so $A = 8r^2 + 2V/r$ for $r > 0$, $dA/dr = 16r - 2V/r^2 = 2(8r^3 - V)/r^2, dA/dr = 0$ when $r = \sqrt[3]{V}/2$. This is the only critical point, $d^2A/dr^2 > 0$ there so the least material is used when $r = \sqrt[3]{V}/2$, $\frac{r}{h} = \frac{r}{V/(\pi r^2)} = \frac{\pi}{V}r^3$ and, for $r = \sqrt[3]{V}/2, \frac{r}{h} = \frac{\pi V}{V} = \frac{\pi}{8}$.
33. Let x be the length of each side of the squares and y the height of the frame, then the volume is $V = x^2 y$. The total length of the wire is L thus $8x + 4y = L, y = (L - 8x)/4$ so $V = x^2(L - 8x)/4 = (Lx^2 - 8x^3)/4$ for $0 \leq x \leq L/8$. $dV/dx = (2Lx - 24x^2)/4, dV/dx = 0$ for $0 < x < L/8$ when $x = L/12$. If $x = 0, L/12, L/8$ then $V = 0, L^3/1728, 0$ so the volume is greatest when $x = L/12$ and $y = L/12$.
34. (a) Let $x =$ diameter of the sphere, $y =$ length of an edge of the cube. The combined volume is $V = \frac{1}{6}\pi x^3 + y^3$ and the surface area is $S = \pi x^2 + 6y^2 = \text{constant}$. Thus $y = \frac{(S - \pi x^2)^{1/2}}{6^{1/2}}$ and $V = \frac{\pi}{6}x^3 + \frac{(S - \pi x^2)^{3/2}}{6^{3/2}}$ for

$0 \leq x \leq \sqrt{\frac{S}{\pi}}$; $\frac{dV}{dx} = \frac{\pi}{2}x^2 - \frac{3\pi}{6^{3/2}}x(S - \pi x^2)^{1/2} = \frac{\pi}{2\sqrt{6}}x(\sqrt{6}x - \sqrt{S - \pi x^2})$. $\frac{dV}{dx} = 0$ when $x = 0$, or when $\sqrt{6}x = \sqrt{S - \pi x^2}$, $6x^2 = S - \pi x^2$, $x^2 = \frac{S}{6 + \pi}$, $x = \sqrt{\frac{S}{6 + \pi}}$. If $x = 0$, $\sqrt{\frac{S}{6 + \pi}}$, $\sqrt{\frac{S}{\pi}}$, then $V = \frac{S^{3/2}}{6^{3/2}}$, $\frac{S^{3/2}}{6\sqrt{6 + \pi}}$, $\frac{S^{3/2}}{6\sqrt{\pi}}$ so that V is smallest when $x = \sqrt{\frac{S}{6 + \pi}}$, and hence when $y = \sqrt{\frac{S}{6 + \pi}}$, thus $x = y$.

(b) From part (a), the sum of the volumes is greatest when there is no cube.

35. Let h and r be the dimensions shown in the figure, then the volume is $V = \frac{1}{3}\pi r^2 h$. But $r^2 + h^2 = L^2$ thus $r^2 = L^2 - h^2$ so $V = \frac{1}{3}\pi(L^2 - h^2)h = \frac{1}{3}\pi(L^2 h - h^3)$ for $0 \leq h \leq L$. $\frac{dV}{dh} = \frac{1}{3}\pi(L^2 - 3h^2)$. $\frac{dV}{dh} = 0$ when $h = L/\sqrt{3}$. If $h = 0, L/\sqrt{3}, 0$ then $V = 0, \frac{2\pi}{9\sqrt{3}}L^3, 0$ so the volume is as large as possible when $h = L/\sqrt{3}$ and $r = \sqrt{2/3}L$.

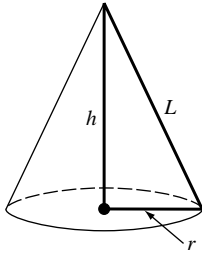

36. Let r and h be the radius and height of the cone (see figure). The slant height of any such cone will be R , the radius of the circular sheet. Refer to the solution of Exercise 35 to find that the largest volume is $\frac{2\pi}{9\sqrt{3}}R^3$.

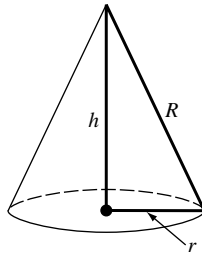

37. The area of the paper is $A = \pi r L = \pi r \sqrt{r^2 + h^2}$, but $V = \frac{1}{3}\pi r^2 h = 100$ so $h = 300/(\pi r^2)$ and $A = \pi r \sqrt{r^2 + 90000/(\pi^2 r^4)}$. To simplify the computations let $S = A^2$, $S = \pi^2 r^2 \left(r^2 + \frac{90000}{\pi^2 r^4} \right) = \pi^2 r^4 + \frac{90000}{r^2}$ for $r > 0$, $\frac{dS}{dr} = 4\pi^2 r^3 - \frac{180000}{r^3} = \frac{4(\pi^2 r^6 - 45000)}{r^3}$, $dS/dr = 0$ when $r = \sqrt[6]{45000/\pi^2}$, $d^2S/dr^2 > 0$, so S and hence A is least when $r = \sqrt[6]{45000/\pi^2} = \sqrt{2} \sqrt[3]{75/\pi}$ cm, $h = \frac{300}{\pi} \sqrt[3]{\pi^2/45000} = 2 \sqrt[3]{75/\pi}$ cm.

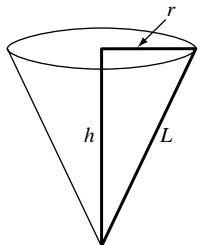

38. The area of the triangle is $A = \frac{1}{2}hb$. By similar triangles (see figure) $\frac{b/2}{h} = \frac{R}{\sqrt{h^2 - 2Rh}}$, $b = \frac{2Rh}{\sqrt{h^2 - 2Rh}}$ so

$A = \frac{Rh^2}{\sqrt{h^2 - 2Rh}}$ for $h > 2R$, $\frac{dA}{dh} = \frac{Rh^2(h - 3R)}{(h^2 - 2Rh)^{3/2}}$, $\frac{dA}{dh} = 0$ for $h > 2R$ when $h = 3R$, by the first derivative test A is minimum when $h = 3R$. If $h = 3R$ then $b = 2\sqrt{3}R$ (the triangle is equilateral).

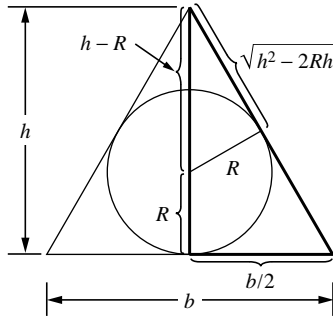

39. The volume of the cone is $V = \frac{1}{3}\pi r^2 h$. By similar triangles (see figure) $\frac{r}{h} = \frac{R}{\sqrt{h^2 - 2Rh}}$, $r = \frac{Rh}{\sqrt{h^2 - 2Rh}}$ so $V = \frac{1}{3}\pi R^2 \frac{h^3}{h^2 - 2Rh} = \frac{1}{3}\pi R^2 \frac{h^2}{h - 2R}$ for $h > 2R$, $\frac{dV}{dh} = \frac{1}{3}\pi R^2 \frac{h(h - 4R)}{(h - 2R)^2}$, $\frac{dV}{dh} = 0$ for $h > 2R$ when $h = 4R$, by the first derivative test V is minimum when $h = 4R$. If $h = 4R$ then $r = \sqrt{2}R$.

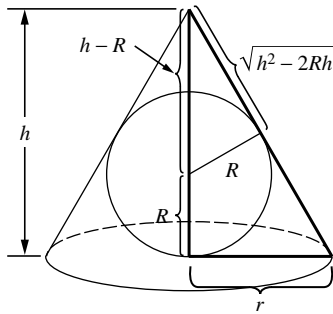

40. Let x = number of steers per acre, w = average market weight per steer, T = total market weight per acre. Then $T = xw$ where $w = 2000 - 50(x - 20) = 3000 - 50x$ so $T = x(3000 - 50x) = 3000x - 50x^2$ for $0 \leq x \leq 60$, $dT/dx = 3000 - 100x$ and $dT/dx = 0$ when $x = 30$. If $x = 0, 30, 60$ then $T = 0, 45000, 0$ so the total market weight per acre is largest when 30 steers per acre are allowed.
41. The revenue is $R(x) = x(225 - 0.25x) = 225x - 0.25x^2$. The marginal revenue is $R'(x) = 225 - 0.5x = \frac{1}{2}(450 - x)$. Since $R'(x) > 0$ for $x < 450$ and $R'(x) < 0$ for $x > 450$, the maximum revenue occurs when the company mines 450 tons of ore.
42. The revenue from producing x units of fertilizer is $R(x) = x(300 - 0.1x) = 300x - 0.1x^2$, so the profit is $P(x) = R(x) - C(x) = -15000 + 175x - 0.125x^2$; we must maximize this for x in $[0, 1000]$. The marginal profit is $P'(x) = 175 - 0.25x$, so the maximum profit occurs when the producer manufactures 700 units of fertilizer.
43. (a) The daily profit is $P = (\text{revenue}) - (\text{production cost}) = 100x - (100,000 + 50x + 0.0025x^2) = -100,000 + 50x - 0.0025x^2$ for $0 \leq x \leq 7000$, so $dP/dx = 50 - 0.005x$ and $dP/dx = 0$ when $x = 10,000$. Because 10,000 is not in the interval $[0, 7000]$, the maximum profit must occur at an endpoint. When $x = 0$, $P = -100,000$; when $x = 7000$, $P = 127,500$ so 7000 units should be manufactured and sold daily.
- (b) Yes, because $dP/dx > 0$ when $x = 7000$ so profit is increasing at this production level.
- (c) $dP/dx = 15$ when $x = 7000$, so $P(7001) - P(7000) \approx 15$, and the marginal profit is \$15.
44. (a) $R(x) = px$ but $p = 1000 - x$ so $R(x) = (1000 - x)x$.
- (b) $P(x) = R(x) - C(x) = (1000 - x)x - (3000 + 20x) = -3000 + 980x - x^2$.

(c) $P'(x) = 980 - 2x$, $P'(x) = 0$ for $0 < x < 500$ when $x = 490$; test the points 0, 490, 500 to find that the profit is a maximum when $x = 490$.

(d) $P(490) = 237,100$.

(e) $p = 1000 - x = 1000 - 490 = 510$.

45. The profit is $P = (\text{profit on nondefective}) - (\text{loss on defective}) = 100(x - y) - 20y = 100x - 120y$ but $y = 0.01x + 0.00003x^2$, so $P = 100x - 120(0.01x + 0.00003x^2) = 98.8x - 0.0036x^2$ for $x > 0$, $dP/dx = 98.8 - 0.0072x$, $dP/dx = 0$ when $x = 98.8/0.0072 \approx 13,722$, $d^2P/dx^2 < 0$ so the profit is maximum at a production level of about 13,722 pounds.

46. To cover 1 mile requires $1/v$ hours, and $1/(10 - 0.07v)$ gallons of diesel fuel, so the total cost to the client is $C = \frac{15}{v} + \frac{2.50}{10 - 0.07v}$, $\frac{dC}{dv} = \frac{0.1015v^2 + 21v - 1500}{v^2(0.07v - 10)^2}$. By the second derivative test, C has a minimum of about 67.9 cents/mile at $v \approx 56.18$ miles per hour.

47. The area is (see figure) $A = \frac{1}{2}(2 \sin \theta)(4 + 4 \cos \theta) = 4(\sin \theta + \sin \theta \cos \theta)$ for $0 \leq \theta \leq \pi/2$; $dA/d\theta = 4(\cos \theta - \sin^2 \theta + \cos^2 \theta) = 4(\cos \theta - [1 - \cos^2 \theta] + \cos^2 \theta) = 4(2 \cos^2 \theta + \cos \theta - 1) = 4(2 \cos \theta - 1)(\cos \theta + 1)$. $dA/d\theta = 0$ when $\theta = \pi/3$ for $0 < \theta < \pi/2$. If $\theta = 0, \pi/3, \pi/2$ then $A = 0, 3\sqrt{3}, 4$ so the maximum area is $3\sqrt{3}$.

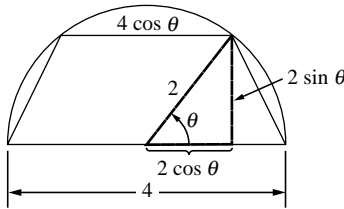

48. Let b and h be the dimensions shown in the figure, then the cross-sectional area is $A = \frac{1}{2}h(5 + b)$. But $h = 5 \sin \theta$ and $b = 5 + 2(5 \cos \theta) = 5 + 10 \cos \theta$ so $A = \frac{5}{2} \sin \theta(10 + 10 \cos \theta) = 25 \sin \theta(1 + \cos \theta)$ for $0 \leq \theta \leq \pi/2$. $dA/d\theta = -25 \sin^2 \theta + 25 \cos \theta(1 + \cos \theta) = 25(-\sin^2 \theta + \cos \theta + \cos^2 \theta) = 25(-1 + \cos^2 \theta + \cos \theta + \cos^2 \theta) = 25(2 \cos^2 \theta + \cos \theta - 1) = 25(2 \cos \theta - 1)(\cos \theta + 1)$. $dA/d\theta = 0$ for $0 < \theta < \pi/2$ when $\cos \theta = 1/2$, $\theta = \pi/3$. If $\theta = 0, \pi/3, \pi/2$ then $A = 0, 75\sqrt{3}/4, 25$ so the cross-sectional area is greatest when $\theta = \pi/3$.

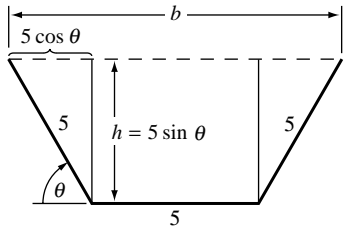

49. $I = k \frac{\cos \phi}{\ell^2}$, k the constant of proportionality. If h is the height of the lamp above the table then $\cos \phi = h/\ell$ and $\ell = \sqrt{h^2 + r^2}$ so $I = k \frac{h}{\ell^3} = k \frac{h}{(h^2 + r^2)^{3/2}}$ for $h > 0$, $\frac{dI}{dh} = k \frac{r^2 - 2h^2}{(h^2 + r^2)^{5/2}}$, $\frac{dI}{dh} = 0$ when $h = r/\sqrt{2}$, by the first derivative test I is maximum when $h = r/\sqrt{2}$.

50. Let $L, L_1,$ and L_2 be as shown in the figure, then $L = L_1 + L_2 = 8 \csc \theta + \sec \theta$, $\frac{dL}{d\theta} = -8 \csc \theta \cot \theta + \sec \theta \tan \theta = -\frac{8 \cos \theta}{\sin^2 \theta} + \frac{\sin \theta}{\cos^2 \theta} = \frac{-8 \cos^3 \theta + \sin^3 \theta}{\sin^2 \theta \cos^2 \theta}$, $0 < \theta < \pi/2$; $\frac{dL}{d\theta} = 0$ if $\sin^3 \theta = 8 \cos^3 \theta$, $\tan^3 \theta = 8$, $\tan \theta = 2$ which gives the absolute minimum for L because $\lim_{\theta \rightarrow 0^+} L = \lim_{\theta \rightarrow \pi/2^-} L = +\infty$. If $\tan \theta = 2$, then $\csc \theta = \sqrt{5}/2$ and $\sec \theta = \sqrt{5}$ so $L = 8(\sqrt{5}/2) + \sqrt{5} = 5\sqrt{5}$ ft.

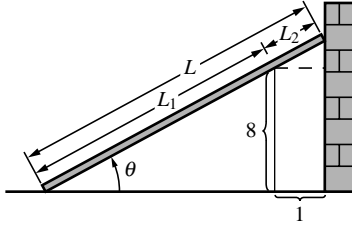

51. The distance between the particles is $D = \sqrt{(1-t-t)^2 + (t-2t)^2} = \sqrt{5t^2 - 4t + 1}$ for $t \geq 0$. For convenience, we minimize D^2 instead, so $D^2 = 5t^2 - 4t + 1$, $dD^2/dt = 10t - 4$, which is 0 when $t = 2/5$. $d^2D^2/dt^2 > 0$ so D^2 hence D is minimum when $t = 2/5$. The minimum distance is $D = 1/\sqrt{5}$.

52. The distance between the particles is $D = \sqrt{(2t-t)^2 + (2-t^2)^2} = \sqrt{t^4 - 3t^2 + 4}$ for $t \geq 0$. For convenience, we minimize D^2 instead, so $D^2 = t^4 - 3t^2 + 4$, $dD^2/dt = 4t^3 - 6t = 4t(t^2 - 3/2)$, which is 0 for $t > 0$ when $t = \sqrt{3/2}$. $d^2D^2/dt^2 = 12t^2 - 6 > 0$ when $t = \sqrt{3/2}$ so D^2 hence D is minimum there. The minimum distance is $D = \sqrt{7/2}$.

53. If $P(x_0, y_0)$ is on the curve $y = 1/x^2$, then $y_0 = 1/x_0^2$. At P the slope of the tangent line is $-2/x_0^3$ so its equation is $y - \frac{1}{x_0^2} = -\frac{2}{x_0^3}(x - x_0)$, or $y = -\frac{2}{x_0^3}x + \frac{3}{x_0^2}$. The tangent line crosses the y -axis at $\frac{3}{x_0^2}$, and the x -axis at $\frac{3}{2}x_0$.

The length of the segment then is $L = \sqrt{\frac{9}{x_0^4} + \frac{9}{4}x_0^2}$ for $x_0 > 0$. For convenience, we minimize L^2 instead, so $L^2 = \frac{9}{x_0^4} + \frac{9}{4}x_0^2$, $\frac{dL^2}{dx_0} = -\frac{36}{x_0^5} + \frac{9}{2}x_0 = \frac{9(x_0^6 - 8)}{2x_0^5}$, which is 0 when $x_0^6 = 8$, $x_0 = \sqrt{2}$. $\frac{d^2L^2}{dx_0^2} > 0$ so L^2 and hence L is minimum when $x_0 = \sqrt{2}$, $y_0 = 1/2$.

54. If $P(x_0, y_0)$ is on the curve $y = 1 - x^2$, then $y_0 = 1 - x_0^2$. At P the slope of the tangent line is $-2x_0$ so its equation is $y - (1 - x_0^2) = -2x_0(x - x_0)$, or $y = -2x_0x + x_0^2 + 1$. The y -intercept is $x_0^2 + 1$ and the x -intercept is $\frac{1}{2}(x_0 + 1/x_0)$ so the area A of the triangle is $A = \frac{1}{4}(x_0^2 + 1)(x_0 + 1/x_0) = \frac{1}{4}(x_0^3 + 2x_0 + 1/x_0)$ for $0 \leq x_0 \leq 1$. $dA/dx_0 = \frac{1}{4}(3x_0^2 + 2 - 1/x_0^2) = \frac{1}{4}(3x_0^4 + 2x_0^2 - 1)/x_0^2$ which is 0 when $x_0^2 = -1$ (reject), or when $x_0^2 = 1/3$ so $x_0 = 1/\sqrt{3}$. $d^2A/dx_0^2 = \frac{1}{4}(6x_0 + 2/x_0^3) > 0$ at $x_0 = 1/\sqrt{3}$ so a relative minimum and hence the absolute minimum occurs there.

55. At each point (x, y) on the curve the slope of the tangent line is $m = \frac{dy}{dx} = -\frac{2x}{(1+x^2)^2}$ for any x , $\frac{dm}{dx} = \frac{2(3x^2 - 1)}{(1+x^2)^3}$, $\frac{dm}{dx} = 0$ when $x = \pm 1/\sqrt{3}$, by the first derivative test the only relative maximum occurs at $x = -1/\sqrt{3}$, which is the absolute maximum because $\lim_{x \rightarrow \pm\infty} m = 0$. The tangent line has greatest slope at the point $(-1/\sqrt{3}, 3/4)$.

56. (a) $\frac{dN}{dt} = 250(20-t)e^{-t/20} = 0$ at $t = 20$, $N(0) = 125,000$, $N(20) \approx 161,788$, and $N(100) \approx 128,369$; the absolute maximum is $N = 161,788$ at $t = 20$, the absolute minimum is $N = 125,000$ at $t = 0$.

(b) The absolute minimum of $\frac{dN}{dt}$ occurs when $\frac{d^2N}{dt^2} = 12.5(t-40)e^{-t/20} = 0$, $t = 40$. The First Derivative Test shows that this is indeed a minimum value.

57. Let C be the center of the circle and let θ be the angle $\angle PWE$. Then $\angle PCE = 2\theta$, so the distance along the shore from E to P is 2θ miles. Also, the distance from P to W is $2 \cos \theta$ miles. So Nancy takes $t(\theta) = \frac{2\theta}{8} + \frac{2 \cos \theta}{2} = \frac{\theta}{4} + \cos \theta$ hours for her training routine; we wish to find the extrema of this for θ in $[0, \frac{\pi}{2}]$. We have $t'(\theta) = \frac{1}{4} - \sin \theta$, so the only critical point in $[0, \frac{\pi}{2}]$ is $\theta = \sin^{-1}(\frac{1}{4})$. So we compute $t(0) = 1$, $t(\sin^{-1}(\frac{1}{4})) = \frac{1}{4} \sin^{-1}(\frac{1}{4}) + \frac{\sqrt{15}}{4} \approx 1.0314$,

and $t(\frac{\pi}{2}) = \frac{\pi}{8} \approx 0.3927$.

(a) The minimum is $t(\frac{\pi}{2}) = \frac{\pi}{8} \approx 0.3927$. To minimize the time, Nancy should choose $P = W$; i.e. she should jog all the way from E to W , π miles.

(b) The maximum is $t(\sin^{-1}(\frac{1}{4})) = \frac{1}{4} \sin^{-1}(\frac{1}{4}) + \frac{\sqrt{15}}{4} \approx 1.0314$. To maximize the time, she should jog $2 \sin^{-1}(\frac{1}{4}) \approx 0.5054$ miles.

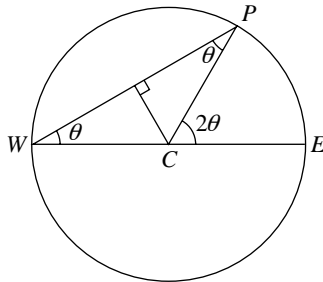

58. Let x be how far P is upstream from where the man starts (see figure), then the total time to reach T is $t =$ (time from M to P) + (time from P to T) = $\frac{\sqrt{x^2 + 1}}{r_R} + \frac{1-x}{r_W}$ for $0 \leq x \leq 1$, where r_R and r_W are the rates at which he can row and walk, respectively.

(a) $t = \frac{\sqrt{x^2 + 1}}{3} + \frac{1-x}{5}$, $\frac{dt}{dx} = \frac{x}{3\sqrt{x^2 + 1}} - \frac{1}{5}$ so $\frac{dt}{dx} = 0$ when $5x = 3\sqrt{x^2 + 1}$, $25x^2 = 9(x^2 + 1)$, $x^2 = 9/16$, $x = 3/4$. If $x = 0, 3/4, 1$ then $t = 8/15, 7/15, \sqrt{2}/3$ so the time is a minimum when $x = 3/4$ mile.

(b) $t = \frac{\sqrt{x^2 + 1}}{4} + \frac{1-x}{5}$, $\frac{dt}{dx} = \frac{x}{4\sqrt{x^2 + 1}} - \frac{1}{5}$ so $\frac{dt}{dx} = 0$ when $x = 4/3$ which is not in the interval $[0, 1]$. Check the endpoints to find that the time is a minimum when $x = 1$ (he should row directly to the town).

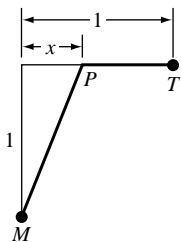

59. With x and y as shown in the figure, the maximum length of pipe will be the smallest value of $L = x + y$. By similar triangles $\frac{y}{8} = \frac{x}{\sqrt{x^2 - 16}}$, $y = \frac{8x}{\sqrt{x^2 - 16}}$ so $L = x + \frac{8x}{\sqrt{x^2 - 16}}$ for $x > 4$, $\frac{dL}{dx} = 1 - \frac{128}{(x^2 - 16)^{3/2}}$, $\frac{dL}{dx} = 0$ when $(x^2 - 16)^{3/2} = 128$, $x^2 - 16 = 128^{2/3} = 16(2^{2/3})$, $x^2 = 16(1 + 2^{2/3})$, $x = 4(1 + 2^{2/3})^{1/2}$, $d^2L/dx^2 = 384x/(x^2 - 16)^{5/2} > 0$ if $x > 4$ so L is smallest when $x = 4(1 + 2^{2/3})^{1/2}$. For this value of x , $L = 4(1 + 2^{2/3})^{3/2}$ ft.

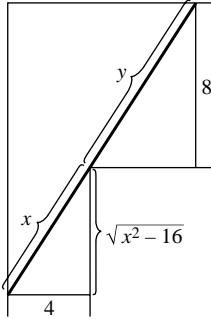

60. Label points as shown at right. Let the distance \overline{AB} be x feet. Since $\overline{BD} = 3$, $\overline{AD} = \sqrt{9 + x^2}$. Since $\overline{AC} = x + 5$ and triangles ABD and ACE are similar, the length of the rod is $L(x) = \overline{AE} = \frac{\overline{AC}}{\overline{AB}} \cdot \overline{AD} = \frac{x+5}{x} \sqrt{9+x^2} = (1+5x^{-1})\sqrt{9+x^2}$. We must minimize this for $x \geq 4$. We have $L'(x) = \frac{x^3-45}{x^2\sqrt{9+x^2}} > 0$ for $x \geq 4$, so L is increasing on $[4, +\infty)$. Hence the minimum length is $L(4) = \frac{45}{4} = 11.25$ feet; it occurs when the left part of the rod lies on top of the left half of the barrier.

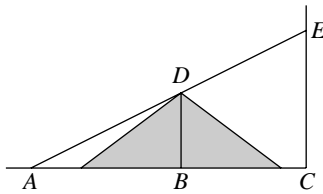

61. Let $x =$ distance from the weaker light source, $I =$ the intensity at that point, and k the constant of proportionality. Then $I = \frac{kS}{x^2} + \frac{8kS}{(90-x)^2}$ if $0 < x < 90$; $\frac{dI}{dx} = -\frac{2kS}{x^3} + \frac{16kS}{(90-x)^3} = \frac{2kS[8x^3 - (90-x)^3]}{x^3(90-x)^3} = 18 \frac{kS(x-30)(x^2+2700)}{x^3(x-90)^3}$, which is 0 when $x = 30$; $\frac{dI}{dx} < 0$ if $x < 30$, and $\frac{dI}{dx} > 0$ if $x > 30$, so the intensity is minimum at a distance of 30 cm from the weaker source.

62. $\theta = \pi - (\alpha + \beta) = \pi - \cot^{-1}(x-2) - \cot^{-1} \frac{5-x}{4}$, $\frac{d\theta}{dx} = \frac{1}{1+(x-2)^2} + \frac{-1/4}{1+(5-x)^2/16} = \frac{-3(x^2-2x-7)}{[1+(x-2)^2][16+(5-x)^2]}$, $\frac{d\theta}{dx} = 0$ when $x = \frac{2 \pm \sqrt{4+28}}{2} = 1 \pm 2\sqrt{2}$, only $1+2\sqrt{2}$ is in $[2, 5]$; $\frac{d\theta}{dx} > 0$ for x in $[2, 1+2\sqrt{2})$, $\frac{d\theta}{dx} < 0$ for x in $(1+2\sqrt{2}, 5]$, θ is maximum when $x = 1+2\sqrt{2}$.

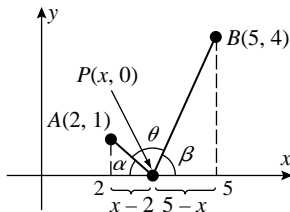

63. $\theta = \alpha - \beta = \cot^{-1}(x/12) - \cot^{-1}(x/2)$, $\frac{d\theta}{dx} = -\frac{12}{144+x^2} + \frac{2}{4+x^2} = \frac{10(24-x^2)}{(144+x^2)(4+x^2)}$, $\frac{d\theta}{dx} = 0$ when $x = \sqrt{24} = 2\sqrt{6}$ feet, by the first derivative test θ is maximum there.

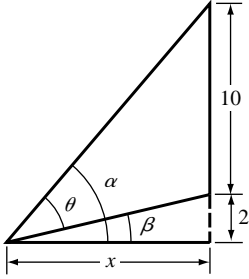

64. Let $v =$ speed of light in the medium. The total time required for the light to travel from A to P to B is $t =$ (total distance from A to P to B)/ $v = \frac{1}{v} (\sqrt{(c-x)^2 + a^2} + \sqrt{x^2 + b^2})$, so $\frac{dt}{dx} = \frac{1}{v} \left[-\frac{c-x}{\sqrt{(c-x)^2 + a^2}} + \frac{x}{\sqrt{x^2 + b^2}} \right]$ and $\frac{dt}{dx} = 0$ when $\frac{x}{\sqrt{x^2 + b^2}} = \frac{c-x}{\sqrt{(c-x)^2 + a^2}}$. But $x/\sqrt{x^2 + b^2} = \sin \theta_2$ and $(c-x)/\sqrt{(c-x)^2 + a^2} = \sin \theta_1$. Hence $dt/dx = 0$ when $\sin \theta_2 = \sin \theta_1$, so $\theta_2 = \theta_1$.
65. The total time required for the light to travel from A to P to B is $t =$ (time from A to P) + (time from P to B) = $\frac{\sqrt{x^2 + a^2}}{v_1} + \frac{\sqrt{(c-x)^2 + b^2}}{v_2}$, $\frac{dt}{dx} = \frac{x}{v_1 \sqrt{x^2 + a^2}} - \frac{c-x}{v_2 \sqrt{(c-x)^2 + b^2}}$ but $x/\sqrt{x^2 + a^2} = \sin \theta_1$ and $(c-x)/\sqrt{(c-x)^2 + b^2} = \sin \theta_2$ thus $\frac{dt}{dx} = \frac{\sin \theta_1}{v_1} - \frac{\sin \theta_2}{v_2}$ so $\frac{dt}{dx} = 0$ when $\frac{\sin \theta_1}{v_1} = \frac{\sin \theta_2}{v_2}$.
66. (a) The rate at which the farmer walks is analogous to the speed of light in Fermat's principle.

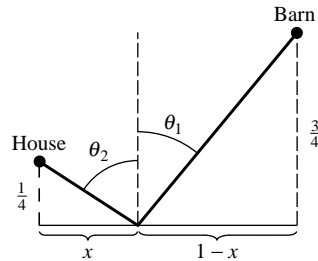

- (b) The best path occurs when $\theta_1 = \theta_2$ (see figure).
- (c) By similar triangles, $x/(1/4) = (1-x)/(3/4)$, $3x = 1-x$, $4x = 1$, $x = 1/4$ mi.
67. $s = (x_1 - \bar{x})^2 + (x_2 - \bar{x})^2 + \dots + (x_n - \bar{x})^2$, $ds/d\bar{x} = -2(x_1 - \bar{x}) - 2(x_2 - \bar{x}) - \dots - 2(x_n - \bar{x})$, $ds/d\bar{x} = 0$ when $(x_1 - \bar{x}) + (x_2 - \bar{x}) + \dots + (x_n - \bar{x}) = 0$, $(x_1 + x_2 + \dots + x_n) - n\bar{x} = 0$, $\bar{x} = \frac{1}{n}(x_1 + x_2 + \dots + x_n)$, $d^2s/d\bar{x}^2 = 2 + 2 + \dots + 2 = 2n > 0$, so s is minimum when $\bar{x} = \frac{1}{n}(x_1 + x_2 + \dots + x_n)$.
68. If $f(x_0)$ is a maximum then $f(x) \leq f(x_0)$ for all x in some open interval containing x_0 thus $\sqrt{f(x)} \leq \sqrt{f(x_0)}$ because \sqrt{x} is an increasing function, so $\sqrt{f(x_0)}$ is a maximum of $\sqrt{f(x)}$ at x_0 . The proof is similar for a minimum value, simply replace \leq by \geq .
69. If we ignored the interval of possible values of the variables, we might find an extremum that is not physically meaningful, or conclude that there is no extremum. For instance, in Example 2, if we didn't restrict x to the interval $[0, 8]$, there would be no maximum value of V , since $\lim_{x \rightarrow +\infty} (480x - 92x^2 + 4x^3) = +\infty$.

Exercise Set 4.6

1. (a) Positive, negative, slowing down.
 (b) Positive, positive, speeding up.

(c) Negative, positive, slowing down.

2. (a) Positive, slowing down.

(b) Negative, slowing down.

(c) Positive, speeding up.

3. (a) Left because $v = ds/dt < 0$ at t_0 .

(b) Negative because $a = d^2s/dt^2$ and the curve is concave down at t_0 ($d^2s/dt^2 < 0$).

(c) Speeding up because v and a have the same sign.

(d) $v < 0$ and $a > 0$ at t_1 so the particle is slowing down because v and a have opposite signs.

4. (a) III (b) I (c) II

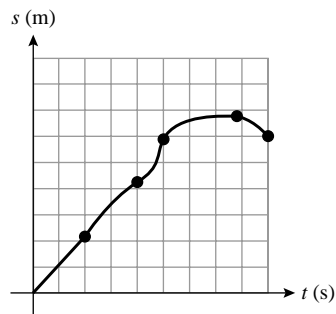

6. (a) When $s \geq 0$, so $0 < t < 2$ and $4 < t \leq 7$.

(b) When the slope is zero, at $t = 3$.

(c) When s is decreasing, so $0 \leq t < 3$.

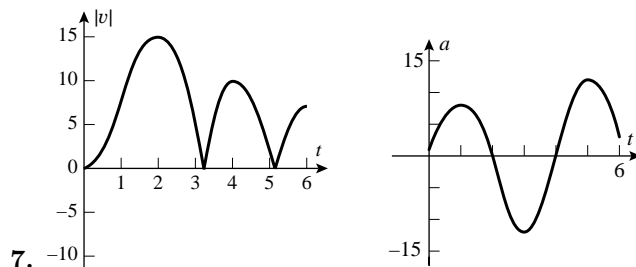

8. (a) $v \approx (30 - 10)/(15 - 10) = 20/5 = 4$ m/s.

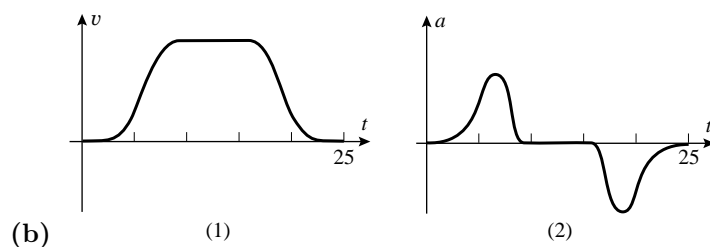

9. False. A particle is speeding up when its speed versus time curve is increasing. When the position versus time graph is increasing, the particle is moving in the positive direction along the s -axis.
10. True; see equation (1).
11. False. Acceleration is the derivative of velocity.
12. True; see the first figure in Table 4.6.1.
13. (a) At 60 mi/h the tangent line seems to pass through the points (5, 42) and (10, 63). Thus the acceleration would be $\frac{v_1 - v_0}{t_1 - t_0} \cdot \frac{5280}{60^2} = \frac{63 - 42}{10 - 5} \cdot \frac{5280}{60^2} \approx 6.2 \text{ ft/s}^2$.
- (b) The maximum acceleration occurs at maximum slope, so when $t = 0$.
14. (a) At 60 mi/h the tangent line seems to pass through the points (5, 52) and (10, 79). Thus the acceleration would be $\frac{v_1 - v_0}{t_1 - t_0} \cdot \frac{5280}{60^2} = \frac{79 - 52}{10 - 5} \cdot \frac{5280}{60^2} \approx 7.9 \text{ ft/s}^2$.
- (b) The maximum acceleration occurs at maximum slope, so when $t = 0$.
15. (a)
- | | | | | | |
|-----|-------|-------|-------|-------|-------|
| t | 1 | 2 | 3 | 4 | 5 |
| s | 0.71 | 1.00 | 0.71 | 0.00 | -0.71 |
| v | 0.56 | 0.00 | -0.56 | -0.79 | -0.56 |
| a | -0.44 | -0.62 | -0.44 | 0.00 | 0.44 |
- (b) To the right at $t = 1$, stopped at $t = 2$, otherwise to the left.
- (c) Speeding up at $t = 3$; slowing down at $t = 1, 5$; neither at $t = 2, 4$.
16. (a)
- | | | | | | |
|-----|------|------|-------|-------|-------|
| t | 1 | 2 | 3 | 4 | 5 |
| s | 0.37 | 2.16 | 4.03 | 4.68 | 4.21 |
| v | 1.10 | 2.16 | 1.34 | 0 | -0.84 |
| a | 1.84 | 0 | -1.34 | -1.17 | -0.51 |
- (b) To the right at $t = 1, 2, 3$, stopped at $t = 4$, to the left at $t = 5$.
- (c) Speeding up at $t = 1, 5$; slowing down at $t = 3$; stopped at $t = 4$, neither at $t = 2$.
17. (a) $v(t) = 3t^2 - 6t$, $a(t) = 6t - 6$.
- (b) $s(1) = -2 \text{ ft}$, $v(1) = -3 \text{ ft/s}$, speed = 3 ft/s, $a(1) = 0 \text{ ft/s}^2$.
- (c) $v = 0$ at $t = 0, 2$.
- (d) For $t \geq 0$, $v(t)$ changes sign at $t = 2$, and $a(t)$ changes sign at $t = 1$; so the particle is speeding up for $0 < t < 1$ and $2 < t$ and is slowing down for $1 < t < 2$.
- (e) Total distance = $|s(2) - s(0)| + |s(5) - s(2)| = |-4 - 0| + |50 - (-4)| = 58 \text{ ft}$.
18. (a) $v(t) = 4t^3 - 8t$, $a(t) = 12t^2 - 8$.
- (b) $s(1) = 1 \text{ ft}$, $v(1) = -4 \text{ ft/s}$, speed = 4 ft/s, $a(1) = 4 \text{ ft/s}^2$.

(c) $v = 0$ at $t = 0, \sqrt{2}$.

(d) For $t \geq 0$, $v(t)$ changes sign at $t = \sqrt{2}$, and $a(t)$ changes sign at $t = \sqrt{6}/3$. The particle is speeding up for $0 < t < \sqrt{6}/3$ and $\sqrt{2} < t$ and slowing down for $\sqrt{6}/3 < t < \sqrt{2}$.

(e) Total distance = $|s(\sqrt{2}) - s(0)| + |s(5) - s(\sqrt{2})| = |0 - 4| + |529 - 0| = 533$ ft.

19. (a) $s(t) = 9 - 9 \cos(\pi t/3)$, $v(t) = 3\pi \sin(\pi t/3)$, $a(t) = \pi^2 \cos(\pi t/3)$.

(b) $s(1) = 9/2$ ft, $v(1) = 3\pi\sqrt{3}/2$ ft/s, speed = $3\pi\sqrt{3}/2$ ft/s, $a(1) = \pi^2/2$ ft/s².

(c) $v = 0$ at $t = 0, 3$.

(d) For $0 < t < 5$, $v(t)$ changes sign at $t = 3$ and $a(t)$ changes sign at $t = 3/2, 9/2$; so the particle is speeding up for $0 < t < 3/2$ and $3 < t < 9/2$ and slowing down for $3/2 < t < 3$ and $9/2 < t < 5$.

(e) Total distance = $|s(3) - s(0)| + |s(5) - s(3)| = |18 - 0| + |9/2 - 18| = 18 + 27/2 = 63/2$ ft.

20. (a) $v(t) = \frac{4 - t^2}{(t^2 + 4)^2}$, $a(t) = \frac{2t(t^2 - 12)}{(t^2 + 4)^3}$.

(b) $s(1) = 1/5$ ft, $v(1) = 3/25$ ft/s, speed = $3/25$ ft/s, $a(1) = -22/125$ ft/s².

(c) $v = 0$ at $t = 2$.

(d) a changes sign at $t = 2\sqrt{3}$, so the particle is speeding up for $2 < t < 2\sqrt{3}$ and it is slowing down for $0 < t < 2$ and for $2\sqrt{3} < t$.

(e) Total distance = $|s(2) - s(0)| + |s(5) - s(2)| = \left| \frac{1}{4} - 0 \right| + \left| \frac{5}{29} - \frac{1}{4} \right| = \frac{19}{58}$ ft.

21. (a) $s(t) = (t^2 + 8)e^{-t/3}$ ft, $v(t) = (-\frac{1}{3}t^2 + 2t - \frac{8}{3})e^{-t/3}$ ft/s, $a(t) = (\frac{1}{9}t^2 - \frac{4}{3}t + \frac{26}{9})e^{-t/3}$ ft/s².

(b) $s(1) = 9e^{-1/3}$ ft, $v(1) = -e^{-1/3}$ ft/s, speed = $e^{-1/3}$ ft/s, $a(1) = \frac{5}{3}e^{-1/3}$ ft/s².

(c) $v = 0$ for $t = 2, 4$.

(d) v changes sign at $t = 2, 4$ and a changes sign at $t = 6 \pm \sqrt{10}$, so the particle is speeding up for $2 < t < 6 - \sqrt{10}$ and $4 < t < 6 + \sqrt{10}$, and slowing down for $0 < t < 2$, $6 - \sqrt{10} < t < 4$ and $t > 6 + \sqrt{10}$.

(e) Total distance = $|s(2) - s(0)| + |s(4) - s(2)| + |s(5) - s(4)| = |12e^{-2/3} - 8| + |24e^{-4/3} - 12e^{-2/3}| + |33e^{-5/3} - 24e^{-4/3}| = (8 - 12e^{-2/3}) + (24e^{-4/3} - 12e^{-2/3}) + (24e^{-4/3} - 33e^{-5/3}) = 8 - 24e^{-2/3} + 48e^{-4/3} - 33e^{-5/3} \approx 2.098$ ft.

22. (a) $s(t) = \frac{1}{4}t^2 - \ln(t + 1)$, $v(t) = \frac{t^2 + t - 2}{2(t + 1)}$, $a(t) = \frac{t^2 + 2t + 3}{2(t + 1)^2}$.

(b) $s(1) = \frac{1}{4} - \ln 2$ ft, $v(1) = 0$ ft/s, speed = 0 ft/s, $a(1) = \frac{3}{4}$ ft/s².

(c) $v = 0$ for $t = 1$.

(d) v changes sign at $t = 1$ and a does not change sign, so the particle is slowing down for $0 < t < 1$ and speeding up for $t > 1$.

(e) Total distance = $|s(5) - s(1)| + |s(1) - s(0)| = |25/4 - \ln 6 - (1/4 - \ln 2)| + |1/4 - \ln 2| = 23/4 + \ln(2/3) \approx 5.345$ ft.

23. $v(t) = \frac{5 - t^2}{(t^2 + 5)^2}, a(t) = \frac{2t(t^2 - 15)}{(t^2 + 5)^3}$.

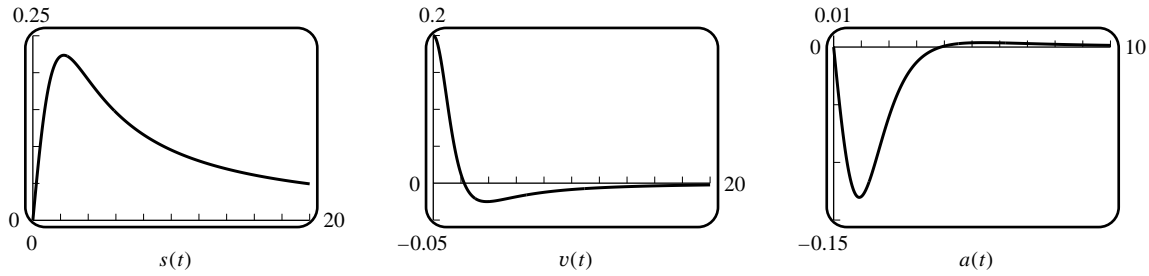

(a) $v = 0$ at $t = \sqrt{5}$.

(b) $s = \sqrt{5}/10$ at $t = \sqrt{5}$.

(c) a changes sign at $t = \sqrt{15}$, so the particle is speeding up for $\sqrt{5} < t < \sqrt{15}$ and slowing down for $0 < t < \sqrt{5}$ and $\sqrt{15} < t$.

24. $v(t) = (1 - t)e^{-t}, a(t) = (t - 2)e^{-t}$.

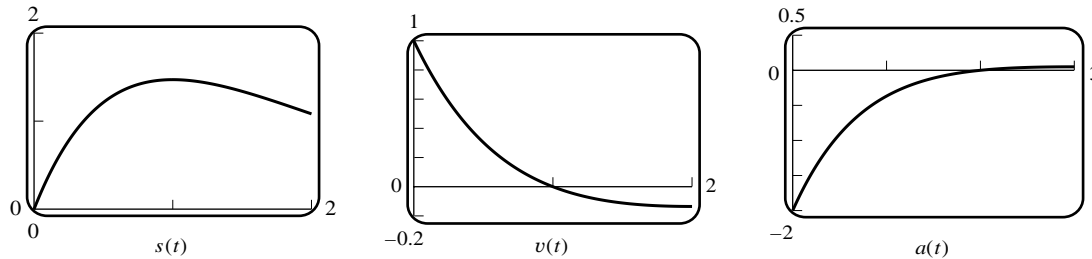

(a) $v = 0$ at $t = 1$.

(b) $s = 1/e$ at $t = 1$.

(c) a changes sign at $t = 2$, so the particle is speeding up for $1 < t < 2$ and slowing down for $0 < t < 1$ and $2 < t$.

25. $s = -4t + 3, v = -4, a = 0$.

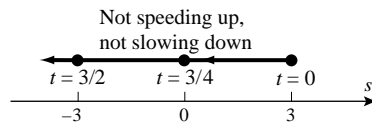

26. $s = 5t^2 - 20t, v = 10t - 20, a = 10$. Starts at $s = 0$ to the left, turns around at $t = 2$ at $s = -20$, then moves to the right, speeding up.

27. $s = t^3 - 9t^2 + 24t, v = 3(t - 2)(t - 4), a = 6(t - 3)$.

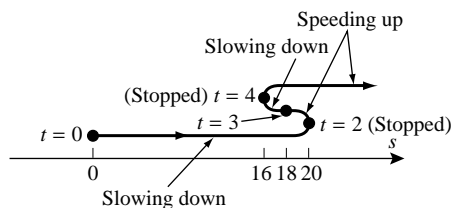

28. $s = t^3 - 6t^2 + 9t + 1, v = 3(t - 1)(t - 3), a = 6(t - 2)$.

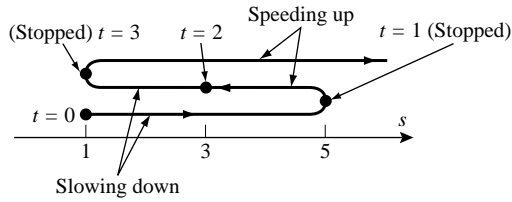

29. $s = 16te^{-t^2/8}$, $v = (-4t^2 + 16)e^{-t^2/8}$, $a = t(-12 + t^2)e^{-t^2/8}$.

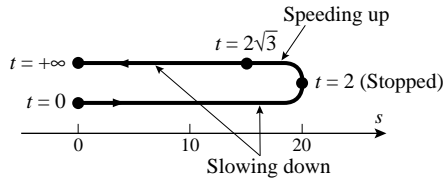

30. $s = t + 25/(t + 2)$, $v = (t - 3)(t + 7)/(t + 2)^2$, $a = 50/(t + 2)^3$.

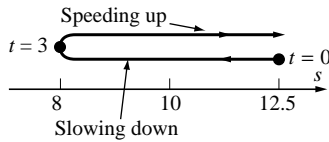

31. $s = \begin{cases} \cos t, & 0 \leq t \leq 2\pi \\ 1, & t > 2\pi \end{cases}$, $v = \begin{cases} -\sin t, & 0 \leq t \leq 2\pi \\ 0, & t > 2\pi \end{cases}$, $a = \begin{cases} -\cos t, & 0 \leq t < 2\pi \\ 0, & t > 2\pi \end{cases}$.

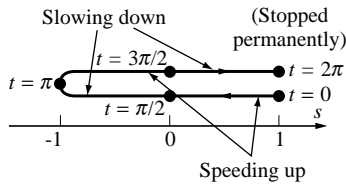

32. $s = \begin{cases} 2t(t-2)^2, & 0 \leq t \leq 3 \\ 13 - 7(t-4)^2, & t > 3 \end{cases}$, $v = \begin{cases} 6t^2 - 16t + 8, & 0 \leq t \leq 3 \\ -14t + 56, & t > 3 \end{cases}$, $a = \begin{cases} 12t - 16, & 0 \leq t < 3 \\ -14, & t > 3 \end{cases}$.

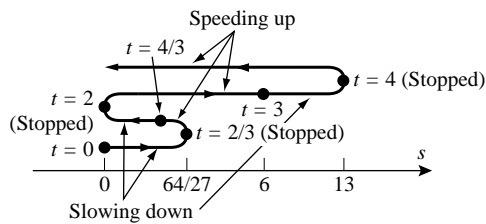

33. (a) $v = 10t - 22$, speed = $|v| = |10t - 22|$. $d|v|/dt$ does not exist at $t = 2.2$ which is the only critical point. If $t = 1, 2.2, 3$ then $|v| = 12, 0, 8$. The maximum speed is 12 ft/s.

(b) The distance from the origin is $|s| = |5t^2 - 22t| = |t(5t - 22)|$, but $t(5t - 22) < 0$ for $1 \leq t \leq 3$ so $|s| = -(5t^2 - 22t) = 22t - 5t^2$, $d|s|/dt = 22 - 10t$, thus the only critical point is $t = 2.2$. $d^2|s|/dt^2 < 0$ so the particle is farthest from the origin when $t = 2.2$ s. Its position is $s = 5(2.2)^2 - 22(2.2) = -24.2$ ft.

34. $v = -\frac{200t}{(t^2 + 12)^2}$, speed = $|v| = \frac{200t}{(t^2 + 12)^2}$ for $t \geq 0$. $\frac{d|v|}{dt} = \frac{600(4 - t^2)}{(t^2 + 12)^3} = 0$ when $t = 2$, which is the only critical point in $(0, +\infty)$. By the first derivative test there is a relative maximum, and hence an absolute maximum, at $t = 2$. The maximum speed is 25/16 ft/s to the left.

35. $s = \ln(3t^2 - 12t + 13)$, $v = \frac{6t - 12}{3t^2 - 12t + 13}$, $a = -\frac{6(3t^2 - 12t + 11)}{(3t^2 - 12t + 13)^2}$.

(a) $a = 0$ when $t = 2 \pm \sqrt{3}/3$; $s(2 - \sqrt{3}/3) = \ln 2$; $s(2 + \sqrt{3}/3) = \ln 2$; $v(2 - \sqrt{3}/3) = -\sqrt{3}$; $v(2 + \sqrt{3}/3) = \sqrt{3}$.

(b) $v = 0$ when $t = 2$; $s(2) = 0$; $a(2) = 6$.

36. $s = t^3 - 6t^2 + 1$, $v = 3t^2 - 12t$, $a = 6t - 12$.

(a) $a = 0$ when $t = 2$; $s = -15$, $v = -12$.

(b) $v = 0$ when $3t^2 - 12t = 3t(t - 4) = 0$, $t = 0$ or $t = 4$. If $t = 0$, then $s = 1$ and $a = -12$; if $t = 4$, then $s = -31$ and $a = 12$.

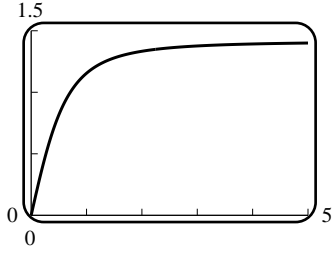

37. (a)

(b) $v = \frac{2t}{\sqrt{2t^2 + 1}}$, $\lim_{t \rightarrow +\infty} v = \frac{2}{\sqrt{2}} = \sqrt{2}$.

38. (a) $a = \frac{dv}{dt} = \frac{dv}{ds} \frac{ds}{dt} = v \frac{dv}{ds}$ because $v = \frac{ds}{dt}$.

(b) $v = \frac{3}{2\sqrt{3t+7}} = \frac{3}{2s}$; $\frac{dv}{ds} = -\frac{3}{2s^2}$; $a = -\frac{9}{4s^3} = -9/500$.

39. (a) $s_1 = s_2$ if they collide, so $\frac{1}{2}t^2 - t + 3 = -\frac{1}{4}t^2 + t + 1$, $\frac{3}{4}t^2 - 2t + 2 = 0$ which has no real solution.

(b) Find the minimum value of $D = |s_1 - s_2| = \left| \frac{3}{4}t^2 - 2t + 2 \right|$. From part (a), $\frac{3}{4}t^2 - 2t + 2$ is never zero, and for $t = 0$ it is positive, hence it is always positive, so $D = \frac{3}{4}t^2 - 2t + 2$. $\frac{dD}{dt} = \frac{3}{2}t - 2 = 0$ when $t = \frac{4}{3}$. $\frac{d^2D}{dt^2} > 0$ so D is minimum when $t = \frac{4}{3}$, $D = \frac{2}{3}$.

(c) $v_1 = t - 1$, $v_2 = -\frac{1}{2}t + 1$. $v_1 < 0$ if $0 \leq t < 1$, $v_1 > 0$ if $t > 1$; $v_2 < 0$ if $t > 2$, $v_2 > 0$ if $0 \leq t < 2$. They are moving in opposite directions during the intervals $0 \leq t < 1$ and $t > 2$.

40. (a) $s_A - s_B = 20 - 0 = 20$.

(b) $s_A = s_B$, $15t^2 + 10t + 20 = 5t^2 + 40t$, $10t^2 - 30t + 20 = 0$, $(t - 2)(t - 1) = 0$, $t = 1$ or $t = 2$.

(c) $v_A = v_B$, $30t + 10 = 10t + 40$, $20t = 30$, $t = 3/2$. When $t = 3/2$, $s_A = 275/4$ and $s_B = 285/4$ so car B is ahead of car A.

41. $r(t) = \sqrt{v^2(t)}$, $r'(t) = 2v(t)v'(t)/[2\sqrt{v^2(t)}] = v(t)a(t)/|v(t)|$ so $r'(t) > 0$ (speed is increasing) if v and a have the same sign, and $r'(t) < 0$ (speed is decreasing) if v and a have opposite signs.

42. If the radius of the wheel is R , then the bicycle travels a distance $2\pi R$ during one wheel rotation. If the time for one rotation is T , then the average velocity during that time is $\frac{2\pi R}{T}$. Usually the bicycle's velocity will not change much during one rotation, so the average will be a good approximation of the instantaneous velocity.

43. While the fuel is burning, the acceleration is positive and the rocket is speeding up. After the fuel is gone, the acceleration (due to gravity) is negative and the rocket slows down until it reaches the highest point of its flight. Then the acceleration is still negative, and the rocket speeds up as it falls, until it hits the ground. After that the acceleration is zero, and the rocket neither speeds up nor slows down. During the powered part of the flight, the acceleration is not constant, and it's hard to say whether it will be increasing or decreasing. First, the power output of the engine may not be constant. Even if it is, the mass of the rocket decreases as the fuel is used up, which tends to increase the acceleration. But as the rocket moves faster, it encounters more air resistance, which tends to decrease the acceleration. Air resistance also acts during the free-fall part of the flight. While the rocket is still rising, air resistance increases the deceleration due to gravity; while the rocket is falling, air resistance decreases the deceleration.

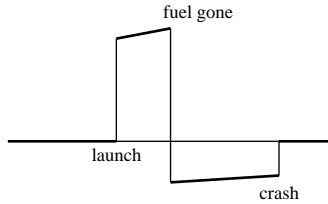

Exercise Set 4.7

- $f(x) = x^2 - 2$, $f'(x) = 2x$, $x_{n+1} = x_n - \frac{x_n^2 - 2}{2x_n}$; $x_1 = 1$, $x_2 = 1.5$, $x_3 \approx 1.416666667$, \dots , $x_5 \approx x_6 \approx 1.414213562$.
- $f(x) = x^2 - 5$, $f'(x) = 2x$, $x_{n+1} = x_n - \frac{x_n^2 - 5}{2x_n}$; $x_1 = 2$, $x_2 = 2.25$, $x_3 \approx 2.236111111$, $x_4 \approx 2.2360679779$, $x_5 \approx 2.2360679775$.
- $f(x) = x^3 - 6$, $f'(x) = 3x^2$, $x_{n+1} = x_n - \frac{x_n^3 - 6}{3x_n^2}$; $x_1 = 2$, $x_2 \approx 1.833333333$, $x_3 \approx 1.817263545$, \dots , $x_5 \approx x_6 \approx 1.817120593$.
- $x^n - a = 0$.
- $f(x) = x^3 - 2x - 2$, $f'(x) = 3x^2 - 2$, $x_{n+1} = x_n - \frac{x_n^3 - 2x_n - 2}{3x_n^2 - 2}$; $x_1 = 2$, $x_2 = 1.8$, $x_3 \approx 1.7699481865$, $x_4 \approx 1.7692926629$, $x_5 \approx x_6 \approx 1.7692923542$.
- $f(x) = x^3 + x - 1$, $f'(x) = 3x^2 + 1$, $x_{n+1} = x_n - \frac{x_n^3 + x_n - 1}{3x_n^2 + 1}$; $x_1 = 1$, $x_2 = 0.75$, $x_3 \approx 0.686046512$, \dots , $x_5 \approx x_6 \approx 0.682327804$.
- $f(x) = x^5 + x^4 - 5$, $f'(x) = 5x^4 + 4x^3$, $x_{n+1} = x_n - \frac{x_n^5 + x_n^4 - 5}{5x_n^4 + 4x_n^3}$; $x_1 = 1$, $x_2 \approx 1.333333333$, $x_3 \approx 1.239420573$, \dots , $x_6 \approx x_7 \approx 1.224439550$.
- $f(x) = x^5 - 3x + 3$, $f'(x) = 5x^4 - 3$, $x_{n+1} = x_n - \frac{x_n^5 - 3x_n + 3}{5x_n^4 - 3}$; $x_1 = -1.5$, $x_2 \approx -1.49579832$, $x_3 \approx x_4 \approx -1.49577135$.
- There are 2 solutions. $f(x) = x^4 + x^2 - 4$, $f'(x) = 4x^3 + 2x$, $x_{n+1} = x_n - \frac{x_n^4 + x_n^2 - 4}{4x_n^3 + 2x_n}$; $x_1 = -1$, $x_2 \approx -1.3333$, $x_3 \approx -1.2561$, $x_4 \approx -1.24966$, \dots , $x_7 \approx x_8 \approx -1.249621068$.

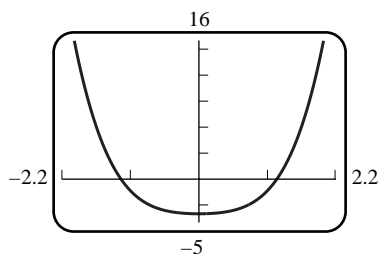

10. There are 3 solutions. $f(x) = x^5 - 5x^3 - 2$, $f'(x) = 5x^4 - 15x^2$, $x_{n+1} = x_n - \frac{x_n^5 - 5x_n^3 - 2}{5x_n^4 - 15x_n^2}$; $x_1 = 2$, $x_2 = 2.5$, $x_3 \approx 2.327384615, \dots, x_7 \approx x_8 \approx 2.273791732$.

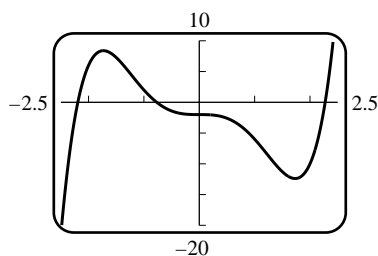

11. There is 1 solution. $f(x) = 2 \cos x - x$, $f'(x) = -2 \sin x - 1$, $x_{n+1} = x_n - \frac{2 \cos x - x}{-2 \sin x - 1}$; $x_1 = 1$, $x_2 \approx 1.03004337$, $x_3 \approx 1.02986654$, $x_4 \approx x_5 \approx 1.02986653$.

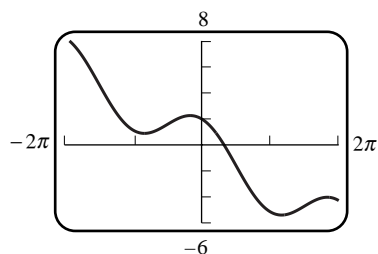

12. There are 2 solutions. $f(x) = \sin x - x^2$, $f'(x) = \cos x - 2x$, $x_{n+1} = x_n - \frac{\sin x_n - x_n^2}{\cos x_n - 2x_n}$; $x_1 = 1$, $x_2 \approx 0.891395995$, $x_3 \approx 0.876984845, \dots, x_5 \approx x_6 \approx 0.876726215$.

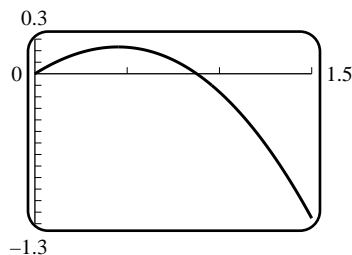

13. There are infinitely many solutions. $f(x) = x - \tan x$, $f'(x) = 1 - \sec^2 x = -\tan^2 x$, $x_{n+1} = x_n + \frac{x_n - \tan x_n}{\tan^2 x_n}$; $x_1 = 4.5$, $x_2 \approx 4.493613903$, $x_3 \approx 4.493409655$, $x_4 \approx x_5 \approx 4.493409458$.

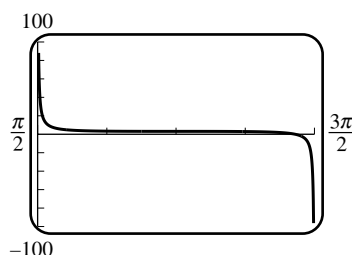

14. There are infinitely many solutions. $f(x) = 1 + e^x \sin x$, $f'(x) = e^x(\cos x + \sin x)$, $x_{n+1} = x_n - \frac{1 + e^{x_n} \sin x_n}{e^{x_n}(\cos x_n + \sin x_n)}$; $x_1 = 3$, $x_2 \approx 3.2249$, $x_3 \approx 3.1847, \dots$, $x_{10} \approx x_{11} \approx 3.183063012$.

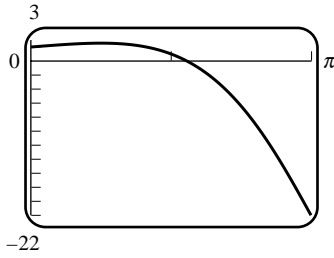

15. The graphs of $y = x^3$ and $y = 1 - x$ intersect once, near $x = 0.7$. Let $f(x) = x^3 + x - 1$, so that $f'(x) = 3x^2 + 1$, and $x_{n+1} = x_n - \frac{x_n^3 + x_n - 1}{3x_n^2 + 1}$. If $x_1 = 0.7$ then $x_2 \approx 0.68259109$, $x_3 \approx 0.68232786$, $x_4 \approx x_5 \approx 0.68232780$.

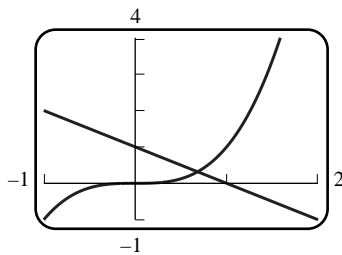

16. The graphs of $y = \sin x$ and $y = x^3 - 2x^2 + 1$ intersect 3 times, near $x = -0.8$ and $x = 0.6$ and $x = 2$. Let $f(x) = \sin x - x^3 + 2x^2 - 1$; then $f'(x) = \cos x - 3x^2 + 4x$, so $x_{n+1} = x_n - \frac{\cos x_n - 3x_n^2 + 4x_n}{\sin x_n - x_n^3 + 2x_n^2 + 1}$. If $x_1 = -0.8$, then $x_2 \approx -0.783124811$, $x_3 \approx -0.782808234$, $x_4 \approx x_5 \approx -0.782808123$; if $x_1 = 0.6$, then $x_2 \approx 0.568003853$, $x_3 \approx x_4 \approx 0.568025739$; if $x_1 = 2$, then $x_2 \approx 1.979461151$, $x_3 \approx 1.979019264$, $x_4 \approx x_5 \approx 1.979019061$.

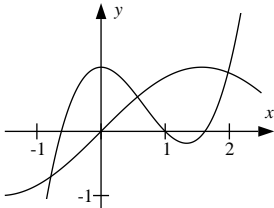

17. The graphs of $y = x^2$ and $y = \sqrt{2x+1}$ intersect twice, near $x = -0.5$ and $x = 1.4$. $x^2 = \sqrt{2x+1}$, $x^4 - 2x - 1 = 0$. Let $f(x) = x^4 - 2x - 1$, then $f'(x) = 4x^3 - 2$ so $x_{n+1} = x_n - \frac{x_n^4 - 2x_n - 1}{4x_n^3 - 2}$. If $x_1 = -0.5$, then $x_2 \approx -0.475$, $x_3 \approx -0.474626695$, $x_4 \approx x_5 \approx -0.474626618$; if $x_1 = 1$, then $x_2 = 2$, $x_3 \approx 1.633333333, \dots$, $x_8 \approx x_9 \approx 1.395336994$.

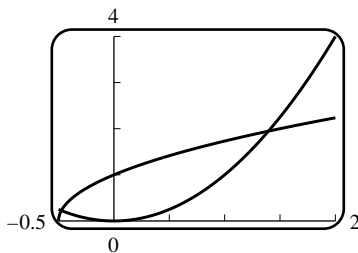

18. The graphs of $y = \frac{1}{8}x^3 - 1$ and $y = \cos x - 2$ intersect twice, at $x = 0$ and near $x = -2$. Let $f(x) = \frac{1}{8}x^3 + 1 - \cos x$ so that $f'(x) = \frac{3}{8}x^2 + \sin x$. Then $x_{n+1} = x_n - \frac{x_n^3/8 + 1 - \cos x_n}{3x_n^2/8 + \sin x_n}$. If $x_1 = -2$ then $x_2 \approx -2.70449471$, $x_3 \approx -2.46018026, \dots, x_6 \approx x_7 \approx -2.40629382$.

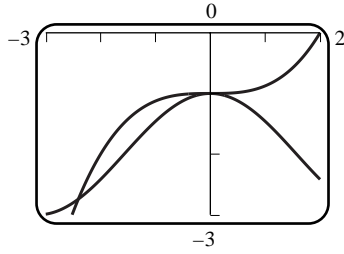

19. Between $x = 0$ and $x = \pi$, the graphs of $y = 1$ and $y = e^x \sin x$ intersect twice, near $x = 1$ and $x = 3$. Let $f(x) = 1 - e^x \sin x$, $f'(x) = -e^x(\cos x + \sin x)$, and $x_{n+1} = x_n + \frac{1 - e^{x_n} \sin x_n}{e^{x_n}(\cos x_n + \sin x_n)}$. If $x_1 = 1$ then $x_2 \approx 0.65725814$, $x_3 \approx 0.59118311, \dots, x_5 \approx x_6 \approx 0.58853274$, and if $x_1 = 3$ then $x_2 \approx 3.10759324$, $x_3 \approx 3.09649396, \dots, x_5 \approx x_6 \approx 3.09636393$.

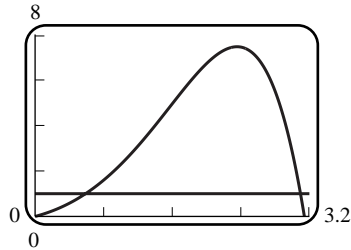

20. The graphs of $y = e^{-x}$ and $y = \ln x$ intersect near $x = 1.3$; let $f(x) = e^{-x} - \ln x$, $f'(x) = -e^{-x} - 1/x$, $x_1 = 1.3$, $x_{n+1} = x_n + \frac{e^{-x_n} - \ln x_n}{e^{-x_n} + 1/x_n}$, $x_2 \approx 1.309759929$, $x_4 = x_5 \approx 1.309799586$.

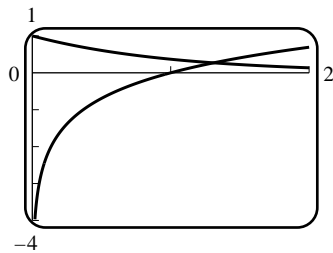

21. True. See the discussion before equation (1).
22. False. Newton's method usually only finds an approximation to a solution of $f(x) = 0$.
23. False. The function $f(x) = x^3 - x^2 - 110x$ has 3 roots: $x = -10$, $x = 0$, and $x = 11$. Newton's method in this case gives $x_{n+1} = x_n - \frac{x_n^3 - x_n^2 - 110x_n}{3x_n^2 - 2x_n - 110} = \frac{2x_n^3 - x_n^2}{3x_n^2 - 2x_n - 110}$. Starting from $x_1 = 5$, we find $x_2 = -5$, $x_3 = x_4 = x_5 = \dots = 11$. So the method converges to the root $x = 11$, although the root closest to x_1 is $x = 0$.
24. True. If the curves are $y = f(x)$ and $y = g(x)$, then the x -coordinates of their intersections are roots of $f(x) = g(x)$. We may approximate these by applying Newton's method to $f(x) - g(x)$.
25. (a) $f(x) = x^2 - a$, $f'(x) = 2x$, $x_{n+1} = x_n - \frac{x_n^2 - a}{2x_n} = \frac{1}{2} \left(x_n + \frac{a}{x_n} \right)$.
- (b) $a = 10$; $x_1 = 3$, $x_2 \approx 3.166666667$, $x_3 \approx 3.162280702$, $x_4 \approx x_5 \approx 3.162277660$.
26. (a) $f(x) = \frac{1}{x} - a$, $f'(x) = -\frac{1}{x^2}$, $x_{n+1} = x_n(2 - ax_n)$.
- (b) $a = 17$; $x_1 = 0.05$, $x_2 = 0.0575$, $x_3 = 0.05879375$, $x_4 \approx 0.05882351$, $x_5 \approx x_6 \approx 0.05882353$.

27. $f'(x) = x^3 + 2x - 5$; solve $f'(x) = 0$ to find the critical points. Graph $y = x^3$ and $y = -2x + 5$ to see that they intersect at a point near $x = 1.25$; $f''(x) = 3x^2 + 2$ so $x_{n+1} = x_n - \frac{x_n^3 + 2x_n - 5}{3x_n^2 + 2}$. $x_1 = 1.25, x_2 \approx 1.3317757009, x_3 \approx 1.3282755613, x_4 \approx 1.3282688557, x_5 \approx 1.3282688557$ so the minimum value of $f(x)$ occurs at $x \approx 1.3282688557$ because $f''(x) > 0$; its value is approximately -4.098859132 .
28. From a rough sketch of $y = x \sin x$ we see that the maximum occurs at a point near $x = 2$, which will be a point where $f'(x) = x \cos x + \sin x = 0$. $f''(x) = 2 \cos x - x \sin x$ so $x_{n+1} = x_n - \frac{x_n \cos x_n + \sin x_n}{2 \cos x_n - x_n \sin x_n} = x_n - \frac{x_n + \tan x_n}{2 - x_n \tan x_n}$. $x_1 = 2, x_2 \approx 2.029048281, x_3 \approx 2.028757866, x_4 \approx x_5 \approx 2.028757838$; the maximum value is approximately 1.819705741 .
29. A graphing utility shows that there are two inflection points at $x \approx 0.25, -1.25$. These points are the zeros of $f''(x) = (x^4 + 4x^3 + 8x^2 + 4x - 1) \frac{e^{-x}}{(x^2 + 1)^3}$. It is equivalent to find the zeros of $g(x) = x^4 + 4x^3 + 8x^2 + 4x - 1$. One root is $x = -1$ by inspection. Since $g'(x) = 4x^3 + 12x^2 + 16x + 4$, Newton's Method becomes $x_{n+1} = x_n - \frac{x_n^4 + 4x_n^3 + 8x_n^2 + 4x_n - 1}{4x_n^3 + 12x_n^2 + 16x_n + 4}$. With $x_0 = 0.25, x_1 \approx 0.18572695, x_2 \approx 0.179563312, x_3 \approx 0.179509029, x_4 \approx x_5 \approx 0.179509025$. So the points of inflection are at $x \approx 0.17951, x = -1$.
30. $f'(x) = -2 \tan^{-1} x + \frac{1 - 2x}{x^2 + 1} = 0$ for $x = x_1 \approx 0.245147, f(x_1) \approx 0.122536$ (with $x_0 = 0.1$).
31. Let $f(x)$ be the square of the distance between $(1, 0)$ and any point (x, x^2) on the parabola, then $f(x) = (x - 1)^2 + (x^2 - 0)^2 = x^4 + x^2 - 2x + 1$ and $f'(x) = 4x^3 + 2x - 2$. Solve $f'(x) = 0$ to find the critical points; $f''(x) = 12x^2 + 2$ so $x_{n+1} = x_n - \frac{4x_n^3 + 2x_n - 2}{12x_n^2 + 2} = x_n - \frac{2x_n^3 + x_n - 1}{6x_n^2 + 1}$. $x_1 = 1, x_2 \approx 0.714285714, x_3 \approx 0.605168701, \dots, x_6 \approx x_7 \approx 0.589754512$; the coordinates are approximately $(0.589754512, 0.347810385)$.
32. The area is $A = xy = x \cos x$ so $dA/dx = \cos x - x \sin x$. Find x so that $dA/dx = 0$; $d^2A/dx^2 = -2 \sin x - x \cos x$ so $x_{n+1} = x_n + \frac{\cos x_n - x_n \sin x_n}{2 \sin x_n + x_n \cos x_n} = x_n + \frac{1 - x_n \tan x_n}{2 \tan x_n + x_n}$. $x_1 = 1, x_2 \approx 0.864536397, x_3 \approx 0.860339078, x_4 \approx x_5 \approx 0.860333589; y \approx 0.652184624$.
33. (a) Let s be the arc length, and L the length of the chord, then $s = 1.5L$. But $s = r\theta$ and $L = 2r \sin(\theta/2)$ so $r\theta = 3r \sin(\theta/2), \theta - 3 \sin(\theta/2) = 0$.
- (b) Let $f(\theta) = \theta - 3 \sin(\theta/2)$, then $f'(\theta) = 1 - 1.5 \cos(\theta/2)$ so $\theta_{n+1} = \theta_n - \frac{\theta_n - 3 \sin(\theta_n/2)}{1 - 1.5 \cos(\theta_n/2)}$. $\theta_1 = 3, \theta_2 \approx 2.991592920, \theta_3 \approx 2.991563137, \theta_4 \approx \theta_5 \approx 2.991563136$ rad so $\theta \approx 171^\circ$.
34. $r^2(\theta - \sin \theta)/2 = \pi r^2/4$ so $\theta - \sin \theta - \pi/2 = 0$. Let $f(\theta) = \theta - \sin \theta - \pi/2$, then $f'(\theta) = 1 - \cos \theta$ so $\theta_{n+1} = \frac{\theta_n - \sin \theta_n - \pi/2}{1 - \cos \theta_n}$. $\theta_1 = 2, \theta_2 \approx 2.339014106, \theta_3 \approx 2.310063197, \dots, \theta_5 \approx \theta_6 \approx 2.309881460$ rad; $\theta \approx 132^\circ$.
35. If $x = 1$, then $y^4 + y = 1, y^4 + y - 1 = 0$. Graph $z = y^4$ and $z = 1 - y$ to see that they intersect near $y = -1$ and $y = 1$. Let $f(y) = y^4 + y - 1$, then $f'(y) = 4y^3 + 1$ so $y_{n+1} = y_n - \frac{y_n^4 + y_n - 1}{4y_n^3 + 1}$. If $y_1 = -1$, then $y_2 \approx -1.333333333, y_3 \approx -1.235807860, \dots, y_6 \approx y_7 \approx -1.220744085$; if $y_1 = 1$, then $y_2 = 0.8, y_3 \approx 0.731233596, \dots, y_6 \approx y_7 \approx 0.724491959$.
36. If $x = 2$, then $2y - \cos y = 0$. Graph $z = 2y$ and $z = \cos y$ to see that they intersect near $y = 0.5$. Let $f(y) = 2y - \cos y$, then $f'(y) = 2 + \sin y$ so $y_{n+1} = y_n - \frac{2y_n - \cos y_n}{2 + \sin y_n}$. $y_1 = 0.5, y_2 \approx 0.450626693, y_3 \approx 0.450183648, y_4 \approx y_5 \approx 0.450183611$.
37. $S(25) = 250,000 = \frac{5000}{i} [(1+i)^{25} - 1]$; set $f(i) = 50i - (1+i)^{25} + 1, f'(i) = 50 - 25(1+i)^{24}$; solve $f(i) = 0$. Set

$i_0 = .06$ and $i_{k+1} = i_k - [50i - (1+i)^{25} + 1] / [50 - 25(1+i)^{24}]$. Then $i_1 \approx 0.05430$, $i_2 \approx 0.05338$, $i_3 \approx 0.05336$, \dots , $i \approx 0.053362$.

38. (a) x_n tends to $+\infty$; $x_1 = 2$, $x_2 \approx 5.3333$, $x_3 \approx 11.055$, $x_4 \approx 22.293$, $x_5 \approx 44.676$.

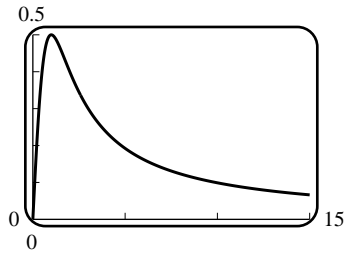

(b) x_n tends to 0. $x_1 = 0.5$, $x_2 \approx -0.3333$, $x_3 \approx 0.0833$, $x_4 \approx -0.0012$, $x_5 \approx 0.0000$.

39. (a)

x_1	x_2	x_3	x_4	x_5	x_6	x_7	x_8	x_9	x_{10}
0.5000	-0.7500	0.2917	-1.5685	-0.4654	0.8415	-0.1734	2.7970	1.2197	0.1999

(b) The sequence x_n must diverge, since if it did converge then $f(x) = x^2 + 1 = 0$ would have a solution. It seems the x_n are oscillating back and forth in a quasi-cyclical fashion.

40. (a) $x_{n+1} = x_n$, i.e. the constant sequence x_n is generated.

(b) This is equivalent to $f(x_n) = 0$ as in part (a).

(c) The x 's oscillate between two values: $x_n = x_{n+2} = x_{n+4} = \dots$ and $x_{n+1} = x_{n+3} = x_{n+5} = \dots$

41. Suppose we know an interval $[a, b]$ such that $f(a)$ and $f(b)$ have opposite signs. Here are some differences between the two methods:

The Intermediate-Value method is guaranteed to converge to a root in $[a, b]$; Newton's Method starting from some x_1 in the interval might not converge, or might converge to some root outside of the interval.

If the starting approximation x_1 is close enough to the actual root, then Newton's Method converges much faster than the Intermediate-Value method.

Newton's Method can only be used if f is differentiable and we have a way to compute $f'(x)$ for any x . For the Intermediate-Value method we only need to be able to compute $f(x)$.

42. As will be shown later in the text, the best quadratic approximation to $f(x)$ at x_n is the function $p(x) = f(x_n) + f'(x_n)(x - x_n) + \frac{1}{2}f''(x_n)(x - x_n)^2$. Solving $p(x) = 0$ by the quadratic formula gives

$$x = x_n + \frac{-f'(x_n) \pm \sqrt{f'(x_n)^2 - 2f(x_n)f''(x_n)}}{f''(x_n)}.$$

We immediately see 3 disadvantages of this method: (1) We need to have a formula for f'' , not just for f' as in Newton's Method. (2) We need to compute a square root, of a number which might be negative. (3) We need to decide which of two roots to use as x_{n+1} .

Point (3) is easily dealt with: we want the method to converge, so the value of x_{n+1} will need to be close to x_n . So let's choose the plus or minus sign so that the numerator is as close to zero as possible. Thus, we'll use a plus sign if $f'(x_n)$ is positive and a minus sign if it's negative. (We'll ignore the case in which $f'(x_n) = 0$.) Thus, we let $x_{n+1} = x_n + \frac{-f'(x_n) + \text{sgn}(f'(x_n))\sqrt{f'(x_n)^2 - 2f(x_n)f''(x_n)}}{f''(x_n)}$, where $\text{sgn}(x)$ is 1 if x is positive and -1 if it's negative.

As an example, let's try to find the root $x = 1$ of $f(x) = x^3 - 1$ using this method and Newton's Method. In Newton's Method,

$$x_{n+1} = x_n - \frac{f(x_n)}{f'(x_n)} = x_n - \frac{x_n^3 - 1}{3x_n^2} = \frac{2x_n^3 + 1}{3x_n^2}.$$

In the quadratic method, $f'(x_n) = 3x_n^2 > 0$ (unless $x_n = 0$), so $\text{sgn}(f'(x_n)) = 1$ and

$$x_{n+1} = x_n + \frac{-3x_n^2 + \sqrt{(3x_n^2)^2 - 2(x_n^3 - 1) \cdot 6x_n}}{6x_n} = \frac{x_n}{2} + \frac{\sqrt{12x_n - 3x_n^4}}{6x_n}.$$

To use this, we'll need to restrict x_n so that $12x_n - 3x_n^4 > 0$; i.e. $0 < x_n < \sqrt[3]{4} \approx 1.587$. So let's start with $x_n = 1.1$ in both methods:

n	x_n (Newton)	x_n (quadratic)
1	1.1	1.1
2	1.0088154269972452	0.999663173605500
3	1.0000768082965652	1.00000000012738
4	1.0000000058989103	$1 - 6.88922 \cdot 10^{-34}$
5	$1 + 3.47971 \cdot 10^{-17}$	$1 + 1.08991 \cdot 10^{-100}$
6	$1 + 1.21084 \cdot 10^{-33}$	$1 - 4.31565 \cdot 10^{-301}$
7	$1 + 1.46614 \cdot 10^{-66}$	$1 + 2.67928 \cdot 10^{-902}$

We see that the quadratic method does converge faster than Newton's Method. It can be shown that in this example, if $x_n = 1 + \epsilon$ where ϵ is close to zero, then Newton's Method gives $x_{n+1} \approx 1 + \epsilon^2$ and the quadratic method gives $x_{n+1} \approx 1 - \frac{1}{3}\epsilon^3$. Roughly speaking, if x_n is accurate to N decimal places then Newton's Method gives x_{n+1} accurate to about $2N$ decimal places, while the quadratic method gives x_{n+1} accurate to about $3N$ decimal places. So one step of the quadratic method improves the accuracy by more than one step of Newton's Method, but not as much as two steps of Newton's Method. In most cases, this faster convergence is offset by the additional amount of computation that's required for each step, so Newton's Method is usually preferable.

Exercise Set 4.8

- f is continuous on $[3, 5]$ and differentiable on $(3, 5)$, $f(3) = f(5) = 0$; $f'(x) = 2x - 8$, $2c - 8 = 0$, $c = 4$, $f'(4) = 0$.
- f is continuous on $[0, 4]$ and differentiable on $(0, 4)$, $f(0) = f(4) = 0$; $f'(x) = \frac{1}{2} - \frac{1}{2\sqrt{x}}$, $\frac{1}{2} - \frac{1}{2\sqrt{c}} = 0$, $c = 1$, $f'(1) = 0$.
- f is continuous on $[\pi/2, 3\pi/2]$ and differentiable on $(\pi/2, 3\pi/2)$, $f(\pi/2) = f(3\pi/2) = 0$, $f'(x) = -\sin x$, $-\sin c = 0$, $c = \pi$.
- f is continuous on $[-1, 3]$ and differentiable on $(-1, 3)$, $f(-1) = f(3) = 0$; $f'(1) = 0$; $f'(x) = 2(1-x)/(4+2x-x^2)$; $2(1-c) = 0$, $c = 1$.
- f is continuous on $[-3, 5]$ and differentiable on $(-3, 5)$, $(f(5) - f(-3))/(5 - (-3)) = 1$; $f'(x) = 2x - 1$; $2c - 1 = 1$, $c = 1$.
- f is continuous on $[-1, 2]$ and differentiable on $(-1, 2)$, $f(-1) = -6$, $f(2) = 6$, $f'(x) = 3x^2 + 1$, $3c^2 + 1 = \frac{6 - (-6)}{2 - (-1)} = 4$, $c^2 = 1$, $c = \pm 1$ of which only $c = 1$ is in $(-1, 2)$.
- f is continuous on $[-5, 3]$ and differentiable on $(-5, 3)$, $(f(3) - f(-5))/(3 - (-5)) = 1/2$; $f'(x) = -\frac{x}{\sqrt{25 - x^2}}$; $-\frac{c}{\sqrt{25 - c^2}} = 1/2$, $c = -\sqrt{5}$.
- f is continuous on $[3, 4]$ and differentiable on $(3, 4)$, $f(4) = 15/4$, $f(3) = 8/3$, solve $f'(c) = (15/4 - 8/3)/1 = 13/12$; $f'(x) = 1 + 1/x^2$, $f'(c) = 1 + 1/c^2 = 13/12$, $c^2 = 12$, $c = \pm 2\sqrt{3}$, but $-2\sqrt{3}$ is not in the interval, so $c = 2\sqrt{3}$.

9. (a) $f(-2) = f(1) = 0$. The interval is $[-2, 1]$.

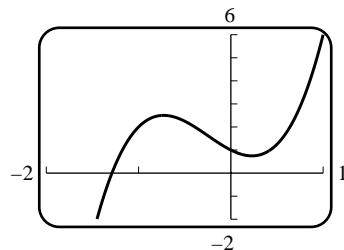

(b) $c \approx -1.29$.

(c) $x_0 = -1, x_1 = -1.5, x_2 = -1.328125, x_3 \approx -1.2903686, x_4 \approx -1.2885882, x_5 \approx x_6 \approx -1.2885843$.

10. (a) $m = \frac{f(-2) - f(1)}{-2 - 1} = \frac{0 + 3}{-3} = -1$ so $y + 3 = -(x - 1), y = -x - 2$.

(b) $f'(x) = 3x^2 - 4 = -1$ has solutions $x = \pm 1$; discard $x = 1$, so $c = -1$.

(c) $y - (3) = -(x - (-1))$ or $y = -x + 2$.

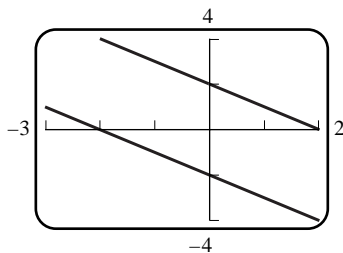

(d)

11. False. Rolle's Theorem only applies to the case in which f is differentiable on (a, b) and the common value of $f(a)$ and $f(b)$ is zero.

12. True. This is a restatement of the Mean-Value Theorem.

13. False. The Constant Difference Theorem states that if the derivatives are equal, then the functions differ by a constant.

14. True. See the proof of Theorem 4.1.2(a) in this Section.

15. (a) $f'(x) = \sec^2 x, \sec^2 c = 0$ has no solution. (b) $\tan x$ is not continuous on $[0, \pi]$.

16. (a) $f(-1) = 1, f(8) = 4, f'(x) = \frac{2}{3}x^{-1/3}, \frac{2}{3}c^{-1/3} = \frac{4-1}{8-(-1)} = \frac{1}{3}, c^{1/3} = 2, c = 8$ which is not in $(-1, 8)$.

(b) $x^{2/3}$ is not differentiable at $x = 0$, which is in $(-1, 8)$.

17. (a) Two x -intercepts of f determine two solutions a and b of $f(x) = 0$; by Rolle's Theorem there exists a point c between a and b such that $f'(c) = 0$, i.e. c is an x -intercept for f' .

(b) $f(x) = \sin x = 0$ at $x = n\pi$, and $f'(x) = \cos x = 0$ at $x = n\pi + \pi/2$, which lies between $n\pi$ and $(n + 1)\pi$, ($n = 0, \pm 1, \pm 2, \dots$)

18. $\frac{f(x_1) - f(x_0)}{x_1 - x_0}$ is the average rate of change of y with respect to x on the interval $[x_0, x_1]$. By the Mean-Value

Theorem there is a value c in (x_0, x_1) such that the instantaneous rate of change $f'(c) = \frac{f(x_1) - f(x_0)}{x_1 - x_0}$.

19. Let $s(t)$ be the position function of the automobile for $0 \leq t \leq 5$, then by the Mean-Value Theorem there is at least one point c in $(0, 5)$ where $s'(c) = v(c) = [s(5) - s(0)]/(5 - 0) = 4/5 = 0.8$ mi/min = 48 mi/h.
20. Let $T(t)$ denote the temperature at time with $t = 0$ denoting 11 AM, then $T(0) = 76$ and $T(12) = 52$.
- (a) By the Mean-Value Theorem there is a value c between 0 and 12 such that $T'(c) = [T(12) - T(0)]/(12 - 0) = (52 - 76)/(12) = -2^\circ$ F/h.
- (b) Assume that $T(t_1) = 88^\circ$ F where $0 < t_1 < 12$, then there is at least one point c in $(t_1, 12)$ where $T'(c) = [T(12) - T(t_1)]/(12 - t_1) = (52 - 88)/(12 - t_1) = -36/(12 - t_1)$. But $12 - t_1 < 12$ so $T'(c) < -3^\circ$ F.
21. Let $f(t)$ and $g(t)$ denote the distances from the first and second runners to the starting point, and let $h(t) = f(t) - g(t)$. Since they start (at $t = 0$) and finish (at $t = t_1$) at the same time, $h(0) = h(t_1) = 0$, so by Rolle's Theorem there is a time t_2 for which $h'(t_2) = 0$, i.e. $f'(t_2) = g'(t_2)$; so they have the same velocity at time t_2 .
22. Let $f(x) = x \ln(2 - x)$. Since $f(0) = f(1) = 0$ and f is differentiable on $(0, 1)$, Rolle's Theorem implies that $f'(x) = 0$ for some x in $(0, 1)$. For this x , we have $\ln(2 - x) - \frac{x}{2 - x} = f'(x) = 0$, so $x = (2 - x) \ln(2 - x)$.
23. (a) By the Constant Difference Theorem $f(x) - g(x) = k$ for some k ; since $f(x_0) = g(x_0)$, $k = 0$, so $f(x) = g(x)$ for all x .
- (b) Set $f(x) = \sin^2 x + \cos^2 x$, $g(x) = 1$; then $f'(x) = 2 \sin x \cos x - 2 \cos x \sin x = 0 = g'(x)$. Since $f(0) = 1 = g(0)$, $f(x) = g(x)$ for all x .
24. (a) By the Constant Difference Theorem $f(x) - g(x) = k$ for some k ; since $f(x_0) - g(x_0) = c$, $k = c$, so $f(x) - g(x) = c$ for all x .
- (b) Set $f(x) = (x - 1)^3$, $g(x) = (x^2 + 3)(x - 3)$. Then $f'(x) = 3(x - 1)^2$ and $g'(x) = (x^2 + 3) + 2x(x - 3) = 3x^2 - 6x + 3 = 3(x^2 - 2x + 1) = 3(x - 1)^2$, so $f'(x) = g'(x)$ and hence $f(x) - g(x) = k$. To find k , let $x = 0$: $k = f(0) - g(0) = -1 - (-9) = 8$.
- (c) $h(x) = x^3 - 3x^2 + 3x - 1 - (x^3 - 3x^2 + 3x - 9) = 8$.
25. By the Constant Difference Theorem it follows that $f(x) = g(x) + c$; since $g(1) = 0$ and $f(1) = 2$ we get $c = 2$; $f(x) = xe^x - e^x + 2$.
26. By the Constant Difference Theorem $f(x) = \tan^{-1} x + C$ and $2 = f(1) = \tan^{-1}(1) + C = \pi/4 + C$, $C = 2 - \pi/4$, $f(x) = \tan^{-1} x + 2 - \pi/4$.
27. (a) If x, y belong to I and $x < y$ then for some c in I , $\frac{f(y) - f(x)}{y - x} = f'(c)$, so $|f(x) - f(y)| = |f'(c)||x - y| \leq M|x - y|$; if $x > y$ exchange x and y ; if $x = y$ the inequality also holds.
- (b) $f(x) = \sin x$, $f'(x) = \cos x$, $|f'(x)| \leq 1 = M$, so $|f(x) - f(y)| \leq |x - y|$ or $|\sin x - \sin y| \leq |x - y|$.
28. (a) If x, y belong to I and $x < y$ then for some c in I , $\frac{f(y) - f(x)}{y - x} = f'(c)$, so $|f(x) - f(y)| = |f'(c)||x - y| \geq M|x - y|$; if $x > y$ exchange x and y ; if $x = y$ the inequality also holds.
- (b) If x and y belong to $(-\pi/2, \pi/2)$ and $f(x) = \tan x$, then $|f'(x)| = \sec^2 x \geq 1$ and $|\tan x - \tan y| \geq |x - y|$.
- (c) y lies in $(-\pi/2, \pi/2)$ if and only if $-y$ does; use part (b) and replace y with $-y$.
29. (a) Let $f(x) = \sqrt{x}$. By the Mean-Value Theorem there is a number c between x and y such that $\frac{\sqrt{y} - \sqrt{x}}{y - x} = \frac{1}{2\sqrt{c}} < \frac{1}{2\sqrt{x}}$ for c in (x, y) , thus $\sqrt{y} - \sqrt{x} < \frac{y - x}{2\sqrt{x}}$.

(b) Multiply through and rearrange to get $\sqrt{xy} < \frac{1}{2}(x + y)$.

30. Suppose that $f(x)$ has at least two distinct real solutions r_1 and r_2 in I . Then $f(r_1) = f(r_2) = 0$ so by Rolle's Theorem there is at least one number between r_1 and r_2 where $f'(x) = 0$, but this contradicts the assumption that $f'(x) \neq 0$, so $f(x) = 0$ must have fewer than two distinct solutions in I .

31. (a) If $f(x) = x^3 + 4x - 1$ then $f'(x) = 3x^2 + 4$ is never zero, so by Exercise 30 f has at most one real root; since f is a cubic polynomial it has at least one real root, so it has exactly one real root.

(b) Let $f(x) = ax^3 + bx^2 + cx + d$. If $f(x) = 0$ has at least two distinct real solutions r_1 and r_2 , then $f(r_1) = f(r_2) = 0$ and by Rolle's Theorem there is at least one number between r_1 and r_2 where $f'(x) = 0$. But $f'(x) = 3ax^2 + 2bx + c = 0$ for $x = (-2b \pm \sqrt{4b^2 - 12ac})/(6a) = (-b \pm \sqrt{b^2 - 3ac})/(3a)$, which are not real if $b^2 - 3ac < 0$ so $f(x) = 0$ must have fewer than two distinct real solutions.

32. $f'(x) = \frac{1}{2\sqrt{x}}$, $\frac{1}{2\sqrt{c}} = \frac{\sqrt{4} - \sqrt{3}}{4 - 3} = 2 - \sqrt{3}$. But $\frac{1}{4} < \frac{1}{2\sqrt{c}} < \frac{1}{2\sqrt{3}}$ for c in $(3, 4)$, so $\frac{1}{4} < 2 - \sqrt{3} < \frac{1}{2\sqrt{3}}$, so $\sqrt{3} < 2 - \frac{1}{4} = 1.75$ and $2 - \sqrt{3} < \frac{1}{2\sqrt{3}}$ yields $\sqrt{3} > \frac{12}{7} > 1.7$.

33. By the Mean-Value Theorem on the interval $[0, x]$, $\frac{\tan^{-1} x - \tan^{-1} 0}{x - 0} = \frac{\tan^{-1} x}{x} = \frac{1}{1 + c^2}$ for c in $(0, x)$, but $\frac{1}{1 + x^2} < \frac{1}{1 + c^2} < 1$ for c in $(0, x)$, so $\frac{1}{1 + x^2} < \frac{\tan^{-1} x}{x} < 1$, $\frac{x}{1 + x^2} < \tan^{-1} x < x$.

34. (a) $\frac{d}{dx}[f^2(x) - g^2(x)] = 2f(x)f'(x) - 2g(x)g'(x) = 2f(x)g(x) - 2g(x)f(x) = 0$, so $f^2 - g^2$ is constant.

(b) $f'(x) = \frac{1}{2}(e^x - e^{-x}) = g(x)$, $g'(x) = \frac{1}{2}(e^x + e^{-x}) = f(x)$.

35. (a) $\frac{d}{dx}[f^2(x) + g^2(x)] = 2f(x)f'(x) + 2g(x)g'(x) = 2f(x)g(x) + 2g(x)[-f(x)] = 0$, so $f^2(x) + g^2(x)$ is constant.

(b) $f(x) = \sin x$ and $g(x) = \cos x$.

36. Let $h = f - g$, then h is continuous on $[a, b]$, differentiable on (a, b) , and $h(a) = f(a) - g(a) = 0$, $h(b) = f(b) - g(b) = 0$. By Rolle's Theorem there is some c in (a, b) where $h'(c) = 0$. But $h'(c) = f'(c) - g'(c)$ so $f'(c) - g'(c) = 0$, $f'(c) = g'(c)$.

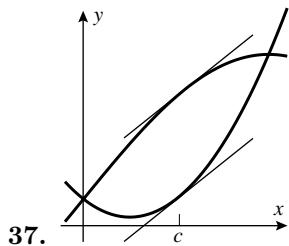

37. (a) Suppose $f'(x) = 0$ more than once in (a, b) , say at c_1 and c_2 . Then $f'(c_1) = f'(c_2) = 0$ and by using Rolle's Theorem on f' , there is some c between c_1 and c_2 where $f''(c) = 0$, which contradicts the fact that $f''(x) > 0$ so $f'(x) = 0$ at most once in (a, b) .

(b) If $f''(x) > 0$ for all x in (a, b) , then f is concave up on (a, b) and has at most one relative extremum, which would be a relative minimum, on (a, b) .

39. (a) Similar to the proof of part (a) with $f'(c) < 0$.

(b) Similar to the proof of part (a) with $f'(c) = 0$.

40. Let $x \neq x_0$ be sufficiently near x_0 so that there exists (by the Mean-Value Theorem) a number c (which depends on x) between x and x_0 , such that $\frac{f(x) - f(x_0)}{x - x_0} = f'(c)$. Since c is between x and x_0 it follows that $\lim_{x \rightarrow x_0} \frac{f(x) - f(x_0)}{x - x_0} = \lim_{x \rightarrow x_0} f'(c)$ (by the Mean-Value Theorem) $= \lim_{x \rightarrow x_0} f'(x)$ (since $\lim_{x \rightarrow x_0} f'(x)$ exists and c is between x and x_0). So $f'(x_0)$ exists and equals $\lim_{x \rightarrow x_0} f'(x)$.

41. If f is differentiable at $x = 1$, then f is continuous there; $\lim_{x \rightarrow 1^+} f(x) = \lim_{x \rightarrow 1^-} f(x) = f(1) = 3$, $a + b = 3$; $\lim_{x \rightarrow 1^+} f'(x) = a$ and $\lim_{x \rightarrow 1^-} f'(x) = 6$ so $a = 6$ and $b = 3 - 6 = -3$.

42. (a) $\lim_{x \rightarrow 0^-} f'(x) = \lim_{x \rightarrow 0^-} 2x = 0$ and $\lim_{x \rightarrow 0^+} f'(x) = \lim_{x \rightarrow 0^+} 2x = 0$; $f'(0)$ does not exist because f is not continuous at $x = 0$.

(b) $\lim_{x \rightarrow 0^-} f'(x) = \lim_{x \rightarrow 0^+} f'(x) = 0$ and f is continuous at $x = 0$, so $f'(0) = 0$; $\lim_{x \rightarrow 0^-} f''(x) = \lim_{x \rightarrow 0^-} (2) = 2$ and $\lim_{x \rightarrow 0^+} f''(x) = \lim_{x \rightarrow 0^+} 6x = 0$, so $f''(0)$ does not exist.

43. From Section 2.2 a function has a vertical tangent line at a point of its graph if the slopes of secant lines through the point approach $+\infty$ or $-\infty$. Suppose f is continuous at $x = x_0$ and $\lim_{x \rightarrow x_0^+} f(x) = +\infty$. Then a secant line through

$(x_1, f(x_1))$ and $(x_0, f(x_0))$, assuming $x_1 > x_0$, will have slope $\frac{f(x_1) - f(x_0)}{x_1 - x_0}$. By the Mean Value Theorem, this quotient is equal to $f'(c)$ for some c between x_0 and x_1 . But as x_1 approaches x_0 , c must also approach x_0 , and it is given that $\lim_{c \rightarrow x_0^+} f'(c) = +\infty$, so the slope of the secant line approaches $+\infty$. The argument can be altered appropriately for $x_1 < x_0$, and/or for $f'(c)$ approaching $-\infty$.

44. The result follows immediately from Rolle's Theorem. Since the proof of Rolle's theorem is based on the Extreme Value Theorem, the result also follows from that theorem.

45. If an object travels s miles in t hours, then at some time during the trip its instantaneous speed is exactly s/t miles per hour.

Chapter 4 Review Exercises

3. $f'(x) = 2x - 5$, $f''(x) = 2$.

(a) $[5/2, +\infty)$ (b) $(-\infty, 5/2]$ (c) $(-\infty, +\infty)$ (d) none (e) none

4. $f'(x) = 4x(x^2 - 4)$, $f''(x) = 12(x^2 - 4/3)$.

(a) $[-2, 0], [2, +\infty)$ (b) $(-\infty, -2], [0, 2]$ (c) $(-\infty, -2/\sqrt{3}), (2/\sqrt{3}, +\infty)$ (d) $(-2/\sqrt{3}, 2/\sqrt{3})$

(e) $-2/\sqrt{3}, 2/\sqrt{3}$

5. $f'(x) = \frac{4x}{(x^2 + 2)^2}$, $f''(x) = -4 \frac{3x^2 - 2}{(x^2 + 2)^3}$.

(a) $[0, +\infty)$ (b) $(-\infty, 0]$ (c) $(-\sqrt{2/3}, \sqrt{2/3})$ (d) $(-\infty, -\sqrt{2/3}), (\sqrt{2/3}, +\infty)$ (e) $-\sqrt{2/3}, \sqrt{2/3}$

6. $f'(x) = \frac{1}{3}(x + 2)^{-2/3}$, $f''(x) = -\frac{2}{9}(x + 2)^{-5/3}$.

(a) $(-\infty, +\infty)$ (b) none (c) $(-\infty, -2)$ (d) $(-2, +\infty)$ (e) -2

7. $f'(x) = \frac{4(x+1)}{3x^{2/3}}, f''(x) = \frac{4(x-2)}{9x^{5/3}}$.

- (a) $[-1, +\infty)$ (b) $(-\infty, -1]$ (c) $(-\infty, 0), (2, +\infty)$ (d) $(0, 2)$ (e) $0, 2$

8. $f'(x) = \frac{4(x-1/4)}{3x^{2/3}}, f''(x) = \frac{4(x+1/2)}{9x^{5/3}}$.

- (a) $[1/4, +\infty)$ (b) $(-\infty, 1/4]$ (c) $(-\infty, -1/2), (0, +\infty)$ (d) $(-1/2, 0)$ (e) $-1/2, 0$

9. $f'(x) = -\frac{2x}{e^{x^2}}, f''(x) = \frac{2(2x^2-1)}{e^{x^2}}$.

- (a) $(-\infty, 0]$ (b) $[0, +\infty)$ (c) $(-\infty, -\sqrt{2}/2), (\sqrt{2}/2, +\infty)$ (d) $(-\sqrt{2}/2, \sqrt{2}/2)$ (e) $-\sqrt{2}/2, \sqrt{2}/2$

10. $f'(x) = \frac{2x}{1+x^4}, f''(x) = -\frac{2(-1+3x^4)}{(1+x^4)^2}$.

- (a) $[0, +\infty)$ (b) $(-\infty, 0]$ (c) $(-1/3^{1/4}, 1/3^{1/4})$ (d) $(-\infty, -1/3^{1/4}), (1/3^{1/4}, +\infty)$ (e) $-1/3^{1/4}, 1/3^{1/4}$

11. $f'(x) = -\sin x, f''(x) = -\cos x$, increasing: $[\pi, 2\pi]$, decreasing: $[0, \pi]$, concave up: $(\pi/2, 3\pi/2)$, concave down: $(0, \pi/2), (3\pi/2, 2\pi)$, inflection points: $\pi/2, 3\pi/2$.

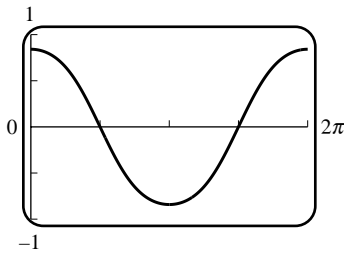

12. $f'(x) = \sec^2 x, f''(x) = 2\sec^2 x \tan x$, increasing: $(-\pi/2, \pi/2)$, decreasing: none, concave up: $(0, \pi/2)$, concave down: $(-\pi/2, 0)$, inflection point: 0 .

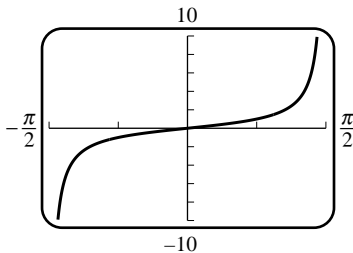

13. $f'(x) = \cos 2x, f''(x) = -2\sin 2x$, increasing: $[0, \pi/4], [3\pi/4, \pi]$, decreasing: $[\pi/4, 3\pi/4]$, concave up: $(\pi/2, \pi)$, concave down: $(0, \pi/2)$, inflection point: $\pi/2$.

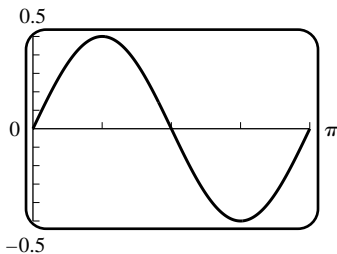

14. $f'(x) = -2\cos x \sin x - 2\cos x = -2\cos x(1 + \sin x), f''(x) = 2\sin x(\sin x + 1) - 2\cos^2 x = 2\sin x(\sin x + 1) - 2 + 2\sin^2 x = 4(1 + \sin x)(\sin x - 1/2)$ (Note: $1 + \sin x \geq 0$), increasing: $[\pi/2, 3\pi/2]$, decreasing: $[0, \pi/2], [3\pi/2, 2\pi]$, concave up: $(\pi/6, 5\pi/6)$, concave down: $(0, \pi/6), (5\pi/6, 2\pi)$, inflection points: $\pi/6, 5\pi/6$.

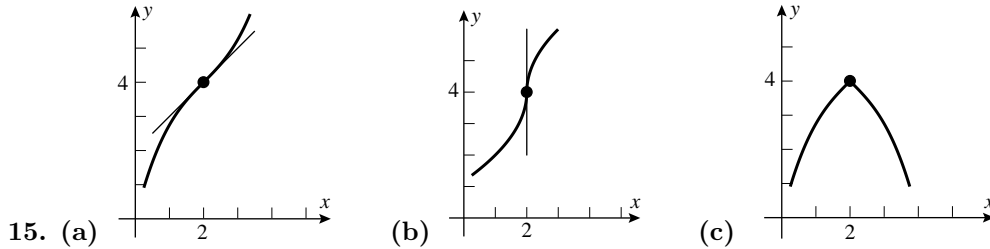
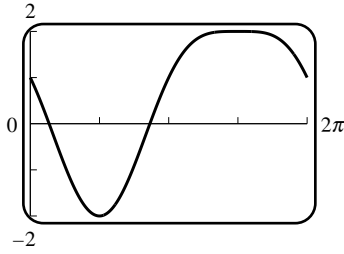

15. (a) $p(x) = x^3 - x$. (b) $p(x) = x^4 - x^2$. (c) $p(x) = x^5 - x^4 - x^3 + x^2$. (d) $p(x) = x^5 - x^3$.

17. $f'(x) = 2ax + b$; $f'(x) > 0$ or $f'(x) < 0$ on $[0, +\infty)$ if $f'(x) = 0$ has no positive solution, so the polynomial is always increasing or always decreasing on $[0, +\infty)$ provided $-b/2a \leq 0$.

18. $f'(x) = 3ax^2 + 2bx + c$; $f'(x) > 0$ or $f'(x) < 0$ on $(-\infty, +\infty)$ if $f'(x) = 0$ has no real solutions so from the quadratic formula $(2b)^2 - 4(3a)c < 0$, $4b^2 - 12ac < 0$, $b^2 - 3ac < 0$. If $b^2 - 3ac = 0$, then $f'(x) = 0$ has only one real solution at, say, $x = c$ so f is always increasing or always decreasing on both $(-\infty, c]$ and $[c, +\infty)$, and hence on $(-\infty, +\infty)$ because f is continuous everywhere. Thus f is always increasing or decreasing if $b^2 - 3ac \leq 0$.

19. The maximum increase in y seems to occur near $x = -1$, $y = 1/4$.

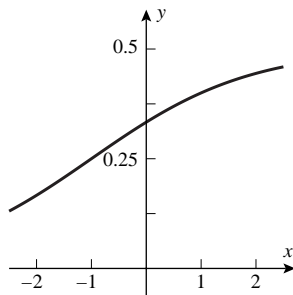

20. $y = \frac{a^x}{1 + a^{x+k}}$, $y' = \frac{a^x \ln a}{(1 + a^{x+k})^2}$, $y'' = -\frac{a^x (\ln a)^2 (a^{x+k} - 1)}{(1 + a^{x+k})^3}$; $y'' = 0$ when $x = -k$ and y'' changes sign there.

22. (a) False; an example is $y = \frac{x^3}{3} - \frac{x^2}{2}$ on $[-2, 2]$; $x = 0$ is a relative maximum and $x = 1$ is a relative minimum, but $y = 0$ is not the largest value of y on the interval, nor is $y = -\frac{1}{6}$ the smallest.

(b) True.

(c) False; for example $y = x^3$ on $(-1, 1)$ which has a critical number but no relative extrema.

24. (a) $f'(x) = 3x^2 + 6x - 9 = 3(x + 3)(x - 1)$, $f'(x) = 0$ when $x = -3, 1$ (stationary points).

(b) $f'(x) = 4x(x^2 - 3)$, $f'(x) = 0$ when $x = 0, \pm\sqrt{3}$ (stationary points).

25. (a) $f'(x) = (2 - x^2)/(x^2 + 2)^2$, $f'(x) = 0$ when $x = \pm\sqrt{2}$ (stationary points).

(b) $f'(x) = 8x/(x^2 + 1)^2$, $f'(x) = 0$ when $x = 0$ (stationary point).

26. (a) $f'(x) = \frac{4(x+1)}{3x^{2/3}}$, $f'(x) = 0$ when $x = -1$ (stationary point), $f'(x)$ does not exist when $x = 0$.

(b) $f'(x) = \frac{4(x-3/2)}{3x^{2/3}}$, $f'(x) = 0$ when $x = 3/2$ (stationary point), $f'(x)$ does not exist when $x = 0$.

27. (a) $f'(x) = \frac{7(x-7)(x-1)}{3x^{2/3}}$; critical numbers at $x = 0, 1, 7$; neither at $x = 0$, relative maximum at $x = 1$, relative minimum at $x = 7$ (First Derivative Test).

(b) $f'(x) = 2 \cos x(1+2 \sin x)$; critical numbers at $x = \pi/2, 3\pi/2, 7\pi/6, 11\pi/6$; relative maximum at $x = \pi/2, 3\pi/2$, relative minimum at $x = 7\pi/6, 11\pi/6$.

(c) $f'(x) = 3 - \frac{3\sqrt{x-1}}{2}$; critical number at $x = 5$; relative maximum at $x = 5$.

28. (a) $f'(x) = \frac{x-9}{18x^{3/2}}$, $f''(x) = \frac{27-x}{36x^{5/2}}$; critical number at $x = 9$; $f''(9) > 0$, relative minimum at $x = 9$.

(b) $f'(x) = 2\frac{x^3-4}{x^2}$, $f''(x) = 2\frac{x^3+8}{x^3}$; critical number at $x = 4^{1/3}$, $f''(4^{1/3}) > 0$, relative minimum at $x = 4^{1/3}$.

(c) $f'(x) = \sin x(2 \cos x + 1)$, $f''(x) = 2 \cos^2 x - 2 \sin^2 x + \cos x$; critical numbers at $x = 2\pi/3, \pi, 4\pi/3$; $f''(2\pi/3) < 0$, relative maximum at $x = 2\pi/3$; $f''(\pi) > 0$, relative minimum at $x = \pi$; $f''(4\pi/3) < 0$, relative maximum at $x = 4\pi/3$.

29. $\lim_{x \rightarrow -\infty} f(x) = +\infty$, $\lim_{x \rightarrow +\infty} f(x) = +\infty$, $f'(x) = x(4x^2 - 9x + 6)$, $f''(x) = 6(2x - 1)(x - 1)$, relative minimum at $x = 0$, points of inflection when $x = 1/2, 1$, no asymptotes.

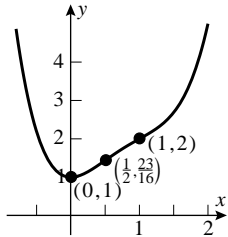

30. $\lim_{x \rightarrow -\infty} f(x) = -\infty$, $\lim_{x \rightarrow +\infty} f(x) = +\infty$, $f(x) = x^3(x-2)^2$, $f'(x) = x^2(5x-6)(x-2)$, $f''(x) = 4x(5x^2 - 12x + 6)$, critical numbers at $x = 0, 6/5, 2$, relative maximum at $x = 6/5$, relative minimum at $x = 2$, points of inflection at $x = 0, \frac{6 \pm \sqrt{6}}{5} \approx 0, 0.71, 1.69$, no asymptotes.

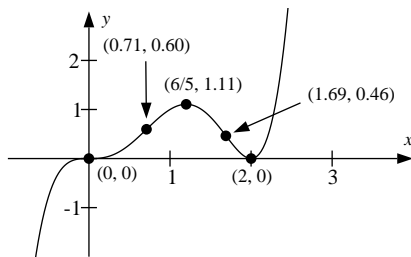

31. $\lim_{x \rightarrow \pm\infty} f(x)$ doesn't exist, $f'(x) = 2x \sec^2(x^2 + 1)$, $f''(x) = 2 \sec^2(x^2 + 1) [1 + 4x^2 \tan(x^2 + 1)]$, critical number at $x = 0$; relative minimum at $x = 0$, point of inflection when $1 + 4x^2 \tan(x^2 + 1) = 0$, vertical asymptotes at $x = \pm \sqrt{\pi(n + \frac{1}{2})} - 1$, $n = 0, 1, 2, \dots$

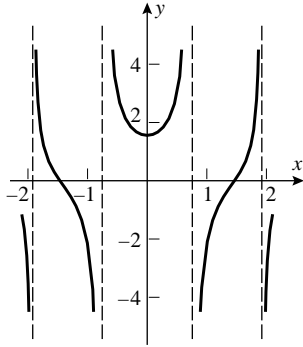

32. $\lim_{x \rightarrow -\infty} f(x) = -\infty$, $\lim_{x \rightarrow +\infty} f(x) = +\infty$, $f'(x) = 1 + \sin x$, $f''(x) = \cos x$, critical numbers at $x = 2n\pi + \pi/2$, $n = 0, \pm 1, \pm 2, \dots$, no extrema because $f' \geq 0$ and by Exercise 59 of Section 5.1, f is increasing on $(-\infty, +\infty)$, inflections points at $x = n\pi + \pi/2$, $n = 0, \pm 1, \pm 2, \dots$, no asymptotes.

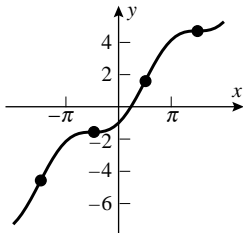

33. $f'(x) = 2 \frac{x(x+5)}{(x^2+2x+5)^2}$, $f''(x) = -2 \frac{2x^3+15x^2-25}{(x^2+2x+5)^3}$, critical numbers at $x = -5, 0$; relative maximum at $x = -5$, relative minimum at $x = 0$, points of inflection at $x \approx -7.26, -1.44, 1.20$, horizontal asymptote $y = 1$ as $x \rightarrow \pm\infty$.

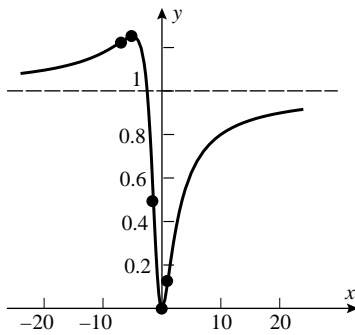

34. $f'(x) = 3 \frac{3x^2-25}{x^4}$, $f''(x) = -6 \frac{3x^2-50}{x^5}$, critical numbers at $x = \pm 5\sqrt{3}/3$; relative maximum at $x = -5\sqrt{3}/3$, relative minimum at $x = +5\sqrt{3}/3$, inflection points at $x = \pm 5\sqrt{2}/3$, horizontal asymptote of $y = 0$ as $x \rightarrow \pm\infty$, vertical asymptote $x = 0$.

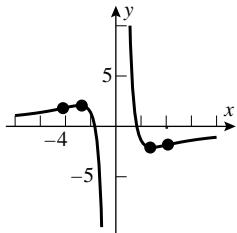

35. $\lim_{x \rightarrow -\infty} f(x) = +\infty$, $\lim_{x \rightarrow +\infty} f(x) = -\infty$, $f'(x) = \begin{cases} x, & x \leq 0 \\ -2x, & x > 0 \end{cases}$, critical number at $x = 0$, no extrema, inflection point at $x = 0$ (f changes concavity), no asymptotes.

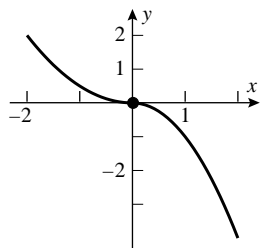

36. $f'(x) = \frac{5-3x}{3(1+x)^{1/3}(3-x)^{2/3}}$, $f''(x) = \frac{-32}{9(1+x)^{4/3}(3-x)^{5/3}}$, critical number at $x = 5/3$; relative maximum at $x = 5/3$, cusp at $x = -1$; point of inflection at $x = 3$, oblique asymptote $y = -x$ as $x \rightarrow \pm\infty$.

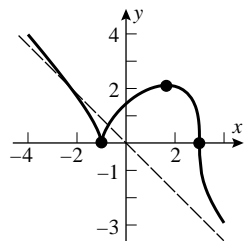

37. $f'(x) = 3x^2 + 5$; no relative extrema because there are no critical numbers.
38. $f'(x) = 4x(x^2 - 1)$; critical numbers $x = 0, 1, -1$, $f''(x) = 12x^2 - 4$; $f''(0) < 0$, $f''(1) > 0$, $f''(-1) > 0$, relative minimum of 6 at $x = 1, -1$, relative maximum of 7 at $x = 0$.
39. $f'(x) = \frac{4}{5}x^{-1/5}$; critical number $x = 0$; relative minimum of 0 at $x = 0$ (first derivative test).
40. $f'(x) = 2 + \frac{2}{3}x^{-1/3}$; critical numbers $x = 0, -1/27$, relative minimum of 0 at $x = 0$, relative maximum of $1/27$ at $x = -1/27$.
41. $f'(x) = 2x/(x^2 + 1)^2$; critical number $x = 0$; relative minimum of 0 at $x = 0$.
42. $f'(x) = 2/(x + 2)^2$; no critical numbers ($x = -2$ is not in the domain of f) no relative extrema.
43. $f'(x) = 2x/(1 + x^2)$; critical point at $x = 0$; relative minimum of 0 at $x = 0$ (first derivative test).
44. $f'(x) = x(2 + x)e^x$; critical points at $x = 0, -2$; relative minimum of 0 at $x = 0$ and relative maximum of $4/e^2$ at $x = -2$ (first derivative test).

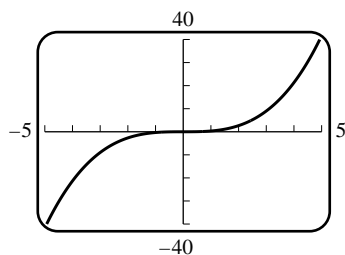

45. (a)
- (b) $f'(x) = x^2 - \frac{1}{400}$, $f''(x) = 2x$, critical points at $x = \pm \frac{1}{20}$; relative maximum at $x = -\frac{1}{20}$, relative minimum at $x = \frac{1}{20}$.
- (c) The finer details can be seen when graphing over a much smaller x -window.

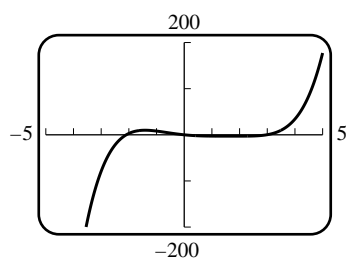
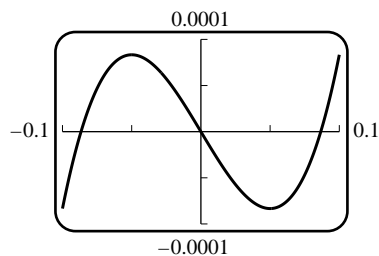

46. (a)

(b) Critical points at $x = \pm\sqrt{2}, \frac{3}{2}, 2$; relative maximum at $x = -\sqrt{2}$, relative minimum at $x = \sqrt{2}$, relative maximum at $x = \frac{3}{2}$, relative minimum at $x = 2$.

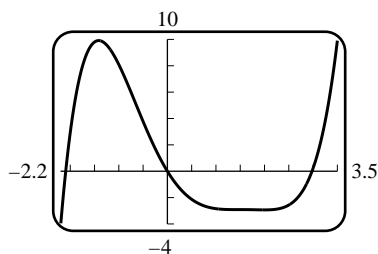

(c)

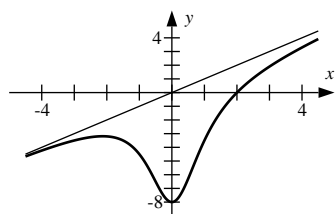
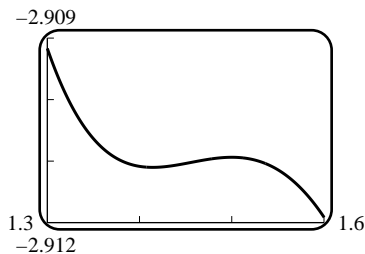

47. (a)

$y = x$ appears to be an asymptote for $y = (x^3 - 8)/(x^2 + 1)$.

(b) $\frac{x^3 - 8}{x^2 + 1} = x - \frac{x + 8}{x^2 + 1}$. Since the limit of $\frac{x + 8}{x^2 + 1}$ as $x \rightarrow \pm\infty$ is 0, $y = x$ is an asymptote for $y = \frac{x^3 - 8}{x^2 + 1}$.

48. $\cos x - (\sin y) \frac{dy}{dx} = 2 \frac{dy}{dx}$; $\frac{dy}{dx} = 0$ when $\cos x = 0$. Use the first derivative test: $\frac{dy}{dx} = \frac{\cos x}{2 + \sin y}$ and $2 + \sin y > 0$, so critical points when $\cos x = 0$, relative maxima when $x = 2n\pi + \pi/2$, relative minima when $x = 2n\pi - \pi/2$, $n = 0, \pm 1, \pm 2, \dots$

49. $f(x) = \frac{(2x - 1)(x^2 + x - 7)}{(2x - 1)(3x^2 + x - 1)} = \frac{x^2 + x - 7}{3x^2 + x - 1}$, $x \neq 1/2$, horizontal asymptote: $y = 1/3$, vertical asymptotes: $x = (-1 \pm \sqrt{13})/6$.

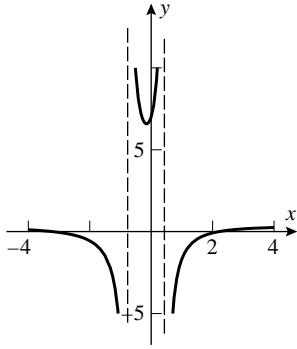

50. (a) $f(x) = \frac{(x-2)(x^2+x+1)(x^2-2)}{(x-2)(x^2-2)^2(x^2+1)} = \frac{x^2+x+1}{(x^2-2)(x^2+1)}$, vertical asymptotes: $x = \pm\sqrt{2}$.

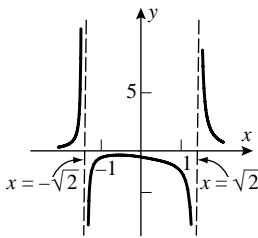

- (b)
51. (a) $f(x) \leq f(x_0)$ for all x in I .
- (b) $f(x) \geq f(x_0)$ for all x in I .
52. f is a continuous function on a finite closed interval $[a, b]$.
53. (a) True. If f has an absolute extremum at a point of (a, b) then it must, by Theorem 4.4.3, be at a critical point of f ; since f is differentiable on (a, b) the critical point is a stationary point.
- (b) False. It could occur at a critical point which is not a stationary point: for example, $f(x) = |x|$ on $[-1, 1]$ has an absolute minimum at $x = 0$ but is not differentiable there.
54. (a) $f'(x) = -1/x^2 \neq 0$, no critical points; by inspection $M = -1/2$ at $x = -2$; $m = -1$ at $x = -1$.
- (b) $f'(x) = 3x^2 - 4x^3 = 0$ at $x = 0, 3/4$; $f(-1) = -2$, $f(0) = 0$, $f(3/4) = 27/256$, $f(3/2) = -27/16$, so $m = -2$ at $x = -1$, $M = 27/256$ at $x = 3/4$.
- (c) $f'(x) = 1 - \sec^2 x$, $f'(x) = 0$ for x in $(-\pi/4, \pi/4)$ when $x = 0$; $f(-\pi/4) = 1 - \pi/4$, $f(0) = 0$, $f(\pi/4) = \pi/4 - 1$ so the maximum value is $1 - \pi/4$ at $x = -\pi/4$ and the minimum value is $\pi/4 - 1$ at $x = \pi/4$.
- (d) Critical point at $x = 2$; $m = -3$ at $x = 3$, $M = 0$ at $x = 2$.
55. (a) $f'(x) = 2x - 3$; critical point $x = 3/2$. Minimum value $f(3/2) = -13/4$, no maximum.
- (b) No maximum or minimum because $\lim_{x \rightarrow +\infty} f(x) = +\infty$ and $\lim_{x \rightarrow -\infty} f(x) = -\infty$.
- (c) $\lim_{x \rightarrow 0^+} f(x) = \lim_{x \rightarrow +\infty} f(x) = +\infty$ and $f'(x) = \frac{e^x(x-2)}{x^3}$, stationary point at $x = 2$; by Theorem 4.4.4 $f(x)$ has absolute minimum value $e^2/4$ at $x = 2$; no maximum value.
- (d) $f'(x) = (1 + \ln x)x^x$, critical point at $x = 1/e$; $\lim_{x \rightarrow 0^+} f(x) = \lim_{x \rightarrow 0^+} e^{x \ln x} = 1$, $\lim_{x \rightarrow +\infty} f(x) = +\infty$; no absolute maximum, absolute minimum $m = e^{-1/e}$ at $x = 1/e$.

56. (a) $f'(x) = 10x^3(x-2)$, critical points at $x = 0, 2$; $\lim_{x \rightarrow 3^-} f(x) = 88$, so $f(x)$ has no maximum; $m = -9$ at $x = 2$.

(b) $\lim_{x \rightarrow 2^-} f(x) = +\infty$ so no maximum; $f'(x) = 1/(x-2)^2$, so $f'(x)$ is never zero, thus no minimum.

(c) $f'(x) = 2 \frac{3-x^2}{(x^2+3)^2}$, critical point at $x = \sqrt{3}$. Since $\lim_{x \rightarrow 0^+} f(x) = 0$, $f(x)$ has no minimum, and $M = \sqrt{3}/3$ at $x = \sqrt{3}$.

(d) $f'(x) = \frac{x(7x-12)}{3(x-2)^{2/3}}$, critical points at $x = 12/7, 2$; $m = f(12/7) = \frac{144}{49} \left(-\frac{2}{7}\right)^{1/3} \approx -1.9356$ at $x = 12/7$, $M = 9$ at $x = 3$.

57. (a) $(x^2 - 1)^2$ can never be less than zero because it is the square of $x^2 - 1$; the minimum value is 0 for $x = \pm 1$, no maximum because $\lim_{x \rightarrow +\infty} f(x) = +\infty$.

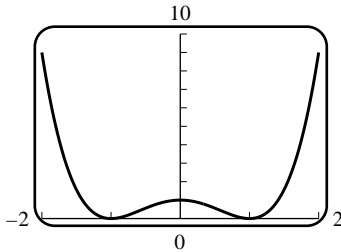

(b) $f'(x) = (1-x^2)/(x^2+1)^2$; critical point $x = 1$. Maximum value $f(1) = 1/2$, minimum value 0 because $f(x)$ is never less than zero on $[0, +\infty)$ and $f(0) = 0$.

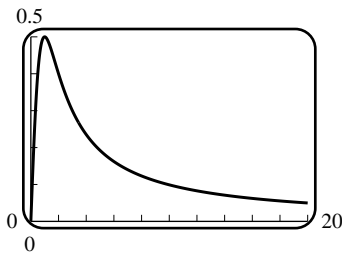

(c) $f'(x) = 2 \sec x \tan x - \sec^2 x = (2 \sin x - 1)/\cos^2 x$, $f'(x) = 0$ for x in $(0, \pi/4)$ when $x = \pi/6$; $f(0) = 2$, $f(\pi/6) = \sqrt{3}$, $f(\pi/4) = 2\sqrt{2} - 1$ so the maximum value is 2 at $x = 0$ and the minimum value is $\sqrt{3}$ at $x = \pi/6$.

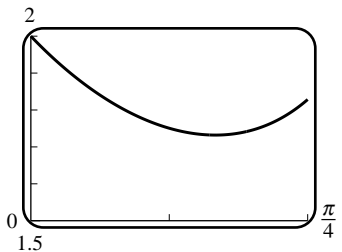

(d) $f'(x) = 1/2 + 2x/(x^2+1)$, $f'(x) = 0$ on $[-4, 0]$ for $x = -2 \pm \sqrt{3}$; if $x = -2 - \sqrt{3}, -2 + \sqrt{3}$, then $f(x) = -1 - \sqrt{3}/2 + \ln 4 + \ln(2 + \sqrt{3}) \approx 0.84$, $-1 + \sqrt{3}/2 + \ln 4 + \ln(2 - \sqrt{3}) \approx -0.06$, absolute maximum at $x = -2 - \sqrt{3}$, absolute minimum at $x = -2 + \sqrt{3}$.

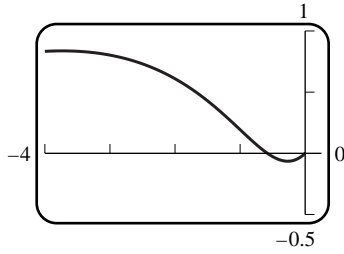

58. Let $f(x) = \sin^{-1} x - x$ for $0 \leq x \leq 1$. $f(0) = 0$ and $f'(x) = \frac{1}{\sqrt{1-x^2}} - 1 = \frac{1 - \sqrt{1-x^2}}{\sqrt{1-x^2}}$. Note that $\sqrt{1-x^2} \leq 1$, so $f'(x) \geq 0$. Thus we know that f is increasing. Since $f(0) = 0$, it follows that $f(x) \geq 0$ for $0 \leq x \leq 1$.

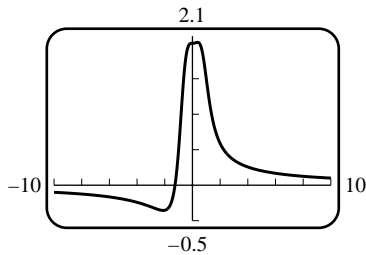

59. (a)

(b) Minimum: $(-2.111985, -0.355116)$, maximum: $(0.372591, 2.012931)$.

60. Let k be the amount of light admitted per unit area of clear glass. The total amount of light admitted by the entire window is $T = k \cdot (\text{area of clear glass}) + \frac{1}{2}k \cdot (\text{area of blue glass}) = 2krh + \frac{1}{4}\pi kr^2$. But $P = 2h + 2r + \pi r$ which gives $2h = P - 2r - \pi r$ so $T = kr(P - 2r - \pi r) + \frac{1}{4}\pi kr^2 = k \left[Pr - \left(2 + \pi - \frac{\pi}{4}\right)r^2 \right] = k \left[Pr - \frac{8 + 3\pi}{4}r^2 \right]$ for $0 < r < \frac{P}{2 + \pi}$, $\frac{dT}{dr} = k \left(P - \frac{8 + 3\pi}{2}r \right)$, $\frac{dT}{dr} = 0$ when $r = \frac{2P}{8 + 3\pi}$. This is the only critical point and $d^2T/dr^2 < 0$ there so the most light is admitted when $r = 2P/(8 + 3\pi)$ ft.

61. If one corner of the rectangle is at (x, y) with $x > 0$, $y > 0$, then $A = 4xy$, $y = 3\sqrt{1 - (x/4)^2}$, $A = 12x\sqrt{1 - (x/4)^2} = 3x\sqrt{16 - x^2}$, $\frac{dA}{dx} = 6\frac{8 - x^2}{\sqrt{16 - x^2}}$, critical point at $x = 2\sqrt{2}$. Since $A = 0$ when $x = 0, 4$ and $A > 0$ otherwise, there is an absolute maximum $A = 24$ at $x = 2\sqrt{2}$. The rectangle has width $2x = 4\sqrt{2}$ and height $2y = A/(2x) = 3\sqrt{2}$.

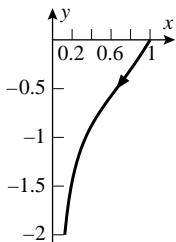

62. (a)

(b) The distance between the boat and the origin is $\sqrt{x^2 + y^2}$, where $y = (x^{10/3} - 1)/(2x^{2/3})$. The minimum distance is about 0.8247 mi when $x \approx 0.6598$ mi. The boat gets swept downstream.

63. $V = x(12 - 2x)^2$ for $0 \leq x \leq 6$; $dV/dx = 12(x - 2)(x - 6)$, $dV/dx = 0$ when $x = 2$ for $0 < x < 6$. If $x = 0, 2, 6$ then $V = 0, 128, 0$ so the volume is largest when $x = 2$ in.

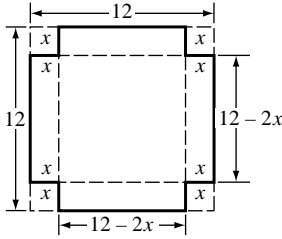

64. False; speeding up means the velocity and acceleration have the same sign, i.e. $av > 0$; the velocity is increasing when the acceleration is positive, i.e. $a > 0$. These are not the same thing. An example is $s = t - t^2$ at $t = 1$, where $v = -1$ and $a = -2$, so $av > 0$ but $a < 0$.
65. (a) Yes. If $s = 2t - t^2$ then $v = ds/dt = 2 - 2t$ and $a = dv/dt = -2$ is constant. The velocity changes sign at $t = 1$, so the particle reverses direction then.

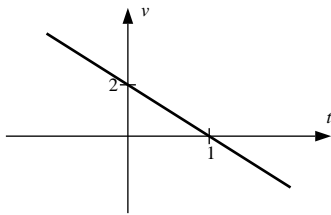

- (b) Yes. If $s = t + e^{-t}$ then $v = ds/dt = 1 - e^{-t}$ and $a = dv/dt = e^{-t}$. For $t > 0$, $v > 0$ and $a > 0$, so the particle is speeding up. But $da/dt = -e^{-t} < 0$, so the acceleration is decreasing.

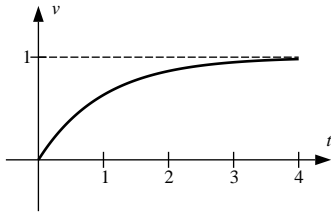

66. (a) $s(t) = t/(2t^2 + 8)$, $v(t) = (4 - t^2)/2(t^2 + 4)^2$, $a(t) = t(t^2 - 12)/(t^2 + 4)^3$.

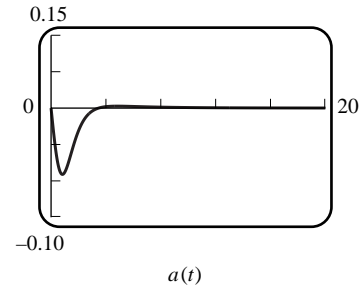
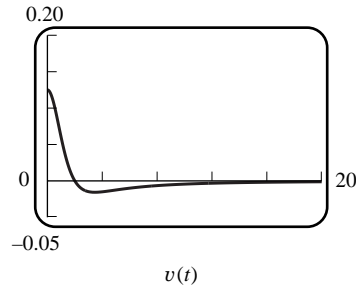
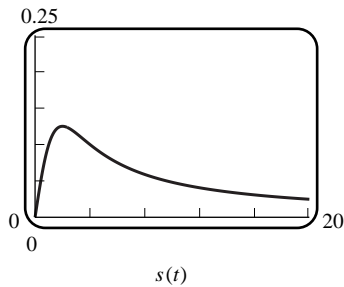

- (b) v changes sign at $t = 2$.
- (c) $s = 1/8$, $v = 0$, $a = -1/32$.
- (d) a changes sign at $t = 2\sqrt{3}$, so the particle is speeding up for $2 < t < 2\sqrt{3}$, and it is slowing down for $0 < t < 2$ and $2\sqrt{3} < t$.
- (e) $v(0) = 1/8$, $\lim_{t \rightarrow +\infty} v(t) = 0$, $v(t)$ has one t -intercept at $t = 2$ and $v(t)$ has one critical point at $t = 2\sqrt{3}$. Consequently the maximum velocity occurs when $t = 0$ and the minimum velocity occurs when $t = 2\sqrt{3}$.

67. (a) $v = -2 \frac{t(t^4 + 2t^2 - 1)}{(t^4 + 1)^2}$, $a = 2 \frac{3t^8 + 10t^6 - 12t^4 - 6t^2 + 1}{(t^4 + 1)^3}$.

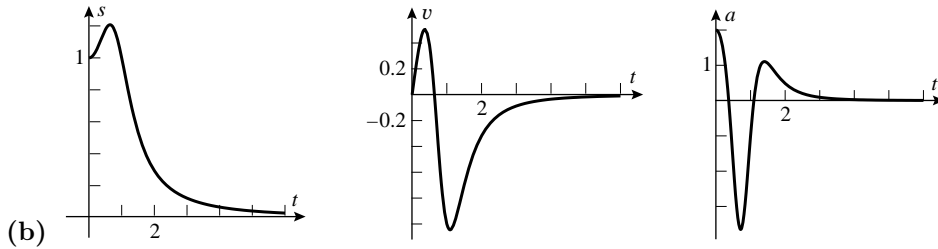

- (b) $t \approx 0.64$
- (c) It is farthest from the origin at $t \approx 0.64$ (when $v = 0$) and $s \approx 1.2$.
- (d) Find t so that the velocity $v = ds/dt > 0$. The particle is moving in the positive direction for $0 \leq t \leq 0.64$, approximately.
- (e) It is speeding up when $a, v > 0$ or $a, v < 0$, so for $0 \leq t < 0.36$ and $0.64 < t < 1.1$ approximately, otherwise it is slowing down.
- (f) Find the maximum value of $|v|$ to obtain: maximum speed ≈ 1.05 when $t \approx 1.10$.

69. $x \approx -2.11491, 0.25410, 1.86081$.

70. $x \approx 2.3561945$.

71. At the point of intersection, $x^3 = 0.5x - 1$, $x^3 - 0.5x + 1 = 0$. Let $f(x) = x^3 - 0.5x + 1$. By graphing $y = x^3$ and $y = 0.5x - 1$ it is evident that there is only one point of intersection and it occurs in the interval $[-2, -1]$; note that $f(-2) < 0$ and $f(-1) > 0$. $f'(x) = 3x^2 - 0.5$ so $x_{n+1} = x_n - \frac{x_n^3 - 0.5x_n + 1}{3x_n^2 - 0.5}$; $x_1 = -1, x_2 = -1.2, x_3 \approx -1.166492147, \dots, x_5 \approx x_6 \approx -1.165373043$.

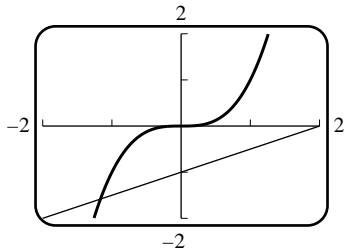

72. Solve $\phi - 0.0167 \sin \phi = 2\pi(90)/365$ to get $\phi \approx 1.565978$ so $r = 150 \times 10^6(1 - 0.0167 \cos \phi) \approx 149.988 \times 10^6$ km.

73. Solve $\phi - 0.0934 \sin \phi = 2\pi(1)/1.88$ to get $\phi \approx 3.325078$ so $r = 228 \times 10^6(1 - 0.0934 \cos \phi) \approx 248.938 \times 10^6$ km.

74. True; by the Mean-Value Theorem there is a point c in (a, b) such that $f'(c) = \frac{f(b) - f(a)}{b - a} = 0$.

75. (a) Yes; $f'(0) = 0$.

(b) No, f is not differentiable on $(-1, 1)$.

(c) Yes, $f'(\sqrt{\pi/2}) = 0$.

76. (a) No, f is not differentiable on $(-2, 2)$.

(b) Yes, $\frac{f(3) - f(2)}{3 - 2} = -1 = f'(1 + \sqrt{2})$.

(c) Yes, $\lim_{x \rightarrow 1^-} f(x) = 2$, $\lim_{x \rightarrow 1^+} f(x) = 2$ so f is continuous on $[0, 2]$; $\lim_{x \rightarrow 1^-} f'(x) = \lim_{x \rightarrow 1^-} -2x = -2$ and $\lim_{x \rightarrow 1^+} f'(x) = \lim_{x \rightarrow 1^+} (-2/x^2) = -2$, so f is differentiable on $(0, 2)$; and $\frac{f(2) - f(0)}{2 - 0} = -1 = f'(\frac{1}{2}) = f'(\sqrt{2})$.

77. $f(x) = x^6 - 2x^2 + x$ satisfies $f(0) = f(1) = 0$, so by Rolle's Theorem $f'(c) = 0$ for some c in $(0, 1)$.

78. If $f'(x) = g'(x)$, then $f(x) = g(x) + k$. Let $x = 1$, $f(1) = g(1) + k = (1)^3 - 4(1) + 6 + k = 3 + k = 2$, so $k = -1$.
 $f(x) = x^3 - 4x + 5$.

Chapter 4 Making Connections

1. (a) $g(x)$ has no zeros. Since $g(x)$ is concave up for $x < 3$, its graph lies on or above the line $y = 2 - \frac{2}{3}x$, which is the tangent line at $(0, 2)$. So for $x < 3$, $g(x) \geq 2 - \frac{2}{3}x > 0$. Since $g(x)$ is concave up for $3 \leq x < 4$, its graph lies above the line $y = 3x - 9$, which is the tangent line at $(4, 3)$. So for $3 \leq x < 4$, $g(x) > 3x - 9 \geq 0$. Finally, if $x \geq 4$, $g(x)$ could only have a zero if $g'(a)$ were negative for some $a > 4$. But then the graph would lie below the tangent line at $(a, g(a))$, which crosses the line $y = -10$ for some $x > a$. So $g(x)$ would be less than -10 for some x .

(b) One, between 0 and 4.

(c) Since $g(x)$ is concave down for $x > 4$ and $g'(4) = 3$, $g'(x) < 3$ for all $x > 4$. Hence the limit can't be 5. If it were -5 then the graph of $g(x)$ would cross the line $y = -10$ at some point. So the limit must be 0.

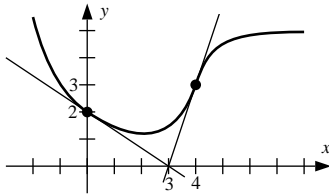

2. (a) $(-2.2, 4), (2, 1.2), (4.2, 3)$.

(b) f' exists everywhere, so the critical numbers are when $f' = 0$, i.e. when $x = \pm 2$ or $r(x) = 0$, so $x \approx -5.1, -2, 0.2, 2$. At $x = -5.1$ f' changes sign from $-$ to $+$, so minimum; at $x = -2$ f' changes sign from $+$ to $-$, so maximum; at $x = 0.2$ f' doesn't change sign, so neither; at $x = 2$ f' changes sign from $-$ to $+$, so minimum. Finally, $f''(1) = (1^2 - 4)r'(1) + 2r(1) \approx -3(0.6) + 2(0.3) = -1.2$.

3. $g''(x) = 1 - r'(x)$, so $g(x)$ has an inflection point where the graph of $y = r'(x)$ crosses the line $y = 1$; i.e. at $x = -4$ and $x = 5$.

4. (a) $|x_{n+1} - x_n| \leq |x_{n+1} - c| + |c - x_n| < 1/n + 1/n = 2/n$.

(b) The closed interval $[c - 1, c + 1]$ contains all of the x_n , since $|x_n - c| < 1/n$. Let M be an upper bound for $|f'(x)|$ on $[c - 1, c + 1]$. Since $x_{n+1} = x_n - f(x_n)/f'(x_n)$ it follows that $|f(x_n)| \leq |f'(x_n)||x_{n+1} - x_n| < M|x_{n+1} - x_n| < 2M/n$.

(c) Assume that $f(c) \neq 0$. The sequence x_n converges to c , since $|x_n - c| < 1/n$. By the continuity of f , $f(c) = f(\lim_{n \rightarrow \infty} x_n) = \lim_{n \rightarrow \infty} f(x_n)$. Let $\epsilon = |f(c)|/2$. Choose N such that $|f(x_n) - f(c)| < \epsilon/2$ for $n > N$. Then $|f(x_n) - f(c)| < |f(c)|/2$ for $n > N$, so $-|f(c)|/2 < f(x_n) - f(c) < |f(c)|/2$. If $f(c) > 0$ then $f(x_n) > f(c) - |f(c)|/2 = f(c)/2$. If $f(c) < 0$, then $f(x_n) < f(c) + |f(c)|/2 = -|f(c)|/2$, or $|f(x_n)| > |f(c)|/2$.

(d) From (b) it follows that $\lim_{n \rightarrow +\infty} f(x_n) = 0$. From (c) it follows that if $f(c) \neq 0$ then $\lim_{n \rightarrow +\infty} f(x_n) \neq 0$, a contradiction. The conclusion, then, is that $f(c) = 0$.

6. (a) Route (i) is 7 inches long, so it would take $7/0.7 = 10$ seconds. Route (iv) is 3 inches long, so it would take $3/0.3 = 10$ seconds.

(b) x is in the interval $[2, 5]$. The bug travels x inches on linoleum and $\sqrt{2^2 + (5-x)^2}$ inches on carpet, so its travel time is $f(x) = \frac{x}{0.7} + \frac{\sqrt{x^2 - 10x + 29}}{0.3} = \frac{10}{21}(3x + 7\sqrt{x^2 - 10x + 29})$. We have $f'(x) = \frac{10}{21} \left(3 + \frac{7(x-5)}{\sqrt{x^2 - 10x + 29}} \right)$; solving $f'(x) = 0$ with x in $[2, 5]$ gives $x = 5 - \frac{3}{\sqrt{10}}$. So we compute $f(x)$ at $x = 2$, $x = 5$, and $x = 5 - \frac{3}{\sqrt{10}}$: $f(2) = \frac{10}{21}(6 + 7\sqrt{13}) \approx 14.87565$, $f(5) = \frac{290}{21} \approx 13.80952$, $f\left(5 - \frac{3}{\sqrt{10}}\right) = \frac{10}{21}(15 + 4\sqrt{10}) \approx 13.16624$. The shortest time for route (ii) is $\frac{10}{21}(15 + 4\sqrt{10}) \approx 13.16624$ seconds.

(c) x is in the interval $[0, 2]$; when $x = 0$ route (iii) is the same as route (iv). If $x > 0$ then the bug travels more than 3 inches on carpet, so it takes longer than it does for $x = 0$. The shortest time for route (iii) is 10 seconds.

(d) Routes (i) and (iv) (and route (iii) with $x = 0$) are the quickest, taking 10 seconds each.

Integration

Exercise Set 5.1

1. Endpoints $0, \frac{1}{n}, \frac{2}{n}, \dots, \frac{n-1}{n}, 1$; using right endpoints,

$$A_n = \left[\sqrt{\frac{1}{n}} + \sqrt{\frac{2}{n}} + \dots + \sqrt{\frac{n-1}{n}} + 1 \right] \frac{1}{n}.$$

n	2	5	10	50	100
A_n	0.853553	0.749739	0.710509	0.676095	0.671463

2. Endpoints $0, \frac{1}{n}, \frac{2}{n}, \dots, \frac{n-1}{n}, 1$; using right endpoints,

$$A_n = \left[\frac{n}{n+1} + \frac{n}{n+2} + \frac{n}{n+3} + \dots + \frac{n}{2n-1} + \frac{1}{2} \right] \frac{1}{n}.$$

n	2	5	10	50	100
A_n	0.583333	0.645635	0.668771	0.688172	0.690653

3. Endpoints $0, \frac{\pi}{n}, \frac{2\pi}{n}, \dots, \frac{(n-1)\pi}{n}, \pi$; using right endpoints,

$$A_n = [\sin(\pi/n) + \sin(2\pi/n) + \dots + \sin(\pi(n-1)/n) + \sin \pi] \frac{\pi}{n}.$$

n	2	5	10	50	100
A_n	1.57080	1.93376	1.98352	1.99935	1.99984

4. Endpoints $0, \frac{\pi}{2n}, \frac{2\pi}{2n}, \dots, \frac{(n-1)\pi}{2n}, \frac{\pi}{2}$; using right endpoints,

$$A_n = [\cos(\pi/2n) + \cos(2\pi/2n) + \dots + \cos((n-1)\pi/2n) + \cos(\pi/2)] \frac{\pi}{2n}.$$

n	2	5	10	50	100
A_n	0.555359	0.834683	0.919405	0.984204	0.992120

5. Endpoints $1, \frac{n+1}{n}, \frac{n+2}{n}, \dots, \frac{2n-1}{n}, 2$; using right endpoints,

$$A_n = \left[\frac{n}{n+1} + \frac{n}{n+2} + \dots + \frac{n}{2n-1} + \frac{1}{2} \right] \frac{1}{n}.$$

n	2	5	10	50	100
A_n	0.583333	0.645635	0.668771	0.688172	0.690653

6. Endpoints $-\frac{\pi}{2}, -\frac{\pi}{2} + \frac{\pi}{n}, -\frac{\pi}{2} + \frac{2\pi}{n}, \dots, -\frac{\pi}{2} + \frac{(n-1)\pi}{n}, \frac{\pi}{2}$; using right endpoints,

$$A_n = \left[\cos\left(-\frac{\pi}{2} + \frac{\pi}{n}\right) + \cos\left(-\frac{\pi}{2} + \frac{2\pi}{n}\right) + \dots + \cos\left(-\frac{\pi}{2} + \frac{(n-1)\pi}{n}\right) + \cos\left(\frac{\pi}{2}\right) \right] \frac{\pi}{n}.$$

n	2	5	10	50	100
A_n	1.57080	1.93376	1.98352	1.99936	1.99985

7. Endpoints $0, \frac{1}{n}, \frac{2}{n}, \dots, \frac{n-1}{n}, 1$; using right endpoints,

$$A_n = \left[\sqrt{1 - \left(\frac{1}{n}\right)^2} + \sqrt{1 - \left(\frac{2}{n}\right)^2} + \dots + \sqrt{1 - \left(\frac{n-1}{n}\right)^2} + 0 \right] \frac{1}{n}.$$

n	2	5	10	50	100
A_n	0.433013	0.659262	0.726130	0.774567	0.780106

8. Endpoints $-1, -1 + \frac{2}{n}, -1 + \frac{4}{n}, \dots, -1 + \frac{2(n-1)}{n}, 1$; using right endpoints,

$$A_n = \left[\sqrt{1 - \left(\frac{n-2}{n}\right)^2} + \sqrt{1 - \left(\frac{n-4}{n}\right)^2} + \dots + \sqrt{1 - \left(\frac{n-2}{n}\right)^2} + 0 \right] \frac{2}{n}.$$

n	2	5	10	50	100
A_n	1	1.423837	1.518524	1.566097	1.569136

9. Endpoints $-1, -1 + \frac{2}{n}, -1 + \frac{4}{n}, \dots, 1 - \frac{2}{n}, 1$; using right endpoints,

$$A_n = \left[e^{-1 + \frac{2}{n}} + e^{-1 + \frac{4}{n}} + e^{-1 + \frac{6}{n}} + \dots + e^{1 - \frac{2}{n}} + e^1 \right] \frac{2}{n}.$$

n	2	5	10	50	100
A_n	3.718281	2.851738	2.59327	2.39772	2.37398

10. Endpoints $1, 1 + \frac{1}{n}, 1 + \frac{2}{n}, \dots, 2 - \frac{1}{n}, 2$; using right endpoints,

$$A_n = \left[\ln\left(1 + \frac{1}{n}\right) + \ln\left(1 + \frac{2}{n}\right) + \dots + \ln\left(2 - \frac{1}{n}\right) + \ln 2 \right] \frac{1}{n}.$$

n	2	5	10	50	100
A_n	0.549	0.454	0.421	0.393	0.390

11. Endpoints $0, \frac{1}{n}, \frac{2}{n}, \dots, \frac{n-1}{n}, 1$; using right endpoints,

$$A_n = \left[\sin^{-1}\left(\frac{1}{n}\right) + \sin^{-1}\left(\frac{2}{n}\right) + \dots + \sin^{-1}\left(\frac{n-1}{n}\right) + \sin^{-1}(1) \right] \frac{1}{n}.$$

n	2	5	10	50	100
A_n	1.04729	0.75089	0.65781	0.58730	0.57894

12. Endpoints $0, \frac{1}{n}, \frac{2}{n}, \dots, \frac{n-1}{n}, 1$; using right endpoints,

$$A_n = \left[\tan^{-1}\left(\frac{1}{n}\right) + \tan^{-1}\left(\frac{2}{n}\right) + \dots + \tan^{-1}\left(\frac{n-1}{n}\right) + \tan^{-1}(1) \right] \frac{1}{n}.$$

n	2	5	10	50	100
A_n	0.62452	0.51569	0.47768	0.44666	0.44274

13. $3(x-1)$.

14. $5(x-2)$.

15. $x(x + 2)$.
16. $\frac{3}{2}(x - 1)^2$.
17. $(x + 3)(x - 1)$.
18. $\frac{3}{2}x(x - 2)$.
19. False; the area is 4π .
20. False; consider the left endpoint approximation on $[1, 2]$.
21. True.
22. True; a differentiable function is continuous.
23. $A(6)$ represents the area between $x = 0$ and $x = 6$; $A(3)$ represents the area between $x = 0$ and $x = 3$; their difference $A(6) - A(3)$ represents the area between $x = 3$ and $x = 6$, and $A(6) - A(3) = \frac{1}{3}(6^3 - 3^3) = 63$.
24. $A(9) = 9^3/3$, $A(-3) = (-3)^3/3$, and the area between $x = -3$ and $x = 9$ is given by $A(9) - A(-3) = (9^3 - (-3)^3)/3 = 252$.
25. B is also the area between the graph of $f(x) = \sqrt{x}$ and the interval $[0, 1]$ on the y -axis, so $A + B$ is the area of the square.
26. Split A at $y = 1/2$ and B at $y = 1$. Then both A and B consist of a rectangle of size $1 \times (1/2)$ and a part which is a symmetric image of the other through the line $y = x$.
27. The area which is under the curve lies to the right of $x = 2$ (or to the left of $x = -2$). Hence $f(x) = A'(x) = 2x$; $0 = A(a) = a^2 - 4$, so take $a = 2$.
28. $f(x) = A'(x) = 2x - 1$, $0 = A(a) = a^2 - a$, so take $a = 1$.
30. Intuitively it is the area represented by a set of tall thin rectangles, stretching from $x = a$ to $x = b$, each having height C ; in other words $C(b - a)$. Analytically it is given by $\int_a^b [(f(x) + C) - f(x)] dx = C(b - a)$.

Exercise Set 5.2

1. (a) $\int \frac{x}{\sqrt{1+x^2}} dx = \sqrt{1+x^2} + C$. (b) $\int (x+1)e^x dx = xe^x + C$.
2. (a) $\frac{d}{dx}(\sin x - x \cos x + C) = \cos x - \cos x + x \sin x = x \sin x$.
- (b) $\frac{d}{dx} \left(\frac{x}{\sqrt{1-x^2}} + C \right) = \frac{\sqrt{1-x^2} + x^2/\sqrt{1-x^2}}{1-x^2} = \frac{1}{(1-x^2)^{3/2}}$.
5. $\frac{d}{dx} [\sqrt{x^3+5}] = \frac{3x^2}{2\sqrt{x^3+5}}$, so $\int \frac{3x^2}{2\sqrt{x^3+5}} dx = \sqrt{x^3+5} + C$.
6. $\frac{d}{dx} \left[\frac{x}{x^2+3} \right] = \frac{3-x^2}{(x^2+3)^2}$, so $\int \frac{3-x^2}{(x^2+3)^2} dx = \frac{x}{x^2+3} + C$.

7. $\frac{d}{dx} [\sin(2\sqrt{x})] = \frac{\cos(2\sqrt{x})}{\sqrt{x}}$, so $\int \frac{\cos(2\sqrt{x})}{\sqrt{x}} dx = \sin(2\sqrt{x}) + C$.
8. $\frac{d}{dx} [\sin x - x \cos x] = x \sin x$, so $\int x \sin x dx = \sin x - x \cos x + C$.
9. (a) $x^9/9 + C$. (b) $\frac{7}{12}x^{12/7} + C$. (c) $\frac{2}{9}x^{9/2} + C$.
10. (a) $\frac{3}{5}x^{5/3} + C$. (b) $-\frac{1}{5}x^{-5} + C = -\frac{1}{5x^5} + C$. (c) $8x^{1/8} + C$.
11. $\int \left[5x + \frac{2}{3x^5}\right] dx = \int 5x dx + \frac{2}{3} \int \frac{1}{x^5} dx = \frac{5}{2}x^2 + \frac{2}{3} \left(\frac{-1}{4}\right) \frac{1}{x^4} + C = \frac{5}{2}x^2 - \frac{1}{6x^4} + C$.
12. $\int \left[x^{-1/2} - 3x^{7/5} + \frac{1}{9}\right] dx = \int x^{-1/2} dx - 3 \int x^{7/5} dx + \int \frac{1}{9} dx = 2x^{1/2} - \frac{5}{4}x^{12/5} + \frac{1}{9}x + C$.
13. $\int \left[x^{-3} - 3x^{1/4} + 8x^2\right] dx = \int x^{-3} dx - 3 \int x^{1/4} dx + 8 \int x^2 dx = -\frac{1}{2}x^{-2} - \frac{12}{5}x^{5/4} + \frac{8}{3}x^3 + C$.
14. $\int \left[\frac{10}{y^{3/4}} - \sqrt[3]{y} + \frac{4}{\sqrt{y}}\right] dy = 10 \int \frac{1}{y^{3/4}} dy - \int \sqrt[3]{y} dy + 4 \int \frac{1}{\sqrt{y}} dy = 10(4)y^{1/4} - \frac{3}{4}y^{4/3} + 4(2)y^{1/2} + C = 40y^{1/4} - \frac{3}{4}y^{4/3} + 8\sqrt{y} + C$.
15. $\int (x + x^4) dx = x^2/2 + x^5/5 + C$.
16. $\int (4 + 4y^2 + y^4) dy = 4y + \frac{4}{3}y^3 + \frac{1}{5}y^5 + C$.
17. $\int x^{1/3}(4 - 4x + x^2) dx = \int (4x^{1/3} - 4x^{4/3} + x^{7/3}) dx = 3x^{4/3} - \frac{12}{7}x^{7/3} + \frac{3}{10}x^{10/3} + C$.
18. $\int (2 - x + 2x^2 - x^3) dx = 2x - \frac{1}{2}x^2 + \frac{2}{3}x^3 - \frac{1}{4}x^4 + C$.
19. $\int (x + 2x^{-2} - x^{-4}) dx = x^2/2 - 2/x + 1/(3x^3) + C$.
20. $\int (t^{-3} - 2) dt = -\frac{1}{2}t^{-2} - 2t + C$.
21. $\int \left[\frac{2}{x} + 3e^x\right] dx = 2 \ln|x| + 3e^x + C$.
22. $\int \left[\frac{1}{2}t^{-1} - \sqrt{2}e^t\right] dt = \frac{1}{2} \ln|t| - \sqrt{2}e^t + C$.
23. $\int [3 \sin x - 2 \sec^2 x] dx = -3 \cos x - 2 \tan x + C$.
24. $\int [\csc^2 t - \sec t \tan t] dt = -\cot t - \sec t + C$.

$$25. \int (\sec^2 x + \sec x \tan x) dx = \tan x + \sec x + C.$$

$$26. \int \csc x (\sin x + \cot x) dx = \int (1 + \csc x \cot x) dx = x - \csc x + C.$$

$$27. \int \frac{\sec \theta}{\cos \theta} d\theta = \int \sec^2 \theta d\theta = \tan \theta + C.$$

$$28. \int \sin y dy = -\cos y + C.$$

$$29. \int \sec x \tan x dx = \sec x + C.$$

$$30. \int (\phi + 2 \csc^2 \phi) d\phi = \phi^2/2 - 2 \cot \phi + C.$$

$$31. \int (1 + \sin \theta) d\theta = \theta - \cos \theta + C.$$

$$32. \int \left[\frac{1}{2} \sec^2 x + \frac{1}{2} \right] dx = \frac{1}{2} \tan x + \frac{1}{2} x + C.$$

$$33. \int \left[\frac{1}{2\sqrt{1-x^2}} - \frac{3}{1+x^2} \right] dx = \frac{1}{2} \sin^{-1} x - 3 \tan^{-1} x + C.$$

$$34. \int \left[\frac{4}{x\sqrt{x^2-1}} + \frac{1+x+x^3}{1+x^2} \right] dx = 4 \sec^{-1} |x| + \int \left(x + \frac{1}{x^2+1} \right) dx = 4 \sec^{-1} |x| + \frac{1}{2} x^2 + \tan^{-1} x + C.$$

$$35. \int \frac{1 - \sin x}{1 - \sin^2 x} dx = \int \frac{1 - \sin x}{\cos^2 x} dx = \int (\sec^2 x - \sec x \tan x) dx = \tan x - \sec x + C.$$

$$36. \int \frac{1}{1 + \cos 2x} dx = \int \frac{1}{2 \cos^2 x} dx = \int \frac{1}{2} \sec^2 x dx = \frac{1}{2} \tan x + C.$$

37. True.

38. True; both are antiderivatives (not the same C though).

39. False; $y(0) = 2$.

40. True.

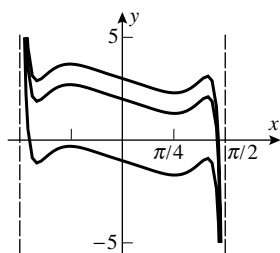

41.

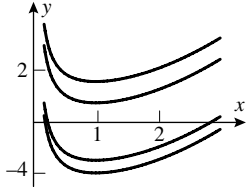

42.

43. (a) $y(x) = \int x^{1/3} dx = \frac{3}{4}x^{4/3} + C$, $y(1) = \frac{3}{4} + C = 2$, $C = \frac{5}{4}$; $y(x) = \frac{3}{4}x^{4/3} + \frac{5}{4}$.

(b) $y(t) = \int (\sin t + 1) dt = -\cos t + t + C$, $y\left(\frac{\pi}{3}\right) = -\frac{1}{2} + \frac{\pi}{3} + C = 1/2$, $C = 1 - \frac{\pi}{3}$; $y(t) = -\cos t + t + 1 - \frac{\pi}{3}$.

(c) $y(x) = \int (x^{1/2} + x^{-1/2}) dx = \frac{2}{3}x^{3/2} + 2x^{1/2} + C$, $y(1) = 0 = \frac{8}{3} + C$, $C = -\frac{8}{3}$, $y(x) = \frac{2}{3}x^{3/2} + 2x^{1/2} - \frac{8}{3}$.

44. (a) $y(x) = \int \left(\frac{1}{8}x^{-3}\right) dx = -\frac{1}{16}x^{-2} + C$, $y(1) = 0 = -\frac{1}{16} + C$, $C = \frac{1}{16}$; $y(x) = -\frac{1}{16}x^{-2} + \frac{1}{16}$.

(b) $y(t) = \int (\sec^2 t - \sin t) dt = \tan t + \cos t + C$, $y\left(\frac{\pi}{4}\right) = 1 = 1 + \frac{\sqrt{2}}{2} + C$, $C = -\frac{\sqrt{2}}{2}$; $y(t) = \tan t + \cos t - \frac{\sqrt{2}}{2}$.

(c) $y(x) = \int x^{7/2} dx = \frac{2}{9}x^{9/2} + C$, $y(0) = 0 = C$, $C = 0$; $y(x) = \frac{2}{9}x^{9/2}$.

45. (a) $y = \int 4e^x dx = 4e^x + C$, $1 = y(0) = 4 + C$, $C = -3$, $y = 4e^x - 3$.

(b) $y(t) = \int t^{-1} dt = \ln |t| + C$, $y(-1) = C = 5$, $C = 5$; $y(t) = \ln |t| + 5$.

46. (a) $y = \int \frac{3}{\sqrt{1-t^2}} dt = 3 \sin^{-1} t + C$, $y\left(\frac{\sqrt{3}}{2}\right) = 0 = \pi + C$, $C = -\pi$, $y = 3 \sin^{-1} t - \pi$.

(b) $\frac{dy}{dx} = 1 - \frac{2}{x^2+1}$, $y = \int \left[1 - \frac{2}{x^2+1}\right] dx = x - 2 \tan^{-1} x + C$, $y(1) = \frac{\pi}{2} = 1 - 2 \frac{\pi}{4} + C$, $C = \pi - 1$, $y = x - 2 \tan^{-1} x + \pi - 1$.

47. $s(t) = 16t^2 + C$; $s(t) = 16t^2 + 20$.

48. $s(t) = \sin t + C$; $s(t) = \sin t + 2$.

49. $s(t) = 2t^{3/2} + C$; $s(t) = 2t^{3/2} - 15$.

50. $s(t) = 3e^t + C$; $s(t) = 3e^t - 3e$.

51. $f'(x) = \frac{2}{3}x^{3/2} + C_1$; $f(x) = \frac{4}{15}x^{5/2} + C_1x + C_2$.

52. $f'(x) = x^2/2 + \sin x + C_1$, use $f'(0) = 2$ to get $C_1 = 2$ so $f'(x) = x^2/2 + \sin x + 2$, $f(x) = x^3/6 - \cos x + 2x + C_2$, use $f(0) = 1$ to get $C_2 = 2$ so $f(x) = x^3/6 - \cos x + 2x + 2$.

53. $dy/dx = 2x + 1$, $y = \int (2x + 1) dx = x^2 + x + C$; $y = 0$ when $x = -3$, so $(-3)^2 + (-3) + C = 0$, $C = -6$ thus $y = x^2 + x - 6$.

54. $f'(x) = m = (x + 1)^2$, so $f(x) = \int (x + 1)^2 dx = \frac{1}{3}(x + 1)^3 + C$; $f(-2) = 8 = \frac{1}{3}(-2 + 1)^3 + C = -\frac{1}{3} + C$,
 $C = 8 + \frac{1}{3} = \frac{25}{3}$, $f(x) = \frac{1}{3}(x + 1)^3 + \frac{25}{3}$.

55. $f'(x) = m = -\sin x$, so $f(x) = \int (-\sin x) dx = \cos x + C$; $f(0) = 2 = 1 + C$, so $C = 1$, $f(x) = \cos x + 1$.

56. $dy/dx = x^2$, $y = \int x^2 dx = x^3/3 + C$; $y = 2$ when $x = -1$, so $(-1)^3/3 + C = 2$, $C = 7/3$, thus $y = x^3/3 + 7/3$.

57. $dy/dx = \int 6x dx = 3x^2 + C_1$. The slope of the tangent line is -3 so $dy/dx = -3$ when $x = 1$. Thus $3(1)^2 + C_1 = -3$,
 $C_1 = -6$ so $dy/dx = 3x^2 - 6$, $y = \int (3x^2 - 6) dx = x^3 - 6x + C_2$. If $x = 1$, then $y = 5 - 3(1) = 2$ so
 $(1)^2 - 6(1) + C_2 = 2$, $C_2 = 7$ thus $y = x^3 - 6x + 7$.

58. (a) $f(x) = \frac{1}{3}x^2 \sin 3x - \frac{2}{27} \sin 3x + \frac{2}{9}x \cos 3x + \frac{9\pi^2 - 116}{108}$.

(b) $f(x) = \sqrt{4 + x^2} + \frac{4}{\sqrt{4 + x^2}} - 6$.

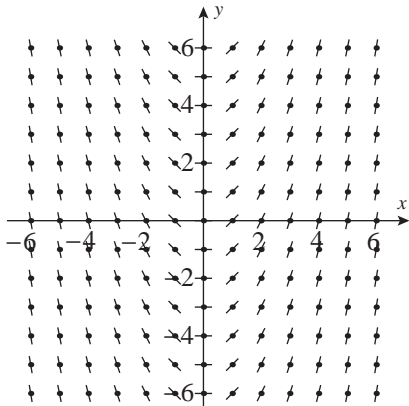

59. (a)

(c) $f(x) = x^2/2 - 1$.

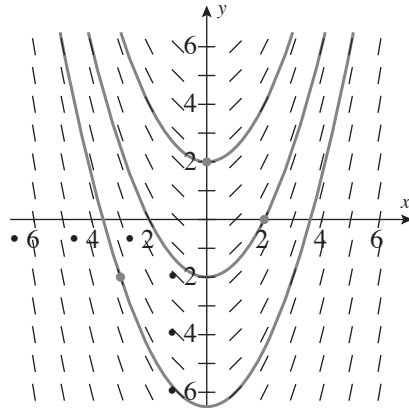

(b)

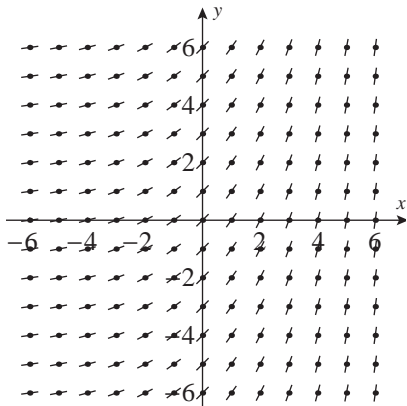

60. (a)

(c) $y = (e^x + 1)/2$.

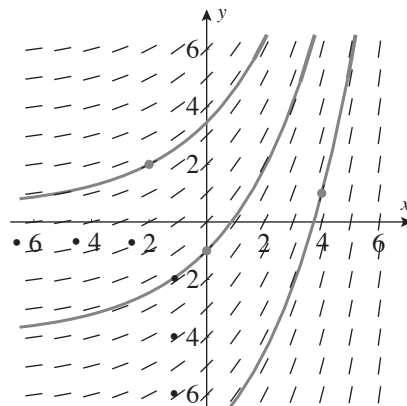

(b)

61. This slope field is zero along the y-axis, and so corresponds to (b).

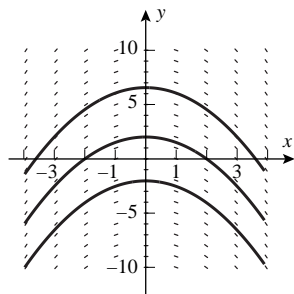

62. This slope field is near zero for large negative values of x , and is very large for large positive x . It must correspond to (d).

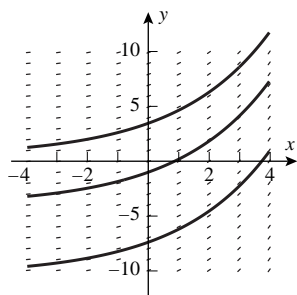

63. This slope field has a negative value along the y -axis, and thus corresponds to (c).

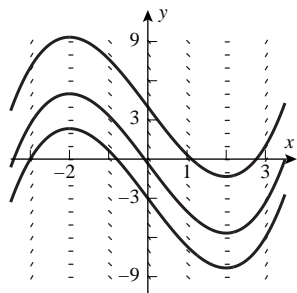

64. This slope field appears to be constant (approximately 2), and thus corresponds to differential equation (a).

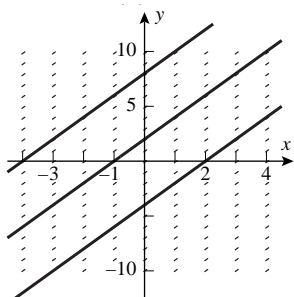

65. Theorem 5.2.3(a) says that $\int cf(x) dx = cF(x) + C$, which means that $\int 0 \cdot 0 dx = 0 \int 0 dx + C$, so the "proof" is not valid.

66. The first equality is incorrect because the right hand side evaluates to $x^2/2 + C_1 - (x^2/2 + C_2) = C_1 - C_2$.

67. (a) $F'(x) = \frac{1}{1+x^2}$, $G'(x) = + \left(\frac{1}{x^2}\right) \frac{1}{1+1/x^2} = \frac{1}{1+x^2} = F'(x)$.

(b) $F(1) = \pi/4$; $G(1) = -\tan^{-1}(1) = -\pi/4$, $\tan^{-1} x + \tan^{-1}(1/x) = \pi/2$.

(c) Draw a triangle with sides 1 and x and hypotenuse $\sqrt{1+x^2}$. If α denotes the angle opposite the side of length x and if β denotes its complement, then $\tan \alpha = x$ and $\tan \beta = 1/x$, and $\sin(\alpha + \beta) = \sin \alpha \cos \beta + \sin \beta \cos \alpha = \frac{x^2}{1+x^2} + \frac{1}{1+x^2} = 1$, and $\cos(\alpha + \beta) = \cos \alpha \cos \beta - \sin \alpha \sin \beta = \frac{x \cdot 1}{1+x^2} - \frac{1 \cdot x}{1+x^2} = 0$, so the cosine of $\alpha + \beta$ is zero and the sine of $\alpha + \beta$ is 1; consequently $\alpha + \beta = \pi/2$, i.e. $\tan^{-1} x + \tan^{-1}(1/x) = \pi/2$.

68. (a) For $x \neq 0$, $F'(x) = G'(x) = 1$. But if I is an interval containing 0 then neither F nor G has a derivative at 0, so neither F nor G is an antiderivative on I .

(b) Suppose $G(x) = F(x) + C$ for some C . Then $F(1) = 4$ and $G(1) = 4 + C$, so $C = 0$, but $F(-1) = 2$ and $G(-1) = -1$, a contradiction.

(c) No, because neither F nor G is an antiderivative on $(-\infty, +\infty)$.

69. $\int (\sec^2 x - 1) dx = \tan x - x + C$.

70. $\int (\csc^2 x - 1) dx = -\cot x - x + C$.

71. (a) $\frac{1}{2} \int (1 - \cos x) dx = \frac{1}{2}(x - \sin x) + C$. (b) $\frac{1}{2} \int (1 + \cos x) dx = \frac{1}{2}(x + \sin x) + C$.

72. For $x > 0$, $\frac{d}{dx}[\sec^{-1} x] = \frac{1}{|x|\sqrt{x^2-1}}$, and for $x < 0$, $\frac{d}{dx}[\sec^{-1} |x|] = \frac{d}{dx}[\sec^{-1}(-x)] = (-1) \frac{1}{|x|\sqrt{x^2-1}} = -\frac{1}{x\sqrt{x^2-1}}$, which yields formula (14) in both cases.

73. $v = \frac{1087}{2\sqrt{273}} \int T^{-1/2} dT = \frac{1087}{\sqrt{273}} T^{1/2} + C$, $v(273) = 1087 = 1087 + C$ so $C = 0$, $v = \frac{1087}{\sqrt{273}} T^{1/2}$ ft/s.

74. $dT/dx = C_1$, $T = C_1x + C_2$; $T = 25$ when $x = 0$, so $C_2 = 25$, $T = C_1x + 25$. $T = 85$ when $x = 50$, so $50C_1 + 25 = 85$, $C_1 = 1.2$, $T = 1.2x + 25$.

Exercise Set 5.3

1. (a) $\int u^{23} du = u^{24}/24 + C = (x^2 + 1)^{24}/24 + C$.

(b) $-\int u^3 du = -u^4/4 + C = -(\cos^4 x)/4 + C$.

2. (a) $2 \int \sin u du = -2 \cos u + C = -2 \cos \sqrt{x} + C$.

(b) $\frac{3}{8} \int u^{-1/2} du = \frac{3}{4} u^{1/2} + C = \frac{3}{4} \sqrt{4x^2 + 5} + C$.

3. (a) $\frac{1}{4} \int \sec^2 u du = \frac{1}{4} \tan u + C = \frac{1}{4} \tan(4x + 1) + C$.

(b) $\frac{1}{4} \int u^{1/2} du = \frac{1}{6} u^{3/2} + C = \frac{1}{6} (1 + 2y^2)^{3/2} + C$.

4. (a) $\frac{1}{\pi} \int u^{1/2} du = \frac{2}{3\pi} u^{3/2} + C = \frac{2}{3\pi} \sin^{3/2}(\pi\theta) + C.$
- (b) $\int u^{4/5} du = \frac{5}{9} u^{9/5} + C = \frac{5}{9} (x^2 + 7x + 3)^{9/5} + C.$
5. (a) $-\int u du = -\frac{1}{2} u^2 + C = -\frac{1}{2} \cot^2 x + C.$
- (b) $\int u^9 du = \frac{1}{10} u^{10} + C = \frac{1}{10} (1 + \sin t)^{10} + C.$
6. (a) $\frac{1}{2} \int \cos u du = \frac{1}{2} \sin u + C = \frac{1}{2} \sin 2x + C.$
- (b) $\frac{1}{2} \int \sec^2 u du = \frac{1}{2} \tan u + C = \frac{1}{2} \tan x^2 + C.$
7. (a) $\int (u-1)^2 u^{1/2} du = \int (u^{5/2} - 2u^{3/2} + u^{1/2}) du = \frac{2}{7} u^{7/2} - \frac{4}{5} u^{5/2} + \frac{2}{3} u^{3/2} + C = \frac{2}{7} (1+x)^{7/2} - \frac{4}{5} (1+x)^{5/2} + \frac{2}{3} (1+x)^{3/2} + C.$
- (b) $\int \csc^2 u du = -\cot u + C = -\cot(\sin x) + C.$
8. (a) $\int \sin u du = -\cos u + C = -\cos(x - \pi) + C.$
- (b) $\int \frac{du}{u^2} = -\frac{1}{u} + C = -\frac{1}{x^5 + 1} + C.$
9. (a) $\int \frac{1}{u} du = \ln |u| + C = \ln |\ln x| + C.$
- (b) $-\frac{1}{5} \int e^u du = -\frac{1}{5} e^u + C = -\frac{1}{5} e^{-5x} + C.$
10. (a) $-\frac{1}{3} \int \frac{1}{u} du = -\frac{1}{3} \ln |u| + C = -\frac{1}{3} \ln |1 + \cos 3\theta| + C.$
- (b) $\int \frac{du}{u} = \ln u + C = \ln(1 + e^x) + C.$
11. (a) $u = x^3, \frac{1}{3} \int \frac{du}{1+u^2} = \frac{1}{3} \tan^{-1}(x^3) + C.$
- (b) $u = \ln x, \int \frac{1}{\sqrt{1-u^2}} du = \sin^{-1}(\ln x) + C.$
12. (a) $u = 3x, \int \frac{1}{u\sqrt{u^2-1}} du = \sec^{-1} |3x| + C.$
- (b) $u = \sqrt{x}, 2 \int \frac{du}{1+u^2} = 2 \tan^{-1} u + C = 2 \tan^{-1}(\sqrt{x}) + C.$
15. $u = 4x - 3, \frac{1}{4} \int u^9 du = \frac{1}{40} u^{10} + C = \frac{1}{40} (4x - 3)^{10} + C.$

$$16. u = 5 + x^4, \quad \frac{1}{4} \int \sqrt{u} \, du = \frac{1}{6} u^{3/2} + C = \frac{1}{6} (5 + x^4)^{3/2} + C.$$

$$17. u = 7x, \quad \frac{1}{7} \int \sin u \, du = -\frac{1}{7} \cos u + C = -\frac{1}{7} \cos 7x + C.$$

$$18. u = x/3, \quad 3 \int \cos u \, du = 3 \sin u + C = 3 \sin(x/3) + C.$$

$$19. u = 4x, \, du = 4dx; \quad \frac{1}{4} \int \sec u \tan u \, du = \frac{1}{4} \sec u + C = \frac{1}{4} \sec 4x + C.$$

$$20. u = 5x, \, du = 5dx; \quad \frac{1}{5} \int \sec^2 u \, du = \frac{1}{5} \tan u + C = \frac{1}{5} \tan 5x + C.$$

$$21. u = 2x, \, du = 2dx; \quad \frac{1}{2} \int e^u \, du = \frac{1}{2} e^u + C = \frac{1}{2} e^{2x} + C.$$

$$22. u = 2x, \, du = 2dx; \quad \frac{1}{2} \int \frac{1}{u} \, du = \frac{1}{2} \ln |u| + C = \frac{1}{2} \ln |2x| + C.$$

$$23. u = 2x, \quad \frac{1}{2} \int \frac{1}{\sqrt{1-u^2}} \, du = \frac{1}{2} \sin^{-1}(2x) + C.$$

$$24. u = 4x, \quad \frac{1}{4} \int \frac{1}{1+u^2} \, du = \frac{1}{4} \tan^{-1}(4x) + C.$$

$$25. u = 7t^2 + 12, \, du = 14t \, dt; \quad \frac{1}{14} \int u^{1/2} \, du = \frac{1}{21} u^{3/2} + C = \frac{1}{21} (7t^2 + 12)^{3/2} + C.$$

$$26. u = 4 - 5x^2, \, du = -10x \, dx; \quad -\frac{1}{10} \int u^{-1/2} \, du = -\frac{1}{5} u^{1/2} + C = -\frac{1}{5} \sqrt{4 - 5x^2} + C.$$

$$27. u = 1 - 2x, \, du = -2dx, \quad -3 \int \frac{1}{u^3} \, du = (-3) \left(-\frac{1}{2} \right) \frac{1}{u^2} + C = \frac{3}{2} \frac{1}{(1-2x)^2} + C.$$

$$28. u = x^3 + 3x, \, du = (3x^2 + 3) \, dx, \quad \frac{1}{3} \int \frac{1}{\sqrt{u}} \, du = \frac{2}{3} \sqrt{x^3 + 3x} + C.$$

$$29. u = 5x^4 + 2, \, du = 20x^3 \, dx, \quad \frac{1}{20} \int \frac{du}{u^3} = -\frac{1}{40} \frac{1}{u^2} + C = -\frac{1}{40(5x^4 + 2)^2} + C.$$

$$30. u = \frac{1}{x}, \, du = -\frac{1}{x^2} \, dx, \quad -\frac{1}{3} \int \sin u \, du = \frac{1}{3} \cos u + C = \frac{1}{3} \cos \left(\frac{1}{x} \right) + C.$$

$$31. u = \sin x, \, du = \cos x \, dx; \quad \int e^u \, du = e^u + C = e^{\sin x} + C.$$

$$32. u = x^4, \, du = 4x^3 \, dx; \quad \frac{1}{4} \int e^u \, du = \frac{1}{4} e^u + C = \frac{1}{4} e^{x^4} + C.$$

$$33. u = -2x^3, \, du = -6x^2, \quad -\frac{1}{6} \int e^u \, du = -\frac{1}{6} e^u + C = -\frac{1}{6} e^{-2x^3} + C.$$

$$34. u = e^x - e^{-x}, \, du = (e^x + e^{-x}) \, dx, \quad \int \frac{1}{u} \, du = \ln |u| + C = \ln |e^x - e^{-x}| + C.$$

$$35. u = e^x, \int \frac{1}{1+u^2} du = \tan^{-1}(e^x) + C.$$

$$36. u = t^2, \frac{1}{2} \int \frac{1}{u^2+1} du = \frac{1}{2} \tan^{-1}(t^2) + C.$$

$$37. u = 5/x, du = -(5/x^2)dx; -\frac{1}{5} \int \sin u du = \frac{1}{5} \cos u + C = \frac{1}{5} \cos(5/x) + C.$$

$$38. u = \sqrt{x}, du = \frac{1}{2\sqrt{x}} dx; 2 \int \sec^2 u du = 2 \tan u + C = 2 \tan \sqrt{x} + C.$$

$$39. u = \cos 3t, du = -3 \sin 3t dt, -\frac{1}{3} \int u^4 du = -\frac{1}{15} u^5 + C = -\frac{1}{15} \cos^5 3t + C.$$

$$40. u = \sin 2t, du = 2 \cos 2t dt; \frac{1}{2} \int u^5 du = \frac{1}{12} u^6 + C = \frac{1}{12} \sin^6 2t + C.$$

$$41. u = x^2, du = 2x dx; \frac{1}{2} \int \sec^2 u du = \frac{1}{2} \tan u + C = \frac{1}{2} \tan(x^2) + C.$$

$$42. u = 1 + 2 \sin 4\theta, du = 8 \cos 4\theta d\theta; \frac{1}{8} \int \frac{1}{u^4} du = -\frac{1}{24} \frac{1}{u^3} + C = -\frac{1}{24} \frac{1}{(1 + 2 \sin 4\theta)^3} + C.$$

$$43. u = 2 - \sin 4\theta, du = -4 \cos 4\theta d\theta; -\frac{1}{4} \int u^{1/2} du = -\frac{1}{6} u^{3/2} + C = -\frac{1}{6} (2 - \sin 4\theta)^{3/2} + C.$$

$$44. u = \tan 5x, du = 5 \sec^2 5x dx; \frac{1}{5} \int u^3 du = \frac{1}{20} u^4 + C = \frac{1}{20} \tan^4 5x + C.$$

$$45. u = \tan x, \int \frac{1}{\sqrt{1-u^2}} du = \sin^{-1}(\tan x) + C.$$

$$46. u = \cos \theta, -\int \frac{1}{u^2+1} du = -\tan^{-1}(\cos \theta) + C.$$

$$47. u = \sec 2x, du = 2 \sec 2x \tan 2x dx; \frac{1}{2} \int u^2 du = \frac{1}{6} u^3 + C = \frac{1}{6} \sec^3 2x + C.$$

$$48. u = \sin \theta, du = \cos \theta d\theta; \int \sin u du = -\cos u + C = -\cos(\sin \theta) + C.$$

$$49. \int e^{-x} dx; u = -x, du = -dx; -\int e^u du = -e^u + C = -e^{-x} + C.$$

$$50. \int e^{x/2} dx; u = x/2, du = dx/2; 2 \int e^u du = 2e^u + C = 2e^{x/2} + C = 2\sqrt{e^x} + C.$$

$$51. u = 2\sqrt{x}, du = \frac{1}{\sqrt{x}} dx; \int \frac{1}{e^u} du = -e^{-u} + C = -e^{-2\sqrt{x}} + C.$$

$$52. u = \sqrt{2y+1}, du = \frac{1}{\sqrt{2y+1}} dy; \int e^u du = e^u + C = e^{\sqrt{2y+1}} + C.$$

$$53. u = 2y+1, du = 2dy; \int \frac{1}{4}(u-1) \frac{1}{\sqrt{u}} du = \frac{1}{6} u^{3/2} - \frac{1}{2} \sqrt{u} + C = \frac{1}{6} (2y+1)^{3/2} - \frac{1}{2} \sqrt{2y+1} + C.$$

54. $u = 4 - x, du = -dx; -\int(4 - u)\sqrt{u} du = -\frac{8}{3}u^{3/2} + \frac{2}{5}u^{5/2} + C = \frac{2}{5}(4 - x)^{5/2} - \frac{8}{3}(4 - x)^{3/2} + C.$

55. $\int \sin^2 2\theta \sin 2\theta d\theta = \int (1 - \cos^2 2\theta) \sin 2\theta d\theta; u = \cos 2\theta, du = -2 \sin 2\theta d\theta, -\frac{1}{2} \int (1 - u^2) du = -\frac{1}{2}u + \frac{1}{6}u^3 + C = -\frac{1}{2} \cos 2\theta + \frac{1}{6} \cos^3 2\theta + C.$

56. $\sec^2 3\theta = \tan^2 3\theta + 1, u = 3\theta, du = 3d\theta, \int \sec^4 3\theta d\theta = \frac{1}{3} \int (\tan^2 u + 1) \sec^2 u du = \frac{1}{9} \tan^3 u + \frac{1}{3} \tan u + C = \frac{1}{9} \tan^3 3\theta + \frac{1}{3} \tan 3\theta + C.$

57. $\int \left(1 + \frac{1}{t}\right) dt = t + \ln |t| + C.$

58. $e^{2 \ln x} = e^{\ln x^2} = x^2, x > 0, \text{ so } \int e^{2 \ln x} dx = \int x^2 dx = \frac{1}{3}x^3 + C.$

59. $\ln(e^x) + \ln(e^{-x}) = \ln(e^x e^{-x}) = \ln 1 = 0, \text{ so } \int [\ln(e^x) + \ln(e^{-x})] dx = C.$

60. $\int \frac{\cos x}{\sin x} dx; u = \sin x, du = \cos x dx; \int \frac{1}{u} du = \ln |u| + C = \ln |\sin x| + C.$

61. (a) $\sin^{-1}(x/3) + C.$ (b) $(1/\sqrt{5}) \tan^{-1}(x/\sqrt{5}) + C.$ (c) $(1/\sqrt{\pi}) \sec^{-1} |x/\sqrt{\pi}| + C.$

62. (a) $u = e^x, \int \frac{1}{4 + u^2} du = \frac{1}{2} \tan^{-1}(e^x/2) + C.$

(b) $u = 2x, \frac{1}{2} \int \frac{1}{\sqrt{9 - u^2}} du = \frac{1}{2} \sin^{-1}(2x/3) + C.$

(c) $u = \sqrt{5}y, \int \frac{1}{u\sqrt{u^2 - 3}} du = \frac{1}{\sqrt{3}} \sec^{-1} |\sqrt{5}y/\sqrt{3}| + C.$

63. $u = a + bx, du = b dx, \int (a + bx)^n dx = \frac{1}{b} \int u^n du = \frac{(a + bx)^{n+1}}{b(n + 1)} + C.$

64. $u = a + bx, du = b dx, dx = \frac{1}{b} du, \frac{1}{b} \int u^{1/n} du = \frac{n}{b(n + 1)} u^{(n+1)/n} + C = \frac{n}{b(n + 1)} (a + bx)^{(n+1)/n} + C.$

65. $u = \sin(a + bx), du = b \cos(a + bx) dx, \frac{1}{b} \int u^n du = \frac{1}{b(n + 1)} u^{n+1} + C = \frac{1}{b(n + 1)} \sin^{n+1}(a + bx) + C.$

67. (a) With $u = \sin x, du = \cos x dx; \int u du = \frac{1}{2}u^2 + C_1 = \frac{1}{2} \sin^2 x + C_1;$

with $u = \cos x, du = -\sin x dx; -\int u du = -\frac{1}{2}u^2 + C_2 = -\frac{1}{2} \cos^2 x + C_2.$

(b) Because they differ by a constant:

$$\left(\frac{1}{2} \sin^2 x + C_1\right) - \left(-\frac{1}{2} \cos^2 x + C_2\right) = \frac{1}{2}(\sin^2 x + \cos^2 x) + C_1 - C_2 = 1/2 + C_1 - C_2.$$

68. (a) First method: $\int (25x^2 - 10x + 1) dx = \frac{25}{3}x^3 - 5x^2 + x + C_1;$

second method: $\frac{1}{5} \int u^2 du = \frac{1}{15} u^3 + C_2 = \frac{1}{15} (5x - 1)^3 + C_2$.

(b) $\frac{1}{15} (5x - 1)^3 + C_2 = \frac{1}{15} (125x^3 - 75x^2 + 15x - 1) + C_2 = \frac{25}{3} x^3 - 5x^2 + x - \frac{1}{15} + C_2$; the answers differ by a constant.

69. $y = \int \sqrt{5x+1} dx = \frac{2}{15} (5x+1)^{3/2} + C$; $-2 = y(3) = \frac{2}{15} 64 + C$, so $C = -2 - \frac{2}{15} 64 = -\frac{158}{15}$, and $y = \frac{2}{15} (5x+1)^{3/2} - \frac{158}{15}$.

70. $y = \int (2 + \sin 3x) dx = 2x - \frac{1}{3} \cos 3x + C$ and $0 = y\left(\frac{\pi}{3}\right) = \frac{2\pi}{3} + \frac{1}{3} + C$, $C = -\frac{2\pi+1}{3}$, $y = 2x - \frac{1}{3} \cos 3x - \frac{2\pi+1}{3}$.

71. $y = -\int e^{2t} dt = -\frac{1}{2} e^{2t} + C$, $6 = y(0) = -\frac{1}{2} + C$, $y = -\frac{1}{2} e^{2t} + \frac{13}{2}$.

72. $y = \int \frac{1}{25+9t^2} dt = \frac{1}{15} \tan^{-1}\left(\frac{3}{5}t\right) + C$, $\frac{\pi}{30} = y\left(-\frac{5}{3}\right) = -\frac{1}{15} \frac{\pi}{4} + C$, $C = \frac{\pi}{20}$, $y = \frac{1}{15} \tan^{-1}\left(\frac{3}{5}t\right) + \frac{\pi}{20}$.

73. (a) $u = x^2 + 1$, $du = 2x dx$; $\frac{1}{2} \int \frac{1}{\sqrt{u}} du = \sqrt{u} + C = \sqrt{x^2 + 1} + C$.

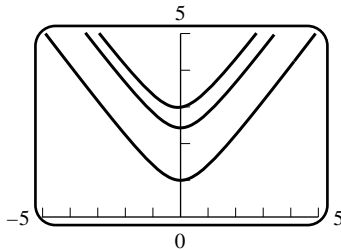

(b)

74. (a) $u = x^2 + 1$, $du = 2x dx$; $\frac{1}{2} \int \frac{1}{u} du = \frac{1}{2} \ln u + C = \frac{1}{2} \ln(x^2 + 1) + C$.

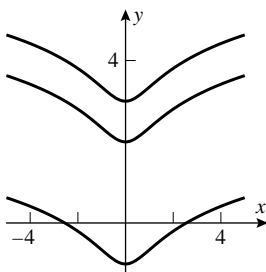

(b)

75. $f'(x) = m = \sqrt{3x+1}$, $f(x) = \int (3x+1)^{1/2} dx = \frac{2}{9} (3x+1)^{3/2} + C$, $f(0) = 1 = \frac{2}{9} + C$, $C = \frac{7}{9}$, so $f(x) = \frac{2}{9} (3x+1)^{3/2} + \frac{7}{9}$.

76. $p(t) = \int (3 + 0.12t)^{3/2} dt = \frac{10}{3} (3 + 0.12t)^{5/2} + C$; $100 = p(0) = \frac{10}{3} 3^{5/2} + C$, $C = 100 - 10 \cdot 3^{3/2} \approx 48.038$ so that $p(5) = \frac{10}{3} (3 + 5 \cdot (0.12))^{5/2} + 100 - 10 \cdot 3^{3/2} \approx 130.005$ so that the population at the beginning of the year 2015 is approximately 130,005.

77. $y(t) = \int (\ln 2) 2^{t/20} dt = 20 \cdot 2^{t/20} + C$; $20 = y(0) = 20 + C$, so $C = 0$ and $y(t) = 20 \cdot 2^{t/20}$. This implies that $y(120) = 20 \cdot 2^{120/20} = 1280$ cells.

78. $u = a \sin \theta$, $du = a \cos \theta d\theta$; $\int \frac{du}{\sqrt{a^2 - u^2}} = \theta + C = \sin^{-1} \frac{u}{a} + C$.

79. If $u > 0$ then $u = a \sec \theta$, $du = a \sec \theta \tan \theta d\theta$; $\int \frac{du}{u\sqrt{u^2 - a^2}} = \frac{1}{a} \theta = \frac{1}{a} \sec^{-1} \frac{u}{a} + C$.

Exercise Set 5.4

1. (a) $1 + 8 + 27 = 36$. (b) $5 + 8 + 11 + 14 + 17 = 55$. (c) $20 + 12 + 6 + 2 + 0 + 0 = 40$

(d) $1 + 1 + 1 + 1 + 1 + 1 = 6$. (e) $1 - 2 + 4 - 8 + 16 = 11$. (f) $0 + 0 + 0 + 0 + 0 + 0 = 0$.

2. (a) $1 + 0 - 3 + 0 = -2$. (b) $1 - 1 + 1 - 1 + 1 - 1 = 0$. (c) $\pi^2 + \pi^2 + \dots + \pi^2 = 14\pi^2$ (14 terms).

(d) $2^4 + 2^5 + 2^6 = 112$. (e) $\sqrt{1} + \sqrt{2} + \sqrt{3} + \sqrt{4} + \sqrt{5} + \sqrt{6}$ (f) $1 - 1 + 1 - 1 + 1 - 1 + 1 - 1 + 1 - 1 + 1 = 1$.

3. $\sum_{k=1}^{10} k$

4. $\sum_{k=1}^{20} 3k$

5. $\sum_{k=1}^{10} 2k$

6. $\sum_{k=1}^8 (2k - 1)$

7. $\sum_{k=1}^6 (-1)^{k+1} (2k - 1)$

8. $\sum_{k=1}^5 (-1)^{k+1} \frac{1}{k}$

9. (a) $\sum_{k=1}^{50} 2k$ (b) $\sum_{k=1}^{50} (2k - 1)$

10. (a) $\sum_{k=1}^5 (-1)^{k+1} a_k$ (b) $\sum_{k=0}^5 (-1)^{k+1} b_k$ (c) $\sum_{k=0}^n a_k x^k$ (d) $\sum_{k=0}^5 a^{5-k} b^k$

11. $\frac{1}{2}(100)(100 + 1) = 5050$.

12. $7 \sum_{k=1}^{100} k + \sum_{k=1}^{100} 1 = \frac{7}{2}(100)(101) + 100 = 35,450$.

$$13. \frac{1}{6}(20)(21)(41) = 2870.$$

$$14. \sum_{k=1}^{20} k^2 - \sum_{k=1}^3 k^2 = 2870 - 14 = 2856.$$

$$15. \sum_{k=1}^{30} k(k^2 - 4) = \sum_{k=1}^{30} (k^3 - 4k) = \sum_{k=1}^{30} k^3 - 4 \sum_{k=1}^{30} k = \frac{1}{4}(30)^2(31)^2 - 4 \cdot \frac{1}{2}(30)(31) = 214,365.$$

$$16. \sum_{k=1}^6 k - \sum_{k=1}^6 k^3 = \frac{1}{2}(6)(7) - \frac{1}{4}(6)^2(7)^2 = -420.$$

$$17. \sum_{k=1}^n \frac{3k}{n} = \frac{3}{n} \sum_{k=1}^n k = \frac{3}{n} \cdot \frac{1}{2}n(n+1) = \frac{3}{2}(n+1).$$

$$18. \sum_{k=1}^{n-1} \frac{k^2}{n} = \frac{1}{n} \sum_{k=1}^{n-1} k^2 = \frac{1}{n} \cdot \frac{1}{6}(n-1)(n)(2n-1) = \frac{1}{6}(n-1)(2n-1).$$

$$19. \sum_{k=1}^{n-1} \frac{k^3}{n^2} = \frac{1}{n^2} \sum_{k=1}^{n-1} k^3 = \frac{1}{n^2} \cdot \frac{1}{4}(n-1)^2 n^2 = \frac{1}{4}(n-1)^2.$$

$$20. \sum_{k=1}^n \left(\frac{5}{n} - \frac{2k}{n} \right) = \frac{5}{n} \sum_{k=1}^n 1 - \frac{2}{n} \sum_{k=1}^n k = \frac{5}{n}(n) - \frac{2}{n} \cdot \frac{1}{2}n(n+1) = 4 - n.$$

21. True.

22. False; the value of a function at the midpoint of an interval need not be the average of the values of the function at the endpoints of the interval.

23. False; if $[a, b]$ consists of positive reals, true; but false on, e.g. $[-2, 1]$.

24. False; e.g. $\sin x$ on $[0, 2\pi]$.

25. (a) $\left(2 + \frac{3}{n}\right)^4 \frac{3}{n}, \left(2 + \frac{6}{n}\right)^4 \frac{3}{n}, \left(2 + \frac{9}{n}\right)^4 \frac{3}{n}, \dots, \left(2 + \frac{3(n-1)}{n}\right)^4 \frac{3}{n}, (2+3)^4 \frac{3}{n}$. When $[2, 5]$ is subdivided into n equal intervals, the endpoints are $2, 2 + \frac{3}{n}, 2 + 2 \cdot \frac{3}{n}, 2 + 3 \cdot \frac{3}{n}, \dots, 2 + (n-1) \frac{3}{n}, 2 + 3 = 5$, and the right endpoint approximation to the area under the curve $y = x^4$ is given by the summands above.

(b) $\sum_{k=0}^{n-1} \left(2 + k \cdot \frac{3}{n}\right)^4 \frac{3}{n}$ gives the left endpoint approximation.

26. n is the number of elements of the partition, x_k^* is an arbitrary point in the k -th interval, $k = 0, 1, 2, \dots, n-1, n$, and Δx is the width of an interval in the partition. In the usual definition of area, the parts above the curve are given a + sign, and the parts below the curve are given a - sign. These numbers are then replaced with their absolute values and summed. In the definition of net signed area, the parts given above are summed without considering absolute values. In this case there could be lots of cancellation of 'positive' areas with 'negative' areas.

27. Endpoints 2, 3, 4, 5, 6; $\Delta x = 1$;

(a) Left endpoints: $\sum_{k=1}^4 f(x_k^*) \Delta x = 7 + 10 + 13 + 16 = 46$.

(b) Midpoints: $\sum_{k=1}^4 f(x_k^*) \Delta x = 8.5 + 11.5 + 14.5 + 17.5 = 52.$

(c) Right endpoints: $\sum_{k=1}^4 f(x_k^*) \Delta x = 10 + 13 + 16 + 19 = 58.$

28. Endpoints 1, 3, 5, 7, 9, $\Delta x = 2$;

(a) Left endpoints: $\sum_{k=1}^4 f(x_k^*) \Delta x = \left(1 + \frac{1}{3} + \frac{1}{5} + \frac{1}{7}\right) 2 = \frac{352}{105}.$

(b) Midpoints: $\sum_{k=1}^4 f(x_k^*) \Delta x = \left(\frac{1}{2} + \frac{1}{4} + \frac{1}{6} + \frac{1}{8}\right) 2 = \frac{25}{12}.$

(c) Right endpoints: $\sum_{k=1}^4 f(x_k^*) \Delta x = \left(\frac{1}{3} + \frac{1}{5} + \frac{1}{7} + \frac{1}{9}\right) 2 = \frac{496}{315}.$

29. Endpoints: $0, \pi/4, \pi/2, 3\pi/4, \pi$; $\Delta x = \pi/4$.

(a) Left endpoints: $\sum_{k=1}^4 f(x_k^*) \Delta x = \left(1 + \sqrt{2}/2 + 0 - \sqrt{2}/2\right) (\pi/4) = \pi/4.$

(b) Midpoints: $\sum_{k=1}^4 f(x_k^*) \Delta x = [\cos(\pi/8) + \cos(3\pi/8) + \cos(5\pi/8) + \cos(7\pi/8)] (\pi/4) =$
 $= [\cos(\pi/8) + \cos(3\pi/8) - \cos(3\pi/8) - \cos(\pi/8)] (\pi/4) = 0.$

(c) Right endpoints: $\sum_{k=1}^4 f(x_k^*) \Delta x = \left(\sqrt{2}/2 + 0 - \sqrt{2}/2 - 1\right) (\pi/4) = -\pi/4.$

30. Endpoints $-1, 0, 1, 2, 3$; $\Delta x = 1$.

(a) $\sum_{k=1}^4 f(x_k^*) \Delta x = -3 + 0 + 1 + 0 = -2.$

(b) $\sum_{k=1}^4 f(x_k^*) \Delta x = -\frac{5}{4} + \frac{3}{4} + \frac{3}{4} - \frac{5}{4} = -1.$

(c) $\sum_{k=1}^4 f(x_k^*) \Delta x = 0 + 1 + 0 - 3 = -2.$

31. (a) 0.718771403, 0.705803382, 0.698172179.

(b) 0.692835360, 0.693069098, 0.693134682.

(c) 0.668771403, 0.680803382, 0.688172179.

32. (a) 0.761923639, 0.712712753, 0.684701150.

(b) 0.663501867, 0.665867079, 0.666538346.

(c) 0.584145862, 0.623823864, 0.649145594.

33. (a) 4.884074734, 5.115572731, 5.248762738.

(b) 5.34707029, 5.338362719, 5.334644416.

(c) 5.684074734, 5.515572731, 5.408762738.

34. (a) 0.919403170, 0.960215997, 0.984209789.

(b) 1.001028824, 1.000257067, 1.000041125.

(c) 1.076482803, 1.038755813, 1.015625715.

$$35. \Delta x = \frac{3}{n}, x_k^* = 1 + \frac{3}{n}k; f(x_k^*)\Delta x = \frac{1}{2}x_k^*\Delta x = \frac{1}{2}\left(1 + \frac{3}{n}k\right)\frac{3}{n} = \frac{3}{2}\left[\frac{1}{n} + \frac{3}{n^2}k\right],$$

$$\sum_{k=1}^n f(x_k^*)\Delta x = \frac{3}{2}\left[\sum_{k=1}^n \frac{1}{n} + \sum_{k=1}^n \frac{3}{n^2}k\right] = \frac{3}{2}\left[1 + \frac{3}{n^2} \cdot \frac{1}{2}n(n+1)\right] = \frac{3}{2}\left[1 + \frac{3}{2}\frac{n+1}{n}\right],$$

$$A = \lim_{n \rightarrow +\infty} \frac{3}{2}\left[1 + \frac{3}{2}\left(1 + \frac{1}{n}\right)\right] = \frac{3}{2}\left(1 + \frac{3}{2}\right) = \frac{15}{4}.$$

$$36. \Delta x = \frac{5}{n}, x_k^* = 0 + k\frac{5}{n}; f(x_k^*)\Delta x = (5 - x_k^*)\Delta x = \left(5 - \frac{5}{n}k\right)\frac{5}{n} = \frac{25}{n} - \frac{25}{n^2}k,$$

$$\sum_{k=1}^n f(x_k^*)\Delta x = \sum_{k=1}^n \frac{25}{n} - \frac{25}{n^2}\sum_{k=1}^n k = 25 - \frac{25}{n^2} \cdot \frac{1}{2}n(n+1) = 25 - \frac{25}{2}\left(\frac{n+1}{n}\right),$$

$$A = \lim_{n \rightarrow +\infty} \left[25 - \frac{25}{2}\left(1 + \frac{1}{n}\right)\right] = 25 - \frac{25}{2} = \frac{25}{2}.$$

$$37. \Delta x = \frac{3}{n}, x_k^* = 0 + k\frac{3}{n}; f(x_k^*)\Delta x = \left(9 - 9\frac{k^2}{n^2}\right)\frac{3}{n},$$

$$\sum_{k=1}^n f(x_k^*)\Delta x = \sum_{k=1}^n \left(9 - 9\frac{k^2}{n^2}\right)\frac{3}{n} = \frac{27}{n}\sum_{k=1}^n \left(1 - \frac{k^2}{n^2}\right) = 27 - \frac{27}{n^3}\sum_{k=1}^n k^2,$$

$$A = \lim_{n \rightarrow +\infty} \left[27 - \frac{27}{n^3}\sum_{k=1}^n k^2\right] = 27 - 27\left(\frac{1}{3}\right) = 18.$$

$$38. \Delta x = \frac{3}{n}, x_k^* = k\frac{3}{n}; f(x_k^*)\Delta x = \left[4 - \frac{1}{4}(x_k^*)^2\right]\Delta x = \left[4 - \frac{1}{4}\frac{9k^2}{n^2}\right]\frac{3}{n} = \frac{12}{n} - \frac{27k^2}{4n^3},$$

$$\sum_{k=1}^n f(x_k^*)\Delta x = \sum_{k=1}^n \frac{12}{n} - \frac{27}{4n^3}\sum_{k=1}^n k^2 = 12 - \frac{27}{4n^3} \cdot \frac{1}{6}n(n+1)(2n+1) = 12 - \frac{9}{8}\frac{(n+1)(2n+1)}{n^2},$$

$$A = \lim_{n \rightarrow +\infty} \left[12 - \frac{9}{8}\left(1 + \frac{1}{n}\right)\left(2 + \frac{1}{n}\right)\right] = 12 - \frac{9}{8}(1)(2) = 39/4.$$

$$39. \Delta x = \frac{4}{n}, x_k^* = 2 + k\frac{4}{n}; f(x_k^*)\Delta x = (x_k^*)^3\Delta x = \left[2 + \frac{4}{n}k\right]^3\frac{4}{n} = \frac{32}{n}\left[1 + \frac{2}{n}k\right]^3 = \frac{32}{n}\left[1 + \frac{6}{n}k + \frac{12}{n^2}k^2 + \frac{8}{n^3}k^3\right],$$

$$\sum_{k=1}^n f(x_k^*)\Delta x = \frac{32}{n}\left[\sum_{k=1}^n 1 + \frac{6}{n}\sum_{k=1}^n k + \frac{12}{n^2}\sum_{k=1}^n k^2 + \frac{8}{n^3}\sum_{k=1}^n k^3\right] =$$

$$= \frac{32}{n}\left[n + \frac{6}{n} \cdot \frac{1}{2}n(n+1) + \frac{12}{n^2} \cdot \frac{1}{6}n(n+1)(2n+1) + \frac{8}{n^3} \cdot \frac{1}{4}n^2(n+1)^2\right] =$$

$$= 32 \left[1 + 3 \frac{n+1}{n} + 2 \frac{(n+1)(2n+1)}{n^2} + 2 \frac{(n+1)^2}{n^2} \right],$$

$$A = \lim_{n \rightarrow +\infty} 32 \left[1 + 3 \left(1 + \frac{1}{n} \right) + 2 \left(1 + \frac{1}{n} \right) \left(2 + \frac{1}{n} \right) + 2 \left(1 + \frac{1}{n} \right)^2 \right] = 32[1 + 3(1) + 2(1)(2) + 2(1)^2] = 320.$$

40. $\Delta x = \frac{2}{n}$, $x_k^* = -3 + k \frac{2}{n}$; $f(x_k^*)\Delta x = [1 - (x_k^*)^3]\Delta x = \left[1 - \left(-3 + \frac{2}{n}k \right)^3 \right] \frac{2}{n} = \frac{2}{n} \left[28 - \frac{54}{n}k + \frac{36}{n^2}k^2 - \frac{8}{n^3}k^3 \right]$,

$$\sum_{k=1}^n f(x_k^*)\Delta x = \frac{2}{n} \left[28n - 27(n+1) + 6 \frac{(n+1)(2n+1)}{n} - 2 \frac{(n+1)^2}{n} \right],$$

$$A = \lim_{n \rightarrow +\infty} 2 \left[28 - 27 \left(1 + \frac{1}{n} \right) + 6 \left(1 + \frac{1}{n} \right) \left(2 + \frac{1}{n} \right) - 2 \left(1 + \frac{1}{n} \right)^2 \right] = 2(28 - 27 + 12 - 2) = 22.$$

41. $\Delta x = \frac{3}{n}$, $x_k^* = 1 + (k-1) \frac{3}{n}$; $f(x_k^*)\Delta x = \frac{1}{2} x_k^* \Delta x = \frac{1}{2} \left[1 + (k-1) \frac{3}{n} \right] \frac{3}{n} = \frac{1}{2} \left[\frac{3}{n} + (k-1) \frac{9}{n^2} \right]$,

$$\sum_{k=1}^n f(x_k^*)\Delta x = \frac{1}{2} \left[\sum_{k=1}^n \frac{3}{n} + \frac{9}{n^2} \sum_{k=1}^n (k-1) \right] = \frac{1}{2} \left[3 + \frac{9}{n^2} \cdot \frac{1}{2}(n-1)n \right] = \frac{3}{2} + \frac{9}{4} \frac{n-1}{n},$$

$$A = \lim_{n \rightarrow +\infty} \left[\frac{3}{2} + \frac{9}{4} \left(1 - \frac{1}{n} \right) \right] = \frac{3}{2} + \frac{9}{4} = \frac{15}{4}.$$

42. $\Delta x = \frac{5}{n}$, $x_k^* = \frac{5}{n}(k-1)$; $f(x_k^*)\Delta x = (5 - x_k^*)\Delta x = \left[5 - \frac{5}{n}(k-1) \right] \frac{5}{n} = \frac{25}{n} - \frac{25}{n^2}(k-1)$,

$$\sum_{k=1}^n f(x_k^*)\Delta x = \frac{25}{n} \sum_{k=1}^n 1 - \frac{25}{n^2} \sum_{k=1}^n (k-1) = 25 - \frac{25}{2} \frac{n-1}{n},$$

$$A = \lim_{n \rightarrow +\infty} \left[25 - \frac{25}{2} \left(1 - \frac{1}{n} \right) \right] = 25 - \frac{25}{2} = \frac{25}{2}.$$

43. $\Delta x = \frac{3}{n}$, $x_k^* = 0 + (k-1) \frac{3}{n}$; $f(x_k^*)\Delta x = \left[9 - 9 \frac{(k-1)^2}{n^2} \right] \frac{3}{n}$,

$$\sum_{k=1}^n f(x_k^*)\Delta x = \sum_{k=1}^n \left[9 - 9 \frac{(k-1)^2}{n^2} \right] \frac{3}{n} = \frac{27}{n} \sum_{k=1}^n \left(1 - \frac{(k-1)^2}{n^2} \right) = 27 - \frac{27}{n^3} \sum_{k=1}^n k^2 + \frac{54}{n^3} \sum_{k=1}^n k - \frac{27}{n^2},$$

$$A = \lim_{n \rightarrow +\infty} = 27 - 27 \left(\frac{1}{3} \right) + 0 + 0 = 18.$$

44. $\Delta x = \frac{3}{n}$, $x_k^* = (k-1) \frac{3}{n}$; $f(x_k^*)\Delta x = \left[4 - \frac{1}{4}(x_k^*)^2 \right] \Delta x = \left[4 - \frac{1}{4} \frac{9(k-1)^2}{n^2} \right] \frac{3}{n} = \frac{12}{n} - \frac{27k^2}{4n^3} + \frac{27k}{2n^3} - \frac{27}{4n^3}$,

$$\begin{aligned} \sum_{k=1}^n f(x_k^*)\Delta x &= \sum_{k=1}^n \frac{12}{n} - \frac{27}{4n^3} \sum_{k=1}^n k^2 + \frac{27}{2n^3} \sum_{k=1}^n k - \frac{27}{4n^3} \sum_{k=1}^n 1 = 12 - \frac{27}{4n^3} \cdot \frac{1}{6} n(n+1)(2n+1) + \frac{27}{2n^3} \frac{n(n+1)}{2} - \frac{27}{4n^2} = \\ &= 12 - \frac{9(n+1)(2n+1)}{8n^2} + \frac{27}{4n} + \frac{27}{4n^2} - \frac{27}{4n^2}, \end{aligned}$$

$$A = \lim_{n \rightarrow +\infty} \left[12 - \frac{9}{8} \left(1 + \frac{1}{n} \right) \left(2 + \frac{1}{n} \right) \right] + 0 + 0 - 0 = 12 - \frac{9}{8}(1)(2) = 39/4.$$

45. Endpoints $0, \frac{4}{n}, \frac{8}{n}, \dots, \frac{4(n-1)}{n}, \frac{4n}{n} = 4$, and midpoints $\frac{2}{n}, \frac{6}{n}, \frac{10}{n}, \dots, \frac{4n-6}{n}, \frac{4n-2}{n}$. Approximate the area with

the sum $\sum_{k=1}^n 2 \left(\frac{4k-2}{n} \right) \frac{4}{n} = \frac{16}{n^2} \left[2 \frac{n(n+1)}{2} - n \right] \rightarrow 16$ (exact) as $n \rightarrow +\infty$.

46. Endpoints $1, 1 + \frac{4}{n}, 1 + \frac{8}{n}, \dots, 1 + \frac{4(n-1)}{n}, 1 + 4 = 5$, and midpoints $1 + \frac{2}{n}, 1 + \frac{6}{n}, 1 + \frac{10}{n}, \dots, 1 + \frac{4(n-1)-2}{n}, \frac{4n-2}{n}$. Approximate the area with the sum $\sum_{k=1}^n \left(6 - \left(1 + \frac{4k-2}{n}\right)\right) \frac{4}{n} = \sum_{k=1}^n \left(5\frac{4}{n} - \frac{16}{n^2}k + \frac{8}{n^2}\right) = 20 - \frac{16}{n^2} \frac{n(n+1)}{2} + \frac{8}{n} = 20 - 8 = 12$, which is exact, because f is linear.

47. $\Delta x = \frac{1}{n}, x_k^* = \frac{2k-1}{2n}; f(x_k^*)\Delta x = \frac{(2k-1)^2}{(2n)^2} \frac{1}{n} = \frac{k^2}{n^3} - \frac{k}{n^3} + \frac{1}{4n^3}, \sum_{k=1}^n f(x_k^*)\Delta x = \frac{1}{n^3} \sum_{k=1}^n k^2 - \frac{1}{n^3} \sum_{k=1}^n k + \frac{1}{4n^3} \sum_{k=1}^n 1$.
Using Theorem 5.4.4, $A = \lim_{n \rightarrow +\infty} \sum_{k=1}^n f(x_k^*)\Delta x = \frac{1}{3} + 0 + 0 = \frac{1}{3}$.

48. $\Delta x = \frac{2}{n}, x_k^* = -1 + \frac{2k-1}{n}; f(x_k^*)\Delta x = \left(-1 + \frac{2k-1}{n}\right)^2 \frac{2}{n} = \frac{8k^2}{n^3} - \frac{8k}{n^3} + \frac{2}{n^3} - \frac{2}{n}, \sum_{k=1}^n f(x_k^*)\Delta x = \frac{8}{n^3} \sum_{k=1}^n k^2 - \frac{8}{n^3} \sum_{k=1}^n k + \frac{2}{n^2} - 2, A = \lim_{n \rightarrow +\infty} \sum_{k=1}^n f(x_k^*)\Delta x = \frac{8}{3} + 0 + 0 - 2 = \frac{2}{3}$.

49. $\Delta x = \frac{2}{n}, x_k^* = -1 + \frac{2k}{n}; f(x_k^*)\Delta x = \left(-1 + \frac{2k}{n}\right) \frac{2}{n} = -\frac{2}{n} + 4\frac{k}{n^2}, \sum_{k=1}^n f(x_k^*)\Delta x = -2 + \frac{4}{n^2} \sum_{k=1}^n k = -2 + \frac{4}{n^2} \frac{n(n+1)}{2} = -2 + 2 + \frac{2}{n}, A = \lim_{n \rightarrow +\infty} \sum_{k=1}^n f(x_k^*)\Delta x = 0$.

The area below the x -axis cancels the area above the x -axis.

50. $\Delta x = \frac{3}{n}, x_k^* = -1 + \frac{3k}{n}; f(x_k^*)\Delta x = \left(-1 + \frac{3k}{n}\right) \frac{3}{n} = -\frac{3}{n} + \frac{9}{n^2}k, \sum_{k=1}^n f(x_k^*)\Delta x = -3 + \frac{9}{n^2} \frac{n(n+1)}{2}, A = \lim_{n \rightarrow +\infty} \sum_{k=1}^n f(x_k^*)\Delta x = -3 + \frac{9}{2} + 0 = \frac{3}{2}$.

The area below the x -axis cancels the area above the x -axis that lies to the left of the line $x = 1$; the remaining area is a trapezoid of width 1 and heights 1, 2, hence its area is $\frac{1+2}{2} = \frac{3}{2}$.

51. $\Delta x = \frac{2}{n}, x_k^* = \frac{2k}{n}; f(x_k^*) = \left[\left(\frac{2k}{n}\right)^2 - 1\right] \frac{2}{n} = \frac{8k^2}{n^3} - \frac{2}{n}, \sum_{k=1}^n f(x_k^*)\Delta x = \frac{8}{n^3} \sum_{k=1}^n k^2 - \frac{2}{n} \sum_{k=1}^n 1 = \frac{8}{n^3} \frac{n(n+1)(2n+1)}{6} - 2, A = \lim_{n \rightarrow +\infty} \sum_{k=1}^n f(x_k^*)\Delta x = \frac{16}{6} - 2 = \frac{2}{3}$.

52. $\Delta x = \frac{2}{n}, x_k^* = -1 + \frac{2k}{n}; f(x_k^*)\Delta x = \left(-1 + \frac{2k}{n}\right)^3 \frac{2}{n} = -\frac{2}{n} + 12\frac{k}{n^2} - 24\frac{k^2}{n^3} + 16\frac{k^3}{n^4}, \sum_{k=1}^n f(x_k^*)\Delta x = -2 + \frac{12}{n^2} \frac{n(n+1)}{2} - \frac{24}{n^3} \frac{n(n+1)(2n+1)}{6} + \frac{16}{n^4} \left(\frac{n(n+1)}{2}\right)^2, A = \lim_{n \rightarrow +\infty} \sum_{k=1}^n f(x_k^*)\Delta x = -2 + \frac{12}{2} - \frac{48}{6} + \frac{16}{2^2} = 0$.

53. (a) With x_k^* as the right endpoint, $\Delta x = \frac{b}{n}, x_k^* = \frac{b}{n}k; f(x_k^*)\Delta x = (x_k^*)^3 \Delta x = \frac{b^4}{n^4} k^3, \sum_{k=1}^n f(x_k^*)\Delta x = \frac{b^4}{n^4} \sum_{k=1}^n k^3 = \frac{b^4}{4} \frac{(n+1)^2}{n^2}, A = \lim_{n \rightarrow +\infty} \frac{b^4}{4} \left(1 + \frac{1}{n}\right)^2 = b^4/4$.

(b) First Method (tedious): $\Delta x = \frac{b-a}{n}, x_k^* = a + \frac{b-a}{n}k; f(x_k^*)\Delta x = (x_k^*)^3 \Delta x = \left[a + \frac{b-a}{n}k\right]^3 \frac{b-a}{n} =$

$$\frac{b-a}{n} \left[a^3 + \frac{3a^2(b-a)}{n}k + \frac{3a(b-a)^2}{n^2}k^2 + \frac{(b-a)^3}{n^3}k^3 \right],$$

$$\sum_{k=1}^n f(x_k^*)\Delta x = (b-a) \left[a^3 + \frac{3}{2}a^2(b-a)\frac{n+1}{n} + \frac{1}{2}a(b-a)^2\frac{(n+1)(2n+1)}{n^2} + \frac{1}{4}(b-a)^3\frac{(n+1)^2}{n^2} \right],$$

$$A = \lim_{n \rightarrow +\infty} \sum_{k=1}^n f(x_k^*)\Delta x = (b-a) \left[a^3 + \frac{3}{2}a^2(b-a) + a(b-a)^2 + \frac{1}{4}(b-a)^3 \right] = \frac{1}{4}(b^4 - a^4).$$

Alternative method: Apply part (a) of the Exercise to the interval $[0, a]$ and observe that the area under the curve and above that interval is given by $\frac{1}{4}a^4$. Apply part (a) again, this time to the interval $[0, b]$ and obtain $\frac{1}{4}b^4$. Now subtract to obtain the correct area and the formula $A = \frac{1}{4}(b^4 - a^4)$.

54. Let A be the area of the region under the curve and above the interval $0 \leq x \leq 1$ on the x -axis, and let B be the area of the region between the curve and the interval $0 \leq y \leq 1$ on the y -axis. Together A and B form the square of side 1, so $A + B = 1$. But B can also be considered as the area between the curve $x = y^2$ and the interval $0 \leq y \leq 1$ on the y -axis. By Exercise 47 above, $B = \frac{1}{3}$, so $A = 1 - \frac{1}{3} = \frac{2}{3}$.

55. If $n = 2m$ then $2m + 2(m-1) + \dots + 2 \cdot 2 + 2 = 2 \sum_{k=1}^m k = 2 \cdot \frac{m(m+1)}{2} = m(m+1) = \frac{n^2 + 2n}{4}$; if $n = 2m + 1$ then $(2m+1) + (2m-1) + \dots + 5 + 3 + 1 = \sum_{k=1}^{m+1} (2k-1) = 2 \sum_{k=1}^{m+1} k - \sum_{k=1}^{m+1} 1 = 2 \cdot \frac{(m+1)(m+2)}{2} - (m+1) = (m+1)^2 = \frac{n^2 + 2n + 1}{4}$.

56. $50 \cdot 30 + 49 \cdot 29 + \dots + 22 \cdot 2 + 21 \cdot 1 = \sum_{k=1}^{30} k(k+20) = \sum_{k=1}^{30} k^2 + 20 \sum_{k=1}^{30} k = \frac{30 \cdot 31 \cdot 61}{6} + 20 \frac{30 \cdot 31}{2} = 18,755$.

57. $(3^5 - 3^4) + (3^6 - 3^5) + \dots + (3^{17} - 3^{16}) = 3^{17} - 3^4$.

58. $\left(1 - \frac{1}{2}\right) + \left(\frac{1}{2} - \frac{1}{3}\right) + \dots + \left(\frac{1}{50} - \frac{1}{51}\right) = \frac{50}{51}$.

59. $\left(\frac{1}{2^2} - \frac{1}{1^2}\right) + \left(\frac{1}{3^2} - \frac{1}{2^2}\right) + \dots + \left(\frac{1}{20^2} - \frac{1}{19^2}\right) = \frac{1}{20^2} - 1 = -\frac{399}{400}$.

60. $(2^2 - 2) + (2^3 - 2^2) + \dots + (2^{101} - 2^{100}) = 2^{101} - 2$.

61. (a) $\sum_{k=1}^n \frac{1}{(2k-1)(2k+1)} = \frac{1}{2} \sum_{k=1}^n \left(\frac{1}{2k-1} - \frac{1}{2k+1} \right) = \frac{1}{2} \left[\left(1 - \frac{1}{3}\right) + \left(\frac{1}{3} - \frac{1}{5}\right) + \left(\frac{1}{5} - \frac{1}{7}\right) + \dots + \left(\frac{1}{2n-1} - \frac{1}{2n+1}\right) \right] = \frac{1}{2} \left[1 - \frac{1}{2n+1} \right] = \frac{n}{2n+1}$.

(b) $\lim_{n \rightarrow +\infty} \frac{n}{2n+1} = \frac{1}{2}$.

62. (a) $\sum_{k=1}^n \frac{1}{k(k+1)} = \sum_{k=1}^n \left(\frac{1}{k} - \frac{1}{k+1} \right) = \left(1 - \frac{1}{2}\right) + \left(\frac{1}{2} - \frac{1}{3}\right) + \left(\frac{1}{3} - \frac{1}{4}\right) + \dots + \left(\frac{1}{n} - \frac{1}{n+1}\right) = 1 - \frac{1}{n+1} = \frac{n}{n+1}$.

(b) $\lim_{n \rightarrow +\infty} \frac{n}{n+1} = 1$.

63. $\sum_{i=1}^n (x_i - \bar{x}) = \sum_{i=1}^n x_i - \sum_{i=1}^n \bar{x} = \sum_{i=1}^n x_i - n\bar{x}$, but $\bar{x} = \frac{1}{n} \sum_{i=1}^n x_i$, thus $\sum_{i=1}^n x_i = n\bar{x}$, so $\sum_{i=1}^n (x_i - \bar{x}) = n\bar{x} - n\bar{x} = 0$.
64. $S - rS = \sum_{k=0}^n ar^k - \sum_{k=0}^n ar^{k+1} = (a + ar + ar^2 + \cdots + ar^n) - (ar + ar^2 + ar^3 + \cdots + ar^{n+1}) = a - ar^{n+1} = a(1 - r^{n+1})$,
so $(1 - r)S = a(1 - r^{n+1})$, hence $S = a(1 - r^{n+1})/(1 - r)$.
65. Both are valid.
66. (d) is valid.
67. $\sum_{k=1}^n (a_k - b_k) = (a_1 - b_1) + (a_2 - b_2) + \cdots + (a_n - b_n) = (a_1 + a_2 + \cdots + a_n) - (b_1 + b_2 + \cdots + b_n) = \sum_{k=1}^n a_k - \sum_{k=1}^n b_k$.
68. (a) $\sum_{k=1}^n 1$ means add 1 to itself n times, which gives the result.
- (b) $\frac{1}{n^2} \sum_{k=1}^n k = \frac{1}{n^2} \frac{n(n+1)}{2} = \frac{1}{2} + \frac{1}{2n}$, so $\lim_{n \rightarrow +\infty} \frac{1}{n^2} \sum_{k=1}^n k = \frac{1}{2}$.
- (c) $\frac{1}{n^3} \sum_{k=1}^n k^2 = \frac{1}{n^3} \frac{n(n+1)(2n+1)}{6} = \frac{2}{6} + \frac{3}{6n} + \frac{1}{6n^2}$, so $\lim_{n \rightarrow +\infty} \frac{1}{n^3} \sum_{k=1}^n k^2 = \frac{1}{3}$.
- (d) $\frac{1}{n^4} \sum_{k=1}^n k^3 = \frac{1}{n^4} \left(\frac{n(n+1)}{2} \right)^2 = \frac{1}{4} + \frac{1}{2n} + \frac{1}{4n^2}$, so $\lim_{n \rightarrow +\infty} \frac{1}{n^4} \sum_{k=1}^n k^3 = \frac{1}{4}$.

Exercise Set 5.5

1. (a) $(4/3)(1) + (5/2)(1) + (4)(2) = 71/6$. (b) 2.
2. (a) $(\sqrt{2}/2)(\pi/2) + (-1)(3\pi/4) + (0)(\pi/2) + (\sqrt{2}/2)(\pi/4) = 3(\sqrt{2} - 2)\pi/8$. (b) $3\pi/4$.
3. (a) $(-9/4)(1) + (3)(2) + (63/16)(1) + (-5)(3) = -117/16$. (b) 3.
4. (a) $(-8)(2) + (0)(1) + (0)(1) + (8)(2) = 0$. (b) 2.
5. $\int_{-1}^2 x^2 dx$
6. $\int_1^2 x^3 dx$
7. $\int_{-3}^3 4x(1 - 3x) dx$
8. $\int_0^{\pi/2} \sin^2 x dx$
9. (a) $\lim_{\max \Delta x_k \rightarrow 0} \sum_{k=1}^n 2x_k^* \Delta x_k$; $a = 1$, $b = 2$. (b) $\lim_{\max \Delta x_k \rightarrow 0} \sum_{k=1}^n \frac{x_k^*}{x_k^* + 1} \Delta x_k$; $a = 0$, $b = 1$.

10. (a) $\lim_{\max \Delta x_k \rightarrow 0} \sum_{k=1}^n \sqrt{x_k^*} \Delta x_k; a = 1, b = 2.$ (b) $\lim_{\max \Delta x_k \rightarrow 0} \sum_{k=1}^n (1 + \cos x_k^*) \Delta x_k; a = -\pi/2, b = \pi/2.$

11. Theorem 5.5.4(a) depends on the fact that a constant can move past an integral sign, which by Definition 5.5.1 is possible because a constant can move past a limit and/or a summation sign.

12. If $f(x) \geq 0$ for all x in $[a, b]$ then we know that positivity (or nonnegativity) is preserved under limits and sums, hence also (by Definition 5.5.1) for integrals.

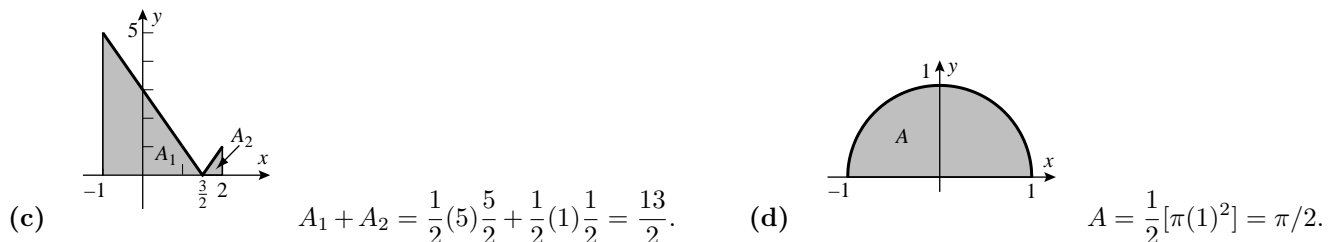
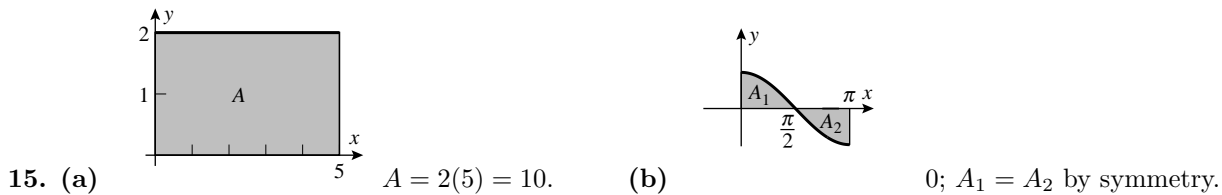
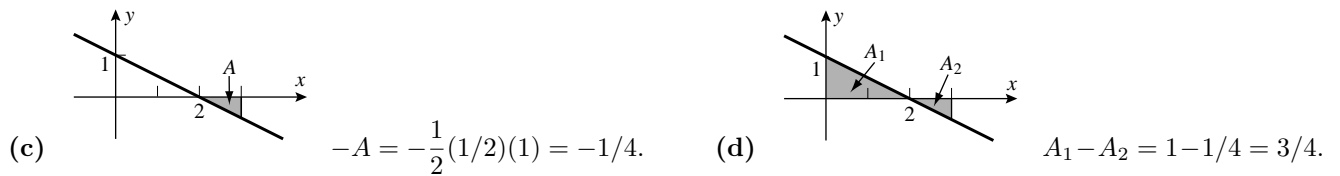
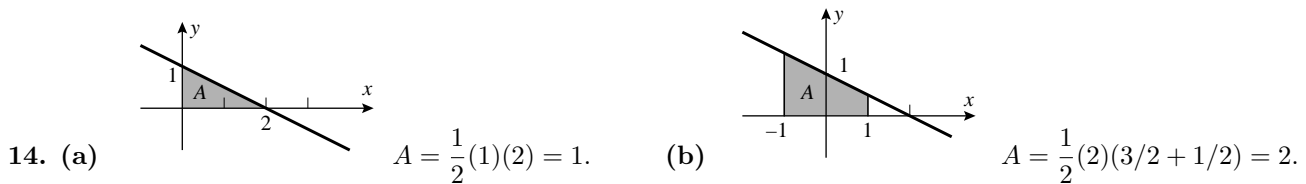
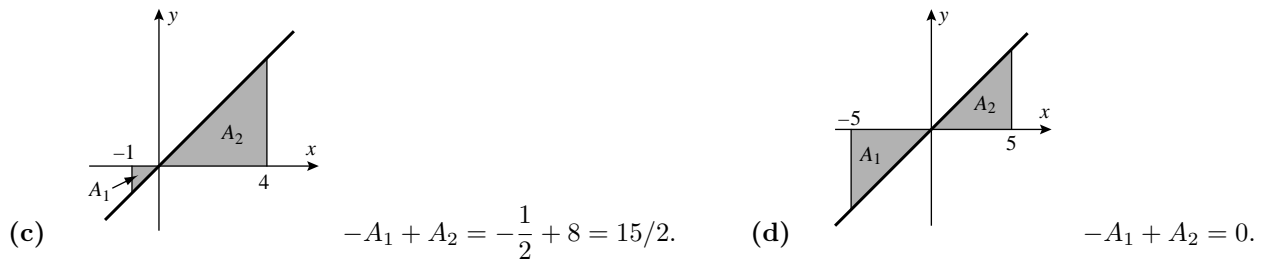
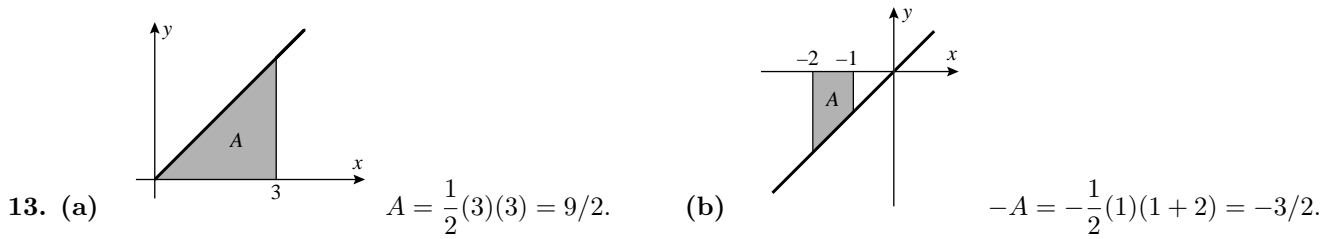

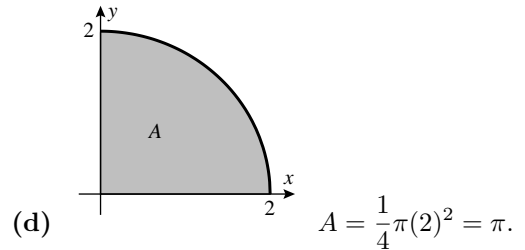
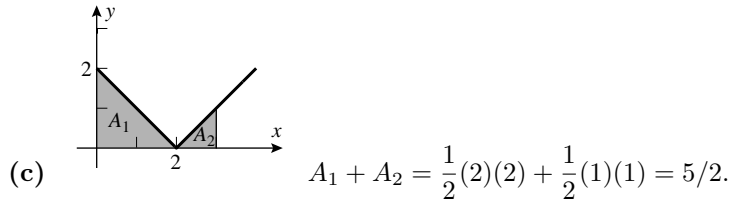
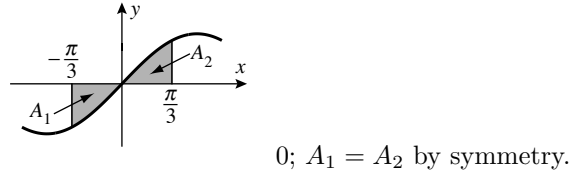
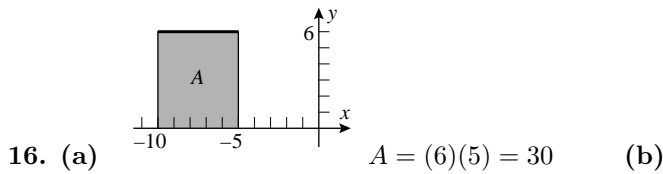

17. (a) $\int_{-2}^0 f(x) dx = \int_{-2}^0 (x+2) dx.$

Triangle of height 2 and width 2, above x -axis, so answer is 2.

(b) $\int_{-2}^2 f(x) dx = \int_{-2}^0 (x+2) dx + \int_0^2 (2-x) dx.$

Two triangles of height 2 and base 2; answer is 4.

(c) $\int_0^6 |x-2| dx = \int_0^2 (2-x) dx + \int_2^6 (x-2) dx.$

Triangle of height 2 and base 2 together with a triangle of height 4 and base 4, so $2 + 8 = 10.$

(d) $\int_{-4}^6 f(x) dx = \int_{-4}^{-2} (x+2) dx + \int_{-2}^0 (x+2) dx + \int_0^2 (2-x) dx + \int_2^6 (x-2) dx.$

Triangle of height 2 and base 2, below axis, plus a triangle of height 2, base 2 above axis, another of height 2 and base 2 above axis, and a triangle of height 4 and base 4, above axis. Thus $\int f(x) = -2 + 2 + 2 + 8 = 10.$

18. (a) $\int_0^1 2x dx =$ area of a triangle with height 2 and base 1, so 1.

(b) $\int_{-1}^1 2x dx = \int_{-1}^0 2x dx + \int_0^1 2x dx.$

Two triangles of height 2 and base 1 on opposite sides of the x -axis, so they cancel to yield 0.

(c) $\int_1^{10} 2 dx.$

Rectangle of height 2 and base 9, area = 18.

(d) $\int_{1/2}^1 2x dx + \int_1^5 2 dx.$

Trapezoid of width $1/2$ and heights 1 and 2, together with a rectangle of height 2 and base 4, so $1/2 \frac{1+2}{2} + 2 \cdot 4 = 3/4 + 8 = 35/4.$

19. (a) 0.8 (b) -2.6 (c) -1.8 (d) -0.3

20. (a) 10 (b) -94 (c) -84 (d) -75

$$21. \int_{-1}^2 f(x)dx + 2 \int_{-1}^2 g(x)dx = 5 + 2(-3) = -1.$$

$$22. 3 \int_1^4 f(x)dx - \int_1^4 g(x)dx = 3(2) - 10 = -4.$$

$$23. \int_1^5 f(x)dx = \int_0^5 f(x)dx - \int_0^1 f(x)dx = 1 - (-2) = 3.$$

$$24. \int_3^{-2} f(x)dx = - \int_{-2}^3 f(x)dx = - \left[\int_{-2}^1 f(x)dx + \int_1^3 f(x)dx \right] = -(2 - 6) = 4.$$

$$25. 4 \int_{-1}^3 dx - 5 \int_{-1}^3 xdx = 4 \cdot 4 - 5(-1/2 + (3 \cdot 3)/2) = -4.$$

$$26. \int_{-2}^2 dx - 3 \int_{-2}^2 |x|dx = 4 \cdot 1 - 3(2)(2 \cdot 2)/2 = -8.$$

$$27. \int_0^1 xdx + 2 \int_0^1 \sqrt{1-x^2}dx = 1/2 + 2(\pi/4) = (1 + \pi)/2.$$

$$28. \int_{-3}^0 2dx + \int_{-3}^0 \sqrt{9-x^2}dx = 2 \cdot 3 + (\pi(3)^2)/4 = 6 + 9\pi/4.$$

29. False; e.g. $f(x) = 1$ if $x > 0$, $f(x) = 0$ otherwise, then f is integrable on $[-1, 1]$ but not continuous.

30. True; $\cos x$ is strictly positive on $[-1, 1]$, so the integrand is positive there, so the integral is positive.

31. False; e.g. $f(x) = x$ on $[-2, +1]$.

32. True; Theorem 5.5.8.

33. (a) $\sqrt{x} > 0$, $1 - x < 0$ on $[2, 3]$ so the integral is negative.

(b) $3 - \cos x > 0$ for all x and $x^2 \geq 0$ for all x and $x^2 > 0$ for all $x > 0$ so the integral is positive.

34. (a) $x^4 > 0$, $\sqrt{3-x} > 0$ on $[-3, -1]$ so the integral is positive.

(b) $x^3 - 9 < 0$, $|x| + 1 > 0$ on $[-2, 2]$ so the integral is negative.

35. If f is continuous on $[a, b]$ then f is integrable on $[a, b]$, and, considering Definition 5.5.1, for every partition and choice of $f(x^*)$ we have $\sum_{k=1}^n m \Delta x_k \leq \sum_{k=1}^n f(x_k^*) \Delta x_k \leq \sum_{k=1}^n M \Delta x_k$. This is equivalent to $m(b-a) \leq \sum_{k=1}^n f(x_k^*) \Delta x_k \leq M(b-a)$, and, taking the limit over $\max \Delta x_k \rightarrow 0$ we obtain the result.

$$36. \sqrt{2} \leq \sqrt{x^3+2} \leq \sqrt{29}, \text{ so } 3\sqrt{2} \leq \int_0^3 \sqrt{x^3+2} dx \leq 3\sqrt{29}.$$

$$37. \int_0^{10} \sqrt{25 - (x-5)^2} dx = \pi(5)^2/2 = 25\pi/2.$$

$$38. \int_0^3 \sqrt{9 - (x-3)^2} dx = \pi(3)^2/4 = 9\pi/4.$$

$$39. \int_0^1 (3x + 1)dx = 5/2.$$

$$40. \int_{-2}^2 \sqrt{4 - x^2}dx = \pi(2)^2/2 = 2\pi.$$

41. (a) The graph of the integrand is the horizontal line $y = C$. At first, assume that $C > 0$. Then the region is a rectangle of height C whose base extends from $x = a$ to $x = b$. Thus $\int_a^b C dx = (\text{area of rectangle}) = C(b - a)$. If $C \leq 0$ then the rectangle lies below the axis and its integral is the negative area, i.e. $-|C|(b - a) = C(b - a)$.

$$(b) \text{ Since } f(x) = C, \text{ the Riemann sum becomes } \lim_{\max \Delta x_k \rightarrow 0} \sum_{k=1}^n f(x_k^*)\Delta x_k = \lim_{\max \Delta x_k \rightarrow 0} \sum_{k=1}^n C\Delta x_k = \\ = \lim_{\max \Delta x_k \rightarrow 0} C(b - a) = C(b - a). \text{ By Definition 5.5.1, } \int_a^b f(x) dx = C(b - a).$$

42. For any partition of $[0, 1]$ we have $f(x_1^*) = 0$ or $f(x_1^*) = 1$; accordingly, either we have $\sum_{k=1}^n f(x_k^*)\Delta x_k = \sum_{k=2}^n \Delta x_k = 1 - \Delta x_1$, or we have $\sum_{k=1}^n f(x_k^*)\Delta x_k = \sum_{k=1}^n \Delta x_k = 1$. This is because $f(x) = 1$ for all x except possibly x_1^* , which could be 0. Both possibilities tend to 1 in the limit, and thus $\int_0^1 f(x) dx = 1$.

43. Each subinterval of a partition of $[a, b]$ contains both rational and irrational numbers. If all x_k^* are chosen to be rational then $\sum_{k=1}^n f(x_k^*)\Delta x_k = \sum_{k=1}^n (1)\Delta x_k = \sum_{k=1}^n \Delta x_k = b - a$ so $\lim_{\max \Delta x_k \rightarrow 0} \sum_{k=1}^n f(x_k^*)\Delta x_k = b - a$. If all x_k^* are irrational then $\lim_{\max \Delta x_k \rightarrow 0} \sum_{k=1}^n f(x_k^*)\Delta x_k = 0$. Thus f is not integrable on $[a, b]$ because the preceding limits are not equal.

44. Choose any large positive integer N and any partition of $[0, a]$. Then choose x_1^* in the first interval so small that $f(x_1^*)\Delta x_1 > N$. For example choose $x_1^* < \Delta x_1/N$. Then with this partition and choice of x_1^* , $\sum_{k=1}^n f(x_k^*)\Delta x_k > f(x_1^*)\Delta x_1 > N$. This shows that the sum is dependent on partition and/or points, so Definition 5.5.1 is not satisfied.

45. (a) f is continuous on $[-1, 1]$ so f is integrable there by Theorem 5.5.2.

(b) $|f(x)| \leq 1$ so f is bounded on $[-1, 1]$, and f has one point of discontinuity, so by part (a) of Theorem 5.5.8 f is integrable on $[-1, 1]$.

(c) f is not bounded on $[-1, 1]$ because $\lim_{x \rightarrow 0} f(x) = +\infty$, so f is not integrable on $[0, 1]$.

(d) $f(x)$ is discontinuous at the point $x = 0$ because $\lim_{x \rightarrow 0} \sin \frac{1}{x}$ does not exist. f is continuous elsewhere. $-1 \leq f(x) \leq 1$ for x in $[-1, 1]$ so f is bounded there. By part (a), Theorem 5.5.8, f is integrable on $[-1, 1]$.

Exercise Set 5.6

$$1. (a) \int_0^2 (2 - x)dx = (2x - x^2/2) \Big|_0^2 = 4 - 4/2 = 2.$$

(b) $\int_{-1}^1 2dx = 2x \Big|_{-1}^1 = 2(1) - 2(-1) = 4.$

(c) $\int_1^3 (x + 1)dx = (x^2/2 + x) \Big|_1^3 = 9/2 + 3 - (1/2 + 1) = 6.$

2. (a) $\int_0^5 xdx = x^2/2 \Big|_0^5 = 25/2.$

(b) $\int_3^9 5dx = 5x \Big|_3^9 = 5(9) - 5(3) = 30.$

(c) $\int_{-1}^2 (x + 3)dx = (x^2/2 + 3x) \Big|_{-1}^2 = 4/2 + 6 - (1/2 - 3) = 21/2.$

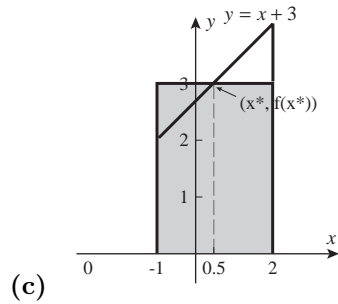
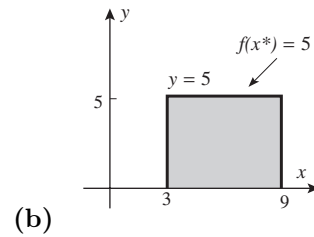
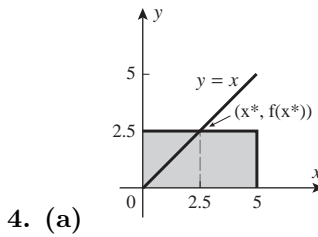
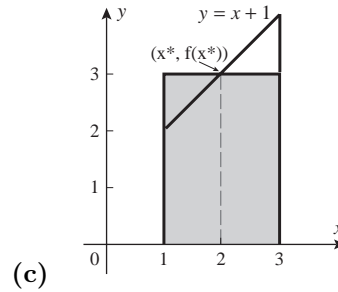
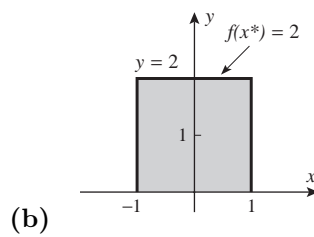
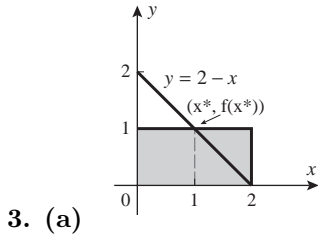

5. $\int_2^3 x^3 dx = x^4/4 \Big|_2^3 = 81/4 - 16/4 = 65/4.$

6. $\int_{-1}^1 x^4 dx = x^5/5 \Big|_{-1}^1 = 1/5 - (-1)/5 = 2/5.$

7. $\int_1^4 3\sqrt{x} dx = 2x^{3/2} \Big|_1^4 = 16 - 2 = 14.$

8. $\int_1^{27} x^{-2/3} dx = 3x^{1/3} \Big|_1^{27} = 3(3 - 1) = 6.$

9. $\int_0^{\ln 2} e^{2x} dx = \frac{1}{2}e^{2x} \Big|_0^{\ln 2} = \frac{1}{2}(4 - 1) = \frac{3}{2}.$

10. $\int_1^5 \frac{1}{x} dx = \ln x \Big|_1^5 = \ln 5 - \ln 1 = \ln 5.$

$$11. \text{ (a) } \int_0^3 \sqrt{x} dx = \left. \frac{2}{3}x^{3/2} \right|_0^3 = 2\sqrt{3} = f(x^*)(3-0), \text{ so } f(x^*) = \frac{2}{\sqrt{3}}, x^* = \frac{4}{3}.$$

$$\text{ (b) } \int_{-12}^0 (x^2 + x) dx = \left. \frac{1}{3}x^3 + \frac{1}{2}x^2 \right|_{-12}^0 = 504, \text{ so } f(x^*)(0 - (-12)) = 504, (x^*)^2 + x^* = 42, x^* = 6, -7 \text{ but only } -7 \text{ lies in the interval. } f(-7) = 49 - 7 = 42, \text{ so the area is that of a rectangle 12 wide and 42 high.}$$

$$12. \text{ (a) } f_{\text{ave}} = \frac{1}{2\pi} \int_{-\pi}^{\pi} \sin x dx = 0; \sin x^* = 0, x^* = -\pi, 0, \pi.$$

$$\text{ (b) } f_{\text{ave}} = \frac{1}{2} \int_1^3 \frac{1}{x^2} dx = \frac{1}{3}; \frac{1}{(x^*)^2} = \frac{1}{3}, x^* = \sqrt{3}.$$

$$13. \int_{-2}^1 (x^2 - 6x + 12) dx = \left. \frac{1}{3}x^3 - 3x^2 + 12x \right|_{-2}^1 = \frac{1}{3} - 3 + 12 - \left(-\frac{8}{3} - 12 - 24 \right) = 48.$$

$$14. \int_{-1}^2 4x(1 - x^2) dx = \left. (2x^2 - x^4) \right|_{-1}^2 = 8 - 16 - (2 - 1) = -9.$$

$$15. \int_1^4 \frac{4}{x^2} dx = \left. -4x^{-1} \right|_1^4 = -1 + 4 = 3.$$

$$16. \int_1^2 x^{-6} dx = \left. -\frac{1}{5x^5} \right|_1^2 = 31/160.$$

$$17. \left. \frac{4}{5}x^{5/2} \right|_4^9 = 844/5.$$

$$18. \int_1^4 \frac{1}{x\sqrt{x}} dx = \left. -\frac{2}{\sqrt{x}} \right|_1^4 = -\frac{2}{2} + \frac{2}{1} = 1.$$

$$19. -\cos \theta \Big|_{-\pi/2}^{\pi/2} = 0.$$

$$20. \tan \theta \Big|_0^{\pi/4} = 1.$$

$$21. \sin x \Big|_{-\pi/4}^{\pi/4} = \sqrt{2}.$$

$$22. (x^2 - \sec x) \Big|_0^{\pi/3} = \frac{\pi^2}{9} - 1.$$

$$23. 5e^x \Big|_{\ln 2}^3 = 5e^3 - 5(2) = 5e^3 - 10.$$

$$24. (\ln x)/2 \Big|_{1/2}^1 = (\ln 2)/2.$$

$$25. \sin^{-1} x \Big|_0^{1/\sqrt{2}} = \sin^{-1}(1/\sqrt{2}) - \sin^{-1} 0 = \pi/4.$$

$$26. \tan^{-1} x \Big|_{-1}^1 = \tan^{-1} 1 - \tan^{-1}(-1) = \pi/4 - (-\pi/4) = \pi/2.$$

27. $\sec^{-1} x \Big|_{\sqrt{2}}^2 = \sec^{-1} 2 - \sec^{-1} \sqrt{2} = \pi/3 - \pi/4 = \pi/12.$

28. $\sec^{-1} |x| \Big|_{-\sqrt{2}}^{-2/\sqrt{3}} = \sec^{-1}(2/\sqrt{3}) - \sec^{-1}(\sqrt{2}) = \pi/6 - \pi/4 = -\pi/12.$

29. $\left(2\sqrt{t} - 2t^{3/2}\right) \Big|_1^4 = -12.$

30. $\left(\frac{1}{2}x^2 - 2 \cot x\right) \Big|_{\pi/6}^{\pi/2} = \pi^2/9 + 2\sqrt{3}.$

31. (a) $\int_{-1}^1 |2x - 1| dx = \int_{-1}^{1/2} (1 - 2x) dx + \int_{1/2}^1 (2x - 1) dx = (x - x^2) \Big|_{-1}^{1/2} + (x^2 - x) \Big|_{1/2}^1 = \frac{5}{2}.$

(b) $\int_0^{\pi/2} \cos x dx + \int_{\pi/2}^{3\pi/4} (-\cos x) dx = \sin x \Big|_0^{\pi/2} - \sin x \Big|_{\pi/2}^{3\pi/4} = 2 - \sqrt{2}/2.$

32. (a) $\int_{-1}^0 \sqrt{2-x} dx + \int_0^2 \sqrt{2+x} dx = -\frac{2}{3}(2-x)^{3/2} \Big|_{-1}^0 + \frac{2}{3}(2+x)^{3/2} \Big|_0^2 = -\frac{2}{3}(2\sqrt{2} - 3\sqrt{3}) + \frac{2}{3}(8 - 2\sqrt{2}) = \frac{2}{3}(8 - 4\sqrt{2} + 3\sqrt{3}).$

(b) $\int_0^{\pi/3} (\cos x - 1/2) dx + \int_{\pi/3}^{\pi/2} (1/2 - \cos x) dx = (\sin x - x/2) \Big|_0^{\pi/3} + (x/2 - \sin x) \Big|_{\pi/3}^{\pi/2} = (\sqrt{3}/2 - \pi/6) + \pi/4 - 1 - (\pi/6 - \sqrt{3}/2) = \sqrt{3} - \pi/12 - 1.$

33. (a) $\int_{-1}^0 (1 - e^x) dx + \int_0^1 (e^x - 1) dx = (x - e^x) \Big|_{-1}^0 + (e^x - x) \Big|_0^1 = -1 - (-1 - e^{-1}) + e - 1 - 1 = e + 1/e - 2.$

(b) $\int_1^2 \frac{2-x}{x} dx + \int_2^4 \frac{x-2}{x} dx = 2 \ln x \Big|_1^2 - 1 + 2 - 2 \ln x \Big|_2^4 = 2 \ln 2 + 1 - 2 \ln 4 + 2 \ln 2 = 1.$

34. (a) The function $f(x) = x^2 - 1 - \frac{15}{x^2 + 1}$ is an even function and changes sign at $x = 2$, thus $\int_{-3}^3 |f(x)| dx = 2 \int_0^3 |f(x)| dx = -2 \int_0^2 f(x) dx + 2 \int_2^3 f(x) dx = \frac{28}{3} - 30 \tan^{-1}(3) + 60 \tan^{-1}(2).$

(b) $\int_0^{\sqrt{3}/2} \left| \frac{1}{\sqrt{1-x^2}} - \sqrt{2} \right| dx = -\int_0^{\sqrt{2}/2} \left[\frac{1}{\sqrt{1-x^2}} - \sqrt{2} \right] dx + \int_{\sqrt{2}/2}^{\sqrt{3}/2} \left[\frac{1}{\sqrt{1-x^2}} - \sqrt{2} \right] dx = -2 \sin^{-1} \left(\frac{\sqrt{2}}{2} \right) + \sin^{-1} \left(\frac{\sqrt{3}}{2} \right) - \sqrt{2} \left(\frac{\sqrt{3}}{2} - \frac{\sqrt{2}}{2} \right) + 1 = -2 \frac{\pi}{4} + \frac{\pi}{3} - \frac{\sqrt{3}}{\sqrt{2}} + 2 = 2 - \frac{\sqrt{3}}{\sqrt{2}} - \frac{\pi}{6}.$

35. (a) 17/6 (b) $F(x) = \begin{cases} \frac{1}{2}x^2, & x \leq 1 \\ \frac{1}{3}x^3 + \frac{1}{6}, & x > 1 \end{cases}$

36. (a) $\int_0^1 \sqrt{x} dx + \int_1^4 \frac{1}{x^2} dx = \frac{2}{3}x^{3/2} \Big|_0^1 - \frac{1}{x} \Big|_1^4 = 17/12.$ (b) $F(x) = \begin{cases} \frac{2}{3}x^{3/2}, & x < 1 \\ -\frac{1}{x} + \frac{5}{3}, & x \geq 1 \end{cases}$

37. False; consider $F(x) = x^2/2$ if $x \geq 0$ and $F(x) = -x^2/2$ if $x \leq 0$.

38. True.

39. True.

40. True, $x = 0$.

$$41. 0.665867079; \int_1^3 \frac{1}{x^2} dx = -\frac{1}{x} \Big|_1^3 = 2/3.$$

$$42. 1.000257067; \int_0^{\pi/2} \sin x dx = -\cos x \Big|_0^{\pi/2} = 1.$$

$$43. 3.106017890; \int_{-1}^1 \sec^2 x dx = \tan x \Big|_{-1}^1 = 2 \tan 1 \approx 3.114815450.$$

$$44. 1.098242635; \int_1^3 \frac{1}{x} dx = \ln x \Big|_1^3 = \ln 3 \approx 1.098612289.$$

$$45. A = \int_0^3 (x^2 + 1) dx = \left(\frac{1}{3}x^3 + x \right) \Big|_0^3 = 12.$$

$$46. A = \int_0^1 (x - x^2) dx = \left(\frac{1}{2}x^2 - \frac{1}{3}x^3 \right) \Big|_0^1 = \frac{1}{2} - \frac{1}{3} = \frac{1}{6}.$$

$$47. A = \int_0^{2\pi/3} 3 \sin x dx = -3 \cos x \Big|_0^{2\pi/3} = 9/2.$$

$$48. A = - \int_{-2}^{-1} x^3 dx = -\frac{1}{4}x^4 \Big|_{-2}^{-1} = 15/4.$$

$$49. \text{Area} = - \int_0^1 (x^2 - x) dx + \int_1^2 (x^2 - x) dx = 5/6 + 1/6 = 1.$$

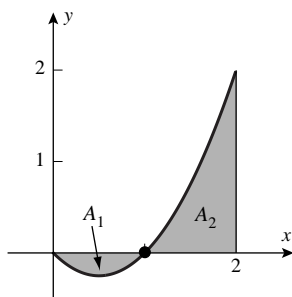

$$50. \text{Area} = \int_0^{\pi} \sin x dx - \int_{\pi}^{3\pi/2} \sin x dx = 2 + 1 = 3.$$

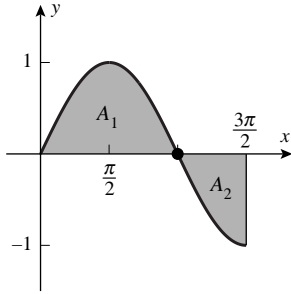

51. Area = $-\int_{-1}^0 (e^x - 1) dx + \int_0^1 (e^x - 1) dx = 1/e + e - 2$.

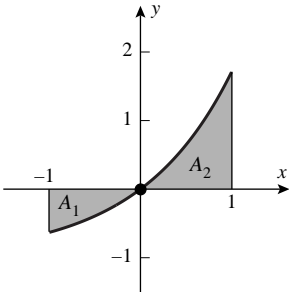

52. Area = $-\int_{1/2}^1 (x^2 - 1)/x^2 dx + \int_1^2 (x^2 - 1)/x^2 dx = 1/2 + 1/2 = 1$.

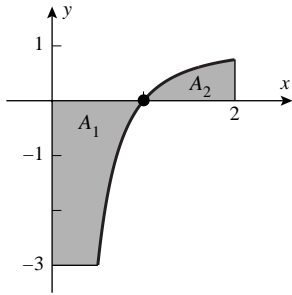

53. (a) $A = \int_0^{0.8} \frac{1}{\sqrt{1-x^2}} dx = \sin^{-1} x \Big|_0^{0.8} = \sin^{-1}(0.8)$.

(b) The calculator was in degree mode instead of radian mode; the correct answer is 0.93.

55. (a) The increase in height in inches, during the first ten years.

(b) The change in the radius in centimeters, during the time interval $t = 1$ to $t = 2$ seconds.

(c) The change in the speed of sound in ft/s, during an increase in temperature from $t = 32^\circ\text{F}$ to $t = 100^\circ\text{F}$.

(d) The displacement of the particle in cm, during the time interval $t = t_1$ to $t = t_2$ hours.

56. (a) Let the areas in quadrants IV, III, I and II be A_4, A_3, A_1 and A_2 respectively. Then it appears that $A_3 < A_2$, and $A_1 > A_4$. Since the total area is given by $A_1 + A_2 - A_3 - A_4$, the area is positive.

(b) Area = $\int_{-2}^5 \frac{1}{100}(x^4 - 5x^3 - 7x^2 + 29x + 30) dx = \frac{4459}{6000}$.

57. (a) $F'(x) = 3x^2 - 3$. (b) $\int_1^x (3t^2 - 3) dt = (t^3 - 3t) \Big|_1^x = x^3 - 3x + 2$, and $\frac{d}{dx}(x^3 - 3x + 2) = 3x^2 - 3$.

58. (a) $F'(x) = \cos 2x$ (b) $F(x) = \frac{1}{2} \sin 2t \Big|_{\pi/4}^x = \frac{1}{2} \sin 2x - \frac{1}{2}$, $F'(x) = \cos 2x$.

59. (a) $\sin x^2$ (b) $e^{\sqrt{x}}$

60. (a) $\frac{1}{1 + \sqrt{x}}$ (b) $\ln x$

61. $-\frac{x}{\cos x}$

62. $|u|$

63. $F'(x) = \sqrt{x^2 + 9}$, $F''(x) = \frac{x}{\sqrt{x^2 + 9}}$. (a) 0 (b) 5 (c) $\frac{4}{5}$

64. $F'(x) = \tan^{-1} x$, $F''(x) = \frac{1}{1 + x^2}$. (a) 0 (b) $\pi/3$ (c) $1/4$

65. (a) $F'(x) = \frac{x-3}{x^2+7} = 0$ when $x = 3$, which is a relative minimum, and hence the absolute minimum, by the first derivative test.

(b) Increasing on $[3, +\infty)$, decreasing on $(-\infty, 3]$.

(c) $F''(x) = \frac{7+6x-x^2}{(x^2+7)^2} = \frac{(7-x)(1+x)}{(x^2+7)^2}$; concave up on $(-1, 7)$, concave down on $(-\infty, -1)$ and on $(7, +\infty)$.

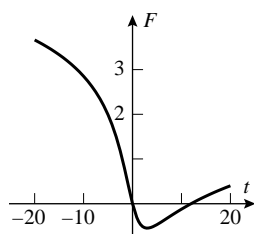

66.

67. (a) $(0, +\infty)$ because f is continuous there and 1 is in $(0, +\infty)$.

(b) At $x = 1$ because $F(1) = 0$.

68. (a) $(-3, 3)$ because f is continuous there and 1 is in $(-3, 3)$.

(b) At $x = 1$ because $F(1) = 0$.

69. (a) Amount of water = (rate of flow)(time) = $4t$ gal, total amount = $4(30) = 120$ gal.

(b) Amount of water = $\int_0^{60} (4 + t/10) dt = 420$ gal.

(c) Amount of water = $\int_0^{120} (10 + \sqrt{t}) dt = 1200 + 160\sqrt{30} \approx 2076.36$ gal.

70. (a) The maximum value of R occurs at 4:30 P.M. when $t = 0$.

(b) $\int_0^{60} 100(1 - 0.0001t^2)dt = 5280$ cars.

71. $\sum_{k=1}^n \frac{\pi}{4n} \sec^2\left(\frac{\pi k}{4n}\right) = \sum_{k=1}^n f(x_k^*)\Delta x$ where $f(x) = \sec^2 x$, $x_k^* = \frac{\pi k}{4n}$ and $\Delta x = \frac{\pi}{4n}$ for $0 \leq x \leq \frac{\pi}{4}$. Thus $\lim_{n \rightarrow +\infty} \sum_{k=1}^n \frac{\pi}{4n} \sec^2\left(\frac{\pi k}{4n}\right) = \lim_{n \rightarrow +\infty} \sum_{k=1}^n f(x_k^*)\Delta x = \int_0^{\pi/4} \sec^2 x dx = \tan x \Big|_0^{\pi/4} = 1$.

72. $\frac{n}{n^2 + k^2} = \frac{1}{1 + k^2/n^2} \frac{1}{n}$ so $\sum_{k=1}^n \frac{n}{n^2 + k^2} = \sum_{k=1}^n f(x_k^*)\Delta x$ where $f(x) = \frac{1}{1 + x^2}$, $x_k^* = \frac{k}{n}$, and $\Delta x = \frac{1}{n}$ for $0 \leq x \leq 1$. Thus $\lim_{n \rightarrow +\infty} \sum_{k=1}^n \frac{n}{n^2 + k^2} = \lim_{n \rightarrow +\infty} \sum_{k=1}^n f(x_k^*)\Delta x = \int_0^1 \frac{1}{1 + x^2} dx = \frac{\pi}{4}$.

73. Let f be continuous on a closed interval $[a, b]$ and let F be an antiderivative of f on $[a, b]$. By Theorem 5.7.2, $\frac{F(b) - F(a)}{b - a} = F'(x^*)$ for some x^* in (a, b) . By Theorem 5.6.1, $\int_a^b f(x) dx = F(b) - F(a)$, i.e. $\int_a^b f(x) dx = F'(x^*)(b - a) = f(x^*)(b - a)$.

Exercise Set 5.7

1. (a) $\text{displ} = s(3) - s(0) = \int_0^3 dt = 3$; $\text{dist} = \int_0^3 dt = 3$.

(b) $\text{displ} = s(3) - s(0) = -\int_0^3 dt = -3$; $\text{dist} = \int_0^3 |v(t)| dt = 3$.

(c) $\text{displ} = s(3) - s(0) = \int_0^3 v(t)dt = \int_0^2 (1 - t)dt + \int_2^3 (t - 3)dt = (t - t^2/2) \Big|_0^2 + (t^2/2 - 3t) \Big|_2^3 = -1/2$; $\text{dist} = \int_0^3 |v(t)|dt = (t - t^2/2) \Big|_0^1 + (t^2/2 - t) \Big|_1^2 - (t^2/2 - 3t) \Big|_2^3 = 3/2$.

(d) $\text{displ} = s(3) - s(0) = \int_0^3 v(t)dt = \int_0^1 tdt + \int_1^2 dt + \int_2^3 (5 - 2t)dt = t^2/2 \Big|_0^1 + t \Big|_1^2 + (5t - t^2) \Big|_2^3 = 3/2$; $\text{dist} = \int_0^1 tdt + \int_1^2 dt + \int_2^{5/2} (5 - 2t)dt + \int_{5/2}^3 (2t - 5)dt = t^2/2 \Big|_0^1 + t \Big|_1^2 + (5t - t^2) \Big|_2^{5/2} + (t^2 - 5t) \Big|_{5/2}^3 = 2$.

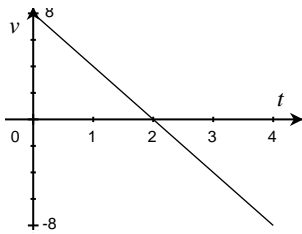

2.

3. (a) $v(t) = 20 + \int_0^t a(u)du$; add areas of the small blocks to get $v(4) \approx 20 + 1.4 + 3.0 + 4.7 + 6.2 = 35.3$ m/s.

(b) $v(6) = v(4) + \int_4^6 a(u)du \approx 35.3 + 7.5 + 8.6 = 51.4$ m/s.

4. (a) Negative, because v is decreasing.
- (b) Speeding up when $av > 0$, so $2 < t < 5$; slowing down when $1 < t < 2$.
- (c) At $t = 5$, the particle's location is to the left of its location at $t = 1$, because the area between the graph of $v(t)$ and the t -axis appears to be greater where $v < 0$ compared to where $v > 0$.
5. (a) $s(t) = t^3 - t^2 + C$; $1 = s(0) = C$, so $s(t) = t^3 - t^2 + 1$.
- (b) $v(t) = -\cos 3t + C_1$; $3 = v(0) = -1 + C_1$, $C_1 = 4$, so $v(t) = -\cos 3t + 4$. Then $s(t) = -\frac{1}{3}\sin 3t + 4t + C_2$; $3 = s(0) = C_2$, so $s(t) = -\frac{1}{3}\sin 3t + 4t + 3$.
6. (a) $s(t) = t - \cos t + C_1$; $-3 = s(0) = -1 + C_1$, $C_1 = -2$, so $s(t) = t - \cos t - 2$.
- (b) $v(t) = \frac{1}{3}t^3 - \frac{3}{2}t^2 + t + C_1$; $0 = v(0) = C_1$, so $C_1 = 0$, $v(t) = \frac{1}{3}t^3 - \frac{3}{2}t^2 + t$. Then $s(t) = \frac{1}{12}t^4 - \frac{1}{2}t^3 + \frac{1}{2}t^2 + C_2$; $0 = s(0) = C_2$, so $C_2 = 0$, $s(t) = \frac{1}{12}t^4 - \frac{1}{2}t^3 + \frac{1}{2}t^2$.
7. (a) $s(t) = \frac{3}{2}t^2 + t + C$; $4 = s(2) = 6 + 2 + C$, $C = -4$ and $s(t) = \frac{3}{2}t^2 + t - 4$.
- (b) $v(t) = -t^{-1} + C_1$, $0 = v(1) = -1 + C_1$, $C_1 = 1$ and $v(t) = -t^{-1} + 1$ so $s(t) = -\ln t + t + C_2$, $2 = s(1) = 1 + C_2$, $C_2 = 1$ and $s(t) = -\ln t + t + 1$.
8. (a) $s(t) = \int t^{2/3} dt = \frac{3}{5}t^{5/3} + C$, $s(8) = 0 = \frac{3}{5}32 + C$, $C = -\frac{96}{5}$, $s(t) = \frac{3}{5}t^{5/3} - \frac{96}{5}$.
- (b) $v(t) = \int \sqrt{t} dt = \frac{2}{3}t^{3/2} + C_1$, $v(4) = 1 = \frac{2}{3}8 + C_1$, $C_1 = -\frac{13}{3}$, $v(t) = \frac{2}{3}t^{3/2} - \frac{13}{3}$, $s(t) = \int \left(\frac{2}{3}t^{3/2} - \frac{13}{3}\right) dt = \frac{4}{15}t^{5/2} - \frac{13}{3}t + C_2$, $s(4) = -5 = \frac{4}{15}32 - \frac{13}{3}4 + C_2 = -\frac{44}{5} + C_2$, $C_2 = \frac{19}{5}$, $s(t) = \frac{4}{15}t^{5/2} - \frac{13}{3}t + \frac{19}{5}$.
9. (a) displacement = $s(\pi/2) - s(0) = \int_0^{\pi/2} \sin t dt = -\cos t \Big|_0^{\pi/2} = 1$ m; distance = $\int_0^{\pi/2} |\sin t| dt = 1$ m.
- (b) displacement = $s(2\pi) - s(\pi/2) = \int_{\pi/2}^{2\pi} \cos t dt = \sin t \Big|_{\pi/2}^{2\pi} = -1$ m; distance = $\int_{\pi/2}^{2\pi} |\cos t| dt = -\int_{\pi/2}^{3\pi/2} \cos t dt + \int_{3\pi/2}^{2\pi} \cos t dt = 3$ m.
10. (a) displacement = $\int_0^2 (3t-2) dt = 2$; distance = $\int_0^2 |3t-2| dt = -\int_0^{2/3} (3t-2) dt + \int_{2/3}^2 (3t-2) dt = \frac{2}{3} + \frac{8}{3} = \frac{10}{3}$ m.
- (b) displacement = $\int_0^2 |1-2t| dt = \frac{5}{2}$ m; distance = $\int_0^2 |1-2t| dt = \frac{5}{2}$ m.
11. (a) $v(t) = t^3 - 3t^2 + 2t = t(t-1)(t-2)$, displacement = $\int_0^3 (t^3 - 3t^2 + 2t) dt = 9/4$ m; distance = $\int_0^3 |v(t)| dt = \int_0^1 v(t) dt + \int_1^2 -v(t) dt + \int_2^3 v(t) dt = 11/4$ m.
- (b) displacement = $\int_0^3 (\sqrt{t} - 2) dt = 2\sqrt{3} - 6$ m; distance = $\int_0^3 |v(t)| dt = -\int_0^3 v(t) dt = 6 - 2\sqrt{3}$ m.

12. (a) displacement = $\int_0^4 (t - \sqrt{t}) dt = \frac{8}{3}$ m; distance = $\int_0^4 |t - \sqrt{t}| dt = 3$ m.

(b) displacement = $\int_0^3 \frac{1}{\sqrt{t+1}} dt = 2$ m; distance = $\int_0^3 \frac{1}{\sqrt{t+1}} dt = 2$ m.

13. $v = 3t - 1$, displacement = $\int_0^2 (3t - 1) dt = 4$ m; distance = $\int_0^2 |3t - 1| dt = \frac{13}{3}$ m.

14. $v(t) = \frac{1}{2}t^2 - 2t$, displacement = $\int_1^5 \left(\frac{1}{2}t^2 - 2t\right) dt = -10/3$ m; distance = $\int_1^5 \left|\frac{1}{2}t^2 - 2t\right| dt = \int_1^4 -\left(\frac{1}{2}t^2 - 2t\right) dt + \int_4^5 \left(\frac{1}{2}t^2 - 2t\right) dt = 17/3$ m.

15. $v = \int 1/\sqrt{3t+1} dt = \frac{2}{3}\sqrt{3t+1} + C$; $v(0) = 4/3$ so $C = 2/3$, $v = \frac{2}{3}\sqrt{3t+1} + 2/3$, displacement = $\int_1^5 \left(\frac{2}{3}\sqrt{3t+1} + \frac{2}{3}\right) dt = \frac{296}{27}$ m; distance = $\int_1^5 \left(\frac{2}{3}\sqrt{3t+1} + \frac{2}{3}\right) dt = \frac{296}{27}$ m.

16. $v(t) = -\cos t + 2$, displacement = $\int_{\pi/4}^{\pi/2} (-\cos t + 2) dt = (\pi + \sqrt{2} - 2)/2$ m; distance = $\int_{\pi/4}^{\pi/2} |-\cos t + 2| dt = \int_{\pi/4}^{\pi/2} (-\cos t + 2) dt = (\pi + \sqrt{2} - 2)/2$ m.

17. (a) $s = \int \sin \frac{1}{2}\pi t dt = -\frac{2}{\pi} \cos \frac{1}{2}\pi t + C$, $s = 0$ when $t = 0$ which gives $C = \frac{2}{\pi}$ so $s = -\frac{2}{\pi} \cos \frac{1}{2}\pi t + \frac{2}{\pi}$.
 $a = \frac{dv}{dt} = \frac{\pi}{2} \cos \frac{1}{2}\pi t$. When $t = 1$: $s = 2/\pi$, $v = 1$, $|v| = 1$, $a = 0$.

(b) $v = -3 \int t dt = -\frac{3}{2}t^2 + C_1$, $v = 0$ when $t = 0$ which gives $C_1 = 0$ so $v = -\frac{3}{2}t^2$.
 $s = -\frac{3}{2} \int t^2 dt = -\frac{1}{2}t^3 + C_2$, $s = 1$ when $t = 0$ which gives $C_2 = 1$ so $s = -\frac{1}{2}t^3 + 1$. When $t = 1$: $s = 1/2$, $v = -3/2$, $|v| = 3/2$, $a = -3$.

18. (a) $s = \int \cos \frac{\pi t}{3} dt = \frac{3}{\pi} \sin \frac{\pi t}{3} + C$, $s = 0$ when $t = \frac{3}{2}$ which gives $C = -\frac{3}{\pi}$ so $s = \frac{3}{\pi} \sin \frac{\pi t}{3} - \frac{3}{\pi}$.
 $a = \frac{dv}{dt} = -\frac{\pi}{3} \sin \frac{\pi t}{3}$; when $t = 1$: $s = \frac{3\sqrt{3}}{\pi} - \frac{3}{\pi}$, speed = $v = \frac{1}{2}$, $a = -\frac{\pi\sqrt{3}}{3}$.

(b) $v = \int 4e^{2t-2} dt = 2e^{2t-2} + C$, $v = \frac{2}{e^2} - 3$ when $t = 0$, hence $C = -3$ so $v = 2e^{2t-2} - 3$. Then $s(t) = \int v(t) dt = e^{2t-2} - 3t + C'$, $s = e^{-2}$ when $t = 0$, so $C' = 0$ and $s(t) = e^{2t-2} - 3t$. When $t = 1$, $s(1) = -2$, $v(1) = -1$, speed = 1, $a(1) = 4$.

19. By inspection the velocity is positive for $t > 0$, and during the first second the ant is at most $5/2$ cm from the starting position. For $T > 1$ the displacement of the ant during the time interval $[0, T]$ is given by $\int_0^T v(t) dt = 5/2 + \int_1^T (6\sqrt{t} - 1/t) dt = 5/2 + (4t^{3/2} - \ln t) \Big|_1^T = -3/2 + 4T^{3/2} - \ln T$, and the displacement equals 4 cm if $4T^{3/2} - \ln T = 11/2$, $T \approx 1.272$ s.

20. The displacement of the mouse during the time interval $[0, T]$ is given by $\int_0^T v(t)dt = 3 \tan^{-1} T - 0.25T^2$. The mouse is 2 m from its starting position when $3 \tan^{-1} T - 0.25T^2 = 2$ or when $3 \tan^{-1} T - 0.25T^2 = -2$; solve for T to get $T = 0.90, 2.51, \text{ and } 4.95$ s.

21. $s(t) = \int (20t^2 - 110t + 120) dt = \frac{20}{3}t^3 - 55t^2 + 120t + C$. But $s = 0$ when $t = 0$, so $C = 0$ and $s = \frac{20}{3}t^3 - 55t^2 + 120t$.
Moreover, $a(t) = \frac{d}{dt}v(t) = 40t - 110$.

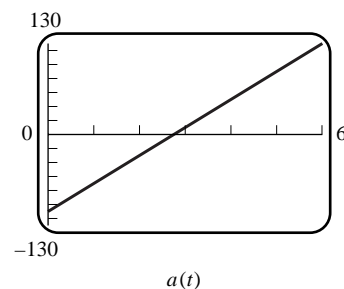
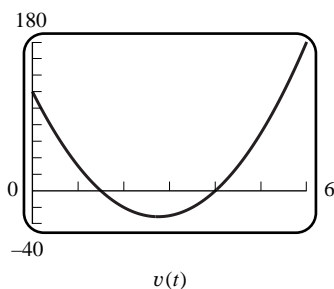
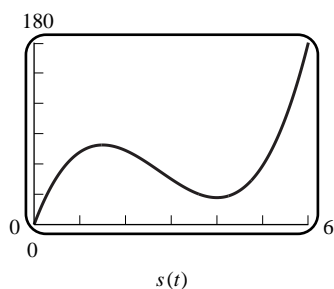

22. $a(t) = 4t - 30, v(t) = 2t^2 - 30t + 3, s(t) = \frac{2}{3}t^3 - 15t^2 + 3t - 5$.

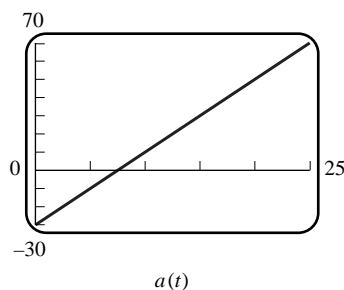
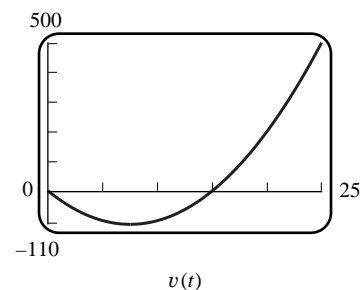
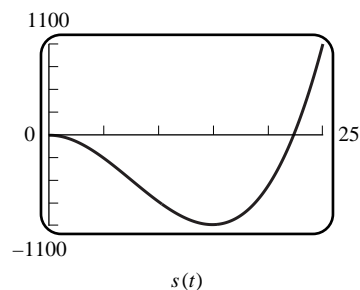

23. True; if $a(t) = a_0$ then $v(t) = a_0t + v_0$.

24. True.

25. False; consider $v(t) = t$ on $[-1, 1]$.

26. True.

27. (a) The displacement is positive on $(0, 5)$.

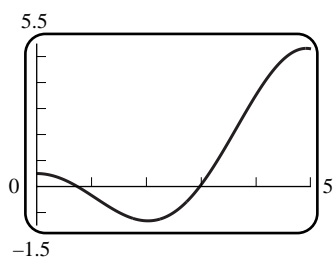

(b) The displacement is $\frac{5}{2} - \sin 5 + 5 \cos 5 \approx 4.877$.

28. (a) The displacement is positive on $(0, 1)$.

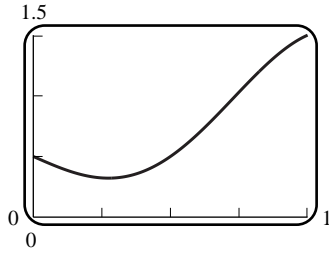

(b) The displacement is $\frac{2}{\pi^2} + \frac{1}{2}$.

29. (a) The displacement is positive on $(0, 5)$.

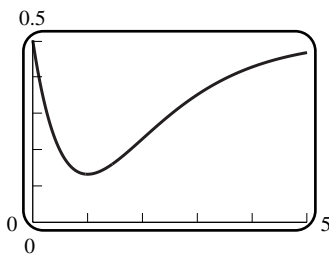

(b) The displacement is $\frac{3}{2} + 6e^{-5}$.

30. (a) The displacement is negative on $(0, 1)$.

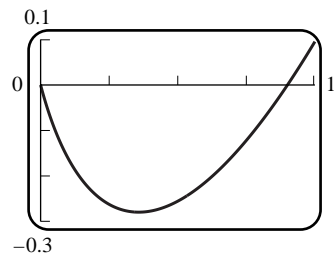

(b) The displacement is $\frac{99}{200} \ln 11 - \frac{1}{2} \ln 2 - \frac{1}{2} \ln 5 - \frac{1}{5} \approx -0.16433$.

31. (a) $a(t) = \begin{cases} 0, & t < 4 \\ -10, & t > 4 \end{cases}$

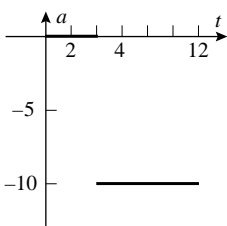

$$(b) v(t) = \begin{cases} 25, & t < 4 \\ 65 - 10t, & t > 4 \end{cases}$$

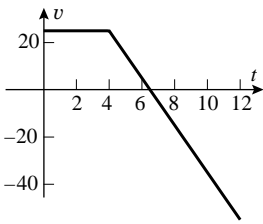

$$(c) x(t) = \begin{cases} 25t, & t < 4 \\ 65t - 5t^2 - 80, & t > 4 \end{cases}, \text{ so } x(8) = 120, x(12) = -20. \quad (d) x(6.5) = 131.25.$$

32. Take $t = 0$ when deceleration begins, then $a = -11$ so $v = -11t + C_1$, but $v = 88$ when $t = 0$ which gives $C_1 = 88$ thus $v = -11t + 88$, $t \geq 0$.

(a) $v = 45 \text{ mi/h} = 66 \text{ ft/s}$, $66 = -11t + 88$, $t = 2 \text{ s}$.

- (b) $v = 0$ (the car is stopped) when $t = 8 \text{ s}$; $s = \int v dt = \int (-11t + 88) dt = -\frac{11}{2}t^2 + 88t + C_2$, and taking $s = 0$ when $t = 0$, $C_2 = 0$ so $s = -\frac{11}{2}t^2 + 88t$. At $t = 8$, $s = 352$. The car travels 352 ft before coming to a stop.

33. $a = a_0 \text{ ft/s}^2$, $v = a_0t + v_0 = a_0t + 132 \text{ ft/s}$, $s = a_0t^2/2 + 132t + s_0 = a_0t^2/2 + 132t \text{ ft}$; $s = 200 \text{ ft}$ when $v = 88 \text{ ft/s}$. Solve $88 = a_0t + 132$ and $200 = a_0t^2/2 + 132t$ to get $a_0 = -\frac{121}{5}$ when $t = \frac{20}{11}$, so $s = -12.1t^2 + 132t$, $v = -\frac{121}{5}t + 132$.

(a) $a_0 = -\frac{121}{5} \text{ ft/s}^2$. (b) $v = 55 \text{ mi/h} = \frac{242}{3} \text{ ft/s}$ when $t = \frac{70}{33} \text{ s}$. (c) $v = 0$ when $t = \frac{60}{11} \text{ s}$.

34. $dv/dt = 5$, $v = 5t + C_1$, but $v = v_0$ when $t = 0$ so $C_1 = v_0$, $v = 5t + v_0$. From $ds/dt = v = 5t + v_0$ we get $s = 5t^2/2 + v_0t + C_2$ and, with $s = 0$ when $t = 0$, $C_2 = 0$ so $s = 5t^2/2 + v_0t$. $s = 60$ when $t = 4$ thus $60 = 5(4)^2/2 + v_0(4)$, $v_0 = 5 \text{ m/s}$.

35. Suppose $s = s_0 = 0$, $v = v_0 = 0$ at $t = t_0 = 0$; $s = s_1 = 120$, $v = v_1$ at $t = t_1$; and $s = s_2$, $v = v_2 = 12$ at $t = t_2$. From formulas (10) and (11), we get that in the case of constant acceleration, $a = \frac{v^2 - v_0^2}{2(s - s_0)}$. This implies that $2.6 = a = \frac{v_1^2 - v_0^2}{2(s_1 - s_0)}$, $v_1^2 = 2as_1 = 5.2(120) = 624$. Applying the formula again, $-1.5 = a = \frac{v_2^2 - v_1^2}{2(s_2 - s_1)}$, $v_2^2 = v_1^2 - 3(s_2 - s_1)$, so $s_2 = s_1 - (v_2^2 - v_1^2)/3 = 120 - (144 - 624)/3 = 280 \text{ m}$.

36. (a) $a(t) = \begin{cases} 4, & t < 2 \\ 0, & t > 2 \end{cases}$, so, with $v_0 = 0$, $v(t) = \begin{cases} 4t, & t < 2 \\ 8, & t > 2 \end{cases}$ and, since $s_0 = 0$, $s(t) = \begin{cases} 2t^2, & t < 2 \\ 8t - 8, & t > 2 \end{cases}$. This means that $s = 100$ when $8t - 8 = 100$, $t = 108/8 = 13.5 \text{ s}$.

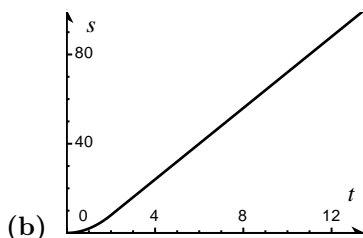

(b)

37. The truck's velocity is $v_T = 50$ and its position is $s_T = 50t + 2500$. The car's acceleration is $a_C = 4 \text{ ft/s}^2$, so $v_C = 4t$, $s_C = 2t^2$ (initial position and initial velocity of the car are both zero). $s_T = s_C$ when $50t + 2500 = 2t^2$, $2t^2 - 50t - 2500 = 2(t + 25)(t - 50) = 0$, $t = 50 \text{ s}$ and $s_C = s_T = 2t^2 = 5000 \text{ ft}$.
38. Let $t = 0$ correspond to the time when the leader is 100 m from the finish line; let $s = 0$ correspond to the finish line. Then $v_C = 12$, $s_C = 12t - 115$; $a_L = 0.5$ for $t > 0$, $v_L = 0.5t + 8$, $s_L = 0.25t^2 + 8t - 100$. $s_C = 0$ at $t = 115/12 \approx 9.58 \text{ s}$, and $s_L = 0$ at $t = -16 + 4\sqrt{41} \approx 9.61$, so the challenger wins.
39. $s = 0$ and $v = 112$ when $t = 0$ so $v(t) = -32t + 112$, $s(t) = -16t^2 + 112t$.
- (a) $v(3) = 16 \text{ ft/s}$, $v(5) = -48 \text{ ft/s}$.
- (b) $v = 0$ when the projectile is at its maximum height so $-32t + 112 = 0$, $t = 7/2 \text{ s}$, $s(7/2) = -16(7/2)^2 + 112(7/2) = 196 \text{ ft}$.
- (c) $s = 0$ when it reaches the ground so $-16t^2 + 112t = 0$, $-16t(t - 7) = 0$, $t = 0, 7$ of which $t = 7$ is when it is at ground level on its way down. $v(7) = -112$, $|v| = 112 \text{ ft/s}$.
40. $s = 112$ when $t = 0$ so $s(t) = -16t^2 + v_0t + 112$. But $s = 0$ when $t = 2$ thus $-16(2)^2 + v_0(2) + 112 = 0$, $v_0 = -24 \text{ ft/s}$.
41. (a) $s(t) = 0$ when it hits the ground, $s(t) = -16t^2 + 16t = -16t(t - 1) = 0$ when $t = 1 \text{ s}$.
- (b) The projectile moves upward until it gets to its highest point where $v(t) = 0$, $v(t) = -32t + 16 = 0$ when $t = 1/2 \text{ s}$.
42. (a) $s(t) = s_0 - \frac{1}{2}gt^2 = 800 - 16t^2 \text{ ft}$, $s(t) = 0$ when $t = \sqrt{\frac{800}{16}} = 5\sqrt{2}$.
- (b) $v(t) = -32t$ and $v(5\sqrt{2}) = -160\sqrt{2} \approx 226.27 \text{ ft/s} = 154.28 \text{ mi/h}$.
43. $s(t) = s_0 + v_0t - \frac{1}{2}gt^2 = 60t - 4.9t^2 \text{ m}$ and $v(t) = v_0 - gt = 60 - 9.8t \text{ m/s}$.
- (a) $v(t) = 0$ when $t = 60/9.8 \approx 6.12 \text{ s}$.
- (b) $s(60/9.8) \approx 183.67 \text{ m}$.
- (c) Another 6.12 s; solve for t in $s(t) = 0$ to get this result, or use the symmetry of the parabola $s = 60t - 4.9t^2$ about the line $t = 6.12$ in the t - s plane.
- (d) Also 60 m/s, as seen from the symmetry of the parabola (or compute $v(6.12)$).
44. (a) They are the same.
- (b) $s(t) = v_0t - \frac{1}{2}gt^2$ and $v(t) = v_0 - gt$; $s(t) = 0$ when $t = 0, 2v_0/g$; $v(0) = v_0$ and $v(2v_0/g) = v_0 - g(2v_0/g) = -v_0$ so the speed is the same at launch ($t = 0$) and at return ($t = 2v_0/g$).
45. $s(t) = -4.9t^2 + 49t + 150$ and $v(t) = -9.8t + 49$.
- (a) The model rocket reaches its maximum height when $v(t) = 0$, $-9.8t + 49 = 0$, $t = 5 \text{ s}$.
- (b) $s(5) = -4.9(5)^2 + 49(5) + 150 = 272.5 \text{ m}$.
- (c) The model rocket reaches its starting point when $s(t) = 150$, $-4.9t^2 + 49t + 150 = 150$, $-4.9t(t - 10) = 0$, $t = 10 \text{ s}$.
- (d) $v(10) = -9.8(10) + 49 = -49 \text{ m/s}$.

(e) $s(t) = 0$ when the model rocket hits the ground, $-4.9t^2 + 49t + 150 = 0$ when (use the quadratic formula) $t \approx 12.46$ s.

(f) $v(12.46) = -9.8(12.46) + 49 \approx -73.1$, the speed at impact is about 73.1 m/s.

Exercise Set 5.8

1. (a) $f_{\text{ave}} = \frac{1}{4-0} \int_0^4 2x \, dx = 4.$ (b) $2x^* = 4, x^* = 2.$

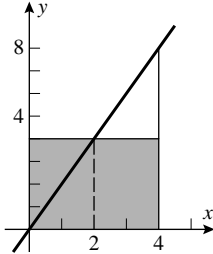

(c)

2. (a) $f_{\text{ave}} = \frac{1}{2-0} \int_0^2 x^2 \, dx = 4/3.$ (b) $(x^*)^2 = 4/3, x^* = \pm 2/\sqrt{3}$, but only $2/\sqrt{3}$ is in $[0, 2]$.

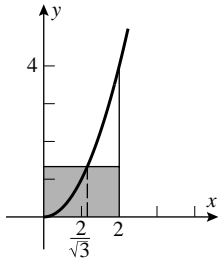

(c)

3. $f_{\text{ave}} = \frac{1}{3-1} \int_1^3 3x \, dx = \frac{3}{4} x^2 \Big|_1^3 = 6.$

4. $f_{\text{ave}} = \frac{1}{8-(-1)} \int_{-1}^8 x^{1/3} \, dx = \frac{1}{9} \frac{3}{4} x^{4/3} \Big|_{-1}^8 = \frac{5}{4}.$

5. $f_{\text{ave}} = \frac{1}{\pi} \int_0^\pi \sin x \, dx = -\frac{1}{\pi} \cos x \Big|_0^\pi = \frac{2}{\pi}.$

6. $f_{\text{ave}} = \frac{3}{\pi} \int_0^{\pi/3} \sec x \tan x \, dx = \frac{3}{\pi} \sec x \Big|_0^{\pi/3} = \frac{3}{\pi}.$

7. $f_{\text{ave}} = \frac{1}{e-1} \int_1^e \frac{1}{x} \, dx = \frac{1}{e-1} (\ln e - \ln 1) = \frac{1}{e-1}.$

8. $f_{\text{ave}} = \frac{1}{1+\ln 5} \int_{-1}^{\ln 5} e^x \, dx = \frac{1}{1+\ln 5} (5 - e^{-1}).$

9. $f_{\text{ave}} = \frac{1}{\sqrt{3}-1} \int_1^{\sqrt{3}} \frac{dx}{1+x^2} = \frac{1}{\sqrt{3}-1} \tan^{-1} x \Big|_1^{\sqrt{3}} = \frac{1}{\sqrt{3}-1} \left(\frac{\pi}{3} - \frac{\pi}{4} \right) = \frac{1}{\sqrt{3}-1} \frac{\pi}{12}.$

$$10. f_{\text{ave}} = 2 \int_{-1/2}^0 \frac{dx}{\sqrt{1-x^2}} = 2 \sin^{-1} x \Big|_{-1/2}^0 = \frac{\pi}{3}.$$

$$11. f_{\text{ave}} = \frac{1}{4} \int_0^4 e^{-2x} dx = -\frac{1}{8} e^{-2x} \Big|_0^4 = \frac{1}{8}(1 - e^{-8}).$$

$$12. f_{\text{ave}} = \frac{1}{\frac{\pi}{4} - (-\frac{\pi}{4})} \int_{-\pi/4}^{\pi/4} \sec^2 x dx = \frac{2}{\pi} \tan x \Big|_{-\pi/4}^{\pi/4} = \frac{4}{\pi}.$$

$$13. (a) \frac{1}{5}[f(0.4) + f(0.8) + f(1.2) + f(1.6) + f(2.0)] = \frac{1}{5}[0.48 + 1.92 + 4.32 + 7.68 + 12.00] = 5.28.$$

$$(b) \frac{1}{20} 3[(0.1)^2 + (0.2)^2 + \dots + (1.9)^2 + (2.0)^2] = \frac{861}{200} = 4.305.$$

$$(c) f_{\text{ave}} = \frac{1}{2} \int_0^2 3x^2 dx = \frac{1}{2} x^3 \Big|_0^2 = 4.$$

(d) Parts (a) and (b) can be interpreted as being two Riemann sums ($n = 5$, $n = 20$) for the average, using right endpoints. Since f is increasing, these sums overestimate the integral.

$$14. (a) \frac{4147}{2520} \approx 1.645634921.$$

$$(b) \frac{388477567}{232792560} \approx 1.668771403.$$

$$(c) f_{\text{ave}} = \int_1^2 \left(1 + \frac{1}{x}\right) dx = (x + \ln x) \Big|_1^2 = 1 + \ln 2 \approx 1.693147181.$$

(d) Parts (a) and (b) can be interpreted as being two Riemann sums ($n = 5$, $n = 10$) for the average, using right endpoints. Since f is decreasing, these sums underestimate the integral.

$$15. (a) \int_0^3 v(t) dt = \int_0^2 (1-t) dt + \int_2^3 (t-3) dt = -\frac{1}{2}, \text{ so } v_{\text{ave}} = -\frac{1}{6}.$$

$$(b) \int_0^3 v(t) dt = \int_0^1 t dt + \int_1^2 dt + \int_2^3 (-2t+5) dt = \frac{1}{2} + 1 + 0 = \frac{3}{2}, \text{ so } v_{\text{ave}} = \frac{1}{2}.$$

$$16. \text{ Find } v = f(t) \text{ such that } \int_0^5 f(t) dt = 10, f(t) \geq 0, f'(5) = f'(0) = 0. \text{ Let } f(t) = ct(5-t); \text{ then } \int_0^5 ct(5-t) dt = \frac{5}{2}ct^2 - \frac{1}{3}ct^3 \Big|_0^5 = c \left(\frac{125}{2} - \frac{125}{3} \right) = \frac{125c}{6} = 10, c = \frac{12}{25}, \text{ so } v = f(t) = \frac{12}{25}t(5-t) \text{ satisfies all the conditions.}$$

$$17. \text{ Linear means } f(\alpha x_1 + \beta x_2) = \alpha f(x_1) + \beta f(x_2), \text{ so } f\left(\frac{a+b}{2}\right) = \frac{1}{2}f(a) + \frac{1}{2}f(b) = \frac{f(a) + f(b)}{2}.$$

18. Suppose $a(t)$ represents acceleration, and that $a(t) = a_0$ for $a \leq t \leq b$. Then the velocity is given by $v(t) = a_0 t + v_0$, and the average velocity $= \frac{1}{b-a} \int_a^b (a_0 t + v_0) dt = \frac{a_0}{2}(b+a) + v_0$, and the velocity at the midpoint is $v\left(\frac{a+b}{2}\right) = a_0 \frac{a+b}{2} + v_0$ which proves the result.

$$19. \text{ False; } f(x) = x, g(x) = -1/2 \text{ on } [-1, 1].$$

20. True; Theorem 5.5.4(a).

21. True; Theorem 5.5.4(b).

22. False; $f(x) = g(x) = x$ on $[0, 1]$, $f_{\text{ave}} = g_{\text{ave}} = 1/2$, $(fg)_{\text{ave}} = 1/3$.

$$23. \text{ (a) } v_{\text{ave}} = \frac{1}{4-1} \int_1^4 (3t^3 + 2) dt = \frac{1}{3} \frac{789}{4} = \frac{263}{4}.$$

$$\text{ (b) } v_{\text{ave}} = \frac{s(4) - s(1)}{4-1} = \frac{100-7}{3} = 31.$$

$$24. \text{ (a) } a_{\text{ave}} = \frac{1}{5-0} \int_0^5 (t+1) dt = 7/2.$$

$$\text{ (b) } a_{\text{ave}} = \frac{v(\pi/4) - v(0)}{\pi/4 - 0} = \frac{\sqrt{2}/2 - 1}{\pi/4} = (2\sqrt{2} - 4)/\pi.$$

25. Time to fill tank = (volume of tank)/(rate of filling) = $[\pi(3)^2 5]/(1) = 45\pi$, weight of water in tank at time $t = (62.4) (\text{rate of filling})(\text{time}) = 62.4t$, $\text{weight}_{\text{ave}} = \frac{1}{45\pi} \int_0^{45\pi} 62.4t dt = 1404\pi = 4410.8 \text{ lb}$.

26. (a) If x is the distance from the cooler end, then the temperature is $T(x) = (15 + 1.5x)^\circ \text{C}$, and $T_{\text{ave}} = \frac{1}{10-0} \int_0^{10} (15 + 1.5x) dx = 22.5^\circ \text{C}$.

(b) By the Mean Value Theorem for integrals there exists x^* in $[0, 10]$ such that

$$f(x^*) = \frac{1}{10-0} \int_0^{10} (15 + 1.5x) dx = 22.5, \quad 15 + 1.5x^* = 22.5, \quad x^* = 5.$$

$$27. \int_0^{30} 100(1 - 0.0001t^2) dt = 2910 \text{ cars, so an average of } \frac{2910}{30} = 97 \text{ cars/min.}$$

$$28. V_{\text{ave}} = \frac{275000}{10-0} \int_0^{10} e^{-0.17t} dt = -161764.7059e^{-0.17t} \Big|_0^{10} = \$132,212.96.$$

$$29. \text{ From the chart we read } \frac{dV}{dt} = f(t) = \begin{cases} 40t, & 0 \leq t \leq 1 \\ 40, & 1 \leq t \leq 3 \\ -20t + 100, & 3 \leq t \leq 5 \end{cases}.$$

It follows that (constants of integration are chosen to ensure that $V(0) = 0$ and that $V(t)$ is continuous)

$$V(t) = \begin{cases} 20t^2, & 0 \leq t \leq 1 \\ 40t - 20, & 1 \leq t \leq 3 \\ -10t^2 + 100t - 110, & 3 \leq t \leq 5 \end{cases}.$$

Now the average rate of change of the volume of juice in the glass during these 5 seconds refers to the quantity $\frac{1}{5}(V(5) - V(0)) = \frac{1}{5}140 = 28$, and the average value of the flow rate is

$$f_{\text{ave}} = \frac{1}{5} \int_0^5 f(t) dt = \frac{1}{5} \left[\int_0^1 40t dt + \int_1^3 40 dt + \int_3^5 (-20t + 100) dt \right] = \frac{1}{5} [20 + 80 - 160 + 200] = 28.$$

$$30. \text{ (a) } J_0(1) = \frac{1}{\pi} \int_0^\pi \cos(\sin t) dt, \text{ so } f(x) = \cos(\sin x), \text{ interval: } [0, \pi]. \quad \text{(b) } 0.7651976866$$

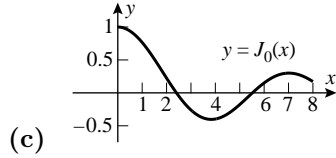

(d) $J_0(x) = 0$ if $x = 2.404826$.

31. Solve for k : $\int_0^k \sqrt{3x} \, dx = 6k$, so $\left. \sqrt{3} \frac{2}{3} x^{3/2} \right|_0^k = \frac{2}{3} \sqrt{3} k^{3/2} = 6k$, $k = (3\sqrt{3})^2 = 27$.

32. $w'(t) = kt$, $w(t) = kt^2/2 + w_0$; $w_{\text{ave}} = \frac{1}{26} \int_{26}^{52} (kt^2/2 + w_0) \, dt = \left. \frac{1}{26} \frac{k}{6} t^3 \right|_{26}^{52} + w_0 = \frac{2366}{3} k + w_0$. Solve $2366k/3 + w_0 = kt^2/2 + w_0$ for t , $t = \sqrt{2 \cdot 2366/3}$, so $t \approx 39.716$.

Exercise Set 5.9

1. (a) $\frac{1}{2} \int_1^5 u^3 \, du$ (b) $\frac{3}{2} \int_9^{25} \sqrt{u} \, du$ (c) $\frac{1}{\pi} \int_{-\pi/2}^{\pi/2} \cos u \, du$ (d) $\int_1^2 (u+1)u^5 \, du$

2. (a) $\frac{1}{2} \int_{-3}^7 u^8 \, du$ (b) $\int_{3/2}^{5/2} \frac{1}{\sqrt{u}} \, du$ (c) $\int_0^1 u^2 \, du$ (d) $\frac{1}{2} \int_3^4 (u-3)u^{1/2} \, du$

3. (a) $\frac{1}{2} \int_{-1}^1 e^u \, du$ (b) $\int_1^2 u \, du$

4. (a) $\int_{\pi/4}^{\pi/3} \sqrt{u} \, du$ (b) $\int_0^{1/2} \frac{du}{\sqrt{1-u^2}}$

5. $u = 2x + 1$, $\frac{1}{2} \int_1^3 u^3 \, du = \frac{1}{8} u^4 \Big|_1^3 = 10$, or $\frac{1}{8} (2x + 1)^4 \Big|_0^1 = 10$.

6. $u = 4x - 2$, $\frac{1}{4} \int_2^6 u^3 \, du = \frac{1}{16} u^4 \Big|_2^6 = 80$, or $\frac{1}{16} (4x - 2)^4 \Big|_1^2 = 80$.

7. $u = 2x - 1$, $\frac{1}{2} \int_{-1}^1 u^3 \, du = 0$, because u^3 is odd on $[-1, 1]$.

8. $u = 4 - 3x$, $-\frac{1}{3} \int_1^{-2} u^8 \, du = -\frac{1}{27} u^9 \Big|_1^{-2} = 19$, or $-\frac{1}{27} (4 - 3x)^9 \Big|_1^2 = 19$.

9. $u = 1 + x$, $\int_1^9 (u-1)u^{1/2} \, du = \int_1^9 (u^{3/2} - u^{1/2}) \, du = \frac{2}{5} u^{5/2} - \frac{2}{3} u^{3/2} \Big|_1^9 = 1192/15$, or $\frac{2}{5} (1+x)^{5/2} - \frac{2}{3} (1+x)^{3/2} \Big|_0^8 = 1192/15$.

10. $u = 1 - x$, $\int_1^4 (1-u)\sqrt{u} \, du = \left[\frac{2}{3} u^{3/2} - \frac{2}{5} u^{5/2} \right]_1^4 = -116/15$, or $\left[\frac{2}{3} (1-x)^{3/2} - \frac{2}{5} (1-x)^{5/2} \right]_{-3}^0 = -116/15$.

11. $u = x/2$, $8 \int_0^{\pi/4} \sin u \, du = -8 \cos u \Big|_0^{\pi/4} = 8 - 4\sqrt{2}$, or $-8 \cos(x/2) \Big|_0^{\pi/2} = 8 - 4\sqrt{2}$.

12. $u = 3x$, $\frac{2}{3} \int_0^{\pi/2} \cos u \, du = \frac{2}{3} \sin u \Big|_0^{\pi/2} = 2/3$, or $\frac{2}{3} \sin 3x \Big|_0^{\pi/6} = 2/3$.

$$13. u = x^2 + 2, \frac{1}{2} \int_6^3 u^{-3} du = -\frac{1}{4u^2} \Big|_6^3 = -1/48, \text{ or } -\frac{1}{4} \frac{1}{(x^2 + 2)^2} \Big|_{-2}^{-1} = -1/48.$$

$$14. u = \frac{1}{4}x - \frac{1}{4}, 4 \int_{-\pi/4}^{\pi/4} \sec^2 u du = 4 \tan u \Big|_{-\pi/4}^{\pi/4} = 8, \text{ or } 4 \tan \left(\frac{1}{4}x - \frac{1}{4} \right) \Big|_{1-\pi}^{1+\pi} = 8.$$

$$15. u = e^x + 4, du = e^x dx, u = e^{-\ln 3} + 4 = \frac{1}{3} + 4 = \frac{13}{3} \text{ when } x = -\ln 3, u = e^{\ln 3} + 4 = 3 + 4 = 7 \text{ when } x = \ln 3; \\ \int_{13/3}^7 \frac{1}{u} du = \ln u \Big|_{13/3}^7 = \ln(7) - \ln(13/3) = \ln(21/13), \text{ or } \ln(e^x + 4) \Big|_{-\ln 3}^{\ln 3} = \ln 7 - \ln(13/3) = \ln(21/13).$$

$$16. u = 3 - 4e^x, du = -4e^x dx, u = -1 \text{ when } x = 0, u = -17 \text{ when } x = \ln 5; -\frac{1}{4} \int_{-1}^{-17} u du = -\frac{1}{8} u^2 \Big|_{-1}^{-17} = -36, \text{ or } \\ -\frac{1}{8} (3 - 4e^x)^2 \Big|_0^{\ln 5} = -36.$$

$$17. u = \sqrt{x}, 2 \int_1^{\sqrt{3}} \frac{1}{u^2 + 1} du = 2 \tan^{-1} u \Big|_1^{\sqrt{3}} = 2(\tan^{-1} \sqrt{3} - \tan^{-1} 1) = 2(\pi/3 - \pi/4) = \pi/6, \text{ or } 2 \tan^{-1} \sqrt{x} \Big|_1^3 = \pi/6.$$

$$18. u = e^{-x}, -\int_{1/2}^{\sqrt{3}/2} \frac{1}{\sqrt{1-u^2}} du = -\sin^{-1} u \Big|_{1/2}^{\sqrt{3}/2} = -\sin^{-1} \frac{\sqrt{3}}{2} + \sin^{-1} \frac{1}{2} = -\frac{\pi}{3} + \frac{\pi}{6} = -\frac{\pi}{6}, \text{ or } -\sin^{-1} e^{-x} \Big|_{\ln 2}^{\ln(2/\sqrt{3})} = \\ -\frac{\pi}{3} + \frac{\pi}{6} = -\pi/6.$$

$$19. \frac{1}{3} \int_{-5}^5 \sqrt{25 - u^2} du = \frac{1}{3} \left[\frac{1}{2} \pi (5)^2 \right] = \frac{25}{6} \pi.$$

$$20. \frac{1}{2} \int_0^4 \sqrt{16 - u^2} du = \frac{1}{2} \left[\frac{1}{4} \pi (4)^2 \right] = 2\pi.$$

$$21. -\frac{1}{2} \int_1^0 \sqrt{1 - u^2} du = \frac{1}{2} \int_0^1 \sqrt{1 - u^2} du = \frac{1}{2} \cdot \frac{1}{4} [\pi(1)^2] = \pi/8.$$

$$22. \int_{-3}^3 \sqrt{9 - u^2} du = \pi(3)^2/2 = \frac{9}{2} \pi.$$

$$23. \int_0^1 \sin \pi x dx = -\frac{1}{\pi} \cos \pi x \Big|_0^1 = -\frac{1}{\pi} (-1 - 1) = 2/\pi \text{ m.}$$

$$24. \int_0^{\pi/8} 3 \cos 2x dx = \frac{3}{2} \sin 2x \Big|_0^{\pi/8} = 3\sqrt{2}/4 \text{ m.}$$

$$25. A = \int_{-1}^1 \frac{9}{(x+2)^2} dx = -9(x+2)^{-1} \Big|_{-1}^1 = -9 \left[\frac{1}{3} - 1 \right] = 6.$$

$$26. A = \int_0^1 \frac{dx}{(3x+1)^2} = -\frac{1}{3(3x+1)} \Big|_0^1 = \frac{1}{4}.$$

$$27. A = \int_0^{1/6} \frac{1}{\sqrt{1-9x^2}} dx = \frac{1}{3} \int_0^{1/2} \frac{1}{\sqrt{1-u^2}} du = \frac{1}{3} \sin^{-1} u \Big|_0^{1/2} = \pi/18.$$

$$28. x = \sin y, A = \int_0^{\pi/2} \sin y \, dy = -\cos y \Big|_0^{\pi/2} = 1.$$

$$29. f_{\text{ave}} = \frac{1}{2-0} \int_0^2 \frac{x}{(5x^2+1)^2} dx = -\frac{1}{2} \frac{1}{10} \frac{1}{5x^2+1} \Big|_0^2 = \frac{1}{21}.$$

$$30. f_{\text{ave}} = \frac{1}{0 - (-\ln 3/6)} \int_{-\ln 3/6}^0 \frac{e^{3x}}{1+e^{6x}} dx = \frac{6}{\ln 3} \frac{1}{3} \tan^{-1} e^{3x} \Big|_{-\ln 3/6}^0 = \frac{\pi}{6 \ln 3}.$$

$$31. u = 2x - 1, \frac{1}{2} \int_1^9 \frac{1}{\sqrt{u}} du = \sqrt{u} \Big|_1^9 = 2.$$

$$32. \frac{2}{15} (5x-1)^{3/2} \Big|_1^2 = 38/15.$$

$$33. \frac{2}{3} (x^3+9)^{1/2} \Big|_{-1}^1 = \frac{2}{3} (\sqrt{10} - 2\sqrt{2}).$$

$$34. u = \cos x + 1, 6 \int_0^1 u^5 du = 1.$$

$$35. u = x^2 + 4x + 7, \frac{1}{2} \int_{12}^{28} u^{-1/2} du = u^{1/2} \Big|_{12}^{28} = \sqrt{28} - \sqrt{12} = 2(\sqrt{7} - \sqrt{3}).$$

$$36. \int_1^2 \frac{1}{(x-3)^2} dx = -\frac{1}{x-3} \Big|_1^2 = 1/2.$$

$$37. 2 \sin^2 x \Big|_0^{\pi/4} = 1.$$

$$38. \frac{2}{3} (\tan x)^{3/2} \Big|_0^{\pi/4} = 2/3.$$

$$39. \frac{5}{2} \sin(x^2) \Big|_0^{\sqrt{\pi}} = 0.$$

$$40. u = \sqrt{x}, 2 \int_{\pi}^{2\pi} \sin u \, du = -2 \cos u \Big|_{\pi}^{2\pi} = -4.$$

$$41. u = 3\theta, \frac{1}{3} \int_{\pi/4}^{\pi/3} \sec^2 u \, du = \frac{1}{3} \tan u \Big|_{\pi/4}^{\pi/3} = (\sqrt{3} - 1)/3.$$

$$42. u = \cos 2\theta, -\frac{1}{2} \int_1^{1/2} \frac{1}{u} du = \frac{1}{2} \ln u \Big|_{1/2}^1 = \ln \sqrt{2}.$$

$$43. u = 4 - 3y, y = \frac{1}{3}(4 - u), dy = -\frac{1}{3} du, -\frac{1}{27} \int_4^1 \frac{16 - 8u + u^2}{u^{1/2}} du = \frac{1}{27} \int_1^4 (16u^{-1/2} - 8u^{1/2} + u^{3/2}) du = \frac{1}{27} \left[32u^{1/2} - \frac{16}{3}u^{3/2} + \frac{2}{5}u^{5/2} \right]_1^4 = 106/405.$$

$$44. u = 5 + x, \int_4^9 \frac{u-5}{\sqrt{u}} du = \int_4^9 (u^{1/2} - 5u^{-1/2}) du = \left[\frac{2}{3} u^{3/2} - 10u^{1/2} \right]_4^9 = 8/3.$$

$$45. \left. \frac{1}{2} \ln(2x + e) \right|_0^e = \frac{1}{2} (\ln(3e) - \ln e) = \frac{\ln 3}{2}.$$

$$46. \left. -\frac{1}{2} e^{-x^2} \right|_1^{\sqrt{2}} = (e^{-1} - e^{-2})/2.$$

$$47. u = \sqrt{3}x^2, \frac{1}{2\sqrt{3}} \int_0^{\sqrt{3}} \frac{1}{\sqrt{4-u^2}} du = \frac{1}{2\sqrt{3}} \sin^{-1} \frac{u}{2} \Big|_0^{\sqrt{3}} = \frac{1}{2\sqrt{3}} \left(\frac{\pi}{3} \right) = \frac{\pi}{6\sqrt{3}}.$$

$$48. u = \sqrt{x}, 2 \int_1^{\sqrt{2}} \frac{1}{\sqrt{4-u^2}} du = 2 \sin^{-1} \frac{u}{2} \Big|_1^{\sqrt{2}} = 2(\pi/4 - \pi/6) = \pi/6.$$

$$49. u = 3x, \frac{1}{3} \int_0^{\sqrt{3}} \frac{1}{1+u^2} du = \frac{1}{3} \tan^{-1} u \Big|_0^{\sqrt{3}} = \frac{1}{3} \frac{\pi}{3} = \frac{\pi}{9}.$$

$$50. u = x^2, \frac{1}{2} \int_1^2 \frac{1}{3+u^2} du = \frac{1}{2\sqrt{3}} \tan^{-1} \frac{u}{\sqrt{3}} \Big|_1^2 = \frac{1}{2\sqrt{3}} (\tan^{-1} \frac{2}{\sqrt{3}} - \pi/6).$$

$$51. (b) \int_0^{\pi/6} \sin^4 x (1 - \sin^2 x) \cos x dx = \left(\frac{1}{5} \sin^5 x - \frac{1}{7} \sin^7 x \right) \Big|_0^{\pi/6} = \frac{1}{160} - \frac{1}{896} = \frac{23}{4480}.$$

$$52. (b) \int_{-\pi/4}^{\pi/4} \tan^2 x (\sec^2 x - 1) dx = \frac{1}{3} \tan^3 x \Big|_{-\pi/4}^{\pi/4} - \int_{-\pi/4}^{\pi/4} (\sec^2 x - 1) dx = \frac{2}{3} + (-\tan x + x) \Big|_{-\pi/4}^{\pi/4} = \frac{2}{3} - 2 + \frac{\pi}{2} = -\frac{4}{3} + \frac{\pi}{2}.$$

$$53. (a) u = 3x + 1, \frac{1}{3} \int_1^4 f(u) du = 5/3.$$

$$(b) u = 3x, \frac{1}{3} \int_0^9 f(u) du = 5/3.$$

$$(c) u = x^2, 1/2 \int_4^0 f(u) du = -1/2 \int_0^4 f(u) du = -1/2.$$

$$54. u = 1 - x, \int_0^1 x^m (1 - x)^n dx = - \int_1^0 (1 - u)^m u^n du = \int_0^1 u^n (1 - u)^m du = \int_0^1 x^n (1 - x)^m dx.$$

$$55. \sin x = \cos(\pi/2 - x), \int_0^{\pi/2} \sin^n x dx = \int_0^{\pi/2} \cos^n(\pi/2 - x) dx = - \int_{\pi/2}^0 \cos^n u du \text{ (with } u = \pi/2 - x) = \int_0^{\pi/2} \cos^n u du = \int_0^{\pi/2} \cos^n x dx, \text{ by replacing } u \text{ by } x.$$

$$56. u = 1 - x, - \int_1^0 (1 - u)u^n du = \int_0^1 (1 - u)u^n du = \int_0^1 (u^n - u^{n+1}) du = \frac{1}{n+1} - \frac{1}{n+2} = \frac{1}{(n+1)(n+2)}.$$

57. Method 1: $\int_0^4 5(e^{-0.2t} - e^{-t}) dt = 5 \left[\frac{1}{-0.2} e^{-0.2t} + 5e^{-t} \right]_0^4 \approx 8.85835$,
 Method 2: $\int_0^4 4(e^{-0.2t} - e^{-3t}) dt = 4 \left[\frac{1}{-0.2} e^{-0.2t} + \frac{4}{3} e^{-3t} \right]_0^4 \approx 9.6801$, so Method 2 provides the greater availability.
58. Method 1: $\int_0^{24} 5(e^{-0.2t} - e^{-t}) dt = 5 \left[\frac{1}{-0.2} e^{-0.2t} + 5e^{-t} \right]_0^{24} \approx 19.7943$,
 Method 2: $\int_0^{24} 4(e^{-0.2t} - e^{-3t}) dt = 4 \left[\frac{1}{-0.2} e^{-0.2t} + \frac{4}{3} e^{-3t} \right]_0^{24} \approx 18.5021$, so Method 1 provides the greater availability.
59. Method 1: $\int_0^4 5.78(e^{-0.4t} - e^{-1.3t}) dt = 5.78 \left[\frac{1}{-0.4} e^{-0.4t} + 5.78 \frac{1}{1.3} e^{-1.3t} \right]_0^4 \approx 7.11097$,
 Method 2: $\int_0^4 4.15(e^{-0.4t} - e^{-3t}) dt = 4.15 \left[\frac{1}{-0.4} e^{-0.4t} + \frac{4.15}{3} e^{-3t} \right]_0^4 \approx 6.897$, so Method 1 provides the greater availability.
60. Method 1: $\int_0^{24} 5.78(e^{-0.4t} - e^{-1.3t}) dt = 5.78 \left[\frac{1}{-0.4} e^{-0.4t} + 5.78 \frac{1}{1.3} e^{-1.3t} \right]_0^{24} \approx 10.0029$,
 Method 2: $\int_0^{24} 4.15(e^{-0.4t} - e^{-3t}) dt = 4.15 \left[\frac{1}{-0.4} e^{-0.4t} + \frac{4.15}{3} e^{-3t} \right]_0^{24} \approx 8.99096$, so Method 1 provides the greater availability.
61. $y(t) = (802.137) \int e^{1.528t} dt = 524.959e^{1.528t} + C$; $y(0) = 750 = 524.959 + C$, $C = 225.041$, $y(t) = 524.959e^{1.528t} + 225.041$, $y(12) \approx 48,233,500,000$.
62. $s(t) = \int (25 + 10e^{-0.05t}) dt = 25t - 200e^{-0.05t} + C$.
 (a) $s(10) - s(0) = 250 - 200(e^{-0.5} - 1) = 450 - 200/\sqrt{e} \approx 328.69$ ft.
 (b) Yes; without it the distance would have been 250 ft.
63. (a) $\frac{1}{7}[0.74 + 0.65 + 0.56 + 0.45 + 0.35 + 0.25 + 0.16] = 0.4514285714$.
 (b) $\frac{1}{7} \int_0^7 [0.5 + 0.5 \sin(0.213x + 2.481)] dx = 0.4614$.
64. (a) $V_{\text{rms}}^2 = \frac{1}{1/f - 0} \int_0^{1/f} V_p^2 \sin^2(2\pi ft) dt = \frac{1}{2} f V_p^2 \int_0^{1/f} [1 - \cos(4\pi ft)] dt = \frac{1}{2} f V_p^2 \left[t - \frac{1}{4\pi f} \sin(4\pi ft) \right]_0^{1/f} = \frac{1}{2} V_p^2$, so $V_{\text{rms}} = V_p/\sqrt{2}$.
 (b) $V_p/\sqrt{2} = 120$, $V_p = 120\sqrt{2} \approx 169.7$ V.
65. $\int_0^k e^{2x} dx = 3$, $\left[\frac{1}{2} e^{2x} \right]_0^k = 3$, $\frac{1}{2}(e^{2k} - 1) = 3$, $e^{2k} = 7$, $k = \frac{1}{2} \ln 7$.
66. The area is given by $\int_0^2 1/(1+kx^2) dx = (1/\sqrt{k}) \tan^{-1}(2\sqrt{k}) = 0.6$; solve for k to get $k = 5.081435$.

67. (a) $\int_0^1 \sin \pi x dx = 2/\pi.$

68. (a) Using part (b) of Theorem 5.5.6 with $g(x) = \frac{1}{2}$ it follows that $I \geq \int_{-1}^1 \frac{1}{2} dx = 1.$

(b) $x = \frac{1}{u}, dx = -\frac{1}{u^2} du, I = \int_{-1}^1 \frac{1}{1+1/u^2} (-1/u^2) du = -\int_{-1}^1 \frac{1}{u^2+1} du = -I$ so $I = 0$ which is impossible because $\frac{1}{1+x^2}$ is positive on $[-1, 1]$. The substitution $u = 1/x$ is not valid because u is not continuous for all x in $[-1, 1]$.

69. (a) Let $u = -x$, then $\int_{-a}^a f(x) dx = -\int_a^{-a} f(-u) du = \int_{-a}^a f(-u) du = -\int_{-a}^a f(u) du$, so, replacing u by x in the latter integral, $\int_{-a}^a f(x) dx = -\int_{-a}^a f(x) dx, 2 \int_{-a}^a f(x) dx = 0, \int_{-a}^a f(x) dx = 0.$ The graph of f is symmetric about the origin, so $\int_{-a}^0 f(x) dx$ is the negative of $\int_0^a f(x) dx$ thus $\int_{-a}^a f(x) dx = \int_{-a}^0 f(x) dx + \int_0^a f(x) dx = 0.$

(b) $\int_{-a}^a f(x) dx = \int_{-a}^0 f(x) dx + \int_0^a f(x) dx$, let $u = -x$ in $\int_{-a}^0 f(x) dx$ to get $\int_{-a}^0 f(x) dx = -\int_a^0 f(-u) du = \int_0^a f(-u) du = \int_0^a f(u) du = \int_0^a f(x) dx$, so $\int_{-a}^a f(x) dx = \int_0^a f(x) dx + \int_0^a f(x) dx = 2 \int_0^a f(x) dx.$ The graph of $f(x)$ is symmetric about the y -axis so there is as much signed area to the left of the y -axis as there is to the right.

70. Let $u = t - x$, then $du = -dx$ and $\int_0^t f(t-x)g(x) dx = -\int_t^0 f(u)g(t-u) du = \int_0^t f(u)g(t-u) du$; the result follows by replacing u by x in the last integral.

71. (a) $I = -\int_a^0 \frac{f(a-u)}{f(a-u)+f(u)} du = \int_0^a \frac{f(a-u)+f(u)-f(u)}{f(a-u)+f(u)} du = \int_0^a du - \int_0^a \frac{f(u)}{f(a-u)+f(u)} du, I = a - I,$
so $2I = a, I = a/2.$

(b) $3/2$ (c) $\pi/4$

72. (a) By Exercise 69(a), $\int_{-1}^1 x \sqrt{\cos(x^2)} dx = 0.$

(b) $u = x - \pi/2, du = dx, \sin(u + \pi/2) = \cos u, \cos(u + \pi/2) = -\sin u, \int_0^\pi \sin^8 x \cos^5 x dx = \int_{-\pi/2}^{\pi/2} \cos^8 u (-\sin^5 u) du = 0$ by Exercise 69(a).

Exercise Set 5.10

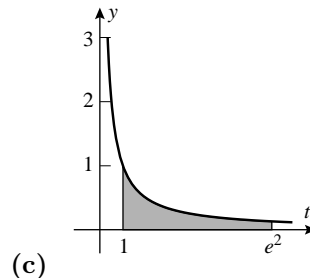
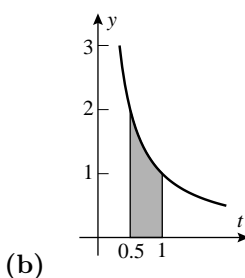
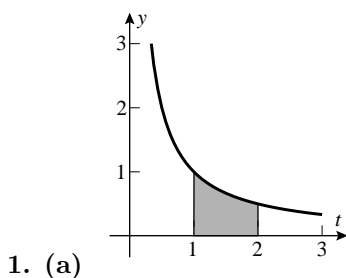

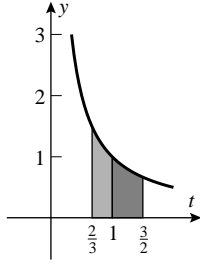

2.

3. (a) $\ln t \Big|_1^{ac} = \ln(ac) = \ln a + \ln c = 7.$ (b) $\ln t \Big|_1^{1/c} = \ln(1/c) = -5.$

(c) $\ln t \Big|_1^{a/c} = \ln(a/c) = 2 - 5 = -3.$ (d) $\ln t \Big|_1^{a^3} = \ln a^3 = 3 \ln a = 6.$

4. (a) $\ln t \Big|_1^{\sqrt{a}} = \ln a^{1/2} = \frac{1}{2} \ln a = 9/2.$ (b) $\ln t \Big|_1^{2a} = \ln 2 + 9.$

(c) $\ln t \Big|_1^{2/a} = \ln 2 - 9.$ (d) $\ln t \Big|_2^a = 9 - \ln 2.$

5. $\ln 5$ midpoint rule approximation: 1.603210678; $\ln 5 \approx 1.609437912$; magnitude of error is < 0.0063 .

6. $\ln 3$ midpoint rule approximation: 1.098242635; $\ln 3 \approx 1.098612289$; magnitude of error is < 0.0004 .

7. (a) $x^{-1}, x > 0.$ (b) $x^2, x \neq 0.$ (c) $-x^2, -\infty < x < +\infty.$ (d) $-x, -\infty < x < +\infty.$

(e) $x^3, x > 0.$ (f) $\ln x + x, x > 0.$ (g) $x - \sqrt[3]{x}, -\infty < x < +\infty.$ (h) $\frac{e^x}{x}, x > 0.$

8. (a) $f(\ln 3) = e^{-2 \ln 3} = e^{\ln(1/9)} = 1/9.$ (b) $f(\ln 2) = e^{\ln 2} + 3e^{-\ln 2} = 2 + 3e^{\ln(1/2)} = 2 + 3/2 = 7/2.$

9. (a) $3\pi = e^{\pi \ln 3}.$ (b) $2^{\sqrt{2}} = e^{\sqrt{2} \ln 2}.$

10. (a) $\pi^{-x} = e^{-x \ln \pi}.$ (b) $x^{2x} = e^{2x \ln x}.$

11. (a) $y = 2x, \lim_{x \rightarrow +\infty} \left(1 + \frac{1}{2x}\right)^x = \lim_{x \rightarrow +\infty} \left[\left(1 + \frac{1}{2x}\right)^{2x}\right]^{1/2} = \lim_{y \rightarrow +\infty} \left[\left(1 + \frac{1}{y}\right)^y\right]^{1/2} = e^{1/2}.$

(b) $y = 2x, \lim_{y \rightarrow 0} (1 + y)^{2/y} = \lim_{y \rightarrow 0} \left[(1 + y)^{1/y}\right]^2 = e^2.$

12. (a) $y = x/3, \lim_{y \rightarrow +\infty} \left[\left(1 + \frac{1}{y}\right)^y\right]^3 = \left[\lim_{y \rightarrow +\infty} \left(1 + \frac{1}{y}\right)^y\right]^3 = e^3.$

(b) $\lim_{x \rightarrow 0} (1 + x)^{1/3x} = \lim_{x \rightarrow 0} \left[(1 + x)^{1/x}\right]^{1/3} = e^{1/3}.$

13. $g'(x) = x^2 - x.$

14. $g'(x) = 1 - \cos x.$

15. (a) $\frac{1}{x^3}(3x^2) = \frac{3}{x}.$ (b) $e^{\ln x} \frac{1}{x} = 1.$

16. (a) $2x\sqrt{x^2+1}$. (b) $-\left(\frac{1}{x^2}\right)\sin\left(\frac{1}{x}\right)$.

17. $F'(x) = \frac{\sin x}{x^2+1}$, $F''(x) = \frac{(x^2+1)\cos x - 2x\sin x}{(x^2+1)^2}$.

(a) 0 (b) 0 (c) 1

18. $F'(x) = \sqrt{3x^2+1}$, $F''(x) = \frac{3x}{\sqrt{3x^2+1}}$.

(a) 0 (b) $\sqrt{13}$ (c) $6/\sqrt{13}$

19. True; both integrals are equal to $-\ln a$.

20. True; both integrals are equal to $\ln a/2$.

21. False; the integral does not exist.

22. True.

23. (a) $\frac{d}{dx} \int_1^{x^2} t\sqrt{1+t} dt = x^2\sqrt{1+x^2}(2x) = 2x^3\sqrt{1+x^2}$.

(b) $\int_1^{x^2} t\sqrt{1+t} dt = -\frac{2}{3}(x^2+1)^{3/2} + \frac{2}{5}(x^2+1)^{5/2} - \frac{4\sqrt{2}}{15}$.

24. (a) $\frac{d}{dx} \int_x^a f(t) dt = -\frac{d}{dx} \int_a^x f(t) dt = -f(x)$.

(b) $\frac{d}{dx} \int_{g(x)}^a f(t) dt = -\frac{d}{dx} \int_a^{g(x)} f(t) dt = -f(g(x))g'(x)$.

25. (a) $-\cos x^3$ (b) $-\frac{\tan^2 x}{1+\tan^2 x} \sec^2 x = -\tan^2 x$.

26. (a) $-\frac{1}{(x^2+1)^2}$ (b) $-\cos^3\left(\frac{1}{x}\right)\left(-\frac{1}{x^2}\right) = \frac{\cos^3(1/x)}{x^2}$.

27. $-3\frac{3x-1}{9x^2+1} + 2x\frac{x^2-1}{x^4+1}$.

28. If f is continuous on an open interval I and $g(x)$, $h(x)$, and a are in I , then $\int_{h(x)}^{g(x)} f(t) dt = \int_{h(x)}^a f(t) dt + \int_a^{g(x)} f(t) dt = -\int_a^{h(x)} f(t) dt + \int_a^{g(x)} f(t) dt$, so $\frac{d}{dx} \int_{h(x)}^{g(x)} f(t) dt = -f(h(x))h'(x) + f(g(x))g'(x)$.

29. (a) $\sin^2(x^3)(3x^2) - \sin^2(x^2)(2x) = 3x^2\sin^2(x^3) - 2x\sin^2(x^2)$.

(b) $\frac{1}{1+x}(1) - \frac{1}{1-x}(-1) = \frac{2}{1-x^2}$ (for $-1 < x < 1$).

30. $F'(x) = \frac{1}{5x}(5) - \frac{1}{x}(1) = 0$ so $F(x)$ is constant on $(0, +\infty)$. $F(1) = \ln 5$ so $F(x) = \ln 5$ for all $x > 0$.

31. From geometry, $\int_0^3 f(t)dt = 0$, $\int_3^5 f(t)dt = 6$, $\int_5^7 f(t)dt = 0$; and $\int_7^{10} f(t)dt = \int_7^{10} (4t - 37)/3dt = -3$.

(a) $F(0) = 0$, $F(3) = 0$, $F(5) = 6$, $F(7) = 6$, $F(10) = 3$.

(b) F is increasing where $F' = f$ is positive, so on $[3/2, 6]$ and $[37/4, 10]$, decreasing on $[0, 3/2]$ and $[6, 37/4]$.

(c) Critical points when $F'(x) = f(x) = 0$, so $x = 3/2, 6, 37/4$; maximum $15/2$ at $x = 6$, minimum $-9/4$ at $x = 3/2$. (Endpoints: $F(0) = 0$ and $F(10) = 3$.)

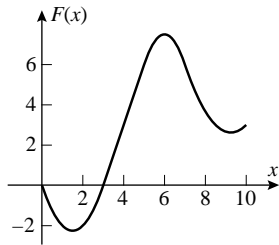

(d)

32. F' is increasing (resp. decreasing) where f is increasing (resp. decreasing), namely on $(0, 3)$ and $(7, 10)$ (resp. $(5, 7)$). The only endpoint common to two of these intervals is $x = 7$, and that is the only point of inflection of F .

33. $x < 0 : F(x) = \int_{-1}^x (-t)dt = -\frac{1}{2}t^2 \Big|_{-1}^x = \frac{1}{2}(1 - x^2)$,

$x \geq 0 : F(x) = \int_{-1}^0 (-t)dt + \int_0^x t dt = \frac{1}{2} + \frac{1}{2}x^2$; $F(x) = \begin{cases} (1 - x^2)/2, & x < 0 \\ (1 + x^2)/2, & x \geq 0 \end{cases}$

34. $0 \leq x \leq 2 : F(x) = \int_0^x t dt = \frac{1}{2}x^2$,

$x > 2 : F(x) = \int_0^2 t dt + \int_2^x 2 dt = 2 + 2(x - 2) = 2x - 2$; $F(x) = \begin{cases} x^2/2, & 0 \leq x \leq 2 \\ 2x - 2, & x > 2 \end{cases}$

35. $y(x) = 2 + \int_1^x \frac{2t^2 + 1}{t} dt = 2 + (t^2 + \ln t) \Big|_1^x = x^2 + \ln x + 1$.

36. $y(x) = \int_1^x (t^{1/2} + t^{-1/2})dt = \frac{2}{3}x^{3/2} - \frac{2}{3} + 2x^{1/2} - 2 = \frac{2}{3}x^{3/2} + 2x^{1/2} - \frac{8}{3}$.

37. $y(x) = 1 + \int_{\pi/4}^x (\sec^2 t - \sin t)dt = \tan x + \cos x - \sqrt{2}/2$.

38. $y(x) = 1 + \int_e^x \frac{1}{x \ln x} dx = 1 + \ln \ln t \Big|_e^x = 1 + \ln \ln x$.

39. $P(x) = P_0 + \int_0^x r(t)dt$ individuals.

40. $s(T) = s_1 + \int_1^T v(t)dt$.

41. II has a minimum at $x = 12$, and I has a zero there, so I could be the derivative of II; on the other hand I has a minimum near $x = 1/3$, but II is not zero there, so II could not be the derivative of I, so I is the graph of $f(x)$ and II is the graph of $\int_0^x f(t) dt$.

42. (b) $\lim_{k \rightarrow 0} \frac{1}{k}(b^k - 1) = \left. \frac{d}{dt} b^t \right|_{t=0} = \ln b.$

43. (a) Where $f(t) = 0$; by the First Derivative Test, at $t = 3$.

(b) Where $f(t) = 0$; by the First Derivative Test, at $t = 1, 5$.

(c) At $t = 0, 1$ or 5 ; from the graph it is evident that it is at $t = 5$.

(d) At $t = 0, 3$ or 5 ; from the graph it is evident that it is at $t = 3$.

(e) F is concave up when $F'' = f'$ is positive, i.e. where f is increasing, so on $(0, 1/2)$ and $(2, 4)$; it is concave down on $(1/2, 2)$ and $(4, 5)$.

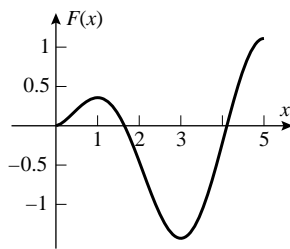

(f)

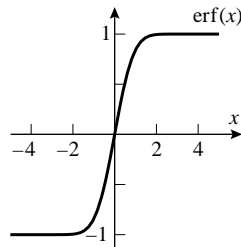

44. (a)

(c) $\text{erf}'(x) > 0$ for all x , so there are no relative extrema.

(e) $\text{erf}''(x) = -4xe^{-x^2}/\sqrt{\pi}$ changes sign only at $x = 0$ so that is the only point of inflection.

(f) Horizontal asymptotes: $y = -1$ and $y = 1$.

(g) $\lim_{x \rightarrow +\infty} \text{erf}(x) = +1, \lim_{x \rightarrow -\infty} \text{erf}(x) = -1.$

45. $C'(x) = \cos(\pi x^2/2), C''(x) = -\pi x \sin(\pi x^2/2).$

(a) $\cos t$ goes from negative to positive at $2k\pi - \pi/2$, and from positive to negative at $t = 2k\pi + \pi/2$, so $C(x)$ has relative minima when $\pi x^2/2 = 2k\pi - \pi/2, x = \pm\sqrt{4k-1}, k = 1, 2, \dots$, and $C(x)$ has relative maxima when $\pi x^2/2 = (4k+1)\pi/2, x = \pm\sqrt{4k+1}, k = 0, 1, \dots$

(b) $\sin t$ changes sign at $t = k\pi$, so $C(x)$ has inflection points at $\pi x^2/2 = k\pi, x = \pm\sqrt{2k}, k = 1, 2, \dots$; the case $k = 0$ is distinct due to the factor of x in $C''(x)$, but x changes sign at $x = 0$ and $\sin(\pi x^2/2)$ does not, so there is also a point of inflection at $x = 0$.

46. Let $F(x) = \int_1^x \ln t dt, F'(x) = \lim_{h \rightarrow 0} \frac{F(x+h) - F(x)}{h} = \lim_{h \rightarrow 0} \frac{1}{h} \int_x^{x+h} \ln t dt$; but $F'(x) = \ln x$, so $\lim_{h \rightarrow 0} \frac{1}{h} \int_x^{x+h} \ln t dt = \ln x.$

47. Differentiate: $f(x) = 2e^{2x}$, so $4 + \int_a^x f(t)dt = 4 + \int_a^x 2e^{2t} dt = 4 + e^{2t} \Big|_a^x = 4 + e^{2x} - e^{2a} = e^{2x}$ provided $e^{2a} = 4$,
 $a = (\ln 4)/2 = \ln 2$.

48. (a) The area under $1/t$ for $x \leq t \leq x+1$ is less than the area of the rectangle with altitude $1/x$ and base 1, but greater than the area of the rectangle with altitude $1/(x+1)$ and base 1.

(b) $\int_x^{x+1} \frac{1}{t} dt = \ln t \Big|_x^{x+1} = \ln(x+1) - \ln x = \ln(1 + 1/x)$, so $1/(x+1) < \ln(1 + 1/x) < 1/x$ for $x > 0$.

(c) From part (b), $e^{1/(x+1)} < e^{\ln(1+1/x)} < e^{1/x}$, $e^{1/(x+1)} < 1 + 1/x < e^{1/x}$, $e^{x/(x+1)} < (1 + 1/x)^x < e$; by the Squeezing Theorem, $\lim_{x \rightarrow +\infty} (1 + 1/x)^x = e$.

(d) Use the inequality $e^{x/(x+1)} < (1 + 1/x)^x$ to get $e < (1 + 1/x)^{x+1}$ so $(1 + 1/x)^x < e < (1 + 1/x)^{x+1}$.

49. From Exercise 48(d) $\left| e - \left(1 + \frac{1}{50}\right)^{50} \right| < y(50)$, and from the graph $y(50) < 0.06$.

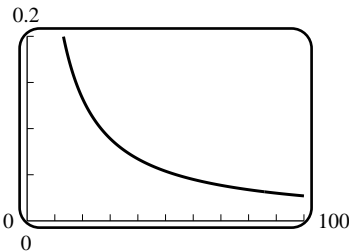

50. $F'(x) = f(x)$, thus $F'(x)$ has a value at each x in I because f is continuous on I so F is continuous on I because a function that is differentiable at a point is also continuous at that point.

Chapter 5 Review Exercises

1. $-\frac{1}{4x^2} + \frac{8}{3}x^{3/2} + C$.

2. $u^4/4 - u^2 + 7u + C$.

3. $-4 \cos x + 2 \sin x + C$.

4. $\int (\sec x \tan x + 1) dx = \sec x + x + C$.

5. $3x^{1/3} - 5e^x + C$.

6. $\frac{3}{4} \ln |x| - \tan x + C$.

7. $\tan^{-1} x + 2 \sin^{-1} x + C$.

8. $12 \sec^{-1} |x| + x - \frac{1}{3}x^3 + C$.

9. (a) $y(x) = 2\sqrt{x} - \frac{2}{3}x^{3/2} + C$; $y(1) = 0$, so $C = -\frac{4}{3}$, $y(x) = 2\sqrt{x} - \frac{2}{3}x^{3/2} - \frac{4}{3}$.

(b) $y(x) = \sin x - 5e^x + C$, $y(0) = 0 = -5 + C$, $C = 5$, $y(x) = \sin x - 5e^x + 5$.

$$(c) \quad y(x) = 2 + \int_1^x t^{1/3} dt = 2 + \left. \frac{3}{4} t^{4/3} \right|_1^x = \frac{5}{4} + \frac{3}{4} x^{4/3}.$$

$$(d) \quad y(x) = \int_0^x t e^{t^2} dt = \frac{1}{2} e^{x^2} - \frac{1}{2}.$$

10. The direction field is clearly an odd function, which means that the solution is even and its derivative is odd. Since $\sin x$ is periodic and the direction field is not, that eliminates all but x , the solution of which is the family $y = x^2/2 + C$.

11. (a) If $u = \sec x$, $du = \sec x \tan x dx$, $\int \sec^2 x \tan x dx = \int u du = u^2/2 + C_1 = (\sec^2 x)/2 + C_1$; if $u = \tan x$, $du = \sec^2 x dx$, $\int \sec^2 x \tan x dx = \int u du = u^2/2 + C_2 = (\tan^2 x)/2 + C_2$.

(b) They are equal only if $\sec^2 x$ and $\tan^2 x$ differ by a constant, which is true.

$$12. \quad \left. \frac{1}{2} \sec^2 x \right|_0^{\pi/4} = \frac{1}{2}(2 - 1) = 1/2 \quad \text{and} \quad \left. \frac{1}{2} \tan^2 x \right|_0^{\pi/4} = \frac{1}{2}(1 - 0) = 1/2.$$

$$13. \quad u = x^2 - 1, \quad du = 2x dx, \quad \frac{1}{2} \int \frac{du}{u\sqrt{u^2 - 1}} = \frac{1}{2} \sec^{-1} |u| + C = \frac{1}{2} \sec^{-1} |x^2 - 1| + C.$$

$$14. \quad \int \sqrt{1 + x^{-2/3}} dx = \int x^{-1/3} \sqrt{x^{2/3} + 1} dx; \quad u = x^{2/3} + 1, \quad du = \frac{2}{3} x^{-1/3} dx, \quad \frac{3}{2} \int u^{1/2} du = u^{3/2} + C = (x^{2/3} + 1)^{3/2} + C.$$

$$15. \quad u = 5 + 2 \sin 3x, \quad du = 6 \cos 3x dx; \quad \int \frac{1}{6\sqrt{u}} du = \frac{1}{3} u^{1/2} + C = \frac{1}{3} \sqrt{5 + 2 \sin 3x} + C.$$

$$16. \quad u = 3 + \sqrt{x}, \quad du = \frac{1}{2\sqrt{x}} dx; \quad \int 2\sqrt{u} du = \frac{4}{3} u^{3/2} + C = \frac{4}{3} (3 + \sqrt{x})^{3/2} + C.$$

$$17. \quad u = ax^3 + b, \quad du = 3ax^2 dx; \quad \int \frac{1}{3au^2} du = -\frac{1}{3au} + C = -\frac{1}{3a^2 x^3 + 3ab} + C.$$

$$18. \quad u = ax^2, \quad du = 2ax dx; \quad \frac{1}{2a} \int \sec^2 u du = \frac{1}{2a} \tan u + C = \frac{1}{2a} \tan(ax^2) + C.$$

$$19. \quad (a) \quad \sum_{k=0}^{14} (k+4)(k+1) \quad (b) \quad \sum_{k=5}^{19} (k-1)(k-4)$$

$$20. \quad (a) \quad 2k - 1 \quad (b) \quad \sum_{k=1}^n (2k - 1) = 2 \sum_{k=1}^n k - \sum_{k=1}^n 1 = 2 \cdot \frac{1}{2} n(n+1) - n = n^2.$$

$$21. \quad \lim_{n \rightarrow +\infty} \sum_{k=1}^n \left[4 \frac{4k}{n} - \left(\frac{4k}{n} \right)^2 \right] \frac{4}{n} = \lim_{n \rightarrow +\infty} \frac{64}{n^3} \sum_{k=1}^n (kn - k^2) = \lim_{n \rightarrow +\infty} \frac{64}{n^3} \left[\frac{n^2(n+1)}{2} - \frac{n(n+1)(2n+1)}{6} \right] = \lim_{n \rightarrow +\infty} \frac{64}{6n^3} [n^3 - n] = \frac{32}{3}.$$

$$22. \quad \lim_{n \rightarrow +\infty} \sum_{k=1}^n \left[\frac{25(k-1)}{n} - \frac{25(k-1)^2}{n^2} \right] \frac{5}{n} = \frac{125}{6}.$$

23. 0.351220577, 0.420535296, 0.386502483.

24. 1.63379940, 1.805627583, 1.717566087.

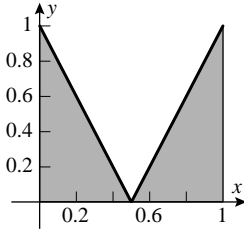

26. $\frac{1}{2}$

27. (a) $\frac{1}{2} + \frac{1}{4} = \frac{3}{4}$. (b) $-1 - \frac{1}{2} = -\frac{3}{2}$. (c) $5\left(-1 - \frac{3}{4}\right) = -\frac{35}{4}$. (d) -2

(e) Not enough information. (f) Not enough information.

28. (a) $\frac{1}{2} + 2 = \frac{5}{2}$. (b) Not enough information. (c) Not enough information. (d) $4(2) - 3\left(\frac{1}{2}\right) = \frac{13}{2}$.

29. (a) $\int_{-1}^1 dx + \int_{-1}^1 \sqrt{1-x^2} dx = 2(1) + \pi(1)^2/2 = 2 + \pi/2$.

(b) $\frac{1}{3}(x^2 + 1)^{3/2} \Big|_0^3 - \pi(3)^2/4 = \frac{1}{3}(10^{3/2} - 1) - 9\pi/4$.

(c) $u = x^2, du = 2xdx; \frac{1}{2} \int_0^1 \sqrt{1-u^2} du = \frac{1}{2}\pi(1)^2/4 = \pi/8$.

30. (a) $\frac{1}{n} \sum_{k=1}^n \sqrt{\frac{k}{n}} = \sum_{k=1}^n f(x_k^*) \Delta x$ where $f(x) = \sqrt{x}$, $x_k^* = k/n$, and $\Delta x = 1/n$ for $0 \leq x \leq 1$. Thus $\lim_{n \rightarrow +\infty} \frac{1}{n} \sum_{k=1}^n \sqrt{\frac{k}{n}} = \int_0^1 x^{1/2} dx = \frac{2}{3}$.

(b) $\frac{1}{n} \sum_{k=1}^n \left(\frac{k}{n}\right)^4 = \sum_{k=1}^n f(x_k^*) \Delta x$ where $f(x) = x^4$, $x_k^* = k/n$, and $\Delta x = 1/n$ for $0 \leq x \leq 1$. Thus $\lim_{n \rightarrow +\infty} \frac{1}{n} \sum_{k=1}^n \left(\frac{k}{n}\right)^4 = \int_0^1 x^4 dx = \frac{1}{5}$.

(c) $\sum_{k=1}^n \frac{e^{k/n}}{n} = \sum_{k=1}^n f(x_k^*) \Delta x$ where $f(x) = e^x$, $x_k^* = k/n$, and $\Delta x = 1/n$ for $0 \leq x \leq 1$. Thus $\lim_{n \rightarrow +\infty} \sum_{k=1}^n \frac{e^{k/n}}{n} = \lim_{n \rightarrow +\infty} \sum_{k=1}^n f(x_k^*) \Delta x = \int_0^1 e^x dx = e - 1$.

31. $\left(\frac{1}{3}x^3 - 2x^2 + 7x\right) \Big|_{-3}^0 = 48$.

32. $\left(\frac{1}{2}x^2 + \frac{1}{5}x^5\right) \Big|_{-1}^2 = 81/10$.

33. $\int_1^3 x^{-2} dx = -\frac{1}{x} \Big|_1^3 = 2/3$.

$$34. \left(3x^{5/3} + \frac{4}{x}\right) \Big|_1^8 = 179/2.$$

$$35. \left(\frac{1}{2}x^2 - \sec x\right) \Big|_0^1 = 3/2 - \sec(1).$$

$$36. \left(6\sqrt{t} - \frac{10}{3}t^{3/2} + \frac{2}{\sqrt{t}}\right) \Big|_1^4 = -55/3.$$

$$37. \int_0^{3/2} (3-2x)dx + \int_{3/2}^2 (2x-3)dx = (3x-x^2) \Big|_0^{3/2} + (x^2-3x) \Big|_{3/2}^2 = 9/4 + 1/4 = 5/2.$$

$$38. \int_0^{\pi/6} (1/2 - \sin x) dx + \int_{\pi/6}^{\pi/2} (\sin x - 1/2) dx = (x/2 + \cos x) \Big|_0^{\pi/6} - (\cos x + x/2) \Big|_{\pi/6}^{\pi/2} = (\pi/12 + \sqrt{3}/2) - 1 - \pi/4 + (\sqrt{3}/2 + \pi/12) = \sqrt{3} - \pi/12 - 1.$$

$$39. \int_1^9 \sqrt{x} dx = \frac{2}{3}x^{3/2} \Big|_1^9 = \frac{2}{3}(27-1) = 52/3.$$

$$40. \int_1^4 x^{-3/5} dx = \frac{5}{2}x^{2/5} \Big|_1^4 = \frac{5}{2}(4^{2/5} - 1).$$

$$41. \int_1^3 e^x dx = e^x \Big|_1^3 = e^3 - e.$$

$$42. \int_1^{e^3} \frac{1}{x} dx = \ln x \Big|_1^{e^3} = 3 - \ln 1 = 3.$$

$$43. A = \int_1^2 (-x^2 + 3x - 2) dx = \left(-\frac{1}{3}x^3 + \frac{3}{2}x^2 - 2x\right) \Big|_1^2 = 1/6.$$

$$44. \text{The only positive zero of } f \text{ is } b = \frac{1 + \sqrt{5}}{2}, \text{ and the area is given by } A = \int_0^b f(x) dx = \frac{13 + 5\sqrt{5}}{24}.$$

$$45. A = A_1 + A_2 = \int_0^1 (1-x^2) dx + \int_1^3 (x^2-1) dx = 2/3 + 20/3 = 22/3.$$

$$46. A = A_1 + A_2 = \int_{-1}^0 [1 - \sqrt{x+1}] dx + \int_0^1 [\sqrt{x+1} - 1] dx = \left(x - \frac{2}{3}(x+1)^{3/2}\right) \Big|_{-1}^0 + \left(\frac{2}{3}(x+1)^{3/2} - x\right) \Big|_0^1 = -\frac{2}{3} + 1 + \frac{4\sqrt{2}}{3} - 1 - \frac{2}{3} = 4\frac{\sqrt{2}-1}{3}.$$

$$47. \text{(a) } x^3 + 1 \quad \text{(b) } F(x) = \left(\frac{1}{4}t^4 + t\right) \Big|_1^x = \frac{1}{4}x^4 + x - \frac{5}{4}; F'(x) = x^3 + 1.$$

$$48. \text{(a) } F'(x) = \frac{1}{\sqrt{x}}. \quad \text{(b) } F(x) = 2\sqrt{t} \Big|_4^x = 2\sqrt{x} - 2; F'(x) = \frac{1}{\sqrt{x}}.$$

$$49. e^{x^2}$$

50. $\frac{x}{\cos x^2}$

51. $|x - 1|$

52. $\cos \sqrt{x}$

53. $\frac{\cos x}{1 + \sin^3 x}$

54. $\frac{(\ln \sqrt{x})^2}{2\sqrt{x}}$

56. (a) $F'(x) = \frac{x^2 - 3}{x^4 + 7}$; increasing on $(-\infty, -\sqrt{3}]$, $[\sqrt{3}, +\infty)$, decreasing on $[-\sqrt{3}, \sqrt{3}]$.

(b) $F''(x) = \frac{-2x^5 + 12x^3 + 14x}{(x^4 + 7)^2}$; concave up on $(-\infty, -\sqrt{7})$, $(0, \sqrt{7})$ concave down on $(-\sqrt{7}, 0)$, $(\sqrt{7}, \infty)$.

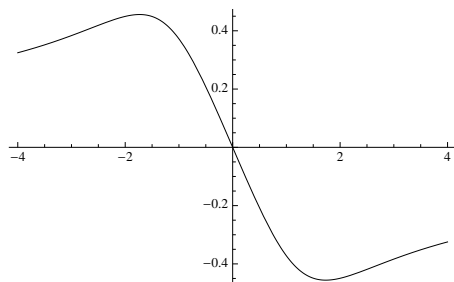
(c) Absolute maximum at $x = -\sqrt{3}$, absolute minimum at $x = \sqrt{3}$.

(d)

57. (a) $F'(x) = \frac{1}{1+x^2} + \frac{1}{1+(1/x)^2}(-1/x^2) = 0$ so F is constant on $(0, +\infty)$.

(b) $F(1) = \int_0^1 \frac{1}{1+t^2} dt + \int_0^1 \frac{1}{1+t^2} dt = 2 \tan^{-1} 1 = \pi/2$, so $F(x) = \tan^{-1} x + \tan^{-1}(1/x) = \pi/2$.

58. $(-3, 3)$ because f is continuous there and 1 is in $(-3, 3)$.59. (a) The domain is $(-\infty, +\infty)$; $F(x)$ is 0 if $x = 1$, positive if $x > 1$, and negative if $x < 1$, because the integrand is positive, so the sign of the integral depends on the orientation (forwards or backwards).(b) The domain is $[-2, 2]$; $F(x)$ is 0 if $x = -1$, positive if $-1 < x \leq 2$, and negative if $-2 \leq x < -1$; same reasons as in part (a).

60. $F(x) = \int_{-1}^x \frac{t}{\sqrt{2+t^3}} dt$, $F'(x) = \frac{x}{\sqrt{2+x^3}}$, so F is increasing on $[1, 3]$; $F_{\max} = F(3) \approx 1.152082854$ and $F_{\min} = F(1) \approx -0.07649493141$.

61. (a) $f_{\text{ave}} = \frac{1}{3} \int_0^3 x^{1/2} dx = 2\sqrt{3}/3$; $\sqrt{x^*} = 2\sqrt{3}/3$, $x^* = \frac{4}{3}$.

(b) $f_{\text{ave}} = \frac{1}{e-1} \int_1^e \frac{1}{x} dx = \frac{1}{e-1} \ln x \Big|_1^e = \frac{1}{e-1}$; $\frac{1}{x^*} = \frac{1}{e-1}$, $x^* = e - 1$.

62. Mar 1 to Jun 7 is 14 weeks, so $w(t) = 10 + \int_0^t \frac{s}{7} ds = 10 + \frac{t^2}{14}$, so the weight on June 7 will be 24 gm.

63. For $0 < x < 3$ the area between the curve and the x -axis consists of two triangles of equal area but of opposite signs, hence 0. For $3 < x < 5$ the area is a rectangle of width 2 and height 3. For $5 < x < 7$ the area consists of two triangles of equal area but opposite sign, hence 0; and for $7 < x < 10$ the curve is given by $y = (4t - 37)/3$ and $\int_7^{10} (4t - 37)/3 dt = -3$. Thus the desired average is $\frac{1}{10}(0 + 6 + 0 - 3) = 0.3$.

$$64. f_{\text{ave}} = \frac{1}{\ln 2 - \ln(1/2)} \int_{\ln(1/2)}^{\ln 2} (e^x + e^{-x}) dx = \frac{1}{2 \ln 2} \int_{-\ln 2}^{\ln 2} (e^x + e^{-x}) dx = \frac{3}{2 \ln 2}.$$

65. If the acceleration $a = \text{const}$, then $v(t) = at + v_0$, $s(t) = \frac{1}{2}at^2 + v_0t + s_0$.

66. (a) No, since the velocity curve is not a straight line.

(b) $[25, 40]$.

$$(c) s = \int_0^{40} v(t) dt \approx 5(0.9 + 2.1 + 2 + 3.4 + 4 + 5.2 + 6 + 7.2) = 5 \cdot 30.8 = 153 \text{ ft.}$$

$$(d) (0.9 + 2.1 + \dots + 7.2)/8 = 30.8/8 = 3.85 \text{ ft/s.}$$

(e) No, since the velocity is positive and the acceleration is never negative.

(f) Need the position at any one given time (e.g. s_0).

$$67. s(t) = \int (t^3 - 2t^2 + 1) dt = \frac{1}{4}t^4 - \frac{2}{3}t^3 + t + C, s(0) = \frac{1}{4}(0)^4 - \frac{2}{3}(0)^3 + 0 + C = 1, C = 1, s(t) = \frac{1}{4}t^4 - \frac{2}{3}t^3 + t + 1.$$

$$68. v(t) = \int 4 \cos 2t dt = 2 \sin 2t + C_1, v(0) = 2 \sin 0 + C_1 = -1, C_1 = -1, v(t) = 2 \sin 2t - 1, s(t) = \int (2 \sin 2t - 1) dt = -\cos 2t - t + C_2, s(0) = -\cos 0 - 0 + C_2 = -3, C_2 = -2, s(t) = -\cos 2t - t - 2.$$

$$69. s(t) = \int (2t - 3) dt = t^2 - 3t + C, s(1) = (1)^2 - 3(1) + C = 5, C = 7, s(t) = t^2 - 3t + 7.$$

$$70. v(t) = \int (\cos t - 2t) dt = \sin t - t^2 + v_0; \text{ but } v_0 = 0 \text{ so } v(t) = \sin t - t^2, s(t) = \int v(t) dt = -\cos t - t^3/3 + C : s(0) = 0 = -1 + C, C = 1, s(t) = -\cos t - t^3/3 + 1.$$

$$71. \text{ displacement} = s(6) - s(0) = \int_0^6 (2t - 4) dt = (t^2 - 4t) \Big|_0^6 = 12 \text{ m.}$$

$$\text{distance} = \int_0^6 |2t - 4| dt = \int_0^2 (4 - 2t) dt + \int_2^6 (2t - 4) dt = (4t - t^2) \Big|_0^2 + (t^2 - 4t) \Big|_2^6 = 20 \text{ m.}$$

$$72. \text{ displacement} = \int_0^5 |t - 3| dt = \int_0^3 -(t - 3) dt + \int_3^5 (t - 3) dt = 13/2 \text{ m.}$$

$$\text{distance} = \int_0^5 |t - 3| dt = 13/2 \text{ m.}$$

$$73. \text{ displacement} = \int_1^3 \left(\frac{1}{2} - \frac{1}{t^2} \right) dt = 1/3 \text{ m.}$$

$$\text{distance} = \int_1^3 |v(t)| dt = -\int_1^{\sqrt{2}} v(t) dt + \int_{\sqrt{2}}^3 v(t) dt = 10/3 - 2\sqrt{2} \text{ m.}$$

74. displacement = $\int_4^9 3t^{-1/2} dt = 6$ m.

distance = $\int_4^9 |v(t)| dt = \int_4^9 v(t) dt = 6$ m.

75. $v(t) = -2t + 3$;

displacement = $\int_1^4 (-2t + 3) dt = -6$ m.

distance = $\int_1^4 |-2t + 3| dt = \int_1^{3/2} (-2t + 3) dt + \int_{3/2}^4 (2t - 3) dt = 13/2$ m.

76. $v(t) = \frac{2}{5}\sqrt{5t+1} + \frac{8}{5}$;

displacement = $\int_0^3 \left(\frac{2}{5}\sqrt{5t+1} + \frac{8}{5} \right) dt = \frac{4}{75}(5t+1)^{3/2} + \frac{8}{5}t \Big|_0^3 = 204/25$ m.

distance = $\int_0^3 |v(t)| dt = \int_0^3 v(t) dt = 204/25$ m.

77. Take $t = 0$ when deceleration begins, then $a = -10$ so $v = -10t + C_1$, but $v = 88$ when $t = 0$ which gives $C_1 = 88$ thus $v = -10t + 88$, $t \geq 0$.

(a) $v = 45$ mi/h = 66 ft/s, $66 = -10t + 88$, $t = 2.2$ s.

(b) $v = 0$ (the car is stopped) when $t = 8.8$ s, $s = \int v dt = \int (-10t + 88) dt = -5t^2 + 88t + C_2$, and taking $s = 0$ when $t = 0$, $C_2 = 0$ so $s = -5t^2 + 88t$. At $t = 8.8$, $s = 387.2$. The car travels 387.2 ft before coming to a stop.

78. $s(t) = \frac{20}{3}t^3 - 50t^2 + 50t + s_0$, $s(0) = 0$ gives $s_0 = 0$, so $s(t) = \frac{20}{3}t^3 - 50t^2 + 50t$, $a(t) = 40t - 100$.

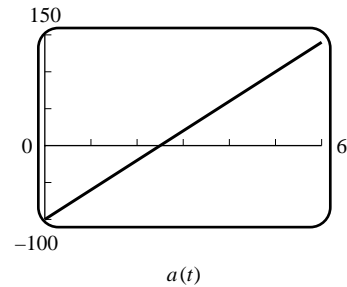
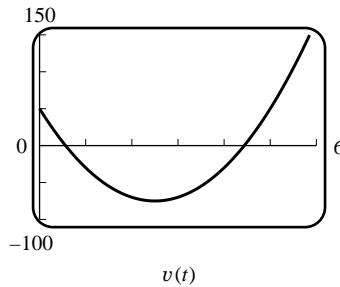
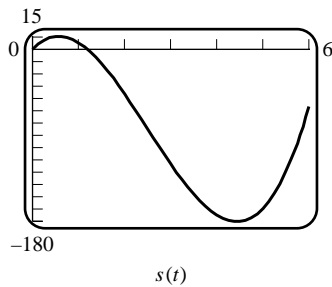

79. From the free-fall model $s = -\frac{1}{2}gt^2 + v_0t + s_0$ the ball is caught when $s_0 = -\frac{1}{2}gt_1^2 + v_0t_1 + s_0$ with the positive root $t_1 = 2v_0/g$ so the average speed of the ball while it is up in the air is average speed = $\frac{1}{t_1} \int_0^{t_1} |v_0 - gt| dt = \frac{g}{2v_0} \left[\int_0^{v_0/g} (v_0 - gt) dt + \int_{v_0/g}^{2v_0/g} (gt - v_0) dt \right] = v_0/2$.

80. $v_0 = 0$ and $g = 9.8$, so $v = -9.8t$, $s = -4.9t^2 + s_0$, find s_0 . The rock strikes the ground when $s = 0$, $t^2 = s_0/4.9$. At that moment the speed is 24, so $|v| = 24 = 9.8\sqrt{\frac{s_0}{4.9}}$, so $s_0 = 4.9 \left(\frac{24}{9.8} \right)^2 = \frac{576}{19.6} \approx 29.39$ m.

81. $u = 2x + 1$, $\frac{1}{2} \int_1^3 u^4 du = \frac{1}{10} u^5 \Big|_1^3 = 121/5$, or $\frac{1}{10} (2x+1)^5 \Big|_0^1 = 121/5$.

$$82. u = 4 - x, \int_9^4 (u - 4)u^{1/2} du = \int_9^4 (u^{3/2} - 4u^{1/2}) du = \left[\frac{2}{5}u^{5/2} - \frac{8}{3}u^{3/2} \right]_9^4 = -506/15, \text{ or}$$

$$\frac{2}{5}(4 - x)^{5/2} - \frac{8}{3}(4 - x)^{3/2} \Big|_{-5}^0 = -506/15.$$

$$83. \frac{2}{3}(3x + 1)^{1/2} \Big|_0^1 = 2/3.$$

$$84. u = x^2, \int_0^\pi \frac{1}{2} \sin u du = -\frac{1}{2} \cos u \Big|_0^\pi = 1.$$

$$85. \frac{1}{3\pi} \sin^3 \pi x \Big|_0^1 = 0.$$

$$86. u = \ln x, du = (1/x)dx; \int_1^2 \frac{1}{u} du = \ln u \Big|_1^2 = \ln 2.$$

$$87. \int_0^1 e^{-x/2} dx = 2(1 - 1/\sqrt{e}).$$

$$88. u = 3x/2, du = 3/2 dx, \frac{1}{6} \int_0^{\sqrt{3}} \frac{1}{1+u^2} du = \frac{1}{6} \tan^{-1} u \Big|_0^{\sqrt{3}} = \frac{1}{18}\pi.$$

$$89. (a) \lim_{x \rightarrow +\infty} \left[\left(1 + \frac{1}{x}\right)^x \right]^2 = \left[\lim_{x \rightarrow +\infty} \left(1 + \frac{1}{x}\right)^x \right]^2 = e^2.$$

$$(b) y = 3x, \lim_{y \rightarrow 0} \left(1 + \frac{1}{y}\right)^{y/3} = \lim_{y \rightarrow 0} \left[\left(1 + \frac{1}{y}\right)^y \right]^{1/3} = e^{1/3}.$$

$$90. \text{Differentiate: } f(x) = 3e^{3x}, \text{ so } 2 + \int_a^x f(t)dt = 2 + \int_a^x 3e^{3t} dt = 2 + e^{3t} \Big|_a^x = 2 + e^{3x} - e^{3a} = e^{3x} \text{ provided } e^{3a} = 2, \\ a = (\ln 2)/3.$$

Chapter 5 Making Connections

$$1. (a) \sum_{k=1}^n 2x_k^* \Delta x_k = \sum_{k=1}^n (x_k + x_{k-1})(x_k - x_{k-1}) = \sum_{k=1}^n (x_k^2 - x_{k-1}^2) = \sum_{k=1}^n x_k^2 - \sum_{k=0}^{n-1} x_k^2 = b^2 - a^2.$$

(b) By Theorem 5.5.2, f is integrable on $[a, b]$. Using part (a) of Definition 5.5.1, in which we choose any partition and use the midpoints $x_k^* = (x_k + x_{k-1})/2$, we see from part (a) of this exercise that the Riemann sum is equal to $x_n^2 - x_0^2 = b^2 - a^2$. Since the right side of this equation does not depend on partitions, the limit of the Riemann sums as $\max(\Delta x_k) \rightarrow 0$ is equal to $b^2 - a^2$.

$$2. \text{For } 0 \leq k \leq n \text{ set } x_k = 4k^2/n^2 \text{ and let } x_k^* = x_k. \text{ We have } \sum_{k=1}^n f(x_k^*) \Delta x_k = \sum_{k=1}^n \sqrt{4 \frac{k^2}{n^2}} 4 \left(\frac{k^2}{n^2} - \frac{(k-1)^2}{n^2} \right) = \\ \sum_{k=1}^n \frac{8}{n^3} (2k^2 - k) = \frac{16}{n^3} \frac{n(n+1)(2n+1)}{6} - \frac{8}{n^3} \frac{n(n+1)}{2} = \frac{4}{3} \frac{4n^2 + 3n - 1}{n^2} \rightarrow \frac{16}{3} \text{ as } n \rightarrow \infty.$$

3. Use the partition $0 < 8(1)^3/n^3 < 8(2)^3/n^3 < \dots < 8(n-1)^3/n^3 < 8$ with x_k^* as the right endpoint of the

k -th interval, $x_k^* = 8k^3/n^3$. Then $\sum_{k=1}^n f(x_k^*)\Delta x_k = \sum_{k=1}^n \sqrt[3]{8k^3/n^3} \left(\frac{8k^3}{n^3} - \frac{8(k-1)^3}{n^3} \right) = \sum_{k=1}^n \frac{16}{n^4} (k^4 - k(k-1)^3) = \frac{16}{n^4} \frac{3n^4 + 2n^3 - n^2}{4} \rightarrow 16 \frac{3}{4} = 12$ as $n \rightarrow \infty$.

4. (a) $\sum_{k=1}^n g(x_k^*)\Delta x_k = \frac{1}{m} \sum_{k=1}^n f(u_k^*)\Delta u_k$ which is $\frac{1}{m}$ times a Riemann sum for f .

$$(b) \int_0^1 g(x) dx = \lim_{\max \Delta x_k \rightarrow 0} \sum_{k=1}^n g(x_k^*)\Delta x_k = \frac{1}{m} \lim_{\max \Delta x_k \rightarrow 0} \sum_{k=1}^n f(u_k)\Delta u_k = \frac{1}{m} \int_0^m f(u) du.$$

(c) To avoid confusion let us denote the function g in Theorem 5.9.1 by the symbol γ , as g is already in use. Then the transformation from $[0, 1]$ to $[0, m]$ is given by $u = \gamma(x) = mx$, and Theorem 5.9.1 says that $\int_{\gamma(a)}^{\gamma(b)} f(u) du = \int_0^8 f(u) du = \int_0^1 f(\gamma(x))\gamma'(x) dx = \int_0^8 f(mx)m dx$.

5. (a) $\sum_{k=1}^n g(x_k^*)\Delta x_k = \sum_{k=1}^n 2x_k^* f((x_k^*)^2)\Delta x_k = \sum_{k=1}^n (x_k + x_{k-1})f((x_k^*)^2)(x_k - x_{k-1}) = \sum_{k=1}^n f((x_k^*)^2)(x_k^2 - x_{k-1}^2) = \sum_{k=1}^n f(u_k^*)\Delta u_k$. The two Riemann sums are equal.

(b) In part (a) note that $\Delta u_k = \Delta x_k^2 = x_k^2 - x_{k-1}^2 = (x_k + x_{k-1})\Delta x_k$, and since $2 \leq x_k \leq 3$, $4\Delta x_k \leq \Delta u_k$ and $\Delta u_k \leq 6\Delta x_k$, so that $\max\{u_k\}$ tends to zero iff $\max\{x_k\}$ tends to zero. $\int_2^3 g(x) dx = \lim_{\max(\Delta x_k) \rightarrow 0} \sum_{k=1}^n g(x_k^*)\Delta x_k = \lim_{\max(\Delta u_k) \rightarrow 0} \sum_{k=1}^n f(u_k^*)\Delta u_k = \int_4^9 f(u) du$.

(c) Since the symbol g is already in use, we shall use γ to denote the mapping $u = \gamma(x) = x^2$ of Theorem 5.9.1. Applying the Theorem, $\int_4^9 f(u) du = \int_2^3 f(\gamma(x))\gamma'(x) dx = \int_2^3 f(x^2)2x dx = \int_2^3 g(x) dx$.

Applications of the Definite Integral in Geometry, Science, and Engineering

Exercise Set 6.1

$$1. A = \int_{-1}^2 (x^2 + 1 - x) dx = \left(\frac{x^3}{3} + x - \frac{x^2}{2} \right) \Big|_{-1}^2 = 9/2.$$

$$2. A = \int_0^4 (\sqrt{x} + x/4) dx = \left(\frac{2x^{3/2}}{3} + x^2/8 \right) \Big|_0^4 = 22/3.$$

$$3. A = \int_1^2 (y - 1/y^2) dy = \left(\frac{y^2}{2} + 1/y \right) \Big|_1^2 = 1.$$

$$4. A = \int_0^2 (2 - y^2 + y) dy = \left(2y - \frac{y^3}{3} + \frac{y^2}{2} \right) \Big|_0^2 = 10/3.$$

$$5. (a) A = \int_0^2 (2x - x^2) dx = 4/3. \quad (b) A = \int_0^4 (\sqrt{y} - y/2) dy = 4/3.$$

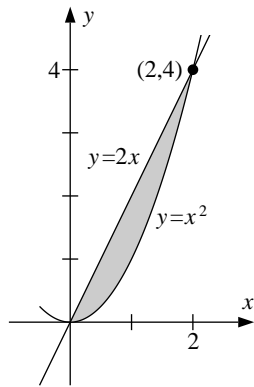

6. Eliminate x to get $y^2 = 4(y + 4)/2$, $y^2 - 2y - 8 = 0$, $(y - 4)(y + 2) = 0$; $y = -2, 4$ with corresponding values of $x = 1, 4$.

$$(a) A = \int_0^1 [2\sqrt{x} - (-2\sqrt{x})] dx + \int_1^4 [2\sqrt{x} - (2x - 4)] dx = \int_0^1 4\sqrt{x} dx + \int_1^4 (2\sqrt{x} - 2x + 4) dx = 8/3 + 19/3 = 9.$$

$$(b) A = \int_{-2}^4 [(y/2 + 2) - y^2/4] dy = 9.$$

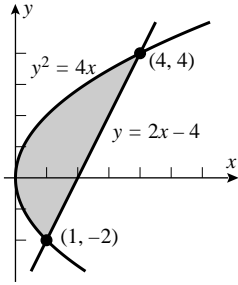

$$7. A = \int_{1/4}^1 (\sqrt{x} - x^2) dx = 49/192.$$

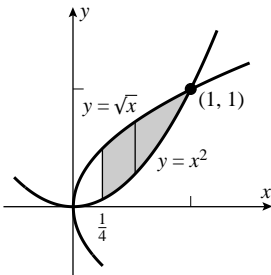

$$8. A = \int_0^2 [0 - (x^3 - 4x)] dx = \int_0^2 (4x - x^3) dx = 4.$$

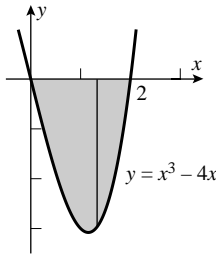

$$9. A = \int_{\pi/4}^{\pi/2} (0 - \cos 2x) dx = - \int_{\pi/4}^{\pi/2} \cos 2x dx = 1/2.$$

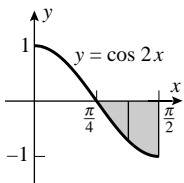

$$10. \text{Equate } \sec^2 x \text{ and } 2 \text{ to get } \sec^2 x = 2, \sec x = \pm\sqrt{2}, x = \pm\pi/4. A = \int_{-\pi/4}^{\pi/4} (2 - \sec^2 x) dx = \pi - 2.$$

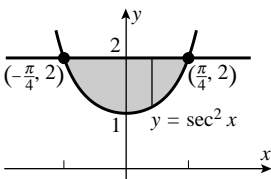

$$11. A = \int_{\pi/4}^{3\pi/4} \sin y dy = \sqrt{2}.$$

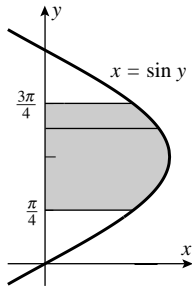

12. $A = \int_{-1}^2 [(x+2) - x^2] dx = 9/2.$

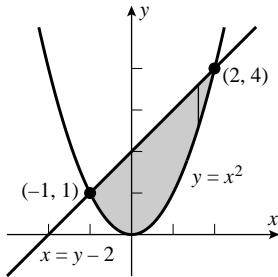

13. $A = \int_0^{\ln 2} (e^{2x} - e^x) dx = \left(\frac{1}{2}e^{2x} - e^x \right) \Big|_0^{\ln 2} = 1/2.$

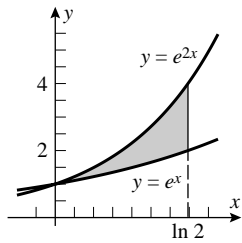

14. $A = \int_1^e \frac{dy}{y} = \ln y \Big|_1^e = 1.$

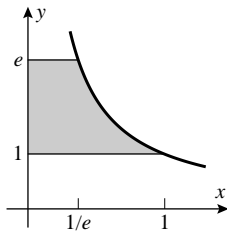

15. $A = \int_{-1}^1 \left(\frac{2}{1+x^2} - |x| \right) dx = 2 \int_0^1 \left(\frac{2}{1+x^2} - x \right) dx = \left[4 \tan^{-1} x - x^2 \right]_0^1 = \pi - 1.$

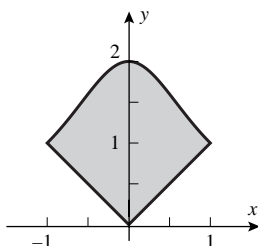

$$16. \frac{1}{\sqrt{1-x^2}} = 2, x = \pm \frac{\sqrt{3}}{2}, \text{ so } A = \int_{-\sqrt{3}/2}^{\sqrt{3}/2} \left(2 - \frac{1}{\sqrt{1-x^2}}\right) dx = \left[2x - \sin^{-1} x\right]_{-\sqrt{3}/2}^{\sqrt{3}/2} = 2\sqrt{3} - \frac{2\pi}{3}.$$

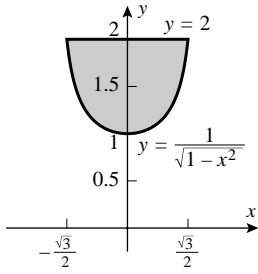

$$17. y = 2 + |x - 1| = \begin{cases} 3 - x, & x \leq 1 \\ 1 + x, & x \geq 1 \end{cases}, A = \int_{-5}^1 \left[\left(-\frac{1}{5}x + 7\right) - (3 - x)\right] dx + \int_1^5 \left[\left(-\frac{1}{5}x + 7\right) - (1 + x)\right] dx = \int_{-5}^1 \left(\frac{4}{5}x + 4\right) dx + \int_1^5 \left(6 - \frac{6}{5}x\right) dx = 72/5 + 48/5 = 24.$$

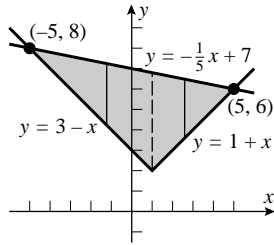

$$18. A = \int_0^{2/5} (4x - x) dx + \int_{2/5}^1 (-x + 2 - x) dx = \int_0^{2/5} 3x dx + \int_{2/5}^1 (2 - 2x) dx = 3/5.$$

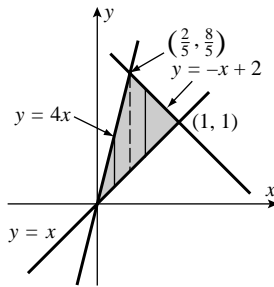

$$19. A = \int_0^1 (x^3 - 4x^2 + 3x) dx + \int_1^3 [-(x^3 - 4x^2 + 3x)] dx = 5/12 + 32/12 = 37/12.$$

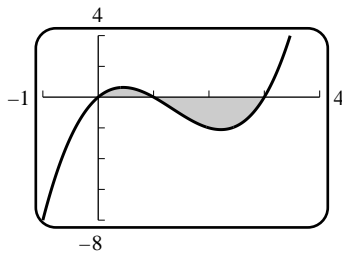

$$20. \text{Equate } y = x^3 - 2x^2 \text{ and } y = 2x^2 - 3x \text{ to get } x^3 - 4x^2 + 3x = 0, x(x-1)(x-3) = 0; x = 0, 1, 3 \text{ with corresponding values of } y = 0, -1, 9. A = \int_0^1 [(x^3 - 2x^2) - (2x^2 - 3x)] dx + \int_1^3 [(2x^3 - 3x) - (x^3 - 2x^2)] dx = \int_0^1 (x^3 - 4x^2 + 3x) dx + \int_1^3 (-x^3 + 4x^2 - 3x) dx = \frac{5}{12} + \frac{8}{3} = \frac{37}{12}.$$

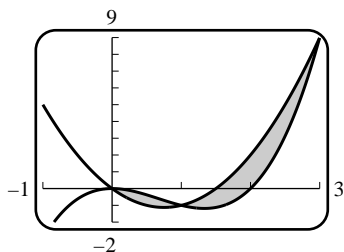

21. From the symmetry of the region $A = 2 \int_{\pi/4}^{5\pi/4} (\sin x - \cos x) dx = 4\sqrt{2}$.

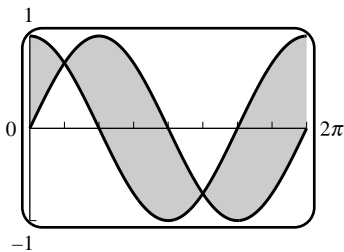

22. The region is symmetric about the origin, so $A = 2 \int_0^2 |x^3 - 4x| dx = 8$.

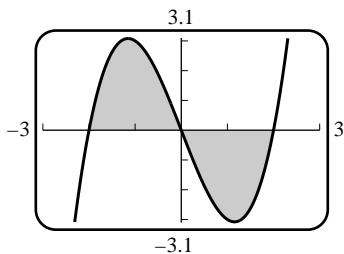

23. $A = \int_{-1}^0 (y^3 - y) dy + \int_0^1 -(y^3 - y) dy = 1/2$.

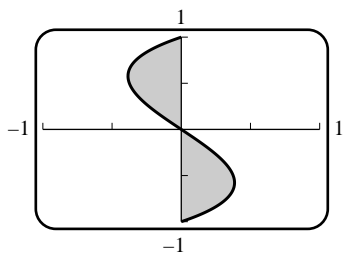

24. $A = \int_0^1 [y^3 - 4y^2 + 3y - (y^2 - y)] dy + \int_1^4 [y^2 - y - (y^3 - 4y^2 + 3y)] dy = 7/12 + 45/4 = 71/6$.

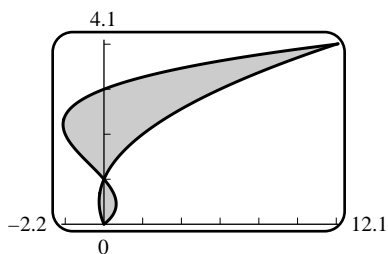

25. The curves meet when $x = 0, \sqrt{\ln 2}$, so $A = \int_0^{\sqrt{\ln 2}} (2x - xe^{x^2}) dx = \left(x^2 - \frac{1}{2}e^{x^2} \right) \Big|_0^{\sqrt{\ln 2}} = \ln 2 - \frac{1}{2}$.

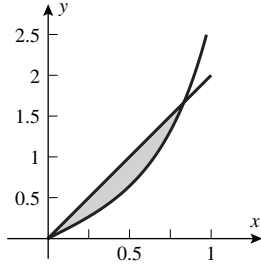

26. The curves meet for $x = e^{-2\sqrt{2}/3}, e^{2\sqrt{2}/3}$, thus

$$A = \int_{e^{-2\sqrt{2}/3}}^{e^{2\sqrt{2}/3}} \left(\frac{3}{x} - \frac{1}{x\sqrt{1-(\ln x)^2}} \right) dx = \left(3 \ln x - \sin^{-1}(\ln x) \right) \Big|_{e^{-2\sqrt{2}/3}}^{e^{2\sqrt{2}/3}} = 4\sqrt{2} - 2 \sin^{-1} \left(\frac{2\sqrt{2}}{3} \right).$$

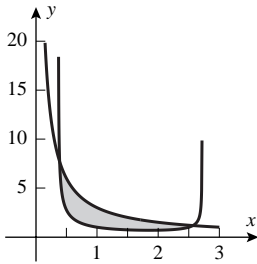

27. True. If $f(x) - g(x) = c > 0$ then $f(x) > g(x)$ so Formula (1) implies that $A = \int_a^b [f(x) - g(x)] dx = \int_a^b c dx = c(b - a)$. If $g(x) - f(x) = c > 0$ then $g(x) > f(x)$ so $A = \int_a^b [g(x) - f(x)] dx = \int_a^b c dx = c(b - a)$.

28. False. Let $f(x) = 2x$, $g(x) = 0$, $a = -2$, and $b = 1$. Then $\int_a^b [f(x) - g(x)] dx = \int_{-2}^1 2x dx = x^2 \Big|_{-2}^1 = -3$, but the area of A is $\int_{-2}^0 (-2x) dx + \int_0^1 2x dx = -x^2 \Big|_{-2}^0 + x^2 \Big|_0^1 = 4 + 1 = 5$.

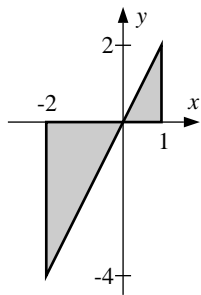

29. True. Since f and g are distinct, there is some point c in $[a, b]$ for which $f(c) \neq g(c)$. Suppose $f(c) > g(c)$. (The case $f(c) < g(c)$ is similar.) Let $p = f(c) - g(c) > 0$. Since $f - g$ is continuous, there is an interval $[d, e]$ containing c such that $f(x) - g(x) > p/2$ for all x in $[d, e]$. So $\int_d^e [f(x) - g(x)] dx \geq \frac{p}{2}(e - d) > 0$. Hence $0 = \int_a^b [f(x) - g(x)] dx = \int_a^d [f(x) - g(x)] dx + \int_d^e [f(x) - g(x)] dx + \int_e^b [f(x) - g(x)] dx, > \int_a^d [f(x) - g(x)] dx + \int_e^b [f(x) - g(x)] dx$, so at least one of $\int_a^d [f(x) - g(x)] dx$ and $\int_e^b [f(x) - g(x)] dx$ is negative. Therefore $f(t) - g(t) < 0$ for some point t in one of the intervals $[a, d]$ and $[e, b]$. So the graph of f is above the graph of g at $x = c$ and below it at $x = t$; by the Intermediate Value Theorem, the curves cross somewhere between c and t .

(Note: It is not necessarily true that the curves cross at a point. For example, let $f(x) = \begin{cases} x & \text{if } x < 0; \\ 0 & \text{if } 0 \leq x \leq 1; \\ x - 1 & \text{if } x > 1, \end{cases}$ and $g(x) = 0$. Then $\int_{-1}^2 [f(x) - g(x)] dx = 0$, and the curves cross between -1 and 2, but there's no single point at which they cross; they coincide for x in $[0, 1]$.)

30. True. Let $h(x) = \begin{cases} f(x) - g(x) & \text{if } f(x) \geq g(x); \\ 0 & \text{if } f(x) < g(x), \end{cases}$ and $k(x) = \begin{cases} 0 & \text{if } f(x) \geq g(x); \\ g(x) - f(x) & \text{if } f(x) < g(x). \end{cases}$

Let $B = \int_a^b h(x) dx$ and $C = \int_a^b k(x) dx$. If the curves cross, then $f(x) > g(x)$ on some interval and $f(x) < g(x)$ on some other interval, so $B > 0$ and $C > 0$. Note that $h(x) + k(x) = |f(x) - g(x)|$ and $h(x) - k(x) = f(x) - g(x)$, so $A = \int_a^b |f(x) - g(x)| dx = \int_a^b h(x) dx + \int_a^b k(x) dx = B + C$. But $A = \left| \int_a^b [f(x) - g(x)] dx \right| = \left| \int_a^b [h(x) - k(x)] dx \right| = \left| \int_a^b h(x) dx - \int_a^b k(x) dx \right| = |B - C| < \max(B, C) < B + C$. Our assumption that the graphs cross leads to a contradiction, so the graphs don't cross.

31. The area is given by $\int_0^k (1/\sqrt{1-x^2} - x) dx = \sin^{-1} k - k^2/2 = 1$; solve for k to get $k \approx 0.997301$.

32. The curves intersect at $x = a = 0$ and $x = b = 0.838422$ so the area is $\int_a^b (\sin 2x - \sin^{-1} x) dx \approx 0.174192$.

33. Solve $3 - 2x = x^6 + 2x^5 - 3x^4 + x^2$ to find the real roots $x = -3, 1$; from a plot it is seen that the line is above the polynomial when $-3 < x < 1$, so $A = \int_{-3}^1 (3 - 2x - (x^6 + 2x^5 - 3x^4 + x^2)) dx = 9152/105$.

34. Solve $x^5 - 2x^3 - 3x = x^3$ to find the roots $x = 0, \pm \frac{1}{2}\sqrt{6 + 2\sqrt{21}}$. Thus, by symmetry,

$$A = 2 \int_0^{\sqrt{(6+2\sqrt{21})}/2} (x^3 - (x^5 - 2x^3 - 3x)) dx = \frac{27}{4} + \frac{7}{4}\sqrt{21}.$$

35. $\int_0^k 2\sqrt{y} dy = \int_k^9 2\sqrt{y} dy$; $\int_0^k y^{1/2} dy = \int_k^9 y^{1/2} dy$, $\frac{2}{3}k^{3/2} = \frac{2}{3}(27 - k^{3/2})$, $k^{3/2} = 27/2$, $k = (27/2)^{2/3} = 9/\sqrt[3]{4}$.

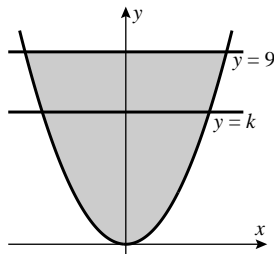

36. $\int_0^k x^2 dx = \int_k^2 x^2 dx$, $\frac{1}{3}k^3 = \frac{1}{3}(8 - k^3)$, $k^3 = 4$, $k = \sqrt[3]{4}$.

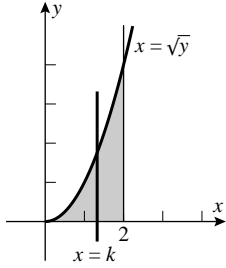

37. (a) $A = \int_0^2 (2x - x^2) dx = 4/3.$

(b) $y = mx$ intersects $y = 2x - x^2$ where $mx = 2x - x^2$, $x^2 + (m - 2)x = 0$, $x(x + m - 2) = 0$ so $x = 0$ or $x = 2 - m$. The area below the curve and above the line is $\int_0^{2-m} (2x - x^2 - mx) dx = \int_0^{2-m} [(2 - m)x - x^2] dx = \left[\frac{1}{2}(2 - m)x^2 - \frac{1}{3}x^3 \right]_0^{2-m} = \frac{1}{6}(2 - m)^3$ so $(2 - m)^3/6 = (1/2)(4/3) = 2/3$, $(2 - m)^3 = 4$, $m = 2 - \sqrt[3]{4}$.

38. The line through $(0, 0)$ and $(5\pi/6, 1/2)$ is $y = \frac{3}{5\pi}x$; $A = \int_0^{5\pi/6} \left(\sin x - \frac{3}{5\pi}x \right) dx = \frac{\sqrt{3}}{2} - \frac{5}{24}\pi + 1.$

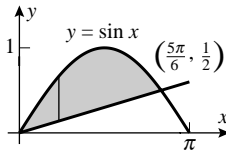

39. The curves intersect at $x = 0$ and, by Newton's Method, at $x \approx 2.595739080 = b$, so $A \approx \int_0^b (\sin x - 0.2x) dx = -\left[\cos x + 0.1x^2 \right]_0^b \approx 1.180898334.$

40. By Newton's Method, the points of intersection are at $x \approx \pm 0.824132312$, so with $b = 0.824132312$ we have $A \approx 2 \int_0^b (\cos x - x^2) dx = 2(\sin x - x^3/3)\Big|_0^b \approx 1.094753609.$

41. By Newton's Method the points of intersection are $x = x_1 \approx 0.4814008713$ and $x = x_2 \approx 2.363938870$, and $A \approx \int_{x_1}^{x_2} \left(\frac{\ln x}{x} - (x - 2) \right) dx \approx 1.189708441.$

42. By Newton's Method the points of intersection are $x = \pm x_1$ where $x_1 \approx 0.6492556537$, thus

$$A \approx 2 \int_0^{x_1} \left(\frac{2}{1+x^2} - 3 + 2 \cos x \right) dx \approx 0.826247888.$$

43. The x -coordinates of the points of intersection are $a \approx -0.423028$ and $b \approx 1.725171$; the area is

$$A = \int_a^b (2 \sin x - x^2 + 1) dx \approx 2.542696.$$

44. Let (a, k) , where $\pi/2 < a < \pi$, be the coordinates of the point of intersection of $y = k$ with $y = \sin x$. Thus $k = \sin a$ and if the shaded areas are equal, $\int_0^a (k - \sin x) dx = \int_0^a (\sin a - \sin x) dx = a \sin a + \cos a - 1 = 0$. Solve for a to get $a \approx 2.331122$, so $k = \sin a \approx 0.724611$.

45. $\int_0^{60} [v_2(t) - v_1(t)] dt = s_2(60) - s_2(0) - [s_1(60) - s_1(0)]$, but they are even at time $t = 60$, so $s_2(60) = s_1(60)$. Consequently the integral gives the difference $s_1(0) - s_2(0)$ of their starting points in meters.

46. Since $v_1(0) = v_2(0) = 0$, $A = \int_0^T [a_2(t) - a_1(t)] dt = v_2(T) - v_1(T)$ is the difference in the velocities of the two cars at time T .

47. The area in question is the increase in population from 1960 to 2010.

48. The area in question is $A = \int_0^8 [a'(t) - e'(t)] dt = a(8) - e(8) - (a(0) - e(0))$, which is the difference between the amount of medication present in the bloodstream at time $t = 8$ and $t = 0$.

49. Solve $x^{1/2} + y^{1/2} = a^{1/2}$ for y to get $y = (a^{1/2} - x^{1/2})^2 = a - 2a^{1/2}x^{1/2} + x$, $A = \int_0^a (a - 2a^{1/2}x^{1/2} + x) dx = a^2/6$.

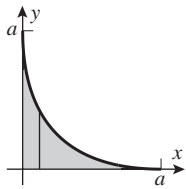

50. Solve for y to get $y = (b/a)\sqrt{a^2 - x^2}$ for the upper half of the ellipse; make use of symmetry to get $A = 4 \int_0^a \frac{b}{a} \sqrt{a^2 - x^2} dx = \frac{4b}{a} \int_0^a \sqrt{a^2 - x^2} dx = \frac{4b}{a} \cdot \frac{1}{4} \pi a^2 = \pi ab$.

51. First find all solutions of the equation $f(x) = g(x)$ in the interval $[a, b]$; call them c_1, \dots, c_n . Let $c_0 = a$ and $c_{n+1} = b$. For $i = 0, 1, \dots, n$, $f(x) - g(x)$ has constant sign on $[c_i, c_{i+1}]$, so the area bounded by $x = c_i$ and $x = c_{i+1}$ is either $\int_{c_i}^{c_{i+1}} [f(x) - g(x)] dx$ or $\int_{c_i}^{c_{i+1}} [g(x) - f(x)] dx$. Compute each of these $n + 1$ areas and add them to get the area bounded by $x = a$ and $x = b$.

52. Let $f(x)$ be the length of the intersection of R with the vertical line with x -coordinate x . Divide the interval $[a, b]$ into n subintervals, and use those to divide R into n strips. If the width of the k 'th strip is Δx_k , approximate the area of the strip by $f(x_k^*)\Delta x_k$, where x_k^* is a point in the k 'th subinterval. Add the approximate areas to approximate the entire area of R by the Riemann sum $\sum_{k=1}^n f(x_k^*)\Delta x_k$. Take the limit as $n \rightarrow +\infty$ and the widths

of the subintervals all approach zero, to obtain the area of R , $\int_a^b f(x) dx$. Since $f(x)$ is also the length of the intersection of S with the vertical line with x -coordinate x , we similarly find that the area of S equals the same integral, so R and S have the same area.

Exercise Set 6.2

1. $V = \pi \int_{-1}^3 (3 - x) dx = 8\pi$.

2. $V = \pi \int_0^1 [(2 - x^2)^2 - x^2] dx = \pi \int_0^1 (4 - 5x^2 + x^4) dx = 38\pi/15$.

3. $V = \pi \int_0^2 \frac{1}{4}(3 - y)^2 dy = 13\pi/6$.

4. $V = \pi \int_{1/2}^2 (4 - 1/y^2) dy = 9\pi/2$.

$$5. V = \pi \int_{\pi/4}^{\pi/2} \cos x \, dx = (1 - \sqrt{2}/2)\pi.$$

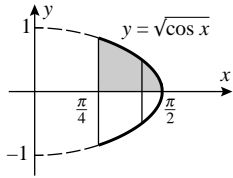

$$6. V = \pi \int_0^1 [(x^2)^2 - (x^3)^2] \, dx = \pi \int_0^1 (x^4 - x^6) \, dx = 2\pi/35.$$

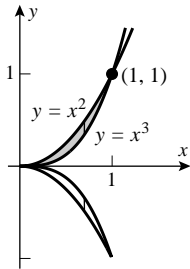

$$7. V = \pi \int_{-1}^3 (1 + y) \, dy = 8\pi.$$

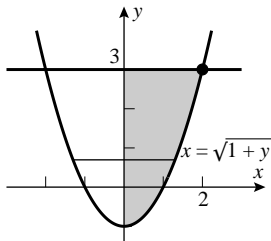

$$8. V = \pi \int_0^3 [2^2 - (y + 1)] \, dy = \pi \int_0^3 (3 - y) \, dy = 9\pi/2.$$

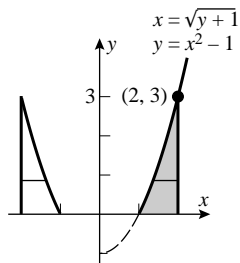

$$9. V = \int_0^2 x^4 \, dx = 32/5.$$

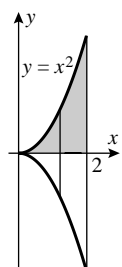

10. $V = \int_{\pi/4}^{\pi/3} \sec^2 x \, dx = \sqrt{3} - 1.$

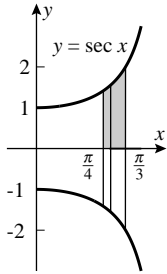

11. $V = \pi \int_{-4}^4 [(25 - x^2) - 9] \, dx = 2\pi \int_0^4 (16 - x^2) \, dx = 256\pi/3.$

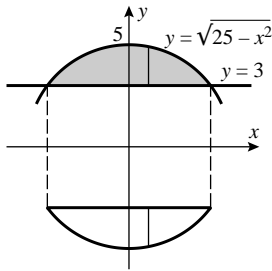

12. $V = \pi \int_{-3}^3 (9 - x^2)^2 \, dx = \pi \int_{-3}^3 (81 - 18x^2 + x^4) \, dx = 1296\pi/5.$

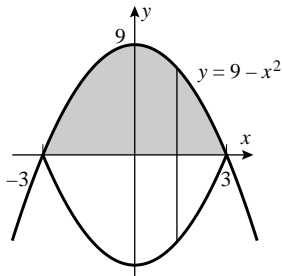

13. $V = \pi \int_0^4 [(4x)^2 - (x^2)^2] \, dx = \pi \int_0^4 (16x^2 - x^4) \, dx = 2048\pi/15.$

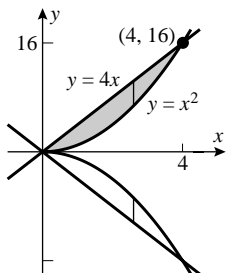

14. $V = \pi \int_0^{\pi/4} (\cos^2 x - \sin^2 x) \, dx = \pi \int_0^{\pi/4} \cos 2x \, dx = \pi/2.$

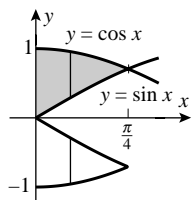

$$15. V = \pi \int_0^{\ln 3} e^{2x} dx = \frac{\pi}{2} e^{2x} \Big|_0^{\ln 3} = 4\pi.$$

$$16. V = \pi \int_0^1 e^{-4x} dx = \frac{\pi}{4} (1 - e^{-4}).$$

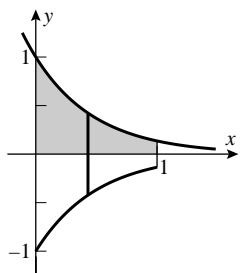

$$17. V = \int_{-2}^2 \pi \frac{1}{4+x^2} dx = \frac{\pi}{2} \tan^{-1}(x/2) \Big|_{-2}^2 = \pi^2/4.$$

$$18. V = \int_0^1 \pi \frac{e^{6x}}{1+e^{6x}} dx = \frac{\pi}{6} \ln(1+e^{6x}) \Big|_0^1 = \frac{\pi}{6} (\ln(1+e^6) - \ln 2).$$

$$19. V = \int_0^1 (y^{1/3})^2 dy = \frac{3}{5}.$$

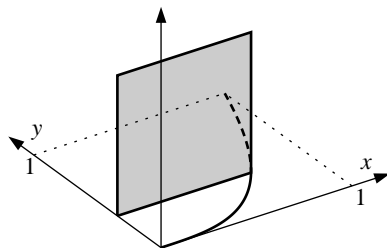

$$20. V = \int_{-1}^1 (1-y^2)^2 dy = 2 \int_0^1 (1-y^2)^2 dy = 2 \left(1 - \frac{2}{3} + \frac{1}{5} \right) = \frac{16}{15}.$$

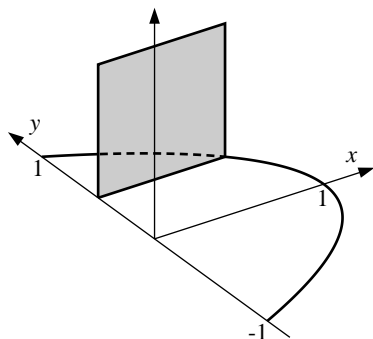

21. $V = \pi \int_{\pi/4}^{3\pi/4} \csc^2 y \, dy = 2\pi.$

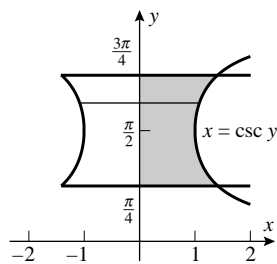

22. $V = \pi \int_0^1 (y - y^4) \, dy = 3\pi/10.$

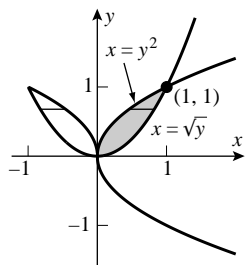

23. $V = \pi \int_{-1}^2 [(y + 2)^2 - y^4] \, dy = 72\pi/5.$

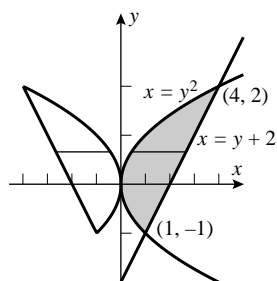

24. $V = \pi \int_{-1}^1 [(2 + y^2)^2 - (1 - y^2)^2] \, dy = \pi \int_{-1}^1 (3 + 6y^2) \, dy = 10\pi.$

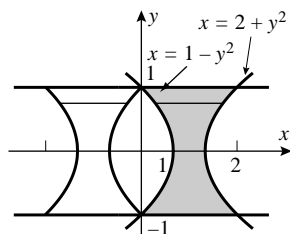

25. $V = \int_0^1 \pi e^{2y} \, dy = \frac{\pi}{2} (e^2 - 1).$

26. $V = \int_0^2 \frac{\pi}{1 + y^2} \, dy = \pi \tan^{-1} 2.$

27. False. For example, consider the pyramid in Example 1, with the roles of the x - and y -axes interchanged.

28. False. If the centers of the disks or washers don't all lie on a line parallel to the x -axis, then S isn't a solid of revolution.

29. False. For example, let S be the solid generated by rotating the region under $y = e^x$ over the interval $[0, 1]$. Then $A(x) = \pi(e^x)^2$.

30. True. By Definition 5.8.1, the average value of $A(x)$ is $\frac{1}{b-a} \int_a^b A(x) dx = \frac{V}{b-a}$.

31. $V = \pi \int_{-a}^a \frac{b^2}{a^2} (a^2 - x^2) dx = 4\pi ab^2/3$.

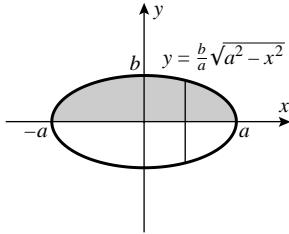

32. $V = \pi \int_b^2 \frac{1}{x^2} dx = \pi(1/b - 1/2)$; $\pi(1/b - 1/2) = 3$, $b = 2\pi/(\pi + 6)$.

33. $V = \pi \int_{-1}^0 (x+1) dx + \pi \int_0^1 [(x+1) - 2x] dx = \pi/2 + \pi/2 = \pi$.

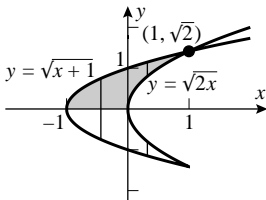

34. $V = \pi \int_0^4 x dx + \pi \int_4^6 (6-x)^2 dx = 8\pi + 8\pi/3 = 32\pi/3$.

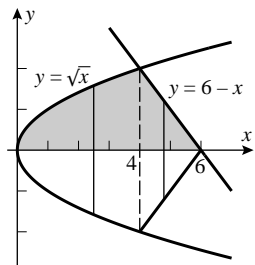

35. Partition the interval $[a, b]$ with $a = x_0 < x_1 < x_2 < \dots < x_{n-1} < x_n = b$. Let x_k^* be an arbitrary point of $[x_{k-1}, x_k]$. The disk in question is obtained by revolving about the line $y = k$ the rectangle for which $x_{k-1} < x < x_k$, and y lies between $y = k$ and $y = f(x)$; the volume of this disk is $\Delta V_k = \pi(f(x_k^*) - k)^2 \Delta x_k$, and the total volume is given by $V = \pi \int_a^b (f(x) - k)^2 dx$.

36. Assume for $c < y < d$ that $k \leq v(y) \leq w(y)$ (A similar proof holds for $k \geq v(y) \geq w(y)$). Partition the interval $[c, d]$ with $c = y_0 < y_1 < y_2 < \dots < y_{n-1} < y_n = d$. Let y_k^* be an arbitrary point of $[y_{k-1}, y_k]$. The washer in question is the region obtained by revolving the strip $v(y_k^*) < x < w(y_k^*)$, $y_{k-1} < y < y_k$ about the line $x = k$. The volume of this washer is $\Delta V = \pi[(v(y_k^*) - k)^2 - (w(y_k^*) - k)^2] \Delta y_k$, and the volume of the solid obtained by rotating R is $V = \pi \int_c^d [(v(y) - k)^2 - (w(y) - k)^2] dy$.

37. (a) Intuitively, it seems that a line segment which is revolved about a line which is perpendicular to the line

segment will generate a larger area, the farther it is from the line. This is because the average point on the line segment will be revolved through a circle with a greater radius, and thus sweeps out a larger circle. Consider the line segment which connects a point (x, y) on the curve $y = \sqrt{3-x}$ to the point $(x, 0)$ beneath it. If this line segment is revolved around the x -axis we generate an area πy^2 .

If on the other hand the segment is revolved around the line $y = 2$ then the area of the resulting (infinitely thin) washer is $\pi[2^2 - (2 - y)^2]$. So the question can be reduced to asking whether $y^2 \geq [2^2 - (2 - y)^2]$, $y^2 \geq 4y - y^2$, or $y \geq 2$. In the present case the curve $y = \sqrt{3-x}$ always satisfies $y \leq 2$, so V_2 has the larger volume.

(b) The volume of the solid generated by revolving the area around the x -axis is $V_1 = \pi \int_{-1}^3 (3-x) dx = 8\pi$, and the volume generated by revolving the area around the line $y = 2$ is $V_2 = \pi \int_{-1}^3 [2^2 - (2 - \sqrt{3-x})^2] dx = \frac{40}{3}\pi$.

38. (a) In general, points in the region R are farther from the y -axis than they are from the line $x = 2.5$, so by the reasoning in Exercise 33(a) the former should generate a larger volume than the latter, i.e. the volume mentioned in Exercise 4 will be greater than that gotten by revolving about the line $x = 2.5$.

(b) The original volume V_1 of Exercise 4 is given by $V_1 = \pi \int_{1/2}^2 (4 - 1/y^2) dy = 9\pi/2$, and the other volume $V_2 = \pi \int_{1/2}^2 \left[\left(\frac{1}{y} - 2.5\right)^2 - (2 - 2.5)^2 \right] dy = \left(\frac{21}{2} - 10 \ln 2\right) \pi \approx 3.568528194\pi$, and thus V_1 is the larger volume.

39. $V = \pi \int_0^3 (9 - y^2)^2 dy = \pi \int_0^3 (81 - 18y^2 + y^4) dy = 648\pi/5$.

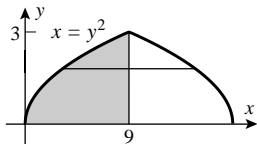

40. $V = \pi \int_0^9 [3^2 - (3 - \sqrt{x})^2] dx = \pi \int_0^9 (6\sqrt{x} - x) dx = 135\pi/2$.

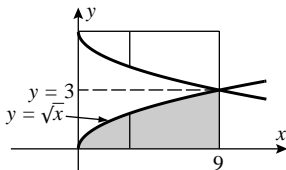

41. $V = \pi \int_0^1 [(\sqrt{x} + 1)^2 - (x + 1)^2] dx = \pi \int_0^1 (2\sqrt{x} - x - x^2) dx = \pi/2$.

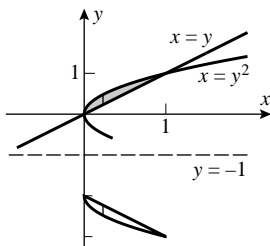

42. $V = \pi \int_0^1 [(y + 1)^2 - (y^2 + 1)^2] dy = \pi \int_0^1 (2y - y^2 - y^4) dy = 7\pi/15$.

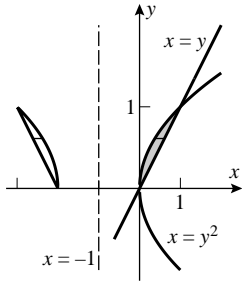

43. The region is given by the inequalities $0 \leq y \leq 1$, $\sqrt{y} \leq x \leq \sqrt[3]{y}$. For each y in the interval $[0, 1]$ the cross-section of the solid perpendicular to the axis $x = 1$ is a washer with outer radius $1 - \sqrt{y}$ and inner radius $1 - \sqrt[3]{y}$. The area of this washer is $A(y) = \pi[(1 - \sqrt{y})^2 - (1 - \sqrt[3]{y})^2] = \pi(-2y^{1/2} + y + 2y^{1/3} - y^{2/3})$, so the volume is
- $$V = \int_0^1 A(y) dy = \pi \int_0^1 (-2y^{1/2} + y + 2y^{1/3} - y^{2/3}) dy = \pi \left[-\frac{4}{3}y^{3/2} + \frac{1}{2}y^2 + \frac{3}{2}y^{4/3} - \frac{3}{5}y^{5/3} \right]_0^1 = \frac{\pi}{15}.$$

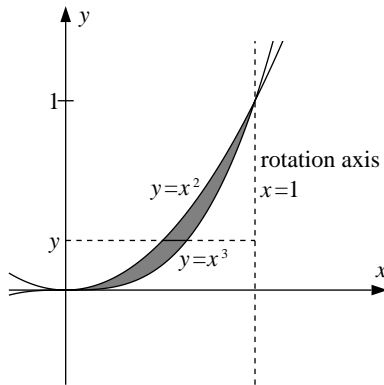

44. The region is given by the inequalities $0 \leq x \leq 1$, $x^3 \leq y \leq x^2$. For each x in the interval $[0, 1]$ the cross-section of the solid perpendicular to the axis $y = -1$ is a washer with outer radius $1 + x^2$ and inner radius $1 + x^3$. The area of this washer is $A(x) = \pi[(1 + x^2)^2 - (1 + x^3)^2] = \pi(2x^2 + x^4 - 2x^3 - x^6)$, so the volume is
- $$V = \int_0^1 A(x) dx = \pi \int_0^1 (2x^2 + x^4 - 2x^3 - x^6) dx = \pi \left[\frac{2}{3}x^3 + \frac{1}{5}x^5 - \frac{1}{2}x^4 - \frac{1}{7}x^7 \right]_0^1 = \frac{47\pi}{210}.$$

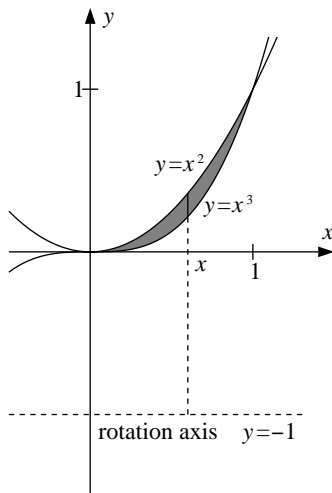

45. $A(x) = \pi(x^2/4)^2 = \pi x^4/16$, $V = \int_0^{20} (\pi x^4/16) dx = 40,000\pi \text{ ft}^3$.

46. $V = \pi \int_0^1 (x - x^4) dx = 3\pi/10.$

47. $V = \int_0^1 (x - x^2)^2 dx = \int_0^1 (x^2 - 2x^3 + x^4) dx = 1/30.$

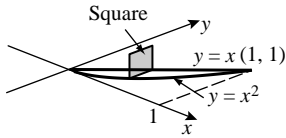

48. $A(x) = \frac{1}{2}\pi \left(\frac{1}{2}\sqrt{x}\right)^2 = \frac{1}{8}\pi x, V = \int_0^4 \frac{1}{8}\pi x dx = \pi.$

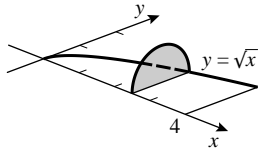

49. On the upper half of the circle, $y = \sqrt{1 - x^2}$, so:

(a) $A(x)$ is the area of a semicircle of radius y , so $A(x) = \pi y^2/2 = \pi(1 - x^2)/2$; $V = \frac{\pi}{2} \int_{-1}^1 (1 - x^2) dx = \pi \int_0^1 (1 - x^2) dx = 2\pi/3.$

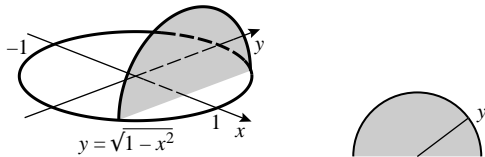

(b) $A(x)$ is the area of a square of side $2y$, so $A(x) = 4y^2 = 4(1 - x^2)$; $V = 4 \int_{-1}^1 (1 - x^2) dx = 8 \int_0^1 (1 - x^2) dx = 16/3.$

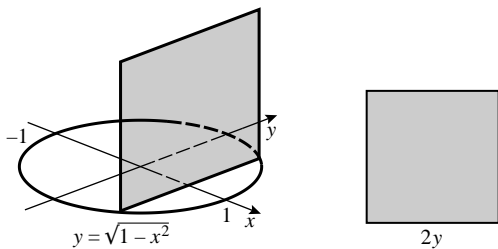

(c) $A(x)$ is the area of an equilateral triangle with sides $2y$, so $A(x) = \frac{\sqrt{3}}{4}(2y)^2 = \sqrt{3}y^2 = \sqrt{3}(1 - x^2)$; $V = \int_{-1}^1 \sqrt{3}(1 - x^2) dx = 2\sqrt{3} \int_0^1 (1 - x^2) dx = 4\sqrt{3}/3.$

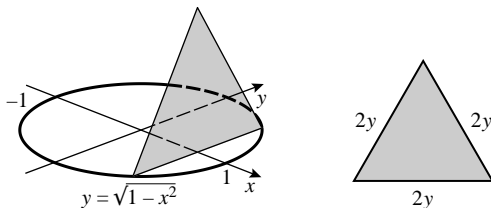

50. The base of the tent is a hexagon of side r . An equation of the circle of radius r that lies in a vertical x - y plane and passes through two opposite vertices of the base hexagon is $x^2 + y^2 = r^2$. A horizontal, hexagonal cross section at height y above the base has area $A(y) = \frac{3\sqrt{3}}{2}x^2 = \frac{3\sqrt{3}}{2}(r^2 - y^2)$, hence the volume is $V = \int_0^r \frac{3\sqrt{3}}{2}(r^2 - y^2) dy = \sqrt{3}r^3$.

51. The two curves cross at $x = b \approx 1.403288534$, so $V = \pi \int_0^b ((2x/\pi)^2 - \sin^{16} x) dx + \pi \int_b^{\pi/2} (\sin^{16} x - (2x/\pi)^2) dx \approx 0.710172176$.

52. Note that $\pi^2 \sin x \cos^3 x = 4x^2$ for $x = \pi/4$. From the graph it is apparent that this is the first positive solution, thus the curves don't cross on $(0, \pi/4)$ and $V = \pi \int_0^{\pi/4} [(\pi^2 \sin x \cos^3 x)^2 - (4x^2)^2] dx = \frac{1}{48}\pi^5 + \frac{17}{2560}\pi^6$.

53. $V = \pi \int_1^e (1 - (\ln y)^2) dy = \pi$.

54. $V = \int_0^{\tan^{-1} 1} \pi[x^2 - x^2 \tan^{-1} x] dx = \frac{\pi}{6}[\tan^2 1 - \ln(1 + \tan^2 1)]$.

55. (a) $V = \pi \int_{r-h}^r (r^2 - y^2) dy = \pi(rh^2 - h^3/3) = \frac{1}{3}\pi h^2(3r - h)$.

(b) By the Pythagorean Theorem, $r^2 = (r - h)^2 + \rho^2$, $2hr = h^2 + \rho^2$; from part (a), $V = \frac{\pi h}{3}(3hr - h^2) = \frac{\pi h}{3} \left(\frac{3}{2}(h^2 + \rho^2) - h^2 \right) = \frac{1}{6}\pi h(3\rho^2 + h^2)$.

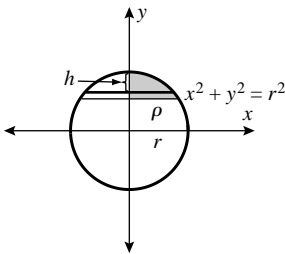

56. First, we find the volume generated by revolving the shaded region about the y -axis: $V = \pi \int_{-10}^{-10+h} (100 - y^2) dy = \frac{\pi}{3}h^2(30 - h)$. Then we find dh/dt when $h = 5$ given that $dV/dt = 1/2$: $V = \frac{\pi}{3}(30h^2 - h^3)$, $\frac{dV}{dt} = \frac{\pi}{3}(60h - 3h^2)\frac{dh}{dt}$, $\frac{1}{2} = \frac{\pi}{3}(300 - 75)\frac{dh}{dt}$, $\frac{dh}{dt} = 1/(150\pi)$ ft/min.

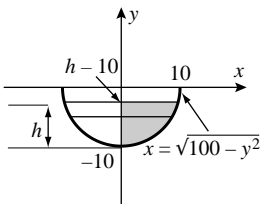

57. (a) The bulb is approximately a sphere of radius 1.25 cm attached to a cylinder of radius 0.625 cm and length 2.5 cm, so its volume is roughly $\frac{4}{3}\pi(1.25)^3 + \pi(0.625)^2 \cdot 2.5 \approx 11.25$ cm. (Other answers are possible, depending on how we approximate the light bulb using familiar shapes.)

(b) $\Delta x = \frac{5}{10} = 0.5$; $\{y_0, y_1, \dots, y_{10}\} = \{0, 2.00, 2.45, 2.45, 2.00, 1.46, 1.26, 1.25, 1.25, 1.25, 1.25\}$;

$$\text{left} = \pi \sum_{i=0}^9 \left(\frac{y_i}{2}\right)^2 \Delta x \approx 11.157; \text{right} = \pi \sum_{i=1}^{10} \left(\frac{y_i}{2}\right)^2 \Delta x \approx 11.771; V \approx \text{average} = 11.464 \text{ cm}^3.$$

58. If $x = r/2$, then from $y^2 = r^2 - x^2$ we get $y = \pm\sqrt{3}r/2$. So the hole consists of a cylinder of radius $r/2$ and length $\sqrt{3}r$ and two spherical caps of radius $r/2$ and height $(1 - \sqrt{3}/2)r$. The cylinder has volume $\pi \left(\frac{r}{2}\right)^2 \sqrt{3}r = \frac{\pi\sqrt{3}}{4}r^3$. From Exercise 55(a), each cap has volume $\frac{1}{3}\pi \left[\left(1 - \frac{\sqrt{3}}{2}\right)r\right]^2 \left(3r - \left(1 - \frac{\sqrt{3}}{2}\right)r\right) = \frac{\pi}{24}(16 - 9\sqrt{3})r^3$. So the volume of the hole is $\frac{\pi\sqrt{3}}{4}r^3 + 2\frac{\pi}{24}(16 - 9\sqrt{3})r^3 = \frac{\pi}{6}(8 - 3\sqrt{3})r^3$ and the volume remaining is $\frac{4}{3}\pi r^3 - \frac{\pi}{6}(8 - 3\sqrt{3})r^3 = \frac{\pi\sqrt{3}}{2}r^3$. To obtain this by integrating, note that, for $-\sqrt{3} \leq y \leq \sqrt{3}$, the cross-section with y -coordinate y has area $A(y) = \pi[(r^2 - y^2) - r^2/4] = \pi(3r^2/4 - y^2)$, thus $V = \pi \int_{-\sqrt{3}r/2}^{\sqrt{3}r/2} (3r^2/4 - y^2) dy = 2\pi \int_0^{\sqrt{3}r/2} (3r^2/4 - y^2) dy = \frac{\pi\sqrt{3}}{2}r^3$.

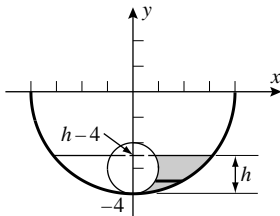
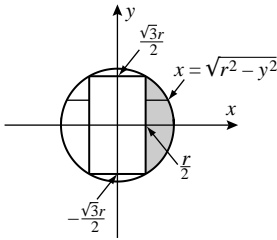

59. (a) $0 \leq h < 2$

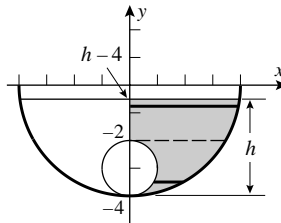

(b) $2 \leq h \leq 4$

If the cherry is partially submerged then $0 \leq h < 2$ as shown in Figure (a); if it is totally submerged then $2 \leq h \leq 4$ as shown in Figure (b). The radius of the glass is 4 cm and that of the cherry is 1 cm so points on the sections shown in the figures satisfy the equations $x^2 + y^2 = 16$ and $x^2 + (y + 3)^2 = 1$. We will find the volumes of the solids that are generated when the shaded regions are revolved about the y -axis. For $0 \leq h < 2$, $V = \pi \int_{-4}^{h-4} [(16 - y^2) - (1 - (y + 3)^2)] dy = 6\pi \int_{-4}^{h-4} (y + 4) dy = 3\pi h^2$; for $2 \leq h \leq 4$, $V = \pi \int_{-4}^{-2} [(16 - y^2) - (1 - (y + 3)^2)] dy + \pi \int_{-2}^{h-4} (16 - y^2) dy = 6\pi \int_{-4}^{-2} (y + 4) dy + \pi \int_{-2}^{h-4} (16 - y^2) dy = 12\pi + \frac{1}{3}\pi(12h^2 - h^3 - 40) = \frac{1}{3}\pi(12h^2 - h^3 - 4)$, so $V = \begin{cases} 3\pi h^2 & \text{if } 0 \leq h < 2 \\ \frac{1}{3}\pi(12h^2 - h^3 - 4) & \text{if } 2 \leq h \leq 4 \end{cases}$.

60. $x = h \pm \sqrt{r^2 - y^2}, V = \pi \int_{-r}^r [(h + \sqrt{r^2 - y^2})^2 - (h - \sqrt{r^2 - y^2})^2] dy = 4\pi h \int_{-r}^r \sqrt{r^2 - y^2} dy = 4\pi h \left(\frac{1}{2}\pi r^2\right) = 2\pi^2 r^2 h$.

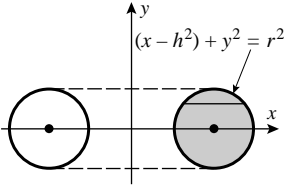

61. $\tan \theta = h/x$ so $h = x \tan \theta$, $A(y) = \frac{1}{2}hx = \frac{1}{2}x^2 \tan \theta = \frac{1}{2}(r^2 - y^2) \tan \theta$, because $x^2 = r^2 - y^2$, and this implies that $V = \frac{1}{2} \tan \theta \int_{-r}^r (r^2 - y^2) dy = \tan \theta \int_0^r (r^2 - y^2) dy = \frac{2}{3}r^3 \tan \theta$.

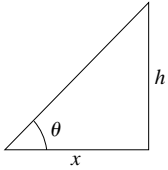

62. $A(x) = (x \tan \theta)(2\sqrt{r^2 - x^2}) = 2(\tan \theta)x\sqrt{r^2 - x^2}$, $V = 2 \tan \theta \int_0^r x\sqrt{r^2 - x^2} dx = \frac{2}{3}r^3 \tan \theta$.

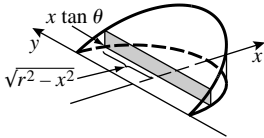

63. Each cross section perpendicular to the y -axis is a square so $A(y) = x^2 = r^2 - y^2$, $\frac{1}{8}V = \int_0^r (r^2 - y^2) dy$, so $V = 8(2r^3/3) = 16r^3/3$.

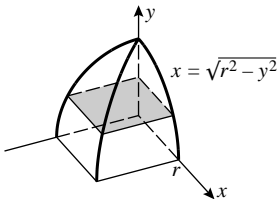

64. The regular cylinder of radius r and height h has the same circular cross sections as do those of the oblique cylinder, so by Cavalieri's Principle, they have the same volume: $\pi r^2 h$.
65. Position an x -axis perpendicular to the bases of the solids. Let a be the smallest x -coordinate of any point in either solid, and let b be the largest. Let $A(x)$ be the common area of the cross-sections of the solids at x -coordinate x . By equation (3), each solid has volume $V = \int_a^b A(x) dx$, so they are equal.
66. Equation (4) is obtained from equation (3) simply by interchanging the x - and y -axes. Equations (5) and (6) are special cases of equation (3) using particular formulas for $A(x)$. Similarly, equations (7) and (8) are special case of equation (4), so they also follow from (3) by interchanging the axes.

Exercise Set 6.3

1. $V = \int_1^2 2\pi x(x^2) dx = 2\pi \int_1^2 x^3 dx = 15\pi/2$.

2. $V = \int_0^{\sqrt{2}} 2\pi x(\sqrt{4-x^2} - x) dx = 2\pi \int_0^{\sqrt{2}} (x\sqrt{4-x^2} - x^2) dx = \frac{8\pi}{3}(2 - \sqrt{2})$.

$$3. V = \int_0^1 2\pi y(2y - 2y^2) dy = 4\pi \int_0^1 (y^2 - y^3) dy = \pi/3.$$

$$4. V = \int_0^2 2\pi y[y - (y^2 - 2)] dy = 2\pi \int_0^2 (y^2 - y^3 + 2y) dy = 16\pi/3.$$

$$5. V = \int_0^1 2\pi(x)(x^3) dx = 2\pi \int_0^1 x^4 dx = 2\pi/5.$$

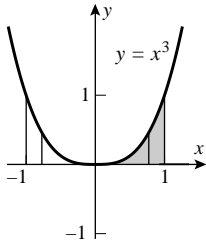

$$6. V = \int_4^9 2\pi x(\sqrt{x}) dx = 2\pi \int_4^9 x^{3/2} dx = 844\pi/5.$$

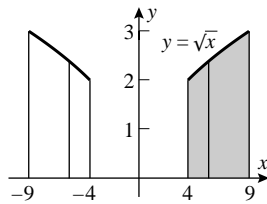

$$7. V = \int_1^3 2\pi x(1/x) dx = 2\pi \int_1^3 dx = 4\pi.$$

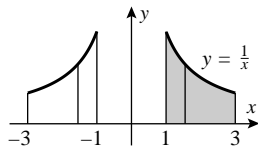

$$8. V = \int_0^{\sqrt{\pi}/2} 2\pi x \cos(x^2) dx = \pi/\sqrt{2}.$$

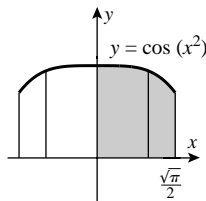

$$9. V = \int_1^2 2\pi x[(2x - 1) - (-2x + 3)] dx = 8\pi \int_1^2 (x^2 - x) dx = 20\pi/3.$$

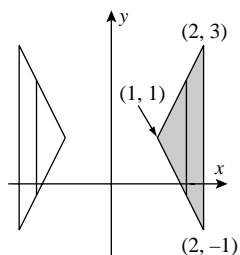

$$10. V = \int_0^2 2\pi x(2x - x^2) dx = 2\pi \int_0^2 (2x^2 - x^3) dx = \frac{8}{3}\pi.$$

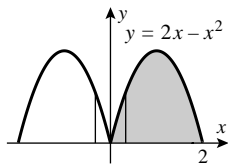

$$11. V = 2\pi \int_0^1 \frac{x}{x^2 + 1} dx = \pi \ln(x^2 + 1) \Big|_0^1 = \pi \ln 2.$$

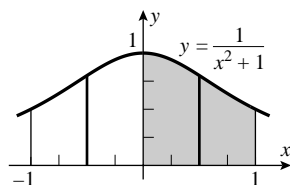

$$12. V = \int_1^{\sqrt{3}} 2\pi x e^{x^2} dx = \pi e^{x^2} \Big|_1^{\sqrt{3}} = \pi(e^3 - e).$$

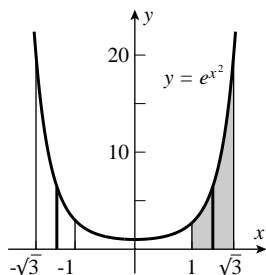

$$13. V = \int_0^1 2\pi y^3 dy = \pi/2.$$

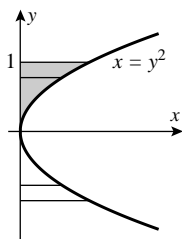

$$14. V = \int_2^3 2\pi y(2y) dy = 4\pi \int_2^3 y^2 dy = 76\pi/3.$$

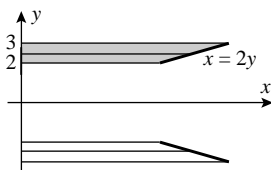

$$15. V = \int_0^1 2\pi y(1 - \sqrt{y}) dy = 2\pi \int_0^1 (y - y^{3/2}) dy = \pi/5.$$

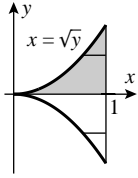

16. $V = \int_1^4 2\pi y(5 - y - 4/y) dy = 2\pi \int_1^4 (5y - y^2 - 4) dy = 9\pi.$

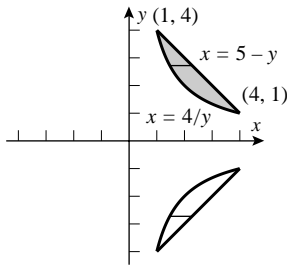

17. True. The surface area of the cylinder is $2\pi \cdot [\text{average radius}] \cdot [\text{height}]$, so by equation (1) the volume equals the thickness times the surface area.

18. False. In the method of cylindrical shells we do not use cross-sections of the solid.

19. True. In 6.3.2 we integrate over an interval on the x -axis, which is perpendicular to the y -axis, which is the axis of revolution.

20. True. If $f(x) = c$ for all x , then the Riemann sum equals $\sum_{k=1}^n 2\pi x_k^* f(x_k^*) \Delta x_k = \sum_{k=1}^n 2\pi \frac{x_k + x_{k-1}}{2} c (x_k - x_{k-1}) = \pi c \sum_{k=1}^n (x_k^2 - x_{k-1}^2) = \pi c (x_n^2 - x_0^2)$. The volume equals $\int_a^b 2\pi x f(x) dx = \int_a^b 2\pi x c dx = \pi c x^2 \Big|_a^b = \pi c (b^2 - a^2)$. Hence each Riemann sum equals the volume.

21. $V = 2\pi \int_1^2 x e^x dx = 2\pi(x - 1)e^x \Big|_1^2 = 2\pi e^2.$

22. $V = 2\pi \int_0^{\pi/2} x \cos x dx = \pi^2 - 2\pi.$

23. The volume is given by $2\pi \int_0^k x \sin x dx = 2\pi(\sin k - k \cos k) = 8$; solve for k to get $k \approx 1.736796$.

24. (a) $\int_a^b 2\pi x[f(x) - g(x)] dx$ (b) $\int_c^d 2\pi y[f(y) - g(y)] dy$

25. (a) $V = \int_0^1 2\pi x(x^3 - 3x^2 + 2x) dx = 7\pi/30.$

(b) Much easier; the method of slicing would require that x be expressed in terms of y .

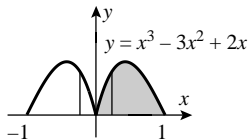

26. Let $a = x_0 < x_1 < x_2 < \dots < x_{n-1} < x_n = b$ be a partition of $[a, b]$. Let x_k^* be the midpoint of $[x_{k-1}, x_k]$. Revolve the strip $x_{k-1} < x < x_k, 0 < y < f(x_k^*)$ about the line $x = k$. The result is a cylindrical shell, a large coin with a very large hole through the center. The volume of the shell is $\Delta V_k = 2\pi(x - k)f(x_k^*)\Delta x_k$, just as the volume of a ring of average radius r , height y and thickness h is $2\pi r y h$. Summing these volumes of cylindrical shells and taking the limit as $\max \Delta x_k$ goes to zero, we obtain $V = 2\pi \int_a^b (x - k)f(x) dx$.

27. (a) For x in $[0, 1]$, the cross-section with x -coordinate x has length x , and its distance from the axis of revolution is $1 - x$, so the volume is $\int_0^1 2\pi(1 - x)x dx$.

(b) For y in $[0, 1]$, the cross-section with y -coordinate y has length $1 - y$, and its distance from the axis of revolution is $1 + y$, so the volume is $\int_0^1 2\pi(1 + y)(1 - y) dy$.

28. (a) For x in $[0, 1]$, the cross-section with x -coordinate x has length $\sqrt{1 - x^2}$, and its distance from the axis of revolution is $1 - x$, so the volume is $\int_0^1 2\pi(1 - x)\sqrt{1 - x^2} dx$.

(b) For y in $[0, 1]$, the cross-section with y -coordinate y has length $\sqrt{1 - y^2}$, and its distance from the axis of revolution is $1 + y$, so the volume is $\int_0^1 2\pi(1 + y)\sqrt{1 - y^2} dy$.

29. $V = \int_1^2 2\pi(x + 1)(1/x^3) dx = 2\pi \int_1^2 (x^{-2} + x^{-3}) dx = 7\pi/4$.

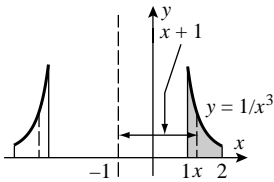

30. $V = \int_0^1 2\pi(1 - y)y^{1/3} dy = 2\pi \int_0^1 (y^{1/3} - y^{4/3}) dy = 9\pi/14$.

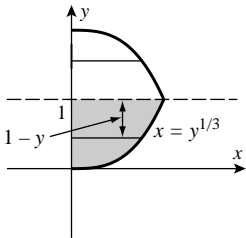

31. $x = \frac{h}{r}(r - y)$ is an equation of the line through $(0, r)$ and $(h, 0)$, so $V = \int_0^r 2\pi y \left[\frac{h}{r}(r - y) \right] dy = \frac{2\pi h}{r} \int_0^r (ry - y^2) dy = \pi r^2 h/3$.

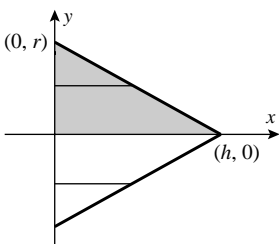

$$32. V = \int_0^{k/4} 2\pi(k/2 - x)2\sqrt{kx} \, dx = 2\pi\sqrt{k} \int_0^{k/4} (kx^{1/2} - 2x^{3/2}) \, dx = 7\pi k^3/60.$$

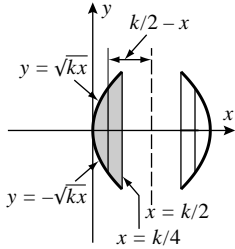

33. Let the sphere have radius R , the hole radius r . By the Pythagorean Theorem, $r^2 + (L/2)^2 = R^2$. Use cylindrical shells to calculate the volume of the solid obtained by rotating about the y -axis the region $r < x < R$, $-\sqrt{R^2 - x^2} < y < \sqrt{R^2 - x^2}$: $V = \int_r^R (2\pi x)2\sqrt{R^2 - x^2} \, dx = -\frac{4}{3}\pi(R^2 - x^2)^{3/2} \Big|_r^R = \frac{4}{3}\pi(L/2)^3$, so the volume is independent of R .

$$34. V = \int_{-a}^a 2\pi(b - x)(2\sqrt{a^2 - x^2}) \, dx = 4\pi b \int_{-a}^a \sqrt{a^2 - x^2} \, dx - 4\pi \int_{-a}^a x\sqrt{a^2 - x^2} \, dx = 4\pi b \cdot (\text{area of a semicircle of radius } a) - 4\pi(0) = 2\pi^2 a^2 b.$$

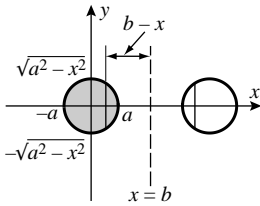

35. $V_x = \pi \int_{1/2}^b \frac{1}{x^2} \, dx = \pi(2 - 1/b)$, $V_y = 2\pi \int_{1/2}^b x \, dx = \pi(2b - 1)$; $V_x = V_y$ if $2 - 1/b = 2b - 1$, $2b^2 - 3b + 1 = 0$, solve to get $b = 1/2$ (reject) or $b = 1$.

$$36. (a) V = 2\pi \int_1^b \frac{x}{1 + x^4} \, dx = \pi \tan^{-1}(x^2) \Big|_1^b = \pi \left[\tan^{-1}(b^2) - \frac{\pi}{4} \right].$$

$$(b) \lim_{b \rightarrow +\infty} V = \pi \left(\frac{\pi}{2} - \frac{\pi}{4} \right) = \frac{1}{4}\pi^2.$$

37. If the formula for the length of a cross-section perpendicular to the axis of revolution is simpler than the formula for the length of a cross-section parallel to the axis of revolution, then the method of disks/washers is probably easier. Otherwise the method of cylindrical shells probably is.

38. In the method of disks/washers, we integrate the area of a flat surface, perpendicular to the axis of revolution. The variable of integration measures distance along the axis of revolution.

In the method of cylindrical shells, we integrate the area of a curved surface surrounding the axis of revolution. The variable of integration measures distance perpendicular to the axis of revolution.

Exercise Set 6.4

1. By the Theorem of Pythagoras, the length is $\sqrt{(2 - 1)^2 + (4 - 2)^2} = \sqrt{1 + 4} = \sqrt{5}$.

$$(a) \frac{dy}{dx} = 2, L = \int_1^2 \sqrt{1 + 4} \, dx = \sqrt{5}.$$

$$(b) \frac{dx}{dy} = \frac{1}{2}, L = \int_2^4 \sqrt{1+1/4} dy = 2\sqrt{5/4} = \sqrt{5}.$$

2. By the Theorem of Pythagoras, the length is $\sqrt{(1-0)^2 + (5-0)^2} = \sqrt{1+25} = \sqrt{26}$.

$$(a) \frac{dy}{dx} = 5, L = \int_0^1 \sqrt{1+25} dx = \sqrt{26}.$$

$$(b) \frac{dx}{dy} = \frac{1}{5}, L = \int_0^5 \sqrt{1+1/25} dy = 5\sqrt{26/25} = \sqrt{26}.$$

$$3. f'(x) = \frac{9}{2}x^{1/2}, 1 + [f'(x)]^2 = 1 + \frac{81}{4}x, L = \int_0^1 \sqrt{1+81x/4} dx = \frac{8}{243} \left(1 + \frac{81}{4}x\right)^{3/2} \Big|_0^1 = (85\sqrt{85} - 8)/243.$$

$$4. g'(y) = y(y^2+2)^{1/2}, 1 + [g'(y)]^2 = 1 + y^2(y^2+2) = y^4 + 2y^2 + 1 = (y^2+1)^2, L = \int_0^1 \sqrt{(y^2+1)^2} dy = \int_0^1 (y^2+1) dy = 4/3.$$

$$5. \frac{dy}{dx} = \frac{2}{3}x^{-1/3}, 1 + \left(\frac{dy}{dx}\right)^2 = 1 + \frac{4}{9}x^{-2/3} = \frac{9x^{2/3} + 4}{9x^{2/3}}, L = \int_1^8 \frac{\sqrt{9x^{2/3} + 4}}{3x^{1/3}} dx = \frac{1}{18} \int_{13}^{40} u^{1/2} du = \frac{1}{27} u^{3/2} \Big|_{13}^{40} = \frac{1}{27}(40\sqrt{40} - 13\sqrt{13}) = \frac{1}{27}(80\sqrt{10} - 13\sqrt{13})$$
 (we used $u = 9x^{2/3} + 4$); or (alternate solution) $x = y^{3/2}, \frac{dx}{dy} = \frac{3}{2}y^{1/2}, 1 + \left(\frac{dx}{dy}\right)^2 = 1 + \frac{9}{4}y = \frac{4+9y}{4}, L = \frac{1}{2} \int_1^4 \sqrt{4+9y} dy = \frac{1}{18} \int_{13}^{40} u^{1/2} du = \frac{1}{27}(80\sqrt{10} - 13\sqrt{13}).$

$$6. f'(x) = \frac{1}{4}x^3 - x^{-3}, 1 + [f'(x)]^2 = 1 + \left(\frac{1}{16}x^6 - \frac{1}{2} + x^{-6}\right) = \frac{1}{16}x^6 + \frac{1}{2} + x^{-6} = \left(\frac{1}{4}x^3 + x^{-3}\right)^2, L = \int_2^3 \sqrt{\left(\frac{1}{4}x^3 + x^{-3}\right)^2} dx = \int_2^3 \left(\frac{1}{4}x^3 + x^{-3}\right) dx = 595/144.$$

$$7. x = g(y) = \frac{1}{24}y^3 + 2y^{-1}, g'(y) = \frac{1}{8}y^2 - 2y^{-2}, 1 + [g'(y)]^2 = 1 + \left(\frac{1}{64}y^4 - \frac{1}{2} + 4y^{-4}\right) = \frac{1}{64}y^4 + \frac{1}{2} + 4y^{-4} = \left(\frac{1}{8}y^2 + 2y^{-2}\right)^2, L = \int_2^4 \left(\frac{1}{8}y^2 + 2y^{-2}\right) dy = 17/6.$$

$$8. g'(y) = \frac{1}{2}y^3 - \frac{1}{2}y^{-3}, 1 + [g'(y)]^2 = 1 + \left(\frac{1}{4}y^6 - \frac{1}{2} + \frac{1}{4}y^{-6}\right) = \left(\frac{1}{2}y^3 + \frac{1}{2}y^{-3}\right)^2, L = \int_1^4 \left(\frac{1}{2}y^3 + \frac{1}{2}y^{-3}\right) dy = 2055/64.$$

9. False. The derivative $\frac{dy}{dx} = -\frac{x}{\sqrt{1-x^2}}$ is not defined at $x = \pm 1$, so it is not continuous on $[-1, 1]$.

10. True. In a Riemann sum the k 'th term has the form $g(x_k^*)\Delta x_k$ for some function g .

11. True. If $f(x) = mx + c$ then the approximation equals $\sum_{k=1}^n \sqrt{1+m^2} \Delta x_k = \sum_{k=1}^n \sqrt{1+m^2} (x_k - x_{k-1}) = \sqrt{1+m^2} (x_n - x_0) = (b-a)\sqrt{1+m^2}$ and the arc length is the distance from $(a, ma+c)$ to $(b, mb+c)$, which equals $\sqrt{(b-a)^2 + [(mb+c) - (ma+c)]^2} = \sqrt{(b-a)^2 + [m(b-a)]^2} = (b-a)\sqrt{1+m^2}$. So each approximation equals the arc length.

12. False. We only need f to be continuous on $[a, b]$ and differentiable on (a, b) .

13. $dy/dx = \frac{\sec x \tan x}{\sec x} = \tan x$, $\sqrt{1+(y')^2} = \sqrt{1+\tan^2 x} = \sec x$ when $0 < x < \pi/4$, so $L = \int_0^{\pi/4} \sec x \, dx = \ln(1 + \sqrt{2})$.

14. $dy/dx = \frac{\cos x}{\sin x} = \cot x$, $\sqrt{1+(y')^2} = \sqrt{1+\cot^2 x} = \csc x$ when $\pi/4 < x < \pi/2$, so $L = \int_{\pi/4}^{\pi/2} \csc x \, dx = -\ln(\sqrt{2}-1) = -\ln\left(\frac{\sqrt{2}-1}{\sqrt{2}+1}(\sqrt{2}+1)\right) = \ln(1 + \sqrt{2})$.

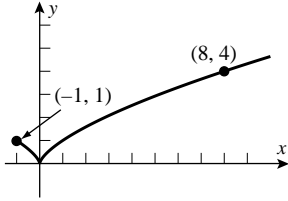

15. (a)  (b) dy/dx does not exist at $x = 0$.

(c) $x = g(y) = y^{3/2}$, $g'(y) = \frac{3}{2}y^{1/2}$, $L = \int_0^1 \sqrt{1+9y/4} \, dy + \int_0^4 \sqrt{1+9y/4} \, dy = \frac{8}{27} \left(\frac{13}{8}\sqrt{13} - 1 \right) + \frac{8}{27}(10\sqrt{10} - 1) = (13\sqrt{13} + 80\sqrt{10} - 16)/27$.

16. First we apply equation (3) with $a = 1$, $b = 2$, $f(x) = x^2$, and $f'(x) = 2x$. The arc length is $L = \int_1^2 \sqrt{1+(2x)^2} \, dx = \int_1^2 \sqrt{1+4x^2} \, dx$. Next we apply equation (5) with $c = 1$, $d = 4$, $g(y) = \sqrt{y}$, and $g'(y) = \frac{1}{2}y^{-1/2}$. The arc length is $L = \int_1^4 \sqrt{1+\left(\frac{1}{2}y^{-1/2}\right)^2} \, dy = \int_1^4 \sqrt{1+\frac{1}{4y}} \, dy$. To see that these are equal, let $y = x^2$, $dy = 2x \, dx$ in the second integral: $\int_1^4 \sqrt{1+\frac{1}{4y}} \, dy = \int_1^2 \sqrt{1+\frac{1}{4x^2}} \, 2x \, dx = \int_1^2 \sqrt{1+4x^2} \, dx$.

17. (a) The function $y = f(x) = x^2$ is inverse to the function $x = g(y) = \sqrt{y} : f(g(y)) = y$ for $1/4 \leq y \leq 4$, and $g(f(x)) = x$ for $1/2 \leq x \leq 2$. Geometrically this means that the graphs of $y = f(x)$ and $x = g(y)$ are symmetric to each other with respect to the line $y = x$ and hence have the same arc length.

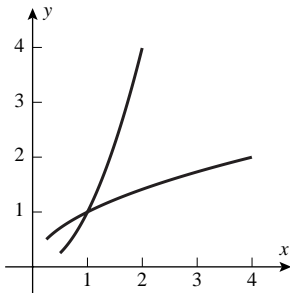

(b) $L_1 = \int_{1/2}^2 \sqrt{1+(2x)^2} \, dx$ and $L_2 = \int_{1/4}^4 \sqrt{1+\left(\frac{1}{2\sqrt{x}}\right)^2} \, dx$. Make the change of variables $x = \sqrt{y}$ in the first integral to obtain $L_1 = \int_{1/4}^4 \sqrt{1+(2\sqrt{y})^2} \frac{1}{2\sqrt{y}} \, dy = \int_{1/4}^4 \sqrt{\left(\frac{1}{2\sqrt{y}}\right)^2 + 1} \, dy = L_2$.

(c) $L_1 = \int_{1/4}^4 \sqrt{1+\left(\frac{1}{2\sqrt{y}}\right)^2} \, dy$, $L_2 = \int_{1/2}^2 \sqrt{1+(2y)^2} \, dy$.

(d) For L_1 , $\Delta x = \frac{3}{20}$, $x_k = \frac{1}{2} + k\frac{3}{20} = \frac{3k+10}{20}$, and thus

$$L_1 \approx \sum_{k=1}^{10} \sqrt{(\Delta x)^2 + [f(x_k) - f(x_{k-1})]^2} = \sum_{k=1}^{10} \sqrt{\left(\frac{3}{20}\right)^2 + \left(\frac{(3k+10)^2 - (3k+7)^2}{400}\right)^2} \approx 4.072396336.$$

For L_2 , $\Delta x = \frac{15}{40} = \frac{3}{8}$, $x_k = \frac{1}{4} + \frac{3k}{8} = \frac{3k+2}{8}$, and thus

$$L_2 \approx \sum_{k=1}^{10} \sqrt{\left(\frac{3}{8}\right)^2 + \left[\sqrt{\frac{3k+2}{8}} - \sqrt{\frac{3k-1}{8}}\right]^2} \approx 4.071626502.$$

(e) Each polygonal path is shorter than the curve segment, so both approximations in (d) are smaller than the actual length. Hence the larger one, the approximation for L_1 , is better.

(f) For L_1 , $\Delta x = \frac{3}{20}$, the midpoint is $x_k^* = \frac{1}{2} + \left(k - \frac{1}{2}\right)\frac{3}{20} = \frac{6k+17}{40}$, and thus

$$L_1 \approx \sum_{k=1}^{10} \frac{3}{20} \sqrt{1 + \left(2\frac{6k+17}{40}\right)^2} \approx 4.072396336.$$

For L_2 , $\Delta x = \frac{15}{40}$, and the midpoint is $x_k^* = \frac{1}{4} + \left(k - \frac{1}{2}\right)\frac{15}{40} = \frac{6k+1}{16}$, and thus

$$L_2 \approx \sum_{k=1}^{10} \frac{15}{40} \sqrt{1 + \left(4\frac{6k+1}{16}\right)^{-1}} \approx 4.066160149.$$

$$(g) L_1 = \int_{1/2}^2 \sqrt{1 + (2x)^2} dx \approx 4.0729, L_2 = \int_{1/4}^4 \sqrt{1 + \left(\frac{1}{2\sqrt{x}}\right)^2} dx \approx 4.0729.$$

18. (a) The function $y = f(x) = x^{8/3}$ is inverse to the function $x = g(y) = y^{3/8} : f(g(y)) = y$ for $10^{-8} \leq y \leq 1$ and $g(f(x)) = x$ for $10^{-3} \leq x \leq 1$. Geometrically this means that the graphs of $y = f(x)$ and $x = g(y)$ are symmetric to each other with respect to the line $y = x$.

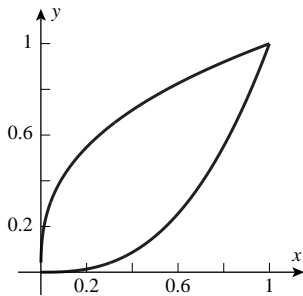

(b) $L_1 = \int_{10^{-3}}^1 \sqrt{1 + \left(\frac{8}{3}x^{5/3}\right)^2} dx$, $L_2 = \int_{10^{-8}}^1 \sqrt{1 + \left(\frac{3}{8}x^{-5/8}\right)^2} dx$. In the expression for L_1 make the change of variable $y = x^{8/3}$. Then $L_1 = \int_{10^{-8}}^1 \sqrt{1 + \left(\frac{8}{3}y^{5/8}\right)^2} \frac{3}{8}y^{-5/8} dy = \int_{10^{-8}}^1 \sqrt{\left(\frac{3}{8}y^{-5/8}\right)^2 + 1} dy = L_2$.

$$(c) L_1 = \int_{10^{-8}}^1 \sqrt{1 + \left(\frac{3}{8}y^{-5/8}\right)^2} dy, L_2 = \int_{10^{-3}}^1 \sqrt{1 + \left(\frac{8}{3}y^{5/3}\right)^2} dy.$$

(d) For L_1 , $\Delta x = \frac{999}{10000}$, $x_k = \frac{1}{1000} + k\frac{999}{10000}$, and thus

$$L_1 \approx \sum_{k=1}^{10} \sqrt{(\Delta x)^2 + [f(x_k) - f(x_{k-1})]^2} \approx 1.524983407.$$

For L_2 , $\Delta y = \frac{99999999}{1000000000}$, $y_k = 10^{-8} + k \frac{99999999}{1000000000}$, and thus

$$L_2 \approx \sum_{k=1}^{10} \sqrt{(\Delta y)^2 + [g(y_k) - g(y_{k-1})]^2} \approx 1.518667833.$$

(e) Each polygonal path is shorter than the curve segment, so both approximations in (d) are smaller than the actual length. Hence the larger one, the approximation for L_1 , is better.

(f) For L_1 , $\Delta x = \frac{999}{10000}$, the midpoint is $x_k^* = 10^{-3} + \left(k - \frac{1}{2}\right) \frac{999}{10000}$, and thus

$$L_1 \approx \sum_{k=1}^{10} \frac{999}{10000} \sqrt{1 + \left(\frac{8}{3}(x_k^*)^{5/3}\right)^2} \approx 1.524166463.$$

For L_2 , $\Delta y = \frac{999999999}{10000000000}$, the midpoint is $y_k^* = 10^{-8} + \left(k - \frac{1}{2}\right) \frac{999999999}{10000000000}$ and thus

$$L_2 \approx \sum_{k=1}^{10} \sqrt{1 + g'(y_k^*)^2} \Delta y \approx 1.347221106.$$

(g) $L_1 = \int_{10^{-3}}^1 \sqrt{1 + \left(\frac{8}{3}x^{5/3}\right)^2} \approx 1.525898203$, $L_2 = \int_{10^{-8}}^1 \sqrt{1 + \left(\frac{3}{8}y^{-5/8}\right)^2} dy \approx 1.525898203$.

19. (a) The function $y = f(x) = \tan x$ is inverse to the function $x = g(y) = \tan^{-1} x : f(g(y)) = y$ for $0 \leq y \leq \sqrt{3}$, and $g(f(x)) = x$ for $0 \leq x \leq \pi/3$. Geometrically this means that the graphs of $y = f(x)$ and $x = g(y)$ are symmetric to each other with respect to the line $y = x$.

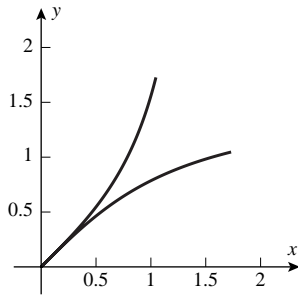

(b) $L_1 = \int_0^{\pi/3} \sqrt{1 + \sec^4 x} dx$, $L_2 = \int_0^{\sqrt{3}} \sqrt{1 + \frac{1}{(1+x^2)^2}} dx$. In the expression for L_1 make the change of variable $y = \tan x$ to obtain $L_1 = \int_0^{\sqrt{3}} \sqrt{1 + (\sqrt{1+y^2})^4} \frac{1}{1+y^2} dy = \int_0^{\sqrt{3}} \sqrt{\frac{1}{(1+y^2)^2} + 1} dy = L_2$.

(c) $L_1 = \int_0^{\sqrt{3}} \sqrt{1 + \frac{1}{(1+y^2)^2}} dy$, $L_2 = \int_0^{\pi/3} \sqrt{1 + \sec^4 y} dy$.

(d) For L_1 , $\Delta x_k = \frac{\pi}{30}$, $x_k = k \frac{\pi}{30}$, and thus

$$L_1 \approx \sum_{k=1}^{10} \sqrt{(\Delta x_k)^2 + [f(x_k) - f(x_{k-1})]^2} = \sum_{k=1}^{10} \sqrt{\left(\frac{\pi}{30}\right)^2 + [\tan(k\pi/30) - \tan((k-1)\pi/30)]^2} \approx 2.056603923.$$

For L_2 , $\Delta x_k = \frac{\sqrt{3}}{10}$, $x_k = k \frac{\sqrt{3}}{10}$, and thus

$$L_2 \approx \sum_{k=1}^{10} \sqrt{\left(\frac{\sqrt{3}}{10}\right)^2 + \left[\tan^{-1}\left(k\frac{\sqrt{3}}{10}\right) - \tan^{-1}\left((k-1)\frac{\sqrt{3}}{10}\right)\right]^2} \approx 2.056724591.$$

(e) Each polygonal path is shorter than the curve segment, so both approximations in (d) are smaller than the actual length. Hence the larger one, the approximation for L_2 , is better.

(f) For L_1 , $\Delta x_k = \frac{\pi}{30}$, the midpoint is $x_k^* = \left(k - \frac{1}{2}\right) \frac{\pi}{30}$, and thus

$$L_1 \approx \sum_{k=1}^{10} \frac{\pi}{30} \sqrt{1 + \sec^4 \left[\left(k - \frac{1}{2}\right) \frac{\pi}{30}\right]} \approx 2.050944217.$$

For L_2 , $\Delta x_k = \frac{\sqrt{3}}{10}$, and the midpoint is $x_k^* = \left(k - \frac{1}{2}\right) \frac{\sqrt{3}}{10}$, and thus

$$L_2 \approx \sum_{k=1}^{10} \frac{\sqrt{3}}{10} \sqrt{1 + \frac{1}{((x_k^*)^2 + 1)^2}} \approx 2.057065139.$$

$$(g) \quad L_1 = \int_0^{\pi/3} \sqrt{1 + \sec^4 x} \, dx \approx 2.0570, \quad L_2 = \int_0^{\sqrt{3}} \sqrt{1 + \frac{1}{(1^2 + y^2)^2}} \, dx \approx 2.0570.$$

20. $0 \leq m \leq f'(x) \leq M$, so $m^2 \leq [f'(x)]^2 \leq M^2$, and $1 + m^2 \leq 1 + [f'(x)]^2 \leq 1 + M^2$; thus $\sqrt{1 + m^2} \leq \sqrt{1 + [f'(x)]^2} \leq \sqrt{1 + M^2}$, $\int_a^b \sqrt{1 + m^2} \, dx \leq \int_a^b \sqrt{1 + [f'(x)]^2} \, dx \leq \int_a^b \sqrt{1 + M^2} \, dx$, and $(b-a)\sqrt{1 + m^2} \leq L \leq (b-a)\sqrt{1 + M^2}$.

21. $f'(x) = \sec x \tan x$, $0 \leq \sec x \tan x \leq 2\sqrt{3}$ for $0 \leq x \leq \pi/3$ so $\frac{\pi}{3} \leq L \leq \frac{\pi}{3}\sqrt{13}$.

22. The distance is $\int_0^{4.6} \sqrt{1 + (2.09 - 0.82x)^2} \, dx \approx 6.65$ m.

23. If we model the cable with a parabola $y = ax^2$, then $500 = a \cdot 2100^2$ and then $a = 500/2100^2$. Then the length of the cable is given by $L = \int_{-2100}^{2100} \sqrt{1 + (2ax)^2} \, dx \approx 4354$ ft.

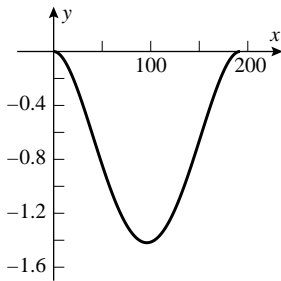

24. (a)

(b) The maximum deflection occurs at $x = 96$ inches (the midpoint of the beam) and is about 1.42 in.

(c) The length of the centerline is $\int_0^{192} \sqrt{1 + (dy/dx)^2} \, dx \approx 192.03$ in.

25. $y = 0$ at $x = b = 12.54/0.41 \approx 30.585$; distance = $\int_0^b \sqrt{1 + (12.54 - 0.82x)^2} \, dx \approx 196.31$ yd.

26. Let P_k be the point on the curve with coordinates $(x(t_k), y(t_k))$. The length of the curve is approximately the length of the polygonal path $P_0P_1 \cdots P_n$, which equals $\sum_{k=1}^n \sqrt{(x(t_k) - x(t_{k-1}))^2 + (y(t_k) - y(t_{k-1}))^2}$.

27. $(dx/dt)^2 + (dy/dt)^2 = (t^2)^2 + (t)^2 = t^2(t^2 + 1)$, $L = \int_0^1 t(t^2 + 1)^{1/2} dt = (2\sqrt{2} - 1)/3$.

28. $(dx/dt)^2 + (dy/dt)^2 = [2(1 + t)]^2 + [3(1 + t)^2]^2 = (1 + t)^2[4 + 9(1 + t)^2]$, $L = \int_0^1 (1 + t)[4 + 9(1 + t)^2]^{1/2} dt = (80\sqrt{10} - 13\sqrt{13})/27$.

29. $(dx/dt)^2 + (dy/dt)^2 = (-2 \sin 2t)^2 + (2 \cos 2t)^2 = 4$, $L = \int_0^{\pi/2} 2 dt = \pi$.

30. $(dx/dt)^2 + (dy/dt)^2 = (-\sin t + \sin t + t \cos t)^2 + (\cos t - \cos t + t \sin t)^2 = t^2$, $L = \int_0^{\pi} t dt = \pi^2/2$.

31. $(dx/dt)^2 + (dy/dt)^2 = [e^t(\cos t - \sin t)]^2 + [e^t(\cos t + \sin t)]^2 = 2e^{2t}$, $L = \int_0^{\pi/2} \sqrt{2}e^t dt = \sqrt{2}(e^{\pi/2} - 1)$.

32. $(dx/dt)^2 + (dy/dt)^2 = (2e^t \cos t)^2 + (-2e^t \sin t)^2 = 4e^{2t}$, $L = \int_1^4 2e^t dt = 2(e^4 - e)$.

33. (a) $(dx/dt)^2 + (dy/dt)^2 = 4 \sin^2 t + \cos^2 t = 4 \sin^2 t + (1 - \sin^2 t) = 1 + 3 \sin^2 t$, $L = \int_0^{2\pi} \sqrt{1 + 3 \sin^2 t} dt = 4 \int_0^{\pi/2} \sqrt{1 + 3 \sin^2 t} dt$.

(b) 9.69 (c) Distance traveled = $\int_{1.5}^{4.8} \sqrt{1 + 3 \sin^2 t} dt \approx 5.16$ cm.

34. $(dx/dt)^2 + (dy/dt)^2 = (-a \sin t)^2 + (b \cos t)^2 = a^2 \sin^2 t + b^2 \cos^2 t = a^2(1 - \cos^2 t) + b^2 \cos^2 t = a^2 - (a^2 - b^2) \cos^2 t = a^2 \left[1 - \frac{a^2 - b^2}{a^2} \cos^2 t \right] = a^2[1 - k^2 \cos^2 t]$, $L = \int_0^{2\pi} a \sqrt{1 - k^2 \cos^2 t} dt = 4a \int_0^{\pi/2} \sqrt{1 - k^2 \cos^2 t} dt$.

35. The length of the curve is approximated by the length of a polygon whose vertices lie on the graph of $y = f(x)$. Each term in the sum is the length of one edge of the approximating polygon. By the distance formula, the length of the k 'th edge is $\sqrt{(\Delta x_k)^2 + (\Delta y_k)^2}$, where Δx_k is the change in x along the edge and Δy_k is the change in y along the edge. We use the Mean Value Theorem to express Δy_k as $f'(x_k^*)\Delta x_k$. Factoring the Δx_k out of the square root yields the k 'th term in the sum.

36. To apply Formula (4), we need to have a formula for dy/dx as a function of x . This may not be possible if either
 (A) the curve is defined by giving x as a function of y , or
 (B) the curve is defined by giving x and y as functions of a parameter t , or
 (C) the curve is defined implicitly by giving an equation satisfied by x and y .

In case (A), we may use Formula (5) instead of (4); for (B) we may use the result of Exercise 26. In case (C), we may have to settle for an approximation, by finding approximate coordinates of many points P_0, P_1, \dots, P_n on the curve, and computing the length of the polygonal path $P_0P_1 \cdots P_n$.

Even in cases where Formula (4) can be applied, we may be unable to evaluate the integral in closed form, so we'll have to use methods for approximate integration, as discussed in Section 7.7.

Exercise Set 6.5

1. $S = \int_0^1 2\pi(7x)\sqrt{1+49} dx = 70\pi\sqrt{2} \int_0^1 x dx = 35\pi\sqrt{2}.$
2. $f'(x) = \frac{1}{2\sqrt{x}}, 1 + [f'(x)]^2 = 1 + \frac{1}{4x}, S = \int_1^4 2\pi\sqrt{x}\sqrt{1 + \frac{1}{4x}} dx = 2\pi \int_1^4 \sqrt{x+1/4} dx = \pi(17\sqrt{17} - 5\sqrt{5})/6.$
3. $f'(x) = -x/\sqrt{4-x^2}, 1 + [f'(x)]^2 = 1 + \frac{x^2}{4-x^2} = \frac{4}{4-x^2}, S = \int_{-1}^1 2\pi\sqrt{4-x^2}(2/\sqrt{4-x^2}) dx = 4\pi \int_{-1}^1 dx = 8\pi.$
4. $y = f(x) = x^3$ for $1 \leq x \leq 2, f'(x) = 3x^2, S = \int_1^2 2\pi x^3 \sqrt{1+9x^4} dx = \frac{\pi}{27} (1+9x^4)^{3/2} \Big|_1^2 = 5\pi(29\sqrt{145} - 2\sqrt{10})/27.$
5. $S = \int_0^2 2\pi(9y+1)\sqrt{82} dy = 2\pi\sqrt{82} \int_0^2 (9y+1) dy = 40\pi\sqrt{82}.$
6. $g'(y) = 3y^2, S = \int_0^1 2\pi y^3 \sqrt{1+9y^4} dy = \pi(10\sqrt{10} - 1)/27.$
7. $g'(y) = -y/\sqrt{9-y^2}, 1 + [g'(y)]^2 = \frac{9}{9-y^2}, S = \int_{-2}^2 2\pi\sqrt{9-y^2} \cdot \frac{3}{\sqrt{9-y^2}} dy = 6\pi \int_{-2}^2 dy = 24\pi.$
8. $g'(y) = -(1-y)^{-1/2}, 1+[g'(y)]^2 = \frac{2-y}{1-y}, S = \int_{-1}^0 2\pi(2\sqrt{1-y})\frac{\sqrt{2-y}}{\sqrt{1-y}} dy = 4\pi \int_{-1}^0 \sqrt{2-y} dy = 8\pi(3\sqrt{3}-2\sqrt{2})/3.$
9. $f'(x) = \frac{1}{2}x^{-1/2} - \frac{1}{2}x^{1/2}, 1 + [f'(x)]^2 = 1 + \frac{1}{4}x^{-1} - \frac{1}{2} + \frac{1}{4}x = \left(\frac{1}{2}x^{-1/2} + \frac{1}{2}x^{1/2}\right)^2,$
 $S = \int_1^3 2\pi \left(x^{1/2} - \frac{1}{3}x^{3/2}\right) \left(\frac{1}{2}x^{-1/2} + \frac{1}{2}x^{1/2}\right) dx = \frac{\pi}{3} \int_1^3 (3+2x-x^2) dx = 16\pi/9.$
10. $f'(x) = x^2 - \frac{1}{4}x^{-2}, 1 + [f'(x)]^2 = 1 + \left(x^4 - \frac{1}{2} + \frac{1}{16}x^{-4}\right) = \left(x^2 + \frac{1}{4}x^{-2}\right)^2,$
 $S = \int_1^2 2\pi \left(\frac{1}{3}x^3 + \frac{1}{4}x^{-1}\right) \left(x^2 + \frac{1}{4}x^{-2}\right) dx = 2\pi \int_1^2 \left(\frac{1}{3}x^5 + \frac{1}{3}x + \frac{1}{16}x^{-3}\right) dx = 515\pi/64.$
11. $x = g(y) = \frac{1}{4}y^4 + \frac{1}{8}y^{-2}, g'(y) = y^3 - \frac{1}{4}y^{-3}, 1 + [g'(y)]^2 = 1 + \left(y^6 - \frac{1}{2} + \frac{1}{16}y^{-6}\right) = \left(y^3 + \frac{1}{4}y^{-3}\right)^2,$
 $S = \int_1^2 2\pi \left(\frac{1}{4}y^4 + \frac{1}{8}y^{-2}\right) \left(y^3 + \frac{1}{4}y^{-3}\right) dy = \frac{\pi}{16} \int_1^2 (8y^7 + 6y + y^{-5}) dy = 16,911\pi/1024.$
12. $x = g(y) = \sqrt{16-y}; g'(y) = -\frac{1}{2\sqrt{16-y}}, 1 + [g'(y)]^2 = \frac{65-4y}{4(16-y)},$
 $S = \int_0^{15} 2\pi\sqrt{16-y} \sqrt{\frac{65-4y}{4(16-y)}} dy = \pi \int_0^{15} \sqrt{65-4y} dy = (65\sqrt{65} - 5\sqrt{5})\frac{\pi}{6}.$
13. $f'(x) = \cos x, 1 + [f'(x)]^2 = 1 + \cos^2 x, S = \int_0^\pi 2\pi \sin x \sqrt{1 + \cos^2 x} dx = 2\pi(\sqrt{2} + \ln(\sqrt{2} + 1)) \approx 14.42.$
14. $x = g(y) = \tan y, g'(y) = \sec^2 y, 1 + [g'(y)]^2 = 1 + \sec^4 y; S = \int_0^{\pi/4} 2\pi \tan y \sqrt{1 + \sec^4 y} dy \approx 3.84.$

15. $f'(x) = e^x$, $1 + [f'(x)]^2 = 1 + e^{2x}$, $S = \int_0^1 2\pi e^x \sqrt{1 + e^{2x}} dx \approx 22.94$.

16. $x = g(y) = \ln y$, $g'(y) = 1/y$, $1 + [g'(y)]^2 = 1 + 1/y^2$; $S = \int_1^e 2\pi \sqrt{1 + 1/y^2} \ln y dy \approx 7.05$.

17. True, by equation (1) with $r_1 = 0$, $r_2 = r$, and $l = \sqrt{r^2 + h^2}$.

18. True. The lateral surface area of the cylinder is $2\pi \frac{r_1 + r_2}{2} l = \pi(r_1 + r_2)l$; by equation (1) this equals the area of the frustum.

19. True. If $f(x) = c$ for all x then $f'(x) = 0$ so the approximation is $\sum_{k=1}^n 2\pi c \Delta x_k = 2\pi c(b - a)$. Since the surface is the lateral surface of a cylinder of length $b - a$ and radius c , its area is also $2\pi c(b - a)$.

20. True. A true Riemann sum only involves one point x_k^* in each interval, not two.

21. $n = 20$, $a = 0$, $b = \pi$, $\Delta x = (b - a)/20 = \pi/20$, $x_k = k\pi/20$,

$$S \approx \pi \sum_{k=1}^{20} [\sin(k-1)\pi/20 + \sin k\pi/20] \sqrt{(\pi/20)^2 + [\sin(k-1)\pi/20 - \sin k\pi/20]^2} \approx 14.39.$$

22. We use equation (2) with x changed to y and with $f(y) = \ln y$. $n = 20$, $a = 1$, $b = e$, $\Delta y = (b - a)/20 = (e - 1)/20$,

$$y_k = 1 + k(e - 1)/20, S = \sum_{k=1}^{20} \pi [\ln y_{k-1} + \ln y_k] \sqrt{(\Delta y)^2 + [\ln y_k - \ln y_{k-1}]^2} \approx 7.05.$$

23. $S = \int_a^b 2\pi [f(x) + k] \sqrt{1 + [f'(x)]^2} dx$.

24. Yes, since the area of a frustum was used to figure out how to define surface area in general.

25. $f(x) = \sqrt{r^2 - x^2}$, $f'(x) = -x/\sqrt{r^2 - x^2}$, $1 + [f'(x)]^2 = r^2/(r^2 - x^2)$, $S = \int_{-r}^r 2\pi \sqrt{r^2 - x^2} (r/\sqrt{r^2 - x^2}) dx = 2\pi r \int_{-r}^r dx = 4\pi r^2$.

26. $g(y) = \sqrt{r^2 - y^2}$, $g'(y) = -y/\sqrt{r^2 - y^2}$, $1 + [g'(y)]^2 = r^2/(r^2 - y^2)$, $S = \int_{r-h}^r 2\pi \sqrt{r^2 - y^2} \sqrt{r^2/(r^2 - y^2)} dy = 2\pi r \int_{r-h}^r dy = 2\pi r h$.

27. Suppose the two planes are $y = y_1$ and $y = y_2$, where $-r \leq y_1 \leq y_2 \leq r$. Then the area of the zone equals the area of a spherical cap of height $r - y_1$ minus the area of a spherical cap of height $r - y_2$. By Exercise 26, this is $2\pi r(r - y_1) - 2\pi r(r - y_2) = 2\pi r(y_2 - y_1)$, which only depends on the radius r and the distance $y_2 - y_1$ between the planes.

28. $2\pi k \sqrt{1 + [f'(x)]^2} \leq 2\pi f(x) \sqrt{1 + [f'(x)]^2} \leq 2\pi K \sqrt{1 + [f'(x)]^2}$, so

$$\int_a^b 2\pi k \sqrt{1 + [f'(x)]^2} dx \leq \int_a^b 2\pi f(x) \sqrt{1 + [f'(x)]^2} dx \leq \int_a^b 2\pi K \sqrt{1 + [f'(x)]^2} dx, \text{ then } 2\pi kL \leq S \leq 2\pi KL.$$

29. Note that $1 \leq \sec x \leq 2$ for $0 \leq x \leq \pi/3$. Let L be the arc length of the curve $y = \tan x$ for $0 < x < \pi/3$.

Then $L = \int_0^{\pi/3} \sqrt{1 + \sec^2 x} dx$, and by Exercise 24, and the inequalities above, $2\pi L \leq S \leq 4\pi L$. But from

the inequalities for $\sec x$ above, we can show that $\sqrt{2}\pi/3 \leq L \leq \sqrt{5}\pi/3$. Hence, combining the two sets of inequalities, $2\pi(\sqrt{2}\pi/3) \leq 2\pi L \leq S \leq 4\pi L \leq 4\pi\sqrt{5}\pi/3$. To obtain the inequalities in the text, observe that $\frac{2\pi^2}{3} < 2\pi \frac{\sqrt{2}\pi}{3} \leq 2\pi L \leq S \leq 4\pi L \leq 4\pi \frac{\sqrt{5}\pi}{3} < \frac{4\pi^2}{3} \sqrt{13}$.

30. (a) $1 \leq \sqrt{1 + [f'(x)]^2}$, so $2\pi f(x) \leq 2\pi f(x)\sqrt{1 + [f'(x)]^2}$, which implies that

$$\int_a^b 2\pi f(x) dx \leq \int_a^b 2\pi f(x)\sqrt{1 + [f'(x)]^2} dx, \text{ and then } 2\pi \int_a^b f(x) dx \leq S, 2\pi A \leq S.$$

(b) $2\pi A = S$ if $f'(x) = 0$ for all x in $[a, b]$ so $f(x)$ is constant on $[a, b]$.

31. Let $a = t_0 < t_1 < \dots < t_{n-1} < t_n = b$ be a partition of $[a, b]$. Then the lateral area of the frustum of slant height $\ell = \sqrt{\Delta x_k^2 + \Delta y_k^2}$ and radii $y(t_1)$ and $y(t_2)$ is $\pi(y(t_k) + y(t_{k-1}))\ell$. Thus the area of the frustum S_k is given by $S_k = \pi(y(t_{k-1}) + y(t_k))\sqrt{[x(t_k) - x(t_{k-1})]^2 + [y(t_k) - y(t_{k-1})]^2}$ with the limit as $\max \Delta t_k \rightarrow 0$ of $S = \int_a^b 2\pi y(t)\sqrt{x'(t)^2 + y'(t)^2} dt$.

32. Let $a = t_0 < t_1 < \dots < t_{n-1} < t_n = b$ be a partition of $[a, b]$. Then the lateral area of the frustum of slant height $\ell = \sqrt{\Delta x_k^2 + \Delta y_k^2}$ and radii $x(t_1)$ and $x(t_2)$ is $\pi(x(t_k) + x(t_{k-1}))\ell$. Thus the area of the frustum S_k is given by $S_k = \pi(x(t_{k-1}) + x(t_k))\sqrt{[x(t_k) - x(t_{k-1})]^2 + [y(t_k) - y(t_{k-1})]^2}$ with the limit as $\max \Delta t_k \rightarrow 0$ of $S = \int_a^b 2\pi x(t)\sqrt{x'(t)^2 + y'(t)^2} dt$.

33. $x' = 2t, y' = 2, (x')^2 + (y')^2 = 4t^2 + 4, S = 2\pi \int_0^4 (2t)\sqrt{4t^2 + 4} dt = 8\pi \int_0^4 t\sqrt{t^2 + 1} dt = \frac{8\pi}{3}(17\sqrt{17} - 1)$.

34. $x' = -2 \cos t \sin t, y' = 5 \cos t, (x')^2 + (y')^2 = 4 \cos^2 t \sin^2 t + 25 \cos^2 t$,
 $S = 2\pi \int_0^{\pi/2} 5 \sin t \sqrt{4 \cos^2 t \sin^2 t + 25 \cos^2 t} dt = \frac{\pi}{6}(145\sqrt{29} - 625)$.

35. $x' = 1, y' = 4t, (x')^2 + (y')^2 = 1 + 16t^2, S = 2\pi \int_0^1 t\sqrt{1 + 16t^2} dt = \frac{\pi}{24}(17\sqrt{17} - 1)$.

36. $x' = -2 \sin t \cos t, y' = 2 \sin t \cos t, (x')^2 + (y')^2 = 8 \sin^2 t \cos^2 t$,
 $S = 2\pi \int_0^{\pi/2} \cos^2 t \sqrt{8 \sin^2 t \cos^2 t} dt = 4\sqrt{2}\pi \int_0^{\pi/2} \cos^3 t \sin t dt = \sqrt{2}\pi$.

37. $x' = -r \sin t, y' = r \cos t, (x')^2 + (y')^2 = r^2, S = 2\pi \int_0^\pi r \sin t \sqrt{r^2} dt = 2\pi r^2 \int_0^\pi \sin t dt = 4\pi r^2$.

38. In each case we approximate a curve by a polygonal path and use a known formula (for length or surface area) to derive a more general formula. Both derivations involve the length of a line segment, which is approximated using the Mean Value Theorem, introducing $\sqrt{1 + [f'(x)]^2}$ into the resulting formulas.

39. Suppose we approximate the k 'th frustum by the lateral surface of a cylinder of width Δx_k and radius $f(x_k^*)$, where x_k^* is between x_{k-1} and x_k . The area of this surface is $2\pi f(x_k^*) \Delta x_k$. Proceeding as before, we would conclude that $S = \int_a^b 2\pi f(x) dx$, which is too small. Basically, when $|f'(x)| > 0$, the area of the frustum is larger than the area of the cylinder, and ignoring this results in an incorrect formula.

Exercise Set 6.6

1. $W = \int_0^3 F(x) dx = \int_0^3 (x + 1) dx = \left[\frac{1}{2}x^2 + x \right]_0^3 = 7.5 \text{ ft}\cdot\text{lb}$.

2. $W = \int_0^5 F(x) dx = \int_0^2 40 dx - \int_2^5 \frac{40}{3}(x - 5) dx = 80 + 60 = 140 \text{ J.}$

3. Since $W = \int_a^b F(x) dx$ = the area under the curve, it follows that $d < 2.5$ since the area increases faster under the left part of the curve. In fact, if $d \leq 2$, $W_d = \int_0^d F(x) dx = 40d$, and $W = \int_0^5 F(x) dx = 140$, so $d = 7/4$.

4. The total work is $\int_a^b F(x) dx$. The average value of F over $[a, b]$ is $\frac{1}{b-a} \int_a^b F(x) dx$, which equals the work divided by the length of the interval.

5. Distance traveled = $\int_0^5 v(t) dt = \int_0^5 \frac{4t}{5} dt = \left. \frac{2}{5}t^2 \right|_0^5 = 10 \text{ ft.}$ The force is a constant 10 lb, so the work done is $10 \cdot 10 = 100 \text{ ft}\cdot\text{lb.}$

6. Hooke's law says that $F(x) = kx$ where x is the distance the spring is stretched beyond its natural length. Since $F(x) = 6$ when $x = 4\frac{1}{2} - 4 = \frac{1}{2}$, we have $k = 12$. Stretching the spring to a length of 6 meters corresponds to $x = 6 - 4 = 2$, so $W = \int_0^2 F(x) dx = \int_0^2 12x dx = 6x^2 \Big|_0^2 = 24 \text{ N}\cdot\text{m} = 24 \text{ J.}$

7. $F(x) = kx, F(0.2) = 0.2k = 100, k = 500 \text{ N/m, } W = \int_0^{0.8} 500x dx = 160 \text{ J.}$

8. (a) $F(x) = kx, F(0.05) = 0.05k = 45, k = 900 \text{ N/m.}$

(b) $W = \int_0^{0.03} 900x dx = 0.405 \text{ J.}$ (c) $W = \int_{0.05}^{0.10} 900x dx = 3.375 \text{ J.}$

9. $W = \int_0^1 kx dx = k/2 = 10, k = 20 \text{ lb/ft.}$

10. False. The distance that the car moves is 0, so no work is done.

11. False. The work depends on the force and the distance, not on the elapsed time.

12. True. If $W_1 = \int_0^D kx dx = \left. \frac{kx^2}{2} \right|_0^D = \frac{kD^2}{2}$, then $W_2 = \int_0^{2D} kx dx = \left. \frac{kx^2}{2} \right|_0^{2D} = 2kD^2 = 4W_1$.

13. True. By equation (6), work and energy have the same units in any system of units.

14. $W = \int_0^6 (9 - x)62.4(25\pi) dx = 1560\pi \int_0^6 (9 - x) dx = 56,160\pi \text{ ft}\cdot\text{lb.}$

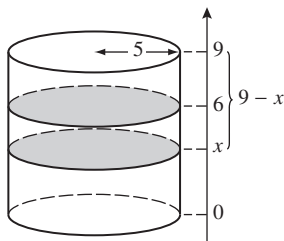

15. $W = \int_0^{9/2} (9 - x)62.4(25\pi) dx = 1560\pi \int_0^{9/2} (9 - x) dx = 47,385\pi \text{ ft}\cdot\text{lb.}$

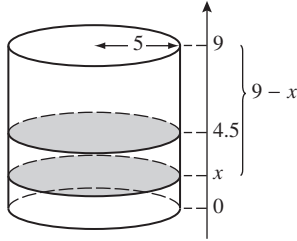

$$16. \quad r/10 = x/15, \quad r = 2x/3, \quad W = \int_0^{10} (15-x)62.4(4\pi x^2/9) dx = \frac{83.2}{3}\pi \int_0^{10} (15x^2 - x^3) dx = 208,000\pi/3 \text{ ft}\cdot\text{lb.}$$

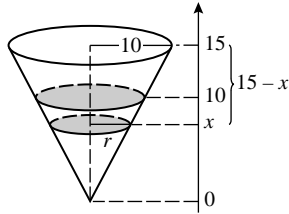

$$17. \quad w/4 = x/3, \quad w = 4x/3, \quad W = \int_0^2 (3-x)(9810)(4x/3)(6) dx = 78480 \int_0^2 (3x - x^2) dx = 261,600 \text{ J.}$$

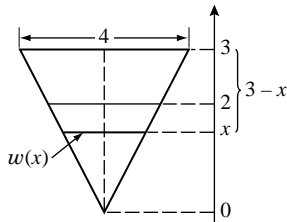

$$18. \quad w = 2\sqrt{4-x^2}, \quad W = \int_{-2}^2 (3-x)(50)(2\sqrt{4-x^2})(10) dx = 3000 \int_{-2}^2 \sqrt{4-x^2} dx - 1000 \int_{-2}^2 x\sqrt{4-x^2} dx = 3000[\pi(2)^2/2] - 0 = 6000\pi \text{ ft}\cdot\text{lb.}$$

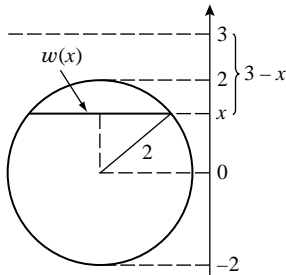

$$19. \quad (a) \quad W = \int_0^9 (10-x)62.4(300) dx = 18,720 \int_0^9 (10-x) dx = 926,640 \text{ ft}\cdot\text{lb.}$$

(b) To empty the pool in one hour would require $926,640/3600 = 257.4$ ft·lb of work per second so hp of motor $= 257.4/550 = 0.468$.

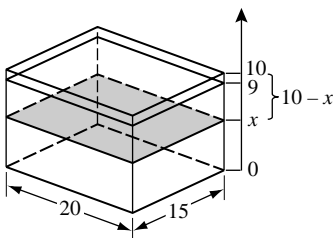

20. $W = \int_0^9 x(62.4)(300) dx = 18,720 \int_0^9 x dx = (81/2)18,720 = 758,160 \text{ ft}\cdot\text{lb}.$

21. $W = \int_0^{100} 15(100 - x) dx = 75,000 \text{ ft}\cdot\text{lb}.$

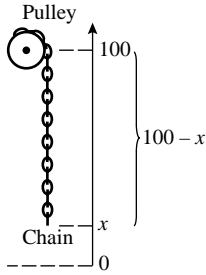

22. The total time of winding the rope is $(20 \text{ ft})/(2 \text{ ft/s}) = 10 \text{ s}$. During the time interval from time t to time $t + \Delta t$ the work done is $\Delta W = F(t) \cdot \Delta x$. The distance $\Delta x = 2\Delta t$, and the force $F(t)$ is given by the weight $w(t)$ of the bucket, rope and water at time t . The bucket and its remaining water together weigh $(3 + 20) - t/2 \text{ lb}$, and the rope is $20 - 2t \text{ ft}$ long and weighs $4(20 - 2t) \text{ oz}$ or $5 - t/2 \text{ lb}$. Thus at time t the bucket, water and rope together weigh $w(t) = 23 - t/2 + 5 - t/2 = 28 - t \text{ lb}$. The amount of work done in the time interval from time t to time $t + \Delta t$ is thus $\Delta W = (28 - t)2\Delta t$, and the total work done is $W = \lim_{n \rightarrow +\infty} \sum (28 - t)2\Delta t = \int_0^{10} (28 - t)2 dt = 2(28t - t^2/2) \Big|_0^{10} = 460 \text{ ft}\cdot\text{lb}.$

23. When the rocket is $x \text{ ft}$ above the ground total weight = weight of rocket + weight of fuel = $3 + [40 - 2(x/1000)] = 43 - x/500 \text{ tons}$, $W = \int_0^{3000} (43 - x/500) dx = 120,000 \text{ ft}\cdot\text{tons}.$

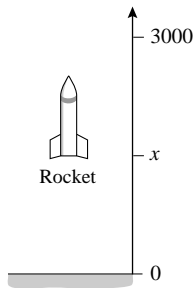

24. Let $F(x)$ be the force needed to hold charge A at position x . Then $F(x) = \frac{c}{(a - x)^2}$, $F(-a) = \frac{c}{4a^2} = k$, so

$c = 4a^2k$. $W = \int_{-a}^0 4a^2k(a - x)^{-2} dx = 2ak \text{ J}.$

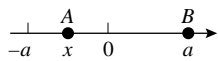

25. (a) $150 = k/(4000)^2$, $k = 2.4 \times 10^9$, $w(x) = k/x^2 = 2,400,000,000/x^2 \text{ lb}.$

(b) $6000 = k/(4000)^2$, $k = 9.6 \times 10^{10}$, $w(x) = (9.6 \times 10^{10})/(x + 4000)^2 \text{ lb}.$

(c) $W = \int_{4000}^{5000} 9.6(10^{10})x^{-2} dx = 4,800,000 \text{ mi}\cdot\text{lb} = 2.5344 \times 10^{10} \text{ ft}\cdot\text{lb}.$

26. (a) $20 = k/(1080)^2$, $k = 2.3328 \times 10^7$, weight = $w(x + 1080) = 2.3328 \cdot 10^7/(x + 1080)^2 \text{ lb}.$

(b) $W = \int_0^{10.8} [2.3328 \cdot 10^7/(x + 1080)^2] dx = 213.86 \text{ mi}\cdot\text{lb} = 1,129,188 \text{ ft}\cdot\text{lb}.$

27. $W = \frac{1}{2}mv_f^2 - \frac{1}{2}mv_i^2 = \frac{1}{2}4.00 \times 10^5(v_f^2 - 20^2)$. But $W = F \cdot d = (6.40 \times 10^5) \cdot (3.00 \times 10^3)$, so $19.2 \times 10^8 = 2.00 \times 10^5 v_f^2 - 8.00 \times 10^7$, $19200 = 2v_f^2 - 800$, $v_f = 100$ m/s.
28. $W = F \cdot d = (2.00 \times 10^5)(1.50 \times 10^5) = 3 \times 10^{10}$ J; from the work-energy relationship (6), $v_f^2 = 2W/m + v_i^2 = 2(3 \times 10^{10})/(2 \times 10^3) + (1 \times 10^4)^2 = 1.3 \times 10^8$, so $v_f \approx 11,402$ m/s.
29. (a) The kinetic energy would have decreased by $\frac{1}{2}mv^2 = \frac{1}{2}4 \cdot 10^6(15000)^2 = 4.5 \times 10^{14}$ J.
- (b) $(4.5 \times 10^{14})/(4.2 \times 10^{15}) \approx 0.107$. (c) $\frac{1000}{13}(0.107) \approx 8.24$ bombs.
30. “Pushing/pulling” problems usually involve a single rigid object being moved; see Examples 1-4 and 6. “Pumping” problems usually involve a liquid or flexible solid, different parts of which move different distances; see Example 5 and Exercises 14-21. Exercise 22 is an example of a combination of the two categories: The bucket is rigid, the water is liquid, and the rope is a flexible solid.
31. The work-energy relationship involves 4 quantities, the work W , the mass m , and the initial and final velocities v_i and v_f . In any problem in which 3 of these are given, the work-energy relationship can be used to compute the fourth. In cases where the force is constant, we may combine equation (1) with the work-energy relationship to get $Fd = \frac{1}{2}mv_f^2 - \frac{1}{2}mv_i^2$. In this form there are 5 quantities, the force F , the distance d , the mass m , and the initial and final velocities v_i and v_f . So if any 4 of these are given, the work-energy relationship can be used to compute the fifth.

Exercise Set 6.7

1. (a) m_1 and m_3 are equidistant from $x = 5$, but m_3 has a greater mass, so the sum is positive.
- (b) Let a be the unknown coordinate of the fulcrum; then the total moment about the fulcrum is $5(0 - a) + 10(5 - a) + 20(10 - a) = 0$ for equilibrium, so $250 - 35a = 0$, $a = 50/7$. The fulcrum should be placed $50/7$ units to the right of m_1 .
2. (a) The sum must be negative, since m_1, m_2 and m_3 are all to the left of the fulcrum, and the magnitude of the moment of m_1 about $x = 4$ is by itself greater than the moment of m about $x = 4$ (i.e. $40 > 28$), so even if we replace the masses of m_2 and m_3 with 0, the sum is negative.
- (b) At equilibrium, $10(0 - 4) + 3(2 - 4) + 4(3 - 4) + m(6 - 4) = 0$, $m = 25$.
3. By symmetry, the centroid is $(1/2, 1/2)$. We confirm this using Formulas (8) and (9) with $a = 0$, $b = 1$, $f(x) = 1$. The area is 1, so $\bar{x} = \int_0^1 x dx = \frac{1}{2}$ and $\bar{y} = \int_0^1 \frac{1}{2} dx = \frac{1}{2}$, as expected.
4. By symmetry, the centroid is $(0, 0)$. We confirm this using Formulas (10) and (11) with $a = -1$, $b = 1$, $f(x) = 1 - |x|$, $g(x) = |x| - 1$. The area is 2, so $\bar{x} = \frac{1}{2} \int_{-1}^1 x(2 - 2|x|) dx = \frac{1}{2} \left(\int_{-1}^0 x(2 + 2x) dx + \int_0^1 x(2 - 2x) dx \right) = \frac{1}{2} \left(\left[x^2 + \frac{2}{3}x^3 \right]_{-1}^0 + \left[x^2 - \frac{2}{3}x^3 \right]_0^1 \right) = \frac{1}{2} \left(-\frac{1}{3} + \frac{1}{3} \right) = 0$ and $\bar{y} = \frac{1}{2} \int_{-1}^1 \frac{1}{2} [(1 - |x|)^2 - (|x| - 1)^2] dx = \frac{1}{2} \int_{-1}^1 0 dx = 0$, as expected.
5. By symmetry, the centroid is $(1, 1/2)$. We confirm this using Formulas (8) and (9) with $a = 0$, $b = 2$, $f(x) = 1$. The area is 2, so $\bar{x} = \frac{1}{2} \int_0^2 x dx = 1$ and $\bar{y} = \frac{1}{2} \int_0^2 \frac{1}{2} dx = \frac{1}{2}$, as expected.

6. By symmetry, the centroid is $(0, 0)$. We confirm this using Formulas (10) and (11) with $a = -1$, $b = 1$, $f(x) = \sqrt{1-x^2}$, $g(x) = -\sqrt{1-x^2}$. The area is π , so $\bar{x} = \frac{1}{\pi} \int_{-1}^1 x \cdot 2\sqrt{1-x^2} dx = -\frac{2}{3\pi} (1-x^2)^{3/2} \Big|_{-1}^1 = 0$ and $\bar{y} = \frac{1}{\pi} \int_{-1}^1 \frac{1}{2} \cdot 0 dx = 0$, as expected.
7. By symmetry, the centroid lies on the line $y = 1 - x$. To find \bar{x} we use Formula (8) with $a = 0$, $b = 1$, $f(x) = x$. The area is $\frac{1}{2}$, so $\bar{x} = 2 \int_0^1 x^2 dx = \frac{2}{3}$. Hence $\bar{y} = 1 - \frac{2}{3} = \frac{1}{3}$ and the centroid is $\left(\frac{2}{3}, \frac{1}{3}\right)$.
8. We use Formulas (8) and (9) with $a = 0$, $b = 1$, $f(x) = x^2$. The area is $\int_0^1 x^2 dx = \frac{1}{3}$, so $\bar{x} = 3 \int_0^1 x^3 dx = \frac{3}{4}$ and $\bar{y} = 3 \int_0^1 \frac{1}{2} x^4 dx = \frac{3}{10}$. The centroid is $\left(\frac{3}{4}, \frac{3}{10}\right)$.
9. We use Formulas (10) and (11) with $a = 0$, $b = 1$, $f(x) = 2 - x^2$, $g(x) = x$. The area is $\int_0^1 (2 - x^2 - x) dx = \left[2x - \frac{1}{3}x^3 - \frac{1}{2}x^2\right]_0^1 = \frac{7}{6}$, so $\bar{x} = \frac{6}{7} \int_0^1 x(2 - x^2 - x) dx = \frac{6}{7} \left[x^2 - \frac{1}{4}x^4 - \frac{1}{3}x^3\right]_0^1 = \frac{5}{14}$ and $\bar{y} = \frac{6}{7} \int_0^1 \frac{1}{2} [(2 - x^2)^2 - x^2] dx = \frac{3}{7} \int_0^1 (4 - 5x^2 + x^4) dx = \frac{3}{7} \left[4x - \frac{5}{3}x^3 + \frac{1}{5}x^5\right]_0^1 = \frac{38}{35}$. The centroid is $\left(\frac{5}{14}, \frac{38}{35}\right)$.
10. By symmetry the centroid lies on the line $y = x$. To find \bar{x} , we use Formula (8) with $a = 0$, $b = 1$, $f(x) = \sqrt{1-x^2}$. The area is $\frac{\pi}{4}$, so $\bar{x} = \frac{4}{\pi} \int_0^1 x\sqrt{1-x^2} dx = \frac{4}{\pi} \left[-\frac{1}{3}(1-x^2)^{3/2}\right]_0^1 = \frac{4}{3\pi}$. The centroid is $\left(\frac{4}{3\pi}, \frac{4}{3\pi}\right)$.
11. We use Formulas (8) and (9) with $a = 0$, $b = 2$, $f(x) = 1 - \frac{x}{2}$. The area is 1, so $\bar{x} = \int_0^2 x \left(1 - \frac{x}{2}\right) dx = \left[\frac{1}{2}x^2 - \frac{1}{6}x^3\right]_0^2 = \frac{2}{3}$ and $\bar{y} = \int_0^2 \frac{1}{2} \left(1 - \frac{x}{2}\right)^2 dx = \frac{1}{8} \int_0^2 (4 - 4x + x^2) dx = \frac{1}{8} \left[4x - 2x^2 + \frac{1}{3}x^3\right]_0^2 = \frac{1}{3}$. The centroid is $\left(\frac{2}{3}, \frac{1}{3}\right)$.
12. By symmetry, $\bar{x} = 1$. To find \bar{y} we use the analogue of Formula (10) with the roles of x and y reversed. The triangle is described by $0 \leq y \leq 1$, $y \leq x \leq 2 - y$. The area is 1, so $\bar{y} = \int_0^1 y [(2 - y) - y] dy = \int_0^1 (2y - 2y^2) dy = \left[y^2 - \frac{2}{3}y^3\right]_0^1 = \frac{1}{3}$. The centroid is $\left(1, \frac{1}{3}\right)$.
13. The graphs of $y = x^2$ and $y = 6 - x$ meet when $x^2 = 6 - x$, so $x = -3$ or $x = 2$. We use Formulas (10) and (11) with $a = -3$, $b = 2$, $f(x) = 6 - x$, $g(x) = x^2$. The area is $\int_{-3}^2 (6 - x - x^2) dx = \left[6x - \frac{1}{2}x^2 - \frac{1}{3}x^3\right]_{-3}^2 = \frac{125}{6}$, so $\bar{x} = \frac{6}{125} \int_{-3}^2 x(6 - x - x^2) dx = \frac{6}{125} \left[3x^2 - \frac{1}{3}x^3 - \frac{1}{4}x^4\right]_{-3}^2 = -\frac{1}{2}$ and $\bar{y} = \frac{6}{125} \int_{-3}^2 \frac{1}{2} [(6 - x)^2 - (x^2)^2] dx = \frac{3}{125} \int_{-3}^2 (36 - 12x + x^2 - x^4) dx = \frac{3}{125} \left[36x - 6x^2 + \frac{1}{3}x^3 - \frac{1}{5}x^5\right]_{-3}^2 = 4$. The centroid is $\left(-\frac{1}{2}, 4\right)$.
14. We use Formulas (10) and (11) with $a = 0$, $b = 2$, $f(x) = x + 6$, $g(x) = x^2$. The area is $\int_0^2 (x + 6 - x^2) dx = \left[\frac{1}{2}x^2 + 6x - \frac{1}{3}x^3\right]_0^2 = \frac{34}{3}$, so $\bar{x} = \frac{3}{34} \int_0^2 x(x + 6 - x^2) dx = \frac{3}{34} \left[\frac{1}{3}x^3 + 3x^2 - \frac{1}{4}x^4\right]_0^2 = \frac{16}{17}$ and $\bar{y} = \frac{3}{34} \int_0^2 \frac{1}{2} [(x + 6)^2 - (x^2)^2] dx =$

$$6)^2 - (x^2)^2] dx = \frac{3}{68} \int_0^2 (x^2 + 12x + 36 - x^4) dx = \frac{3}{68} \left[\frac{1}{3}x^3 + 6x^2 + 36x - \frac{1}{5}x^5 \right]_0^2 = \frac{346}{85}. \text{ The centroid is } \left(\frac{16}{17}, \frac{346}{85} \right).$$

15. The curves meet at $(-1, 1)$ and $(2, 4)$. We use Formulas (10) and (11) with $a = -1$, $b = 2$, $f(x) = x + 2$, $g(x) = x^2$. The area is $\int_{-1}^2 (x + 2 - x^2) dx = \left[\frac{1}{2}x^2 + 2x - \frac{1}{3}x^3 \right]_{-1}^2 = \frac{9}{2}$, so $\bar{x} = \frac{2}{9} \int_{-1}^2 x(x + 2 - x^2) dx = \frac{2}{9} \left[\frac{1}{3}x^3 + x^2 - \frac{1}{4}x^4 \right]_{-1}^2 = \frac{1}{2}$ and $\bar{y} = \frac{2}{9} \int_{-1}^2 \frac{1}{2} [(x + 2)^2 - (x^2)^2] dx = \frac{1}{9} \int_{-1}^2 (x^2 + 4x + 4 - x^4) dx = \frac{1}{9} \left[\frac{1}{3}x^3 + 2x^2 + 4x - \frac{1}{5}x^5 \right]_{-1}^2 = \frac{8}{5}$. The centroid is $\left(\frac{1}{2}, \frac{8}{5} \right)$.

16. By symmetry, $\bar{x} = 0$. To find \bar{y} we use Formula (11) with $a = -1$, $b = 1$, $f(x) = 1$, $g(x) = x^2$. The area is $\int_{-1}^1 (1 - x^2) dx = \left[x - \frac{1}{3}x^3 \right]_{-1}^1 = \frac{4}{3}$, so $\bar{y} = \frac{3}{4} \int_{-1}^1 \frac{1}{2} [1^2 - (x^2)^2] dx = \frac{3}{8} \int_{-1}^1 (1 - x^4) dx = \frac{3}{8} \left[x - \frac{1}{5}x^5 \right]_{-1}^1 = \frac{3}{5}$. The centroid is $\left(0, \frac{3}{5} \right)$.

17. By symmetry, $\bar{y} = \bar{x}$. To find \bar{x} we use Formula (10) with $a = 0$, $b = 1$, $f(x) = \sqrt{x}$, $g(x) = x^2$. The area is $\int_0^1 (\sqrt{x} - x^2) dx = \left[\frac{2}{3}x^{3/2} - \frac{1}{3}x^3 \right]_0^1 = \frac{1}{3}$, so $\bar{x} = 3 \int_0^1 x(\sqrt{x} - x^2) dx = 3 \left[\frac{2}{5}x^{5/2} - \frac{1}{4}x^4 \right]_0^1 = \frac{9}{20}$. The centroid is $\left(\frac{9}{20}, \frac{9}{20} \right)$.

18. We use Formulas (12) and (13) with $c = 1$, $d = 2$, $w(y) = \frac{1}{y}$. The area is $\int_1^2 \frac{1}{y} dy = \ln 2$, so $\bar{x} = \frac{1}{\ln 2} \int_1^2 \frac{1}{2} \left(\frac{1}{y} \right)^2 dy = \frac{1}{2 \ln 2} \left[-\frac{1}{y} \right]_1^2 = \frac{1}{4 \ln 2}$ and $\bar{y} = \frac{1}{\ln 2} \int_1^2 y \cdot \frac{1}{y} dy = \frac{1}{\ln 2}$. The centroid is $\left(\frac{1}{4 \ln 2}, \frac{1}{\ln 2} \right)$.

19. We use the analogue of Formulas (10) and (11) with the roles of x and y reversed. The region is described by $1 \leq y \leq 2$, $y^{-2} \leq x \leq y$. The area is $\int_1^2 (y - y^{-2}) dy = \left[\frac{1}{2}y^2 + y^{-1} \right]_1^2 = 1$, so $\bar{x} = \int_1^2 \frac{1}{2} [y^2 - (y^{-2})^2] dy = \frac{1}{2} \int_1^2 (y^2 - y^{-4}) dy = \frac{1}{2} \left[\frac{1}{3}y^3 + \frac{1}{3}y^{-3} \right]_1^2 = \frac{49}{48}$ and $\bar{y} = \int_1^2 y(y - y^{-2}) dy = \left[\frac{1}{3}y^3 - \ln y \right]_1^2 = \frac{7}{3} - \ln 2$. The centroid is $\left(\frac{49}{48}, \frac{7}{3} - \ln 2 \right)$.

20. By symmetry, $\bar{y} = \bar{x}$. To find \bar{x} we use Formula (10) with $a = 1$, $b = 4$, $f(x) = 5 - x$, $g(x) = 4x^{-1}$. The area is $\int_1^4 (5 - x - 4x^{-1}) dx = \left[5x - \frac{1}{2}x^2 - 4 \ln x \right]_1^4 = \frac{15 - 16 \ln 2}{2}$, so $\bar{x} = \frac{2}{15 - 16 \ln 2} \int_1^4 x(5 - x - 4x^{-1}) dx = \frac{2}{15 - 16 \ln 2} \left[\frac{5}{2}x^2 - \frac{1}{3}x^3 - 4x \right]_1^4 = \frac{9}{15 - 16 \ln 2}$. The centroid is $\left(\frac{9}{15 - 16 \ln 2}, \frac{9}{15 - 16 \ln 2} \right)$.

21. An isosceles triangle is symmetric across the median to its base. So, if the density is constant, it will balance on a knife-edge under the median. Hence the centroid lies on the median.

22. An ellipse is symmetric across both its major axis and its minor axis. So, if the density is constant, it will balance on a knife-edge under either axis. Hence the centroid lies on both axes, so it is at the intersection of the axes.

23. The region is described by $0 \leq x \leq 1$, $0 \leq y \leq \sqrt{x}$. The area is $A = \int_0^1 \sqrt{x} dx = \frac{2}{3}$, so the mass is $M = \delta A = 2 \cdot \frac{2}{3} = \frac{4}{3}$. By Formulas (8) and (9), $\bar{x} = \frac{3}{2} \int_0^1 x\sqrt{x} dx = \frac{3}{2} \left[\frac{2}{5}x^{5/2} \right]_0^1 = \frac{3}{5}$ and $\bar{y} = \frac{3}{2} \int_0^1 \frac{1}{2} (\sqrt{x})^2 dx = \frac{3}{4} \int_0^1 x dx = \frac{3}{8}$.

The center of gravity is $\left(\frac{3}{5}, \frac{3}{8}\right)$.

24. The region is described by $-1 \leq y \leq 1, y^4 \leq x \leq 1$. The area is $A = \int_{-1}^1 (1 - y^4) dy = \left[y - \frac{1}{5}y^5 \right]_{-1}^1 = \frac{8}{5}$, so the mass is $M = \delta A = 15 \cdot \frac{8}{5} = 24$. By symmetry, $\bar{y} = 0$. By the analogue of Formula (11) with the roles of x and y reversed, $\bar{x} = \frac{5}{8} \int_{-1}^1 \frac{1}{2} [1^2 - (y^4)^2] dy = \frac{5}{16} \int_{-1}^1 (1 - y^8) dy = \frac{5}{16} \left[y - \frac{1}{9}y^9 \right]_{-1}^1 = \frac{5}{9}$. The center of gravity is $\left(\frac{5}{9}, 0\right)$.

25. The region is described by $0 \leq y \leq 1, -y \leq x \leq y$. The area is $A = 1$, so the mass is $M = \delta A = 3 \cdot 1 = 3$. By symmetry, $\bar{x} = 0$. By the analogue of Formula (10) with the roles of x and y reversed, $\bar{y} = \int_0^1 y[y - (-y)] dy = \int_0^1 2y^2 dy = \left[\frac{2}{3}y^3 \right]_0^1 = \frac{2}{3}$. The center of gravity is $\left(0, \frac{2}{3}\right)$.

26. The region is described by $-1 \leq x \leq 1, 0 \leq y \leq 1 - x^2$. The area is $A = \int_{-1}^1 (1 - x^2) dx = \left[x - \frac{1}{3}x^3 \right]_{-1}^1 = \frac{4}{3}$, so the mass is $M = \delta A = 3 \cdot \frac{4}{3} = 4$. By symmetry, $\bar{x} = 0$. By Formula (9), $\bar{y} = \frac{3}{4} \int_{-1}^1 \frac{1}{2}(1 - x^2)^2 dx = \frac{3}{8} \int_{-1}^1 (1 - 2x^2 + x^4) dx = \frac{3}{8} \left[x - \frac{2}{3}x^3 + \frac{1}{5}x^5 \right]_{-1}^1 = \frac{2}{5}$. The center of gravity is $\left(0, \frac{2}{5}\right)$.

27. The region is described by $0 \leq x \leq \pi, 0 \leq y \leq \sin x$. The area is $A = \int_0^\pi \sin x dx = 2$, so the mass is $M = \delta A = 4 \cdot 2 = 8$. By symmetry, $\bar{x} = \frac{\pi}{2}$. By Formula (9), $\bar{y} = \frac{1}{2} \int_0^\pi \frac{1}{2}(\sin x)^2 dx = \frac{\pi}{8}$. The center of gravity is $\left(\frac{\pi}{2}, \frac{\pi}{8}\right)$.

28. The region is described by $0 \leq x \leq 1, 0 \leq y \leq e^x$. The area is $A = \int_0^1 e^x dx = e - 1$, so the mass is $M = \delta A = \frac{1}{e-1} \cdot (e - 1) = 1$. By Formulas (8) and (9), $\bar{x} = \frac{1}{e-1} \int_0^1 x e^x dx = \frac{1}{e-1}$ and $\bar{y} = \frac{1}{e-1} \int_0^1 \frac{1}{2}(e^x)^2 dx = \frac{e+1}{4}$. The center of gravity is $\left(\frac{1}{e-1}, \frac{e+1}{4}\right)$.

29. The region is described by $1 \leq x \leq 2, 0 \leq y \leq \ln x$. The area is $A = \int_1^2 \ln x dx = 2 \ln 2 - 1 = \ln 4 - 1$, so the mass is $M = \delta A = \ln 4 - 1$. By Formulas (8) and (9), $\bar{x} = \frac{1}{\ln 4 - 1} \int_1^2 x \ln x dx = \frac{1}{\ln 4 - 1} \left(\ln 4 - \frac{3}{4} \right) = \frac{4 \ln 4 - 3}{4(\ln 4 - 1)}$ and $\bar{y} = \frac{1}{\ln 4 - 1} \int_1^2 \frac{1}{2}(\ln x)^2 dx = \frac{(\ln 2)^2 - \ln 4 + 1}{\ln 4 - 1}$. The center of gravity is $\left(\frac{4 \ln 4 - 3}{4(\ln 4 - 1)}, \frac{(\ln 2)^2 - \ln 4 + 1}{\ln 4 - 1}\right)$.

30. The region is described by $0 \leq x \leq \frac{\pi}{4}, \sin x \leq y \leq \cos x$. The area is $A = \int_0^{\pi/4} (\cos x - \sin x) dx = \sqrt{2} - 1$, so the mass is $M = \delta A = (1 + \sqrt{2})(\sqrt{2} - 1) = 1$. By Formulas (10) and (11), $\bar{x} = \frac{1}{\sqrt{2} - 1} \int_0^{\pi/4} x(\cos x - \sin x) dx = \frac{(\pi\sqrt{2} - 4)(\sqrt{2} + 1)}{4}$ and $\bar{y} = \frac{1}{\sqrt{2} - 1} \int_0^{\pi/4} \frac{1}{2}(\cos^2 x - \sin^2 x) dx = \frac{\sqrt{2} + 1}{4}$. The center of gravity is $\left(\frac{(\pi\sqrt{2} - 4)(\sqrt{2} + 1)}{4}, \frac{\sqrt{2} + 1}{4}\right)$.

31. True, by symmetry.

32. True, by symmetry.

33. True, by symmetry.

34. False. Rotating the square does not change its area or its centroid, so the Theorem of Pappus implies that the volume is also unchanged.

35. By symmetry, $\bar{y} = 0$. We use Formula (10) with a replaced by 0, b replaced by a , $f(x) = \frac{bx}{a}$, and $g(x) = -\frac{bx}{a}$:
The area is ab , so $\bar{x} = \frac{1}{ab} \int_0^a x \left(\frac{bx}{a} - \left(-\frac{bx}{a} \right) \right) dx = \frac{2}{a^2} \int_0^a x^2 dx = \frac{2}{a^2} \cdot \frac{a^3}{3} = \frac{2a}{3}$. The centroid is $\left(\frac{2a}{3}, 0 \right)$.

36. Let M be a median of the triangle, joining one vertex to the midpoint P of the opposite side. Establish a coordinate system so that the origin is at P , the side containing P lies along the y -axis, and the rest of the triangle is to the right of the y -axis. Then the coordinates of the vertices are $(0, -a)$, $(0, a)$, and (b, c) , where $a > 0$ and $b > 0$. The upper edge has equation $y = a + \frac{c-a}{b}x = \frac{cx}{b} + \frac{a(b-x)}{b}$ and the lower edge has equation $y = -a + \frac{c+a}{b}x = \frac{cx}{b} - \frac{a(b-x)}{b}$, where x runs from 0 to b . The triangle's area is $\frac{1}{2} \cdot 2a \cdot b = ab$. By Formulas (8) and (9),

$$\bar{x} = \frac{1}{ab} \int_0^b x \left[\left(\frac{cx}{b} + \frac{a(b-x)}{b} \right) - \left(\frac{cx}{b} - \frac{a(b-x)}{b} \right) \right] dx = \frac{1}{ab} \int_0^b \frac{2a}{b} (bx - x^2) dx = \frac{2}{b^2} \left[\frac{b}{2}x^2 - \frac{1}{3}x^3 \right]_0^b = \frac{b}{3}, \text{ and}$$

$$\bar{y} = \frac{1}{ab} \int_0^b \frac{1}{2} \left[\left(\frac{cx}{b} + \frac{a(b-x)}{b} \right)^2 - \left(\frac{cx}{b} - \frac{a(b-x)}{b} \right)^2 \right] dx = \frac{1}{2ab} \int_0^b \frac{4acx(b-x)}{b^2} dx = \frac{1}{2ab} \cdot \frac{4ac}{b^2} \left[\frac{b}{2}x^2 - \frac{1}{3}x^3 \right]_0^b = \frac{c}{3}.$$

The centroid is $\left(\frac{b}{3}, \frac{c}{3} \right)$. Note that this lies on the line $y = \frac{c}{b}x$, which is the median M . Since we picked M arbitrarily, the centroid lies on all 3 medians, so it is their intersection.

37. We will assume that a , b , and c are positive; the other cases are similar. The region is described by $0 \leq y \leq c$, $-a - \frac{b-a}{c}y \leq x \leq a + \frac{b-a}{c}y$. By symmetry, $\bar{x} = 0$. To find \bar{y} , we use the analogue of Formula (10) with the roles of x and y reversed. The area is $c(a+b)$, so $\bar{y} = \frac{1}{c(a+b)} \int_0^c y \left[\left(a + \frac{b-a}{c}y \right) - \left(-a - \frac{b-a}{c}y \right) \right] dy =$

$$\frac{1}{c(a+b)} \int_0^c \left(2ay + \frac{2(b-a)}{c}y^2 \right) dy = \frac{1}{c(a+b)} \left[ay^2 + \frac{2(b-a)}{3c}y^3 \right]_0^c = \frac{c(a+2b)}{3(a+b)}. \text{ The centroid is } \left(0, \frac{c(a+2b)}{3(a+b)} \right).$$

38. A parallelogram is symmetric about the intersection of its diagonals: it is identical to its 180° rotation about that point. By symmetry, the intersection of the diagonals is the centroid.

39. $\bar{x} = 0$ from the symmetry of the region, $\pi a^2/2$ is the area of the semicircle, $2\pi\bar{y}$ is the distance traveled by the centroid to generate the sphere so $4\pi a^3/3 = (\pi a^2/2)(2\pi\bar{y})$, $\bar{y} = 4a/(3\pi)$.

40. (a) $V = \left[\frac{1}{2}\pi a^2 \right] \left[2\pi \left(a + \frac{4a}{3\pi} \right) \right] = \frac{1}{3}\pi(3\pi + 4)a^3.$

(b) The distance between the centroid and the line is $\frac{\sqrt{2}}{2} \left(a + \frac{4a}{3\pi} \right)$, so $V = \left[\frac{1}{2}\pi a^2 \right] \left[2\pi \frac{\sqrt{2}}{2} \left(a + \frac{4a}{3\pi} \right) \right] = \frac{1}{6}\sqrt{2}\pi(3\pi + 4)a^3.$

41. $\bar{x} = k$ so $V = (\pi ab)(2\pi k) = 2\pi^2 abk.$

42. $\bar{y} = 4$ from the symmetry of the region, $A = \int_{-2}^2 \int_{x^2}^{8-x^2} dy dx = 64/3$ so $V = (64/3)[2\pi(4)] = 512\pi/3$.

43. The region generates a cone of volume $\frac{1}{3}\pi ab^2$ when it is revolved about the x -axis, the area of the region is $\frac{1}{2}ab$ so $\frac{1}{3}\pi ab^2 = \left(\frac{1}{2}ab\right)(2\pi\bar{y})$, $\bar{y} = b/3$. A cone of volume $\frac{1}{3}\pi a^2b$ is generated when the region is revolved about the y -axis so $\frac{1}{3}\pi a^2b = \left(\frac{1}{2}ab\right)(2\pi\bar{x})$, $\bar{x} = a/3$. The centroid is $(a/3, b/3)$.

44. The centroid of a region is defined to be the center of gravity of a lamina of constant density occupying the region. So assume that both R_1 and R_2 have density δ . By equation (6), the moment of R_1 about the y -axis is $\delta A_1 \bar{x}_1$, and the moment of R_2 about the y -axis is $\delta A_2 \bar{x}_2$. The moment of the union R is the sum of these, $\delta(A_1 \bar{x}_1 + A_2 \bar{x}_2)$. The mass of R is the sum of the masses of R_1 and R_2 , $\delta(A_1 + A_2)$. Again using equation (6), the x -coordinate of the centroid of R is $\frac{\delta(A_1 \bar{x}_1 + A_2 \bar{x}_2)}{\delta(A_1 + A_2)} = \frac{A_1 \bar{x}_1 + A_2 \bar{x}_2}{A_1 + A_2}$. Similarly, the y -coordinate of the centroid of R is $\frac{A_1 \bar{y}_1 + A_2 \bar{y}_2}{A_1 + A_2}$. In words, the centroid of R lies on the line segment joining the centroids of R_1 and R_2 , and its distance from the centroid of R_1 is $\frac{A_2}{A_1 + A_2}$ times the distance between the centroids of R_1 and R_2 . For example, if $A_1 = 2A_2$ then the centroid of R is one third of the way from the centroid of R_1 to the centroid of R_2 . If R is decomposed into n regions R_1, \dots, R_n of areas A_1, \dots, A_n and centroids $(\bar{x}_1, \bar{y}_1), \dots, (\bar{x}_n, \bar{y}_n)$, then the centroid of R is $\left(\frac{A_1 \bar{x}_1 + \dots + A_n \bar{x}_n}{A_1 + \dots + A_n}, \frac{A_1 \bar{y}_1 + \dots + A_n \bar{y}_n}{A_1 + \dots + A_n}\right)$.

45. The Theorem of Pappus says that $V = 2\pi Ad$, where A is the area of a region in the plane, d is the distance from the region's centroid to an axis of rotation, and V is the volume of the resulting solid of revolution. In any problem in which 2 of these quantities are given, the Theorem of Pappus can be used to compute the third.

Exercise Set 6.8

1. (a) $F = \rho h A = 62.4(5)(100) = 31,200$ lb, $P = \rho h = 62.4(5) = 312$ lb/ft².

(b) $F = \rho h A = 9810(10)(25) = 2,452,500$ N, $P = \rho h = 9810(10) = 98.1$ kPa.

2. (a) $F = P A = 6 \cdot 10^5(160) = 9.6 \times 10^7$ N. (b) $F = P A = 100(60) = 6000$ lb.

3. $F = \int_0^2 62.4x(4) dx = 249.6 \int_0^2 x dx = 499.2$ lb.

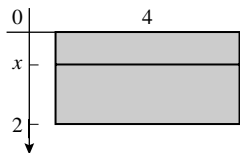

4. $F = \int_1^3 9810x(4) dx = 39,240 \int_1^3 x dx = 156,960$ N.

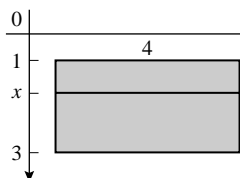

5. $F = \int_0^5 9810x(2\sqrt{25-x^2}) dx = 19,620 \int_0^5 x(25-x^2)^{1/2} dx = 8.175 \times 10^5$ N.

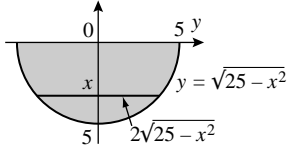

6. By similar triangles, $\frac{w(x)}{4} = \frac{2\sqrt{3} - x}{2\sqrt{3}}$, $w(x) = \frac{2}{\sqrt{3}}(2\sqrt{3} - x)$, so $F = \int_0^{2\sqrt{3}} 62.4x \left[\frac{2}{\sqrt{3}}(2\sqrt{3} - x) \right] dx = \frac{124.8}{\sqrt{3}} \int_0^{2\sqrt{3}} (2\sqrt{3}x - x^2) dx = 499.2 \text{ lb.}$

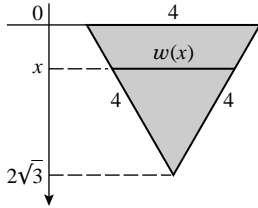

7. By similar triangles, $\frac{w(x)}{6} = \frac{10 - x}{8}$, $w(x) = \frac{3}{4}(10 - x)$, so $F = \int_2^{10} 9810x \left[\frac{3}{4}(10 - x) \right] dx = 7357.5 \int_2^{10} (10x - x^2) dx = 1,098,720 \text{ N.}$

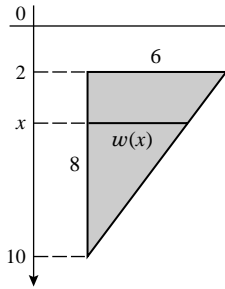

8. $w(x) = 16 + 2u(x)$, but $\frac{u(x)}{4} = \frac{12 - x}{8}$, so $u(x) = \frac{1}{2}(12 - x)$, $w(x) = 16 + (12 - x) = 28 - x$, and $F = \int_4^{12} 62.4x(28 - x) dx = 62.4 \int_4^{12} (28x - x^2) dx = 77,209.6 \text{ lb.}$

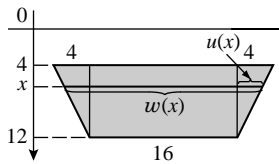

9. Yes: if $\rho_2 = 2\rho_1$ then $F_2 = \int_a^b \rho_2 h(x)w(x) dx = \int_a^b 2\rho_1 h(x)w(x) dx = 2 \int_a^b \rho_1 h(x)w(x) dx = 2F_1$.

10. $F = \int_0^2 50x(2\sqrt{4 - x^2}) dx = 100 \int_0^2 x(4 - x^2)^{1/2} dx = 800/3 \text{ lb.}$

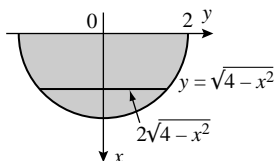

11. Find the forces on the upper and lower halves and add them: $\frac{w_1(x)}{\sqrt{2}a} = \frac{x}{\sqrt{2}a/2}$, $w_1(x) = 2x$, $F_1 = \int_0^{\sqrt{2}a/2} \rho x(2x) dx = 2\rho \int_0^{\sqrt{2}a/2} x^2 dx = \sqrt{2}\rho a^3/6$, $\frac{w_2(x)}{\sqrt{2}a} = \frac{\sqrt{2}a - x}{\sqrt{2}a/2}$, $w_2(x) = 2(\sqrt{2}a - x)$, $F_2 = \int_{\sqrt{2}a/2}^{\sqrt{2}a} \rho x[2(\sqrt{2}a - x)] dx = 2\rho \int_{\sqrt{2}a/2}^{\sqrt{2}a} (\sqrt{2}ax - x^2) dx = \sqrt{2}\rho a^3/3$, $F = F_1 + F_2 = \sqrt{2}\rho a^3/6 + \sqrt{2}\rho a^3/3 = \rho a^3/\sqrt{2}$ lb.

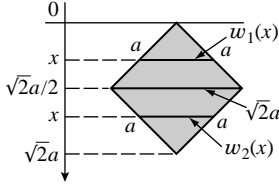

12. False. The units of pressure are the units of force divided by the units of area. In SI, the units of force are newtons and the units of pressure are newtons per square meter, or pascals.
13. True. By equation (6), the fluid force equals ρhA . For a cylinder, hA is the volume, so ρhA is the weight of the water.
14. False. Consider a tank of height h , whose horizontal cross-sections are a by b rectangles. By equation (6), the fluid force on the bottom of the tank is ρhab . By equation (8), the fluid force on either a by h side of the tank is $\int_0^h \rho xa dx = \frac{\rho h^2 a}{2}$. So if $h > 2b$, then the fluid force on the side is larger than the fluid force on the bottom.
15. False. Let the height of the tank be h , the area of the base be A , and the volume of the tank be V . Then the fluid force on the base is ρhA and the weight of the water is ρV . So if $hA > V$, then the force exceeds the weight. This is true, for example, for a conical tank with its vertex at the top, for which $V = \frac{hA}{3}$.

16. Suppose that a flat surface is immersed, at an angle θ with the vertical, in a fluid of weight density ρ , and that the submerged portion of the surface extends from $x = a$ to $x = b$ along an x -axis whose positive direction is down. Following the derivation of equation (8), we divide the interval $[a, b]$ into n subintervals $a = x_0 < x_1 < \dots < x_{n-1} < x_n = b$. As in that derivation, we have $F_k = \rho h(x_k^*)A_k$, for some point x_k^* between x_{k-1} and x_k . Because the surface is tilted, the k 'th strip is approximately a rectangle with width $w(x_k^*)$ and length $\Delta x_k \sec \theta$; its area is $A_k \approx w(x_k^*)\Delta x_k \sec \theta$. So $F_k \approx \rho h(x_k^*)w(x_k^*)\Delta x_k \sec \theta$. Following the argument in the text we arrive at the desired equation $F = \int_a^b \rho h(x)w(x) \sec \theta dx$.

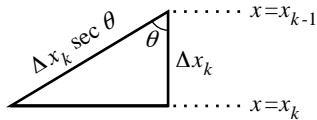

17. Place the x -axis pointing down with its origin at the top of the pool, so that $h(x) = x$ and $w(x) = 10$. The angle between the bottom of the pool and the vertical is $\theta = \tan^{-1}(16/(8 - 4)) = \tan^{-1} 4$, so $\sec \theta = \sqrt{17}$. Hence $F = \int_4^8 62.4h(x)w(x) \sec \theta dx = 624\sqrt{17} \int_4^8 x dx = 14976\sqrt{17} \approx 61748$ lb.
18. If we lower the water level by k ft, $k < 4$, then the force is computed as in Exercise 17, but with $h(x) = x - k$, so $F = \int_4^8 62.4h(x)w(x) \sec \theta dx = 624\sqrt{17} \int_4^8 (x - k) dx = 624\sqrt{17}(24 - 4k)$ lb. For this to be half of $14976\sqrt{17}$, we need $k = 3$, so we should lower the water level by 3 ft. (Note that this is plausible, since this lowers the average depth from 6 ft to 3 ft, cutting the volume and weight of the water in half.)

19. Place the x -axis starting from the surface, pointing downward. Then using the given formula with $\theta = 30^\circ$, $\sec \theta = 2/\sqrt{3}$, the force is $F = \int_0^{50\sqrt{3}} 9810x(200)(2/\sqrt{3}) dx = 4,905,000,000\sqrt{3}$ N.

20. $F = \int_h^{h+2} \rho_0 x(2) dx = 2\rho_0 \int_h^{h+2} x dx = 4\rho_0(h+1)$.

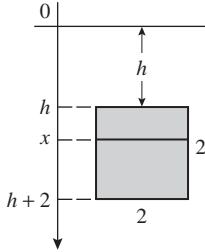

21. (a) The force on the window is $F = \int_h^{h+2} \rho_0 x(2) dx = 4\rho_0(h+1)$ so (assuming that ρ_0 is constant) $dF/dt = 4\rho_0(dh/dt)$ which is a positive constant if dh/dt is a positive constant.

(b) If $dh/dt = 20$, then $dF/dt = 80\rho_0$ lb/min from part (a).

22. (a) Let h_1 and h_2 be the maximum and minimum depths of the disk D_r . The pressure $P(r)$ on one side of the disk satisfies inequality (5): $\rho h_1 \leq P(r) \leq \rho h_2$. But $\lim_{r \rightarrow 0^+} h_1 = \lim_{r \rightarrow 0^+} h_2 = h$, and hence $\rho h = \lim_{r \rightarrow 0^+} \rho h_1 \leq \lim_{r \rightarrow 0^+} P(r) \leq \lim_{r \rightarrow 0^+} \rho h_2 = \rho h$, so $\lim_{r \rightarrow 0^+} P(r) = \rho h$.

(b) The disks D_r in part (a) have no particular direction (the axes of the disks have arbitrary direction). Thus P , the limiting value of $P(r)$, is independent of direction.

23. $h = \frac{P}{\rho} = \frac{14.7 \text{ lb/in}^2}{4.66 \times 10^{-5} \text{ lb/in}^3} \approx 315,000 \text{ in} \approx 5 \text{ mi}$. The answer is not reasonable. In fact the atmosphere is thinner at higher altitudes, and it's difficult to define where the "top" of the atmosphere is.

24. According to equation (6), if the density is constant then the fluid force on a horizontal surface of area A at depth h equals the weight of the water above it. It is plausible to assume that this is also true if the density is not constant. To compute this weight, partition the interval $[0, h]$ with $0 = x_0 < x_1 < \dots < x_{n-1} < x_n = h$. Let x_k^* be an arbitrary point of $[x_{k-1}, x_k]$. The volume of water which is above the flat surface and at depth between x_{k-1} and x_k is $A \Delta x_k$ so its weight is approximately $\rho(x_k^*)A \Delta x_k$. Adding these estimates, we find that the total weight is approximately $\sum_{k=1}^n \rho(x_k^*)A \Delta x_k$. Taking the limit as $n \rightarrow +\infty$ and the lengths of the subintervals all

approach zero gives the total weight, and hence the total force on the surface: $\int_0^h \rho(x)A dx$. Dividing by A gives

the pressure: $P = \int_0^h \rho(x) dx$.

Exercise Set 6.9

1. (a) $\sinh 3 \approx 10.0179$. (b) $\cosh(-2) \approx 3.7622$. (c) $\tanh(\ln 4) = 15/17 \approx 0.8824$.

(d) $\sinh^{-1}(-2) \approx -1.4436$. (e) $\cosh^{-1} 3 \approx 1.7627$. (f) $\tanh^{-1} \frac{3}{4} \approx 0.9730$.

2. (a) $\operatorname{csch}(-1) \approx -0.8509$. (b) $\operatorname{sech}(\ln 2) = 0.8$. (c) $\operatorname{coth} 1 \approx 1.3130$.

(d) $\operatorname{sech}^{-1} \frac{1}{2} \approx 1.3170$. (e) $\operatorname{coth}^{-1} 3 \approx 0.3466$. (f) $\operatorname{csch}^{-1}(-\sqrt{3}) \approx -0.5493$.

3. (a) $\sinh(\ln 3) = \frac{1}{2}(e^{\ln 3} - e^{-\ln 3}) = \frac{1}{2}\left(3 - \frac{1}{3}\right) = \frac{4}{3}$.

(b) $\cosh(-\ln 2) = \frac{1}{2}(e^{-\ln 2} + e^{\ln 2}) = \frac{1}{2}\left(\frac{1}{2} + 2\right) = \frac{5}{4}$.

(c) $\tanh(2 \ln 5) = \frac{e^{2 \ln 5} - e^{-2 \ln 5}}{e^{2 \ln 5} + e^{-2 \ln 5}} = \frac{25 - 1/25}{25 + 1/25} = \frac{312}{313}$.

(d) $\sinh(-3 \ln 2) = \frac{1}{2}(e^{-3 \ln 2} - e^{3 \ln 2}) = \frac{1}{2}\left(\frac{1}{8} - 8\right) = -\frac{63}{16}$.

4. (a) $\frac{1}{2}(e^{\ln x} + e^{-\ln x}) = \frac{1}{2}\left(x + \frac{1}{x}\right) = \frac{x^2 + 1}{2x}, x > 0$.

(b) $\frac{1}{2}(e^{\ln x} - e^{-\ln x}) = \frac{1}{2}\left(x - \frac{1}{x}\right) = \frac{x^2 - 1}{2x}, x > 0$.

(c) $\frac{e^{2 \ln x} - e^{-2 \ln x}}{e^{2 \ln x} + e^{-2 \ln x}} = \frac{x^2 - 1/x^2}{x^2 + 1/x^2} = \frac{x^4 - 1}{x^4 + 1}, x > 0$.

(d) $\frac{1}{2}(e^{-\ln x} + e^{\ln x}) = \frac{1}{2}\left(\frac{1}{x} + x\right) = \frac{1 + x^2}{2x}, x > 0$.

5.

	$\sinh x_0$	$\cosh x_0$	$\tanh x_0$	$\coth x_0$	$\operatorname{sech} x_0$	$\operatorname{csch} x_0$
(a)	2	$\sqrt{5}$	$2/\sqrt{5}$	$\sqrt{5}/2$	$1/\sqrt{5}$	$1/2$
(b)	$3/4$	$5/4$	$3/5$	$5/3$	$4/5$	$4/3$
(c)	$4/3$	$5/3$	$4/5$	$5/4$	$3/5$	$3/4$

(a) $\cosh^2 x_0 = 1 + \sinh^2 x_0 = 1 + (2)^2 = 5, \cosh x_0 = \sqrt{5}$.

(b) $\sinh^2 x_0 = \cosh^2 x_0 - 1 = \frac{25}{16} - 1 = \frac{9}{16}, \sinh x_0 = \frac{3}{4}$ (because $x_0 > 0$).

(c) $\operatorname{sech}^2 x_0 = 1 - \tanh^2 x_0 = 1 - \left(\frac{4}{5}\right)^2 = 1 - \frac{16}{25} = \frac{9}{25}, \operatorname{sech} x_0 = \frac{3}{5}, \cosh x_0 = \frac{1}{\operatorname{sech} x_0} = \frac{5}{3}$, from $\frac{\sinh x_0}{\cosh x_0} = \tanh x_0$ we get $\sinh x_0 = \left(\frac{5}{3}\right)\left(\frac{4}{5}\right) = \frac{4}{3}$.

6. $\frac{d}{dx} \operatorname{csch} x = \frac{d}{dx} \frac{1}{\sinh x} = -\frac{\cosh x}{\sinh^2 x} = -\coth x \operatorname{csch} x$ for $x \neq 0$.

$\frac{d}{dx} \operatorname{sech} x = \frac{d}{dx} \frac{1}{\cosh x} = -\frac{\sinh x}{\cosh^2 x} = -\tanh x \operatorname{sech} x$ for all x .

$\frac{d}{dx} \coth x = \frac{d}{dx} \frac{\cosh x}{\sinh x} = \frac{\sinh^2 x - \cosh^2 x}{\sinh^2 x} = -\operatorname{csch}^2 x$ for $x \neq 0$.

7. $\frac{d}{dx} \cosh^{-1} x = \frac{d}{dx} \ln(x + \sqrt{x^2 - 1}) = \frac{1}{x + \sqrt{x^2 - 1}} \left(1 + \frac{2x}{2\sqrt{x^2 - 1}}\right) = \frac{1}{x + \sqrt{x^2 - 1}} \frac{\sqrt{x^2 - 1} + x}{\sqrt{x^2 - 1}} = \frac{1}{\sqrt{x^2 - 1}}$.

$\frac{d}{dx} \tanh^{-1} x = \frac{d}{dx} \left[\frac{1}{2} \ln \left(\frac{1+x}{1-x}\right)\right] = \frac{1}{2} \cdot \frac{1}{\frac{1+x}{1-x}} \cdot \frac{(1-x) \cdot 1 - (1+x)(-1)}{(1-x)^2} = \frac{2}{2(1+x)(1-x)} = \frac{1}{1-x^2}$.

8. $y = \sinh^{-1} x$ if and only if $x = \sinh y$; $1 = \frac{dy}{dx} \frac{dx}{dy} = \frac{dy}{dx} \cosh y$; so $\frac{d}{dx}[\sinh^{-1} x] = \frac{dy}{dx} = \frac{1}{\cosh y} = \frac{1}{\sqrt{1 + \sinh^2 y}} = \frac{1}{\sqrt{1 + x^2}}$ for all x .
- Let $x \geq 1$. Then $y = \cosh^{-1} x$ if and only if $x = \cosh y$; $1 = \frac{dy}{dx} \frac{dx}{dy} = \frac{dy}{dx} \sinh y$, so $\frac{d}{dx}[\cosh^{-1} x] = \frac{dy}{dx} = \frac{1}{\sinh y} = \frac{1}{\sqrt{\cosh^2 y - 1}} = \frac{1}{\sqrt{x^2 - 1}}$ for $x \geq 1$.
- Let $-1 < x < 1$. Then $y = \tanh^{-1} x$ if and only if $x = \tanh y$; thus $1 = \frac{dy}{dx} \frac{dx}{dy} = \frac{dy}{dx} \operatorname{sech}^2 y = \frac{dy}{dx} (1 - \tanh^2 y) = 1 - x^2$, so $\frac{d}{dx}[\tanh^{-1} x] = \frac{dy}{dx} = \frac{1}{1 - x^2}$.
9. $\frac{dy}{dx} = 4 \cosh(4x - 8)$.
10. $\frac{dy}{dx} = 4x^3 \sinh(x^4)$.
11. $\frac{dy}{dx} = -\frac{1}{x} \operatorname{csch}^2(\ln x)$.
12. $\frac{dy}{dx} = 2 \frac{\operatorname{sech}^2 2x}{\tanh 2x}$.
13. $\frac{dy}{dx} = \frac{1}{x^2} \operatorname{csch}(1/x) \coth(1/x)$.
14. $\frac{dy}{dx} = -2e^{2x} \operatorname{sech}(e^{2x}) \tanh(e^{2x})$.
15. $\frac{dy}{dx} = \frac{2 + 5 \cosh(5x) \sinh(5x)}{\sqrt{4x + \cosh^2(5x)}}$.
16. $\frac{dy}{dx} = 6 \sinh^2(2x) \cosh(2x)$.
17. $\frac{dy}{dx} = x^{5/2} \tanh(\sqrt{x}) \operatorname{sech}^2(\sqrt{x}) + 3x^2 \tanh^2(\sqrt{x})$.
18. $\frac{dy}{dx} = -3 \cosh(\cos 3x) \sin 3x$.
19. $\frac{dy}{dx} = \frac{1}{\sqrt{1 + x^2/9}} \left(\frac{1}{3}\right) = 1/\sqrt{9 + x^2}$.
20. $\frac{dy}{dx} = \frac{1}{\sqrt{1 + 1/x^2}} (-1/x^2) = -\frac{1}{|x|\sqrt{x^2 + 1}}$.
21. $\frac{dy}{dx} = 1/[(\cosh^{-1} x)\sqrt{x^2 - 1}]$.
22. $\frac{dy}{dx} = 1/\left[\sqrt{(\sinh^{-1} x)^2 - 1} \sqrt{1 + x^2}\right]$.
23. $\frac{dy}{dx} = -(\tanh^{-1} x)^{-2}/(1 - x^2)$.

$$24. \frac{dy}{dx} = 2(\coth^{-1} x)/(1 - x^2).$$

$$25. \frac{dy}{dx} = \frac{\sinh x}{\sqrt{\cosh^2 x - 1}} = \frac{\sinh x}{|\sinh x|} = \begin{cases} 1, & x > 0 \\ -1, & x < 0 \end{cases}.$$

$$26. \frac{dy}{dx} = (\operatorname{sech}^2 x)/\sqrt{1 + \tanh^2 x}.$$

$$27. \frac{dy}{dx} = -\frac{e^x}{2x\sqrt{1-x}} + e^x \operatorname{sech}^{-1} \sqrt{x}.$$

$$28. \frac{dy}{dx} = 10(1 + x \operatorname{csch}^{-1} x)^9 \left(-\frac{x}{|x|\sqrt{1+x^2}} + \operatorname{csch}^{-1} x \right).$$

$$29. u = \sinh x, \int u^6 du = \frac{1}{7} \sinh^7 x + C.$$

$$30. u = 2x - 3, \int \frac{1}{2} \cosh u du = \frac{1}{2} \sinh(2x - 3) + C.$$

$$31. u = \tanh x, \int \sqrt{u} du = \frac{2}{3} (\tanh x)^{3/2} + C.$$

$$32. u = 3x, \int \frac{1}{3} \operatorname{csch}^2 u du = -\frac{1}{3} \coth(3x) + C.$$

$$33. u = \cosh x, \int \frac{1}{u} du = \ln(\cosh x) + C.$$

$$34. u = \coth x, -\int u^2 du = -\frac{1}{3} \coth^3 x + C.$$

$$35. -\frac{1}{3} \operatorname{sech}^3 x \Big|_{\ln 2}^{\ln 3} = 37/375.$$

$$36. \ln(\cosh x) \Big|_0^{\ln 3} = \ln 5 - \ln 3.$$

$$37. u = 3x, \frac{1}{3} \int \frac{1}{\sqrt{1+u^2}} du = \frac{1}{3} \sinh^{-1} 3x + C.$$

$$38. x = \sqrt{2}u, \int \frac{\sqrt{2}}{\sqrt{2u^2-2}} du = \int \frac{1}{\sqrt{u^2-1}} du = \cosh^{-1}(x/\sqrt{2}) + C.$$

$$39. u = e^x, \int \frac{1}{u\sqrt{1-u^2}} du = -\operatorname{sech}^{-1}(e^x) + C.$$

$$40. u = \cos \theta, -\int \frac{1}{\sqrt{1+u^2}} du = -\sinh^{-1}(\cos \theta) + C$$

$$41. u = 2x, \int \frac{du}{u\sqrt{1+u^2}} = -\operatorname{csch}^{-1}|u| + C = -\operatorname{csch}^{-1}|2x| + C.$$

$$42. x = 5u/3, \int \frac{5/3}{\sqrt{25u^2-25}} du = \frac{1}{3} \int \frac{1}{\sqrt{u^2-1}} du = \frac{1}{3} \cosh^{-1}(3x/5) + C.$$

$$43. \tanh^{-1} x \Big|_0^{1/2} = \tanh^{-1}(1/2) - \tanh^{-1}(0) = \frac{1}{2} \ln \frac{1+1/2}{1-1/2} = \frac{1}{2} \ln 3.$$

$$44. \sinh^{-1} t \Big|_0^{\sqrt{3}} = \sinh^{-1} \sqrt{3} - \sinh^{-1} 0 = \ln(\sqrt{3} + 2).$$

$$45. \text{True. } \cosh x - \sinh x = \frac{e^x + e^{-x}}{2} - \frac{e^x - e^{-x}}{2} = e^{-x} \text{ is positive for all } x.$$

46. True. $\tanh x$ and $\operatorname{sech} x$ are bounded; the other 4 hyperbolic functions are not.

47. True. Only $\sinh x$ has this property.

48. False. For example, $\cos^2 x + \sin^2 x = 1$, but the corresponding identity for hyperbolic functions has a minus sign: $\cosh^2 x - \sinh^2 x = 1$.

$$49. A = \int_0^{\ln 3} \sinh 2x \, dx = \frac{1}{2} \cosh 2x \Big|_0^{\ln 3} = \frac{1}{2} [\cosh(2 \ln 3) - 1], \text{ but } \cosh(2 \ln 3) = \cosh(\ln 9) = \frac{1}{2}(e^{\ln 9} + e^{-\ln 9}) = \frac{1}{2}(9 + 1/9) = 41/9 \text{ so } A = \frac{1}{2}[41/9 - 1] = 16/9.$$

$$50. V = \pi \int_0^{\ln 2} \operatorname{sech}^2 x \, dx = \pi \tanh x \Big|_0^{\ln 2} = \pi \tanh(\ln 2) = 3\pi/5.$$

$$51. V = \pi \int_0^5 (\cosh^2 2x - \sinh^2 2x) \, dx = \pi \int_0^5 dx = 5\pi.$$

$$52. \int_0^1 \cosh ax \, dx = 2, \frac{1}{a} \sinh ax \Big|_0^1 = 2, \frac{1}{a} \sinh a = 2, \sinh a = 2a; \text{ let } f(a) = \sinh a - 2a, \text{ then } a_{n+1} = a_n - \frac{\sinh a_n - 2a_n}{\cosh a_n - 2}, a_1 = 2.2, \dots, a_4 \approx a_5 \approx 2.177318985.$$

$$53. y' = \sinh x, 1 + (y')^2 = 1 + \sinh^2 x = \cosh^2 x, L = \int_0^{\ln 2} \cosh x \, dx = \sinh x \Big|_0^{\ln 2} = \sinh(\ln 2) = \frac{1}{2}(e^{\ln 2} - e^{-\ln 2}) = \frac{1}{2} \left(2 - \frac{1}{2} \right) = \frac{3}{4}.$$

$$54. y' = \sinh(x/a), 1 + (y')^2 = 1 + \sinh^2(x/a) = \cosh^2(x/a), L = \int_0^{x_1} \cosh(x/a) \, dx = a \sinh(x/a) \Big|_0^{x_1} = a \sinh(x_1/a).$$

$$55. (a) \lim_{x \rightarrow +\infty} \sinh x = \lim_{x \rightarrow +\infty} \frac{1}{2}(e^x - e^{-x}) = +\infty - 0 = +\infty.$$

$$(b) \lim_{x \rightarrow -\infty} \sinh x = \lim_{x \rightarrow -\infty} \frac{1}{2}(e^x - e^{-x}) = 0 - \infty = -\infty.$$

$$(c) \lim_{x \rightarrow +\infty} \tanh x = \lim_{x \rightarrow +\infty} \frac{e^x - e^{-x}}{e^x + e^{-x}} = \lim_{x \rightarrow +\infty} \frac{1 - e^{-2x}}{1 + e^{-2x}} = 1.$$

$$(d) \lim_{x \rightarrow -\infty} \tanh x = \lim_{x \rightarrow -\infty} \frac{e^x - e^{-x}}{e^x + e^{-x}} = \lim_{x \rightarrow -\infty} \frac{e^{2x} - 1}{e^{2x} + 1} = -1.$$

$$(e) \lim_{x \rightarrow +\infty} \sinh^{-1} x = \lim_{x \rightarrow +\infty} \ln(x + \sqrt{x^2 + 1}) = +\infty.$$

$$(f) \lim_{x \rightarrow 1^-} \tanh^{-1} x = \lim_{x \rightarrow 1^-} \frac{1}{2} [\ln(1+x) - \ln(1-x)] = +\infty.$$

56. Since $\lim_{x \rightarrow +\infty} \frac{\sinh x}{e^{x/2}} = 1$ and $\lim_{x \rightarrow +\infty} \frac{\cosh x}{e^{x/2}} = 1$, $\lim_{x \rightarrow +\infty} \tanh x = \frac{\lim_{x \rightarrow +\infty} \frac{\sinh x}{e^{x/2}}}{\lim_{x \rightarrow +\infty} \frac{\cosh x}{e^{x/2}}} = 1$.

Since $\lim_{x \rightarrow -\infty} \frac{\sinh x}{e^{-x/2}} = -1$ and $\lim_{x \rightarrow -\infty} \frac{\cosh x}{e^{-x/2}} = 1$, $\lim_{x \rightarrow -\infty} \tanh x = \frac{\lim_{x \rightarrow -\infty} \frac{\sinh x}{e^{-x/2}}}{\lim_{x \rightarrow +\infty} \frac{\cosh x}{e^{-x/2}}} = -1$.

57. $\sinh(-x) = \frac{1}{2}(e^{-x} - e^x) = -\frac{1}{2}(e^x - e^{-x}) = -\sinh x$, $\cosh(-x) = \frac{1}{2}(e^{-x} + e^x) = \frac{1}{2}(e^x + e^{-x}) = \cosh x$.

58. (a) $\cosh x + \sinh x = \frac{1}{2}(e^x + e^{-x}) + \frac{1}{2}(e^x - e^{-x}) = e^x$.

(b) $\cosh x - \sinh x = \frac{1}{2}(e^x + e^{-x}) - \frac{1}{2}(e^x - e^{-x}) = e^{-x}$.

(c) $\sinh x \cosh y + \cosh x \sinh y = \frac{1}{4}(e^x - e^{-x})(e^y + e^{-y}) + \frac{1}{4}(e^x + e^{-x})(e^y - e^{-y}) =$
 $= \frac{1}{4}[(e^{x+y} - e^{-x+y} + e^{x-y} - e^{-x-y}) + (e^{x+y} + e^{-x+y} - e^{x-y} - e^{-x-y})] = \frac{1}{2}[e^{(x+y)} - e^{-(x+y)}] = \sinh(x+y)$.

(d) Let $y = x$ in part (c).

(e) The proof is similar to part (c), or: treat x as variable and y as constant, and differentiate the result in part (c) with respect to x .

(f) Let $y = x$ in part (e).

(g) Use $\cosh^2 x = 1 + \sinh^2 x$ together with part (f).

(h) Use $\sinh^2 x = \cosh^2 x - 1$ together with part (f).

59. (a) Divide $\cosh^2 x - \sinh^2 x = 1$ by $\cosh^2 x$.

(b) $\tanh(x+y) = \frac{\sinh x \cosh y + \cosh x \sinh y}{\cosh x \cosh y + \sinh x \sinh y} = \frac{\frac{\sinh x}{\cosh x} + \frac{\sinh y}{\cosh y}}{1 + \frac{\sinh x \sinh y}{\cosh x \cosh y}} = \frac{\tanh x + \tanh y}{1 + \tanh x \tanh y}$.

(c) Let $y = x$ in part (b).

60. (a) Let $y = \cosh^{-1} x$; then $x = \cosh y = \frac{1}{2}(e^y + e^{-y})$, $e^y - 2x + e^{-y} = 0$, $e^{2y} - 2xe^y + 1 = 0$, $e^y = \frac{2x \pm \sqrt{4x^2 - 4}}{2} = x \pm \sqrt{x^2 - 1}$. To determine which sign to take, note that $y \geq 0$ so $e^{-y} \leq e^y$, $x = (e^y + e^{-y})/2 \leq (e^y + e^y)/2 = e^y$, hence $e^y \geq x$ thus $e^y = x + \sqrt{x^2 - 1}$, $y = \cosh^{-1} x = \ln(x + \sqrt{x^2 - 1})$.

(b) Let $y = \tanh^{-1} x$; then $x = \tanh y = \frac{e^y - e^{-y}}{e^y + e^{-y}} = \frac{e^{2y} - 1}{e^{2y} + 1}$, $xe^{2y} + x = e^{2y} - 1$, $1 + x = e^{2y}(1 - x)$,
 $e^{2y} = (1+x)/(1-x)$, $2y = \ln \frac{1+x}{1-x}$, $y = \frac{1}{2} \ln \frac{1+x}{1-x}$.

61. (a) $\frac{d}{dx}(\cosh^{-1} x) = \frac{1+x/\sqrt{x^2-1}}{x+\sqrt{x^2-1}} = 1/\sqrt{x^2-1}$.

$$(b) \frac{d}{dx}(\tanh^{-1} x) = \frac{d}{dx} \left[\frac{1}{2}(\ln(1+x) - \ln(1-x)) \right] = \frac{1}{2} \left(\frac{1}{1+x} + \frac{1}{1-x} \right) = 1/(1-x^2).$$

62. Let $y = \operatorname{sech}^{-1} x$ then $x = \operatorname{sech} y = 1/\cosh y$, $\cosh y = 1/x$, $y = \cosh^{-1}(1/x)$; the proofs for the remaining two are similar.

63. If $|u| < 1$ then, by Theorem 6.9.6, $\int \frac{du}{1-u^2} = \tanh^{-1} u + C$. For $|u| > 1$, $\int \frac{du}{1-u^2} = \operatorname{coth}^{-1} u + C = \tanh^{-1}(1/u) + C$.

$$64. (a) \frac{d}{dx}(\operatorname{sech}^{-1}|x|) = \frac{d}{dx}(\operatorname{sech}^{-1}\sqrt{x^2}) = -\frac{1}{\sqrt{x^2}\sqrt{1-x^2}} \frac{x}{\sqrt{x^2}} = -\frac{1}{x\sqrt{1-x^2}}.$$

(b) Similar to solution of part (a).

65. (a) $\lim_{x \rightarrow +\infty} (\cosh^{-1} x - \ln x) = \lim_{x \rightarrow +\infty} [\ln(x + \sqrt{x^2 - 1}) - \ln x] = \lim_{x \rightarrow +\infty} \ln \frac{x + \sqrt{x^2 - 1}}{x} = \lim_{x \rightarrow +\infty} \ln(1 + \sqrt{1 - 1/x^2}) = \ln 2$.

$$(b) \lim_{x \rightarrow +\infty} \frac{\cosh x}{e^x} = \lim_{x \rightarrow +\infty} \frac{e^x + e^{-x}}{2e^x} = \lim_{x \rightarrow +\infty} \frac{1}{2}(1 + e^{-2x}) = 1/2.$$

66. For $|x| < 1$, $y = \tanh^{-1} x$ is defined and $dy/dx = 1/(1-x^2) > 0$; $y'' = 2x/(1-x^2)^2$ changes sign at $x = 0$, so there is a point of inflection there.

67. Let $x = -u/a$, $\int \frac{1}{\sqrt{u^2 - a^2}} du = -\int \frac{a}{a\sqrt{x^2 - 1}} dx = -\cosh^{-1} x + C = -\cosh^{-1}(-u/a) + C$.

$$-\cosh^{-1}(-u/a) = -\ln(-u/a + \sqrt{u^2/a^2 - 1}) = \ln \left[\frac{a}{-u + \sqrt{u^2 - a^2}} \frac{u + \sqrt{u^2 - a^2}}{u + \sqrt{u^2 - a^2}} \right] = \ln \left| u + \sqrt{u^2 - a^2} \right| - \ln a = \ln \left| u + \sqrt{u^2 - a^2} \right| + C_1, \text{ so } \int \frac{1}{\sqrt{u^2 - a^2}} du = \ln \left| u + \sqrt{u^2 - a^2} \right| + C_2.$$

68. Using $\sinh x + \cosh x = e^x$ (Exercise 58a), $(\sinh x + \cosh x)^n = (e^x)^n = e^{nx} = \sinh nx + \cosh nx$.

$$69. \int_{-a}^a e^{tx} dx = \frac{1}{t} e^{tx} \Big|_{-a}^a = \frac{1}{t}(e^{at} - e^{-at}) = \frac{2 \sinh at}{t} \text{ for } t \neq 0.$$

70. (a) $y' = \sinh(x/a)$, $1 + (y')^2 = 1 + \sinh^2(x/a) = \cosh^2(x/a)$, so

$$L = 2 \int_0^b \cosh(x/a) dx = 2a \sinh(x/a) \Big|_0^b = 2a \sinh(b/a).$$

(b) The highest point is at $x = -b$ and $x = b$, the lowest at $x = 0$, so $S = a \cosh(b/a) - a \cosh(0) = a \cosh(b/a) - a$.

71. From part (b) of Exercise 70, $S = a \cosh(b/a) - a$ so $30 = a \cosh(200/a) - a$. Let $u = 200/a$, then $a = 200/u$ so $30 = (200/u)[\cosh u - 1]$, $\cosh u - 1 = 0.15u$. If $f(u) = \cosh u - 0.15u - 1$, then $u_{n+1} = u_n - \frac{\cosh u_n - 0.15u_n - 1}{\sinh u_n - 0.15}$; $u_1 = 0.3, \dots, u_4 \approx u_5 \approx 0.297792782 \approx 200/a$ so $a \approx 671.6079505$. From part (a), $L = 2a \sinh(b/a) \approx 2(671.6079505) \sinh(0.297792782) \approx 405.9$ ft.

72. From part (a) of Exercise 70, $L = 2a \sinh(b/a)$ so $120 = 2a \sinh(50/a)$, $a \sinh(50/a) = 60$. Let $u = 50/a$, then $a = 50/u$ so $(50/u) \sinh u = 60$, $\sinh u = 1.2u$. If $f(u) = \sinh u - 1.2u$, then $u_{n+1} = u_n - \frac{\sinh u_n - 1.2u_n}{\cosh u_n - 1.2}$; $u_1 = 1, \dots, u_5 \approx u_6 \approx 1.064868548 \approx 50/a$ so $a \approx 46.95415231$. From part (b), $S = a \cosh(b/a) - a \approx 46.95415231[\cosh(1.064868548) - 1] \approx 29.2$ ft.

73. Set $a = 68.7672$, $b = 0.0100333$, $c = 693.8597$, $d = 299.2239$.

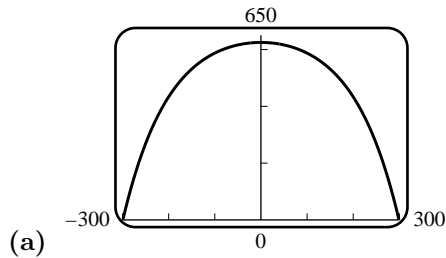

(a) $L = 2 \int_0^d \sqrt{1 + a^2 b^2 \sinh^2 bx} dx \approx 1480.2798$ ft.

(c) $x \approx \pm 283.6249$ ft. (d) 82°

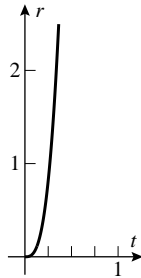

74. (a) $r = 1$ when $t \approx 0.673080$ s. (c) $dr/dt \approx 4.48$ m/s.

75. (a) When the bow of the boat is at the point (x, y) and the person has walked a distance D , then the person is located at the point $(0, D)$, the line segment connecting $(0, D)$ and (x, y) has length a ; thus $a^2 = x^2 + (D - y)^2$, $D = y + \sqrt{a^2 - x^2} = a \operatorname{sech}^{-1}(x/a)$.

(b) Find D when $a = 15$, $x = 10$: $D = 15 \operatorname{sech}^{-1}(10/15) = 15 \ln \left(\frac{1 + \sqrt{5/9}}{2/3} \right) \approx 14.44$ m.

(c) $dy/dx = -\frac{a^2}{x\sqrt{a^2 - x^2}} + \frac{x}{\sqrt{a^2 - x^2}} = \frac{1}{\sqrt{a^2 - x^2}} \left[-\frac{a^2}{x} + x \right] = -\frac{1}{x} \sqrt{a^2 - x^2}$, $1 + [y']^2 = 1 + \frac{a^2 - x^2}{x^2} = \frac{a^2}{x^2}$;
 with $a = 15$, $L = \int_5^{15} \sqrt{\frac{225}{x^2}} dx = \int_5^{15} \frac{15}{x} dx = 15 \ln x \Big|_5^{15} = 15 \ln 3 \approx 16.48$ m.

76. First we would need to show that the line segment from the origin to P meets the right branch of the hyperbola only at P , so that the shaded region in Figure 6.9.3b is well-defined. (This is easy.)

Next we'd need to show that the area of the shaded region approaches $+\infty$ as the point P moves upward and to the right along the curve, so that $\cosh t$ and $\sinh t$ will be defined for all $t > 0$ (and hence, by symmetry, for all t .) (This is not quite as easy.)

77. Since $(\cosh t, \sinh t)$ lies on the hyperbola $x^2 - y^2 = 1$, we have $\cosh^2 t - \sinh^2 t = 1$. Since it lies on the right half of the hyperbola, $\cosh t > 0$. From the symmetry of the hyperbola, $\cosh(-t) = \cosh t$ and $\sinh(-t) = -\sinh t$.

Next, we can obtain the derivatives of the hyperbolic functions. Define $\tanh t = \frac{\sinh t}{\cosh t}$ and $\operatorname{sech} t = \frac{1}{\cosh t}$. Suppose that h is a small positive number, $(x_0, y_0) = (\cosh t, \sinh t)$, and $(x_1, y_1) = (\cosh(t+h), \sinh(t+h))$. Then $h/2 = (t+h)/2 - t/2$ is approximately the area of the triangle with vertices $(0, 0)$, (x_0, y_0) , and (x_1, y_1) , which equals $(x_0 y_1 - x_1 y_0)/2$. Hence $\cosh t \sinh(t+h) - \cosh(t+h) \sinh t \approx h$. Dividing by $\cosh t \cosh(t+h)$ implies $\tanh(t+h) - \tanh t \approx \frac{h}{\cosh t \cosh(t+h)} \approx h \operatorname{sech}^2 t$. Taking the limit as $h \rightarrow 0$ gives $\frac{d}{dt} \tanh t = \operatorname{sech}^2 t$. Dividing

$\cosh^2 t - \sinh^2 t = 1$ by $\cosh^2 t$ gives $1 - \tanh^2 t = \frac{1}{\cosh^2 t}$, so $\cosh t = (1 - \tanh^2 t)^{-1/2}$. Hence $\frac{d}{dt} \cosh t = -\frac{1}{2}(1 - \tanh^2 t)^{-3/2}(-2) \tanh t \cdot \frac{d}{dt} \tanh t = \cosh^3 t \tanh t \operatorname{sech}^2 t = \sinh t$ and $\frac{d}{dt} \sinh t = \frac{d}{dt}(\cosh t \tanh t) = \cosh t \cdot \frac{d}{dt} \tanh t + \tanh t \cdot \frac{d}{dt} \cosh t = \cosh t \operatorname{sech}^2 t + \tanh t \sinh t = \frac{1 + \sinh^2 t}{\cosh t} = \cosh t$.

Chapter 6 Review Exercises

$$6. \text{ (a) } A = \int_0^2 (2 + x - x^2) dx. \quad \text{(b) } A = \int_0^2 \sqrt{y} dy + \int_2^4 [\sqrt{y} - (y - 2)] dy.$$

$$\text{(c) } V = \pi \int_0^2 [(2 + x)^2 - x^4] dx. \quad \text{(d) } V = 2\pi \int_0^2 y\sqrt{y} dy + 2\pi \int_2^4 y[\sqrt{y} - (y - 2)] dy.$$

$$\text{(e) } V = 2\pi \int_0^2 x(2 + x - x^2) dx. \quad \text{(f) } V = \pi \int_0^2 y dy + \int_2^4 \pi(y - (y - 2)^2) dy.$$

$$\text{(g) } V = \pi \int_0^2 [(2 + x + 3)^2 - (x^2 + 3)^2] dx. \quad \text{(h) } V = 2\pi \int_0^2 [2 + x - x^2](5 - x) dx.$$

$$7. \text{ (a) } A = \int_a^b (f(x) - g(x)) dx + \int_b^c (g(x) - f(x)) dx + \int_c^d (f(x) - g(x)) dx.$$

$$\text{(b) } A = \int_{-1}^0 (x^3 - x) dx + \int_0^1 (x - x^3) dx + \int_1^2 (x^3 - x) dx = \frac{1}{4} + \frac{1}{4} + \frac{9}{4} = \frac{11}{4}.$$

$$8. \text{ Distance} = \int |v| dt, \text{ so}$$

$$\text{(a) distance} = \int_0^{60} (3t - t^2/20) dt = 1800 \text{ ft.}$$

$$\text{(b) If } T \leq 60, \text{ then distance} = \int_0^T (3t - t^2/20) dt = \frac{3}{2}T^2 - \frac{1}{60}T^3 \text{ ft.}$$

9. Find where the curves cross: set $x^3 = x^2 + 4$; by observation $x = 2$ is a solution. Then

$$V = \pi \int_0^2 [(x^2 + 4)^2 - (x^3)^2] dx = \frac{4352}{105}\pi.$$

$$10. V = 2 \int_0^{L/2} \pi \frac{16R^2}{L^4} (x^2 - L^2/4)^2 dx = \frac{8\pi}{15} LR^2.$$

$$11. V = \int_1^4 \left(\sqrt{x} - \frac{1}{\sqrt{x}} \right)^2 dx = 2 \ln 2 + \frac{3}{2}.$$

$$12. \text{ (a) } \pi \int_0^1 (\sin^{-1} x)^2 dx. \quad \text{(b) } 2\pi \int_0^{\pi/2} y(1 - \sin y) dy.$$

$$13. \text{ By implicit differentiation } \frac{dy}{dx} = -\left(\frac{y}{x}\right)^{1/3}, \text{ so } 1 + \left(\frac{dy}{dx}\right)^2 = 1 + \left(\frac{y}{x}\right)^{2/3} = \frac{x^{2/3} + y^{2/3}}{x^{2/3}} = \frac{4}{x^{2/3}}, L = \int_{-8}^{-1} \frac{2}{(-x)^{1/3}} dx = 9.$$

$$14. \text{ (a) } L = \int_0^{\ln 10} \sqrt{1 + (e^x)^2} dx. \quad \text{(b) } L = \int_1^{10} \sqrt{1 + \frac{1}{y^2}} dy.$$

$$15. A = \int_9^{16} 2\pi\sqrt{25-x} \sqrt{1 + \left(\frac{-1}{2\sqrt{25-x}}\right)^2} dx = \pi \int_9^{16} \sqrt{101 - 4x} dx = \frac{\pi}{6} (65^{3/2} - 37^{3/2}).$$

$$16. \text{ (a) } S = \int_0^{8/27} 2\pi \cdot 3x^{1/3} \sqrt{1+x^{-4/3}} dx. \quad \text{ (b) } S = \int_0^2 2\pi \frac{y^3}{27} \sqrt{1+y^4/81} dy.$$

$$\text{ (c) } S = \int_0^2 2\pi(y+2) \sqrt{1+y^4/81} dy.$$

17. A cross section of the solid, perpendicular to the x -axis, has area equal to $\pi(\sec x)^2$, and the average of these cross sectional areas is given by $A_{\text{ave}} = \frac{1}{\pi/3} \int_0^{\pi/3} \pi(\sec x)^2 dx = \frac{3}{\pi} \pi \tan x \Big|_0^{\pi/3} = 3\sqrt{3}$.

18. The solid we generate this way is just a sphere with radius a . The average value of the area of the cross sections is then the volume of this sphere divided by the diameter, so it is $A_{\text{ave}} = \frac{1}{2a} \frac{4}{3} a^3 \pi = 2a^2 \pi/3$.

$$19. \text{ (a) } F = kx, \frac{1}{2} = k \frac{1}{4}, k = 2, W = \int_0^{1/4} kx dx = 1/16 \text{ J.} \quad \text{ (b) } 25 = \int_0^L kx dx = kL^2/2, L = 5 \text{ m.}$$

$$20. F = 30x + 2000, W = \int_0^{150} (30x + 2000) dx = 15 \cdot 150^2 + 2000 \cdot 150 = 637,500 \text{ lb-ft.}$$

21. The region is described by $-4 \leq y \leq 4$, $\frac{y^2}{4} \leq x \leq 2 + \frac{y^2}{8}$. By symmetry, $\bar{y} = 0$. To find \bar{x} , we use the analogue of Formula (11) in Section 6.7. The area is $A = \int_{-4}^4 \left(2 + \frac{y^2}{8} - \frac{y^2}{4}\right) dy = \int_{-4}^4 \left(2 - \frac{y^2}{8}\right) dy = \left[2y - \frac{y^3}{24}\right]_{-4}^4 = \frac{32}{3}$. So $\bar{x} = \frac{3}{32} \int_{-4}^4 \frac{1}{2} \left[\left(2 + \frac{y^2}{8}\right)^2 - \left(\frac{y^2}{4}\right)^2 \right] dy = \frac{3}{64} \int_{-4}^4 \left(4 + \frac{y^2}{2} - \frac{3y^4}{64}\right) dy = \frac{3}{64} \left[4y + \frac{y^3}{6} - \frac{3y^5}{320}\right]_{-4}^4 = \frac{8}{5}$. The centroid is $\left(\frac{8}{5}, 0\right)$.

22. The region is described by $-a \leq x \leq a$, $0 \leq y \leq \frac{b}{a} \sqrt{a^2 - x^2}$. By symmetry, $\bar{x} = 0$. To find \bar{y} , we use Formula (9) in Section 6.7. The area is $A = \int_{-a}^a \left(\frac{b}{a} \sqrt{a^2 - x^2}\right) dx$. This is $\frac{b}{a}$ times the area of a half-disc of radius a , so $A = \frac{\pi ab}{2}$. Hence $\bar{y} = \frac{2}{\pi ab} \int_{-a}^a \frac{1}{2} \left(\frac{b}{a} \sqrt{a^2 - x^2}\right)^2 dx = \frac{b}{\pi a^3} \int_{-a}^a (a^2 - x^2) dx = \frac{b}{\pi a^3} \left[a^2 x - \frac{x^3}{3}\right]_{-a}^a = \frac{4b}{3\pi}$. The centroid is $\left(0, \frac{4b}{3\pi}\right)$.

$$23. \text{ (a) } F = \int_0^1 \rho x^3 dx \text{ N.}$$

$$\text{ (b) } \text{By similar triangles, } \frac{w(x)}{4} = \frac{x}{2}, w(x) = 2x, \text{ so } F = \int_0^2 \rho(1+x)2x dx \text{ lb/ft}^2.$$

$$\text{ (c) } \text{A formula for the parabola is } y = \frac{8}{125} x^2 - 10, \text{ so } F = \int_{-10}^0 9810|y|2\sqrt{\frac{125}{8}(y+10)} dy \text{ N.}$$

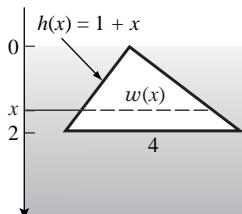

24. $y' = a \cosh ax$, $y'' = a^2 \sinh ax = a^2 y$.
25. (a) $\cosh 3x = \cosh(2x + x) = \cosh 2x \cosh x + \sinh 2x \sinh x = (2 \cosh^2 x - 1) \cosh x + (2 \sinh x \cosh x) \sinh x = 2 \cosh^3 x - \cosh x + 2 \sinh^2 x \cosh x = 2 \cosh^3 x - \cosh x + 2(\cosh^2 x - 1) \cosh x = 4 \cosh^3 x - 3 \cosh x$.
- (b) From Theorem 6.9.2 with x replaced by $\frac{x}{2}$: $\cosh x = 2 \cosh^2 \frac{x}{2} - 1$, $2 \cosh^2 \frac{x}{2} = \cosh x + 1$, $\cosh^2 \frac{x}{2} = \frac{1}{2}(\cosh x + 1)$, $\cosh \frac{x}{2} = \sqrt{\frac{1}{2}(\cosh x + 1)}$ (because $\cosh \frac{x}{2} > 0$).
- (c) From Theorem 6.9.2 with x replaced by $\frac{x}{2}$: $\cosh x = 2 \sinh^2 \frac{x}{2} + 1$, $2 \sinh^2 \frac{x}{2} = \cosh x - 1$, $\sinh^2 \frac{x}{2} = \frac{1}{2}(\cosh x - 1)$, $\sinh \frac{x}{2} = \pm \sqrt{\frac{1}{2}(\cosh x - 1)}$.

Chapter 6 Making Connections

1. (a) By equation (2) of Section 6.3, the volume is $V = \int_0^1 2\pi x f(x^2) dx$. Making the substitution $u = x^2$, $du = 2x dx$ gives $V = \int_0^1 2\pi f(u) \cdot \frac{1}{2} du = \pi \int_0^1 f(u) du = \pi A_1$.
- (b) By the Theorem of Pappus, the volume in (a) equals $2\pi A_2 \bar{x}$, where $\bar{x} = a$ is the x -coordinate of the centroid of R . Hence $a = \frac{\pi A_1}{2\pi A_2} = \frac{A_1}{2A_2}$.
2. (a) At depth x feet below the surface, the radius is $10 - \frac{x}{3}$ ft, so the area is $\pi \left(10 - \frac{x}{3}\right)^2 = \frac{\pi}{9}(30 - x)^2$ ft². Hence the weight of a thin layer at depth x ft with height Δx ft is approximately $62.4 \frac{\pi}{9}(30 - x)^2 \Delta x$ lb. The work needed to lift this layer to the top is approximately $62.4 \frac{\pi}{9} x(30 - x)^2 \Delta x$ ft·lb. Hence the total work needed to empty the tank is $\int_0^{15} 62.4 \frac{\pi}{9} x(30 - x)^2 dx = 62.4 \frac{\pi}{9} \int_0^{15} (900x - 60x^2 + x^3) dx = 62.4 \frac{\pi}{9} \left[450x^2 - 20x^3 + \frac{1}{4}x^4\right]_0^{15} = 321750\pi \approx 1010807$ ft·lb.
- (b) When the piston has risen x feet from the bottom of the tank, its radius is $5 + \frac{x}{3}$ ft, so its area is $\pi \left(5 + \frac{x}{3}\right)^2 = \frac{\pi}{9}(15 + x)^2$ ft². The depth of the water above the piston is $15 - x$ ft, so the fluid force pushing down on the piston is $62.4(15 - x) \frac{\pi}{9}(15 + x)^2$ lb; this also equals the force needed to raise the piston. So the total work done raising the piston is $\int_0^{15} 62.4(15 - x) \frac{\pi}{9}(15 + x)^2 dx = 62.4 \frac{\pi}{9} \int_0^{15} (3375 + 225x - 15x^2 - x^3) dx = 62.4 \frac{\pi}{9} \left[3375x + \frac{225}{2}x^2 - 5x^3 - \frac{1}{4}x^4\right]_0^{15} = 321750\pi$ ft·lb.
3. The area of the annulus with inner radius r and outer radius $r + \Delta r$ is $\pi(r + \Delta r)^2 - \pi r^2 \approx 2\pi r \Delta r$, so its mass is approximately $2\pi r f(r) \Delta r$. Hence the total mass of the lamina is $\int_a^b 2\pi r f(r) dr$.
4. Let the x -axis point downward, with $x = 0$ at the surface of the fluid. Let the y -axis be perpendicular to the x -axis and in the plane of the submerged surface. Suppose the surface has area A and is described by $a \leq x \leq b$, $g(x) \leq y \leq f(x)$. In Formula (8) of Section 6.8 we have $h(x) = x$ and $w(x) = f(x) - g(x)$, so the fluid force on the submerged surface is $F = \int_a^b \rho x(f(x) - g(x)) dx = \rho A \cdot \frac{1}{A} \int_a^b x(f(x) - g(x)) dx = \rho A \bar{x} = A \cdot \rho \bar{x}$, by Formula (10) of Section 6.7. Since $\rho \bar{x}$ is the pressure at the centroid, the fluid force equals the area times the pressure at the centroid.

If the same surface were horizontal at the depth of the centroid, then Formula (6) of Section 6.8 implies that the fluid force would be $\rho\bar{x}A$, the same as above.

5. (a) Consider any solid obtained by sliding a horizontal region, of any shape, some distance vertically. Thus the top and bottom faces, and every horizontal cross-section in between, are all congruent. This includes all of the cases described in part (a) of the problem.

Suppose such a solid, whose base has area A , is floating in a fluid so that its base is a distance h below the surface. The pressure at the base is ρh , so the fluid exerts an upward force on the base of magnitude $\rho h A$. The fluid also exerts forces on the sides of the solid, but those are horizontal, so they don't contribute to the buoyancy. Hence the buoyant force equals $\rho h A$. Since the part of the solid which is below the surface has volume hA , the buoyant force equals the weight of fluid which would fill that volume; i.e. the weight of the fluid displaced by the solid.

(b) Now consider a solid which is the union of finitely many solids of the type described above. The buoyant force on such a solid is the sum of the buoyant forces on its constituents, which equals the sum of the weights of the fluid displaced by them, which equals the weight of the fluid displaced by the whole solid. So the Archimedes Principle applies to the union.

Any solid can be approximated by such unions, so it is plausible that the Archimedes Principle applies to all solids.

Principles of Integral Evaluation

Exercise Set 7.1

1. $u = 4 - 2x, du = -2dx, -\frac{1}{2} \int u^3 du = -\frac{1}{8}u^4 + C = -\frac{1}{8}(4 - 2x)^4 + C.$
2. $u = 4 + 2x, du = 2dx, \frac{3}{2} \int \sqrt{u} du = u^{3/2} + C = (4 + 2x)^{3/2} + C.$
3. $u = x^2, du = 2xdx, \frac{1}{2} \int \sec^2 u du = \frac{1}{2} \tan u + C = \frac{1}{2} \tan(x^2) + C.$
4. $u = x^2, du = 2xdx, 2 \int \tan u du = -2 \ln |\cos u| + C = -2 \ln |\cos(x^2)| + C.$
5. $u = 2 + \cos 3x, du = -3 \sin 3xdx, -\frac{1}{3} \int \frac{du}{u} = -\frac{1}{3} \ln |u| + C = -\frac{1}{3} \ln(2 + \cos 3x) + C.$
6. $u = \frac{2}{3}x, du = \frac{2}{3}dx, \frac{1}{6} \int \frac{du}{1+u^2} = \frac{1}{6} \tan^{-1} u + C = \frac{1}{6} \tan^{-1} \frac{2}{3}x + C.$
7. $u = e^x, du = e^x dx, \int \sinh u du = \cosh u + C = \cosh e^x + C.$
8. $u = \ln x, du = \frac{1}{x} dx, \int \sec u \tan u du = \sec u + C = \sec(\ln x) + C.$
9. $u = \tan x, du = \sec^2 x dx, \int e^u du = e^u + C = e^{\tan x} + C.$
10. $u = x^2, du = 2xdx, \frac{1}{2} \int \frac{du}{\sqrt{1-u^2}} = \frac{1}{2} \sin^{-1} u + C = \frac{1}{2} \sin^{-1}(x^2) + C.$
11. $u = \cos 5x, du = -5 \sin 5xdx, -\frac{1}{5} \int u^5 du = -\frac{1}{30}u^6 + C = -\frac{1}{30} \cos^6 5x + C.$
12. $u = \sin x, du = \cos x dx, \int \frac{du}{u\sqrt{u^2+1}} = -\ln \left| \frac{1+\sqrt{1+u^2}}{u} \right| + C = -\ln \left| \frac{1+\sqrt{1+\sin^2 x}}{\sin x} \right| + C.$
13. $u = e^x, du = e^x dx, \int \frac{du}{\sqrt{4+u^2}} = \ln(u + \sqrt{u^2+4}) + C = \ln(e^x + \sqrt{e^{2x}+4}) + C.$
14. $u = \tan^{-1} x, du = \frac{1}{1+x^2} dx, \int e^u du = e^u + C = e^{\tan^{-1} x} + C.$
15. $u = \sqrt{x-1}, du = \frac{1}{2\sqrt{x-1}} dx, 2 \int e^u du = 2e^u + C = 2e^{\sqrt{x-1}} + C.$

$$16. u = x^2 + 2x, du = (2x + 2)dx, \quad \frac{1}{2} \int \cot u du = \frac{1}{2} \ln |\sin u| + C = \frac{1}{2} \ln \sin |x^2 + 2x| + C.$$

$$17. u = \sqrt{x}, du = \frac{1}{2\sqrt{x}} dx, \quad \int 2 \cosh u du = 2 \sinh u + C = 2 \sinh \sqrt{x} + C.$$

$$18. u = \ln x, du = \frac{dx}{x}, \quad \int \frac{du}{u^2} = -\frac{1}{u} + C = -\frac{1}{\ln x} + C.$$

$$19. u = \sqrt{x}, du = \frac{1}{2\sqrt{x}} dx, \quad \int \frac{2 du}{3^u} = 2 \int e^{-u \ln 3} du = -\frac{2}{\ln 3} e^{-u \ln 3} + C = -\frac{2}{\ln 3} 3^{-\sqrt{x}} + C.$$

$$20. u = \sin \theta, du = \cos \theta d\theta, \quad \int \sec u \tan u du = \sec u + C = \sec(\sin \theta) + C.$$

$$21. u = \frac{2}{x}, du = -\frac{2}{x^2} dx, \quad -\frac{1}{2} \int \operatorname{csch}^2 u du = \frac{1}{2} \coth u + C = \frac{1}{2} \coth \frac{2}{x} + C.$$

$$22. \int \frac{dx}{\sqrt{x^2 - 4}} = \ln \left| x + \sqrt{x^2 - 4} \right| + C.$$

$$23. u = e^{-x}, du = -e^{-x} dx, \quad -\int \frac{du}{4 - u^2} = -\frac{1}{4} \ln \left| \frac{2 + u}{2 - u} \right| + C = -\frac{1}{4} \ln \left| \frac{2 + e^{-x}}{2 - e^{-x}} \right| + C.$$

$$24. u = \ln x, du = \frac{1}{x} dx, \quad \int \cos u du = \sin u + C = \sin(\ln x) + C.$$

$$25. u = e^x, du = e^x dx, \quad \int \frac{e^x dx}{\sqrt{1 - e^{2x}}} = \int \frac{du}{\sqrt{1 - u^2}} = \sin^{-1} u + C = \sin^{-1} e^x + C.$$

$$26. u = x^{-1/2}, du = -\frac{1}{2x^{3/2}} dx, \quad -\int 2 \sinh u du = -2 \cosh u + C = -2 \cosh(x^{-1/2}) + C.$$

$$27. u = x^2, du = 2x dx, \quad \frac{1}{2} \int \frac{du}{\csc u} = \frac{1}{2} \int \sin u du = -\frac{1}{2} \cos u + C = -\frac{1}{2} \cos(x^2) + C.$$

$$28. 2u = e^x, 2du = e^x dx, \quad \int \frac{2du}{\sqrt{4 - 4u^2}} = \sin^{-1} u + C = \sin^{-1}(e^x/2) + C.$$

$$29. 4^{-x^2} = e^{-x^2 \ln 4}, u = -x^2 \ln 4, du = -2x \ln 4 dx = -x \ln 16 dx, -\frac{1}{\ln 16} \int e^u du = -\frac{1}{\ln 16} e^u + C = -\frac{1}{\ln 16} e^{-x^2 \ln 4} + C = -\frac{1}{\ln 16} 4^{-x^2} + C.$$

$$30. 2^{\pi x} = e^{\pi x \ln 2}, \quad \int 2^{\pi x} dx = \frac{1}{\pi \ln 2} e^{\pi x \ln 2} + C = \frac{1}{\pi \ln 2} 2^{\pi x} + C.$$

$$31. (a) u = \sin x, du = \cos x dx, \quad \int u du = \frac{1}{2} u^2 + C = \frac{1}{2} \sin^2 x + C.$$

$$(b) \int \sin x \cos x dx = \frac{1}{2} \int \sin 2x dx = -\frac{1}{4} \cos 2x + C = -\frac{1}{4} (\cos^2 x - \sin^2 x) + C.$$

$$(c) -\frac{1}{4} (\cos^2 x - \sin^2 x) + C = -\frac{1}{4} (1 - \sin^2 x - \sin^2 x) + C = -\frac{1}{4} + \frac{1}{2} \sin^2 x + C, \text{ and this is the same as the answer in part (a) except for the constants.}$$

32. (a) $\operatorname{sech} 2x = \frac{1}{\cosh 2x} = \frac{1}{\cosh^2 x + \sinh^2 x} = \frac{\operatorname{sech}^2 x}{1 + \tanh^2 x}$.

(b) $\int \operatorname{sech} 2x \, dx = \int \frac{\operatorname{sech}^2 x}{1 + \tanh^2 x} \, dx = \tan^{-1}(\tanh x) + C$, or, by substituting $u = 2x$, we obtain that $\int \operatorname{sech} x \, dx = 2 \tan^{-1}(\tanh(x/2)) + C$.

(c) $\operatorname{sech} x = \frac{1}{\cosh x} = \frac{2}{e^x + e^{-x}} = \frac{2e^x}{e^{2x} + 1}$.

(d) $\int \operatorname{sech} x \, dx = 2 \int \frac{e^x}{e^{2x} + 1} \, dx = 2 \tan^{-1}(e^x) + C$.

(e) Using the identity $\tan^{-1} x + \tan^{-1} y = \tan^{-1} \left(\frac{x + y}{1 - xy} \right)$, the difference between the two functions obtained is the constant $\tan^{-1}(e^x) - \tan^{-1}(\tanh(x/2)) = \tan^{-1} \frac{e^{3x/2} + e^{-x/2}}{e^{3x/2} + e^{-x/2}} = \tan^{-1}(1) = \pi/2$.

33. (a) $\frac{\sec^2 x}{\tan x} = \frac{1}{\cos^2 x \tan x} = \frac{1}{\cos x \sin x}$.

(b) $\csc 2x = \frac{1}{\sin 2x} = \frac{1}{2 \sin x \cos x} = \frac{1}{2} \frac{\sec^2 x}{\tan x}$, so $\int \csc 2x \, dx = \frac{1}{2} \ln |\tan x| + C$, then using the substitution $u = 2x$ we obtain that $\int \csc x \, dx = \ln |\tan(x/2)| + C$.

(c) $\sec x = \frac{1}{\cos x} = \frac{1}{\sin(\pi/2 - x)} = \csc(\pi/2 - x)$, so $\int \sec x \, dx = -\int \csc(\pi/2 - x) \, dx = -\ln |\tan(\pi/4 - x/2)| + C$.

Exercise Set 7.2

1. $u = x, dv = e^{-2x} dx, du = dx, v = -\frac{1}{2}e^{-2x}; \int x e^{-2x} dx = -\frac{1}{2}x e^{-2x} + \int \frac{1}{2}e^{-2x} dx = -\frac{1}{2}x e^{-2x} - \frac{1}{4}e^{-2x} + C$.

2. $u = x, dv = e^{3x} dx, du = dx, v = \frac{1}{3}e^{3x}; \int x e^{3x} dx = \frac{1}{3}x e^{3x} - \frac{1}{3} \int e^{3x} dx = \frac{1}{3}x e^{3x} - \frac{1}{9}e^{3x} + C$.

3. $u = x^2, dv = e^x dx, du = 2x dx, v = e^x; \int x^2 e^x dx = x^2 e^x - 2 \int x e^x dx$. For $\int x e^x dx$ use $u = x, dv = e^x dx, du = dx, v = e^x$ to get $\int x e^x dx = x e^x - e^x + C_1$ so $\int x^2 e^x dx = x^2 e^x - 2x e^x + 2e^x + C$.

4. $u = x^2, dv = e^{-2x} dx, du = 2x dx, v = -\frac{1}{2}e^{-2x}; \int x^2 e^{-2x} dx = -\frac{1}{2}x^2 e^{-2x} + \int x e^{-2x} dx$. For $\int x e^{-2x} dx$ use $u = x, dv = e^{-2x} dx$ to get $\int x e^{-2x} dx = -\frac{1}{2}x e^{-2x} + \frac{1}{2} \int e^{-2x} dx = -\frac{1}{2}x e^{-2x} - \frac{1}{4}e^{-2x} + C$, so $\int x^2 e^{-2x} dx = -\frac{1}{2}x^2 e^{-2x} - \frac{1}{2}x e^{-2x} - \frac{1}{4}e^{-2x} + C$.

5. $u = x, dv = \sin 3x dx, du = dx, v = -\frac{1}{3} \cos 3x; \int x \sin 3x dx = -\frac{1}{3}x \cos 3x + \frac{1}{3} \int \cos 3x dx = -\frac{1}{3}x \cos 3x + \frac{1}{9} \sin 3x + C$.

6. $u = x, dv = \cos 2x dx, du = dx, v = \frac{1}{2} \sin 2x; \int x \cos 2x dx = \frac{1}{2}x \sin 2x - \frac{1}{2} \int \sin 2x dx = \frac{1}{2}x \sin 2x + \frac{1}{4} \cos 2x + C$.

7. $u = x^2$, $dv = \cos x dx$, $du = 2x dx$, $v = \sin x$; $\int x^2 \cos x dx = x^2 \sin x - 2 \int x \sin x dx$. For $\int x \sin x dx$ use $u = x$, $dv = \sin x dx$ to get $\int x \sin x dx = -x \cos x + \sin x + C_1$ so $\int x^2 \cos x dx = x^2 \sin x + 2x \cos x - 2 \sin x + C$.
8. $u = x^2$, $dv = \sin x dx$, $du = 2x dx$, $v = -\cos x$; $\int x^2 \sin x dx = -x^2 \cos x + 2 \int x \cos x dx$; for $\int x \cos x dx$ use $u = x$, $dv = \cos x dx$ to get $\int x \cos x dx = x \sin x + \cos x + C_1$ so $\int x^2 \sin x dx = -x^2 \cos x + 2x \sin x + 2 \cos x + C$.
9. $u = \ln x$, $dv = x dx$, $du = \frac{1}{x} dx$, $v = \frac{1}{2}x^2$; $\int x \ln x dx = \frac{1}{2}x^2 \ln x - \frac{1}{2} \int x dx = \frac{1}{2}x^2 \ln x - \frac{1}{4}x^2 + C$.
10. $u = \ln x$, $dv = \sqrt{x} dx$, $du = \frac{1}{x} dx$, $v = \frac{2}{3}x^{3/2}$; $\int \sqrt{x} \ln x dx = \frac{2}{3}x^{3/2} \ln x - \frac{2}{3} \int x^{1/2} dx = \frac{2}{3}x^{3/2} \ln x - \frac{4}{9}x^{3/2} + C$.
11. $u = (\ln x)^2$, $dv = dx$, $du = 2 \frac{\ln x}{x} dx$, $v = x$; $\int (\ln x)^2 dx = x(\ln x)^2 - 2 \int \ln x dx$. Use $u = \ln x$, $dv = dx$ to get $\int \ln x dx = x \ln x - \int dx = x \ln x - x + C_1$ so $\int (\ln x)^2 dx = x(\ln x)^2 - 2x \ln x + 2x + C$.
12. $u = \ln x$, $dv = \frac{1}{\sqrt{x}} dx$, $du = \frac{1}{x} dx$, $v = 2\sqrt{x}$; $\int \frac{\ln x}{\sqrt{x}} dx = 2\sqrt{x} \ln x - 2 \int \frac{1}{\sqrt{x}} dx = 2\sqrt{x} \ln x - 4\sqrt{x} + C$.
13. $u = \ln(3x - 2)$, $dv = dx$, $du = \frac{3}{3x - 2} dx$, $v = x$; $\int \ln(3x - 2) dx = x \ln(3x - 2) - \int \frac{3x}{3x - 2} dx$, but $\int \frac{3x}{3x - 2} dx = \int \left(1 + \frac{2}{3x - 2}\right) dx = x + \frac{2}{3} \ln(3x - 2) + C_1$ so $\int \ln(3x - 2) dx = x \ln(3x - 2) - x - \frac{2}{3} \ln(3x - 2) + C$.
14. $u = \ln(x^2 + 4)$, $dv = dx$, $du = \frac{2x}{x^2 + 4} dx$, $v = x$; $\int \ln(x^2 + 4) dx = x \ln(x^2 + 4) - 2 \int \frac{x^2}{x^2 + 4} dx$, but $\int \frac{x^2}{x^2 + 4} dx = \int \left(1 - \frac{4}{x^2 + 4}\right) dx = x - 2 \tan^{-1} \frac{x}{2} + C_1$ so $\int \ln(x^2 + 4) dx = x \ln(x^2 + 4) - 2x + 4 \tan^{-1} \frac{x}{2} + C$.
15. $u = \sin^{-1} x$, $dv = dx$, $du = 1/\sqrt{1 - x^2} dx$, $v = x$; $\int \sin^{-1} x dx = x \sin^{-1} x - \int x/\sqrt{1 - x^2} dx = x \sin^{-1} x + \sqrt{1 - x^2} + C$.
16. $u = \cos^{-1}(2x)$, $dv = dx$, $du = -\frac{2}{\sqrt{1 - 4x^2}} dx$, $v = x$; $\int \cos^{-1}(2x) dx = x \cos^{-1}(2x) + \int \frac{2x}{\sqrt{1 - 4x^2}} dx = x \cos^{-1}(2x) - \frac{1}{2} \sqrt{1 - 4x^2} + C$.
17. $u = \tan^{-1}(3x)$, $dv = dx$, $du = \frac{3}{1 + 9x^2} dx$, $v = x$; $\int \tan^{-1}(3x) dx = x \tan^{-1}(3x) - \int \frac{3x}{1 + 9x^2} dx = x \tan^{-1}(3x) - \frac{1}{6} \ln(1 + 9x^2) + C$.
18. $u = \tan^{-1} x$, $dv = x dx$, $du = \frac{1}{1 + x^2} dx$, $v = \frac{1}{2}x^2$; $\int x \tan^{-1} x dx = \frac{1}{2}x^2 \tan^{-1} x - \frac{1}{2} \int \frac{x^2}{1 + x^2} dx$, but $\int \frac{x^2}{1 + x^2} dx = \int \left(1 - \frac{1}{1 + x^2}\right) dx = x - \tan^{-1} x + C_1$ so $\int x \tan^{-1} x dx = \frac{1}{2}x^2 \tan^{-1} x - \frac{1}{2}x + \frac{1}{2} \tan^{-1} x + C$.
19. $u = e^x$, $dv = \sin x dx$, $du = e^x dx$, $v = -\cos x$; $\int e^x \sin x dx = -e^x \cos x + \int e^x \cos x dx$. For $\int e^x \cos x dx$ use $u = e^x$, $dv = \cos x dx$ to get $\int e^x \cos x dx = e^x \sin x - \int e^x \sin x dx$, so $\int e^x \sin x dx = -e^x \cos x + e^x \sin x - \int e^x \sin x dx$,

$$2 \int e^x \sin x \, dx = e^x(\sin x - \cos x) + C_1, \int e^x \sin x \, dx = \frac{1}{2}e^x(\sin x - \cos x) + C.$$

20. $u = e^{3x}$, $dv = \cos 2x \, dx$, $du = 3e^{3x} \, dx$, $v = \frac{1}{2} \sin 2x$; $\int e^{3x} \cos 2x \, dx = \frac{1}{2}e^{3x} \sin 2x - \frac{3}{2} \int e^{3x} \sin 2x \, dx$. Use $u = e^{3x}$, $dv = \sin 2x \, dx$ to get $\int e^{3x} \sin 2x \, dx = -\frac{1}{2}e^{3x} \cos 2x + \frac{3}{2} \int e^{3x} \cos 2x \, dx$, so $\int e^{3x} \cos 2x \, dx = \frac{1}{2}e^{3x} \sin 2x + \frac{3}{4}e^{3x} \cos 2x - \frac{9}{4} \int e^{3x} \cos 2x \, dx$, $\frac{13}{4} \int e^{3x} \cos 2x \, dx = \frac{1}{4}e^{3x}(2 \sin 2x + 3 \cos 2x) + C_1$, $\int e^{3x} \cos 2x \, dx = \frac{1}{13}e^{3x}(2 \sin 2x + 3 \cos 2x) + C$.

21. $u = \sin(\ln x)$, $dv = dx$, $du = \frac{\cos(\ln x)}{x} \, dx$, $v = x$; $\int \sin(\ln x) \, dx = x \sin(\ln x) - \int \cos(\ln x) \, dx$. Use $u = \cos(\ln x)$, $dv = dx$ to get $\int \cos(\ln x) \, dx = x \cos(\ln x) + \int \sin(\ln x) \, dx$ so $\int \sin(\ln x) \, dx = x \sin(\ln x) - x \cos(\ln x) - \int \sin(\ln x) \, dx$, $\int \sin(\ln x) \, dx = \frac{1}{2}x[\sin(\ln x) - \cos(\ln x)] + C$.

22. $u = \cos(\ln x)$, $dv = dx$, $du = -\frac{1}{x} \sin(\ln x) \, dx$, $v = x$; $\int \cos(\ln x) \, dx = x \cos(\ln x) + \int \sin(\ln x) \, dx$. Use $u = \sin(\ln x)$, $dv = dx$ to get $\int \sin(\ln x) \, dx = x \sin(\ln x) - \int \cos(\ln x) \, dx$ so $\int \cos(\ln x) \, dx = x \cos(\ln x) + x \sin(\ln x) - \int \cos(\ln x) \, dx$, $\int \cos(\ln x) \, dx = \frac{1}{2}x[\cos(\ln x) + \sin(\ln x)] + C$.

23. $u = x$, $dv = \sec^2 x \, dx$, $du = dx$, $v = \tan x$; $\int x \sec^2 x \, dx = x \tan x - \int \tan x \, dx = x \tan x - \int \frac{\sin x}{\cos x} \, dx = x \tan x + \ln |\cos x| + C$.

24. $u = x$, $dv = \tan^2 x \, dx = (\sec^2 x - 1) \, dx$, $du = dx$, $v = \tan x - x$; $\int x \tan^2 x \, dx = x \tan x - x^2 - \int (\tan x - x) \, dx = x \tan x - x^2 + \ln |\cos x| + \frac{1}{2}x^2 + C = x \tan x - \frac{1}{2}x^2 + \ln |\cos x| + C$.

25. $u = x^2$, $dv = xe^{x^2} \, dx$, $du = 2x \, dx$, $v = \frac{1}{2}e^{x^2}$; $\int x^3 e^{x^2} \, dx = \frac{1}{2}x^2 e^{x^2} - \int xe^{x^2} \, dx = \frac{1}{2}x^2 e^{x^2} - \frac{1}{2}e^{x^2} + C$.

26. $u = xe^x$, $dv = \frac{1}{(x+1)^2} \, dx$, $du = (x+1)e^x \, dx$, $v = -\frac{1}{x+1}$; $\int \frac{xe^x}{(x+1)^2} \, dx = -\frac{xe^x}{x+1} + \int e^x \, dx = -\frac{xe^x}{x+1} + e^x + C = \frac{e^x}{x+1} + C$.

27. $u = x$, $dv = e^{2x} \, dx$, $du = dx$, $v = \frac{1}{2}e^{2x}$; $\int_0^2 xe^{2x} \, dx = \left[\frac{1}{2}xe^{2x} \right]_0^2 - \frac{1}{2} \int_0^2 e^{2x} \, dx = e^4 - \frac{1}{4}e^{2x} \Big|_0^2 = e^4 - \frac{1}{4}(e^4 - 1) = (3e^4 + 1)/4$.

28. $u = x$, $dv = e^{-5x} \, dx$, $du = dx$, $v = -\frac{1}{5}e^{-5x}$; $\int_0^1 xe^{-5x} \, dx = -\frac{1}{5}xe^{-5x} \Big|_0^1 + \frac{1}{5} \int_0^1 e^{-5x} \, dx = -\frac{1}{5}e^{-5} - \frac{1}{25}e^{-5x} \Big|_0^1 = -\frac{1}{5}e^{-5} - \frac{1}{25}(e^{-5} - 1) = (1 - 6e^{-5})/25$.

29. $u = \ln x$, $dv = x^2 \, dx$, $du = \frac{1}{x} \, dx$, $v = \frac{1}{3}x^3$; $\int_1^e x^2 \ln x \, dx = \left[\frac{1}{3}x^3 \ln x \right]_1^e - \frac{1}{3} \int_1^e x^2 \, dx = \frac{1}{3}e^3 - \frac{1}{9}x^3 \Big|_1^e = \frac{1}{3}e^3 - \frac{1}{9}(e^3 - 1) = (2e^3 + 1)/9$.

30. $u = \ln x$, $dv = \frac{1}{x^2} \, dx$, $du = \frac{1}{x} \, dx$, $v = -\frac{1}{x}$; $\int_{\sqrt{e}}^e \frac{\ln x}{x^2} \, dx = -\frac{1}{x} \ln x \Big|_{\sqrt{e}}^e + \int_{\sqrt{e}}^e \frac{1}{x^2} \, dx = -\frac{1}{e} + \frac{1}{\sqrt{e}} \ln \sqrt{e} - \frac{1}{x} \Big|_{\sqrt{e}}^e =$

$$-\frac{1}{e} + \frac{1}{2\sqrt{e}} - \frac{1}{e} + \frac{1}{\sqrt{e}} = \frac{3\sqrt{e} - 4}{2e}.$$

$$31. u = \ln(x+2), dv = dx, du = \frac{1}{x+2}dx, v = x; \int_{-1}^1 \ln(x+2)dx = x \ln(x+2) \Big|_{-1}^1 - \int_{-1}^1 \frac{x}{x+2}dx = \ln 3 + \ln 1 - \int_{-1}^1 \left[1 - \frac{2}{x+2}\right]dx = \ln 3 - [x - 2 \ln(x+2)] \Big|_{-1}^1 = \ln 3 - (1 - 2 \ln 3) + (-1 - 2 \ln 1) = 3 \ln 3 - 2.$$

$$32. u = \sin^{-1} x, dv = dx, du = \frac{1}{\sqrt{1-x^2}}dx, v = x; \int_0^{\sqrt{3}/2} \sin^{-1} x dx = x \sin^{-1} x \Big|_0^{\sqrt{3}/2} - \int_0^{\sqrt{3}/2} \frac{x}{\sqrt{1-x^2}}dx = \frac{\sqrt{3}}{2} \sin^{-1} \frac{\sqrt{3}}{2} + \sqrt{1-x^2} \Big|_0^{\sqrt{3}/2} = \frac{\sqrt{3}}{2} \left(\frac{\pi}{3}\right) + \frac{1}{2} - 1 = \frac{\pi\sqrt{3}}{6} - \frac{1}{2}.$$

$$33. u = \sec^{-1} \sqrt{\theta}, dv = d\theta, du = \frac{1}{2\theta\sqrt{\theta-1}}d\theta, v = \theta; \int_2^4 \sec^{-1} \sqrt{\theta} d\theta = \theta \sec^{-1} \sqrt{\theta} \Big|_2^4 - \frac{1}{2} \int_2^4 \frac{1}{\sqrt{\theta-1}}d\theta = 4 \sec^{-1} 2 - 2 \sec^{-1} \sqrt{2} - \sqrt{\theta-1} \Big|_2^4 = 4 \left(\frac{\pi}{3}\right) - 2 \left(\frac{\pi}{4}\right) - \sqrt{3} + 1 = \frac{5\pi}{6} - \sqrt{3} + 1.$$

$$34. u = \sec^{-1} x, dv = x dx, du = \frac{1}{x\sqrt{x^2-1}}dx, v = \frac{1}{2}x^2; \int_1^2 x \sec^{-1} x dx = \frac{1}{2}x^2 \sec^{-1} x \Big|_1^2 - \frac{1}{2} \int_1^2 \frac{x}{\sqrt{x^2-1}}dx = \frac{1}{2} [(4)(\pi/3) - (1)(0)] - \frac{1}{2} \sqrt{x^2-1} \Big|_1^2 = 2\pi/3 - \sqrt{3}/2.$$

$$35. u = x, dv = \sin 2x dx, du = dx, v = -\frac{1}{2} \cos 2x; \int_0^\pi x \sin 2x dx = -\frac{1}{2}x \cos 2x \Big|_0^\pi + \frac{1}{2} \int_0^\pi \cos 2x dx = -\pi/2 + \frac{1}{4} \sin 2x \Big|_0^\pi = -\pi/2.$$

$$36. \int_0^\pi (x + x \cos x)dx = \frac{1}{2}x^2 \Big|_0^\pi + \int_0^\pi x \cos x dx = \frac{\pi^2}{2} + \int_0^\pi x \cos x dx; u = x, dv = \cos x dx, du = dx, v = \sin x; \int_0^\pi x \cos x dx = x \sin x \Big|_0^\pi - \int_0^\pi \sin x dx = \cos x \Big|_0^\pi = -2, \text{ so } \int_0^\pi (x + x \cos x)dx = \pi^2/2 - 2.$$

$$37. u = \tan^{-1} \sqrt{x}, dv = \sqrt{x}dx, du = \frac{1}{2\sqrt{x}(1+x)}dx, v = \frac{2}{3}x^{3/2}; \int_1^3 \sqrt{x} \tan^{-1} \sqrt{x}dx = \frac{2}{3}x^{3/2} \tan^{-1} \sqrt{x} \Big|_1^3 - \frac{1}{3} \int_1^3 \frac{x}{1+x}dx = \frac{2}{3}x^{3/2} \tan^{-1} \sqrt{x} \Big|_1^3 - \frac{1}{3} \int_1^3 \left[1 - \frac{1}{1+x}\right]dx = \left[\frac{2}{3}x^{3/2} \tan^{-1} \sqrt{x} - \frac{1}{3}x + \frac{1}{3} \ln|1+x|\right]_1^3 = (2\sqrt{3}\pi - \pi/2 - 2 + \ln 2)/3.$$

$$38. u = \ln(x^2 + 1), dv = dx, du = \frac{2x}{x^2 + 1}dx, v = x; \int_0^2 \ln(x^2 + 1)dx = x \ln(x^2 + 1) \Big|_0^2 - \int_0^2 \frac{2x^2}{x^2 + 1}dx = 2 \ln 5 - 2 \int_0^2 \left(1 - \frac{1}{x^2 + 1}\right)dx = 2 \ln 5 - 2(x - \tan^{-1} x) \Big|_0^2 = 2 \ln 5 - 4 + 2 \tan^{-1} 2.$$

39. True.

40. False; choose $u = \ln x$.

41. False; e^x is not a factor of the integrand.

42. True; the column of $p(x)$ eventually has zero entries.

43. $t = \sqrt{x}$, $t^2 = x$, $dx = 2t dt$, $\int e^{\sqrt{x}} dx = 2 \int t e^t dt$; $u = t$, $dv = e^t dt$, $du = dt$, $v = e^t$, $\int e^{\sqrt{x}} dx = 2te^t - 2 \int e^t dt = 2(t-1)e^t + C = 2(\sqrt{x}-1)e^{\sqrt{x}} + C$.

44. $t = \sqrt{x}$, $t^2 = x$, $dx = 2t dt$, $\int \cos \sqrt{x} dx = 2 \int t \cos t dt$; $u = t$, $dv = \cos t dt$, $du = dt$, $v = \sin t$, $\int \cos \sqrt{x} dx = 2t \sin t - 2 \int \sin t dt = 2t \sin t + 2 \cos t + C = 2\sqrt{x} \sin \sqrt{x} + 2 \cos \sqrt{x} + C$.

45. Let $f_1(x), f_2(x), f_3(x)$ denote successive antiderivatives of $f(x)$, so that $f'_3(x) = f_2(x)$, $f'_2(x) = f_1(x)$, $f'_1(x) = f(x)$. Let $p(x) = ax^2 + bx + c$.

diff.		antidiff.
$ax^2 + bx + c$		$f(x)$
$2ax + b$	$\searrow +$	$f_1(x)$
$2a$	$\searrow -$	$f_2(x)$
0	$\searrow +$	$f_3(x)$

Then $\int p(x)f(x) dx = (ax^2 + bx + c)f_1(x) - (2ax + b)f_2(x) + 2af_3(x) + C$. Check: $\frac{d}{dx}[(ax^2 + bx + c)f_1(x) - (2ax + b)f_2(x) + 2af_3(x)] = (2ax + b)f_1(x) + (ax^2 + bx + c)f(x) - 2af_2(x) - (2ax + b)f_1(x) + 2af_2(x) = p(x)f(x)$.

46. Let I denote $\int e^x \cos x dx$. Then (Method 1)

diff.		antidiff.
e^x		$\cos x$
e^x	$\searrow +$	$\sin x$
e^x	$\searrow -$	$-\cos x$

and thus $I = e^x(\sin x + \cos x) - I$, so $I = \frac{1}{2}e^x(\sin x + \cos x) + C$.

On the other hand (Method 2)

diff.		antidiff.
$\cos x$		e^x
$-\sin x$	$\searrow +$	e^x
$-\cos x$	$\searrow -$	e^x

and thus $I = e^x(\sin x + \cos x) - I$, so $I = \frac{1}{2}e^x(\sin x + \cos x) + C$, as before.

47. Let I denote $\int (3x^2 - x + 2)e^{-x} dx$. Then

diff.		antidiff.
$3x^2 - x + 2$		e^{-x}
$6x - 1$	$\searrow +$	$-e^{-x}$
6	$\searrow -$	e^{-x}
0	$\searrow +$	$-e^{-x}$

$$I = \int (3x^2 - x + 2)e^{-x} = -(3x^2 - x + 2)e^{-x} - (6x - 1)e^{-x} - 6e^{-x} + C = -e^{-x}[3x^2 + 5x + 7] + C.$$

48. Let I denote $\int (x^2 + x + 1) \sin x \, dx$. Then

diff.		antidiff.
$x^2 + x + 1$		$\sin x$
	$\searrow +$	
$2x + 1$		$-\cos x$
	$\searrow -$	
2		$-\sin x$
	$\searrow +$	
0		$\cos x$

$$I = \int (x^2 + x + 1) \sin x \, dx = -(x^2 + x + 1) \cos x + (2x + 1) \sin x + 2 \cos x + C = -(x^2 + x - 1) \cos x + (2x + 1) \sin x + C.$$

49. Let I denote $\int 4x^4 \sin 2x \, dx$. Then

diff.		antidiff.
$4x^4$		$\sin 2x$
	$\searrow +$	
$16x^3$		$-\frac{1}{2} \cos 2x$
	$\searrow -$	
$48x^2$		$-\frac{1}{4} \sin 2x$
	$\searrow +$	
$96x$		$\frac{1}{8} \cos 2x$
	$\searrow -$	
96		$\frac{1}{16} \sin 2x$
	$\searrow +$	
0		$-\frac{1}{32} \cos 2x$

$$I = \int 4x^4 \sin 2x \, dx = (-2x^4 + 6x^2 - 3) \cos 2x + (4x^3 - 6x) \sin 2x + C.$$

50. Let I denote $\int x^3 \sqrt{2x + 1} \, dx$. Then

diff.		antidiff.
x^3		$\sqrt{2x + 1}$
	$\searrow +$	
$3x^2$		$\frac{1}{3}(2x + 1)^{3/2}$
	$\searrow -$	
$6x$		$\frac{1}{15}(2x + 1)^{5/2}$
	$\searrow +$	
6		$\frac{1}{105}(2x + 1)^{7/2}$
	$\searrow -$	
0		$\frac{1}{945}(2x + 1)^{9/2}$

$$I = \int x^3 \sqrt{2x + 1} \, dx = \frac{1}{3}x^3(2x + 1)^{3/2} - \frac{1}{5}x^2(2x + 1)^{5/2} + \frac{2}{35}x(2x + 1)^{7/2} - \frac{2}{315}(2x + 1)^{9/2} + C.$$

51. Let I denote $\int e^{ax} \sin bx \, dx$. Then

$\frac{\text{diff.}}{e^{ax}}$	$\searrow +$	$\frac{\text{antidiff.}}{\sin bx}$
ae^{ax}	$\searrow -$	$-\frac{1}{b} \cos bx$
$a^2 e^{ax}$		$-\frac{1}{b^2} \sin bx$

$$I = \int e^{ax} \sin bx \, dx = -\frac{1}{b} e^{ax} \cos bx + \frac{a}{b^2} e^{ax} \sin bx - \frac{a^2}{b^2} I, \text{ so } I = \frac{e^{ax}}{a^2 + b^2} (a \sin bx - b \cos bx) + C.$$

52. From Exercise 51 with $a = -3, b = 5, x = \theta$, answer = $\frac{e^{-3\theta}}{34} (-3 \sin 5\theta - 5 \cos 5\theta) + C$.

53. (a) We perform a single integration by parts: $u = \cos x, dv = \sin x \, dx, du = -\sin x \, dx, v = -\cos x$,

$$\int \sin x \cos x \, dx = -\cos^2 x - \int \sin x \cos x \, dx. \text{ This implies that } 2 \int \sin x \cos x \, dx = -\cos^2 x + C, \int \sin x \cos x \, dx = -\frac{1}{2} \cos^2 x + C.$$

$$\text{Alternatively, } u = \sin x, du = \cos x \, dx, \int \sin x \cos x \, dx = \int u \, du = \frac{1}{2} u^2 + C = \frac{1}{2} \sin^2 x + C.$$

(b) Since $\sin^2 x + \cos^2 x = 1$, they are equal (although the symbol 'C' refers to different constants in the two equations).

54. (a) $u = x^2, dv = \frac{x}{\sqrt{x^2+1}}, du = 2x \, dx, v = \sqrt{x^2+1}, \int_0^1 \frac{x^3}{\sqrt{x^2+1}} \, dx = x^2 \sqrt{x^2+1} \Big|_0^1 - \int_0^1 2x \sqrt{x^2+1} \, dx = \sqrt{2} - \frac{2}{3} (x^2+1)^{3/2} \Big|_0^1 = -\frac{1}{3} \sqrt{2} + \frac{2}{3}.$

$$(b) u = \sqrt{x^2+1}, du = \frac{x}{\sqrt{x^2+1}} \, dx, \int_1^{\sqrt{2}} (u^2 - 1) \, du = \left(\frac{1}{3} u^3 - u \right) \Big|_1^{\sqrt{2}} = \frac{2}{3} \sqrt{2} - \sqrt{2} - \frac{1}{3} + 1 = -\frac{1}{3} \sqrt{2} + \frac{2}{3}.$$

55. (a) $A = \int_1^e \ln x \, dx = (x \ln x - x) \Big|_1^e = 1.$

$$(b) V = \pi \int_1^e (\ln x)^2 \, dx = \pi \left[(x(\ln x)^2 - 2x \ln x + 2x) \Big|_1^e \right] = \pi(e - 2).$$

56. $A = \int_0^{\pi/2} (x - x \sin x) \, dx = \frac{1}{2} x^2 \Big|_0^{\pi/2} - \int_0^{\pi/2} x \sin x \, dx = \frac{\pi^2}{8} - (-x \cos x + \sin x) \Big|_0^{\pi/2} = \pi^2/8 - 1.$

57. $V = 2\pi \int_0^\pi x \sin x \, dx = 2\pi(-x \cos x + \sin x) \Big|_0^\pi = 2\pi^2.$

58. $V = 2\pi \int_0^{\pi/2} x \cos x \, dx = 2\pi(\cos x + x \sin x) \Big|_0^{\pi/2} = \pi(\pi - 2).$

59. Distance = $\int_0^\pi t^3 \sin t \, dt;$

diff.	antidiff.
t^3	$\sin t$
$3t^2$	$\searrow +$ $-\cos t$
$6t$	$\searrow -$ $-\sin t$
6	$\searrow +$ $\cos t$
0	$\searrow -$ $\sin t$

$$\int_0^\pi t^3 \sin t \, dx = [(-t^3 \cos t + 3t^2 \sin t + 6t \cos t - 6 \sin t)]_0^\pi = \pi^3 - 6\pi.$$

60. $u = 2t, dv = \sin(k\omega t)dt, du = 2dt, v = -\frac{1}{k\omega} \cos(k\omega t)$; the integrand is an even function of t so $\int_{-\pi/\omega}^{\pi/\omega} t \sin(k\omega t) dt = 2 \int_0^{\pi/\omega} t \sin(k\omega t) dt = -\frac{2}{k\omega} t \cos(k\omega t) \Big|_0^{\pi/\omega} + 2 \int_0^{\pi/\omega} \frac{1}{k\omega} \cos(k\omega t) dt = \frac{2\pi(-1)^{k+1}}{k\omega^2} + \frac{2}{k^2\omega^2} \sin(k\omega t) \Big|_0^{\pi/\omega} = \frac{2\pi(-1)^{k+1}}{k\omega^2}$.

61. (a) $\int \sin^4 x \, dx = -\frac{1}{4} \sin^3 x \cos x + \frac{3}{4} \int \sin^2 x \, dx = -\frac{1}{4} \sin^3 x \cos x + \frac{3}{4} \left(-\frac{1}{2} \sin x \cos x + \frac{1}{2} x \right) + C = -\frac{1}{4} \sin^3 x \cos x - \frac{3}{8} \sin x \cos x + \frac{3}{8} x + C$.

(b) $\int_0^{\pi/2} \sin^5 x \, dx = -\frac{1}{5} \sin^4 x \cos x \Big|_0^{\pi/2} + \frac{4}{5} \int_0^{\pi/2} \sin^3 x \, dx = \frac{4}{5} \left(-\frac{1}{3} \sin^2 x \cos x \Big|_0^{\pi/2} + \frac{2}{3} \int_0^{\pi/2} \sin x \, dx \right) = -\frac{8}{15} \cos x \Big|_0^{\pi/2} = \frac{8}{15}$.

62. (a) $\int \cos^5 x \, dx = \frac{1}{5} \cos^4 x \sin x + \frac{4}{5} \int \cos^3 x \, dx = \frac{1}{5} \cos^4 x \sin x + \frac{4}{5} \left[\frac{1}{3} \cos^2 x \sin x + \frac{2}{3} \sin x \right] + C = \frac{1}{5} \cos^4 x \sin x + \frac{4}{15} \cos^2 x \sin x + \frac{8}{15} \sin x + C$.

(b) $\int \cos^6 x \, dx = \frac{1}{6} \cos^5 x \sin x + \frac{5}{6} \int \cos^4 x \, dx = \frac{1}{6} \cos^5 x \sin x + \frac{5}{6} \left[\frac{1}{4} \cos^3 x \sin x + \frac{3}{4} \int \cos^2 x \, dx \right] = \frac{1}{6} \cos^5 x \sin x + \frac{5}{24} \cos^3 x \sin x + \frac{5}{8} \left[\frac{1}{2} \cos x \sin x + \frac{1}{2} x \right] + C$, so $\left[\frac{1}{6} \cos^5 x \sin x + \frac{5}{24} \cos^3 x \sin x + \frac{5}{16} \cos x \sin x + \frac{5}{16} x \right]_0^{\pi/2} = 5\pi/32$.

63. $u = \sin^{n-1} x, dv = \sin x \, dx, du = (n-1) \sin^{n-2} x \cos x \, dx, v = -\cos x$; $\int \sin^n x \, dx = -\sin^{n-1} x \cos x + (n-1) \int \sin^{n-2} x \cos^2 x \, dx = -\sin^{n-1} x \cos x + (n-1) \int \sin^{n-2} x (1 - \sin^2 x) \, dx = -\sin^{n-1} x \cos x + (n-1) \int \sin^{n-2} x \, dx - (n-1) \int \sin^n x \, dx$, so $n \int \sin^n x \, dx = -\sin^{n-1} x \cos x + (n-1) \int \sin^{n-2} x \, dx$, and $\int \sin^n x \, dx = -\frac{1}{n} \sin^{n-1} x \cos x + \frac{n-1}{n} \int \sin^{n-2} x \, dx$.

64. (a) $u = \sec^{n-2} x, dv = \sec^2 x \, dx, du = (n-2) \sec^{n-2} x \tan x \, dx, v = \tan x$; $\int \sec^n x \, dx = \sec^{n-2} x \tan x - (n-2) \int \sec^{n-2} x \tan^2 x \, dx = \sec^{n-2} x \tan x - (n-2) \int \sec^{n-2} x (\sec^2 x - 1) \, dx = \sec^{n-2} x \tan x - (n-2) \int \sec^n x \, dx + (n-2) \int \sec^{n-2} x \, dx$, so $(n-1) \int \sec^n x \, dx = \sec^{n-2} x \tan x + (n-2) \int \sec^{n-2} x \, dx$, and then

$$\int \sec^n x \, dx = \frac{1}{n-1} \sec^{n-2} x \tan x + \frac{n-2}{n-1} \int \sec^{n-2} x \, dx.$$

(b) $\int \tan^n x \, dx = \int \tan^{n-2} x (\sec^2 x - 1) \, dx = \int \tan^{n-2} x \sec^2 x \, dx - \int \tan^{n-2} x \, dx = \frac{1}{n-1} \tan^{n-1} x - \int \tan^{n-2} x \, dx.$

(c) $u = x^n, dv = e^x dx, du = nx^{n-1} dx, v = e^x; \int x^n e^x dx = x^n e^x - n \int x^{n-1} e^x dx.$

65. (a) $\int \tan^4 x \, dx = \frac{1}{3} \tan^3 x - \int \tan^2 x \, dx = \frac{1}{3} \tan^3 x - \tan x + \int dx = \frac{1}{3} \tan^3 x - \tan x + x + C.$

(b) $\int \sec^4 x \, dx = \frac{1}{3} \sec^2 x \tan x + \frac{2}{3} \int \sec^2 x \, dx = \frac{1}{3} \sec^2 x \tan x + \frac{2}{3} \tan x + C.$

(c) $\int x^3 e^x dx = x^3 e^x - 3 \int x^2 e^x dx = x^3 e^x - 3 \left[x^2 e^x - 2 \int x e^x dx \right] = x^3 e^x - 3x^2 e^x + 6 \left[x e^x - \int e^x dx \right] = x^3 e^x - 3x^2 e^x + 6x e^x - 6e^x + C.$

66. (a) $u = 3x, \int x^2 e^{3x} dx = \frac{1}{27} \int u^2 e^u du = \frac{1}{27} \left[u^2 e^u - 2 \int u e^u du \right] = \frac{1}{27} u^2 e^u - \frac{2}{27} \left[u e^u - \int e^u du \right] = \frac{1}{27} u^2 e^u - \frac{2}{27} u e^u + \frac{2}{27} e^u + C = \frac{1}{3} x^2 e^{3x} - \frac{2}{9} x e^{3x} + \frac{2}{27} e^{3x} + C.$

(b) $u = -\sqrt{x}, \int_0^1 x e^{-\sqrt{x}} dx = 2 \int_0^{-1} u^3 e^u du, \int u^3 e^u du = u^3 e^u - 3 \int u^2 e^u du = u^3 e^u - 3 \left[u^2 e^u - 2 \int u e^u du \right] = u^3 e^u - 3u^2 e^u + 6 \left[u e^u - \int e^u du \right] = u^3 e^u - 3u^2 e^u + 6u e^u - 6e^u + C, \text{ so } 2 \int_0^{-1} u^3 e^u du = 2(u^3 - 3u^2 + 6u - 6)e^u \Big|_0^{-1} = 12 - 32e^{-1}.$

67. $u = x, dv = f''(x) dx, du = dx, v = f'(x); \int_{-1}^1 x f''(x) dx = x f'(x) \Big|_{-1}^1 - \int_{-1}^1 f'(x) dx = f'(1) + f'(-1) - f(x) \Big|_{-1}^1 = f'(1) + f'(-1) - f(1) + f(-1).$

68. (a) $\int u \, dv = uv - \int v \, du = x(\sin x + C_1) + \cos x - C_1 x + C_2 = x \sin x + \cos x + C_2; \text{ the constant } C_1 \text{ cancels out and hence plays no role in the answer.}$

(b) $u(v + C_1) - \int (v + C_1) \, du = uv + C_1 u - \int v \, du - C_1 u = uv - \int v \, du.$

69. $u = \ln(x+1), dv = dx, du = \frac{dx}{x+1}, v = x+1; \int \ln(x+1) \, dx = \int u \, dv = uv - \int v \, du = (x+1) \ln(x+1) - \int dx = (x+1) \ln(x+1) - x + C.$

70. $u = \ln(3x-2), dv = dx, du = \frac{3dx}{3x-2}, v = x - \frac{2}{3}; \int \ln(3x-2) \, dx = \int u \, dv = uv - \int v \, du = \left(x - \frac{2}{3}\right) \ln(3x-2) - \int \left(x - \frac{2}{3}\right) \frac{1}{x-2/3} \, dx = \left(x - \frac{2}{3}\right) \ln(3x-2) - \left(x - \frac{2}{3}\right) + C.$

71. $u = \tan^{-1} x, dv = x \, dx, du = \frac{1}{1+x^2} dx, v = \frac{1}{2}(x^2 + 1) \int x \tan^{-1} x \, dx = \int u \, dv = uv - \int v \, du = \frac{1}{2}(x^2 + 1) \tan^{-1} x - \frac{1}{2} \int dx = \frac{1}{2}(x^2 + 1) \tan^{-1} x - \frac{1}{2} x + C.$

72. $u = \frac{1}{\ln x}$, $dv = \frac{1}{x} dx$, $du = -\frac{1}{x(\ln x)^2} dx$, $v = \ln x$, $\int \frac{1}{x \ln x} dx = 1 + \int \frac{1}{x \ln x} dx$. This seems to imply that $1 = 0$, but recall that both sides represent a function *plus an arbitrary constant*; these two arbitrary constants will take care of the 1.

Exercise Set 7.3

1. $u = \cos x$, $-\int u^3 du = -\frac{1}{4} \cos^4 x + C$.
2. $u = \sin 3x$, $\frac{1}{3} \int u^5 du = \frac{1}{18} \sin^6 3x + C$.
3. $\int \sin^2 5\theta = \frac{1}{2} \int (1 - \cos 10\theta) d\theta = \frac{1}{2} \theta - \frac{1}{20} \sin 10\theta + C$.
4. $\int \cos^2 3x dx = \frac{1}{2} \int (1 + \cos 6x) dx = \frac{1}{2} x + \frac{1}{12} \sin 6x + C$.
5. $\int \sin^3 a\theta d\theta = \int \sin a\theta (1 - \cos^2 a\theta) d\theta = -\frac{1}{a} \cos a\theta + \frac{1}{3a} \cos^3 a\theta + C$. ($a \neq 0$)
6. $\int \cos^3 at dt = \int (1 - \sin^2 at) \cos at dt = \int \cos at dt - \int \sin^2 at \cos at dt = \frac{1}{a} \sin at - \frac{1}{3a} \sin^3 at + C$. ($a \neq 0$)
7. $u = \sin ax$, $\frac{1}{a} \int u du = \frac{1}{2a} \sin^2 ax + C$. ($a \neq 0$)
8. $\int \sin^3 x \cos^3 x dx = \int \sin^3 x (1 - \sin^2 x) \cos x dx = \int (\sin^3 x - \sin^5 x) \cos x dx = \frac{1}{4} \sin^4 x - \frac{1}{6} \sin^6 x + C$.
9. $\int \sin^2 t \cos^3 t dt = \int \sin^2 t (1 - \sin^2 t) \cos t dt = \int (\sin^2 t - \sin^4 t) \cos t dt = \frac{1}{3} \sin^3 t - \frac{1}{5} \sin^5 t + C$.
10. $\int \sin^3 x \cos^2 x dx = \int (1 - \cos^2 x) \cos^2 x \sin x dx = \int (\cos^2 x - \cos^4 x) \sin x dx = -\frac{1}{3} \cos^3 x + \frac{1}{5} \cos^5 x + C$.
11. $\int \sin^2 x \cos^2 x dx = \frac{1}{4} \int \sin^2 2x dx = \frac{1}{8} \int (1 - \cos 4x) dx = \frac{1}{8} x - \frac{1}{32} \sin 4x + C$.
12. $\int \sin^2 x \cos^4 x dx = \frac{1}{8} \int (1 - \cos 2x)(1 + \cos 2x)^2 dx = \frac{1}{8} \int (1 - \cos^2 2x)(1 + \cos 2x) dx$
 $= \frac{1}{8} \int \sin^2 2x dx + \frac{1}{8} \int \sin^2 2x \cos 2x dx = \frac{1}{16} \int (1 - \cos 4x) dx + \frac{1}{48} \sin^3 2x = \frac{1}{16} x - \frac{1}{64} \sin 4x + \frac{1}{48} \sin^3 2x + C$.
13. $\int \sin 2x \cos 3x dx = \frac{1}{2} \int (\sin 5x - \sin x) dx = -\frac{1}{10} \cos 5x + \frac{1}{2} \cos x + C$.
14. $\int \sin 3\theta \cos 2\theta d\theta = \frac{1}{2} \int (\sin 5\theta + \sin \theta) d\theta = -\frac{1}{10} \cos 5\theta - \frac{1}{2} \cos \theta + C$.
15. $\int \sin x \cos(x/2) dx = \frac{1}{2} \int [\sin(3x/2) + \sin(x/2)] dx = -\frac{1}{3} \cos(3x/2) - \cos(x/2) + C$.
16. $u = \cos x$, $-\int u^{1/3} du = -\frac{3}{4} \cos^{4/3} x + C$.

$$17. \int_0^{\pi/2} \cos^3 x \, dx = \int_0^{\pi/2} (1 - \sin^2 x) \cos x \, dx = \left[\sin x - \frac{1}{3} \sin^3 x \right]_0^{\pi/2} = \frac{2}{3}.$$

$$18. \int_0^{\pi/2} \sin^2(x/2) \cos^2(x/2) \, dx = \frac{1}{4} \int_0^{\pi/2} \sin^2 x \, dx = \frac{1}{8} \int_0^{\pi/2} (1 - \cos 2x) \, dx = \frac{1}{8} \left(x - \frac{1}{2} \sin 2x \right) \Big|_0^{\pi/2} = \pi/16.$$

$$19. \int_0^{\pi/3} \sin^4 3x \cos^3 3x \, dx = \int_0^{\pi/3} \sin^4 3x (1 - \sin^2 3x) \cos 3x \, dx = \left[\frac{1}{15} \sin^5 3x - \frac{1}{21} \sin^7 3x \right]_0^{\pi/3} = 0.$$

$$20. \int_{-\pi}^{\pi} \cos^2 5\theta \, d\theta = \frac{1}{2} \int_{-\pi}^{\pi} (1 + \cos 10\theta) \, d\theta = \frac{1}{2} \left(\theta + \frac{1}{10} \sin 10\theta \right) \Big|_{-\pi}^{\pi} = \pi.$$

$$21. \int_0^{\pi/6} \sin 4x \cos 2x \, dx = \frac{1}{2} \int_0^{\pi/6} (\sin 2x + \sin 6x) \, dx = \left[-\frac{1}{4} \cos 2x - \frac{1}{12} \cos 6x \right]_0^{\pi/6} = [(-1/4)(1/2) - (1/12)(-1)] - [-1/4 - 1/12] = 7/24.$$

$$22. \int_0^{2\pi} \sin^2 kx \, dx = \frac{1}{2} \int_0^{2\pi} (1 - \cos 2kx) \, dx = \frac{1}{2} \left(x - \frac{1}{2k} \sin 2kx \right) \Big|_0^{2\pi} = \pi - \frac{1}{4k} \sin 4\pi k. \quad (k \neq 0)$$

$$23. u = 2x - 1, \, du = 2dx, \, \frac{1}{2} \int \sec^2 u \, du = \frac{1}{2} \tan(2x - 1) + C.$$

$$24. u = 5x, \, du = 5dx, \, \frac{1}{5} \int \tan u \, du = -\frac{1}{5} \ln |\cos 5x| + C.$$

$$25. u = e^{-x}, \, du = -e^{-x} \, dx; \, - \int \tan u \, du = \ln |\cos u| + C = \ln |\cos(e^{-x})| + C.$$

$$26. u = 3x, \, du = 3dx, \, \frac{1}{3} \int \cot u \, du = \frac{1}{3} \ln |\sin 3x| + C.$$

$$27. u = 4x, \, du = 4dx, \, \frac{1}{4} \int \sec u \, du = \frac{1}{4} \ln |\sec 4x + \tan 4x| + C.$$

$$28. u = \sqrt{x}, \, du = \frac{1}{2\sqrt{x}} \, dx; \, \int 2 \sec u \, du = 2 \ln |\sec u + \tan u| + C = 2 \ln |\sec \sqrt{x} + \tan \sqrt{x}| + C.$$

$$29. u = \tan x, \, \int u^2 \, du = \frac{1}{3} \tan^3 x + C.$$

$$30. \int \tan^5 x (1 + \tan^2 x) \sec^2 x \, dx = \int (\tan^5 x + \tan^7 x) \sec^2 x \, dx = \frac{1}{6} \tan^6 x + \frac{1}{8} \tan^8 x + C.$$

$$31. \int \tan 4x (1 + \tan^2 4x) \sec^2 4x \, dx = \int (\tan 4x + \tan^3 4x) \sec^2 4x \, dx = \frac{1}{8} \tan^2 4x + \frac{1}{16} \tan^4 4x + C.$$

$$32. \int \tan^4 \theta (1 + \tan^2 \theta) \sec^2 \theta \, d\theta = \frac{1}{5} \tan^5 \theta + \frac{1}{7} \tan^7 \theta + C.$$

$$33. \int \sec^4 x (\sec^2 x - 1) \sec x \tan x \, dx = \int (\sec^6 x - \sec^4 x) \sec x \tan x \, dx = \frac{1}{7} \sec^7 x - \frac{1}{5} \sec^5 x + C.$$

$$34. \int (\sec^2 \theta - 1)^2 \sec \theta \tan \theta \, d\theta = \int (\sec^4 \theta - 2 \sec^2 \theta + 1) \sec \theta \tan \theta \, d\theta = \frac{1}{5} \sec^5 \theta - \frac{2}{3} \sec^3 \theta + \sec \theta + C.$$

$$35. \int (\sec^2 x - 1)^2 \sec x dx = \int (\sec^5 x - 2\sec^3 x + \sec x) dx = \int \sec^5 x dx - 2 \int \sec^3 x dx + \int \sec x dx = \frac{1}{4} \sec^3 x \tan x + \frac{3}{4} \int \sec^3 x dx - 2 \int \sec^3 x dx + \ln |\sec x + \tan x| = \frac{1}{4} \sec^3 x \tan x - \frac{5}{4} \left[\frac{1}{2} \sec x \tan x + \frac{1}{2} \ln |\sec x + \tan x| \right] + \ln |\sec x + \tan x| + C = \frac{1}{4} \sec^3 x \tan x - \frac{5}{8} \sec x \tan x + \frac{3}{8} \ln |\sec x + \tan x| + C.$$

$$36. \int [\sec^2 x - 1] \sec^3 x dx = \int [\sec^5 x - \sec^3 x] dx = \left(\frac{1}{4} \sec^3 x \tan x + \frac{3}{4} \int \sec^3 x dx \right) - \int \sec^3 x dx = \frac{1}{4} \sec^3 x \tan x - \frac{1}{4} \int \sec^3 x dx = \frac{1}{4} \sec^3 x \tan x - \frac{1}{8} \sec x \tan x - \frac{1}{8} \ln |\sec x + \tan x| + C.$$

$$37. \int \sec^2 t (\sec t \tan t) dt = \frac{1}{3} \sec^3 t + C.$$

$$38. \int \sec^4 x (\sec x \tan x) dx = \frac{1}{5} \sec^5 x + C.$$

$$39. \int \sec^4 x dx = \int (1 + \tan^2 x) \sec^2 x dx = \int (\sec^2 x + \tan^2 x \sec^2 x) dx = \tan x + \frac{1}{3} \tan^3 x + C.$$

$$40. \text{Using equation (20), } \int \sec^5 x dx = \frac{1}{4} \sec^3 x \tan x + \frac{3}{4} \int \sec^3 x dx = \frac{1}{4} \sec^3 x \tan x + \frac{3}{8} \sec x \tan x + \frac{3}{8} \ln |\sec x + \tan x| + C.$$

$$41. u = 4x, \text{ use equation (19) to get } \frac{1}{4} \int \tan^3 u du = \frac{1}{4} \left[\frac{1}{2} \tan^2 u + \ln |\cos u| \right] + C = \frac{1}{8} \tan^2 4x + \frac{1}{4} \ln |\cos 4x| + C.$$

$$42. \text{Use equation (19) to get } \int \tan^4 x dx = \frac{1}{3} \tan^3 x - \tan x + x + C.$$

$$43. \int \sqrt{\tan x} (1 + \tan^2 x) \sec^2 x dx = \frac{2}{3} \tan^{3/2} x + \frac{2}{7} \tan^{7/2} x + C.$$

$$44. \int \sec^{1/2} x (\sec x \tan x) dx = \frac{2}{3} \sec^{3/2} x + C.$$

$$45. \int_0^{\pi/8} (\sec^2 2x - 1) dx = \left[\frac{1}{2} \tan 2x - x \right]_0^{\pi/8} = 1/2 - \pi/8.$$

$$46. \int_0^{\pi/6} \sec^2 2\theta (\sec 2\theta \tan 2\theta) d\theta = \frac{1}{6} \sec^3 2\theta \Big|_0^{\pi/6} = (1/6)(2)^3 - (1/6)(1) = 7/6.$$

$$47. u = x/2, 2 \int_0^{\pi/4} \tan^5 u du = \left[\frac{1}{2} \tan^4 u - \tan^2 u - 2 \ln |\cos u| \right]_0^{\pi/4} = 1/2 - 1 - 2 \ln(1/\sqrt{2}) = -1/2 + \ln 2.$$

$$48. u = \pi x, \frac{1}{\pi} \int_0^{\pi/4} \sec u \tan u du = \frac{1}{\pi} \sec u \Big|_0^{\pi/4} = (\sqrt{2} - 1)/\pi.$$

$$49. \int (\csc^2 x - 1) \csc^2 x (\csc x \cot x) dx = \int (\csc^4 x - \csc^2 x) (\csc x \cot x) dx = -\frac{1}{5} \csc^5 x + \frac{1}{3} \csc^3 x + C.$$

$$50. \int \frac{\cos^2 3t}{\sin^2 3t} \cdot \frac{1}{\cos 3t} dt = \int \csc 3t \cot 3t dt = -\frac{1}{3} \csc 3t + C.$$

$$51. \int (\csc^2 x - 1) \cot x \, dx = \int \csc x (\csc x \cot x) \, dx - \int \frac{\cos x}{\sin x} \, dx = -\frac{1}{2} \csc^2 x - \ln |\sin x| + C.$$

$$52. \int (\cot^2 x + 1) \csc^2 x \, dx = -\frac{1}{3} \cot^3 x - \cot x + C.$$

53. True.

54. False; the method would work but is tedious. Better to use the identity $\cos^2 x = 1 - \sin^2 x$ and the substitution $u = \sin x$.

55. False.

56. True.

$$57. \text{(a)} \int_0^{2\pi} \sin mx \cos nx \, dx = \frac{1}{2} \int_0^{2\pi} [\sin(m+n)x + \sin(m-n)x] \, dx = \left[-\frac{\cos(m+n)x}{2(m+n)} - \frac{\cos(m-n)x}{2(m-n)} \right]_0^{2\pi},$$

but we know that $\cos(m+n)x \Big|_0^{2\pi} = 0$, $\cos(m-n)x \Big|_0^{2\pi} = 0$.

$$\text{(b)} \int_0^{2\pi} \cos mx \cos nx \, dx = \frac{1}{2} \int_0^{2\pi} [\cos(m+n)x + \cos(m-n)x] \, dx;$$

since $m \neq n$, evaluate sine at integer multiples of 2π to get 0.

$$\text{(c)} \int_0^{2\pi} \sin mx \sin nx \, dx = \frac{1}{2} \int_0^{2\pi} [\cos(m-n)x - \cos(m+n)x] \, dx;$$

since $m \neq n$, evaluate sine at integer multiples of 2π to get 0.

$$58. \text{(a)} \int_0^{2\pi} \sin mx \cos mx \, dx = \frac{1}{2} \int_0^{2\pi} \sin 2mx \, dx = -\frac{1}{4m} \cos 2mx \Big|_0^{2\pi} = 0.$$

$$\text{(b)} \int_0^{2\pi} \cos^2 mx \, dx = \frac{1}{2} \int_0^{2\pi} (1 + \cos 2mx) \, dx = \frac{1}{2} \left(x + \frac{1}{2m} \sin 2mx \right) \Big|_0^{2\pi} = \pi.$$

$$\text{(c)} \int_0^{2\pi} \sin^2 mx \, dx = \frac{1}{2} \int_0^{2\pi} (1 - \cos 2mx) \, dx = \frac{1}{2} \left(x - \frac{1}{2m} \sin 2mx \right) \Big|_0^{2\pi} = \pi.$$

$$59. y' = \tan x, 1 + (y')^2 = 1 + \tan^2 x = \sec^2 x, L = \int_0^{\pi/4} \sqrt{\sec^2 x} \, dx = \int_0^{\pi/4} \sec x \, dx = \ln |\sec x + \tan x| \Big|_0^{\pi/4} = \ln(\sqrt{2} + 1).$$

$$60. V = \pi \int_0^{\pi/4} (1 - \tan^2 x) \, dx = \pi \int_0^{\pi/4} (2 - \sec^2 x) \, dx = \pi(2x - \tan x) \Big|_0^{\pi/4} = \frac{1}{2} \pi(\pi - 2).$$

$$61. V = \pi \int_0^{\pi/4} (\cos^2 x - \sin^2 x) \, dx = \pi \int_0^{\pi/4} \cos 2x \, dx = \frac{1}{2} \pi \sin 2x \Big|_0^{\pi/4} = \pi/2.$$

$$62. V = \pi \int_0^{\pi} \sin^2 x \, dx = \frac{\pi}{2} \int_0^{\pi} (1 - \cos 2x) \, dx = \frac{\pi}{2} \left(x - \frac{1}{2} \sin 2x \right) \Big|_0^{\pi} = \pi^2/2.$$

$$63. \text{With } 0 < \alpha < \beta, D = D_\beta - D_\alpha = \frac{L}{2\pi} \int_{\alpha\pi/180}^{\beta\pi/180} \sec x \, dx = \frac{L}{2\pi} \ln |\sec x + \tan x| \Big|_{\alpha\pi/180}^{\beta\pi/180} = \frac{L}{2\pi} \ln \left| \frac{\sec \beta^\circ + \tan \beta^\circ}{\sec \alpha^\circ + \tan \alpha^\circ} \right|.$$

64. (a) $D = \frac{100}{2\pi} \ln(\sec 25^\circ + \tan 25^\circ) = 7.18 \text{ cm.}$

(b) $D = \frac{100}{2\pi} \ln \left| \frac{\sec 50^\circ + \tan 50^\circ}{\sec 30^\circ + \tan 30^\circ} \right| = 7.34 \text{ cm.}$

65. (a) $\int \csc x \, dx = \int \sec(\pi/2 - x) \, dx = -\ln |\sec(\pi/2 - x) + \tan(\pi/2 - x)| + C = -\ln |\csc x + \cot x| + C.$

(b) $-\ln |\csc x + \cot x| = \ln \frac{1}{|\csc x + \cot x|} = \ln \frac{|\csc x - \cot x|}{|\csc^2 x - \cot^2 x|} = \ln |\csc x - \cot x|, -\ln |\csc x + \cot x| =$
 $-\ln \left| \frac{1}{\sin x} + \frac{\cos x}{\sin x} \right| = \ln \left| \frac{\sin x}{1 + \cos x} \right| = \ln \left| \frac{2 \sin(x/2) \cos(x/2)}{2 \cos^2(x/2)} \right| = \ln |\tan(x/2)|.$

66. $\sin x + \cos x = \sqrt{2} \left[(1/\sqrt{2}) \sin x + (1/\sqrt{2}) \cos x \right] = \sqrt{2} [\sin x \cos(\pi/4) + \cos x \sin(\pi/4)] = \sqrt{2} \sin(x + \pi/4),$

$$\int \frac{dx}{\sin x + \cos x} = \frac{1}{\sqrt{2}} \int \csc(x + \pi/4) \, dx = \frac{-1}{\sqrt{2}} \ln |\csc(x + \pi/4) + \cot(x + \pi/4)| + C = \frac{-1}{\sqrt{2}} \ln \left| \frac{\sqrt{2} + \cos x - \sin x}{\sin x + \cos x} \right| + C.$$

67. $a \sin x + b \cos x = \sqrt{a^2 + b^2} \left[\frac{a}{\sqrt{a^2 + b^2}} \sin x + \frac{b}{\sqrt{a^2 + b^2}} \cos x \right] = \sqrt{a^2 + b^2} (\sin x \cos \theta + \cos x \sin \theta),$ where $\cos \theta = a/\sqrt{a^2 + b^2}$ and $\sin \theta = b/\sqrt{a^2 + b^2}$, so $a \sin x + b \cos x = \sqrt{a^2 + b^2} \sin(x + \theta)$ and then we obtain that

$$\int \frac{dx}{a \sin x + b \cos x} = \frac{1}{\sqrt{a^2 + b^2}} \int \csc(x + \theta) \, dx = -\frac{1}{\sqrt{a^2 + b^2}} \ln |\csc(x + \theta) + \cot(x + \theta)| + C =$$

$$= -\frac{1}{\sqrt{a^2 + b^2}} \ln \left| \frac{\sqrt{a^2 + b^2} + a \cos x - b \sin x}{a \sin x + b \cos x} \right| + C.$$

68. (a) $\int_0^{\pi/2} \sin^n x \, dx = -\frac{1}{n} \sin^{n-1} x \cos x \Big|_0^{\pi/2} + \frac{n-1}{n} \int_0^{\pi/2} \sin^{n-2} x \, dx = \frac{n-1}{n} \int_0^{\pi/2} \sin^{n-2} x \, dx.$

(b) By repeated application of the formula in Part (a)

$$\int_0^{\pi/2} \sin^n x \, dx = \left(\frac{n-1}{n} \right) \left(\frac{n-3}{n-2} \right) \int_0^{\pi/2} \sin^{n-4} x \, dx =$$

$$= \begin{cases} \left(\frac{n-1}{n} \right) \left(\frac{n-3}{n-2} \right) \left(\frac{n-5}{n-4} \right) \cdots \left(\frac{1}{2} \right) \int_0^{\pi/2} dx, & n \text{ even} \\ \left(\frac{n-1}{n} \right) \left(\frac{n-3}{n-2} \right) \left(\frac{n-5}{n-4} \right) \cdots \left(\frac{2}{3} \right) \int_0^{\pi/2} \sin x \, dx, & n \text{ odd} \end{cases} = \begin{cases} \frac{1 \cdot 3 \cdot 5 \cdots (n-1)}{2 \cdot 4 \cdot 6 \cdots n} \cdot \frac{\pi}{2}, & n \text{ even} \\ \frac{2 \cdot 4 \cdot 6 \cdots (n-1)}{3 \cdot 5 \cdot 7 \cdots n}, & n \text{ odd} \end{cases}.$$

69. (a) $\int_0^{\pi/2} \sin^3 x \, dx = \frac{2}{3}.$ (b) $\int_0^{\pi/2} \sin^4 x \, dx = \frac{1 \cdot 3}{2 \cdot 4} \cdot \frac{\pi}{2} = 3\pi/16.$

(c) $\int_0^{\pi/2} \sin^5 x \, dx = \frac{2 \cdot 4}{3 \cdot 5} = 8/15.$ (d) $\int_0^{\pi/2} \sin^6 x \, dx = \frac{1 \cdot 3 \cdot 5}{2 \cdot 4 \cdot 6} \cdot \frac{\pi}{2} = 5\pi/32.$

70. Similar to proof in Exercise 68.

Exercise Set 7.4

1. $x = 2 \sin \theta, dx = 2 \cos \theta \, d\theta, 4 \int \cos^2 \theta \, d\theta = 2 \int (1 + \cos 2\theta) \, d\theta = 2\theta + \sin 2\theta + C = 2\theta + 2 \sin \theta \cos \theta + C =$
 $2 \sin^{-1}(x/2) + \frac{1}{2} x \sqrt{4 - x^2} + C.$

2. $x = \frac{1}{2} \sin \theta$, $dx = \frac{1}{2} \cos \theta d\theta$, $\frac{1}{2} \int \cos^2 \theta d\theta = \frac{1}{4} \int (1 + \cos 2\theta) d\theta = \frac{1}{4} \theta + \frac{1}{8} \sin 2\theta + C = \frac{1}{4} \theta + \frac{1}{4} \sin \theta \cos \theta + C = \frac{1}{4} \sin^{-1} 2x + \frac{1}{2} x \sqrt{1 - 4x^2} + C.$
3. $x = 4 \sin \theta$, $dx = 4 \cos \theta d\theta$, $16 \int \sin^2 \theta d\theta = 8 \int (1 - \cos 2\theta) d\theta = 8\theta - 4 \sin 2\theta + C = 8\theta - 8 \sin \theta \cos \theta + C = 8 \sin^{-1}(x/4) - \frac{1}{2} x \sqrt{16 - x^2} + C.$
4. $x = 3 \sin \theta$, $dx = 3 \cos \theta d\theta$, $\frac{1}{9} \int \frac{1}{\sin^2 \theta} d\theta = \frac{1}{9} \int \csc^2 \theta d\theta = -\frac{1}{9} \cot \theta + C = -\frac{\sqrt{9 - x^2}}{9x} + C.$
5. $x = 2 \tan \theta$, $dx = 2 \sec^2 \theta d\theta$, $\frac{1}{8} \int \frac{1}{\sec^2 \theta} d\theta = \frac{1}{8} \int \cos^2 \theta d\theta = \frac{1}{16} \int (1 + \cos 2\theta) d\theta = \frac{1}{16} \theta + \frac{1}{32} \sin 2\theta + C = \frac{1}{16} \theta + \frac{1}{16} \sin \theta \cos \theta + C = \frac{1}{16} \tan^{-1} \frac{x}{2} + \frac{x}{8(4 + x^2)} + C.$
6. $x = \sqrt{5} \tan \theta$, $dx = \sqrt{5} \sec^2 \theta d\theta$, $5 \int \tan^2 \theta \sec \theta d\theta = 5 \int (\sec^3 \theta - \sec \theta) d\theta = 5 \left(\frac{1}{2} \sec \theta \tan \theta - \frac{1}{2} \ln |\sec \theta + \tan \theta| \right) + C_1 = \frac{1}{2} x \sqrt{5 + x^2} - \frac{5}{2} \ln \frac{\sqrt{5 + x^2} + x}{\sqrt{5}} + C_1 = \frac{1}{2} x \sqrt{5 + x^2} - \frac{5}{2} \ln(\sqrt{5 + x^2} + x) + C.$
7. $x = 3 \sec \theta$, $dx = 3 \sec \theta \tan \theta d\theta$, $3 \int \tan^2 \theta d\theta = 3 \int (\sec^2 \theta - 1) d\theta = 3 \tan \theta - 3\theta + C = \sqrt{x^2 - 9} - 3 \sec^{-1} \frac{x}{3} + C.$
8. $x = 4 \sec \theta$, $dx = 4 \sec \theta \tan \theta d\theta$, $\frac{1}{16} \int \frac{1}{\sec \theta} d\theta = \frac{1}{16} \int \cos \theta d\theta = \frac{1}{16} \sin \theta + C = \frac{\sqrt{x^2 - 16}}{16x} + C.$
9. $x = \sin \theta$, $dx = \cos \theta d\theta$, $3 \int \sin^3 \theta d\theta = 3 \int [1 - \cos^2 \theta] \sin \theta d\theta = 3(-\cos \theta + \cos^3 \theta) + C = -3\sqrt{1 - x^2} + (1 - x^2)^{3/2} + C.$
10. $x = \sqrt{5} \sin \theta$, $dx = \sqrt{5} \cos \theta d\theta$, $25\sqrt{5} \int \sin^3 \theta \cos^2 \theta d\theta = 25\sqrt{5} \left(-\frac{1}{3} \cos^3 \theta + \frac{1}{5} \cos^5 \theta \right) + C = -\frac{5}{3} (5 - x^2)^{3/2} + \frac{1}{5} (5 - x^2)^{5/2} + C.$
11. $x = \frac{2}{3} \sec \theta$, $dx = \frac{2}{3} \sec \theta \tan \theta d\theta$, $\frac{3}{4} \int \frac{1}{\sec \theta} d\theta = \frac{3}{4} \int \cos \theta d\theta = \frac{3}{4} \sin \theta + C = \frac{1}{4x} \sqrt{9x^2 - 4} + C.$
12. $t = \tan \theta$, $dt = \sec^2 \theta d\theta$, $\int \frac{\sec^3 \theta}{\tan \theta} d\theta = \int \frac{\tan^2 \theta + 1}{\tan \theta} \sec \theta d\theta = \int (\sec \theta \tan \theta + \csc \theta) d\theta = \sec \theta + \ln |\csc \theta - \cot \theta| + C = \sqrt{1 + t^2} + \ln \frac{\sqrt{1 + t^2} - 1}{|t|} + C.$
13. $x = \sin \theta$, $dx = \cos \theta d\theta$, $\int \frac{1}{\cos^2 \theta} d\theta = \int \sec^2 \theta d\theta = \tan \theta + C = x/\sqrt{1 - x^2} + C.$
14. $x = 5 \tan \theta$, $dx = 5 \sec^2 \theta d\theta$, $\frac{1}{25} \int \frac{\sec \theta}{\tan^2 \theta} d\theta = \frac{1}{25} \int \csc \theta \cot \theta d\theta = -\frac{1}{25} \csc \theta + C = -\frac{\sqrt{x^2 + 25}}{25x} + C.$
15. $x = 3 \sec \theta$, $dx = 3 \sec \theta \tan \theta d\theta$, $\int \sec \theta d\theta = \ln |\sec \theta + \tan \theta| + C = \ln \left| \frac{1}{3} x + \frac{1}{3} \sqrt{x^2 - 9} \right| + C.$

$$16. 1 + 2x^2 + x^4 = (1 + x^2)^2, x = \tan \theta, dx = \sec^2 \theta d\theta, \int \frac{1}{\sec^2 \theta} d\theta = \int \cos^2 \theta d\theta = \frac{1}{2} \int (1 + \cos 2\theta) d\theta = \frac{1}{2} \theta + \frac{1}{4} \sin 2\theta + C = \frac{1}{2} \theta + \frac{1}{2} \sin \theta \cos \theta + C = \frac{1}{2} \tan^{-1} x + \frac{x}{2(1+x^2)} + C.$$

$$17. x = \frac{3}{2} \sec \theta, dx = \frac{3}{2} \sec \theta \tan \theta d\theta, \frac{3}{2} \int \frac{\sec \theta \tan \theta d\theta}{27 \tan^3 \theta} = \frac{1}{18} \int \frac{\cos \theta}{\sin^2 \theta} d\theta = -\frac{1}{18} \frac{1}{\sin \theta} + C = -\frac{1}{18} \csc \theta + C = -\frac{x}{9\sqrt{4x^2 - 9}} + C.$$

$$18. x = 5 \sec \theta, dx = 5 \sec \theta \tan \theta d\theta, 375 \int \sec^4 \theta d\theta = 125 \sec^2 \theta \tan \theta + 250 \int \sec^2 \theta d\theta = 125 \sec^2 \theta \tan \theta + 250 \tan \theta + C = x^2 \sqrt{x^2 - 25} + 50 \sqrt{x^2 - 25} + C.$$

$$19. e^x = \sin \theta, e^x dx = \cos \theta d\theta, \int \cos^2 \theta d\theta = \frac{1}{2} \int (1 + \cos 2\theta) d\theta = \frac{1}{2} \theta + \frac{1}{4} \sin 2\theta + C = \frac{1}{2} \sin^{-1}(e^x) + \frac{1}{2} e^x \sqrt{1 - e^{2x}} + C.$$

$$20. u = \sin \theta, \int \frac{1}{\sqrt{2-u^2}} du = \sin^{-1} \left(\frac{\sin \theta}{\sqrt{2}} \right) + C.$$

$$21. x = \sin \theta, dx = \cos \theta d\theta, 5 \int_0^1 \sin^3 \theta \cos^2 \theta d\theta = 5 \left[-\frac{1}{3} \cos^3 \theta + \frac{1}{5} \cos^5 \theta \right]_0^{\pi/2} = 5(1/3 - 1/5) = 2/3.$$

$$22. x = \sin \theta, dx = \cos \theta d\theta, \int_0^{\pi/6} \sec^3 \theta d\theta = \left[\frac{1}{2} \sec \theta \tan \theta + \frac{1}{2} \ln |\sec \theta + \tan \theta| \right]_0^{\pi/6} = \left(\frac{1}{2} \frac{2}{\sqrt{3}} \frac{1}{\sqrt{3}} + \frac{1}{2} \ln \left(\frac{2}{\sqrt{3}} + \frac{1}{\sqrt{3}} \right) \right) = \frac{1}{3} + \frac{1}{4} \ln 3.$$

$$23. x = \sec \theta, dx = \sec \theta \tan \theta d\theta, \int_{\pi/4}^{\pi/3} \frac{1}{\sec \theta} d\theta = \int_{\pi/4}^{\pi/3} \cos \theta d\theta = \sin \theta \Big|_{\pi/4}^{\pi/3} = (\sqrt{3} - \sqrt{2})/2.$$

$$24. x = \sqrt{2} \sec \theta, dx = \sqrt{2} \sec \theta \tan \theta d\theta, 2 \int_0^{\pi/4} \tan^2 \theta d\theta = \left[2 \tan \theta - 2\theta \right]_0^{\pi/4} = 2 - \pi/2.$$

$$25. x = \sqrt{3} \tan \theta, dx = \sqrt{3} \sec^2 \theta d\theta, \frac{1}{9} \int_{\pi/6}^{\pi/3} \frac{\sec \theta}{\tan^4 \theta} d\theta = \frac{1}{9} \int_{\pi/6}^{\pi/3} \frac{\cos^3 \theta}{\sin^4 \theta} d\theta = \frac{1}{9} \int_{\pi/6}^{\pi/3} \frac{1 - \sin^2 \theta}{\sin^4 \theta} \cos \theta d\theta = \frac{1}{9} \int_{1/2}^{\sqrt{3}/2} \frac{1-u^2}{u^4} du \text{ (with } u = \sin \theta) = \frac{1}{9} \int_{1/2}^{\sqrt{3}/2} (u^{-4} - u^{-2}) du = \frac{1}{9} \left[-\frac{1}{3u^3} + \frac{1}{u} \right]_{1/2}^{\sqrt{3}/2} = \frac{10\sqrt{3} + 18}{243}.$$

$$26. x = \sqrt{3} \tan \theta, dx = \sqrt{3} \sec^2 \theta d\theta, \frac{\sqrt{3}}{3} \int_0^{\pi/3} \frac{\tan^3 \theta}{\sec^3 \theta} d\theta = \frac{\sqrt{3}}{3} \int_0^{\pi/3} \sin^3 \theta d\theta = \frac{\sqrt{3}}{3} \int_0^{\pi/3} [1 - \cos^2 \theta] \sin \theta d\theta = \frac{\sqrt{3}}{3} \left[-\cos \theta + \frac{1}{3} \cos^3 \theta \right]_0^{\pi/3} = \frac{\sqrt{3}}{3} \left[\left(-\frac{1}{2} + \frac{1}{24} \right) - \left(-1 + \frac{1}{3} \right) \right] = 5\sqrt{3}/72.$$

27. True.

28. False; $-\pi/2 \leq \theta \leq \pi/2$.

29. False; $x = a \sec \theta$.

30. True; $A = 4 \left(\frac{1}{2} \right) \int_0^1 \sqrt{1-x^2} dx$; let $x = \sin \theta, 0 \leq \theta \leq \pi/2$, and $A = 2 \int_0^{\pi/2} \cos^2 \theta d\theta = \pi/2$.

31. $u = x^2 + 4, du = 2x dx, \frac{1}{2} \int \frac{1}{u} du = \frac{1}{2} \ln|u| + C = \frac{1}{2} \ln(x^2 + 4) + C$; or $x = 2 \tan \theta, dx = 2 \sec^2 \theta d\theta, \int \tan \theta d\theta = \ln|\sec \theta| + C_1 = \ln \frac{\sqrt{x^2 + 4}}{2} + C_1 = \ln(x^2 + 4)^{1/2} - \ln 2 + C_1 = \frac{1}{2} \ln(x^2 + 4) + C$ with $C = C_1 - \ln 2$.

32. $x = 2 \tan \theta, dx = 2 \sec^2 \theta d\theta, \int 2 \tan^2 \theta d\theta = 2 \tan \theta - 2\theta + C = x - 2 \tan^{-1} \frac{x}{2} + C$; alternatively $\int \frac{x^2}{x^2 + 4} dx = \int dx - 4 \int \frac{dx}{x^2 + 4} = x - 2 \tan^{-1} \frac{x}{2} + C$.

33. $y' = \frac{1}{x}, 1 + (y')^2 = 1 + \frac{1}{x^2} = \frac{x^2 + 1}{x^2}, L = \int_1^2 \sqrt{\frac{x^2 + 1}{x^2}} dx; x = \tan \theta, dx = \sec^2 \theta d\theta, L = \int_{\pi/4}^{\tan^{-1}(2)} \frac{\sec^3 \theta}{\tan \theta} d\theta = \int_{\pi/4}^{\tan^{-1}(2)} \frac{\tan^2 \theta + 1}{\tan \theta} \sec \theta d\theta = \int_{\pi/4}^{\tan^{-1}(2)} (\sec \theta \tan \theta + \csc \theta) d\theta = \left[\sec \theta + \ln|\csc \theta - \cot \theta| \right]_{\pi/4}^{\tan^{-1}(2)} = \sqrt{5} + \ln \left(\frac{\sqrt{5}}{2} - \frac{1}{2} \right) - \left[\sqrt{2} + \ln|\sqrt{2} - 1| \right] = \sqrt{5} - \sqrt{2} + \ln \frac{2 + 2\sqrt{2}}{1 + \sqrt{5}}$.

34. $y' = 2x, 1 + (y')^2 = 1 + 4x^2, L = \int_0^1 \sqrt{1 + 4x^2} dx; x = \frac{1}{2} \tan \theta, dx = \frac{1}{2} \sec^2 \theta d\theta, L = \frac{1}{2} \int_0^{\tan^{-1} 2} \sec^3 \theta d\theta = \frac{1}{2} \left(\frac{1}{2} \sec \theta \tan \theta + \frac{1}{2} \ln|\sec \theta + \tan \theta| \right) \Big|_0^{\tan^{-1} 2} = \frac{1}{4} (\sqrt{5})(2) + \frac{1}{4} \ln|\sqrt{5} + 2| = \frac{1}{2} \sqrt{5} + \frac{1}{4} \ln(2 + \sqrt{5})$.

35. $y' = 2x, 1 + (y')^2 = 1 + 4x^2, S = 2\pi \int_0^1 x^2 \sqrt{1 + 4x^2} dx; x = \frac{1}{2} \tan \theta, dx = \frac{1}{2} \sec^2 \theta d\theta, S = \frac{\pi}{4} \int_0^{\tan^{-1} 2} \tan^2 \theta \sec^3 \theta d\theta = \frac{\pi}{4} \int_0^{\tan^{-1} 2} (\sec^2 \theta - 1) \sec^3 \theta d\theta = \frac{\pi}{4} \int_0^{\tan^{-1} 2} (\sec^5 \theta - \sec^3 \theta) d\theta = \frac{\pi}{4} \left[\frac{1}{4} \sec^3 \theta \tan \theta - \frac{1}{8} \sec \theta \tan \theta - \frac{1}{8} \ln|\sec \theta + \tan \theta| \right]_0^{\tan^{-1} 2} = \frac{\pi}{32} [18\sqrt{5} - \ln(2 + \sqrt{5})]$.

36. $V = \pi \int_0^1 y^2 \sqrt{1 - y^2} dy; y = \sin \theta, dy = \cos \theta d\theta, V = \pi \int_0^{\pi/2} \sin^2 \theta \cos^2 \theta d\theta = \frac{\pi}{4} \int_0^{\pi/2} \sin^2 2\theta d\theta = \frac{\pi}{8} \int_0^{\pi/2} (1 - \cos 4\theta) d\theta = \frac{\pi}{8} \left(\theta - \frac{1}{4} \sin 4\theta \right) \Big|_0^{\pi/2} = \frac{\pi^2}{16}$.

37. $\int \frac{1}{(x - 2)^2 + 1} dx = \tan^{-1}(x - 2) + C$.

38. $\int \frac{1}{\sqrt{1 - (x - 1)^2}} dx = \sin^{-1}(x - 1) + C$.

39. $\int \frac{1}{\sqrt{4 - (x - 1)^2}} dx = \sin^{-1} \left(\frac{x - 1}{2} \right) + C$

40. $\int \frac{1}{16(x + 1/2)^2 + 1} dx = \int \frac{1}{(4x + 2)^2 + 1} dx = \frac{1}{4} \tan^{-1}(4x + 2) + C$.

41. $\int \frac{1}{\sqrt{(x - 3)^2 + 1}} dx = \ln \left(x - 3 + \sqrt{(x - 3)^2 + 1} \right) + C$.

42. $\int \frac{x}{(x + 1)^2 + 1} dx, \text{ let } u = x + 1, \int \frac{u - 1}{u^2 + 1} du = \int \left(\frac{u}{u^2 + 1} - \frac{1}{u^2 + 1} \right) du = \frac{1}{2} \ln(u^2 + 1) - \tan^{-1} u + C =$

$$\frac{1}{2} \ln(x^2 + 2x + 2) - \tan^{-1}(x + 1) + C.$$

$$43. \int \sqrt{4 - (x + 1)^2} dx, \quad \text{let } x + 1 = 2 \sin \theta, \quad \int 4 \cos^2 \theta d\theta = \int 2(1 + \cos 2\theta) d\theta = 2\theta + \sin 2\theta + C = 2 \sin^{-1} \left(\frac{x + 1}{2} \right) + \frac{1}{2}(x + 1)\sqrt{3 - 2x - x^2} + C.$$

$$44. \int \frac{e^x}{\sqrt{(e^x + 1/2)^2 + 3/4}} dx, \quad \text{let } u = e^x + 1/2, \quad \int \frac{1}{\sqrt{u^2 + 3/4}} du = \sinh^{-1}(2u/\sqrt{3}) + C = \sinh^{-1} \left(\frac{2e^x + 1}{\sqrt{3}} \right) + C; \text{ or,}$$

alternatively, let $e^x + 1/2 = \frac{\sqrt{3}}{2} \tan \theta$, $\int \sec \theta d\theta = \ln |\sec \theta + \tan \theta| + C = \ln \left(\frac{2\sqrt{e^{2x} + e^x + 1}}{\sqrt{3}} + \frac{2e^x + 1}{\sqrt{3}} \right) + C_1 = \ln(2\sqrt{e^{2x} + e^x + 1} + 2e^x + 1) + C.$

$$45. \int \frac{1}{2(x + 1)^2 + 5} dx = \frac{1}{2} \int \frac{1}{(x + 1)^2 + 5/2} dx = \frac{1}{\sqrt{10}} \tan^{-1} \sqrt{2/5}(x + 1) + C.$$

$$46. \int \frac{2x + 3}{4(x + 1/2)^2 + 4} dx, \quad \text{let } u = x + 1/2, \quad \int \frac{2u + 2}{4u^2 + 4} du = \frac{1}{2} \int \left(\frac{u}{u^2 + 1} + \frac{1}{u^2 + 1} \right) du = \frac{1}{4} \ln(u^2 + 1) + \frac{1}{2} \tan^{-1} u + C = \frac{1}{4} \ln(x^2 + x + 5/4) + \frac{1}{2} \tan^{-1}(x + 1/2) + C.$$

$$47. \int_1^2 \frac{1}{\sqrt{4x - x^2}} dx = \int_1^2 \frac{1}{\sqrt{4 - (x - 2)^2}} dx = \left[\sin^{-1} \frac{x - 2}{2} \right]_1^2 = \pi/6.$$

$$48. \int_0^4 \sqrt{4x - x^2} dx = \int_0^4 \sqrt{4 - (x - 2)^2} dx, \quad \text{let } x - 2 = 2 \sin \theta, \quad 4 \int_{-\pi/2}^{\pi/2} \cos^2 \theta d\theta = \left[2\theta + \sin 2\theta \right]_{-\pi/2}^{\pi/2} = 2\pi.$$

$$49. u = \sin^2 x, \quad du = 2 \sin x \cos x dx; \quad \frac{1}{2} \int \sqrt{1 - u^2} du = \frac{1}{4} \left[u\sqrt{1 - u^2} + \sin^{-1} u \right] + C = \frac{1}{4} \left[\sin^2 x \sqrt{1 - \sin^4 x} + \sin^{-1}(\sin^2 x) \right] + C.$$

$$50. u = x \sin x, \quad du = (x \cos x + \sin x) dx; \quad \int \sqrt{1 + u^2} du = \frac{1}{2} u \sqrt{1 + u^2} + \frac{1}{2} \sinh^{-1} u + C = \frac{1}{2} x \sin x \sqrt{1 + x^2 \sin^2 x} + \frac{1}{2} \sinh^{-1}(x \sin x) + C.$$

$$51. \text{(a) } x = 3 \sinh u, \quad dx = 3 \cosh u du, \quad \int du = u + C = \sinh^{-1}(x/3) + C.$$

$$\text{(b) } x = 3 \tan \theta, \quad dx = 3 \sec^2 \theta d\theta, \quad \int \sec \theta d\theta = \ln |\sec \theta + \tan \theta| + C = \ln \left(\frac{\sqrt{x^2 + 9}}{3} + x/3 \right) + C, \quad \text{but } \sinh^{-1}(x/3) = \ln \left(x/3 + \sqrt{x^2/9 + 1} \right) = \ln \left(x/3 + \sqrt{x^2 + 9}/3 \right), \text{ so the results agree.}$$

$$52. x = \cosh u, \quad dx = \sinh u du, \quad \int \sinh^2 u du = \frac{1}{2} \int (\cosh 2u - 1) du = \frac{1}{4} \sinh 2u - \frac{1}{2} u + C = \frac{1}{2} \sinh u \cosh u - \frac{1}{2} u + C = \frac{1}{2} x \sqrt{x^2 - 1} - \frac{1}{2} \cosh^{-1} x + C, \quad \text{because } \cosh u = x, \quad \text{and } \sinh u = \sqrt{\cosh^2 u - 1} = \sqrt{x^2 - 1}.$$

Exercise Set 7.5

$$1. \frac{3x - 1}{(x - 3)(x + 4)} = \frac{A}{x - 3} + \frac{B}{x + 4}.$$

2. $\frac{5}{x(x-2)(x+2)} = \frac{A}{x} + \frac{B}{x-2} + \frac{C}{x+2}$.
3. $\frac{2x-3}{x^2(x-1)} = \frac{A}{x} + \frac{B}{x^2} + \frac{C}{x-1}$.
4. $\frac{x^2}{(x+2)^3} = \frac{A}{x+2} + \frac{B}{(x+2)^2} + \frac{C}{(x+2)^3}$.
5. $\frac{1-x^2}{x^3(x^2+2)} = \frac{A}{x} + \frac{B}{x^2} + \frac{C}{x^3} + \frac{Dx+E}{x^2+2}$.
6. $\frac{3x}{(x-1)(x^2+6)} = \frac{A}{x-1} + \frac{Bx+C}{x^2+6}$.
7. $\frac{4x^3-x}{(x^2+5)^2} = \frac{Ax+B}{x^2+5} + \frac{Cx+D}{(x^2+5)^2}$.
8. $\frac{1-3x^4}{(x-2)(x^2+1)^2} = \frac{A}{x-2} + \frac{Bx+C}{x^2+1} + \frac{Dx+E}{(x^2+1)^2}$.
9. $\frac{1}{(x-4)(x+1)} = \frac{A}{x-4} + \frac{B}{x+1}$; $A = \frac{1}{5}$, $B = -\frac{1}{5}$, so $\frac{1}{5} \int \frac{1}{x-4} dx - \frac{1}{5} \int \frac{1}{x+1} dx = \frac{1}{5} \ln|x-4| - \frac{1}{5} \ln|x+1| + C = \frac{1}{5} \ln \left| \frac{x-4}{x+1} \right| + C$.
10. $\frac{1}{(x+1)(x-7)} = \frac{A}{x+1} + \frac{B}{x-7}$; $A = -\frac{1}{8}$, $B = \frac{1}{8}$, so $-\frac{1}{8} \int \frac{1}{x+1} dx + \frac{1}{8} \int \frac{1}{x-7} dx = -\frac{1}{8} \ln|x+1| + \frac{1}{8} \ln|x-7| + C = \frac{1}{8} \ln \left| \frac{x-7}{x+1} \right| + C$.
11. $\frac{11x+17}{(2x-1)(x+4)} = \frac{A}{2x-1} + \frac{B}{x+4}$; $A = 5$, $B = 3$, so $5 \int \frac{1}{2x-1} dx + 3 \int \frac{1}{x+4} dx = \frac{5}{2} \ln|2x-1| + 3 \ln|x+4| + C$.
12. $\frac{5x-5}{(x-3)(3x+1)} = \frac{A}{x-3} + \frac{B}{3x+1}$; $A = 1$, $B = 2$, so $\int \frac{1}{x-3} dx + 2 \int \frac{1}{3x+1} dx = \ln|x-3| + \frac{2}{3} \ln|3x+1| + C$.
13. $\frac{2x^2-9x-9}{x(x+3)(x-3)} = \frac{A}{x} + \frac{B}{x+3} + \frac{C}{x-3}$; $A = 1$, $B = 2$, $C = -1$, so $\int \frac{1}{x} dx + 2 \int \frac{1}{x+3} dx - \int \frac{1}{x-3} dx = \ln|x| + 2 \ln|x+3| - \ln|x-3| + C = \ln \left| \frac{x(x+3)^2}{x-3} \right| + C$. Note that the symbol C has been recycled; to save space this recycling is usually not mentioned.
14. $\frac{1}{x(x+1)(x-1)} = \frac{A}{x} + \frac{B}{x+1} + \frac{C}{x-1}$; $A = -1$, $B = \frac{1}{2}$, $C = \frac{1}{2}$, so $-\int \frac{1}{x} dx + \frac{1}{2} \int \frac{1}{x+1} dx + \frac{1}{2} \int \frac{1}{x-1} dx = -\ln|x| + \frac{1}{2} \ln|x+1| + \frac{1}{2} \ln|x-1| + C = \frac{1}{2} \ln \left| \frac{(x+1)(x-1)}{x^2} \right| + C = \frac{1}{2} \ln \frac{|x^2-1|}{x^2} + C$.
15. $\frac{x^2-8}{x+3} = x-3 + \frac{1}{x+3}$, $\int \left(x-3 + \frac{1}{x+3} \right) dx = \frac{1}{2}x^2 - 3x + \ln|x+3| + C$.
16. $\frac{x^2+1}{x-1} = x+1 + \frac{2}{x-1}$, $\int \left(x+1 + \frac{2}{x-1} \right) dx = \frac{1}{2}x^2 + x + 2 \ln|x-1| + C$.

$$17. \frac{3x^2 - 10}{x^2 - 4x + 4} = 3 + \frac{12x - 22}{x^2 - 4x + 4}, \frac{12x - 22}{(x-2)^2} = \frac{A}{x-2} + \frac{B}{(x-2)^2}; A = 12, B = 2, \text{ so } \int 3dx + 12 \int \frac{1}{x-2} dx + 2 \int \frac{1}{(x-2)^2} dx = 3x + 12 \ln|x-2| - 2/(x-2) + C.$$

$$18. \frac{x^2}{x^2 - 3x + 2} = 1 + \frac{3x - 2}{x^2 - 3x + 2}, \frac{3x - 2}{(x-1)(x-2)} = \frac{A}{x-1} + \frac{B}{x-2}; A = -1, B = 4, \text{ so } \int dx - \int \frac{1}{x-1} dx + 4 \int \frac{1}{x-2} dx = x - \ln|x-1| + 4 \ln|x-2| + C.$$

$$19. u = x^2 - 3x - 10, du = (2x - 3) dx, \int \frac{du}{u} = \ln|u| + C = \ln|x^2 - 3x - 10| + C.$$

$$20. u = 3x^2 + 2x - 1, du = (6x + 2) dx, \frac{1}{2} \int \frac{du}{u} = \frac{1}{2} \ln|u| + C = \frac{1}{2} \ln|3x^2 + 2x - 1| + C.$$

$$21. \frac{x^5 + x^2 + 2}{x^3 - x} = x^2 + 1 + \frac{x^2 + x + 2}{x^3 - x}, \frac{x^2 + x + 2}{x(x+1)(x-1)} = \frac{A}{x} + \frac{B}{x+1} + \frac{C}{x-1}; A = -2, B = 1, C = 2, \text{ so } \int (x^2 + 1) dx - \int \frac{2}{x} dx + \int \frac{1}{x+1} dx + \int \frac{2}{x-1} dx = \frac{1}{3}x^3 + x - 2 \ln|x| + \ln|x+1| + 2 \ln|x-1| + C = \frac{1}{3}x^3 + x + \ln \left| \frac{(x+1)(x-1)^2}{x^2} \right| + C.$$

$$22. \frac{x^5 - 4x^3 + 1}{x^3 - 4x} = x^2 + \frac{1}{x^3 - 4x}, \frac{1}{x(x+2)(x-2)} = \frac{A}{x} + \frac{B}{x+2} + \frac{C}{x-2}; A = -\frac{1}{4}, B = \frac{1}{8}, C = \frac{1}{8}, \text{ so } \int x^2 dx - \frac{1}{4} \int \frac{1}{x} dx + \frac{1}{8} \int \frac{1}{x+2} dx + \frac{1}{8} \int \frac{1}{x-2} dx = \frac{1}{3}x^3 - \frac{1}{4} \ln|x| + \frac{1}{8} \ln|x+2| + \frac{1}{8} \ln|x-2| + C.$$

$$23. \frac{2x^2 + 3}{x(x-1)^2} = \frac{A}{x} + \frac{B}{x-1} + \frac{C}{(x-1)^2}; A = 3, B = -1, C = 5, \text{ so } 3 \int \frac{1}{x} dx - \int \frac{1}{x-1} dx + 5 \int \frac{1}{(x-1)^2} dx = 3 \ln|x| - \ln|x-1| - 5/(x-1) + C.$$

$$24. \frac{3x^2 - x + 1}{x^2(x-1)} = \frac{A}{x} + \frac{B}{x^2} + \frac{C}{x-1}; A = 0, B = -1, C = 3, \text{ so } - \int \frac{1}{x^2} dx + 3 \int \frac{1}{x-1} dx = 1/x + 3 \ln|x-1| + C.$$

$$25. \frac{2x^2 - 10x + 4}{(x+1)(x-3)^2} = \frac{A}{x+1} + \frac{B}{x-3} + \frac{C}{(x-3)^2}; A = 1, B = 1, C = -2, \text{ so } \int \frac{1}{x+1} dx + \int \frac{1}{x-3} dx - \int \frac{2}{(x-3)^2} dx = \ln|x+1| + \ln|x-3| + \frac{2}{x-3} + C_1.$$

$$26. \frac{2x^2 - 2x - 1}{x^2(x-1)} = \frac{A}{x} + \frac{B}{x^2} + \frac{C}{x-1}; A = 3, B = 1, C = -1, \text{ so } 3 \int \frac{1}{x} dx + \int \frac{1}{x^2} dx - \int \frac{1}{x-1} dx = 3 \ln|x| - \frac{1}{x} - \ln|x-1| + C.$$

$$27. \frac{x^2}{(x+1)^3} = \frac{A}{x+1} + \frac{B}{(x+1)^2} + \frac{C}{(x+1)^3}; A = 1, B = -2, C = 1, \text{ so } \int \frac{1}{x+1} dx - \int \frac{2}{(x+1)^2} dx + \int \frac{1}{(x+1)^3} dx = \ln|x+1| + \frac{2}{x+1} - \frac{1}{2(x+1)^2} + C.$$

$$28. \frac{2x^2 + 3x + 3}{(x+1)^3} = \frac{A}{x+1} + \frac{B}{(x+1)^2} + \frac{C}{(x+1)^3}; A = 2, B = -1, C = 2, \text{ so } 2 \int \frac{1}{x+1} dx - \int \frac{1}{(x+1)^2} dx + 2 \int \frac{1}{(x+1)^3} dx = 2 \ln|x+1| + \frac{1}{x+1} - \frac{1}{(x+1)^2} + C.$$

$$29. \frac{2x^2 - 1}{(4x-1)(x^2+1)} = \frac{A}{4x-1} + \frac{Bx+C}{x^2+1}; A = -14/17, B = 12/17, C = 3/17, \text{ so } \int \frac{2x^2 - 1}{(4x-1)(x^2+1)} dx = -\frac{7}{34} \ln|4x-1| + \frac{6}{17} \ln(x^2+1) + \frac{3}{17} \tan^{-1} x + C.$$

30. $\frac{1}{x(x^2+2)} = \frac{A}{x} + \frac{Bx+C}{x^2+2}$; $A = \frac{1}{2}$, $B = -\frac{1}{2}$, $C = 0$, so $\int \frac{1}{x^3+2x} dx = \frac{1}{2} \ln|x| - \frac{1}{4} \ln(x^2+2) + C = \frac{1}{4} \ln \frac{x^2}{x^2+2} + C$.

31. $\frac{x^3+3x^2+x+9}{(x^2+1)(x^2+3)} = \frac{Ax+B}{x^2+1} + \frac{Cx+D}{x^2+3}$; $A = 0$, $B = 3$, $C = 1$, $D = 0$, so $\int \frac{x^3+3x^2+x+9}{(x^2+1)(x^2+3)} dx = 3 \tan^{-1} x + \frac{1}{2} \ln(x^2+3) + C$.

32. $\frac{x^3+x^2+x+2}{(x^2+1)(x^2+2)} = \frac{Ax+B}{x^2+1} + \frac{Cx+D}{x^2+2}$; $A = D = 0$, $B = C = 1$, so $\int \frac{x^3+x^2+x+2}{(x^2+1)(x^2+2)} dx = \tan^{-1} x + \frac{1}{2} \ln(x^2+2) + C$.

33. $\frac{x^3-2x^2+2x-2}{x^2+1} = x-2 + \frac{x}{x^2+1}$, so $\int \frac{x^3-2x^2+2x-2}{x^2+1} dx = \frac{1}{2}x^2 - 2x + \frac{1}{2} \ln(x^2+1) + C$.

34. $\frac{x^4+6x^3+10x^2+x}{x^2+6x+10} = x^2 + \frac{x}{x^2+6x+10}$, $\int \frac{x}{x^2+6x+10} dx = \int \frac{x}{(x+3)^2+1} dx = \int \frac{u-3}{u^2+1} du$, $u = x+3 = \frac{1}{2} \ln(u^2+1) - 3 \tan^{-1} u + C_1$, so $\int \frac{x^4+6x^3+10x^2+x}{x^2+6x+10} dx = \frac{1}{3}x^3 + \frac{1}{2} \ln(x^2+6x+10) - 3 \tan^{-1}(x+3) + C$.

35. True.

36. False; degree of numerator should be less than that of denominator.

37. True.

38. True.

39. Let $x = \sin \theta$ to get $\int \frac{1}{x^2+4x-5} dx$, and $\frac{1}{(x+5)(x-1)} = \frac{A}{x+5} + \frac{B}{x-1}$; $A = -1/6$, $B = 1/6$, so we get $-\frac{1}{6} \int \frac{1}{x+5} dx + \frac{1}{6} \int \frac{1}{x-1} dx = \frac{1}{6} \ln \left| \frac{x-1}{x+5} \right| + C = \frac{1}{6} \ln \left(\frac{1-\sin \theta}{5+\sin \theta} \right) + C$.

40. Let $x = e^t$; then $\int \frac{e^t}{e^{2t}-4} dt = \int \frac{1}{x^2-4} dx$, $\frac{1}{(x+2)(x-2)} = \frac{A}{x+2} + \frac{B}{x-2}$; $A = -1/4$, $B = 1/4$, so $-\frac{1}{4} \int \frac{1}{x+2} dx + \frac{1}{4} \int \frac{1}{x-2} dx = \frac{1}{4} \ln \left| \frac{x-2}{x+2} \right| + C = \frac{1}{4} \ln \left| \frac{e^t-2}{e^t+2} \right| + C$.

41. $u = e^x$, $du = e^x dx$, $\int \frac{e^{3x}}{e^{2x}+4} dx = \int \frac{u^2}{u^2+4} du = u - 2 \tan^{-1} \frac{u}{2} + C = e^x - 2 \tan^{-1}(e^x/2) + C$.

42. Set $u = 1 + \ln x$, $du = \frac{1}{x} dx$, $\int \frac{5+2 \ln x}{x(1+\ln x)^2} dx = \int \frac{3+2u}{u^2} du = -\frac{3}{u} + 2 \ln|u| + C = -\frac{3}{1+\ln x} + 2 \ln|1+\ln x| + C$.

43. $V = \pi \int_0^2 \frac{x^4}{(9-x^2)^2} dx$, $\frac{x^4}{x^4-18x^2+81} = 1 + \frac{18x^2-81}{x^4-18x^2+81}$, $\frac{18x^2-81}{(9-x^2)^2} = \frac{18x^2-81}{(x+3)^2(x-3)^2} = \frac{A}{x+3} + \frac{B}{(x+3)^2} + \frac{C}{x-3} + \frac{D}{(x-3)^2}$; $A = -\frac{9}{4}$, $B = \frac{9}{4}$, $C = \frac{9}{4}$, $D = \frac{9}{4}$, so $V = \pi \left[x - \frac{9}{4} \ln|x+3| - \frac{9/4}{x+3} + \frac{9}{4} \ln|x-3| - \frac{9/4}{x-3} \right]_0^2 = \pi \left(\frac{19}{5} - \frac{9}{4} \ln 5 \right)$.

44. Let $u = e^x$ to get $\int_{-\ln 5}^{\ln 5} \frac{dx}{1+e^x} = \int_{-\ln 5}^{\ln 5} \frac{e^x dx}{e^x(1+e^x)} = \int_{1/5}^5 \frac{du}{u(1+u)}$, $\frac{1}{u(1+u)} = \frac{A}{u} + \frac{B}{1+u}$; $A = 1$, $B = -1$; $\int_{1/5}^5 \frac{du}{u(1+u)} = (\ln u - \ln(1+u)) \Big|_{1/5}^5 = \ln 5$.

$$45. \frac{x^2 + 1}{(x^2 + 2x + 3)^2} = \frac{Ax + B}{x^2 + 2x + 3} + \frac{Cx + D}{(x^2 + 2x + 3)^2}; A = 0, B = 1, C = D = -2, \text{ so } \int \frac{x^2 + 1}{(x^2 + 2x + 3)^2} dx = \int \frac{1}{(x+1)^2 + 2} dx - \int \frac{2x+2}{(x^2+2x+3)^2} dx = \frac{1}{\sqrt{2}} \tan^{-1} \frac{x+1}{\sqrt{2}} + 1/(x^2+2x+3) + C.$$

$$46. \frac{x^5 + x^4 + 4x^3 + 4x^2 + 4x + 4}{(x^2 + 2)^3} = \frac{Ax + B}{x^2 + 2} + \frac{Cx + D}{(x^2 + 2)^2} + \frac{Ex + F}{(x^2 + 2)^3}; A = B = 1, C = D = E = F = 0, \text{ so } \int \frac{x+1}{x^2+2} dx = \frac{1}{2} \ln(x^2+2) + \frac{1}{\sqrt{2}} \tan^{-1}(x/\sqrt{2}) + C.$$

$$47. x^4 - 3x^3 - 7x^2 + 27x - 18 = (x-1)(x-2)(x-3)(x+3), \frac{1}{(x-1)(x-2)(x-3)(x+3)} = \frac{A}{x-1} + \frac{B}{x-2} + \frac{C}{x-3} + \frac{D}{x+3}; A = 1/8, B = -1/5, C = 1/12, D = -1/120, \text{ so } \int \frac{dx}{x^4 - 3x^3 - 7x^2 + 27x - 18} = \frac{1}{8} \ln|x-1| - \frac{1}{5} \ln|x-2| + \frac{1}{12} \ln|x-3| - \frac{1}{120} \ln|x+3| + C.$$

$$48. 16x^3 - 4x^2 + 4x - 1 = (4x-1)(4x^2+1), \frac{1}{(4x-1)(4x^2+1)} = \frac{A}{4x-1} + \frac{Bx+C}{4x^2+1}; A = 4/5, B = -4/5, C = -1/5, \text{ so } \int \frac{dx}{16x^3 - 4x^2 + 4x - 1} = \frac{1}{5} \ln|4x-1| - \frac{1}{10} \ln(4x^2+1) - \frac{1}{10} \tan^{-1}(2x) + C.$$

$$49. \text{ Let } u = x^2, du = 2x dx, \int_0^1 \frac{x}{x^4+1} dx = \frac{1}{2} \int_0^1 \frac{1}{1+u^2} du = \frac{1}{2} \tan^{-1} u \Big|_0^1 = \frac{1}{2} \frac{\pi}{4} = \frac{\pi}{8}.$$

$$50. \frac{1}{a^2 - x^2} = \frac{A}{a-x} + \frac{B}{a+x}; A = \frac{1}{2a}, B = \frac{1}{2a}, \text{ so } \frac{1}{2a} \int \left(\frac{1}{a-x} + \frac{1}{a+x} \right) dx = \frac{1}{2a} (-\ln|a-x| + \ln|a+x|) + C = \frac{1}{2a} \ln \left| \frac{a+x}{a-x} \right| + C.$$

51. If the polynomial has distinct roots $r_1, r_2, r_1 \neq r_2$, then the partial fraction decomposition will contain terms of the form $\frac{A}{x-r_1}, \frac{B}{x-r_2}$, and they will give logarithms and no inverse tangents. If there are two roots not distinct, say $x=r$, then the terms $\frac{A}{x-r}, \frac{B}{(x-r)^2}$ will appear, and neither will give an inverse tangent term. The only other possibility is no real roots, and the integrand can be written in the form $\frac{1}{a(x+\frac{b}{2a})^2 + c - \frac{b^2}{4a}}$, which will yield an inverse tangent, specifically of the form $\tan^{-1} \left[A \left(x + \frac{b}{2a} \right) \right]$ for some constant A .

52. Since there are no inverse tangent terms, the roots are real. Since there are no logarithmic terms, there are no terms of the form $\frac{1}{x-r}$, so the only terms that can arise in the partial fraction decomposition form is one like $\frac{1}{(x-a)^2}$. Therefore the original quadratic had a multiple root.

53. Yes, for instance the integrand $\frac{1}{x^2+1}$, whose integral is precisely $\tan^{-1} x + C$.

Exercise Set 7.6

1. Formula (60): $\frac{4}{9} [3x + \ln|-1+3x|] + C.$

2. Formula (62): $\frac{1}{25} \left[\frac{4}{4-5x} + \ln|4-5x| \right] + C.$

3. Formula (65): $\frac{1}{5} \ln \left| \frac{x}{5+2x} \right| + C.$
4. Formula (66): $-\frac{1}{x} - 5 \ln \left| \frac{1-5x}{x} \right| + C.$
5. Formula (102): $\frac{1}{5} (x-1)(2x+3)^{3/2} + C.$
6. Formula (105): $\frac{2}{3} (-x-4)\sqrt{2-x} + C.$
7. Formula (108): $\frac{1}{2} \ln \left| \frac{\sqrt{4-3x}-2}{\sqrt{4-3x}+2} \right| + C.$
8. Formula (108): $\tan^{-1} \frac{\sqrt{3x-4}}{2} + C.$
9. Formula (69): $\frac{1}{8} \ln \left| \frac{x+4}{x-4} \right| + C.$
10. Formula (70): $\frac{1}{6} \ln \left| \frac{x-3}{x+3} \right| + C.$
11. Formula (73): $\frac{x}{2} \sqrt{x^2-3} - \frac{3}{2} \ln \left| x + \sqrt{x^2-3} \right| + C.$
12. Formula (94): $-\frac{\sqrt{x^2-5}}{x} + \ln(x + \sqrt{x^2-5}) + C.$
13. Formula (95): $\frac{x}{2} \sqrt{x^2+4} - 2 \ln(x + \sqrt{x^2+4}) + C.$
14. Formula (90): $\frac{\sqrt{x^2-2}}{2x} + C.$
15. Formula (74): $\frac{x}{2} \sqrt{9-x^2} + \frac{9}{2} \sin^{-1} \frac{x}{3} + C.$
16. Formula (80): $-\frac{\sqrt{4-x^2}}{x} - \sin^{-1} \frac{x}{2} + C.$
17. Formula (79): $\sqrt{4-x^2} - 2 \ln \left| \frac{2 + \sqrt{4-x^2}}{x} \right| + C.$
18. Formula (117): $-\frac{\sqrt{6x-x^2}}{3x} + C.$
19. Formula (38): $-\frac{1}{14} \sin(7x) + \frac{1}{2} \sin x + C.$
20. Formula (40): $-\frac{1}{14} \cos(7x) + \frac{1}{6} \cos(3x) + C.$
21. Formula (50): $\frac{x^4}{16} [4 \ln x - 1] + C.$

22. Formula (50): $-2\frac{\ln x + 2}{\sqrt{x}} + C.$

23. Formula (42): $\frac{e^{-2x}}{13}(-2\sin(3x) - 3\cos(3x)) + C.$

24. Formula (43): $\frac{e^x}{5}(\cos(2x) + 2\sin(2x)) + C.$

25. $u = e^{2x}, du = 2e^{2x} dx$, Formula (62): $\frac{1}{2} \int \frac{u du}{(4-3u)^2} = \frac{1}{18} \left[\frac{4}{4-3e^{2x}} + \ln|4-3e^{2x}| \right] + C.$

26. $u = \cos 2x, du = -2\sin 2x dx$, Formula (65): $-\int \frac{du}{2u(3-u)} = -\frac{1}{6} \ln \left| \frac{\cos 2x}{3 - \cos 2x} \right| + C.$

27. $u = 3\sqrt{x}, du = \frac{3}{2\sqrt{x}} dx$, Formula (68): $\frac{2}{3} \int \frac{du}{u^2+4} = \frac{1}{3} \tan^{-1} \frac{3\sqrt{x}}{2} + C.$

28. $u = \sin 4x, du = 4\cos 4x dx$, Formula (68): $\frac{1}{4} \int \frac{du}{9+u^2} = \frac{1}{12} \tan^{-1} \frac{\sin 4x}{3} + C.$

29. $u = 2x, du = 2dx$, Formula (76): $\frac{1}{2} \int \frac{du}{\sqrt{u^2-9}} = \frac{1}{2} \ln|2x + \sqrt{4x^2-9}| + C.$

30. $u = \sqrt{2x^2}, du = 2\sqrt{2}x dx$, Formula (72): $\frac{1}{2\sqrt{2}} \int \sqrt{u^2+3} du = \frac{x^2}{4} \sqrt{2x^4+3} + \frac{3}{4\sqrt{2}} \ln(\sqrt{2x^2} + \sqrt{2x^4+3}) + C.$

31. $u = 2x^2, du = 4x dx, u^2 du = 16x^5 dx$, Formula (81): $\frac{1}{4} \int \frac{u^2 du}{\sqrt{2-u^2}} = -\frac{x^2}{4} \sqrt{2-4x^4} + \frac{1}{4} \sin^{-1}(\sqrt{2x^2}) + C.$

32. $u = 2x, du = 2dx$, Formula (83): $2 \int \frac{du}{u^2\sqrt{3-u^2}} = -\frac{1}{3x} \sqrt{3-4x^2} + C.$

33. $u = \ln x, du = dx/x$, Formula (26): $\int \sin^2 u du = \frac{1}{2} \ln x - \frac{1}{4} \sin(2\ln x) + C.$

34. $u = e^{-2x}, du = -2e^{-2x}$, Formula (27): $-\frac{1}{2} \int \cos^2 u du = -\frac{1}{4} e^{-2x} - \frac{1}{8} \sin(2e^{-2x}) + C.$

35. $u = -2x, du = -2dx$, Formula (51): $\frac{1}{4} \int u e^u du = \frac{1}{4}(-2x-1)e^{-2x} + C.$

36. $u = 3x+1, du = 3 dx$, Formula (11): $\frac{1}{3} \int \ln u du = \frac{1}{3}(u \ln u - u) + C = \frac{1}{3}(3x+1)[\ln(3x+1) - 1] + C.$

37. $u = \sin 3x, du = 3\cos 3x dx$, Formula (67): $\frac{1}{3} \int \frac{du}{u(u+1)^2} = \frac{1}{3} \left[\frac{1}{1+\sin 3x} + \ln \left| \frac{\sin 3x}{1+\sin 3x} \right| \right] + C.$

38. $u = \ln x, du = \frac{1}{x} dx$, Formula (105): $\int \frac{u du}{\sqrt{4u-1}} = \frac{1}{12}(2\ln x + 1)\sqrt{4\ln x - 1} + C.$

39. $u = 4x^2, du = 8x dx$, Formula (70): $\frac{1}{8} \int \frac{du}{u^2-1} = \frac{1}{16} \ln \left| \frac{4x^2-1}{4x^2+1} \right| + C.$

40. $u = 2e^x, du = 2e^x dx$, Formula (69): $\frac{1}{2} \int \frac{du}{3-u^2} = \frac{1}{4\sqrt{3}} \ln \left| \frac{2e^x + \sqrt{3}}{2e^x - \sqrt{3}} \right| + C.$

$$41. u = 2e^x, du = 2e^x dx, \text{ Formula (74): } \frac{1}{2} \int \sqrt{3-u^2} du = \frac{1}{4}u\sqrt{3-u^2} + \frac{3}{4} \sin^{-1}(u/\sqrt{3}) + C = \frac{1}{2}e^x \sqrt{3-4e^{2x}} + \frac{3}{4} \sin^{-1}(2e^x/\sqrt{3}) + C.$$

$$42. u = 3x, du = 3dx, \text{ Formula (80): } 3 \int \frac{\sqrt{4-u^2} du}{u^2} = -3 \frac{\sqrt{4-u^2}}{u} - 3 \sin^{-1}(u/2) + C = -\frac{\sqrt{4-9x^2}}{x} - 3 \sin^{-1}(3x/2) + C.$$

$$43. u = 3x, du = 3dx, \text{ Formula (112): } \frac{1}{3} \int \sqrt{\frac{5}{3}u - u^2} du = \frac{1}{6} \left(u - \frac{5}{6} \right) \sqrt{\frac{5}{3}u - u^2} + \frac{25}{216} \sin^{-1} \left(\frac{6u-5}{5} \right) + C = \frac{18x-5}{36} \sqrt{5x-9x^2} + \frac{25}{216} \sin^{-1} \left(\frac{18x-5}{5} \right) + C.$$

$$44. u = \sqrt{5}x, du = \sqrt{5} dx, \text{ Formula (117): } \int \frac{du}{u\sqrt{(u/\sqrt{5})-u^2}} = -\frac{\sqrt{(u/\sqrt{5})-u^2}}{u/(2\sqrt{5})} + C = -2 \frac{\sqrt{x-5x^2}}{x} + C.$$

$$45. u = 2x, du = 2dx, \text{ Formula (44): } \int u \sin u du = (\sin u - u \cos u) + C = \sin 2x - 2x \cos 2x + C.$$

$$46. u = \sqrt{x}, u^2 = x, 2udu = dx, \text{ Formula (45): } 2 \int u \cos u du = 2 \cos \sqrt{x} + 2\sqrt{x} \sin \sqrt{x} + C.$$

$$47. u = -\sqrt{x}, u^2 = x, 2udu = dx, \text{ Formula (51): } 2 \int u e^u du = -2(\sqrt{x}+1)e^{-\sqrt{x}} + C.$$

$$48. u = 2+x^2, du = 2x dx, \text{ Formula (11): } \frac{1}{2} \int \ln u du = \frac{1}{2}(u \ln u - u) + C = \frac{1}{2}(2+x^2) \ln(2+x^2) - \frac{1}{2}(2+x^2) + C.$$

$$49. x^2 + 6x - 7 = (x+3)^2 - 16; u = x+3, du = dx, \text{ Formula (70): } \int \frac{du}{u^2-16} = \frac{1}{8} \ln \left| \frac{u-4}{u+4} \right| + C = \frac{1}{8} \ln \left| \frac{x-1}{x+7} \right| + C.$$

$$50. x^2 + 2x - 3 = (x+1)^2 - 4, u = x+1, du = dx, \text{ Formula (74): } \int \sqrt{4-u^2} du = \frac{1}{2}u\sqrt{4-u^2} + 2 \sin^{-1}(u/2) + C = \frac{1}{2}(x+1)\sqrt{3-2x-x^2} + 2 \sin^{-1}((x+1)/2) + C.$$

$$51. x^2 - 4x - 5 = (x-2)^2 - 9, u = x-2, du = dx, \text{ Formula (77): } \int \frac{u+2}{\sqrt{9-u^2}} du = \int \frac{u du}{\sqrt{9-u^2}} + 2 \int \frac{du}{\sqrt{9-u^2}} = -\sqrt{9-u^2} + 2 \sin^{-1} \frac{u}{3} + C = -\sqrt{5+4x-x^2} + 2 \sin^{-1} \left(\frac{x-2}{3} \right) + C.$$

$$52. x^2 + 6x + 13 = (x+3)^2 + 4, u = x+3, du = dx, \text{ Formula (71): } \int \frac{(u-3) du}{u^2+4} = \frac{1}{2} \ln(u^2+4) - \frac{3}{2} \tan^{-1}(u/2) + C = \frac{1}{2} \ln(x^2+6x+13) - \frac{3}{2} \tan^{-1}((x+3)/2) + C.$$

$$53. u = \sqrt{x-2}, x = u^2+2, dx = 2u du; \int 2u^2(u^2+2) du = 2 \int (u^4+2u^2) du = \frac{2}{5}u^5 + \frac{4}{3}u^3 + C = \frac{2}{5}(x-2)^{5/2} + \frac{4}{3}(x-2)^{3/2} + C.$$

$$54. u = \sqrt{x+1}, x = u^2-1, dx = 2u du; 2 \int (u^2-1) du = \frac{2}{3}u^3 - 2u + C = \frac{2}{3}(x+1)^{3/2} - 2\sqrt{x+1} + C.$$

$$55. u = \sqrt{x^3 + 1}, x^3 = u^2 - 1, 3x^2 dx = 2u du; \frac{2}{3} \int u^2(u^2 - 1) du = \frac{2}{3} \int (u^4 - u^2) du = \frac{2}{15} u^5 - \frac{2}{9} u^3 + C = \frac{2}{15} (x^3 + 1)^{5/2} - \frac{2}{9} (x^3 + 1)^{3/2} + C.$$

$$56. u = \sqrt{x^3 - 1}, x^3 = u^2 + 1, 3x^2 dx = 2u du; \frac{2}{3} \int \frac{1}{u^2 + 1} du = \frac{2}{3} \tan^{-1} u + C = \frac{2}{3} \tan^{-1} \sqrt{x^3 - 1} + C.$$

$$57. u = x^{1/3}, x = u^3, dx = 3u^2 du; \int \frac{3u^2}{u^3 - u} du = 3 \int \frac{u}{u^2 - 1} du = 3 \int \left[\frac{1}{2(u+1)} + \frac{1}{2(u-1)} \right] du = \frac{3}{2} \ln |x^{1/3} + 1| + \frac{3}{2} \ln |x^{1/3} - 1| + C.$$

$$58. u = x^{1/6}, x = u^6, dx = 6u^5 du; \int \frac{6u^5}{u^3 + u^2} du = 6 \int \frac{u^3}{u+1} du = 6 \int \left[u^2 - u + 1 - \frac{1}{u+1} \right] du = 2x^{1/2} - 3x^{1/3} + 6x^{1/6} - 6 \ln(x^{1/6} + 1) + C.$$

$$59. u = x^{1/4}, x = u^4, dx = 4u^3 du; 4 \int \frac{1}{u(1-u)} du = 4 \int \left[\frac{1}{u} + \frac{1}{1-u} \right] du = 4 \ln \frac{x^{1/4}}{|1 - x^{1/4}|} + C.$$

$$60. u = x^{1/2}, x = u^2, dx = 2u du; \int \frac{2u^2}{u^2 + 1} du = 2 \int \frac{u^2 + 1 - 1}{u^2 + 1} du = 2u - 2 \tan^{-1} u + C = 2\sqrt{x} - 2 \tan^{-1} \sqrt{x} + C.$$

$$61. u = x^{1/6}, x = u^6, dx = 6u^5 du; 6 \int \frac{u^3}{u-1} du = 6 \int \left[u^2 + u + 1 + \frac{1}{u-1} \right] du = 2x^{1/2} + 3x^{1/3} + 6x^{1/6} + 6 \ln |x^{1/6} - 1| + C.$$

$$62. u = \sqrt{x}, x = u^2, dx = 2u du; -2 \int \frac{u^2 + u}{u-1} du = -2 \int \left(u + 2 + \frac{2}{u-1} \right) du = -x - 4\sqrt{x} - 4 \ln |\sqrt{x} - 1| + C.$$

$$63. u = \sqrt{1+x^2}, x^2 = u^2 - 1, 2x dx = 2u du, x dx = u du; \int (u^2 - 1) du = \frac{1}{3} (1+x^2)^{3/2} - (1+x^2)^{1/2} + C.$$

$$64. u = (x+3)^{1/5}, x = u^5 - 3, dx = 5u^4 du; 5 \int (u^8 - 3u^3) du = \frac{5}{9} (x+3)^{9/5} - \frac{15}{4} (x+3)^{4/5} + C.$$

$$65. u = \tan(x/2), \int \frac{1}{1 + \frac{2u}{1+u^2} + \frac{1-u^2}{1+u^2}} \frac{2}{1+u^2} du = \int \frac{1}{u+1} du = \ln |\tan(x/2) + 1| + C.$$

$$66. \int \frac{1}{2 + \frac{2u}{1+u^2}} \frac{2}{1+u^2} du = \int \frac{1}{u^2 + u + 1} du = \int \frac{1}{(u+1/2)^2 + 3/4} du = \frac{2}{\sqrt{3}} \tan^{-1} \left(\frac{2 \tan(x/2) + 1}{\sqrt{3}} \right) + C.$$

$$67. u = \tan(\theta/2), \int \frac{d\theta}{1 - \cos \theta} = \int \frac{1}{u^2} du = -\frac{1}{u} + C = -\cot(\theta/2) + C.$$

$$68. u = \tan(x/2), \int \frac{2}{3u^2 + 8u - 3} du = \frac{2}{3} \int \frac{1}{(u+4/3)^2 - 25/9} du = \frac{2}{3} \int \frac{1}{z^2 - 25/9} dz \text{ (using } z = u + 4/3) = \frac{1}{5} \ln \left| \frac{z - 5/3}{z + 5/3} \right| + C = \frac{1}{5} \ln \left| \frac{\tan(x/2) - 1/3}{\tan(x/2) + 3} \right| + C.$$

$$69. u = \tan(x/2), \frac{1}{2} \int \frac{1-u^2}{u} du = \frac{1}{2} \int (1/u - u) du = \frac{1}{2} \ln |\tan(x/2)| - \frac{1}{4} \tan^2(x/2) + C.$$

$$70. u = \tan(x/2), \int \frac{1-u^2}{1+u^2} du = -u + 2 \tan^{-1} u + C = x - \tan(x/2) + C.$$

71. $\int_2^x \frac{1}{t(4-t)} dt = \frac{1}{4} \ln \frac{t}{4-t} \Big|_2^x$ (Formula (65), $a = 4, b = -1$) $= \frac{1}{4} \left[\ln \frac{x}{4-x} - \ln 1 \right] = \frac{1}{4} \ln \frac{x}{4-x}, \frac{1}{4} \ln \frac{x}{4-x} = 0.5, \ln \frac{x}{4-x} = 2, \frac{x}{4-x} = e^2, x = 4e^2 - e^2x, x(1 + e^2) = 4e^2, x = 4e^2/(1 + e^2) \approx 3.523188312.$

72. $\int_1^x \frac{1}{t\sqrt{2t-1}} dt = 2 \tan^{-1} \sqrt{2t-1} \Big|_1^x$ (Formula (108), $a = -1, b = 2$) $= 2 (\tan^{-1} \sqrt{2x-1} - \tan^{-1} 1) = 2 (\tan^{-1} \sqrt{2x-1} - \pi/4), 2(\tan^{-1} \sqrt{2x-1} - \pi/4) = 1, \tan^{-1} \sqrt{2x-1} = 1/2 + \pi/4, \sqrt{2x-1} = \tan(1/2 + \pi/4), x = [1 + \tan^2(1/2 + \pi/4)]/2 \approx 6.307993516.$

73. $A = \int_0^4 \sqrt{25-x^2} dx = \left(\frac{1}{2} x \sqrt{25-x^2} + \frac{25}{2} \sin^{-1} \frac{x}{5} \right) \Big|_0^4$ (Formula (74), $a = 5$) $= 6 + \frac{25}{2} \sin^{-1} \frac{4}{5} \approx 17.59119023.$

74. $A = \int_{2/3}^2 \sqrt{9x^2-4} dx; u = 3x, A = \frac{1}{3} \int_2^6 \sqrt{u^2-4} du = \frac{1}{3} \left(\frac{1}{2} u \sqrt{u^2-4} - 2 \ln |u + \sqrt{u^2-4}| \right) \Big|_2^6$
 (Formula (73), $a^2 = 4$) $= \frac{1}{3} (3\sqrt{32} - 2 \ln(6 + \sqrt{32}) + 2 \ln 2) = 4\sqrt{2} - \frac{2}{3} \ln(3 + 2\sqrt{2}) \approx 4.481689467.$

75. $A = \int_0^1 \frac{1}{25-16x^2} dx; u = 4x, A = \frac{1}{4} \int_0^4 \frac{1}{25-u^2} du = \frac{1}{40} \ln \left| \frac{u+5}{u-5} \right| \Big|_0^4 = \frac{1}{40} \ln 9 \approx 0.054930614.$ (Formula (69), $a = 5$)

76. $A = \int_1^4 \sqrt{x} \ln x dx = \frac{4}{9} x^{3/2} \left(\frac{3}{2} \ln x - 1 \right) \Big|_1^4$ (Formula (50), $n = 1/2$) $= \frac{4}{9} (12 \ln 4 - 7) \approx 4.282458815.$

77. $V = 2\pi \int_0^{\pi/2} x \cos x dx = 2\pi (\cos x + x \sin x) \Big|_0^{\pi/2} = \pi(\pi - 2) \approx 3.586419094.$ (Formula (45))

78. $V = 2\pi \int_4^8 x\sqrt{x-4} dx = \frac{4\pi}{15} (3x+8)(x-4)^{3/2} \Big|_4^8$ (Formula (102), $a = -4, b = 1$) $= \frac{1024}{15} \pi \approx 214.4660585.$

79. $V = 2\pi \int_0^3 x e^{-x} dx; u = -x, V = 2\pi \int_0^{-3} u e^u du = 2\pi e^u (u-1) \Big|_0^{-3} = 2\pi(1 - 4e^{-3}) \approx 5.031899801.$ (Formula (51))

80. $V = 2\pi \int_1^5 x \ln x dx = \frac{\pi}{2} x^2 (2 \ln x - 1) \Big|_1^5 = \pi(25 \ln 5 - 12) \approx 88.70584621.$ (Formula (50), $n = 1$)

81. $L = \int_0^2 \sqrt{1+16x^2} dx; u = 4x, L = \frac{1}{4} \int_0^8 \sqrt{1+u^2} du = \frac{1}{4} \left(\frac{u}{2} \sqrt{1+u^2} + \frac{1}{2} \ln (u + \sqrt{1+u^2}) \right) \Big|_0^8$
 (Formula (72), $a^2 = 1$) $= \sqrt{65} + \frac{1}{8} \ln(8 + \sqrt{65}) \approx 8.409316783.$

82. $L = \int_1^3 \sqrt{1+9/x^2} dx = \int_1^3 \frac{\sqrt{x^2+9}}{x} dx = \left(\sqrt{x^2+9} - 3 \ln \left| \frac{3 + \sqrt{x^2+9}}{x} \right| \right) \Big|_1^3 = 3\sqrt{2} - \sqrt{10} + 3 \ln \frac{3 + \sqrt{10}}{1 + \sqrt{2}} \approx 3.891581644.$ (Formula (89), $a = 3$)

83. $S = 2\pi \int_0^\pi (\sin x) \sqrt{1 + \cos^2 x} dx; u = \cos x, a^2 = 1, S = -2\pi \int_1^{-1} \sqrt{1+u^2} du = 4\pi \int_0^1 \sqrt{1+u^2} du$
 $= 4\pi \left(\frac{u}{2} \sqrt{1+u^2} + \frac{1}{2} \ln (u + \sqrt{1+u^2}) \right) \Big|_0^1 = 2\pi [\sqrt{2} + \ln(1 + \sqrt{2})] \approx 14.42359945.$ (Formula (72))

$$84. S = 2\pi \int_1^4 \frac{1}{x} \sqrt{1+1/x^4} dx = 2\pi \int_1^4 \frac{\sqrt{x^4+1}}{x^3} dx; u = x^2, S = \pi \int_1^{16} \frac{\sqrt{u^2+1}}{u^2} du =$$

$$= \pi \left(-\frac{\sqrt{u^2+1}}{u} + \ln(u + \sqrt{u^2+1}) \right) \Big|_1^{16} = \pi \left(\sqrt{2} - \frac{\sqrt{257}}{16} + \ln \frac{16 + \sqrt{257}}{1 + \sqrt{2}} \right) \approx 9.417237485. \quad (\text{Formula (93)}, a^2 = 1)$$

$$85. (a) s(t) = 2 + \int_0^t 20 \cos^6 u \sin^3 u du = -\frac{20}{9} \sin^2 t \cos^7 t - \frac{40}{63} \cos^7 t + \frac{166}{63}.$$

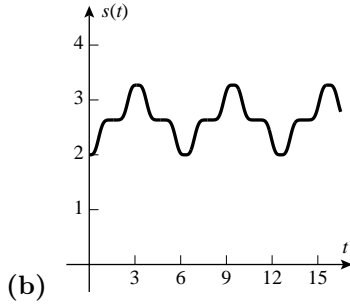

$$86. (a) v(t) = \int_0^t a(u) du = -\frac{1}{10} e^{-t} \cos 2t + \frac{1}{5} e^{-t} \sin 2t + \frac{1}{74} e^{-t} \cos 6t - \frac{3}{37} e^{-t} \sin 6t + \frac{1}{10} - \frac{1}{74}$$

$$s(t) = 10 + \int_0^t v(u) du = -\frac{3}{50} e^{-t} \cos 2t - \frac{2}{25} e^{-t} \sin 2t + \frac{35}{2738} e^{-t} \cos 6t + \frac{6}{1369} e^{-t} \sin 6t + \frac{16}{185} t + \frac{343866}{34225}.$$

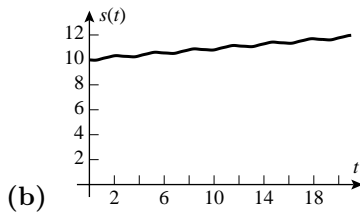

$$87. (a) \int \sec x dx = \int \frac{1}{\cos x} dx = \int \frac{2}{1-u^2} du = \ln \left| \frac{1+u}{1-u} \right| + C = \ln \left| \frac{1+\tan(x/2)}{1-\tan(x/2)} \right| + C =$$

$$= \ln \left\{ \left| \frac{\cos(x/2) + \sin(x/2)}{\cos(x/2) - \sin(x/2)} \right| \left| \frac{\cos(x/2) + \sin(x/2)}{\cos(x/2) + \sin(x/2)} \right| \right\} + C = \ln \left| \frac{1 + \sin x}{\cos x} \right| + C = \ln |\sec x + \tan x| + C.$$

$$(b) \tan \left(\frac{\pi}{4} + \frac{x}{2} \right) = \frac{\tan \frac{\pi}{4} + \tan \frac{x}{2}}{1 - \tan \frac{\pi}{4} \tan \frac{x}{2}} = \frac{1 + \tan \frac{x}{2}}{1 - \tan \frac{x}{2}}.$$

$$88. \int \csc x dx = \int \frac{1}{\sin x} dx = \int 1/u du = \ln |\tan(x/2)| + C, \text{ but } \ln |\tan(x/2)| = \frac{1}{2} \ln \frac{\sin^2(x/2)}{\cos^2(x/2)} = \frac{1}{2} \ln \frac{(1-\cos x)/2}{(1+\cos x)/2} =$$

$$\frac{1}{2} \ln \frac{1-\cos x}{1+\cos x}; \text{ also, } \frac{1-\cos x}{1+\cos x} = \frac{1-\cos^2 x}{(1+\cos x)^2} = \frac{1}{(\csc x + \cot x)^2} \text{ so } \frac{1}{2} \ln \frac{1-\cos x}{1+\cos x} = -\ln |\csc x + \cot x|.$$

$$89. \text{ Let } u = \tanh(x/2) \text{ then } \cosh(x/2) = 1/\operatorname{sech}(x/2) = 1/\sqrt{1-\tanh^2(x/2)} = 1/\sqrt{1-u^2},$$

$$\sinh(x/2) = \tanh(x/2) \cosh(x/2) = u/\sqrt{1-u^2}, \text{ so } \sinh x = 2 \sinh(x/2) \cosh(x/2) = 2u/(1-u^2), \cosh x =$$

$$\cosh^2(x/2) + \sinh^2(x/2) = (1+u^2)/(1-u^2), x = 2 \tanh^{-1} u, dx = [2/(1-u^2)] du; \int \frac{dx}{2 \cosh x + \sinh x} =$$

$$\int \frac{1}{u^2 + u + 1} du = \frac{2}{\sqrt{3}} \tan^{-1} \frac{2u+1}{\sqrt{3}} + C = \frac{2}{\sqrt{3}} \tan^{-1} \frac{2 \tanh(x/2) + 1}{\sqrt{3}} + C.$$

90. Let $u = x^4$ to get $\frac{1}{4} \int \frac{1}{\sqrt{1-u^2}} du = \frac{1}{4} \sin^{-1} u + C = \frac{1}{4} \sin^{-1}(x^4) + C$.
91. $\int (\cos^{32} x \sin^{30} x - \cos^{30} x \sin^{32} x) dx = \int \cos^{30} x \sin^{30} x (\cos^2 x - \sin^2 x) dx = \frac{1}{2^{30}} \int \sin^{30} 2x \cos 2x dx =$
 $= \frac{\sin^{31} 2x}{31(2^{31})} + C$.
92. $\int \sqrt{x - \sqrt{x^2 - 4}} dx = \frac{1}{\sqrt{2}} \int (\sqrt{x+2} - \sqrt{x-2}) dx = \frac{\sqrt{2}}{3} [(x+2)^{3/2} - (x-2)^{3/2}] + C$.
93. $\int \frac{1}{x^{10}(1+x^{-9})} dx = -\frac{1}{9} \int \frac{1}{u} du = -\frac{1}{9} \ln |u| + C = -\frac{1}{9} \ln |1+x^{-9}| + C$.
94. (a) $(x+4)(x-5)(x^2+1)^2; \frac{A}{x+4} + \frac{B}{x-5} + \frac{Cx+D}{x^2+1} + \frac{Ex+F}{(x^2+1)^2}$.
- (b) $-\frac{3}{x+4} + \frac{2}{x-5} - \frac{x-2}{x^2+1} - \frac{3}{(x^2+1)^2}$.
- (c) $-3 \ln |x+4| + 2 \ln |x-5| + 2 \tan^{-1} x - \frac{1}{2} \ln(x^2+1) - \frac{3}{2} \left(\frac{x}{x^2+1} + \tan^{-1} x \right) + C$.

Exercise Set 7.7

- Exact value = $14/3 \approx 4.666666667$.
 (a) 4.667600662, $|E_M| \approx 0.000933995$. (b) 4.664795676, $|E_T| \approx 0.001870991$. (c) 4.666666602, $|E_S| \approx 9.9 \cdot 10^{-7}$.
- Exact value = 2.
 (a) 1.999542900, $|E_M| \approx 0.000457100$. (b) 2.000915091, $|E_T| \approx 0.000915091$. (c) 2.000000019, $|E_S| \approx 2.97 \cdot 10^{-7}$.
- Exact value = 1.
 (a) 1.001028824, $|E_M| \approx 0.001028824$. (b) 0.997942986, $|E_T| \approx 0.002057013$. (c) 1.000000013, $|E_S| \approx 2.12 \cdot 10^{-7}$.
- Exact value = $1 - \cos(2) \approx 1.416146836$.
 (a) 1.418509838, $|E_M| \approx 0.002363002$. (b) 1.411423197, $|E_T| \approx 0.004723639$. (c) 1.416146888, $|E_S| \approx 7.88 \cdot 10^{-7}$.
- Exact value = $\frac{1}{2}(e^{-2} - e^{-6}) \approx 0.06642826551$.
 (a) 0.065987468, $|E_M| \approx 0.000440797$. (b) 0.067311623, $|E_T| \approx 0.000883357$. (c) 0.066428302, $|E_S| \approx 5.88 \cdot 10^{-7}$.
- Exact value = $\frac{1}{3} \ln 10 \approx 0.7675283641$.
 (a) 0.757580075, $|E_M| \approx 0.009948289$. (b) 0.788404810, $|E_T| \approx 0.020876446$. (c) 0.767855, $|E_S| \approx 0.0003266$.
- $f(x) = \sqrt{x+1}$, $f''(x) = -\frac{1}{4}(x+1)^{-3/2}$, $f^{(4)}(x) = -\frac{15}{16}(x+1)^{-7/2}$; $K_2 = 1/4$, $K_4 = 15/16$.
 (a) $|E_M| \leq \frac{27}{2400}(1/4) = 0.002812500$. (b) $|E_T| \leq \frac{27}{1200}(1/4) = 0.00562500$.
 (c) $|E_S| \leq \frac{81}{10240000} \approx 0.000007910156250$.

8. $f(x) = 1/\sqrt{x}$, $f''(x) = \frac{3}{4}x^{-5/2}$, $f^{(4)}(x) = \frac{105}{16}x^{-9/2}$; $K_2 = 3/128$, $K_4 = 105/8192$.
- (a) $|E_M| \leq \frac{125}{2400}(3/128) = 0.001220703125$ (b) $|E_T| \leq \frac{125}{1200}(3/128) = 0.002441406250$.
- (c) $|E_S| \leq \frac{35}{25165824} \approx 0.000001390775045$.
9. $f(x) = \cos x$, $f''(x) = -\cos x$, $f^{(4)}(x) = \cos x$; $K_2 = K_4 = 1$.
- (a) $|E_M| \leq \frac{\pi^3/8}{2400}(1) \approx 0.00161491$. (b) $|E_T| \leq \frac{\pi^3/8}{1200}(1) \approx 0.003229820488$.
- (c) $|E_S| \leq \frac{\pi^5/32}{180 \times 20^4}(1) \approx 3.320526095 \cdot 10^{-7}$.
10. $f(x) = \sin x$, $f''(x) = -\sin x$, $f^{(4)}(x) = \sin x$; $K_2 = K_4 = 1$.
- (a) $|E_M| \leq \frac{8}{2400}(1) \approx 0.0033333333$. (b) $|E_T| \leq \frac{8}{1200}(1) \approx 0.0066666667$.
- (c) $|E_S| \leq \frac{32}{180 \times 20^4}(1) \approx 0.000001111$.
11. $f(x) = e^{-2x}$, $f''(x) = 4e^{-2x}$; $f^{(4)}(x) = 16e^{-2x}$; $K_2 = 4e^{-2}$; $K_4 = 16e^{-2}$.
- (a) $|E_M| \leq \frac{8}{2400}(4e^{-2}) \approx 0.0018044704$. (b) $|E_T| \leq \frac{8}{1200}(4e^{-2}) \approx 0.0036089409$.
- (c) $|E_S| \leq \frac{32}{180 \times 20^4}(16e^{-2}) \approx 0.00000240596$.
12. $f(x) = 1/(3x + 1)$, $f''(x) = 18(3x + 1)^{-3}$, $f^{(4)}(x) = 1944(3x + 1)^{-5}$; $K_2 = 18$, $K_4 = 1944$.
- (a) $|E_M| \leq \frac{27}{2400}(18) \approx 0.202500$. (b) $|E_T| \leq \frac{27}{1200}(18) \approx 0.4050000000$.
- (c) $|E_S| \leq \frac{243}{180 \times 20^4}(1944) \approx 0.0164025$.
13. (a) $n > \left[\frac{(27)(1/4)}{(24)(5 \times 10^{-4})} \right]^{1/2} \approx 23.7$; $n = 24$. (b) $n > \left[\frac{(27)(1/4)}{(12)(5 \times 10^{-4})} \right]^{1/2} \approx 33.5$; $n = 34$.
- (c) $n > \left[\frac{(243)(15/16)}{(180)(5 \times 10^{-4})} \right]^{1/4} \approx 7.1$; $n = 8$.
14. (a) $n > \left[\frac{(125)(3/128)}{(24)(5 \times 10^{-4})} \right]^{1/2} \approx 15.6$; $n = 16$. (b) $n > \left[\frac{(125)(3/128)}{(12)(5 \times 10^{-4})} \right]^{1/2} \approx 22.1$; $n = 23$.
- (c) $n > \left[\frac{(3125)(105/8192)}{(180)(5 \times 10^{-4})} \right]^{1/4} \approx 4.59$; $n = 6$.
15. (a) $n > \left[\frac{(\pi^3/8)(1)}{(24)(10^{-3})} \right]^{1/2} \approx 12.7$; $n = 13$. (b) $n > \left[\frac{(\pi^3/8)(1)}{(12)(10^{-3})} \right]^{1/2} \approx 17.97$; $n = 18$.
- (c) $n > \left[\frac{(\pi^5/32)(1)}{(180)(10^{-3})} \right]^{1/4} \approx 2.7$; $n = 4$.

16. (a) $n > \left[\frac{(8)(1)}{(24)(10^{-3})} \right]^{1/2} \approx 18.26; n = 19.$ (b) $n > \left[\frac{(8)(1)}{(12)(10^{-3})} \right]^{1/2} \approx 25.8; n = 26.$

(c) $n > \left[\frac{(32)(1)}{(180)(10^{-3})} \right]^{1/4} \approx 3.7; n = 4.$

17. (a) $n > \left[\frac{(8)(4e^{-2})}{(24)(10^{-6})} \right]^{1/2} \approx 42.5; n = 43.$ (b) $n > \left[\frac{(8)(4e^{-2})}{(12)(10^{-6})} \right]^{1/2} \approx 60.2; n = 61.$

(c) $n > \left[\frac{(32)(16e^{-2})}{(180)(10^{-6})} \right]^{1/4} \approx 7.9; n = 8.$

18. (a) $n > \left[\frac{(27)(18)}{(24)(10^{-6})} \right]^{1/2} = 450; n = 451.$ (b) $n > \left[\frac{(27)(18)}{(12)(10^{-6})} \right]^{1/2} \approx 636.4; n = 637.$

(c) $n > \left[\frac{(243)(1944)}{(180)(10^{-6})} \right]^{1/4} \approx 71.6; n = 72.$

19. False; T_n is the average of L_n and R_n .

20. True, see Theorem 7.7.1(b).

21. False, it is the weighted average of M_{25} and T_{25} .

22. True.

23. $g(X_0) = aX_0^2 + bX_0 + c = 4a + 2b + c = f(X_0) = 1/X_0 = 1/2$; similarly $9a + 3b + c = 1/3, 16a + 4b + c = 1/4$. Three equations in three unknowns, with solution $a = 1/24, b = -3/8, c = 13/12, g(x) = x^2/24 - 3x/8 + 13/12$.
 $\int_2^4 g(x) dx = \int_2^4 \left(\frac{x^2}{24} - \frac{3x}{8} + \frac{13}{12} \right) dx = \frac{25}{36}, \frac{\Delta x}{3} [f(X_0) + 4f(X_1) + f(X_2)] = \frac{1}{3} \left[\frac{1}{2} + \frac{4}{3} + \frac{1}{4} \right] = \frac{25}{36}.$

24. Suppose $g(x) = ax^2 + bx + c$ passes through the points $(0, f(0)) = (0, 0), (m, f(m)) = (1/6, 1/4)$, and $(1/3, f(2m)) = (1/3, 3/4)$. Then $g(0) = c = 0, 1/4 = g(1/6) = a/36 + b/6$, and $3/4 = g(1/3) = a/9 + b/3$, with solution $a = 9/2, b = 3/4$ or $g(x) = 9x^2/2 + 3x/4$. Then $(\Delta x/3)(Y_0 + 4Y_1 + Y_2) = (1/18)(0 + 4(1/4) + 3/4) = 7/72$, and
 $\int_0^{1/3} g(x) dx = \left[(3/2)x^3 + (3/8)x^2 \right]_0^{1/3} = 1/18 + 1/24 = 7/72.$

25. 1.49367411, 1.493648266.

26. 1.367402147, 1.367479548.

27. 3.806779393, 3.805537256.

28. 1.899430473, 1.899406253.

29. 0.9045242448, 0.9045242380.

30. 0.265328932, 0.265280129.

31. Exact value = $4 \tan^{-1}(x/2) \Big|_0^2 = \pi.$

(a) 3.142425985, $|E_M| \approx 0.000833331.$ (b) 3.139925989, $|E_T| \approx 0.001666665.$

(c) 3.141592654, $|E_S| \approx 6.2 \times 10^{-10}.$

32. Exact value = $\left(\frac{2}{9}x\sqrt{9-x^2} + 2\sin^{-1}\frac{x}{3}\right)\Big|_0^3 = \pi$.

(a) 3.152411433, $|E_M| \approx 0.010818779$. (b) 3.104518327, $|E_T| \approx 0.037074327$.

(c) 3.136447064, $|E_S| \approx 0.005146787$.

33. $S_{14} = 0.693147984$, $|E_S| \approx 0.000000803 = 8.03 \times 10^{-7}$; the method used in Example 6 results in a value of n which ensures that the magnitude of the error will be less than 10^{-6} , this is not necessarily the *smallest* value of n .

34. (a) Underestimates, because the graph of $\cos x^2$ is concave down on the interval $(0, 1)$.

(b) Overestimates, because the graph of $\cos x^2$ is concave up on the interval $(3/2, 2)$.

35. $f(x) = x \sin x$, $f''(x) = 2 \cos x - x \sin x$, $|f''(x)| \leq 2|\cos x| + |x||\sin x| \leq 2 + 2 = 4$, so $K_2 \leq 4$, $n > \left[\frac{(8)(4)}{(24)(10^{-4})}\right]^{1/2} \approx 115.5$; $n = 116$ (a smaller n might suffice).

36. $f(x) = e^{\cos x}$, $f''(x) = (\sin^2 x)e^{\cos x} - (\cos x)e^{\cos x}$, $|f''(x)| \leq e^{\cos x}(\sin^2 x + |\cos x|) \leq 2e$, so $K_2 \leq 2e$, $n > \left[\frac{(1)(2e)}{(24)(10^{-4})}\right]^{1/2} \approx 47.6$; $n = 48$ (a smaller n might suffice).

37. $f(x) = x\sqrt{x}$, $f''(x) = \frac{3}{4\sqrt{x}}$, $\lim_{x \rightarrow 0^+} |f''(x)| = +\infty$.

38. $f(x) = \sin \sqrt{x}$, $f''(x) = -\frac{\sqrt{x} \sin \sqrt{x} + \cos \sqrt{x}}{4x^{3/2}}$, $\lim_{x \rightarrow 0^+} |f''(x)| = +\infty$.

39. $s(x) = \int_0^x \sqrt{1 + (y'(t))^2} dt = \int_0^x \sqrt{1 + \cos^2 t} dt$, $\ell = \int_0^\pi \sqrt{1 + \cos^2 t} dt \approx 3.820187624$.

40. $s(x) = \int_1^x \sqrt{1 + (y'(t))^2} dt = \int_1^x \sqrt{1 + 4/t^6} dt$, $\ell = \int_1^2 \sqrt{1 + 4/t^6} dt \approx 1.296827279$.

41. $\int_0^{30} v dt \approx \frac{30}{(3)(6)} \frac{22}{15} [0 + 4(60) + 2(90) + 4(110) + 2(126) + 4(138) + 146] \approx 4424$ ft.

42.

t	0	1	2	3	4	5	6	7	8
a	0	0.02	0.08	0.20	0.40	0.60	0.70	0.60	0

$\int_0^8 a dt \approx \frac{8}{(3)(8)} [0 + 4(0.02) + 2(0.08) + 4(0.20) + 2(0.40) + 4(0.60) + 2(0.70) + 4(0.60) + 0] \approx 2.7$ cm/s.

43. $\int_0^{180} v dt \approx \frac{180}{(3)(6)} [0.00 + 4(0.03) + 2(0.08) + 4(0.16) + 2(0.27) + 4(0.42) + 0.65] = 37.9$ mi.

44. $\int_0^{1800} (1/v) dx \approx \frac{1800}{(3)(6)} \left[\frac{1}{3100} + \frac{4}{2908} + \frac{2}{2725} + \frac{4}{2549} + \frac{2}{2379} + \frac{4}{2216} + \frac{1}{2059} \right] \approx 0.71$ s.

45. $V = \int_0^{16} \pi r^2 dy = \pi \int_0^{16} r^2 dy \approx \pi \frac{16}{(3)(4)} [(8.5)^2 + 4(11.5)^2 + 2(13.8)^2 + 4(15.4)^2 + (16.8)^2] \approx 9270$ cm³ ≈ 9.3 L.

46. $A = \int_0^{600} h dx \approx \frac{600}{(3)(6)} [0 + 4(7) + 2(16) + 4(24) + 2(25) + 4(16) + 0] = 9000$ ft², $V = 75A \approx 75(9000) = 675,000$ ft³.

47. (a) The maximum value of $|f'''(x)|$ is approximately 3.8442. (b) $n = 18$. (c) 0.9047406684.

48. (a) The maximum value of $|f'''(x)|$ is approximately 1.46789. (b) $n = 12$. (c) 1.112830350.

49. (a) $K_4 = \max_{0 \leq x \leq 1} |f^{(4)}(x)| \approx 12.4282$.

(b) $\frac{(b-a)^5 K_4}{180n^4} < 10^{-4}$ provided $n^4 > \frac{10^4 K_4}{180}$, $n > 5.12$, so $n \geq 6$.

(c) $\frac{K_4}{180} \cdot 6^4 \approx 0.0000531$ with $S_6 \approx 0.983347$.

50. (a) $K_4 = \max_{0 \leq x \leq 1} |f^{(4)}(x)| \approx 3.94136281877$.

(b) $\frac{(b-a)^5 K_4}{180n^4} < 10^{-6}$ provided $n^4 > \frac{10^6 K_4}{180} \approx 21896.5$, $n > 12.2$ and even, so $n \geq 14$.

(c) With $n = 14$, $S_{14} \approx 1.497185037$, with possible error $|E_S| \leq \frac{(b-a)^5 K_4}{180n^4} \approx 0.00000057$.

51. (a) Left endpoint approximation $\approx \frac{b-a}{n}[y_0 + y_1 + \dots + y_{n-2} + y_{n-1}]$. Right endpoint approximation $\approx \frac{b-a}{n}[y_1 + y_2 + \dots + y_{n-1} + y_n]$. Average of the two $= \frac{b-a}{n} \frac{1}{2}[y_0 + 2y_1 + 2y_2 + \dots + 2y_{n-2} + 2y_{n-1} + y_n]$.

(b) Area of trapezoid $= (x_{k+1} - x_k) \frac{y_k + y_{k+1}}{2}$. If we sum from $k = 0$ to $k = n - 1$ then we get the right hand side of (2).

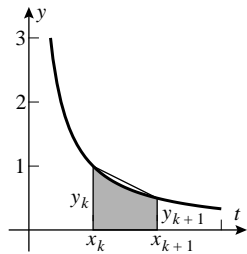

52. Right endpoint, trapezoidal, midpoint, left endpoint.

53. Given $g(x) = Ax^2 + Bx + C$, suppose $\Delta x = 1$ and $m = 0$. Then set $Y_0 = g(-1)$, $Y_1 = g(0)$, $Y_2 = g(1)$. Also $Y_0 = g(-1) = A - B + C$, $Y_1 = g(0) = C$, $Y_2 = g(1) = A + B + C$, with solution $C = Y_1$, $B = \frac{1}{2}(Y_2 - Y_0)$, and $A = \frac{1}{2}(Y_0 + Y_2) - Y_1$. Then $\int_{-1}^1 g(x) dx = 2 \int_0^1 (Ax^2 + C) dx = \frac{2}{3}A + 2C = \frac{1}{3}(Y_0 + Y_2) - \frac{2}{3}Y_1 + 2Y_1 = \frac{1}{3}(Y_0 + 4Y_1 + Y_2)$, which is exactly what one gets applying the Simpson's Rule. The general case with the interval $(m - \Delta x, m + \Delta x)$ and values Y_0, Y_1, Y_2 , can be converted by the change of variables $z = \frac{x-m}{\Delta x}$. Set $g(x) = h(z) = h((x-m)/\Delta x)$ to get $dx = \Delta x dz$ and $\Delta x \int_{m-\Delta x}^{m+\Delta x} h(z) dz = \int_{-1}^1 g(x) dx$. Finally, $Y_0 = g(m - \Delta x) = h(-1)$, $Y_1 = g(m) = h(0)$, $Y_2 = g(m + \Delta x) = h(1)$.

54. From Exercise 53 we know, for $i = 0, 1, \dots, n-1$ that $\int_{x_{2i}}^{x_{2i+2}} g_i(x) dx = \frac{1}{3} \frac{b-a}{2n} [y_{2i} + 4y_{2i+1} + y_{2i+2}]$, because $\frac{b-a}{2n}$ is the width of the partition and acts as Δx in Exercise 53. Summing over all the subintervals note that y_0 and y_{2n} are only listed once; so $\int_a^b f(x) dx = \sum_{i=0}^{n-1} \left(\int_{x_{2i}}^{x_{2i+2}} g_i(x) dx \right) = \frac{1}{3} \frac{b-a}{2n} [y_0 + 4y_1 + 2y_2 + 4y_3 + \dots + 4y_{2n-2} + 2y_{2n-1} + y_{2n}]$.

Exercise Set 7.8

1. (a) Improper; infinite discontinuity at $x = 3$. (b) Continuous integrand, not improper.
 (c) Improper; infinite discontinuity at $x = 0$. (d) Improper; infinite interval of integration.
 (e) Improper; infinite interval of integration and infinite discontinuity at $x = 1$.
 (f) Continuous integrand, not improper.
2. (a) Improper if $p > 0$. (b) Improper if $1 \leq p \leq 2$.
 (c) Integrand is continuous for all p , not improper.
3. $\lim_{\ell \rightarrow +\infty} \left(-\frac{1}{2}e^{-2x} \right) \Big|_0^\ell = \frac{1}{2} \lim_{\ell \rightarrow +\infty} (-e^{-2\ell} + 1) = \frac{1}{2}$.
4. $\lim_{\ell \rightarrow +\infty} \frac{1}{2} \ln(1 + x^2) \Big|_{-1}^\ell = \lim_{\ell \rightarrow +\infty} \frac{1}{2} [\ln(1 + \ell^2) - \ln 2] = +\infty$, divergent.
5. $\lim_{\ell \rightarrow +\infty} -2 \coth^{-1} x \Big|_3^\ell = \lim_{\ell \rightarrow +\infty} (2 \coth^{-1} 3 - 2 \coth^{-1} \ell) = 2 \coth^{-1} 3$.
6. $\lim_{\ell \rightarrow +\infty} -\frac{1}{2}e^{-x^2} \Big|_0^\ell = \lim_{\ell \rightarrow +\infty} \frac{1}{2} (-e^{-\ell^2} + 1) = 1/2$.
7. $\lim_{\ell \rightarrow +\infty} -\frac{1}{2 \ln^2 x} \Big|_e^\ell = \lim_{\ell \rightarrow +\infty} \left[-\frac{1}{2 \ln^2 \ell} + \frac{1}{2} \right] = \frac{1}{2}$.
8. $\lim_{\ell \rightarrow +\infty} 2\sqrt{\ln x} \Big|_2^\ell = \lim_{\ell \rightarrow +\infty} (2\sqrt{\ln \ell} - 2\sqrt{\ln 2}) = +\infty$, divergent.
9. $\lim_{\ell \rightarrow -\infty} -\frac{1}{4(2x-1)^2} \Big|_\ell^0 = \lim_{\ell \rightarrow -\infty} \frac{1}{4} [-1 + 1/(2\ell-1)^2] = -1/4$.
10. $\lim_{\ell \rightarrow -\infty} \frac{1}{3} \tan^{-1} \frac{x}{3} \Big|_\ell^3 = \lim_{\ell \rightarrow -\infty} \frac{1}{3} \left[\frac{\pi}{4} - \tan^{-1} \frac{\ell}{3} \right] = \frac{1}{3} [\pi/4 - (-\pi/2)] = \pi/4$.
11. $\lim_{\ell \rightarrow -\infty} \frac{1}{3} e^{3x} \Big|_\ell^0 = \lim_{\ell \rightarrow -\infty} \left[\frac{1}{3} - \frac{1}{3} e^{3\ell} \right] = \frac{1}{3}$.
12. $\lim_{\ell \rightarrow -\infty} -\frac{1}{2} \ln(3 - 2e^x) \Big|_\ell^0 = \lim_{\ell \rightarrow -\infty} \frac{1}{2} \ln(3 - 2e^\ell) = \frac{1}{2} \ln 3$.
13. $\int_{-\infty}^{+\infty} x \, dx$ converges if $\int_{-\infty}^0 x \, dx$ and $\int_0^{+\infty} x \, dx$ both converge; it diverges if either (or both) diverges. $\int_0^{+\infty} x \, dx = \lim_{\ell \rightarrow +\infty} \frac{1}{2} x^2 \Big|_0^\ell = \lim_{\ell \rightarrow +\infty} \frac{1}{2} \ell^2 = +\infty$, so $\int_{-\infty}^{+\infty} x \, dx$ is divergent.
14. $\int_0^{+\infty} \frac{x}{\sqrt{x^2+2}} dx = \lim_{\ell \rightarrow +\infty} \sqrt{x^2+2} \Big|_0^\ell = \lim_{\ell \rightarrow +\infty} (\sqrt{\ell^2+2} - \sqrt{2}) = +\infty$, so $\int_{-\infty}^{+\infty} \frac{x}{\sqrt{x^2+2}} dx$ is divergent.

15. $\int_0^{+\infty} \frac{x}{(x^2+3)^2} dx = \lim_{\ell \rightarrow +\infty} \left[-\frac{1}{2(x^2+3)} \right]_0^\ell = \lim_{\ell \rightarrow +\infty} \frac{1}{2} [-1/(\ell^2+3) + 1/3] = \frac{1}{6}$, similarly $\int_{-\infty}^0 \frac{x}{(x^2+3)^2} dx = -1/6$,
 so $\int_{-\infty}^{+\infty} \frac{x}{(x^2+3)^2} dx = 1/6 + (-1/6) = 0$.

16. $\int_0^{+\infty} \frac{e^{-t}}{1+e^{-2t}} dt = \lim_{\ell \rightarrow +\infty} \left[-\tan^{-1}(e^{-t}) \right]_0^\ell = \lim_{\ell \rightarrow +\infty} \left[-\tan^{-1}(e^{-\ell}) + \frac{\pi}{4} \right] = \frac{\pi}{4}$,
 $\int_{-\infty}^0 \frac{e^{-t}}{1+e^{-2t}} dt = \lim_{\ell \rightarrow -\infty} \left[-\tan^{-1}(e^{-t}) \right]_\ell^0 = \lim_{\ell \rightarrow -\infty} \left[-\frac{\pi}{4} + \tan^{-1}(e^{-\ell}) \right] = \frac{\pi}{4}$, so $\int_{-\infty}^{+\infty} \frac{e^{-t}}{1+e^{-2t}} dt = \frac{\pi}{4} + \frac{\pi}{4} = \frac{\pi}{2}$.

17. $\lim_{\ell \rightarrow 4^-} \left[-\frac{1}{x-4} \right]_0^\ell = \lim_{\ell \rightarrow 4^-} \left[-\frac{1}{\ell-4} - \frac{1}{4} \right] = +\infty$, divergent.

18. $\lim_{\ell \rightarrow 0^+} \left[\frac{3}{2} x^{2/3} \right]_\ell^8 = \lim_{\ell \rightarrow 0^+} \frac{3}{2} (4 - \ell^{2/3}) = 6$.

19. $\lim_{\ell \rightarrow \pi/2^-} \left[-\ln(\cos x) \right]_0^\ell = \lim_{\ell \rightarrow \pi/2^-} -\ln(\cos \ell) = +\infty$, divergent.

20. $\lim_{\ell \rightarrow 4^-} \left[-2\sqrt{4-x} \right]_0^\ell = \lim_{\ell \rightarrow 4^-} 2(-\sqrt{4-\ell} + 2) = 4$.

21. $\lim_{\ell \rightarrow 1^-} \left[\sin^{-1} x \right]_0^\ell = \lim_{\ell \rightarrow 1^-} \sin^{-1} \ell = \pi/2$.

22. $\lim_{\ell \rightarrow -3^+} \left[-\sqrt{9-x^2} \right]_\ell^1 = \lim_{\ell \rightarrow -3^+} (-\sqrt{8} + \sqrt{9-\ell^2}) = -\sqrt{8}$.

23. $\lim_{\ell \rightarrow \pi/3^+} \left[\sqrt{1-2\cos x} \right]_\ell^{\pi/2} = \lim_{\ell \rightarrow \pi/3^+} (1 - \sqrt{1-2\cos \ell}) = 1$.

24. $\lim_{\ell \rightarrow \pi/4^-} \left[-\ln(1-\tan x) \right]_0^\ell = \lim_{\ell \rightarrow \pi/4^-} -\ln(1-\tan \ell) = +\infty$, divergent.

25. $\int_0^2 \frac{dx}{x-2} = \lim_{\ell \rightarrow 2^-} \ln|x-2| \Big|_0^\ell = \lim_{\ell \rightarrow 2^-} (\ln|\ell-2| - \ln 2) = -\infty$, so $\int_0^2 \frac{dx}{x-2}$ is divergent.

26. $\int_0^2 \frac{dx}{x^2} = \lim_{\ell \rightarrow 0^+} \left[-1/x \right]_\ell^2 = \lim_{\ell \rightarrow 0^+} (-1/2 + 1/\ell) = +\infty$, so $\int_0^2 \frac{dx}{x^2}$ is divergent.

27. $\int_0^8 x^{-1/3} dx = \lim_{\ell \rightarrow 0^+} \left[\frac{3}{2} x^{2/3} \right]_\ell^8 = \lim_{\ell \rightarrow 0^+} \frac{3}{2} (4 - \ell^{2/3}) = 6$, $\int_{-1}^0 x^{-1/3} dx = \lim_{\ell \rightarrow 0^-} \left[\frac{3}{2} x^{2/3} \right]_{-1}^\ell = \lim_{\ell \rightarrow 0^-} \frac{3}{2} (\ell^{2/3} - 1) = -3/2$,
 so $\int_{-1}^8 x^{-1/3} dx = 6 + (-3/2) = 9/2$.

28. $\int_0^1 \frac{dx}{(x-1)^{2/3}} = \lim_{\ell \rightarrow 1^-} \left[3(x-1)^{1/3} \right]_0^\ell = \lim_{\ell \rightarrow 1^-} 3[(\ell-1)^{1/3} - (-1)^{1/3}] = 3$.

29. $\int_0^{+\infty} \frac{1}{x^2} dx = \int_0^a \frac{1}{x^2} dx + \int_a^{+\infty} \frac{1}{x^2} dx$ where $a > 0$; take $a = 1$ for convenience, $\int_0^1 \frac{1}{x^2} dx = \lim_{\ell \rightarrow 0^+} \left[-1/x \right]_\ell^1 =$

$\lim_{\ell \rightarrow 0^+} (1/\ell - 1) = +\infty$ so $\int_0^{+\infty} \frac{1}{x^2} dx$ is divergent.

30. $\int_1^{+\infty} \frac{dx}{x\sqrt{x^2-1}} = \int_1^a \frac{dx}{x\sqrt{x^2-1}} + \int_a^{+\infty} \frac{dx}{x\sqrt{x^2-1}}$ where $a > 1$, take $a = 2$ for convenience to get $\int_1^2 \frac{dx}{x\sqrt{x^2-1}} = \lim_{\ell \rightarrow 1^+} \sec^{-1} x \Big|_1^\ell = \lim_{\ell \rightarrow 1^+} (\pi/3 - \sec^{-1} \ell) = \pi/3$, $\int_2^{+\infty} \frac{dx}{x\sqrt{x^2-1}} = \lim_{\ell \rightarrow +\infty} \sec^{-1} x \Big|_2^\ell = \pi/2 - \pi/3$, so $\int_1^{+\infty} \frac{dx}{x\sqrt{x^2-1}} = \pi/2$.

31. Let $u = \sqrt{x}$, $x = u^2$, $dx = 2u du$. Then $\int \frac{dx}{\sqrt{x}(x+1)} = \int \frac{2u du}{u^2+1} = 2 \tan^{-1} u + C = 2 \tan^{-1} \sqrt{x} + C$ and $\int_0^1 \frac{dx}{\sqrt{x}(x+1)} = 2 \lim_{\epsilon \rightarrow 0^+} \tan^{-1} \sqrt{x} \Big|_\epsilon^1 = 2 \lim_{\epsilon \rightarrow 0^+} (\pi/4 - \tan^{-1} \sqrt{\epsilon}) = \pi/2$.

32. $\int_0^{+\infty} = \int_0^1 + \int_1^{+\infty}$. The first integral was studied in Exercise 31 through the transformation $x = u^2$. We apply the same transformation to the second integral and obtain $\int_1^{+\infty} \frac{dx}{\sqrt{x}(x+1)} = \lim_{A \rightarrow +\infty} \int_1^A \frac{2du}{u^2+1} = \lim_{A \rightarrow +\infty} [2 \tan^{-1} A - 2 \tan^{-1} 1] = 2 \frac{\pi}{2} - 2 \frac{\pi}{4} = \frac{\pi}{2}$, and thus $\int_0^{+\infty} \frac{dx}{\sqrt{x}(x+1)} = \pi$.

33. True, Theorem 7.8.2.

34. False; consider $f(x) = 1$.

35. False, neither 0 nor 3 lies in $[1, 2]$, so the integrand is continuous.

36. False, the integral is divergent.

37. $\int_0^{+\infty} \frac{e^{-\sqrt{x}}}{\sqrt{x}} dx = 2 \int_0^{+\infty} e^{-u} du = 2 \lim_{\ell \rightarrow +\infty} (-e^{-u}) \Big|_0^\ell = 2 \lim_{\ell \rightarrow +\infty} (1 - e^{-\ell}) = 2$.

38. $\int_{12}^{+\infty} \frac{dx}{\sqrt{x}(x+4)} = 2 \int_{2\sqrt{3}}^{+\infty} \frac{du}{u^2+4} = 2 \lim_{\ell \rightarrow +\infty} \frac{1}{2} \tan^{-1} \frac{u}{2} \Big|_{2\sqrt{3}}^\ell = \lim_{\ell \rightarrow +\infty} \tan^{-1} \frac{\ell}{2} - \tan^{-1} \sqrt{3} = \frac{\pi}{6}$.

39. $\int_0^{+\infty} \frac{e^{-x}}{\sqrt{1-e^{-x}}} dx = \int_0^1 \frac{du}{\sqrt{u}} = \lim_{\ell \rightarrow 0^+} 2\sqrt{u} \Big|_\ell^1 = \lim_{\ell \rightarrow 0^+} 2(1 - \sqrt{\ell}) = 2$.

40. $\int_0^{+\infty} \frac{e^{-x}}{\sqrt{1-e^{-2x}}} dx = - \int_1^0 \frac{du}{\sqrt{1-u^2}} = \int_0^1 \frac{du}{\sqrt{1-u^2}} = \lim_{\ell \rightarrow 1} \sin^{-1} u \Big|_0^\ell = \lim_{\ell \rightarrow 1} \sin^{-1} \ell = \frac{\pi}{2}$.

41. $\lim_{\ell \rightarrow +\infty} \int_0^\ell e^{-x} \cos x dx = \lim_{\ell \rightarrow +\infty} \frac{1}{2} e^{-x} (\sin x - \cos x) \Big|_0^\ell = 1/2$.

42. $A = \int_0^{+\infty} x e^{-3x} dx = \lim_{\ell \rightarrow +\infty} -\frac{1}{9} (3x+1)e^{-3x} \Big|_0^\ell = 1/9$.

43. (a) 2.726585 (b) 2.804364 (c) 0.219384 (d) 0.504067

45. $1 + \left(\frac{dy}{dx}\right)^2 = 1 + \frac{4-x^{2/3}}{x^{2/3}} = \frac{4}{x^{2/3}}$; the arc length is $\int_0^8 \frac{2}{x^{1/3}} dx = 3x^{2/3} \Big|_0^8 = 12$.

46. $1 + \left(\frac{dy}{dx}\right)^2 = 1 + \frac{x^2}{4-x^2} = \frac{4}{4-x^2}$; the arc length is $\int_0^2 \sqrt{\frac{4}{4-x^2}} dx = \lim_{\ell \rightarrow 2^-} \int_0^\ell \frac{2}{\sqrt{4-x^2}} dx = \lim_{\ell \rightarrow 2^-} 2 \sin^{-1} \frac{x}{2} \Big|_0^\ell = 2 \sin^{-1} 1 = \pi$.

47. $\int \ln x dx = x \ln x - x + C$, $\int_0^1 \ln x dx = \lim_{\ell \rightarrow 0^+} \int_\ell^1 \ln x dx = \lim_{\ell \rightarrow 0^+} (x \ln x - x) \Big|_\ell^1 = \lim_{\ell \rightarrow 0^+} (-1 - \ell \ln \ell + \ell)$, but $\lim_{\ell \rightarrow 0^+} \ell \ln \ell = \lim_{\ell \rightarrow 0^+} \frac{\ln \ell}{1/\ell} = \lim_{\ell \rightarrow 0^+} (-\ell) = 0$, so $\int_0^1 \ln x dx = -1$.

48. $\int \frac{\ln x}{x^2} dx = -\frac{\ln x}{x} - \frac{1}{x} + C$, $\int_1^{+\infty} \frac{\ln x}{x^2} dx = \lim_{\ell \rightarrow +\infty} \int_1^\ell \frac{\ln x}{x^2} dx = \lim_{\ell \rightarrow +\infty} \left(-\frac{\ln x}{x} - \frac{1}{x}\right) \Big|_1^\ell = \lim_{\ell \rightarrow +\infty} \left(-\frac{\ln \ell}{\ell} - \frac{1}{\ell} + 1\right)$, but $\lim_{\ell \rightarrow +\infty} \frac{\ln \ell}{\ell} = \lim_{\ell \rightarrow +\infty} \frac{1}{\ell} = 0$, so $\int_1^{+\infty} \frac{\ln x}{x^2} dx = 1$.

49. $\int_0^\infty e^{-3x} dx = \lim_{\ell \rightarrow +\infty} \int_0^\ell e^{-3x} dx = \lim_{\ell \rightarrow +\infty} \left[-\frac{1}{3} e^{-3x}\right]_0^\ell = \frac{1}{3}$.

50. $\int_4^\infty \frac{8}{x^2-4} dx = \lim_{\ell \rightarrow +\infty} \int_4^\ell \frac{8}{x^2-4} dx = \lim_{\ell \rightarrow +\infty} 2 \ln \frac{x-2}{x+2} \Big|_4^\ell = 2 \ln 3$.

51. (a) $V = \pi \int_0^{+\infty} e^{-2x} dx = -\frac{\pi}{2} \lim_{\ell \rightarrow +\infty} e^{-2x} \Big|_0^\ell = \pi/2$.

(b) $S = \pi + 2\pi \int_0^{+\infty} e^{-x} \sqrt{1+e^{-2x}} dx$, let $u = e^{-x}$ to get

$S = \pi - 2\pi \int_1^0 \sqrt{1+u^2} du = \pi + 2\pi \left[\frac{u}{2} \sqrt{1+u^2} + \frac{1}{2} \ln |u + \sqrt{1+u^2}| \right]_0^1 = \pi + \pi [\sqrt{2} + \ln(1 + \sqrt{2})]$.

53. (a) For $x \geq 1, x^2 \geq x, e^{-x^2} \leq e^{-x}$.

(b) $\int_1^{+\infty} e^{-x} dx = \lim_{\ell \rightarrow +\infty} \int_1^\ell e^{-x} dx = \lim_{\ell \rightarrow +\infty} [-e^{-x}]_1^\ell = \lim_{\ell \rightarrow +\infty} (e^{-1} - e^{-\ell}) = 1/e$.

(c) By parts (a) and (b) and Exercise 52(b), $\int_1^{+\infty} e^{-x^2} dx$ is convergent and is $\leq 1/e$.

54. (a) If $x \geq 0$ then $e^x \geq 1, \frac{1}{2x+1} \leq \frac{e^x}{2x+1}$.

(b) $\lim_{\ell \rightarrow +\infty} \int_0^\ell \frac{dx}{2x+1} = \lim_{\ell \rightarrow +\infty} \left[\frac{1}{2} \ln(2x+1) \right]_0^\ell = +\infty$.

(c) By parts (a) and (b) and Exercise 52(a), $\int_0^{+\infty} \frac{e^x}{2x+1} dx$ is divergent.

55. $V = \lim_{\ell \rightarrow +\infty} \int_1^\ell (\pi/x^2) dx = \lim_{\ell \rightarrow +\infty} [-(\pi/x)]_1^\ell = \lim_{\ell \rightarrow +\infty} (\pi - \pi/\ell) = \pi$, $A = \pi + \lim_{\ell \rightarrow +\infty} \int_1^\ell 2\pi(1/x) \sqrt{1+1/x^4} dx$; use Exercise 52(a) with $f(x) = 2\pi/x, g(x) = (2\pi/x) \sqrt{1+1/x^4}$ and $a = 1$ to see that the area is infinite.

56. (a) $1 \leq \frac{\sqrt{x^3+1}}{x}$ for $x \geq 2, \int_2^{+\infty} 1 dx = +\infty$.

$$(b) \int_2^{+\infty} \frac{x}{x^5+1} dx \leq \int_2^{+\infty} \frac{dx}{x^4} = \lim_{\ell \rightarrow +\infty} \left[-\frac{1}{3x^3} \right]_2^\ell = 1/24.$$

$$(c) \int_0^\infty \frac{xe^x}{2x+1} dx \geq \int_1^{+\infty} \frac{xe^x}{2x+1} \geq \int_1^{+\infty} \frac{dx}{2x+1} = +\infty.$$

57. The area under the curve $y = \frac{1}{1+x^2}$, above the x -axis, and to the right of the y -axis is given by $\int_0^\infty \frac{1}{1+x^2}$. Solving for $x = \sqrt{\frac{1-y}{y}}$, the area is also given by the improper integral $\int_0^1 \sqrt{\frac{1-y}{y}} dy$.

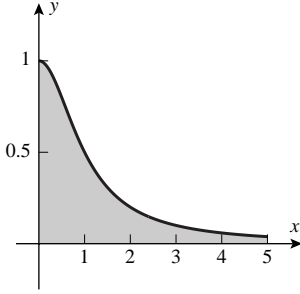

58. (b) $u = \sqrt{x}$, $\int_0^{+\infty} \frac{\cos \sqrt{x}}{\sqrt{x}} dx = 2 \int_0^{+\infty} \cos u du$; $\int_0^{+\infty} \cos u du$ diverges by part (a).

59. Let $x = r \tan \theta$ to get $\int \frac{dx}{(r^2+x^2)^{3/2}} = \frac{1}{r^2} \int \cos \theta d\theta = \frac{1}{r^2} \sin \theta + C = \frac{x}{r^2 \sqrt{r^2+x^2}} + C$, so

$$u = \frac{2\pi NI r}{k} \lim_{\ell \rightarrow +\infty} \left[\frac{x}{r^2 \sqrt{r^2+x^2}} \right]_a^\ell = \frac{2\pi NI}{kr} \lim_{\ell \rightarrow +\infty} (\ell / \sqrt{r^2+\ell^2} - a / \sqrt{r^2+a^2}) = \frac{2\pi NI}{kr} (1 - a / \sqrt{r^2+a^2}).$$

60. Let $a^2 = \frac{M}{2RT}$ to get

$$(a) \bar{v} = \frac{4}{\sqrt{\pi}} \left(\frac{M}{2RT} \right)^{3/2} \frac{1}{2} \left(\frac{M}{2RT} \right)^{-2} = \frac{2}{\sqrt{\pi}} \sqrt{\frac{2RT}{M}} = \sqrt{\frac{8RT}{\pi M}}.$$

$$(b) v_{\text{rms}}^2 = \frac{4}{\sqrt{\pi}} \left(\frac{M}{2RT} \right)^{3/2} \frac{3\sqrt{\pi}}{8} \left(\frac{M}{2RT} \right)^{-5/2} = \frac{3RT}{M} \text{ so } v_{\text{rms}} = \sqrt{\frac{3RT}{M}}.$$

61. $\int_0^{+\infty} 5(e^{-0.2t} - e^{-t}) dt = \lim_{\ell \rightarrow +\infty} [-25e^{-0.2t} + 5e^{-t}]_0^\ell = 20$; $\int_0^{+\infty} 4(e^{-0.2t} - e^{-3t}) dt = \lim_{\ell \rightarrow +\infty} [-20e^{-0.2t} + \frac{4}{3}e^{-3t}]_0^\ell = \frac{56}{3}$, so Method 1 provides greater availability.

62. $\int_0^{+\infty} 6(e^{-0.4t} - e^{-1.3t}) dt = \lim_{\ell \rightarrow +\infty} [-15e^{-0.4t} + \frac{6}{1.3}e^{-1.3t}]_0^\ell = \frac{135}{13}$; $\int_0^{+\infty} 5(e^{-0.4t} - e^{-3t}) dt = \lim_{\ell \rightarrow +\infty} [-12.5e^{-0.4t} + \frac{5}{3}e^{-3t}]_0^\ell = \frac{65}{6}$, so Method 2 provides greater availability.

63. (a) Satellite's weight = $w(x) = k/x^2$ lb when x = distance from center of Earth; $w(4000) = 6000$, so $k = 9.6 \times 10^{10}$ and $W = \int_{4000}^{4000+b} 9.6 \times 10^{10} x^{-2} dx$ mi-lb.

$$(b) \int_{4000}^{+\infty} 9.6 \times 10^{10} x^{-2} dx = \lim_{\ell \rightarrow +\infty} [-9.6 \times 10^{10}/x]_{4000}^\ell = 2.4 \times 10^7 \text{ mi-lb.}$$

64. (a) $\mathcal{L}\{1\} = \int_0^{+\infty} e^{-st} dt = \lim_{\ell \rightarrow +\infty} \left. -\frac{1}{s} e^{-st} \right|_0^\ell = \frac{1}{s}.$

(b) $\mathcal{L}\{e^{2t}\} = \int_0^{+\infty} e^{-st} e^{2t} dt = \int_0^{+\infty} e^{-(s-2)t} dt = \lim_{\ell \rightarrow +\infty} \left. -\frac{1}{s-2} e^{-(s-2)t} \right|_0^\ell = \frac{1}{s-2}.$

(c) $\mathcal{L}\{\sin t\} = \int_0^{+\infty} e^{-st} \sin t dt = \lim_{\ell \rightarrow +\infty} \left. \frac{e^{-st}}{s^2 + 1} (-s \sin t - \cos t) \right|_0^\ell = \frac{1}{s^2 + 1}.$

(d) $\mathcal{L}\{\cos t\} = \int_0^{+\infty} e^{-st} \cos t dt = \lim_{\ell \rightarrow +\infty} \left. \frac{e^{-st}}{s^2 + 1} (-s \cos t + \sin t) \right|_0^\ell = \frac{s}{s^2 + 1}.$

65. (a) $\mathcal{L}\{f(t)\} = \int_0^{+\infty} t e^{-st} dt = \lim_{\ell \rightarrow +\infty} \left. -(t/s + 1/s^2) e^{-st} \right|_0^\ell = \frac{1}{s^2}.$

(b) $\mathcal{L}\{f(t)\} = \int_0^{+\infty} t^2 e^{-st} dt = \lim_{\ell \rightarrow +\infty} \left. -(t^2/s + 2t/s^2 + 2/s^3) e^{-st} \right|_0^\ell = \frac{2}{s^3}.$

(c) $\mathcal{L}\{f(t)\} = \int_3^{+\infty} e^{-st} dt = \lim_{\ell \rightarrow +\infty} \left. -\frac{1}{s} e^{-st} \right|_3^\ell = \frac{e^{-3s}}{s}.$

66.

b	10	100	1000	10,000
$\int_0^b e^{-x^2} dx$	0.8862269	0.8862269	0.8862269	0.8862269

67. (a) $u = \sqrt{ax}, du = \sqrt{a} dx, 2 \int_0^{+\infty} e^{-ax^2} dx = \frac{2}{\sqrt{a}} \int_0^{+\infty} e^{-u^2} du = \sqrt{\pi/a}.$

(b) $x = \sqrt{2}\sigma u, dx = \sqrt{2}\sigma du, \frac{2}{\sqrt{2\pi}\sigma} \int_0^{+\infty} e^{-x^2/2\sigma^2} dx = \frac{2}{\sqrt{\pi}} \int_0^{+\infty} e^{-u^2} du = 1.$

68. (a) $\int_0^3 e^{-x^2} dx \approx 0.8862; \sqrt{\pi}/2 \approx 0.8862.$

(b) $\int_0^{+\infty} e^{-x^2} dx = \int_0^3 e^{-x^2} dx + \int_3^{+\infty} e^{-x^2} dx, \text{ so } E = \int_3^{+\infty} e^{-x^2} dx < \frac{1}{3} \int_3^{+\infty} x e^{-x^2} dx = -\frac{1}{6} e^{-x^2} \Big|_3^\infty = \frac{1}{6} e^{-9} < 2.1 \times 10^{-5}.$

69. (a) $\int_0^4 \frac{1}{x^6 + 1} dx \approx 1.047; \pi/3 \approx 1.047$

(b) $\int_0^{+\infty} \frac{1}{x^6 + 1} dx = \int_0^4 \frac{1}{x^6 + 1} dx + \int_4^{+\infty} \frac{1}{x^6 + 1} dx, \text{ so } E = \int_4^{+\infty} \frac{1}{x^6 + 1} dx < \int_4^{+\infty} \frac{1}{x^6} dx = \frac{1}{5(4)^5} < 2 \times 10^{-4}.$

70. If $p = 0$, then $\int_0^{+\infty} (1) dx = \lim_{\ell \rightarrow +\infty} x \Big|_0^\ell = +\infty$, if $p \neq 0$, then $\int_0^{+\infty} e^{px} dx = \lim_{\ell \rightarrow +\infty} \left. \frac{1}{p} e^{px} \right|_0^\ell = \lim_{\ell \rightarrow +\infty} \frac{1}{p} (e^{p\ell} - 1) = \begin{cases} -1/p, & p < 0 \\ +\infty, & p > 0 \end{cases}$, so the integral converges for $p < 0$.

71. If $p = 1$, then $\int_0^1 \frac{dx}{x} = \lim_{\ell \rightarrow 0^+} \ln x \Big|_\ell^1 = +\infty$; if $p \neq 1$, then $\int_0^1 \frac{dx}{x^p} = \lim_{\ell \rightarrow 0^+} \left. \frac{x^{1-p}}{1-p} \right|_\ell^1 = \lim_{\ell \rightarrow 0^+} [(1 - \ell^{1-p})/(1-p)] = \begin{cases} 1/(1-p), & p < 1 \\ +\infty, & p > 1 \end{cases}.$

$$72. u = \sqrt{1-x}, u^2 = 1-x, 2u du = -dx; -2 \int_1^0 \sqrt{2-u^2} du = 2 \int_0^1 \sqrt{2-u^2} du = \left[u\sqrt{2-u^2} + 2 \sin^{-1}(u/\sqrt{2}) \right]_0^1 = 1 + \pi/2.$$

$$73. 2 \int_0^1 \cos(u^2) du \approx 1.809.$$

$$74. -2 \int_1^0 \sin(1-u^2) du = 2 \int_0^1 \sin(1-u^2) du \approx 1.187.$$

Chapter 7 Review Exercises

$$1. u = 4 + 9x, du = 9 dx, \frac{1}{9} \int u^{1/2} du = \frac{2}{27}(4 + 9x)^{3/2} + C.$$

$$2. u = \pi x, du = \pi dx, \frac{1}{\pi} \int \cos u du = \frac{1}{\pi} \sin u + C = \frac{1}{\pi} \sin \pi x + C.$$

$$3. u = \cos \theta, - \int u^{1/2} du = -\frac{2}{3} \cos^{3/2} \theta + C.$$

$$4. u = \ln x, du = \frac{dx}{x}, \int \frac{du}{u} = \ln |u| + C = \ln |\ln x| + C.$$

$$5. u = \tan(x^2), \frac{1}{2} \int u^2 du = \frac{1}{6} \tan^3(x^2) + C.$$

$$6. u = \sqrt{x}, x = u^2, dx = 2u du, 2 \int_0^3 \frac{u^2}{u^2+9} du = 2 \int_0^3 \left(1 - \frac{9}{u^2+9} \right) du = \left(2u - 6 \tan^{-1} \frac{u}{3} \right) \Big|_0^3 = 6 - \frac{3}{2}\pi.$$

7. (a) With $u = \sqrt{x}$: $\int \frac{1}{\sqrt{x}\sqrt{2-x}} dx = 2 \int \frac{1}{\sqrt{2-u^2}} du = 2 \sin^{-1}(u/\sqrt{2}) + C = 2 \sin^{-1}(\sqrt{x/2}) + C$; with $u = \sqrt{2-x}$: $\int \frac{1}{\sqrt{x}\sqrt{2-x}} dx = -2 \int \frac{1}{\sqrt{2-u^2}} du = -2 \sin^{-1}(u/\sqrt{2}) + C = -2 \sin^{-1}(\sqrt{2-x}/\sqrt{2}) + C_1$; completing the square: $\int \frac{1}{\sqrt{1-(x-1)^2}} dx = \sin^{-1}(x-1) + C.$

(b) In the three results in part (a) the antiderivatives differ by a constant, in particular $2 \sin^{-1}(\sqrt{x/2}) = \pi - 2 \sin^{-1}(\sqrt{2-x}/\sqrt{2}) = \pi/2 + \sin^{-1}(x-1).$

$$8. (a) u = x^2, dv = \frac{x}{\sqrt{x^2+1}} dx, du = 2x dx, v = \sqrt{x^2+1}; \int_0^1 \frac{x^3}{\sqrt{x^2+1}} dx = x^2 \sqrt{x^2+1} \Big|_0^1 - 2 \int_0^1 x(x^2+1)^{1/2} dx = \sqrt{2} - \frac{2}{3}(x^2+1)^{3/2} \Big|_0^1 = \sqrt{2} - \frac{2}{3}[2\sqrt{2}-1] = (2-\sqrt{2})/3.$$

$$(b) u^2 = x^2+1, x^2 = u^2-1, 2x dx = 2u du, x dx = u du; \int_0^1 \frac{x^3}{\sqrt{x^2+1}} dx = \int_0^1 \frac{x^2}{\sqrt{x^2+1}} x dx = \int_1^{\sqrt{2}} \frac{u^2-1}{u} u du = \int_1^{\sqrt{2}} (u^2-1) du = \left(\frac{1}{3}u^3 - u \right) \Big|_1^{\sqrt{2}} = (2-\sqrt{2})/3.$$

$$9. u = x, dv = e^{-x} dx, du = dx, v = -e^{-x}; \int x e^{-x} dx = -x e^{-x} + \int e^{-x} dx = -x e^{-x} - e^{-x} + C.$$

10. $u = x$, $dv = \sin 2x dx$, $du = dx$, $v = -\frac{1}{2} \cos 2x$; $\int x \sin 2x dx = -\frac{1}{2}x \cos 2x + \frac{1}{2} \int \cos 2x dx = -\frac{1}{2}x \cos 2x + \frac{1}{4} \sin 2x + C$.

11. $u = \ln(2x + 3)$, $dv = dx$, $du = \frac{2}{2x + 3} dx$, $v = x$; $\int \ln(2x + 3) dx = x \ln(2x + 3) - \int \frac{2x}{2x + 3} dx$, but $\int \frac{2x}{2x + 3} dx = \int \left(1 - \frac{3}{2x + 3}\right) dx = x - \frac{3}{2} \ln(2x + 3) + C_1$, so $\int \ln(2x + 3) dx = x \ln(2x + 3) - x + \frac{3}{2} \ln(2x + 3) + C$.

12. $u = \tan^{-1}(2x)$, $dv = dx$, $du = \frac{2}{1 + 4x^2} dx$, $v = x$; $\int \tan^{-1}(2x) dx = x \tan^{-1}(2x) - \int \frac{2x}{1 + 4x^2} dx = x \tan^{-1}(2x) - \frac{1}{4} \ln(1 + 4x^2) + C$, thus $\int_0^{1/2} \tan^{-1}(2x) dx = (1/2)(\pi/4) - \frac{1}{4} \ln 2 = \pi/8 - \frac{1}{4} \ln 2$.

13. Let I denote $\int 8x^4 \cos 2x dx$. Then

diff.	antidiff.
$8x^4$	$\cos 2x$
$\searrow +$	
$32x^3$	$\frac{1}{2} \sin 2x$
$\searrow -$	
$96x^2$	$-\frac{1}{4} \cos 2x$
$\searrow +$	
$192x$	$-\frac{1}{8} \sin 2x$
$\searrow -$	
192	$\frac{1}{16} \cos 2x$
$\searrow +$	
0	$\frac{1}{32} \sin 2x$

$$I = \int 8x^4 \cos 2x dx = (4x^4 - 12x^2 + 6) \sin 2x + (8x^3 - 12x) \cos 2x + C.$$

14. Distance = $\int_0^5 t^2 e^{-t} dt$; $u = t^2$, $dv = e^{-t} dt$, $du = 2t dt$, $v = -e^{-t}$, so distance = $-t^2 e^{-t} \Big|_0^5 + 2 \int_0^5 t e^{-t} dt$; $u = 2t$, $dv = e^{-t} dt$, $du = 2 dt$, $v = -e^{-t}$, so distance = $-25e^{-5} - 2te^{-t} \Big|_0^5 + 2 \int_0^5 e^{-t} dt = -25e^{-5} - 10e^{-5} - 2e^{-t} \Big|_0^5 = -25e^{-5} - 10e^{-5} - 2e^{-5} + 2 = -37e^{-5} + 2$.

15. $\int \sin^2 5\theta d\theta = \frac{1}{2} \int (1 - \cos 10\theta) d\theta = \frac{1}{2} \theta - \frac{1}{20} \sin 10\theta + C$.

16. $\int \sin^3 2x \cos^2 2x dx = \int (1 - \cos^2 2x) \cos^2 2x \sin 2x dx = \int (\cos^2 2x - \cos^4 2x) \sin 2x dx = -\frac{1}{6} \cos^3 2x + \frac{1}{10} \cos^5 2x + C$.

17. $\int \sin x \cos 2x dx = \frac{1}{2} \int (\sin 3x - \sin x) dx = -\frac{1}{6} \cos 3x + \frac{1}{2} \cos x + C$.

18. $\int_0^{\pi/6} \sin 2x \cos 4x dx = \frac{1}{2} \int_0^{\pi/6} (\sin 6x - \sin 2x) dx = \left[-\frac{1}{12} \cos 6x + \frac{1}{4} \cos 2x \right]_0^{\pi/6} = [(-1/12)(-1) + (1/4)(1/2)] - [-1/12 + 1/4] = 1/24$.

19. $u = 2x$, $\int \sin^4 2x dx = \frac{1}{2} \int \sin^4 u du = \frac{1}{2} \left[-\frac{1}{4} \sin^3 u \cos u + \frac{3}{4} \int \sin^2 u du \right] = -\frac{1}{8} \sin^3 u \cos u + \frac{3}{8} \left[-\frac{1}{2} \sin u \cos u + \frac{1}{2} \int du \right] = -\frac{1}{8} \sin^3 u \cos u - \frac{3}{16} \sin u \cos u + \frac{3}{16} u + C = -\frac{1}{8} \sin^3 2x \cos 2x - \frac{3}{16} \sin 2x \cos 2x + \frac{3}{8} x + C.$
20. $u = x^2$, $\int x \cos^5(x^2) dx = \frac{1}{2} \int \cos^5 u du = \frac{1}{2} \int (\cos u)(1 - \sin^2 u)^2 du = \frac{1}{2} \int \cos u du - \int \cos u \sin^2 u du + \frac{1}{2} \int \cos u \sin^4 u du = \frac{1}{2} \sin u - \frac{1}{3} \sin^3 u + \frac{1}{10} \sin^5 u + C = \frac{1}{2} \sin(x^2) - \frac{1}{3} \sin^3(x^2) + \frac{1}{10} \sin^5(x^2) + C.$
21. $x = 3 \sin \theta$, $dx = 3 \cos \theta d\theta$, $9 \int \sin^2 \theta d\theta = \frac{9}{2} \int (1 - \cos 2\theta) d\theta = \frac{9}{2} \theta - \frac{9}{4} \sin 2\theta + C = \frac{9}{2} \theta - \frac{9}{2} \sin \theta \cos \theta + C = \frac{9}{2} \sin^{-1}(x/3) - \frac{1}{2} x \sqrt{9 - x^2} + C.$
22. $x = 4 \sin \theta$, $dx = 4 \cos \theta d\theta$, $\frac{1}{16} \int \frac{1}{\sin^2 \theta} d\theta = \frac{1}{16} \int \csc^2 \theta d\theta = -\frac{1}{16} \cot \theta + C = -\frac{\sqrt{16 - x^2}}{16x} + C.$
23. $x = \sec \theta$, $dx = \sec \theta \tan \theta d\theta$, $\int \sec \theta d\theta = \ln |\sec \theta + \tan \theta| + C = \ln |x + \sqrt{x^2 - 1}| + C.$
24. $x = 5 \sec \theta$, $dx = 5 \sec \theta \tan \theta d\theta$, $25 \int \sec^3 \theta d\theta = \frac{25}{2} \sec \theta \tan \theta + \frac{25}{2} \ln |\sec \theta + \tan \theta| + C_1 = \frac{1}{2} x \sqrt{x^2 - 25} + \frac{25}{2} \ln |x + \sqrt{x^2 - 25}| + C.$
25. $x = 3 \tan \theta$, $dx = 3 \sec^2 \theta d\theta$, $9 \int \tan^2 \theta \sec \theta d\theta = 9 \int \sec^3 \theta d\theta - 9 \int \sec \theta d\theta = \frac{9}{2} \sec \theta \tan \theta - \frac{9}{2} \ln |\sec \theta + \tan \theta| + C = \frac{1}{2} x \sqrt{9 + x^2} - \frac{9}{2} \ln \left| \frac{1}{3} \sqrt{9 + x^2} + \frac{1}{3} x \right| + C.$
26. $2x = \tan \theta$, $2 dx = \sec^2 \theta d\theta$, $\int \sec^2 \theta \csc \theta d\theta = \int (\sec \theta \tan \theta + \csc \theta) d\theta = \sec \theta - \ln |\csc \theta + \cot \theta| + C = \sqrt{1 + 4x^2} - \ln \left| \frac{\sqrt{1 + 4x^2}}{2x} + \frac{1}{2x} \right| + C.$
27. $\frac{1}{(x+4)(x-1)} = \frac{A}{x+4} + \frac{B}{x-1}$; $A = -\frac{1}{5}$, $B = \frac{1}{5}$, so $-\frac{1}{5} \int \frac{1}{x+4} dx + \frac{1}{5} \int \frac{1}{x-1} dx = -\frac{1}{5} \ln |x+4| + \frac{1}{5} \ln |x-1| + C = \frac{1}{5} \ln \left| \frac{x-1}{x+4} \right| + C.$
28. $\frac{1}{(x+1)(x+7)} = \frac{A}{x+1} + \frac{B}{x+7}$; $A = \frac{1}{6}$, $B = -\frac{1}{6}$, so $\frac{1}{6} \int \frac{1}{x+1} dx - \frac{1}{6} \int \frac{1}{x+7} dx = \frac{1}{6} \ln |x+1| - \frac{1}{6} \ln |x+7| + C = \frac{1}{6} \ln \left| \frac{x+1}{x+7} \right| + C.$
29. $\frac{x^2 + 2}{x + 2} = x - 2 + \frac{6}{x + 2}$, $\int \left(x - 2 + \frac{6}{x + 2} \right) dx = \frac{1}{2} x^2 - 2x + 6 \ln |x + 2| + C.$
30. $\frac{x^2 + x - 16}{(x-1)(x-3)^2} = \frac{A}{x-1} + \frac{B}{x-3} + \frac{C}{(x-3)^2}$; $A = -7/2$, $B = 9/2$, $C = -2$, so $-\frac{7}{2} \int \frac{1}{x-1} dx + \frac{9}{2} \int \frac{1}{x-3} dx - 2 \int \frac{1}{(x-3)^2} dx = -\frac{7}{2} \ln |x-1| + \frac{9}{2} \ln |x-3| + \frac{2}{x-3} + C.$

$$31. \frac{x^2}{(x+2)^3} = \frac{A}{x+2} + \frac{B}{(x+2)^2} + \frac{C}{(x+2)^3}; A = 1, B = -4, C = 4, \text{ so } \int \frac{1}{x+2} dx - 4 \int \frac{1}{(x+2)^2} dx + 4 \int \frac{1}{(x+2)^3} dx = \ln|x+2| + \frac{4}{x+2} - \frac{2}{(x+2)^2} + C.$$

$$32. \frac{1}{x(x^2+1)} = \frac{A}{x} + \frac{Bx+C}{x^2+1}; A = 1, B = -1, C = 0, \text{ so } \int \frac{1}{x^3+x} dx = \ln|x| - \frac{1}{2} \ln(x^2+1) + C = \frac{1}{2} \ln \frac{x^2}{x^2+1} + C.$$

$$33. \text{(a) With } x = \sec \theta: \int \frac{1}{x^3-x} dx = \int \cot \theta d\theta = \ln|\sin \theta| + C = \ln \frac{\sqrt{x^2-1}}{|x|} + C; \text{ valid for } |x| > 1.$$

$$\text{(b) With } x = \sin \theta: \int \frac{1}{x^3-x} dx = - \int \frac{1}{\sin \theta \cos \theta} d\theta = - \int 2 \csc 2\theta d\theta = - \ln|\csc 2\theta - \cot 2\theta| + C = \ln|\cot \theta| + C = \ln \frac{\sqrt{1-x^2}}{|x|} + C, \quad 0 < |x| < 1.$$

$$\text{(c) } \frac{1}{x^3-x} = \frac{A}{x} + \frac{B}{x-1} + \frac{C}{x+1} = -\frac{1}{x} + \frac{1}{2(x-1)} + \frac{1}{2(x+1)}; \int \frac{1}{x^3-x} dx = -\ln|x| + \frac{1}{2} \ln|x-1| + \frac{1}{2} \ln|x+1| + C, \text{ valid on any interval not containing the numbers } x = 0, \pm 1.$$

$$34. A = \int_1^2 \frac{3-x}{x^3+x^2} dx, \frac{3-x}{x^2(x+1)} = \frac{A}{x} + \frac{B}{x^2} + \frac{C}{x+1}; A = -4, B = 3, C = 4, A = \left[-4 \ln|x| - \frac{3}{x} + 4 \ln|x+1| \right]_1^2 = (-4 \ln 2 - \frac{3}{2} + 4 \ln 3) - (-4 \ln 1 - 3 + 4 \ln 2) = \frac{3}{2} - 8 \ln 2 + 4 \ln 3 = \frac{3}{2} + 4 \ln \frac{3}{4}.$$

$$35. \text{Formula (40); } \frac{1}{4} \cos 2x - \frac{1}{32} \cos 16x + C.$$

$$36. \text{Formula (52); } (-x^3 - 2x^2 - 4x - 4)e^{-x} + C.$$

$$37. \text{Formula (113); } \frac{1}{24}(8x^2 - 2x - 3)\sqrt{x-x^2} + \frac{1}{16} \sin^{-1}(2x-1) + C.$$

$$38. \text{Formula (108); } -\frac{2}{\sqrt{3}} \tanh^{-1} \sqrt{\frac{4x+3}{3}}.$$

$$39. \text{Formula (28); } \frac{1}{2} \tan 2x - x + C.$$

$$40. \text{Formula (71); } -\frac{1}{\sqrt{2}} \tan^{-1} \frac{x}{\sqrt{2}} + \frac{3}{2} \ln(2+x^2) + C.$$

$$41. \text{Exact value} = 4 - 2\sqrt{2} \approx 1.17157.$$

$$\text{(a) } 1.17138, |E_M| \approx 0.000190169. \text{ (b) } 1.17195, |E_T| \approx 0.000380588. \text{ (c) } 1.17157, |E_S| \approx 8.35 \times 10^{-8}.$$

$$42. \text{exact value} = \frac{\pi}{2} \approx 1.57080.$$

$$\text{(a) } 1.57246, |E_M| \approx 0.00166661. \text{ (b) } 1.56746, |E_T| \approx 0.00333327. \text{ (c) } 1.57080, |E_S| \approx 2.0 \times 10^{-8}.$$

$$43. f(x) = \frac{1}{\sqrt{x+1}}, f''(x) = \frac{3}{4(x+1)^{5/2}}, f^{(4)}(x) = \frac{105}{16(x+1)^{9/2}}(x+1)^{-7/2}; K_2 = \frac{3}{2^4\sqrt{2}}, K_4 = \frac{105}{2^8\sqrt{2}}.$$

$$\text{(a) } |E_M| \leq \frac{2^3}{2400} \frac{3}{2^4\sqrt{2}} = \frac{1}{10^2 2^4 \sqrt{2}} \approx 4.419417 \times 10^{-4}.$$

$$(b) |E_T| \leq \frac{2^3}{1200} \frac{3}{2^4 \sqrt{2}} = 8.838834 \times 10^{-4}.$$

$$(c) |E_S| \leq \frac{2^5}{180 \times 20^4} \frac{105}{2^8 \sqrt{2}} = \frac{7}{3 \cdot 10^4 \cdot 2^9 \sqrt{2}} \approx 3.2224918 \times 10^{-7}.$$

44. Let $f(x) = \frac{1}{1+x^2}$ and use a CAS to compute and then plot $f''(x)$ and $f^{(4)}(x)$. One sees that the absolute maxima $|f''(x)|$ and $|f^{(4)}(x)|$ both occur at $x = 0$, and hence $K_2 = 2, K_4 = 24$.

$$(a) |E_M| \leq \frac{8}{2400}(2) \approx 0.006666667.$$

$$(b) |E_T| \leq \frac{8}{1200}(2) \approx 0.013333333.$$

$$(c) |E_S| \leq \frac{2^5 \cdot 24}{180 \cdot 2^4 \cdot 10^4} \approx 0.000026666667.$$

$$45. (a) n^2 \geq 10^4 \frac{8 \cdot 3}{24 \times 2^4 \sqrt{2}}, \text{ so } n \geq \frac{10^2}{2^2 2^{1/4}} \approx 21.02, n \geq 22.$$

$$(b) n^2 \geq \frac{10^4}{2^3 \sqrt{2}}, \text{ so } n \geq \frac{10^2}{2 \cdot 2^{3/4}} \approx 29.73, n \geq 30.$$

$$(c) \text{ Let } n = 2k, \text{ then want } \frac{2^5 K_4}{180(2k)^4} \leq 10^{-4}, \text{ or } k^4 \geq 10^4 \frac{2^5}{180} \frac{105}{2^8 \sqrt{2}} = 10^4 \frac{7}{2^9 \cdot 3 \sqrt{2}}, \text{ so } k \geq 10 \left(\frac{7}{3 \cdot 2^9 \sqrt{2}} \right)^{1/4} \approx 2.38; \text{ so } k \geq 3, n \geq 6$$

46. Recall from Exercise 44 that $K_2 = 2, K_4 = 24$.

$$(a) n > \left[\frac{(8)(2)}{(24)(10^{-4})} \right]^{1/2} \approx 81.6; n \geq 82.$$

$$(b) n > \left[\frac{(8)(2)}{(12)(10^{-4})} \right]^{1/2} \approx 115.47; n \geq 116.$$

$$(c) \text{ Let } n = 2k, \text{ then want } \frac{2^5 K_4}{180(2k)^4} \leq 10^{-4}, \text{ or } k \geq \left[10^4 \frac{2^5}{180} \frac{24}{2^4} \right]^{1/4} \approx 7.19, k \geq 8, n \geq 16.$$

$$47. \lim_{\ell \rightarrow +\infty} (-e^{-x}) \Big|_0^\ell = \lim_{\ell \rightarrow +\infty} (-e^{-\ell} + 1) = 1.$$

$$48. \lim_{\ell \rightarrow -\infty} \frac{1}{2} \tan^{-1} \frac{x}{2} \Big|_\ell^2 = \lim_{\ell \rightarrow -\infty} \frac{1}{2} \left[\frac{\pi}{4} - \tan^{-1} \frac{\ell}{2} \right] = \frac{1}{2} [\pi/4 - (-\pi/2)] = 3\pi/8.$$

$$49. \lim_{\ell \rightarrow 9^-} -2\sqrt{9-x} \Big|_0^\ell = \lim_{\ell \rightarrow 9^-} 2(-\sqrt{9-\ell} + 3) = 6.$$

$$50. \int_0^1 \frac{1}{2x-1} dx = \int_0^{1/2} \frac{1}{2x-1} dx + \int_{1/2}^1 \frac{1}{2x-1} dx = \lim_{\ell \rightarrow 1/2^-} \frac{1}{2} \ln(1-2\ell) + \lim_{\ell \rightarrow 1/2^+} \frac{1}{2} \ln(2\ell-1) + C; \text{ neither limit exists hence the integral diverges.}$$

$$51. A = \int_e^{+\infty} \frac{\ln x - 1}{x^2} dx = \lim_{\ell \rightarrow +\infty} \left[c - \frac{\ln x}{x} \right]_e^\ell = 1/e.$$

$$52. V = 2\pi \int_0^{+\infty} x e^{-x} dx = 2\pi \lim_{\ell \rightarrow +\infty} \left[-e^{-x}(x+1) \right]_0^{\ell} = 2\pi \lim_{\ell \rightarrow +\infty} [1 - e^{-\ell}(\ell+1)], \text{ but } \lim_{\ell \rightarrow +\infty} e^{-\ell}(\ell+1) = \lim_{\ell \rightarrow +\infty} \frac{\ell+1}{e^{\ell}} = \lim_{\ell \rightarrow +\infty} \frac{1}{e^{\ell}} = 0, \text{ so } V = 2\pi.$$

$$53. \int_0^{+\infty} \frac{dx}{x^2 + a^2} = \lim_{\ell \rightarrow +\infty} \left[\frac{1}{a} \tan^{-1}(x/a) \right]_0^{\ell} = \lim_{\ell \rightarrow +\infty} \frac{1}{a} \tan^{-1}(\ell/a) = \frac{\pi}{2a} = 1, a = \pi/2.$$

54. (a) Integration by parts, $u = x$, $dv = \sin x dx$. (b) u -substitution: $u = \sin x$.

(c) Reduction formula. (d) u -substitution: $u = \tan x$.

(e) u -substitution: $u = x^3 + 1$. (f) u -substitution: $u = x + 1$.

(g) Integration by parts: $dv = dx$, $u = \tan^{-1} x$. (h) Trigonometric substitution: $x = 2 \sin \theta$.

(i) u -substitution: $u = 4 - x^2$.

$$55. x = \sqrt{3} \tan \theta, dx = \sqrt{3} \sec^2 \theta d\theta, \frac{1}{3} \int \frac{1}{\sec \theta} d\theta = \frac{1}{3} \int \cos \theta d\theta = \frac{1}{3} \sin \theta + C = \frac{x}{3\sqrt{3+x^2}} + C.$$

$$56. u = x, dv = \cos 3x dx, du = dx, v = \frac{1}{3} \sin 3x; \int x \cos 3x dx = \frac{1}{3} x \sin 3x - \frac{1}{3} \int \sin 3x dx = \frac{1}{3} x \sin 3x + \frac{1}{9} \cos 3x + C.$$

$$57. \text{ Use Endpaper Formula (31) to get } \int_0^{\pi/4} \tan^7 \theta d\theta = \frac{1}{6} \tan^6 \theta \Big|_0^{\pi/4} - \frac{1}{4} \tan^4 \theta \Big|_0^{\pi/4} + \frac{1}{2} \tan^2 \theta \Big|_0^{\pi/4} + \ln |\cos \theta| \Big|_0^{\pi/4} = \frac{1}{6} - \frac{1}{4} + \frac{1}{2} - \ln \sqrt{2} = \frac{5}{12} - \ln \sqrt{2}.$$

$$58. \int \frac{\cos \theta}{(\sin \theta - 3)^2 + 3} d\theta, \text{ let } u = \sin \theta - 3, \int \frac{1}{u^2 + 3} du = \frac{1}{\sqrt{3}} \tan^{-1}[(\sin \theta - 3)/\sqrt{3}] + C.$$

$$59. \int \sin^2 2x \cos^3 2x dx = \int \sin^2 2x (1 - \sin^2 2x) \cos 2x dx = \int (\sin^2 2x - \sin^4 2x) \cos 2x dx = \frac{1}{6} \sin^3 2x - \frac{1}{10} \sin^5 2x + C.$$

$$60. \int_0^3 \frac{1}{(x-3)^2} dx = \lim_{\ell \rightarrow 3^-} \int_0^{\ell} \frac{1}{(x-3)^2} dx = \lim_{\ell \rightarrow 3^-} \left[-\frac{1}{x-3} \right]_0^{\ell} \text{ which is clearly divergent, so } \int_0^4 \frac{1}{(x-3)^2} dx \text{ diverges.}$$

$$61. u = e^{2x}, dv = \cos 3x dx, du = 2e^{2x} dx, v = \frac{1}{3} \sin 3x; \int e^{2x} \cos 3x dx = \frac{1}{3} e^{2x} \sin 3x - \frac{2}{3} \int e^{2x} \sin 3x dx. \text{ Use } u = e^{2x}, dv = \sin 3x dx \text{ to get } \int e^{2x} \sin 3x dx = -\frac{1}{3} e^{2x} \cos 3x + \frac{2}{3} \int e^{2x} \cos 3x dx, \text{ so } \int e^{2x} \cos 3x dx = \frac{1}{3} e^{2x} \sin 3x + \frac{2}{9} e^{2x} \cos 3x - \frac{4}{9} \int e^{2x} \cos 3x dx, \frac{13}{9} \int e^{2x} \cos 3x dx = \frac{1}{9} e^{2x} (3 \sin 3x + 2 \cos 3x) + C_1, \int e^{2x} \cos 3x dx = \frac{1}{13} e^{2x} (3 \sin 3x + 2 \cos 3x) + C.$$

$$62. x = (1/\sqrt{2}) \sin \theta, dx = (1/\sqrt{2}) \cos \theta d\theta, \frac{1}{\sqrt{2}} \int_{-\pi/2}^{\pi/2} \cos^4 \theta d\theta = \frac{1}{\sqrt{2}} \left\{ \frac{1}{4} \cos^3 \theta \sin \theta \Big|_{-\pi/2}^{\pi/2} + \frac{3}{4} \int_{-\pi/2}^{\pi/2} \cos^2 \theta d\theta \right\} = \frac{3}{4\sqrt{2}} \left\{ \frac{1}{2} \cos \theta \sin \theta \Big|_{-\pi/2}^{\pi/2} + \frac{1}{2} \int_{-\pi/2}^{\pi/2} d\theta \right\} = \frac{3}{4\sqrt{2}} \frac{1}{2} \pi = \frac{3\pi}{8\sqrt{2}}.$$

$$63. \frac{1}{(x-1)(x+2)(x-3)} = \frac{A}{x-1} + \frac{B}{x+2} + \frac{C}{x-3}; A = -\frac{1}{6}, B = \frac{1}{15}, C = \frac{1}{10}, \text{ so } -\frac{1}{6} \int \frac{1}{x-1} dx + \frac{1}{15} \int \frac{1}{x+2} dx + \frac{1}{10} \int \frac{1}{x-3} dx = -\frac{1}{6} \ln |x-1| + \frac{1}{15} \ln |x+2| + \frac{1}{10} \ln |x-3| + C.$$

$$64. x = \frac{2}{3} \sin \theta, dx = \frac{2}{3} \cos \theta d\theta, \frac{1}{24} \int_0^{\pi/6} \frac{1}{\cos^3 \theta} d\theta = \frac{1}{24} \int_0^{\pi/6} \sec^3 \theta d\theta = \left[\frac{1}{48} \sec \theta \tan \theta + \frac{1}{48} \ln |\sec \theta + \tan \theta| \right]_0^{\pi/6} \\ = \frac{1}{48} [(2/\sqrt{3})(1/\sqrt{3}) + \ln |2/\sqrt{3} + 1/\sqrt{3}|] = \frac{1}{48} \left(\frac{2}{3} + \frac{1}{2} \ln 3 \right).$$

$$65. u = \sqrt{x-4}, x = u^2 + 4, dx = 2u du, \int_0^2 \frac{2u^2}{u^2+4} du = 2 \int_0^2 \left[1 - \frac{4}{u^2+4} \right] du = \left[2u - 4 \tan^{-1}(u/2) \right]_0^2 = 4 - \pi.$$

$$66. u = \sqrt{e^x - 1}, e^x = u^2 + 1, x = \ln(u^2 + 1), dx = \frac{2u}{u^2 + 1} du, \int_0^1 \frac{2u^2}{u^2 + 1} du = 2 \int_0^1 \left(1 - \frac{1}{u^2 + 1} \right) du = \\ = (2u - 2 \tan^{-1} u) \Big|_0^1 = 2 - \frac{\pi}{2}.$$

$$67. u = \sqrt{e^x + 1}, e^x = u^2 - 1, x = \ln(u^2 - 1), dx = \frac{2u}{u^2 - 1} du, \int \frac{2}{u^2 - 1} du = \int \left[\frac{1}{u-1} - \frac{1}{u+1} \right] du = \ln |u-1| - \\ \ln |u+1| + C = \ln \frac{\sqrt{e^x + 1} - 1}{\sqrt{e^x + 1} + 1} + C.$$

$$68. \frac{1}{x(x^2 + x + 1)} = \frac{A}{x} + \frac{Bx + C}{x^2 + x + 1}; A = 1, B = C = -1, \text{ so } \int \frac{-x-1}{x^2 + x + 1} dx = - \int \frac{x+1}{(x+1/2)^2 + 3/4} dx = \\ - \int \frac{u+1/2}{u^2 + 3/4} du, u = x + 1/2; = -\frac{1}{2} \ln(u^2 + 3/4) - \frac{1}{\sqrt{3}} \tan^{-1}(2u/\sqrt{3}) + C_1, \text{ so } \int \frac{dx}{x(x^2 + x + 1)} = \ln |x| - \\ \frac{1}{2} \ln(x^2 + x + 1) - \frac{1}{\sqrt{3}} \tan^{-1} \frac{2x+1}{\sqrt{3}} + C.$$

$$69. u = \sin^{-1} x, dv = dx, du = \frac{1}{\sqrt{1-x^2}} dx, v = x; \int_0^{1/2} \sin^{-1} x dx = x \sin^{-1} x \Big|_0^{1/2} - \int_0^{1/2} \frac{x}{\sqrt{1-x^2}} dx = \frac{1}{2} \sin^{-1} \frac{1}{2} + \\ \sqrt{1-x^2} \Big|_0^{1/2} = \frac{1}{2} \left(\frac{\pi}{6} \right) + \sqrt{\frac{3}{4}} - 1 = \frac{\pi}{12} + \frac{\sqrt{3}}{2} - 1.$$

$$70. \int \tan^5 4x(1 + \tan^2 4x) \sec^2 4x dx = \int (\tan^5 4x + \tan^7 4x) \sec^2 4x dx = \frac{1}{24} \tan^6 4x + \frac{1}{32} \tan^8 4x + C.$$

$$71. \int \frac{x+3}{\sqrt{(x+1)^2 + 1}} dx, \text{ let } u = x+1, \int \frac{u+2}{\sqrt{u^2+1}} du = \int \left[u(u^2+1)^{-1/2} + \frac{2}{\sqrt{u^2+1}} \right] du = \sqrt{u^2+1} + 2 \sinh^{-1} u + C = \\ \sqrt{x^2 + 2x + 2} + 2 \sinh^{-1}(x+1) + C.$$

Alternate solution: let $x+1 = \tan \theta$, $\int (\tan \theta + 2) \sec \theta d\theta = \int \sec \theta \tan \theta d\theta + 2 \int \sec \theta d\theta = \sec \theta + 2 \ln |\sec \theta + \tan \theta| + C = \sqrt{x^2 + 2x + 2} + 2 \ln(\sqrt{x^2 + 2x + 2} + x + 1) + C.$

$$72. \text{ Let } x = \tan \theta \text{ to get } \int \frac{1}{x^3 - x^2} dx. \frac{1}{x^2(x-1)} = \frac{A}{x} + \frac{B}{x^2} + \frac{C}{x-1}; A = -1, B = -1, C = 1, \text{ so } - \int \frac{1}{x} dx - \int \frac{1}{x^2} dx + \\ \int \frac{1}{x-1} dx = -\ln |x| + \frac{1}{x} + \ln |x-1| + C = \frac{1}{x} + \ln \left| \frac{x-1}{x} \right| + C = \cot \theta + \ln \left| \frac{\tan \theta - 1}{\tan \theta} \right| + C = \cot \theta + \ln |1 - \cot \theta| + C.$$

$$73. \lim_{\ell \rightarrow +\infty} \left[-\frac{1}{2(x^2+1)} \right]_a^\ell = \lim_{\ell \rightarrow +\infty} \left[-\frac{1}{2(\ell^2+1)} + \frac{1}{2(a^2+1)} \right] = \frac{1}{2(a^2+1)}.$$

$$74. \lim_{\ell \rightarrow +\infty} \left[\frac{1}{ab} \tan^{-1} \frac{bx}{a} \right]_0^\ell = \lim_{\ell \rightarrow +\infty} \frac{1}{ab} \tan^{-1} \frac{b\ell}{a} = \frac{\pi}{2ab}.$$

Chapter 7 Making Connections

1. (a) $u = f(x), dv = dx, du = f'(x), v = x; \int_a^b f(x) dx = xf(x) \Big|_a^b - \int_a^b xf'(x) dx = bf(b) - af(a) - \int_a^b xf'(x) dx.$

(b) Substitute $y = f(x), dy = f'(x) dx, x = a$ when $y = f(a), x = b$ when $y = f(b), \int_a^b xf'(x) dx = \int_{f(a)}^{f(b)} x dy = \int_{f(a)}^{f(b)} f^{-1}(y) dy.$

(c) From $a = f^{-1}(\alpha)$ and $b = f^{-1}(\beta)$, we get $bf(b) - af(a) = \beta f^{-1}(\beta) - \alpha f^{-1}(\alpha)$; then $\int_{\alpha}^{\beta} f^{-1}(x) dx = \int_{\alpha}^{\beta} f^{-1}(y) dy = \int_{f(a)}^{f(b)} f^{-1}(y) dy$, which, by part (b), yields $\int_{\alpha}^{\beta} f^{-1}(x) dx = bf(b) - af(a) - \int_a^b f(x) dx = \beta f^{-1}(\beta) - \alpha f^{-1}(\alpha) - \int_{f^{-1}(\alpha)}^{f^{-1}(\beta)} f(x) dx.$ Note from the figure that $A_1 = \int_{\alpha}^{\beta} f^{-1}(x) dx, A_2 = \int_{f^{-1}(\alpha)}^{f^{-1}(\beta)} f(x) dx,$ and $A_1 + A_2 = \beta f^{-1}(\beta) - \alpha f^{-1}(\alpha)$, a "picture proof".

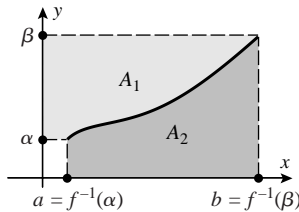

2. (a) Use Exercise 1(c); $\int_0^{1/2} \sin^{-1} x dx = \frac{1}{2} \sin^{-1} \left(\frac{1}{2} \right) - 0 \cdot \sin^{-1} 0 - \int_{\sin^{-1}(0)}^{\sin^{-1}(1/2)} \sin x dx = \frac{1}{2} \sin^{-1} \left(\frac{1}{2} \right) - \int_0^{\pi/6} \sin x dx.$ Now $\sin^{-1}(1/2)/2 = \pi/12, \int_0^{1/2} \sin^{-1} x dx = \sqrt{1-x^2} + x \sin^{-1} x \Big|_0^{1/2} = \pi/12 + \sqrt{3}/2 - 1$ and $\int_0^{\pi/6} \sin x dx = -\cos x \Big|_0^{\pi/6} = 1 - \sqrt{3}/2.$

(b) Use Exercise 1(b); $\int_e^{e^2} \ln x dx = e^2 \ln e^2 - e \ln e - \int_{\ln e}^{\ln e^2} f^{-1}(y) dy = 2e^2 - e - \int_1^2 e^y dy = 2e^2 - e - \int_1^2 e^x dx.$ Also, $\int_e^{e^2} \ln x dx = x \ln x - x \Big|_e^{e^2} = e^2$ and $\int_1^2 e^x dx = e^2 - e.$

3. (a) $\Gamma(1) = \int_0^{+\infty} e^{-t} dt = \lim_{\ell \rightarrow +\infty} -e^{-t} \Big|_0^{\ell} = \lim_{\ell \rightarrow +\infty} (-e^{-\ell} + 1) = 1.$

(b) $\Gamma(x+1) = \int_0^{+\infty} t^x e^{-t} dt;$ let $u = t^x, dv = e^{-t} dt$ to get $\Gamma(x+1) = -t^x e^{-t} \Big|_0^{+\infty} + x \int_0^{+\infty} t^{x-1} e^{-t} dt = -t^x e^{-t} \Big|_0^{+\infty} + x\Gamma(x), \lim_{t \rightarrow +\infty} t^x e^{-t} = \lim_{t \rightarrow +\infty} \frac{t^x}{e^t} = 0$ (by multiple applications of L'Hôpital's rule), so $\Gamma(x+1) = x\Gamma(x).$

(c) $\Gamma(2) = (1)\Gamma(1) = (1)(1) = 1, \Gamma(3) = 2\Gamma(2) = (2)(1) = 2, \Gamma(4) = 3\Gamma(3) = (3)(2) = 6.$ Thus $\Gamma(n) = (n-1)!$ if n is a positive integer.

(d) $\Gamma\left(\frac{1}{2}\right) = \int_0^{+\infty} t^{-1/2} e^{-t} dt = 2 \int_0^{+\infty} e^{-u^2} du$ (with $u = \sqrt{t}$) $= 2(\sqrt{\pi}/2) = \sqrt{\pi}.$

$$(e) \quad \Gamma\left(\frac{3}{2}\right) = \frac{1}{2}\Gamma\left(\frac{1}{2}\right) = \frac{1}{2}\sqrt{\pi}, \quad \Gamma\left(\frac{5}{2}\right) = \frac{3}{2}\Gamma\left(\frac{3}{2}\right) = \frac{3}{4}\sqrt{\pi}.$$

$$4. (a) \quad t = -\ln x, x = e^{-t}, dx = -e^{-t} dt, \int_0^1 (\ln x)^n dx = -\int_{+\infty}^0 (-t)^n e^{-t} dt = (-1)^n \int_0^{+\infty} t^n e^{-t} dt = (-1)^n \Gamma(n+1).$$

$$(b) \quad t = x^n, x = t^{1/n}, dx = (1/n)t^{1/n-1} dt, \int_0^{+\infty} e^{-x^n} dx = (1/n) \int_0^{+\infty} t^{1/n-1} e^{-t} dt = (1/n)\Gamma(1/n) = \Gamma(1/n+1).$$

$$5. (a) \quad \sqrt{\cos \theta - \cos \theta_0} = \sqrt{2[\sin^2(\theta_0/2) - \sin^2(\theta/2)]} = \sqrt{2(k^2 - k^2 \sin^2 \phi)} = \sqrt{2k^2 \cos^2 \phi} = \sqrt{2} k \cos \phi; k \sin \phi = \sin(\theta/2), \text{ so } k \cos \phi d\phi = \frac{1}{2} \cos(\theta/2) d\theta = \frac{1}{2} \sqrt{1 - \sin^2(\theta/2)} d\theta = \frac{1}{2} \sqrt{1 - k^2 \sin^2 \phi} d\theta, \text{ thus } d\theta = \frac{2k \cos \phi}{\sqrt{1 - k^2 \sin^2 \phi}} d\phi$$

$$\text{and hence } T = \sqrt{\frac{8L}{g}} \int_0^{\pi/2} \frac{1}{\sqrt{2}k \cos \phi} \cdot \frac{2k \cos \phi}{\sqrt{1 - k^2 \sin^2 \phi}} d\phi = 4\sqrt{\frac{L}{g}} \int_0^{\pi/2} \frac{1}{\sqrt{1 - k^2 \sin^2 \phi}} d\phi.$$

$$(b) \quad \text{If } L = 1.5 \text{ ft and } \theta_0 = (\pi/180)(20) = \pi/9, \text{ then } T = \frac{\sqrt{3}}{2} \int_0^{\pi/2} \frac{d\phi}{\sqrt{1 - \sin^2(\pi/18) \sin^2 \phi}} \approx 1.37 \text{ s.}$$

Mathematical Modeling with Differential Equations

Exercise Set 8.1

1. $y' = 9x^2e^{x^3} = 3x^2y$ and $y(0) = 3$ by inspection.
2. $y' = x^3 - 2\sin x$, $y(0) = 3$ by inspection.
3. (a) First order; $\frac{dy}{dx} = c; (1+x)\frac{dy}{dx} = (1+x)c = y$.
(b) Second order; $y' = c_1 \cos t - c_2 \sin t$, $y'' + y = -c_1 \sin t - c_2 \cos t + (c_1 \sin t + c_2 \cos t) = 0$.
4. (a) First order; $2\frac{dy}{dx} + y = 2\left(-\frac{c}{2}e^{-x/2} + 1\right) + ce^{-x/2} + x - 3 = x - 1$.
(b) Second order; $y' = c_1e^t - c_2e^{-t}$, $y'' - y = c_1e^t + c_2e^{-t} - (c_1e^t + c_2e^{-t}) = 0$.
5. False. It is a first-order equation, because it involves y and dy/dx , but not $d^n y/dx^n$ for $n > 1$.
6. True. $y = -1/2$ is a solution.
7. True. As mentioned in the marginal note after equation (2), the general solution of an n 'th order differential equation usually involves n arbitrary constants.
8. False. Every solution of the first order differential equation $y' = y$ has the form $y = Ae^x = Ae^{x+b}$ with $b = 0$.
9. (a) If $y = e^{-2x}$ then $y' = -2e^{-2x}$ and $y'' = 4e^{-2x}$, so $y'' + y' - 2y = 4e^{-2x} + (-2e^{-2x}) - 2e^{-2x} = 0$.
If $y = e^x$ then $y' = e^x$ and $y'' = e^x$, so $y'' + y' - 2y = e^x + e^x - 2e^x = 0$.
(b) If $y = c_1e^{-2x} + c_2e^x$ then $y' = -2c_1e^{-2x} + c_2e^x$ and $y'' = 4c_1e^{-2x} + c_2e^x$, so $y'' + y' - 2y = (4c_1e^{-2x} + c_2e^x) + (-2c_1e^{-2x} + c_2e^x) - 2(c_1e^{-2x} + c_2e^x) = 0$.
10. (a) If $y = e^{-2x}$ then $y' = -2e^{-2x}$ and $y'' = 4e^{-2x}$, so $y'' - y' - 6y = 4e^{-2x} - (-2e^{-2x}) - 6e^{-2x} = 0$.
If $y = e^{3x}$ then $y' = 3e^{3x}$ and $y'' = 9e^{3x}$, so $y'' - y' - 6y = 9e^{3x} - 3e^{3x} - 6e^{3x} = 0$.
(b) If $y = c_1e^{-2x} + c_2e^{3x}$ then $y' = -2c_1e^{-2x} + 3c_2e^{3x}$ and $y'' = 4c_1e^{-2x} + 9c_2e^{3x}$, so $y'' - y' - 6y = (4c_1e^{-2x} + 9c_2e^{3x}) - (-2c_1e^{-2x} + 3c_2e^{3x}) - 6(c_1e^{-2x} + c_2e^{3x}) = 0$.
11. (a) If $y = e^{2x}$ then $y' = 2e^{2x}$ and $y'' = 4e^{2x}$, so $y'' - 4y' + 4y = 4e^{2x} - 4(2e^{2x}) + 4e^{2x} = 0$.
If $y = xe^{2x}$ then $y' = (2x+1)e^{2x}$ and $y'' = (4x+4)e^{2x}$, so $y'' - 4y' + 4y = (4x+4)e^{2x} - 4(2x+1)e^{2x} + 4xe^{2x} = 0$.
(b) If $y = c_1e^{2x} + c_2xe^{2x}$ then $y' = 2c_1e^{2x} + c_2(2x+1)e^{2x}$ and $y'' = 4c_1e^{2x} + c_2(4x+4)e^{2x}$, so $y'' - 4y' + 4y = (4c_1e^{2x} + c_2(4x+4)e^{2x}) - 4(2c_1e^{2x} + c_2(2x+1)e^{2x}) + 4(c_1e^{2x} + c_2xe^{2x}) = 0$.

12. (a) If $y = e^{4x}$ then $y' = 4e^{4x}$ and $y'' = 16e^{4x}$, so $y'' - 8y' + 16y = 16e^{4x} - 8(4e^{4x}) + 16e^{4x} = 0$.
If $y = xe^{4x}$ then $y' = (4x+1)e^{4x}$ and $y'' = (16x+8)e^{4x}$, so $y'' - 8y' + 16y = (16x+8)e^{4x} - 8(4x+1)e^{4x} + 16xe^{4x} = 0$.
- (b) If $y = c_1e^{4x} + c_2xe^{4x}$ then $y' = 4c_1e^{4x} + c_2(4x+1)e^{4x}$ and $y'' = 16c_1e^{4x} + c_2(16x+8)e^{4x}$, so $y'' - 8y' + 16y = (16c_1e^{4x} + c_2(16x+8)e^{4x}) - 8(4c_1e^{4x} + c_2(4x+1)e^{4x}) + 16(c_1e^{4x} + c_2xe^{4x}) = 0$.
13. (a) If $y = \sin 2x$ then $y' = 2 \cos 2x$ and $y'' = -4 \sin 2x$, so $y'' + 4y = -4 \sin 2x + 4 \sin 2x = 0$.
If $y = \cos 2x$ then $y' = -2 \sin 2x$ and $y'' = -4 \cos 2x$, so $y'' + 4y = -4 \cos 2x + 4 \cos 2x = 0$.
- (b) If $y = c_1 \sin 2x + c_2 \cos 2x$ then $y' = 2c_1 \cos 2x - 2c_2 \sin 2x$ and $y'' = -4c_1 \sin 2x - 4c_2 \cos 2x$, so $y'' + 4y = (-4c_1 \sin 2x - 4c_2 \cos 2x) + 4(c_1 \sin 2x + c_2 \cos 2x) = 0$.
14. (a) If $y = e^{-2x} \sin 3x$ then $y' = e^{-2x}(-2 \sin 3x + 3 \cos 3x)$ and $y'' = e^{-2x}(-5 \sin 3x - 12 \cos 3x)$, so $y'' + 4y' + 13y = e^{-2x}(-5 \sin 3x - 12 \cos 3x) + 4e^{-2x}(-2 \sin 3x + 3 \cos 3x) + 13e^{-2x} \sin 3x = 0$.
If $y = e^{-2x} \cos 3x$ then $y' = e^{-2x}(-3 \sin 3x - 2 \cos 3x)$ and $y'' = e^{-2x}(12 \sin 3x - 5 \cos 3x)$, so $y'' + 4y' + 13y = e^{-2x}(12 \sin 3x - 5 \cos 3x) + 4e^{-2x}(-3 \sin 3x - 2 \cos 3x) + 13e^{-2x} \cos 3x = 0$.
- (b) If $y = e^{-2x}(c_1 \sin 3x + c_2 \cos 3x)$ then $y' = e^{-2x}[-(2c_1 + 3c_2) \sin 3x + (3c_1 - 2c_2) \cos 3x]$ and $y'' = e^{-2x}[(-5c_1 + 12c_2) \sin 3x - (12c_1 + 5c_2) \cos 3x]$, so $y'' + 4y' + 13y = e^{-2x}[(-5c_1 + 12c_2) \sin 3x - (12c_1 + 5c_2) \cos 3x] + 4e^{-2x}[-(2c_1 + 3c_2) \sin 3x + (3c_1 - 2c_2) \cos 3x] + 13e^{-2x}(c_1 \sin 3x + c_2 \cos 3x) = 0$.
15. From Exercise 9, $y = c_1e^{-2x} + c_2e^x$ is a solution of the differential equation, with $y' = -2c_1e^{-2x} + c_2e^x$. Setting $y(0) = -1$ and $y'(0) = -4$ gives $c_1 + c_2 = -1$ and $-2c_1 + c_2 = -4$. So $c_1 = 1$, $c_2 = -2$, and $y = e^{-2x} - 2e^x$.
16. From Exercise 10, $y = c_1e^{-2x} + c_2e^{3x}$ is a solution of the differential equation, with $y' = -2c_1e^{-2x} + 3c_2e^{3x}$. Setting $y(0) = 1$ and $y'(0) = 8$ gives $c_1 + c_2 = 1$ and $-2c_1 + 3c_2 = 8$. So $c_1 = -1$, $c_2 = 2$, and $y = -e^{-2x} + 2e^{3x}$.
17. From Exercise 11, $y = c_1e^{2x} + c_2xe^{2x}$ is a solution of the differential equation, with $y' = 2c_1e^{2x} + c_2(2x+1)e^{2x}$. Setting $y(0) = 2$ and $y'(0) = 2$ gives $c_1 = 2$ and $2c_1 + c_2 = 2$, so $c_2 = -2$ and $y = 2e^{2x} - 2xe^{2x}$.
18. From Exercise 12, $y = c_1e^{4x} + c_2xe^{4x}$ is a solution of the differential equation, with $y' = 4c_1e^{4x} + c_2(4x+1)e^{4x}$. Setting $y(0) = 1$ and $y'(0) = 1$ gives $c_1 = 1$ and $4c_1 + c_2 = 1$, so $c_2 = -3$ and $y = e^{4x} - 3xe^{4x}$.
19. From Exercise 13, $y = c_1 \sin 2x + c_2 \cos 2x$ is a solution of the differential equation, with $y' = 2c_1 \cos 2x - 2c_2 \sin 2x$. Setting $y(0) = 1$ and $y'(0) = 2$ gives $c_2 = 1$ and $2c_1 = 2$, so $c_1 = 1$ and $y = \sin 2x + \cos 2x$.
20. From Exercise 14, $y = e^{-2x}(c_1 \sin 3x + c_2 \cos 3x)$ is a solution of the differential equation, with $y' = e^{-2x}[-(2c_1 + 3c_2) \sin 3x + (3c_1 - 2c_2) \cos 3x]$. Setting $y(0) = -1$ and $y'(0) = -1$ gives $c_2 = -1$ and $3c_1 - 2c_2 = -1$, so $c_1 = -1$ and $y = -e^{-2x}(\sin 3x + \cos 3x)$.
21. $y' = 2 - 4x$, so $y = \int (2 - 4x) dx = -2x^2 + 2x + C$. Setting $y(0) = 3$ gives $C = 3$, so $y = -2x^2 + 2x + 3$.
22. $(y')' = -6x$ so $y' = \int (-6x) dx = -3x^2 + C$. Setting $y'(0) = 2$ gives $C = 2$, so $y' = -3x^2 + 2$ and $y = \int (-3x^2 + 2) dx = -x^3 + 2x + D$. Setting $y(0) = 1$ gives $D = 1$ so $y = -x^3 + 2x + 1$.
23. If the solution has an inverse function $x(y)$ then, by equation (3) of Section 3.3, $\frac{dx}{dy} = \frac{1}{dy/dx} = y^{-2}$. So $x = \int y^{-2} dy = -y^{-1} + C$. When $x = 1$, $y = 2$, so $C = \frac{3}{2}$ and $x = \frac{3}{2} - y^{-1}$. Solving for y gives $y = \frac{2}{3 - 2x}$. The solution is valid for $x < \frac{3}{2}$.

24. If the solution has an inverse function $x(y)$ then, by equation (3) of Section 3.3, $\frac{dx}{dy} = \frac{1}{dy/dx} = \frac{1}{1+y^2}$. So $x = \int \frac{dy}{1+y^2} = \tan^{-1} y + C$. When $x = 0$, $y = 0$, so $C = 0$, $x = \tan^{-1} y$, and $y = \tan x$. The solution is valid for $-\pi/2 < x < \pi/2$.
25. By the product rule, $\frac{d}{dx}(x^2 y) = x^2 y' + 2xy = 0$, so $x^2 y = C$ and $y = C/x^2$. Setting $y(1) = 2$ gives $C = 2$ so $y = 2/x^2$. The solution is valid for $x > 0$.
26. By the product rule, $\frac{d}{dx}(xy) = xy' + y = e^x$, so $xy = \int e^x dx = e^x + C$. Setting $y(1) = 1 + e$ gives $C = 1$, so $xy = e^x + 1$ and $y = \frac{e^x + 1}{x}$. The solution is valid for $x > 0$.
27. (a) $\frac{dy}{dt} = ky^2$, $y(0) = y_0$, $k > 0$. (b) $\frac{dy}{dt} = -ky^2$, $y(0) = y_0$, $k > 0$.
28. (a) Either y is always zero, or y is positive and increases at a rate proportional to the square root of y .
- (b) Either y is always zero, or y is positive and decreases at a rate proportional to the cube of y , or y is negative and increases at a rate proportional to the cube of y .
29. (a) $\frac{ds}{dt} = \frac{1}{2}s$. (b) $\frac{d^2s}{dt^2} = 2\frac{ds}{dt}$.
30. (a) $\frac{dv}{dt} = -2v^2$. (b) $\frac{d^2s}{dt^2} = -2\left(\frac{ds}{dt}\right)^2$.
31. (a) Since $k > 0$ and $y > 0$, equation (3) gives $\frac{dy}{dt} = ky > 0$, so y is increasing.
- (b) $\frac{d^2y}{dt^2} = \frac{d}{dt}(ky) = k\frac{dy}{dt} = k^2y > 0$, so y is concave upward.
32. (a) Both $y = 0$ and $y = L$ satisfy equation (4).
- (b) The rate of growth is $\frac{dy}{dt} = k\left(1 - \frac{y}{L}\right)y$; we wish to find the value of y which maximizes this. Since $\frac{d}{dy}\left[k\left(1 - \frac{y}{L}\right)y\right] = \frac{k}{L}(L - 2y)$, which is positive for $y < L/2$ and negative for $y > L/2$, the maximum growth rate occurs for $y = L/2$.
33. (a) Both $y = 0$ and $y = L$ satisfy equation (6).
- (b) The rate of growth is $\frac{dy}{dt} = ky(L-y)$; we wish to find the value of y which maximizes this. Since $\frac{d}{dy}[ky(L-y)] = k(L - 2y)$, which is positive for $y < L/2$ and negative for $y > L/2$, the maximum growth rate occurs for $y = L/2$.
34. If T is constant then $\frac{dT}{dt} = 0$, so equation (7) gives $T = T_e$. Hence $T = T_e$ is the unique constant solution of (7).
35. If $x = c_1 \cos\left(\sqrt{\frac{k}{m}} t\right) + c_2 \sin\left(\sqrt{\frac{k}{m}} t\right)$ then $\frac{dx}{dt} = -c_1 \sqrt{\frac{k}{m}} \sin\left(\sqrt{\frac{k}{m}} t\right) + c_2 \sqrt{\frac{k}{m}} \cos\left(\sqrt{\frac{k}{m}} t\right)$ and $\frac{d^2x}{dt^2} = -c_1 \frac{k}{m} \cos\left(\sqrt{\frac{k}{m}} t\right) - c_2 \frac{k}{m} \sin\left(\sqrt{\frac{k}{m}} t\right) = -\frac{k}{m}x$. So $m\frac{d^2x}{dt^2} = -kx$; thus x satisfies the differential equation for the vibrating string.

36. (a) From Exercise 35 we have $x = c_1 \cos\left(\sqrt{\frac{k}{m}} t\right) + c_2 \sin\left(\sqrt{\frac{k}{m}} t\right)$ and

$$x' = c_2 \sqrt{\frac{k}{m}} \cos\left(\sqrt{\frac{k}{m}} t\right) - c_1 \sqrt{\frac{k}{m}} \sin\left(\sqrt{\frac{k}{m}} t\right). \text{ Setting } x(0) = x_0 \text{ and } x'(0) = 0 \text{ gives } c_1 = x_0 \text{ and } c_2 \sqrt{\frac{k}{m}} = 0,$$

so $c_2 = 0$ and $x = x_0 \cos\left(\sqrt{\frac{k}{m}} t\right)$.

(b) From the discussion before Example 2 in Section 0.3, the amplitude is $|x_0|$, the period is $\frac{2\pi}{\sqrt{k/m}} = 2\pi\sqrt{\frac{m}{k}}$, and the frequency is $\frac{\sqrt{k/m}}{2\pi}$. The amplitude is the maximum displacement of the mass from its rest position. The period is the length of time the mass takes to move back and forth once. The frequency tells how often the mass moves back and forth in one unit of time.

Exercise Set 8.2

- $\frac{1}{y} dy = \frac{1}{x} dx$, $\ln|y| = \ln|x| + C_1$, $\ln\left|\frac{y}{x}\right| = C_1$, $\frac{y}{x} = \pm e^{C_1} = C$, $y = Cx$, including $C = 0$ by inspection.
- $\frac{dy}{1+y^2} = 2x dx$, $\tan^{-1} y = x^2 + C$, $y = \tan(x^2 + C)$.
- $\frac{dy}{1+y} = -\frac{x}{\sqrt{1+x^2}} dx$, $\ln|1+y| = -\sqrt{1+x^2} + C_1$, $1+y = \pm e^{-\sqrt{1+x^2}} e^{C_1} = C e^{-\sqrt{1+x^2}}$, $y = C e^{-\sqrt{1+x^2}} - 1$, $C \neq 0$.
- $y dy = \frac{x^3 dx}{1+x^4}$, $\frac{y^2}{2} = \frac{1}{4} \ln(1+x^4) + C_1$, $2y^2 = \ln(1+x^4) + C$, $y = \pm \sqrt{[\ln(1+x^4) + C]/2}$.
- $\frac{2(1+y^2)}{y} dy = e^x dx$, $2 \ln|y| + y^2 = e^x + C$; by inspection, $y = 0$ is also a solution.
- $\frac{dy}{y} = -x dx$, $\ln|y| = -x^2/2 + C_1$, $y = \pm e^{C_1} e^{-x^2/2} = C e^{-x^2/2}$, including $C = 0$ by inspection.
- $e^y dy = \frac{\sin x}{\cos^2 x} dx = \sec x \tan x dx$, $e^y = \sec x + C$, $y = \ln(\sec x + C)$.
- $\frac{dy}{1+y^2} = (1+x) dx$, $\tan^{-1} y = x + \frac{x^2}{2} + C$, $y = \tan(x + x^2/2 + C)$.
- $\frac{dy}{y^2 - y} = \frac{dx}{\sin x}$, $\int \left[-\frac{1}{y} + \frac{1}{y-1}\right] dy = \int \csc x dx$, $\ln\left|\frac{y-1}{y}\right| = \ln|\csc x - \cot x| + C_1$, $\frac{y-1}{y} = \pm e^{C_1} (\csc x - \cot x) = C(\csc x - \cot x)$, $y = \frac{1}{1 - C(\csc x - \cot x)}$, $C \neq 0$; by inspection, $y = 0$ is also a solution, as is $y = 1$.
- $\frac{1}{y} dy = \cos x dx$, $\ln|y| = \sin x + C$, $y = C_1 e^{\sin x}$.
- $(2y + \cos y) dy = 3x^2 dx$, $y^2 + \sin y = x^3 + C$, $\pi^2 + \sin \pi = C$, $C = \pi^2$, $y^2 + \sin y = x^3 + \pi^2$.
- $\frac{dy}{dx} = (x+2)e^y$, $e^{-y} dy = (x+2) dx$, $-e^{-y} = \frac{1}{2}x^2 + 2x + C$, $-1 = C$, $-e^{-y} = \frac{1}{2}x^2 + 2x - 1$, $e^{-y} = -\frac{1}{2}x^2 - 2x + 1$, $y = -\ln\left(1 - 2x - \frac{1}{2}x^2\right)$.

13. $2(y - 1) dy = (2t + 1) dt, y^2 - 2y = t^2 + t + C, 1 + 2 = C, C = 3, y^2 - 2y = t^2 + t + 3.$

14. $\frac{dy}{dx} \cosh^2 x = y \cosh 2x, y^{-1} dy = \frac{\cosh 2x}{\cosh^2 x} dx = \frac{2 \cosh^2 x - 1}{\cosh^2 x} dx = (2 - \operatorname{sech}^2 x) dx, \ln y = 2x - \tanh x + C,$
 $y = e^C e^{2x - \tanh x}, 3 = e^C e^{2 \cdot 0 - \tanh 0} = e^C, y = 3e^{2x - \tanh x}.$

15. (a) $\frac{dy}{y} = \frac{dx}{2x}, \ln |y| = \frac{1}{2} \ln |x| + C_1, |y| = C_2 |x|^{1/2}, y^2 = Cx; \text{ by inspection } y = 0 \text{ is also a solution.}$

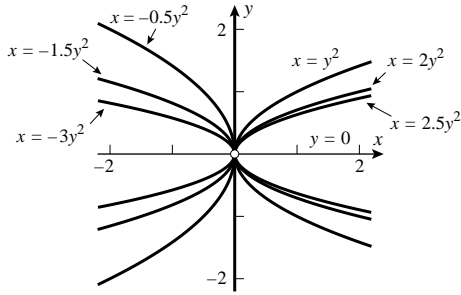

(b) $1^2 = C \cdot 2, C = 1/2, y^2 = x/2.$

16. (a) $y dy = -x dx, \frac{y^2}{2} = -\frac{x^2}{2} + C_1, y = \pm \sqrt{C^2 - x^2}.$

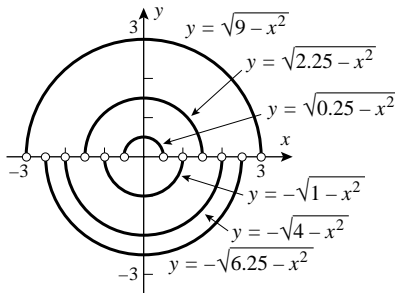

(b) $y = \sqrt{25 - x^2}.$

17. $\frac{dy}{y} = -\frac{x dx}{x^2 + 4}, \ln |y| = -\frac{1}{2} \ln(x^2 + 4) + C_1, y = \frac{C}{\sqrt{x^2 + 4}}.$

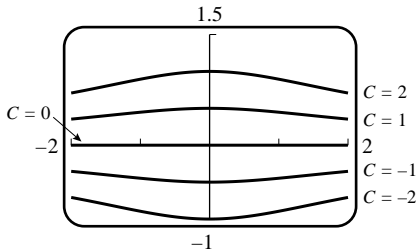

18. $\cos y dy = \cos x dx, \sin y = \sin x + C, y = 2n\pi + \sin^{-1}(\sin x + C)$ or $y = (2n + 1)\pi - \sin^{-1}(\sin x + C)$ for some integer n . For $C = 0$, the integral curves are lines of the form $y = 2n\pi + x$ and $y = (2n + 1)\pi - x$ for integers n . These divide the xy -plane into squares rotated 45° from the axes. For $C \neq 0, -2 < C < 2$, each integral curve stays within either the top half or the bottom half of one of these squares. The figure shows 5 such curves in the square $x - 2\pi < y < x, \pi - x < y < 3\pi - x$. From top to bottom, their equations are $y = \pi - \sin^{-1}(\sin x + 0.5), y = \pi - \sin^{-1}(\sin x + 1.5), y = \sin^{-1}(\sin x + 1.7), y = \sin^{-1}(\sin x + 1),$ and $y = \sin^{-1}(\sin x + 0.3).$

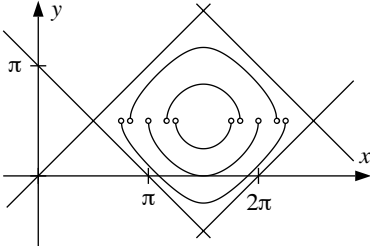

19. $(1 - y^2) dy = x^2 dx$, $y - \frac{y^3}{3} = \frac{x^3}{3} + C_1$, $x^3 + y^3 - 3y = C$.

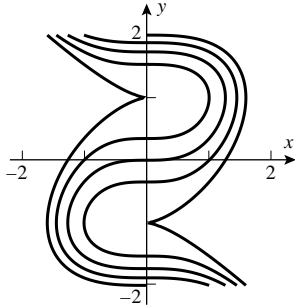

20. $\left(\frac{1}{y} + y\right) dy = dx$, $\ln|y| + \frac{y^2}{2} = x + C_1$, $ye^{y^2/2} = \pm e^{C_1} e^x = Ce^x$ including $C = 0$.

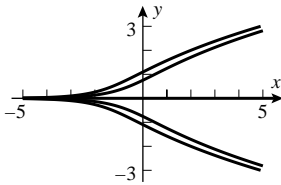

21. True. The equation can be rewritten as $\frac{1}{f(y)} \frac{dy}{dx} = 1$, which has the form (1).

22. False. The equation can be rewritten as $\frac{1}{g(y)} \frac{dy}{dx} = \frac{1}{h(x)}$, which has the form (1).

23. True. After t minutes there will be $32 \cdot (1/2)^t$ grams left; when $t = 5$ there will be $32 \cdot (1/2)^5 = 1$ gram.

24. True. The population will quadruple in twice the doubling time.

25. Of the solutions $y = \frac{1}{2x^2 - C}$, all pass through the point $\left(0, -\frac{1}{C}\right)$ and thus never through $(0, 0)$. A solution of the initial value problem with $y(0) = 0$ is (by inspection) $y = 0$. The method of Example 1 fails in this case because it starts with a division by $y^2 = 0$.

26. If $y_0 \neq 0$ then, proceeding as before, we get $C = 2x^2 - \frac{1}{y}$, $C = 2x_0^2 - \frac{1}{y_0}$, and $y = \frac{1}{2x^2 - 2x_0^2 + 1/y_0}$, which is defined for all x provided $2x^2$ is never equal to $2x_0^2 - 1/y_0$; this last condition will be satisfied if and only if $2x_0^2 - 1/y_0 < 0$, or $0 < 2x_0^2 y_0 < 1$. If $y_0 = 0$ then $y = 0$ is, by inspection, also a solution for all real x .

27. $\frac{dy}{dx} = xe^{-y}$, $e^y dy = x dx$, $e^y = \frac{x^2}{2} + C$, $x = 2$ when $y = 0$ so $1 = 2 + C$, $C = -1$, $e^y = x^2/2 - 1$, so $y = \ln(x^2/2 - 1)$.

28. $\frac{dy}{dx} = \frac{3x^2}{2y}$, $2y dy = 3x^2 dx$, $y^2 = x^3 + C$, $1 = 1 + C$, $C = 0$, $y^2 = x^3$, $y = x^{3/2}$ passes through $(1, 1)$.

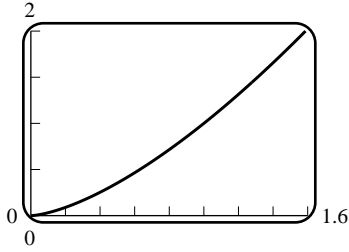

29. (a) $\frac{dy}{dt} = 0.02y$, $y_0 = 10,000$.

(b) $y = 10,000e^{t/50}$.

(c) $T = \frac{1}{0.02} \ln 2 \approx 34.657$ h.

(d) $45,000 = 10,000e^{t/50}$, $t = 50 \ln \frac{45,000}{10,000} \approx 75.20$ h.

30. $k = \frac{1}{T} \ln 2 = \frac{1}{20} \ln 2$.

(a) $\frac{dy}{dt} = ((\ln 2)/20)y$, $y(0) = 1$.

(b) $y(t) = e^{t(\ln 2)/20} = 2^{t/20}$.

(c) $y(120) = 2^6 = 64$.

(d) $1,000,000 = 2^{t/20}$, $t = 20 \frac{\ln 10^6}{\ln 2} \approx 398.63$ min.

31. (a) $\frac{dy}{dt} = -ky$, $y(0) = 5.0 \times 10^7$; $3.83 = T = \frac{1}{k} \ln 2$, so $k = \frac{\ln 2}{3.83} \approx 0.1810$.

(b) $y = 5.0 \times 10^7 e^{-0.181t}$.

(c) $y(30) = 5.0 \times 10^7 e^{-0.181(30)} \approx 219,000$.

(d) $y(t) = (0.1)y_0 = y_0 e^{-kt}$, $-kt = \ln 0.1$, $t = -\frac{\ln 0.1}{0.1810} = 12.72$ days.

32. (a) $k = \frac{1}{T} \ln 2 = \frac{1}{140} \ln 2 \approx 0.0050$, so $\frac{dy}{dt} = -0.0050y$, $y_0 = 10$.

(b) $y = 10e^{-0.0050t}$.

(c) 10 weeks = 70 days so $y = 10e^{-0.35} \approx 7$ mg.

(d) $0.3y_0 = y_0 e^{-kt}$, $t = -\frac{\ln 0.3}{0.0050} \approx 240.8$ days.

33. $100e^{0.02t} = 10,000$, $e^{0.02t} = 100$, $t = \frac{1}{0.02} \ln 100 \approx 230$ days.

34. $y = 10,000e^{kt}$, but $y = 12,000$ when $t = 5$ so $10,000e^{5k} = 12,000$, $k = \frac{1}{5} \ln 1.2$. $y = 20,000$ when $2 = e^{kt}$, $t = \frac{\ln 2}{k} = 5 \frac{\ln 2}{\ln 1.2} \approx 19$, in the year 2030.

35. $y(t) = y_0 e^{-kt} = 10.0e^{-kt}$, $3.5 = 10.0e^{-k(5)}$, $k = -\frac{1}{5} \ln \frac{3.5}{10.0} \approx 0.2100$, $T = \frac{1}{k} \ln 2 \approx 3.30$ days.

36. $y = y_0 e^{-kt}$, $0.7y_0 = y_0 e^{-5k}$, $k = -\frac{1}{5} \ln 0.7 \approx 0.071335$.

(a) $T = \frac{\ln 2}{k} \approx 9.72$ yr.

(b) $y(t) \approx y_0 e^{-0.0713t}$, $\frac{y}{y_0} \approx e^{-0.0713t}$, so $e^{-0.0713t} \times 100$ percent will remain.

38. (a) None; the half-life and doubling time are both independent of the initial amount.

(b) $kT = \ln 2$, so T is inversely proportional to k .

39. (a) $T = \frac{\ln 2}{k}$; and $\ln 2 \approx 0.6931$. If k is measured in percent, $k' = 100k$, then $T = \frac{\ln 2}{k} \approx \frac{69.31}{k'} \approx \frac{70}{k'}$.

(b) 70 yr (c) 20 yr (d) 7%

40. Let $y = y_0 e^{kt}$ with $y = y_1$ when $t = t_1$ and $y = 3y_1$ when $t = t_1 + T$; then $y_0 e^{kt_1} = y_1$ (i) and $y_0 e^{k(t_1+T)} = 3y_1$ (ii). Divide (ii) by (i) to get $e^{kT} = 3$, $T = \frac{1}{k} \ln 3$.

41. From (19), $y(t) = y_0 e^{-0.000121t}$. If $0.27 = \frac{y(t)}{y_0} = e^{-0.000121t}$ then $t = -\frac{\ln 0.27}{0.000121} \approx 10,820$ yr, and if $0.30 = \frac{y(t)}{y_0}$ then $t = -\frac{\ln 0.30}{0.000121} \approx 9950$, or roughly between 9000 B.C. and 8000 B.C.

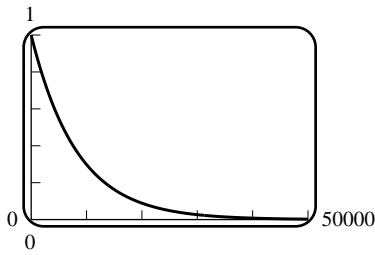

42. (a) $t = 1988$ yields $y/y_0 = e^{-0.000121(1988)} \approx 79\%$.

43. (a) Let $T_1 = 5730 - 40 = 5690$, $k_1 = \frac{\ln 2}{T_1} \approx 0.00012182$; $T_2 = 5730 + 40 = 5770$, $k_2 \approx 0.00012013$. With $y/y_0 = 0.92, 0.93$, $t_1 = -\frac{1}{k_1} \ln \frac{y}{y_0} = 684.5, 595.7$; $t_2 = -\frac{1}{k_2} \ln(y/y_0) = 694.1, 604.1$; in 1988 the shroud was at most 695 years old, which places its creation in or after the year 1293.

(b) Suppose T is the true half-life of carbon-14 and $T_1 = T(1 + r/100)$ is the false half-life. Then with $k = \frac{\ln 2}{T}$, $k_1 = \frac{\ln 2}{T_1}$ we have the formulae $y(t) = y_0 e^{-kt}$, $y_1(t) = y_0 e^{-k_1 t}$. At a certain point in time a reading of the carbon-14 is taken resulting in a certain value y , which in the case of the true formula is given by $y = y(t)$ for some t , and in the case of the false formula is given by $y = y_1(t_1)$ for some t_1 . If the true formula is used then the time t since the beginning is given by $t = -\frac{1}{k} \ln \frac{y}{y_0}$. If the false formula is used we get a false value $t_1 = -\frac{1}{k_1} \ln \frac{y}{y_0}$; note that in both cases the value y/y_0 is the same. Thus $t_1/t = k/k_1 = T_1/T = 1 + r/100$, so the percentage error in the time to be measured is the same as the percentage error in the half-life.

44. If $y = y_0 e^{kt}$ and $y = y_1 = y_0 e^{k t_1}$ then $y_1/y_0 = e^{k t_1}$, $k = \frac{\ln(y_1/y_0)}{t_1}$; if $y = y_0 e^{-kt}$ and $y = y_1 = y_0 e^{-k t_1}$ then $y_1/y_0 = e^{-k t_1}$, $k = -\frac{\ln(y_1/y_0)}{t_1}$.

45. (a) If $y = y_0 e^{kt}$, then $y_1 = y_0 e^{k t_1}$, $y_2 = y_0 e^{k t_2}$, divide: $y_2/y_1 = e^{k(t_2-t_1)}$, $k = \frac{1}{t_2-t_1} \ln(y_2/y_1)$, $T = \frac{\ln 2}{k} = \frac{(t_2-t_1) \ln 2}{\ln(y_2/y_1)}$. If $y = y_0 e^{-kt}$, then $y_1 = y_0 e^{-k t_1}$, $y_2 = y_0 e^{-k t_2}$, $y_2/y_1 = e^{-k(t_2-t_1)}$, $k = -\frac{1}{t_2-t_1} \ln(y_2/y_1)$, $T = \frac{\ln 2}{k} = -\frac{(t_2-t_1) \ln 2}{\ln(y_2/y_1)}$. In either case, T is positive, so $T = \left| \frac{(t_2-t_1) \ln 2}{\ln(y_2/y_1)} \right|$.

(b) In part (a) assume $t_2 = t_1 + 1$ and $y_2 = 1.25y_1$. Then $T = \frac{\ln 2}{\ln 1.25} \approx 3.1$ h.

46. (a) In t years the interest will be compounded nt times at an interest rate of r/n each time. The value at the end of 1 interval is $P + (r/n)P = P(1 + r/n)$, at the end of 2 intervals it is $P(1 + r/n) + (r/n)P(1 + r/n) = P(1 + r/n)^2$, and continuing in this fashion the value at the end of nt intervals is $P(1 + r/n)^{nt}$.

(b) Let $x = r/n$, then $n = r/x$ and $\lim_{n \rightarrow +\infty} P(1 + r/n)^{nt} = \lim_{x \rightarrow 0^+} P(1 + x)^{rt/x} = \lim_{x \rightarrow 0^+} P[(1 + x)^{1/x}]^{rt} = Pe^{rt}$.

(c) The rate of increase is $dA/dt = rPe^{rt} = rA$.

47. (a) $A = 1000e^{(0.08)(5)} = 1000e^{0.4} \approx \$1,491.82$.

(b) $Pe^{(0.08)(10)} = 10,000$, $Pe^{0.8} = 10,000$, $P = 10,000e^{-0.8} \approx \$4,493.29$.

(c) From (11), with $k = r = 0.08$, $T = (\ln 2)/0.08 \approx 8.7$ years.

48. Let r be the annual interest rate when compounded continuously and r_1 the effective annual interest rate. Then an amount P invested at the beginning of the year is worth $Pe^r = P(1 + r_1)$ at the end of the year, and $r_1 = e^r - 1$.

49. (a) Given $\frac{dy}{dt} = k\left(1 - \frac{y}{L}\right)y$, separation of variables yields $\left(\frac{1}{y} + \frac{1}{L-y}\right) dy = k dt$ so that $\ln \frac{y}{L-y} = \ln y - \ln(L-y) = kt + C$. The initial condition gives $C = \ln \frac{y_0}{L-y_0}$ so $\ln \frac{y}{L-y} = kt + \ln \frac{y_0}{L-y_0}$, $\frac{y}{L-y} = e^{kt} \frac{y_0}{L-y_0}$, and $y(t) = \frac{y_0 L}{y_0 + (L-y_0)e^{-kt}}$.

(b) If $y_0 > 0$ then $y_0 + (L-y_0)e^{-kt} = Le^{-kt} + y_0(1 - e^{-kt}) > 0$ for all $t \geq 0$, so $y(t)$ exists for all such t . Since $\lim_{t \rightarrow +\infty} e^{-kt} = 0$, $\lim_{t \rightarrow +\infty} y(t) = \frac{y_0 L}{y_0 + (L-y_0) \cdot 0} = L$. (Note that for $y_0 < 0$ the solution “blows up” at $t = -\frac{1}{k} \ln \frac{-y_0}{L-y_0}$, so $\lim_{t \rightarrow +\infty} y(t)$ is undefined.)

50. The differential equation for the spread of disease can be rewritten as $\frac{dy}{dt} = kL\left(1 - \frac{y}{L}\right)y$, which is the logistic equation with k replaced by kL . Making this replacement in the solution from Exercise 49 gives $y(t) = \frac{y_0 L}{y_0 + (L-y_0)e^{-kLt}}$.

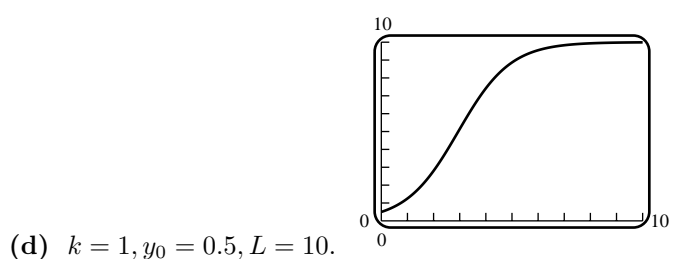
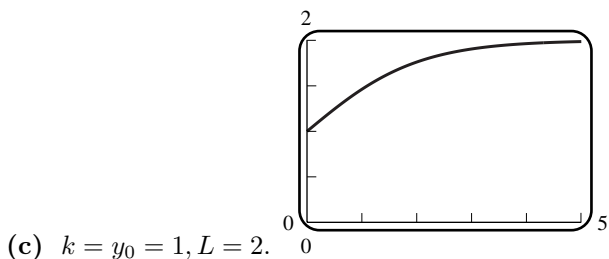
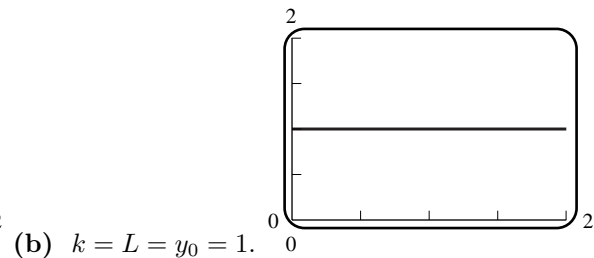
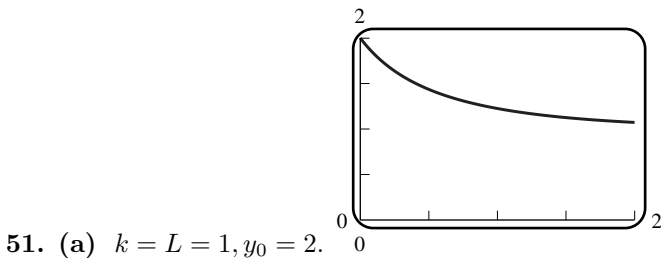

52. $y_0 \approx 400$, $L \approx 1000$; since the curve $y = \frac{400,000}{400 + 600e^{-kt}}$ passes through the point (200, 600),

$$600 = \frac{400,000}{400 + 600e^{-200k}}, \quad 600e^{-200k} = \frac{800}{3}, \quad k = \frac{1}{200} \ln 2.25 \approx 0.00405.$$

53. $y_0 \approx 2$, $L \approx 8$; since the curve $y = \frac{2 \cdot 8}{2 + 6e^{-kt}}$ passes through the point (2, 4), $4 = \frac{16}{2 + 6e^{-2k}}$, $6e^{-2k} = 2$, $k = \frac{1}{2} \ln 3 \approx 0.5493$.

54. This is the logistic equation (Equation (4) of Section 8.1) with $k = 0.98$, $L = 5$, and $y_0 = 1$. From Exercise 49, the solution is given by $y(t) = \frac{5}{1 + 4e^{-0.98t}}$.

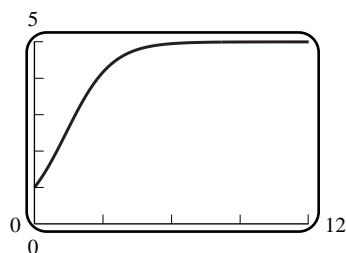

55. (a) $y_0 = 5$. (b) $L = 12$. (c) $k = 1$.

(d) $L/2 = 6 = \frac{60}{5 + 7e^{-t}}$, $5 + 7e^{-t} = 10$, $t = -\ln(5/7) \approx 0.3365$.

(e) $\frac{dy}{dt} = \frac{1}{12}y(12 - y)$, $y(0) = 5$.

56. (a) $y_0 = 1$. (b) $L = 1000$. (c) $k = 0.9$.

(d) $750 = \frac{1000}{1 + 999e^{-0.9t}}$, $3(1 + 999e^{-0.9t}) = 4$, $t = \frac{1}{0.9} \ln(3 \cdot 999) \approx 8.8949$.

(e) $\frac{dy}{dt} = \frac{0.9}{1000}y(1000 - y)$, $y(0) = 1$.

57. (a) Assume that $y(t)$ students have had the flu t days after the break. If the disease spreads as predicted by equation (6) of Section 8.1 and if nobody is immune, then Exercise 50 gives $y(t) = \frac{y_0 L}{y_0 + (L - y_0)e^{-kLt}}$, where $y_0 = 20$ and $L = 1000$. So $y(t) = \frac{20000}{20 + 980e^{-1000kt}} = \frac{1000}{1 + 49e^{-1000kt}}$. Using $y(5) = 35$ we find that $k = -\frac{\ln(193/343)}{5000}$. Hence $y = \frac{1000}{1 + 49(193/343)^{t/5}}$.

(b)

t	0	1	2	3	4	5	6	7	8	9	10	11	12	13	14
$y(t)$	20	22	25	28	31	35	39	44	49	54	61	67	75	83	93

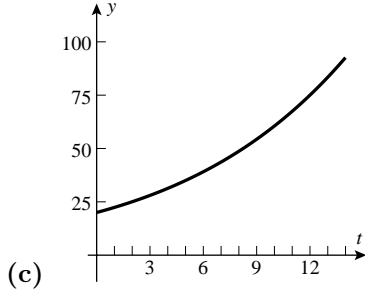

58. If $T_0 < T_a$ then $\frac{dT}{dt} = k(T_a - T)$ where $k > 0$. If $T_0 > T_a$ then $\frac{dT}{dt} = -k(T - T_a)$ where $k > 0$; Separating the variables gives $\int \frac{dT}{T - T_a} = \int -k dt$, which implies that $\ln |T - T_a| = -kt + C$, then solving for T and matching the initial condition in both cases yield $T(t) = T_a + (T_0 - T_a)e^{-kt}$ with $k > 0$.

59. (a) From Exercise 58 with $T_0 = 95$ and $T_a = 21$, we have $T = 21 + 74e^{-kt}$ for some $k > 0$.

(b) $85 = T(1) = 21 + 74e^{-k}$, $k = -\ln \frac{64}{74} = -\ln \frac{32}{37}$, $T = 21 + 74e^{t \ln(32/37)} = 21 + 74 \left(\frac{32}{37}\right)^t$, $T = 51$ when $\frac{30}{74} = \left(\frac{32}{37}\right)^t$, $t = \frac{\ln(30/74)}{\ln(32/37)} \approx 6.22$ min.

60. $\frac{dT}{dt} = k(70 - T)$, $T(0) = 40$; $-\ln(70 - T) = kt + C$, $70 - T = e^{-kt}e^{-C}$, $T = 40$ when $t = 0$, so $30 = e^{-C}$, $T = 70 - 30e^{-kt}$; $52 = T(1) = 70 - 30e^{-k}$, $k = -\ln \frac{70 - 52}{30} = \ln \frac{5}{3} \approx 0.5$, $T \approx 70 - 30e^{-0.5t}$.

61. (a) $\frac{dv}{dt} = \frac{ck}{m_0 - kt} - g$, $v = -c \ln(m_0 - kt) - gt + C$; $v = 0$ when $t = 0$ so $0 = -c \ln m_0 + C$, $C = c \ln m_0$, $v = c \ln m_0 - c \ln(m_0 - kt) - gt = c \ln \frac{m_0}{m_0 - kt} - gt$.

(b) $m_0 - kt = 0.2m_0$ when $t = 100$, so $v = 2500 \ln \frac{m_0}{0.2m_0} - 9.8(100) = 2500 \ln 5 - 980 \approx 3044$ m/s.

62. (a) By the chain rule, $\frac{dv}{dt} = \frac{dv}{dx} \frac{dx}{dt} = \frac{dv}{dx} v$ so $m \frac{dv}{dt} = mv \frac{dv}{dx}$.

(b) $\frac{mv}{kv^2 + mg} dv = -dx$, $\frac{m}{2k} \ln(kv^2 + mg) = -x + C$; $v = v_0$ when $x = 0$, so $C = \frac{m}{2k} \ln(kv_0^2 + mg)$, $\frac{m}{2k} \ln(kv^2 + mg) = -x + \frac{m}{2k} \ln(kv_0^2 + mg)$, $x = \frac{m}{2k} \ln \frac{kv_0^2 + mg}{kv^2 + mg}$.

(c) $x = x_{max}$ when $v = 0$, so $x_{max} = \frac{m}{2k} \ln \frac{kv_0^2 + mg}{mg} = \frac{3.56 \times 10^{-3}}{2(7.3 \times 10^{-6})} \ln \frac{(7.3 \times 10^{-6})(988)^2 + (3.56 \times 10^{-3})(9.8)}{(3.56 \times 10^{-3})(9.8)} \approx 1298$ m.

63. (a) $A(h) = \pi(1)^2 = \pi$, $\pi \frac{dh}{dt} = -0.025\sqrt{h}$, $\frac{\pi}{\sqrt{h}} dh = -0.025 dt$, $2\pi\sqrt{h} = -0.025t + C$; $h = 4$ when $t = 0$, so $4\pi = C$, $2\pi\sqrt{h} = -0.025t + 4\pi$, $\sqrt{h} = 2 - \frac{0.025}{2\pi}t$, $h \approx (2 - 0.003979t)^2$.

(b) $h = 0$ when $t \approx 2/0.003979 \approx 502.6$ s ≈ 8.4 min.

64. (a) $A(h) = 6 \left[2\sqrt{4 - (h - 2)^2} \right] = 12\sqrt{4h - h^2}$, $12\sqrt{4h - h^2} \frac{dh}{dt} = -0.025\sqrt{h}$, $12\sqrt{4 - h} dh = -0.025 dt$, $-8(4 - h)^{3/2} = -0.025t + C$; $h = 4$ when $t = 0$ so $C = 0$, $(4 - h)^{3/2} = (0.025/8)t$, $4 - h = (0.025/8)^{2/3} t^{2/3}$, $h \approx 4 - 0.021375t^{2/3}$ ft.

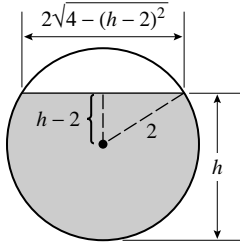

(b) $h = 0$ when $t = \frac{8}{0.025}(4 - 0)^{3/2} = 2560 \text{ s} \approx 42.7 \text{ min}$.

65. $\frac{dv}{dt} = -\frac{1}{32}v^2$, $\frac{1}{v^2}dv = -\frac{1}{32}dt$, $-\frac{1}{v} = -\frac{1}{32}t + C$; $v = 128$ when $t = 0$ so $-\frac{1}{128} = C$, $-\frac{1}{v} = -\frac{1}{32}t - \frac{1}{128}$, $v = \frac{128}{4t + 1}$ cm/s. But $v = \frac{dx}{dt}$ so $\frac{dx}{dt} = \frac{128}{4t + 1}$, $x = 32 \ln(4t + 1) + C_1$; $x = 0$ when $t = 0$ so $C_1 = 0$, $x = 32 \ln(4t + 1)$ cm.

66. $\frac{dv}{dt} = -0.02\sqrt{v}$, $\frac{1}{\sqrt{v}}dv = -0.02dt$, $2\sqrt{v} = -0.02t + C$; $v = 9$ when $t = 0$ so $6 = C$, $2\sqrt{v} = -0.02t + 6$, $v = (3 - 0.01t)^2$ cm/s. But $v = \frac{dx}{dt}$ so $\frac{dx}{dt} = (3 - 0.01t)^2$, $x = -\frac{100}{3}(3 - 0.01t)^3 + C_1$; $x = 0$ when $t = 0$ so $C_1 = 900$, $x = 900 - \frac{100}{3}(3 - 0.01t)^3$ cm.

67. Suppose that $H(y) = G(x) + C$. Then $\frac{dH}{dy} \frac{dy}{dx} = G'(x)$. But $\frac{dH}{dy} = h(y)$ and $\frac{dG}{dx} = g(x)$, hence $y(x)$ is a solution of (1).

68. Suppose that $y(x)$ satisfies $y(x_0) = y_0$ and $\int_{y_0}^{y(x)} h(r) dr = \int_{x_0}^x g(s) ds$ for all x in some interval containing x_0 . Differentiate with respect to x ; by the Fundamental Theorem of Calculus (Theorem 5.6.3) and the chain rule, we have $h(y(x)) \frac{dy}{dx} = g(x)$.

69. If $h(y) = 0$ then (1) implies that $g(x) = 0$, so $h(y) dy = 0 = g(x) dx$. Otherwise the slope of L is $\frac{dy}{dx} = \frac{g(x)}{h(y)}$. Since (x_1, y_1) and (x_2, y_2) lie on L , we have $\frac{y_2 - y_1}{x_2 - x_1} = \frac{g(x)}{h(y)}$. So $h(y)(y_2 - y_1) = g(x)(x_2 - x_1)$; i.e. $h(y) dy = g(x) dx$.

70. It is true that the method may not give a formula for y as a function of x . But sometimes such a formula (in terms of familiar functions) does not exist. In such cases the method at least gives a relationship between x and y , from which we can find as good an approximation to y as we want.

71. Suppose that $y = f(x)$ satisfies $h(y) \frac{dy}{dx} = g(x)$. Integrating both sides of this with respect to x gives $\int h(y) \frac{dy}{dx} dx = \int g(x) dx$, so $\int h(f(x)) f'(x) dx = \int g(x) dx$. By equation (2) of Section 5.3 with f replaced by h , g replaced by f , and F replaced by $\int h(y) dy$, the left side equals $F(f(x)) = F(y)$. Thus $\int h(y) dy = \int g(x) dx$.

Exercise Set 8.3

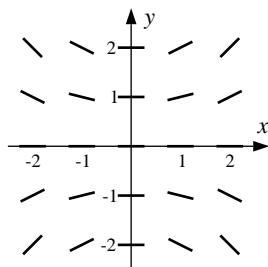

1.

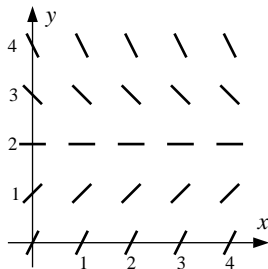

2.

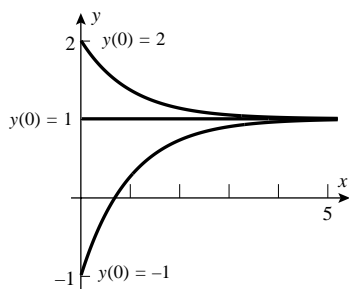

3.

4. $\frac{dy}{dx} = 1 - y$, separating the variables gives $\int \frac{dy}{1 - y} = \int dx$, which implies that $-\ln(1 - y) = x + C$, and we obtain $y = 1 + Ce^{-x}$.

(a) $-1 = 1 + C, C = -2, y = 1 - 2e^{-x}$.

(b) $1 = 1 + C, C = 0, y = 1$.

(c) $2 = 1 + C, C = 1, y = 1 + e^{-x}$.

5. $\lim_{x \rightarrow +\infty} y = 1$.

6. (a) IV, since the slope is positive for $x > 0$ and negative for $x < 0$.
 (b) VI, since the slope is positive for $y > 0$ and negative for $y < 0$.
 (c) V, since the slope is always positive.
 (d) II, since the slope changes sign when crossing the lines $y = \pm 1$.
 (e) I, since the slope can be positive or negative in each quadrant but is not periodic.
 (f) III, since the slope is periodic in both x and y .

7. $y_0 = 1, y_{n+1} = y_n + \frac{1}{2}y_n^{1/3}$.

n	0	1	2	3	4	5	6	7	8
x_n	0	0.5	1	1.5	2	2.5	3	3.5	4
y_n	1	1.5	2.07	2.71	3.41	4.16	4.96	5.81	6.71

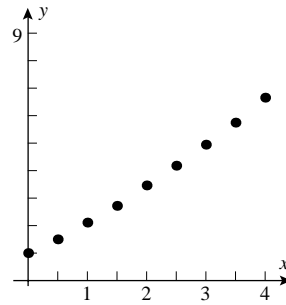

8. $y_0 = 1, y_{n+1} = y_n + (x_n - y_n^2)/4.$

n	0	1	2	3	4	5	6	7	8
x_n	0	0.25	0.50	0.75	1.00	1.25	1.50	1.75	2.00
y_n	1	0.75	0.67	0.68	0.75	0.86	0.99	1.12	1.24

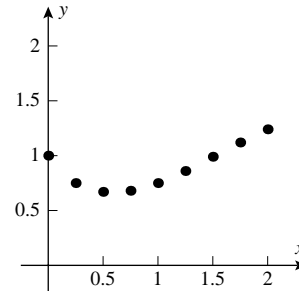

9. $y_0 = 1, y_{n+1} = y_n + \frac{1}{2} \cos y_n.$

n	0	1	2	3	4
t_n	0	0.5	1	1.5	2
y_n	1	1.27	1.42	1.49	1.53

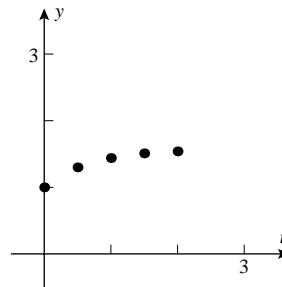

10. $y_0 = 0, y_{n+1} = y_n + e^{-y_n}/10.$

n	0	1	2	3	4	5	6	7	8	9	10
t_n	0	0.1	0.2	0.3	0.4	0.5	0.6	0.7	0.8	0.9	1.0
y_n	0	0.10	0.19	0.27	0.35	0.42	0.49	0.55	0.60	0.66	0.71

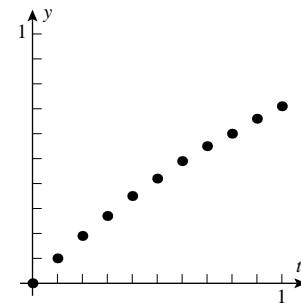

11. $h = 1/5, y_0 = 1, y_{n+1} = y_n + \frac{1}{5} \sin(\pi n/5).$

n	0	1	2	3	4	5
t_n	0	0.2	0.4	0.6	0.8	1.0
y_n	0.00	0.00	0.12	0.31	0.50	0.62

12. False. This is only true if the slope at (x, y) does not depend on y .

13. True. $\frac{dy}{dx} = e^{xy} > 0$ for all x and y . So, for any integral curve, y is an increasing function of x .

14. True. $\frac{d^2y}{dx^2} = \frac{d}{dx}(e^y) = e^y \frac{dy}{dx} = e^{2y} > 0$ for all y .
15. True. Every cubic polynomial has at least one real root. If $p(y_0) = 0$ then $y = y_0$ is an integral curve that is a horizontal line.
16. (a) By inspection, $\frac{dy}{dx} = e^{-x^2}$ and $y(0) = 0$.
- (b) $y_{n+1} = y_n + e^{-x_n^2}/20 = y_n + e^{-(n/20)^2}/20$ and $y_{20} = 0.7625$. From a CAS, $y(1) = 0.7468$.
17. (b) $y dy = -x dx$, $y^2/2 = -x^2/2 + C_1$, $x^2 + y^2 = C$; if $y(0) = 1$ then $C = 1$ so $y(1/2) = \sqrt{3}/2$.
18. (a) Yes. (b) $y = 0$ is an integral curve of $y' = 2xy$ which is a horizontal line.
19. (b) The equation $y' = 1 - y$ is separable: $\frac{dy}{1-y} = dx$, so $\int \frac{dy}{1-y} = \int dx$, $-\ln|1-y| = x + C$. Substituting $x = 0$ and $y = -1$ gives $C = -\ln 2$, so $x = \ln 2 - \ln|1-y| = \ln \left| \frac{2}{1-y} \right|$. Since the integral curve stays below the line $y = 1$, we can drop the absolute value signs: $x = \ln \frac{2}{1-y}$ and $y = 1 - 2e^{-x}$. Solving $y = 0$ shows that the x -intercept is $\ln 2 \approx 0.693$.
20. (a) $y_0 = 1$, $y_{n+1} = y_n + (\sqrt{y_n}/2)\Delta x$; $\Delta x = 0.2$: $y_{n+1} = y_n + \sqrt{y_n}/10$; $y_5 \approx 1.5489$, $\Delta x = 0.1$: $y_{n+1} = y_n + \sqrt{y_n}/20$; $y_{10} \approx 1.5556$, $\Delta x = 0.05$: $y_{n+1} = y_n + \sqrt{y_n}/40$; $y_{20} \approx 1.5590$.
- (b) $\frac{dy}{\sqrt{y}} = \frac{1}{2}dx$, $2\sqrt{y} = x/2 + C$, $2 = C$, $\sqrt{y} = x/4 + 1$, $y = (x/4 + 1)^2$, $y(1) = 25/16 = 1.5625$.
21. (a) The slope field does not vary with x , hence along a given parallel line all values are equal since they only depend on the height y .
- (b) As in part (a), the slope field does not vary with x ; it is independent of x .
- (c) From $G(y) - x = C$ we obtain $\frac{d}{dx}(G(y) - x) = \frac{1}{f(y)} \frac{dy}{dx} - 1 = \frac{d}{dx}C = 0$, i.e. $\frac{dy}{dx} = f(y)$.
22. (a) Separate variables: $\frac{dy}{\sqrt{y}} = dx$, $2\sqrt{y} = x + C$, $y = (x/2 + C_1)^2$ is a parabola that opens up, and is therefore concave up.
- (b) A curve is concave up if its derivative is increasing, and $y' = \sqrt{y}$ is increasing, because $y'' = \frac{d}{dx}y' = \frac{d}{dx}\sqrt{y} = \frac{1}{2\sqrt{y}}y' = \frac{1}{2\sqrt{y}}\sqrt{y} = \frac{1}{2} > 0$.
23. (a) By implicit differentiation, $y^3 + 3xy^2 \frac{dy}{dx} - 2xy - x^2 \frac{dy}{dx} = 0$, $\frac{dy}{dx} = \frac{2xy - y^3}{3xy^2 - x^2}$.
- (b) If $y(x)$ is an integral curve of the slope field in part (a), then $\frac{d}{dx}\{x[y(x)]^3 - x^2y(x)\} = [y(x)]^3 + 3xy(x)^2y'(x) - 2xy(x) - x^2y'(x) = 0$, so the integral curve must be of the form $x[y(x)]^3 - x^2y(x) = C$.
- (c) $x[y(x)]^3 - x^2y(x) = 2$.
24. (a) By implicit differentiation, $e^y + xe^y \frac{dy}{dx} + e^x \frac{dy}{dx} + ye^x = 0$, $\frac{dy}{dx} = -\frac{e^y + ye^x}{xe^y + e^x}$.

(b) If $y(x)$ is an integral curve of the slope field in part (a), then $\frac{d}{dx}\{xe^{y(x)} + y(x)e^x\} = e^{y(x)} + xy'(x)e^{y(x)} + y'(x)e^x + y(x)e^x = 0$ from part (a). Thus $xe^{y(x)} + y(x)e^x = C$.

(c) Any integral curve $y(x)$ of the slope field above satisfies $xe^{y(x)} + y(x)e^x = C$; if it passes through $(1, 1)$ then $e + e = C$, so $xe^{y(x)} + y(x)e^x = 2e$ defines the curve implicitly.

25. (a) For any n , y_n is the value of the discrete approximation at the right endpoint, that is, an approximation of $y(1)$. By increasing the number of subdivisions of the interval $[0, 1]$ one might expect more accuracy, and hence in the limit $y(1)$.

(b) For a fixed value of n we have, for $k = 1, 2, \dots, n$, $y_k = y_{k-1} + y_{k-1} \frac{1}{n} = \frac{n+1}{n} y_{k-1}$. In particular $y_n = \frac{n+1}{n} y_{n-1} = \left(\frac{n+1}{n}\right)^2 y_{n-2} = \dots = \left(\frac{n+1}{n}\right)^n y_0 = \left(\frac{n+1}{n}\right)^n$. Consequently, $\lim_{n \rightarrow +\infty} y_n = \lim_{n \rightarrow +\infty} \left(\frac{n+1}{n}\right)^n = e$, which is the (correct) value $y = e^x \Big|_{x=1}$.

26. Euler's Method is repeated application of local linear approximation, each step dependent on the previous step.

27. Visual inspection of the slope field may show where the integral curves are increasing, decreasing, concave up, or concave down. It may also help to identify asymptotes for the integral curves. For example, in Exercise 3 we see that $y = 1$ is an integral curve that is an asymptote of all other integral curves. Those curves with $y < 1$ are increasing and concave down; those with $y > 1$ are decreasing and concave up.

Exercise Set 8.4

1. $\mu = e^{\int 4 dx} = e^{4x}$, $e^{4x} y = \int e^x dx = e^x + C$, $y = e^{-3x} + Ce^{-4x}$.

2. $\mu = e^{2 \int x dx} = e^{x^2}$, $\frac{d}{dx} [ye^{x^2}] = xe^{x^2}$, $ye^{x^2} = \frac{1}{2}e^{x^2} + C$, $y = \frac{1}{2} + Ce^{-x^2}$

3. $\mu = e^{\int dx} = e^x$, $e^x y = \int e^x \cos(e^x) dx = \sin(e^x) + C$, $y = e^{-x} \sin(e^x) + Ce^{-x}$.

4. $\frac{dy}{dx} + 2y = \frac{1}{2}$, $\mu = e^{\int 2 dx} = e^{2x}$, $e^{2x} y = \int \frac{1}{2} e^{2x} dx = \frac{1}{4} e^{2x} + C$, $y = \frac{1}{4} + Ce^{-2x}$.

5. $\frac{dy}{dx} + \frac{x}{x^2+1} y = 0$, $\mu = e^{\int (x/(x^2+1)) dx} = e^{\frac{1}{2} \ln(x^2+1)} = \sqrt{x^2+1}$, $\frac{d}{dx} [y\sqrt{x^2+1}] = 0$, $y\sqrt{x^2+1} = C$, $y = \frac{C}{\sqrt{x^2+1}}$.

6. $\frac{dy}{dx} + y = -\frac{1}{1-e^x}$, $\mu = e^{\int dx} = e^x$, $e^x y = -\int \frac{e^x}{1-e^x} dx = \ln(1-e^x) + C$, $y = e^{-x} \ln(1-e^x) + Ce^{-x}$.

7. $\frac{dy}{dx} + \frac{1}{x} y = 1$, $\mu = e^{\int (1/x) dx} = e^{\ln x} = x$, $\frac{d}{dx} [xy] = x$, $xy = \frac{1}{2}x^2 + C$, $y = \frac{x}{2} + \frac{C}{x}$, $2 = y(1) = \frac{1}{2} + C$, $C = \frac{3}{2}$, $y = \frac{x}{2} + \frac{3}{2x}$.

8. Divide by x to put the differential equation in the form (3): $\frac{dy}{dx} - x^{-1}y = x$. We have $p(x) = -\frac{1}{x}$ and $q(x) = x$, so $\int p(x) dx = -\ln|x|$. So we may take $e^{-\ln|x|} = |x^{-1}|$ as an integrating factor. Since integrating factors are only determined up to a constant factor, we may drop the absolute value signs and simply take $\mu = x^{-1}$. We have $\frac{d}{dx}(x^{-1}y) = x^{-1} \frac{dy}{dx} - x^{-2}y = x^{-1} \left(\frac{dy}{dx} - x^{-1}y \right) = 1$, so $x^{-1}y = x + C$ and $y = x^2 + Cx$. Since $y(1) = -1$, $C = -2$ and $y = x^2 - 2x$.

9. $\mu = e^{-2 \int x dx} = e^{-x^2}$, $e^{-x^2} y = \int 2xe^{-x^2} dx = -e^{-x^2} + C$, $y = -1 + Ce^{x^2}$, $3 = -1 + C$, $C = 4$, $y = -1 + 4e^{x^2}$.
10. $\mu = e^{\int dt} = e^t$, $e^t y = \int 2e^t dt = 2e^t + C$, $y = 2 + Ce^{-t}$, $1 = 2 + C$, $C = -1$, $y = 2 - e^{-t}$.
11. False. If y_1 and y_2 both satisfy $\frac{dy}{dx} + p(x)y = q(x)$ then $\frac{d}{dx}(y_1 + y_2) + p(x)(y_1 + y_2) = 2q(x)$. Unless $q(x) = 0$ for all x , $y_1 + y_2$ is not a solution of the original differential equation.
12. True. If $y = C$ is a solution, then $dy/dx = 0$, so $p(x)C = q(x)$.
13. True. The concentration in the tank will approach the concentration in the solution flowing into the tank.
14. False. Although equation (18) implies that $v_\tau = \frac{mg}{c}$, where mg is the weight of the object, the model does not specify exactly how c depends on the object.

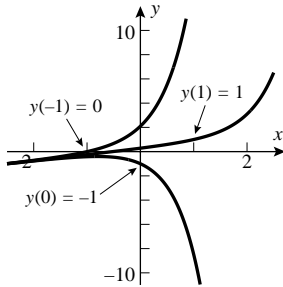

- 15.
16. $\frac{dy}{dx} - 2y = -x$, $\mu = e^{-2 \int dx} = e^{-2x}$, $\frac{d}{dx} [ye^{-2x}] = -xe^{-2x}$, $ye^{-2x} = \frac{1}{4}(2x + 1)e^{-2x} + C$, $y = \frac{1}{4}(2x + 1) + Ce^{2x}$.
- (a) $1 = 3/4 + Ce^2$, $C = 1/(4e^2)$, $y = \frac{1}{4}(2x + 1) + \frac{1}{4}e^{2x-2}$.
- (b) $-1 = 1/4 + C$, $C = -5/4$, $y = \frac{1}{4}(2x + 1) - \frac{5}{4}e^{2x}$.
- (c) $0 = -1/4 + Ce^{-2}$, $C = e^2/4$, $y = \frac{1}{4}(2x + 1) + \frac{1}{4}e^{2x+2}$.

17. It appears that $\lim_{x \rightarrow +\infty} y = \begin{cases} +\infty, & \text{if } y_0 \geq 1/4; \\ -\infty, & \text{if } y_0 < 1/4. \end{cases}$ To confirm this, we solve the equation using the method of integrating factors: $\frac{dy}{dx} - 2y = -x$, $\mu = e^{-2 \int dx} = e^{-2x}$, $\frac{d}{dx} [ye^{-2x}] = -xe^{-2x}$, $ye^{-2x} = \frac{1}{4}(2x + 1)e^{-2x} + C$, $y = \frac{1}{4}(2x + 1) + Ce^{2x}$. Setting $y(0) = y_0$ gives $C = y_0 - \frac{1}{4}$, so $y = \frac{1}{4}(2x + 1) + \left(y_0 - \frac{1}{4}\right)e^{2x}$. If $y_0 = 1/4$, then $y = \frac{1}{4}(2x + 1) \rightarrow +\infty$ as $x \rightarrow +\infty$. Otherwise, we rewrite the solution as $y = e^{2x} \left(y_0 - \frac{1}{4} + \frac{2x + 1}{4e^{2x}}\right)$; since $\lim_{x \rightarrow +\infty} \frac{2x + 1}{4e^{2x}} = 0$, we obtain the conjectured limit.

18. (a) $y_0 = 1$, $y_{n+1} = y_n + (2y_n - x_n)(0.1) = (12y_n - x_n)/10$.

n	0	1	2	3	4	5
x_n	0	0.1	0.2	0.3	0.4	0.5
y_n	1	1.2	1.43	1.696	2.0052	2.36624

(b) Less. The integral curve appears to be concave up, so each y_n is an underestimate of the actual value of $y(x_n)$.

(c) From Exercise 16, we have $y = \frac{1}{4}(2x + 1) + Ce^{2x}$ for some constant C . Since $y(0) = 1$ we find $C = \frac{3}{4}$, so $y = \frac{3e^{2x} + 2x + 1}{4}$ and $y\left(\frac{1}{2}\right) = \frac{3e + 2}{4} \approx 2.53871$.

19. (a) $y_0 = 1, y_{n+1} = y_n + (x_n + y_n)(0.2) = (x_n + 6y_n)/5$.

n	0	1	2	3	4	5
x_n	0	0.2	0.4	0.6	0.8	1.0
y_n	1	1.20	1.48	1.86	2.35	2.98

(b) $y' - y = x, \mu = e^{-x}, \frac{d}{dx} [ye^{-x}] = xe^{-x}, ye^{-x} = -(x+1)e^{-x} + C, 1 = -1 + C, C = 2, y = -(x+1) + 2e^x$.

x_n	0	0.2	0.4	0.6	0.8	1.0
$y(x_n)$	1	1.24	1.58	2.04	2.65	3.44
abs. error	0	0.04	0.10	0.19	0.30	0.46
perc. error	0	3	6	9	11	13

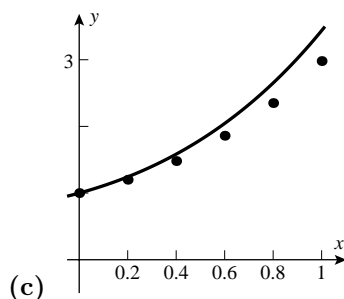

20. $h = 0.1, y_{n+1} = (x_n + 11y_n)/10$.

n	0	1	2	3	4	5	6	7	8	9	10
x_n	0	0.1	0.2	0.3	0.4	0.5	0.6	0.7	0.8	0.9	1.0
y_n	1.00	1.10	1.22	1.36	1.53	1.72	1.94	2.20	2.49	2.82	3.19

With $\Delta x = 0.2$, Euler's method gives $y(1) \approx 2.98$; with $\Delta x = 0.1$, it gives $y(1) \approx 3.19$. The true value is $y(1) = 2e - 2 \approx 3.44$; so the absolute errors are approximately 0.46 and 0.25, respectively.

21. $\frac{dy}{dt} = \text{rate in} - \text{rate out}$, where y is the amount of salt at time t , $\frac{dy}{dt} = (4)(2) - \left(\frac{y}{50}\right)(2) = 8 - \frac{1}{25}y$, so $\frac{dy}{dt} + \frac{1}{25}y = 8$ and $y(0) = 25$. $\mu = e^{\int(1/25)dt} = e^{t/25}, e^{t/25}y = \int 8e^{t/25}dt = 200e^{t/25} + C, y = 200 + Ce^{-t/25}, 25 = 200 + C, C = -175$,

(a) $y = 200 - 175e^{-t/25}$ oz. (b) when $t = 25, y = 200 - 175e^{-1} \approx 136$ oz.

22. $\frac{dy}{dt} = (5)(20) - \frac{y}{200}(20) = 100 - \frac{1}{10}y$, so $\frac{dy}{dt} + \frac{1}{10}y = 100$ and $y(0) = 0$. $\mu = e^{\int(1/10)dt} = e^{t/10}, e^{t/10}y = \int 100e^{t/10}dt = 1000e^{t/10} + C, y = 1000 + Ce^{-t/10}, 0 = 1000 + C, C = -1000$;

(a) $y = 1000 - 1000e^{-t/10}$ lb. (b) when $t = 30, y = 1000 - 1000e^{-3} \approx 950$ lb.

23. The volume V of the (polluted) water is $V(t) = 500 + (20 - 10)t = 500 + 10t$; if $y(t)$ is the number of pounds of particulate matter in the water, then $y(0) = 50$ and $\frac{dy}{dt} = 0 - 10\frac{y}{V} = -\frac{y}{50+t}$. Using the method of integrating

factors, we have $\frac{dy}{dt} + \frac{1}{50+t}y = 0$; $\mu = e^{\int \frac{dt}{50+t}} = 50+t$; $\frac{d}{dt}[(50+t)y] = 0$, $(50+t)y = C$, $2500 = 50y(0) = C$, $y(t) = 2500/(50+t)$. (The differential equation may also be solved by separation of variables.) The tank reaches the point of overflowing when $V = 500 + 10t = 1000$, $t = 50$ min, so $y = 2500/(50+50) = 25$ lb.

24. The volume of the lake (in gallons) is $V = 264\pi r^2 h = 264\pi(15)^2 3 = 178,200\pi$ gals. Let $y(t)$ denote the number of pounds of mercury salts at time t ; then $\frac{dy}{dt} = 0 - 10^3 \frac{y}{V} = -\frac{y}{178.2\pi}$ lb/h and $y_0 = 10^{-5}V = 1.782\pi$ lb; $\frac{dy}{y} = -\frac{dt}{178.2\pi}$, $\ln y = -\frac{t}{178.2\pi} + C_1$, $y = Ce^{-t/(178.2\pi)}$, and $C = y(0) = y_0 = 1.782\pi$, $y = 1.782\pi e^{-t/(178.2\pi)}$ lb of mercury salts.

t	1	2	3	4	5	6	7	8	9	10	11	12
$y(t)$	5.588	5.578	5.568	5.558	5.549	5.539	5.529	5.519	5.509	5.499	5.489	5.480

We assumed that the mercury is always distributed uniformly throughout the lake, and doesn't settle to the bottom.

25. (a) $\frac{dv}{dt} + \frac{c}{m}v = -g$, $\mu = e^{(c/m) \int dt} = e^{ct/m}$, $\frac{d}{dt} [ve^{ct/m}] = -ge^{ct/m}$, $ve^{ct/m} = -\frac{gm}{c}e^{ct/m} + C$, $v = -\frac{gm}{c} + Ce^{-ct/m}$, but $v_0 = v(0) = -\frac{gm}{c} + C$, $C = v_0 + \frac{gm}{c}$, $v = -\frac{gm}{c} + \left(v_0 + \frac{gm}{c}\right)e^{-ct/m}$.

(b) Replace $\frac{mg}{c}$ with v_τ and $-ct/m$ with $-gt/v_\tau$ in (16).

(c) From part (b), $s(t) = C - v_\tau t - (v_0 + v_\tau)\frac{v_\tau}{g}e^{-gt/v_\tau}$; $s_0 = s(0) = C - (v_0 + v_\tau)\frac{v_\tau}{g}$, $C = s_0 + (v_0 + v_\tau)\frac{v_\tau}{g}$, $s(t) = s_0 - v_\tau t + \frac{v_\tau}{g}(v_0 + v_\tau)\left(1 - e^{-gt/v_\tau}\right)$.

26. (a) Let t denote time elapsed in seconds after the moment of the drop. From Exercise 25(b), while the parachute is closed $v(t) = e^{-gt/v_\tau}(v_0 + v_\tau) - v_\tau = e^{-32t/120}(0 + 120) - 120 = 120(e^{-4t/15} - 1)$ and thus $v(25) = 120(e^{-20/3} - 1) \approx -119.85$, so the skydiver is falling at a speed of 119.85 ft/s when the parachute opens. From Exercise 25(c), $s(t) = s_0 - 120t + \frac{120}{32}120(1 - e^{-4t/15})$, $s(25) = 10000 - 120 \cdot 25 + 450(1 - e^{-20/3}) \approx 7449.43$ ft.

(b) If t denotes time elapsed after the parachute opens, then, by Exercise 25(c), $s(t) \approx 7449.43 - 24t + \frac{24}{32}(-119.85 + 24)(1 - e^{-32t/24})$. A calculating utility finds that $s(t) = 0$ for $t \approx 307.4$ s, so the skydiver is in the air for about $25 + 307.4 = 332.4$ s.

27. $\frac{dI}{dt} + \frac{R}{L}I = \frac{V(t)}{L}$, $\mu = e^{(R/L) \int dt} = e^{Rt/L}$, $\frac{d}{dt}(e^{Rt/L}I) = \frac{V(t)}{L}e^{Rt/L}$, $Ie^{Rt/L} = I(0) + \frac{1}{L} \int_0^t V(u)e^{Ru/L} du$, so $I(t) = I(0)e^{-Rt/L} + \frac{1}{L}e^{-Rt/L} \int_0^t V(u)e^{Ru/L} du$.

(a) $I(t) = \frac{1}{5}e^{-2t} \int_0^t 20e^{2u} du = 2e^{-2t}e^{2u} \Big|_0^t = 2(1 - e^{-2t})$ A. (b) $\lim_{t \rightarrow +\infty} I(t) = 2$ A.

28. From Exercise 27 and Endpaper Table (42), $I(t) = 15e^{-2t} + \frac{1}{3}e^{-2t} \int_0^t 3e^{2u} \sin u du = 15e^{-2t} + e^{-2t} \frac{e^{2u}}{5}(2 \sin u - \cos u) \Big|_0^t = 15e^{-2t} + \frac{1}{5}(2 \sin t - \cos t) + \frac{1}{5}e^{-2t}$.

29. (a) Let $y = \frac{1}{\mu}[H(x) + C]$ where $\mu = e^{P(x)}$, $\frac{dP}{dx} = p(x)$, $\frac{d}{dx}H(x) = \mu q$, and C is an arbitrary constant. Then

$$\frac{dy}{dx} + p(x)y = \frac{1}{\mu}H'(x) - \frac{\mu'}{\mu^2}[H(x) + C] + p(x)y = q - \frac{p}{\mu}[H(x) + C] + p(x)y = q.$$

(b) Given the initial value problem, let $C = \mu(x_0)y_0 - H(x_0)$. Then $y = \frac{1}{\mu}[H(x) + C]$ is a solution of the initial value problem with $y(x_0) = y_0$. This shows that the initial value problem has a solution. To show uniqueness, suppose $u(x)$ also satisfies (3) together with $u(x_0) = y_0$. Following the arguments in the text we arrive at $u(x) = \frac{1}{\mu}[H(x) + C]$ for some constant C . The initial condition requires $C = \mu(x_0)y_0 - H(x_0)$, and thus $u(x)$ is identical with $y(x)$.

30. (a) $y = x$ and $y = -x$ are both solutions of the given initial value problem.

(b) $\int y dy = -\int x dx, y^2 = -x^2 + C$; but $y(0) = 0$, so $C = 0$. Thus $y^2 = -x^2$, which is impossible.

Chapter 8 Review Exercises

1. (a) Linear. (b) Both. (c) Separable. (d) Neither.

2. (a) Separable. (b) Separable. (c) Not separable. (d) Separable.

3. $\frac{dy}{1+y^2} = x^2 dx, \tan^{-1} y = \frac{1}{3}x^3 + C, y = \tan\left(\frac{1}{3}x^3 + C\right).$

4. $\frac{1}{\tan y} dy = \frac{3}{\sec x} dx, \frac{\cos y}{\sin y} dy = 3 \cos x dx, \ln|\sin y| = 3 \sin x + C_1, \sin y = \pm e^{3 \sin x + C_1} = \pm e^{C_1} e^{3 \sin x} = C e^{3 \sin x}, C \neq 0, y = \sin^{-1}(C e^{3 \sin x}),$ as is $y = 0$ by inspection.

5. $\left(\frac{1}{y} + y\right) dy = e^x dx, \ln|y| + y^2/2 = e^x + C$; by inspection, $y = 0$ is also a solution.

6. $\frac{dy}{y^2+1} = dx, \tan^{-1} y = x + C, \pi/4 = C; y = \tan(x + \pi/4).$

7. $\left(\frac{1}{y^5} + \frac{1}{y}\right) dy = \frac{dx}{x}, -\frac{1}{4}y^{-4} + \ln|y| = \ln|x| + C; -\frac{1}{4} = C, y^{-4} + 4 \ln(x/y) = 1.$

8. $\frac{dy}{y^2} = 4 \sec^2 2x dx, -\frac{1}{y} = 2 \tan 2x + C, -1 = 2 \tan\left(2\frac{\pi}{8}\right) + C = 2 \tan \frac{\pi}{4} + C = 2 + C, C = -3, y = \frac{1}{3 - 2 \tan 2x}.$

9. $\frac{dy}{y^2} = -2x dx, -\frac{1}{y} = -x^2 + C, -1 = C, y = 1/(x^2 + 1).$

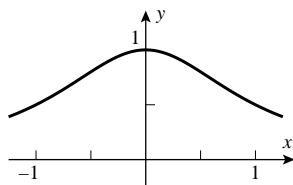

10. $2y dy = dx, y^2 = x + C$; if $y(0) = 1$ then $C = 1, y^2 = x + 1, y = \sqrt{x + 1}$; if $y(0) = -1$, then $C = 1, y^2 = x + 1, y = -\sqrt{x + 1}$.

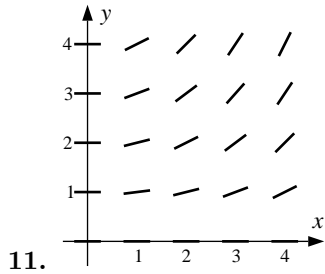
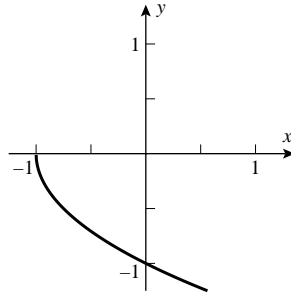
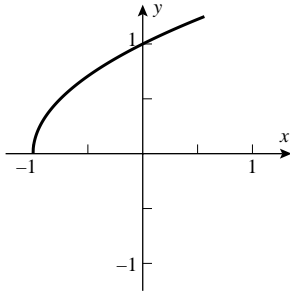

12. $\frac{dy}{y} = \frac{1}{8}x dx, \ln |y| = \frac{1}{16}x^2 + C, y = C_1 e^{x^2/16}.$

13. $y_0 = 1, y_{n+1} = y_n + \sqrt{y_n}/2.$

n	0	1	2	3	4	5	6	7	8
x_n	0	0.5	1	1.5	2	2.5	3	3.5	4
y_n	1	1.50	2.11	2.84	3.68	4.64	5.72	6.91	8.23

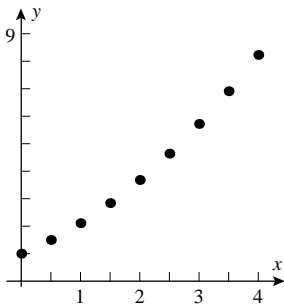

14. $y_0 = 1, y_{n+1} = y_n + \frac{1}{2} \sin y_n.$

n	0	1	2	3	4
t_n	0	0.5	1	1.5	2
y_n	1	1.42	1.92	2.39	2.73

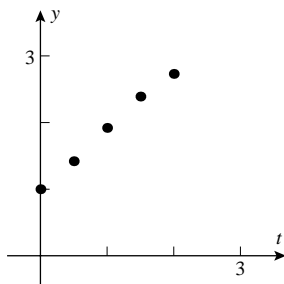

15. $h = 1/5, y_0 = 1, y_{n+1} = y_n + \frac{1}{5} \cos(2\pi n/5).$

n	0	1	2	3	4	5
t_n	0	0.2	0.4	0.6	0.8	1.0
y_n	1.00	1.20	1.26	1.10	0.94	1.00

16. From formula (19) of Section 8.2, $y(t) = y_0 e^{-0.000121t}$, so $0.785y_0 = y_0 e^{-0.000121t}$, $t = -\ln 0.785/0.000121 \approx 2000.6$ yr.

17. (a) $k = \frac{\ln 2}{5} \approx 0.1386$; $y \approx 2e^{0.1386t}$. (b) $y(t) = 5e^{0.015t}$.

(c) $y = y_0 e^{kt}$, $1 = y_0 e^k$, $100 = y_0 e^{10k}$. We obtain that $100 = e^{9k}$, $k = \frac{1}{9} \ln 100 \approx 0.5117$, $y \approx y_0 e^{0.5117t}$; also $y(1) = 1$, so $y_0 = e^{-0.5117} \approx 0.5995$, $y \approx 0.5995e^{0.5117t}$.

(d) $\frac{\ln 2}{T} \approx 0.1386$, $1 = y(1) \approx y_0 e^{0.1386}$, $y_0 \approx e^{-0.1386} \approx 0.8706$, $y \approx 0.8706e^{0.1386t}$.

18. (a) $\frac{d}{dt}y(t) = 0.01y$, $y(0) = 5000$. (b) $y(t) = 5000e^{0.01t}$.

(c) $2 = e^{0.01t}$, $t = 100 \ln 2 \approx 69.31$ h. (d) $30,000 = 5000e^{0.01t}$, $t = 100 \ln 6 \approx 179.18$ h.

19. $\mu = e^{\int 3 dx} = e^{3x}$, $e^{3x}y = \int e^x dx = e^x + C$, $y = e^{-2x} + Ce^{-3x}$.

20. $\frac{dy}{dx} + y = \frac{1}{1+e^x}$, $\mu = e^{\int dx} = e^x$, $e^x y = \int \frac{e^x}{1+e^x} dx = \ln(1+e^x) + C$, $y = e^{-x} \ln(1+e^x) + Ce^{-x}$.

21. $\mu = e^{-\int x dx} = e^{-x^2/2}$, $e^{-x^2/2}y = \int xe^{-x^2/2} dx = -e^{-x^2/2} + C$, $y = -1 + Ce^{x^2/2}$, $3 = -1 + C$, $C = 4$, $y = -1 + 4e^{x^2/2}$.

22. $\frac{dy}{dx} + \frac{2}{x}y = 4x$, $\mu = e^{\int (2/x) dx} = x^2$, $\frac{d}{dx}[yx^2] = 4x^3$, $yx^2 = x^4 + C$, $y = x^2 + Cx^{-2}$, $2 = y(1) = 1 + C$, $C = 1$, $y = x^2 + 1/x^2$.

23. By inspection, the left side of the equation is $\frac{d}{dx}(y \cosh x)$, so $\frac{d}{dx}(y \cosh x) = \cosh^2 x = \frac{1}{2}(1 + \cosh 2x)$ and $y \cosh x = \frac{1}{2}x + \frac{1}{4} \sinh 2x + C = \frac{1}{2}(x + \sinh x \cosh x) + C$. When $x = 0$, $y = 2$ so $2 = C$, and $y = 2 \operatorname{sech} x + \frac{1}{2}(x \operatorname{sech} x + \sinh x)$.

24. (a) $\mu = e^{-\int dx} = e^{-x}$, $\frac{d}{dx}[ye^{-x}] = xe^{-x} \sin 3x$, $ye^{-x} = \int xe^{-x} \sin 3x dx = \left(-\frac{3}{10}x - \frac{3}{50}\right)e^{-x} \cos 3x + \left(-\frac{1}{10}x + \frac{2}{25}\right)e^{-x} \sin 3x + C$; $1 = y(0) = -\frac{3}{50} + C$, $C = \frac{53}{50}$, $y = \left(-\frac{3}{10}x - \frac{3}{50}\right) \cos 3x + \left(-\frac{1}{10}x + \frac{2}{25}\right) \sin 3x + \frac{53}{50}e^x$.

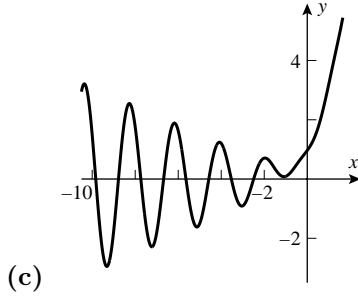

25. Assume the tank contains $y(t)$ oz of salt at time t . Then $y_0 = 0$ and for $0 < t < 15$, $\frac{dy}{dt} = 5 \cdot 10 - \frac{y}{1000}10 = (50 - y/100)$ oz/min, with solution $y = 5000 + Ce^{-t/100}$. But $y(0) = 0$ so $C = -5000$, $y = 5000(1 - e^{-t/100})$ for $0 \leq t \leq 15$, and $y(15) = 5000(1 - e^{-0.15})$. For $15 < t < 30$, $\frac{dy}{dt} = 0 - \frac{y}{1000}5$, $y = C_1 e^{-t/200}$, $C_1 e^{-0.075} = y(15) = 5000(1 - e^{-0.15})$, $C_1 = 5000(e^{0.075} - e^{-0.075})$, $y = 5000(e^{0.075} - e^{-0.075})e^{-t/200}$, $y(30) = 5000(e^{0.075} - e^{-0.075})e^{-0.15} \approx 646.14$ oz.
26. (a) Assume the air contains $y(t)$ ft³ of carbon monoxide at time t . Then $y_0 = 0$ and for $t > 0$, $\frac{dy}{dt} = 0.04(0.1) - \frac{y}{1200}(0.1) = 1/250 - y/12000$, $\frac{d}{dt} \left[ye^{t/12000} \right] = \frac{1}{250}e^{t/12000}$, $ye^{t/12000} = 48e^{t/12000} + C$, $y(0) = 0$, $C = -48$; $y = 48(1 - e^{-t/12000})$. Thus the percentage of carbon monoxide is $P = \frac{y}{1200}100 = 4(1 - e^{-t/12000})$ percent.
- (b) $0.012 = 4(1 - e^{-t/12000})$, $t = 36.05$ min.

Chapter 8 Making Connections

1. (a) $u(x) = q - py(x)$ so $\frac{du}{dx} = -p\frac{dy}{dx} = -p(q - py(x)) = (-p)u(x)$. If $p < 0$ then $-p > 0$ so $u(x)$ grows exponentially. If $p > 0$ then $-p < 0$ so $u(x)$ decays exponentially.
- (b) From (a), $u(x) = 4 - 2y(x)$ satisfies $\frac{du}{dx} = -2u(x)$, so equation (14) of Section 8.2 gives $u(x) = u_0 e^{-2x}$ for some constant u_0 . Since $u(0) = 4 - 2y(0) = 6$, we have $u(x) = 6e^{-2x}$; hence $y(x) = 2 - 3e^{-2x}$.
2. (a) $\frac{du}{dx} = \frac{d}{dx}(ax + by(x) + c) = a + b\frac{dy}{dx} = a + bf(ax + by + c) = a + bf(u)$, so $\frac{1}{a + bf(u)} \frac{du}{dx} = 1$.
- (b) From (a) with $a = b = 1$, $c = 0$, $f(t) = 1/t$, we have $\frac{1}{1 + 1/u} \frac{du}{dx} = 1$, where $u = x + y$. So $\frac{u}{u + 1} du = dx$, $\int \frac{u}{u + 1} du = \int dx$, $u - \ln|u + 1| = x + C$, $x + y - \ln|x + y + 1| = x + C$, and $y - \ln|x + y + 1| = C$.
3. (a) $\frac{du}{dx} = \frac{d}{dx} \left(\frac{y}{x} \right) = \frac{x\frac{dy}{dx} - y}{x^2} = \frac{xf\left(\frac{y}{x}\right) - y}{x^2}$. Since $y = ux$, $\frac{du}{dx} = \frac{xf(u) - ux}{x^2} = \frac{f(u) - u}{x}$ and $\frac{1}{f(u) - u} \frac{du}{dx} = \frac{1}{x}$.
- (b) $\frac{dy}{dx} = \frac{x - y}{x + y} = \frac{1 - y/x}{1 + y/x}$ has the form given in (a), with $f(t) = \frac{1 - t}{1 + t}$. So $\frac{1}{\frac{1 - u}{1 + u} - u} \frac{du}{dx} = \frac{1}{x}$, $\frac{1 + u}{1 - 2u - u^2} du = \frac{dx}{x}$, $\int \frac{1 + u}{1 - 2u - u^2} du = \int \frac{dx}{x}$, $-\frac{1}{2} \ln|1 - 2u - u^2| = \ln|x| + C_1$, and $|1 - 2u - u^2| = e^{-2C_1} x^{-2}$. Hence $1 - 2u - u^2 = Cx^{-2}$ where C is either e^{-2C_1} or $-e^{-2C_1}$. Substituting $u = \frac{y}{x}$ gives $1 - \frac{2y}{x} - \frac{y^2}{x^2} = Cx^{-2}$, and $x^2 - 2xy - y^2 = C$.

4. (a) $\frac{du}{dx} = (1-n)y^{-n} \frac{dy}{dx} = (1-n)y^{-n}[q(x)y^n - p(x)y] = (1-n)q(x) - (1-n)p(x)y^{1-n} = (1-n)q(x) - (1-n)p(x)u.$

Hence $\frac{du}{dx} + (1-n)p(x)u = (1-n)q(x).$

(b) $\frac{dy}{dx} - \frac{1}{x}y = -2y^2$, so this has the form given in (a) with $p(x) = -1/x$, $q(x) = -2$, and $n = 2$. So $u = y^{-1}$ satisfies $\frac{du}{dx} + \frac{1}{x}u = 2$. An integrating factor is given by $\mu = e^{\int dx/x} = e^{\ln x} = x$. So $\frac{d}{dx}(xu) = x \frac{du}{dx} + u = 2x$, $xu = x^2 + C$, $u = x + Cx^{-1}$, and $y = u^{-1} = \frac{1}{x + Cx^{-1}} = \frac{x}{x^2 + C}$. Since $y(1) = \frac{1}{2}$, $C = 1$ and $y = \frac{x}{x^2 + 1}$.

Infinite Series

Exercise Set 9.1

- (a) $\frac{1}{3^{n-1}}$ (b) $\frac{(-1)^{n-1}}{3^{n-1}}$ (c) $\frac{2n-1}{2n}$ (d) $\frac{n^2}{\pi^{1/(n+1)}}$
- (a) $(-r)^{n-1}; (-r)^n$ (b) $-(-r)^n; (-1)^n r^{n+1}$
- (a) 2, 0, 2, 0 (b) 1, -1, 1, -1 (c) $2(1 + (-1)^n); 2 + 2 \cos n\pi$
- (a) $(2n)!$ (b) $(2n-1)!$
- (a) No; $f(n)$ oscillates between ± 1 and 0. (b) -1, +1, -1, +1, -1 (c) No, it oscillates between +1 and -1.
- If n is an integer then $f(2n+1) = 0$.
(a) 0, 0, 0, 0, 0 (b) $b_n = 0$ for all n , so the sequence converges to 0. (c) No, it oscillates between ± 1 and 0.
- $1/3, 2/4, 3/5, 4/6, 5/7, \dots; \lim_{n \rightarrow +\infty} \frac{n}{n+2} = 1$, converges.
- $1/3, 4/5, 9/7, 16/9, 25/11, \dots; \lim_{n \rightarrow +\infty} \frac{n^2}{2n+1} = +\infty$, diverges.
- $2, 2, 2, 2, 2, \dots; \lim_{n \rightarrow +\infty} 2 = 2$, converges.
- $\ln 1, \ln \frac{1}{2}, \ln \frac{1}{3}, \ln \frac{1}{4}, \ln \frac{1}{5}, \dots; \lim_{n \rightarrow +\infty} \ln(1/n) = -\infty$, diverges.
- $\frac{\ln 1}{1}, \frac{\ln 2}{2}, \frac{\ln 3}{3}, \frac{\ln 4}{4}, \frac{\ln 5}{5}, \dots; \lim_{n \rightarrow +\infty} \frac{\ln n}{n} = \lim_{n \rightarrow +\infty} \frac{1}{n} = 0$ (apply L'Hôpital's Rule to $\frac{\ln x}{x}$), converges.
- $\sin \pi, 2 \sin(\pi/2), 3 \sin(\pi/3), 4 \sin(\pi/4), 5 \sin(\pi/5), \dots; \lim_{n \rightarrow +\infty} n \sin(\pi/n) = \lim_{n \rightarrow +\infty} \frac{\sin(\pi/n)}{1/n}$; but using L'Hospital's rule, $\lim_{x \rightarrow +\infty} \frac{\sin(\pi/x)}{1/x} = \lim_{x \rightarrow +\infty} \frac{(-\pi/x^2) \cos(\pi/x)}{-1/x^2} = \pi$, so the sequence also converges to π .
- $0, 2, 0, 2, 0, \dots$; diverges.
- $1, -1/4, 1/9, -1/16, 1/25, \dots; \lim_{n \rightarrow +\infty} \frac{(-1)^{n+1}}{n^2} = 0$, converges.
- $-1, 16/9, -54/28, 128/65, -250/126, \dots$; diverges because odd-numbered terms approach -2, even-numbered terms approach 2.

16. $1/2, 2/4, 3/8, 4/16, 5/32, \dots$; using L'Hospital's rule, $\lim_{x \rightarrow +\infty} \frac{x}{2^x} = \lim_{x \rightarrow +\infty} \frac{1}{2^x \ln 2} = 0$, so the sequence also converges to 0.
17. $6/2, 12/8, 20/18, 30/32, 42/50, \dots$; $\lim_{n \rightarrow +\infty} \frac{1}{2}(1 + 1/n)(1 + 2/n) = 1/2$, converges.
18. $\pi/4, \pi^2/4^2, \pi^3/4^3, \pi^4/4^4, \pi^5/4^5, \dots$; $\lim_{n \rightarrow +\infty} (\pi/4)^n = 0$, converges.
19. $e^{-1}, 4e^{-2}, 9e^{-3}, 16e^{-4}, 25e^{-5}, \dots$; using L'Hospital's rule, $\lim_{x \rightarrow +\infty} x^2 e^{-x} = \lim_{x \rightarrow +\infty} \frac{x^2}{e^x} = \lim_{x \rightarrow +\infty} \frac{2x}{e^x} = \lim_{x \rightarrow +\infty} \frac{2}{e^x} = 0$, so $\lim_{n \rightarrow +\infty} n^2 e^{-n} = 0$, converges.
20. $1, \sqrt{10}-2, \sqrt{18}-3, \sqrt{28}-4, \sqrt{40}-5, \dots$; $\lim_{n \rightarrow +\infty} (\sqrt{n^2 + 3n} - n) = \lim_{n \rightarrow +\infty} \frac{3n}{\sqrt{n^2 + 3n} + n} = \lim_{n \rightarrow +\infty} \frac{3}{\sqrt{1 + 3/n} + 1} = \frac{3}{2}$, converges.
21. $2, (5/3)^2, (6/4)^3, (7/5)^4, (8/6)^5, \dots$; let $y = \left[\frac{x+3}{x+1} \right]^x$, converges because $\lim_{x \rightarrow +\infty} \ln y = \lim_{x \rightarrow +\infty} \frac{\ln \frac{x+3}{x+1}}{1/x} = \lim_{x \rightarrow +\infty} \frac{2x^2}{(x+1)(x+3)} = 2$, so $\lim_{n \rightarrow +\infty} \left[\frac{n+3}{n+1} \right]^n = e^2$.
22. $-1, 0, (1/3)^3, (2/4)^4, (3/5)^5, \dots$; let $y = (1 - 2/x)^x$, converges because $\lim_{x \rightarrow +\infty} \ln y = \lim_{x \rightarrow +\infty} \frac{\ln(1 - 2/x)}{1/x} = \lim_{x \rightarrow +\infty} \frac{-2}{1 - 2/x} = -2$, $\lim_{n \rightarrow +\infty} (1 - 2/n)^n = \lim_{x \rightarrow +\infty} y = e^{-2}$.
23. $\left\{ \frac{2n-1}{2n} \right\}_{n=1}^{+\infty}$; $\lim_{n \rightarrow +\infty} \frac{2n-1}{2n} = 1$, converges.
24. $\left\{ \frac{n-1}{n^2} \right\}_{n=1}^{+\infty}$; $\lim_{n \rightarrow +\infty} \frac{n-1}{n^2} = 0$, converges.
25. $\left\{ (-1)^{n-1} \frac{1}{3^n} \right\}_{n=1}^{+\infty}$; $\lim_{n \rightarrow +\infty} \frac{(-1)^{n-1}}{3^n} = 0$, converges.
26. $\{(-1)^n n\}_{n=1}^{+\infty}$; diverges because odd-numbered terms tend toward $-\infty$, even-numbered terms tend toward $+\infty$.
27. $\left\{ (-1)^{n+1} \left(\frac{1}{n} - \frac{1}{n+1} \right) \right\}_{n=1}^{+\infty}$; the sequence converges to 0.
28. $\{3/2^{n-1}\}_{n=1}^{+\infty}$; $\lim_{n \rightarrow +\infty} 3/2^{n-1} = 0$, converges.
29. $\{\sqrt{n+1} - \sqrt{n+2}\}_{n=1}^{+\infty}$; converges because $\lim_{n \rightarrow +\infty} (\sqrt{n+1} - \sqrt{n+2}) = \lim_{n \rightarrow +\infty} \frac{(n+1) - (n+2)}{\sqrt{n+1} + \sqrt{n+2}} = \lim_{n \rightarrow +\infty} \frac{-1}{\sqrt{n+1} + \sqrt{n+2}} = 0$.
30. $\{(-1)^{n+1}/3^{n+4}\}_{n=1}^{+\infty}$; $\lim_{n \rightarrow +\infty} (-1)^{n+1}/3^{n+4} = 0$, converges.
31. True; a function whose domain is a set of integers.

32. False, e.g. $a_n = 1 - n, b_n = n - 1$.

33. False, e.g. $a_n = (-1)^n$.

34. True.

35. Let $a_n = 0, b_n = \frac{\sin^2 n}{n}, c_n = \frac{1}{n}$; then $a_n \leq b_n \leq c_n, \lim_{n \rightarrow +\infty} a_n = \lim_{n \rightarrow +\infty} c_n = 0$, so $\lim_{n \rightarrow +\infty} b_n = 0$.

36. Let $a_n = 0, b_n = \left(\frac{1+n}{2n}\right)^n, c_n = \left(\frac{3}{4}\right)^n$; then (for $n \geq 2$), $a_n \leq b_n \leq \left(\frac{n/2+n}{2n}\right)^n = c_n$,
 $\lim_{n \rightarrow +\infty} a_n = \lim_{n \rightarrow +\infty} c_n = 0$, so $\lim_{n \rightarrow +\infty} b_n = 0$.

37. $a_n = \begin{cases} +1 & k \text{ even} \\ -1 & k \text{ odd} \end{cases}$ oscillates; there is no limit point which attracts all of the a_n . $b_n = \cos n$; the terms lie all over the interval $[-1, 1]$ without any limit.

38. (a) No, because given $N > 0$, all values of $f(x)$ are greater than N provided x is close enough to zero. But certainly the terms $1/n$ will be arbitrarily close to zero, and when so then $f(1/n) > N$, so $f(1/n)$ cannot converge.

(b) $f(x) = \sin(\pi/x)$. Then $f = 0$ when $x = 1/n$ and $f \neq 0$ otherwise; indeed, the values of f are located all over the interval $[-1, 1]$.

39. (a) 1, 2, 1, 4, 1, 6 (b) $a_n = \begin{cases} n, & n \text{ odd} \\ 1/2^n, & n \text{ even} \end{cases}$ (c) $a_n = \begin{cases} 1/n, & n \text{ odd} \\ 1/(n+1), & n \text{ even} \end{cases}$

(d) In part (a) the sequence diverges, since the even terms diverge to $+\infty$ and the odd terms equal 1; in part (b) the sequence diverges, since the odd terms diverge to $+\infty$ and the even terms tend to zero; in part (c) $\lim_{n \rightarrow +\infty} a_n = 0$.

40. The even terms are zero, so the odd terms must converge to zero, and this is true if and only if $\lim_{n \rightarrow +\infty} b^n = 0$, or $0 < b < 1$ (b is required to be positive).

41. $\lim_{n \rightarrow +\infty} x_{n+1} = \frac{1}{2} \lim_{n \rightarrow +\infty} \left(x_n + \frac{a}{x_n}\right)$ or $L = \frac{1}{2} \left(L + \frac{a}{L}\right), 2L^2 - L^2 - a = 0, L = \sqrt{a}$ (we reject $-\sqrt{a}$ because $x_n > 0$, thus $L \geq 0$).

42. (a) $a_{n+1} = \sqrt{6 + a_n}$.

(b) $\lim_{n \rightarrow +\infty} a_{n+1} = \lim_{n \rightarrow +\infty} \sqrt{6 + a_n}, L = \sqrt{6 + L}, L^2 - L - 6 = 0, (L - 3)(L + 2) = 0, L = -2$ (reject, because the terms in the sequence are positive) or $L = 3; \lim_{n \rightarrow +\infty} a_n = 3$.

43. (a) $a_1 = (0.5)^2, a_2 = a_1^2 = (0.5)^4, \dots, a_n = (0.5)^{2^n}$.

(c) $\lim_{n \rightarrow +\infty} a_n = \lim_{n \rightarrow +\infty} e^{2^n \ln(0.5)} = 0$, since $\ln(0.5) < 0$.

(d) Replace 0.5 in part (a) with a_0 ; then the sequence converges for $-1 \leq a_0 \leq 1$, because if $a_0 = \pm 1$, then $a_n = 1$ for $n \geq 1$; if $a_0 = 0$ then $a_n = 0$ for $n \geq 1$; and if $0 < |a_0| < 1$ then $a_1 = a_0^2 > 0$ and $\lim_{n \rightarrow +\infty} a_n = \lim_{n \rightarrow +\infty} e^{2^{n-1} \ln a_1} = 0$ since $0 < a_1 < 1$. This same argument proves divergence to $+\infty$ for $|a| > 1$ since then $\ln a_1 > 0$.

44. $f(0.2) = 0.4, f(0.4) = 0.8, f(0.8) = 0.6, f(0.6) = 0.2$ and then the cycle repeats, so the sequence does not converge.

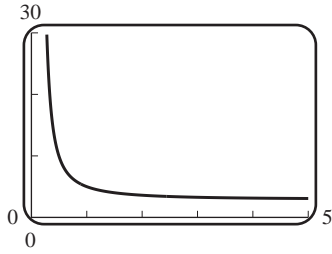

45. (a)

(b) Let $y = (2^x + 3^x)^{1/x}$, $\lim_{x \rightarrow +\infty} \ln y = \lim_{x \rightarrow +\infty} \frac{\ln(2^x + 3^x)}{x} = \lim_{x \rightarrow +\infty} \frac{2^x \ln 2 + 3^x \ln 3}{2^x + 3^x} = \lim_{x \rightarrow +\infty} \frac{(2/3)^x \ln 2 + \ln 3}{(2/3)^x + 1} = \ln 3$, so $\lim_{n \rightarrow +\infty} (2^n + 3^n)^{1/n} = e^{\ln 3} = 3$. Alternate proof: $3 = (3^n)^{1/n} < (2^n + 3^n)^{1/n} < (2 \cdot 3^n)^{1/n} = 3 \cdot 2^{1/n}$. Then apply the Squeezing Theorem.

46. Let $f(x) = 1/(1+x)$, $0 \leq x \leq 1$. Take $\Delta x_k = 1/n$ and $x_k^* = k/n$ then $a_n = \sum_{k=1}^n \frac{1}{1+(k/n)} (1/n) = \sum_{k=1}^n \frac{1}{1+x_k^*} \Delta x_k$

$$\text{so } \lim_{n \rightarrow +\infty} a_n = \int_0^1 \frac{1}{1+x} dx = \ln(1+x) \Big|_0^1 = \ln 2.$$

47. (a) If $n \geq 1$, then $a_{n+2} = a_{n+1} + a_n$, so $\frac{a_{n+2}}{a_{n+1}} = 1 + \frac{a_n}{a_{n+1}}$.

(c) With $L = \lim_{n \rightarrow +\infty} (a_{n+2}/a_{n+1}) = \lim_{n \rightarrow +\infty} (a_{n+1}/a_n)$, $L = 1 + 1/L$, $L^2 - L - 1 = 0$, $L = (1 \pm \sqrt{5})/2$, so $L = (1 + \sqrt{5})/2$ because the limit cannot be negative.

48. $\left| \frac{1}{n} - 0 \right| = \frac{1}{n} < \epsilon$ if $n > 1/\epsilon$;

(a) $1/\epsilon = 1/0.5 = 2$, $N = 3$. (b) $1/\epsilon = 1/0.1 = 10$, $N = 11$. (c) $1/\epsilon = 1/0.001 = 1000$, $N = 1001$.

49. $\left| \frac{n}{n+1} - 1 \right| = \frac{1}{n+1} < \epsilon$ if $n+1 > 1/\epsilon$, $n > 1/\epsilon - 1$;

(a) $1/\epsilon - 1 = 1/0.25 - 1 = 3$, $N = 4$. (b) $1/\epsilon - 1 = 1/0.1 - 1 = 9$, $N = 10$. (c) $1/\epsilon - 1 = 1/0.001 - 1 = 999$, $N = 1000$.

50. (a) $\left| \frac{1}{n} - 0 \right| = \frac{1}{n} < \epsilon$ if $n > 1/\epsilon$, choose any $N > 1/\epsilon$.

(b) $\left| \frac{n}{n+1} - 1 \right| = \frac{1}{n+1} < \epsilon$ if $n > 1/\epsilon - 1$, choose any $N > 1/\epsilon - 1$.

Exercise Set 9.2

1. $a_{n+1} - a_n = \frac{1}{n+1} - \frac{1}{n} = -\frac{1}{n(n+1)} < 0$ for $n \geq 1$, so strictly decreasing.

2. $a_{n+1} - a_n = \left(1 - \frac{1}{n+1}\right) - \left(1 - \frac{1}{n}\right) = \frac{1}{n(n+1)} > 0$ for $n \geq 1$, so strictly increasing.

3. $a_{n+1} - a_n = \frac{n+1}{2n+3} - \frac{n}{2n+1} = \frac{1}{(2n+1)(2n+3)} > 0$ for $n \geq 1$, so strictly increasing.

4. $a_{n+1} - a_n = \frac{n+1}{4n+3} - \frac{n}{4n-1} = -\frac{1}{(4n-1)(4n+3)} < 0$ for $n \geq 1$, so strictly decreasing.

5. $a_{n+1} - a_n = (n + 1 - 2^{n+1}) - (n - 2^n) = 1 - 2^n < 0$ for $n \geq 1$, so strictly decreasing.
6. $a_{n+1} - a_n = [(n + 1) - (n + 1)^2] - (n - n^2) = -2n < 0$ for $n \geq 1$, so strictly decreasing.
7. $\frac{a_{n+1}}{a_n} = \frac{(n + 1)/(2n + 3)}{n/(2n + 1)} = \frac{(n + 1)(2n + 1)}{n(2n + 3)} = \frac{2n^2 + 3n + 1}{2n^2 + 3n} > 1$ for $n \geq 1$, so strictly increasing.
8. $\frac{a_{n+1}}{a_n} = \frac{2^{n+1}}{1 + 2^{n+1}} \cdot \frac{1 + 2^n}{2^n} = \frac{2 + 2^{n+1}}{1 + 2^{n+1}} = 1 + \frac{1}{1 + 2^{n+1}} > 1$ for $n \geq 1$, so strictly increasing.
9. $\frac{a_{n+1}}{a_n} = \frac{(n + 1)e^{-(n+1)}}{ne^{-n}} = (1 + 1/n)e^{-1} < 1$ for $n \geq 1$, so strictly decreasing.
10. $\frac{a_{n+1}}{a_n} = \frac{10^{n+1}}{(2n + 2)!} \cdot \frac{(2n)!}{10^n} = \frac{10}{(2n + 2)(2n + 1)} < 1$ for $n \geq 1$, so strictly decreasing.
11. $\frac{a_{n+1}}{a_n} = \frac{(n + 1)^{n+1}}{(n + 1)!} \cdot \frac{n!}{n^n} = \frac{(n + 1)^n}{n^n} = (1 + 1/n)^n > 1$ for $n \geq 1$, so strictly increasing.
12. $\frac{a_{n+1}}{a_n} = \frac{5^{n+1}}{2^{(n+1)^2}} \cdot \frac{2^n}{5^n} = \frac{5}{2^{2n+1}} < 1$ for $n \geq 1$, so strictly decreasing.
13. True by definition.
14. False; either $a_{n+1} \leq a_n$ always or else $a_{n+1} \geq a_n$ always.
15. False, e.g. $a_n = (-1)^n$.
16. False; such a sequence could decrease until a_{300} , e.g.
17. $f(x) = x/(2x + 1)$, $f'(x) = 1/(2x + 1)^2 > 0$ for $x \geq 1$, so strictly increasing.
18. $f(x) = \frac{\ln(x + 2)}{x + 2}$, $f'(x) = \frac{1 - \ln(x + 2)}{(x + 2)^2} < 0$ for $x \geq 1$, so strictly decreasing.
19. $f(x) = \tan^{-1} x$, $f'(x) = 1/(1 + x^2) > 0$ for $x \geq 1$, so strictly increasing.
20. $f(x) = xe^{-2x}$, $f'(x) = (1 - 2x)e^{-2x} < 0$ for $x \geq 1$, so strictly decreasing.
21. $f(x) = 2x^2 - 7x$, $f'(x) = 4x - 7 > 0$ for $x \geq 2$, so eventually strictly increasing.
22. $f(x) = \frac{x}{x^2 + 10}$, $f'(x) = \frac{10 - x^2}{(x^2 + 10)^2} < 0$ for $x \geq 4$, so eventually strictly decreasing.
23. $\frac{a_{n+1}}{a_n} = \frac{(n + 1)!}{3^{n+1}} \cdot \frac{3^n}{n!} = \frac{n + 1}{3} > 1$ for $n \geq 3$, so eventually strictly increasing.
24. $f(x) = x^5 e^{-x}$, $f'(x) = x^4(5 - x)e^{-x} < 0$ for $x \geq 6$, so eventually strictly decreasing.
25. Yes: a monotone sequence is increasing or decreasing; if it is increasing, then it is increasing and bounded above, so by Theorem 9.2.3 it converges; if decreasing, then use Theorem 9.2.4. The limit lies in the interval $[1, 2]$.
26. Such a sequence may converge, in which case, by the argument in part (a), its limit is ≤ 2 . If the sequence is also increasing then it will converge. But convergence may not happen: for example, the sequence $\{-n\}_{n=1}^{+\infty}$ diverges.

27. (a) $\sqrt{2}, \sqrt{2 + \sqrt{2}}, \sqrt{2 + \sqrt{2 + \sqrt{2}}}$.

(b) $a_1 = \sqrt{2} < 2$ so $a_2 = \sqrt{2 + a_1} < \sqrt{2 + 2} = 2$, $a_3 = \sqrt{2 + a_2} < \sqrt{2 + 2} = 2$, and so on indefinitely.

(c) $a_{n+1}^2 - a_n^2 = (2 + a_n) - a_n^2 = 2 + a_n - a_n^2 = (2 - a_n)(1 + a_n)$.

(d) $a_n > 0$ and, from part (b), $a_n < 2$ so $2 - a_n > 0$ and $1 + a_n > 0$ thus, from part (c), $a_{n+1}^2 - a_n^2 > 0$, $a_{n+1} - a_n > 0$, $a_{n+1} > a_n$; $\{a_n\}$ is a strictly increasing sequence.

(e) The sequence is increasing and has 2 as an upper bound so it must converge to a limit L , $\lim_{n \rightarrow +\infty} a_{n+1} = \lim_{n \rightarrow +\infty} \sqrt{2 + a_n}$, $L = \sqrt{2 + L}$, $L^2 - L - 2 = 0$, $(L - 2)(L + 1) = 0$, thus $\lim_{n \rightarrow +\infty} a_n = 2$.

28. (a) If $f(x) = \frac{1}{2}(x + 3/x)$, then $f'(x) = (x^2 - 3)/(2x^2)$ and $f'(x) = 0$ for $x = \sqrt{3}$; the minimum value of $f(x)$ for $x > 0$ is $f(\sqrt{3}) = \sqrt{3}$. Thus $f(x) \geq \sqrt{3}$ for $x > 0$ and hence $a_n \geq \sqrt{3}$ for $n \geq 2$.

(b) $a_{n+1} - a_n = (3 - a_n^2)/(2a_n) \leq 0$ for $n \geq 2$ since $a_n \geq \sqrt{3}$ for $n \geq 2$; $\{a_n\}$ is eventually decreasing.

(c) $\sqrt{3}$ is a lower bound for a_n so $\{a_n\}$ converges; $\lim_{n \rightarrow +\infty} a_{n+1} = \lim_{n \rightarrow +\infty} \frac{1}{2}(a_n + 3/a_n)$, $L = \frac{1}{2}(L + 3/L)$, $L^2 - 3 = 0$, $L = \sqrt{3}$.

29. (a) $x_1 = 60$, $x_2 = \frac{1500}{7} \approx 214.3$, $x_3 = \frac{3750}{13} \approx 288.5$, $x_4 = \frac{75000}{251} \approx 298.8$.

(b) We can see that $x_{n+1} = \frac{RK}{K/x_n + (R-1)} = \frac{10 \cdot 300}{300/x_n + 9}$; if $0 < x_n$ then clearly $0 < x_{n+1}$. Also, if $x_n < 300$, then $x_{n+1} = \frac{10 \cdot 300}{300/x_n + 9} < \frac{10 \cdot 300}{300/300 + 9} = 300$, so the conclusion is valid.

(c) $\frac{x_{n+1}}{x_n} = \frac{RK}{K + (R-1)x_n} = \frac{10 \cdot 300}{300 + 9x_n} > \frac{10 \cdot 300}{300 + 9 \cdot 300} = 1$, because $x_n < 300$. So x_n is increasing.

(d) x_n is increasing and bounded above, so it is convergent. The limit can be found by letting $L = \frac{RKL}{K + (R-1)L}$, this gives us $L = K = 300$. (The other root, $L = 0$ can be ruled out by the increasing property of the sequence.)

30. (a) Again, $x_{n+1} = \frac{RK}{K/x_n + (R-1)}$, so if $x_n > K$, then $x_{n+1} = \frac{RK}{K/x_n + (R-1)} > \frac{RK}{K/K + (R-1)} = K$, so the conclusion is valid (we only used $R > 1$ and $K > 0$).

(b) $\frac{x_{n+1}}{x_n} = \frac{RK}{K + (R-1)x_n} < \frac{RK}{K + (R-1)K} = 1$, because $x_n > K$. So x_n is decreasing.

(c) x_n is decreasing and bounded below, so it is convergent. The limit can be found by letting $L = \frac{RKL}{K + (R-1)L}$, this gives us $L = K$. (The other root, $L = 0$ can be ruled out by the fact that $x_n > K$.)

31. (a) $a_{n+1} = \frac{|x|^{n+1}}{(n+1)!} = \frac{|x|}{n+1} \frac{|x|^n}{n!} = \frac{|x|}{n+1} a_n$.

(b) $a_{n+1}/a_n = |x|/(n+1) < 1$ if $n > |x| - 1$.

(c) From part (b) the sequence is eventually decreasing, and it is bounded below by 0, so by Theorem 9.2.4 it converges.

32. (a) The altitudes of the rectangles are $\ln k$ for $k = 2$ to n , and their bases all have length 1 so the sum of their areas is $\ln 2 + \ln 3 + \dots + \ln n = \ln(2 \cdot 3 \cdot \dots \cdot n) = \ln n!$. The area under the curve $y = \ln x$ for x in the interval $[1, n]$ is $\int_1^n \ln x \, dx$, and $\int_1^{n+1} \ln x \, dx$ is the area for x in the interval $[1, n+1]$ so, from the figure, $\int_1^n \ln x \, dx < \ln n! < \int_1^{n+1} \ln x \, dx$.

(b) $\int_1^n \ln x \, dx = (x \ln x - x) \Big|_1^n = n \ln n - n + 1$ and $\int_1^{n+1} \ln x \, dx = (n+1) \ln(n+1) - n$, so from part (a), $n \ln n - n + 1 < \ln n! < (n+1) \ln(n+1) - n$, $e^{n \ln n - n + 1} < n! < e^{(n+1) \ln(n+1) - n}$, $e^n e^{-n} e^{1-n} < n! < e^{(n+1) \ln(n+1)} e^{-n}$, $\frac{n^n}{e^{n-1}} < n! < \frac{(n+1)^{n+1}}{e^n}$.

(c) From part (b), $\left[\frac{n^n}{e^{n-1}} \right]^{1/n} < \sqrt[n]{n!} < \left[\frac{(n+1)^{n+1}}{e^n} \right]^{1/n}$, $\frac{n}{e^{1-1/n}} < \sqrt[n]{n!} < \frac{(n+1)^{1+1/n}}{e}$, $\frac{1}{e^{1-1/n}} < \frac{\sqrt[n]{n!}}{n} < \frac{(1+1/n)(n+1)^{1/n}}{e}$, but $\frac{1}{e^{1-1/n}} \rightarrow \frac{1}{e}$ and $\frac{(1+1/n)(n+1)^{1/n}}{e} \rightarrow \frac{1}{e}$ as $n \rightarrow +\infty$ (why?), so $\lim_{n \rightarrow +\infty} \frac{\sqrt[n]{n!}}{n} = \frac{1}{e}$.

33. $n! > \frac{n^n}{e^{n-1}}$, $\sqrt[n]{n!} > \frac{n}{e^{1-1/n}}$, $\lim_{n \rightarrow +\infty} \frac{n}{e^{1-1/n}} = +\infty$, so $\lim_{n \rightarrow +\infty} \sqrt[n]{n!} = +\infty$.

Exercise Set 9.3

1. (a) $s_1 = 2, s_2 = 12/5, s_3 = \frac{62}{25}, s_4 = \frac{312}{125}, s_n = \frac{2 - 2(1/5)^n}{1 - 1/5} = \frac{5}{2} - \frac{5}{2}(1/5)^n$, $\lim_{n \rightarrow +\infty} s_n = \frac{5}{2}$, converges.

(b) $s_1 = \frac{1}{4}, s_2 = \frac{3}{4}, s_3 = \frac{7}{4}, s_4 = \frac{15}{4}, s_n = \frac{(1/4) - (1/4)2^n}{1 - 2} = -\frac{1}{4} + \frac{1}{4}(2^n)$, $\lim_{n \rightarrow +\infty} s_n = +\infty$, diverges.

(c) $\frac{1}{(k+1)(k+2)} = \frac{1}{k+1} - \frac{1}{k+2}, s_1 = \frac{1}{6}, s_2 = \frac{1}{4}, s_3 = \frac{3}{10}, s_4 = \frac{1}{3}; s_n = \frac{1}{2} - \frac{1}{n+2}, \lim_{n \rightarrow +\infty} s_n = \frac{1}{2}$, converges.

2. (a) $s_1 = 1/4, s_2 = 5/16, s_3 = 21/64, s_4 = 85/256, s_n = \frac{1}{4} \left(1 + \frac{1}{4} + \dots + \left(\frac{1}{4}\right)^{n-1} \right) = \frac{1}{4} \frac{1 - (1/4)^n}{1 - 1/4} = \frac{1}{3} \left(1 - \left(\frac{1}{4}\right)^n \right); \lim_{n \rightarrow +\infty} s_n = \frac{1}{3}$.

(b) $s_1 = 1, s_2 = 5, s_3 = 21, s_4 = 85; s_n = \frac{4^n - 1}{3}$, diverges.

(c) $s_1 = 1/20, s_2 = 1/12, s_3 = 3/28, s_4 = 1/8; s_n = \sum_{k=1}^n \left(\frac{1}{k+3} - \frac{1}{k+4} \right) = \frac{1}{4} - \frac{1}{n+4}, \lim_{n \rightarrow +\infty} s_n = 1/4$.

3. Geometric, $a = 1, r = -3/4, |r| = 3/4 < 1$, series converges, sum = $\frac{1}{1 - (-3/4)} = 4/7$.

4. Geometric, $a = (2/3)^3, r = 2/3, |r| = 2/3 < 1$, series converges, sum = $\frac{(2/3)^3}{1 - 2/3} = 8/9$.

5. Geometric, $a = 7, r = -1/6, |r| = 1/6 < 1$, series converges, sum = $\frac{7}{1 + 1/6} = 6$.

6. Geometric, $r = -3/2, |r| = 3/2 \geq 1$, diverges.

7. $s_n = \sum_{k=1}^n \left(\frac{1}{k+2} - \frac{1}{k+3} \right) = \frac{1}{3} - \frac{1}{n+3}$, $\lim_{n \rightarrow +\infty} s_n = 1/3$, series converges by definition, sum = 1/3.
8. $s_n = \sum_{k=1}^n \left(\frac{1}{2^k} - \frac{1}{2^{k+1}} \right) = \frac{1}{2} - \frac{1}{2^{n+1}}$, $\lim_{n \rightarrow +\infty} s_n = 1/2$, series converges by definition, sum = 1/2.
9. $s_n = \sum_{k=1}^n \left(\frac{1/3}{3k-1} - \frac{1/3}{3k+2} \right) = \frac{1}{6} - \frac{1/3}{3n+2}$, $\lim_{n \rightarrow +\infty} s_n = 1/6$, series converges by definition, sum = 1/6.
10. $s_n = \sum_{k=2}^{n+1} \left[\frac{1/2}{k-1} - \frac{1/2}{k+1} \right] = \frac{1}{2} \left[\sum_{k=2}^{n+1} \frac{1}{k-1} - \sum_{k=2}^{n+1} \frac{1}{k+1} \right] = \frac{1}{2} \left[\sum_{k=2}^{n+1} \frac{1}{k-1} - \sum_{k=4}^{n+3} \frac{1}{k-1} \right] =$
 $= \frac{1}{2} \left[1 + \frac{1}{2} - \frac{1}{n+1} - \frac{1}{n+2} \right]$; $\lim_{n \rightarrow +\infty} s_n = \frac{3}{4}$, series converges by definition, sum = 3/4.
11. $\sum_{k=3}^{\infty} \frac{1}{k-2} = \sum_{k=1}^{\infty} 1/k$, the harmonic series, so the series diverges.
12. Geometric, $a = (e/\pi)^4$, $r = e/\pi$, $|r| = e/\pi < 1$, series converges, sum = $\frac{(e/\pi)^4}{1 - e/\pi} = \frac{e^4}{\pi^3(\pi - e)}$.
13. $\sum_{k=1}^{\infty} \frac{4^{k+2}}{7^{k-1}} = \sum_{k=1}^{\infty} 64 \left(\frac{4}{7} \right)^{k-1}$; geometric, $a = 64$, $r = 4/7$, $|r| = 4/7 < 1$, series converges, sum = $\frac{64}{1 - 4/7} = 448/3$.
14. Geometric, $a = 125$, $r = 125/7$, $|r| = 125/7 \geq 1$, diverges.
15. (a) Exercise 5 (b) Exercise 3 (c) Exercise 7 (d) Exercise 9
16. (a) Exercise 10 (b) Exercise 6 (c) Exercise 4 (d) Exercise 8
17. False; e.g. $a_n = 1/n$.
18. True, Theorem 9.3.3.
19. True.
20. True.
21. $0.9999 \dots = 0.9 + 0.09 + 0.009 + \dots = \frac{0.9}{1 - 0.1} = 1$.
22. $0.4444 \dots = 0.4 + 0.04 + 0.004 + \dots = \frac{0.4}{1 - 0.1} = 4/9$.
23. $5.373737 \dots = 5 + 0.37 + 0.0037 + 0.000037 + \dots = 5 + \frac{0.37}{1 - 0.01} = 5 + 37/99 = 532/99$.
24. $0.451141414 \dots = 0.451 + 0.00014 + 0.0000014 + 0.000000014 + \dots = 0.451 + \frac{0.00014}{1 - 0.01} = \frac{44663}{99000}$.
25. $0.a_1 a_2 \dots a_n 9999 \dots = 0.a_1 a_2 \dots a_n + 0.9(10^{-n}) + 0.09(10^{-n}) + \dots = 0.a_1 a_2 \dots a_n + \frac{0.9(10^{-n})}{1 - 0.1} = 0.a_1 a_2 \dots a_n + 10^{-n} = 0.a_1 a_2 \dots (a_n + 1) = 0.a_1 a_2 \dots (a_n + 1) 0000 \dots$

26. The series converges to $1/(1-x)$ only if $-1 < x < 1$.

27. $d = 10 + 2 \cdot \frac{3}{4} \cdot 10 + 2 \cdot \frac{3}{4} \cdot \frac{3}{4} \cdot 10 + 2 \cdot \frac{3}{4} \cdot \frac{3}{4} \cdot \frac{3}{4} \cdot 10 + \dots = 10 + 20 \left(\frac{3}{4}\right) + 20 \left(\frac{3}{4}\right)^2 + 20 \left(\frac{3}{4}\right)^3 + \dots = 10 + \frac{20(3/4)}{1-3/4} = 10 + 60 = 70$ meters.

28. Volume = $1^3 + \left(\frac{1}{2}\right)^3 + \left(\frac{1}{4}\right)^3 + \dots + \left(\frac{1}{2^n}\right)^3 + \dots = 1 + \frac{1}{8} + \left(\frac{1}{8}\right)^2 + \dots + \left(\frac{1}{8}\right)^n + \dots = \frac{1}{1-(1/8)} = 8/7$.

29. (a) $s_n = \ln \frac{1}{2} + \ln \frac{2}{3} + \ln \frac{3}{4} + \dots + \ln \frac{n}{n+1} = \ln \left(\frac{1}{2} \cdot \frac{2}{3} \cdot \frac{3}{4} \dots \frac{n}{n+1}\right) = \ln \frac{1}{n+1} = -\ln(n+1)$, $\lim_{n \rightarrow +\infty} s_n = -\infty$, series diverges.

(b) $\ln(1 - 1/k^2) = \ln \frac{k^2 - 1}{k^2} = \ln \frac{(k-1)(k+1)}{k^2} = \ln \frac{k-1}{k} + \ln \frac{k+1}{k} = \ln \frac{k-1}{k} - \ln \frac{k}{k+1}$, so

$s_n = \sum_{k=2}^{n+1} \left[\ln \frac{k-1}{k} - \ln \frac{k}{k+1} \right] = \left(\ln \frac{1}{2} - \ln \frac{2}{3} \right) + \left(\ln \frac{2}{3} - \ln \frac{3}{4} \right) + \left(\ln \frac{3}{4} - \ln \frac{4}{5} \right) + \dots + \left(\ln \frac{n}{n+1} - \ln \frac{n+1}{n+2} \right) = \ln \frac{1}{2} - \ln \frac{n+1}{n+2}$, and then $\lim_{n \rightarrow +\infty} s_n = \ln \frac{1}{2} = -\ln 2$.

30. (a) $\sum_{k=0}^{\infty} (-1)^k x^k = 1 - x + x^2 - x^3 + \dots = \frac{1}{1-(-x)} = \frac{1}{1+x}$ if $|-x| < 1$, $|x| < 1$, $-1 < x < 1$.

(b) $\sum_{k=0}^{\infty} (x-3)^k = 1 + (x-3) + (x-3)^2 + \dots = \frac{1}{1-(x-3)} = \frac{1}{4-x}$ if $|x-3| < 1$, $2 < x < 4$.

(c) $\sum_{k=0}^{\infty} (-1)^k x^{2k} = 1 - x^2 + x^4 - x^6 + \dots = \frac{1}{1-(-x^2)} = \frac{1}{1+x^2}$ if $|-x^2| < 1$, $|x| < 1$, $-1 < x < 1$.

31. (a) Geometric series, $a = x$, $r = -x^2$. Converges for $|-x^2| < 1$, $|x| < 1$; $S = \frac{x}{1-(-x^2)} = \frac{x}{1+x^2}$.

(b) Geometric series, $a = 1/x^2$, $r = 2/x$. Converges for $|2/x| < 1$, $|x| > 2$; $S = \frac{1/x^2}{1-2/x} = \frac{1}{x^2-2x}$.

(c) Geometric series, $a = e^{-x}$, $r = e^{-x}$. Converges for $|e^{-x}| < 1$, $e^{-x} < 1$, $e^x > 1$, $x > 0$; $S = \frac{e^{-x}}{1-e^{-x}} = \frac{1}{e^x-1}$.

32. Geometric series, $a = \sin x$, $r = -\frac{1}{2} \sin x$. Converges for $|\frac{1}{2} \sin x| < 1$, $|\sin x| < 2$, so converges for all values of x . $S = \frac{\sin x}{1 + \frac{1}{2} \sin x} = \frac{2 \sin x}{2 + \sin x}$.

33. $a_2 = \frac{1}{2}a_1 + \frac{1}{2}$, $a_3 = \frac{1}{2}a_2 + \frac{1}{2} = \frac{1}{2^2}a_1 + \frac{1}{2^2} + \frac{1}{2}$, $a_4 = \frac{1}{2}a_3 + \frac{1}{2} = \frac{1}{2^3}a_1 + \frac{1}{2^3} + \frac{1}{2^2} + \frac{1}{2}$, $a_5 = \frac{1}{2}a_4 + \frac{1}{2} = \frac{1}{2^4}a_1 + \frac{1}{2^4} + \frac{1}{2^3} + \frac{1}{2^2} + \frac{1}{2}$, \dots , $a_n = \frac{1}{2^{n-1}}a_1 + \frac{1}{2^{n-1}} + \frac{1}{2^{n-2}} + \dots + \frac{1}{2}$, $\lim_{n \rightarrow +\infty} a_n = \lim_{n \rightarrow +\infty} \frac{a_1}{2^{n-1}} + \sum_{n=1}^{\infty} \left(\frac{1}{2}\right)^n = 0 + \frac{1/2}{1-1/2} = 1$.

34. $\frac{\sqrt{k+1} - \sqrt{k}}{\sqrt{k^2+k}} = \frac{\sqrt{k+1} - \sqrt{k}}{\sqrt{k}\sqrt{k+1}} = \frac{1}{\sqrt{k}} - \frac{1}{\sqrt{k+1}}$, $s_n = \sum_{k=1}^n \left(\frac{1}{\sqrt{k}} - \frac{1}{\sqrt{k+1}}\right) = \left(\frac{1}{\sqrt{1}} - \frac{1}{\sqrt{2}}\right) + \left(\frac{1}{\sqrt{2}} - \frac{1}{\sqrt{3}}\right) + \left(\frac{1}{\sqrt{3}} - \frac{1}{\sqrt{4}}\right) + \dots + \left(\frac{1}{\sqrt{n}} - \frac{1}{\sqrt{n+1}}\right) = 1 - \frac{1}{\sqrt{n+1}}$; $\lim_{n \rightarrow +\infty} s_n = 1$.

$$35. s_n = (1 - 1/3) + (1/2 - 1/4) + (1/3 - 1/5) + (1/4 - 1/6) + \dots + [1/n - 1/(n+2)] = (1 + 1/2 + 1/3 + \dots + 1/n) - (1/3 + 1/4 + 1/5 + \dots + 1/(n+2)) = 3/2 - 1/(n+1) - 1/(n+2), \lim_{n \rightarrow +\infty} s_n = 3/2.$$

$$36. s_n = \sum_{k=1}^n \frac{1}{k(k+2)} = \sum_{k=1}^n \left[\frac{1/2}{k} - \frac{1/2}{k+2} \right] = \frac{1}{2} \left[\sum_{k=1}^n \frac{1}{k} - \sum_{k=1}^n \frac{1}{k+2} \right] = \frac{1}{2} \left[\sum_{k=1}^n \frac{1}{k} - \sum_{k=3}^{n+2} \frac{1}{k} \right] = \frac{1}{2} \left[1 + \frac{1}{2} - \frac{1}{n+1} - \frac{1}{n+2} \right]; \lim_{n \rightarrow +\infty} s_n = \frac{3}{4}.$$

$$37. s_n = \sum_{k=1}^n \frac{1}{(2k-1)(2k+1)} = \sum_{k=1}^n \left[\frac{1/2}{2k-1} - \frac{1/2}{2k+1} \right] = \frac{1}{2} \left[\sum_{k=1}^n \frac{1}{2k-1} - \sum_{k=1}^n \frac{1}{2k+1} \right] = \frac{1}{2} \left[\sum_{k=1}^n \frac{1}{2k-1} - \sum_{k=2}^{n+1} \frac{1}{2k-1} \right] = \frac{1}{2} \left[1 - \frac{1}{2n+1} \right]; \lim_{n \rightarrow +\infty} s_n = \frac{1}{2}.$$

$$38. A_1 + A_2 + A_3 + \dots = 1 + 1/2 + 1/4 + \dots = \frac{1}{1 - (1/2)} = 2.$$

$$39. \text{By inspection, } \frac{\theta}{2} - \frac{\theta}{4} + \frac{\theta}{8} - \frac{\theta}{16} + \dots = \frac{\theta/2}{1 - (-1/2)} = \theta/3.$$

$$40. \text{(a) Geometric; } 18/5. \quad \text{(b) Geometric; diverges.} \quad \text{(c) } \sum_{k=1}^{\infty} \frac{1}{2} \left(\frac{1}{2k-1} - \frac{1}{2k+1} \right) = 1/2.$$

Exercise Set 9.4

$$1. \text{(a) } \sum_{k=1}^{\infty} \frac{1}{2^k} = \frac{1/2}{1 - 1/2} = 1; \sum_{k=1}^{\infty} \frac{1}{4^k} = \frac{1/4}{1 - 1/4} = 1/3; \sum_{k=1}^{\infty} \left(\frac{1}{2^k} + \frac{1}{4^k} \right) = 1 + 1/3 = 4/3.$$

$$\text{(b) } \sum_{k=1}^{\infty} \frac{1}{5^k} = \frac{1/5}{1 - 1/5} = 1/4; \sum_{k=1}^{\infty} \frac{1}{k(k+1)} = 1, \text{ (Ex. 5, Section 9.3); } \sum_{k=1}^{\infty} \left[\frac{1}{5^k} - \frac{1}{k(k+1)} \right] = 1/4 - 1 = -3/4.$$

$$2. \text{(a) } \sum_{k=2}^{\infty} \frac{1}{k^2 - 1} = 3/4 \text{ (Ex. 10, Section 9.3); } \sum_{k=2}^{\infty} \frac{7}{10^{k-1}} = \frac{7/10}{1 - 1/10} = 7/9; \text{ so } \sum_{k=2}^{\infty} \left[\frac{1}{k^2 - 1} - \frac{7}{10^{k-1}} \right] = 3/4 - 7/9 = -1/36.$$

$$\text{(b) With } a = 9/7, r = 3/7, \text{ geometric, } \sum_{k=1}^{\infty} 7^{-k} 3^{k+1} = \frac{9/7}{1 - (3/7)} = 9/4; \text{ with } a = 4/5, r = 2/5, \text{ geometric, } \sum_{k=1}^{\infty} \frac{2^{k+1}}{5^k} = \frac{4/5}{1 - (2/5)} = 4/3; \sum_{k=1}^{\infty} \left[7^{-k} 3^{k+1} - \frac{2^{k+1}}{5^k} \right] = 9/4 - 4/3 = 11/12.$$

$$3. \text{(a) } p=3 > 1, \text{ converges.} \quad \text{(b) } p=1/2 \leq 1, \text{ diverges.} \quad \text{(c) } p=1 \leq 1, \text{ diverges.} \quad \text{(d) } p=2/3 \leq 1, \text{ diverges.}$$

$$4. \text{(a) } p=4/3 > 1, \text{ converges.} \quad \text{(b) } p=1/4 \leq 1, \text{ diverges.} \quad \text{(c) } p=5/3 > 1, \text{ converges.} \quad \text{(d) } p=\pi > 1, \text{ converges.}$$

$$5. \text{(a) } \lim_{k \rightarrow +\infty} \frac{k^2 + k + 3}{2k^2 + 1} = \frac{1}{2} \neq 0; \text{ the series diverges.} \quad \text{(b) } \lim_{k \rightarrow +\infty} \left(1 + \frac{1}{k} \right)^k = e \neq 0; \text{ the series diverges.}$$

$$\text{(c) } \lim_{k \rightarrow +\infty} \cos k\pi \text{ does not exist; the series diverges.} \quad \text{(d) } \lim_{k \rightarrow +\infty} \frac{1}{k!} = 0; \text{ no information.}$$

6. (a) $\lim_{k \rightarrow +\infty} \frac{k}{e^k} = 0$; no information. (b) $\lim_{k \rightarrow +\infty} \ln k = +\infty \neq 0$; the series diverges.
- (c) $\lim_{k \rightarrow +\infty} \frac{1}{\sqrt{k}} = 0$; no information. (d) $\lim_{k \rightarrow +\infty} \frac{\sqrt{k}}{\sqrt{k} + 3} = 1 \neq 0$; the series diverges.
7. (a) $\int_1^{+\infty} \frac{1}{5x+2} dx = \lim_{\ell \rightarrow +\infty} \left. \frac{1}{5} \ln(5x+2) \right|_1^\ell = +\infty$, the series diverges by the Integral Test (which can be applied, because the series has positive terms, and f is decreasing and continuous).
- (b) $\int_1^{+\infty} \frac{1}{1+9x^2} dx = \lim_{\ell \rightarrow +\infty} \left. \frac{1}{3} \tan^{-1} 3x \right|_1^\ell = \frac{1}{3} (\pi/2 - \tan^{-1} 3)$, the series converges by the Integral Test (which can be applied, because the series has positive terms, and f is decreasing and continuous).
8. (a) $\int_1^{+\infty} \frac{x}{1+x^2} dx = \lim_{\ell \rightarrow +\infty} \left. \frac{1}{2} \ln(1+x^2) \right|_1^\ell = +\infty$, the series diverges by the Integral Test (which can be applied, because the series has positive terms, and f is decreasing and continuous).
- (b) $\int_1^{+\infty} (4+2x)^{-3/2} dx = \lim_{\ell \rightarrow +\infty} \left. -1/\sqrt{4+2x} \right|_1^\ell = 1/\sqrt{6}$, the series converges by the Integral Test (which can be applied, because the series has positive terms, and f is decreasing and continuous).
9. $\sum_{k=1}^{\infty} \frac{1}{k+6} = \sum_{k=7}^{\infty} \frac{1}{k}$, diverges because the harmonic series diverges.
10. $\sum_{k=1}^{\infty} \frac{3}{5k} = \sum_{k=1}^{\infty} \frac{3}{5} \left(\frac{1}{k} \right)$, diverges because the harmonic series diverges.
11. $\sum_{k=1}^{\infty} \frac{1}{\sqrt{k+5}} = \sum_{k=6}^{\infty} \frac{1}{\sqrt{k}}$, diverges because the p -series with $p = 1/2 \leq 1$ diverges.
12. $\lim_{k \rightarrow +\infty} \frac{1}{e^{1/k}} = 1$, the series diverges by the Divergence Test, because $\lim_{k \rightarrow +\infty} u_k = 1 \neq 0$.
13. $\int_1^{+\infty} (2x-1)^{-1/3} dx = \lim_{\ell \rightarrow +\infty} \left. \frac{3}{4} (2x-1)^{2/3} \right|_1^\ell = +\infty$, the series diverges by the Integral Test (which can be applied, because the series has positive terms, and f is decreasing and continuous).
14. $\frac{\ln x}{x}$ is decreasing for $x \geq e$, and $\int_3^{+\infty} \frac{\ln x}{x} dx = \lim_{\ell \rightarrow +\infty} \left. \frac{1}{2} (\ln x)^2 \right|_3^\ell = +\infty$, so the series diverges by the Integral Test (which can be applied, because the series has positive terms, and f is decreasing and continuous).
15. $\lim_{k \rightarrow +\infty} \frac{k}{\ln(k+1)} = \lim_{k \rightarrow +\infty} \frac{1}{1/(k+1)} = +\infty$, the series diverges by the Divergence Test, because $\lim_{k \rightarrow +\infty} u_k \neq 0$.
16. $\int_1^{+\infty} x e^{-x^2} dx = \lim_{\ell \rightarrow +\infty} \left. -\frac{1}{2} e^{-x^2} \right|_1^\ell = e^{-1}/2$, the series converges by the Integral Test (which can be applied, because the series has positive terms, and f is decreasing and continuous).
17. $\lim_{k \rightarrow +\infty} (1+1/k)^{-k} = 1/e \neq 0$, the series diverges by the Divergence Test.

18. $\lim_{k \rightarrow +\infty} \frac{k^2 + 1}{k^2 + 3} = 1 \neq 0$, the series diverges by the Divergence Test.

19. $\int_1^{+\infty} \frac{\tan^{-1} x}{1+x^2} dx = \lim_{\ell \rightarrow +\infty} \frac{1}{2} (\tan^{-1} x)^2 \Big|_1^\ell = 3\pi^2/32$, the series converges by the Integral Test (which can be applied, because the series has positive terms, and f is decreasing and continuous), since $\frac{d}{dx} \frac{\tan^{-1} x}{1+x^2} = \frac{1-2x \tan^{-1} x}{(1+x^2)^2} < 0$ for $x \geq 1$.

20. $\int_1^{+\infty} \frac{1}{\sqrt{x^2+1}} dx = \lim_{\ell \rightarrow +\infty} \sinh^{-1} x \Big|_1^\ell = +\infty$, the series diverges by the Integral Test (which can be applied, because the series has positive terms, and f is decreasing and continuous).

21. $\lim_{k \rightarrow +\infty} k^2 \sin^2(1/k) = 1 \neq 0$, the series diverges by the Divergence Test.

22. $\int_1^{+\infty} x^2 e^{-x^3} dx = \lim_{\ell \rightarrow +\infty} -\frac{1}{3} e^{-x^3} \Big|_1^\ell = e^{-1}/3$, the series converges by the Integral Test (which can be applied, because $x^2 e^{-x^3}$ is decreasing for $x \geq 1$, it is continuous and the series has positive terms).

23. $7 \sum_{k=5}^{\infty} k^{-1.01}$, p -series with $p = 1.01 > 1$, converges.

24. $\int_1^{+\infty} \operatorname{sech}^2 x dx = \lim_{\ell \rightarrow +\infty} \tanh x \Big|_1^\ell = 1 - \tanh(1)$, the series converges by the Integral Test (which can be applied, because the series has positive terms, and f is decreasing and continuous).

25. $\frac{1}{x(\ln x)^p}$ is decreasing for $x \geq e^{-p}$, so use the Integral Test (which can be applied, because f is continuous and the series has positive terms) with $a = e^\alpha$, i.e. $\int_{e^\alpha}^{+\infty} \frac{dx}{x(\ln x)^p}$ to get $\lim_{\ell \rightarrow +\infty} \ln(\ln x) \Big|_{e^\alpha}^\ell = +\infty$ if $p = 1$,
 $\lim_{\ell \rightarrow +\infty} \frac{(\ln x)^{1-p}}{1-p} \Big|_{e^\alpha}^\ell = \begin{cases} +\infty & \text{if } p < 1 \\ \frac{\alpha^{1-p}}{p-1} & \text{if } p > 1 \end{cases}$. Thus the series converges for $p > 1$.

26. If $p > 0$ set $g(x) = x(\ln x)[\ln(\ln x)]^p$, $g'(x) = (\ln(\ln x))^{p-1} [(1 + \ln x) \ln(\ln x) + p]$, and, for $x > e^e$, $g'(x) > 0$, thus $1/g(x)$ is decreasing for $x > e^e$; use the Integral Test with $\int_{e^e}^{+\infty} \frac{dx}{x(\ln x)[\ln(\ln x)]^p}$ to get $\lim_{\ell \rightarrow +\infty} \ln[\ln(\ln x)] \Big|_{e^e}^\ell = +\infty$
if $p = 1$, $\lim_{\ell \rightarrow +\infty} \frac{[\ln(\ln x)]^{1-p}}{1-p} \Big|_{e^e}^\ell = \begin{cases} +\infty & \text{if } p < 1, \\ \frac{1}{p-1} & \text{if } p > 1 \end{cases}$. Thus the series converges for $p > 1$ and diverges for $0 < p \leq 1$. If $p \leq 0$ then $\frac{[\ln(\ln x)]^{-p}}{x \ln x} \geq \frac{1}{x \ln x}$ for $x > e^e$ so the series diverges, since $\int \frac{1}{x \ln x} dx$ is divergent by Exercise 25. (The Integral Test can be applied, because f is continuous and the series has positive terms).

27. Suppose $\sum(u_k + v_k)$ converges; then so does $\sum[(u_k + v_k) - u_k]$, but $\sum[(u_k + v_k) - u_k] = \sum v_k$, so $\sum v_k$ converges which contradicts the assumption that $\sum v_k$ diverges. Suppose $\sum(u_k - v_k)$ converges; then so does $\sum[u_k - (u_k - v_k)] = \sum v_k$ which leads to the same contradiction as before.

28. Let $u_k = 2/k$ and $v_k = 1/k$; then both $\sum(u_k + v_k)$ and $\sum(u_k - v_k)$ diverge; let $u_k = 1/k$ and $v_k = -1/k$ then $\sum(u_k + v_k)$ converges; let $u_k = v_k = 1/k$ then $\sum(u_k - v_k)$ converges.

29. (a) Diverges because $\sum_{k=1}^{\infty} (2/3)^{k-1}$ converges (geometric series, $r = 2/3$, $|r| < 1$) and $\sum_{k=1}^{\infty} 1/k$ diverges (the harmonic series).

(b) Diverges because $\sum_{k=1}^{\infty} 1/(3k + 2)$ diverges (Integral Test) and $\sum_{k=1}^{\infty} 1/k^{3/2}$ converges (p -series, $p = 3/2 > 1$).

30. (a) Converges because both $\sum_{k=2}^{\infty} \frac{1}{k(\ln k)^2}$ (Exercise 25) and $\sum_{k=2}^{\infty} \frac{1}{k^2}$ converge (p -series, $p = 2 > 1$).

(b) Diverges, because $\sum_{k=2}^{+\infty} ke^{-k^2}$ converges (Integral Test), and, by Exercise 25, $\sum_{k=2}^{+\infty} \frac{1}{k \ln k}$ diverges.

31. False; if $\sum u_k$ converges then $\lim u_k = 0$, so $\lim \frac{1}{u_k}$ diverges, so $\sum \frac{1}{u_k}$ cannot converge.

32. True; if $\sum cu_k$ diverges then $c \neq 0$ so $\sum u_k$ diverges.

33. True, see Theorem 9.4.4.

34. False, $\sum_{k=1}^{\infty} \frac{1}{k^p}$ is a p -series.

35. (a) $3 \sum_{k=1}^{\infty} \frac{1}{k^2} - \sum_{k=1}^{\infty} \frac{1}{k^4} = \pi^2/2 - \pi^4/90$. (b) $\sum_{k=1}^{\infty} \frac{1}{k^2} - 1 - \frac{1}{2^2} = \pi^2/6 - 5/4$. (c) $\sum_{k=2}^{\infty} \frac{1}{(k-1)^4} = \sum_{k=1}^{\infty} \frac{1}{k^4} = \pi^4/90$.

36. (a) If $S = \sum_{k=1}^{\infty} u_k$ and $s_n = \sum_{k=1}^n u_k$, then $S - s_n = \sum_{k=n+1}^{\infty} u_k$. Interpret u_k , $k = n + 1, n + 2, \dots$, as the areas of inscribed or circumscribed rectangles with height u_k and base of length one for the curve $y = f(x)$ to obtain the result.

(b) Add $s_n = \sum_{k=1}^n u_k$ to each term in the conclusion of part (a) to get the desired result: $s_n + \int_n^{+\infty} f(x) dx < \sum_{k=1}^{+\infty} u_k < s_n + \int_n^{+\infty} f(x) dx$.

37. (a) In Exercise 36 above let $f(x) = \frac{1}{x^2}$. Then $\int_n^{+\infty} f(x) dx = -\frac{1}{x} \Big|_n^{+\infty} = \frac{1}{n}$; use this result and the same result with $n + 1$ replacing n to obtain the desired result.

(b) $s_3 = 1 + 1/4 + 1/9 = 49/36$; $58/36 = s_3 + \frac{1}{4} < \frac{1}{6}\pi^2 < s_3 + \frac{1}{3} = 61/36$.

(d) $1/11 < \frac{1}{6}\pi^2 - s_{10} < 1/10$.

38. Apply Exercise 36 in each case:

(a) $f(x) = \frac{1}{(2x + 1)^2}$, $\int_n^{+\infty} f(x) dx = \frac{1}{2(2n + 1)}$, so $\frac{1}{46} < \sum_{k=1}^{\infty} \frac{1}{(2k + 1)^2} - s_{10} < \frac{1}{42}$.

$$(b) f(x) = \frac{1}{k^2 + 1}, \int_n^{+\infty} f(x) dx = \frac{\pi}{2} - \tan^{-1}(n), \text{ so } \pi/2 - \tan^{-1}(11) < \sum_{k=1}^{\infty} \frac{1}{k^2 + 1} - s_{10} < \pi/2 - \tan^{-1}(10).$$

$$(c) f(x) = \frac{x}{e^x}, \int_n^{+\infty} f(x) dx = (n+1)e^{-n}, \text{ so } 12e^{-11} < \sum_{k=1}^{\infty} \frac{k}{e^k} - s_{10} < 11e^{-10}.$$

39. (a) Let $S_n = \sum_{k=1}^n \frac{1}{k^4}$. By Exercise 36(a), with $f(x) = \frac{1}{x^4}$, the result follows.

(b) $h(x) = \frac{1}{3x^3} - \frac{1}{3(x+1)^3}$ is a decreasing function, and the smallest n such that $\left| \frac{1}{3n^3} - \frac{1}{3(n+1)^3} \right| \leq 0.001$ is $n = 6$.

(c) The midpoint of the interval indicated in Part c is $S_6 + \frac{\frac{1}{3 \cdot 6^3} + \frac{1}{3 \cdot 7^3}}{2} \approx 1.082381$. A calculator gives $\pi^4/90 \approx 1.08232$.

40. (a) Let $F(x) = \frac{1}{x}$, then $\int_1^n \frac{1}{x} dx = \ln n$ and $\int_1^{n+1} \frac{1}{x} dx = \ln(n+1)$, $u_1 = 1$, so $\ln(n+1) < s_n < 1 + \ln n$.

(b) $\ln(1,000,001) < s_{1,000,000} < 1 + \ln(1,000,000)$, $13 < s_{1,000,000} < 15$.

(c) $s_{10^9} < 1 + \ln 10^9 = 1 + 9 \ln 10 < 22$.

(d) $s_n > \ln(n+1) \geq 100$, $n \geq e^{100} - 1 \approx 2.688 \times 10^{43}$; $n = 2.69 \times 10^{43}$.

41. $x^2 e^{-x}$ is continuous, decreasing and positive for $x > 2$ so the Integral Test applies: $\int_1^{\infty} x^2 e^{-x} dx = -(x^2 + 2x + 2)e^{-x} \Big|_1^{\infty} = 5e^{-1}$ so the series converges.

42. (a) $f(x) = 1/(x^3 + 1)$ is continuous, decreasing and positive on the interval $[1, +\infty]$, so the Integral Test applies.

(c)

n	10	20	30	40	50	60	70	80	90	100
s_n	0.681980	0.685314	0.685966	0.686199	0.686307	0.686367	0.686403	0.686426	0.686442	0.686454

(e) Set $g(n) = \int_n^{+\infty} \frac{1}{x^3 + 1} dx = \frac{\sqrt{3}}{6} \pi + \frac{1}{6} \ln \frac{n^3 + 1}{(n+1)^3} - \frac{\sqrt{3}}{3} \tan^{-1} \left(\frac{2n-1}{\sqrt{3}} \right)$; for $n \geq 13$, $g(n) - g(n+1) \leq 0.0005$; $s_{13} + (g(13) + g(14))/2 \approx 0.6865$, so the sum ≈ 0.6865 to three decimal places.

Exercise Set 9.5

All convergence tests in this section require that the series have positive terms - this requirement is met in all these exercises.

1. (a) $\frac{1}{5k^2 - k} \leq \frac{1}{5k^2 - k^2} = \frac{1}{4k^2}$, $\sum_{k=1}^{\infty} \frac{1}{4k^2}$ converges, so the original series also converges.

(b) $\frac{3}{k - 1/4} > \frac{3}{k}$, $\sum_{k=1}^{\infty} \frac{3}{k}$ diverges, so the original series also diverges.

2. (a) $\frac{k+1}{k^2-k} > \frac{k}{k^2} = \frac{1}{k}$, $\sum_{k=2}^{\infty} \frac{1}{k}$ diverges, so the original series also diverges.
- (b) $\frac{2}{k^4+k} < \frac{2}{k^4}$, $\sum_{k=1}^{\infty} \frac{2}{k^4}$ converges, so the original series also converges.
3. (a) $\frac{1}{3^k+5} < \frac{1}{3^k}$, $\sum_{k=1}^{\infty} \frac{1}{3^k}$ converges, so the original series also converges.
- (b) $\frac{5 \sin^2 k}{k!} < \frac{5}{k!}$, $\sum_{k=1}^{\infty} \frac{5}{k!}$ converges, so the original series also converges.
4. (a) $\frac{\ln k}{k} > \frac{1}{k}$ for $k \geq 3$, $\sum_{k=1}^{\infty} \frac{1}{k}$ diverges, so the original series also diverges.
- (b) $\frac{k}{k^{3/2}-1/2} > \frac{k}{k^{3/2}} = \frac{1}{\sqrt{k}}$, $\sum_{k=1}^{\infty} \frac{1}{\sqrt{k}}$ diverges, so the original series also diverges.
5. Compare with the convergent series $\sum_{k=1}^{\infty} \frac{1}{k^5}$, $\rho = \lim_{k \rightarrow +\infty} \frac{4k^7 - 2k^6 + 6k^5}{8k^7 + k - 8} = 1/2$, which is finite and positive, therefore the original series converges.
6. Compare with the divergent series $\sum_{k=1}^{\infty} \frac{1}{k}$, $\rho = \lim_{k \rightarrow +\infty} \frac{k}{9k+6} = 1/9$, which is finite and positive, therefore the original series diverges.
7. Compare with the convergent series $\sum_{k=1}^{\infty} \frac{5}{3^k}$, $\rho = \lim_{k \rightarrow +\infty} \frac{3^k}{3^k+1} = 1$, which is finite and positive, therefore the original series converges.
8. Compare with the divergent series $\sum_{k=1}^{\infty} \frac{1}{k}$, $\rho = \lim_{k \rightarrow +\infty} \frac{k^2(k+3)}{(k+1)(k+2)(k+5)} = 1$, which is finite and positive, therefore the original series diverges.
9. Compare with the divergent series $\sum_{k=1}^{\infty} \frac{1}{k^{2/3}}$, $\rho = \lim_{k \rightarrow +\infty} \frac{k^{2/3}}{(8k^2-3k)^{1/3}} = \lim_{k \rightarrow +\infty} \frac{1}{(8-3/k)^{1/3}} = 1/2$, which is finite and positive, therefore the original series diverges.
10. Compare with the convergent series $\sum_{k=1}^{\infty} \frac{1}{k^{17}}$, $\rho = \lim_{k \rightarrow +\infty} \frac{k^{17}}{(2k+3)^{17}} = \lim_{k \rightarrow +\infty} \frac{1}{(2+3/k)^{17}} = 1/2^{17}$, which is finite and positive, therefore the original series converges.
11. $\rho = \lim_{k \rightarrow +\infty} \frac{3^{k+1}/(k+1)!}{3^k/k!} = \lim_{k \rightarrow +\infty} \frac{3}{k+1} = 0 < 1$, the series converges.
12. $\rho = \lim_{k \rightarrow +\infty} \frac{4^{k+1}/(k+1)^2}{4^k/k^2} = \lim_{k \rightarrow +\infty} \frac{4k^2}{(k+1)^2} = 4 > 1$, the series diverges.
13. $\rho = \lim_{k \rightarrow +\infty} \frac{k}{k+1} = 1$, the result is inconclusive.

14. $\rho = \lim_{k \rightarrow +\infty} \frac{(k+1)(1/2)^{k+1}}{k(1/2)^k} = \lim_{k \rightarrow +\infty} \frac{k+1}{2k} = 1/2 < 1$, the series converges.
15. $\rho = \lim_{k \rightarrow +\infty} \frac{(k+1)!/(k+1)^3}{k!/k^3} = \lim_{k \rightarrow +\infty} \frac{k^3}{(k+1)^2} = +\infty$, the series diverges.
16. $\rho = \lim_{k \rightarrow +\infty} \frac{(k+1)/[(k+1)^2+1]}{k/(k^2+1)} = \lim_{k \rightarrow +\infty} \frac{(k+1)(k^2+1)}{k(k^2+2k+2)} = 1$, the result is inconclusive.
17. $\rho = \lim_{k \rightarrow +\infty} \frac{3k+2}{2k-1} = 3/2 > 1$, the series diverges.
18. $\rho = \lim_{k \rightarrow +\infty} k/100 = +\infty$, the series diverges.
19. $\rho = \lim_{k \rightarrow +\infty} \frac{k^{1/k}}{5} = 1/5 < 1$, the series converges.
20. $\rho = \lim_{k \rightarrow +\infty} (1 - e^{-k}) = 1$, the result is inconclusive.
21. False; it uses terms from two different sequences.
22. True, Ratio Test.
23. True, Limit Comparison Test with $v_k = 1/k^2$.
24. False; it decides convergence based on a limit of k -th roots of the terms of the series.
25. Ratio Test, $\rho = \lim_{k \rightarrow +\infty} 7/(k+1) = 0$, converges.
26. Limit Comparison Test, compare with the divergent series $\sum_{k=1}^{\infty} 1/k$, $\rho = \lim_{k \rightarrow +\infty} \frac{k}{2k+1} = 1/2$, which is finite and positive, therefore the original series diverges.
27. Ratio Test, $\rho = \lim_{k \rightarrow +\infty} \frac{(k+1)^2}{5k^2} = 1/5 < 1$, converges.
28. Ratio Test, $\rho = \lim_{k \rightarrow +\infty} (10/3)(k+1) = +\infty$, diverges.
29. Ratio Test, $\rho = \lim_{k \rightarrow +\infty} e^{-1}(k+1)^{50}/k^{50} = e^{-1} < 1$, converges.
30. Limit Comparison Test, compare with the divergent series $\sum_{k=1}^{\infty} 1/k$.
31. Limit Comparison Test, compare with the convergent series $\sum_{k=1}^{\infty} 1/k^{5/2}$, $\rho = \lim_{k \rightarrow +\infty} \frac{k^3}{k^3+1} = 1$, converges.
32. $\frac{4}{2+3^k k} < \frac{4}{3^k k}$, $\sum_{k=1}^{\infty} \frac{4}{3^k k}$ converges (Ratio Test) so $\sum_{k=1}^{\infty} \frac{4}{2+3^k k}$ converges by the Comparison Test.
33. Limit Comparison Test, compare with the divergent series $\sum_{k=1}^{\infty} 1/k$, $\rho = \lim_{k \rightarrow +\infty} \frac{k}{\sqrt{k^2+k}} = 1$, diverges.

34. $\frac{2 + (-1)^k}{5^k} \leq \frac{3}{5^k}$, $\sum_{k=1}^{\infty} 3/5^k$ converges so $\sum_{k=1}^{\infty} \frac{2 + (-1)^k}{5^k}$ converges by the Comparison Test.

35. Limit Comparison Test, compare with the convergent series $\sum_{k=1}^{\infty} \frac{1}{k^{5/2}}$, $\rho = \lim_{k \rightarrow +\infty} \frac{k^3 + 2k^{5/2}}{k^3 + 3k^2 + 3k} = 1$, converges.

36. $\frac{4 + |\cos x|}{k^3} < \frac{5}{k^3}$, $\sum_{k=1}^{\infty} 5/k^3$ converges so $\sum_{k=1}^{\infty} \frac{4 + |\cos x|}{k^3}$ converges.

37. Limit Comparison Test, compare with the divergent series $\sum_{k=1}^{\infty} 1/\sqrt{k}$.

38. Ratio Test, $\rho = \lim_{k \rightarrow +\infty} (1 + 1/k)^{-k} = 1/e < 1$, converges.

39. Ratio Test, $\rho = \lim_{k \rightarrow +\infty} \frac{\ln(k+1)}{e \ln k} = \lim_{k \rightarrow +\infty} \frac{k}{e(k+1)} = 1/e < 1$, converges.

40. Ratio Test, $\rho = \lim_{k \rightarrow +\infty} \frac{k+1}{e^{2k+1}} = \lim_{k \rightarrow +\infty} \frac{1}{2e^{2k+1}} = 0$, converges.

41. Ratio Test, $\rho = \lim_{k \rightarrow +\infty} \frac{k+5}{4(k+1)} = 1/4$, converges.

42. Root Test, $\rho = \lim_{k \rightarrow +\infty} \left(\frac{k}{k+1} \right)^k = \lim_{k \rightarrow +\infty} \frac{1}{(1 + 1/k)^k} = 1/e$, converges.

43. Diverges by the Divergence Test, because $\lim_{k \rightarrow +\infty} \frac{1}{4 + 2^{-k}} = 1/4 \neq 0$.

44. $\sum_{k=1}^{\infty} \frac{\sqrt{k} \ln k}{k^3 + 1} = \sum_{k=2}^{\infty} \frac{\sqrt{k} \ln k}{k^3 + 1}$ because $\ln 1 = 0$, $\frac{\sqrt{k} \ln k}{k^3 + 1} < \frac{k \ln k}{k^3} = \frac{\ln k}{k^2}$, $\int_2^{+\infty} \frac{\ln x}{x^2} dx = \lim_{\ell \rightarrow +\infty} \left(-\frac{\ln x}{x} - \frac{1}{x} \right) \Big|_2^{\ell} = \frac{1}{2}(\ln 2 + 1)$, so $\sum_{k=2}^{\infty} \frac{\ln k}{k^2}$ converges and so does $\sum_{k=1}^{\infty} \frac{\sqrt{k} \ln k}{k^3 + 1}$.

45. $\frac{\tan^{-1} k}{k^2} < \frac{\pi/2}{k^2}$, $\sum_{k=1}^{\infty} \frac{\pi/2}{k^2}$ converges so $\sum_{k=1}^{\infty} \frac{\tan^{-1} k}{k^2}$ converges.

46. $\frac{5^k + k}{k! + 3} < \frac{5^k + 5^k}{k!} = \frac{2(5^k)}{k!}$, $\sum_{k=1}^{\infty} 2 \left(\frac{5^k}{k!} \right)$ converges (Ratio Test), so $\sum_{k=1}^{\infty} \frac{5^k + k}{k! + 3}$ converges.

47. Ratio Test, $\rho = \lim_{k \rightarrow +\infty} \frac{(k+1)^2}{(2k+2)(2k+1)} = 1/4$, converges.

48. Root Test: $\rho = \lim_{k \rightarrow +\infty} \frac{\pi(k+1)}{k^{1+1/k}} = \lim_{k \rightarrow +\infty} \pi \frac{k+1}{k} = \pi$, diverges.

49. $a_k = \frac{\ln k}{3^k}$, $\frac{a_{k+1}}{a_k} = \frac{\ln(k+1)}{\ln k} \frac{3^k}{3^{k+1}} \rightarrow \frac{1}{3}$, converges.

50. $a_k = \frac{\alpha^k}{k^\alpha}$, $\frac{a_{k+1}}{a_k} = \alpha \left(\frac{k+1}{k} \right)^\alpha \rightarrow \alpha$, converges if and only if $\alpha < 1$. ($\alpha = 1$: harmonic series)

51. $u_k = \frac{k!}{1 \cdot 3 \cdot 5 \cdot \dots \cdot (2k-1)}$, by the Ratio Test $\rho = \lim_{k \rightarrow +\infty} \frac{k+1}{2k+1} = 1/2$; converges.
52. $u_k = \frac{1 \cdot 3 \cdot 5 \cdot \dots \cdot (2k-1)}{(2k-1)!}$, by the Ratio Test $\rho = \lim_{k \rightarrow +\infty} \frac{1}{2k} = 0$; converges.
53. Set $g(x) = \sqrt{x} - \ln x$; $\frac{d}{dx}g(x) = \frac{1}{2\sqrt{x}} - \frac{1}{x} = 0$ only at $x = 4$. Since $\lim_{x \rightarrow 0^+} g(x) = \lim_{x \rightarrow +\infty} g(x) = +\infty$ it follows that $g(x)$ has its absolute minimum at $x = 4$, $g(4) = \sqrt{4} - \ln 4 > 0$, and thus $\sqrt{x} - \ln x > 0$ for $x > 0$.
- (a) $\frac{\ln k}{k^2} < \frac{\sqrt{k}}{k^2} = \frac{1}{k^{3/2}}$, $\sum_{k=1}^{\infty} \frac{1}{k^{3/2}}$ converges so $\sum_{k=1}^{\infty} \frac{\ln k}{k^2}$ converges.
- (b) $\frac{1}{(\ln k)^2} > \frac{1}{k}$, $\sum_{k=2}^{\infty} \frac{1}{k}$ diverges so $\sum_{k=2}^{\infty} \frac{1}{(\ln k)^2}$ diverges.
54. (b) $\rho = \lim_{k \rightarrow +\infty} \frac{\sin(\pi/k)}{\pi/k} = 1$ and $\sum_{k=1}^{\infty} \pi/k$ diverges, so the original series also diverges.
55. (a) $\cos x \approx 1 - x^2/2$, $1 - \cos\left(\frac{1}{k}\right) \approx \frac{1}{2k^2}$. (b) $\rho = \lim_{k \rightarrow +\infty} \frac{1 - \cos(1/k)}{1/k^2} = 1/2$, converges.
56. (a) If $\lim_{k \rightarrow +\infty} (a_k/b_k) = 0$ then for $k \geq K$, $a_k/b_k < 1$, $a_k < b_k$ so $\sum a_k$ converges by the Comparison Test.
- (b) If $\lim_{k \rightarrow +\infty} (a_k/b_k) = +\infty$ then for $k \geq K$, $a_k/b_k > 1$, $a_k > b_k$ so $\sum a_k$ diverges by the Comparison Test.
57. (a) If $\sum b_k$ converges, then set $M = \sum b_k$. Then $a_1 + a_2 + \dots + a_n \leq b_1 + b_2 + \dots + b_n \leq M$; apply Theorem 9.4.6 to get convergence of $\sum a_k$.
- (b) Assume the contrary, that $\sum b_k$ converges; then use part (a) of the Theorem to show that $\sum a_k$ converges, a contradiction.

Exercise Set 9.6

- For $a_k = \frac{1}{2k+1}$, $a_{k+1} < a_k$, $\lim_{k \rightarrow +\infty} a_k = 0$, $a_k > 0$.
- $a_k > 0$, $\frac{a_{k+1}}{a_k} = \frac{k+1}{3k} \leq \frac{2k}{3k} = \frac{2}{3}$ for $k \geq 1$, so $\{a_k\}$ is decreasing and tends to zero.
- Diverges by the Divergence Test, because $\lim_{k \rightarrow +\infty} a_k = \lim_{k \rightarrow +\infty} \frac{k+1}{3k+1} = 1/3 \neq 0$.
- Diverges by the Divergence Test, because $\lim_{k \rightarrow +\infty} a_k = \lim_{k \rightarrow +\infty} \frac{k+1}{\sqrt{k+1}} = +\infty \neq 0$.
- $e^{-k} > 0$, $\{e^{-k}\}$ is decreasing and $\lim_{k \rightarrow +\infty} e^{-k} = 0$, converges.
- $\frac{\ln k}{k} > 0$ ($k \geq 3$), $\left\{\frac{\ln k}{k}\right\}$ is decreasing and $\lim_{k \rightarrow +\infty} \frac{\ln k}{k} = 0$, converges.
- $\rho = \lim_{k \rightarrow +\infty} \frac{(3/5)^{k+1}}{(3/5)^k} = 3/5 < 1$, converges absolutely.

8. $\rho = \lim_{k \rightarrow +\infty} \frac{2}{k+1} = 0 < 1$, converges absolutely.
9. $\rho = \lim_{k \rightarrow +\infty} \frac{3k^2}{(k+1)^2} = 3 > 1$, diverges.
10. $\rho = \lim_{k \rightarrow +\infty} \frac{k+1}{5k} = 1/5 < 1$, converges absolutely.
11. $\rho = \lim_{k \rightarrow +\infty} \frac{(k+1)^3}{ek^3} = 1/e < 1$, converges absolutely.
12. $\rho = \lim_{k \rightarrow +\infty} \frac{(k+1)^{k+1}k!}{(k+1)!k^k} = \lim_{k \rightarrow +\infty} (1+1/k)^k = e > 1$, diverges.
13. Conditionally convergent: $\sum_{k=1}^{\infty} \frac{(-1)^{k+1}}{3k}$ converges by the Alternating Series Test, but $\sum_{k=1}^{\infty} \frac{1}{3k}$ diverges (Limit Comparison Test with the harmonic series).
14. Absolutely convergent: $\sum_{k=1}^{\infty} \frac{1}{k^{4/3}}$ converges (p -series, $p = 4/3 > 1$).
15. Divergent by the Divergence Test, $\lim_{k \rightarrow +\infty} a_k \neq 0$.
16. Absolutely convergent, use the Ratio Test for absolute convergence.
17. $\sum_{k=1}^{\infty} \frac{\cos k\pi}{k} = \sum_{k=1}^{\infty} \frac{(-1)^k}{k}$ is conditionally convergent: $\sum_{k=1}^{\infty} \frac{(-1)^k}{k}$ converges by the Alternating Series Test, but $\sum_{k=1}^{\infty} 1/k$ diverges (harmonic series).
18. Conditionally convergent: $\sum_{k=3}^{\infty} \frac{(-1)^k \ln k}{k}$ converges by the Alternating Series Test, but $\sum_{k=3}^{\infty} \frac{\ln k}{k}$ diverges (Comparison Test with $\sum 1/k$).
19. Conditionally convergent: $\sum_{k=1}^{\infty} (-1)^{k+1} \frac{k+2}{k(k+3)}$ converges by the Alternating Series Test, but $\sum_{k=1}^{\infty} \frac{k+2}{k(k+3)}$ diverges (Limit Comparison Test with $\sum 1/k$).
20. Conditionally convergent: $\sum_{k=1}^{\infty} \frac{(-1)^{k+1}k^2}{k^3+1}$ converges by the Alternating Series Test, but $\sum_{k=1}^{\infty} \frac{k^2}{k^3+1}$ diverges (Limit Comparison Test with $\sum 1/k$).
21. $\sum_{k=1}^{\infty} \sin(k\pi/2) = 1 + 0 - 1 + 0 + 1 + 0 - 1 + 0 + \dots$, divergent by the Divergence Test ($\lim_{k \rightarrow +\infty} \sin(k\pi/2)$ does not exist).
22. Absolutely convergent: $\sum_{k=1}^{\infty} \frac{|\sin k|}{k^3}$ converges (Comparison Test with the convergent p -series $\sum 1/k^3$).

23. Conditionally convergent: $\sum_{k=2}^{\infty} \frac{(-1)^k}{k \ln k}$ converges by the Alternating Series Test, but $\sum_{k=2}^{\infty} \frac{1}{k \ln k}$ diverges (Integral Test).
24. Conditionally convergent: $\sum_{k=1}^{\infty} \frac{(-1)^k}{\sqrt{k(k+1)}}$ converges by the Alternating Series Test, but $\sum_{k=1}^{\infty} \frac{1}{\sqrt{k(k+1)}}$ diverges (Limit Comparison Test with the harmonic series $\sum 1/k$).
25. Absolutely convergent: $\sum_{k=2}^{\infty} (1/\ln k)^k$ converges by the Root Test.
26. $\sum_{k=1}^{\infty} \frac{k \cos k\pi}{k^2 + 1} = \sum_{k=1}^{\infty} \frac{(-1)^k k}{k^2 + 1}$ is conditionally convergent: $\sum_{k=1}^{\infty} \frac{(-1)^k k}{k^2 + 1}$ converges by the Alternating Series Test, but $\sum_{k=1}^{\infty} \frac{k}{k^2 + 1}$ diverges (Limit Comparison Test with the harmonic series $\sum 1/k$).
27. Absolutely convergent by the Ratio Test, $\rho = \lim_{k \rightarrow +\infty} \frac{k+1}{(2k+1)(2k)} = 0 < 1$.
28. Divergent by the Divergence Test, $\lim_{k \rightarrow +\infty} a_k = +\infty$.
29. False; terms alternate by sign.
30. True.
31. True.
32. False, e.g. $u_k = 1/k$.
33. $|\text{error}| < a_8 = 1/8 = 0.125$.
34. $|\text{error}| < a_6 = 1/6! < 0.0014$.
35. $|\text{error}| < a_{100} = 1/\sqrt{100} = 0.1$.
36. $|\text{error}| < a_4 = 1/(5 \ln 5) < 0.125$.
37. $|\text{error}| < 0.0001$ if $a_{n+1} \leq 0.0001$, $1/(n+1) \leq 0.0001$, $n+1 \geq 10,000$, $n \geq 9,999$, $n = 9,999$.
38. $|\text{error}| < 0.00001$ if $a_{n+1} \leq 0.00001$, $1/(n+1)! \leq 0.00001$, $(n+1)! \geq 100,000$. But $8! = 40,320$, $9! = 362,880$ so $(n+1)! \geq 100,000$ if $n+1 \geq 9$, $n \geq 8$, $n = 8$.
39. $|\text{error}| < 0.005$ if $a_{n+1} \leq 0.005$, $1/\sqrt{n+1} \leq 0.005$, $\sqrt{n+1} \geq 200$, $n+1 \geq 40,000$, $n \geq 39,999$, $n = 39,999$.
40. $|\text{error}| < 0.05$ if $a_{n+1} \leq 0.05$, $1/[(n+2) \ln(n+2)] \leq 0.05$, $(n+2) \ln(n+2) \geq 20$. But $9 \ln 9 \approx 19.8$ and $10 \ln 10 \approx 23.0$ so $(n+2) \ln(n+2) \geq 20$ if $n+2 \geq 10$, $n \geq 8$, $n = 8$.
41. $a_k = \frac{3}{2^{k+1}}$, $|\text{error}| < a_{11} = \frac{3}{2^{12}} < 0.00074$; $s_{10} \approx 0.4995$; $S = \frac{3/4}{1 - (-1/2)} = 0.5$.
42. $a_k = \left(\frac{2}{3}\right)^{k-1}$, $|\text{error}| < a_{11} = \left(\frac{2}{3}\right)^{10} < 0.01735$; $s_{10} \approx 0.5896$; $S = \frac{1}{1 - (-2/3)} = 0.6$.

43. $a_k = \frac{1}{(2k-1)!}$, $a_{n+1} = \frac{1}{(2n+1)!} \leq 0.005$, $(2n+1)! \geq 200$, $2n+1 \geq 6$, $n \geq 2.5$; $n = 3$, $s_3 = 1 - 1/6 + 1/120 \approx 0.84$.

44. $a_k = \frac{1}{(2k-2)!}$, $a_{n+1} = \frac{1}{(2n)!} \leq 0.005$, $(2n)! \geq 200$, $2n \geq 6$, $n \geq 3$; $n = 3$, $s_3 \approx 0.54$.

45. $a_k = \frac{1}{k2^k}$, $a_{n+1} = \frac{1}{(n+1)2^{n+1}} \leq 0.005$, $(n+1)2^{n+1} \geq 200$, $n+1 \geq 6$, $n \geq 5$; $n = 5$, $s_5 \approx 0.41$.

46. $a_k = \frac{1}{(2k-1)^5 + 4(2k-1)}$, $a_{n+1} = \frac{1}{(2n+1)^5 + 4(2n+1)} \leq 0.005$, $(2n+1)^5 + 4(2n+1) \geq 200$, $2n+1 \geq 3$, $n \geq 1$; $n = 1$, $s_1 = 0.20$.

47. (c) $a_k = \frac{1}{2k-1}$, $a_{n+1} = \frac{1}{2n+1} \leq 10^{-2}$, $2n+1 \geq 100$, $n \geq 49.5$; $n = 50$.

48. Suppose $\sum |a_k|$ converges, then $\lim_{k \rightarrow +\infty} |a_k| = 0$ so $|a_k| < 1$ for $k \geq K$ and thus $|a_k|^2 < |a_k|$, $a_k^2 < |a_k|$ hence $\sum a_k^2$ converges by the Comparison Test.

49. (a) $\sum \frac{(-1)^k}{\sqrt{k}}$ converges but $\sum \frac{1}{k}$ diverges; $\sum \frac{(-1)^k}{k}$ converges and $\sum \frac{1}{k^2}$ converges.

(b) Let $a_k = \frac{(-1)^k}{k}$, then $\sum a_k^2$ converges but $\sum |a_k|$ diverges, $\sum a_k$ converges.

50. Note that, for all k , i) $p_k \leq u_k, q_k \leq |u_k|$, and ii) $u_k = p_k - q_k, |u_k| = p_k + q_k$.

(a) From inequalities i), if $\sum |u_k|$ converges, then so do $\sum p_k$ and $\sum q_k$. Conversely if they both converge then so does $\sum |u_k|$.

(b) From equations ii) it is not possible for exactly two of $\sum u_k, \sum p_k, \sum q_k$ to converge. Therefore if $\sum p_k$ or $\sum q_k$ converges (exclusive 'or'), then in both cases $\sum u_k$ must diverge.

(c) If $\sum u_k$ converges and $\sum |u_k|$ diverges, then from the second equality of ii) it follows that $\sum p_k$ or $\sum q_k$ (or both) is divergent, and from the first equality of ii) it follows that both must diverge.

51. Every positive integer can be written in exactly one of the three forms $2k-1$ or $4k-2$ or $4k$, so a rearrangement is

$$\left(1 - \frac{1}{2} - \frac{1}{4}\right) + \left(\frac{1}{3} - \frac{1}{6} - \frac{1}{8}\right) + \left(\frac{1}{5} - \frac{1}{10} - \frac{1}{12}\right) + \dots + \left(\frac{1}{2k-1} - \frac{1}{4k-2} - \frac{1}{4k}\right) + \dots = \left(\frac{1}{2} - \frac{1}{4}\right) + \left(\frac{1}{6} - \frac{1}{8}\right) + \left(\frac{1}{10} - \frac{1}{12}\right) + \dots + \left(\frac{1}{4k-2} - \frac{1}{4k}\right) + \dots = \frac{1}{2} \ln 2.$$

52. $1 + \frac{1}{3^2} + \frac{1}{5^2} + \dots = \left[1 + \frac{1}{2^2} + \frac{1}{3^2} + \dots\right] - \left[\frac{1}{2^2} + \frac{1}{4^2} + \frac{1}{6^2} + \dots\right] = \frac{\pi^2}{6} - \frac{1}{2^2} \left[1 + \frac{1}{2^2} + \frac{1}{3^2} + \dots\right] = \frac{\pi^2}{6} - \frac{1}{4} \frac{\pi^2}{6} = \frac{\pi^2}{8}$.

53. Let $A = 1 - \frac{1}{2^2} + \frac{1}{3^2} - \frac{1}{4^2} + \dots$; since the series all converge absolutely, $\frac{\pi^2}{6} - A = 2\frac{1}{2^2} + 2\frac{1}{4^2} + 2\frac{1}{6^2} + \dots = \frac{1}{2} \left(1 + \frac{1}{2^2} + \frac{1}{3^2} + \dots\right) = \frac{1}{2} \frac{\pi^2}{6}$, so $A = \frac{1}{2} \frac{\pi^2}{6} = \frac{\pi^2}{12}$.

54. $1 + \frac{1}{3^4} + \frac{1}{5^4} + \dots = \left[1 + \frac{1}{2^4} + \frac{1}{3^4} + \dots\right] - \left[\frac{1}{2^4} + \frac{1}{4^4} + \frac{1}{6^4} + \dots\right] = \frac{\pi^4}{90} - \frac{1}{2^4} \left[1 + \frac{1}{2^4} + \frac{1}{3^4} + \dots\right] = \frac{\pi^4}{90} - \frac{1}{16} \frac{\pi^4}{90} = \frac{\pi^4}{96}$.

Exercise Set 9.7

1. (a) $f^{(k)}(x) = (-1)^k e^{-x}$, $f^{(k)}(0) = (-1)^k$; $e^{-x} \approx 1 - x + x^2/2$ (quadratic), $e^{-x} \approx 1 - x$ (linear).
 (b) $f'(x) = -\sin x$, $f''(x) = -\cos x$, $f(0) = 1$, $f'(0) = 0$, $f''(0) = -1$, $\cos x \approx 1 - x^2/2$ (quadratic), $\cos x \approx 1$ (linear).
2. (a) $f'(x) = \cos x$, $f''(x) = -\sin x$, $f(\pi/2) = 1$, $f'(\pi/2) = 0$, $f''(\pi/2) = -1$, $\sin x \approx 1 - (x - \pi/2)^2/2$ (quadratic), $\sin x \approx 1$ (linear).
 (b) $f(1) = 1$, $f'(1) = 1/2$, $f''(1) = -1/4$; $\sqrt{x} = 1 + \frac{1}{2}(x-1) - \frac{1}{8}(x-1)^2$ (quadratic), $\sqrt{x} \approx 1 + \frac{1}{2}(x-1)$ (linear).
3. (a) $f'(x) = \frac{1}{2}x^{-1/2}$, $f''(x) = -\frac{1}{4}x^{-3/2}$; $f(1) = 1$, $f'(1) = \frac{1}{2}$, $f''(1) = -\frac{1}{4}$; $\sqrt{x} = 1 + \frac{1}{2}(x-1) - \frac{1}{8}(x-1)^2$.
 (b) $x = 1.1$, $x_0 = 1$, $\sqrt{1.1} \approx 1 + \frac{1}{2}(0.1) - \frac{1}{8}(0.1)^2 = 1.04875$, calculator value ≈ 1.0488088 .
4. (a) $\cos x \approx 1 - x^2/2$.
 (b) $2^\circ = \pi/90$ rad, $\cos 2^\circ = \cos(\pi/90) \approx 1 - \frac{\pi^2}{2 \cdot 90^2} \approx 0.99939077$, calculator value ≈ 0.99939083 .
5. $f(x) = \tan x$, $61^\circ = \pi/3 + \pi/180$ rad; $x_0 = \pi/3$, $f'(x) = \sec^2 x$, $f''(x) = 2 \sec^2 x \tan x$; $f(\pi/3) = \sqrt{3}$, $f'(\pi/3) = 4$, $f''(\pi/3) = 8\sqrt{3}$; $\tan x \approx \sqrt{3} + 4(x - \pi/3) + 4\sqrt{3}(x - \pi/3)^2$, $\tan 61^\circ = \tan(\pi/3 + \pi/180) \approx \sqrt{3} + 4\pi/180 + 4\sqrt{3}(\pi/180)^2 \approx 1.80397443$, calculator value ≈ 1.80404776 .
6. $f(x) = \sqrt{x}$, $x_0 = 36$, $f'(x) = \frac{1}{2}x^{-1/2}$, $f''(x) = -\frac{1}{4}x^{-3/2}$; $f(36) = 6$, $f'(36) = \frac{1}{12}$, $f''(36) = -\frac{1}{864}$; $\sqrt{x} \approx 6 + \frac{1}{12}(x-36) - \frac{1}{1728}(x-36)^2$; $\sqrt{36.03} \approx 6 + \frac{0.03}{12} - \frac{(0.03)^2}{1728} \approx 6.00249947917$, calculator value ≈ 6.00249947938 .
7. $f^{(k)}(x) = (-1)^k e^{-x}$, $f^{(k)}(0) = (-1)^k$; $p_0(x) = 1$, $p_1(x) = 1 - x$, $p_2(x) = 1 - x + \frac{1}{2}x^2$, $p_3(x) = 1 - x + \frac{1}{2}x^2 - \frac{1}{3!}x^3$, $p_4(x) = 1 - x + \frac{1}{2}x^2 - \frac{1}{3!}x^3 + \frac{1}{4!}x^4$; $\sum_{k=0}^n \frac{(-1)^k}{k!} x^k$.
8. $f^{(k)}(x) = a^k e^{ax}$, $f^{(k)}(0) = a^k$; $p_0(x) = 1$, $p_1(x) = 1 + ax$, $p_2(x) = 1 + ax + \frac{a^2}{2}x^2$, $p_3(x) = 1 + ax + \frac{a^2}{2}x^2 + \frac{a^3}{3!}x^3$, $p_4(x) = 1 + ax + \frac{a^2}{2}x^2 + \frac{a^3}{3!}x^3 + \frac{a^4}{4!}x^4$; $\sum_{k=0}^n \frac{a^k}{k!} x^k$.
9. $f^{(k)}(0) = 0$ if k is odd, $f^{(k)}(0)$ is alternately π^k and $-\pi^k$ if k is even; $p_0(x) = 1$, $p_1(x) = 1$, $p_2(x) = 1 - \frac{\pi^2}{2!}x^2$; $p_3(x) = 1 - \frac{\pi^2}{2!}x^2$, $p_4(x) = 1 - \frac{\pi^2}{2!}x^2 + \frac{\pi^4}{4!}x^4$; $\sum_{k=0}^{\lfloor \frac{n}{2} \rfloor} \frac{(-1)^k \pi^{2k}}{(2k)!} x^{2k}$.

NB: The function $[x]$ defined for real x indicates the greatest integer which is $\leq x$.

10. $f^{(k)}(0) = 0$ if k is even, $f^{(k)}(0)$ is alternately π^k and $-\pi^k$ if k is odd; $p_0(x) = 0$, $p_1(x) = \pi x$, $p_2(x) = \pi x$; $p_3(x) = \pi x - \frac{\pi^3}{3!}x^3$, $p_4(x) = \pi x - \frac{\pi^3}{3!}x^3$; $\sum_{k=0}^{\lfloor \frac{n-1}{2} \rfloor} \frac{(-1)^k \pi^{2k+1}}{(2k+1)!} x^{2k+1}$.

NB: If $n = 0$ then $\lfloor \frac{n-1}{2} \rfloor = -1$; by definition any sum which runs from $k = 0$ to $k = -1$ is called the 'empty sum' and has value 0.

11. $f^{(0)}(0) = 0$; for $k \geq 1$, $f^{(k)}(x) = \frac{(-1)^{k+1}(k-1)!}{(1+x)^k}$, $f^{(k)}(0) = (-1)^{k+1}(k-1)!$; $p_0(x) = 0$, $p_1(x) = x$, $p_2(x) = x - \frac{1}{2}x^2$, $p_3(x) = x - \frac{1}{2}x^2 + \frac{1}{3}x^3$, $p_4(x) = x - \frac{1}{2}x^2 + \frac{1}{3}x^3 - \frac{1}{4}x^4$; $\sum_{k=1}^n \frac{(-1)^{k+1}}{k} x^k$.

12. $f^{(k)}(x) = (-1)^k \frac{k!}{(1+x)^{k+1}}$; $f^{(k)}(0) = (-1)^k k!$; $p_0(x) = 1$, $p_1(x) = 1 - x$, $p_2(x) = 1 - x + x^2$, $p_3(x) = 1 - x + x^2 - x^3$, $p_4(x) = 1 - x + x^2 - x^3 + x^4$; $\sum_{k=0}^n (-1)^k x^k$.

13. $f^{(k)}(0) = 0$ if k is odd, $f^{(k)}(0) = 1$ if k is even; $p_0(x) = 1$, $p_1(x) = 1$, $p_2(x) = 1 + x^2/2$, $p_3(x) = 1 + x^2/2$, $p_4(x) = 1 + x^2/2 + x^4/4!$; $\sum_{k=0}^{\lfloor \frac{n}{2} \rfloor} \frac{1}{(2k)!} x^{2k}$.

14. $f^{(k)}(0) = 0$ if k is even, $f^{(k)}(0) = 1$ if k is odd; $p_0(x) = 0$, $p_1(x) = x$, $p_2(x) = x$, $p_3(x) = x + x^3/3!$, $p_4(x) = x + x^3/3!$; $\sum_{k=0}^{\lfloor \frac{n-1}{2} \rfloor} \frac{1}{(2k+1)!} x^{2k+1}$.

15. $f^{(k)}(x) = \begin{cases} (-1)^{k/2}(x \sin x - k \cos x) & k \text{ even} \\ (-1)^{(k-1)/2}(x \cos x + k \sin x) & k \text{ odd} \end{cases}$, $f^{(k)}(0) = \begin{cases} (-1)^{1+k/2}k & k \text{ even} \\ 0 & k \text{ odd} \end{cases}$. $p_0(x) = 0$, $p_1(x) = 0$, $p_2(x) = x^2$, $p_3(x) = x^2$, $p_4(x) = x^2 - \frac{1}{6}x^4$; $\sum_{k=0}^{\lfloor \frac{n}{2} \rfloor - 1} \frac{(-1)^k}{(2k+1)!} x^{2k+2}$.

16. $f^{(k)}(x) = (k+x)e^x$, $f^{(k)}(0) = k$; $p_0(x) = 0$, $p_1(x) = x$, $p_2(x) = x + x^2$, $p_3(x) = x + x^2 + \frac{1}{2}x^3$, $p_4(x) = x + x^2 + \frac{1}{2}x^3 + \frac{1}{3!}x^4$; $\sum_{k=1}^n \frac{1}{(k-1)!} x^k$.

17. $f^{(k)}(x_0) = e$; $p_0(x) = e$, $p_1(x) = e + e(x-1)$, $p_2(x) = e + e(x-1) + \frac{e}{2}(x-1)^2$, $p_3(x) = e + e(x-1) + \frac{e}{2}(x-1)^2 + \frac{e}{3!}(x-1)^3$, $p_4(x) = e + e(x-1) + \frac{e}{2}(x-1)^2 + \frac{e}{3!}(x-1)^3 + \frac{e}{4!}(x-1)^4$; $\sum_{k=0}^n \frac{e}{k!} (x-1)^k$.

18. $f^{(k)}(x) = (-1)^k e^{-x}$, $f^{(k)}(\ln 2) = (-1)^k \frac{1}{2}$; $p_0(x) = \frac{1}{2}$, $p_1(x) = \frac{1}{2} - \frac{1}{2}(x - \ln 2)$, $p_2(x) = \frac{1}{2} - \frac{1}{2}(x - \ln 2) + \frac{1}{2 \cdot 2}(x - \ln 2)^2$, $p_3(x) = \frac{1}{2} - \frac{1}{2}(x - \ln 2) + \frac{1}{2 \cdot 2}(x - \ln 2)^2 - \frac{1}{2 \cdot 3!}(x - \ln 2)^3$, $p_4(x) = \frac{1}{2} - \frac{1}{2}(x - \ln 2) + \frac{1}{2 \cdot 2}(x - \ln 2)^2 - \frac{1}{2 \cdot 3!}(x - \ln 2)^3 + \frac{1}{2 \cdot 4!}(x - \ln 2)^4$; $\sum_{k=0}^n \frac{(-1)^k}{2 \cdot k!} (x - \ln 2)^k$.

19. $f^{(k)}(x) = \frac{(-1)^k k!}{x^{k+1}}$, $f^{(k)}(-1) = -k!$; $p_0(x) = -1$, $p_1(x) = -1 - (x+1)$, $p_2(x) = -1 - (x+1) - (x+1)^2$, $p_3(x) = -1 - (x+1) - (x+1)^2 - (x+1)^3$, $p_4(x) = -1 - (x+1) - (x+1)^2 - (x+1)^3 - (x+1)^4$; $\sum_{k=0}^n (-1)(x+1)^k$.

20. $f^{(k)}(x) = \frac{(-1)^k k!}{(x+2)^{k+1}}$, $f^{(k)}(3) = \frac{(-1)^k k!}{5^{k+1}}$; $p_0(x) = \frac{1}{5}$, $p_1(x) = \frac{1}{5} - \frac{1}{25}(x-3)$, $p_2(x) = \frac{1}{5} - \frac{1}{25}(x-3) + \frac{1}{125}(x-3)^2$, $p_3(x) = \frac{1}{5} - \frac{1}{25}(x-3) + \frac{1}{125}(x-3)^2 - \frac{1}{625}(x-3)^3$, $p_4(x) = \frac{1}{5} - \frac{1}{25}(x-3) + \frac{1}{125}(x-3)^2 - \frac{1}{625}(x-3)^3 + \frac{1}{3125}(x-3)^4$; $\sum_{k=0}^n \frac{(-1)^k}{5^{k+1}} (x-3)^k$.

21. $f^{(k)}(1/2) = 0$ if k is odd, $f^{(k)}(1/2)$ is alternately π^k and $-\pi^k$ if k is even; $p_0(x) = p_1(x) = 1, p_2(x) = p_3(x) = 1 - \frac{\pi^2}{2}(x - 1/2)^2, p_4(x) = 1 - \frac{\pi^2}{2}(x - 1/2)^2 + \frac{\pi^4}{4!}(x - 1/2)^4; \sum_{k=0}^{\lfloor \frac{n}{2} \rfloor} \frac{(-1)^k \pi^{2k}}{(2k)!} (x - 1/2)^{2k}$.
22. $f^{(k)}(\pi/2) = 0$ if k is even, $f^{(k)}(\pi/2)$ is alternately -1 and 1 if k is odd; $p_0(x) = 0, p_1(x) = -(x - \pi/2), p_2(x) = -(x - \pi/2), p_3(x) = -(x - \pi/2) + \frac{1}{3!}(x - \pi/2)^3, p_4(x) = -(x - \pi/2) + \frac{1}{3!}(x - \pi/2)^3; \sum_{k=0}^{\lfloor \frac{n-1}{2} \rfloor} \frac{(-1)^{k+1}}{(2k+1)!} (x - \pi/2)^{2k+1}$.
23. $f(1) = 0$, for $k \geq 1, f^{(k)}(x) = \frac{(-1)^{k-1}(k-1)!}{x^k}; f^{(k)}(1) = (-1)^{k-1}(k-1)!; p_0(x) = 0, p_1(x) = (x-1); p_2(x) = (x-1) - \frac{1}{2}(x-1)^2; p_3(x) = (x-1) - \frac{1}{2}(x-1)^2 + \frac{1}{3}(x-1)^3, p_4(x) = (x-1) - \frac{1}{2}(x-1)^2 + \frac{1}{3}(x-1)^3 - \frac{1}{4}(x-1)^4; \sum_{k=1}^n \frac{(-1)^{k-1}}{k} (x-1)^k$.
24. $f(e) = 1$, for $k \geq 1, f^{(k)}(x) = \frac{(-1)^{k-1}(k-1)!}{x^k}; f^{(k)}(e) = \frac{(-1)^{k-1}(k-1)!}{e^k}; p_0(x) = 1, p_1(x) = 1 + \frac{1}{e}(x-e); p_2(x) = 1 + \frac{1}{e}(x-e) - \frac{1}{2e^2}(x-e)^2; p_3(x) = 1 + \frac{1}{e}(x-e) - \frac{1}{2e^2}(x-e)^2 + \frac{1}{3e^3}(x-e)^3, p_4(x) = 1 + \frac{1}{e}(x-e) - \frac{1}{2e^2}(x-e)^2 + \frac{1}{3e^3}(x-e)^3 - \frac{1}{4e^4}(x-e)^4; 1 + \sum_{k=1}^n \frac{(-1)^{k-1}}{ke^k} (x-e)^k$.
25. (a) $f(0) = 1, f'(0) = 2, f''(0) = -2, f'''(0) = 6$, the third MacLaurin polynomial for $f(x)$ is $f(x)$.
- (b) $f(1) = 1, f'(1) = 2, f''(1) = -2, f'''(1) = 6$, the third Taylor polynomial for $f(x)$ is $f(x)$.
26. (a) $f^{(k)}(0) = k!c_k$ for $k \leq n$; the n th Maclaurin polynomial for $f(x)$ is $f(x)$.
- (b) $f^{(k)}(x_0) = k!c_k$ for $k \leq n$; the n th Taylor polynomial about $x = 1$ for $f(x)$ is $f(x)$.
27. $f^{(k)}(0) = (-2)^k; p_0(x) = 1, p_1(x) = 1 - 2x, p_2(x) = 1 - 2x + 2x^2, p_3(x) = 1 - 2x + 2x^2 - \frac{4}{3}x^3$.

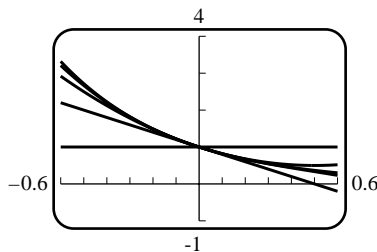

28. $f^{(k)}(\pi/2) = 0$ if k is odd, $f^{(k)}(\pi/2)$ is alternately 1 and -1 if k is even; $p_0(x) = 1, p_2(x) = 1 - \frac{1}{2}(x - \pi/2)^2, p_4(x) = 1 - \frac{1}{2}(x - \pi/2)^2 + \frac{1}{24}(x - \pi/2)^4, p_6(x) = 1 - \frac{1}{2}(x - \pi/2)^2 + \frac{1}{24}(x - \pi/2)^4 - \frac{1}{720}(x - \pi/2)^6$.

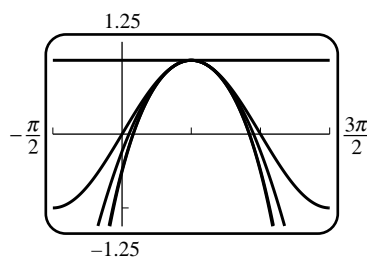

29. $f^{(k)}(\pi) = 0$ if k is odd, $f^{(k)}(\pi)$ is alternately -1 and 1 if k is even; $p_0(x) = -1$, $p_2(x) = -1 + \frac{1}{2}(x - \pi)^2$, $p_4(x) = -1 + \frac{1}{2}(x - \pi)^2 - \frac{1}{24}(x - \pi)^4$, $p_6(x) = -1 + \frac{1}{2}(x - \pi)^2 - \frac{1}{24}(x - \pi)^4 + \frac{1}{720}(x - \pi)^6$.

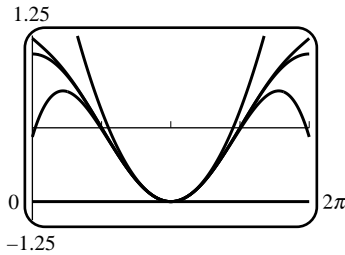

30. $f(0) = 0$; for $k \geq 1$, $f^{(k)}(x) = \frac{(-1)^{k-1}(k-1)!}{(x+1)^k}$, $f^{(k)}(0) = (-1)^{k-1}(k-1)!$; $p_0(x) = 0$, $p_1(x) = x$, $p_2(x) = x - \frac{1}{2}x^2$, $p_3(x) = x - \frac{1}{2}x^2 + \frac{1}{3}x^3$.

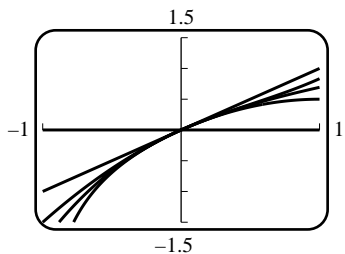

31. True.

32. True, $a_0 = f(0)$.

33. False, $p_6^{(4)}(x_0) = f^{(4)}(x_0)$.

34. False, since $M = e^2$, $|e^2 - p_4(2)| \leq \frac{M|x-0|^{n+1}}{(n+1)!} \leq \frac{e^2 \cdot 2^5}{5!} < \frac{9 \cdot 2^5}{5!}$.

35. $\sqrt{e} = e^{1/2}$, $f(x) = e^x$, $M = e^{1/2}$, $|e^{1/2} - p_n(1/2)| \leq M \frac{|x-1/2|^{n+1}}{(n+1)!} \leq 0.00005$, by experimentation take $n = 5$, $\sqrt{e} \approx p_5(1/2) \approx 1.648698$, calculator value ≈ 1.648721 , difference ≈ 0.000023 .

36. $1/e = e^{-1}$, $f(x) = e^x$, $M_n = \max |f^{(n+1)}(x)| = e^0 = 1$, $|e^{-1} - p_n(-1)| \leq M \frac{|0+1|^{n+1}}{(n+1)!}$, so want $\frac{1}{(n+1)!} \leq 0.0005$, $n = 7$, $e^{-1} \approx p_7(-1) \approx 0.367857$, calculator gives $e^{-1} \approx 0.367879$, $|1/e - p_7(-1)| \approx 0.000022$.

37. $p(0) = 1$, $p(x)$ has slope -1 at $x = 0$, and $p(x)$ is concave up at $x = 0$, eliminating I, II and III respectively and leaving IV.

38. Let $p_0(x) = 2$, $p_1(x) = p_2(x) = 2 - 3(x - 1)$, $p_3(x) = 2 - 3(x - 1) + (x - 1)^3$.

39. From Exercise 2(a), $p_1(x) = 1 + x$, $p_2(x) = 1 + x + x^2/2$.

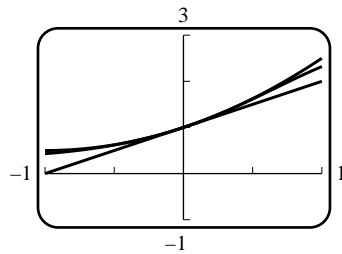

(a)

x	-1.000	-0.750	-0.500	-0.250	0.000	0.250	0.500	0.750	1.000
$f(x)$	0.431	0.506	0.619	0.781	1.000	1.281	1.615	1.977	2.320
$p_1(x)$	0.000	0.250	0.500	0.750	1.000	1.250	1.500	1.750	2.000
$p_2(x)$	0.500	0.531	0.625	0.781	1.000	1.281	1.625	2.031	2.500

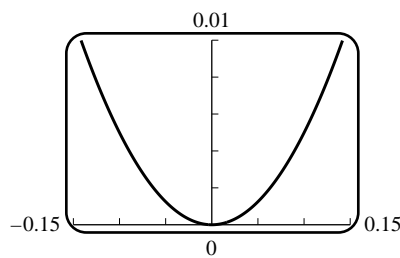
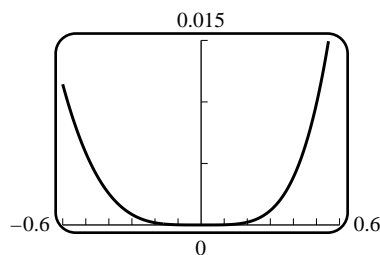
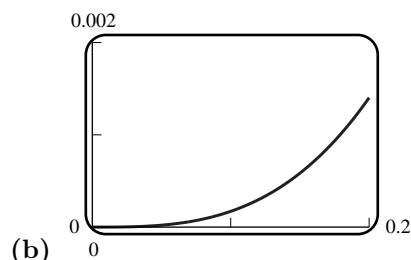
(c) $|e^{\sin x} - (1 + x)| < 0.01$ for $-0.14 < x < 0.14$.(d) $|e^{\sin x} - (1 + x + x^2/2)| < 0.01$ for $-0.50 < x < 0.50$.40. (a) $\cos \alpha \approx 1 - \alpha^2/2$; $x = r - r \cos \alpha = r(1 - \cos \alpha) \approx r\alpha^2/2$.(b) In Figure Ex-36 let $r = 4000$ mi and $\alpha = 1/80$ so that the arc has length $2r\alpha = 100$ mi. Then $x \approx r\alpha^2/2 = \frac{4000}{2 \cdot 80^2} = 5/16$ mi.41. (a) $f^{(k)}(x) = e^x \leq e^b$, $|R_2(x)| \leq \frac{e^b b^3}{3!} < 0.0005$, $e^b b^3 < 0.003$ if $b \leq 0.137$ (by trial and error with a hand calculator), so $[0, 0.137]$.

(b)

42. $f^{(k)}(\ln 4) = 15/8$ for k even, $f^{(k)}(\ln 4) = 17/8$ for k odd, which can be written as $f^{(k)}(\ln 4) = \frac{16 - (-1)^k}{8}$;

$$\sum_{k=0}^n \frac{16 - (-1)^k}{8k!} (x - \ln 4)^k.$$

43. $\sin x = x - \frac{x^3}{3!} + 0 \cdot x^4 + R_4(x)$, $|R_4(x)| \leq \frac{|x|^5}{5!} < 0.5 \times 10^{-3}$ if $|x|^5 < 0.06$, $|x| < (0.06)^{1/5} \approx 0.569$, $(-0.569, 0.569)$.

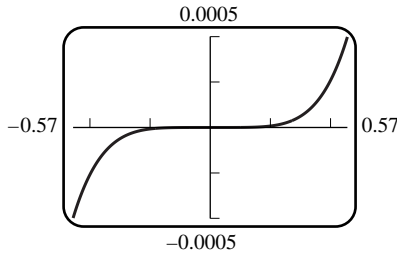

44. $M = 1$, $\cos x = 1 - \frac{x^2}{2!} + \frac{x^4}{4!} + R_5(x)$, $R_5(x) \leq \frac{1}{6!}|x|^6 \leq 0.0005$ if $|x| < 0.8434$.

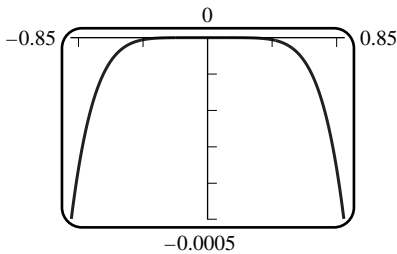

45. $f^{(6)}(x) = \frac{46080x^6}{(1+x^2)^7} - \frac{57600x^4}{(1+x^2)^6} + \frac{17280x^2}{(1+x^2)^5} - \frac{720}{(1+x^2)^4}$, assume first that $|x| < 1/2$, then $|f^{(6)}(x)| < 46080|x|^6 + 57600|x|^4 + 17280|x|^2 + 720$, so let $M = 9360$, $R_5(x) \leq \frac{9360}{5!}|x|^5 < 0.0005$ if $x < 0.0915$.

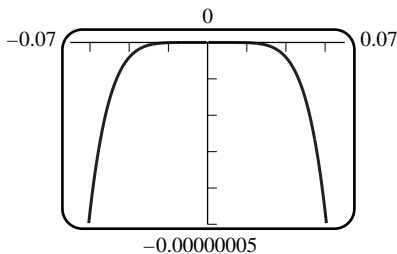

46. $f(x) = \ln(1+x)$, $f^{(4)}(x) = -6/(1+x)^4$, first assume $|x| < 0.8$, then we can calculate $M = 6/2^{-4} = 96$, and $|f(x) - p(x)| \leq \frac{96}{4!}|x|^4 < 0.0005$ if $|x| < 0.1057$.

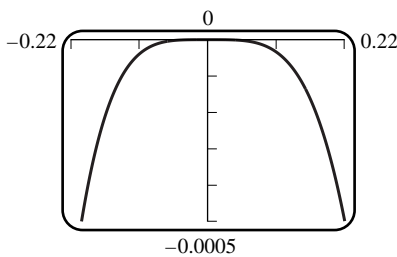

Exercise Set 9.8

1. $f^{(k)}(x) = (-1)^k e^{-x}$, $f^{(k)}(0) = (-1)^k$; $\sum_{k=0}^{\infty} \frac{(-1)^k}{k!} x^k.$

2. $f^{(k)}(x) = a^k e^{ax}$, $f^{(k)}(0) = a^k$; $\sum_{k=0}^{\infty} \frac{a^k}{k!} x^k$.
3. $f^{(k)}(0) = 0$ if k is odd, $f^{(k)}(0)$ is alternately π^k and $-\pi^k$ if k is even; $\sum_{k=0}^{\infty} \frac{(-1)^k \pi^{2k}}{(2k)!} x^{2k}$.
4. $f^{(k)}(0) = 0$ if k is even, $f^{(k)}(0)$ is alternately π^k and $-\pi^k$ if k is odd; $\sum_{k=0}^{\infty} \frac{(-1)^k \pi^{2k+1}}{(2k+1)!} x^{2k+1}$.
5. $f^{(0)}(0) = 0$; for $k \geq 1$, $f^{(k)}(x) = \frac{(-1)^{k+1}(k-1)!}{(1+x)^k}$, $f^{(k)}(0) = (-1)^{k+1}(k-1)!$; $\sum_{k=1}^{\infty} \frac{(-1)^{k+1}}{k} x^k$.
6. $f^{(k)}(x) = (-1)^k \frac{k!}{(1+x)^{k+1}}$; $f^{(k)}(0) = (-1)^k k!$; $\sum_{k=0}^{\infty} (-1)^k x^k$.
7. $f^{(k)}(0) = 0$ if k is odd, $f^{(k)}(0) = 1$ if k is even; $\sum_{k=0}^{\infty} \frac{1}{(2k)!} x^{2k}$.
8. $f^{(k)}(0) = 0$ if k is even, $f^{(k)}(0) = 1$ if k is odd; $\sum_{k=0}^{\infty} \frac{1}{(2k+1)!} x^{2k+1}$.
9. $f^{(k)}(x) = \begin{cases} (-1)^{k/2}(x \sin x - k \cos x) & k \text{ even} \\ (-1)^{(k-1)/2}(x \cos x + k \sin x) & k \text{ odd} \end{cases}$, $f^{(k)}(0) = \begin{cases} (-1)^{1+k/2} k & k \text{ even} \\ 0 & k \text{ odd} \end{cases}$; $\sum_{k=0}^{\infty} \frac{(-1)^k}{(2k+1)!} x^{2k+2}$.
10. $f^{(k)}(x) = (k+x)e^x$, $f^{(k)}(0) = k$; $\sum_{k=1}^{\infty} \frac{1}{(k-1)!} x^k$.
11. $f^{(k)}(x_0) = e$; $\sum_{k=0}^{\infty} \frac{e}{k!} (x-1)^k$.
12. $f^{(k)}(x) = (-1)^k e^{-x}$, $f^{(k)}(\ln 2) = (-1)^k \frac{1}{2}$; $\sum_{k=0}^{\infty} \frac{(-1)^k}{2 \cdot k!} (x - \ln 2)^k$.
13. $f^{(k)}(x) = \frac{(-1)^k k!}{x^{k+1}}$, $f^{(k)}(-1) = -k!$; $\sum_{k=0}^{\infty} (-1)(x+1)^k$.
14. $f^{(k)}(x) = \frac{(-1)^k k!}{(x+2)^{k+1}}$, $f^{(k)}(3) = \frac{(-1)^k k!}{5^{k+1}}$; $\sum_{k=0}^{\infty} \frac{(-1)^k}{5^{k+1}} (x-3)^k$.
15. $f^{(k)}(1/2) = 0$ if k is odd, $f^{(k)}(1/2)$ is alternately π^k and $-\pi^k$ if k is even; $\sum_{k=0}^{\infty} \frac{(-1)^k \pi^{2k}}{(2k)!} (x-1/2)^{2k}$.
16. $f^{(k)}(\pi/2) = 0$ if k is even, $f^{(k)}(\pi/2)$ is alternately -1 and 1 if k is odd; $\sum_{k=0}^{\infty} \frac{(-1)^{k+1}}{(2k+1)!} (x-\pi/2)^{2k+1}$.
17. $f(1) = 0$, for $k \geq 1$, $f^{(k)}(x) = \frac{(-1)^{k-1}(k-1)!}{x^k}$; $f^{(k)}(1) = (-1)^{k-1}(k-1)!$; $\sum_{k=1}^{\infty} \frac{(-1)^{k-1}}{k} (x-1)^k$.

18. $f(e) = 1$, for $k \geq 1$, $f^{(k)}(x) = \frac{(-1)^{k-1}(k-1)!}{x^k}$; $f^{(k)}(e) = \frac{(-1)^{k-1}(k-1)!}{e^k}$; $1 + \sum_{k=1}^{\infty} \frac{(-1)^{k-1}}{ke^k}(x-e)^k$.
19. Geometric series, $r = -x$, $|r| = |x|$, so the interval of convergence is $-1 < x < 1$, converges there to $\frac{1}{1+x}$ (the series diverges for $x = \pm 1$).
20. Geometric series, $r = x^2$, $|r| = x^2$, so the interval of convergence is $-1 < x < 1$, converges there to $\frac{1}{1-x^2}$ (the series diverges for $x = \pm 1$).
21. Geometric series, $r = x - 2$, $|r| = |x - 2|$, so the interval of convergence is $1 < x < 3$, converges there to $\frac{1}{1-(x-2)} = \frac{1}{3-x}$ (the series diverges for $x = 1, 3$).
22. Geometric series, $r = -(x+3)$, $|r| = |x+3|$, so the interval of convergence is $-4 < x < -2$, converges there to $\frac{1}{1+(x+3)} = \frac{1}{4+x}$ (the series diverges for $x = -4, -2$).
23. (a) Geometric series, $r = -x/2$, $|r| = |x/2|$, so the interval of convergence is $-2 < x < 2$, converges there to $\frac{1}{1+x/2} = \frac{2}{2+x}$ (the series diverges for $x = -2, 2$).
- (b) $f(0) = 1$, $f(1) = 2/3$.
24. (a) Geometric series, $r = -\frac{x-5}{3}$, $|r| = \left|\frac{x-5}{3}\right|$, so the interval of convergence is $2 < x < 8$, converges to $\frac{1}{1+(x-5)/3} = \frac{3}{x-2}$ (the series diverges for $x = 2, 8$).
- (b) $f(3) = 3$, $f(6) = 3/4$.
25. True.
26. False.
27. True.
28. False, it converges for all x .
29. $\rho = \lim_{k \rightarrow +\infty} \frac{k+1}{k+2}|x| = |x|$, the series converges if $|x| < 1$ and diverges if $|x| > 1$. If $x = -1$, $\sum_{k=0}^{\infty} \frac{(-1)^k}{k+1}$ converges by the Alternating Series Test; if $x = 1$, $\sum_{k=0}^{\infty} \frac{1}{k+1}$ diverges. The radius of convergence is 1, the interval of convergence is $[-1, 1)$.
30. $\rho = \lim_{k \rightarrow +\infty} 3|x| = 3|x|$, the series converges if $3|x| < 1$ or $|x| < 1/3$ and diverges if $|x| > 1/3$. If $x = -1/3$, $\sum_{k=0}^{\infty} (-1)^k$ diverges, if $x = 1/3$, $\sum_{k=0}^{\infty} (1)$ diverges. The radius of convergence is $1/3$, the interval of convergence is $(-1/3, 1/3)$.
31. $\rho = \lim_{k \rightarrow +\infty} \frac{|x|}{k+1} = 0$, the radius of convergence is $+\infty$, the interval is $(-\infty, +\infty)$.

32. If $x \neq 0$, $\rho = \lim_{k \rightarrow +\infty} \frac{k+1}{2}|x| = +\infty$, the radius of convergence is 0, the series converges only if $x = 0$.
33. $\rho = \lim_{k \rightarrow +\infty} \frac{5k^2|x|}{(k+1)^2} = 5|x|$, converges if $|x| < 1/5$ and diverges if $|x| > 1/5$. If $x = -1/5$, $\sum_{k=1}^{\infty} \frac{(-1)^k}{k^2}$ converges; if $x = 1/5$, $\sum_{k=1}^{\infty} 1/k^2$ converges. Radius of convergence is $1/5$, interval of convergence is $[-1/5, 1/5]$.
34. $\rho = \lim_{k \rightarrow +\infty} \frac{\ln k}{\ln(k+1)}|x| = |x|$, the series converges if $|x| < 1$ and diverges if $|x| > 1$. If $x = -1$, $\sum_{k=2}^{\infty} \frac{(-1)^k}{\ln k}$ converges; if $x = 1$, $\sum_{k=2}^{\infty} 1/(\ln k)$ diverges (compare to $\sum(1/k)$). Radius of convergence is 1, interval of convergence is $[-1, 1)$.
35. $\rho = \lim_{k \rightarrow +\infty} \frac{k|x|}{k+2} = |x|$, converges if $|x| < 1$, diverges if $|x| > 1$. If $x = -1$, $\sum_{k=1}^{\infty} \frac{(-1)^k}{k(k+1)}$ converges; if $x = 1$, $\sum_{k=1}^{\infty} \frac{1}{k(k+1)}$ converges. Radius of convergence is 1, interval of convergence is $[-1, 1]$.
36. $\rho = \lim_{k \rightarrow +\infty} 2 \frac{k+1}{k+2}|x| = 2|x|$, converges if $|x| < 1/2$, diverges if $|x| > 1/2$. If $x = -1/2$, $\sum_{k=0}^{\infty} \frac{-1}{2(k+1)}$ diverges; if $x = 1/2$, $\sum_{k=0}^{\infty} \frac{(-1)^k}{2(k+1)}$ converges. Radius of convergence is $1/2$, interval of convergence is $(-1/2, 1/2]$.
37. $\rho = \lim_{k \rightarrow +\infty} \frac{\sqrt{k}}{\sqrt{k+1}}|x| = |x|$, converges if $|x| < 1$, diverges if $|x| > 1$. If $x = -1$, $\sum_{k=1}^{\infty} \frac{-1}{\sqrt{k}}$ diverges; if $x = 1$, $\sum_{k=1}^{\infty} \frac{(-1)^{k-1}}{\sqrt{k}}$ converges. Radius of convergence is 1, interval of convergence is $(-1, 1]$.
38. $\rho = \lim_{k \rightarrow +\infty} \frac{|x|^2}{(2k+2)(2k+1)} = 0$, radius of convergence is $+\infty$, interval of convergence is $(-\infty, +\infty)$.
39. $\rho = \lim_{k \rightarrow +\infty} \frac{3|x|}{k+1} = 0$, radius of convergence is $+\infty$, interval of convergence is $(-\infty, +\infty)$.
40. $\rho = \lim_{k \rightarrow +\infty} \frac{k(\ln k)^2|x|}{(k+1)[\ln(k+1)]^2} = |x|$, converges if $|x| < 1$, diverges if $|x| > 1$. If $x = -1$, then, by Exercise 9.4.25, $\sum_{k=2}^{\infty} \frac{-1}{k(\ln k)^2}$ converges; if $x = 1$, $\sum_{k=2}^{\infty} \frac{(-1)^{k+1}}{k(\ln k)^2}$ converges. Radius of convergence is 1, interval of convergence is $[-1, 1]$.
41. $\rho = \lim_{k \rightarrow +\infty} \frac{1+k^2}{1+(k+1)^2}|x| = |x|$, converges if $|x| < 1$, diverges if $|x| > 1$. If $x = -1$, $\sum_{k=0}^{\infty} \frac{(-1)^k}{1+k^2}$ converges; if $x = 1$, $\sum_{k=0}^{\infty} \frac{1}{1+k^2}$ converges. Radius of convergence is 1, interval of convergence is $[-1, 1]$.
42. $\rho = \lim_{k \rightarrow +\infty} \frac{|x|^2}{(2k+3)(2k+2)} = 0$, radius of convergence is $+\infty$, interval of convergence is $(-\infty, +\infty)$.

43. $\rho = \lim_{k \rightarrow +\infty} (3/4)|x + 5| = \frac{3}{4}|x + 5|$, converges if $|x + 5| < 4/3$, diverges if $|x + 5| > 4/3$. If $x = -19/3$, $\sum_{k=0}^{\infty} (-1)^k$ diverges; if $x = -11/3$, $\sum_{k=0}^{\infty} 1$ diverges. Radius of convergence is $4/3$, interval of convergence is $(-19/3, -11/3)$.

44. $\rho = \lim_{k \rightarrow +\infty} \frac{1}{2}|x - 3| = \frac{1}{2}|x - 3|$, converges if $|x - 3| < 2$, diverges if $|x - 3| > 2$. If $x = 1$, $\sum_{k=0}^{\infty} (-1)^k$ diverges; if $x = 5$, $\sum_{k=0}^{\infty} 1$ diverges. Radius of convergence is 2 , interval of convergence is $(1, 5)$.

45. $\rho = \lim_{k \rightarrow +\infty} \frac{k|x + 1|}{k + 1} = |x + 1|$, converges if $|x + 1| < 1$, diverges if $|x + 1| > 1$. If $x = -2$, $\sum_{k=1}^{\infty} \frac{-1}{k}$ diverges; if $x = 0$, $\sum_{k=1}^{\infty} \frac{(-1)^{k+1}}{k}$ converges. Radius of convergence is 1 , interval of convergence is $(-2, 0]$.

46. $\rho = \lim_{k \rightarrow +\infty} \frac{(k + 1)^2}{(k + 2)^2}|x - 4| = |x - 4|$, converges if $|x - 4| < 1$, diverges if $|x - 4| > 1$. If $x = 3$, $\sum_{k=0}^{\infty} 1/(k + 1)^2$ converges; if $x = 5$, $\sum_{k=0}^{\infty} (-1)^k/(k + 1)^2$ converges. Radius of convergence is 1 , interval of convergence is $[3, 5]$.

47. $\rho = \lim_{k \rightarrow +\infty} \frac{k^2 + 4}{(k + 1)^2 + 4}|x + 1|^2 = |x + 1|^2$, converges if $|x + 1| < 1$, diverges if $|x + 1| > 1$. If $x = -2$, $\sum_{k=0}^{\infty} \frac{(-1)^{3k+1}}{k^2 + 4}$ converges; if $x = 0$, $\sum_{k=0}^{\infty} \frac{(-1)^k}{k^2 + 4}$ converges. Radius of convergence is 1 , interval of convergence is $[-2, 0]$.

48. If $x \neq 2$, $\rho = \lim_{k \rightarrow +\infty} \frac{(2k + 3)(2k + 2)k^3}{(k + 1)^3}|x - 2| = +\infty$, radius of convergence is 0 , series converges only at $x = 2$.

49. $\rho = \lim_{k \rightarrow +\infty} \frac{\pi|x - 1|^2}{(2k + 3)(2k + 2)} = 0$, radius of convergence $+\infty$, interval of convergence $(-\infty, +\infty)$.

50. $\rho = \lim_{k \rightarrow +\infty} \frac{1}{16}|2x - 3| = \frac{1}{16}|2x - 3|$, converges if $\frac{1}{16}|2x - 3| < 1$ or $|x - 3/2| < 8$, diverges if $|x - 3/2| > 8$. If $x = -13/2$, $\sum_{k=0}^{\infty} (-1)^k$ diverges; if $x = 19/2$, $\sum_{k=0}^{\infty} 1$ diverges. Radius of convergence is 8 , interval of convergence is $(-13/2, 19/2)$.

51. $\rho = \lim_{k \rightarrow +\infty} \sqrt[k]{|u_k|} = \lim_{k \rightarrow +\infty} \frac{|x|}{\ln k} = 0$, the series converges absolutely for all x so the interval of convergence is $(-\infty, +\infty)$.

52. $\rho = \lim_{k \rightarrow +\infty} \frac{2k + 1}{(2k)(2k - 1)}|x| = 0$, so $R = +\infty$ and the domain of f is $(-\infty, +\infty)$.

53. If $x \geq 0$, then $\cos \sqrt{x} = 1 - \frac{(\sqrt{x})^2}{2!} + \frac{(\sqrt{x})^4}{4!} - \frac{(\sqrt{x})^6}{6!} + \dots = 1 - \frac{x}{2!} + \frac{x^2}{4!} - \frac{x^3}{6!} + \dots$; if $x \leq 0$, then $\cosh(\sqrt{-x}) = 1 + \frac{(\sqrt{-x})^2}{2!} + \frac{(\sqrt{-x})^4}{4!} + \frac{(\sqrt{-x})^6}{6!} + \dots = 1 - \frac{x}{2!} + \frac{x^2}{4!} - \frac{x^3}{6!} + \dots$

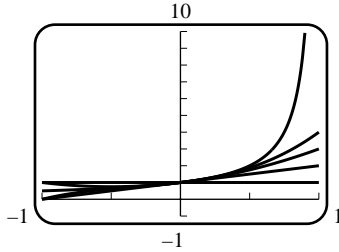

54. (a)

55. By Exercise 76 of Section 3.6, the derivative of an odd (even) function is even (odd); hence all odd-numbered derivatives of an odd function are even, all even-numbered derivatives of an odd function are odd; a similar statement holds for an even function.

(a) If $f(x)$ is an even function, then $f^{(2k-1)}(x)$ is an odd function, so $f^{(2k-1)}(0) = 0$, and thus the MacLaurin series coefficients $a_{2k-1} = 0, k = 1, 2, \dots$

(b) If $f(x)$ is an odd function, then $f^{(2k)}(x)$ is an even function, so $f^{(2k)}(0) = 0$, and thus the MacLaurin series coefficients $a_{2k} = 0, k = 1, 2, \dots$

56. By Theorem 9.4.3(b) both series converge or diverge together, so they have the same radius of convergence.

57. By Theorem 9.4.3(a) the series $\sum (c_k + d_k)(x - x_0)^k$ converges if $|x - x_0| < R$; if $|x - x_0| > R$ then $\sum (c_k + d_k)(x - x_0)^k$ cannot converge, as otherwise $\sum c_k(x - x_0)^k$ would converge by the same Theorem. Hence the radius of convergence of $\sum (c_k + d_k)(x - x_0)^k$ is R .

58. Let r be the radius of convergence of $\sum (c_k + d_k)(x - x_0)^k$. If $|x - x_0| < \min(R_1, R_2)$ then $\sum c_k(x - x_0)^k$ and $\sum d_k(x - x_0)^k$ converge, so $\sum (c_k + d_k)(x - x_0)^k$ converges. Hence $r \geq \min(R_1, R_2)$ (to see that $r > \min(R_1, R_2)$ is possible consider the case $c_k = -d_k = 1$). If in addition $R_1 \neq R_2$, and $R_1 < |x - x_0| < R_2$ (or $R_2 < |x - x_0| < R_1$) then $\sum (c_k + d_k)(x - x_0)^k$ cannot converge, as otherwise all three series would converge. Thus in this case $r = \min(R_1, R_2)$.

59. By the Ratio Test for absolute convergence,

$$\begin{aligned} \rho &= \lim_{k \rightarrow +\infty} \frac{(pk + p)!(k!)^p}{(pk)!(k + 1)!^p} |x| = \lim_{k \rightarrow +\infty} \frac{(pk + p)(pk + p - 1)(pk + p - 2) \dots (pk + p - [p - 1])}{(k + 1)^p} |x| = \\ &= \lim_{k \rightarrow +\infty} p \left(p - \frac{1}{k + 1} \right) \left(p - \frac{2}{k + 1} \right) \dots \left(p - \frac{p - 1}{k + 1} \right) |x| = p^p |x|, \text{ converges if } |x| < 1/p^p, \text{ diverges if } |x| > 1/p^p. \\ &\text{Radius of convergence is } 1/p^p. \end{aligned}$$

60. By the Ratio Test for absolute convergence,

$$\rho = \lim_{k \rightarrow +\infty} \frac{(k + 1 + p)k!(k + q)!}{(k + p)!(k + 1)!(k + 1 + q)!} |x| = \lim_{k \rightarrow +\infty} \frac{k + 1 + p}{(k + 1)(k + 1 + q)} |x| = 0, \text{ radius of convergence is } +\infty.$$

61. Ratio Test: $\rho = \lim_{k \rightarrow +\infty} \frac{|x|^2}{4(k + 1)(k + 2)} = 0, R = +\infty.$

62. $J_0(x) = \sum_{k=0}^{\infty} u_k(x) = \sum_{k=0}^{\infty} \frac{(-1)^k x^{2k}}{2^{2k} (k!)^2}$, alternating series, $|u_4(1)| \approx 0.00000678$, small enough, so $J_0(1) \approx \sum_{k=0}^3 \frac{(-1)^k}{2^{2k} (k!)^2} \approx$

0.76519 with an error less than 7×10^{-6} . Next, $J_1(x)$ is given by $J_1(x) = \sum_{k=0}^{\infty} u_k(x) = \sum_{k=0}^{\infty} \frac{(-1)^k x^{2k+1}}{2^{2k+1} (k!) (k + 1)!}$, alternating series, $|u_4(1)| \approx 6.78 \times 10^{-7}$, small enough (though $|u_3(1)|$ isn't), so $J_1(1) \approx \sum_{k=0}^3 \frac{(-1)^k}{2^{2k+1} (k!) (k + 1)!} \approx 0.44005$

with an error less than 7×10^{-7} .

63. (a) $\int_n^{+\infty} \frac{1}{x^{3.7}} dx < 0.005$ if $n > 4.93$; let $n = 5$. (b) $s_n \approx 1.1062$; $s_n : 1.10628824$.
64. By the Root Test for absolute convergence, $\rho = \lim_{k \rightarrow +\infty} |c_k|^{1/k} |x| = L|x|$, $L|x| < 1$ if $|x| < 1/L$ so the radius of convergence is $1/L$.
65. By assumption $\sum_{k=0}^{\infty} c_k x^k$ converges if $|x| < R$ so $\sum_{k=0}^{\infty} c_k x^{2k} = \sum_{k=0}^{\infty} c_k (x^2)^k$ converges if $|x^2| < R$, $|x| < \sqrt{R}$. Moreover, $\sum_{k=0}^{\infty} c_k x^{2k} = \sum_{k=0}^{\infty} c_k (x^2)^k$ diverges if $|x^2| > R$, $|x| > \sqrt{R}$. Thus $\sum_{k=0}^{\infty} c_k x^{2k}$ has radius of convergence \sqrt{R} .
66. The assumption is that $\sum_{k=0}^{\infty} c_k R^k$ is convergent and $\sum_{k=0}^{\infty} c_k (-R)^k$ is divergent. Suppose that $\sum_{k=0}^{\infty} c_k R^k$ is absolutely convergent then $\sum_{k=0}^{\infty} c_k (-R)^k$ is also absolutely convergent and hence convergent, because $|c_k R^k| = |c_k (-R)^k|$, which contradicts the assumption that $\sum_{k=0}^{\infty} c_k (-R)^k$ is divergent so $\sum_{k=0}^{\infty} c_k R^k$ must be conditionally convergent.

Exercise Set 9.9

- $f(x) = \sin x$, $f^{(n+1)}(x) = \pm \sin x$ or $\pm \cos x$, $|f^{(n+1)}(x)| \leq 1$, $|R_n(x)| \leq \frac{|x - \pi/4|^{n+1}}{(n+1)!}$, $\lim_{n \rightarrow +\infty} \frac{|x - \pi/4|^{n+1}}{(n+1)!} = 0$; by the Squeezing Theorem, $\lim_{n \rightarrow +\infty} |R_n(x)| = 0$, so $\lim_{n \rightarrow +\infty} R_n(x) = 0$ for all x .
- $f(x) = e^x$, $f^{(n+1)}(x) = e^x$; if $x > 1$ then $|R_n(x)| \leq \frac{e^x}{(n+1)!} |x - 1|^{n+1}$; if $x < 1$, then $|R_n(x)| \leq \frac{e}{(n+1)!} |x - 1|^{n+1}$.
But $\lim_{n \rightarrow +\infty} \frac{|x - 1|^{n+1}}{(n+1)!} = 0$ so $\lim_{n \rightarrow +\infty} R_n(x) = 0$.
- $\sin 4^\circ = \sin\left(\frac{\pi}{45}\right) = \frac{\pi}{45} - \frac{(\pi/45)^3}{3!} + \frac{(\pi/45)^5}{5!} - \dots$

(a) Method 1: $|R_n(\pi/45)| \leq \frac{(\pi/45)^{n+1}}{(n+1)!} < 0.000005$ for $n + 1 = 4$, $n = 3$; $\sin 4^\circ \approx \frac{\pi}{45} - \frac{(\pi/45)^3}{3!} \approx 0.069756$.

(b) Method 2: The first term in the alternating series that is less than 0.000005 is $\frac{(\pi/45)^5}{5!}$, so the result is the same as in part (a).
- $\cos 3^\circ = \cos\left(\frac{\pi}{60}\right) = 1 - \frac{(\pi/60)^2}{2} + \frac{(\pi/60)^4}{4!} - \dots$

(a) Method 1: $|R_n(\pi/60)| \leq \frac{(\pi/60)^{n+1}}{(n+1)!} < 0.0005$ for $n = 2$; $\cos 3^\circ \approx 1 - \frac{(\pi/60)^2}{2} \approx 0.9986$.

(b) Method 2: The first term in the alternating series that is less than 0.0005 is $\frac{(\pi/60)^4}{4!}$, so the result is the same as in part (a).
- $|R_n(0.1)| \leq \frac{(0.1)^{n+1}}{(n+1)!} \leq 0.000005$ for $n = 3$; $\cos 0.1 \approx 1 - (0.1)^2/2 = 0.99500$, calculator value 0.995004...
- $(0.1)^3/3 < 0.5 \times 10^{-3}$ so $\tan^{-1}(0.1) \approx 0.100$, calculator value ≈ 0.0997 .

7. Expand about $\pi/2$ to get $\sin x = 1 - \frac{1}{2!}(x-\pi/2)^2 + \frac{1}{4!}(x-\pi/2)^4 - \dots$, $85^\circ = 17\pi/36$ radians, $|R_n(x)| \leq \frac{|x-\pi/2|^{n+1}}{(n+1)!}$, $|R_n(17\pi/36)| \leq \frac{|17\pi/36 - \pi/2|^{n+1}}{(n+1)!} = \frac{(\pi/36)^{n+1}}{(n+1)!} < 0.5 \times 10^{-4}$, if $n = 3$, $\sin 85^\circ \approx 1 - \frac{1}{2}(-\pi/36)^2 \approx 0.99619$, calculator value 0.99619...
8. $-175^\circ = -\pi + \pi/36$ rad; $x_0 = -\pi, x = -\pi + \pi/36$, $\cos x = -1 + \frac{(x+\pi)^2}{2} - \frac{(x+\pi)^4}{4!} - \dots$; $|R_n| \leq \frac{(\pi/36)^{n+1}}{(n+1)!} \leq 0.00005$ for $n = 3$; $\cos(-\pi + \pi/36) = -1 + \frac{(\pi/36)^2}{2} \approx -0.99619$, calculator value -0.99619 ...
9. $f^{(k)}(x) = \cosh x$ or $\sinh x$, $|f^{(k)}(x)| \leq \cosh x \leq \cosh 0.5 = \frac{1}{2}(e^{0.5} + e^{-0.5}) < \frac{1}{2}(2+1) = 1.5$, so $|R_n(x)| < \frac{1.5(0.5)^{n+1}}{(n+1)!} \leq 0.5 \times 10^{-3}$ if $n = 4$, $\sinh 0.5 \approx 0.5 + \frac{(0.5)^3}{3!} \approx 0.5208$, calculator value 0.52109...
10. $f^{(k)}(x) = \cosh x$ or $\sinh x$, $|f^{(k)}(x)| \leq \cosh x \leq \cosh 0.1 = \frac{1}{2}(e^{0.1} + e^{-0.1}) < 1.006$, so $|R_n(x)| < \frac{1.006(0.1)^{n+1}}{(n+1)!} \leq 0.006 \times 10^{-3}$ for $n = 2$, $\cosh 0.1 \approx 1 + \frac{(0.1)^2}{2!} = 1.005$, calculator value 1.0050...
11. (a) Let $x = 1/9$ in series (12).
 (b) $\ln 1.25 \approx 2 \left(1/9 + \frac{(1/9)^3}{3} \right) = 2(1/9 + 1/3^7) \approx 0.223$, which agrees with the calculator value 0.22314... to three decimal places.
12. (a) Let $x = 1/2$ in series (12).
 (b) $\ln 3 \approx 2 \left(1/2 + \frac{(1/2)^3}{3} \right) = 2(1/2 + 1/24) = 13/12 \approx 1.083$; the calculator value is 1.099 to three decimal places.
13. (a) $(1/2)^9/9 < 0.5 \times 10^{-3}$ and $(1/3)^7/7 < 0.5 \times 10^{-3}$, so $\tan^{-1}(1/2) \approx 1/2 - \frac{(1/2)^3}{3} + \frac{(1/2)^5}{5} - \frac{(1/2)^7}{7} \approx 0.4635$, $\tan^{-1}(1/3) \approx 1/3 - \frac{(1/3)^3}{3} + \frac{(1/3)^5}{5} \approx 0.3218$.
 (b) From Formula (16), $\pi \approx 4(0.4635 + 0.3218) = 3.1412$.
 (c) Let $a = \tan^{-1} \frac{1}{2}, b = \tan^{-1} \frac{1}{3}$; then $|a - 0.4635| < 0.0005$ and $|b - 0.3218| < 0.0005$, so $|4(a+b) - 3.1412| \leq 4|a - 0.4635| + 4|b - 0.3218| < 0.004$, so two decimal-place accuracy is guaranteed, but not three.
14. (a) $f'(0) = \lim_{h \rightarrow 0} \frac{f(h) - f(0)}{h} = \lim_{h \rightarrow 0} \frac{e^{-1/h^2}}{h}$, let $t = 1/h$ then $h = 1/t$ and $\lim_{h \rightarrow 0^+} \frac{e^{-1/h^2}}{h} = \lim_{t \rightarrow +\infty} te^{-t^2} = \lim_{t \rightarrow +\infty} \frac{t}{e^{t^2}} = \lim_{t \rightarrow +\infty} \frac{1}{2te^{t^2}} = 0$, similarly $\lim_{h \rightarrow 0^-} \frac{e^{-1/h^2}}{h} = 0$ so $f'(0) = 0$.
 (b) The Maclaurin series is $0 + 0 \cdot x + 0 \cdot x^2 + \dots = 0$, but $f(0) = 0$ and $f(x) > 0$ if $x \neq 0$ so the series converges to $f(x)$ only at the point $x = 0$.
15. (a) $\cos x = 1 - \frac{x^2}{2!} + \frac{x^4}{4!} + (0)x^5 + R_5(x)$, $|R_5(x)| \leq \frac{|x|^6}{6!} \leq \frac{(0.2)^6}{6!} < 9 \times 10^{-8}$.

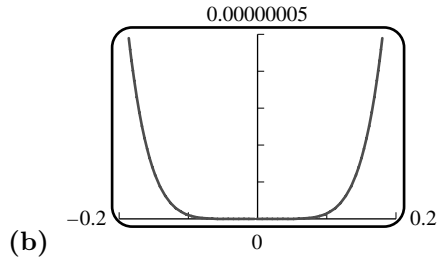

16. (a) $f''(x) = -1/(1+x)^2$, $|f''(x)| < 1/(0.99)^2 \leq 1.03$, $|R_1(x)| \leq \frac{1.03|x|^2}{2} \leq \frac{1.03(0.01)^2}{2} \leq 5.15 \times 10^{-5}$ for $-0.01 \leq x \leq 0.01$.

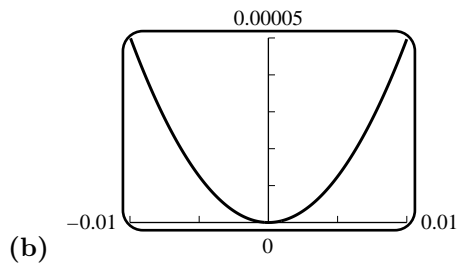

17. (a) $(1+x)^{-1} = 1 - x + \frac{-1(-2)}{2!}x^2 + \frac{-1(-2)(-3)}{3!}x^3 + \dots + \frac{-1(-2)(-3)\dots(-k)}{k!}x^k + \dots = \sum_{k=0}^{\infty} (-1)^k x^k$.

(b) $(1+x)^{1/3} = 1 + (1/3)x + \frac{(1/3)(-2/3)}{2!}x^2 + \frac{(1/3)(-2/3)(-5/3)}{3!}x^3 + \dots + \frac{(1/3)(-2/3)\dots(4-3k)/3}{k!}x^k + \dots = 1 + x/3 + \sum_{k=2}^{\infty} (-1)^{k-1} \frac{2 \cdot 5 \dots (3k-4)}{3^k k!} x^k$.

(c) $(1+x)^{-3} = 1 - 3x + \frac{(-3)(-4)}{2!}x^2 + \frac{(-3)(-4)(-5)}{3!}x^3 + \dots + \frac{(-3)(-4)\dots(-2-k)}{k!}x^k + \dots = \sum_{k=0}^{\infty} (-1)^k \frac{(k+2)!}{2 \cdot k!} x^k = \sum_{k=0}^{\infty} (-1)^k \frac{(k+2)(k+1)}{2} x^k$.

18. $(1+x)^m = \binom{m}{0} + \sum_{k=1}^{\infty} \binom{m}{k} x^k = \sum_{k=0}^{\infty} \binom{m}{k} x^k$.

19. (a) $\frac{d}{dx} \ln(1+x) = \frac{1}{1+x}$, $\frac{d^k}{dx^k} \ln(1+x) = (-1)^{k-1} \frac{(k-1)!}{(1+x)^k}$; similarly $\frac{d}{dx} \ln(1-x) = -\frac{(k-1)!}{(1-x)^k}$, so $f^{(n+1)}(x) = n! \left[\frac{(-1)^n}{(1+x)^{n+1}} + \frac{1}{(1-x)^{n+1}} \right]$.

(b) $|f^{(n+1)}(x)| \leq n! \left| \frac{(-1)^n}{(1+x)^{n+1}} \right| + n! \left| \frac{1}{(1-x)^{n+1}} \right| = n! \left[\frac{1}{(1+x)^{n+1}} + \frac{1}{(1-x)^{n+1}} \right]$.

(c) If $|f^{(n+1)}(x)| \leq M$ on the interval $[0, 1/3]$ then $|R_n(1/3)| \leq \frac{M}{(n+1)!} \left(\frac{1}{3}\right)^{n+1}$.

(d) If $0 \leq x \leq 1/3$ then $1+x \geq 1$, $1-x \geq 2/3$, $|f^{(n+1)}(x)| \leq M = n! \left[1 + \frac{1}{(2/3)^{n+1}} \right]$.

(e) $0.000005 \geq \frac{M}{(n+1)!} \left(\frac{1}{3}\right)^{n+1} = \frac{1}{n+1} \left[\left(\frac{1}{3}\right)^{n+1} + \frac{\left(\frac{1}{3}\right)^{n+1}}{\left(\frac{2}{3}\right)^{n+1}} \right] = \frac{1}{n+1} \left[\left(\frac{1}{3}\right)^{n+1} + \left(\frac{1}{2}\right)^{n+1} \right]$. By inspection the inequality holds for $n = 13$ but for no smaller n .

20. Set $x = 1/4$ in Formula (12). Follow the argument of Exercise 19: parts (a) and (b) remain unchanged; in part (c) replace $(1/3)$ with $(1/4)$: $\left| R_n \left(\frac{1}{4} \right) \right| \leq \frac{M}{(n+1)!} \left(\frac{1}{4} \right)^{n+1} \leq 0.000005$ for x in the interval $[0, 1/4]$. From part (b), together with $0 \leq x \leq 1/4$, $1+x \geq 1$, $1-x \geq 3/4$, follows part (d): $M = n! \left[1 + \frac{1}{(3/4)^{n+1}} \right]$. Part (e) now becomes $0.000005 \geq \frac{M}{(n+1)!} \left(\frac{1}{4} \right)^{n+1} = \frac{1}{n+1} \left[\left(\frac{1}{4} \right)^{n+1} + \left(\frac{1}{3} \right)^{n+1} \right]$, which is true for $n = 9$.

21. $f(x) = \cos x$, $f^{(n+1)}(x) = \pm \sin x$ or $\pm \cos x$, $|f^{(n+1)}(x)| \leq 1$, set $M = 1$, $|R_n(x)| \leq \frac{1}{(n+1)!} |x - x_0|^{n+1}$,

$$\lim_{n \rightarrow +\infty} \frac{|x - x_0|^{n+1}}{(n+1)!} = 0 \text{ so } \lim_{n \rightarrow +\infty} R_n(x) = 0 \text{ for all } x.$$

22. $f(x) = \sin x$, $f^{(n+1)}(x) = \pm \sin x$ or $\pm \cos x$, $|f^{(n+1)}(x)| \leq 1$, follow Exercise 21.

23. $e^{-x} = 1 - x + x^2/2! + \dots$. Replace x with $\left(\frac{x-100}{16}\right)^2/2$ to obtain $e^{-\left(\frac{x-100}{16}\right)^2/2} = 1 - \frac{(x-100)^2}{2 \cdot 16^2} + \frac{(x-100)^4}{8 \cdot 16^4} + \dots$, thus $p \approx \frac{1}{16\sqrt{2\pi}} \int_{100}^{110} \left[1 - \frac{(x-100)^2}{2 \cdot 16^2} + \frac{(x-100)^4}{8 \cdot 16^4} \right] dx \approx 0.23406$ or 23.406%.

24. (a) From Machin's formula and a CAS, $\frac{\pi}{4} \approx 0.7853981633974483096156608$, accurate to the 25th decimal place.

(b)

n	s_n
0	0.3183098 78 ...
1	0.3183098 861837906 067 ...
2	0.3183098 861837906 7153776 695 ...
3	0.3183098 861837906 7153776 752674502 34 ...
$1/\pi$	0.3183098 861837906 7153776 752674502 87 ...

Exercise Set 9.10

1. (a) Replace x with $-x$: $\frac{1}{1+x} = 1 - x + x^2 - \dots + (-1)^k x^k + \dots$; $R = 1$.

(b) Replace x with x^2 : $\frac{1}{1-x^2} = 1 + x^2 + x^4 + \dots + x^{2k} + \dots$; $R = 1$.

(c) Replace x with $2x$: $\frac{1}{1-2x} = 1 + 2x + 4x^2 + \dots + 2^k x^k + \dots$; $R = 1/2$.

(d) $\frac{1}{2-x} = \frac{1/2}{1-x/2}$; replace x with $x/2$: $\frac{1}{2-x} = \frac{1}{2} + \frac{1}{2^2}x + \frac{1}{2^3}x^2 + \dots + \frac{1}{2^{k+1}}x^k + \dots$; $R = 2$.

2. (a) Replace x with $-x$: $\ln(1-x) = -x - x^2/2 - x^3/3 - \dots - x^k/k - \dots$; $R = 1$.

(b) Replace x with x^2 : $\ln(1+x^2) = x^2 - x^4/2 + x^6/3 - \dots + (-1)^{k-1} x^{2k}/k + \dots$; $R = 1$.

(c) Replace x with $2x$: $\ln(1+2x) = 2x - (2x)^2/2 + (2x)^3/3 - \dots + (-1)^{k-1} (2x)^k/k + \dots$; $R = 1/2$.

(d) $\ln(2+x) = \ln 2 + \ln(1+x/2)$; replace x with $x/2$: $\ln(2+x) = \ln 2 + x/2 - (x/2)^2/2 + (x/2)^3/3 + \dots + (-1)^{k-1}(x/2)^k/k + \dots$; $R = 2$.

3. (a) From Section 9.9, Example 4(b), $\frac{1}{\sqrt{1+x}} = 1 - \frac{1}{2}x + \frac{1 \cdot 3}{2^2 \cdot 2!}x^2 - \frac{1 \cdot 3 \cdot 5}{2^3 \cdot 3!}x^3 + \dots$, so $(2+x)^{-1/2} = \frac{1}{\sqrt{2}\sqrt{1+x/2}} = \frac{1}{2^{1/2}} - \frac{1}{2^{5/2}}x + \frac{1 \cdot 3}{2^{9/2} \cdot 2!}x^2 - \frac{1 \cdot 3 \cdot 5}{2^{13/2} \cdot 3!}x^3 + \dots$

(b) Example 4(a): $\frac{1}{(1+x)^2} = 1 - 2x + 3x^2 - 4x^3 + \dots$, so $\frac{1}{(1-x)^2} = 1 + 2x^2 + 3x^4 + 4x^6 + \dots$

4. (a) $\frac{1}{a-x} = \frac{1/a}{1-x/a} = 1/a + x/a^2 + x^2/a^3 + \dots + x^k/a^{k+1} + \dots$; $R = |a|$.

(b) $1/(a+x)^2 = \frac{1}{a^2} \frac{1}{(1+x/a)^2} = \frac{1}{a^2} (1 - 2(x/a) + 3(x/a)^2 - 4(x/a)^3 + \dots) = \frac{1}{a^2} - \frac{2}{a^3}x + \frac{3}{a^4}x^2 - \frac{4}{a^5}x^3 + \dots$; $R = |a|$.

5. (a) $2x - \frac{2^3}{3!}x^3 + \frac{2^5}{5!}x^5 - \frac{2^7}{7!}x^7 + \dots$; $R = +\infty$.

(b) $1 - 2x + 2x^2 - \frac{4}{3}x^3 + \dots$; $R = +\infty$.

(c) $1 + x^2 + \frac{1}{2!}x^4 + \frac{1}{3!}x^6 + \dots$; $R = +\infty$.

(d) $x^2 - \frac{\pi^2}{2}x^4 + \frac{\pi^4}{4!}x^6 - \frac{\pi^6}{6!}x^8 + \dots$; $R = +\infty$.

6. (a) $1 - \frac{2^2}{2!}x^2 + \frac{2^4}{4!}x^4 - \frac{2^6}{6!}x^6 + \dots$; $R = +\infty$.

(b) $x^2 \left(1 + x + \frac{1}{2!}x^2 + \frac{1}{3!}x^3 + \dots\right) = x^2 + x^3 + \frac{1}{2!}x^4 + \frac{1}{3!}x^5 + \dots$; $R = +\infty$.

(c) $x \left(1 - x + \frac{1}{2!}x^2 - \frac{1}{3!}x^3 + \dots\right) = x - x^2 + \frac{1}{2!}x^3 - \frac{1}{3!}x^4 + \dots$; $R = +\infty$.

(d) $x^2 - \frac{1}{3!}x^6 + \frac{1}{5!}x^{10} - \frac{1}{7!}x^{14} + \dots$; $R = +\infty$.

7. (a) $x^2(1 - 3x + 9x^2 - 27x^3 + \dots) = x^2 - 3x^3 + 9x^4 - 27x^5 + \dots$; $R = 1/3$.

(b) $x \left(2x + \frac{2^3}{3!}x^3 + \frac{2^5}{5!}x^5 + \frac{2^7}{7!}x^7 + \dots\right) = 2x^2 + \frac{2^3}{3!}x^4 + \frac{2^5}{5!}x^6 + \frac{2^7}{7!}x^8 + \dots$; $R = +\infty$.

(c) Substitute $3/2$ for m and $-x^2$ for x in Equation (17) of Section 9.9, then multiply by x : $x - \frac{3}{2}x^3 + \frac{3}{8}x^5 + \frac{1}{16}x^7 + \dots$; $R = 1$.

8. (a) $\frac{x}{x-1} = \frac{-x}{1-x} = -x(1+x+x^2+x^3+\dots) = -x - x^2 - x^3 - x^4 - \dots$; $R = 1$.

(b) $3 + \frac{3}{2!}x^4 + \frac{3}{4!}x^8 + \frac{3}{6!}x^{12} + \dots$; $R = +\infty$.

(c) From Table 9.9.1 with $m = -3$, $(1+x)^{-3} = 1 - 3x + 6x^2 - 10x^3 + \dots$, so $x(1+2x)^{-3} = x - 6x^2 + 24x^3 - 80x^4 + \dots$; $R = 1/2$.

$$9. \text{ (a) } \sin^2 x = \frac{1}{2}(1 - \cos 2x) = \frac{1}{2} \left[1 - \left(1 - \frac{2^2}{2!}x^2 + \frac{2^4}{4!}x^4 - \frac{2^6}{6!}x^6 + \dots \right) \right] = x^2 - \frac{2^3}{4!}x^4 + \frac{2^5}{6!}x^6 - \frac{2^7}{8!}x^8 + \dots$$

$$\text{(b) } \ln[(1+x^3)^{12}] = 12 \ln(1+x^3) = 12x^3 - 6x^6 + 4x^9 - 3x^{12} + \dots$$

$$10. \text{ (a) } \cos^2 x = \frac{1}{2}(1 + \cos 2x) = \frac{1}{2} \left[1 + \left(1 - \frac{2^2}{2!}x^2 + \frac{2^4}{4!}x^4 - \frac{2^6}{6!}x^6 + \dots \right) \right] = 1 - x^2 + \frac{2^3}{4!}x^4 - \frac{2^5}{6!}x^6 + \dots$$

$$\text{(b) } \text{In Equation (12) of Section 9.9 replace } x \text{ with } -x: \ln\left(\frac{1-x}{1+x}\right) = -2\left(x + \frac{1}{3}x^3 + \frac{1}{5}x^5 + \frac{1}{7}x^7 + \dots\right)$$

$$11. \text{ (a) } \frac{1}{x} = \frac{1}{1-(1-x)} = 1 + (1-x) + (1-x)^2 + \dots + (1-x)^k + \dots = 1 - (x-1) + (x-1)^2 - \dots + (-1)^k(x-1)^k + \dots$$

$$\text{(b) } (0, 2).$$

$$12. \text{ (a) } \frac{1}{x} = \frac{1/x_0}{1+(x-x_0)/x_0} = 1/x_0 - (x-x_0)/x_0^2 + (x-x_0)^2/x_0^3 - \dots + (-1)^k(x-x_0)^k/x_0^{k+1} + \dots$$

$$\text{(b) } (0, 2x_0).$$

$$13. \text{ (a) } (1+x+x^2/2+x^3/3!+x^4/4!+\dots)(x-x^3/3!+x^5/5!-\dots) = x+x^2+x^3/3-x^5/30+\dots$$

$$\text{(b) } (1+x/2-x^2/8+x^3/16-(5/128)x^4+\dots)(x-x^2/2+x^3/3-x^4/4+x^5/5-\dots) = x-x^3/24+x^4/24-(71/1920)x^5+\dots$$

$$14. \text{ (a) } (1-x^2+x^4/2-x^6/6+\dots)\left(1-\frac{1}{2}x^2+\frac{1}{24}x^4-\frac{1}{720}x^6+\dots\right) = 1-\frac{3}{2}x^2+\frac{25}{24}x^4-\frac{331}{720}x^6+\dots$$

$$\text{(b) } \left(1+\frac{4}{3}x^2+\dots\right)\left(1+\frac{1}{3}x-\frac{1}{9}x^2+\frac{5}{81}x^3-\dots\right) = 1+\frac{1}{3}x+\frac{11}{9}x^2+\frac{41}{81}x^3+\dots$$

$$15. \text{ (a) } \frac{1}{\cos x} = 1/\left(1-\frac{1}{2!}x^2+\frac{1}{4!}x^4-\frac{1}{6!}x^6+\dots\right) = 1+\frac{1}{2}x^2+\frac{5}{24}x^4+\frac{61}{720}x^6+\dots$$

$$\text{(b) } \frac{\sin x}{e^x} = \left(x-\frac{x^3}{3!}+\frac{x^5}{5!}-\dots\right)/\left(1+x+\frac{x^2}{2!}+\frac{x^3}{3!}+\frac{x^4}{4!}+\dots\right) = x-x^2+\frac{1}{3}x^3-\frac{1}{30}x^5+\dots$$

$$16. \text{ (a) } \frac{\tan^{-1} x}{1+x} = (x-x^3/3+x^5/5-\dots)/(1+x) = x-x^2+\frac{2}{3}x^3-\frac{2}{3}x^4+\dots$$

$$\text{(b) } \frac{\ln(1+x)}{1-x} = (x-x^2/2+x^3/3-x^4/4+\dots)/(1-x) = x+\frac{1}{2}x^2+\frac{5}{6}x^3+\frac{7}{12}x^4+\dots$$

$$17. e^x = 1+x+x^2/2+x^3/3!+\dots+x^k/k!+\dots, e^{-x} = 1-x+x^2/2-x^3/3!+\dots+(-1)^k x^k/k!+\dots; \sinh x = \frac{1}{2}(e^x - e^{-x}) = x+x^3/3!+x^5/5!+\dots+x^{2k+1}/(2k+1)!+\dots, R = +\infty; \cosh x = \frac{1}{2}(e^x + e^{-x}) = 1+x^2/2+x^4/4!+\dots+x^{2k}/(2k)!+\dots, R = +\infty.$$

$$18. \tanh x = \frac{x+x^3/3!+x^5/5!+x^7/7!+\dots}{1+x^2/2+x^4/4!+x^6/6!+\dots} = x-\frac{1}{3}x^3+\frac{2}{15}x^5-\frac{17}{315}x^7+\dots$$

19. $\frac{4x-2}{x^2-1} = \frac{-1}{1-x} + \frac{3}{1+x} = -(1+x+x^2+x^3+x^4+\dots) + 3(1-x+x^2-x^3+x^4+\dots) = 2-4x+2x^2-4x^3+2x^4+\dots$

20. $\frac{x^3+x^2+2x-2}{x^2-1} = x+1-\frac{1}{1-x}+\frac{2}{1+x} = x+1-(1+x+x^2+x^3+x^4+\dots)+2(1-x+x^2-x^3+x^4+\dots) = 2-2x+x^2-3x^3+x^4-\dots$

21. (a) $\frac{d}{dx}(1-x^2/2!+x^4/4!-x^6/6!+\dots) = -x+x^3/3!-x^5/5!+\dots = -\sin x$.

(b) $\frac{d}{dx}(x-x^2/2+x^3/3-\dots) = 1-x+x^2-\dots = 1/(1+x)$.

22. (a) $\frac{d}{dx}(x+x^3/3!+x^5/5!+\dots) = 1+x^2/2!+x^4/4!+\dots = \cosh x$.

(b) $\frac{d}{dx}(x-x^3/3+x^5/5-x^7/7+\dots) = 1-x^2+x^4-x^6+\dots = \frac{1}{1+x^2}$.

23. (a) $\int(1+x+x^2/2!+\dots)dx = (x+x^2/2!+x^3/3!+\dots)+C_1 = (1+x+x^2/2!+x^3/3!+\dots)+C_1-1 = e^x+C$.

(b) $\int(x+x^3/3!+x^5/5!+\dots) = x^2/2!+x^4/4!+\dots+C_1 = 1+x^2/2!+x^4/4!+\dots+C_1-1 = \cosh x+C$.

24. (a) $\int(x-x^3/3!+x^5/5!-\dots)dx = (x^2/2!-x^4/4!+x^6/6!-\dots)+C_1 = -(1-x^2/2!+x^4/4!-x^6/6!+\dots)+C_1+1 = -\cos x+C$.

(b) $\int(1-x+x^2-\dots)dx = (x-x^2/2+x^3/3-\dots)+C = \ln(1+x)+C$ (Note: $-1 < x < 1$, so $|1+x| = 1+x$).

25. $\frac{d}{dx} \sum_{k=0}^{\infty} \frac{x^{k+1}}{(k+1)(k+2)} = \sum_{k=0}^{\infty} \frac{x^k}{k+2}$. Each series has radius of convergence $\rho = 1$, as can be seen from the Ratio Test. The intervals of convergence are $[-1, 1]$ and $[-1, 1)$, respectively.

26. $\int \sum_{k=1}^{\infty} \frac{(-3)^k}{k} x^k = \sum_{k=1}^{\infty} \frac{(-3)^k x^{k+1}}{k(k+1)}$. Each series has radius of convergence $\rho = \frac{1}{3}$, as can be seen from the Ratio Test. The intervals of convergence are $(-1/3, 1/3]$ and $[-1/3, 1/3]$, respectively.

27. (a) Substitute x^2 for x in the Maclaurin Series for $1/(1-x)$ (Table 9.9.1) and then multiply by x : $\frac{x}{1-x^2} = x \sum_{k=0}^{\infty} (x^2)^k = \sum_{k=0}^{\infty} x^{2k+1}$.

(b) $f^{(5)}(0) = 5!c_5 = 5!$, $f^{(6)}(0) = 6!c_6 = 0$.

(c) $f^{(n)}(0) = n!c_n = \begin{cases} n! & \text{if } n \text{ odd} \\ 0 & \text{if } n \text{ even} \end{cases}$

28. $x^2 \cos 2x = \sum_{k=0}^{\infty} \frac{(-1)^k 2^{2k}}{(2k)!} x^{2k+2}$; $f^{(99)}(0) = 0$ because $c_{99} = 0$.

29. (a) $\lim_{x \rightarrow 0} \frac{\sin x}{x} = \lim_{x \rightarrow 0} (1-x^2/3!+x^4/5!-\dots) = 1$.

$$(b) \lim_{x \rightarrow 0} \frac{\tan^{-1} x - x}{x^3} = \lim_{x \rightarrow 0} \frac{(x - x^3/3 + x^5/5 - x^7/7 + \dots) - x}{x^3} = -1/3.$$

$$30. (a) \frac{1 - \cos x}{\sin x} = \frac{1 - (1 - x^2/2! + x^4/4! - x^6/6! + \dots)}{x - x^3/3! + x^5/5! - \dots} = \frac{x^2/2! - x^4/4! + x^6/6! - \dots}{x - x^3/3! + x^5/5! - \dots} = \frac{x/2! - x^3/4! + x^5/6! - \dots}{1 - x^2/3! + x^4/5! - \dots},$$

$$x \neq 0; \lim_{x \rightarrow 0} \frac{1 - \cos x}{\sin x} = \frac{0}{1} = 0.$$

$$(b) \lim_{x \rightarrow 0} \frac{1}{x} [\ln \sqrt{1+x} - \sin 2x] = \lim_{x \rightarrow 0} \frac{1}{x} \left[\frac{1}{2} \ln(1+x) - \sin 2x \right] =$$

$$= \lim_{x \rightarrow 0} \frac{1}{x} \left[\frac{1}{2} \left(x - \frac{1}{2}x^2 + \frac{1}{3}x^3 - \dots \right) - \left(2x - \frac{4}{3}x^3 + \frac{4}{15}x^5 - \dots \right) \right] = \lim_{x \rightarrow 0} \left(-\frac{3}{2} - \frac{1}{4}x + \frac{3}{2}x^2 + \dots \right) = -3/2.$$

$$31. \int_0^1 \sin(x^2) dx = \int_0^1 \left(x^2 - \frac{1}{3!}x^6 + \frac{1}{5!}x^{10} - \frac{1}{7!}x^{14} + \dots \right) dx = \left[\frac{1}{3}x^3 - \frac{1}{7 \cdot 3!}x^7 + \frac{1}{11 \cdot 5!}x^{11} - \frac{1}{15 \cdot 7!}x^{15} + \dots \right]_0^1 =$$

$$\frac{1}{3} - \frac{1}{7 \cdot 3!} + \frac{1}{11 \cdot 5!} - \frac{1}{15 \cdot 7!} + \dots, \text{ but } \frac{1}{15 \cdot 7!} < 0.5 \times 10^{-3} \text{ so } \int_0^1 \sin(x^2) dx \approx \frac{1}{3} - \frac{1}{7 \cdot 3!} + \frac{1}{11 \cdot 5!} \approx 0.3103.$$

$$32. \int_0^{1/2} \tan^{-1}(2x^2) dx = \int_0^{1/2} \left(2x^2 - \frac{8}{3}x^6 + \frac{32}{5}x^{10} - \frac{128}{7}x^{14} + \dots \right) dx = \left[\frac{2}{3}x^3 - \frac{8}{21}x^7 + \frac{32}{55}x^{11} - \frac{128}{105}x^{15} + \dots \right]_0^{1/2} =$$

$$= \frac{2}{3} \frac{1}{2^3} - \frac{8}{21} \frac{1}{2^7} + \frac{32}{55} \frac{1}{2^{11}} - \frac{128}{105} \frac{1}{2^{15}} - \dots, \text{ but } \frac{32}{55 \cdot 2^{11}} < 0.5 \times 10^{-3} \text{ so } \int_0^{1/2} \tan^{-1}(2x^2) dx \approx \frac{2}{3 \cdot 2^3} - \frac{8}{21 \cdot 2^7} \approx 0.0804.$$

$$33. \int_0^{0.2} (1+x^4)^{1/3} dx = \int_0^{0.2} \left(1 + \frac{1}{3}x^4 - \frac{1}{9}x^8 + \dots \right) dx = \left[x + \frac{1}{15}x^5 - \frac{1}{81}x^9 + \dots \right]_0^{0.2} = 0.2 + \frac{1}{15}(0.2)^5 - \frac{1}{81}(0.2)^9 +$$

$$\dots, \text{ but } \frac{1}{15}(0.2)^5 < 0.5 \times 10^{-3} \text{ so } \int_0^{0.2} (1+x^4)^{1/3} dx \approx 0.200.$$

$$34. \int_0^{1/2} (1+x^2)^{-1/4} dx = \int_0^{1/2} \left(1 - \frac{1}{4}x^2 + \frac{5}{32}x^4 - \frac{15}{128}x^6 + \dots \right) dx = \left[x - \frac{1}{12}x^3 + \frac{1}{32}x^5 - \frac{15}{896}x^7 + \dots \right]_0^{1/2} = 1/2 -$$

$$\frac{1}{12}(1/2)^3 + \frac{1}{32}(1/2)^5 - \frac{15}{896}(1/2)^7 + \dots, \text{ but } \frac{15}{896}(1/2)^7 < 0.5 \times 10^{-3} \text{ so } \int_0^{1/2} (1+x^2)^{-1/4} dx \approx 1/2 - \frac{1}{12}(1/2)^3 +$$

$$\frac{1}{32}(1/2)^5 \approx 0.4906$$

$$35. (a) \text{ Substitute } x^4 \text{ for } x \text{ in the MacLaurin Series for } e^x \text{ to obtain } \sum_{k=0}^{+\infty} \frac{x^{4k}}{k!}. \text{ The radius of convergence is } R = +\infty.$$

$$(b) \text{ The first method is to multiply the MacLaurin Series for } e^{x^4} \text{ by } x^3: x^3 e^{x^4} = \sum_{k=0}^{+\infty} \frac{x^{4k+3}}{k!}. \text{ The second method}$$

$$\text{involves differentiation: } \frac{d}{dx} e^{x^4} = 4x^3 e^{x^4}, \text{ so } x^3 e^{x^4} = \frac{1}{4} \frac{d}{dx} e^{x^4} = \frac{1}{4} \frac{d}{dx} \sum_{k=0}^{+\infty} \frac{x^{4k}}{k!} = \frac{1}{4} \sum_{k=0}^{+\infty} \frac{4kx^{4k-1}}{k!} = \sum_{k=1}^{+\infty} \frac{x^{4k-1}}{(k-1)!}.$$

Use the change of variable $j = k - 1$ to show equality of the two series.

$$36. (a) \frac{x}{(1-x)^2} = x \frac{d}{dx} \left[\frac{1}{1-x} \right] = x \frac{d}{dx} \left[\sum_{k=0}^{\infty} x^k \right] = x \left[\sum_{k=1}^{\infty} kx^{k-1} \right] = \sum_{k=1}^{\infty} kx^k.$$

$$(b) -\ln(1-x) = \int \frac{1}{1-x} dx - C = \int \left[\sum_{k=0}^{\infty} x^k \right] dx - C = \sum_{k=0}^{\infty} \frac{x^{k+1}}{k+1} - C = \sum_{k=1}^{\infty} \frac{x^k}{k} - C, -\ln(1-0) = 0 \text{ so } C = 0.$$

(c) Replace x with $-x$ in part (b): $\ln(1+x) = -\sum_{k=1}^{+\infty} \frac{(-1)^k}{k} x^k = \sum_{k=1}^{+\infty} \frac{(-1)^{k+1}}{k} x^k$.

(d) $\sum_{k=1}^{+\infty} \frac{(-1)^{k+1}}{k}$ converges by the Alternating Series Test.

(e) By parts (c) and (d) and the remark, $\sum_{k=1}^{+\infty} \frac{(-1)^{k+1}}{k} x^k$ converges to $\ln(1+x)$ for $-1 < x \leq 1$.

37. (a) In Exercise 36(a), set $x = \frac{1}{3}$, $S = \frac{1/3}{(1-1/3)^2} = \frac{3}{4}$.

(b) In part (b) set $x = 1/4$, $S = \ln(4/3)$.

38. (a) In part (c) set $x = 1$, $S = \ln 2$.

(b) In part (b) set $x = (e-1)/e$, $S = \ln e = 1$.

39. (a) $\sinh^{-1} x = \int (1+x^2)^{-1/2} dx - C = \int \left(1 - \frac{1}{2}x^2 + \frac{3}{8}x^4 - \frac{5}{16}x^6 + \dots\right) dx - C =$
 $= \left(x - \frac{1}{6}x^3 + \frac{3}{40}x^5 - \frac{5}{112}x^7 + \dots\right) - C$; $\sinh^{-1} 0 = 0$ so $C = 0$.

(b) $(1+x^2)^{-1/2} = 1 + \sum_{k=1}^{\infty} \frac{(-1/2)(-3/2)(-5/2)\dots(-1/2-k+1)}{k!} (x^2)^k = 1 + \sum_{k=1}^{\infty} (-1)^k \frac{1 \cdot 3 \cdot 5 \dots (2k-1)}{2^k k!} x^{2k}$,
 $\sinh^{-1} x = x + \sum_{k=1}^{\infty} (-1)^k \frac{1 \cdot 3 \cdot 5 \dots (2k-1)}{2^k k!(2k+1)} x^{2k+1}$.

(c) $R = 1$.

40. (a) $\sin^{-1} x = \int (1-x^2)^{-1/2} dx - C = \int \left(1 + \frac{1}{2}x^2 + \frac{3}{8}x^4 + \frac{5}{16}x^6 + \dots\right) dx - C = \left(x + \frac{1}{6}x^3 + \frac{3}{40}x^5 + \frac{5}{112}x^7 + \dots\right) - C$, $\sin^{-1} 0 = 0$ so $C = 0$.

(b) $(1-x^2)^{-1/2} = 1 + \sum_{k=1}^{\infty} \frac{(-1/2)(-3/2)(-5/2)\dots(-1/2-k+1)}{k!} (-x^2)^k =$
 $= 1 + \sum_{k=1}^{\infty} \frac{(-1)^k (1/2)^k (1)(3)(5)\dots(2k-1)}{k!} (-1)^k x^{2k} = 1 + \sum_{k=1}^{\infty} \frac{1 \cdot 3 \cdot 5 \dots (2k-1)}{2^k k!} x^{2k} \sin^{-1} x =$
 $= x + \sum_{k=1}^{\infty} \frac{1 \cdot 3 \cdot 5 \dots (2k-1)}{2^k k!(2k+1)} x^{2k+1}$.

(c) $R = 1$.

41. (a) $y(t) = y_0 \sum_{k=0}^{\infty} \frac{(-1)^k (0.000121)^k t^k}{k!}$.

(b) $y(1) \approx y_0(1 - 0.000121t) \Big|_{t=1} = 0.999879y_0$.

(c) $y_0 e^{-0.000121} \approx 0.9998790073y_0$.

42. $\theta_0 = 5^\circ = \pi/36$ rad, $k = \sin(\pi/72)$.

(a) $T \approx 2\pi\sqrt{\frac{L}{g}} = 2\pi\sqrt{1/9.8} \approx 2.00709$.

(b) $T \approx 2\pi\sqrt{\frac{L}{g}} \left(1 + \frac{k^2}{4}\right) \approx 2.008044621$.

(c) 2.008045644.

43. The third order model gives the same result as the second, because there is no term of degree three in (8). By the Wallis sine formula, $\int_0^{\pi/2} \sin^4 \phi d\phi = \frac{1 \cdot 3}{2 \cdot 4} \frac{\pi}{2}$, and $T \approx 4\sqrt{\frac{L}{g}} \int_0^{\pi/2} \left(1 + \frac{1}{2}k^2 \sin^2 \phi + \frac{1 \cdot 3}{2 \cdot 2!} k^4 \sin^4 \phi\right) d\phi = 4\sqrt{\frac{L}{g}} \left(\frac{\pi}{2} + \frac{k^2 \pi}{2 \cdot 4} + \frac{3k^4 \pi}{8 \cdot 16}\right) = 2\pi\sqrt{\frac{L}{g}} \left(1 + \frac{k^2}{4} + \frac{9k^4}{64}\right)$.

44. (a) $F = \frac{mgR^2}{(R+h)^2} = \frac{mg}{(1+h/R)^2} = mg(1 - 2h/R + 3h^2/R^2 - 4h^3/R^3 + \dots)$.

(b) If $h = 0$, then the binomial series converges to 1 and $F = mg$.

(c) Sum the series to the linear term, $F \approx mg - 2mgh/R$.

(d) $\frac{mg - 2mgh/R}{mg} = 1 - \frac{2h}{R} = 1 - \frac{2 \cdot 29,028}{4000 \cdot 5280} \approx 0.9973$, so about 0.27% less.

45. (a) We can differentiate term-by-term: $y' = \sum_{k=1}^{\infty} \frac{(-1)^k x^{2k-1}}{2^{2k-1} k!(k-1)!} = \sum_{k=0}^{\infty} \frac{(-1)^{k+1} x^{2k+1}}{2^{2k+1} (k+1)!k!}$, $y'' = \sum_{k=0}^{\infty} \frac{(-1)^{k+1} (2k+1)x^{2k}}{2^{2k+1} (k+1)!k!}$,

and $xy'' + y' + xy = \sum_{k=0}^{\infty} \frac{(-1)^{k+1} (2k+1)x^{2k+1}}{2^{2k+1} (k+1)!k!} + \sum_{k=0}^{\infty} \frac{(-1)^{k+1} x^{2k+1}}{2^{2k+1} (k+1)!k!} + \sum_{k=0}^{\infty} \frac{(-1)^k x^{2k+1}}{2^{2k} (k!)^2}$, so

$$xy'' + y' + xy = \sum_{k=0}^{\infty} \frac{(-1)^{k+1} x^{2k+1}}{2^{2k} (k!)^2} \left[\frac{2k+1}{2(k+1)} + \frac{1}{2(k+1)} - 1 \right] = 0.$$

(b) $y' = \sum_{k=0}^{\infty} \frac{(-1)^k (2k+1)x^{2k}}{2^{2k+1} k!(k+1)!}$, $y'' = \sum_{k=1}^{\infty} \frac{(-1)^k (2k+1)x^{2k-1}}{2^{2k} (k-1)!(k+1)!}$. Since $J_1(x) = \sum_{k=0}^{\infty} \frac{(-1)^k x^{2k+1}}{2^{2k+1} k!(k+1)!}$ and $x^2 J_1(x) = \sum_{k=1}^{\infty} \frac{(-1)^{k-1} x^{2k+1}}{2^{2k-1} (k-1)!k!}$, it follows that $x^2 y'' + xy' + (x^2 - 1)y = \sum_{k=1}^{\infty} \frac{(-1)^k (2k+1)x^{2k+1}}{2^{2k} (k-1)!(k+1)!} + \sum_{k=0}^{\infty} \frac{(-1)^k (2k+1)x^{2k+1}}{2^{2k+1} (k!)^2} + \sum_{k=1}^{\infty} \frac{(-1)^{k-1} x^{2k+1}}{2^{2k-1} (k-1)!k!} - \sum_{k=0}^{\infty} \frac{(-1)^k x^{2k+1}}{2^{2k+1} k!(k+1)!} = \frac{x}{2} - \frac{x}{2} + \sum_{k=1}^{\infty} \frac{(-1)^k x^{2k+1}}{2^{2k-1} (k-1)!k!} \left(\frac{2k+1}{2(k+1)} + \frac{2k+1}{4k(k+1)} - 1 - \frac{1}{4k(k+1)} \right) = 0$.

(c) From part (a), $J_0'(x) = \sum_{k=0}^{\infty} \frac{(-1)^{k+1} x^{2k+1}}{2^{2k+1} (k+1)!k!} = -J_1(x)$.

46. Suppose not, and suppose that k_0 is the first integer for which $a_k \neq b_k$. Then $a_{k_0} x^{k_0} + a_{k_0+1} x^{k_0+1} + \dots = b_{k_0} x^{k_0} + b_{k_0+1} x^{k_0+1} + \dots$. Divide by x^{k_0} and let $x \rightarrow 0$ to show that $a_{k_0} = b_{k_0}$ which contradicts the assumption that they were not equal. Thus $a_k = b_k$ for all k .

Chapter 9 Review Exercises

7. The series converges for $|x - x_0| < R$ and may or may not converge at $x = x_0 \pm R$.

8. (a) $\sum_{k=0}^{\infty} \frac{f^{(k)}(0)}{k!} x^k$. (b) $\sum_{k=0}^{\infty} \frac{f^{(k)}(x_0)}{k!} (x - x_0)^k$.
9. (a) Always true by Theorem 9.4.2.
- (b) Sometimes false, for example the harmonic series diverges but $\sum(1/k^2)$ converges.
- (c) Sometimes false, for example $f(x) = \sin \pi x, a_k = 0, L = 0$.
- (d) Always true by the comments which follow Example 3(d) of Section 9.1.
- (e) Sometimes false, for example $a_n = \frac{1}{2} + (-1)^n \frac{1}{4}$.
- (f) Sometimes false, for example $u_k = 1/2$.
- (g) Always false by Theorem 9.4.3.
- (h) Sometimes false, for example $u_k = 1/k, v_k = 2/k$.
- (i) Always true by the Comparison Test.
- (j) Always true by the Comparison Test.
- (k) Sometimes false, for example $\sum(-1)^k/k$.
- (l) Sometimes false, for example $\sum(-1)^k/k$.
10. (a) False, $f(x)$ is not differentiable at $x = 0$, Definition 9.8.1.
- (b) True: $s_n = 1$ if n is odd and $s_{2n} = 1 + 1/(n + 1)$; $\lim_{n \rightarrow +\infty} s_n = 1$.
- (c) False, $\lim a_k \neq 0$.
11. (a) $a_n = \frac{n + 2}{(n + 1)^2 - n^2} = \frac{n + 2}{((n + 1) + n)((n + 1) - n)} = \frac{n + 2}{2n + 1}$, limit = $1/2$.
- (b) $a_n = (-1)^{n-1} \frac{n}{2n + 1}$, limit does not exist because of alternating signs.
12. $a_k = \sqrt{a_{k-1}} = a_{k-1}^{1/2} = a_{k-2}^{1/4} = \dots = a_1^{1/2^{k-1}} = c^{1/2^k}$.
- (a) If $c = 1/2$ then $\lim_{k \rightarrow +\infty} a_k = 1$. (b) If $c = 3/2$ then $\lim_{k \rightarrow +\infty} a_k = 1$.
13. (a) $a_{n+1}/a_n = (n + 1 - 10)^4/(n - 10)^4 = (n - 9)^4/(n - 10)^4$. Since $n - 9 > n - 10$, for all $n > 10$ it follows that $(n - 9)^4 > (n - 10)^4$ and thus that $a_{n+1}/a_n > 1$ for all $n > 10$, hence the sequence is eventually strictly monotone increasing.
- (b) $\frac{100^{n+1}}{(2(n + 1))!(n + 1)!} \cdot \frac{(2n)!n!}{100^n} = \frac{100}{(2n + 2)(2n + 1)(n + 1)} < 1$ for $n \geq 3$, so the sequence is eventually strictly monotone decreasing.
14. (a) $a_n = (-1)^n$. (b) $a_n = n$.

15. (a) Geometric series, $r = 1/5$, $|r| = 1/5 < 1$, series converges.

(b) $1/(5^k + 1) < 1/5^k$, Comparison Test with part (a), series converges.

16. (a) Converges by the Alternating Series Test.

(b) Absolutely convergent: $\sum_{k=1}^{\infty} \left[\frac{k+2}{3k-1} \right]^k$ converges by the Root Test.

17. (a) $\frac{1}{k^3 + 2k + 1} < \frac{1}{k^3}$, $\sum_{k=1}^{\infty} 1/k^3$ converges (p -series with $p = 3 > 1$), so $\sum_{k=1}^{\infty} \frac{1}{k^3 + 2k + 1}$ converges by the Comparison Test.

(b) Limit Comparison Test, compare with the divergent p -series ($p = 2/5 < 1$) $\sum_{k=1}^{\infty} \frac{1}{k^{2/5}}$, diverges.

18. (a) $\sum_{k=1}^{\infty} \frac{\ln k}{k\sqrt{k}} = \sum_{k=2}^{\infty} \frac{\ln k}{k\sqrt{k}}$ because $\ln 1 = 0$, $\int_2^{+\infty} \frac{\ln x}{x^{3/2}} dx = \lim_{\ell \rightarrow +\infty} \left[-\frac{2 \ln x}{x^{1/2}} - \frac{4}{x^{1/2}} \right]_2^{\ell} = \sqrt{2}(\ln 2 + 2)$ which implies that $\sum_{k=2}^{\infty} \frac{\ln k}{k^{3/2}}$ converges. (Integral Test, assumptions are true.)

(b) Comparison Test: $\frac{k^{4/3}}{8k^2 + 5k + 1} \geq \frac{k^{4/3}}{8k^2 + 5k^2 + k^2} = \frac{1}{14k^{2/3}}$, $\frac{1}{14} \sum_{k=1}^{\infty} \frac{1}{k^{2/3}}$ diverges (p -series with $p = 2/3 < 1$), so the original series also diverges.

19. (a) Comparison Test: $\frac{9}{\sqrt{k} + 1} \geq \frac{9}{\sqrt{k} + \sqrt{k}} = \frac{9}{2\sqrt{k}}$, $\frac{9}{2} \sum_{k=1}^{\infty} \frac{1}{\sqrt{k}}$ diverges (p -series with $p = 1/2 < 1$), so the original series also diverges.

(b) Converges absolutely using the Comparison Test: $\left| \frac{\cos(1/k)}{k^2} \right| \leq \frac{1}{k^2}$ and $\sum_{k=1}^{+\infty} \frac{1}{k^2}$ converges (p -series with $p = 2 > 1$).

20. (a) Comparison Test: $\frac{k^{-1/2}}{2 + \sin^2 k} > \frac{k^{-1}}{2 + 1} = \frac{1}{3k}$, $\frac{1}{3} \sum_{k=1}^{\infty} \frac{1}{k}$ diverges (harmonic series), so the original series also diverges.

(b) Absolutely convergent: $\sum_{k=1}^{\infty} \frac{1}{k^2 + 1}$ converges (Comparison Test with the p -series $\sum 1/k^2$).

21. $\sum_{k=0}^{\infty} \frac{1}{5^k} - \sum_{k=0}^{99} \frac{1}{5^k} = \sum_{k=100}^{\infty} \frac{1}{5^k} = \frac{1}{5^{100}} \sum_{k=0}^{\infty} \frac{1}{5^k} = \frac{1}{4 \cdot 5^{99}}$.

22. (a) $u_{100} = \sum_{k=1}^{100} u_k - \sum_{k=1}^{99} u_k = \left(2 - \frac{1}{100} \right) - \left(2 - \frac{1}{99} \right) = \frac{1}{9900}$.

(b) $u_1 = 1$; for $k \geq 2$, $u_k = \left(2 - \frac{1}{k} \right) - \left(2 - \frac{1}{k-1} \right) = \frac{1}{k(k-1)}$, $\lim_{k \rightarrow +\infty} u_k = 0$.

$$(c) \sum_{k=1}^{\infty} u_k = \lim_{n \rightarrow +\infty} \sum_{k=1}^n u_k = \lim_{n \rightarrow +\infty} \left(2 - \frac{1}{n}\right) = 2.$$

$$23. (a) \sum_{k=1}^{\infty} \left(\frac{3}{2^k} - \frac{2}{3^k}\right) = \sum_{k=1}^{\infty} \frac{3}{2^k} - \sum_{k=1}^{\infty} \frac{2}{3^k} = \left(\frac{3}{2}\right) \frac{1}{1 - (1/2)} - \left(\frac{2}{3}\right) \frac{1}{1 - (1/3)} = 2 \text{ (geometric series).}$$

$$(b) \sum_{k=1}^n [\ln(k+1) - \ln k] = \ln(n+1), \text{ so } \sum_{k=1}^{\infty} [\ln(k+1) - \ln k] = \lim_{n \rightarrow +\infty} \ln(n+1) = +\infty, \text{ diverges.}$$

$$(c) \lim_{n \rightarrow +\infty} \sum_{k=1}^n \frac{1}{2} \left(\frac{1}{k} - \frac{1}{k+2}\right) = \lim_{n \rightarrow +\infty} \frac{1}{2} \left(1 + \frac{1}{2} - \frac{1}{n+1} - \frac{1}{n+2}\right) = \frac{3}{4}.$$

$$(d) \lim_{n \rightarrow +\infty} \sum_{k=1}^n [\tan^{-1}(k+1) - \tan^{-1} k] = \lim_{n \rightarrow +\infty} [\tan^{-1}(n+1) - \tan^{-1}(1)] = \frac{\pi}{2} - \frac{\pi}{4} = \frac{\pi}{4}.$$

$$24. (a) \rho = \lim_{k \rightarrow +\infty} \left(\frac{2^k}{k!}\right)^{1/k} = \lim_{k \rightarrow +\infty} \frac{2}{\sqrt[k]{k!}} = 0, \text{ converges.}$$

$$(b) \rho = \lim_{k \rightarrow +\infty} u_k^{1/k} = \lim_{k \rightarrow +\infty} \frac{k}{\sqrt[k]{k!}} = e, \text{ diverges.}$$

25. Compare with $1/k^p$: converges if $p > 1$, diverges otherwise.

26. By the Ratio Test for absolute convergence, $\rho = \lim_{k \rightarrow +\infty} \frac{|x - x_0|}{b} = \frac{|x - x_0|}{b}$; converges if $|x - x_0| < b$, diverges if $|x - x_0| > b$. If $x = x_0 - b$, $\sum_{k=0}^{\infty} (-1)^k$ diverges; if $x = x_0 + b$, $\sum_{k=0}^{\infty} 1$ diverges. The interval of convergence is $(x_0 - b, x_0 + b)$.

27. (a) $1 \leq k, 2 \leq k, 3 \leq k, \dots, k \leq k$, therefore $1 \cdot 2 \cdot 3 \dots k \leq k \cdot k \cdot k \dots k$, or $k! \leq k^k$.

$$(b) \sum \frac{1}{k^k} \leq \sum \frac{1}{k!}, \text{ converges.}$$

$$(c) \lim_{k \rightarrow +\infty} \left(\frac{1}{k^k}\right)^{1/k} = \lim_{k \rightarrow +\infty} \frac{1}{k} = 0, \text{ converges.}$$

28. No, $(-1)^{k+1} \frac{k}{2k-1}$ does not approach 0, therefore the given series diverges by the Divergence Test.

29. (a) $p_0(x) = 1, p_1(x) = 1 - 7x, p_2(x) = 1 - 7x + 5x^2, p_3(x) = 1 - 7x + 5x^2 + 4x^3, p_4(x) = 1 - 7x + 5x^2 + 4x^3$.

(b) If $f(x)$ is a polynomial of degree n and $k \geq n$ then the Maclaurin polynomial of degree k is the polynomial itself; if $k < n$ then it is the truncated polynomial.

30. $\sin x = x - x^3/3! + x^5/5! - x^7/7! + \dots$ is an alternating series, so $|\sin x - x + x^3/3! - x^5/5!| \leq x^7/7! \leq \pi^7/(4^7 7!) \leq 0.00005$.

31. $\ln(1+x) = x - x^2/2 + \dots$; so $|\ln(1+x) - x| \leq x^2/2$ by Theorem 9.6.2.

32. $\int_0^1 \frac{1 - \cos x}{x} dx = \left[\frac{x^2}{2 \cdot 2!} - \frac{x^4}{4 \cdot 4!} + \frac{x^6}{6 \cdot 6!} - \dots \right]_0^1 = \frac{1}{2 \cdot 2!} - \frac{1}{4 \cdot 4!} + \frac{1}{6 \cdot 6!} - \dots$, and $\frac{1}{6 \cdot 6!} < 0.0005$, so $\int_0^1 \frac{1 - \cos x}{x} dx = \frac{1}{2 \cdot 2!} - \frac{1}{4 \cdot 4!} = 0.2396$ to three decimal-place accuracy.

33. (a) $e^2 - 1$. (b) $\sin \pi = 0$. (c) $\cos e$. (d) $e^{-\ln 3} = 1/3$.
34. (a) $x + \frac{1}{2}x^2 + \frac{3}{14}x^3 + \frac{3}{35}x^4 + \dots$; $\rho = \lim_{k \rightarrow +\infty} \frac{k+1}{3k+1}|x| = \frac{1}{3}|x|$, converges if $\frac{1}{3}|x| < 1$, $|x| < 3$ so $R = 3$.
- (b) $-x^3 + \frac{2}{3}x^5 - \frac{2}{5}x^7 + \frac{8}{35}x^9 - \dots$; $\rho = \lim_{k \rightarrow +\infty} \frac{k+1}{2k+1}|x|^2 = \frac{1}{2}|x|^2$, converges if $\frac{1}{2}|x|^2 < 1$, $|x|^2 < 2$, $|x| < \sqrt{2}$ so $R = \sqrt{2}$.
35. $(27+x)^{1/3} = 3(1+x/3^3)^{1/3} = 3\left(1 + \frac{1}{3^4}x - \frac{1 \cdot 2}{3^8 2}x^2 + \frac{1 \cdot 2 \cdot 5}{3^{12} 3!}x^3 + \dots\right)$, alternates after first term, $\frac{3 \cdot 2}{3^8 2} < 0.0005$, $\sqrt[3]{28} \approx 3\left(1 + \frac{1}{3^4}\right) \approx 3.0370$.
36. $(x+1)e^x = \frac{d}{dx}(xe^x) = \frac{d}{dx} \sum_{k=0}^{\infty} \frac{x^{k+1}}{k!} = \sum_{k=0}^{\infty} \frac{k+1}{k!} x^k$, so set $x = 1$ to obtain the result.
37. Both (a) and (b): $x - \frac{2}{3}x^3 + \frac{2}{15}x^5 - \frac{4}{315}x^7$.

Chapter 9 Making Connections

1. $P_0P_1 = a \sin \theta$, $P_1P_2 = a \sin \theta \cos \theta$, $P_2P_3 = a \sin \theta \cos^2 \theta$, $P_3P_4 = a \sin \theta \cos^3 \theta, \dots$ (see figure). Each sum is a geometric series.

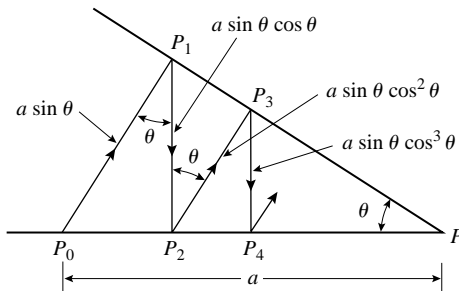

- (a) $P_0P_1 + P_1P_2 + P_2P_3 + \dots = a \sin \theta + a \sin \theta \cos \theta + a \sin \theta \cos^2 \theta + \dots = \frac{a \sin \theta}{1 - \cos \theta}$.
- (b) $P_0P_1 + P_2P_3 + P_4P_5 + \dots = a \sin \theta + a \sin \theta \cos^2 \theta + a \sin \theta \cos^4 \theta + \dots = \frac{a \sin \theta}{1 - \cos^2 \theta} = \frac{a \sin \theta}{\sin^2 \theta} = a \csc \theta$.
- (c) $P_1P_2 + P_3P_4 + P_5P_6 + \dots = a \sin \theta \cos \theta + a \sin \theta \cos^3 \theta + \dots = \frac{a \sin \theta \cos \theta}{1 - \cos^2 \theta} = \frac{a \sin \theta \cos \theta}{\sin^2 \theta} = a \cot \theta$.
2. (a) $\frac{2^k A}{3^k - 2^k} + \frac{2^k B}{3^{k+1} - 2^{k+1}} = \frac{2^k (3^{k+1} - 2^{k+1}) A + 2^k (3^k - 2^k) B}{(3^k - 2^k)(3^{k+1} - 2^{k+1})} = \frac{(3 \cdot 6^k - 2 \cdot 2^{2k}) A + (6^k - 2^{2k}) B}{(3^k - 2^k)(3^{k+1} - 2^{k+1})} = \frac{(3A + B)6^k - (2A + B)2^{2k}}{(3^k - 2^k)(3^{k+1} - 2^{k+1})}$, so $3A + B = 1$ and $2A + B = 0$, $A = 1$ and $B = -2$.

- (b) $s_n = \sum_{k=1}^n \left[\frac{2^k}{3^k - 2^k} - \frac{2^{k+1}}{3^{k+1} - 2^{k+1}} \right] = \sum_{k=1}^n (a_k - a_{k+1})$ where $a_k = \frac{2^k}{3^k - 2^k}$. But $s_n = (a_1 - a_2) + (a_2 - a_3) + (a_3 - a_4) + \dots + (a_n - a_{n+1})$ which is a telescoping sum, $s_n = a_1 - a_{n+1} = 2 - \frac{2^{n+1}}{3^{n+1} - 2^{n+1}}$, $\lim_{n \rightarrow +\infty} s_n = \lim_{n \rightarrow +\infty} \left[2 - \frac{(2/3)^{n+1}}{1 - (2/3)^{n+1}} \right] = 2$.

3. $\sum(1/k^p)$ converges if $p > 1$ and diverges if $p \leq 1$, so $\sum_{k=1}^{\infty} (-1)^k \frac{1}{k^p}$ converges absolutely if $p > 1$, and converges conditionally if $0 < p \leq 1$ since it satisfies the Alternating Series Test; it diverges for $p \leq 0$ since $\lim_{k \rightarrow +\infty} a_k \neq 0$.
4. (a) The distance d from the starting point is $d = 180 - \frac{180}{2} + \frac{180}{3} - \dots - \frac{180}{1000} = 180 \left[1 - \frac{1}{2} + \frac{1}{3} - \dots - \frac{1}{1000} \right]$.
From Theorem 9.6.2, $1 - \frac{1}{2} + \frac{1}{3} - \dots - \frac{1}{1000}$ differs from $\ln 2$ by less than $1/1001$, so $180(\ln 2 - 1/1001) < d < 180 \ln 2$, $124.58 < d < 124.77$.
- (b) The total distance traveled is $s = 180 + \frac{180}{2} + \frac{180}{3} + \dots + \frac{180}{1000}$, and from inequality (2) in Section 9.4, $\int_1^{1001} \frac{180}{x} dx < s < 180 + \int_1^{1000} \frac{180}{x} dx$, $180 \ln 1001 < s < 180(1 + \ln 1000)$, $1243 < s < 1424$.
5. $\left(1 - \frac{v^2}{c^2}\right)^{-1/2} \approx 1 + \frac{v^2}{2c^2}$, so $K = m_0 c^2 \left[\frac{1}{\sqrt{1 - v^2/c^2}} - 1 \right] \approx m_0 c^2 (v^2/2c^2) = m_0 v^2/2$.
6. (a) If $\frac{ct}{m} \approx 0$ then $e^{-ct/m} \approx 1 - \frac{ct}{m}$, and $v(t) \approx \left(1 - \frac{ct}{m}\right) \left(v_0 + \frac{mg}{c}\right) - \frac{mg}{c} = v_0 - \left(\frac{cv_0}{m} + g\right) t$.
- (b) The quadratic approximation is $v_0 \approx \left(1 - \frac{ct}{m} + \frac{(ct)^2}{2m^2}\right) \left(v_0 + \frac{mg}{c}\right) - \frac{mg}{c} = v_0 - \left(\frac{cv_0}{m} + g\right) t + \frac{c^2}{2m^2} \left(v_0 + \frac{mg}{c}\right) t^2$.

Parametric and Polar Curves; Conic Sections

Exercise Set 10.1

1. (a) $x + 1 = t = y - 1, y = x + 2.$

(c)

t	0	1	2	3	4	5
x	-1	0	1	2	3	4
y	1	2	3	4	5	6

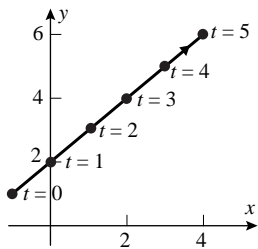

2. (a) $x^2 + y^2 = 1.$

(c)

t	0	0.2500	0.50	0.7500	1
x	1	0.7071	0.00	-0.7071	-1
y	0	0.7071	1.00	0.7071	0

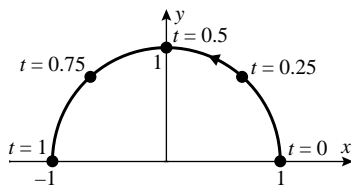

3. $t = (x + 4)/3; y = 2x + 10.$

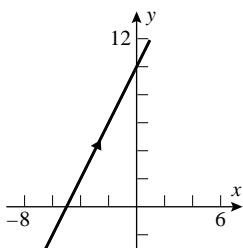

4. $t = x + 3; y = 3x + 2, -3 \leq x \leq 0.$

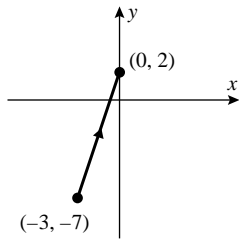

5. $\cos t = x/2$, $\sin t = y/5$; $x^2/4 + y^2/25 = 1$.

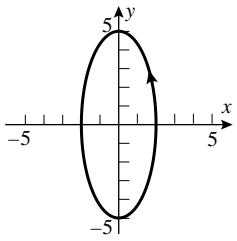

6. $t = x^2$; $y = 2x^2 + 4$, $x \geq 0$.

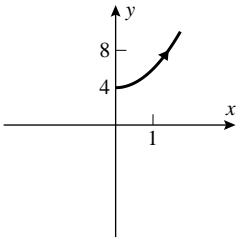

7. $\cos t = (x - 3)/2$, $\sin t = (y - 2)/4$; $(x - 3)^2/4 + (y - 2)^2/16 = 1$.

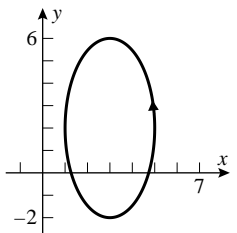

8. $\sec^2 t - \tan^2 t = 1$; $x^2 - y^2 = 1$, $x \leq -1$ and $y \geq 0$.

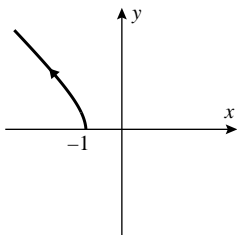

9. $\cos 2t = 1 - 2\sin^2 t$; $x = 1 - 2y^2$, $-1 \leq y \leq 1$.

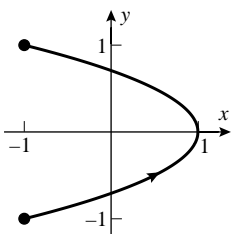

10. $t = (x - 3)/4; y = (x - 3)^2 - 9.$

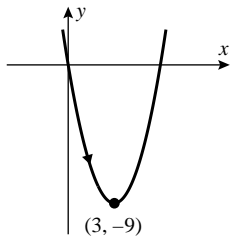

11. $x/2 + y/3 = 1, 0 \leq x \leq 2, 0 \leq y \leq 3.$

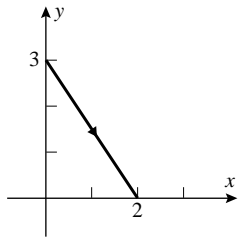

12. $y = x - 1, x \geq 1, y \geq 0$

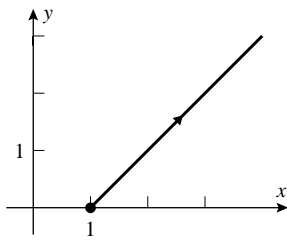

13. $x = 5 \cos t, y = -5 \sin t, 0 \leq t \leq 2\pi.$

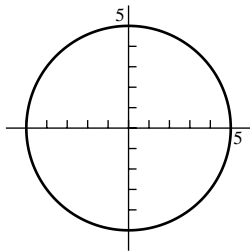

14. $x = \cos t, y = \sin t, \pi \leq t \leq 3\pi/2.$

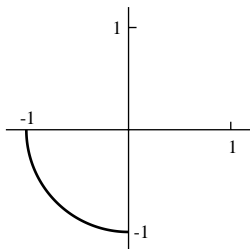

15. $x = 2, y = t.$

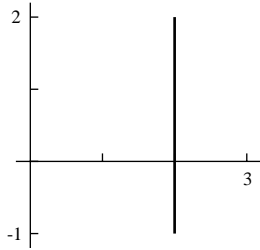

16. $x = 2 \cos t, y = 3 \sin t, 0 \leq t \leq 2\pi$.

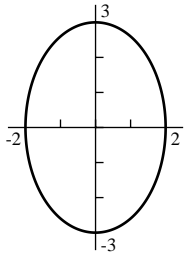

17. $x = t^2, y = t, -1 \leq t \leq 1$.

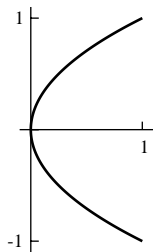

18. $x = 1 + 4 \cos t, y = -3 + 4 \sin t, 0 \leq t \leq 2\pi$.

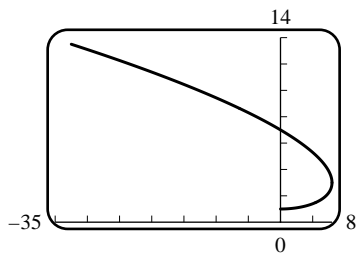
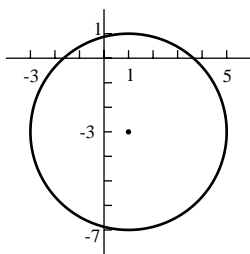

19. (a)

t	0	1	2	3	4	5
x	0	5.5	8	4.5	-8	-32.5
y	1	1.5	3	5.5	9	13.5

(c) $x = 0$ when $t = 0, 2\sqrt{3}$. (d) For $0 < t < 2\sqrt{2}$. (e) At $t = 2$.

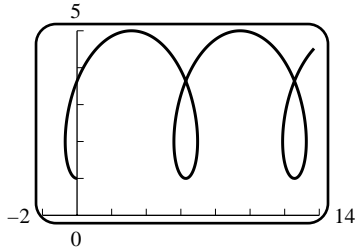

20. (a)

(b) y is always ≥ 1 since $\cos t \leq 1$.

(c) Greater than 5, since $\cos t \geq -1$.

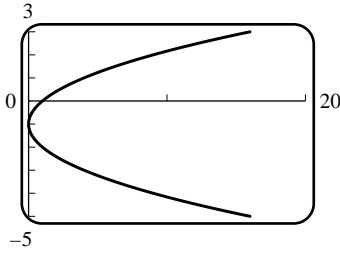

21. (a)

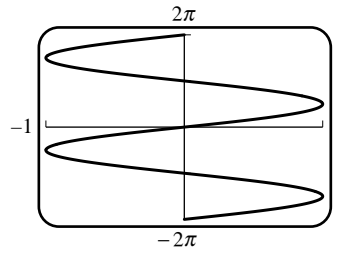

(b)

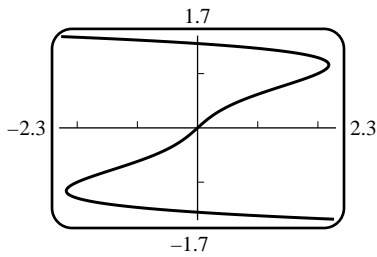

22. (a)

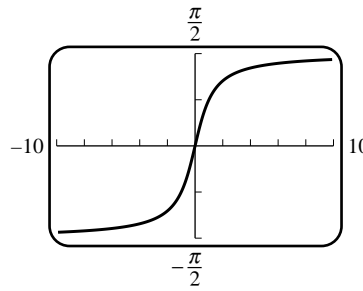

(b)

23. (a) IV, because x always increases whereas y oscillates.

(b) II, because $(x/2)^2 + (y/3)^2 = 1$, an ellipse.

(c) V, because $x^2 + y^2 = t^2$ increases in magnitude while x and y keep changing sign.

(d) VI; examine the cases $t < -1$ and $t > -1$ and you see the curve lies in the first, second and fourth quadrants only.

(e) III, because $y > 0$.

(f) I; since x and y are bounded, the answer must be I or II; since $x = y = 0$ when $t = \pi/2$, the curve passes through the origin, so it must be I.

24. (a) (a) (IV): from left to right. (b) (II): counterclockwise. (c) (V): counterclockwise. (d) (VI): As t travels from $-\infty$ to -1 , the curve goes from (near) the origin in the fourth quadrant and travels down and right. As t travels from -1 to $+\infty$ the curve comes from way up in the second quadrant, hits the origin at $t = 0$, and then makes the loop in the first quadrant counterclockwise and finally approaches the origin again as $t \rightarrow +\infty$. (e) (III): from left to right. (f) (I): Starting, say, at $(1/2, 0)$ at $t = 0$, the curve goes up into the first quadrant, loops back through the origin and into the third quadrant, and then continues the figure-eight.

(b) The two branches corresponding to $-1 \leq t \leq 0$ and $0 \leq t \leq 1$ coincide, with opposite directions.

25. (a) $|R - P|^2 = (x - x_0)^2 + (y - y_0)^2 = t^2[(x_1 - x_0)^2 + (y_1 - y_0)^2]$ and $|Q - P|^2 = (x_1 - x_0)^2 + (y_1 - y_0)^2$, so $r = |R - P| = |Q - P|t = qt$.

(b) $t = 1/2$. (c) $t = 3/4$.

26. $x = 2 + t$, $y = -1 + 2t$.

(a) $(5/2, 0)$ (b) $(9/4, -1/2)$ (c) $(11/4, 1/2)$

27. (a) Eliminate $\frac{t-t_0}{t_1-t_0}$ from the parametric equations to obtain $\frac{y-y_0}{x-x_0} = \frac{y_1-y_0}{x_1-x_0}$, which is an equation of the line through the 2 points.

(b) From (x_0, y_0) to (x_1, y_1) .

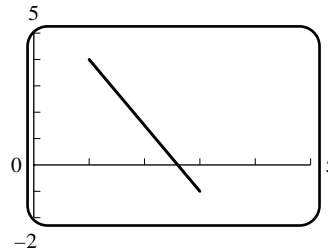

(c) $x = 3 - 2(t - 1)$, $y = -1 + 5(t - 1)$.

28. (a) If $a \neq 0$ then $t = \frac{x-b}{a}$ and $y = c\frac{x-b}{a} + d = \frac{c}{a}x + \left(d - \frac{bc}{a}\right)$ so the graph is the part of the line $y = \frac{c}{a}x + \left(d - \frac{bc}{a}\right)$ with x between $at_0 + b$ and $at_1 + b$. If $a = 0$ then $c \neq 0$ and the graph is the part of the vertical line $x = b$ with y between $ct_0 + d$ and $ct_1 + d$.

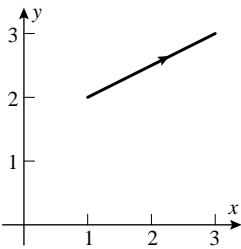

(b)

(c) If $a = 0$ the line segment is vertical; if $c = 0$ it is horizontal.

(d) The curve degenerates to the point (b, d) .

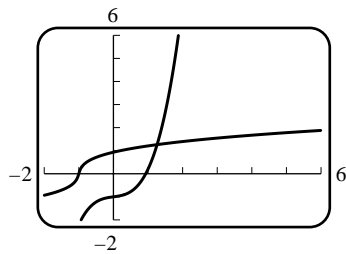

29.

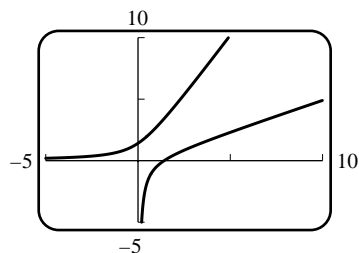

30.

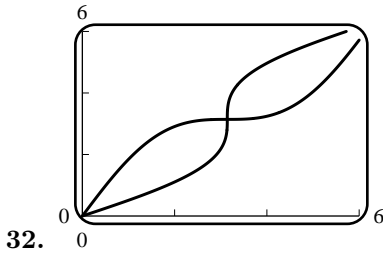
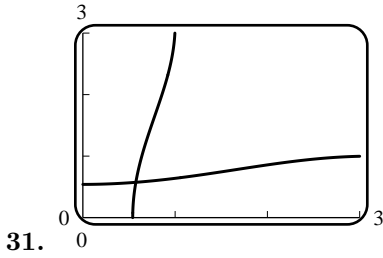

33. False. The parametric curve only gives the part of $y = 1 - x^2$ with $-1 \leq x \leq 1$.

34. False. It is the reflection of $y = f(x)$ across the line $y = x$.

35. True. By equation (4), $\frac{dy}{dx} = \frac{dy/dt}{dx/dt} = \frac{12t^3 - 6t^2}{x'(t)}$.

36. False. $t = x^{1/3}$ so $y = x^2 + x^{1/3}$, $y' = 2x + \frac{1}{3}x^{-2/3}$, and $y'' = 2 - \frac{2}{9}x^{-5/3}$. For $t < 0$, $x < 0$ and $y'' > 2$, so the curve is concave up for $t < 0$. In fact the only part of the curve which is concave down is the part with $0 < x < 9^{-3/5}$; i.e. $0 < t < 9^{-1/5}$.

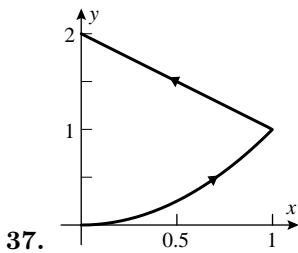

38. $x = 1/2 - 4t$, $y = 1/2$ for $0 \leq t \leq 1/4$; $x = -1/2$, $y = 1/2 - 4(t - 1/4)$ for $1/4 \leq t \leq 1/2$; $x = -1/2 + 4(t - 1/2)$, $y = -1/2$ for $1/2 \leq t \leq 3/4$; $x = 1/2$, $y = -1/2 + 4(t - 3/4)$ for $3/4 \leq t \leq 1$.

39. (a) $x = 4 \cos t$, $y = 3 \sin t$. (b) $x = -1 + 4 \cos t$, $y = 2 + 3 \sin t$.

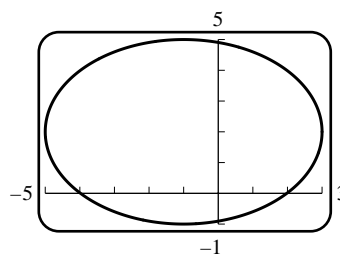
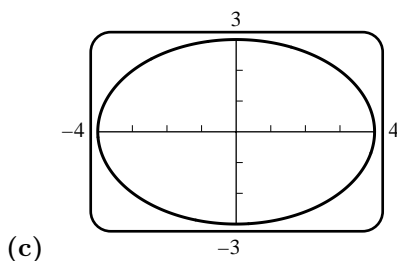

40. (a) $t = \frac{x}{v_0 \cos \alpha}$, so $y = -\frac{g}{2v_0^2 \cos^2 \alpha} x^2 + (\tan \alpha) x$.

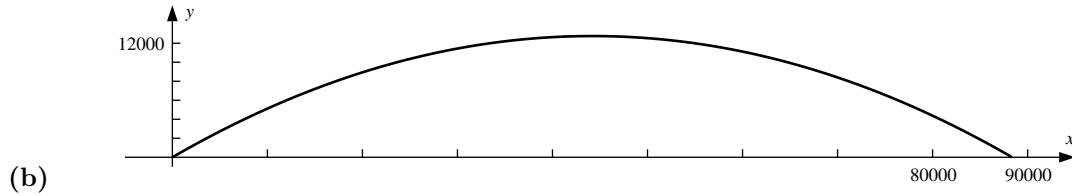

(c) The parametric equations are $x = 500\sqrt{3}t$, $y = 500t - 4.9t^2$. So $\frac{dy}{dt} = 500 - 9.8t = 0$ when $t = \frac{500}{9.8} = \frac{2500}{49}$. The maximum height is $y\left(\frac{2500}{49}\right) = \frac{625,000}{49} \approx 12755$ m.

(d) $y = t(500 - 4.9t) = 0$ when $t = 0$ or $t = \frac{500}{4.9} = \frac{5000}{49}$. So the horizontal distance is $x\left(\frac{5000}{49}\right) = \frac{2,500,000\sqrt{3}}{49} \approx 88370$ m.

41. (a) $\frac{dy}{dx} = \frac{2t}{1/2} = 4t$; $\frac{dy}{dx}\Big|_{t=-1} = -4$; $\frac{dy}{dx}\Big|_{t=1} = 4$.

(b) $y = (2x)^2 + 1$, $\frac{dy}{dx} = 8x$, $\frac{dy}{dx}\Big|_{x=\pm(1/2)} = \pm 4$.

42. (a) $\frac{dy}{dx} = \frac{4 \cos t}{-3 \sin t} = -\frac{4}{3} \cot t$; $\frac{dy}{dx}\Big|_{t=\pi/4} = -\frac{4}{3}$, $\frac{dy}{dx}\Big|_{t=7\pi/4} = \frac{4}{3}$.

(b) Since $\frac{x^2}{9} + \frac{y^2}{16} = \cos^2 t + \sin^2 t = 1$, we have $y = \pm \frac{4}{3}\sqrt{9-x^2}$. For $0 \leq t \leq \pi$, $y \geq 0$ so $y = \frac{4}{3}\sqrt{9-x^2}$ and $\frac{dy}{dx} = -\frac{4x}{3\sqrt{9-x^2}}$; at $t = \frac{\pi}{4}$, $x = \frac{3}{\sqrt{2}}$ and $\frac{dy}{dx} = -\frac{4}{3}$. For $\pi \leq t \leq 2\pi$, $y \leq 0$ so $y = -\frac{4}{3}\sqrt{9-x^2}$ and $\frac{dy}{dx} = \frac{4x}{3\sqrt{9-x^2}}$; at $t = \frac{7\pi}{4}$, $x = \frac{3}{\sqrt{2}}$ and $\frac{dy}{dx} = \frac{4}{3}$.

43. From Exercise 41(a), $\frac{dy}{dx} = 4t$ so $\frac{d^2y}{dx^2} = \frac{d}{dt}\left(\frac{dy}{dx}\right) \Big/ \frac{dx}{dt} = \frac{4}{1/2} = 8$. The sign of $\frac{d^2y}{dx^2}$ is positive for all t , including $t = \pm 1$.

44. From Exercise 42(a), $\frac{d^2y}{dx^2} = \frac{d}{dt}\left(\frac{dy}{dx}\right) \Big/ \frac{dx}{dt} = \frac{-(4/3)(-\csc^2 t)}{-3 \sin t} = -\frac{4}{9} \csc^3 t$; negative at $t = \pi/4$, positive at $t = 7\pi/4$.

45. $\frac{dy}{dx} = \frac{dy/dt}{dx/dt} = \frac{2}{1/(2\sqrt{t})} = 4\sqrt{t}$, $\frac{d^2y}{dx^2} = \frac{d}{dt}\left(\frac{dy}{dx}\right) \Big/ \frac{dx}{dt} = \frac{2/\sqrt{t}}{1/(2\sqrt{t})} = 4$, $\frac{dy}{dx}\Big|_{t=1} = 4$, $\frac{d^2y}{dx^2}\Big|_{t=1} = 4$.

46. $\frac{dy}{dx} = \frac{dy/dt}{dx/dt} = \frac{t^2-1}{t} = t - \frac{1}{t}$, $\frac{d^2y}{dx^2} = \frac{d}{dt}\left(\frac{dy}{dx}\right) \Big/ \frac{dx}{dt} = \left(1 + \frac{1}{t^2}\right) \Big/ t = \frac{t^2+1}{t^3}$, $\frac{dy}{dx}\Big|_{t=2} = \frac{3}{2}$, $\frac{d^2y}{dx^2}\Big|_{t=2} = \frac{5}{8}$

47. $\frac{dy}{dx} = \frac{dy/dt}{dx/dt} = \frac{\sec^2 t}{\sec t \tan t} = \csc t$, $\frac{d^2y}{dx^2} = \frac{d}{dt}\left(\frac{dy}{dx}\right) \Big/ \frac{dx}{dt} = \frac{-\csc t \cot t}{\sec t \tan t} = -\cot^3 t$, $\frac{dy}{dx}\Big|_{t=\pi/3} = \frac{2}{\sqrt{3}}$, $\frac{d^2y}{dx^2}\Big|_{t=\pi/3} = -\frac{1}{3\sqrt{3}}$.

48. $\frac{dy}{dx} = \frac{dy/dt}{dx/dt} = \frac{\sinh t}{\cosh t} = \tanh t$, $\frac{d^2y}{dx^2} = \frac{d}{dt}\left(\frac{dy}{dx}\right) \Big/ \frac{dx}{dt} = \frac{\text{sech}^2 t}{\cosh t} = \text{sech}^3 t$, $\frac{dy}{dx}\Big|_{t=0} = 0$, $\frac{d^2y}{dx^2}\Big|_{t=0} = 1$.

49. $\frac{dy}{dx} = \frac{dy/d\theta}{dx/d\theta} = \frac{\cos \theta}{1 - \sin \theta}$; $\frac{d^2y}{dx^2} = \frac{d}{d\theta} \left(\frac{dy}{dx} \right) / \frac{dx}{d\theta} = \frac{(1 - \sin \theta)(-\sin \theta) + \cos^2 \theta}{(1 - \sin \theta)^2} \frac{1}{1 - \sin \theta} = \frac{1}{(1 - \sin \theta)^2}$;

$\frac{dy}{dx} \Big|_{\theta=\pi/6} = \frac{\sqrt{3}/2}{1 - 1/2} = \sqrt{3}$; $\frac{d^2y}{dx^2} \Big|_{\theta=\pi/6} = \frac{1}{(1 - 1/2)^2} = 4$.

50. $\frac{dy}{dx} = \frac{dy/d\phi}{dx/d\phi} = \frac{3 \cos \phi}{-\sin \phi} = -3 \cot \phi$; $\frac{d^2y}{dx^2} = \frac{d}{d\phi} \left(\frac{dy}{dx} \right) / \frac{dx}{d\phi} = \frac{-3(-\csc^2 \phi)}{-\sin \phi} = -3 \csc^3 \phi$; $\frac{dy}{dx} \Big|_{\phi=5\pi/6} = 3\sqrt{3}$;

$\frac{d^2y}{dx^2} \Big|_{\phi=5\pi/6} = -24$.

51. (a) $dy/dx = \frac{-e^{-t}}{e^t} = -e^{-2t}$; for $t = 1$, $dy/dx = -e^{-2}$, $(x, y) = (e, e^{-1})$; $y - e^{-1} = -e^{-2}(x - e)$, $y = -e^{-2}x + 2e^{-1}$.

(b) $y = 1/x$, $dy/dx = -1/x^2$, $m = -1/e^2$, $y - e^{-1} = -\frac{1}{e^2}(x - e)$, $y = -\frac{1}{e^2}x + \frac{2}{e}$.

52. At $t = 1$, $x = 6$ and $y = 10$.

(a) $\frac{dy}{dx} = \frac{16t - 2}{2} = 8t - 1$; for $t = 1$, $\frac{dy}{dx} = 7$. The tangent line is $y - 10 = 7(x - 6)$, $y = 7x - 32$.

(b) $t = \frac{x - 4}{2}$ so $y = 2x^2 - 17x + 40$. At $t = 1$, $x = 6$ so $\frac{dy}{dx} = 4x - 17 = 7$ and the tangent line is $y - 10 = 7(x - 6)$, $y = 7x - 32$.

53. $dy/dx = \frac{-4 \sin t}{2 \cos t} = -2 \tan t$.

(a) $dy/dx = 0$ if $\tan t = 0$; $t = 0, \pi, 2\pi$.

(b) $dx/dy = -\frac{1}{2} \cot t = 0$ if $\cot t = 0$; $t = \pi/2, 3\pi/2$.

54. $dy/dx = \frac{2t + 1}{6t^2 - 30t + 24} = \frac{2t + 1}{6(t - 1)(t - 4)}$.

(a) $dy/dx = 0$ if $t = -1/2$.

(b) $dx/dy = \frac{6(t - 1)(t - 4)}{2t + 1} = 0$ if $t = 1, 4$.

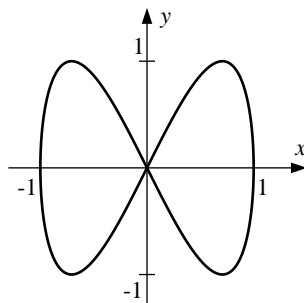

55. (a) $a = 1, b = 2$.

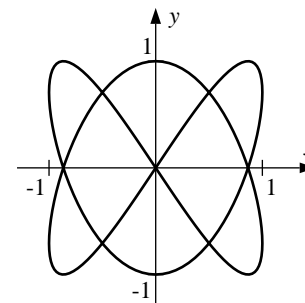

$a = 2, b = 3$.

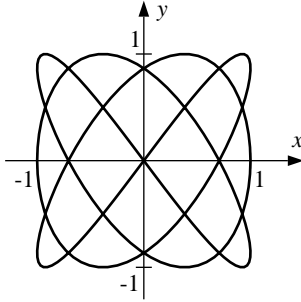

$$a = 3, b = 4.$$

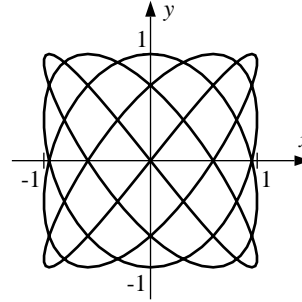

$$a = 4, b = 5.$$

(b) $x = y = 0$ when $t = 0, \pi$; $\frac{dy}{dx} = \frac{2 \cos 2t}{\cos t}$; $\frac{dy}{dx}\bigg|_{t=0} = 2$, $\frac{dy}{dx}\bigg|_{t=\pi} = -2$, the equations of the tangent lines are $y = -2x, y = 2x$.

56. $y(t) = 0$ has three solutions, $t = 0, \pm\pi/2$; the last two correspond to the crossing point. For $t = \pm\pi/2$, $m = \frac{dy}{dx} = \frac{2}{\pm\pi}$; the tangent lines are given by $y = \pm\frac{2}{\pi}(x - 2)$.

57. If $x = 4$ then $t^2 = 4$, $t = \pm 2$, $y = 0$ for $t = \pm 2$ so $(4, 0)$ is reached when $t = \pm 2$. $dy/dx = (3t^2 - 4)/2t$. For $t = 2$, $dy/dx = 2$ and for $t = -2$, $dy/dx = -2$. The tangent lines are $y = \pm 2(x - 4)$.

58. If $x = 3$ then $t^2 - 3t + 5 = 3$, $t^2 - 3t + 2 = 0$, $(t - 1)(t - 2) = 0$, $t = 1$ or 2 . If $t = 1$ or 2 then $y = 1$ so $(3, 1)$ is reached when $t = 1$ or 2 . $dy/dx = (3t^2 + 2t - 10)/(2t - 3)$. For $t = 1$, $dy/dx = 5$, the tangent line is $y - 1 = 5(x - 3)$, $y = 5x - 14$. For $t = 2$, $dy/dx = 6$, the tangent line is $y - 1 = 6(x - 3)$, $y = 6x - 17$.

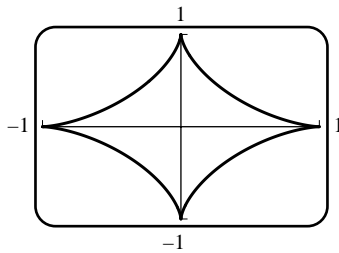

59. (a)

(b) $\frac{dx}{dt} = -3 \cos^2 t \sin t$ and $\frac{dy}{dt} = 3 \sin^2 t \cos t$ are both zero when $t = 0, \pi/2, \pi, 3\pi/2, 2\pi$, so singular points occur at these values of t .

60. By equations (4) and (10), $\frac{dy}{dx} = \frac{dy/d\theta}{dx/d\theta} = \frac{a \sin \theta}{a - a \cos \theta} = \frac{\sin \theta}{1 - \cos \theta} = \frac{1 + \cos \theta}{\sin \theta}$. The x -intercepts occur when $y = a - a \cos \theta = 0$, so $\cos \theta = 1$ and $\theta = 2\pi n$ for some integer n . As $\theta \rightarrow (2\pi n)^-$, $\sin \theta \rightarrow 0^-$ and $\cos \theta \rightarrow 1$, so $\frac{dy}{dx} = \frac{1 + \cos \theta}{\sin \theta} \rightarrow -\infty$. As $\theta \rightarrow (2\pi n)^+$, $\sin \theta \rightarrow 0^+$ and $\cos \theta \rightarrow 1$, so $\frac{dy}{dx} = \frac{1 + \cos \theta}{\sin \theta} \rightarrow +\infty$. Hence there are cusps at the x -intercepts. When $\theta = \pi + 2\pi n$ for some integer n , we have $x = \pi a(2n + 1)$, which is halfway between the x -intercepts $x = 2\pi a n$ and $x = 2\pi a(n + 1)$. At these points, $\frac{dy}{dx} = \frac{\sin \theta}{1 - \cos \theta} = \frac{0}{1 - (-1)} = 0$, so the tangent line is horizontal.

61. (a) From (6), $\frac{dy}{dx} = \frac{3 \sin t}{1 - 3 \cos t}$.

(b) At $t = 10$, $\frac{dy}{dx} = \frac{3 \sin 10}{1 - 3 \cos 10} \approx -0.46402$, $\theta \approx \tan^{-1}(-0.46402) = -0.4345$.

62. (a) $\frac{dy}{dx} = 0$ when $\frac{dy}{dt} = -2 \cos t = 0$, $t = \pi/2, 3\pi/2, 5\pi/2$.

(b) $\frac{dx}{dt} = 0$ when $1 + 2 \sin t = 0$, $\sin t = -1/2$, $t = 7\pi/6, 11\pi/6, 19\pi/6$.

63. Eliminate the parameter to get $(x - h)^2/a^2 + (y - k)^2/b^2 = 1$, which is the equation of an ellipse centered at (h, k) . Depending on the relative sizes of h and k , the ellipse may be a circle, or may have a horizontal or vertical major axis.

(a) Ellipses with a fixed center and varying shapes and sizes.

(b) Ellipses with varying centers and fixed shape and size.

(c) Circles of radius 1 with centers on the line $y = x - 1$.

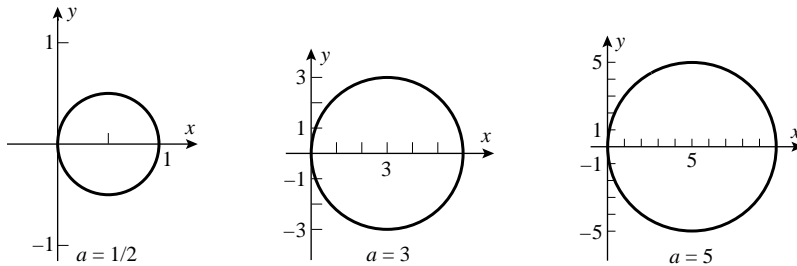

64. (a) $a = 1/2$

$a = 3$

$a = 5$

(b) $(x - a)^2 + y^2 = (2a \cos^2 t - a)^2 + (2a \cos t \sin t)^2 = 4a^2 \cos^4 t - 4a^2 \cos^2 t + a^2 + 4a^2 \cos^2 t \sin^2 t = 4a^2 \cos^4 t - 4a^2 \cos^2 t + a^2 + 4a^2 \cos^2 t (1 - \cos^2 t) = a^2$, a circle about $(a, 0)$ of radius a .

65. $L = \int_0^1 \sqrt{(dx/dt)^2 + (dy/dt)^2} dt = \int_0^1 \sqrt{(2t)^2 + (t^2)^2} dt = \int_0^1 t \sqrt{4 + t^2} dt$. Let $u = 4 + t^2$, $du = 2t dt$. Then $L = \int_4^5 \frac{1}{2} \sqrt{u} du = \frac{1}{3} u^{3/2} \Big|_4^5 = \frac{1}{3} (5\sqrt{5} - 8)$.

66. Let $t = u^2$; the curve is also parameterized by $x = u - 2$, $y = 2u^{3/2}$, $(1 \leq u \leq 4)$. So

$$L = \int_1^4 \sqrt{(dx/du)^2 + (dy/du)^2} du = \int_1^4 \sqrt{1 + 9u} du = \frac{2}{27} (1 + 9u)^{3/2} \Big|_1^4 = \frac{2}{27} (37\sqrt{37} - 10\sqrt{10}).$$

67. The curve is a circle of radius 1, traced one and a half times, so the arc length is $\frac{3}{2} \cdot 2\pi \cdot 1 = 3\pi$.

68. $L = \int_0^\pi \sqrt{(dx/dt)^2 + (dy/dt)^2} dt = \int_0^\pi \sqrt{(\cos t - \sin t)^2 + (\cos t + \sin t)^2} dt = \int_0^\pi \sqrt{2(\cos^2 t + \sin^2 t)} dt = \int_0^\pi \sqrt{2} dt = \sqrt{2}\pi$.

69. $L = \int_{-1}^1 \sqrt{(dx/dt)^2 + (dy/dt)^2} dt = \int_{-1}^1 \sqrt{[e^{2t}(3 \cos t + \sin t)]^2 + [e^{2t}(3 \sin t - \cos t)]^2} dt = \int_{-1}^1 \sqrt{10} e^{2t} dt = \frac{1}{2} \sqrt{10} e^{2t} \Big|_{-1}^1 = \frac{1}{2} \sqrt{10} (e^2 - e^{-2})$.

70. $L = \int_0^{1/2} \sqrt{(dx/dt)^2 + (dy/dt)^2} dt = \int_0^{1/2} \sqrt{\left(\frac{2}{\sqrt{1-t^2}}\right)^2 + \left(\frac{-2t}{1-t^2}\right)^2} dt = \int_0^{1/2} \frac{2}{1-t^2} dt = \ln \left| \frac{t+1}{t-1} \right| \Big|_0^{1/2} = \ln 3$.

71. (a) $(dx/d\theta)^2 + (dy/d\theta)^2 = (a(1 - \cos \theta))^2 + (a \sin \theta)^2 = a^2(2 - 2 \cos \theta)$, so $L = \int_0^{2\pi} \sqrt{(dx/d\theta)^2 + (dy/d\theta)^2} d\theta = a \int_0^{2\pi} \sqrt{2(1 - \cos \theta)} d\theta$.

(b) If you type the definite integral from (a) into your CAS, the output should be something equivalent to “8a”. Here’s a proof that doesn’t use a CAS: $\cos \theta = 1 - 2 \sin^2(\theta/2)$, so $2(1 - \cos \theta) = 4 \sin^2(\theta/2)$, and $L = a \int_0^{2\pi} \sqrt{2(1 - \cos \theta)} d\theta = a \int_0^{2\pi} 2 \sin(\theta/2) d\theta = -4a \cos(\theta/2) \Big|_0^{2\pi} = 8a$.

72. From (10), $\frac{dy}{dx} = \frac{dy/d\theta}{dx/d\theta} = \frac{\sin \theta}{1 - \cos \theta}$, so $\left(1 + \left(\frac{dy}{dx}\right)^2\right) y = \left(1 + \frac{\sin^2 \theta}{(1 - \cos \theta)^2}\right) (a - a \cos \theta) =$
 $= a \frac{(1 - \cos \theta)^2 + \sin^2 \theta}{1 - \cos \theta} = a \frac{2 - 2 \cos \theta}{1 - \cos \theta} = 2a$.

73. (a) The end of the inner arm traces out the circle $x_1 = \cos t, y_1 = \sin t$. Relative to the end of the inner arm, the outer arm traces out the circle $x_2 = \cos 2t, y_2 = -\sin 2t$. Add to get the motion of the center of the rider cage relative to the center of the inner arm: $x = \cos t + \cos 2t, y = \sin t - \sin 2t$.

(b) Same as part (a), except $x_2 = \cos 2t, y_2 = \sin 2t$, so $x = \cos t + \cos 2t, y = \sin t + \sin 2t$.

(c) $L_1 = \int_0^{2\pi} \left[\left(\frac{dx}{dt}\right)^2 + \left(\frac{dy}{dt}\right)^2 \right]^{1/2} dt = \int_0^{2\pi} \sqrt{5 - 4 \cos 3t} dt \approx 13.36489321$, $L_2 = \int_0^{2\pi} \sqrt{5 + 4 \cos t} dt \approx 13.36489322$; L_1 and L_2 appear to be equal, and indeed, with the substitution $u = 3t - \pi$ and the periodicity of $\cos u$, $L_1 = \frac{1}{3} \int_{-\pi}^{5\pi} \sqrt{5 - 4 \cos(u + \pi)} du = \int_0^{2\pi} \sqrt{5 + 4 \cos u} du = L_2$.

74. (a) The thread leaves the circle at the point $x_1 = a \cos \theta, y_1 = a \sin \theta$, and the end of the thread is, relative to the point on the circle, on the tangent line at $x_2 = a\theta \sin \theta, y_2 = -a\theta \cos \theta$; adding, $x = a(\cos \theta + \theta \sin \theta), y = a(\sin \theta - \theta \cos \theta)$.

(b) $dx/d\theta = a\theta \cos \theta, dy/d\theta = a\theta \sin \theta; dx/d\theta = 0$ has solutions $\theta = 0, \pi/2, 3\pi/2$; and $dy/d\theta = 0$ has solutions $\theta = 0, \pi, 2\pi$. At $\theta = \pi/2, dy/d\theta > 0$, so the direction is North; at $\theta = \pi, dx/d\theta < 0$, so West; at $\theta = 3\pi/2, dy/d\theta < 0$, so South; at $\theta = 2\pi, dx/d\theta > 0$, so East. Finally, $\lim_{\theta \rightarrow 0^+} \frac{dy}{dx} = \lim_{\theta \rightarrow 0^+} \tan \theta = 0$, so East.

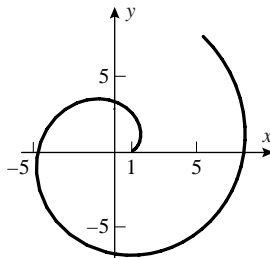

(c) $a = 1$

75. $x' = 2t, y' = 3, (x')^2 + (y')^2 = 4t^2 + 9$, and $S = 2\pi \int_0^2 (3t)\sqrt{4t^2 + 9} dt = 6\pi \int_0^4 t\sqrt{4t^2 + 9} dt = \frac{\pi}{2} (4t^2 + 9)^{3/2} \Big|_0^2 =$
 $\frac{\pi}{2} (125 - 27) = 49\pi$.

76. $x' = e^t(\cos t - \sin t), y' = e^t(\cos t + \sin t), (x')^2 + (y')^2 = 2e^{2t}$, so $S = 2\pi \int_0^{\pi/2} (e^t \sin t)\sqrt{2e^{2t}} dt =$
 $= 2\sqrt{2}\pi \int_0^{\pi/2} e^{2t} \sin t dt = 2\sqrt{2}\pi \left[\frac{1}{5} e^{2t} (2 \sin t - \cos t) \right]_0^{\pi/2} = \frac{2\sqrt{2}}{5} \pi (2e^\pi + 1)$.

77. $x' = -2 \sin t \cos t, y' = 2 \sin t \cos t, (x')^2 + (y')^2 = 8 \sin^2 t \cos^2 t$, so $S = 2\pi \int_0^{\pi/2} \cos^2 t \sqrt{8 \sin^2 t \cos^2 t} dt =$

$$4\sqrt{2}\pi \int_0^{\pi/2} \cos^3 t \sin t dt = -\sqrt{2}\pi \cos^4 t \Big|_0^{\pi/2} = \sqrt{2}\pi.$$

78. $x' = 6, y' = 8t, (x')^2 + (y')^2 = 36 + 64t^2$, so $S = 2\pi \int_0^1 6t\sqrt{36 + 64t^2} dt = 49\pi$.

79. $x' = -r \sin t, y' = r \cos t, (x')^2 + (y')^2 = r^2$, so $S = 2\pi \int_0^\pi r \sin t \sqrt{r^2} dt = 2\pi r^2 \int_0^\pi \sin t dt = 4\pi r^2$.

80. $\frac{dx}{d\phi} = a(1 - \cos \phi), \frac{dy}{d\phi} = a \sin \phi, \left(\frac{dx}{d\phi}\right)^2 + \left(\frac{dy}{d\phi}\right)^2 = 2a^2(1 - \cos \phi)$, so $S = 2\pi \int_0^{2\pi} a(1 - \cos \phi) \sqrt{2a^2(1 - \cos \phi)} d\phi = 2\sqrt{2}\pi a^2 \int_0^{2\pi} (1 - \cos \phi)^{3/2} d\phi$, but $1 - \cos \phi = 2 \sin^2 \frac{\phi}{2}$ so $(1 - \cos \phi)^{3/2} = 2\sqrt{2} \sin^3 \frac{\phi}{2}$ for $0 \leq \phi \leq \pi$ and, taking advantage of the symmetry of the cycloid, $S = 16\pi a^2 \int_0^\pi \sin^3 \frac{\phi}{2} d\phi = 64\pi a^2 / 3$.

82. For some curves, we may not be able to find a formula for $f(x)$, so a parametric form may be our only option. For example, for the curve $x = t + e^t, y = t$ there is no elementary function f such that $y = f(x)$. Even if we can find a formula for $f(x)$, the parametric form may provide more information. For example, if the curve is the path traced out by a moving object, then expressing x and y in terms of time tells us where the object is at any given time; the $y = f(x)$ form does not.

Exercise Set 10.2

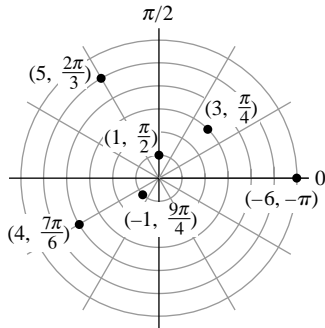

1.

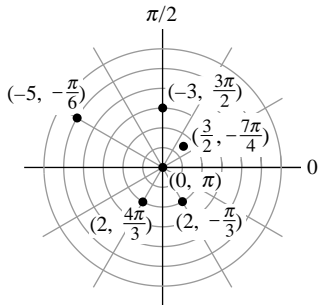

2.

3. (a) $(3\sqrt{3}, 3)$ (b) $(-7/2, 7\sqrt{3}/2)$ (c) $(3\sqrt{3}, 3)$ (d) $(0, 0)$ (e) $(-7\sqrt{3}/2, 7/2)$ (f) $(-5, 0)$

4. (a) $(-\sqrt{2}, -\sqrt{2})$ (b) $(3\sqrt{2}, -3\sqrt{2})$ (c) $(2\sqrt{2}, 2\sqrt{2})$ (d) $(3, 0)$ (e) $(0, -4)$ (f) $(0, 0)$

5. (a) $(5, \pi), (5, -\pi)$ (b) $(4, 11\pi/6), (4, -\pi/6)$ (c) $(2, 3\pi/2), (2, -\pi/2)$ (d) $(8\sqrt{2}, 5\pi/4), (8\sqrt{2}, -3\pi/4)$
 (e) $(6, 2\pi/3), (6, -4\pi/3)$ (f) $(\sqrt{2}, \pi/4), (\sqrt{2}, -7\pi/4)$

6. (a) $(2, 5\pi/6)$ (b) $(-2, 11\pi/6)$ (c) $(2, -7\pi/6)$ (d) $(-2, -\pi/6)$

7. (a) $(5, 0.92730)$ (b) $(10, -0.92730)$ (c) $(1.27155, 2.47582)$
8. (a) $(5, 2.21430)$ (b) $(3.44819, 2.62604)$ (c) $(2.06740, 0.25605)$
9. (a) $r^2 = x^2 + y^2 = 4$; circle.
 (b) $y = 4$; horizontal line.
 (c) $r^2 = 3r \cos \theta$, $x^2 + y^2 = 3x$, $(x - 3/2)^2 + y^2 = 9/4$; circle.
 (d) $3r \cos \theta + 2r \sin \theta = 6$, $3x + 2y = 6$; line.
10. (a) $r \cos \theta = 5$, $x = 5$; vertical line.
 (b) $r^2 = 2r \sin \theta$, $x^2 + y^2 = 2y$, $x^2 + (y - 1)^2 = 1$; circle.
 (c) $r^2 = 4r \cos \theta + 4r \sin \theta$, $x^2 + y^2 = 4x + 4y$, $(x - 2)^2 + (y - 2)^2 = 8$; circle.
 (d) $r = \frac{1}{\cos \theta} \frac{\sin \theta}{\cos \theta}$, $r \cos^2 \theta = \sin \theta$, $r^2 \cos^2 \theta = r \sin \theta$, $x^2 = y$; parabola.
11. (a) $r \cos \theta = 3$. (b) $r = \sqrt{7}$. (c) $r^2 + 6r \sin \theta = 0$, $r = -6 \sin \theta$.
 (d) $9(r \cos \theta)(r \sin \theta) = 4$, $9r^2 \sin \theta \cos \theta = 4$, $r^2 \sin 2\theta = 8/9$.
12. (a) $r \sin \theta = -3$. (b) $r = \sqrt{5}$. (c) $r^2 + 4r \cos \theta = 0$, $r = -4 \cos \theta$.
 (d) $r^4 \cos^2 \theta = r^2 \sin^2 \theta$, $r^2 = \tan^2 \theta$, $r = \pm \tan \theta$.

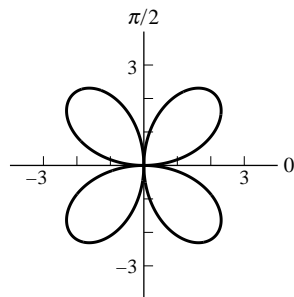

13. $r = 3 \sin 2\theta$.

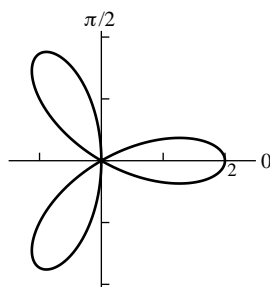

14. $r = 2 \cos 3\theta$.

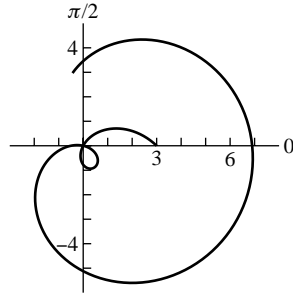

15. $r = 3 - 4 \sin\left(\frac{\pi}{4}\theta\right)$.

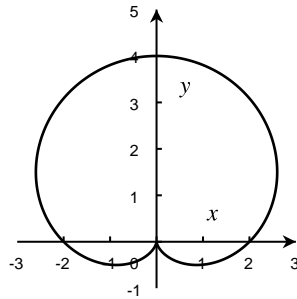

16. $r = 2 + 2 \sin \theta$.

17. (a) $r = 5$.

(b) $(x - 3)^2 + y^2 = 9, r = 6 \cos \theta$.

(c) Example 8, $r = 1 - \cos \theta$.

18. (a) From (8-9), $r = a \pm b \sin \theta$ or $r = a \pm b \cos \theta$. The curve is not symmetric about the y -axis, so Theorem 10.2.1(b) eliminates the sine function, thus $r = a \pm b \cos \theta$. The cartesian point $(-3, 0)$ is either the polar point $(3, \pi)$ or $(-3, 0)$, and the cartesian point $(-1, 0)$ is either the polar point $(1, \pi)$ or $(-1, 0)$. A solution is $a = 1, b = -2$; we may take the equation as $r = 1 - 2 \cos \theta$.

(b) $x^2 + (y + 3/2)^2 = 9/4, r = -3 \sin \theta$.

(c) Figure 10.2.19, $a = 1, n = 3, r = \sin 3\theta$.

19. (a) Figure 10.2.19, $a = 3, n = 2, r = 3 \sin 2\theta$.

(b) From (8-9), symmetry about the y -axis and Theorem 10.2.1(b), the equation is of the form $r = a \pm b \sin \theta$. The cartesian points $(3, 0)$ and $(0, 5)$ give $a = 3$ and $5 = a + b$, so $b = 2$ and $r = 3 + 2 \sin \theta$.

(c) Example 9, $r^2 = 9 \cos 2\theta$.

20. (a) Example 8 rotated through $\pi/2$ radians: $a = 3, r = 3 - 3 \sin \theta$.

(b) Figure 10.2.19, $a = 1, r = \cos 5\theta$.

(c) $x^2 + (y - 2)^2 = 4, r = 4 \sin \theta$.

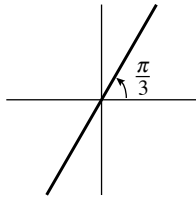

21. Line

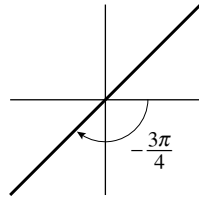

22. Line

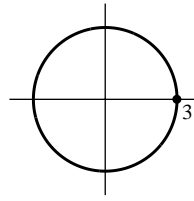

23. Circle

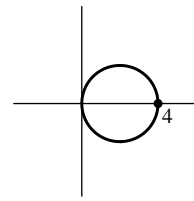

24. Circle

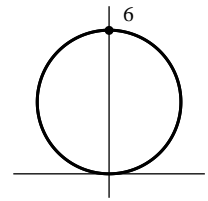

25. Circle

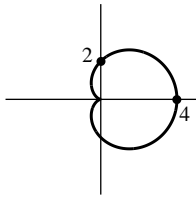

26. Cardioid

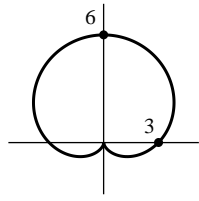

27. Cardioid

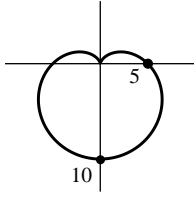

28. Cardioid

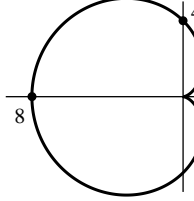

29. Cardioid

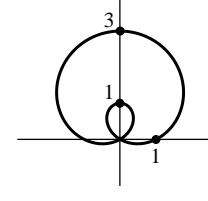

30. Limaçon

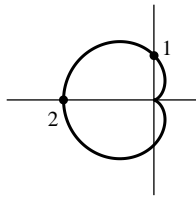

31. Cardioid

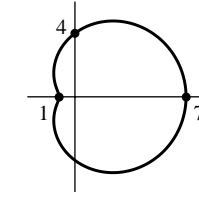

32. Limaçon

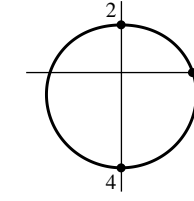

33. Limaçon

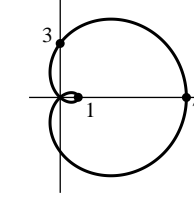

34. Limaçon

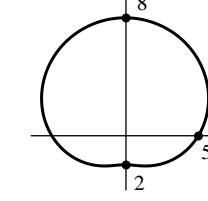

35. Limaçon

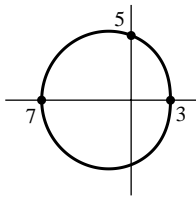

36. Limaçon

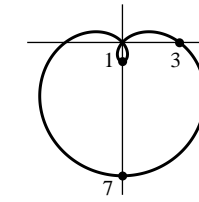

37. Limaçon

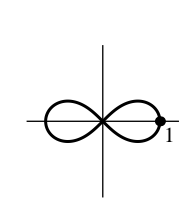

38. Lemniscate

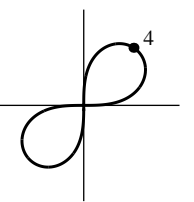

39. Lemniscate

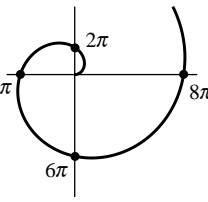

40. Spiral

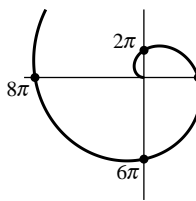

41. Spiral

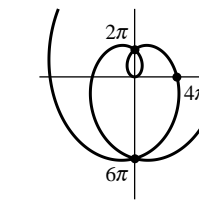

42. Spiral

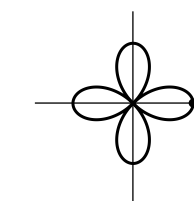

43. Four-petal rose

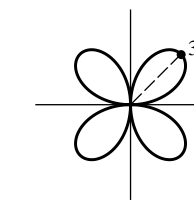

44. Four-petal rose

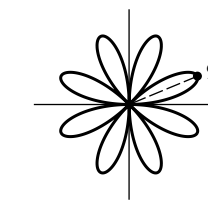

45. Eight-petal rose

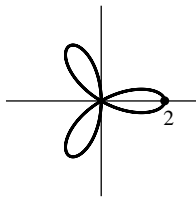

46. Three-petal rose

47. True. Both have rectangular coordinates $(-1/2, -\sqrt{3}/2)$.

48. True. If the graph in rectangular θr -coordinates is symmetric across the r -axis, then $f(\theta) = f(-\theta)$ for all θ . So for each point $(f(\theta), \theta)$ on the graph in polar coordinates, the point $(f(-\theta), -\theta) = (f(\theta), -\theta)$ is also on the graph. But this point is the reflection of $(f(\theta), \theta)$ across the x -axis, so the graph is symmetric across the x -axis.

49. False. For $\pi/2 < \theta < \pi$, $\sin 2\theta < 0$. Hence the point with polar coordinates $(\sin 2\theta, \theta)$ is in the fourth quadrant.

50. False. If $1 < a/b < 2$, then $a \pm b \sin \theta = b(a/b \pm \sin \theta) > 0$, and similarly $a \pm b \cos \theta > 0$. So none of the curves described by equations (8-9) pass through the origin.

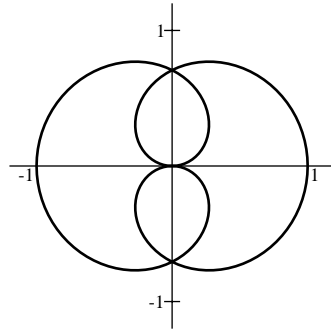

51. $0 \leq \theta < 4\pi$

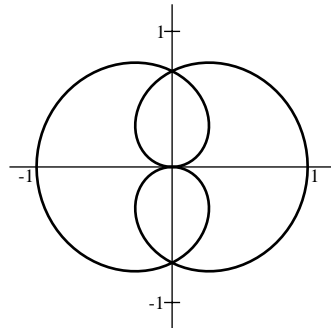

52. $0 \leq \theta < 4\pi$

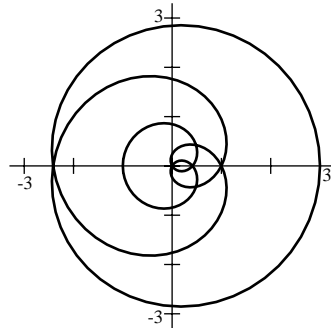

53. $0 \leq \theta < 8\pi$

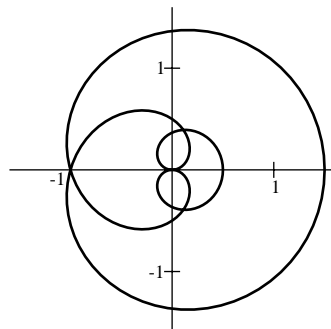

54. $0 \leq \theta < 6\pi$

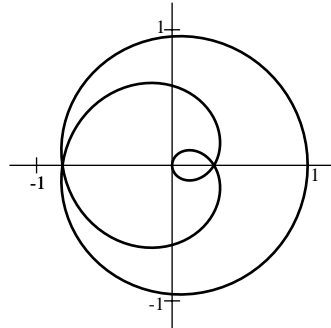

55. $0 \leq \theta < 5\pi$

56. $0 \leq \theta < 8\pi$.

57. (a) $-4\pi \leq \theta \leq 4\pi$.

58. Family I: $x^2 + (y - b)^2 = b^2, b < 0$, or $r = 2b \sin \theta$; Family II: $(x - a)^2 + y^2 = a^2, a < 0$, or $r = 2a \cos \theta$.

59. (a) $r = \frac{a}{\cos \theta}, r \cos \theta = a, x = a$. (b) $r \sin \theta = b, y = b$.

60. In I, along the x -axis, $x = r$ grows ever slower with θ . In II $x = r$ grows linearly with θ . Hence I: $r = \sqrt{\theta}$; II: $r = \theta$.

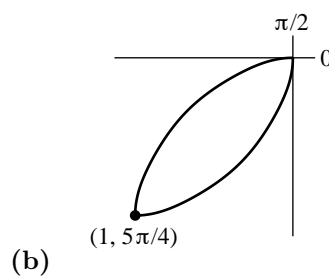
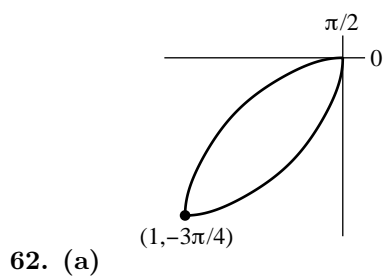
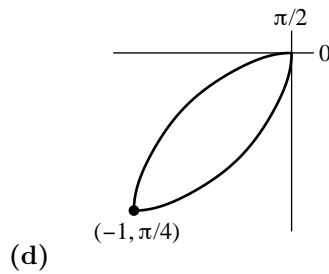
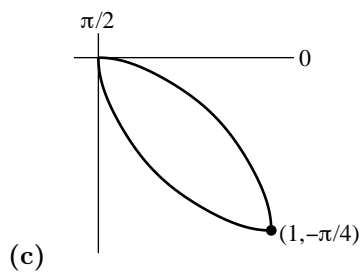
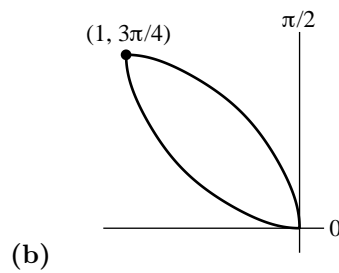
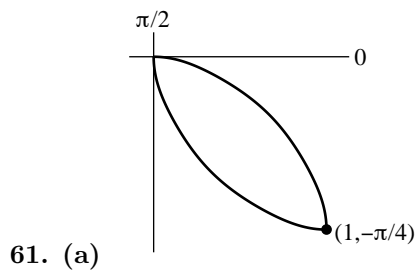

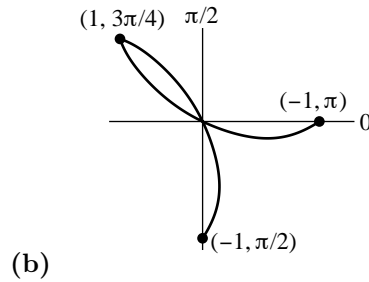
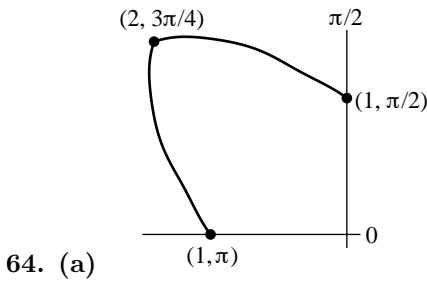
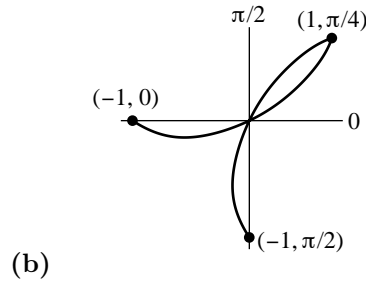
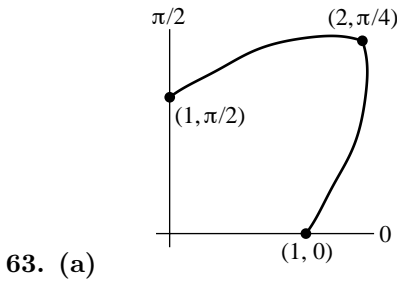
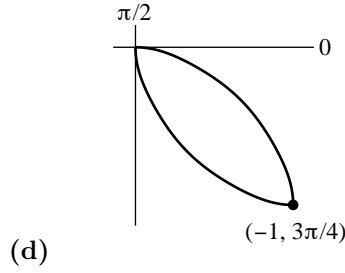
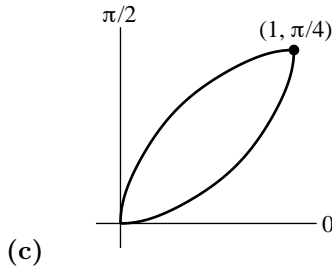

65. The image of (r_0, θ_0) under a rotation through an angle α is $(r_0, \theta_0 + \alpha)$. Hence $(f(\theta), \theta)$ lies on the original curve if and only if $(f(\theta), \theta + \alpha)$ lies on the rotated curve, i.e. (r, θ) lies on the rotated curve if and only if $r = f(\theta - \alpha)$.

66. $r^2 = 4 \cos 2(\theta - \pi/2) = -4 \cos 2\theta$.

67. (a) $r = 1 + \cos(\theta - \pi/4) = 1 + \frac{\sqrt{2}}{2}(\cos \theta + \sin \theta)$.

(b) $r = 1 + \cos(\theta - \pi/2) = 1 + \sin \theta$.

(c) $r = 1 + \cos(\theta - \pi) = 1 - \cos \theta$.

(d) $r = 1 + \cos(\theta - 5\pi/4) = 1 - \frac{\sqrt{2}}{2}(\cos \theta + \sin \theta)$.

68. (a) $r^2 = Ar \sin \theta + Br \cos \theta$, $x^2 + y^2 = Ay + Bx$, $(x - B/2)^2 + (y - A/2)^2 = (A^2 + B^2)/4$, which is a circle of radius $\frac{1}{2}\sqrt{A^2 + B^2}$.

(b) Formula (4) follows by setting $A = 0, B = 2a$, $(x - a)^2 + y^2 = a^2$, the circle of radius a about $(a, 0)$. Formula (5) is derived in a similar fashion.

69. $y = r \sin \theta = (1 + \cos \theta) \sin \theta = \sin \theta + \sin \theta \cos \theta$, $dy/d\theta = \cos \theta - \sin^2 \theta + \cos^2 \theta = 2 \cos^2 \theta + \cos \theta - 1 = (2 \cos \theta - 1)(\cos \theta + 1)$; $dy/d\theta = 0$ if $\cos \theta = 1/2$ or if $\cos \theta = -1$; $\theta = \pi/3$ or π (or $\theta = -\pi/3$, which leads to the minimum point). If $\theta = \pi/3, \pi$, then $y = 3\sqrt{3}/4, 0$ so the maximum value of y is $3\sqrt{3}/4$ and the polar coordinates of the highest point are $(3/2, \pi/3)$.

70. $x = r \cos \theta = (1 + \cos \theta) \cos \theta = \cos \theta + \cos^2 \theta$, $dx/d\theta = -\sin \theta - 2 \sin \theta \cos \theta = -\sin \theta(1 + 2 \cos \theta)$, $dx/d\theta = 0$ if $\sin \theta = 0$ or if $\cos \theta = -1/2$; $\theta = 0, 2\pi/3$, or π . If $\theta = 0, 2\pi/3, \pi$, then $x = 2, -1/4, 0$ so the minimum value of x is $-1/4$. The leftmost point has polar coordinates $(1/2, 2\pi/3)$.

71. Let (x_1, y_1) and (x_2, y_2) be the rectangular coordinates of the points (r_1, θ_1) and (r_2, θ_2) then

$$\begin{aligned} d &= \sqrt{(x_2 - x_1)^2 + (y_2 - y_1)^2} = \sqrt{(r_2 \cos \theta_2 - r_1 \cos \theta_1)^2 + (r_2 \sin \theta_2 - r_1 \sin \theta_1)^2} = \\ &= \sqrt{r_1^2 + r_2^2 - 2r_1 r_2 (\cos \theta_1 \cos \theta_2 + \sin \theta_1 \sin \theta_2)} = \sqrt{r_1^2 + r_2^2 - 2r_1 r_2 \cos(\theta_1 - \theta_2)}. \end{aligned}$$

An alternate proof follows directly from the Law of Cosines.

72. From Exercise 71, $d = \sqrt{9 + 4 - 2 \cdot 3 \cdot 2 \cos(\pi/6 - \pi/3)} = \sqrt{13 - 6\sqrt{3}} \approx 1.615$.

73. The tips occur when $\theta = 0, \pi/2, \pi, 3\pi/2$ for which $r = 1$: $d = \sqrt{1^2 + 1^2 - 2(1)(1) \cos(\pm\pi/2)} = \sqrt{2}$. Geometrically, find the distance between, e.g., the points $(0, 1)$ and $(1, 0)$.

74. The tips are located at $r = 1, \theta = \pi/6, 5\pi/6, 3\pi/2$ and, for example, $d = \sqrt{1 + 1 - 2 \cos(5\pi/6 - \pi/6)} = \sqrt{2(1 - \cos(2\pi/3))} = \sqrt{3}$. By trigonometry, $d = 2 \sin(\pi/3) = \sqrt{3}$.

75. (a) $0 = (r^2 + a^2)^2 - a^4 - 4a^2 r^2 \cos^2 \theta = r^4 + a^4 + 2r^2 a^2 - a^4 - 4a^2 r^2 \cos^2 \theta = r^4 + 2r^2 a^2 - 4a^2 r^2 \cos^2 \theta$, so $r^2 = 2a^2(2 \cos^2 \theta - 1) = 2a^2 \cos 2\theta$.

(b) The distance from the point (r, θ) to $(a, 0)$ is (from Exercise 73(a))

$$\begin{aligned} \sqrt{r^2 + a^2 - 2ra \cos(\theta - 0)} &= \sqrt{r^2 - 2ar \cos \theta + a^2}, \text{ and to the point } (a, \pi) \text{ is } \sqrt{r^2 + a^2 - 2ra \cos(\theta - \pi)} = \\ &= \sqrt{r^2 + 2ar \cos \theta + a^2}, \text{ and their product is} \end{aligned}$$

$$\sqrt{(r^2 + a^2)^2 - 4a^2 r^2 \cos^2 \theta} = \sqrt{r^4 + a^4 + 2a^2 r^2 (1 - 2 \cos^2 \theta)} = \sqrt{4a^4 \cos^2 2\theta + a^4 + 2a^2 (2a^2 \cos 2\theta)(-\cos 2\theta)} = a^2.$$

76. $\lim_{\theta \rightarrow 0^+} y = \lim_{\theta \rightarrow 0^+} r \sin \theta = \lim_{\theta \rightarrow 0^+} \frac{\sin \theta}{\theta} = 1$, and $\lim_{\theta \rightarrow 0^+} x = \lim_{\theta \rightarrow 0^+} r \cos \theta = \lim_{\theta \rightarrow 0^+} \frac{\cos \theta}{\theta} = +\infty$.

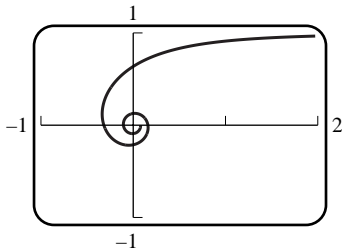

77. $\lim_{\theta \rightarrow 0^\pm} y = \lim_{\theta \rightarrow 0^\pm} r \sin \theta = \lim_{\theta \rightarrow 0^\pm} \frac{\sin \theta}{\theta^2} = \lim_{\theta \rightarrow 0^\pm} \frac{\sin \theta}{\theta} \lim_{\theta \rightarrow 0^\pm} \frac{1}{\theta} = 1 \cdot \lim_{\theta \rightarrow 0^\pm} \frac{1}{\theta}$, so $\lim_{\theta \rightarrow 0^\pm} y$ does not exist.

78. Let $r = a \sin n\theta$ (the proof for $r = a \cos n\theta$ is similar). If θ starts at 0, then θ would have to increase by some positive integer multiple of π radians in order to reach the starting point and begin to retrace the curve. Let (r, θ) be the coordinates of a point P on the curve for $0 \leq \theta < 2\pi$. Now $a \sin n(\theta + 2\pi) = a \sin(n\theta + 2\pi n) = a \sin n\theta = r$ so P is reached again with coordinates $(r, \theta + 2\pi)$ thus the curve is traced out either exactly once or exactly twice for $0 \leq \theta < 2\pi$. If for $0 \leq \theta < \pi$, $P(r, \theta)$ is reached again with coordinates $(-r, \theta + \pi)$ then the curve is traced out exactly once for $0 \leq \theta < \pi$, otherwise exactly once for $0 \leq \theta < 2\pi$. But

$$a \sin n(\theta + \pi) = a \sin(n\theta + n\pi) = \begin{cases} a \sin n\theta, & n \text{ even} \\ -a \sin n\theta, & n \text{ odd} \end{cases}$$

so the curve is traced out exactly once for $0 \leq \theta < 2\pi$ if n is even, and exactly once for $0 \leq \theta < \pi$ if n is odd.

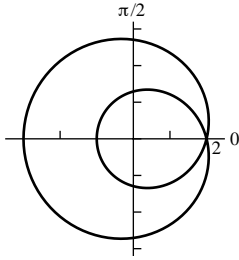

79. (a)

(b) Replacing θ with $-\theta$ changes $r = 2 - \sin(\theta/2)$ into $r = 2 + \sin(\theta/2)$ which is not an equivalent equation. But the locus of points satisfying the first equation, when θ runs from 0 to 4π , is the same as the locus of points satisfying the second equation when θ runs from 0 to 4π , as can be seen under the change of variables (equivalent to reversing direction of θ) $\theta \rightarrow 4\pi - \theta$, for which $2 + \sin(4\pi - \theta) = 2 - \sin \theta$.

80. The curve is symmetric with respect to rotation about the origin through an angle of $2\pi/n$. If $a < 1$ it has n 'lobes' and does not pass through the origin. It can be shown that the curve is convex if $a \leq \frac{1}{n^2 + 1}$; otherwise it has n 'dimples' between the lobes. If $a = 1$ it still has n lobes but each one just touches the origin. If $a > 1$ it passes through the origin and has $2n$ lobes. For n odd, half of the lobes are contained in the other half; for n even none of them are contained in others. Some examples are shown below:

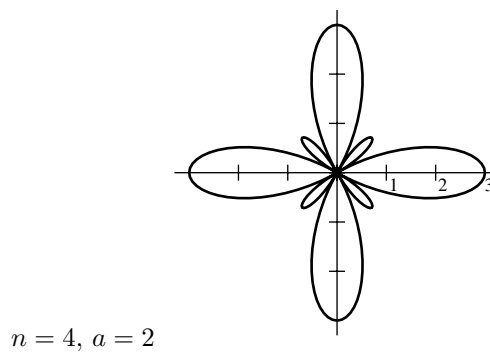
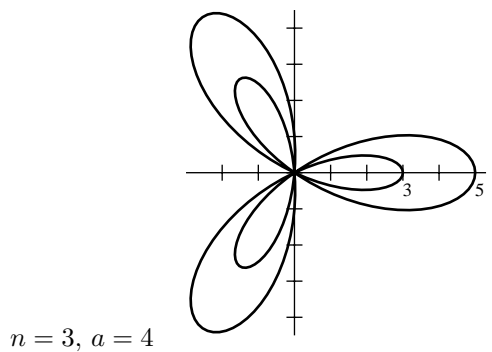
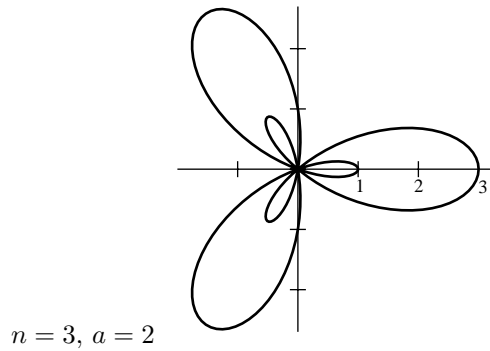
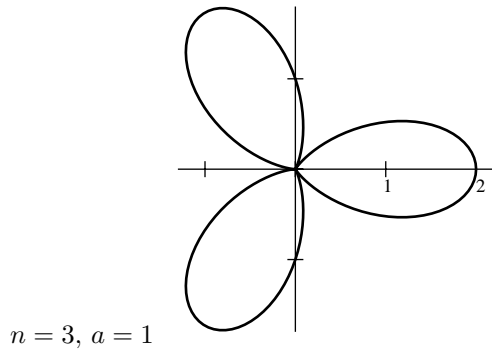
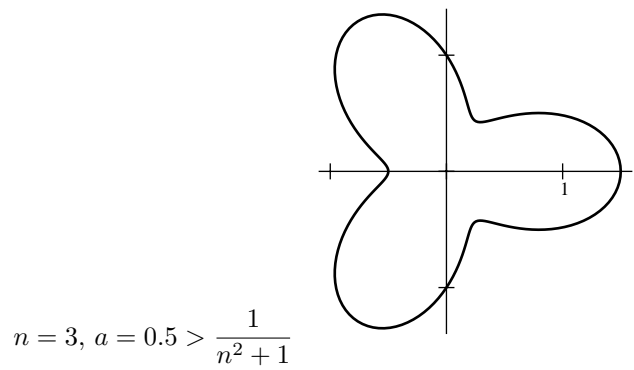
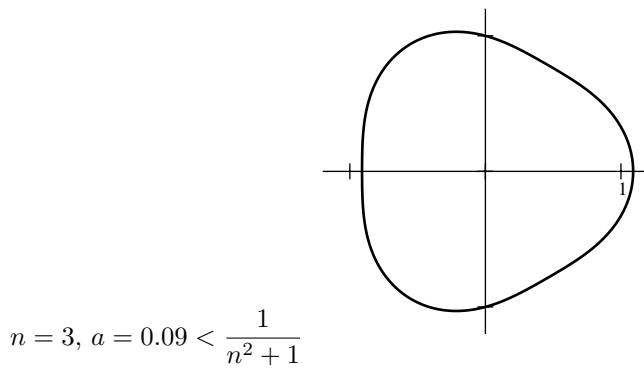

Exercise Set 10.3

- Substituting $\theta = \pi/6$, $r = 1$, and $dr/d\theta = \sqrt{3}$ in equation (2) gives slope $m = \sqrt{3}$.
- As in Exercise 1, $\theta = \pi/2$, $dr/d\theta = -1$, $r = 1$, $m = 1$.
- As in Exercise 1, $\theta = 2$, $dr/d\theta = -1/4$, $r = 1/2$, $m = \frac{\tan 2 - 2}{2 \tan 2 + 1}$.
- As in Exercise 1, $\theta = \pi/6$, $dr/d\theta = 4\sqrt{3}a$, $r = 2a$, $m = 3\sqrt{3}/5$.
- As in Exercise 1, $\theta = \pi/4$, $dr/d\theta = -3\sqrt{2}/2$, $r = \sqrt{2}/2$, $m = 1/2$.
- As in Exercise 1, $\theta = \pi$, $dr/d\theta = 3$, $r = 4$, $m = 4/3$.
- $m = \frac{dy}{dx} = \frac{r \cos \theta + (\sin \theta)(dr/d\theta)}{-r \sin \theta + (\cos \theta)(dr/d\theta)} = \frac{\cos \theta + 2 \sin \theta \cos \theta}{-\sin \theta + \cos^2 \theta - \sin^2 \theta}$; if $\theta = 0, \pi/2, \pi$, then $m = 1, 0, -1$.
- $m = \frac{dy}{dx} = \frac{\cos \theta(4 \sin \theta - 1)}{4 \cos^2 \theta + \sin \theta - 2}$; if $\theta = 0, \pi/2, \pi$ then $m = -1/2, 0, 1/2$.

9. $dx/d\theta = -a \sin \theta(1 + 2 \cos \theta)$, $dy/d\theta = a(2 \cos \theta - 1)(\cos \theta + 1)$.

The tangent line is horizontal if $dy/d\theta = 0$ and $dx/d\theta \neq 0$. $dy/d\theta = 0$ when $\cos \theta = 1/2$ or $\cos \theta = -1$ so $\theta = \pi/3, 5\pi/3$, or π ; $dx/d\theta \neq 0$ for $\theta = \pi/3$ and $5\pi/3$. For the singular point $\theta = \pi$ we find that $\lim_{\theta \rightarrow \pi} dy/dx = 0$. There are horizontal tangent lines at $(3a/2, \pi/3)$, $(0, \pi)$, and $(3a/2, 5\pi/3)$.

The tangent line is vertical if $dy/d\theta \neq 0$ and $dx/d\theta = 0$. $dx/d\theta = 0$ when $\sin \theta = 0$ or $\cos \theta = -1/2$ so $\theta = 0, \pi, 2\pi/3$, or $4\pi/3$; $dy/d\theta \neq 0$ for $\theta = 0, 2\pi/3$, and $4\pi/3$. The singular point $\theta = \pi$ was discussed earlier. There are vertical tangent lines at $(2a, 0)$, $(a/2, 2\pi/3)$, and $(a/2, 4\pi/3)$.

10. $dx/d\theta = a(\cos^2 \theta - \sin^2 \theta) = a \cos 2\theta$, $dy/d\theta = 2a \sin \theta \cos \theta = a \sin 2\theta$.

The tangent line is horizontal if $dy/d\theta = 0$ and $dx/d\theta \neq 0$. $dy/d\theta = 0$ when $\theta = 0, \pi/2, \pi, 3\pi/2$; $dx/d\theta \neq 0$ for $(0, 0)$, $(a, \pi/2)$, $(0, \pi)$, $(-a, 3\pi/2)$; in reality only two distinct points.

The tangent line is vertical if $dy/d\theta \neq 0$ and $dx/d\theta = 0$. $dx/d\theta = 0$ when $\theta = \pi/4, 3\pi/4, 5\pi/4, 7\pi/4$; $dy/d\theta \neq 0$ there, so vertical tangent line at $(a/\sqrt{2}, \pi/4)$, $(a/\sqrt{2}, 3\pi/4)$, $(-a/\sqrt{2}, 5\pi/4)$, $(-a/\sqrt{2}, 7\pi/4)$, only two distinct points.

11. Since $r(\theta + \pi) = -r(\theta)$, the curve is traced out once as θ goes from 0 to π . $dy/d\theta = (d/d\theta)(\sin^2 \theta \cos^2 \theta) = (\sin 4\theta)/2 = 0$ at $\theta = 0, \pi/4, \pi/2, 3\pi/4, \pi$. When $\theta = 0, \pi/2$, or π , $r = 0$, so these 3 values give the same point, and we only have 3 points to consider. $dx/d\theta = (d/d\theta)(\sin \theta \cos^3 \theta) = \cos^2 \theta(4 \cos^2 \theta - 3)$ is nonzero when $\theta = 0, \pi/4$, or $3\pi/4$. Hence there are horizontal tangents at all 3 of these points. (There is also a singular point at the origin corresponding to $\theta = \pi/2$.)

12. $dx/d\theta = 4 \sin^2 \theta - \sin \theta - 2$, $dy/d\theta = \cos \theta(1 - 4 \sin \theta)$. $dy/d\theta = 0$ when $\cos \theta = 0$ or $\sin \theta = 1/4$ so $\theta = \pi/2, 3\pi/2, \sin^{-1}(1/4)$, or $\pi - \sin^{-1}(1/4)$; $dx/d\theta \neq 0$ at these four points, so there is a horizontal tangent at each one.

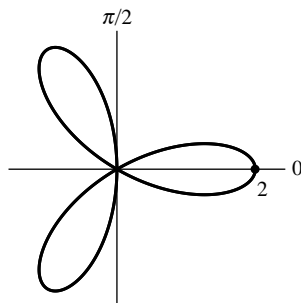

13. $\theta = \pi/6, \pi/2, 5\pi/6$.

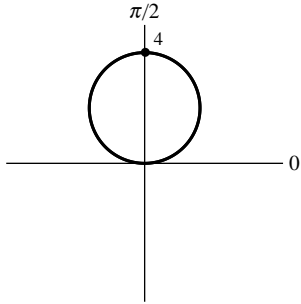

14. $\theta = 0$.

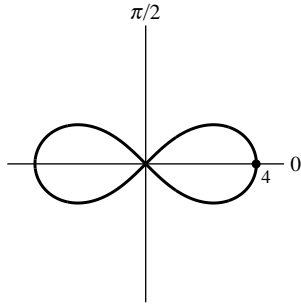

15. $\theta = \pm\pi/4$.

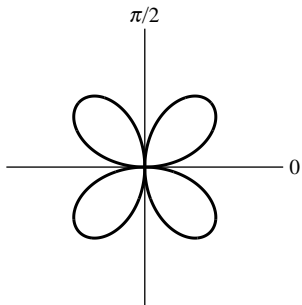

16. $\theta = 0, \pi/2$

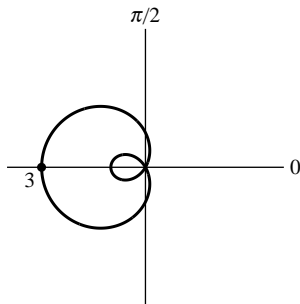

17. $\theta = \pi/3, 5\pi/3$

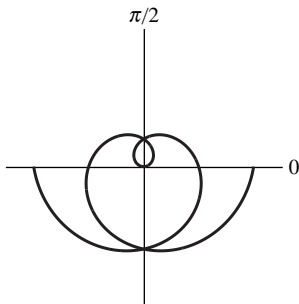

18. $\theta = 0$

19. $r^2 + (dr/d\theta)^2 = a^2 + 0^2 = a^2, L = \int_0^{2\pi} a d\theta = 2\pi a.$

$$20. r^2 + (dr/d\theta)^2 = (2a \cos \theta)^2 + (-2a \sin \theta)^2 = 4a^2, L = \int_{-\pi/2}^{\pi/2} 2a d\theta = 2\pi a.$$

$$21. r^2 + (dr/d\theta)^2 = [a(1 - \cos \theta)]^2 + [a \sin \theta]^2 = 4a^2 \sin^2(\theta/2), L = 2 \int_0^\pi 2a \sin(\theta/2) d\theta = 8a.$$

$$22. r^2 + (dr/d\theta)^2 = (e^{3\theta})^2 + (3e^{3\theta})^2 = 10e^{6\theta}, L = \int_0^2 \sqrt{10}e^{3\theta} d\theta = \sqrt{10}(e^6 - 1)/3.$$

$$23. (a) r^2 + (dr/d\theta)^2 = (\cos n\theta)^2 + (-n \sin n\theta)^2 = \cos^2 n\theta + n^2 \sin^2 n\theta = (1 - \sin^2 n\theta) + n^2 \sin^2 n\theta = 1 + (n^2 - 1) \sin^2 n\theta. \text{ The top half of the petal along the polar axis is traced out as } \theta \text{ goes from } 0 \text{ to } \pi/(2n), \text{ so } L = 2 \int_0^{\pi/(2n)} \sqrt{1 + (n^2 - 1) \sin^2 n\theta} d\theta.$$

$$(b) L = 2 \int_0^{\pi/4} \sqrt{1 + 3 \sin^2 2\theta} d\theta \approx 2.42.$$

(c)

n	2	3	4	5	6	7	8	9	10	11
L	2.42211	2.22748	2.14461	2.10100	2.07501	2.05816	2.04656	2.03821	2.03199	2.02721
n	12	13	14	15	16	17	18	19	20	
L	2.02346	2.02046	2.01802	2.01600	2.01431	2.01288	2.01167	2.01062	2.00971	

The limit seems to be 2. This is to be expected, since as $n \rightarrow +\infty$ each petal more closely resembles a pair of straight lines of length 1.

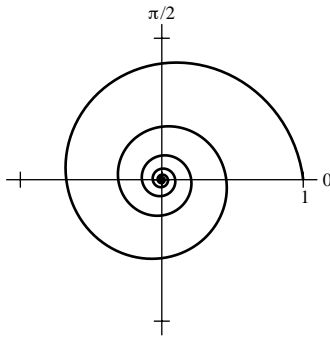

24. (a)

$$(b) r^2 + (dr/d\theta)^2 = (e^{-\theta/8})^2 + (-\frac{1}{8}e^{-\theta/8})^2 = \frac{65}{64}e^{-\theta/4}, \text{ so } L = \frac{\sqrt{65}}{8} \int_0^{+\infty} e^{-\theta/8} d\theta.$$

$$(c) L = \lim_{\theta_0 \rightarrow +\infty} \frac{\sqrt{65}}{8} \int_0^{\theta_0} e^{-\theta/8} d\theta = \lim_{\theta_0 \rightarrow +\infty} \sqrt{65}(1 - e^{-\theta_0/8}) = \sqrt{65}.$$

$$25. (a) \int_{\pi/2}^\pi \frac{1}{2}(1 - \cos \theta)^2 d\theta. \quad (b) \int_0^{\pi/2} 2 \cos^2 \theta d\theta. \quad (c) \int_0^{\pi/2} \frac{1}{2} \sin^2 2\theta d\theta.$$

$$(d) \int_0^{2\pi} \frac{1}{2} \theta^2 d\theta. \quad (e) \int_{-\pi/2}^{\pi/2} \frac{1}{2}(1 - \sin \theta)^2 d\theta. \quad (f) \int_{-\pi/4}^{\pi/4} \frac{1}{2} \cos^2 2\theta d\theta = \int_0^{\pi/4} \cos^2 2\theta d\theta.$$

$$26. A = \int_0^{2\pi} \frac{1}{2} \theta^2 d\theta = \left. \frac{1}{6} \theta^3 \right|_0^{2\pi} = \frac{4\pi^3}{3}.$$

$$27. (a) A = \int_0^\pi \frac{1}{2} 4a^2 \sin^2 \theta d\theta = \pi a^2. \quad (b) A = \int_{-\pi/2}^{\pi/2} \frac{1}{2} 4a^2 \cos^2 \theta d\theta = \pi a^2.$$

28. (a) $r^2 = 2r \sin \theta + 2r \cos \theta$, $x^2 + y^2 - 2y - 2x = 0$, $(x - 1)^2 + (y - 1)^2 = 2$.

(b) The circle's radius is $\sqrt{2}$, so its area is $\pi(\sqrt{2})^2 = 2\pi$. $A = \int_{-\pi/4}^{3\pi/4} \frac{1}{2}(2 \sin \theta + 2 \cos \theta)^2 d\theta = 2\pi$.

29. $A = \int_0^{2\pi} \frac{1}{2}(2 + 2 \sin \theta)^2 d\theta = 6\pi$.

30. $A = \int_0^{\pi/2} \frac{1}{2}(1 + \cos \theta)^2 d\theta = \frac{3\pi}{8} + 1$.

31. $A = 6 \int_0^{\pi/6} \frac{1}{2}(16 \cos^2 3\theta) d\theta = 4\pi$.

32. The petal in the first quadrant has area $\int_0^{\pi/2} \frac{1}{2}4 \sin^2 2\theta d\theta = \frac{\pi}{2}$, so total area = 2π .

33. $A = 2 \int_{2\pi/3}^{\pi} \frac{1}{2}(1 + 2 \cos \theta)^2 d\theta = \pi - \frac{3\sqrt{3}}{2}$.

34. $A = \int_1^3 \frac{2}{\theta^2} d\theta = \frac{4}{3}$.

35. Area = $A_1 - A_2 = \int_0^{\pi/2} \frac{1}{2}4 \cos^2 \theta d\theta - \int_0^{\pi/4} \frac{1}{2} \cos 2\theta d\theta = \frac{\pi}{2} - \frac{1}{4}$.

36. Area = $A_1 - A_2 = \int_0^{\pi} \frac{1}{2}(1 + \cos \theta)^2 d\theta - \int_0^{\pi/2} \frac{1}{2} \cos^2 \theta d\theta = \frac{5\pi}{8}$.

37. The circles intersect when $\cos \theta = \sqrt{3} \sin \theta$, $\tan \theta = 1/\sqrt{3}$, $\theta = \pi/6$, so $A = A_1 + A_2 = \int_0^{\pi/6} \frac{1}{2}(4\sqrt{3} \sin \theta)^2 d\theta + \int_{\pi/6}^{\pi/2} \frac{1}{2}(4 \cos \theta)^2 d\theta = 2\pi - 3\sqrt{3} + \frac{4\pi}{3} - \sqrt{3} = \frac{10\pi}{3} - 4\sqrt{3}$.

38. The curves intersect when $1 + \cos \theta = 3 \cos \theta$, $\cos \theta = 1/2$, $\theta = \pm\pi/3$, so the total area is $A = 2 \int_0^{\pi/3} \frac{1}{2}(1 + \cos \theta)^2 d\theta + 2 \int_{\pi/3}^{\pi/2} \frac{1}{2}9 \cos^2 \theta d\theta = 2 \left(\frac{\pi}{4} + \frac{9\sqrt{3}}{16} + \frac{3\pi}{8} - \frac{9\sqrt{3}}{16} \right) = \frac{5\pi}{4}$.

39. $A = 2 \int_{\pi/6}^{\pi/2} \frac{1}{2}[9 \sin^2 \theta - (1 + \sin \theta)^2] d\theta = \pi$.

40. $A = 2 \int_0^{\pi} \frac{1}{2}[16 - (2 - 2 \cos \theta)^2] d\theta = 10\pi$.

41. $A = 2 \int_0^{\pi/3} \frac{1}{2}[(2 + 2 \cos \theta)^2 - 9] d\theta = \frac{9\sqrt{3}}{2} - \pi$.

42. $A = 2 \int_0^{\pi/4} \frac{1}{2}(2 \sin \theta)^2 d\theta = \left[2\theta - \sin 2\theta \right]_0^{\pi/4} = \frac{\pi}{2} - 1$.

$$43. A = 2 \left[\int_0^{2\pi/3} \frac{1}{2} (1/2 + \cos \theta)^2 d\theta - \int_{2\pi/3}^{\pi} \frac{1}{2} (1/2 + \cos \theta)^2 d\theta \right] = \frac{\pi + 3\sqrt{3}}{4}.$$

$$44. A = 2 \int_0^{\pi/3} \frac{1}{2} \left[(2 + 2 \cos \theta)^2 - \frac{9}{4} \sec^2 \theta \right] d\theta = 2\pi + \frac{9}{4}\sqrt{3}.$$

$$45. A = 2 \int_0^{\pi/4} \frac{1}{2} (4 - 2 \sec^2 \theta) d\theta = \pi - 2.$$

$$46. A = 8 \int_0^{\pi/8} \frac{1}{2} (4a^2 \cos^2 2\theta - 2a^2) d\theta = 2a^2.$$

47. True. When $\theta = 3\pi$, $r = \cos(3\pi/2) = 0$ so the curve passes through the origin. Also, $\frac{dr}{d\theta} = -\frac{1}{2} \sin(\theta/2) = \frac{1}{2} \neq 0$. Hence, by Theorem 10.3.1, the line $\theta = 3\pi$ is tangent to the curve at the origin. But $\theta = 3\pi$ is the x -axis.

48. False. By Formula (3), the arc length is $\int_0^{\pi/2} \sqrt{(\sqrt{\theta})^2 + \left(\frac{1}{2\sqrt{\theta}}\right)^2} d\theta = \int_0^{\pi/2} \sqrt{\theta + \frac{1}{4\theta}} d\theta \approx 1.988$. The integral given in the exercise is $\int_0^{\pi/2} \sqrt{1 + \frac{1}{4\theta}} d\theta \approx 2.104$.

49. False. The area is $\frac{\theta}{2\pi}$ times the area of the circle $= \frac{\theta}{2\pi} \cdot \pi r^2 = \frac{\theta}{2} r^2$, not θr^2 .

50. True. The inner loop is traced out as θ ranges from $-\pi/4$ to $\pi/4$ and r is ≤ 0 for θ in that range. So Theorem 10.3.4 implies that the area is $\int_{-\pi/4}^{\pi/4} \frac{1}{2} (1 - \sqrt{2} \cos \theta)^2 d\theta$.

51. (a) r is not real for $\pi/4 < \theta < 3\pi/4$ and $5\pi/4 < \theta < 7\pi/4$.

$$(b) A = 4 \int_0^{\pi/4} \frac{1}{2} a^2 \cos 2\theta d\theta = a^2.$$

$$(c) A = 4 \int_0^{\pi/6} \frac{1}{2} [4 \cos 2\theta - 2] d\theta = 2\sqrt{3} - \frac{2\pi}{3}.$$

$$52. A = 2 \int_0^{\pi/2} \frac{1}{2} \sin 2\theta d\theta = 1.$$

$$53. A = \int_{2\pi}^{4\pi} \frac{1}{2} a^2 \theta^2 d\theta - \int_0^{2\pi} \frac{1}{2} a^2 \theta^2 d\theta = 8\pi^3 a^2.$$

54. (a) $\frac{dr}{dt} = 2$ and $\frac{d\theta}{dt} = 1$ so $\frac{dr}{d\theta} = \frac{dr/dt}{d\theta/dt} = \frac{2}{1} = 2$, $r = 2\theta + C$, $r = 10$ when $\theta = 0$ so $10 = C$, $r = 2\theta + 10$.

(b) $r^2 + (dr/d\theta)^2 = (2\theta + 10)^2 + 4$, during the first 5 seconds the rod rotates through an angle of $(1)(5) = 5$ radians so $L = \int_0^5 \sqrt{(2\theta + 10)^2 + 4} d\theta$, let $u = 2\theta + 10$ to get $L = \frac{1}{2} \int_{10}^{20} \sqrt{u^2 + 4} du = \frac{1}{2} \left[\frac{u}{2} \sqrt{u^2 + 4} + 2 \ln |u + \sqrt{u^2 + 4}| \right]_{10}^{20} = \frac{1}{2} \left[10\sqrt{404} - 5\sqrt{104} + 2 \ln \frac{20 + \sqrt{404}}{10 + \sqrt{104}} \right] \approx 75.7$ mm.

55. (a) $r^3 \cos^3 \theta - 3r^2 \cos \theta \sin \theta + r^3 \sin^3 \theta = 0$, $r = \frac{3 \cos \theta \sin \theta}{\cos^3 \theta + \sin^3 \theta}$.

$$(b) A = \int_0^{\pi/2} \frac{1}{2} \left(\frac{3 \cos \theta \sin \theta}{\cos^3 \theta + \sin^3 \theta} \right)^2 d\theta = \left. \frac{2 \sin^3 \theta - \cos^3 \theta}{2(\cos^3 \theta + \sin^3 \theta)} \right|_0^{\pi/2} = \frac{3}{2}.$$

$$56. (a) A = 2 \int_0^{\pi/(2n)} \frac{1}{2} a^2 \cos^2 n\theta d\theta = \frac{\pi a^2}{4n}. \quad (b) A = 2 \int_0^{\pi/(2n)} \frac{1}{2} a^2 \cos^2 n\theta d\theta = \frac{\pi a^2}{4n}.$$

$$(c) \text{ Total area} = 2n \cdot \frac{\pi a^2}{4n} = \frac{\pi a^2}{2}. \quad (d) \text{ Total area} = n \cdot \frac{\pi a^2}{4n} = \frac{\pi a^2}{4}.$$

57. If the upper right corner of the square is the point (a, a) then the large circle has equation $r = \sqrt{2}a$ and the small circle has equation $(x - a)^2 + y^2 = a^2$, $r = 2a \cos \theta$, so area of crescent $= 2 \int_0^{\pi/4} \frac{1}{2} [(2a \cos \theta)^2 - (\sqrt{2}a)^2] d\theta = a^2 =$ area of square.

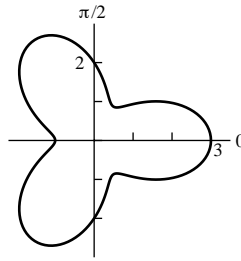

$$58. A = \int_0^{2\pi} \frac{1}{2} (\cos 3\theta + 2)^2 d\theta = 9\pi/2.$$

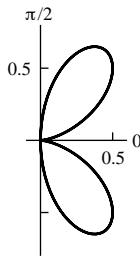

$$59. A = \int_0^{\pi/2} \frac{1}{2} 4 \cos^2 \theta \sin^4 \theta d\theta = \pi/16.$$

$$60. x = r \cos \theta, y = r \sin \theta, \frac{dx}{d\theta} = \frac{dr}{d\theta} \cos \theta - r \sin \theta, \frac{dy}{d\theta} = r \cos \theta + \frac{dr}{d\theta} \sin \theta, \left(\frac{dx}{d\theta} \right)^2 + \left(\frac{dy}{d\theta} \right)^2 = r^2 + \left(\frac{dr}{d\theta} \right)^2, \text{ and}$$

$$\text{Formula (9) of Section 10.1 becomes } L = \int_{\alpha}^{\beta} \sqrt{r^2 + \left(\frac{dr}{d\theta} \right)^2} d\theta.$$

$$61. \tan \psi = \tan(\phi - \theta) = \frac{\tan \phi - \tan \theta}{1 + \tan \phi \tan \theta} = \frac{\frac{dy}{dx} - \frac{y}{x}}{1 + \frac{y}{x} \frac{dy}{dx}} = \frac{\frac{r \cos \theta + (dr/d\theta) \sin \theta}{-r \sin \theta + (dr/d\theta) \cos \theta} - \frac{\sin \theta}{\cos \theta}}{1 + \left(\frac{r \cos \theta + (dr/d\theta) \sin \theta}{-r \sin \theta + (dr/d\theta) \cos \theta} \right) \left(\frac{\sin \theta}{\cos \theta} \right)} = \frac{r}{dr/d\theta}.$$

$$62. (a) \text{ From Exercise 61, } \tan \psi = \frac{r}{dr/d\theta} = \frac{1 - \cos \theta}{\sin \theta} = \tan \frac{\theta}{2}, \text{ so } \psi = \theta/2.$$

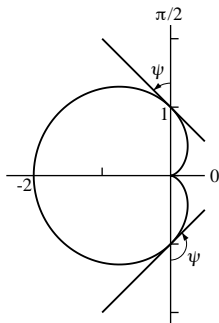

(b)

(c) At $\theta = \pi/2$, $\psi = \theta/2 = \pi/4$. At $\theta = 3\pi/2$, $\psi = \theta/2 = 3\pi/4$.

63. $\tan \psi = \frac{r}{dr/d\theta} = \frac{ae^{b\theta}}{abe^{b\theta}} = \frac{1}{b}$ is constant, so ψ is constant.

64. (a) $x = r \cos \theta$, $y = r \sin \theta$, $(dx/d\theta)^2 + (dy/d\theta)^2 = (f'(\theta) \cos \theta - f(\theta) \sin \theta)^2 + (f'(\theta) \sin \theta + f(\theta) \cos \theta)^2 = f'(\theta)^2 + f(\theta)^2$; $S = \int_{\alpha}^{\beta} 2\pi f(\theta) \sin \theta \sqrt{f'(\theta)^2 + f(\theta)^2} d\theta$ if about $\theta = 0$; similarly for $\theta = \pi/2$.

(b) f' is continuous and no segment of the curve is traced more than once.

65. $r^2 + \left(\frac{dr}{d\theta}\right)^2 = \cos^2 \theta + \sin^2 \theta = 1$, so $S = \int_{-\pi/2}^{\pi/2} 2\pi \cos^2 \theta d\theta = \pi^2$.

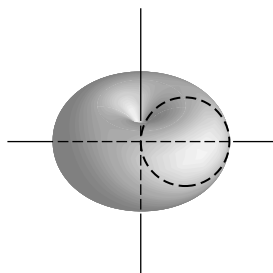

66. $S = \int_0^{\pi/2} 2\pi e^{\theta} \cos \theta \sqrt{2e^{2\theta}} d\theta = 2\sqrt{2}\pi \int_0^{\pi/2} e^{2\theta} \cos \theta d\theta = \frac{2\sqrt{2}\pi}{5} (e^{\pi} - 2)$.

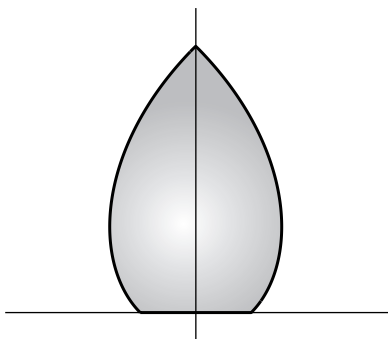

67. $S = \int_0^{\pi} 2\pi(1-\cos \theta) \sin \theta \sqrt{1-2\cos \theta + \cos^2 \theta + \sin^2 \theta} d\theta = 2\sqrt{2}\pi \int_0^{\pi} \sin \theta (1-\cos \theta)^{3/2} d\theta = \frac{2}{5} 2\sqrt{2}\pi (1-\cos \theta)^{5/2} \Big|_0^{\pi} = 32\pi/5$.

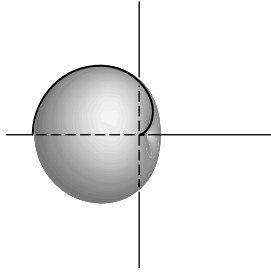

68. $S = \int_0^\pi 2\pi a(\sin \theta)a d\theta = 4\pi a^2.$

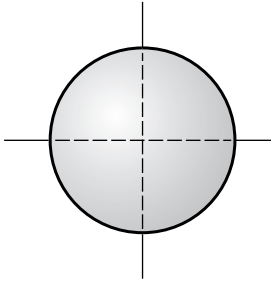

69. (a) Let P and Q have polar coordinates $(r_1, \theta_1), (r_2, \theta_2)$, respectively. Then the perpendicular from Q to OP has length $h = r_2 \sin(\theta_2 - \theta_1)$ and $A = \frac{1}{2}hr_1 = \frac{1}{2}r_1r_2 \sin(\theta_2 - \theta_1)$.

(b) Define $\theta_1, \dots, \theta_{n-1}$ and A_1, \dots, A_n as in the text's solution to the area problem. Also let $\theta_0 = \alpha$ and $\theta_n = \beta$. Then A_n is approximately the area of the triangle whose vertices have polar coordinates $(0, 0), (f(\theta_{n-1}), \theta_{n-1})$, and $(f(\theta_n), \theta_n)$. From part (a), $A_n \approx \frac{1}{2}f(\theta_{n-1})f(\theta_n) \sin(\theta_n - \theta_{n-1})$, so $A = \sum_{k=1}^n A_k \approx \sum_{k=1}^n \frac{1}{2}f(\theta_{k-1})f(\theta_k) \sin(\Delta\theta_k)$.

If the mesh size of the partition is small, then $\theta_{n-1} \approx \theta_n$ and $\sin(\Delta\theta_n) \approx \Delta\theta_n$, so $A \approx \sum_{k=1}^n \frac{1}{2}f(\theta_k)^2 \Delta\theta_k \approx$

$$\int_\alpha^\beta \frac{1}{2}[f(\theta)]^2 d\theta.$$

70. Let $f(\theta) = \cos 2\theta$ and $g(\theta) = 1$. As shown in the figure, the graph of $r = f(\theta)$ is a 4-petal rose and the graph of $r = g(\theta)$ is a circle; they meet at 4 points. But $f(\theta) = g(\theta)$ when $\theta = n\pi$ for integers n ; this only gives 2 of the intersection points, $(1, 0)$ and $(1, \pi)$. In general, to find all of the intersection points other than the origin, we must solve the equations $f(\theta) = g(\theta + 2n\pi)$ and $f(\theta) = -g(\theta + (2n + 1)\pi)$ for all integers n . Additionally, if both $f(\theta) = 0$ and $g(\theta) = 0$ have solutions, then the origin is an intersection point.

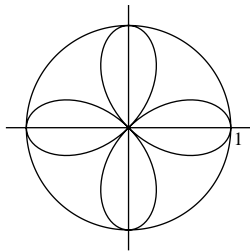

Exercise Set 10.4

1. (a) $4px = y^2$, point $(1, 1), 4p = 1, x = y^2$.

(b) $-4py = x^2$, point $(3, -3), 12p = 9, -3y = x^2$.

(c) $a = 3, b = 2, \frac{x^2}{9} + \frac{y^2}{4} = 1.$

(d) $a = 2, b = 3, \frac{x^2}{4} + \frac{y^2}{9} = 1.$

(e) Asymptotes: $y = \pm x$, so $a = b$; point $(0, 1)$, so $y^2 - x^2 = 1.$

(f) Asymptotes: $y = \pm x$, so $b = a$; point $(2, 0)$, so $\frac{x^2}{4} - \frac{y^2}{4} = 1.$

2. (a) Part (a): vertex $(0, 0), p = 1/4$; focus $(1/4, 0)$, directrix: $x = -1/4$. Part (b): vertex $(0, 0), p = 3/4$; focus $(0, -3/4)$, directrix: $y = 3/4$.

(b) Part (c): $c = \sqrt{a^2 - b^2} = \sqrt{5}$, foci $(\pm\sqrt{5}, 0)$. Part (d): $c = \sqrt{a^2 - b^2} = \sqrt{5}$, foci $(0, \pm\sqrt{5})$.

(c) Part (e): $c = \sqrt{a^2 + b^2} = \sqrt{2}$, foci at $(0, \pm\sqrt{2})$; asymptotes: $y^2 - x^2 = 0, y = \pm x$. Part (f): $c = \sqrt{a^2 + b^2} = \sqrt{8} = 2\sqrt{2}$, foci at $(\pm 2\sqrt{2}, 0)$; asymptotes: $\frac{x^2}{4} - \frac{y^2}{4} = 0, y = \pm x$.

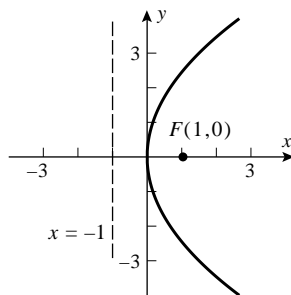

3. (a)

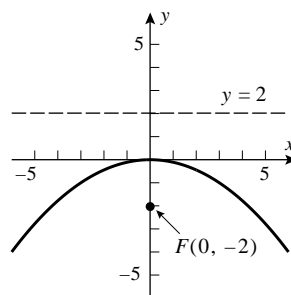

3. (b)

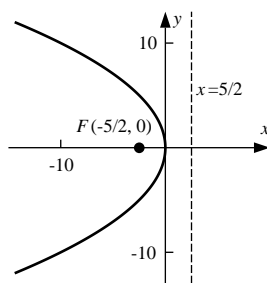

4. (a)

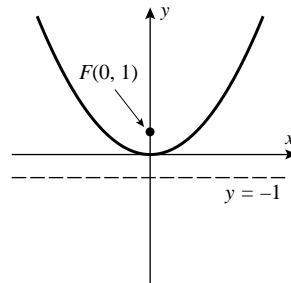

4. (b)

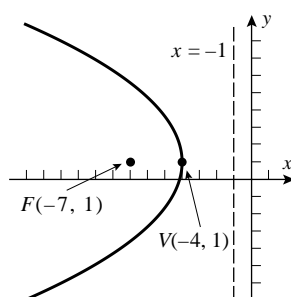

5. (a)

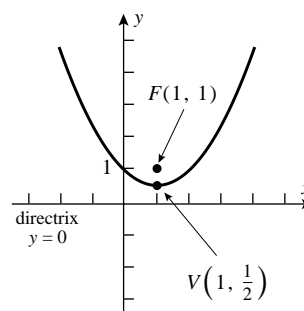

5. (b)

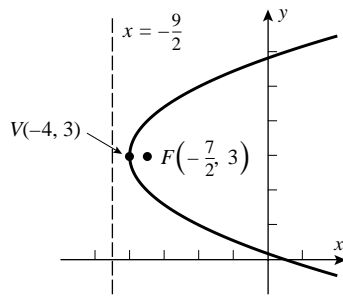

6. (a)

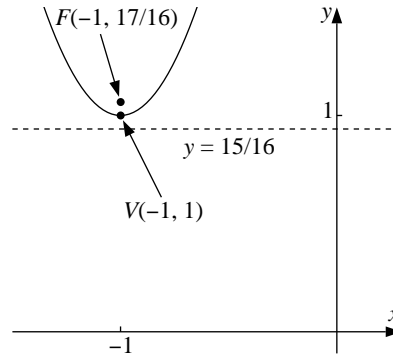

(b)

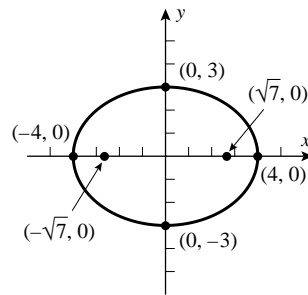

7. (a) $c^2 = 16 - 9 = 7$, $c = \sqrt{7}$.

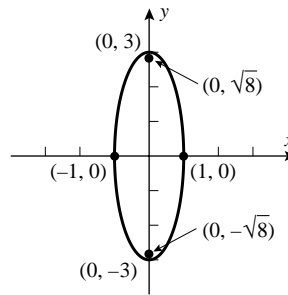

(b) $\frac{x^2}{1} + \frac{y^2}{9} = 1$, $c^2 = 9 - 1 = 8$, $c = 2\sqrt{2}$.

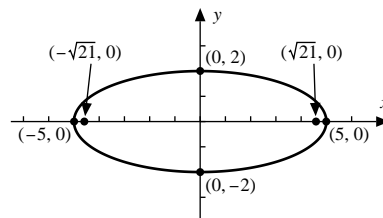

8. (a) $c^2 = 25 - 4 = 21$, $c = \sqrt{21}$.

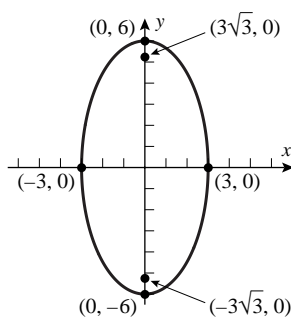

(b) $\frac{x^2}{9} + \frac{y^2}{36} = 1$, $c^2 = 36 - 9 = 27$, $c = 3\sqrt{3}$.

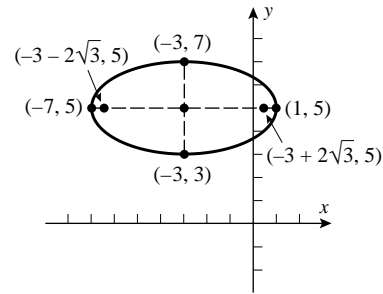

9. (a) $\frac{(x+3)^2}{16} + \frac{(y-5)^2}{4} = 1$, $c^2 = 16 - 4 = 12$, $c = 2\sqrt{3}$.

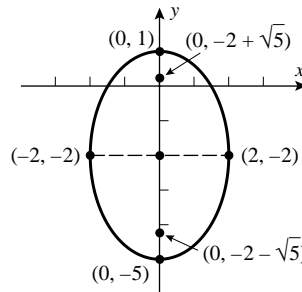

(b) $\frac{x^2}{4} + \frac{(y+2)^2}{9} = 1$, $c^2 = 9 - 4 = 5$, $c = \sqrt{5}$.

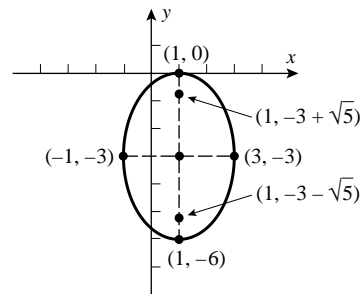

10. (a) $\frac{(x-1)^2}{4} + \frac{(y+3)^2}{9} = 1$, $c^2 = 9 - 4 = 5$, $c = \sqrt{5}$.

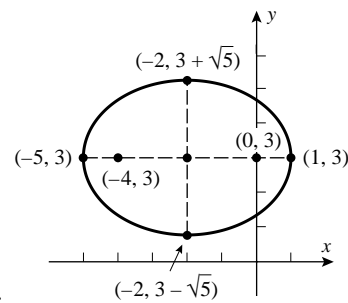

(b) $\frac{(x+2)^2}{9} + \frac{(y-3)^2}{5} = 1$, $c^2 = 9 - 5 = 4$, $c = 2$.

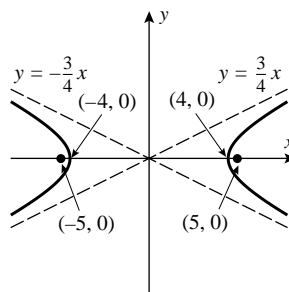

11. (a) $c^2 = a^2 + b^2 = 16 + 9 = 25$, $c = 5$.

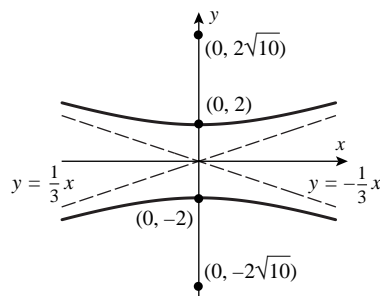

(b) $y^2/4 - x^2/36 = 1, c^2 = 4 + 36 = 40, c = 2\sqrt{10}.$

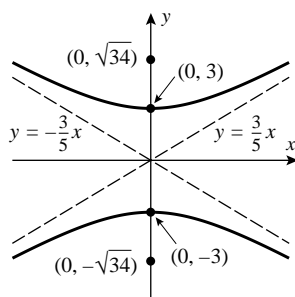

12. (a) $c^2 = a^2 + b^2 = 9 + 25 = 34, c = \sqrt{34}.$

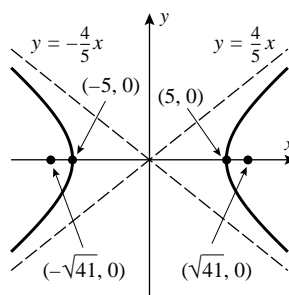

(b) $x^2/25 - y^2/16 = 1, c^2 = 25 + 16 = 41, c = \sqrt{41}.$

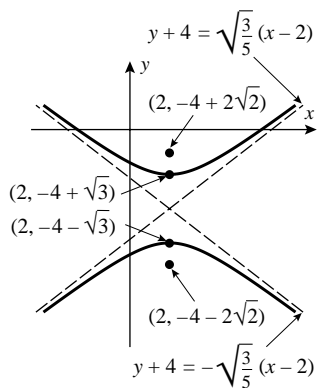

13. (a) $c^2 = 3 + 5 = 8, c = 2\sqrt{2}.$

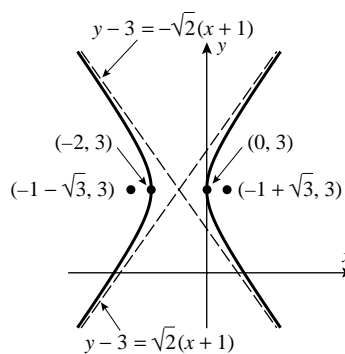

(b) $(x + 1)^2/1 - (y - 3)^2/2 = 1, c^2 = 1 + 2 = 3, c = \sqrt{3}.$

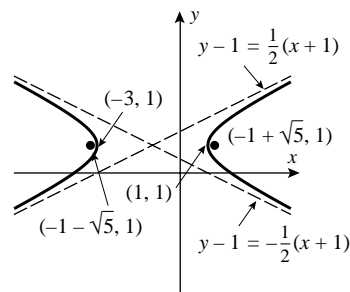

14. (a) $(x + 1)^2/4 - (y - 1)^2/1 = 1$, $c^2 = 4 + 1 = 5$, $c = \sqrt{5}$.

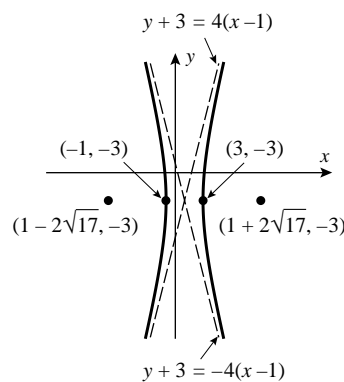

(b) $(x - 1)^2/4 - (y + 3)^2/64 = 1$, $c^2 = 4 + 64 = 68$, $c = 2\sqrt{17}$.

15. (a) $y^2 = 4px$, $p = 3$, $y^2 = 12x$. (b) $x^2 = -4py$, $p = 1/4$, $x^2 = -y$.

16. (a) $y^2 = 4px$, $p = 6$, $y^2 = 24x$.

(b) The focus is 3 units above the directrix so $p = 3/2$. The vertex is halfway between the focus and the directrix, at $(1, -1/2)$. So the equation is $(x - 1)^2 = 6(y + 1/2)$.

17. $y^2 = a(x - h)$, $4 = a(3 - h)$ and $2 = a(2 - h)$, solve simultaneously to get $h = 1$, $a = 2$ so $y^2 = 2(x - 1)$.

18. $(x - 5)^2 = a(y + 3)$, $(9 - 5)^2 = a(5 + 3)$ so $a = 2$, $(x - 5)^2 = 2(y + 3)$.

19. (a) $x^2/9 + y^2/4 = 1$. (b) $b = 4$, $c = 3$, $a^2 = b^2 + c^2 = 16 + 9 = 25$; $x^2/16 + y^2/25 = 1$.

20. (a) $c = 1$, $a^2 = b^2 + c^2 = 2 + 1 = 3$; $x^2/3 + y^2/2 = 1$.

(b) $b^2 = 16 - 12 = 4$; either $x^2/16 + y^2/4 = 1$ or $x^2/4 + y^2/16 = 1$.

21. (a) $a = 6$, $(-3, 2)$ satisfies $\frac{x^2}{a^2} + \frac{y^2}{36} = 1$ so $\frac{9}{a^2} + \frac{4}{36} = 1$, $a^2 = \frac{81}{8}$; $\frac{x^2}{81/8} + \frac{y^2}{36} = 1$.

(b) The center is midway between the foci so it is at $(-1, 2)$, thus $c = 1$, $b = 2$, $a^2 = 1 + 4 = 5$, $a = \sqrt{5}$; $(x + 1)^2/4 + (y - 2)^2/5 = 1$.

22. (a) Substitute $(3, 2)$ and $(1, 6)$ into $x^2/A + y^2/B = 1$ to get $9/A + 4/B = 1$ and $1/A + 36/B = 1$ which yields $A = 10$, $B = 40$; $x^2/10 + y^2/40 = 1$.

(b) The center is at $(2, -1)$ thus $c = 2$, $a = 3$, $b^2 = 9 - 4 = 5$; $(x - 2)^2/5 + (y + 1)^2/9 = 1$.

23. (a) $a = 2$, $c = 3$, $b^2 = 9 - 4 = 5$; $x^2/4 - y^2/5 = 1$. (b) $a = 2$, $a/b = 2/3$, $b = 3$; $y^2/4 - x^2/9 = 1$.

24. (a) Vertices along x -axis: $b/a = 3/2$ so $a = 8/3$; $x^2/(64/9) - y^2/16 = 1$. Vertices along y -axis: $a/b = 3/2$ so $a = 6$; $y^2/36 - x^2/16 = 1$.

(b) $c = 5$, $a/b = 2$ and $a^2 + b^2 = 25$, solve to get $a^2 = 20$, $b^2 = 5$; $y^2/20 - x^2/5 = 1$.

25. (a) Foci along the x -axis: $b/a = 3/4$ and $a^2 + b^2 = 25$, solve to get $a^2 = 16$, $b^2 = 9$; $x^2/16 - y^2/9 = 1$. Foci along the y -axis: $a/b = 3/4$ and $a^2 + b^2 = 25$ which results in $y^2/9 - x^2/16 = 1$.

(b) $c = 3$, $b/a = 2$ and $a^2 + b^2 = 9$ so $a^2 = 9/5$, $b^2 = 36/5$; $x^2/(9/5) - y^2/(36/5) = 1$.

26. (a) The center is at $(3, 6)$, $a = 3$, $c = 5$, $b^2 = 25 - 9 = 16$; $(x - 3)^2/9 - (y - 6)^2/16 = 1$.

(b) The asymptotes intersect at $(3, 1)$ which is the center, $(x - 3)^2/a^2 - (y - 1)^2/b^2 = 1$ is the form of the equation because $(0, 0)$ is to the left of both asymptotes, $9/a^2 - 1/b^2 = 1$ and $a/b = 1$ which yields $a^2 = 8$, $b^2 = 8$; $(x - 3)^2/8 - (y - 1)^2/8 = 1$.

27. False. The set described is a parabola.

28. True, by the definition of "major axis".

29. False. The distance is $2p$, as shown in Figure 10.4.6.

30. False, unless $a = \pm 1$. The equations of the asymptotes can be found by substituting 0 for 1 in the equation of the hyperbola. So the asymptotes satisfy $\frac{y^2}{a^2} - x^2 = 0$; i.e. $y = \pm ax$.

31. (a) $y = ax^2 + b$, $(20, 0)$ and $(10, 12)$ are on the curve, so $400a + b = 0$ and $100a + b = 12$. Solve for b to get $b = 16$ ft = height of arch.

(b) $\frac{x^2}{a^2} + \frac{y^2}{b^2} = 1$, $400 = a^2$, $a = 20$; $\frac{100}{400} + \frac{144}{b^2} = 1$, $b = 8\sqrt{3}$ ft = height of arch.

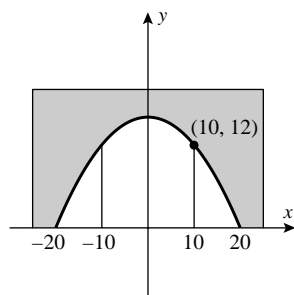

32. (a) $(x - b/2)^2 = a(y - h)$, but $(0, 0)$ is on the parabola so $b^2/4 = -ah$, $a = -\frac{b^2}{4h}$, $(x - b/2)^2 = -\frac{b^2}{4h}(y - h)$.

(b) As in part (a), $y = -\frac{4h}{b^2}(x - b/2)^2 + h$, $A = \int_0^b \left[-\frac{4h}{b^2}(x - b/2)^2 + h \right] dx = \frac{2}{3}bh$.

33. We may assume that the vertex is $(0, 0)$ and the parabola opens to the right. Let $P(x_0, y_0)$ be a point on the parabola $y^2 = 4px$, then by the definition of a parabola, $PF =$ distance from P to directrix $x = -p$, so $PF = x_0 + p$ where $x_0 \geq 0$ and PF is a minimum when $x_0 = 0$ (the vertex).

34. Let $p =$ distance (in millions of miles) between the vertex (closest point) and the focus F . Then $PF = PD$, $40 = 2p + 40 \cos(60^\circ) = 2p + 20$, and $p = 10$ million miles.

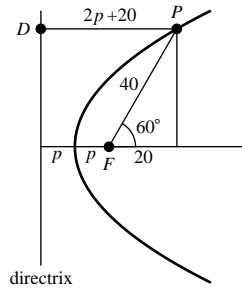

35. Use an xy -coordinate system so that $y^2 = 4px$ is an equation of the parabola. Then $(1, 1/2)$ is a point on the curve so $(1/2)^2 = 4p(1)$, $p = 1/16$. The light source should be placed at the focus which is $1/16$ ft. from the vertex.
36. (a) For any point (x, y) , the equation $y = b \sinh t$ has a unique solution t , $-\infty < t < +\infty$. On the hyperbola, $\frac{x^2}{a^2} = 1 + \frac{y^2}{b^2} = 1 + \sinh^2 t = \cosh^2 t$, so $x = \pm a \cosh t$.

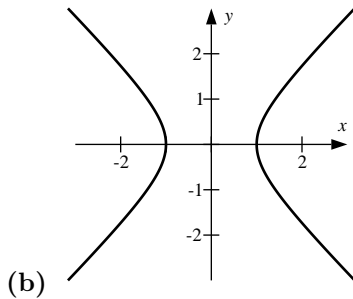

37. (a) For any point (x, y) , the equation $y = b \tan t$ has a unique solution t , $-\pi/2 < t < \pi/2$. On the hyperbola, $\frac{x^2}{a^2} = 1 + \frac{y^2}{b^2} = 1 + \tan^2 t = \sec^2 t$, so $x = \pm a \sec t$.

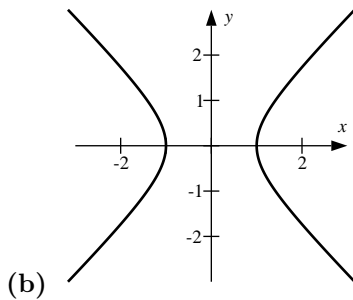

38. $(x - 2)^2 + (y - 4)^2 = y^2$, $(x - 2)^2 = 8y - 16$, $(x - 2)^2 = 8(y - 2)$.
39. $(4, 1)$ and $(4, 5)$ are the foci so the center is at $(4, 3)$ thus $c = 2$, $a = 12/2 = 6$, $b^2 = 36 - 4 = 32$; $(x - 4)^2/32 + (y - 3)^2/36 = 1$.
40. From the definition of a hyperbola, $\left| \sqrt{(x - 1)^2 + (y - 1)^2} - \sqrt{x^2 + y^2} \right| = 1$, $\sqrt{(x - 1)^2 + (y - 1)^2} - \sqrt{x^2 + y^2} = \pm 1$, transpose the second radical to the right hand side of the equation and square and simplify to get $\pm 2\sqrt{x^2 + y^2} = -2x - 2y + 1$, square and simplify again to get $8xy - 4x - 4y + 1 = 0$.
41. Let the ellipse have equation $\frac{4}{81}x^2 + \frac{y^2}{4} = 1$, then $A(x) = (2y)^2 = 16 \left(1 - \frac{4x^2}{81} \right)$, so $V = 2 \int_0^{9/2} 16 \left(1 - \frac{4x^2}{81} \right) dx = 96$.

42. See Exercise 41, $A(y) = \sqrt{3}x^2 = \sqrt{3} \frac{81}{4} \left(1 - \frac{y^2}{4}\right)$, so $V = 2 \int_0^2 \sqrt{3} \frac{81}{4} \left(1 - \frac{y^2}{4}\right) dy = 54\sqrt{3}$.

43. Assume $\frac{x^2}{a^2} + \frac{y^2}{b^2} = 1$, $A = 4 \int_0^a b\sqrt{1 - x^2/a^2} dx = \pi ab$.

44. In the $x'y'$ -plane an equation of the circle is $(x')^2 + (y')^2 = r^2$ where r is the radius of the cylinder. Let $P(x, y)$ be a point on the curve in the xy -plane, then $x' = x \cos \theta$ and $y' = y$ so $x^2 \cos^2 \theta + y^2 = r^2$ which is an equation of an ellipse in the xy -plane.

45. $L = 2a = \sqrt{D^2 + p^2 D^2} = D\sqrt{1 + p^2}$ (see figure), so $a = \frac{1}{2}D\sqrt{1 + p^2}$, but $b = \frac{1}{2}D$, $T = c = \sqrt{a^2 - b^2} = \sqrt{\frac{1}{4}D^2(1 + p^2) - \frac{1}{4}D^2} = \frac{1}{2}pD$.

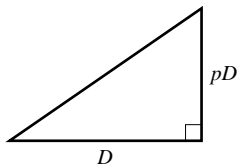

46. Let d_1 and d_2 be the distances of the first and second observers, respectively, from the point of the explosion. Then $t = (\text{time for sound to reach the second observer}) - (\text{time for sound to reach the first observer}) = d_2/v - d_1/v$ so $d_2 - d_1 = vt$. For constant v and t the difference of distances, d_2 and d_1 is constant so the explosion occurred somewhere on a branch of a hyperbola whose foci are where the observers are. Since $d_2 - d_1 = 2a$, $a = \frac{vt}{2}$, $b^2 = c^2 - \frac{v^2 t^2}{4}$, and $\frac{x^2}{v^2 t^2/4} - \frac{y^2}{c^2 - (v^2 t^2/4)} = 1$.

47. As in Exercise 46, $d_2 - d_1 = 2a = vt = (299,792,458 \text{ m/s})(100 \cdot 10^{-6} \text{ s}) \approx 29979 \text{ m} = 29.979 \text{ km}$. $a^2 = (vt/2)^2 \approx 224.689 \text{ km}^2$; $c^2 = (50)^2 = 2500 \text{ km}^2$, $b^2 = c^2 - a^2 \approx 2275.311 \text{ km}^2$, $\frac{x^2}{224.688} - \frac{y^2}{2275.311} = 1$. But $y = 200 \text{ km}$, so $x \approx 64.612 \text{ km}$. The ship is located at $(64.612, 200)$.

48. (a) $\frac{x^2}{225} - \frac{y^2}{1521} = 1$, so $V = 2 \int_0^{h/2} 225\pi \left(1 + \frac{y^2}{1521}\right) dy = \frac{25}{2028}\pi h^3 + 225\pi h \text{ ft}^3$.

(b) $S = 2 \int_0^{h/2} 2\pi x \sqrt{1 + (dx/dy)^2} dy = 4\pi \int_0^{h/2} \sqrt{225 + y^2 \left(\frac{225}{1521} + \left(\frac{225}{1521}\right)^2\right)} dy = \frac{5\pi h}{338} \sqrt{1028196 + 194h^2} + \frac{7605\sqrt{194}}{97} \pi \ln \left[\frac{\sqrt{194}h + \sqrt{1028196 + 194h^2}}{1014} \right] \text{ ft}^2$.

49. (a) $V = \int_a^{\sqrt{a^2+b^2}} \pi (b^2 x^2/a^2 - b^2) dx = \frac{\pi b^2}{3a^2} (b^2 - 2a^2) \sqrt{a^2 + b^2} + \frac{2}{3} ab^2 \pi$.

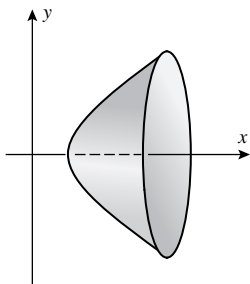

$$(b) V = 2\pi \int_a^{\sqrt{a^2+b^2}} x \sqrt{b^2x^2/a^2 - b^2} dx = (2b^4/3a)\pi.$$

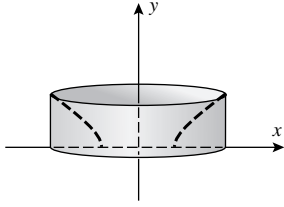

$$50. (a) \text{ Use } \frac{x^2}{9} + \frac{y^2}{4} = 1, x = \frac{3}{2}\sqrt{4-y^2}. \text{ We obtain that } V = \int_{-2}^{-2+h} (2)(3/2)\sqrt{4-y^2}(18)dy = 54 \int_{-2}^{-2+h} \sqrt{4-y^2}dy = 54 \left[\frac{y}{2}\sqrt{4-y^2} + 2\sin^{-1}\frac{y}{2} \right]_{-2}^{-2+h} = 27 \left(4\sin^{-1}\frac{h-2}{2} + (h-2)\sqrt{4h-h^2} + 2\pi \right) \text{ ft}^3.$$

(b) When $h = 4$ ft, $V_{\text{full}} = 108\sin^{-1}1 + 54\pi = 108\pi \text{ ft}^3$, so solve for h when $V = (k/4)V_{\text{full}}$, $k = 1, 2, 3$, to get $h = 1.19205, 2, 2.80795$ ft or $14.30465, 24, 33.69535$ in.

$$51. y = \frac{1}{4p}x^2, dy/dx = \frac{1}{2p}x, dy/dx|_{x=x_0} = \frac{1}{2p}x_0, \text{ the tangent line at } (x_0, y_0) \text{ has the formula } y - y_0 = \frac{x_0}{2p}(x - x_0) = \frac{x_0}{2p}x - \frac{x_0^2}{2p}, \text{ but } \frac{x_0^2}{2p} = 2y_0 \text{ because } (x_0, y_0) \text{ is on the parabola } y = \frac{1}{4p}x^2. \text{ Thus the tangent line is } y - y_0 = \frac{x_0}{2p}x - 2y_0, y = \frac{x_0}{2p}x - y_0.$$

52. By implicit differentiation, $\left. \frac{dy}{dx} \right|_{(x_0, y_0)} = -\frac{b^2x_0}{a^2y_0}$ if $y_0 \neq 0$, the tangent line is $y - y_0 = -\frac{b^2x_0}{a^2y_0}(x - x_0)$, $a^2y_0y - a^2y_0^2 = -b^2x_0x + b^2x_0^2$, $b^2x_0x + a^2y_0y = b^2x_0^2 + a^2y_0^2$, but (x_0, y_0) is on the ellipse so $b^2x_0^2 + a^2y_0^2 = a^2b^2$; thus the tangent line is $b^2x_0x + a^2y_0y = a^2b^2$, $x_0x/a^2 + y_0y/b^2 = 1$. If $y_0 = 0$ then $x_0 = \pm a$ and the tangent lines are $x = \pm a$ which also follows from $x_0x/a^2 + y_0y/b^2 = 1$.

53. By implicit differentiation, $\left. \frac{dy}{dx} \right|_{(x_0, y_0)} = \frac{b^2x_0}{a^2y_0}$ if $y_0 \neq 0$, the tangent line is $y - y_0 = \frac{b^2x_0}{a^2y_0}(x - x_0)$, $b^2x_0x - a^2y_0y = b^2x_0^2 - a^2y_0^2 = a^2b^2$, $x_0x/a^2 - y_0y/b^2 = 1$. If $y_0 = 0$ then $x_0 = \pm a$ and the tangent lines are $x = \pm a$ which also follow from $x_0x/a^2 - y_0y/b^2 = 1$.

54. Use $\frac{x^2}{a^2} + \frac{y^2}{b^2} = 1$ and $\frac{x^2}{A^2} - \frac{y^2}{B^2} = 1$ as the equations of the ellipse and hyperbola. If (x_0, y_0) is a point of intersection then $\frac{x_0^2}{a^2} + \frac{y_0^2}{b^2} = 1 = \frac{x_0^2}{A^2} - \frac{y_0^2}{B^2}$, so $x_0^2 \left(\frac{1}{A^2} - \frac{1}{a^2} \right) = y_0^2 \left(\frac{1}{B^2} + \frac{1}{b^2} \right)$ and $a^2A^2y_0^2(b^2 + B^2) = b^2B^2x_0^2(a^2 - A^2)$. Since the conics have the same foci, $a^2 - b^2 = c^2 = A^2 + B^2$, so $a^2 - A^2 = b^2 + B^2$. Hence $a^2A^2y_0^2 = b^2B^2x_0^2$. From Exercises 52 and 53, the slopes of the tangent lines are $-\frac{b^2x_0}{a^2y_0}$ and $\frac{B^2x_0}{A^2y_0}$, whose product is $-\frac{b^2B^2x_0^2}{a^2A^2y_0^2} = -1$. Hence the tangent lines are perpendicular.

55. Use implicit differentiation on $x^2 + 4y^2 = 8$ to get $\left. \frac{dy}{dx} \right|_{(x_0, y_0)} = -\frac{x_0}{4y_0}$ where (x_0, y_0) is the point of tangency, but $-x_0/(4y_0) = -1/2$ because the slope of the line is $-1/2$, so $x_0 = 2y_0$. (x_0, y_0) is on the ellipse so $x_0^2 + 4y_0^2 = 8$ which when solved with $x_0 = 2y_0$ yields the points of tangency $(2, 1)$ and $(-2, -1)$. Substitute these into the equation of the line to get $k = \pm 4$.

56. Let (x_0, y_0) be such a point. The foci are at $(-\sqrt{5}, 0)$ and $(\sqrt{5}, 0)$, the lines are perpendicular if the product of their slopes is -1 so $\frac{y_0}{x_0 + \sqrt{5}} \cdot \frac{y_0}{x_0 - \sqrt{5}} = -1$, $y_0^2 = 5 - x_0^2$ and $4x_0^2 - y_0^2 = 4$. Solve these to get $x_0 = \pm 3/\sqrt{5}$, $y_0 = \pm 4/\sqrt{5}$. The coordinates are $(\pm 3/\sqrt{5}, 4/\sqrt{5})$, $(\pm 3/\sqrt{5}, -4/\sqrt{5})$.

57. Let (x_0, y_0) be one of the points; then $\left. \frac{dy}{dx} \right|_{(x_0, y_0)} = \frac{4x_0}{y_0}$, the tangent line is $y = (4x_0/y_0)x + 4$, but (x_0, y_0) is on both the line and the curve which leads to $4x_0^2 - y_0^2 + 4y_0 = 0$ and $4x_0^2 - y_0^2 = 36$, so we obtain that $x_0 = \pm 3\sqrt{13}/2$, $y_0 = -9$.

58. We may assume $A > 0$, since if $A < 0$ then we can multiply the equation by -1 , and if $A = 0$ then we can exchange x with y and thus A with C (C cannot be zero if $A = 0$). Then $Ax^2 + Cy^2 + Dx + Ey + F = A\left(x + \frac{D}{2A}\right)^2 + C\left(y + \frac{E}{2C}\right)^2 + F - \frac{D^2}{4A} - \frac{E^2}{4C} = 0$.

(a) Let $AC > 0$. If $F < \frac{D^2}{4A} + \frac{E^2}{4C}$ the equation represents an ellipse (a circle if $A = C$); if $F = \frac{D^2}{4A} + \frac{E^2}{4C}$, the point $x = -D/(2A), y = -E/(2C)$; and if $F > \frac{D^2}{4A} + \frac{E^2}{4C}$ then the graph is empty.

(b) If $AC < 0$ and $F = \frac{D^2}{4A} + \frac{E^2}{4C}$, then $\left[\sqrt{A}\left(x + \frac{D}{2A}\right) + \sqrt{-C}\left(y + \frac{E}{2C}\right)\right]\left[\sqrt{A}\left(x + \frac{D}{2A}\right) - \sqrt{-C}\left(y + \frac{E}{2C}\right)\right] = 0$, a pair of lines; otherwise a hyperbola.

(c) Assume $C = 0$, so $Ax^2 + Dx + Ey + F = 0$. If $E \neq 0$, parabola; if $E = 0$ then $Ax^2 + Dx + F = 0$. If this polynomial has roots $x = x_1, x_2$ with $x_1 \neq x_2$ then a pair of parallel lines; if $x_1 = x_2$ then one line; if no roots, then graph is empty. If $A = 0, C \neq 0$ then a similar argument applies.

59. (a) $(x - 1)^2 - 5(y + 1)^2 = 5$, hyperbola.

(b) $x^2 - 3(y + 1)^2 = 0, x = \pm\sqrt{3}(y + 1)$, two lines.

(c) $4(x + 2)^2 + 8(y + 1)^2 = 4$, ellipse.

(d) $3(x + 2)^2 + (y + 1)^2 = 0$, the point $(-2, -1)$ (degenerate case).

(e) $(x + 4)^2 + 2y = 2$, parabola.

(f) $5(x + 4)^2 + 2y = -14$, parabola.

60. The distance from the point (x, y) to the focus $(0, p)$ is equal to the distance to the directrix $y = -p$, so $x^2 + (y - p)^2 = (y + p)^2, x^2 = 4py$.

61. The distance from the point (x, y) to the focus $(0, -c)$ plus distance to the focus $(0, c)$ is equal to the constant $2a$, so $\sqrt{x^2 + (y + c)^2} + \sqrt{x^2 + (y - c)^2} = 2a, x^2 + (y + c)^2 = 4a^2 + x^2 + (y - c)^2 - 4a\sqrt{x^2 + (y - c)^2}, \sqrt{x^2 + (y - c)^2} = a - \frac{c}{a}y$, and since $a^2 - c^2 = b^2, \frac{x^2}{b^2} + \frac{y^2}{a^2} = 1$.

62. The distance from the point (x, y) to the focus $(-c, 0)$ less distance to the focus $(c, 0)$ is equal to $2a, \sqrt{(x + c)^2 + y^2} - \sqrt{(x - c)^2 + y^2} = \pm 2a, (x + c)^2 + y^2 = (x - c)^2 + y^2 + 4a^2 \pm 4a\sqrt{(x - c)^2 + y^2}, \sqrt{(x - c)^2 + y^2} = \pm\left(\frac{cx}{a} - a\right)$, and, since $c^2 - a^2 = b^2, \frac{x^2}{a^2} - \frac{y^2}{b^2} = 1$.

63. Assume the equation of the parabola is $x^2 = 4py$. The tangent line at $P = (x_0, y_0)$ (see figure) is given by $(y - y_0)/(x - x_0) = m = x_0/2p$. To find the y -intercept set $x = 0$ and obtain $y = -y_0$. Thus the tangent line meets the y -axis at $Q = (0, -y_0)$. The focus is $F = (0, p) = (0, x_0^2/4y_0)$, so the distance from P to the focus is $\sqrt{x_0^2 + (y_0 - p)^2} = \sqrt{4py_0 + (y_0 - p)^2} = \sqrt{(y_0 + p)^2} = y_0 + p$ and the distance from the focus to Q is $p + y_0$. Hence triangle FPQ is isosceles, and angles FPQ and FQP are equal. The angle between the tangent line and the vertical line through P equals angle FQP , so it also equals angle FPQ , as stated in the theorem.

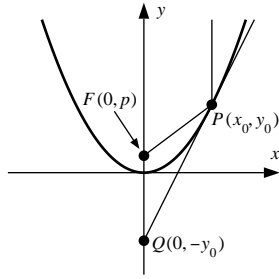

64. (a) $\tan \theta = \tan(\phi_2 - \phi_1) = \frac{\tan \phi_2 - \tan \phi_1}{1 + \tan \phi_2 \tan \phi_1} = \frac{m_2 - m_1}{1 + m_1 m_2}$.

(b) Let $P(x_0, y_0)$ be a point in the first quadrant on the ellipse and let m be the slope of the tangent line at P . By implicit differentiation, $m = \left. \frac{dy}{dx} \right|_{P(x_0, y_0)} = -\frac{b^2 x_0}{a^2 y_0}$ if $y_0 \neq 0$. Let m_1 and m_2 be the slopes of the lines through P and the foci at $(-c, 0)$ and $(c, 0)$ respectively; then $m_1 = \frac{y_0}{x_0 + c}$ and $m_2 = \frac{y_0}{x_0 - c}$. Let α and β be the angles shown in the figure; then $\tan \alpha = \frac{m - m_2}{1 + mm_2} = \frac{-(b^2 x_0)/(a^2 y_0) - y_0/(x_0 - c)}{1 - (b^2 x_0)/[a^2(x_0 - c)]} = \frac{-b^2 x_0^2 - a^2 y_0^2 + b^2 c x_0}{[(a^2 - b^2)x_0 - a^2 c] y_0} = \frac{-a^2 b^2 + b^2 c x_0}{(c^2 x_0 - a^2 c) y_0} = \frac{b^2}{c y_0}$, and similarly $\tan(\pi - \beta) = \frac{m - m_1}{1 + mm_1} = -\frac{b^2}{c y_0} = -\tan \beta$ so $\tan \alpha = \tan \beta$, $\alpha = \beta$. The proof for the case $y_0 = 0$ follows trivially. By symmetry, the result holds for P in the other three quadrants as well.

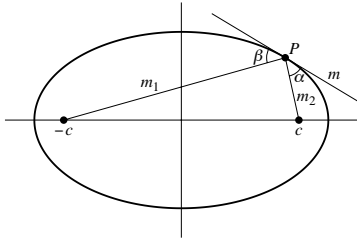

(c) Let $P(x_0, y_0)$ be a point in the third quadrant on the hyperbola and let m be the slope of the tangent line at P . By implicit differentiation, $m = \left. \frac{dy}{dx} \right|_{(x_0, y_0)} = \frac{b^2 x_0}{a^2 y_0}$ if $y_0 \neq 0$. Let m_1 and m_2 be the slopes of the lines through P and the foci at $(-c, 0)$ and $(c, 0)$ respectively; then $m_1 = \frac{y_0}{x_0 + c}$, $m_2 = \frac{y_0}{x_0 - c}$. Use $\tan \alpha = \frac{m_1 - m}{1 + m_1 m}$ and $\tan \beta = \frac{m - m_2}{1 + mm_2}$ to get $\tan \alpha = \tan \beta = -\frac{b^2}{c y_0}$ so $\alpha = \beta$. If $y_0 = 0$ the result follows trivially and by symmetry the result holds for P in the other three quadrants as well.

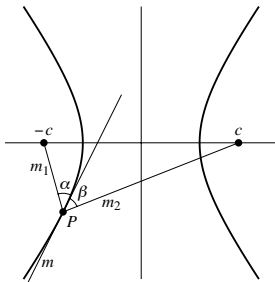

65. Assuming that the major and minor axes have already been drawn, open the compass to the length of half the major axis, place the point of the compass at an end of the minor axis, and draw arcs that cross the major axis to both sides of the center of the ellipse. Place the tacks where the arcs intersect the major axis.

Exercise Set 10.5

1. (a) $\sin \theta = \sqrt{3}/2, \cos \theta = 1/2; x' = (-2)(1/2) + (6)(\sqrt{3}/2) = -1 + 3\sqrt{3}, y' = -(-2)(\sqrt{3}/2) + 6(1/2) = 3 + \sqrt{3}.$

(b) $x = \frac{1}{2}x' - \frac{\sqrt{3}}{2}y' = \frac{1}{2}(x' - \sqrt{3}y'), y = \frac{\sqrt{3}}{2}x' + \frac{1}{2}y' = \frac{1}{2}(\sqrt{3}x' + y'); \sqrt{3} \left[\frac{1}{2}(x' - \sqrt{3}y') \right] \left[\frac{1}{2}(\sqrt{3}x' + y') \right] + \left[\frac{1}{2}(\sqrt{3}x' + y') \right]^2 = 6, \frac{\sqrt{3}}{4}(\sqrt{3}(x')^2 - 2x'y' - \sqrt{3}(y')^2) + \frac{1}{4}(3(x')^2 + 2\sqrt{3}x'y' + (y')^2) = 6, \frac{3}{2}(x')^2 - \frac{1}{2}(y')^2 = 6, 3(x')^2 - (y')^2 = 12$

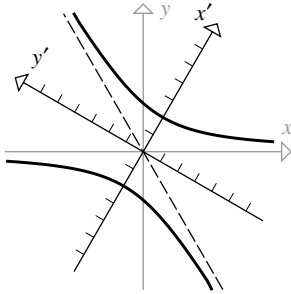

(c)

2. (a) $\sin \theta = 1/2, \cos \theta = \sqrt{3}/2; x' = (1)(\sqrt{3}/2) + (-\sqrt{3})(1/2) = 0, y' = -(1)(1/2) + (-\sqrt{3})(\sqrt{3}/2) = -2.$

(b) $x = \frac{\sqrt{3}}{2}x' - \frac{1}{2}y' = \frac{1}{2}(\sqrt{3}x' - y'), y = \frac{1}{2}x' + \frac{\sqrt{3}}{2}y' = \frac{1}{2}(x' + \sqrt{3}y');$

$2 \left[\frac{1}{2}(\sqrt{3}x' - y') \right]^2 + 2\sqrt{3} \left[\frac{1}{2}(\sqrt{3}x' - y') \right] \left[\frac{1}{2}(x' + \sqrt{3}y') \right] = 3, \frac{1}{2}(3(x')^2 - 2\sqrt{3}x'y' + (y')^2) + \frac{\sqrt{3}}{2}(\sqrt{3}(x')^2 + 2x'y' - \sqrt{3}(y')^2) = 3, 3(x')^2 - (y')^2 = 3, (x')^2/1 - (y')^2/3 = 1.$

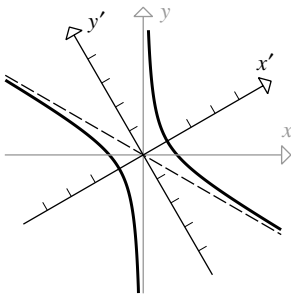

(c)

3. $\cot 2\theta = (0 - 0)/1 = 0, 2\theta = 90^\circ, \theta = 45^\circ, x = (\sqrt{2}/2)(x' - y'), y = (\sqrt{2}/2)(x' + y'), (y')^2/18 - (x')^2/18 = 1,$ hyperbola.

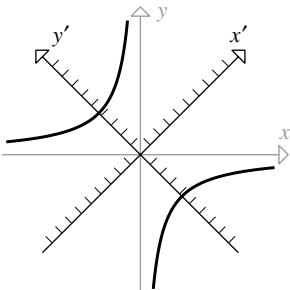

4. $\cot 2\theta = (1 - 1)/(-1) = 0, \theta = 45^\circ, x = (\sqrt{2}/2)(x' - y'), y = (\sqrt{2}/2)(x' + y'), (x')^2/4 + (y')^2/(4/3) = 1,$ ellipse.

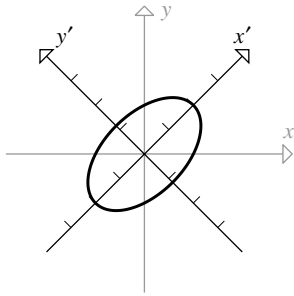

5. $\cot 2\theta = [1 - (-2)]/4 = 3/4$, $\cos 2\theta = 3/5$, $\sin \theta = \sqrt{(1-3/5)/2} = 1/\sqrt{5}$, $\cos \theta = \sqrt{(1+3/5)/2} = 2/\sqrt{5}$,
 $x = (1/\sqrt{5})(2x' - y')$, $y = (1/\sqrt{5})(x' + 2y')$, $(x')^2/3 - (y')^2/2 = 1$, hyperbola.

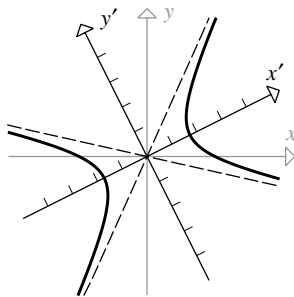

6. $\cot 2\theta = (31 - 21)/(10\sqrt{3}) = 1/\sqrt{3}$, $2\theta = 60^\circ$, $\theta = 30^\circ$, $x = (1/2)(\sqrt{3}x' - y')$, $y = (1/2)(x' + \sqrt{3}y')$, $(x')^2/4 + (y')^2/9 = 1$, ellipse.

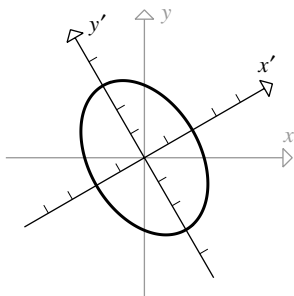

7. $\cot 2\theta = (1 - 3)/(2\sqrt{3}) = -1/\sqrt{3}$, $2\theta = 120^\circ$, $\theta = 60^\circ$, $x = (1/2)(x' - \sqrt{3}y')$, $y = (1/2)(\sqrt{3}x' + y')$, $y' = (x')^2$, parabola.

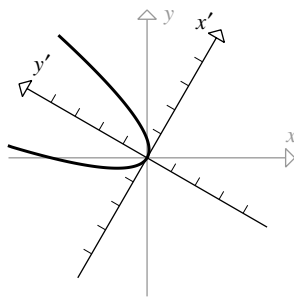

8. $\cot 2\theta = (34 - 41)/(-24) = 7/24$, $\cos 2\theta = 7/25$, $\sin \theta = \sqrt{(1-7/25)/2} = 3/5$, $\cos \theta = \sqrt{(1+7/25)/2} = 4/5$,
 $x = (1/5)(4x' - 3y')$, $y = (1/5)(3x' + 4y')$, $(x')^2 + (y')^2/(1/2) = 1$, ellipse.

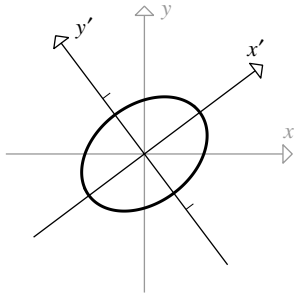

9. $\cot 2\theta = (9 - 16)/(-24) = 7/24$, $\cos 2\theta = 7/25$, $\sin \theta = 3/5$, $\cos \theta = 4/5$, $x = (1/5)(4x' - 3y')$, $y = (1/5)(3x' + 4y')$, $(y')^2 = 4(x' - 1)$, parabola.

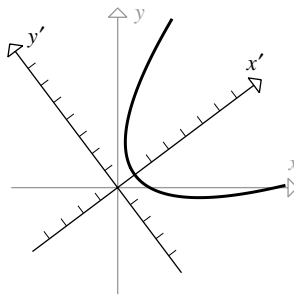

10. $\cot 2\theta = (5 - 5)/(-6) = 0$, $\theta = 45^\circ$, $x = (\sqrt{2}/2)(x' - y')$, $y = (\sqrt{2}/2)(x' + y')$, $(x')^2/8 + (y' + 1)^2/2 = 1$, ellipse.

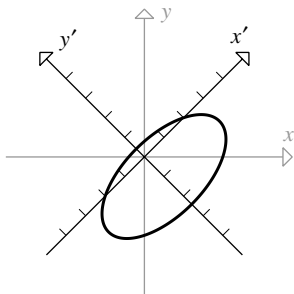

11. $\cot 2\theta = (52 - 73)/(-72) = 7/24$, $\cos 2\theta = 7/25$, $\sin \theta = 3/5$, $\cos \theta = 4/5$, $x = (1/5)(4x' - 3y')$, $y = (1/5)(3x' + 4y')$, $(x' + 1)^2/4 + (y')^2 = 1$, ellipse.

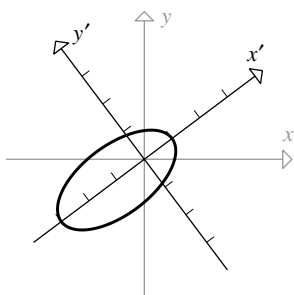

12. $\cot 2\theta = [6 - (-1)]/24 = 7/24$, $\cos 2\theta = 7/25$, $\sin \theta = 3/5$, $\cos \theta = 4/5$, $x = (1/5)(4x' - 3y')$, $y = (1/5)(3x' + 4y')$, $(y' - 7/5)^2/3 - (x' + 1/5)^2/2 = 1$, hyperbola.

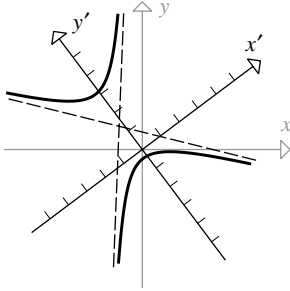

13. $x' = (\sqrt{2}/2)(x + y)$, $y' = (\sqrt{2}/2)(-x + y)$ which when substituted into $3(x')^2 + (y')^2 = 6$ yields $x^2 + xy + y^2 = 3$.
14. From (5), $x = \frac{1}{2}(\sqrt{3}x' - y')$ and $y = \frac{1}{2}(x' + \sqrt{3}y')$ so $y = x^2$ becomes $\frac{1}{2}(x' + \sqrt{3}y') = \frac{1}{4}(\sqrt{3}x' - y')^2$; simplify to get $3(x')^2 - 2\sqrt{3}x'y' + (y')^2 - 2x' - 2\sqrt{3}y' = 0$.
15. Let $x = x' \cos \theta - y' \sin \theta$, $y = x' \sin \theta + y' \cos \theta$ then $x^2 + y^2 = r^2$ becomes $(\sin^2 \theta + \cos^2 \theta)(x')^2 + (\sin^2 \theta + \cos^2 \theta)(y')^2 = r^2$, $(x')^2 + (y')^2 = r^2$. Under a rotation transformation the center of the circle stays at the origin of both coordinate systems.
16. Multiply the first equation through by $\cos \theta$ and the second by $\sin \theta$ and add to get $x \cos \theta + y \sin \theta = (\cos^2 \theta + \sin^2 \theta)x' = x'$. Multiply the first by $-\sin \theta$ and the second by $\cos \theta$ and add to get y' .
17. Use the Rotation Equations (5).
18. If the line is given by $Dx' + Ey' + F = 0$ then from (6), $D(x \cos \theta + y \sin \theta) + E(-x \sin \theta + y \cos \theta) + F = 0$, or $(D \cos \theta - E \sin \theta)x + (D \sin \theta + E \cos \theta)y + F = 0$, which is a line in the xy -coordinates.
19. Set $\cot 2\theta = (A - C)/B = 0$, $2\theta = \pi/2$, $\theta = \pi/4$, $\cos \theta = \sin \theta = 1/\sqrt{2}$. Set $x = (x' - y')/\sqrt{2}$, $y = (x' + y')/\sqrt{2}$ and insert these into the equation to obtain $4y' = (x')^2$; parabola, $p = 1$. In $x'y'$ -coordinates: vertex $(0, 0)$, focus $(0, 1)$, directrix $y' = -1$. In xy -coordinates: vertex $(0, 0)$, focus $(-1/\sqrt{2}, 1/\sqrt{2})$, directrix $y = x - \sqrt{2}$.
20. $\cot 2\theta = (1 - 3)/(-2\sqrt{3}) = 1/\sqrt{3}$, $2\theta = \pi/3$, $\theta = \pi/6$, $\cos \theta = \sqrt{3}/2$, $\sin \theta = 1/2$. Set $x = \sqrt{3}x'/2 - y'/2$, $y = x'/2 + \sqrt{3}y'/2$ and obtain $4x' = (y')^2$; parabola, $p = 1$. In $x'y'$ -coordinates: vertex $(0, 0)$, focus $(1, 0)$, directrix $x' = -1$. In xy -coordinates: vertex $(0, 0)$, focus $(\sqrt{3}/2, 1/2)$, directrix $y = -\sqrt{3}x - 2$.
21. $\cot 2\theta = (9 - 16)/(-24) = 7/24$. Use the method of Example 4 to obtain $\cos 2\theta = \frac{7}{25}$, so $\cos \theta = \sqrt{\frac{1 + \cos 2\theta}{2}} = \sqrt{\frac{1 + \frac{7}{25}}{2}} = \frac{4}{5}$, $\sin \theta = \sqrt{\frac{1 - \cos 2\theta}{2}} = \frac{3}{5}$. Set $x = \frac{4}{5}x' - \frac{3}{5}y'$, $y = \frac{3}{5}x' + \frac{4}{5}y'$, and insert these into the original equation to obtain $(y')^2 = 4(x' - 1)$; parabola, $p = 1$. In $x'y'$ -coordinates: vertex $(1, 0)$, focus $(2, 0)$, directrix $x' = 0$. In xy -coordinates: vertex $(4/5, 3/5)$, focus $(8/5, 6/5)$, directrix $y = -4x/3$.
22. $\cot 2\theta = (1 - 3)/(2\sqrt{3}) = -1/\sqrt{3}$, $2\theta = 2\pi/3$, $\theta = \pi/3$, $\cos \theta = 1/2$, $\sin \theta = \sqrt{3}/2$. Set $x = (x' - \sqrt{3}y')/2$, $y = (\sqrt{3}x' + y')/2$, and the equation is transformed into $(x')^2 = 8(y' + 3)$; parabola, $p = 2$. In $x'y'$ -coordinates: vertex $(0, -3)$, focus $(0, -1)$, directrix $y' = -5$. In xy -coordinates: vertex $(3\sqrt{3}/2, -3/2)$, focus $(\sqrt{3}/2, -1/2)$, directrix $y = \sqrt{3}x - 10$.
23. $\cot 2\theta = (288 - 337)/(-168) = 49/168 = 7/24$; proceed as in Exercise 21 to obtain $\cos \theta = 4/5$, $\sin \theta = 3/5$. Set $x = (4x' - 3y')/5$, $y = (3x' + 4y')/5$ to get $(x')^2/16 + (y')^2/9 = 1$; ellipse, $a = 4$, $b = 3$, $c = \sqrt{7}$. In $x'y'$ -coordinates: foci $(\pm\sqrt{7}, 0)$, vertices $(\pm 4, 0)$, minor axis endpoints $(0, \pm 3)$. In xy -coordinates: foci $\pm(4\sqrt{7}/5, 3\sqrt{7}/5)$, vertices $\pm(16/5, 12/5)$, minor axis endpoints $\pm(-9/5, 12/5)$.
24. $\cot 2\theta = 0$, $2\theta = \pi/2$, $\theta = \pi/4$, $\cos \theta = \sin \theta = 1/\sqrt{2}$. Set $x = (x' - y')/\sqrt{2}$, $y = (x' + y')/\sqrt{2}$ and the equation becomes $(x')^2/16 + (y')^2/9 = 1$; ellipse, $a = 4$, $b = 3$, $c = \sqrt{7}$. In $x'y'$ -coordinates: foci $(\pm\sqrt{7}, 0)$, vertices $(\pm 4, 0)$,

minor axis endpoints $(0, \pm 3)$. In xy -coordinates: foci $\pm(\sqrt{7/2}, \sqrt{7/2})$, vertices $\pm(2\sqrt{2}, 2\sqrt{2})$, minor axis endpoints $\pm(-3/\sqrt{2}, 3/\sqrt{2})$.

25. $\cot 2\theta = (31 - 21)/(10\sqrt{3}) = 1/\sqrt{3}$, $2\theta = \pi/3$, $\theta = \pi/6$, $\cos \theta = \sqrt{3}/2$, $\sin \theta = 1/2$. Set $x = \sqrt{3}x'/2 - y'/2$, $y = x'/2 + \sqrt{3}y'/2$ and obtain $(x')^2/4 + (y'+2)^2/9 = 1$; ellipse, $a = 3$, $b = 2$, $c = \sqrt{9-4} = \sqrt{5}$. In $x'y'$ -coordinates: foci $(0, -2 \pm \sqrt{5})$, vertices $(0, 1)$ and $(0, -5)$, ends of minor axis $(\pm 2, -2)$. In xy -coordinates: foci $\left(1 - \frac{\sqrt{5}}{2}, -\sqrt{3} + \frac{\sqrt{15}}{2}\right)$ and $\left(1 + \frac{\sqrt{5}}{2}, -\sqrt{3} - \frac{\sqrt{15}}{2}\right)$, vertices $\left(-\frac{1}{2}, \frac{\sqrt{3}}{2}\right)$ and $\left(\frac{5}{2}, -\frac{5\sqrt{3}}{2}\right)$, ends of minor axis $\left(1 + \sqrt{3}, 1 - \sqrt{3}\right)$ and $\left(1 - \sqrt{3}, -1 - \sqrt{3}\right)$.

26. $\cot 2\theta = 1/\sqrt{3}$, $2\theta = \pi/3$, $\theta = \pi/6$, $\cos \theta = \sqrt{3}/2$, $\sin \theta = 1/2$. Set $x = \sqrt{3}x'/2 - y'/2$, $y = x'/2 + \sqrt{3}y'/2$ and obtain $(x' - 1)^2/16 + (y')^2/9 = 1$; ellipse, $a = 4$, $b = 3$, $c = \sqrt{16-9} = \sqrt{7}$. In $x'y'$ -coordinates: foci $(1 \pm \sqrt{7}, 0)$, vertices $(5, 0)$ and $(-3, 0)$, ends of minor axis $(1, \pm 3)$. In xy -coordinates: foci $\left(\frac{\sqrt{3} + \sqrt{21}}{2}, \frac{1 + \sqrt{7}}{2}\right)$ and $\left(\frac{\sqrt{3} - \sqrt{21}}{2}, \frac{1 - \sqrt{7}}{2}\right)$, vertices $\left(\frac{5\sqrt{3}}{2}, \frac{5}{2}\right)$ and $\left(-\frac{3\sqrt{3}}{2}, -\frac{3}{2}\right)$, ends of minor axis $\left(\frac{\sqrt{3} - 3}{2}, \frac{1 + 3\sqrt{3}}{2}\right)$ and $\left(\frac{\sqrt{3} + 3}{2}, \frac{1 - 3\sqrt{3}}{2}\right)$.

27. $\cot 2\theta = (1 - 11)/(-10\sqrt{3}) = 1/\sqrt{3}$, $2\theta = \pi/3$, $\theta = \pi/6$, $\cos \theta = \sqrt{3}/2$, $\sin \theta = 1/2$. Set $x = \sqrt{3}x'/2 - y'/2$, $y = x'/2 + \sqrt{3}y'/2$ and obtain $(x')^2/16 - (y')^2/4 = 1$; hyperbola, $a = 4$, $b = 2$, $c = \sqrt{20} = 2\sqrt{5}$. In $x'y'$ -coordinates: foci $(\pm 2\sqrt{5}, 0)$, vertices $(\pm 4, 0)$, asymptotes $y' = \pm x'/2$. In xy -coordinates: foci $\pm(\sqrt{15}, \sqrt{5})$, vertices $\pm(2\sqrt{3}, 2)$, asymptotes $y = \frac{5\sqrt{3} \pm 8}{11}x$.

28. $\cot 2\theta = (17 - 108)/(-312) = 7/24$; proceed as in Exercise 21 to obtain $\cos \theta = 4/5$, $\sin \theta = 3/5$. Set $x = (4x' - 3y')/5$, $y = (3x' + 4y')/5$ to get $(y')^2/4 - (x')^2/9 = 1$; hyperbola, $a = 2$, $b = 3$, $c = \sqrt{13}$. In $x'y'$ -coordinates: foci $(0, \pm\sqrt{13})$, vertices $(0, \pm 2)$, asymptotes $y = \pm 2x/3$. In xy -coordinates: foci $\pm\left(-\frac{3\sqrt{13}}{5}, \frac{4\sqrt{13}}{5}\right)$, vertices $\pm\left(-\frac{6}{5}, \frac{8}{5}\right)$, asymptotes $y = \frac{x}{18}$ and $y = \frac{17x}{6}$.

29. $\cot 2\theta = ((-7) - 32)/(-52) = 3/4$; proceed as in Example 4 to obtain $\cos 2\theta = 3/5$, $\cos \theta = \sqrt{\frac{1 + \cos 2\theta}{2}} = \frac{2}{\sqrt{5}}$, $\sin \theta = \frac{1}{\sqrt{5}}$. Set $x = \frac{2x' - y'}{\sqrt{5}}$, $y = \frac{x' + 2y'}{\sqrt{5}}$ and the equation becomes $\frac{(x')^2}{9} - \frac{(y' - 4)^2}{4} = 1$; hyperbola, $a = 3$, $b = 2$, $c = \sqrt{13}$. In $x'y'$ -coordinates: foci $(\pm\sqrt{13}, 4)$, vertices $(\pm 3, 4)$, asymptotes $y' = 4 \pm 2x'/3$. In xy -coordinates: foci $\left(\frac{-4 + 2\sqrt{13}}{\sqrt{5}}, \frac{8 + \sqrt{13}}{\sqrt{5}}\right)$ and $\left(\frac{-4 - 2\sqrt{13}}{\sqrt{5}}, \frac{8 - \sqrt{13}}{\sqrt{5}}\right)$, vertices $\left(\frac{2}{\sqrt{5}}, \frac{11}{\sqrt{5}}\right)$ and $(-2\sqrt{5}, \sqrt{5})$, asymptotes $y = \frac{7x}{4} + 3\sqrt{5}$ and $y = -\frac{x}{8} + \frac{3\sqrt{5}}{2}$.

30. $\cot 2\theta = 0$, $2\theta = \pi/2$, $\theta = \pi/4$, $\cos \theta = \sin \theta = 1/\sqrt{2}$. Set $x = (x' - y')/\sqrt{2}$, $y = (x' + y')/\sqrt{2}$ and the equation becomes $(y')^2/36 - (x' + 2)^2/4 = 1$; hyperbola, $a = 6$, $b = 2$, $c = \sqrt{36 + 4} = 2\sqrt{10}$. In $x'y'$ -coordinates: foci $(-2, \pm 2\sqrt{10})$, vertices $(-2, \pm 6)$, asymptotes $y' = \pm 3(x' + 2)$. In xy -coordinates: foci $(-\sqrt{2} - 2\sqrt{5}, -\sqrt{2} + 2\sqrt{5})$ and $(-\sqrt{2} + 2\sqrt{5}, -\sqrt{2} - 2\sqrt{5})$, vertices $(-4\sqrt{2}, 2\sqrt{2})$ and $(2\sqrt{2}, -4\sqrt{2})$, asymptotes $y = -2x - 3\sqrt{2}$ and $y = -\frac{x}{2} - \frac{3}{\sqrt{2}}$.

31. $(\sqrt{x} + \sqrt{y})^2 = 1 = x + y + 2\sqrt{xy}$, $(1 - x - y)^2 = x^2 + y^2 + 1 - 2x - 2y + 2xy = 4xy$, so $x^2 - 2xy + y^2 - 2x - 2y + 1 = 0$. Set $\cot 2\theta = 0$, then $\theta = \pi/4$. Change variables by the Rotation Equations to obtain $2(y')^2 - 2\sqrt{2}x' + 1 = 0$, which is the equation of a parabola. The original equation implies that x and y are in the interval $[0, 1]$, so we only get part of the parabola.

32. When (5) is substituted into (7), the term $x'y'$ will occur in the terms $A(x' \cos \theta - y' \sin \theta)^2 + B(x' \cos \theta - y' \sin \theta)(x' \sin \theta + y' \cos \theta) + C(x' \sin \theta + y' \cos \theta)^2 = (x')^2(\dots) + x'y'(-2A \cos \theta \sin \theta + B(\cos^2 \theta - \sin^2 \theta) + 2C \cos \theta \sin \theta) + (y')^2(\dots) + \dots$, so the coefficient of $x'y'$ is $B' = B(\cos^2 \theta - \sin^2 \theta) + 2(C - A) \sin \theta \cos \theta$.
33. It suffices to show that the expression $B'^2 - 4A'C'$ is independent of θ . Set $g = B' = B(\cos^2 \theta - \sin^2 \theta) + 2(C - A) \sin \theta \cos \theta$, $f = A' = (A \cos^2 \theta + B \cos \theta \sin \theta + C \sin^2 \theta)$, $h = C' = (A \sin^2 \theta - B \sin \theta \cos \theta + C \cos^2 \theta)$. It is easy to show that $g'(\theta) = -2B \sin 2\theta + 2(C - A) \cos 2\theta$, $f'(\theta) = (C - A) \sin 2\theta + B \cos 2\theta$, $h'(\theta) = (A - C) \sin 2\theta - B \cos 2\theta$ and it is a bit more tedious to show that $\frac{d}{d\theta}(g^2 - 4fh) = 0$. It follows that $B'^2 - 4A'C'$ is independent of θ and by taking $\theta = 0$, we have $B'^2 - 4A'C' = B^2 - 4AC$.
34. From equations (9), $A' + C' = A(\sin^2 \theta + \cos^2 \theta) + C(\sin^2 \theta + \cos^2 \theta) = A + C$.
35. If $A = C$ then $\cot 2\theta = (A - C)B = 0$, so $2\theta = \pi/2$, and $\theta = \pi/4$.
36. If $F = 0$ then $x^2 + Bxy = 0$, $x(x + By) = 0$ so $x = 0$ or $x + By = 0$ which are lines that intersect at $(0, 0)$. Suppose $F \neq 0$, rotate through an angle θ where $\cot 2\theta = 1/B$ eliminating the cross product term to get $A'(x')^2 + C'(y')^2 + F' = 0$, and note that $F' = F$ so $F' \neq 0$. From (9), $A' = \cos^2 \theta + B \cos \theta \sin \theta = \cos \theta(\cos \theta + B \sin \theta)$ and $C' = \sin^2 \theta - B \sin \theta \cos \theta = \sin \theta(\sin \theta - B \cos \theta)$, so $A'C' = \sin \theta \cos \theta[\sin \theta \cos \theta - B(\cos^2 \theta - \sin^2 \theta) - B^2 \sin \theta \cos \theta] = \frac{1}{2} \sin 2\theta \left[\frac{1}{2} \sin 2\theta - B \cos 2\theta - \frac{1}{2} B^2 \sin 2\theta \right] = \frac{1}{4} \sin^2 2\theta [1 - 2B \cot 2\theta - B^2] = \frac{1}{4} \sin^2 2\theta [1 - 2B(1/B) - B^2] = -\frac{1}{4} \sin^2 2\theta (1 + B^2) < 0$, thus A' and C' have unlike signs so the graph is a hyperbola.

Exercise Set 10.6

1. (a) $r = \frac{3/2}{1 - \cos \theta}$, $e = 1$, $d = 3/2$.

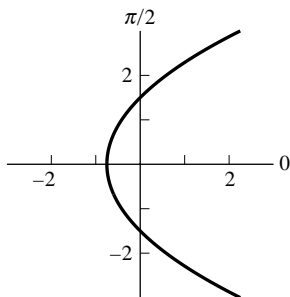

(b) $r = \frac{3/2}{1 + \frac{1}{2} \sin \theta}$, $e = 1/2$, $d = 3$.

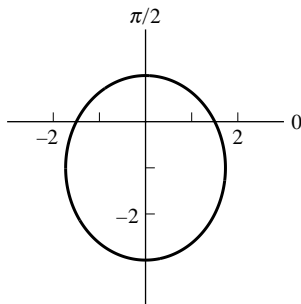

2. (a) $r = \frac{2}{1 + \frac{3}{2} \cos \theta}$, $e = 3/2$, $d = 4/3$.

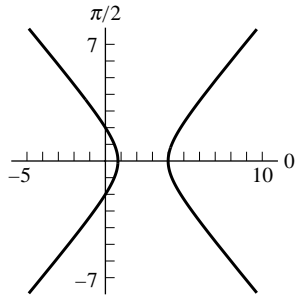

(b) $r = \frac{5/3}{1 + \sin \theta}$, $e = 1$, $d = 5/3$.

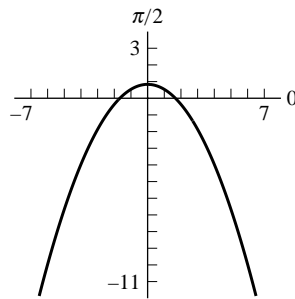

3. (a) $e = 1$, $d = 8$, parabola, opens up.

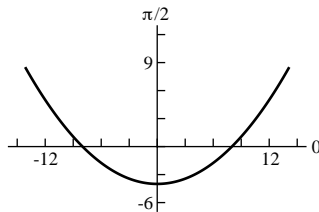

(b) $r = \frac{4}{1 + \frac{3}{4} \sin \theta}$, $e = 3/4$, $d = 16/3$, ellipse, directrix $16/3$ units above the pole.

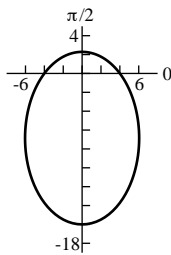

4. (a) $r = \frac{2}{1 - \frac{3}{2} \sin \theta}$, $e = 3/2$, $d = 4/3$, hyperbola, directrix $4/3$ units below the pole.

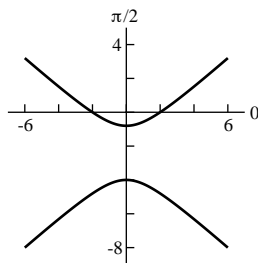

- (b) $r = \frac{3}{1 + \frac{1}{4} \cos \theta}$, $e = 1/4$, $d = 12$, ellipse, directrix 12 units to the right of the pole.

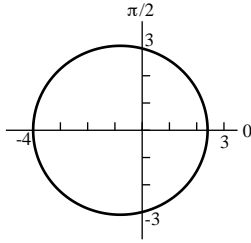

5. (a) $d = 2$, $r = \frac{ed}{1 + e \cos \theta} = \frac{3/2}{1 + \frac{3}{4} \cos \theta} = \frac{6}{4 + 3 \cos \theta}$.

(b) $e = 1$, $d = 1$, $r = \frac{ed}{1 + e \cos \theta} = \frac{1}{1 + \cos \theta}$.

(c) $e = 4/3$, $d = 3$, $r = \frac{ed}{1 + e \sin \theta} = \frac{4}{1 + \frac{4}{3} \sin \theta} = \frac{12}{3 + 4 \sin \theta}$.

6. (a) $r = \frac{ed}{1 \pm e \sin \theta}$, $2 = \frac{ed}{1 \pm e}$, $6 = \frac{ed}{1 \mp e}$, $2 \pm 2e = 6 \mp 6e$, upper sign yields $e = 1/2$, $d = 6$, $r = \frac{3}{1 + \frac{1}{2} \sin \theta} = \frac{6}{2 + \sin \theta}$.

(b) $e = 1$, $r = \frac{d}{1 - \cos \theta}$, $2 = \frac{d}{2}$, $d = 4$, $r = \frac{4}{1 - \cos \theta}$.

(c) $e = \sqrt{2}$, $r = \frac{\sqrt{2}d}{1 + \sqrt{2} \cos \theta}$; $r = 2$ when $\theta = 0$, so $d = 2 + \sqrt{2}$, $r = \frac{2 + 2\sqrt{2}}{1 + \sqrt{2} \cos \theta}$.

7. (a) $r = \frac{3}{1 + \frac{1}{2} \sin \theta}$, $e = 1/2$, $d = 6$, directrix 6 units above pole; if $\theta = \pi/2$: $r_0 = 2$; if $\theta = 3\pi/2$: $r_1 = 6$, $a = (r_0 + r_1)/2 = 4$, $b = \sqrt{r_0 r_1} = 2\sqrt{3}$, center $(0, -2)$ (rectangular coordinates), $\frac{x^2}{12} + \frac{(y+2)^2}{16} = 1$.

(b) $r = \frac{1/2}{1 - \frac{1}{2} \cos \theta}$, $e = 1/2$, $d = 1$, directrix 1 unit left of pole; if $\theta = \pi$: $r_0 = \frac{1/2}{3/2} = 1/3$; if $\theta = 0$: $r_1 = 1$, $a = 2/3$, $b = 1/\sqrt{3}$, center $(1/3, 0)$ (rectangular coordinates), $\frac{9}{4}(x - 1/3)^2 + 3y^2 = 1$.

8. (a) $r = \frac{6/5}{1 + \frac{2}{5} \cos \theta}$, $e = 2/5$, $d = 3$, directrix 3 units right of pole, if $\theta = 0$: $r_0 = 6/7$, if $\theta = \pi$: $r_1 = 2$, $a = 10/7$, $b = 2\sqrt{3}/\sqrt{7}$, center $(-4/7, 0)$ (rectangular coordinates), $\frac{49}{100}(x + 4/7)^2 + \frac{7}{12}y^2 = 1$.

(b) $r = \frac{2}{1 - \frac{3}{4} \sin \theta}$, $e = 3/4$, $d = 8/3$, directrix $8/3$ units below pole, if $\theta = 3\pi/2$: $r_0 = 8/7$, if $\theta = \pi/2$: $r_1 = 8$, $a = 32/7$, $b = 8/\sqrt{7}$, center: $(0, 24/7)$ (rectangular coordinates), $\frac{7}{64}x^2 + \frac{49}{1024}\left(y - \frac{24}{7}\right)^2 = 1$.

9. (a) $r = \frac{3}{1 + 2 \sin \theta}$, $e = 2$, $d = 3/2$, hyperbola, directrix $3/2$ units above pole, if $\theta = \pi/2$: $r_0 = 1$; $\theta = 3\pi/2$: $r = -3$, so $r_1 = 3$, center $(0, 2)$, $a = 1$, $b = \sqrt{3}$, $-\frac{x^2}{3} + (y - 2)^2 = 1$.

(b) $r = \frac{5/2}{1 - \frac{3}{2} \cos \theta}$, $e = 3/2$, $d = 5/3$, hyperbola, directrix $5/3$ units left of pole, if $\theta = \pi : r_0 = 1$; $\theta = 0 : r = -5$, $r_1 = 5$, center $(-3, 0)$, $a = 2$, $b = \sqrt{5}$, $\frac{1}{4}(x + 3)^2 - \frac{1}{5}y^2 = 1$.

10. (a) $r = \frac{4}{1 - 2 \sin \theta}$, $e = 2$, $d = 2$, hyperbola, directrix 2 units below pole, if $\theta = 3\pi/2 : r_0 = 4/3$; $\theta = \pi/2 : r_1 = \left| \frac{4}{1 - 2} \right| = 4$, center $(0, -8/3)$, $a = 4/3$, $b = 4/\sqrt{3}$, $\frac{9}{16} \left(y + \frac{8}{3} \right)^2 - \frac{3}{16}x^2 = 1$.

(b) $r = \frac{15/2}{1 + 4 \cos \theta}$, $e = 4$, $d = 15/8$, hyperbola, directrix $15/8$ units right of pole, if $\theta = 0 : r_0 = 3/2$; $\theta = \pi : r_1 = \left| -\frac{5}{2} \right| = 5/2$, $a = 1/2$, $b = \frac{\sqrt{15}}{2}$, center $(2, 0)$, $4(x - 2)^2 - \frac{4}{15}y^2 = 1$.

11. (a) $r = \frac{\frac{1}{2}d}{1 + \frac{1}{2} \cos \theta} = \frac{d}{2 + \cos \theta}$, if $\theta = 0 : r_0 = d/3$; $\theta = \pi$, $r_1 = d$, $8 = a = \frac{1}{2}(r_1 + r_0) = \frac{2}{3}d$, $d = 12$, $r = \frac{12}{2 + \cos \theta}$.

(b) $r = \frac{\frac{3}{5}d}{1 - \frac{3}{5} \sin \theta} = \frac{3d}{5 - 3 \sin \theta}$, if $\theta = 3\pi/2 : r_0 = \frac{3}{8}d$; $\theta = \pi/2$, $r_1 = \frac{3}{2}d$, $4 = a = \frac{1}{2}(r_1 + r_0) = \frac{15}{16}d$, $d = \frac{64}{15}$, $r = \frac{3(64/15)}{5 - 3 \sin \theta} = \frac{64}{25 - 15 \sin \theta}$.

12. (a) $r = \frac{\frac{3}{5}d}{1 - \frac{3}{5} \cos \theta} = \frac{3d}{5 - 3 \cos \theta}$, if $\theta = \pi : r_0 = \frac{3}{8}d$; $\theta = 0$, $r_1 = \frac{3}{2}d$, $4 = b = \frac{3}{4}d$, $d = 16/3$, $r = \frac{16}{5 - 3 \cos \theta}$.

(b) $r = \frac{\frac{1}{5}d}{1 + \frac{1}{5} \sin \theta} = \frac{d}{5 + \sin \theta}$, if $\theta = \pi/2 : r_0 = d/6$; $\theta = 3\pi/2$, $r_1 = d/4$, $5 = c = \frac{1}{2}d \left(\frac{1}{4} - \frac{1}{6} \right) = \frac{1}{24}d$, $d = 120$, $r = \frac{120}{5 + \sin \theta}$.

13. For a hyperbola, both vertices and the directrix lie between the foci. So if one focus is at the origin and one vertex is at $(5, 0)$, then the directrix must lie to the right of the origin. By Theorem 10.6.2, the equation of the hyperbola has the form $r = \frac{ed}{1 + e \cos \theta}$. Since the hyperbola is equilateral, $a = b$, so $c = \sqrt{2}a$ and $e = c/a = \sqrt{2}$. Since $(5, 0)$ lies on the hyperbola, either $r(0) = 5$ or $r(\pi) = -5$. In the first case the equation is $r = \frac{5\sqrt{2} + 5}{1 + \sqrt{2} \cos \theta}$; in the second case it is $r = \frac{5\sqrt{2} - 5}{1 + \sqrt{2} \cos \theta}$.

14. If a hyperbola is equilateral, then $a = b$, but then $c = \sqrt{a^2 + b^2} = \sqrt{2a^2} = a\sqrt{2}$ and then $e = c/a = \sqrt{2}$. Now let $e = \sqrt{2}$, then $c = a\sqrt{2}$ and $c^2 = 2a^2$, but $c^2 = a^2 + b^2$, so $a^2 = b^2$ and then $a = b$, so the hyperbola is equilateral.

15. (a) From Figure 10.4.22, $\frac{x^2}{a^2} - \frac{y^2}{b^2} = 1$, $\frac{x^2}{a^2} - \frac{y^2}{c^2 - a^2} = 1$, $\left(1 - \frac{c^2}{a^2} \right) x^2 + y^2 = a^2 - c^2$, $c^2 + x^2 + y^2 = \left(\frac{c}{a}x \right)^2 + a^2$, $(x - c)^2 + y^2 = \left(\frac{c}{a}x - a \right)^2$, $\sqrt{(x - c)^2 + y^2} = \frac{c}{a}x - a$ for $x > a^2/c$.

(b) From part (a) and Figure 10.6.1, $PF = \frac{c}{a}PD$, $\frac{PF}{PD} = \frac{c}{a}$.

16. (a) $e = c/a = \frac{\frac{1}{2}(r_1 - r_0)}{\frac{1}{2}(r_1 + r_0)} = \frac{r_1 - r_0}{r_1 + r_0}$.

$$(b) e = \frac{r_1/r_0 - 1}{r_1/r_0 + 1}, e(r_1/r_0 + 1) = r_1/r_0 - 1, \frac{r_1}{r_0} = \frac{1+e}{1-e}.$$

$$17. (a) e = c/a = \frac{\frac{1}{2}(r_1 + r_0)}{\frac{1}{2}(r_1 - r_0)} = \frac{r_1 + r_0}{r_1 - r_0}.$$

$$(b) e = \frac{r_1/r_0 + 1}{r_1/r_0 - 1}, e(r_1/r_0 - 1) = r_1/r_0 + 1, \frac{r_1}{r_0} = \frac{e+1}{e-1}.$$

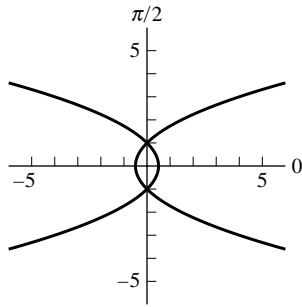

$$18. (a) \quad (b) \theta = \pi/2, 3\pi/2, r = 1.$$

$$(c) \frac{dy}{dx} = \frac{r \cos \theta + (dr/d\theta) \sin \theta}{-r \sin \theta + (dr/d\theta) \cos \theta}; \text{ at } \theta = \pi/2, m_1 = -1, m_2 = 1, m_1 m_2 = -1; \text{ and at } \theta = 3\pi/2, m_1 = 1, m_2 = -1, m_1 m_2 = -1.$$

19. True. A non-circular ellipse can be described by the focus-directrix characterization as shown in Figure 10.6.1, so its eccentricity satisfies $0 < e < 1$ by part (b) of Theorem 10.6.1.

20. False. The eccentricity of a parabola equals 1.

21. False. The eccentricity is determined by the ellipse's shape, not its size.

22. True. For a parabola $e = 1$, so equation (3) reduces to $r = \frac{d}{1 + \cos \theta}$.

$$23. (a) T = a^{3/2} = 39.5^{1.5} \approx 248 \text{ yr.}$$

$$(b) r_0 = a(1 - e) = 39.5(1 - 0.249) = 29.6645 \text{ AU} \approx 4,449,675,000 \text{ km}, r_1 = a(1 + e) = 39.5(1 + 0.249) = 49.3355 \text{ AU} \approx 7,400,325,000 \text{ km.}$$

$$(c) r = \frac{a(1 - e^2)}{1 + e \cos \theta} \approx \frac{39.5(1 - (0.249)^2)}{1 + 0.249 \cos \theta} \approx \frac{37.05}{1 + 0.249 \cos \theta} \text{ AU.}$$

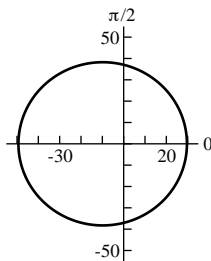

(d)

$$24. (a) \text{ In yr and AU, } T = a^{3/2}; \text{ in days and km, } \frac{T}{365} = \left(\frac{a}{150 \times 10^6} \right)^{3/2}, \text{ so } T = 365 \times 10^{-9} \left(\frac{a}{150} \right)^{3/2} \text{ days.}$$

$$(b) T = 365 \times 10^{-9} \left(\frac{57.95 \times 10^6}{150} \right)^{3/2} \approx 87.6 \text{ days.}$$

(c) From (17) the polar equation of the orbit has the form $r = \frac{a(1 - e^2)}{1 + e \cos \theta} = \frac{55490833.8}{1 + 0.206 \cos \theta}$ km, or $r = \frac{0.3699}{1 + 0.206 \cos \theta}$ AU.

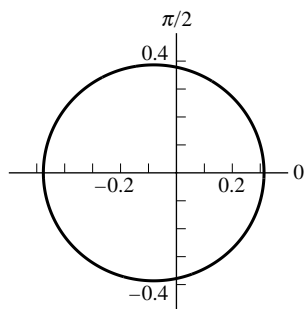

(d)

25. (a) $a = T^{2/3} = 2380^{2/3} \approx 178.26$ AU.

(b) $r_0 = a(1 - e) \approx 0.8735$ AU, $r_1 = a(1 + e) \approx 355.64$ AU.

(c) $r = \frac{a(1 - e^2)}{1 + e \cos \theta} \approx \frac{1.74}{1 + 0.9951 \cos \theta}$ AU.

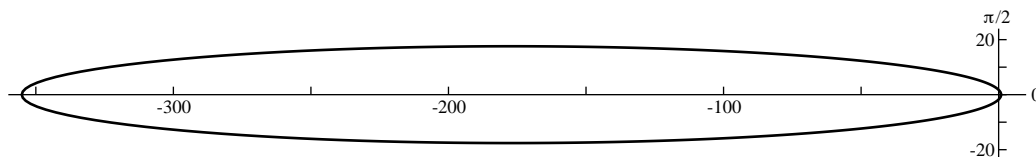

(d)

26. (a) By Exercise 15(a), $e = \frac{r_1 - r_0}{r_1 + r_0} \approx 0.092635$.

(b) $a = \frac{1}{2}(r_0 + r_1) = 225,400,000$ km ≈ 1.503 AU, so $T = a^{3/2} \approx 1.84$ yr.

(c) $r = \frac{a(1 - e^2)}{1 + e \cos \theta} \approx \frac{223465774.6}{1 + 0.092635 \cos \theta}$ km, or $\approx \frac{1.48977}{1 + 0.092635 \cos \theta}$ AU.

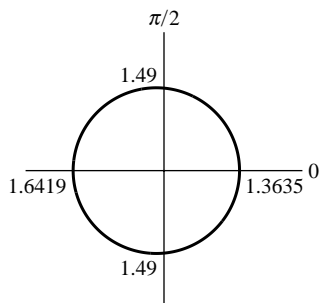

(d)

27. $r_0 = a(1 - e) \approx 7003$ km, $h_{\min} \approx 7003 - 6440 = 563$ km, $r_1 = a(1 + e) \approx 10,726$ km, $h_{\max} \approx 10,726 - 6440 = 4286$ km.

28. $r_0 = a(1 - e) \approx 651,736$ km, $h_{\min} \approx 581,736$ km; $r_1 = a(1 + e) \approx 6,378,102$ km, $h_{\max} \approx 6,308,102$ km.

29. Position the hyperbola so that its foci are on a horizontal line. As $e \rightarrow 1^+$, the hyperbola becomes 'pointier', squeezed between almost horizontal asymptotes. As $e \rightarrow +\infty$, it becomes more like a pair of parallel lines, with almost vertical asymptotes.

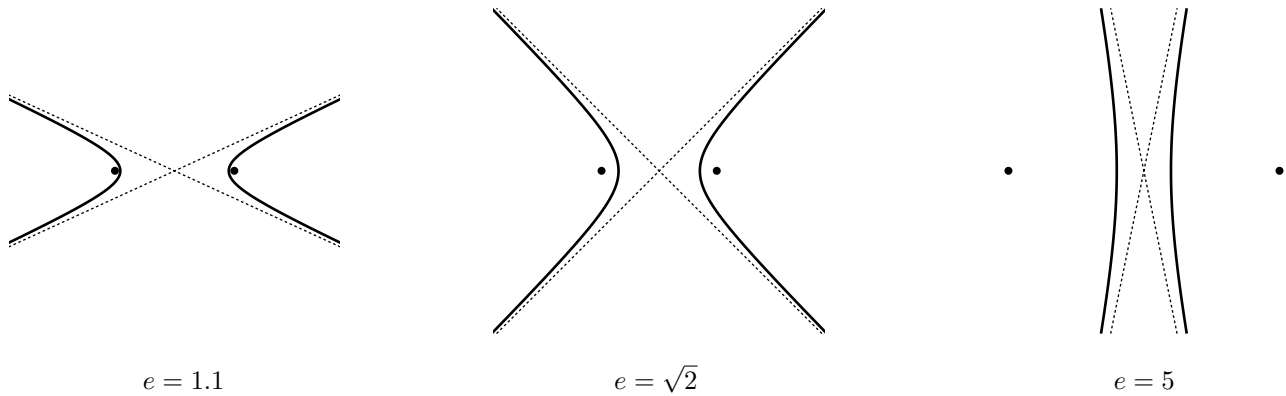

30. Let x be the distance between the foci and z the distance between the center and the directrix. From Figure 10.6.11, $x = 2ae$ and $z = \frac{a}{e}$, so $z = \frac{x}{2e^2}$. If x is fixed, then $z \rightarrow +\infty$ as $e \rightarrow 0^+$.

Chapter 10 Review Exercises

- $x(t) = \sqrt{2} \cos t$, $y(t) = -\sqrt{2} \sin t$, $0 \leq t \leq 3\pi/2$.
- (a) $x = f(1-t)$, $y = g(1-t)$.
- (a) $dy/dx = \frac{1/2}{2t} = 1/(4t)$; $dy/dx|_{t=-1} = -1/4$; $dy/dx|_{t=1} = 1/4$.
(b) $x = (2y)^2 + 1$, $dx/dy = 8y$, $dy/dx|_{y=\pm(1/2)} = \pm 1/4$.
- $\frac{dy}{dx} = \frac{t^2}{t} = t$, $\frac{d^2y}{dx^2} = \frac{d}{dt} \left(\frac{dy}{dx} \right) / \frac{dx}{dt} = \frac{1}{t}$, $\frac{dy}{dx}|_{t=2} = 2$, $\frac{d^2y}{dx^2}|_{t=2} = \frac{1}{2}$.
- $dy/dx = \frac{4 \cos t}{-2 \sin t} = -2 \cot t$.
(a) $dy/dx = 0$ if $\cot t = 0$, $t = \pi/2 + n\pi$ for $n = 0, \pm 1, \dots$
(b) $dx/dy = -\frac{1}{2} \tan t = 0$ if $\tan t = 0$, $t = n\pi$ for $n = 0, \pm 1, \dots$
- We have $dx/dt = -20t^3$ and $dy/dt = 20t^4$, so, by Formula (9) of Section 10.1, $L = \int_0^1 \sqrt{(-20t^3)^2 + (20t^4)^2} dt = 20 \int_0^1 t^3 \sqrt{1+t^2} dt$. Let $u = 1+t^2$, $du = 2t dt$. Then $L = 20 \int_1^2 (u-1) \sqrt{u} \frac{1}{2} du = 10 \int_1^2 (u^{3/2} - u^{1/2}) du = 10 \left[\frac{2}{5} u^{5/2} - \frac{2}{3} u^{3/2} \right]_1^2 = \frac{8}{3}(\sqrt{2}+1)$.
- (a) $(-4\sqrt{2}, -4\sqrt{2})$ (b) $(7/\sqrt{2}, -7/\sqrt{2})$ (c) $(4\sqrt{2}, 4\sqrt{2})$ (d) $(5, 0)$ (e) $(0, -2)$ (f) $(0, 0)$
- (a) $(\sqrt{2}, 3\pi/4)$ (b) $(-\sqrt{2}, 7\pi/4)$ (c) $(\sqrt{2}, 3\pi/4)$ (d) $(-\sqrt{2}, -\pi/4)$
- (a) $(5, 0.6435)$ (b) $(\sqrt{29}, 5.0929)$ (c) $(1.2716, 0.6658)$

10. (a) circle (b) rose (c) line (d) limaçon (e) limaçon (f) none (g) none (h) spiral

11. (a) $r = 2a/(1 + \cos \theta)$, $r + x = 2a$, $x^2 + y^2 = (2a - x)^2$, $y^2 = -4ax + 4a^2$, parabola.

(b) $r^2(\cos^2 \theta - \sin^2 \theta) = x^2 - y^2 = a^2$, hyperbola.

(c) $r \sin(\theta - \pi/4) = (\sqrt{2}/2)r(\sin \theta - \cos \theta) = 4$, $y - x = 4\sqrt{2}$, line.

(d) $r^2 = 4r \cos \theta + 8r \sin \theta$, $x^2 + y^2 = 4x + 8y$, $(x - 2)^2 + (y - 4)^2 = 20$, circle.

12. (a) $r \cos \theta = 7$.

(b) $r = 3$.

(c) $r^2 - 6r \sin \theta = 0$, $r = 6 \sin \theta$.

(d) $4(r \cos \theta)(r \sin \theta) = 9$, $4r^2 \sin \theta \cos \theta = 9$, $r^2 \sin 2\theta = 9/2$.

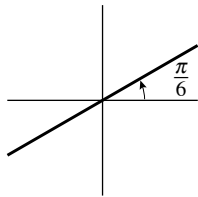

13. Line

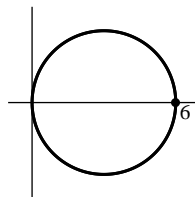

14. Circle

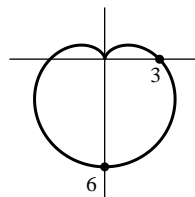

15. Cardioid

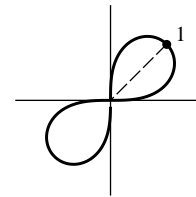

16. Lemniscate

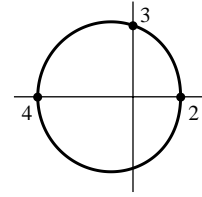

17. Limaçon

18. (a) $y = r \sin \theta = (\sin \theta)/\sqrt{\theta}$, $dy/d\theta = \frac{2\theta \cos \theta - \sin \theta}{2\theta^{3/2}} = 0$ if $2\theta \cos \theta = \sin \theta$, $\tan \theta = 2\theta$ which only happens once on $(0, \pi]$. Since $\lim_{\theta \rightarrow 0^+} y = 0$ and $y = 0$ at $\theta = \pi$, y has a maximum when $\tan \theta = 2\theta$.

(b) $\theta \approx 1.16556$.

(c) $y_{\max} = (\sin \theta)/\sqrt{\theta} \approx 0.85124$.

19. (a) $x = r \cos \theta = \cos \theta - \cos^2 \theta$, $dx/d\theta = -\sin \theta + 2 \sin \theta \cos \theta = \sin \theta(2 \cos \theta - 1) = 0$ if $\sin \theta = 0$ or $\cos \theta = 1/2$, so $\theta = 0, \pi, \pi/3, 5\pi/3$; maximum $x = 1/4$ at $\theta = \pi/3, 5\pi/3$, minimum $x = -2$ at $\theta = \pi$.

(b) $y = r \sin \theta = \sin \theta - \sin \theta \cos \theta$, $dy/d\theta = \cos \theta + 1 - 2 \cos^2 \theta = 0$ at $\cos \theta = 1, -1/2$, so $\theta = 0, 2\pi/3, 4\pi/3$; maximum $y = 3\sqrt{3}/4$ at $\theta = 2\pi/3$, minimum $y = -3\sqrt{3}/4$ at $\theta = 4\pi/3$.

20. Use equation (2) of Section 10.3: $\frac{dy}{dx} = \frac{dy/d\theta}{dx/d\theta} = \frac{r \cos \theta + \sin \theta \frac{dr}{d\theta}}{-r \sin \theta + \cos \theta \frac{dr}{d\theta}}$, then set $\theta = \pi/4$, $dr/d\theta = \sqrt{2}/2$, $r = 1 + \sqrt{2}/2$, $m = -1 - \sqrt{2}$.

21. (a) As t runs from 0 to π , the upper portion of the curve is traced out from right to left; as t runs from π to 2π the bottom portion is traced out from right to left, except for the bottom part of the loop. The loop is traced out counterclockwise for $\pi + \sin^{-1} \frac{1}{4} < t < 2\pi - \sin^{-1} \frac{1}{4}$.

(b) $\lim_{t \rightarrow 0^+} x = +\infty$, $\lim_{t \rightarrow 0^+} y = 1$; $\lim_{t \rightarrow \pi^-} x = -\infty$, $\lim_{t \rightarrow \pi^-} y = 1$; $\lim_{t \rightarrow \pi^+} x = +\infty$, $\lim_{t \rightarrow \pi^+} y = 1$; $\lim_{t \rightarrow \pi^+} x = -\infty$, $\lim_{t \rightarrow 2\pi^-} y = 1$; the horizontal asymptote is $y = 1$.

(c) Horizontal tangent line when $dy/dx = 0$, or $dy/dt = 0$, so $\cos t = 0$, $t = \pi/2, 3\pi/2$; vertical tangent line when $dx/dt = 0$, so $-\csc^2 t - 4 \sin t = 0$, $t = \pi + \sin^{-1} \frac{1}{\sqrt[3]{4}}$, $2\pi - \sin^{-1} \frac{1}{\sqrt[3]{4}}$, $t \approx 3.823, 5.602$.

(d) Since $\tan \theta = \frac{y}{x} = \tan t$, we may take $\theta = t$. $r^2 = x^2 + y^2 = x^2(1 + \tan^2 t) = x^2 \sec^2 t = (4 + \csc t)^2 = (4 + \csc \theta)^2$, so $r = 4 + \csc \theta$. $r = 0$ when $\csc \theta = -4$, $\sin \theta = -\frac{1}{4}$. The tangent lines at the pole are $\theta = \pi + \sin^{-1} \frac{1}{4}$ and $\theta = 2\pi - \sin^{-1} \frac{1}{4}$.

22. (a) $r = 1/\theta$, $dr/d\theta = -1/\theta^2$, $r^2 + (dr/d\theta)^2 = 1/\theta^2 + 1/\theta^4$, $L = \int_{\pi/4}^{\pi/2} \frac{1}{\theta^2} \sqrt{1 + \theta^2} d\theta =$
 $= \left[-\frac{\sqrt{1 + \theta^2}}{\theta} + \ln(\theta + \sqrt{1 + \theta^2}) \right]_{\pi/4}^{\pi/2} \approx 0.9457$ by Endpaper Integral Table Formula 93.

(b) The integral $\int_1^{+\infty} \frac{1}{\theta^2} \sqrt{1 + \theta^2} d\theta$ diverges by the comparison test (with $1/\theta$), and thus the arc length is infinite.

23. $A = 2 \int_0^{\pi} \frac{1}{2} (2 + 2 \cos \theta)^2 d\theta = 6\pi$.

24. $A = \int_0^{\pi/2} \frac{1}{2} (1 + \sin \theta)^2 d\theta = \frac{3\pi}{8} + 1$.

25. $A = \int_0^{\pi/6} \frac{1}{2} (2 \sin \theta)^2 d\theta + \int_{\pi/6}^{\pi/3} \frac{1}{2} \cdot 1^2 d\theta + \int_{\pi/3}^{\pi/2} \frac{1}{2} (2 \cos \theta)^2 d\theta$. The first and third integrals are equal, by symmetry, so $A = \int_0^{\pi/6} 4 \sin^2 \theta d\theta + \frac{1}{2} \left(\frac{\pi}{3} - \frac{\pi}{6} \right) = \int_0^{\pi/6} 2(1 - \cos 2\theta) d\theta + \frac{\pi}{12} = (2\theta - \sin 2\theta) \Big|_0^{\pi/6} + \frac{\pi}{12} = \frac{\pi}{3} - \frac{\sqrt{3}}{2} + \frac{\pi}{12} = \frac{5\pi}{12} - \frac{\sqrt{3}}{2}$.

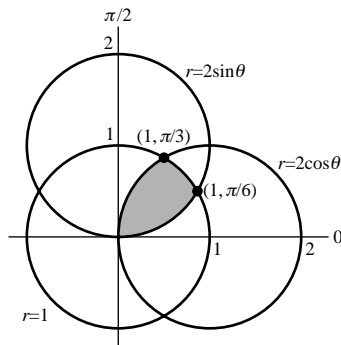

26. The circle has radius $a/2$ and lies entirely inside the cardioid, so $A = \int_0^{2\pi} \frac{1}{2} a^2 (1 + \sin \theta)^2 d\theta - \pi a^2 / 4 = \frac{3a^2}{2} \pi - \frac{a^2}{4} \pi = \frac{5a^2}{4} \pi$.

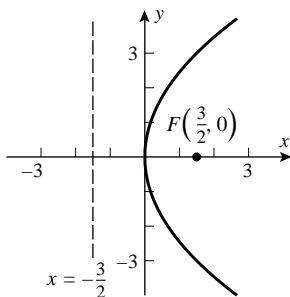

27.

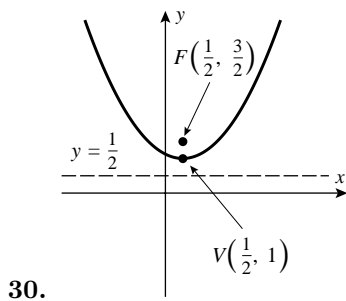
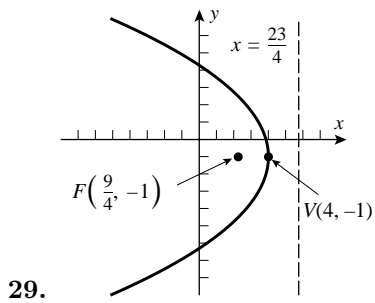
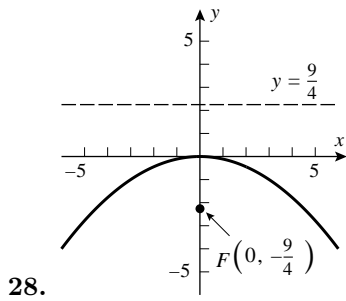

31. $c^2 = 25 - 4 = 21, c = \sqrt{21}.$

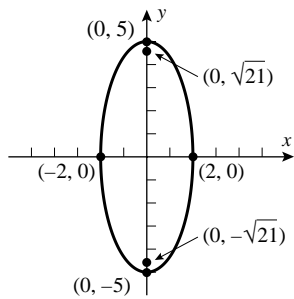

32. $\frac{x^2}{9} + \frac{y^2}{4} = 1, c^2 = 9 - 4 = 5, c = \sqrt{5}.$

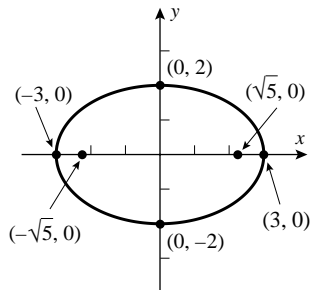

33. $\frac{(x-1)^2}{16} + \frac{(y-3)^2}{9} = 1, c^2 = 16 - 9 = 7, c = \sqrt{7}.$

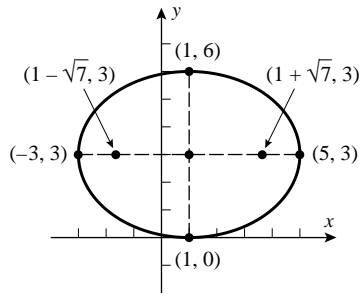

34. $\frac{(x+2)^2}{4} + \frac{(y+1)^2}{3} = 1$, $c^2 = 4 - 3 = 1$, $c = 1$.

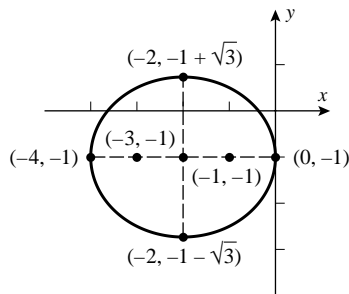

35. $c^2 = a^2 + b^2 = 16 + 4 = 20$, $c = 2\sqrt{5}$.

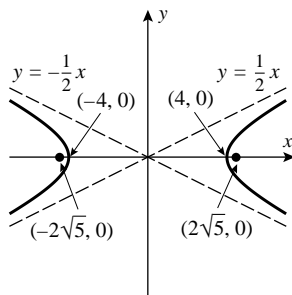

36. $y^2/4 - x^2/9 = 1$, $c^2 = 4 + 9 = 13$, $c = \sqrt{13}$.

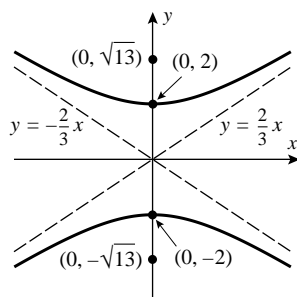

37. $c^2 = 9 + 4 = 13$, $c = \sqrt{13}$.

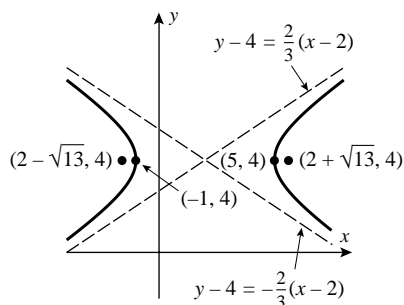

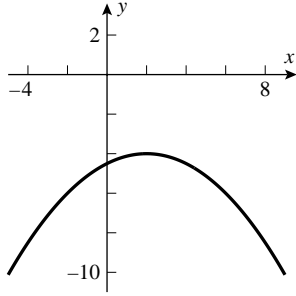

38. (a)

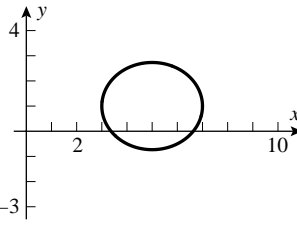

(b)

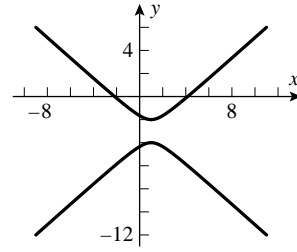

(c)

39. $x^2 = -4py$, $p = 4$, $x^2 = -16y$.

40. $x^2 + y^2/5 = 1$.

41. $a = 3$, $a/b = 1$, $b = 3$; $y^2/9 - x^2/9 = 1$.

42. (a) The equation of the parabola is $y = ax^2$ and it passes through $(2100, 470)$, thus $a = \frac{470}{2100^2}$, $y = \frac{470}{2100^2}x^2$.

$$(b) L = 2 \int_0^{2100} \sqrt{1 + \left(2 \frac{470}{2100^2} x\right)^2} dx = \frac{x}{220500} \sqrt{48620250000 + 2209x^2} + \frac{220500}{47} \sinh^{-1} \left(\frac{47}{220500} x \right) \approx 4336.3 \text{ ft.}$$

43. (a) $y = y_0 + (v_0 \sin \alpha) \frac{x}{v_0 \cos \alpha} - \frac{g}{2} \left(\frac{x}{v_0 \cos \alpha} \right)^2 = y_0 + x \tan \alpha - \frac{g}{2v_0^2 \cos^2 \alpha} x^2$.

$$(b) \frac{dy}{dx} = \tan \alpha - \frac{g}{v_0^2 \cos^2 \alpha} x, \frac{dy}{dx} = 0 \text{ at } x = \frac{v_0^2}{g} \sin \alpha \cos \alpha, y = y_0 + \frac{v_0^2}{g} \sin^2 \alpha - \frac{g}{2v_0^2 \cos^2 \alpha} \left(\frac{v_0^2 \sin \alpha \cos \alpha}{g} \right)^2 = y_0 + \frac{v_0^2}{2g} \sin^2 \alpha.$$

44. $\alpha = \pi/4$, $y_0 = 3$, $x = v_0 t/\sqrt{2}$, $y = 3 + v_0 t/\sqrt{2} - 16t^2$.

$$(a) \text{ Assume the ball passes through } x = 391, y = 50, \text{ then } 391 = v_0 t/\sqrt{2}, 50 = 3 + 391 - 16t^2, 16t^2 = 344, t = \sqrt{21.5}, v_0 = \sqrt{2}x/t \approx 119.2538820 \text{ ft/s.}$$

$$(b) \frac{dy}{dt} = \frac{v_0}{\sqrt{2}} - 32t = 0 \text{ at } t = \frac{v_0}{32\sqrt{2}}, y_{\max} = 3 + \frac{v_0}{\sqrt{2}} \frac{v_0}{32\sqrt{2}} - 16 \frac{v_0^2}{2^{11}} = 3 + \frac{v_0^2}{128} \approx 114.1053779 \text{ ft.}$$

$$(c) y = 0 \text{ when } t = \frac{-v_0/\sqrt{2} \pm \sqrt{v_0^2/2 + 192}}{-32}, t \approx -0.035339577 \text{ (discard) and } 5.305666365, \text{ dist} = 447.4015292 \text{ ft.}$$

45. $\cot 2\theta = \frac{A-C}{B} = 0$, $2\theta = \pi/2$, $\theta = \pi/4$, $\cos \theta = \sin \theta = \sqrt{2}/2$, so $x = (\sqrt{2}/2)(x' - y')$, $y = (\sqrt{2}/2)(x' + y')$, $5(y')^2 - (x')^2 = 6$, hyperbola.

46. $\cot 2\theta = (7-5)/(2\sqrt{3}) = 1/\sqrt{3}$, $2\theta = \pi/3$, $\theta = \pi/6$ then the transformed equation is $8(x')^2 + 4(y')^2 - 4 = 0$, $2(x')^2 + (y')^2 = 1$, ellipse.

47. $\cot 2\theta = (4\sqrt{5} - \sqrt{5})/(4\sqrt{5}) = 3/4$, so $\cos 2\theta = 3/5$ and thus $\cos \theta = \sqrt{(1 + \cos 2\theta)/2} = 2/\sqrt{5}$ and $\sin \theta = \sqrt{(1 - \cos 2\theta)/2} = 1/\sqrt{5}$. Hence the transformed equation is $5\sqrt{5}(x')^2 - 5\sqrt{5}y' = 0$, $y' = (x')^2$, parabola.

48. $\cot 2\theta = (17-108)/(-312) = 7/24$. Use the methods of Example 4 of Section 10.5 to obtain $\cos \theta = 4/5$, $\sin \theta = 3/5$, and the new equation is $-100(x')^2 + 225(y')^2 - 1800y' + 4500 = 0$, which, upon completing the square, becomes

$-\frac{4}{9}(x')^2 + (y' - 4)^2 + 4 = 0$, or $\frac{1}{9}(x')^2 - \frac{1}{4}(y' - 4)^2 = 1$. Thus center at $(0, 4)$, $c^2 = 9 + 4 = 13$, $c = \sqrt{13}$, so vertices at $(-3, 4)$ and $(3, 4)$; foci at $(\pm\sqrt{13}, 4)$ and asymptotes $y' - 4 = \frac{2}{3}x'$.

49. (a) $r = \frac{1/3}{1 + \frac{1}{3}\cos\theta}$, ellipse, right of pole, distance = 1.

(b) Hyperbola, left of pole, distance = $1/3$.

(c) $r = \frac{1/3}{1 + \sin\theta}$, parabola, above pole, distance = $1/3$.

(d) Parabola, below pole, distance = 3.

50. (a) $\frac{c}{a} = e = \frac{2}{7}$ and $2b = 6$, $b = 3$, $a^2 = b^2 + c^2 = 9 + \frac{4}{49}a^2$, $\frac{45}{49}a^2 = 9$, $a = \frac{7}{\sqrt{5}}$, $\frac{5}{49}x^2 + \frac{1}{9}y^2 = 1$.

(b) $x^2 = -4py$, directrix $y = 4$, focus $(-4, 0)$, $2p = 8$, $x^2 = -16y$.

(c) For the ellipse, $a = 4$, $b = \sqrt{3}$, $c^2 = a^2 - b^2 = 16 - 3 = 13$, foci $(\pm\sqrt{13}, 0)$; for the hyperbola, $c = \sqrt{13}$, $b/a = 2/3$, $b = 2a/3$, $13 = c^2 = a^2 + b^2 = a^2 + \frac{4}{9}a^2 = \frac{13}{9}a^2$, $a = 3$, $b = 2$, $\frac{x^2}{9} - \frac{y^2}{4} = 1$.

51. (a) $e = 4/5 = c/a$, $c = 4a/5$, but $a = 5$ so $c = 4$, $b = 3$, $\frac{(x+3)^2}{25} + \frac{(y-2)^2}{9} = 1$.

(b) Directrix $y = 2$, $p = 2$, $(x+2)^2 = -8y$.

(c) Center $(-1, 5)$, vertices $(-1, 7)$ and $(-1, 3)$, $a = 2$, $a/b = 8$, $b = 1/4$, $\frac{(y-5)^2}{4} - 16(x+1)^2 = 1$.

52. $C = 4 \int_0^{\pi/2} \left[\left(\frac{dx}{dt} \right)^2 + \left(\frac{dy}{dt} \right)^2 \right]^{1/2} dt = 4 \int_0^{\pi/2} (a^2 \sin^2 t + b^2 \cos^2 t)^{1/2} dt = 4 \int_0^{\pi/2} (a^2 \sin^2 t + (a^2 - c^2) \cos^2 t)^{1/2} dt = 4a \int_0^{\pi/2} (1 - e^2 \cos^2 t)^{1/2} dt$. Set $u = \frac{\pi}{2} - t$, $C = 4a \int_0^{\pi/2} (1 - e^2 \sin^2 t)^{1/2} dt$.

53. $a = 3$, $b = 2$, $c = \sqrt{5}$, $C = 4(3) \int_0^{\pi/2} \sqrt{1 - (5/9) \cos^2 u} du \approx 15.86543959$.

54. (a) $\frac{r_0}{r_1} = \frac{59}{61} = \frac{1-e}{1+e}$, $e = \frac{1}{60}$.

(b) $a = 93 \times 10^6$, $r_0 = a(1-e) = \frac{59}{60} (93 \times 10^6) = 91,450,000$ mi.

(c) $C = 4 \times 93 \times 10^6 \int_0^{\pi/2} \left[1 - \left(\frac{\cos\theta}{60} \right)^2 \right]^{1/2} d\theta \approx 584,295,652.5$ mi.

Chapter 10 Making Connections

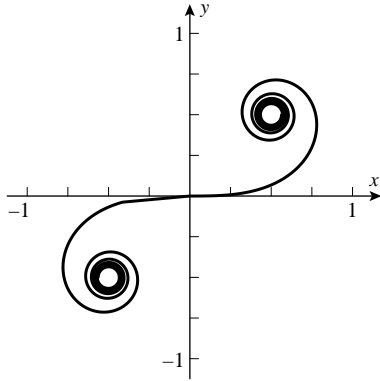

1. (a)

(b) As $t \rightarrow +\infty$, the curve spirals in toward a point P in the first quadrant. As $t \rightarrow -\infty$, it spirals in toward the reflection of P through the origin. (It can be shown that $P = (1/2, 1/2)$.)

$$(c) L = \int_{-1}^1 \sqrt{\cos^2\left(\frac{\pi t^2}{2}\right) + \sin^2\left(\frac{\pi t^2}{2}\right)} dt = 2.$$

2. (a) $P : (b \cos t, b \sin t)$; $Q : (a \cos t, a \sin t)$; $R : (a \cos t, b \sin t)$.

(b) For a circle, t measures the angle between the positive x -axis and the line segment joining the origin to the point. For an ellipse, t measures the angle between the x -axis and OPQ , not OR .

3. Let P denote the pencil tip, and let $R(x, 0)$ be the point below Q and P which lies on the line L . Then $QP + PF$ is the length of the string and $QR = QP + PR$ is the length of the side of the triangle. These two are equal, so $PF = PR$. But this is the definition of a parabola according to Definition 10.4.1.

4. Let P denote the pencil tip, and let k be the difference between the length of the ruler and that of the string. Then $QP + PF_2 + k = QF_1$, and hence $PF_2 + k = PF_1$, $PF_1 - PF_2 = k$. But this is the definition of a hyperbola according to Definition 10.4.3.

5. (a) Position the ellipse so its equation is $\frac{x^2}{a^2} + \frac{y^2}{b^2} = 1$. Then $y = \frac{b}{a}\sqrt{a^2 - x^2}$, so

$$\begin{aligned} V &= 2 \int_0^a \pi y^2 dx = 2 \int_0^a \pi \frac{b^2}{a^2} (a^2 - x^2) dx = \frac{4}{3} \pi ab^2. \text{ Also, } \frac{dy}{dx} = -\frac{bx}{a\sqrt{a^2 - x^2}} \text{ so } 1 + \left(\frac{dy}{dx}\right)^2 = \frac{a^4 - (a^2 - b^2)x^2}{a^2(a^2 - x^2)} = \\ &= \frac{a^4 - c^2x^2}{a^2(a^2 - x^2)}, \text{ where } c = \sqrt{a^2 - b^2}. \text{ Then } S = 2 \int_0^a 2\pi y \sqrt{1 + (dy/dx)^2} dx = \frac{4\pi b}{a} \int_0^a \sqrt{a^2 - x^2} \sqrt{\frac{a^4 - c^2x^2}{a^2(a^2 - x^2)}} dx \\ &= \frac{4\pi bc}{a^2} \int_0^a \sqrt{\frac{a^4}{c^2} - x^2} dx = \frac{4\pi bc}{a^2} \left[\frac{x}{2} \sqrt{\frac{a^4}{c^2} - x^2} + \frac{a^4}{2c^2} \sin^{-1} \frac{cx}{a^2} \right]_0^a = 2\pi ab \left(\frac{b}{a} + \frac{a}{c} \sin^{-1} \frac{c}{a} \right), \text{ by Endpaper Integral} \\ &\text{Table Formula 74.} \end{aligned}$$

(b) Position the ellipse so its equation is $\frac{x^2}{a^2} + \frac{y^2}{b^2} = 1$. Then $x = \frac{a}{b}\sqrt{b^2 - y^2}$, so

$$\begin{aligned} V &= 2 \int_0^b \pi x^2 dy = 2 \int_0^b \pi \frac{a^2}{b^2} (b^2 - y^2) dy = \frac{4}{3} \pi a^2 b. \text{ Also, } \frac{dx}{dy} = -\frac{ay}{b\sqrt{b^2 - y^2}} \text{ so } 1 + \left(\frac{dx}{dy}\right)^2 = \frac{b^4 + (a^2 - b^2)y^2}{b^2(b^2 - y^2)} = \\ &= \frac{b^4 + c^2y^2}{b^2(b^2 - y^2)}, \text{ where } c = \sqrt{a^2 - b^2}. \text{ Then } S = 2 \int_0^b 2\pi x \sqrt{1 + (dx/dy)^2} dy = \frac{4\pi a}{b} \int_0^b \sqrt{b^2 - y^2} \sqrt{\frac{b^4 + c^2y^2}{b^2(b^2 - y^2)}} dy \\ &= \frac{4\pi ac}{b^2} \int_0^b \sqrt{\frac{b^4}{c^2} + y^2} dy = 2\pi ab \left(\frac{a}{b} + \frac{b}{c} \ln \frac{a+c}{b} \right). \end{aligned}$$

Three-Dimensional Space; Vectors

Exercise Set 11.1

- $(0, 0, 0), (3, 0, 0), (3, 5, 0), (0, 5, 0), (0, 0, 4), (3, 0, 4), (3, 5, 4), (0, 5, 4)$.
 - $(0, 1, 0), (4, 1, 0), (4, 6, 0), (0, 6, 0), (0, 1, -2), (4, 1, -2), (4, 6, -2), (0, 6, -2)$.
- Corners: $(2, 2, \pm 2), (2, -2, \pm 2), (-2, 2, \pm 2), (-2, -2, \pm 2)$.

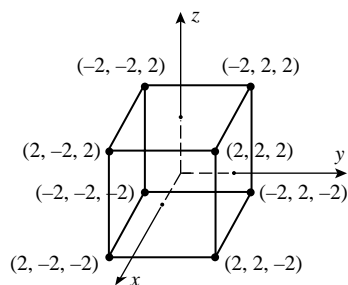

- Corners: $(4, 2, -2), (4, 2, 1), (4, 1, 1), (4, 1, -2), (-6, 1, 1), (-6, 2, 1), (-6, 2, -2), (-6, 1, -2)$.

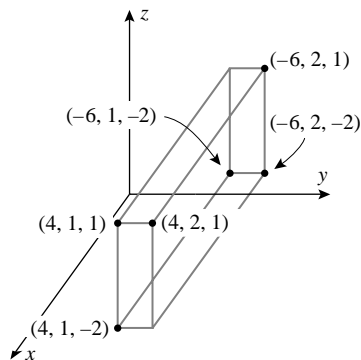

- $(x_2, y_1, z_1), (x_2, y_2, z_1), (x_1, y_2, z_1), (x_1, y_1, z_2), (x_2, y_1, z_2), (x_1, y_2, z_2)$.
 - The midpoint of the diagonal has coordinates which are the coordinates of the midpoints of the edges. The midpoint of the edge (x_1, y_1, z_1) and (x_2, y_1, z_1) is $\left(\frac{1}{2}(x_1 + x_2), y_1, z_1\right)$; the midpoint of the edge (x_2, y_1, z_1) and (x_2, y_2, z_1) is $\left(x_2, \frac{1}{2}(y_1 + y_2), z_1\right)$; the midpoint of the edge (x_2, y_2, z_1) and (x_2, y_2, z_2) is $\left(x_2, y_2, \frac{1}{2}(z_1 + z_2)\right)$. Thus the coordinates of the midpoint of the diagonal are $\left(\frac{1}{2}(x_1 + x_2), \frac{1}{2}(y_1 + y_2), \frac{1}{2}(z_1 + z_2)\right)$.
- A single point on that line.
 - A line in that plane.
 - A plane in 3-space.
- $R(1, 4, 0)$ and Q lie on the same vertical line, and so does the side of the triangle which connects them.

$R(1, 4, 0)$ and P lie in the plane $z = 0$. Clearly the two sides are perpendicular, and the sum of the squares of the two sides is $|RQ|^2 + |RP|^2 = 4^2 + (2^2 + 3^2) = 29$, so the distance from P to Q is $\sqrt{29}$.

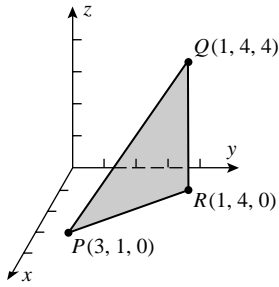

(b) Clearly, SP is parallel to the y -axis. $S(3, 4, 0)$ and Q lie in the plane $y = 4$, and so does SQ . Hence the two sides $|SP|$ and $|SQ|$ are perpendicular, and $|PQ| = \sqrt{|PS|^2 + |QS|^2} = \sqrt{3^2 + (2^2 + 4^2)} = \sqrt{29}$.

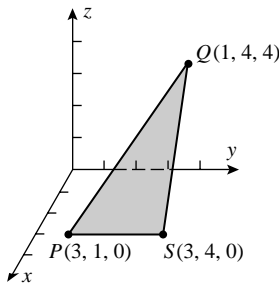

(c) $T(1, 1, 4)$ and Q lie on a line through $(1, 0, 4)$ and is thus parallel to the y -axis, and TQ lies on this line. T and P lie in the same plane $y = 1$ which is perpendicular to any line which is parallel to the y -axis, thus TP , which lies on such a line, is perpendicular to TQ . Thus $|PQ|^2 = |PT|^2 + |QT|^2 = (4 + 16) + 9 = 29$.

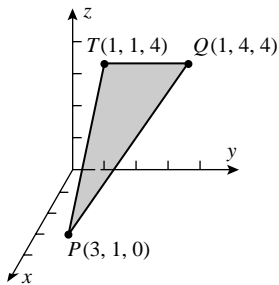

7. (a) Let the base of the box have sides a and b and diagonal d_1 . Then $a^2 + b^2 = d_1^2$, and d_1 is the base of a rectangular of height c and diagonal d , with $d^2 = d_1^2 + c^2 = a^2 + b^2 + c^2$.
- (b) Two unequal points (x_1, y_1, z_1) and (x_2, y_2, z_2) form diagonally opposite corners of a rectangular box with sides $x_1 - x_2, y_1 - y_2, z_1 - z_2$, and by Part (a) the diagonal has length $\sqrt{(x_1 - x_2)^2 + (y_1 - y_2)^2 + (z_1 - z_2)^2}$.
8. (a) The vertical plane that passes through $(\frac{1}{2}, 0, 0)$ and is perpendicular to the x -axis.
- (b) Equidistant: $(x - \frac{1}{2})^2 + y^2 + z^2 = x^2 + y^2 + z^2$, or $-2x + 1 = 0$ or $x = \frac{1}{2}$.
9. The diameter is $d = \sqrt{(1-3)^2 + (-2-4)^2 + (4+12)^2} = \sqrt{296}$, so the radius is $\sqrt{296}/2 = \sqrt{74}$. The midpoint $(2, 1, -4)$ of the endpoints of the diameter is the center of the sphere.
10. Each side has length $\sqrt{14}$ so the triangle is equilateral.
11. (a) The sides have lengths 7, 14, and $7\sqrt{5}$; it is a right triangle because the sides satisfy the Pythagorean theorem, $(7\sqrt{5})^2 = 7^2 + 14^2$.

(b) (2,1,6) is the vertex of the 90° angle because it is opposite the longest side (the hypotenuse).

(c) Area = $(1/2)(\text{altitude})(\text{base}) = (1/2)(7)(14) = 49$.

12. (a) 3 (b) 2 (c) 5 (d) $\sqrt{(2)^2 + (-3)^2} = \sqrt{13}$. (e) $\sqrt{(-5)^2 + (-3)^2} = \sqrt{34}$. (f) $\sqrt{(-5)^2 + (2)^2} = \sqrt{29}$.

13. (a) $(x - 7)^2 + (y - 1)^2 + (z - 1)^2 = 16$.

(b) $(x - 1)^2 + y^2 + (z + 1)^2 = 16$.

(c) $r = \sqrt{(-1 - 0)^2 + (3 - 0)^2 + (2 - 0)^2} = \sqrt{14}$, $(x + 1)^2 + (y - 3)^2 + (z - 2)^2 = 14$.

(d) $r = \frac{1}{2}\sqrt{(-1 - 0)^2 + (2 - 2)^2 + (1 - 3)^2} = \frac{1}{2}\sqrt{5}$, center $(-1/2, 2, 2)$, $(x + 1/2)^2 + (y - 2)^2 + (z - 2)^2 = 5/4$.

14. $r = |[\text{distance between } (0,0,0) \text{ and } (3, -2, 4)] \pm 1| = \sqrt{29} \pm 1$, $x^2 + y^2 + z^2 = r^2 = (\sqrt{29} \pm 1)^2 = 30 \pm 2\sqrt{29}$.

15. $(x - 2)^2 + (y + 1)^2 + (z + 3)^2 = r^2$, so

(a) $(x - 2)^2 + (y + 1)^2 + (z + 3)^2 = 9$. (b) $(x - 2)^2 + (y + 1)^2 + (z + 3)^2 = 1$. (c) $(x - 2)^2 + (y + 1)^2 + (z + 3)^2 = 4$.

16. (a) The sides have length 1, so the radius is $\frac{1}{2}$; hence $(x + 2)^2 + (y - 1)^2 + (z - 3)^2 = \frac{1}{4}$.

(b) The diagonal has length $\sqrt{1 + 1 + 1} = \sqrt{3}$ and is a diameter, so $(x + 2)^2 + (y - 1)^2 + (z - 3)^2 = \frac{3}{4}$.

(c) Radius: $(6 - 2)/2 = 2$, center: $(\frac{6 + 2}{2}, \frac{5 + 9}{2}, \frac{4 + 0}{2})$, so $(x - 4)^2 + (y - 7)^2 + (z - 2)^2 = 4$.

(d) Center is the same, radius is half the diagonal, $r = 2\sqrt{3}$, so $(x - 4)^2 + (y - 7)^2 + (z - 2)^2 = 12$.

17. Let the center of the sphere be (a, b, c) . The height of the center over the x - y plane is measured along the radius that is perpendicular to the plane. But this is the radius itself, so height = radius, i.e. $c = r$. Similarly $a = r$ and $b = r$.

18. If r is the radius of the sphere, then the center of the sphere has coordinates (r, r, r) (see Exercise 17). Thus the distance from the origin to the center is $\sqrt{r^2 + r^2 + r^2} = \sqrt{3}r$, from which it follows that the distance from the origin to the sphere is $\sqrt{3}r - r$. Equate that with $3 - \sqrt{3}$: $\sqrt{3}r - r = 3 - \sqrt{3}$, $r = \sqrt{3}$. The sphere is given by the equation $(x - \sqrt{3})^2 + (y - \sqrt{3})^2 + (z - \sqrt{3})^2 = 3$.

19. False; need be neither right nor circular, see "extrusion".

20. False, it is a right circular cylinder.

21. True; $y = z = 0$.

22. False, the sphere satisfies the equality, not the inequality.

23. $(x + 5)^2 + (y + 2)^2 + (z + 1)^2 = 49$; sphere, $C(-5, -2, -1)$, $r = 7$.

24. $x^2 + (y - 1/2)^2 + z^2 = 1/4$; sphere, $C(0, 1/2, 0)$, $r = 1/2$.

25. $(x - 1/2)^2 + (y - 3/4)^2 + (z + 5/4)^2 = 54/16$; sphere, $C(1/2, 3/4, -5/4)$, $r = 3\sqrt{6}/4$.

26. $(x + 1)^2 + (y - 1)^2 + (z + 1)^2 = 0$; the point $(-1, 1, -1)$.

27. $(x - 3/2)^2 + (y + 2)^2 + (z - 4)^2 = -11/4$; no graph.

28. $(x - 1)^2 + (y - 3)^2 + (z - 4)^2 = 25$; sphere, $C(1, 3, 4)$, $r = 5$.

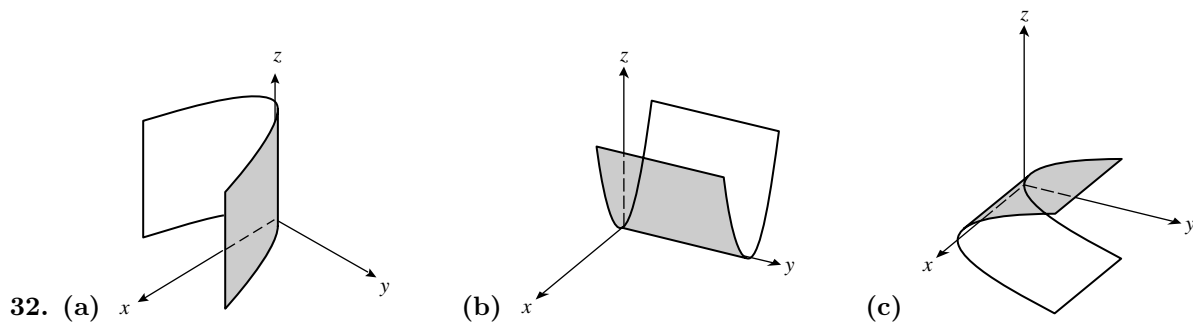
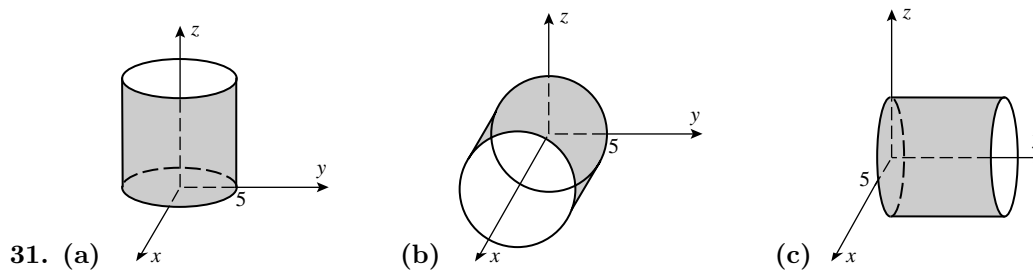
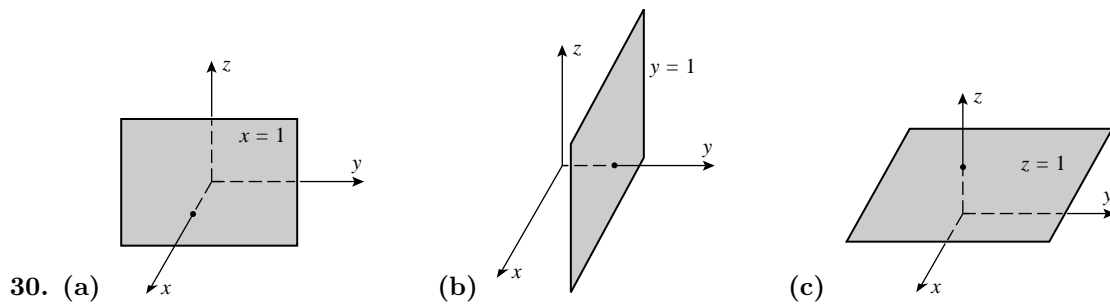
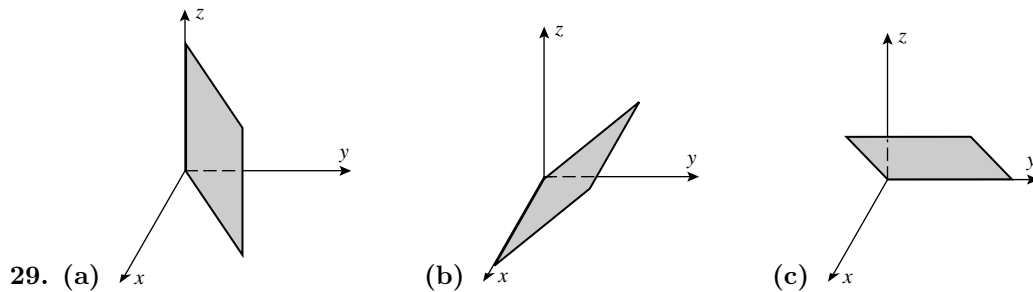

33. (a) $-2y + z = 0$. (b) $-2x + z = 0$. (c) $(x - 1)^2 + (y - 1)^2 = 1$. (d) $(x - 1)^2 + (z - 1)^2 = 1$.

34. (a) $(x - a)^2 + (z - a)^2 = a^2$. (b) $(x - a)^2 + (y - a)^2 = a^2$. (c) $(y - a)^2 + (z - a)^2 = a^2$.

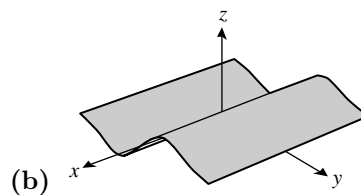
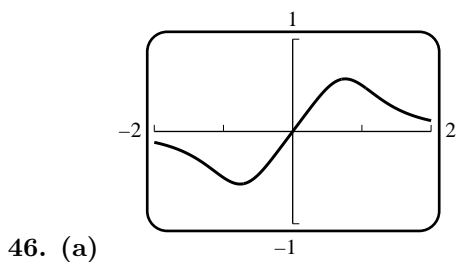
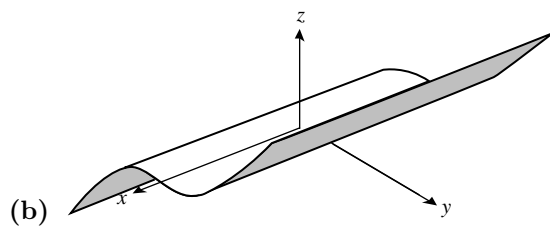
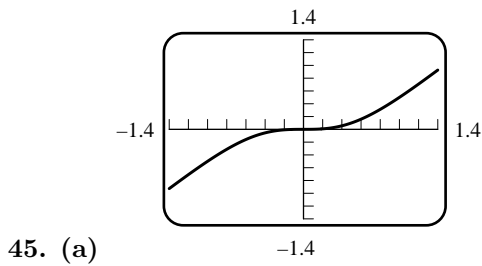
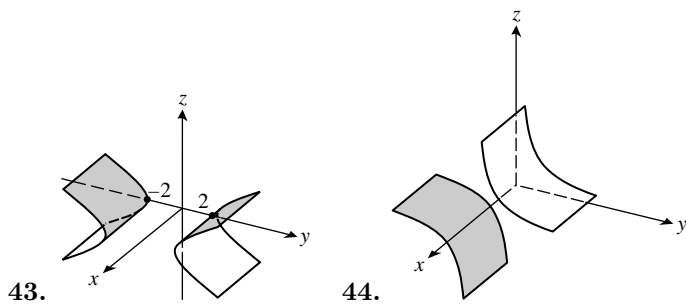
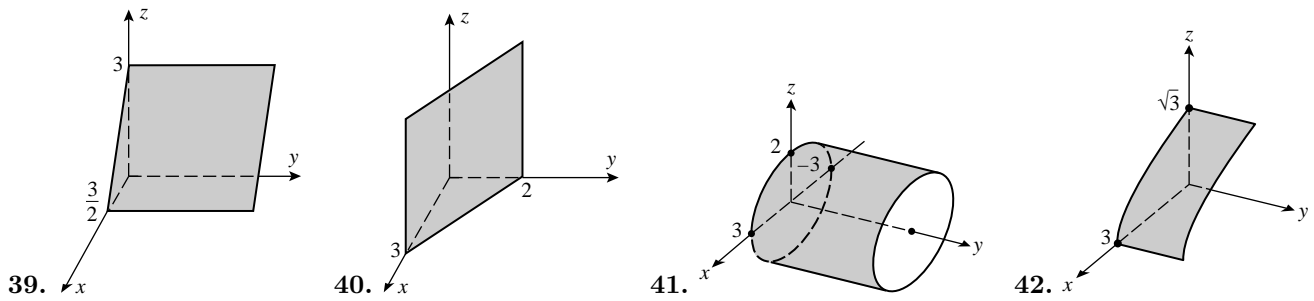
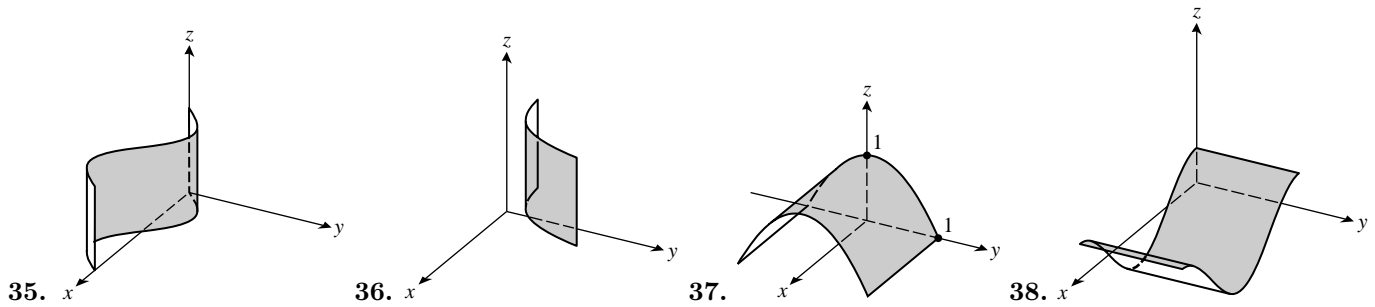

47. Complete the squares to get $(x + 1)^2 + (y - 1)^2 + (z - 2)^2 = 9$; center $(-1, 1, 2)$, radius 3. The distance between the origin and the center is $\sqrt{6} < 3$ so the origin is inside the sphere. The largest distance is $3 + \sqrt{6}$, the smallest is $3 - \sqrt{6}$.

48. $(x - 1)^2 + y^2 + (z + 4)^2 \leq 25$; all points on and inside the sphere of radius 5 with center at $(1, 0, -4)$.

49. $(y + 3)^2 + (z - 2)^2 > 16$; all points outside the circular cylinder $(y + 3)^2 + (z - 2)^2 = 16$.

50. $\sqrt{(x-1)^2 + (y+2)^2 + z^2} = 2\sqrt{x^2 + (y-1)^2 + (z-1)^2}$, square and simplify to get $3x^2 + 3y^2 + 3z^2 + 2x - 12y - 8z + 3 = 0$, then complete the squares to get $(x+1/3)^2 + (y-2)^2 + (z-4/3)^2 = 44/9$; center $(-1/3, 2, 4/3)$, radius $2\sqrt{11}/3$.
51. Let r be the radius of a styrofoam sphere. The distance from the origin to the center of the bowling ball is equal to the sum of the distance from the origin to the center of the styrofoam sphere nearest the origin and the distance between the center of this sphere and the center of the bowling ball so $\sqrt{3}R = \sqrt{3}r + r + R$, $(\sqrt{3}+1)r = (\sqrt{3}-1)R$,
 $r = \frac{\sqrt{3}-1}{\sqrt{3}+1}R = (2-\sqrt{3})R$.
52. (a) Complete the squares to get $(x+G/2)^2 + (y+H/2)^2 + (z+I/2)^2 = K/4$, so the equation represents a sphere when $K > 0$, a point when $K = 0$, and no graph when $K < 0$.
- (b) $C(-G/2, -H/2, -I/2)$, $r = \sqrt{K}/2$.
53. (a) At $x = c$ the trace of the surface is the circle $y^2 + z^2 = [f(c)]^2$, so the surface is given by $y^2 + z^2 = [f(x)]^2$.
- (b) $y^2 + z^2 = e^{2x}$.
- (c) $y^2 + z^2 = 4 - \frac{3}{4}x^2$, so let $f(x) = \sqrt{4 - \frac{3}{4}x^2}$.
54. (a) Permute x and y in Exercise 53a: $x^2 + z^2 = [f(y)]^2$.
- (b) Permute x and z in Exercise 53a: $x^2 + y^2 = [f(z)]^2$.
- (c) Permute y and z in Exercise 53a: $y^2 + z^2 = [f(x)]^2$.
55. $(a \sin \phi \cos \theta)^2 + (a \sin \phi \sin \theta)^2 + (a \cos \phi)^2 = a^2 \sin^2 \phi \cos^2 \theta + a^2 \sin^2 \phi \sin^2 \theta + a^2 \cos^2 \phi = a^2 \sin^2 \phi (\cos^2 \theta + \sin^2 \theta) + a^2 \cos^2 \phi = a^2 \sin^2 \phi + a^2 \cos^2 \phi = a^2 (\sin^2 \phi + \cos^2 \phi) = a^2$.

Exercise Set 11.2

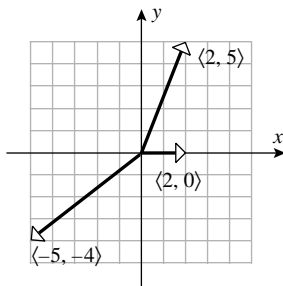

1. (a-c)

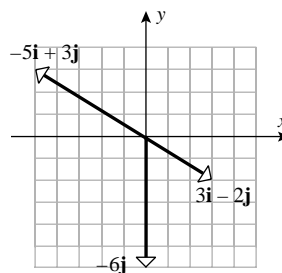

(d-f)

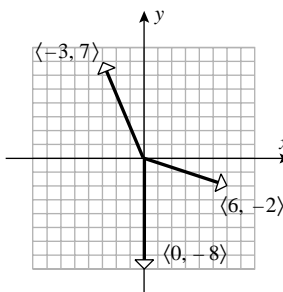

2. (a-c)

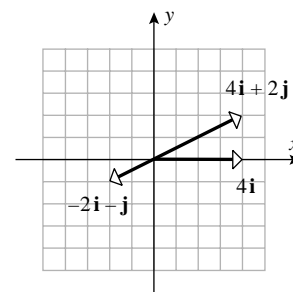

(d-f)

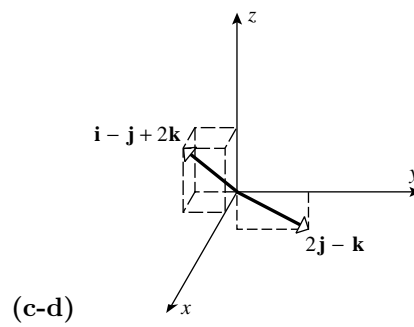
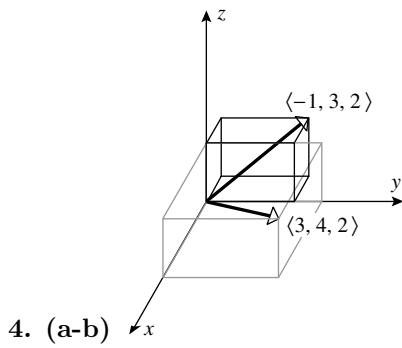
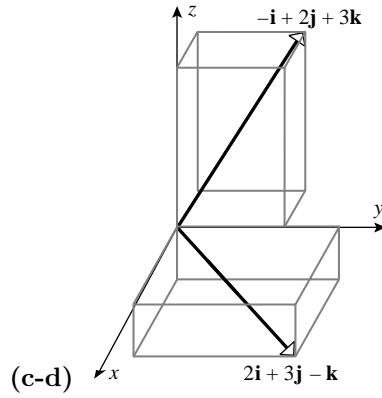
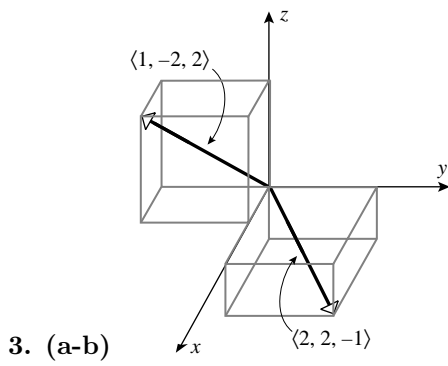

5. (a) $\langle 4 - 1, 1 - 5 \rangle = \langle 3, -4 \rangle$

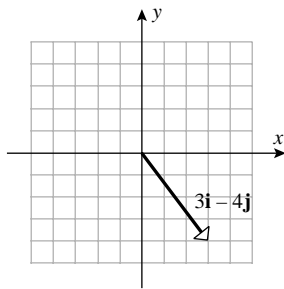

(b) $\langle 0 - 2, 0 - 3, 4 - 0 \rangle = \langle -2, -3, 4 \rangle$

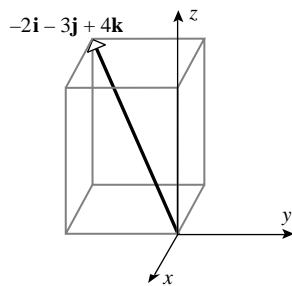

6. (a) $\langle -3 - 2, 3 - 3 \rangle = \langle -5, 0 \rangle$

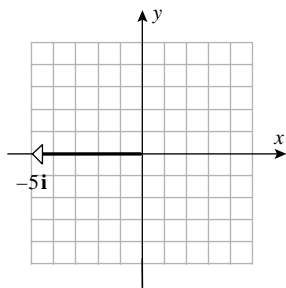

(b) $\langle 0 - 3, 4 - 0, 4 - 4 \rangle = \langle -3, 4, 0 \rangle$

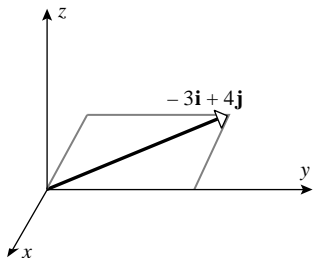

7. (a) $\langle 2 - 3, 8 - 5 \rangle = \langle -1, 3 \rangle$ (b) $\langle 0 - 7, 0 - (-2) \rangle = \langle -7, 2 \rangle$ (c) $\langle -3, 6, 1 \rangle$
8. (a) $\langle -4 - (-6), -1 - (-2) \rangle = \langle 2, 1 \rangle$ (b) $\langle -1, 6, 1 \rangle$ (c) $\langle 5, 0, 0 \rangle$
9. (a) Let (x, y) be the terminal point, then $x - 1 = 3$, $x = 4$ and $y - (-2) = -2$, $y = -4$. The terminal point is $(4, -4)$.
- (b) Let (x, y, z) be the initial point, then $5 - x = -3$, $-y = 1$, and $-1 - z = 2$ so $x = 8$, $y = -1$, and $z = -3$. The initial point is $(8, -1, -3)$.
10. (a) Let (x, y) be the terminal point, then $x - 2 = 7$, $x = 9$ and $y - (-1) = 6$, $y = 5$. The terminal point is $(9, 5)$.
- (b) Let (x, y, z) be the terminal point, then $x + 2 = 1$, $y - 1 = 2$, and $z - 4 = -3$ so $x = -1$, $y = 3$, and $z = 1$. The terminal point is $(-1, 3, 1)$.
11. (a) $-\mathbf{i} + 4\mathbf{j} - 2\mathbf{k}$ (b) $18\mathbf{i} + 12\mathbf{j} - 6\mathbf{k}$ (c) $-\mathbf{i} - 5\mathbf{j} - 2\mathbf{k}$ (d) $40\mathbf{i} - 4\mathbf{j} - 4\mathbf{k}$ (e) $-2\mathbf{i} - 16\mathbf{j} - 18\mathbf{k}$ (f) $-\mathbf{i} + 13\mathbf{j} - 2\mathbf{k}$
12. (a) $\langle 1, -2, 0 \rangle$ (b) $\langle 28, 0, -14 \rangle + \langle 3, 3, 9 \rangle = \langle 31, 3, -5 \rangle$ (c) $\langle 3, -1, -5 \rangle$
- (d) $3(\langle 2, -1, 3 \rangle - \langle 28, 0, -14 \rangle) = 3\langle -26, -1, 17 \rangle = \langle -78, -3, 51 \rangle$ (e) $\langle -12, 0, 6 \rangle - \langle 8, 8, 24 \rangle = \langle -20, -8, -18 \rangle$
- (f) $\langle 8, 0, -4 \rangle - \langle 3, 0, 6 \rangle = \langle 5, 0, -10 \rangle$
13. (a) $\|\mathbf{v}\| = \sqrt{1+1} = \sqrt{2}$ (b) $\|\mathbf{v}\| = \sqrt{1+49} = 5\sqrt{2}$ (c) $\|\mathbf{v}\| = \sqrt{21}$ (d) $\|\mathbf{v}\| = \sqrt{14}$
14. (a) $\|\mathbf{v}\| = \sqrt{9+16} = 5$ (b) $\|\mathbf{v}\| = \sqrt{2+7} = 3$ (c) $\|\mathbf{v}\| = 3$ (d) $\|\mathbf{v}\| = \sqrt{3}$
15. (a) $\|\mathbf{u} + \mathbf{v}\| = \|\mathbf{2i} - \mathbf{2j} + \mathbf{2k}\| = 2\sqrt{3}$ (b) $\|\mathbf{u}\| + \|\mathbf{v}\| = \sqrt{14} + \sqrt{2}$ (c) $\|-\mathbf{2u}\| + \|\mathbf{2v}\| = 2\sqrt{14} + 2\sqrt{2}$
- (d) $\|\mathbf{3u} - \mathbf{5v} + \mathbf{w}\| = \|\mathbf{-12j} + \mathbf{2k}\| = 2\sqrt{37}$ (e) $(1/\sqrt{6})\mathbf{i} + (1/\sqrt{6})\mathbf{j} - (2/\sqrt{6})\mathbf{k}$ (f) 1
16. Yes, it is possible. Consider $\mathbf{u} = \mathbf{i}$ and $\mathbf{v} = \mathbf{j}$.
17. False; only if one vector is a positive scalar multiple of the other. If one vector is a positive multiple of the other, say $\mathbf{u} = \alpha\mathbf{v}$ with $\alpha > 0$, then \mathbf{u}, \mathbf{v} and $\mathbf{u} + \mathbf{v}$ are parallel and $\|\mathbf{u} + \mathbf{v}\| = (1 + \alpha)\|\mathbf{v}\| = \|\mathbf{u}\| + \|\mathbf{v}\|$.

18. True.

19. True (assuming they have the same initial point), namely $\pm x/\|x\|$.

20. True, $\mathbf{a} = \frac{1}{c}(\mathbf{d} - \mathbf{b})$.

21. (a) $\|-\mathbf{i} + 4\mathbf{j}\| = \sqrt{17}$ so the required vector is $(-1/\sqrt{17})\mathbf{i} + (4/\sqrt{17})\mathbf{j}$.

(b) $\|6\mathbf{i} - 4\mathbf{j} + 2\mathbf{k}\| = 2\sqrt{14}$ so the required vector is $(-3\mathbf{i} + 2\mathbf{j} - \mathbf{k})/\sqrt{14}$.

(c) $\vec{AB} = 4\mathbf{i} + \mathbf{j} - \mathbf{k}$, $\|\vec{AB}\| = 3\sqrt{2}$ so the required vector is $(4\mathbf{i} + \mathbf{j} - \mathbf{k})/(3\sqrt{2})$.

22. (a) $\|3\mathbf{i} - 4\mathbf{j}\| = 5$ so the required vector is $-\frac{1}{5}(3\mathbf{i} - 4\mathbf{j}) = -\frac{3}{5}\mathbf{i} + \frac{4}{5}\mathbf{j}$.

(b) $\|2\mathbf{i} - \mathbf{j} - 2\mathbf{k}\| = 3$ so the required vector is $\frac{2}{3}\mathbf{i} - \frac{1}{3}\mathbf{j} - \frac{2}{3}\mathbf{k}$.

(c) $\vec{AB} = 4\mathbf{i} - 3\mathbf{j}$, $\|\vec{AB}\| = 5$ so the required vector is $\frac{4}{5}\mathbf{i} - \frac{3}{5}\mathbf{j}$.

23. (a) $-\frac{1}{2}\mathbf{v} = \langle -3/2, 2 \rangle$. (b) $\|\mathbf{v}\| = \sqrt{85}$, so $\frac{\sqrt{17}}{\sqrt{85}}\mathbf{v} = \frac{1}{\sqrt{5}}\langle 7, 0, -6 \rangle$ has length $\sqrt{17}$.

24. (a) $3\mathbf{v} = -6\mathbf{i} + 9\mathbf{j}$. (b) $-\frac{2}{\|\mathbf{v}\|}\mathbf{v} = \frac{6}{\sqrt{26}}\mathbf{i} - \frac{8}{\sqrt{26}}\mathbf{j} - \frac{2}{\sqrt{26}}\mathbf{k}$.

25. (a) $\mathbf{v} = \|\mathbf{v}\|\langle \cos(\pi/4), \sin(\pi/4) \rangle = \langle 3\sqrt{2}/2, 3\sqrt{2}/2 \rangle$. (b) $\mathbf{v} = \|\mathbf{v}\|\langle \cos 90^\circ, \sin 90^\circ \rangle = \langle 0, 2 \rangle$.

(c) $\mathbf{v} = \|\mathbf{v}\|\langle \cos 120^\circ, \sin 120^\circ \rangle = \langle -5/2, 5\sqrt{3}/2 \rangle$. (d) $\mathbf{v} = \|\mathbf{v}\|\langle \cos \pi, \sin \pi \rangle = \langle -1, 0 \rangle$.

26. From (12), $\mathbf{v} = \langle \cos(\pi/6), \sin(\pi/6) \rangle = \langle \sqrt{3}/2, 1/2 \rangle$ and $\mathbf{w} = \langle \cos(3\pi/4), \sin(3\pi/4) \rangle = \langle -\sqrt{2}/2, \sqrt{2}/2 \rangle$, so $\mathbf{v} + \mathbf{w} = ((\sqrt{3} - \sqrt{2})/2, (1 + \sqrt{2})/2)$, $\mathbf{v} - \mathbf{w} = ((\sqrt{3} + \sqrt{2})/2, (1 - \sqrt{2})/2)$.

27. From (12), $\mathbf{v} = \langle \cos 30^\circ, \sin 30^\circ \rangle = \langle \sqrt{3}/2, 1/2 \rangle$ and $\mathbf{w} = \langle \cos 135^\circ, \sin 135^\circ \rangle = \langle -\sqrt{2}/2, \sqrt{2}/2 \rangle$, so $\mathbf{v} + \mathbf{w} = ((\sqrt{3} - \sqrt{2})/2, (1 + \sqrt{2})/2)$.

28. $\mathbf{w} = \langle 1, 0 \rangle$, and from (12), $\mathbf{v} = \langle \cos 120^\circ, \sin 120^\circ \rangle = \langle -1/2, \sqrt{3}/2 \rangle$, so $\mathbf{v} + \mathbf{w} = \langle 1/2, \sqrt{3}/2 \rangle$.

29. (a) The initial point of $\mathbf{u} + \mathbf{v} + \mathbf{w}$ is the origin and the endpoint is $(-2, 5)$, so $\mathbf{u} + \mathbf{v} + \mathbf{w} = \langle -2, 5 \rangle$.

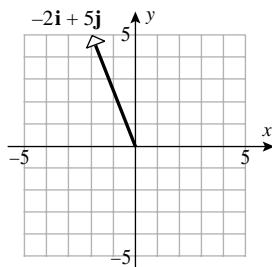

(b) The initial point of $\mathbf{u} + \mathbf{v} + \mathbf{w}$ is $(-5, 4)$ and the endpoint is $(-2, -4)$, so $\mathbf{u} + \mathbf{v} + \mathbf{w} = \langle 3, -8 \rangle$.

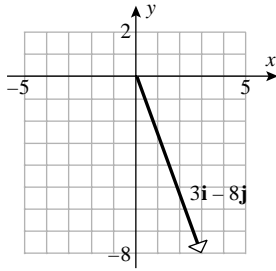

30. (a) $\mathbf{v} = \langle -10, 2 \rangle$ by inspection, so $\mathbf{u} - \mathbf{v} + \mathbf{w} = \mathbf{u} + \mathbf{v} + \mathbf{w} - 2\mathbf{v} = \langle -2, 5 \rangle + \langle 20, -4 \rangle = \langle 18, 1 \rangle$.

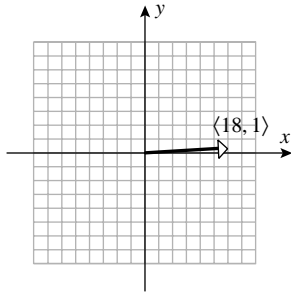

- (b) $\mathbf{v} = \langle -3, 8 \rangle$ by inspection, so $\mathbf{u} - \mathbf{v} + \mathbf{w} = \mathbf{u} + \mathbf{v} + \mathbf{w} - 2\mathbf{v} = \langle 3, -8 \rangle + \langle 6, -16 \rangle = \langle 9, -24 \rangle$.

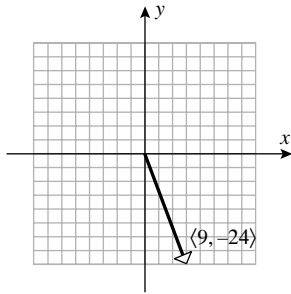

31. $6\mathbf{x} = 2\mathbf{u} - \mathbf{v} - \mathbf{w} = \langle -4, 6 \rangle, \mathbf{x} = \langle -2/3, 1 \rangle$.

32. $\mathbf{u} - 2\mathbf{x} = \mathbf{x} - \mathbf{w} + 3\mathbf{v}, 3\mathbf{x} = \mathbf{u} + \mathbf{w} - 3\mathbf{v}, \mathbf{x} = \frac{1}{3}(\mathbf{u} + \mathbf{w} - 3\mathbf{v}) = \langle 2/3, 2/3 \rangle$.

33. $\mathbf{u} = \frac{5}{7}\mathbf{i} + \frac{2}{7}\mathbf{j} + \frac{1}{7}\mathbf{k}, \mathbf{v} = \frac{8}{7}\mathbf{i} - \frac{1}{7}\mathbf{j} - \frac{4}{7}\mathbf{k}$.

34. $3\mathbf{u} + 2\mathbf{v} - 2(\mathbf{u} + \mathbf{v}) = \mathbf{u} = \langle -5, 8 \rangle, \mathbf{v} = \mathbf{u} + \mathbf{v} - \mathbf{u} = \langle 7, -11 \rangle$.

35. $\|(\mathbf{i} + \mathbf{j}) + (\mathbf{i} - 2\mathbf{j})\| = \|2\mathbf{i} - \mathbf{j}\| = \sqrt{5}, \|(\mathbf{i} + \mathbf{j}) - (\mathbf{i} - 2\mathbf{j})\| = \|3\mathbf{j}\| = 3$.

36. Let A, B, C be the vertices $(0,0), (1,3), (2,4)$ and D the fourth vertex (x, y) . For the parallelogram $ABCD, \overrightarrow{AD} = \overrightarrow{BC}, \langle x, y \rangle = \langle 1, 1 \rangle$ so $x = 1, y = 1$ and D is at $(1,1)$. For the parallelogram $ACBD, \overrightarrow{AD} = \overrightarrow{CB}, \langle x, y \rangle = \langle -1, -1 \rangle$ so $x = -1, y = -1$ and D is at $(-1, -1)$. For the parallelogram $ABDC, \overrightarrow{AC} = \overrightarrow{BD}, \langle x - 1, y - 3 \rangle = \langle 2, 4 \rangle$, so $x = 3, y = 7$ and D is at $(3, 7)$.

37. (a) $5 = \|k\mathbf{v}\| = |k|\|\mathbf{v}\| = \pm 3k$, so $k = \pm 5/3$.

(b) $6 = \|k\mathbf{v}\| = |k|\|\mathbf{v}\| = 2\|\mathbf{v}\|$, so $\|\mathbf{v}\| = 3$.

38. If $\|k\mathbf{v}\| = 0$ then $|k|\|\mathbf{v}\| = 0$ so either $k = 0$ or $\|\mathbf{v}\| = 0$; in the latter case, by (9) or (10), $\mathbf{v} = \mathbf{0}$.

39. (a) Choose two points on the line, for example $P_1(0, 2)$ and $P_2(1, 5)$; then $\overrightarrow{P_1P_2} = \langle 1, 3 \rangle$ is parallel to the line, $\|\langle 1, 3 \rangle\| = \sqrt{10}$, so $\langle 1/\sqrt{10}, 3/\sqrt{10} \rangle$ and $\langle -1/\sqrt{10}, -3/\sqrt{10} \rangle$ are unit vectors parallel to the line.
- (b) Choose two points on the line, for example $P_1(0, 4)$ and $P_2(1, 3)$; then $\overrightarrow{P_1P_2} = \langle 1, -1 \rangle$ is parallel to the line, $\|\langle 1, -1 \rangle\| = \sqrt{2}$ so $\langle 1/\sqrt{2}, -1/\sqrt{2} \rangle$ and $\langle -1/\sqrt{2}, 1/\sqrt{2} \rangle$ are unit vectors parallel to the line.
- (c) Pick any line that is perpendicular to the line $y = -5x + 1$, for example $y = x/5$; then $P_1(0, 0)$ and $P_2(5, 1)$ are on the line, so $\overrightarrow{P_1P_2} = \langle 5, 1 \rangle$ is perpendicular to the line, so $\pm \frac{1}{\sqrt{26}} \langle 5, 1 \rangle$ are unit vectors perpendicular to the line.
40. (a) $\pm \mathbf{k}$ (b) $\pm \mathbf{j}$ (c) $\pm \mathbf{i}$
41. (a) The circle of radius 1 about the origin.
 (b) The closed disk of radius 1 about the origin.
 (c) All points outside the closed disk of radius 1 about the origin.
42. (a) The circle of radius 1 about the tip of \mathbf{r}_0 .
 (b) The closed disk of radius 1 about the tip of \mathbf{r}_0 .
 (c) All points outside the closed disk of radius 1 about the tip of \mathbf{r}_0 .
43. (a) The (hollow) sphere of radius 1 about the origin.
 (b) The closed ball of radius 1 about the origin.
 (c) All points outside the closed ball of radius 1 about the origin.
44. The sum of the distances between (x, y) and the points (x_1, y_1) , (x_2, y_2) is the constant k , so the set consists of all points on the ellipse with foci at (x_1, y_1) and (x_2, y_2) , and major axis of length k .
45. Since $\phi = \pi/2$, from (14) we get $\|\mathbf{F}_1 + \mathbf{F}_2\|^2 = \|\mathbf{F}_1\|^2 + \|\mathbf{F}_2\|^2 = 3600 + 900$, so $\|\mathbf{F}_1 + \mathbf{F}_2\| = 30\sqrt{5}$ lb, and $\sin \alpha = \frac{\|\mathbf{F}_2\|}{\|\mathbf{F}_1 + \mathbf{F}_2\|} \sin \phi = \frac{30}{30\sqrt{5}}$, $\alpha \approx 26.57^\circ$, $\theta = \alpha \approx 26.57^\circ$.
46. $\|\mathbf{F}_1 + \mathbf{F}_2\|^2 = \|\mathbf{F}_1\|^2 + \|\mathbf{F}_2\|^2 + 2\|\mathbf{F}_1\|\|\mathbf{F}_2\| \cos \phi = 14,400 + 10,000 + 2(120)(100)\frac{1}{2} = 36,400$, so $\|\mathbf{F}_1 + \mathbf{F}_2\| = 20\sqrt{91}$ N, $\sin \alpha = \frac{\|\mathbf{F}_2\|}{\|\mathbf{F}_1 + \mathbf{F}_2\|} \sin \phi = \frac{100}{20\sqrt{91}} \sin 60^\circ = \frac{5\sqrt{3}}{2\sqrt{91}}$, $\alpha \approx 27.00^\circ$, $\theta = \alpha \approx 27.00^\circ$.
47. $\|\mathbf{F}_1 + \mathbf{F}_2\|^2 = \|\mathbf{F}_1\|^2 + \|\mathbf{F}_2\|^2 + 2\|\mathbf{F}_1\|\|\mathbf{F}_2\| \cos \phi = 160,000 + 160,000 - 2(400)(400)\frac{\sqrt{3}}{2}$, so $\|\mathbf{F}_1 + \mathbf{F}_2\| \approx 207.06$ N, and $\sin \alpha = \frac{\|\mathbf{F}_2\|}{\|\mathbf{F}_1 + \mathbf{F}_2\|} \sin \phi \approx \frac{400}{207.06} \left(\frac{1}{2}\right)$, $\alpha = 75.00^\circ$, $\theta = \alpha - 30^\circ = 45.00^\circ$.
48. $\|\mathbf{F}_1 + \mathbf{F}_2\|^2 = \|\mathbf{F}_1\|^2 + \|\mathbf{F}_2\|^2 + 2\|\mathbf{F}_1\|\|\mathbf{F}_2\| \cos \phi = 16 + 4 + 2(4)(2) \cos 77^\circ$, so $\|\mathbf{F}_1 + \mathbf{F}_2\| \approx 4.86$ lb, and $\sin \alpha = \frac{\|\mathbf{F}_2\|}{\|\mathbf{F}_1 + \mathbf{F}_2\|} \sin \phi = \frac{2}{4.86} \sin 77^\circ$, $\alpha \approx 23.64^\circ$, $\theta = \alpha - 27^\circ \approx -3.36^\circ$.
49. Let $\mathbf{F}_1, \mathbf{F}_2, \mathbf{F}_3$ be the forces in the diagram with magnitudes 40, 50, 75 respectively. Then $\mathbf{F}_1 + \mathbf{F}_2 + \mathbf{F}_3 = (\mathbf{F}_1 + \mathbf{F}_2) + \mathbf{F}_3$. Following the examples, $\mathbf{F}_1 + \mathbf{F}_2$ has magnitude 45.83 N and makes an angle 79.11° with the positive x -axis. Then $\|(\mathbf{F}_1 + \mathbf{F}_2) + \mathbf{F}_3\|^2 \approx 45.83^2 + 75^2 + 2(45.83)(75) \cos 79.11^\circ$, so $\mathbf{F}_1 + \mathbf{F}_2 + \mathbf{F}_3$ has magnitude ≈ 94.995 N and makes an angle $\theta = \alpha \approx 28.28^\circ$ with the positive x -axis.

50. Let $\mathbf{F}_1, \mathbf{F}_2, \mathbf{F}_3$ be the forces in the diagram with magnitudes 150, 200, 100 respectively. Then $\mathbf{F}_1 + \mathbf{F}_2 + \mathbf{F}_3 = (\mathbf{F}_1 + \mathbf{F}_2) + \mathbf{F}_3$. Following the examples, $\mathbf{F}_1 + \mathbf{F}_2$ has magnitude 279.34 N and makes an angle 91.24° with the positive x -axis. Then $\|\mathbf{F}_1 + \mathbf{F}_2 + \mathbf{F}_3\|^2 \approx 279.34^2 + 100^2 + 2(279.34)(100)\cos(270 - 91.24)^\circ$, and $\mathbf{F}_1 + \mathbf{F}_2 + \mathbf{F}_3$ has magnitude ≈ 179.37 N and makes an angle 91.94° with the positive x -axis.
51. Let $\mathbf{F}_1, \mathbf{F}_2$ be the forces in the diagram with magnitudes 8, 10 respectively. Then $\|\mathbf{F}_1 + \mathbf{F}_2\|$ has magnitude $\sqrt{8^2 + 10^2 + 2 \cdot 8 \cdot 10 \cos 120^\circ} = 2\sqrt{21} \approx 9.165$ lb, and makes an angle $60^\circ + \sin^{-1} \frac{\|\mathbf{F}_1\|}{\|\mathbf{F}_1 + \mathbf{F}_2\|} \sin 120 \approx 109.11^\circ$ with the positive x -axis, so \mathbf{F} has magnitude 9.165 lb and makes an angle -70.89° with the positive x -axis.
52. $\|\mathbf{F}_1 + \mathbf{F}_2\| = \sqrt{120^2 + 150^2 + 2 \cdot 120 \cdot 150 \cos 75^\circ} = 214.98$ N and makes an angle 92.63° with the positive x -axis, and $\|\mathbf{F}_1 + \mathbf{F}_2 + \mathbf{F}_3\| = 232.90$ N and makes an angle 67.23° with the positive x -axis, hence \mathbf{F} has magnitude 232.90 N and makes an angle -112.77° with the positive x -axis.
53. $\mathbf{F}_1 + \mathbf{F}_2 + \mathbf{F} = \mathbf{0}$, where \mathbf{F} has magnitude 250 and makes an angle -90° with the positive x -axis. Thus $\|\mathbf{F}_1 + \mathbf{F}_2\|^2 = \|\mathbf{F}_1\|^2 + \|\mathbf{F}_2\|^2 + 2\|\mathbf{F}_1\|\|\mathbf{F}_2\|\cos 105^\circ = 250^2$ and $45^\circ = \alpha = \sin^{-1} \left(\frac{\|\mathbf{F}_2\|}{250} \sin 105^\circ \right)$, so $\frac{\sqrt{2}}{2} \approx \frac{\|\mathbf{F}_2\|}{250} \cdot 0.9659$, $\|\mathbf{F}_2\| \approx 183.02$ lb, $\|\mathbf{F}_1\|^2 + 2(183.02)(-0.2588)\|\mathbf{F}_1\| + (183.02)^2 = 62,500$, $\|\mathbf{F}_1\| = 224.13$ lb.
54. Similar to Exercise 53, $\|\mathbf{F}_1\| = 100\sqrt{3}$ N, $\|\mathbf{F}_2\| = 100$ N.
55. Three forces act on the block: its weight $-300\mathbf{j}$; the tension in cable A, which has the form $a(-\mathbf{i} + \mathbf{j})$; and the tension in cable B, which has the form $b(\sqrt{3}\mathbf{i} + \mathbf{j})$, where a, b are positive constants. The sum of these forces is zero, which yields $a = 450 - 150\sqrt{3}$, $b = 150\sqrt{3} - 150$. Thus the forces along cables A and B are, respectively, $\|150(3 - \sqrt{3})(\mathbf{i} - \mathbf{j})\| = 450\sqrt{2} - 150\sqrt{6}$ lb, and $\|150(\sqrt{3} - 1)(\sqrt{3}\mathbf{i} - \mathbf{j})\| = 300\sqrt{3} - 300$ lb.
56. (a) Let \mathbf{T}_A and \mathbf{T}_B be the forces exerted on the block by cables A and B. Then $\mathbf{T}_A = a(-10\mathbf{i} + d\mathbf{j})$ and $\mathbf{T}_B = b(20\mathbf{i} + d\mathbf{j})$ for some positive a, b . Since $\mathbf{T}_A + \mathbf{T}_B - 100\mathbf{j} = \mathbf{0}$, we find that $a = \frac{200}{3d}$, $b = \frac{100}{3d}$, $\mathbf{T}_A = -\frac{2000}{3d}\mathbf{i} + \frac{200}{3}\mathbf{j}$, and $\mathbf{T}_B = \frac{2000}{3d}\mathbf{i} + \frac{100}{3}\mathbf{j}$. Thus $\mathbf{T}_A = \frac{200}{3}\sqrt{1 + \frac{100}{d^2}}$, $\mathbf{T}_B = \frac{100}{3}\sqrt{1 + \frac{400}{d^2}}$, and the graphs are:

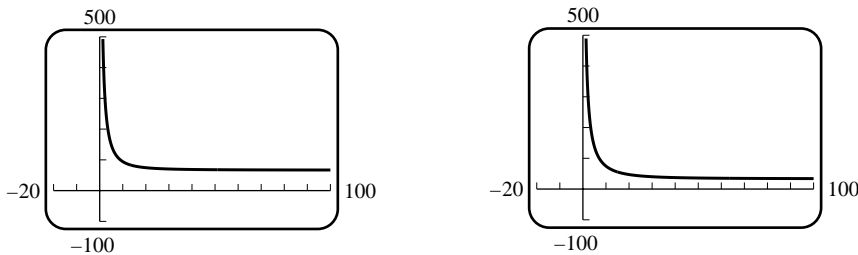

(b) An increase in d will decrease both forces.

(c) The inequality $\|\mathbf{T}_A\| \leq 150$ is equivalent to $d \geq \frac{40}{\sqrt{65}}$, and $\|\mathbf{T}_B\| \leq 150$ is equivalent to $d \geq \frac{40}{\sqrt{77}}$. Hence we must have $d \geq \frac{40}{\sqrt{65}}$.

57. (a) $c_1\mathbf{v}_1 + c_2\mathbf{v}_2 = (2c_1 + 4c_2)\mathbf{i} + (-c_1 + 2c_2)\mathbf{j} = 4\mathbf{j}$, so $2c_1 + 4c_2 = 0$ and $-c_1 + 2c_2 = 4$, which gives $c_1 = -2$, $c_2 = 1$.

(b) $c_1\mathbf{v}_1 + c_2\mathbf{v}_2 = \langle c_1 - 2c_2, -3c_1 + 6c_2 \rangle = \langle 3, 5 \rangle$, so $c_1 - 2c_2 = 3$ and $-3c_1 + 6c_2 = 5$ which has no solution.

58. (a) Equate corresponding components to get the system of equations $c_1 + 3c_2 = -1$, $2c_2 + c_3 = 1$, and $c_1 + c_3 = 5$. Solve to get $c_1 = 2$, $c_2 = -1$, and $c_3 = 3$.

(b) Equate corresponding components to get the system of equations $c_1 + 3c_2 + 4c_3 = 2$, $-c_1 - c_3 = 1$, and $c_2 + c_3 = -1$. From the second and third equations, $c_1 = -1 - c_3$ and $c_2 = -1 - c_3$; substitute these into the first equation to get $-4 = 2$, which is false so the system has no solution.

59. Place \mathbf{u} and \mathbf{v} tip to tail so that $\mathbf{u} + \mathbf{v}$ is the vector from the initial point of \mathbf{u} to the terminal point of \mathbf{v} . The shortest distance between two points is along the line joining these points so $\|\mathbf{u} + \mathbf{v}\| \leq \|\mathbf{u}\| + \|\mathbf{v}\|$.

60. (a): $\mathbf{u} + \mathbf{v} = (u_1\mathbf{i} + u_2\mathbf{j}) + (v_1\mathbf{i} + v_2\mathbf{j}) = (v_1\mathbf{i} + v_2\mathbf{j}) + (u_1\mathbf{i} + u_2\mathbf{j}) = \mathbf{v} + \mathbf{u}$.

(c): $\mathbf{u} + \mathbf{0} = (u_1\mathbf{i} + u_2\mathbf{j}) + 0\mathbf{i} + 0\mathbf{j} = u_1\mathbf{i} + u_2\mathbf{j} = \mathbf{u}$.

(e): $k(l\mathbf{u}) = k(l(u_1\mathbf{i} + u_2\mathbf{j})) = k(lu_1\mathbf{i} + lu_2\mathbf{j}) = klu_1\mathbf{i} + klu_2\mathbf{j} = (kl)\mathbf{u}$.

61. (d): $\mathbf{u} + (-\mathbf{u}) = (u_1\mathbf{i} + u_2\mathbf{j}) + (-u_1\mathbf{i} - u_2\mathbf{j}) = (u_1 - u_1)\mathbf{i} + (u_2 - u_2)\mathbf{j} = \mathbf{0}$.

(g): $(k + l)\mathbf{u} = (k + l)(u_1\mathbf{i} + u_2\mathbf{j}) = ku_1\mathbf{i} + ku_2\mathbf{j} + lu_1\mathbf{i} + lu_2\mathbf{j} = k\mathbf{u} + l\mathbf{u}$.

(h): $1\mathbf{u} = 1(u_1\mathbf{i} + u_2\mathbf{j}) = 1u_1\mathbf{i} + 1u_2\mathbf{j} = u_1\mathbf{i} + u_2\mathbf{j} = \mathbf{u}$.

62. Draw the triangles with sides formed by the vectors \mathbf{u} , \mathbf{v} , $\mathbf{u} + \mathbf{v}$ and $k\mathbf{u}$, $k\mathbf{v}$, $k\mathbf{u} + k\mathbf{v}$. By similar triangles, $k(\mathbf{u} + \mathbf{v}) = k\mathbf{u} + k\mathbf{v}$.

63. Let \mathbf{a} , \mathbf{b} , \mathbf{c} be vectors along the sides of the triangle and A,B the midpoints of \mathbf{a} and \mathbf{b} , then $\mathbf{u} = \frac{1}{2}\mathbf{a} - \frac{1}{2}\mathbf{b} = \frac{1}{2}(\mathbf{a} - \mathbf{b}) = \frac{1}{2}\mathbf{c}$ so \mathbf{u} is parallel to \mathbf{c} and half as long.

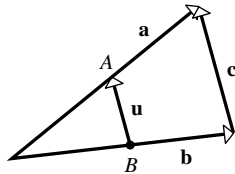

64. Let \mathbf{a} , \mathbf{b} , \mathbf{c} , \mathbf{d} be vectors along the sides of the quadrilateral and A, B, C, D the corresponding midpoints, then $\mathbf{u} = \frac{1}{2}\mathbf{b} + \frac{1}{2}\mathbf{c}$ and $\mathbf{v} = \frac{1}{2}\mathbf{d} - \frac{1}{2}\mathbf{a}$ but $\mathbf{d} = \mathbf{a} + \mathbf{b} + \mathbf{c}$ so $\mathbf{v} = \frac{1}{2}(\mathbf{a} + \mathbf{b} + \mathbf{c}) - \frac{1}{2}\mathbf{a} = \frac{1}{2}\mathbf{b} + \frac{1}{2}\mathbf{c} = \mathbf{u}$ thus ABCD is a parallelogram because sides AD and BC are equal and parallel.

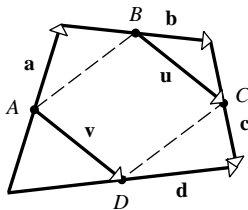

Exercise Set 11.3

1. (a) $(1)(6) + (2)(-8) = -10$; $\cos \theta = (-10)/[(\sqrt{5})(10)] = -1/\sqrt{5}$.

(b) $(-7)(0) + (-3)(1) = -3$; $\cos \theta = (-3)/[(\sqrt{58})(1)] = -3/\sqrt{58}$.

(c) $(1)(8) + (-3)(-2) + (7)(-2) = 0$; $\cos \theta = 0$.

(d) $(-3)(4) + (1)(2) + (2)(-5) = -20$; $\cos \theta = (-20)/[(\sqrt{14})(\sqrt{45})] = -20/(3\sqrt{70})$.

2. (a) $\mathbf{u} \cdot \mathbf{v} = (1)(2) \cos(\pi/6) = \sqrt{3}$ (b) $\mathbf{u} \cdot \mathbf{v} = (2)(3) \cos 135^\circ = -3\sqrt{2}$.

3. (a) $\mathbf{u} \cdot \mathbf{v} = -34 < 0$, obtuse. (b) $\mathbf{u} \cdot \mathbf{v} = 6 > 0$, acute. (c) $\mathbf{u} \cdot \mathbf{v} = -1 < 0$, obtuse. (d) $\mathbf{u} \cdot \mathbf{v} = 0$, orthogonal.

4. Let the points be P, Q, R in order, then $\vec{PQ} = \langle 2 - (-1), -2 - 2, 0 - 3 \rangle = \langle 3, -4, -3 \rangle$, $\vec{QR} = \langle 3 - 2, 1 - (-2), -4 - 0 \rangle = \langle 1, 3, -4 \rangle$, $\vec{RP} = \langle -1 - 3, 2 - 1, 3 - (-4) \rangle = \langle -4, 1, 7 \rangle$; since $\vec{QP} \cdot \vec{QR} = -3(1) + 4(3) + 3(-4) = -3 < 0$, $\angle PQR$ is obtuse; since $\vec{RP} \cdot \vec{RQ} = -4(-1) + (-3) + 7(4) = 29 > 0$, $\angle PRQ$ is acute; since $\vec{PR} \cdot \vec{PQ} = 4(3) - 1(-4) - 7(-3) = 37 > 0$, $\angle RPQ$ is acute.
5. Since $\mathbf{v}_0 \cdot \mathbf{v}_i = \cos \phi_i$, the answers are, in order, $\sqrt{2}/2, 0, -\sqrt{2}/2, -1, -\sqrt{2}/2, 0, \sqrt{2}/2$.
6. Proceed as in Exercise 5; $25/2, -25/2, -25, -25/2, 25/2$.
7. (a) $\vec{AB} = \langle 1, 3, -2 \rangle$, $\vec{BC} = \langle 4, -2, -1 \rangle$, $\vec{AB} \cdot \vec{BC} = 0$ so \vec{AB} and \vec{BC} are orthogonal; it is a right triangle with the right angle at vertex B .
- (b) Let A, B , and C be the vertices $(-1, 0)$, $(2, -1)$, and $(1, 4)$ with corresponding interior angles α, β , and γ , then $\cos \alpha = \frac{\vec{AB} \cdot \vec{AC}}{\|\vec{AB}\| \|\vec{AC}\|} = \frac{\langle 3, -1 \rangle \cdot \langle 2, 4 \rangle}{\sqrt{10}\sqrt{20}} = 1/(5\sqrt{2})$, so $\alpha \approx 82^\circ$, $\cos \beta = \frac{\vec{BA} \cdot \vec{BC}}{\|\vec{BA}\| \|\vec{BC}\|} = \frac{\langle -3, 1 \rangle \cdot \langle -1, 5 \rangle}{\sqrt{10}\sqrt{26}} = 4/\sqrt{65}$, so $\beta \approx 60^\circ$, $\cos \gamma = \frac{\vec{CA} \cdot \vec{CB}}{\|\vec{CA}\| \|\vec{CB}\|} = \frac{\langle -2, -4 \rangle \cdot \langle 1, -5 \rangle}{\sqrt{20}\sqrt{26}} = 9/\sqrt{130}$, so $\gamma \approx 38^\circ$.
8. (a) $\mathbf{v} \cdot \mathbf{v}_1 = -ab + ba = 0$; $\mathbf{v} \cdot \mathbf{v}_2 = ab + b(-a) = 0$.

- (b) Let $\mathbf{v}_1 = 2\mathbf{i} + 3\mathbf{j}$, $\mathbf{v}_2 = -2\mathbf{i} - 3\mathbf{j}$; take $\mathbf{u}_1 = \frac{\mathbf{v}_1}{\|\mathbf{v}_1\|} = \frac{2}{\sqrt{13}}\mathbf{i} + \frac{3}{\sqrt{13}}\mathbf{j}$, $\mathbf{u}_2 = -\mathbf{u}_1$.

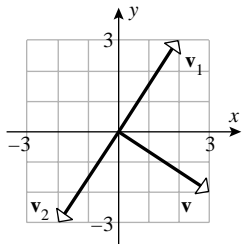

9. (a) The dot product of a vector \mathbf{u} and a scalar $\mathbf{v} \cdot \mathbf{w}$ is not defined.
- (b) The sum of a scalar $\mathbf{u} \cdot \mathbf{v}$ and a vector \mathbf{w} is not defined.
- (c) $\mathbf{u} \cdot \mathbf{v}$ is not a vector.
- (d) The dot product of a scalar k and a vector $\mathbf{u} + \mathbf{v}$ is not defined.
10. (a) A scalar $\mathbf{u} \cdot \mathbf{v}$ times a vector \mathbf{w} . (b) A scalar $\mathbf{u} \cdot \mathbf{v}$ times a scalar $\mathbf{v} \cdot \mathbf{w}$.
- (c) A scalar $\mathbf{u} \cdot \mathbf{v}$ plus a scalar k . (d) A dot product of a vector $k\mathbf{u}$ with a vector \mathbf{v} .
11. (b): $\mathbf{u} \cdot (\mathbf{v} + \mathbf{w}) = (6\mathbf{i} - \mathbf{j} + 2\mathbf{k}) \cdot ((2\mathbf{i} + 7\mathbf{j} + 4\mathbf{k}) + (\mathbf{i} + \mathbf{j} - 3\mathbf{k})) = (6\mathbf{i} - \mathbf{j} + 2\mathbf{k}) \cdot (3\mathbf{i} + 8\mathbf{j} + \mathbf{k}) = 12$; $\mathbf{u} \cdot \mathbf{v} + \mathbf{u} \cdot \mathbf{w} = (6\mathbf{i} - \mathbf{j} + 2\mathbf{k}) \cdot (2\mathbf{i} + 7\mathbf{j} + 4\mathbf{k}) + (6\mathbf{i} - \mathbf{j} + 2\mathbf{k}) \cdot (\mathbf{i} + \mathbf{j} - 3\mathbf{k}) = 13 - 1 = 12$. (c): $k(\mathbf{u} \cdot \mathbf{v}) = -5(13) = -65$; $(k\mathbf{u}) \cdot \mathbf{v} = (-30\mathbf{i} + 5\mathbf{j} - 10\mathbf{k}) \cdot (2\mathbf{i} + 7\mathbf{j} + 4\mathbf{k}) = -65$; $\mathbf{u} \cdot (k\mathbf{v}) = (6\mathbf{i} - \mathbf{j} + 2\mathbf{k}) \cdot (-10\mathbf{i} - 35\mathbf{j} - 20\mathbf{k}) = -65$.
12. (a) $\langle 1, 2 \rangle \cdot (\langle 28, -14 \rangle + \langle 6, 0 \rangle) = \langle 1, 2 \rangle \cdot \langle 34, -14 \rangle = 6$. (b) $\|6\mathbf{w}\| = 6\|\mathbf{w}\| = 36$. (c) $24\sqrt{5}$ (d) $24\sqrt{5}$
13. $\vec{AB} \cdot \vec{AP} = [2\mathbf{i} + \mathbf{j} + 2\mathbf{k}] \cdot [(r-1)\mathbf{i} + (r+1)\mathbf{j} + (r-3)\mathbf{k}] = 2(r-1) + (r+1) + 2(r-3) = 5r - 7 = 0, r = 7/5$.

14. By inspection, $3\mathbf{i} - 4\mathbf{j}$ is orthogonal to and has the same length as $4\mathbf{i} + 3\mathbf{j}$, so $\mathbf{u}_1 = (4\mathbf{i} + 3\mathbf{j}) + (3\mathbf{i} - 4\mathbf{j}) = 7\mathbf{i} - \mathbf{j}$ and $\mathbf{u}_2 = (4\mathbf{i} + 3\mathbf{j}) + (-1)(3\mathbf{i} - 4\mathbf{j}) = \mathbf{i} + 7\mathbf{j}$ each make an angle of 45° with $4\mathbf{i} + 3\mathbf{j}$; unit vectors in the directions of \mathbf{u}_1 and \mathbf{u}_2 are $(7\mathbf{i} - \mathbf{j})/\sqrt{50}$ and $(\mathbf{i} + 7\mathbf{j})/\sqrt{50}$.

15. (a) $\|\mathbf{v}\| = \sqrt{3}$, so $\cos \alpha = \cos \beta = 1/\sqrt{3}$, $\cos \gamma = -1/\sqrt{3}$, $\alpha = \beta \approx 55^\circ$, $\gamma \approx 125^\circ$.

(b) $\|\mathbf{v}\| = 3$, so $\cos \alpha = 2/3$, $\cos \beta = -2/3$, $\cos \gamma = 1/3$, $\alpha \approx 48^\circ$, $\beta \approx 132^\circ$, $\gamma \approx 71^\circ$.

16. (a) $\|\mathbf{v}\| = 7$, so $\cos \alpha = 3/7$, $\cos \beta = -2/7$, $\cos \gamma = -6/7$, $\alpha \approx 65^\circ$, $\beta \approx 107^\circ$, $\gamma \approx 149^\circ$.

(b) $\|\mathbf{v}\| = 5$, so $\cos \alpha = 3/5$, $\cos \beta = 0$, $\cos \gamma = -4/5$, $\alpha \approx 53^\circ$, $\beta = 90^\circ$, $\gamma \approx 143^\circ$.

17. $\cos^2 \alpha + \cos^2 \beta + \cos^2 \gamma = \frac{v_1^2}{\|\mathbf{v}\|^2} + \frac{v_2^2}{\|\mathbf{v}\|^2} + \frac{v_3^2}{\|\mathbf{v}\|^2} = (v_1^2 + v_2^2 + v_3^2) / \|\mathbf{v}\|^2 = \|\mathbf{v}\|^2 / \|\mathbf{v}\|^2 = 1.$

18. Let $\mathbf{v} = \langle x, y, z \rangle$, then $x = \sqrt{x^2 + y^2} \cos \theta$, $y = \sqrt{x^2 + y^2} \sin \theta$, $\sqrt{x^2 + y^2} = \|\mathbf{v}\| \cos \lambda$, and $z = \|\mathbf{v}\| \sin \lambda$, so $x/\|\mathbf{v}\| = \cos \theta \cos \lambda$, $y/\|\mathbf{v}\| = \sin \theta \cos \lambda$, and $z/\|\mathbf{v}\| = \sin \lambda$.

19. (a) Let k be the length of an edge and introduce a coordinate system as shown in the figure, then $\mathbf{d} = \langle k, k, k \rangle$, $\mathbf{u} = \langle k, k, 0 \rangle$, $\cos \theta = \frac{\mathbf{d} \cdot \mathbf{u}}{\|\mathbf{d}\| \|\mathbf{u}\|} = \frac{2k^2}{(k\sqrt{3})(k\sqrt{2})} = 2/\sqrt{6}$, so $\theta = \cos^{-1}(2/\sqrt{6}) \approx 35^\circ$.

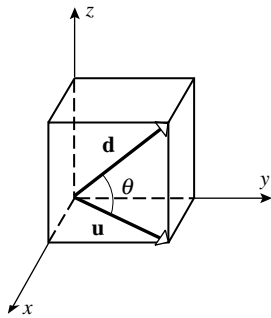

(b) $\mathbf{v} = \langle -k, 0, k \rangle$, $\cos \theta = \frac{\mathbf{d} \cdot \mathbf{v}}{\|\mathbf{d}\| \|\mathbf{v}\|} = 0$, so $\theta = \pi/2$ radians.

20. Let $\mathbf{u}_1 = \|\mathbf{u}_1\| \langle \cos \alpha_1, \cos \beta_1, \cos \gamma_1 \rangle$, $\mathbf{u}_2 = \|\mathbf{u}_2\| \langle \cos \alpha_2, \cos \beta_2, \cos \gamma_2 \rangle$, \mathbf{u}_1 and \mathbf{u}_2 are perpendicular if and only if $\mathbf{u}_1 \cdot \mathbf{u}_2 = 0$ so $\|\mathbf{u}_1\| \|\mathbf{u}_2\| (\cos \alpha_1 \cos \alpha_2 + \cos \beta_1 \cos \beta_2 + \cos \gamma_1 \cos \gamma_2) = 0$, $\cos \alpha_1 \cos \alpha_2 + \cos \beta_1 \cos \beta_2 + \cos \gamma_1 \cos \gamma_2 = 0$.

21. $\cos \alpha = \frac{\sqrt{3}}{2} \frac{1}{2} = \frac{\sqrt{3}}{4}$, $\cos \beta = \frac{\sqrt{3}}{2} \frac{\sqrt{3}}{2} = \frac{3}{4}$, $\cos \gamma = \frac{1}{2}$; $\alpha \approx 64^\circ$, $\beta \approx 41^\circ$, $\gamma = 60^\circ$.

22. With the cube as shown in the diagram, and a the length of each edge, $\mathbf{d}_1 = a\mathbf{i} + a\mathbf{j} + a\mathbf{k}$, $\mathbf{d}_2 = a\mathbf{i} + a\mathbf{j} - a\mathbf{k}$, $\cos \theta = (\mathbf{d}_1 \cdot \mathbf{d}_2) / (\|\mathbf{d}_1\| \|\mathbf{d}_2\|) = 1/3$, $\theta \approx 71^\circ$.

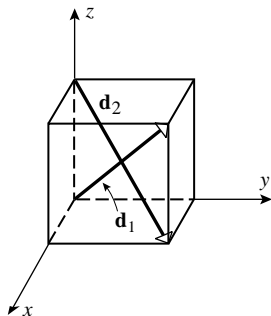

23. Take \mathbf{i} , \mathbf{j} , and \mathbf{k} along adjacent edges of the box, then $10\mathbf{i} + 15\mathbf{j} + 25\mathbf{k}$ is along a diagonal, and a unit vector in this direction is $\frac{2}{\sqrt{38}}\mathbf{i} + \frac{3}{\sqrt{38}}\mathbf{j} + \frac{5}{\sqrt{38}}\mathbf{k}$. The direction cosines are $\cos \alpha = 2/\sqrt{38}$, $\cos \beta = 3/\sqrt{38}$, and $\cos \gamma = 5/\sqrt{38}$ so $\alpha \approx 71^\circ$, $\beta \approx 61^\circ$, and $\gamma \approx 36^\circ$.

24. (a) $\frac{\mathbf{b}}{\|\mathbf{b}\|} = \langle 3/5, 4/5 \rangle$, so $\text{proj}_{\mathbf{b}}\mathbf{v} = \langle 6/25, 8/25 \rangle$ and $\mathbf{v} - \text{proj}_{\mathbf{b}}\mathbf{v} = \langle 44/25, -33/25 \rangle$.

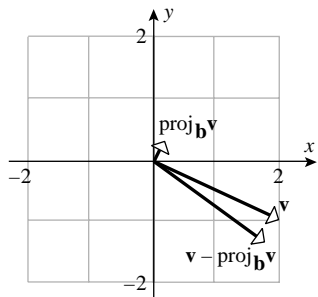

- (b) $\frac{\mathbf{b}}{\|\mathbf{b}\|} = \langle 1/\sqrt{5}, -2/\sqrt{5} \rangle$, so $\text{proj}_{\mathbf{b}}\mathbf{v} = \langle -6/5, 12/5 \rangle$ and $\mathbf{v} - \text{proj}_{\mathbf{b}}\mathbf{v} = \langle 26/5, 13/5 \rangle$.

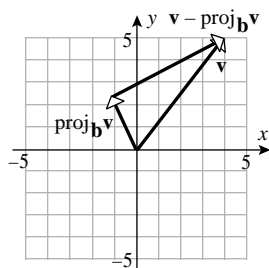

- (c) $\frac{\mathbf{b}}{\|\mathbf{b}\|} = \langle 2/\sqrt{5}, 1/\sqrt{5} \rangle$, so $\text{proj}_{\mathbf{b}}\mathbf{v} = \langle -16/5, -8/5 \rangle$ and $\mathbf{v} - \text{proj}_{\mathbf{b}}\mathbf{v} = \langle 1/5, -2/5 \rangle$.

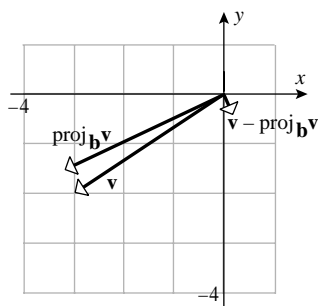

25. (a) $\frac{\mathbf{b}}{\|\mathbf{b}\|} = \langle 1/3, 2/3, 2/3 \rangle$, so $\text{proj}_{\mathbf{b}}\mathbf{v} = \langle 2/3, 4/3, 4/3 \rangle$ and $\mathbf{v} - \text{proj}_{\mathbf{b}}\mathbf{v} = \langle 4/3, -7/3, 5/3 \rangle$.

- (b) $\frac{\mathbf{b}}{\|\mathbf{b}\|} = \langle 2/7, 3/7, -6/7 \rangle$, so $\text{proj}_{\mathbf{b}}\mathbf{v} = \langle -74/49, -111/49, 222/49 \rangle$ and $\mathbf{v} - \text{proj}_{\mathbf{b}}\mathbf{v} = \langle 270/49, 62/49, 121/49 \rangle$.

26. (a) $\text{proj}_{\mathbf{b}}\mathbf{v} = \langle -1, -1 \rangle$, so $\mathbf{v} = \langle -1, -1 \rangle + \langle 3, -3 \rangle$.

- (b) $\text{proj}_{\mathbf{b}}\mathbf{v} = \langle 16/5, 0, -8/5 \rangle$, so $\mathbf{v} = \langle 16/5, 0, -8/5 \rangle + \langle -1/5, 1, -2/5 \rangle$.

- (c) $\mathbf{v} = -2\mathbf{b} + \mathbf{0}$.

27. (a) $\text{proj}_{\mathbf{b}}\mathbf{v} = \langle 1, 1 \rangle$, so $\mathbf{v} = \langle 1, 1 \rangle + \langle -4, 4 \rangle$.

(b) $\text{proj}_{\mathbf{b}} \mathbf{v} = \langle 0, -8/5, 4/5 \rangle$, so $\mathbf{v} = \langle 0, -8/5, 4/5 \rangle + \langle -2, 13/5, 26/5 \rangle$.

(c) $\mathbf{v} \cdot \mathbf{b} = 0$, hence $\text{proj}_{\mathbf{b}} \mathbf{v} = \mathbf{0}$, $\mathbf{v} = \mathbf{0} + \mathbf{v}$.

28. False, for example $\mathbf{a} = \langle 1, 2 \rangle$, $\mathbf{b} = \langle -1, 0 \rangle$, $\mathbf{c} = \langle 5, -3 \rangle$.

29. True, because $(\mathbf{v} + \mathbf{w}) \cdot (\mathbf{v} + \mathbf{w}) = \|\mathbf{v}\|^2 + \|\mathbf{w}\|^2 \neq 0$.

30. True, by Theorem 11.3.3, $\mathbf{u} \cdot \mathbf{v} = \|\mathbf{u}\| \|\mathbf{v}\| \cos \theta = 1 \cdot \|\mathbf{v}\| \cdot (\pm 1) = \pm \|\mathbf{v}\|$.

31. True, $\text{proj}_{\mathbf{b}}(\mathbf{v}) = \frac{\mathbf{v} \cdot \mathbf{b}}{\|\mathbf{b}\|^2} \mathbf{b}$ is a scalar multiple of the vector \mathbf{b} and is therefore parallel to \mathbf{b} .

32. $\vec{AP} = -\mathbf{i} + 3\mathbf{j}$, $\vec{AB} = 3\mathbf{i} + 4\mathbf{j}$, $\|\text{proj}_{\vec{AB}} \vec{AP}\| = |\vec{AP} \cdot \vec{AB}| / \|\vec{AB}\| = 9/5$, $\|\vec{AP}\| = \sqrt{10}$, $\sqrt{10 - 81/25} = 13/5$.

33. $\vec{AP} = -4\mathbf{i} + 2\mathbf{k}$, $\vec{AB} = -3\mathbf{i} + 2\mathbf{j} - 4\mathbf{k}$, $\|\text{proj}_{\vec{AB}} \vec{AP}\| = |\vec{AP} \cdot \vec{AB}| / \|\vec{AB}\| = 4/\sqrt{29}$. $\|\vec{AP}\| = \sqrt{20}$, $\sqrt{20 - 16/29} = \sqrt{564/29}$.

34. Let $\mathbf{e}_1 = -\langle \cos 27^\circ, \sin 27^\circ \rangle$ and $\mathbf{e}_2 = \langle \sin 27^\circ, -\cos 27^\circ \rangle$ be the forces parallel to and perpendicular to the slide, and let \mathbf{F} be the downward force of gravity on the child. Then $\|\mathbf{F}\| = 34(9.8) = 333.2$ N, and $\mathbf{F} = \mathbf{F}_1 + \mathbf{F}_2 = (\mathbf{F} \cdot \mathbf{e}_1)\mathbf{e}_1 + (\mathbf{F} \cdot \mathbf{e}_2)\mathbf{e}_2$. The force parallel to the slide is therefore $\|\mathbf{F}\| \cos 63^\circ \approx 151.27$ N, and the force against the slide is $\|\mathbf{F}\| \cos 27^\circ \approx 296.88$ N, so it takes a force of 151.27 N to prevent the child from sliding.

35. Let x denote the magnitude of the force in the direction of \mathbf{Q} . Then the force \mathbf{F} acting on the child is $\mathbf{F} = x\mathbf{i} - 333.2\mathbf{j}$. Let $\mathbf{e}_1 = -\langle \cos 27^\circ, \sin 27^\circ \rangle$ and $\mathbf{e}_2 = \langle \sin 27^\circ, -\cos 27^\circ \rangle$ be the unit vectors in the directions along and against the slide. Then the component of \mathbf{F} in the direction of \mathbf{e}_1 is $\mathbf{F} \cdot \mathbf{e}_1 = -x \cos 27^\circ + 333.2 \sin 27^\circ$ and the child is prevented from sliding down if this quantity is negative, i.e. $x > 333.2 \tan 27^\circ \approx 169.77$ N.

36. We will obtain the work in two different ways. First, it is simply $4 \cdot 151.27 = 605.08$ J. (Force times displacement.) Second, it is the same as the change in potential energy, so it is $mgh = 34 \cdot 9.8 \cdot 4 \sin(27^\circ) = 605.08$ J.

37. $W = \mathbf{F} \cdot 15\mathbf{i} = 15 \cdot 50 \cos 60^\circ = 375$ ft · lb.

38. Let P and Q be the points $(1,3)$ and $(4,7)$ then $\vec{PQ} = 3\mathbf{i} + 4\mathbf{j}$ so $W = \mathbf{F} \cdot \vec{PQ} = -12$ ft · lb.

39. $W = \mathbf{F} \cdot (15/\sqrt{3})(\mathbf{i} + \mathbf{j} + \mathbf{k}) = -15/\sqrt{3}$ N · m = $-5\sqrt{3}$ J.

40. $W = \mathbf{F} \cdot \vec{PQ} = \|\mathbf{F}\| \|\vec{PQ}\| \cos 45^\circ = (500)(100) \left(\frac{\sqrt{2}}{2}\right) = 25,000\sqrt{2}$ N · m = $25,000\sqrt{2}$ J.

41. $\mathbf{u} + \mathbf{v}$ and $\mathbf{u} - \mathbf{v}$ are vectors along the diagonals, $(\mathbf{u} + \mathbf{v}) \cdot (\mathbf{u} - \mathbf{v}) = \mathbf{u} \cdot \mathbf{u} - \mathbf{u} \cdot \mathbf{v} + \mathbf{v} \cdot \mathbf{u} - \mathbf{v} \cdot \mathbf{v} = \|\mathbf{u}\|^2 - \|\mathbf{v}\|^2$ so $(\mathbf{u} + \mathbf{v}) \cdot (\mathbf{u} - \mathbf{v}) = 0$ if and only if $\|\mathbf{u}\| = \|\mathbf{v}\|$.

42. The diagonals have lengths $\|\mathbf{u} + \mathbf{v}\|$ and $\|\mathbf{u} - \mathbf{v}\|$ but $\|\mathbf{u} + \mathbf{v}\|^2 = (\mathbf{u} + \mathbf{v}) \cdot (\mathbf{u} + \mathbf{v}) = \|\mathbf{u}\|^2 + 2\mathbf{u} \cdot \mathbf{v} + \|\mathbf{v}\|^2$, and $\|\mathbf{u} - \mathbf{v}\|^2 = (\mathbf{u} - \mathbf{v}) \cdot (\mathbf{u} - \mathbf{v}) = \|\mathbf{u}\|^2 - 2\mathbf{u} \cdot \mathbf{v} + \|\mathbf{v}\|^2$. If the parallelogram is a rectangle then $\mathbf{u} \cdot \mathbf{v} = 0$ so $\|\mathbf{u} + \mathbf{v}\|^2 = \|\mathbf{u} - \mathbf{v}\|^2$; the diagonals are equal. If the diagonals are equal, then $4\mathbf{u} \cdot \mathbf{v} = 0$, $\mathbf{u} \cdot \mathbf{v} = 0$ so \mathbf{u} is perpendicular to \mathbf{v} and hence the parallelogram is a rectangle.

43. $\|\mathbf{u} + \mathbf{v}\|^2 = (\mathbf{u} + \mathbf{v}) \cdot (\mathbf{u} + \mathbf{v}) = \|\mathbf{u}\|^2 + 2\mathbf{u} \cdot \mathbf{v} + \|\mathbf{v}\|^2$ and $\|\mathbf{u} - \mathbf{v}\|^2 = (\mathbf{u} - \mathbf{v}) \cdot (\mathbf{u} - \mathbf{v}) = \|\mathbf{u}\|^2 - 2\mathbf{u} \cdot \mathbf{v} + \|\mathbf{v}\|^2$, add to get $\|\mathbf{u} + \mathbf{v}\|^2 + \|\mathbf{u} - \mathbf{v}\|^2 = 2\|\mathbf{u}\|^2 + 2\|\mathbf{v}\|^2$. The sum of the squares of the lengths of the diagonals of a parallelogram is equal to twice the sum of the squares of the lengths of the sides.

44. $\|\mathbf{u} + \mathbf{v}\|^2 = (\mathbf{u} + \mathbf{v}) \cdot (\mathbf{u} + \mathbf{v}) = \|\mathbf{u}\|^2 + 2\mathbf{u} \cdot \mathbf{v} + \|\mathbf{v}\|^2$ and $\|\mathbf{u} - \mathbf{v}\|^2 = (\mathbf{u} - \mathbf{v}) \cdot (\mathbf{u} - \mathbf{v}) = \|\mathbf{u}\|^2 - 2\mathbf{u} \cdot \mathbf{v} + \|\mathbf{v}\|^2$, subtract to get $\|\mathbf{u} + \mathbf{v}\|^2 - \|\mathbf{u} - \mathbf{v}\|^2 = 4\mathbf{u} \cdot \mathbf{v}$, the result follows by dividing both sides by 4.

45. $\mathbf{v} = c_1\mathbf{v}_1 + c_2\mathbf{v}_2 + c_3\mathbf{v}_3$ so $\mathbf{v} \cdot \mathbf{v}_i = c_i\mathbf{v}_i \cdot \mathbf{v}_i$ because $\mathbf{v}_i \cdot \mathbf{v}_j = 0$ if $i \neq j$, thus $\mathbf{v} \cdot \mathbf{v}_i = c_i\|\mathbf{v}_i\|^2$, $c_i = \mathbf{v} \cdot \mathbf{v}_i / \|\mathbf{v}_i\|^2$ for $i = 1, 2, 3$.
46. $\mathbf{v}_1 \cdot \mathbf{v}_2 = \mathbf{v}_1 \cdot \mathbf{v}_3 = \mathbf{v}_2 \cdot \mathbf{v}_3 = 0$ so they are mutually perpendicular. Let $\mathbf{v} = \mathbf{i} - \mathbf{j} + \mathbf{k}$, then $c_1 = \frac{\mathbf{v} \cdot \mathbf{v}_1}{\|\mathbf{v}_1\|^2} = \frac{3}{7}$,
 $c_2 = \frac{\mathbf{v} \cdot \mathbf{v}_2}{\|\mathbf{v}_2\|^2} = -\frac{1}{3}$, and $c_3 = \frac{\mathbf{v} \cdot \mathbf{v}_3}{\|\mathbf{v}_3\|^2} = \frac{1}{21}$.
47. (a) $\mathbf{u} = x\mathbf{i} + (x^2 + 1)\mathbf{j}$, $\mathbf{v} = x\mathbf{i} - (x + 1)\mathbf{j}$, $\theta = \cos^{-1}[(\mathbf{u} \cdot \mathbf{v})/(\|\mathbf{u}\|\|\mathbf{v}\|)]$. Use a CAS to solve $d\theta/dx = 0$ to find that the minimum value of θ occurs when $x \approx -0.53567$ so the minimum angle is about 40° . NB: Since $\cos^{-1} u$ is a decreasing function of u , it suffices to maximize $(\mathbf{u} \cdot \mathbf{v})/(\|\mathbf{u}\|\|\mathbf{v}\|)$, or, what is easier, its square.
- (b) Solve $\mathbf{u} \cdot \mathbf{v} = 0$ for x to get $x \approx -0.682328$.
48. (a) $\mathbf{u} = \cos \theta_1 \mathbf{i} \pm \sin \theta_1 \mathbf{j}$, $\mathbf{v} = \pm \sin \theta_2 \mathbf{j} + \cos \theta_2 \mathbf{k}$, $\cos \theta = \mathbf{u} \cdot \mathbf{v} = \pm \sin \theta_1 \sin \theta_2$.
- (b) $\cos \theta = \pm \sin^2 45^\circ = \pm 1/2$, $\theta = 60^\circ$.
- (c) Let $\theta(t) = \cos^{-1}(\sin t \sin 2t)$; solve $\theta'(t) = 0$ for t to find that $\theta_{\max} \approx 140^\circ$ (reject, since θ is acute) when $t \approx 2.186276$ and that $\theta_{\min} \approx 40^\circ$ when $t \approx 0.955317$; for θ_{\max} check the endpoints $t = 0, \pi/2$ to obtain $\theta_{\max} = \cos^{-1}(0) = \pi/2$.
49. Let $\mathbf{u} = \langle u_1, u_2, u_3 \rangle$, $\mathbf{v} = \langle v_1, v_2, v_3 \rangle$, $\mathbf{w} = \langle w_1, w_2, w_3 \rangle$. Then $\mathbf{u} \cdot (\mathbf{v} + \mathbf{w}) = u_1(v_1 + w_1) + u_2(v_2 + w_2) + u_3(v_3 + w_3) = u_1v_1 + u_1w_1 + u_2v_2 + u_2w_2 + u_3v_3 + u_3w_3 = u_1v_1 + u_2v_2 + u_3v_3 + u_1w_1 + u_2w_2 + u_3w_3 = \mathbf{u} \cdot \mathbf{v} + \mathbf{u} \cdot \mathbf{w}$, also $\mathbf{0} \cdot \mathbf{v} = 0 \cdot v_1 + 0 \cdot v_2 + 0 \cdot v_3 = 0$.

Exercise Set 11.4

1. (a) $\mathbf{i} \times (\mathbf{i} + \mathbf{j} + \mathbf{k}) = \begin{vmatrix} \mathbf{i} & \mathbf{j} & \mathbf{k} \\ 1 & 0 & 0 \\ 1 & 1 & 1 \end{vmatrix} = -\mathbf{j} + \mathbf{k}$.

(b) $\mathbf{i} \times (\mathbf{i} + \mathbf{j} + \mathbf{k}) = (\mathbf{i} \times \mathbf{i}) + (\mathbf{i} \times \mathbf{j}) + (\mathbf{i} \times \mathbf{k}) = -\mathbf{j} + \mathbf{k}$.

2. (a) $\mathbf{j} \times (\mathbf{i} + \mathbf{j} + \mathbf{k}) = \begin{vmatrix} \mathbf{i} & \mathbf{j} & \mathbf{k} \\ 0 & 1 & 0 \\ 1 & 1 & 1 \end{vmatrix} = \mathbf{i} - \mathbf{k}$; $\mathbf{j} \times (\mathbf{i} + \mathbf{j} + \mathbf{k}) = (\mathbf{j} \times \mathbf{i}) + (\mathbf{j} \times \mathbf{j}) + (\mathbf{j} \times \mathbf{k}) = \mathbf{i} - \mathbf{k}$.

(b) $\mathbf{k} \times (\mathbf{i} + \mathbf{j} + \mathbf{k}) = \begin{vmatrix} \mathbf{i} & \mathbf{j} & \mathbf{k} \\ 0 & 0 & 1 \\ 1 & 1 & 1 \end{vmatrix} = -\mathbf{i} + \mathbf{j}$; $\mathbf{k} \times (\mathbf{i} + \mathbf{j} + \mathbf{k}) = (\mathbf{k} \times \mathbf{i}) + (\mathbf{k} \times \mathbf{j}) + (\mathbf{k} \times \mathbf{k}) = \mathbf{j} - \mathbf{i} + \mathbf{0} = -\mathbf{i} + \mathbf{j}$.

3. $\langle 7, 10, 9 \rangle$

4. $-\mathbf{i} - 2\mathbf{j} - 7\mathbf{k}$

5. $\langle -4, -6, -3 \rangle$

6. $\mathbf{i} + 2\mathbf{j} - 4\mathbf{k}$

7. (a) $\mathbf{v} \times \mathbf{w} = \langle -23, 7, -1 \rangle$, $\mathbf{u} \times (\mathbf{v} \times \mathbf{w}) = \langle -20, -67, -9 \rangle$.

(b) $\mathbf{u} \times \mathbf{v} = \langle -10, -14, 2 \rangle$, $(\mathbf{u} \times \mathbf{v}) \times \mathbf{w} = \langle -78, 52, -26 \rangle$.

(c) $(\mathbf{u} \times \mathbf{v}) \times (\mathbf{v} \times \mathbf{w}) = \langle -10, -14, 2 \rangle \times \langle -23, 7, -1 \rangle = \langle 0, -56, -392 \rangle$.

(d) $(\mathbf{v} \times \mathbf{w}) \times (\mathbf{u} \times \mathbf{v}) = \langle 0, 56, 392 \rangle$.

9. $\mathbf{u} \times \mathbf{v} = (\mathbf{i} + \mathbf{j}) \times (\mathbf{i} + \mathbf{j} + \mathbf{k}) = \mathbf{k} - \mathbf{j} - \mathbf{k} + \mathbf{i} = \mathbf{i} - \mathbf{j}$, the direction cosines are $\frac{1}{\sqrt{2}}, -\frac{1}{\sqrt{2}}, 0$.

10. $\mathbf{u} \times \mathbf{v} = 12\mathbf{i} + 30\mathbf{j} - 6\mathbf{k}$, so $\pm \left(\frac{2}{\sqrt{30}}\mathbf{i} + \frac{\sqrt{5}}{\sqrt{6}}\mathbf{j} - \frac{1}{\sqrt{30}}\mathbf{k} \right)$.

11. $\mathbf{n} = \overrightarrow{AB} \times \overrightarrow{AC} = \langle 1, 1, -3 \rangle \times \langle -1, 3, -1 \rangle = \langle 8, 4, 4 \rangle$, unit vectors are $\pm \frac{1}{\sqrt{6}}\langle 2, 1, 1 \rangle$.

12. A vector parallel to the yz -plane must be perpendicular to \mathbf{i} ; $\mathbf{i} \times (3\mathbf{i} - \mathbf{j} + 2\mathbf{k}) = -2\mathbf{j} - \mathbf{k}$, $\| -2\mathbf{j} - \mathbf{k} \| = \sqrt{5}$, the unit vectors are $\pm(2\mathbf{j} + \mathbf{k})/\sqrt{5}$.

13. True.

14. False; $(\mathbf{i} \times \mathbf{j}) \times \mathbf{j} = -\mathbf{k} \times \mathbf{j} = \mathbf{i}$, $\mathbf{i} \times (\mathbf{j} \times \mathbf{j}) = \mathbf{0}$.

15. False; let $\mathbf{v} = \langle 2, 1, -1 \rangle$, $\mathbf{u} = \langle 1, 3, -1 \rangle$, $\mathbf{w} = \langle -5, 0, 2 \rangle$, then $\mathbf{v} \times \mathbf{u} = \mathbf{v} \times \mathbf{w} = \langle 2, 1, 5 \rangle$, but $\mathbf{u} \neq \mathbf{w}$.

16. True; by Theorem 11.4.6(b); if one row of a determinant is a linear combination of the other two rows, then the determinant is zero. Equivalently, if $\mathbf{u} = a\mathbf{v} + b\mathbf{w}$ then \mathbf{u} lies in the plane of \mathbf{v} and \mathbf{w} and is thus perpendicular to their cross product.

17. $A = \|\mathbf{u} \times \mathbf{v}\| = \|-7\mathbf{i} - \mathbf{j} + 3\mathbf{k}\| = \sqrt{59}$.

18. $A = \|\mathbf{u} \times \mathbf{v}\| = \|-6\mathbf{i} + 4\mathbf{j} + 7\mathbf{k}\| = \sqrt{101}$.

19. $A = \frac{1}{2} \|\overrightarrow{PQ} \times \overrightarrow{PR}\| = \frac{1}{2} \|\langle -1, -5, 2 \rangle \times \langle 2, 0, 3 \rangle\| = \frac{1}{2} \|\langle -15, 7, 10 \rangle\| = \sqrt{374}/2$.

20. $A = \frac{1}{2} \|\overrightarrow{PQ} \times \overrightarrow{PR}\| = \frac{1}{2} \|\langle -1, 4, 8 \rangle \times \langle 5, 2, 12 \rangle\| = \frac{1}{2} \|\langle 32, 52, -22 \rangle\| = 9\sqrt{13}$.

21. $(2\mathbf{i} - 3\mathbf{j} + \mathbf{k}) \cdot (8\mathbf{i} - 20\mathbf{j} + 4\mathbf{k}) = 80$.

22. $\langle 1, -2, 2 \rangle \cdot \langle -11, -8, 12 \rangle = 29$.

23. $\langle 2, 1, 0 \rangle \cdot \langle -3, 3, 12 \rangle = -3$.

24. $\mathbf{i} \cdot (\mathbf{i} - \mathbf{j}) = 1$.

25. $V = |\mathbf{u} \cdot (\mathbf{v} \times \mathbf{w})| = |-16| = 16$.

26. $V = |\mathbf{u} \cdot (\mathbf{v} \times \mathbf{w})| = |45| = 45$.

27. (a) $\mathbf{u} \cdot (\mathbf{v} \times \mathbf{w}) = 0$, yes. (b) $\mathbf{u} \cdot (\mathbf{v} \times \mathbf{w}) = 0$, yes. (c) $\mathbf{u} \cdot (\mathbf{v} \times \mathbf{w}) = 245$, no.

28. (a) $\mathbf{u} \cdot (\mathbf{w} \times \mathbf{v}) = -\mathbf{u} \cdot (\mathbf{v} \times \mathbf{w}) = -3$. (b) $(\mathbf{v} \times \mathbf{w}) \cdot \mathbf{u} = \mathbf{u} \cdot (\mathbf{v} \times \mathbf{w}) = 3$. (c) $\mathbf{w} \cdot (\mathbf{u} \times \mathbf{v}) = \mathbf{u} \cdot (\mathbf{v} \times \mathbf{w}) = 3$.

(d) $\mathbf{v} \cdot (\mathbf{u} \times \mathbf{w}) = \mathbf{u} \cdot (\mathbf{w} \times \mathbf{v}) = -3$. (e) $(\mathbf{u} \times \mathbf{w}) \cdot \mathbf{v} = \mathbf{u} \cdot (\mathbf{w} \times \mathbf{v}) = -3$. (f) $\mathbf{v} \cdot (\mathbf{w} \times \mathbf{w}) = \mathbf{v} \cdot \mathbf{0} = 0$.

29. (a) $V = |\mathbf{u} \cdot (\mathbf{v} \times \mathbf{w})| = |-9| = 9$.

(b) $A = \|\mathbf{u} \times \mathbf{w}\| = \|3\mathbf{i} - 8\mathbf{j} + 7\mathbf{k}\| = \sqrt{122}$.

(c) $\mathbf{v} \times \mathbf{w} = -3\mathbf{i} - \mathbf{j} + 2\mathbf{k}$ is perpendicular to the plane determined by \mathbf{v} and \mathbf{w} ; let θ be the angle between \mathbf{u} and $\mathbf{v} \times \mathbf{w}$, then $\cos \theta = \frac{\mathbf{u} \cdot (\mathbf{v} \times \mathbf{w})}{\|\mathbf{u}\| \|\mathbf{v} \times \mathbf{w}\|} = \frac{-9}{\sqrt{14}\sqrt{14}} = -9/14$, so the acute angle ϕ that \mathbf{u} makes with the plane determined by \mathbf{v} and \mathbf{w} is $\phi = \theta - \pi/2 = \sin^{-1}(9/14)$.

30. From the diagram, $d = \|\mathbf{u}\| \sin \theta = \frac{\|\mathbf{u}\| \|\mathbf{v}\| \sin \theta}{\|\mathbf{v}\|} = \frac{\|\mathbf{u} \times \mathbf{v}\|}{\|\mathbf{v}\|}$.

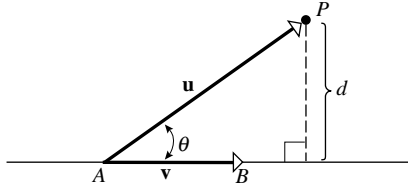

31. (a) $\mathbf{u} = \overrightarrow{AP} = -4\mathbf{i} + 2\mathbf{k}$, $\mathbf{v} = \overrightarrow{AB} = -3\mathbf{i} + 2\mathbf{j} - 4\mathbf{k}$, $\mathbf{u} \times \mathbf{v} = -4\mathbf{i} - 22\mathbf{j} - 8\mathbf{k}$; distance $= \|\mathbf{u} \times \mathbf{v}\| / \|\mathbf{v}\| = 2\sqrt{141/29}$.

(b) $\mathbf{u} = \overrightarrow{AP} = 2\mathbf{i} + 2\mathbf{j}$, $\mathbf{v} = \overrightarrow{AB} = -2\mathbf{i} + \mathbf{j}$, $\mathbf{u} \times \mathbf{v} = 6\mathbf{k}$; distance $= \|\mathbf{u} \times \mathbf{v}\| / \|\mathbf{v}\| = 6/\sqrt{5}$.

32. Take \mathbf{v} and \mathbf{w} as sides of the (triangular) base, then area of base $= \frac{1}{2} \|\mathbf{v} \times \mathbf{w}\|$ and height $= \|\text{proj}_{\mathbf{v} \times \mathbf{w}} \mathbf{u}\| = \frac{|\mathbf{u} \cdot (\mathbf{v} \times \mathbf{w})|}{\|\mathbf{v} \times \mathbf{w}\|}$ so $V = \frac{1}{3}$ (area of base) (height) $= \frac{1}{6} |\mathbf{u} \cdot (\mathbf{v} \times \mathbf{w})|$.

33. $\overrightarrow{PQ} = \langle 3, -1, -3 \rangle$, $\overrightarrow{PR} = \langle 2, -2, 1 \rangle$, $\overrightarrow{PS} = \langle 4, -4, 3 \rangle$, $V = \frac{1}{6} |\overrightarrow{PQ} \cdot (\overrightarrow{PR} \times \overrightarrow{PS})| = \frac{1}{6} |-4| = 2/3$.

34. (a) $\cos \theta = \frac{\mathbf{u} \cdot \mathbf{v}}{\|\mathbf{u}\| \|\mathbf{v}\|} = -\frac{23}{49}$.

(b) $\sin \theta = \frac{\|\mathbf{u} \times \mathbf{v}\|}{\|\mathbf{u}\| \|\mathbf{v}\|} = \frac{\|36\mathbf{i} - 24\mathbf{j}\|}{49} = \frac{12\sqrt{13}}{49}$.

(c) $\frac{23^2}{49^2} + \frac{144 \cdot 13}{49^2} = \frac{2401}{49^2} = 1$.

35. Since $\overrightarrow{AC} \cdot (\overrightarrow{AB} \times \overrightarrow{AD}) = \overrightarrow{AC} \cdot (\overrightarrow{AB} \times \overrightarrow{CD}) + \overrightarrow{AC} \cdot (\overrightarrow{AB} \times \overrightarrow{AC}) = \mathbf{0} + \mathbf{0} = \mathbf{0}$, the volume of the parallelepiped determined by \overrightarrow{AB} , \overrightarrow{AC} , and \overrightarrow{AD} is zero, thus A, B, C , and D are coplanar (lie in the same plane). Since $\overrightarrow{AB} \times \overrightarrow{CD} \neq \mathbf{0}$, the lines are not parallel. Hence they must intersect.

36. The points P lie on the plane determined by A, B and C .

37. From Theorems 11.3.3 and 11.4.5a it follows that $\sin \theta = \cos \theta$, so $\theta = \pi/4$.

38. $\|\mathbf{u} \times \mathbf{v}\|^2 = \|\mathbf{u}\|^2 \|\mathbf{v}\|^2 \sin^2 \theta = \|\mathbf{u}\|^2 \|\mathbf{v}\|^2 (1 - \cos^2 \theta) = \|\mathbf{u}\|^2 \|\mathbf{v}\|^2 - (\mathbf{u} \cdot \mathbf{v})^2$.

39. (a) $\mathbf{F} = 10\mathbf{j}$ and $\overrightarrow{PQ} = \mathbf{i} + \mathbf{j} + \mathbf{k}$, so the vector moment of \mathbf{F} about P is $\overrightarrow{PQ} \times \mathbf{F} = \begin{vmatrix} \mathbf{i} & \mathbf{j} & \mathbf{k} \\ 1 & 1 & 1 \\ 0 & 10 & 0 \end{vmatrix} = -10\mathbf{i} + 10\mathbf{k}$,

and the scalar moment is $10\sqrt{2}$ lb-ft. The direction of rotation of the cube about P is counterclockwise looking along $\overrightarrow{PQ} \times \mathbf{F} = -10\mathbf{i} + 10\mathbf{k}$ toward its initial point.

(b) $\mathbf{F} = 10\mathbf{j}$ and $\overrightarrow{PQ} = \mathbf{j} + \mathbf{k}$, so the vector moment of \mathbf{F} about P is $\overrightarrow{PQ} \times \mathbf{F} = \begin{vmatrix} \mathbf{i} & \mathbf{j} & \mathbf{k} \\ 0 & 1 & 1 \\ 0 & 10 & 0 \end{vmatrix} = -10\mathbf{i}$, and the

scalar moment is 10 lb·ft. The direction of rotation of the cube about P is counterclockwise looking along $-10\mathbf{i}$ toward its initial point.

(c) $\mathbf{F} = 10\mathbf{j}$ and $\vec{PQ} = \mathbf{j}$, so the vector moment of \mathbf{F} about P is $\vec{PQ} \times \mathbf{F} = \begin{vmatrix} \mathbf{i} & \mathbf{j} & \mathbf{k} \\ 0 & 1 & 0 \\ 0 & 10 & 0 \end{vmatrix} = \mathbf{0}$, and the scalar moment is 0 lb·ft. Since the force is parallel to the direction of motion, there is no rotation about P .

40. (a) $\mathbf{F} = \frac{1000}{\sqrt{2}}(-\mathbf{i} + \mathbf{k})$ and $\vec{PQ} = 2\mathbf{j} - \mathbf{k}$, so the vector moment of \mathbf{F} about P is $\vec{PQ} \times \mathbf{F} = 500\sqrt{2} \begin{vmatrix} \mathbf{i} & \mathbf{j} & \mathbf{k} \\ 0 & 2 & -1 \\ -1 & 0 & 1 \end{vmatrix} = 500\sqrt{2}(2\mathbf{i} + \mathbf{j} + 2\mathbf{k})$, and the scalar moment is $1500\sqrt{2}$ N·m.

(b) The direction angles of the vector moment of \mathbf{F} about the point P are $\cos^{-1}(2/3) \approx 48^\circ$, $\cos^{-1}(1/3) \approx 71^\circ$, and $\cos^{-1}(2/3) \approx 48^\circ$.

41. Take the center of the bolt as the origin of the plane. Then \mathbf{F} makes an angle 72° with the positive x -axis, so $\mathbf{F} = 200 \cos 72^\circ \mathbf{i} + 200 \sin 72^\circ \mathbf{j}$ and $\vec{PQ} = 0.2 \mathbf{i} + 0.03 \mathbf{j}$. The scalar moment is given by $\left| \begin{vmatrix} \mathbf{i} & \mathbf{j} & \mathbf{k} \\ 0.2 & 0.03 & 0 \\ 200 \cos 72^\circ & 200 \sin 72^\circ & 0 \end{vmatrix} \right| = \left| 40 \frac{1}{4}(\sqrt{5} - 1) - 6 \frac{1}{4} \sqrt{10 + 2\sqrt{5}} \right| \approx 36.1882$ N·m.

42. Part (b): let $\mathbf{u} = \langle u_1, u_2, u_3 \rangle$, $\mathbf{v} = \langle v_1, v_2, v_3 \rangle$, and $\mathbf{w} = \langle w_1, w_2, w_3 \rangle$; show that $\mathbf{u} \times (\mathbf{v} + \mathbf{w})$ and $(\mathbf{u} \times \mathbf{v}) + (\mathbf{u} \times \mathbf{w})$ are the same.

Part (c): $(\mathbf{u} + \mathbf{v}) \times \mathbf{w} = -[\mathbf{w} \times (\mathbf{u} + \mathbf{v})]$ (from Part (a)) = $-[(\mathbf{w} \times \mathbf{u}) + (\mathbf{w} \times \mathbf{v})]$ (from Part (b)) = $(\mathbf{u} \times \mathbf{w}) + (\mathbf{v} \times \mathbf{w})$ (from Part (a)).

43. Let $\mathbf{u} = \langle u_1, u_2, u_3 \rangle$ and $\mathbf{v} = \langle v_1, v_2, v_3 \rangle$; show that $k(\mathbf{u} \times \mathbf{v})$, $(k\mathbf{u}) \times \mathbf{v}$, and $\mathbf{u} \times (k\mathbf{v})$ are all the same; Part (e) is proved in a similar fashion.

44. Suppose the first two rows are interchanged. Then by definition,

$$\begin{vmatrix} b_1 & b_2 & b_3 \\ a_1 & a_2 & a_3 \\ c_1 & c_2 & c_3 \end{vmatrix} = b_1 \begin{vmatrix} a_2 & a_3 \\ c_2 & c_3 \end{vmatrix} - b_2 \begin{vmatrix} a_1 & a_3 \\ c_1 & c_3 \end{vmatrix} + b_3 \begin{vmatrix} a_1 & a_2 \\ c_1 & c_2 \end{vmatrix} = b_1(a_2c_3 - a_3c_2) - b_2(a_1c_3 - a_3c_1) + b_3(a_1c_2 - a_2c_1),$$

which is the negative of the right hand side of (2) after expansion. If two other rows were to be exchanged, a similar proof would hold. Finally, suppose Δ were a determinant with two identical rows. Then the value is unchanged if we interchange those two rows, yet $\Delta = -\Delta$ by Part (b) of Theorem 12.4.1. Hence $\Delta = -\Delta$, $\Delta = 0$.

45. $-8\mathbf{i} - 8\mathbf{k}$, $-8\mathbf{i} - 20\mathbf{j} + 2\mathbf{k}$. In the first triple, \mathbf{u} is 'outer' because it's not inside the parentheses, \mathbf{v} is 'adjacent' because it lies next to \mathbf{u} and \mathbf{w} (typographically speaking), and \mathbf{w} is 'remote' because it's inside the parentheses far from \mathbf{u} . In the second triple product, \mathbf{w} is 'outer', \mathbf{u} is 'remote' and \mathbf{v} is 'adjacent'.

46. (a) From the first formula in Exercise 45, it follows that $\mathbf{u} \times (\mathbf{v} \times \mathbf{w})$ is a linear combination of \mathbf{v} and \mathbf{w} and hence lies in the plane determined by them, and from the second formula it follows that $(\mathbf{u} \times \mathbf{v}) \times \mathbf{w}$ is a linear combination of \mathbf{u} and \mathbf{v} and hence lies in their plane.

(b) $\mathbf{u} \times (\mathbf{v} \times \mathbf{w})$ is orthogonal to $\mathbf{v} \times \mathbf{w}$ and hence lies in the plane of \mathbf{v} and \mathbf{w} ; similarly for $(\mathbf{u} \times \mathbf{v}) \times \mathbf{w}$.

47. (a) Replace \mathbf{u} with $\mathbf{a} \times \mathbf{b}$, \mathbf{v} with \mathbf{c} , and \mathbf{w} with \mathbf{d} in the first formula of Exercise 41.

(b) From the second formula of Exercise 41, $(\mathbf{a} \times \mathbf{b}) \times \mathbf{c} + (\mathbf{b} \times \mathbf{c}) \times \mathbf{a} + (\mathbf{c} \times \mathbf{a}) \times \mathbf{b} = (\mathbf{c} \cdot \mathbf{a})\mathbf{b} - (\mathbf{c} \cdot \mathbf{b})\mathbf{a} + (\mathbf{a} \cdot \mathbf{b})\mathbf{c} - (\mathbf{a} \cdot \mathbf{c})\mathbf{b} + (\mathbf{b} \cdot \mathbf{c})\mathbf{a} - (\mathbf{b} \cdot \mathbf{a})\mathbf{c} = \mathbf{0}$.

48. If \mathbf{a} , \mathbf{b} , \mathbf{c} , and \mathbf{d} lie in the same plane then $\mathbf{a} \times \mathbf{b}$ and $\mathbf{c} \times \mathbf{d}$ are parallel so $(\mathbf{a} \times \mathbf{b}) \times (\mathbf{c} \times \mathbf{d}) = \mathbf{0}$.
49. Let \mathbf{u} and \mathbf{v} be the vectors from a point on the curve to the points $(2, -1, 0)$ and $(3, 2, 2)$, respectively. Then $\mathbf{u} = (2-x)\mathbf{i} + (-1-\ln x)\mathbf{j}$ and $\mathbf{v} = (3-x)\mathbf{i} + (2-\ln x)\mathbf{j} + 2\mathbf{k}$. The area of the triangle is given by $A = (1/2)\|\mathbf{u} \times \mathbf{v}\|$; solve $dA/dx = 0$ for x to get $x = 2.091581$. The minimum area is 1.887850.
50. $\overrightarrow{PQ'} \times \mathbf{F} = \overrightarrow{PQ} \times \mathbf{F} + \overrightarrow{QQ'} \times \mathbf{F} = \overrightarrow{PQ} \times \mathbf{F}$, since \mathbf{F} and $\overrightarrow{QQ'}$ are parallel.

Exercise Set 11.5

In many of the exercises in this section other answers are also possible.

1. (a) $L_1: P(1, 0), \mathbf{v} = \mathbf{j}, x = 1, y = t; L_2: P(0, 1), \mathbf{v} = \mathbf{i}, x = t, y = 1; L_3: P(0, 0), \mathbf{v} = \mathbf{i} + \mathbf{j}, x = t, y = t$.
- (b) $L_1: P(1, 1, 0), \mathbf{v} = \mathbf{k}, x = 1, y = 1, z = t; L_2: P(0, 1, 1), \mathbf{v} = \mathbf{i}, x = t, y = 1, z = 1; L_3: P(1, 0, 1), \mathbf{v} = \mathbf{j}, x = 1, y = t, z = 1; L_4: P(0, 0, 0), \mathbf{v} = \mathbf{i} + \mathbf{j} + \mathbf{k}, x = t, y = t, z = t$.
2. (a) $L_1: x = t, y = 1, 0 \leq t \leq 1; L_2: x = 1, y = t, 0 \leq t \leq 1; L_3: x = t, y = t, 0 \leq t \leq 1$.
- (b) $L_1: x = 1, y = 1, z = t, 0 \leq t \leq 1; L_2: x = t, y = 1, z = 1, 0 \leq t \leq 1; L_3: x = 1, y = t, z = 1, 0 \leq t \leq 1; L_4: x = t, y = t, z = t, 0 \leq t \leq 1$.
3. (a) $\overrightarrow{P_1P_2} = \langle 2, 3 \rangle$ so $x = 3 + 2t, y = -2 + 3t$ for the line; for the line segment add the condition $0 \leq t \leq 1$.
- (b) $\overrightarrow{P_1P_2} = \langle -3, 6, 1 \rangle$ so $x = 5 - 3t, y = -2 + 6t, z = 1 + t$ for the line; for the line segment add the condition $0 \leq t \leq 1$.
4. (a) $\overrightarrow{P_1P_2} = \langle -3, -5 \rangle$ so $x = -3t, y = 1 - 5t$ for the line; for the line segment add the condition $0 \leq t \leq 1$.
- (b) $\overrightarrow{P_1P_2} = \langle 0, 0, -3 \rangle$ so $x = -1, y = 3, z = 5 - 3t$ for the line; for the line segment add the condition $0 \leq t \leq 1$.
5. (a) $x = 2 + t, y = -3 - 4t$. (b) $x = t, y = -t, z = 1 + t$.
6. (a) $x = 3 + 2t, y = -4 + t$. (b) $x = -1 - t, y = 3t, z = 2$.
7. (a) $\mathbf{r}_0 = 2\mathbf{i} - \mathbf{j}$ so $P(2, -1)$ is on the line, and $\mathbf{v} = 4\mathbf{i} - \mathbf{j}$ is parallel to the line.
- (b) At $t = 0, P(-1, 2, 4)$ is on the line, and $\mathbf{v} = 5\mathbf{i} + 7\mathbf{j} - 8\mathbf{k}$ is parallel to the line.
8. (a) At $t = 0, P(-1, 5)$ is on the line, and $\mathbf{v} = 2\mathbf{i} + 3\mathbf{j}$ is parallel to the line.
- (b) $\mathbf{r}_0 = \mathbf{i} + \mathbf{j} - 2\mathbf{k}$ so $P(1, 1, -2)$ is on the line, and $\mathbf{v} = \mathbf{j}$ is parallel to the line.
9. (a) $\langle x, y \rangle = \langle -3, 4 \rangle + t\langle 1, 5 \rangle; \mathbf{r} = -3\mathbf{i} + 4\mathbf{j} + t(\mathbf{i} + 5\mathbf{j})$.
- (b) $\langle x, y, z \rangle = \langle 2, -3, 0 \rangle + t\langle -1, 5, 1 \rangle; \mathbf{r} = 2\mathbf{i} - 3\mathbf{j} + t(-\mathbf{i} + 5\mathbf{j} + \mathbf{k})$.
10. (a) $\langle x, y \rangle = \langle 0, -2 \rangle + t\langle 1, 1 \rangle; \mathbf{r} = -2\mathbf{j} + t(\mathbf{i} + \mathbf{j})$.
- (b) $\langle x, y, z \rangle = \langle 1, -7, 4 \rangle + t\langle 1, 3, -5 \rangle; \mathbf{r} = \mathbf{i} - 7\mathbf{j} + 4\mathbf{k} + t(\mathbf{i} + 3\mathbf{j} - 5\mathbf{k})$.
11. False; $x = t, y = 0, z = 0$ is not parallel to $x = 0, y = 1 + t, z = 0$, nor do they intersect.

12. True: \mathbf{v}_0 is parallel to L_0 is parallel to L_1 is parallel to \mathbf{v}_1 , so \mathbf{v}_0 is parallel to \mathbf{v}_1 . Since they are nonzero vectors, each is a scalar multiple of the other.
13. False; if (x, y, z) is the point of intersection then there exists t_0 such that $x = x_0 + a_0t_0, y = y_0 + b_0t_0, z = z_0 + c_0t_0$ and there exists t_1 such that $x = x_0 + a_0t_1, y = y_0 + b_0t_1, z = z_0 + c_0t_1$, but it is not necessary that $t_0 = t_1$.
14. True; for some $t_0, 0 = x_0 + a_0t_0, 0 = y_0 + b_0t_0, 0 = z_0 + c_0t_0$, so $\langle x_0, y_0, z_0 \rangle = -t_0 \langle a_0, b_0, c_0 \rangle$.
15. $x = -5 + 2t, y = 2 - 3t$.
16. $x = t, y = 3 - 2t$.
17. $2x + 2yy' = 0, y' = -x/y = -(3)/(-4) = 3/4, \mathbf{v} = 4\mathbf{i} + 3\mathbf{j}; x = 3 + 4t, y = -4 + 3t$.
18. $y' = 2x = 2(-2) = -4, \mathbf{v} = \mathbf{i} - 4\mathbf{j}; x = -2 + t, y = 4 - 4t$.
19. $x = -1 + 3t, y = 2 - 4t, z = 4 + t$.
20. $x = 2 - t, y = -1 + 2t, z = 5 + 7t$.
21. The line is parallel to the vector $\langle 2, -1, 2 \rangle$ so $x = -2 + 2t, y = -t, z = 5 + 2t$.
22. The line is parallel to the vector $\langle 1, 1, 0 \rangle$ so $x = t, y = t, z = 0$.
23. (a) $y = 0, 2 - t = 0, t = 2, x = 7$. (b) $x = 0, 1 + 3t = 0, t = -1/3, y = 7/3$.
- (c) $y = x^2, 2 - t = (1 + 3t)^2, 9t^2 + 7t - 1 = 0, t = \frac{-7 \pm \sqrt{85}}{18}, x = \frac{-1 \pm \sqrt{85}}{6}, y = \frac{43 \mp \sqrt{85}}{18}$.
24. $(4t)^2 + (3t)^2 = 25, 25t^2 = 25, t = \pm 1$, the line intersects the circle at $\pm \langle 4, 3 \rangle$.
25. (a) $z = 0$ when $t = 3$ so the point is $(-2, 10, 0)$. (b) $y = 0$ when $t = -2$ so the point is $(-2, 0, -5)$.
- (c) x is always -2 so the line does not intersect the yz -plane.
26. (a) $z = 0$ when $t = 4$ so the point is $(7, 7, 0)$. (b) $y = 0$ when $t = -3$ so the point is $(-7, 0, 7)$.
- (c) $x = 0$ when $t = 1/2$ so the point is $(0, 7/2, 7/2)$.
27. $(1 + t)^2 + (3 - t)^2 = 16, t^2 - 2t - 3 = 0, (t + 1)(t - 3) = 0; t = -1, 3$. The points of intersection are $(0, 4, -2)$ and $(4, 0, 6)$.
28. $2(3t) + 3(-1 + 2t) = 6, 12t = 9; t = 3/4$. The point of intersection is $(5/4, 9/4, 1/2)$.
29. The lines intersect if we can find values of t_1 and t_2 that satisfy the equations $2 + t_1 = 2 + t_2, 2 + 3t_1 = 3 + 4t_2$, and $3 + t_1 = 4 + 2t_2$. Solutions of the first two of these equations are $t_1 = -1, t_2 = -1$ which also satisfy the third equation so the lines intersect at $(1, -1, 2)$.
30. Solve the equations $-1 + 4t_1 = -13 + 12t_2, 3 + t_1 = 1 + 6t_2$, and $1 = 2 + 3t_2$. The third equation yields $t_2 = -1/3$ which when substituted into the first and second equations gives $t_1 = -4$ in both cases; the lines intersect at $(-17, -1, 1)$.
31. The lines are parallel, respectively, to the vectors $\langle 7, 1, -3 \rangle$ and $\langle -1, 0, 2 \rangle$. These vectors are not parallel so the lines are not parallel. The system of equations $1 + 7t_1 = 4 - t_2, 3 + t_1 = 6$, and $5 - 3t_1 = 7 + 2t_2$ has no solution so the lines do not intersect.

32. The vectors $\langle 8, -8, 10 \rangle$ and $\langle 8, -3, 1 \rangle$ are not parallel so the lines are not parallel. The lines do not intersect because the system of equations $2 + 8t_1 = 3 + 8t_2$, $6 - 8t_1 = 5 - 3t_2$, $10t_1 = 6 + t_2$ has no solution.
33. The lines are parallel, respectively, to the vectors $\mathbf{v}_1 = \langle -2, 1, -1 \rangle$ and $\mathbf{v}_2 = \langle -4, 2, -2 \rangle$; $\mathbf{v}_2 = 2\mathbf{v}_1$, \mathbf{v}_1 and \mathbf{v}_2 are parallel so the lines are parallel.
34. The lines are not parallel because the vectors $\langle 3, -2, 3 \rangle$ and $\langle 9, -6, 8 \rangle$ are not parallel.
35. $\overrightarrow{P_1P_2} = \langle 3, -7, -7 \rangle$, $\overrightarrow{P_2P_3} = \langle -9, -7, -3 \rangle$; these vectors are not parallel so the points do not lie on the same line.
36. $\overrightarrow{P_1P_2} = \langle 2, -4, -4 \rangle$, $\overrightarrow{P_2P_3} = \langle 1, -2, -2 \rangle$; $\overrightarrow{P_1P_2} = 2 \overrightarrow{P_2P_3}$ so the vectors are parallel and the points lie on the same line.
37. The point $(3, 1)$ is on both lines ($t = 0$ for L_1 , $t = 4/3$ for L_2), as well as the point $(-1, 9)$ ($t = 4$ for L_1 , $t = 0$ for L_2). An alternative method: if t_2 gives the point $\langle -1 + 3t_2, 9 - 6t_2 \rangle$ on the second line, then $t_1 = 4 - 3t_2$ yields the point $\langle 3 - (4 - 3t_2), 1 + 2(4 - 3t_2) \rangle = \langle -1 + 3t_2, 9 - 6t_2 \rangle$ on the first line, so each point of L_2 is a point of L_1 ; the converse is shown with $t_2 = (4 - t_1)/3$.
38. The point $(1, -2, 0)$ is on both lines ($t = 0$ for L_1 , $t = 1/2$ for L_2), as well as the point $(4, -1, 2)$ ($t = 1$ for L_1 , $t = 0$ for L_2). An alternative method: if t_1 gives the point $\langle 1 + 3t_1, -2 + t_1, 2t_1 \rangle$ on L_1 , then $t_2 = (1 - t_1)/2$ gives the point $\langle 4 - 6(1 - t_1)/2, -1 - 2(1 - t_1)/2, 2 - 4(1 - t_1)/2 \rangle = \langle 1 + 3t_1, -2 + t_1, 2t_1 \rangle$ on L_2 , so each point of L_1 is a point of L_2 ; the converse is shown with $t_1 = 1 - 2t_2$.
39. L passes through the tips of the vectors. $\langle x, y \rangle = \langle -1, 2 \rangle + t\langle 1, 1 \rangle$.

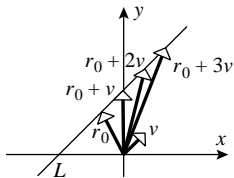

40. It passes through the tips of the vectors. $\langle x, y, z \rangle = \langle 0, 2, 1 \rangle + t\langle 1, 0, 1 \rangle$.

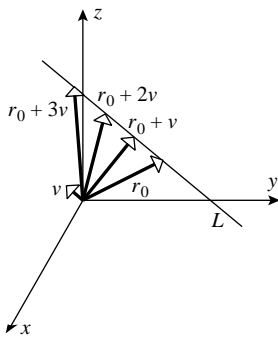

41. $\frac{1}{n}$ of the way from $\langle -2, 0 \rangle$ to $\langle 1, 3 \rangle$.

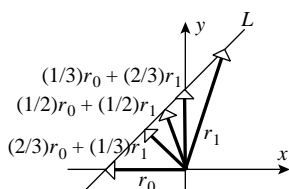

42. $\frac{1}{n}$ of the way from $\langle 2, 0, 4 \rangle$ to $\langle 0, 4, 0 \rangle$.

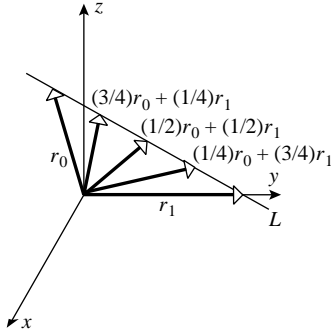

43. The line segment joining the points $(1,0)$ and $(-3,6)$.
44. The line segment joining the points $(-2,1,4)$ and $(7,1,1)$.
45. Let the desired point be $P(x_0, y_0)$; then $\vec{P_1P} = (2/5) \vec{P_1P_2}$, $\langle x_0 - 3, y_0 - 6 \rangle = (2/5)\langle 5, -10 \rangle = \langle 2, -4 \rangle$, so $x_0 = 5, y_0 = 2$.
46. Let the desired point be $P(x_0, y_0, z_0)$, then $\vec{P_1P} = (2/3) \vec{P_1P_2}$, $\langle x_0 - 1, y_0 - 4, z_0 + 3 \rangle = (2/3)\langle 0, 1, 2 \rangle = \langle 0, 2/3, 4/3 \rangle$; equate corresponding components to get $x_0 = 1, y_0 = 14/3, z_0 = -5/3$.
47. $A(3,0,1)$ and $B(2,1,3)$ are on the line, and (with the method of Exercise 11.3.32) $\vec{AP} = -5\mathbf{i} + \mathbf{j}, \vec{AB} = -\mathbf{i} + \mathbf{j} + 2\mathbf{k}$, $\|\text{proj}_{\vec{AB}} \vec{AP}\| = |\vec{AP} \cdot \vec{AB}| / \|\vec{AB}\| = \sqrt{6}$ and $\|\vec{AP}\| = \sqrt{26}$, so distance $= \sqrt{26 - 6} = 2\sqrt{5}$. Using the method of Exercise 11.4.30, distance $= \frac{\|\vec{AP} \times \vec{AB}\|}{\|\vec{AB}\|} = 2\sqrt{5}$.
48. $A(2,-1,0)$ and $B(3,-2,3)$ are on the line, and (with the method of Exercise 11.3.32) $\vec{AP} = -\mathbf{i} + 5\mathbf{j} - 3\mathbf{k}, \vec{AB} = \mathbf{i} - \mathbf{j} + 3\mathbf{k}$, $\|\text{proj}_{\vec{AB}} \vec{AP}\| = |\vec{AP} \cdot \vec{AB}| / \|\vec{AB}\| = \frac{15}{\sqrt{11}}$ and $\|\vec{AP}\| = \sqrt{35}$, so distance $= \sqrt{35 - 225/11} = 4\sqrt{10/11}$.
Using the method of Exercise 11.4.30, distance $= \frac{\|\vec{AP} \times \vec{AB}\|}{\|\vec{AB}\|} = 4\sqrt{10/11}$.
49. The vectors $\mathbf{v}_1 = -\mathbf{i} + 2\mathbf{j} + \mathbf{k}$ and $\mathbf{v}_2 = 2\mathbf{i} - 4\mathbf{j} - 2\mathbf{k}$ are parallel to the lines, $\mathbf{v}_2 = -2\mathbf{v}_1$ so \mathbf{v}_1 and \mathbf{v}_2 are parallel. Let $t = 0$ to get the points $P(2,0,1)$ and $Q(1,3,5)$ on the first and second lines, respectively. Let $\mathbf{u} = \vec{PQ} = -\mathbf{i} + 3\mathbf{j} + 4\mathbf{k}$, $\mathbf{v} = \frac{1}{2}\mathbf{v}_2 = \mathbf{i} - 2\mathbf{j} - \mathbf{k}$; $\mathbf{u} \times \mathbf{v} = 5\mathbf{i} + 3\mathbf{j} - \mathbf{k}$; by the method of Exercise 30 of Section 11.4, distance $= \|\mathbf{u} \times \mathbf{v}\| / \|\mathbf{v}\| = \sqrt{35/6}$.
50. The vectors $\mathbf{v}_1 = 2\mathbf{i} + 4\mathbf{j} - 6\mathbf{k}$ and $\mathbf{v}_2 = 3\mathbf{i} + 6\mathbf{j} - 9\mathbf{k}$ are parallel to the lines, $\mathbf{v}_2 = (3/2)\mathbf{v}_1$ so \mathbf{v}_1 and \mathbf{v}_2 are parallel. Let $t = 0$ to get the points $P(0,3,2)$ and $Q(1,0,0)$ on the first and second lines, respectively. Let $\mathbf{u} = \vec{PQ} = \mathbf{i} - 3\mathbf{j} - 2\mathbf{k}$, $\mathbf{v} = \frac{1}{2}\mathbf{v}_1 = \mathbf{i} + 2\mathbf{j} - 3\mathbf{k}$; $\mathbf{u} \times \mathbf{v} = 13\mathbf{i} + \mathbf{j} + 5\mathbf{k}$, distance $= \|\mathbf{u} \times \mathbf{v}\| / \|\mathbf{v}\| = \sqrt{195/14}$ (Exercise 30, Section 11.4).
51. (a) The line is parallel to the vector $\langle x_1 - x_0, y_1 - y_0, z_1 - z_0 \rangle$ so $x = x_0 + (x_1 - x_0)t, y = y_0 + (y_1 - y_0)t, z = z_0 + (z_1 - z_0)t$.
- (b) The line is parallel to the vector $\langle a, b, c \rangle$ so $x = x_1 + at, y = y_1 + bt, z = z_1 + ct$.
52. Solve each of the given parametric equations (2) for t to get $t = (x - x_0)/a, t = (y - y_0)/b, t = (z - z_0)/c$, so (x, y, z) is on the line if and only if $(x - x_0)/a = (y - y_0)/b = (z - z_0)/c$.
53. (a) It passes through the point $(1, -3, 5)$ and is parallel to $\mathbf{v} = 2\mathbf{i} + 4\mathbf{j} + \mathbf{k}$.

(b) $\langle x, y, z \rangle = \langle 1 + 2t, -3 + 4t, 5 + t \rangle$.

54. (a) Perpendicular, since $\langle 2, 1, 2 \rangle \cdot \langle -1, -2, 2 \rangle = 0$.

(b) $L_1: \langle x, y, z \rangle = \langle 1 + 2t, -\frac{3}{2} + t, -1 + 2t \rangle$; $L_2: \langle x, y, z \rangle = \langle 4 - t, 3 - 2t, -4 + 2t \rangle$.

(c) Solve simultaneously $1 + 2t_1 = 4 - t_2$, $-\frac{3}{2} + t_1 = 3 - 2t_2$, $-1 + 2t_1 = -4 + 2t_2$, solution $t_1 = \frac{1}{2}$, $t_2 = 2$, $x = 2$, $y = -1$, $z = 0$.

55. (a) Let $t = 3$ and $t = -2$, respectively, in the equations for L_1 and L_2 .

(b) $\mathbf{u} = 2\mathbf{i} - \mathbf{j} - 2\mathbf{k}$ and $\mathbf{v} = \mathbf{i} + 3\mathbf{j} - \mathbf{k}$ are parallel to L_1 and L_2 , $\cos \theta = \mathbf{u} \cdot \mathbf{v} / (\|\mathbf{u}\| \|\mathbf{v}\|) = 1 / (3\sqrt{11})$, $\theta \approx 84^\circ$.

(c) $\mathbf{u} \times \mathbf{v} = 7\mathbf{i} + 7\mathbf{k}$ is perpendicular to both L_1 and L_2 , and hence so is $\mathbf{i} + \mathbf{k}$, thus $x = 7 + t$, $y = -1$, $z = -2 + t$.

56. (a) Let $t = 1/2$ and $t = 1$, respectively, in the equations for L_1 and L_2 .

(b) $\mathbf{u} = 4\mathbf{i} - 2\mathbf{j} + 2\mathbf{k}$ and $\mathbf{v} = \mathbf{i} - \mathbf{j} + 4\mathbf{k}$ are parallel to L_1 and L_2 , $\cos \theta = \mathbf{u} \cdot \mathbf{v} / (\|\mathbf{u}\| \|\mathbf{v}\|) = 14 / \sqrt{432}$, $\theta \approx 48^\circ$.

(c) $\mathbf{u} \times \mathbf{v} = -6\mathbf{i} - 14\mathbf{j} - 2\mathbf{k}$ is perpendicular to both L_1 and L_2 , and hence so is $3\mathbf{i} + 7\mathbf{j} + \mathbf{k}$, thus $x = 2 + 3t$, $y = 7t$, $z = 3 + t$.

57. $Q(0, 1, 2)$ lies on the line L ($t = 0$) so $\mathbf{u} = \mathbf{j} - \mathbf{k}$ is a vector from Q to the point $P(0, 2, 1)$, $\mathbf{v} = 2\mathbf{i} - \mathbf{j} + \mathbf{k}$ is parallel to the given line (set $t = 0, 1$). Next, $\mathbf{u} \times \mathbf{v} = -2\mathbf{j} - 2\mathbf{k}$, and hence $\mathbf{w} = \mathbf{j} + \mathbf{k}$, are perpendicular to both lines, so $\mathbf{v} \times \mathbf{w} = -2\mathbf{i} - 2\mathbf{j} + 2\mathbf{k}$, and hence $\mathbf{i} + \mathbf{j} - \mathbf{k}$, is parallel to the line we seek. Thus $x = t$, $y = 2 + t$, $z = 1 - t$ are parametric equations of the line. $Q(-2/3, 4/3, 5/3)$ lies on both lines, so distance $= |PQ| = 2\sqrt{3}/3$.

58. $(-2, 4, 2)$ is on the given line ($t = 0$) so $\mathbf{u} = 5\mathbf{i} - 3\mathbf{j} - 4\mathbf{k}$ is a vector from this point to the point $(3, 1, -2)$, and $\mathbf{v} = 2\mathbf{i} + 2\mathbf{j} + \mathbf{k}$ is parallel to the given line. Hence $\mathbf{u} \times \mathbf{v} = 5\mathbf{i} - 13\mathbf{j} + 16\mathbf{k}$ is perpendicular to both lines so $\mathbf{v} \times (\mathbf{u} \times \mathbf{v}) = 45\mathbf{i} - 27\mathbf{j} - 36\mathbf{k}$, and hence $5\mathbf{i} - 3\mathbf{j} - 4\mathbf{k}$ is parallel to the line we seek. Thus $x = 3 + 5t$, $y = 1 - 3t$, $z = -2 - 4t$ are parametric equations of the line. Finally $Q(-2, 4, 2)$ lies on both lines, so the distance between the lines is $|PQ| = 5\sqrt{2}$.

59. (a) When $t = 0$ the bugs are at $(4, 1, 2)$ and $(0, 1, 1)$ so the distance between them is $\sqrt{4^2 + 0^2 + 1^2} = \sqrt{17}$ cm.

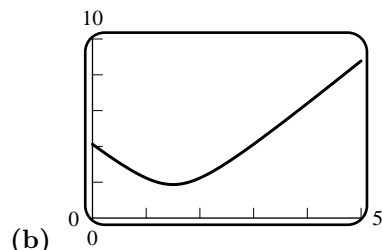

(c) The distance has a minimum value.

(d) Minimize D^2 instead of D (the distance between the bugs). $D^2 = [t - (4 - t)]^2 + [(1 + t) - (1 + 2t)]^2 + [(1 + 2t) - (2 + t)]^2 = 6t^2 - 18t + 17$, $d(D^2)/dt = 12t - 18 = 0$ when $t = 3/2$; the minimum distance is $\sqrt{6(3/2)^2 - 18(3/2) + 17} = \sqrt{14}/2$ cm.

60. The line intersects the xz -plane when $t = -1$, the xy -plane when $t = 3/2$. Along the line, $T = 25t^2(1 + t)(3 - 2t)$ for $-1 \leq t \leq 3/2$. Solve $dT/dt = 0$ for t to find that the maximum value of T is about 50.96 when $t \approx 1.073590$.

Exercise Set 11.6

1. $P_1 : z = 5, P_2 : x = 3, P_3 : y = 4.$
2. $P_1 : z = z_0, P_2 : x = x_0, P_3 : y = y_0.$
3. $(x - 2) + 4(y - 6) + 2(z - 1) = 0, x + 4y + 2z = 28.$
4. $-(x + 1) + 7(y + 1) + 6(z - 2) = 0, -x + 7y + 6z = 6.$
5. $0(x - 1) + 0(y - 0) + 1(z - 0) = 0, \text{ i.e. } z = 0.$
6. $2x - 3y - 4z = 0.$
7. $\mathbf{n} = \mathbf{i} - \mathbf{j}, P(0, 0, 0), x - y = 0.$
8. $\mathbf{n} = \mathbf{i} + \mathbf{j}, P(1, 0, 0), (x - 1) + y = 0, x + y = 1.$
9. $\mathbf{n} = \mathbf{j} + \mathbf{k}, P(0, 1, 0), (y - 1) + z = 0, y + z = 1.$
10. $\mathbf{n} = \mathbf{j} - \mathbf{k}, P(0, 0, 0), y - z = 0.$
11. $\vec{P_1P_2} \times \vec{P_1P_3} = \langle 2, 1, 2 \rangle \times \langle 3, -1, -2 \rangle = \langle 0, 10, -5 \rangle$, for convenience choose $\langle 0, 2, -1 \rangle$ which is also normal to the plane. Use any of the given points to get $2y - z = 1.$
12. $\vec{P_1P_2} \times \vec{P_1P_3} = \langle -1, -1, -2 \rangle \times \langle -4, 1, 1 \rangle = \langle 1, 9, -5 \rangle, x + 9y - 5z = 16.$
13. (a) Parallel, because $\langle 2, -8, -6 \rangle$ and $\langle -1, 4, 3 \rangle$ are parallel.
 (b) Perpendicular, because $\langle 3, -2, 1 \rangle$ and $\langle 4, 5, -2 \rangle$ are orthogonal.
 (c) Neither, because $\langle 1, -1, 3 \rangle$ and $\langle 2, 0, 1 \rangle$ are neither parallel nor orthogonal.
14. (a) Neither, because $\langle 3, -2, 1 \rangle$ and $\langle 6, -4, 3 \rangle$ are neither parallel nor orthogonal.
 (b) Parallel, because $\langle 4, -1, -2 \rangle$ and $\langle 1, -1/4, -1/2 \rangle$ are parallel.
 (c) Perpendicular, because $\langle 1, 4, 7 \rangle$ and $\langle 5, -3, 1 \rangle$ are orthogonal.
15. (a) Parallel, because $\langle 2, -1, -4 \rangle$ and $\langle 3, 2, 1 \rangle$ are orthogonal.
 (b) Neither, because $\langle 1, 2, 3 \rangle$ and $\langle 1, -1, 2 \rangle$ are neither parallel nor orthogonal.
 (c) Perpendicular, because $\langle 2, 1, -1 \rangle$ and $\langle 4, 2, -2 \rangle$ are parallel.
16. (a) Parallel, because $\langle -1, 1, -3 \rangle$ and $\langle 2, 2, 0 \rangle$ are orthogonal.
 (b) Perpendicular, because $\langle -2, 1, -1 \rangle$ and $\langle 6, -3, 3 \rangle$ are parallel.
 (c) Neither, because $\langle 1, -1, 1 \rangle$ and $\langle 1, 1, 1 \rangle$ are neither parallel nor orthogonal.
17. (a) $3t - 2t + t - 5 = 0, t = 5/2$ so $x = y = z = 5/2$, the point of intersection is $(5/2, 5/2, 5/2).$
 (b) $2(2 - t) + (3 + t) + t = 1$ has no solution so the line and plane do not intersect.

18. (a) $2(3t) - 5t + (-t) + 1 = 0$, $1 = 0$ has no solution so the line and the plane do not intersect.
- (b) $(1+t) - (-1+3t) + 4(2+4t) = 7$, $t = -3/14$ so $x = 1 - 3/14 = 11/14$, $y = -1 - 9/14 = -23/14$, $z = 2 - 12/14 = 8/7$, the point is $(11/14, -23/14, 8/7)$.
19. $\mathbf{n}_1 = \langle 1, 0, 0 \rangle$, $\mathbf{n}_2 = \langle 2, -1, 1 \rangle$, $\mathbf{n}_1 \cdot \mathbf{n}_2 = 2$, so $\cos \theta = \frac{\mathbf{n}_1 \cdot \mathbf{n}_2}{\|\mathbf{n}_1\| \|\mathbf{n}_2\|} = \frac{2}{\sqrt{1}\sqrt{6}} = 2/\sqrt{6}$, $\theta = \cos^{-1}(2/\sqrt{6}) \approx 35^\circ$.
20. $\mathbf{n}_1 = \langle 1, 2, -2 \rangle$, $\mathbf{n}_2 = \langle 6, -3, 2 \rangle$, $\mathbf{n}_1 \cdot \mathbf{n}_2 = -4$, so $\cos \theta = \frac{(-\mathbf{n}_1) \cdot \mathbf{n}_2}{\|-\mathbf{n}_1\| \|\mathbf{n}_2\|} = \frac{4}{(3)(7)} = 4/21$, $\theta = \cos^{-1}(4/21) \approx 79^\circ$.
(Note: $-\mathbf{n}_1$ is used instead of \mathbf{n}_1 to get a value of θ in the range $[0, \pi/2]$.)
21. True. (\pm)
22. True.
23. True.
24. True, see Theorem 11.6.2.
25. $\langle 4, -2, 7 \rangle$ is normal to the desired plane and $(0, 0, 0)$ is a point on it; $4x - 2y + 7z = 0$.
26. $\mathbf{v} = \langle 3, 2, -1 \rangle$ is parallel to the line and $\mathbf{n} = \langle 1, -2, 1 \rangle$ is normal to the given plane so $\mathbf{v} \times \mathbf{n} = \langle 0, -4, -8 \rangle$ is normal to the desired plane. Let $t = 0$ in the line to get $(-2, 4, 3)$ which is also a point on the desired plane, use this point and (for convenience) the normal $\langle 0, 1, 2 \rangle$ to find that $y + 2z = 10$.
27. Find two points P_1 and P_2 on the line of intersection of the given planes and then find an equation of the plane that contains P_1 , P_2 , and the given point $P_0(-1, 4, 2)$. Let (x_0, y_0, z_0) be on the line of intersection of the given planes; then $4x_0 - y_0 + z_0 - 2 = 0$ and $2x_0 + y_0 - 2z_0 - 3 = 0$, eliminate y_0 by addition of the equations to get $6x_0 - z_0 - 5 = 0$; if $x_0 = 0$ then $z_0 = -5$, if $x_0 = 1$ then $z_0 = 1$. Substitution of these values of x_0 and z_0 into either of the equations of the planes gives the corresponding values $y_0 = -7$ and $y_0 = 3$ so $P_1(0, -7, -5)$ and $P_2(1, 3, 1)$ are on the line of intersection of the planes. $\overrightarrow{P_0P_1} \times \overrightarrow{P_0P_2} = \langle 4, -13, 21 \rangle$ is normal to the desired plane whose equation is $4x - 13y + 21z = -14$.
28. $\langle 1, 2, -1 \rangle$ is parallel to the line and hence normal to the plane $x + 2y - z = 10$.
29. $\mathbf{n}_1 = \langle 2, 1, 1 \rangle$ and $\mathbf{n}_2 = \langle 1, 2, 1 \rangle$ are normals to the given planes, $\mathbf{n}_1 \times \mathbf{n}_2 = \langle -1, -1, 3 \rangle$ so $\langle 1, 1, -3 \rangle$ is normal to the desired plane whose equation is $x + y - 3z = 6$.
30. $\mathbf{n} = \langle 4, -1, 3 \rangle$ is normal to the given plane, $\overrightarrow{P_1P_2} = \langle 3, -1, -1 \rangle$ is parallel to the line through the given points, $\mathbf{n} \times \overrightarrow{P_1P_2} = \langle 4, 13, -1 \rangle$ is normal to the desired plane whose equation is $4x + 13y - z = 1$.
31. $\mathbf{n}_1 = \langle 2, -1, 1 \rangle$ and $\mathbf{n}_2 = \langle 1, 1, -2 \rangle$ are normals to the given planes, $\mathbf{n}_1 \times \mathbf{n}_2 = \langle 1, 5, 3 \rangle$ is normal to the desired plane whose equation is $x + 5y + 3z = -6$.
32. Let $t = 0$ and $t = 1$ to get the points $P_1(-1, 0, -4)$ and $P_2(0, 1, -2)$ that lie on the line. Denote the given point by P_0 , then $\overrightarrow{P_0P_1} \times \overrightarrow{P_0P_2} = \langle 7, -1, -3 \rangle$ is normal to the desired plane whose equation is $7x - y - 3z = 5$.
33. The plane is the perpendicular bisector of the line segment that joins $P_1(2, -1, 1)$ and $P_2(3, 1, 5)$. The midpoint of the line segment is $(5/2, 0, 3)$ and $\overrightarrow{P_1P_2} = \langle 1, 2, 4 \rangle$ is normal to the plane so an equation is $x + 2y + 4z = 29/2$.
34. $\mathbf{n}_1 = \langle 2, -1, 1 \rangle$ and $\mathbf{n}_2 = \langle 0, 1, 1 \rangle$ are normals to the given planes, $\mathbf{n}_1 \times \mathbf{n}_2 = \langle -2, -2, 2 \rangle$ so $\mathbf{n} = \langle 1, 1, -1 \rangle$ is parallel to the line of intersection of the planes. $\mathbf{v} = \langle 3, 1, 2 \rangle$ is parallel to the given line, $\mathbf{v} \times \mathbf{n} = \langle -3, 5, 2 \rangle$ so $\langle 3, -5, -2 \rangle$ is normal to the desired plane. Let $t = 0$ to find the point $(0, 1, 0)$ that lies on the given line and hence on the desired plane. An equation of the plane is $3x - 5y - 2z = -5$.

35. The line is parallel to the line of intersection of the planes if it is parallel to both planes. Normals to the given planes are $\mathbf{n}_1 = \langle 1, -4, 2 \rangle$ and $\mathbf{n}_2 = \langle 2, 3, -1 \rangle$ so $\mathbf{n}_1 \times \mathbf{n}_2 = \langle -2, 5, 11 \rangle$ is parallel to the line of intersection of the planes and hence parallel to the desired line whose equations are $x = 5 - 2t$, $y = 5t$, $z = -2 + 11t$.
36. (a) The equation of the plane is satisfied by the points on the line: $2(3t + 1) + (-5t) - (t) = 2$.
- (b) The vector $\langle 3, -5, 1 \rangle$ is a direction vector for the line and $\langle 1, 1, 2 \rangle$ is a normal to the plane; $\langle 3, -5, 1 \rangle \cdot \langle 1, 1, 2 \rangle = 0$, so the line is parallel to the plane. Fix t ; then the point $\langle 3t + 1, -5t, t \rangle$ satisfies $3t + 1 - 5t + 2t = 1$, i.e. it lies in the plane $x + y + 2z = 1$ which in turn lies above the given plane.
37. $\mathbf{v}_1 = \langle 1, 2, -1 \rangle$ and $\mathbf{v}_2 = \langle -1, -2, 1 \rangle$ are parallel, respectively, to the given lines and to each other so the lines are parallel. Let $t = 0$ to find the points $P_1(-2, 3, 4)$ and $P_2(3, 4, 0)$ that lie, respectively, on the given lines. $\mathbf{v}_1 \times \overrightarrow{P_1P_2} = \langle -7, -1, -9 \rangle$ so $\langle 7, 1, 9 \rangle$ is normal to the desired plane whose equation is $7x + y + 9z = 25$.
38. The system $4t_1 - 1 = 12t_2 - 13$, $t_1 + 3 = 6t_2 + 1$, $1 = 3t_2 + 2$ has the solution (Exercise 30, Section 11.5) $t_1 = -4$, $t_2 = -1/3$ so $(-17, -1, 1)$ is the point of intersection. $\mathbf{v}_1 = \langle 4, 1, 0 \rangle$ and $\mathbf{v}_2 = \langle 12, 6, 3 \rangle$ are (respectively) parallel to the lines, $\mathbf{v}_1 \times \mathbf{v}_2 = \langle 3, -12, 12 \rangle$ so $\langle 1, -4, 4 \rangle$ is normal to the desired plane whose equation is $x - 4y + 4z = -9$.
39. Denote the points by A, B, C , and D , respectively. The points lie in the same plane if $\overrightarrow{AB} \times \overrightarrow{AC}$ and $\overrightarrow{AB} \times \overrightarrow{AD}$ are parallel (method 1). $\overrightarrow{AB} \times \overrightarrow{AC} = \langle 0, -10, 5 \rangle$, $\overrightarrow{AB} \times \overrightarrow{AD} = \langle 0, 16, -8 \rangle$, these vectors are parallel because $\langle 0, -10, 5 \rangle = (-10/16)\langle 0, 16, -8 \rangle$. The points lie in the same plane if D lies in the plane determined by A, B, C (method 2), and since $\overrightarrow{AB} \times \overrightarrow{AC} = \langle 0, -10, 5 \rangle$, an equation of the plane is $-2y + z + 1 = 0$, $2y - z = 1$ which is satisfied by the coordinates of D .
40. The intercepts correspond to the points $A(a, 0, 0)$, $B(0, b, 0)$, and $C(0, 0, c)$. $\overrightarrow{AB} \times \overrightarrow{AC} = \langle bc, ac, ab \rangle$ is normal to the plane so $bcx + acy + abz = abc$ or $x/a + y/b + z/c = 1$.
41. $\mathbf{n}_1 = \langle -2, 3, 7 \rangle$ and $\mathbf{n}_2 = \langle 1, 2, -3 \rangle$ are normals to the planes, $\mathbf{n}_1 \times \mathbf{n}_2 = \langle -23, 1, -7 \rangle$ is parallel to the line of intersection. Let $z = 0$ in both equations and solve for x and y to get $x = -11/7$, $y = -12/7$ so $(-11/7, -12/7, 0)$ is on the line, a parametrization of which is $x = -11/7 - 23t$, $y = -12/7 + t$, $z = -7t$.
42. Similar to Exercise 41 with $\mathbf{n}_1 = \langle 3, -5, 2 \rangle$, $\mathbf{n}_2 = \langle 0, 0, 1 \rangle$, $\mathbf{n}_1 \times \mathbf{n}_2 = \langle -5, -3, 0 \rangle$. $z = 0$ so $3x - 5y = 0$, let $x = 0$ then $y = 0$ and $(0, 0, 0)$ is on the line, a parametrization of which is $x = -5t$, $y = -3t$, $z = 0$.
43. $D = |2(1) - 2(-2) + (3) - 4|/\sqrt{4 + 4 + 1} = 5/3$.
44. $D = |3(0) + 6(1) - 2(5) - 5|/\sqrt{9 + 36 + 4} = 9/7$.
45. $(0, 0, 0)$ is on the first plane so $D = |6(0) - 3(0) - 3(0) - 5|/\sqrt{36 + 9 + 9} = 5/\sqrt{54}$.
46. $(0, 0, 1)$ is on the first plane so $D = |(0) + (0) + (1) + 1|/\sqrt{1 + 1 + 1} = 2/\sqrt{3}$.
47. $(1, 3, 5)$ and $(4, 6, 7)$ are on L_1 and L_2 , respectively. $\mathbf{v}_1 = \langle 7, 1, -3 \rangle$ and $\mathbf{v}_2 = \langle -1, 0, 2 \rangle$ are, respectively, parallel to L_1 and L_2 , $\mathbf{v}_1 \times \mathbf{v}_2 = \langle 2, -11, 1 \rangle$ so the plane $2x - 11y + z + 51 = 0$ contains L_2 and is parallel to L_1 , $D = |2(1) - 11(3) + (5) + 51|/\sqrt{4 + 121 + 1} = 25/\sqrt{126}$.
48. $(3, 4, 1)$ and $(0, 3, 0)$ are on L_1 and L_2 , respectively. $\mathbf{v}_1 = \langle -1, 4, 2 \rangle$ and $\mathbf{v}_2 = \langle 1, 0, 2 \rangle$ are parallel to L_1 and L_2 , $\mathbf{v}_1 \times \mathbf{v}_2 = \langle 8, 4, -4 \rangle = 4\langle 2, 1, -1 \rangle$ so $2x + y - z - 3 = 0$ contains L_2 and is parallel to L_1 , $D = |2(3) + (4) - (1) - 3|/\sqrt{4 + 1 + 1} = \sqrt{6}$.
49. The distance between $(2, 1, -3)$ and the plane is $|2 - 3(1) + 2(-3) - 4|/\sqrt{1 + 9 + 4} = 11/\sqrt{14}$ which is the radius of the sphere; an equation is $(x - 2)^2 + (y - 1)^2 + (z + 3)^2 = 121/14$.

50. The vector $2\mathbf{i} + \mathbf{j} - \mathbf{k}$ is normal to the plane and hence parallel to the line so parametric equations of the line are $x = 3 + 2t$, $y = 1 + t$, $z = -t$. Substitution into the equation of the plane yields $2(3 + 2t) + (1 + t) - (-t) = 0$, $t = -7/6$; the point of intersection is $(2/3, -1/6, 7/6)$.
51. $\mathbf{v} = \langle 1, 2, -1 \rangle$ is parallel to the line, $\mathbf{n} = \langle 2, -2, -2 \rangle$ is normal to the plane, $\mathbf{v} \cdot \mathbf{n} = 0$ so \mathbf{v} is parallel to the plane because \mathbf{v} and \mathbf{n} are perpendicular. $(-1, 3, 0)$ is on the line so $D = |2(-1) - 2(3) - 2(0) + 3|/\sqrt{4 + 4 + 4} = 5/\sqrt{12}$.

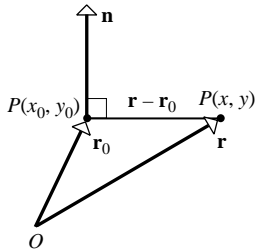

52. (a) O
- (b) $\mathbf{n} \cdot (\mathbf{r} - \mathbf{r}_0) = a(x - x_0) + b(y - y_0) = 0$.
- (c) See the proof of Theorem 11.6.1. Since a and b are not both zero, there is at least one point (x_0, y_0) that satisfies $ax + by + c = 0$, so $ax_0 + by_0 + c = 0$. If (x, y) also satisfies $ax + by + c = 0$ then, subtracting, $a(x - x_0) + b(y - y_0) = 0$, which is the equation of a line with $\mathbf{n} = \langle a, b \rangle$ as normal.
- (d) Let $Q(x_1, y_1)$ be a point on the line, and position the normal $\mathbf{n} = \langle a, b \rangle$, with length $\sqrt{a^2 + b^2}$, so that its initial point is at Q . The distance is the orthogonal projection of $\vec{QP}_0 = \langle x_0 - x_1, y_0 - y_1 \rangle$ onto \mathbf{n} . Then $D = \|\text{proj}_{\mathbf{n}} \vec{QP}_0\| = \left\| \frac{\vec{QP}_0 \cdot \mathbf{n}}{\|\mathbf{n}\|^2} \mathbf{n} \right\| = \frac{|ax_0 + by_0 + c|}{\sqrt{a^2 + b^2}}$.
- (e) $D = |2(-3) + (5) - 1|/\sqrt{4 + 1} = 2/\sqrt{5}$.
53. (a) If $\langle x_0, y_0, z_0 \rangle$ lies on the second plane, so that $ax_0 + by_0 + cz_0 + d_2 = 0$, then by Theorem 11.6.2, the distance between the planes is $D = \frac{|ax_0 + by_0 + cz_0 + d_1|}{\sqrt{a^2 + b^2 + c^2}} = \frac{|-d_2 + d_1|}{\sqrt{a^2 + b^2 + c^2}}$.
- (b) The distance between the planes $-2x + y + z = 0$ and $-2x + y + z + \frac{5}{3} = 0$ is $D = \frac{|0 - 5/3|}{\sqrt{4 + 1 + 1}} = \frac{5}{3\sqrt{6}}$.

Exercise Set 11.7

1. (a) Elliptic paraboloid, $a = 2, b = 3$. (b) Hyperbolic paraboloid, $a = 1, b = 5$.
- (c) Hyperboloid of one sheet, $a = b = c = 4$. (d) Circular cone, $a = b = 1$.
- (e) Elliptic paraboloid, $a = 2, b = 1$. (f) Hyperboloid of two sheets, $a = b = c = 1$.
2. (a) Ellipsoid, $a = \sqrt{2}, b = 2, c = \sqrt{3}$. (b) Hyperbolic paraboloid, $a = b = 1$.
- (c) Hyperboloid of one sheet, $a = 1, b = 3, c = 1$. (d) Hyperboloid of two sheets, $a = 1, b = 2, c = 1$.
- (e) Elliptic paraboloid, $a = \sqrt{2}, b = \sqrt{2}/2$. (f) Elliptic cone, $a = 2, b = \sqrt{3}$.

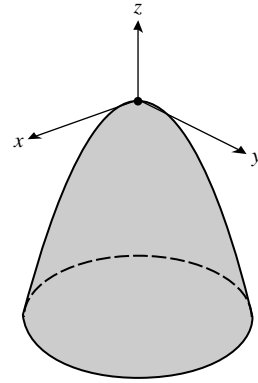

3. (a) $-z = x^2 + y^2$, circular paraboloid opening down the negative z -axis.

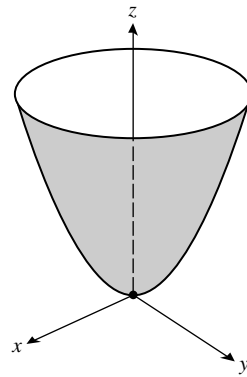

(b,c,d) $z = x^2 + y^2$, circular paraboloid, no change.

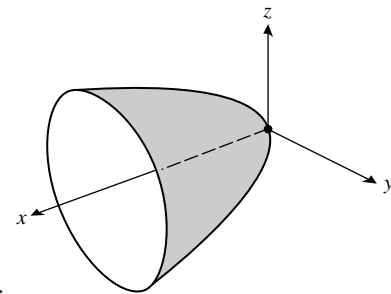

(e) $x = y^2 + z^2$, circular paraboloid opening along the positive x -axis.

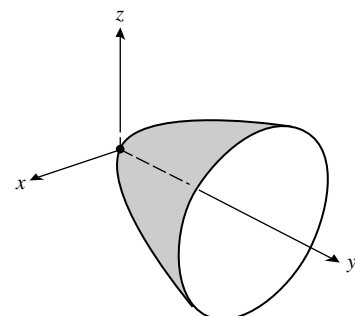

(f) $y = x^2 + z^2$, circular paraboloid opening along the positive y -axis.

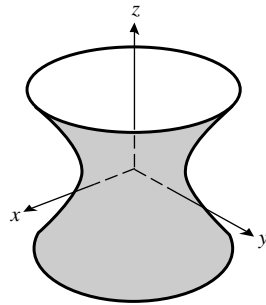

4. (a,b,c,d) $x^2 + y^2 - z^2 = 1$, no change.

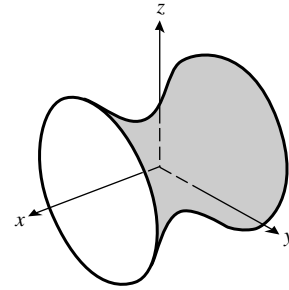

(e) $-x^2 + y^2 + z^2 = 1$, hyperboloid of one sheet with x -axis as axis.

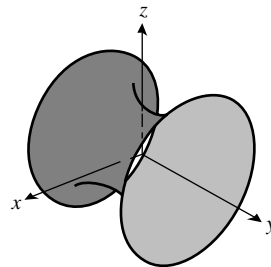

(f) $x^2 - y^2 + z^2 = 1$, hyperboloid of one sheet with y -axis as axis.

5. (a) Hyperboloid of one sheet, axis is y -axis. (b) Hyperboloid of two sheets separated by yz -plane.
 (c) Elliptic paraboloid opening along the positive x -axis. (d) Elliptic cone with x -axis as axis.
 (e) Hyperbolic paraboloid straddling the z -axis. (f) Paraboloid opening along the negative y -axis.

6. (a) Same. (b) Same. (c) Same. (d) Same. (e) $y = \frac{x^2}{a^2} - \frac{z^2}{c^2}$. (f) $y = \frac{x^2}{a^2} + \frac{z^2}{c^2}$.

7. (a) $x = 0 : \frac{y^2}{25} + \frac{z^2}{4} = 1; y = 0 : \frac{x^2}{9} + \frac{z^2}{4} = 1; z = 0 : \frac{x^2}{9} + \frac{y^2}{25} = 1$.

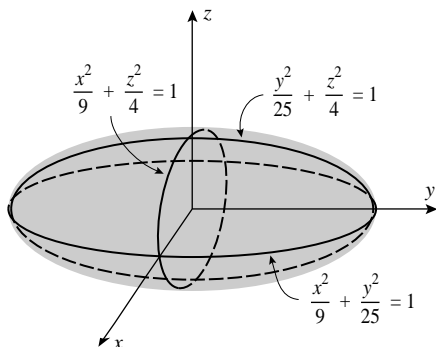

(b) $x = 0 : z = 4y^2; y = 0 : z = x^2; z = 0 : x = y = 0$.

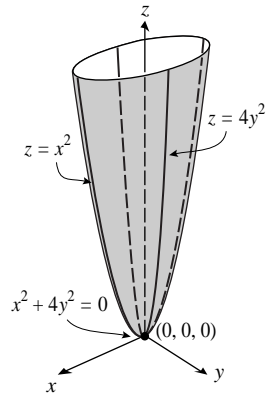

(c) $x = 0 : \frac{y^2}{16} - \frac{z^2}{4} = 1; y = 0 : \frac{x^2}{9} - \frac{z^2}{4} = 1; z = 0 : \frac{x^2}{9} + \frac{y^2}{16} = 1.$

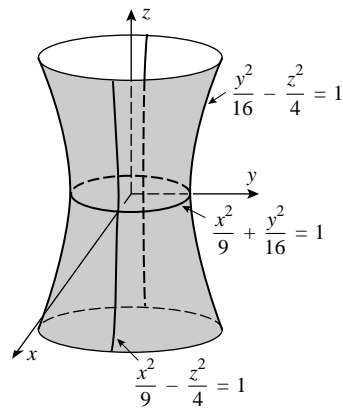

8. (a) $x = 0 : y = z = 0; y = 0 : x = 9z^2; z = 0 : x = y^2.$

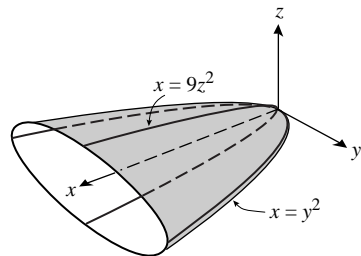

(b) $x = 0 : -y^2 + 4z^2 = 4; y = 0 : x^2 + z^2 = 1; z = 0 : 4x^2 - y^2 = 4$

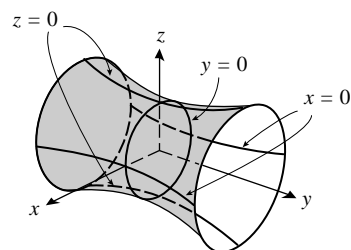

(c) $x = 0 : z = \pm \frac{y}{2}; y = 0 : z = \pm x; z = 0 : x = y = 0$

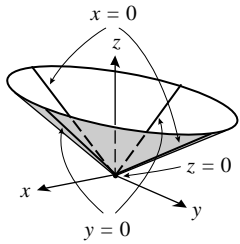

9. (a) $4x^2 + z^2 = 3$; ellipse. (b) $y^2 + z^2 = 3$; circle. (c) $y^2 + z^2 = 20$; circle.
- (d) $9x^2 - y^2 = 20$; hyperbola. (e) $z = 9x^2 + 16$; parabola. (f) $9x^2 + 4y^2 = 4$; ellipse.
10. (a) $y^2 - 4z^2 = 27$; hyperbola. (b) $9x^2 + 4z^2 = 25$; ellipse. (c) $9z^2 - x^2 = 4$; hyperbola.
- (d) $x^2 + 4y^2 = 9$; ellipse. (e) $z = 1 - 4y^2$; parabola. (f) $x^2 - 4y^2 = 4$; hyperbola.
11. False; 'quadric' surfaces are of second degree.
12. False; $(x - 1)^2 + y^2 + z^2 = 1/4$ has no solution if $x = y = 0$.
13. False.
14. True: $y = \pm(b/a)x$.

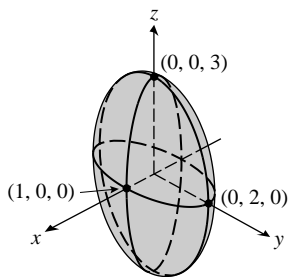

15. Ellipsoid

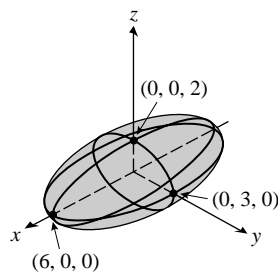

16. Ellipsoid

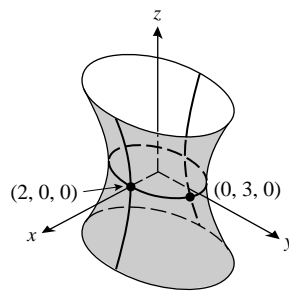

17. Hyperboloid of one sheet

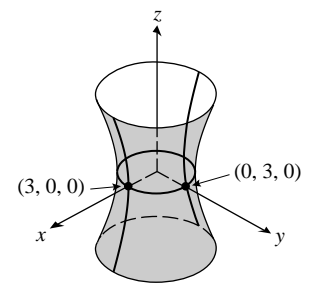

18. Hyperboloid of one sheet

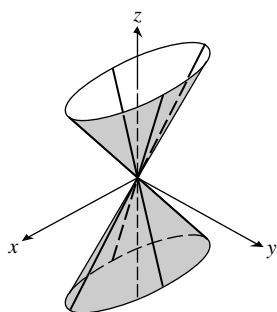

19. Elliptic cone

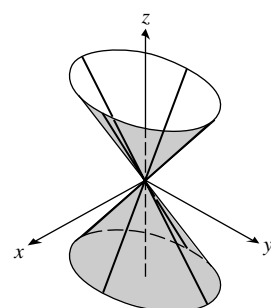

20. Elliptic cone

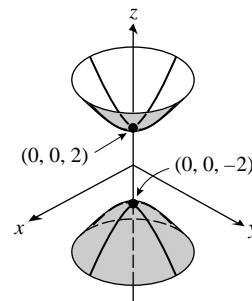

21. Hyperboloid of two sheets

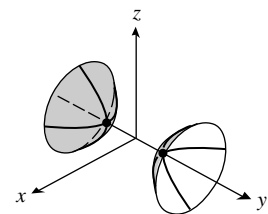

22. Hyperboloid of two sheets

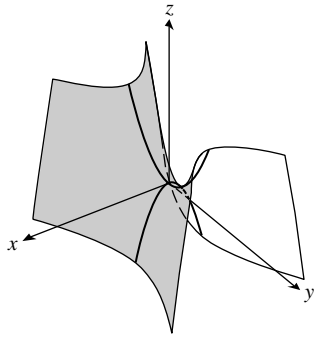

23. Hyperbolic paraboloid

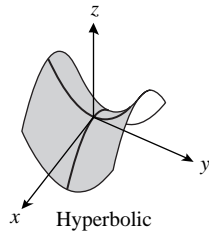

24. Hyperbolic paraboloid

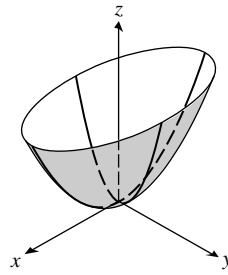

25. Elliptic paraboloid

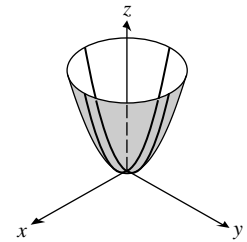

26. Circular paraboloid

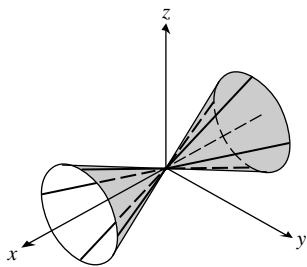

27. Circular cone

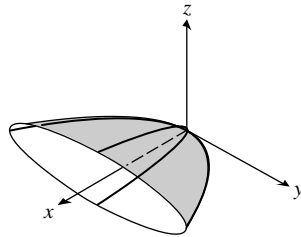

28. Elliptic paraboloid

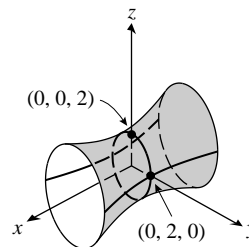

29. Hyperboloid of one sheet

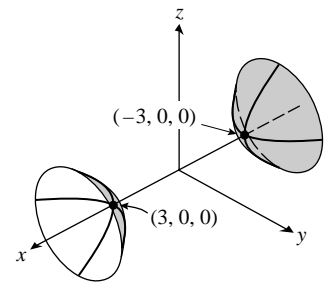

30. Hyperboloid of two sheets

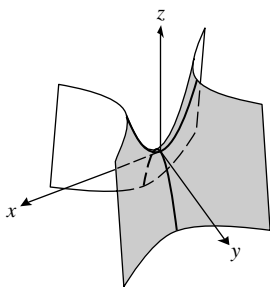

31. Hyperbolic paraboloid

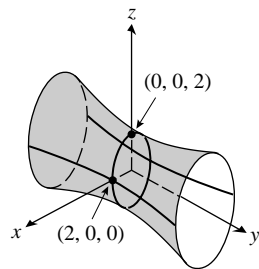

32. Hyperboloid of one sheet

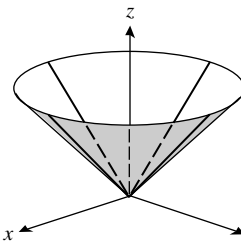

33.

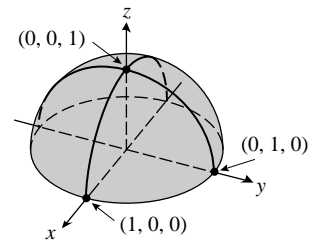

34.

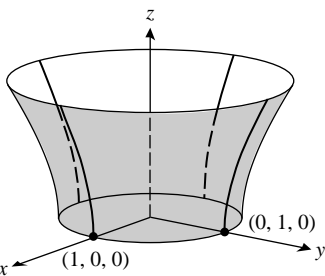

35.

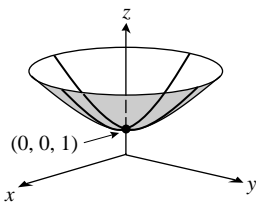

36.

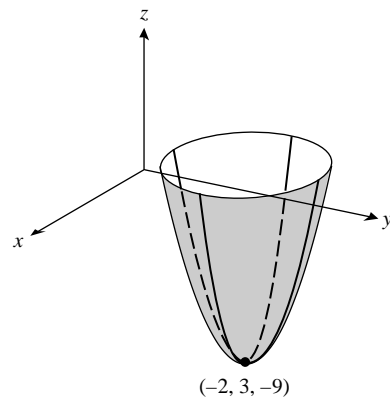

37. Circular paraboloid

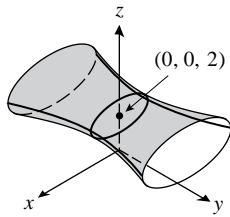

38. Hyperboloid of one sheet

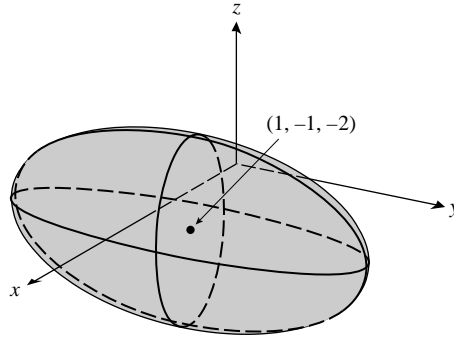

39. Ellipsoid

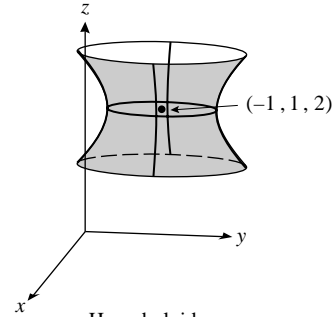

40. Hyperboloid of one sheet

41. (a) $\frac{x^2}{9} + \frac{y^2}{4} = 1$. (b) 6, 4. (c) $(\pm\sqrt{5}, 0, \sqrt{2})$. (d) The focal axis is parallel to the x -axis.
42. (a) $\frac{y^2}{4} + \frac{z^2}{2} = 1$. (b) $4, 2\sqrt{2}$. (c) $(3, \pm\sqrt{2}, 0)$. (d) The focal axis is parallel to the y -axis.
43. (a) $\frac{y^2}{4} - \frac{x^2}{4} = 1$. (b) $(0, \pm 2, 4)$. (c) $(0, \pm 2\sqrt{2}, 4)$. (d) The focal axis is parallel to the y -axis.
44. (a) $\frac{x^2}{4} - \frac{y^2}{4} = 1$. (b) $(\pm 2, 0, -4)$. (c) $(\pm 2\sqrt{2}, 0, -4)$. (d) The focal axis is parallel to the x -axis.
45. (a) $z + 4 = y^2$. (b) $(2, 0, -4)$. (c) $(2, 0, -15/4)$. (d) The focal axis is parallel to the z -axis.
46. (a) $z - 4 = -x^2$. (b) $(0, 2, 4)$. (c) $(0, 2, 15/4)$. (d) The focal axis is parallel to the z -axis.
47. $x^2 + y^2 = 4 - x^2 - y^2, x^2 + y^2 = 2$; circle of radius $\sqrt{2}$ in the plane $z = 2$, centered at $(0, 0, 2)$.

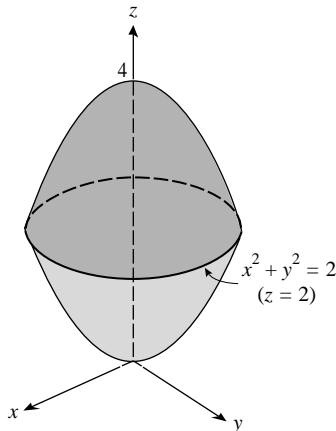

48. $3 = 2(x^2 + y^2) + z^2 = 2z + z^2, (z + 3)(z - 1) = 0$; circle $x^2 + y^2 = 1$ in the plane $z = 1$ (the root $z = -3$ is extraneous).

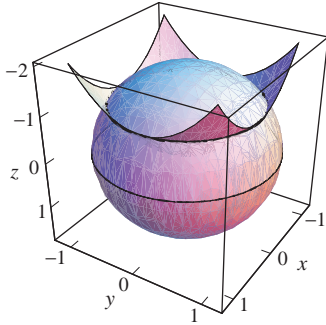

49. $y = 4(x^2 + z^2)$.
50. $y^2 = 4(x^2 + z^2)$.
51. $|z - (-1)| = \sqrt{x^2 + y^2 + (z - 1)^2}$, $z^2 + 2z + 1 = x^2 + y^2 + z^2 - 2z + 1$, $z = (x^2 + y^2)/4$; circular paraboloid.
52. $|z + 1| = 2\sqrt{x^2 + y^2 + (z - 1)^2}$, $z^2 + 2z + 1 = 4(x^2 + y^2 + z^2 - 2z + 1)$, $4x^2 + 4y^2 + 3z^2 - 10z + 3 = 0$, $\frac{x^2}{4/3} + \frac{y^2}{4/3} + \frac{(z - 5/3)^2}{16/9} = 1$; ellipsoid, center at $(0, 0, 5/3)$.
53. If $z = 0$, $\frac{x^2}{a^2} + \frac{y^2}{a^2} = 1$; if $y = 0$ then $\frac{x^2}{a^2} + \frac{z^2}{c^2} = 1$; since $c < a$ the major axis has length $2a$, the minor axis has length $2c$.
54. $\frac{x^2}{a^2} + \frac{y^2}{a^2} + \frac{z^2}{b^2} = 1$, where $a = 6378.1370$, $b = 6356.5231$.
55. Each slice perpendicular to the z -axis for $|z| < c$ is an ellipse whose equation is $\frac{x^2}{a^2} + \frac{y^2}{b^2} = \frac{c^2 - z^2}{c^2}$, or $\frac{x^2}{(a^2/c^2)(c^2 - z^2)} + \frac{y^2}{(b^2/c^2)(c^2 - z^2)} = 1$, the area of which is $\pi \left(\frac{a}{c} \sqrt{c^2 - z^2} \right) \left(\frac{b}{c} \sqrt{c^2 - z^2} \right) = \pi \frac{ab}{c^2} (c^2 - z^2)$
 so $V = 2 \int_0^c \pi \frac{ab}{c^2} (c^2 - z^2) dz = \frac{4}{3} \pi abc$.

Exercise Set 11.8

1. (a) $(8, \pi/6, -4)$ (b) $(5\sqrt{2}, 3\pi/4, 6)$ (c) $(2, \pi/2, 0)$ (d) $(8, 5\pi/3, 6)$
2. (a) $(2, 7\pi/4, 1)$ (b) $(1, \pi/2, 1)$ (c) $(4\sqrt{2}, 3\pi/4, -7)$ (d) $(2\sqrt{2}, 7\pi/4, -2)$
3. (a) $(2\sqrt{3}, 2, 3)$ (b) $(-4\sqrt{2}, 4\sqrt{2}, -2)$ (c) $(5, 0, 4)$ (d) $(-7, 0, -9)$
4. (a) $(3, -3\sqrt{3}, 7)$ (b) $(0, 1, 0)$ (c) $(0, 3, 5)$ (d) $(0, 4, -1)$
5. (a) $(2\sqrt{2}, \pi/3, 3\pi/4)$ (b) $(2, 7\pi/4, \pi/4)$ (c) $(6, \pi/2, \pi/3)$ (d) $(10, 5\pi/6, \pi/2)$
6. (a) $(8\sqrt{2}, \pi/4, \pi/6)$ (b) $(2\sqrt{2}, 5\pi/3, 3\pi/4)$ (c) $(2, 0, \pi/2)$ (d) $(4, \pi/6, \pi/6)$
7. (a) $(5\sqrt{6}/4, 5\sqrt{2}/4, 5\sqrt{2}/2)$ (b) $(7, 0, 0)$ (c) $(0, 0, 1)$ (d) $(0, -2, 0)$
8. (a) $(-\sqrt{2}/4, \sqrt{6}/4, -\sqrt{2}/2)$ (b) $(3\sqrt{2}/4, -3\sqrt{2}/4, -3\sqrt{3}/2)$ (c) $(2\sqrt{6}, 2\sqrt{2}, 4\sqrt{2})$ (d) $(0, 2\sqrt{3}, 2)$

9. (a) $(2\sqrt{3}, \pi/6, \pi/6)$ (b) $(\sqrt{2}, \pi/4, 3\pi/4)$ (c) $(2, 3\pi/4, \pi/2)$ (d) $(4\sqrt{3}, 1, 2\pi/3)$
10. (a) $(4\sqrt{2}, 5\pi/6, \pi/4)$ (b) $(2\sqrt{2}, 0, 3\pi/4)$ (c) $(5, \pi/2, \tan^{-1}(4/3))$ (d) $(2\sqrt{10}, \pi, \tan^{-1} 3)$
11. (a) $(5\sqrt{3}/2, \pi/4, -5/2)$ (b) $(0, 7\pi/6, -1)$ (c) $(0, 0, 3)$ (d) $(4, \pi/6, 0)$
12. (a) $(0, \pi/2, 5)$ (b) $(3\sqrt{2}, 0, -3\sqrt{2})$ (c) $(0, 3\pi/4, -\sqrt{2})$ (d) $(5/2, 2\pi/3, -5\sqrt{3}/2)$
15. True.
16. True.
17. True.
18. True.

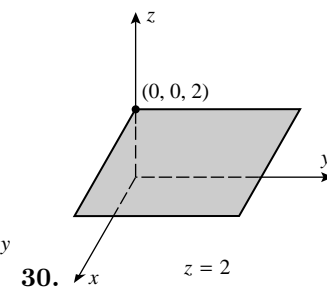
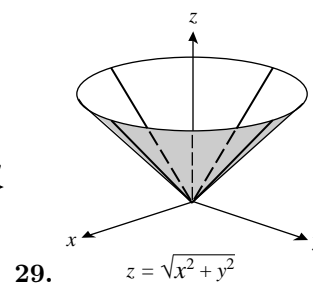
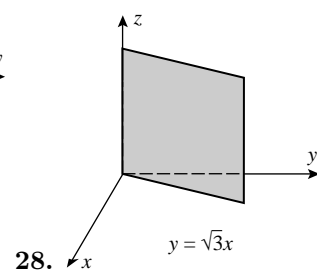
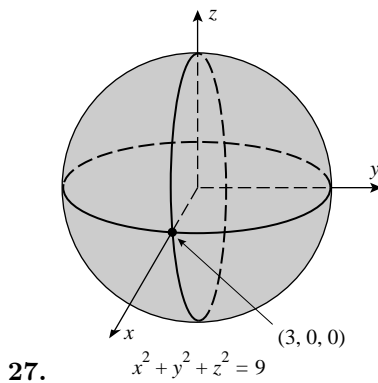
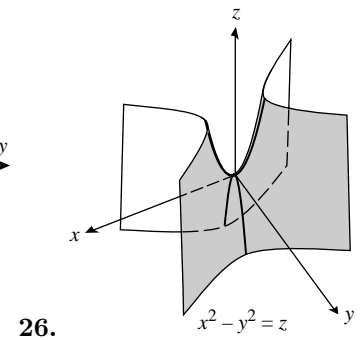
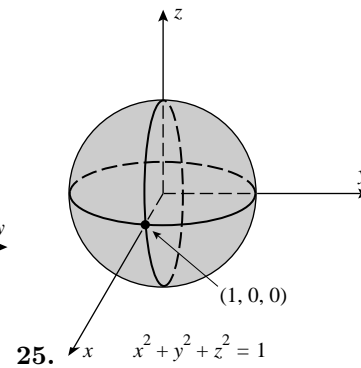
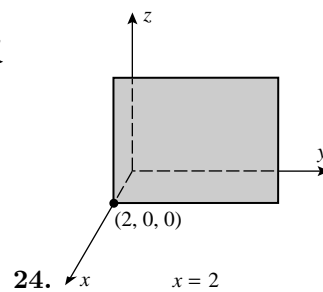
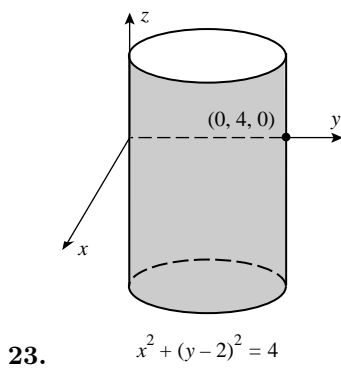
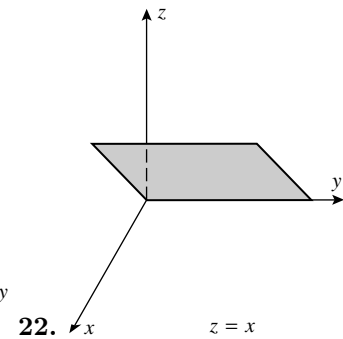
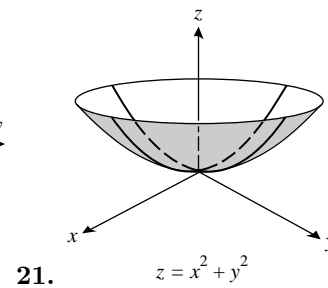
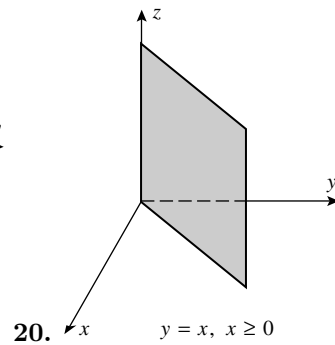
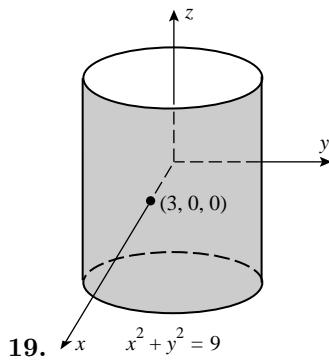

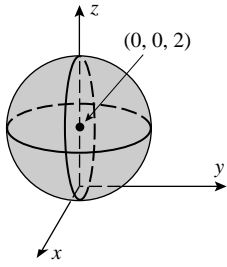

31. $x^2 + y^2 + (z - 2)^2 = 4$

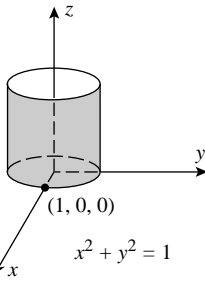

32. $x^2 + y^2 = 1$

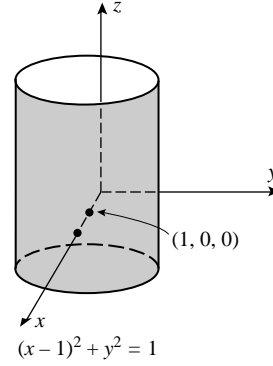

33. $(x - 1)^2 + y^2 = 1$

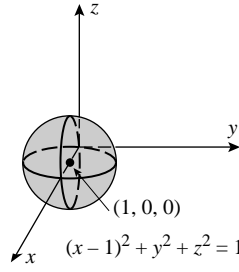

34. $(x - 1)^2 + y^2 + z^2 = 1$

35. (a) $z = 3$. (b) $\rho \cos \phi = 3, \rho = 3 \sec \phi$.

36. (a) $r \sin \theta = 2, r = 2 \csc \theta$. (b) $\rho \sin \phi \sin \theta = 2, \rho = 2 \csc \phi \csc \theta$.

37. (a) $z = 3r^2$. (b) $\rho \cos \phi = 3\rho^2 \sin^2 \phi, \rho = \frac{1}{3} \csc \phi \cot \phi$.

38. (a) $z = \sqrt{3}r$. (b) $\rho \cos \phi = \sqrt{3}\rho \sin \phi, \tan \phi = \frac{1}{\sqrt{3}}, \phi = \frac{\pi}{6}$.

39. (a) $r = 2$. (b) $\rho \sin \phi = 2, \rho = 2 \csc \phi$.

40. (a) $r^2 - 6r \sin \theta = 0, r = 6 \sin \theta$. (b) $\rho \sin \phi = 6 \sin \theta, \rho = 6 \sin \theta \csc \phi$.

41. (a) $r^2 + z^2 = 9$. (b) $\rho = 3$.

42. (a) $z^2 = r^2 \cos^2 \theta - r^2 \sin^2 \theta = r^2(\cos^2 \theta - \sin^2 \theta), z^2 = r^2 \cos 2\theta$.

(b) Use the result in part (a) with $r = \rho \sin \phi, z = \rho \cos \phi$ to get $\rho^2 \cos^2 \phi = \rho^2 \sin^2 \phi \cos 2\theta, \cot^2 \phi = \cos 2\theta$.

43. (a) $2r \cos \theta + 3r \sin \theta + 4z = 1$. (b) $2\rho \sin \phi \cos \theta + 3\rho \sin \phi \sin \theta + 4\rho \cos \phi = 1$.

44. (a) $r^2 - z^2 = 1$.

(b) Use the result of part (a) with $r = \rho \sin \phi, z = \rho \cos \phi$ to get $\rho^2 \sin^2 \phi - \rho^2 \cos^2 \phi = 1, \rho^2 \cos 2\phi = -1$.

45. (a) $r^2 \cos^2 \theta = 16 - z^2$.

(b) $x^2 = 16 - z^2, x^2 + y^2 + z^2 = 16 + y^2, \rho^2 = 16 + \rho^2 \sin^2 \phi \sin^2 \theta, \rho^2 (1 - \sin^2 \phi \sin^2 \theta) = 16$.

46. (a) $r^2 + z^2 = 2z$. (b) $\rho^2 = 2\rho \cos \phi, \rho = 2 \cos \phi$.

47. All points on or above the paraboloid $z = x^2 + y^2$, that are also on or below the plane $z = 4$.

48. A right circular cylindrical solid of height 3 and radius 1 whose axis is the line $x = 0, y = 1$.

49. All points on or between concentric spheres of radii 1 and 3 centered at the origin.

50. All points on or above the cone $\phi = \pi/6$, that are also on or below the sphere $\rho = 2$.

51. $\theta = \pi/6, \phi = \pi/6$, spherical $(4000, \pi/6, \pi/6)$, rectangular $(1000\sqrt{3}, 1000, 2000\sqrt{3})$.

52. (a) $y = r \sin \theta = a \sin \theta$, but $az = a \sin \theta$ so $y = az$, which is a plane that contains the curve of intersection of $z = \sin \theta$ and the circular cylinder $r = a$. The curve of intersection of a plane and a circular cylinder is an ellipse.

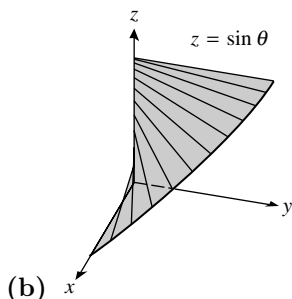

53. (a) $(10, \pi/2, 1)$ (b) $(0, 10, 1)$ (c) $(\sqrt{101}, \pi/2, \tan^{-1} 10)$

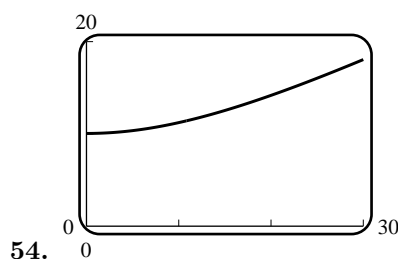

Chapter 11 Review Exercises

- (b) \mathbf{u} and \mathbf{v} are orthogonal if and only if $\mathbf{u} \cdot \mathbf{v} = 0$.

(c) \mathbf{u} and \mathbf{v} are parallel if and only if $\mathbf{u} = a\mathbf{v}$ or $\mathbf{v} = b\mathbf{u}$.

(d) \mathbf{u} , \mathbf{v} and \mathbf{w} lie in the same plane if and only if $\mathbf{u} \cdot (\mathbf{v} \times \mathbf{w}) = 0$.
- (a) E.g. \mathbf{i} and \mathbf{j} .

(b) For points A , B , C and D consider the vectors \vec{AB} , \vec{AC} and \vec{AD} , then apply Exercise 1.(d).

(c) $\mathbf{F} = -\mathbf{i} - \mathbf{j}$.

(d) $\|\langle 1, -2, 2 \rangle\| = 3$, so $\|\mathbf{r} - \langle 1, -2, 2 \rangle\| = 3$, or $(x-1)^2 + (y+2)^2 + (z-2)^2 = 9$.
- (b) $x = \cos 120^\circ = -1/2$, $y = \pm \sin 120^\circ = \pm\sqrt{3}/2$.

(d) True: $\|\mathbf{u} \times \mathbf{v}\| = \|\mathbf{u}\|\|\mathbf{v}\|\sin(\theta) = 1$.
- (b) Area of the parallelogram spanned by \mathbf{u} and \mathbf{v} .

(c) Volume of the parallelepiped spanned by \mathbf{u} , \mathbf{v} and \mathbf{w} .

(d) $x + 2y - z = 0$.
- $(x+3)^2 + (y-5)^2 + (z+4)^2 = r^2$, so

(a) $(x+3)^2 + (y-5)^2 + (z+4)^2 = 16$. (b) $(x+3)^2 + (y-5)^2 + (z+4)^2 = 25$. (c) $(x+3)^2 + (y-5)^2 + (z+4)^2 = 9$.

6. The sphere $x^2 + (y - 1)^2 + (z + 3)^2 = 16$ has center $Q(0, 1, -3)$ and radius 4, and $\|\vec{PQ}\| = \sqrt{1^2 + 4^2} = \sqrt{17}$, so minimum distance is $\sqrt{17} - 4$, maximum distance is $\sqrt{17} + 4$.
7. $\vec{OS} = \vec{OP} + \vec{PS} = 3\mathbf{i} + 4\mathbf{j} + \vec{QR} = 3\mathbf{i} + 4\mathbf{j} + (4\mathbf{i} + \mathbf{j}) = 7\mathbf{i} + 5\mathbf{j}$.
8. (a) $\langle 16, 0, 13 \rangle$ (b) $\langle 2/\sqrt{17}, -2/\sqrt{17}, 3/\sqrt{17} \rangle$ (c) $\sqrt{35}$ (d) $\sqrt{66}$
9. (a) $\mathbf{a} \cdot \mathbf{b} = 0$, $4c + 3 = 0$, $c = -3/4$.
- (b) Use $\mathbf{a} \cdot \mathbf{b} = \|\mathbf{a}\| \|\mathbf{b}\| \cos \theta$ to get $4c + 3 = \sqrt{c^2 + 1}(5) \cos(\pi/4)$, $4c + 3 = 5\sqrt{c^2 + 1}/\sqrt{2}$. Square both sides and rearrange to get $7c^2 + 48c - 7 = 0$, $(7c - 1)(c + 7) = 0$ so $c = -7$ (invalid) or $c = 1/7$.
- (c) Proceed as in (b) with $\theta = \pi/6$ to get $11c^2 - 96c + 39 = 0$ and use the quadratic formula to get $c = (48 \pm 25\sqrt{3})/11$.
- (d) \mathbf{a} must be a scalar multiple of \mathbf{b} , so $c\mathbf{i} + \mathbf{j} = k(4\mathbf{i} + 3\mathbf{j})$, $k = 1/3$, $c = 4/3$.
10. (a) The plane through the origin which is perpendicular to \mathbf{r}_0 .
- (b) The plane through the tip of \mathbf{r}_0 which is perpendicular to \mathbf{r}_0 .
11. $\|\mathbf{u} - \mathbf{v}\|^2 = (\mathbf{u} - \mathbf{v}) \cdot (\mathbf{u} - \mathbf{v}) = \|\mathbf{u}\|^2 + \|\mathbf{v}\|^2 - 2\|\mathbf{u}\|\|\mathbf{v}\|\cos \theta = 2(1 - \cos \theta) = 4\sin^2(\theta/2)$, so $\|\mathbf{u} - \mathbf{v}\| = 2\sin(\theta/2)$.
12. $5\langle \cos 60^\circ, \cos 120^\circ, \cos 135^\circ \rangle = \langle 5/2, -5/2, -5\sqrt{2}/2 \rangle$.
13. $\vec{PQ} = \langle 1, -1, 6 \rangle$, and $W = \mathbf{F} \cdot \vec{PQ} = 13$ lb-ft.
14. $\mathbf{F} = \mathbf{F}_1 + \mathbf{F}_2 = 2\mathbf{i} - \mathbf{j} + 3\mathbf{k}$, $\vec{PQ} = \mathbf{i} + 4\mathbf{j} - 3\mathbf{k}$, $W = \mathbf{F} \cdot \vec{PQ} = -11$ N·m = -11 J.
15. (a) $\vec{AB} = -\mathbf{i} + 2\mathbf{j} + 2\mathbf{k}$, $\vec{AC} = \mathbf{i} + \mathbf{j} - \mathbf{k}$, $\vec{AB} \times \vec{AC} = -4\mathbf{i} + \mathbf{j} - 3\mathbf{k}$, area = $\frac{1}{2}\|\vec{AB} \times \vec{AC}\| = \sqrt{26}/2$.
- (b) Area = $\frac{1}{2}h\|\vec{AB}\| = \frac{3}{2}h = \frac{1}{2}\sqrt{26}$, $h = \sqrt{26}/3$.
16. (a) False; perhaps they are orthogonal.
- (b) False; perhaps they are parallel.
- (c) True; $0 = \|\mathbf{u}\| \cdot \|\mathbf{v}\| \cos \theta = \|\mathbf{u}\| \cdot \|\mathbf{v}\| \sin \theta$, so either $\mathbf{u} = \mathbf{0}$ or $\mathbf{v} = \mathbf{0}$ since $\cos \theta = \sin \theta = 0$ is impossible.
17. $\vec{AB} = \mathbf{i} - 2\mathbf{j} - 2\mathbf{k}$, $\vec{AC} = -2\mathbf{i} - \mathbf{j} - 2\mathbf{k}$, $\vec{AD} = \mathbf{i} + 2\mathbf{j} - 3\mathbf{k}$.
- (a) From Theorem 11.4.6 and formula (9) of Section 11.4, $\begin{vmatrix} 1 & -2 & -2 \\ -2 & -1 & -2 \\ 1 & 2 & -3 \end{vmatrix} = 29$, so $V = 29$.
- (b) The plane containing A, B , and C has normal $\vec{AB} \times \vec{AC} = 2\mathbf{i} + 6\mathbf{j} - 5\mathbf{k}$, so the equation of the plane is $2(x-1) + 6(y+1) - 5(z-2) = 0$, $2x + 6y - 5z = -14$. From Theorem 11.6.2, $D = \frac{|2(2) + 6(1) - 5(-1) + 14|}{\sqrt{65}} = \frac{29}{\sqrt{65}}$.
18. (a) $\mathbf{F} = -6\mathbf{i} + 3\mathbf{j} - 6\mathbf{k}$.
- (b) $\vec{OA} = \langle 5, 0, 2 \rangle$, so the vector moment is $\vec{OA} \times \mathbf{F} = -6\mathbf{i} + 18\mathbf{j} + 15\mathbf{k}$.

19. $x = 4 + t, y = 1 - t, z = 2$.
20. (a) $\langle 2, 1, -1 \rangle \times \langle 1, 2, 1 \rangle = \langle 3, -3, 3 \rangle$, so the line is parallel to $\mathbf{i} - \mathbf{j} + \mathbf{k}$. To find one common point, choose $x = 0$ and solve the system of equations $y - z = 3, 2y + z = 3$ to obtain that $(0, 2, -1)$ lies on both planes, so the line has an equation $\mathbf{r} = 2\mathbf{j} - \mathbf{k} + t(\mathbf{i} - \mathbf{j} + \mathbf{k})$, that is, $x = t, y = 2 - t, z = -1 + t$.
- (b) $\cos \theta = \frac{\langle 2, 1, -1 \rangle \cdot \langle 1, 2, 1 \rangle}{\|\langle 2, 1, -1 \rangle\| \|\langle 1, 2, 1 \rangle\|} = 1/2$, so $\theta = \pi/3$.
21. A normal to the plane is given by $\langle 1, 5, -1 \rangle$, so the equation of the plane is of the form $x + 5y - z = D$. Insert $(1, 1, 4)$ to obtain $D = 2, x + 5y - z = 2$.
22. $(\mathbf{i} + \mathbf{k}) \times (2\mathbf{j} - \mathbf{k}) = -2\mathbf{i} + \mathbf{j} + 2\mathbf{k}$ is a normal to the plane, so an equation of the plane is of the form $-2x + y + 2z = D, -2(4) + (3) + 2(0) = -5, -2x + y + 2z = -5$.
23. The normals to the planes are given by $\langle a_1, b_1, c_1 \rangle$ and $\langle a_2, b_2, c_2 \rangle$, so the condition is $a_1a_2 + b_1b_2 + c_1c_2 = 0$.
24. (b) $(y, x, z), (x, z, y), (z, y, x)$.
- (c) The set of points $\{(5, \theta, 1)\}, 0 \leq \theta \leq 2\pi$.
- (d) The set of points $\{(\rho, \pi/4, 0)\}, 0 \leq \rho < +\infty$.
25. (a) $(x - 3)^2 + 4(y + 1)^2 - (z - 2)^2 = 9$, hyperboloid of one sheet.
- (b) $(x + 3)^2 + (y - 2)^2 + (z + 6)^2 = 49$, sphere.
- (c) $(x - 1)^2 + (y + 2)^2 - z^2 = 0$, circular cone.
26. (a) $r^2 = z; \rho^2 \sin^2 \phi = \rho \cos \phi, \rho = \cot \phi \csc \phi$.
- (b) $r^2(\cos^2 \theta - \sin^2 \theta) - z^2 = 0, z^2 = r^2 \cos 2\theta; \rho^2 \sin^2 \phi \cos^2 \theta - \rho^2 \sin^2 \phi \sin^2 \theta - \rho^2 \cos^2 \phi = 0, \cos 2\theta = \cot^2 \phi$.
27. (a) $z = r^2 \cos^2 \theta - r^2 \sin^2 \theta = x^2 - y^2$. (b) $(\rho \sin \phi \cos \theta)(\rho \cos \phi) = 1, xz = 1$.

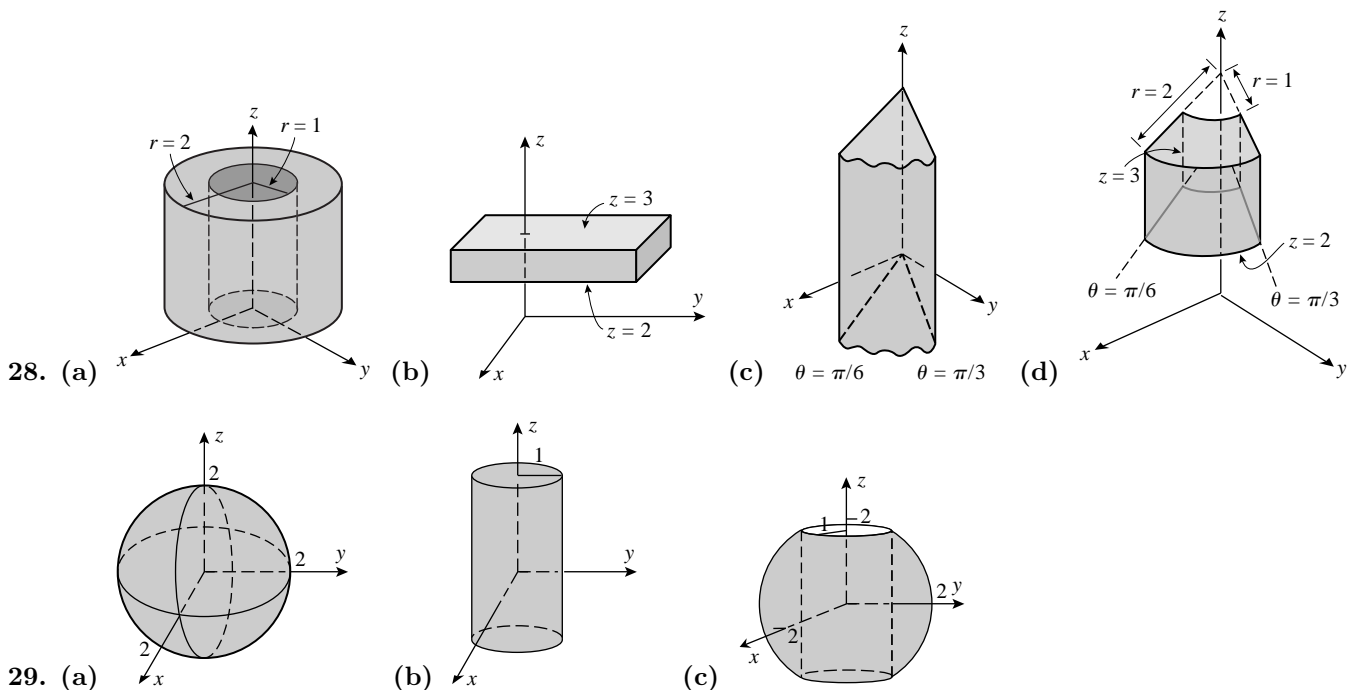

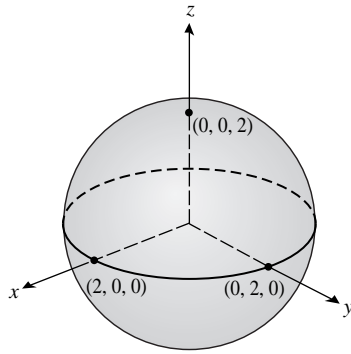

30. (a)

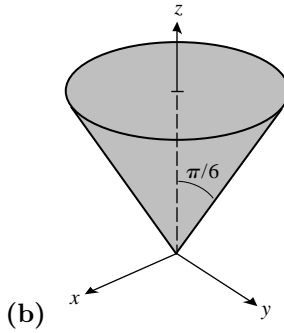

(b)

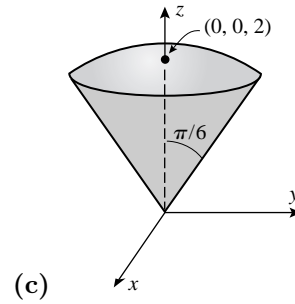

(c)

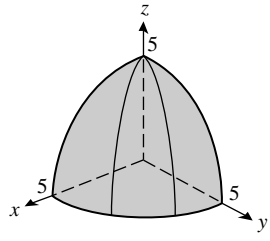

31. (a)

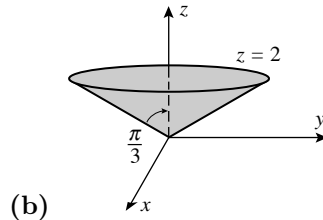

(b)

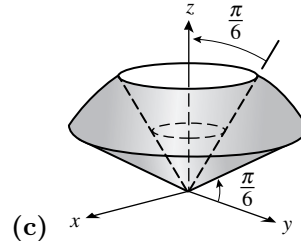

(c)

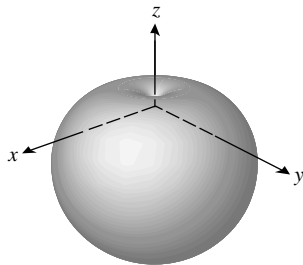

32.

Chapter 11 Making Connections

1. (a) $R(x\mathbf{i} + y\mathbf{j}) \cdot (x\mathbf{i} + y\mathbf{j}) = -yx + xy = 0$, so they are perpendicular. From $R(\mathbf{i}) = \mathbf{j}$ and $R(\mathbf{j}) = -\mathbf{i}$ it follows that R rotates vectors counterclockwise.

(b) If $\mathbf{v} = x\mathbf{i} + y\mathbf{j}$ and $\mathbf{w} = r\mathbf{i} + s\mathbf{j}$, then $R(c\mathbf{v}) = R(c[x\mathbf{i} + y\mathbf{j}]) = R((cx)\mathbf{i} + (cy)\mathbf{j}) = -cy\mathbf{i} + cx\mathbf{j} = c[-y\mathbf{i} + x\mathbf{j}] = cR(x\mathbf{i} + y\mathbf{j}) = cR(\mathbf{v})$ and $R(\mathbf{v} + \mathbf{w}) = R([x\mathbf{i} + y\mathbf{j}] + [r\mathbf{i} + s\mathbf{j}]) = R((x+r)\mathbf{i} + (y+s)\mathbf{j}) = -(y+s)\mathbf{i} + (x+r)\mathbf{j} = (-y\mathbf{i} + x\mathbf{j}) + (-s\mathbf{i} + r\mathbf{j}) = R(x\mathbf{i} + y\mathbf{j}) + R(r\mathbf{i} + s\mathbf{j}) = R(\mathbf{v}) + R(\mathbf{w})$.

2. Although the problem is a two-dimensional one, we add a dimension in order to use the cross-product. Let the triangle be part of the x - y plane, and introduce the z -direction with the unit vector \mathbf{k} . Let the vertices of the triangle be A, B, C taken in a counter-clockwise fashion. Then under a right-handed system, $\mathbf{k} \times \overrightarrow{AB}$ is a vector \mathbf{n}_1 which is perpendicular to \mathbf{k} , and therefore in the plane, and perpendicular to \overrightarrow{AB} , so it is normal to the side AB , and in fact it is an exterior normal because of the right-handedness of the system $\{\overrightarrow{AB}, \mathbf{n}_1, \mathbf{k}\}$, and, finally, $\|\mathbf{n}_1\| = \|\mathbf{k}\| \|\overrightarrow{AB}\| \sin \theta = \|\overrightarrow{AB}\|$. Similarly, we define $\mathbf{n}_2 = \overrightarrow{BC} \times \mathbf{k}$ and $\mathbf{n}_3 = \overrightarrow{CA} \times \mathbf{k}$.

(a) With the definitions above we have $\mathbf{n}_1 + \mathbf{n}_2 + \mathbf{n}_3 = (\overrightarrow{AB} + \overrightarrow{BC} + \overrightarrow{CA}) \times \mathbf{k} = \overrightarrow{AA} \times \mathbf{k} = \mathbf{0} \times \mathbf{k} = \mathbf{0}$.

(b) Given a polygon with vertices A_1, A_2, \dots, A_k (define $A_0 = A_k$) we define normal vectors $\mathbf{n}_1, \mathbf{n}_2, \dots, \mathbf{n}_k$ in the manner described above; and then $\sum_{i=1}^k \mathbf{n}_i = \left(\sum_{i=1}^k \overrightarrow{A_{i-1}A_i} \right) \times \mathbf{k} = (\overrightarrow{A_1A_1}) \times \mathbf{k} = \mathbf{0}$.

3. (a) Suppose one face lies in the x - y plane and has vertices A, B, C taken in counter-clockwise order as one traverses the boundary of the triangle looking down. Then the outer normal to triangle ABC points down. One normal to

triangle ABC is given by $\vec{CB} \times \vec{BA}$. The length of this vector is twice the area of the triangle (Theorem 11.4.5), so we take $\mathbf{n}_1 = \frac{1}{2}(\vec{CB} \times \vec{BA})$. Similarly, $\mathbf{n}_2 = \frac{1}{2}(\vec{BC} \times \vec{CD})$, $\mathbf{n}_3 = \frac{1}{2}(\vec{AD} \times \vec{DC})$, $\mathbf{n}_4 = \frac{1}{2}(\vec{AB} \times \vec{BD})$. Then $2(\mathbf{n}_1 + \mathbf{n}_2 + \mathbf{n}_3 + \mathbf{n}_4) = \vec{AB} \times (\vec{BD} + \vec{CB}) + \vec{CD} \times (\vec{CB} + \vec{AD}) = \vec{AB} \times \vec{CD} + \vec{CD} \times (\vec{CB} + \vec{AD}) = \vec{CD} \times (\vec{BA} + \vec{CB} + \vec{AD}) = \vec{CD} \times \vec{CD} = \mathbf{0}$.

(b) Use the hint and note that everything works out except the two normal vectors on the face which actually divides the larger tetrahedron (pyramid, four-sided base) into the smaller ones with triangular bases. But the normal vectors point in opposite directions and have the same magnitude (the area of the common face) and thus cancel in all the calculations.

(c) Consider a polyhedron each face of which is a triangle, save possibly one which is an arbitrary polygon. Then this last face can be broken into triangles and the results of parts (a) and (b) can be applied, with the same conclusion, that the sum of the exterior normals is the zero vector.

4. The three faces that meet at the chosen vertex are called A, B and C ; let the fourth face be D , with area d . Using Exercise 3 choose a vector n_A which is normal to face A , likewise n_B, n_C, n_D . Each vector is assumed to have length equal to the area of the corresponding face.

(a) Since the sum of the normal vectors is the zero vector, we have $0 = (n_D + n_A + n_B + n_C) \cdot (n_D - n_A - n_B - n_C) = d^2 - a^2 - b^2 - c^2 - 2ab \cos \alpha - 2bc \cos \beta - 2ac \cos \gamma$.

(b) If all of the angles formed at the chosen vertex are right angles, then $d^2 = a^2 + b^2 + c^2$. (Note that such a tetrahedron could be considered a corner cut from a rectangular solid).

5. Let P and Q have spherical coordinates $(\rho, \theta_i, \phi_i), i = 1, 2$. Then Cartesian coordinates are given by $(\rho \sin \phi_i \cos \theta_i, \rho \sin \phi_i \sin \theta_i, \rho \cos \phi_i), i = 1, 2$, and the distance between the two points as taken on the great circle is $\rho \cos \alpha$, where α is the angle between the vectors that go from the origin to the points P and Q . Taking dot products, we have $\rho^2 \cos \alpha = \rho^2(\sin \phi_1 \sin \phi_2 \cos \theta_1 \cos \theta_2 + \sin \phi_1 \sin \phi_2 \sin \theta_1 \sin \theta_2 + \cos \phi_1 \cos \phi_2) = \rho^2(\sin \phi_1 \sin \phi_2 \cos(\theta_1 - \theta_2) + \cos \phi_1 \cos \phi_2)$, and the great circle distance is given by $d = \rho \cos^{-1}(\sin \phi_1 \sin \phi_2 \cos(\theta_1 - \theta_2) + \cos \phi_1 \cos \phi_2)$.
6. Using spherical coordinates: for point A , $\theta_A = 360^\circ - 60^\circ = 300^\circ, \phi_A = 90^\circ - 40^\circ = 50^\circ$; for point B , $\theta_B = 360^\circ - 40^\circ = 320^\circ, \phi_B = 90^\circ - 20^\circ = 70^\circ$. Unit vectors directed from the origin to the points A and B , respectively, are $\mathbf{u}_A = \sin 50^\circ \cos 300^\circ \mathbf{i} + \sin 50^\circ \sin 300^\circ \mathbf{j} + \cos 50^\circ \mathbf{k}$, and $\mathbf{u}_B = \sin 70^\circ \cos 320^\circ \mathbf{i} + \sin 70^\circ \sin 320^\circ \mathbf{j} + \cos 70^\circ \mathbf{k}$. The angle α between \mathbf{u}_A and \mathbf{u}_B is $\alpha = \cos^{-1}(\mathbf{u}_A \cdot \mathbf{u}_B) \approx 0.459486$ so the shortest distance is $6370\alpha \approx 2927$ km.

Vector-Valued Functions

Exercise Set 12.1

1. $(-\infty, +\infty)$; $\mathbf{r}(\pi) = -\mathbf{i} - 3\pi\mathbf{j}$.
2. $[-1/3, +\infty)$; $\mathbf{r}(1) = \langle 2, 1 \rangle$.
3. $[2, +\infty)$; $\mathbf{r}(3) = -\mathbf{i} - \ln 3\mathbf{j} + \mathbf{k}$.
4. $[-1, 1)$; $\mathbf{r}(0) = \langle 2, 0, 0 \rangle$.
5. $\mathbf{r} = 3 \cos t \mathbf{i} + (t + \sin t)\mathbf{j}$.
6. $\mathbf{r} = 2t\mathbf{i} + 2 \sin 3t \mathbf{j} + 5 \cos 3t \mathbf{k}$.
7. $x = 3t^2, y = -2$.
8. $x = 2t - 1, y = -3\sqrt{t}, z = \sin 3t$.
9. The line in 2-space through the point $(3, 0)$ and parallel to the vector $-2\mathbf{i} + 5\mathbf{j}$.
10. The circle of radius 2 in the xy -plane, with center at the origin.
11. The line in 3-space through the point $(0, -3, 1)$ and parallel to the vector $2\mathbf{i} + 3\mathbf{k}$.
12. The circle of radius 2 in the plane $x = 3$, with center at $(3, 0, 0)$.
13. An ellipse in the plane $z = 1$, center at $(0, 0, 1)$, major axis of length 6 parallel to y -axis, minor axis of length 4 parallel to x -axis.
14. A parabola in the plane $x = -3$, vertex at $(-3, 1, 0)$, opening to the 'left' (negative y).
15. (a) The line is parallel to the vector $-2\mathbf{i} + 3\mathbf{j}$; the slope is $-3/2$.

(b) $y = 0$ in the xz -plane so $1 - 2t = 0, t = 1/2$ thus $x = 2 + 1/2 = 5/2$ and $z = 3(1/2) = 3/2$; the coordinates are $(5/2, 0, 3/2)$.
16. (a) $x = 3 + 2t = 0, t = -3/2$ so $y = 5(-3/2) = -15/2$.

(b) $x = t, y = 1 + 2t, z = -3t$ so $3(t) - (1 + 2t) - (-3t) = 2, t = 3/4$; the point of intersection is $(3/4, 5/2, -9/4)$.

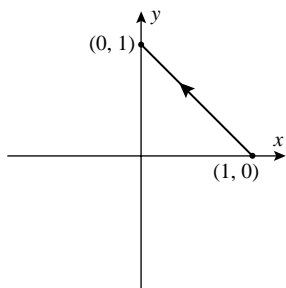

17. (a)

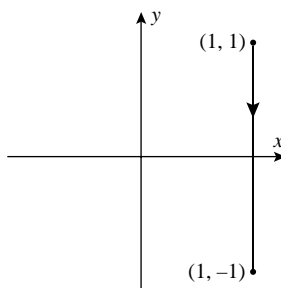

(b)

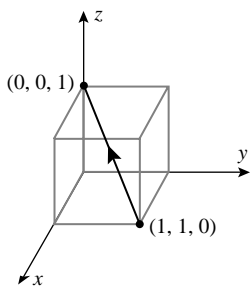

18. (a)

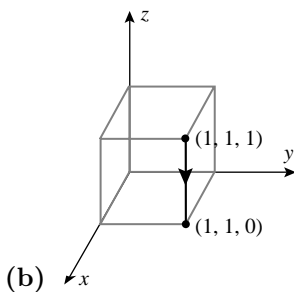

(b)

19. $\mathbf{r} = (1 - t)(3\mathbf{i} + 4\mathbf{j}), 0 \leq t \leq 1.$

20. $\mathbf{r} = (1 - t)4\mathbf{k} + t(2\mathbf{i} + 3\mathbf{j}), 0 \leq t \leq 1.$

21. $x = 2.$

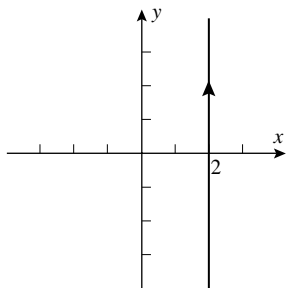

22. $y = 2x + 10.$

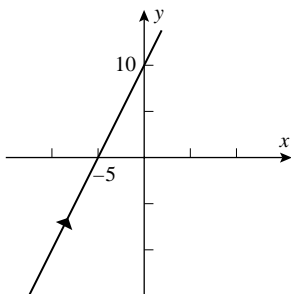

23. $(x - 1)^2 + (y - 3)^2 = 1.$

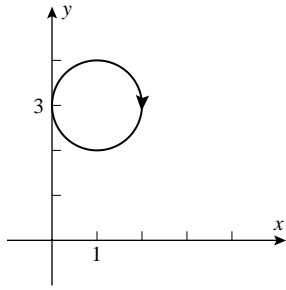

24. $x^2/4 + y^2/25 = 1$.

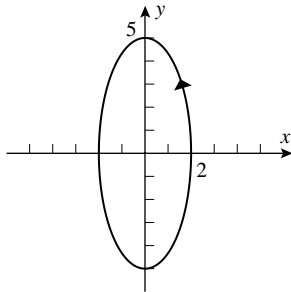

25. $x^2 - y^2 = 1, x \geq 1$.

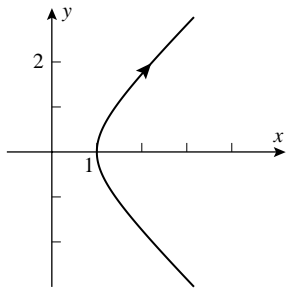

26. $y = 2x^2 + 4, x \geq 0$.

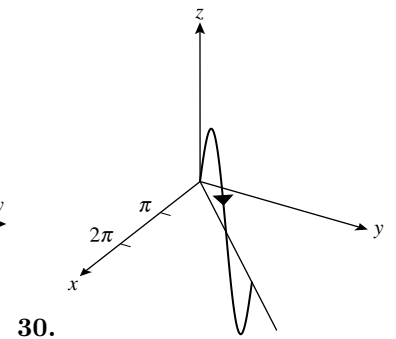
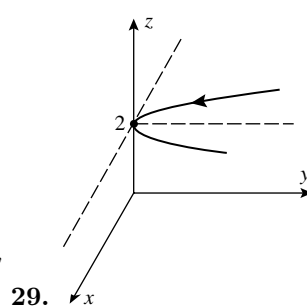
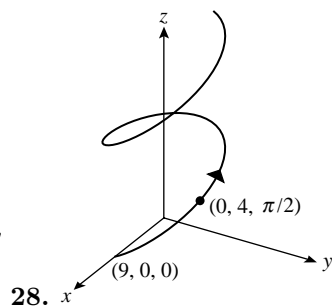
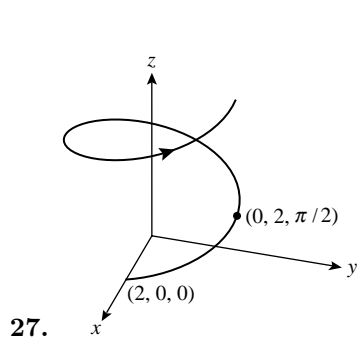
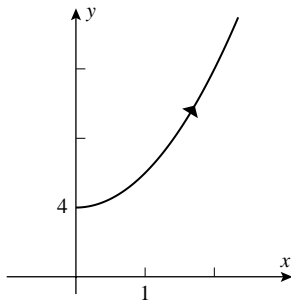

31. False. It is the intersection of the domains of the components.
32. False. It is a curve in 2-space.
33. True. See equation (8).
34. True. This is a special case of Example 2, with $a = 2$ and $c = 1$.
35. $x = t, y = t, z = 2t^2$.

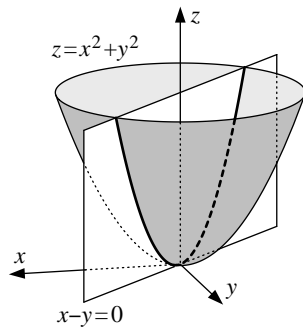

36. $x = t, y = -t, z = \sqrt{2}\sqrt{1-t^2}$.

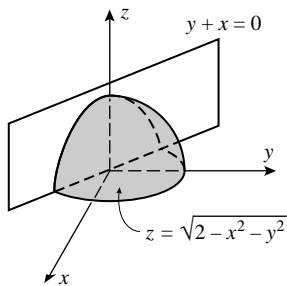

37. $\mathbf{r} = t\mathbf{i} + t^2\mathbf{j} + \frac{1}{3}\sqrt{81 - 9t^2 - t^4}\mathbf{k}$.

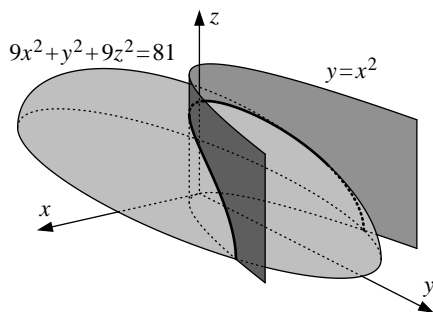

38. $\mathbf{r} = t\mathbf{i} + t\mathbf{j} + (1 - 2t)\mathbf{k}$.

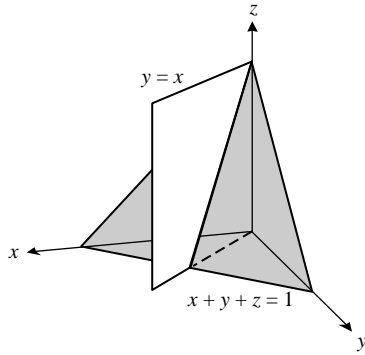

39. $x^2 + y^2 = (t \sin t)^2 + (t \cos t)^2 = t^2(\sin^2 t + \cos^2 t) = t^2 = z$.
40. $x - y + z + 1 = t - (1 + t)/t + (1 - t^2)/t + 1 = [t^2 - (1 + t) + (1 - t^2) + t]/t = 0$.
41. $x = \sin t, y = 2 \cos t, z = \sqrt{3} \sin t$ so $x^2 + y^2 + z^2 = \sin^2 t + 4 \cos^2 t + 3 \sin^2 t = 4$ and $z = \sqrt{3}x$; it is the curve of intersection of the sphere $x^2 + y^2 + z^2 = 4$ and the plane $z = \sqrt{3}x$, which is a circle with center at $(0, 0, 0)$ and radius 2.
42. $x = 3 \cos t, y = 3 \sin t, z = 3 \sin t$ so $x^2 + y^2 = 9 \cos^2 t + 9 \sin^2 t = 9$ and $z = y$; it is the curve of intersection of the circular cylinder $x^2 + y^2 = 9$ and the plane $z = y$, which is an ellipse with major axis of length $6\sqrt{2}$ and minor axis of length 6.
43. The helix makes one turn as t varies from 0 to 2π so $z = c(2\pi) = 3, c = 3/(2\pi)$.
44. $0.2t = 10, t = 50$; the helix has made one revolution when $t = 2\pi$ so when $t = 50$ it has made $50/(2\pi) = 25/\pi \approx 7.96$ revolutions.
45. $x^2 + y^2 = t^2 \cos^2 t + t^2 \sin^2 t = t^2, \sqrt{x^2 + y^2} = t = z$; a conical helix.
46. The curve wraps around an elliptic cylinder with axis along the z -axis; an elliptical helix.
47. (a) III, since the curve is a subset of the plane $y = -x$.
- (b) IV, since only x is periodic in t , and y, z increase without bound.
- (c) II, since all three components are periodic in t .
- (d) I, since the projection onto the yz -plane is a circle and the curve increases without bound in the x -direction.

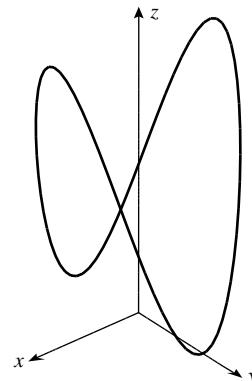

49. (a) Let $x = 3 \cos t$ and $y = 3 \sin t$, then $z = 9 \cos^2 t$.

(b)

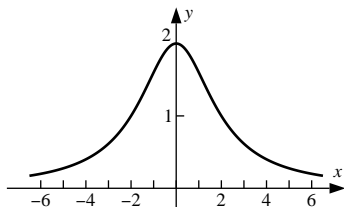

50. (a) $y = \frac{2}{1 + (x/2)^2} = \frac{8}{4 + x^2}$. (b) In part (a) set $x = 2t$; then $y = 2/(1 + (x/2)^2) = 8/(4 + x^2)$.

51. The intersection of a cone and a plane is a conic section. In this case the plane is parallel to the line $x = 0, z = y$, which lies within the double-napped cone $z^2 = x^2 + y^2$, so the intersection is a parabola. We can parametrize it by solving the equations $z = \sqrt{x^2 + y^2}$ and $z = y + 2$. These imply that $x^2 + y^2 = z^2 = (y + 2)^2 = y^2 + 4y + 4$, so $x^2 = 4y + 4$ and $y = \frac{x^2 - 4}{4}$. The curve is parametrized by $x = t, y = \frac{t^2 - 4}{4}, z = y + 2 = \frac{t^2 + 4}{4}$, so $\mathbf{r}(t) = \left\langle t, \frac{t^2 - 4}{4}, \frac{t^2 + 4}{4} \right\rangle$.

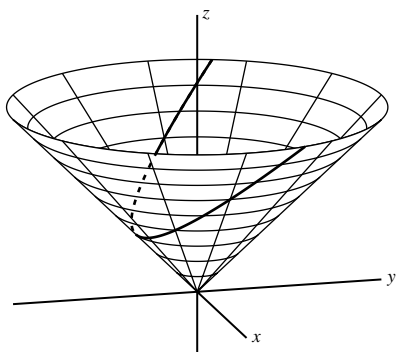

52. An intersection occurs whenever $\mathbf{r}_1(t) = \mathbf{r}_2(u)$ for some values of t and u . There is no need for t and u to be equal.

Exercise Set 12.2

- $\lim_{t \rightarrow +\infty} \left\langle \frac{t^2 + 1}{3t^2 + 2}, \frac{1}{t} \right\rangle = \langle 1/3, 0 \rangle$.
- $\lim_{t \rightarrow 0^+} \left(\sqrt{t} \mathbf{i} + \frac{\sin t}{t} \mathbf{j} \right) = \mathbf{j}$. (using L'Hospital's rule)
- $\lim_{t \rightarrow 2} (t \mathbf{i} - 3 \mathbf{j} + t^2 \mathbf{k}) = 2 \mathbf{i} - 3 \mathbf{j} + 4 \mathbf{k}$.
- $\lim_{t \rightarrow 1} \left\langle \frac{3}{t^2}, \frac{\ln t}{t^2 - 1}, \sin 2t \right\rangle = \langle 3, 1/2, \sin 2 \rangle$. (using L'Hospital's rule)
- (a) Continuous, $\lim_{t \rightarrow 0} \mathbf{r}(t) = \mathbf{0} = \mathbf{r}(0)$. (b) Not continuous, $\lim_{t \rightarrow 0} (1/t)$ does not exist.
- (a) Not continuous, $\lim_{t \rightarrow 0} \csc t$ does not exist. (b) Continuous, $\lim_{t \rightarrow 0} \mathbf{r}(t) = 5 \mathbf{i} - \mathbf{j} + \mathbf{k} = \mathbf{r}(0)$.

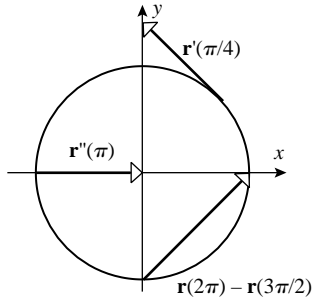

7.

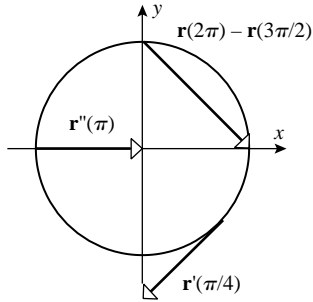

8.

9. $\mathbf{r}'(t) = \sin t \mathbf{j}$.

10. $\mathbf{r}'(t) = \frac{1}{1+t^2} \mathbf{i} + (\cos t - t \sin t) \mathbf{j} - \frac{1}{2\sqrt{t}} \mathbf{k}$.

11. $\mathbf{r}'(t) = \langle 1, 2t \rangle$, $\mathbf{r}'(2) = \langle 1, 4 \rangle$, $\mathbf{r}(2) = \langle 2, 4 \rangle$.

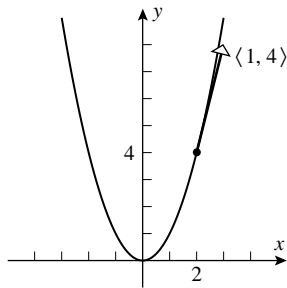

12. $\mathbf{r}'(t) = 3t^2 \mathbf{i} + 2t \mathbf{j}$, $\mathbf{r}'(1) = 3\mathbf{i} + 2\mathbf{j}$, $\mathbf{r}(1) = \mathbf{i} + \mathbf{j}$.

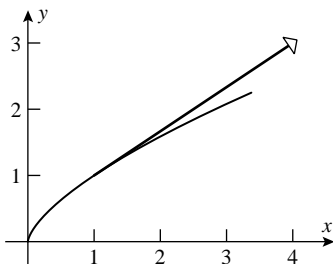

13. $\mathbf{r}'(t) = \sec t \tan t \mathbf{i} + \sec^2 t \mathbf{j}$, $\mathbf{r}'(0) = \mathbf{j}$, $\mathbf{r}(0) = \mathbf{i}$.

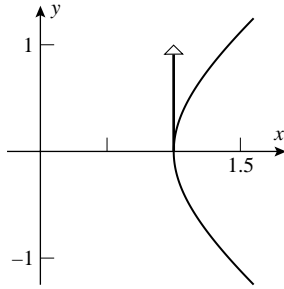

14. $\mathbf{r}'(t) = 2 \cos t \mathbf{i} - 3 \sin t \mathbf{j}$, $\mathbf{r}'\left(\frac{\pi}{6}\right) = \sqrt{3}\mathbf{i} - \frac{3}{2}\mathbf{j}$, $\mathbf{r}\left(\frac{\pi}{6}\right) = \mathbf{i} + \frac{3\sqrt{3}}{2}\mathbf{j}$.

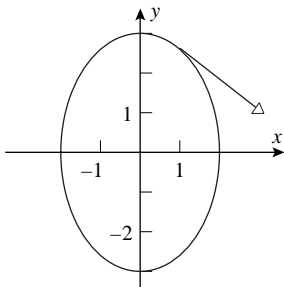

15. $\mathbf{r}'(t) = 2 \cos t \mathbf{i} - 2 \sin t \mathbf{k}$, $\mathbf{r}'(\pi/2) = -2\mathbf{k}$, $\mathbf{r}(\pi/2) = 2\mathbf{i} + \mathbf{j}$.

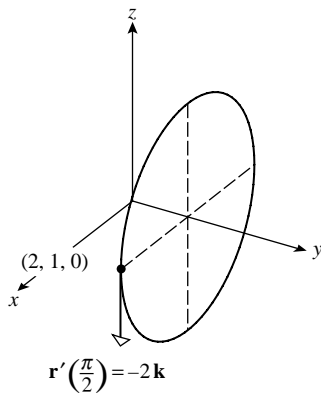

16. $\mathbf{r}'(t) = -\sin t \mathbf{i} + \cos t \mathbf{j} + \mathbf{k}$, $\mathbf{r}'(\pi/4) = -\frac{1}{\sqrt{2}}\mathbf{i} + \frac{1}{\sqrt{2}}\mathbf{j} + \mathbf{k}$, $\mathbf{r}(\pi/4) = \frac{1}{\sqrt{2}}\mathbf{i} + \frac{1}{\sqrt{2}}\mathbf{j} + \frac{\pi}{4}\mathbf{k}$.

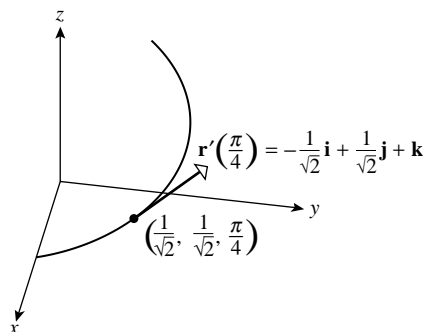

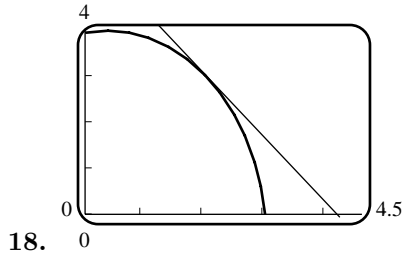
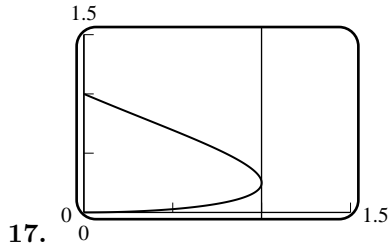

19. $\mathbf{r}'(t) = 2t\mathbf{i} - \frac{1}{t}\mathbf{j}$, $\mathbf{r}'(1) = 2\mathbf{i} - \mathbf{j}$, $\mathbf{r}(1) = \mathbf{i} + 2\mathbf{j}$; $x = 1 + 2t$, $y = 2 - t$.

20. $\mathbf{r}'(t) = 2e^{2t}\mathbf{i} + 6\sin 3t\mathbf{j}$, $\mathbf{r}'(0) = 2\mathbf{i}$, $\mathbf{r}(0) = \mathbf{i} - 2\mathbf{j}$; $x = 1 + 2t$, $y = -2$.

21. $\mathbf{r}'(t) = -2\pi\sin\pi t\mathbf{i} + 2\pi\cos\pi t\mathbf{j} + 3\mathbf{k}$, $\mathbf{r}'(1/3) = -\sqrt{3}\pi\mathbf{i} + \pi\mathbf{j} + 3\mathbf{k}$, $\mathbf{r}(1/3) = \mathbf{i} + \sqrt{3}\mathbf{j} + \mathbf{k}$; $x = 1 - \sqrt{3}\pi t$, $y = \sqrt{3} + \pi t$, $z = 1 + 3t$.

22. $\mathbf{r}'(t) = \frac{1}{t}\mathbf{i} - e^{-t}\mathbf{j} + 3t^2\mathbf{k}$, $\mathbf{r}'(2) = \frac{1}{2}\mathbf{i} - e^{-2}\mathbf{j} + 12\mathbf{k}$, $\mathbf{r}(2) = \ln 2\mathbf{i} + e^{-2}\mathbf{j} + 8\mathbf{k}$; $x = \ln 2 + \frac{1}{2}t$, $y = e^{-2} - e^{-2}t$, $z = 8 + 12t$.

23. $\mathbf{r}'(t) = 2\mathbf{i} + \frac{3}{2\sqrt{3t+4}}\mathbf{j}$, $t = 0$ at P_0 so $\mathbf{r}'(0) = 2\mathbf{i} + \frac{3}{4}\mathbf{j}$, $\mathbf{r}(0) = -\mathbf{i} + 2\mathbf{j}$; $\mathbf{r} = (-\mathbf{i} + 2\mathbf{j}) + t\left(2\mathbf{i} + \frac{3}{4}\mathbf{j}\right)$.

24. $\mathbf{r}'(t) = -4\sin t\mathbf{i} - 3\mathbf{j}$, $t = \pi/3$ at P_0 so $\mathbf{r}'(\pi/3) = -2\sqrt{3}\mathbf{i} - 3\mathbf{j}$, $\mathbf{r}(\pi/3) = 2\mathbf{i} - \pi\mathbf{j}$; $\mathbf{r} = (2\mathbf{i} - \pi\mathbf{j}) + t(-2\sqrt{3}\mathbf{i} - 3\mathbf{j})$.

25. $\mathbf{r}'(t) = 2t\mathbf{i} + \frac{1}{(t+1)^2}\mathbf{j} - 2t\mathbf{k}$, $t = -2$ at P_0 so $\mathbf{r}'(-2) = -4\mathbf{i} + \mathbf{j} + 4\mathbf{k}$, $\mathbf{r}(-2) = 4\mathbf{i} + \mathbf{j}$; $\mathbf{r} = (4\mathbf{i} + \mathbf{j}) + t(-4\mathbf{i} + \mathbf{j} + 4\mathbf{k})$.

26. $\mathbf{r}'(t) = \cos t\mathbf{i} + \sinh t\mathbf{j} + \frac{1}{1+t^2}\mathbf{k}$, $t = 0$ at P_0 so $\mathbf{r}'(0) = \mathbf{i} + \mathbf{k}$, $\mathbf{r}(0) = \mathbf{j}$; $\mathbf{r} = t\mathbf{i} + \mathbf{j} + t\mathbf{k}$.

27. (a) $\lim_{t \rightarrow 0} (\mathbf{r}(t) - \mathbf{r}'(t)) = \mathbf{i} - \mathbf{j} + \mathbf{k}$.

(b) $\lim_{t \rightarrow 0} (\mathbf{r}(t) \times \mathbf{r}'(t)) = \lim_{t \rightarrow 0} (-\cos t\mathbf{i} - \sin t\mathbf{j} + k) = -\mathbf{i} + \mathbf{k}$.

(c) $\lim_{t \rightarrow 0} (\mathbf{r}(t) \cdot \mathbf{r}'(t)) = 0$.

28. $\mathbf{r}(t) \cdot (\mathbf{r}'(t) \times \mathbf{r}''(t)) = \begin{vmatrix} t & t^2 & t^3 \\ 1 & 2t & 3t^2 \\ 0 & 2 & 6t \end{vmatrix} = 2t^3$, so $\lim_{t \rightarrow 1} \mathbf{r}(t) \cdot (\mathbf{r}'(t) \times \mathbf{r}''(t)) = 2$.

29. $\mathbf{r}'_1 = 2\mathbf{i} + 6t\mathbf{j} + 3t^2\mathbf{k}$, $\mathbf{r}'_2 = 4t^3\mathbf{k}$, $\mathbf{r}_1 \cdot \mathbf{r}_2 = t^7$; $\frac{d}{dt}(\mathbf{r}_1 \cdot \mathbf{r}_2) = 7t^6 = \mathbf{r}_1 \cdot \mathbf{r}'_2 + \mathbf{r}'_1 \cdot \mathbf{r}_2$, $\mathbf{r}_1 \times \mathbf{r}_2 = 3t^6\mathbf{i} - 2t^5\mathbf{j}$, $\frac{d}{dt}(\mathbf{r}_1 \times \mathbf{r}_2) = 18t^5\mathbf{i} - 10t^4\mathbf{j} = \mathbf{r}_1 \times \mathbf{r}'_2 + \mathbf{r}'_1 \times \mathbf{r}_2$.

30. $\mathbf{r}'_1 = -\sin t\mathbf{i} + \cos t\mathbf{j} + \mathbf{k}$, $\mathbf{r}'_2 = \mathbf{k}$, $\mathbf{r}_1 \cdot \mathbf{r}_2 = \cos t + t^2$; $\frac{d}{dt}(\mathbf{r}_1 \cdot \mathbf{r}_2) = -\sin t + 2t = \mathbf{r}_1 \cdot \mathbf{r}'_2 + \mathbf{r}'_1 \cdot \mathbf{r}_2$, $\mathbf{r}_1 \times \mathbf{r}_2 = t\sin t\mathbf{i} + t(1 - \cos t)\mathbf{j} - \sin t\mathbf{k}$, $\frac{d}{dt}(\mathbf{r}_1 \times \mathbf{r}_2) = (\sin t + t\cos t)\mathbf{i} + (1 + t\sin t - \cos t)\mathbf{j} - \cos t\mathbf{k} = \mathbf{r}_1 \times \mathbf{r}'_2 + \mathbf{r}'_1 \times \mathbf{r}_2$.

31. $3t\mathbf{i} + 2t^2\mathbf{j} + \mathbf{C}$.

32. $(t^3/3)\mathbf{i} - t^2\mathbf{j} + \ln|t|\mathbf{k} + \mathbf{C}$.

33. $\langle te^t - e^t, t \ln t - t \rangle + \mathbf{C}$.

34. $\langle -e^{-t}, e^t, t^3 \rangle + \mathbf{C}$.

35. $\left\langle \frac{1}{2} \sin 2t, -\frac{1}{2} \cos 2t \right\rangle \Big|_0^{\pi/2} = \langle 0, 1 \rangle$.

36. $\left(\frac{1}{3} t^3 \mathbf{i} + \frac{1}{4} t^4 \mathbf{j} \right) \Big|_0^1 = \frac{1}{3} \mathbf{i} + \frac{1}{4} \mathbf{j}$.

37. $\int_0^2 \sqrt{t^2 + t^4} dt = \int_0^2 t(1 + t^2)^{1/2} dt = \frac{1}{3} (1 + t^2)^{3/2} \Big|_0^2 = (5\sqrt{5} - 1)/3$.

38. $\left\langle -\frac{2}{5}(3-t)^{5/2}, \frac{2}{5}(3+t)^{5/2}, t \right\rangle \Big|_{-3}^3 = \langle 72\sqrt{6}/5, 72\sqrt{6}/5, 6 \rangle$.

39. $\left(\frac{2}{3} t^{3/2} \mathbf{i} + 2t^{1/2} \mathbf{j} \right) \Big|_1^9 = \frac{52}{3} \mathbf{i} + 4\mathbf{j}$.

40. $\frac{1}{2}(e^2 - 1)\mathbf{i} + (1 - e^{-1})\mathbf{j} + \frac{1}{2}\mathbf{k}$.

41. False. The limit only exists if $\mathbf{r}(t)$ is differentiable at $t = a$. As with functions of a single variable, continuity does not imply differentiability. For example, $\mathbf{r}(t) = \langle |t|, 0 \rangle$ is continuous at $t = 0$, but not differentiable there.

42. False. By Theorem 12.2.8 they are orthogonal. They are only parallel if $\mathbf{r}(t)$ is constant, in which case $\mathbf{r}'(t) = \mathbf{0}$.

43. True. Equations (11) and (12) express $\int_a^b \mathbf{r}(t) dt$ as a vector, whose components are the definite integrals of the components of $\mathbf{r}(t)$.

44. True. In 2-space, if $\mathbf{r}(t) = x(t)\mathbf{i} + y(t)\mathbf{j}$ then by the Fundamental Theorem of Calculus, equation (11) implies that $\frac{d}{dt} \int_a^t \mathbf{r}(u) du = \frac{d}{dt} \left[\left(\int_a^t x(u) du \right) \mathbf{i} + \left(\int_a^t y(u) du \right) \mathbf{j} \right] = \left(\frac{d}{dt} \int_a^t x(u) du \right) \mathbf{i} + \left(\frac{d}{dt} \int_a^t y(u) du \right) \mathbf{j} = x(t)\mathbf{i} + y(t)\mathbf{j} = \mathbf{r}(t)$. The proof for vectors in 3-space is similar.

45. $\mathbf{y}(t) = \int \mathbf{y}'(t) dt = t^2\mathbf{i} + t^3\mathbf{j} + \mathbf{C}, \mathbf{y}(0) = \mathbf{C} = \mathbf{i} - \mathbf{j}, \mathbf{y}(t) = (t^2 + 1)\mathbf{i} + (t^3 - 1)\mathbf{j}$.

46. $\mathbf{y}(t) = \int \mathbf{y}'(t) dt = (\sin t)\mathbf{i} - (\cos t)\mathbf{j} + \mathbf{C}, \mathbf{y}(0) = -\mathbf{j} + \mathbf{C} = \mathbf{i} - \mathbf{j}$ so $\mathbf{C} = \mathbf{i}$ and $\mathbf{y}(t) = (1 + \sin t)\mathbf{i} - (\cos t)\mathbf{j}$.

47. $\mathbf{y}'(t) = \int \mathbf{y}''(t) dt = t\mathbf{i} + e^t\mathbf{j} + \mathbf{C}_1, \mathbf{y}'(0) = \mathbf{j} + \mathbf{C}_1 = \mathbf{j}$ so $\mathbf{C}_1 = \mathbf{0}$ and $\mathbf{y}'(t) = t\mathbf{i} + e^t\mathbf{j}$. $\mathbf{y}(t) = \int \mathbf{y}'(t) dt = \frac{1}{2}t^2\mathbf{i} + e^t\mathbf{j} + \mathbf{C}_2, \mathbf{y}(0) = \mathbf{j} + \mathbf{C}_2 = 2\mathbf{i}$ so $\mathbf{C}_2 = 2\mathbf{i} - \mathbf{j}$ and $\mathbf{y}(t) = \left(\frac{1}{2}t^2 + 2 \right) \mathbf{i} + (e^t - 1)\mathbf{j}$.

48. $\mathbf{y}'(t) = \int \mathbf{y}''(t) dt = 4t^3\mathbf{i} - t^2\mathbf{j} + \mathbf{C}_1, \mathbf{y}'(0) = \mathbf{C}_1 = \mathbf{0}, \mathbf{y}'(t) = 4t^3\mathbf{i} - t^2\mathbf{j}, \mathbf{y}(t) = \int \mathbf{y}'(t) dt = t^4\mathbf{i} - \frac{1}{3}t^3\mathbf{j} + \mathbf{C}_2, \mathbf{y}(0) = \mathbf{C}_2 = 2\mathbf{i} - 4\mathbf{j}, \mathbf{y}(t) = (t^4 + 2)\mathbf{i} - \left(\frac{1}{3}t^3 + 4 \right) \mathbf{j}$.

49. (a) $2t - t^2 - 3t = -2$, $t^2 + t - 2 = 0$, $(t + 2)(t - 1) = 0$ so $t = -2, 1$. The points of intersection are $(-2, 4, 6)$ and $(1, 1, -3)$.

(b) $\mathbf{r}' = \mathbf{i} + 2t\mathbf{j} - 3\mathbf{k}$; $\mathbf{r}'(-2) = \mathbf{i} - 4\mathbf{j} - 3\mathbf{k}$, $\mathbf{r}'(1) = \mathbf{i} + 2\mathbf{j} - 3\mathbf{k}$, and $\mathbf{n} = 2\mathbf{i} - \mathbf{j} + \mathbf{k}$ is normal to the plane. Let θ be the acute angle, then for $t = -2$: $\cos \theta = |\mathbf{n} \cdot \mathbf{r}'|/(\|\mathbf{n}\| \|\mathbf{r}'\|) = 3/\sqrt{156}$, $\theta \approx 76^\circ$; for $t = 1$: $\cos \theta = |\mathbf{n} \cdot \mathbf{r}'|/(\|\mathbf{n}\| \|\mathbf{r}'\|) = 3/\sqrt{84}$, $\theta \approx 71^\circ$.

50. $\mathbf{r}' = -2e^{-2t}\mathbf{i} - \sin t\mathbf{j} + 3\cos t\mathbf{k}$, $t = 0$ at the point $(1, 1, 0)$ so $\mathbf{r}'(0) = -2\mathbf{i} + 3\mathbf{k}$ and hence the tangent line is $x = 1 - 2t$, $y = 1$, $z = 3t$. But $x = 0$ in the yz -plane so $1 - 2t = 0$, $t = 1/2$. The point of intersection is $(0, 1, 3/2)$.

51. $\mathbf{r}_1(1) = \mathbf{r}_2(2) = \mathbf{i} + \mathbf{j} + 3\mathbf{k}$ so the graphs intersect at P; $\mathbf{r}'_1(t) = 2t\mathbf{i} + \mathbf{j} + 9t^2\mathbf{k}$ and $\mathbf{r}'_2(t) = \mathbf{i} + \frac{1}{2}t\mathbf{j} - \mathbf{k}$ so $\mathbf{r}'_1(1) = 2\mathbf{i} + \mathbf{j} + 9\mathbf{k}$ and $\mathbf{r}'_2(2) = \mathbf{i} + \mathbf{j} - \mathbf{k}$ are tangent to the graphs at P, thus $\cos \theta = \frac{\mathbf{r}'_1(1) \cdot \mathbf{r}'_2(2)}{\|\mathbf{r}'_1(1)\| \|\mathbf{r}'_2(2)\|} = -\frac{6}{\sqrt{86}\sqrt{3}}$, $\theta = \cos^{-1}(6/\sqrt{258}) \approx 68^\circ$.

52. $\mathbf{r}_1(0) = \mathbf{r}_2(-1) = 2\mathbf{i} + \mathbf{j} + 3\mathbf{k}$ so the graphs intersect at P; $\mathbf{r}'_1(t) = -2e^{-t}\mathbf{i} - (\sin t)\mathbf{j} + 2t\mathbf{k}$ and $\mathbf{r}'_2(t) = -\mathbf{i} + 2t\mathbf{j} + 3t^2\mathbf{k}$ so $\mathbf{r}'_1(0) = -2\mathbf{i}$ and $\mathbf{r}'_2(-1) = -\mathbf{i} - 2\mathbf{j} + 3\mathbf{k}$ are tangent to the graphs at P, thus $\cos \theta = \frac{\mathbf{r}'_1(0) \cdot \mathbf{r}'_2(-1)}{\|\mathbf{r}'_1(0)\| \|\mathbf{r}'_2(-1)\|} = \frac{1}{\sqrt{14}}$, $\theta \approx 74^\circ$.

53. $\frac{d}{dt}[\mathbf{r}(t) \times \mathbf{r}'(t)] = \mathbf{r}(t) \times \mathbf{r}''(t) + \mathbf{r}'(t) \times \mathbf{r}'(t) = \mathbf{r}(t) \times \mathbf{r}''(t) + \mathbf{0} = \mathbf{r}(t) \times \mathbf{r}''(t)$.

54. $\frac{d}{dt}[\mathbf{u} \cdot (\mathbf{v} \times \mathbf{w})] = \mathbf{u} \cdot \frac{d}{dt}[\mathbf{v} \times \mathbf{w}] + \frac{d\mathbf{u}}{dt} \cdot [\mathbf{v} \times \mathbf{w}] = \mathbf{u} \cdot \left(\mathbf{v} \times \frac{d\mathbf{w}}{dt} + \frac{d\mathbf{v}}{dt} \times \mathbf{w} \right) + \frac{d\mathbf{u}}{dt} \cdot [\mathbf{v} \times \mathbf{w}] = \mathbf{u} \cdot \left[\mathbf{v} \times \frac{d\mathbf{w}}{dt} \right] + \mathbf{u} \cdot \left[\frac{d\mathbf{v}}{dt} \times \mathbf{w} \right] + \frac{d\mathbf{u}}{dt} \cdot [\mathbf{v} \times \mathbf{w}]$.

55. In Exercise 54, write each scalar triple product as a determinant.

56. Let $\mathbf{c} = c_1\mathbf{i} + c_2\mathbf{j}$, $\mathbf{r}(t) = x(t)\mathbf{i} + y(t)\mathbf{j}$, $\mathbf{r}_1(t) = x_1(t)\mathbf{i} + y_1(t)\mathbf{j}$, $\mathbf{r}_2(t) = x_2(t)\mathbf{i} + y_2(t)\mathbf{j}$ and use properties of derivatives.

57. Let $\mathbf{r}_1(t) = x_1(t)\mathbf{i} + y_1(t)\mathbf{j} + z_1(t)\mathbf{k}$ and $\mathbf{r}_2(t) = x_2(t)\mathbf{i} + y_2(t)\mathbf{j} + z_2(t)\mathbf{k}$, in both (6) and (7); show that the left and right members of the equalities are the same.

58. (a) $\int k\mathbf{r}(t) dt = \int k(x(t)\mathbf{i} + y(t)\mathbf{j} + z(t)\mathbf{k}) dt = k \int x(t) dt \mathbf{i} + k \int y(t) dt \mathbf{j} + k \int z(t) dt \mathbf{k} = k \int \mathbf{r}(t) dt$.

(b) Similar to part (a).

(c) Use part (a) and part (b) with $k = -1$.

59. See discussion after Definition 12.2.3.

60. $\mathbf{r}'(t) = \langle 2t, 3t^2 \rangle$, $\mathbf{r}(t) \cdot \mathbf{r}'(t) = 3t^5 + 2t^3 + 3t^2$, $\|\mathbf{r}(t)\| = \sqrt{t^4 + (t^3 + 1)^2}$, $\|\mathbf{r}'(t)\| = \sqrt{4t^2 + 9t^4}$, so

$\theta = \cos^{-1} \frac{3t^5 + 2t^3 + 3t^2}{\sqrt{t^4 + (t^3 + 1)^2} \sqrt{4t^2 + 9t^4}}$. For large negative values of t , the position and tangent vectors point in almost opposite directions, so θ is almost π . θ decreases until $t \approx -0.439$ and then increases again, approaching $\pi/2$ as $t \rightarrow 0^-$. There is a cusp in the graph at $t = 0$, so the tangent vector and θ are undefined there. As t increases from 0 to $\sqrt[3]{2}$, θ decreases; at $t = \sqrt[3]{2}$ the tangent line to the curve passes through the origin so $\theta = 0$ there. θ increases again until $t \approx 2.302$ and then decreases again, approaching 0 as $t \rightarrow +\infty$.

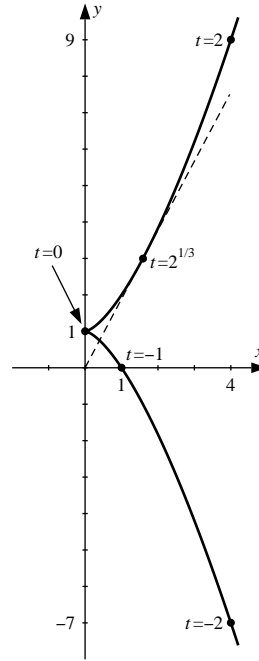
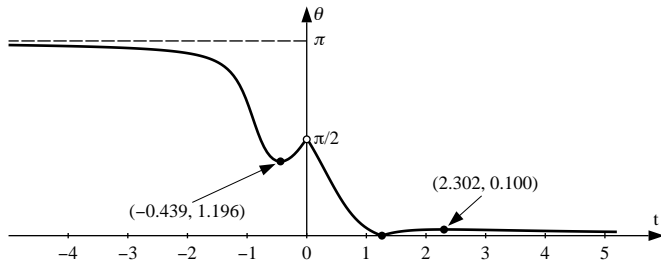

Exercise Set 12.3

1. $\mathbf{r}'(t) = 3t^2\mathbf{i} + (6t - 2)\mathbf{j} + 2t\mathbf{k}$; smooth.
2. $\mathbf{r}'(t) = -2t \sin(t^2)\mathbf{i} + 2t \cos(t^2)\mathbf{j} - e^{-t}\mathbf{k}$; smooth.
3. $\mathbf{r}'(t) = (1 - t)e^{-t}\mathbf{i} + (2t - 2)\mathbf{j} - \pi \sin(\pi t)\mathbf{k}$; not smooth, $\mathbf{r}'(1) = \mathbf{0}$.
4. $\mathbf{r}'(t) = \pi \cos(\pi t)\mathbf{i} + (2 - 1/t)\mathbf{j} + (2t - 1)\mathbf{k}$; not smooth, $\mathbf{r}'(1/2) = \mathbf{0}$.
5. $(dx/dt)^2 + (dy/dt)^2 + (dz/dt)^2 = (-3 \cos^2 t \sin t)^2 + (3 \sin^2 t \cos t)^2 + 0^2 = 9 \sin^2 t \cos^2 t$, $L = \int_0^{\pi/2} 3 \sin t \cos t dt = 3/2$.
6. $(dx/dt)^2 + (dy/dt)^2 + (dz/dt)^2 = (-3 \sin t)^2 + (3 \cos t)^2 + 16 = 25$, $L = \int_0^{\pi} 5 dt = 5\pi$.
7. $\mathbf{r}'(t) = \langle e^t, -e^{-t}, \sqrt{2} \rangle$, $\|\mathbf{r}'(t)\| = e^t + e^{-t}$, $L = \int_0^1 (e^t + e^{-t}) dt = e - e^{-1}$.
8. $(dx/dt)^2 + (dy/dt)^2 + (dz/dt)^2 = 1/4 + (1 - t)/4 + (1 + t)/4 = 3/4$, $L = \int_{-1}^1 (\sqrt{3}/2) dt = \sqrt{3}$.
9. $\mathbf{r}'(t) = 3t^2\mathbf{i} + \mathbf{j} + \sqrt{6}t\mathbf{k}$, $\|\mathbf{r}'(t)\| = 3t^2 + 1$, $L = \int_1^3 (3t^2 + 1) dt = 28$.
10. $\mathbf{r}'(t) = 3\mathbf{i} - 2\mathbf{j} + \mathbf{k}$, $\|\mathbf{r}'(t)\| = \sqrt{14}$, $L = \int_3^4 \sqrt{14} dt = \sqrt{14}$.
11. $\mathbf{r}'(t) = -3 \sin t\mathbf{i} + 3 \cos t\mathbf{j} + \mathbf{k}$, $\|\mathbf{r}'(t)\| = \sqrt{10}$, $L = \int_0^{2\pi} \sqrt{10} dt = 2\pi\sqrt{10}$.

12. $\mathbf{r}'(t) = 2t\mathbf{i} + t \cos t\mathbf{j} + t \sin t\mathbf{k}$, $\|\mathbf{r}'(t)\| = \sqrt{5}t$, $L = \int_0^\pi \sqrt{5}t \, dt = \pi^2\sqrt{5}/2$.

13. $(d\mathbf{r}/dt)(dt/d\tau) = (\mathbf{i} + 2t\mathbf{j})(4) = 4\mathbf{i} + 8t\mathbf{j} = 4\mathbf{i} + 8(4\tau + 1)\mathbf{j}$; $\mathbf{r}(\tau) = (4\tau + 1)\mathbf{i} + (4\tau + 1)^2\mathbf{j}$, $\mathbf{r}'(\tau) = 4\mathbf{i} + 2(4)(4\tau + 1)\mathbf{j}$.

14. $(d\mathbf{r}/dt)(dt/d\tau) = \langle -3 \sin t, 3 \cos t \rangle(\pi) = \langle -3\pi \sin \pi\tau, 3\pi \cos \pi\tau \rangle$; $\mathbf{r}(\tau) = \langle 3 \cos \pi\tau, 3 \sin \pi\tau \rangle$,
 $\mathbf{r}'(\tau) = \langle -3\pi \sin \pi\tau, 3\pi \cos \pi\tau \rangle$.

15. $(d\mathbf{r}/dt)(dt/d\tau) = (e^t\mathbf{i} - 4e^{-t}\mathbf{j})(2\tau) = 2\tau e^{\tau^2}\mathbf{i} - 8\tau e^{-\tau^2}\mathbf{j}$; $\mathbf{r}(\tau) = e^{\tau^2}\mathbf{i} + 4e^{-\tau^2}\mathbf{j}$, $\mathbf{r}'(\tau) = 2\tau e^{\tau^2}\mathbf{i} - 4(2)\tau e^{-\tau^2}\mathbf{j}$.

16. $(d\mathbf{r}/dt)(dt/d\tau) = \left(\frac{9}{2}t^{1/2}\mathbf{j} + \mathbf{k}\right)(-1/\tau^2) = -\frac{9}{2\tau^{5/2}}\mathbf{j} - \frac{1}{\tau^2}\mathbf{k}$; $\mathbf{r}(\tau) = \mathbf{i} + 3\tau^{-3/2}\mathbf{j} + \frac{1}{\tau}\mathbf{k}$, $\mathbf{r}'(\tau) = -\frac{9}{2}\tau^{-5/2}\mathbf{j} - \frac{1}{\tau^2}\mathbf{k}$.

17. False. $\|\mathbf{r}'(t)\|$ is a scalar, so $\int_a^b \|\mathbf{r}'(t)\| \, dt$ is also a scalar.

18. False. For example, the line can be parametrized by $\mathbf{r}(t) = \langle t^3, t^3 \rangle$. But then $\mathbf{r}'(t) = \langle 3t^2, 3t^2 \rangle$ which equals $\mathbf{0}$ for $t = 0$. So $\mathbf{r}(t)$ is not smooth.

19. False; $\mathbf{r}'(s)$ is undefined for the value of s such that $\mathbf{r}(s) = \mathbf{0}$. For example, we may take $\mathbf{r}(s) = \frac{s}{\sqrt{2}}\mathbf{i} + \frac{|s|}{\sqrt{2}}\mathbf{j}$. Then $\mathbf{r}'(0)$ is undefined, since $|s|$ is not differentiable at $s = 0$.

20. True. By Theorem 12.3.4(b), $\|\mathbf{r}'(s)\| = 1$, so $\int_{-1}^3 \|\mathbf{r}'(s)\| \, ds = \int_{-1}^3 1 \, ds = 4$.

21. (a) $\|\mathbf{r}'(t)\| = \sqrt{2}$, $s = \int_0^t \sqrt{2} \, dt = \sqrt{2}t$; $\mathbf{r} = \frac{s}{\sqrt{2}}\mathbf{i} + \frac{s}{\sqrt{2}}\mathbf{j}$, $x = \frac{s}{\sqrt{2}}$, $y = \frac{s}{\sqrt{2}}$.

(b) Similar to part (a), $x = y = z = \frac{s}{\sqrt{3}}$.

22. (a) $x = -\frac{s}{\sqrt{2}}$, $y = -\frac{s}{\sqrt{2}}$. (b) $x = -\frac{s}{\sqrt{3}}$, $y = -\frac{s}{\sqrt{3}}$, $z = -\frac{s}{\sqrt{3}}$.

23. (a) $\mathbf{r}(t) = \langle 1, 3, 4 \rangle$ when $t = 0$, so $s = \int_0^t \sqrt{1+4+4} \, du = 3t$, $x = 1 + s/3$, $y = 3 - 2s/3$, $z = 4 + 2s/3$.

(b) $\mathbf{r}(s) \Big|_{s=25} = \langle 28/3, -41/3, 62/3 \rangle$.

24. (a) $\mathbf{r}(t) = \langle -5, 0, 5 \rangle$ when $t = 0$, so $s = \int_0^t \sqrt{9+4+1} \, du = \sqrt{14}t$, $x = -5 + 3s/\sqrt{14}$, $y = 2s/\sqrt{14}$, $z = 5 + s/\sqrt{14}$.

(b) $\mathbf{r}(s) \Big|_{s=10} = \langle -5 + 30/\sqrt{14}, 20/\sqrt{14}, 5 + 10/\sqrt{14} \rangle$.

25. $x = 3 + \cos t$, $y = 2 + \sin t$, $(dx/dt)^2 + (dy/dt)^2 = 1$, $s = \int_0^t du = t$ so $t = s$, $x = 3 + \cos s$, $y = 2 + \sin s$ for $0 \leq s \leq 2\pi$.

26. $x = \cos^3 t$, $y = \sin^3 t$, $(dx/dt)^2 + (dy/dt)^2 = 9 \sin^2 t \cos^2 t$, $s = \int_0^t 3 \sin u \cos u \, du = \frac{3}{2} \sin^2 t$ so $\sin t = (2s/3)^{1/2}$,
 $\cos t = (1 - 2s/3)^{1/2}$, $x = (1 - 2s/3)^{3/2}$, $y = (2s/3)^{3/2}$ for $0 \leq s \leq 3/2$.

27. $x = t^3/3$, $y = t^2/2$, $(dx/dt)^2 + (dy/dt)^2 = t^2(t^2 + 1)$, $s = \int_0^t u(u^2 + 1)^{1/2} du = \frac{1}{3}[(t^2 + 1)^{3/2} - 1]$ so $t = [(3s + 1)^{2/3} - 1]^{1/2}$, $x = \frac{1}{3}[(3s + 1)^{2/3} - 1]^{3/2}$, $y = \frac{1}{2}[(3s + 1)^{2/3} - 1]$ for $s \geq 0$.

28. $x = (1+t)^2$, $y = (1+t)^3$, $(dx/dt)^2 + (dy/dt)^2 = (1+t)^2[4+9(1+t)^2]$, $s = \int_0^t (1+u)[4+9(1+u)^2]^{1/2} du = \frac{1}{27}([4+9(1+t)^2]^{3/2} - 13\sqrt{13})$ so $1+t = \frac{1}{3}[(27s+13\sqrt{13})^{2/3} - 4]^{1/2}$, $x = \frac{1}{9}[(27s+13\sqrt{13})^{2/3} - 4]$, $y = \frac{1}{27}[(27s+13\sqrt{13})^{2/3} - 4]^{3/2}$ for $0 \leq s \leq (80\sqrt{10} - 13\sqrt{13})/27$.

29. $x = e^t \cos t$, $y = e^t \sin t$, $(dx/dt)^2 + (dy/dt)^2 = 2e^{2t}$, $s = \int_0^t \sqrt{2} e^u du = \sqrt{2}(e^t - 1)$ so $t = \ln(s/\sqrt{2} + 1)$, $x = (s/\sqrt{2} + 1) \cos[\ln(s/\sqrt{2} + 1)]$, $y = (s/\sqrt{2} + 1) \sin[\ln(s/\sqrt{2} + 1)]$ for $0 \leq s \leq \sqrt{2}(e^{\pi/2} - 1)$.

30. $x = \sin(e^t)$, $y = \cos(e^t)$, $z = \sqrt{3}e^t$, $(dx/dt)^2 + (dy/dt)^2 + (dz/dt)^2 = 4e^{2t}$, $s = \int_0^t 2e^u du = 2(e^t - 1)$ so $e^t = 1 + s/2$; $x = \sin(1 + s/2)$, $y = \cos(1 + s/2)$, $z = \sqrt{3}(1 + s/2)$ for $s \geq 0$.

31. $dx/dt = -a \sin t$, $dy/dt = a \cos t$, $dz/dt = c$, $s(t_0) = L = \int_0^{t_0} \sqrt{a^2 \sin^2 t + a^2 \cos^2 t + c^2} dt = \int_0^{t_0} \sqrt{a^2 + c^2} dt = t_0 \sqrt{a^2 + c^2}$.

32. From Exercise 31, $s(t_0) = t_0 \sqrt{a^2 + c^2} = wt_0$, so $s(t) = wt$ and $\mathbf{r} = \left(a \cos \frac{s}{w}\right) \mathbf{i} + \left(a \sin \frac{s}{w}\right) \mathbf{j} + \frac{cs}{w} \mathbf{k}$.

33. $x = at - a \sin t$, $y = a - a \cos t$, $(dx/dt)^2 + (dy/dt)^2 = 4a^2 \sin^2(t/2)$, $s = \int_0^t 2a \sin(u/2) du = 4a[1 - \cos(t/2)]$ so $\cos(t/2) = 1 - s/(4a)$, $t = 2 \cos^{-1}[1 - s/(4a)]$, $\cos t = 2 \cos^2(t/2) - 1 = 2[1 - s/(4a)]^2 - 1$, $\sin t = 2 \sin(t/2) \cos(t/2) = 2(1 - [1 - s/(4a)]^2)^{1/2}(1 - s/(4a))$, $x = 2a \cos^{-1}[1 - s/(4a)] - 2a(1 - [1 - s/(4a)]^2)^{1/2}(1 - s/(4a))$, $y = \frac{s(8a - s)}{8a}$ for $0 \leq s \leq 8a$.

34. $\frac{dx}{dt} = \cos \theta \frac{dr}{dt} - r \sin \theta \frac{d\theta}{dt}$, $\frac{dy}{dt} = \sin \theta \frac{dr}{dt} + r \cos \theta \frac{d\theta}{dt}$, $\left(\frac{dx}{dt}\right)^2 + \left(\frac{dy}{dt}\right)^2 + \left(\frac{dz}{dt}\right)^2 = \left(\frac{dr}{dt}\right)^2 + r^2 \left(\frac{d\theta}{dt}\right)^2 + \left(\frac{dz}{dt}\right)^2$.

35. (a) $(dr/dt)^2 + r^2(d\theta/dt)^2 + (dz/dt)^2 = 9e^{4t}$, $L = \int_0^{\ln 2} 3e^{2t} dt = \frac{3}{2}e^{2t} \Big|_0^{\ln 2} = \frac{9}{2}$.

(b) $(dr/dt)^2 + r^2(d\theta/dt)^2 + (dz/dt)^2 = 5t^2 + t^4 = t^2(5 + t^2)$, $L = \int_1^2 t(5 + t^2)^{1/2} dt = 9 - 2\sqrt{6}$.

36. $\frac{dx}{dt} = \sin \phi \cos \theta \frac{d\rho}{dt} + \rho \cos \phi \cos \theta \frac{d\phi}{dt} - \rho \sin \phi \sin \theta \frac{d\theta}{dt}$, $\frac{dy}{dt} = \sin \phi \sin \theta \frac{d\rho}{dt} + \rho \cos \phi \sin \theta \frac{d\phi}{dt} + \rho \sin \phi \cos \theta \frac{d\theta}{dt}$, $\frac{dz}{dt} = \cos \phi \frac{d\rho}{dt} - \rho \sin \phi \frac{d\phi}{dt}$, $\left(\frac{dx}{dt}\right)^2 + \left(\frac{dy}{dt}\right)^2 + \left(\frac{dz}{dt}\right)^2 = \left(\frac{d\rho}{dt}\right)^2 + \rho^2 \sin^2 \phi \left(\frac{d\theta}{dt}\right)^2 + \rho^2 \left(\frac{d\phi}{dt}\right)^2$.

37. (a) $(d\rho/dt)^2 + \rho^2 \sin^2 \phi (d\theta/dt)^2 + \rho^2 (d\phi/dt)^2 = 3e^{-2t}$, $L = \int_0^2 \sqrt{3}e^{-t} dt = \sqrt{3}(1 - e^{-2})$.

(b) $(d\rho/dt)^2 + \rho^2 \sin^2 \phi (d\theta/dt)^2 + \rho^2 (d\phi/dt)^2 = 5$, $L = \int_1^5 \sqrt{5} dt = 4\sqrt{5}$.

38. (a) $\frac{d}{dt} \mathbf{r}(t) = \mathbf{i} + 2t\mathbf{j}$ is never zero, but $\frac{d}{d\tau} \mathbf{r}(\tau^3) = \frac{d}{d\tau} (\tau^3 \mathbf{i} + \tau^6 \mathbf{j}) = 3\tau^2 \mathbf{i} + 6\tau^5 \mathbf{j}$ is zero at $\tau = 0$.

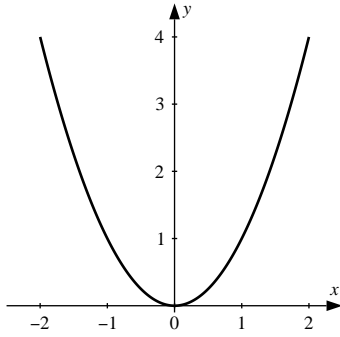

(b) Since $\frac{d}{d\tau} \mathbf{r}(\tau^3) = \mathbf{0}$ when $\tau = 0$, the ‘direction’ of the second parametrization of the curve is undefined there. For a smooth curve, the direction must be defined at every point of the curve.

39. (a) $g(\tau) = \pi\tau$. (b) $g(\tau) = \pi(1 - \tau)$.

40. $t = 1 - \tau$.

41. Represent the helix by $x = a \cos t$, $y = a \sin t$, $z = ct$ with $a = 6.25$ and $c = 10/\pi$, so that the radius of the helix is the distance from the axis of the cylinder to the center of the copper cable, and the helix makes one turn in a distance of 20 in. ($t = 2\pi$). From Exercise 31 the length of the helix is $2\pi\sqrt{6.25^2 + (10/\pi)^2} \approx 44$ in.

42. $\mathbf{r}(t) = \langle \cos t, \sin t, t^{3/2} \rangle$, $\mathbf{r}'(t) = \langle -\sin t, \cos t, \frac{3}{2}t^{1/2} \rangle$.

(a) $\|\mathbf{r}'(t)\| = \sqrt{\sin^2 t + \cos^2 t + 9t/4} = \frac{1}{2}\sqrt{4 + 9t}$. (b) $\frac{ds}{dt} = \frac{1}{2}\sqrt{4 + 9t}$. (c) $\int_0^2 \frac{1}{2}\sqrt{4 + 9t} dt = \frac{2}{27}(11\sqrt{22} - 4)$.

43. $\mathbf{r}'(t) = (1/t)\mathbf{i} + 2\mathbf{j} + 2t\mathbf{k}$.

(a) $\|\mathbf{r}'(t)\| = \sqrt{1/t^2 + 4 + 4t^2} = \sqrt{(2t + 1/t)^2} = 2t + 1/t$. (b) $\frac{ds}{dt} = 2t + 1/t$. (c) $\int_1^3 (2t + 1/t) dt = 8 + \ln 3$.

44. $\mathbf{r}'(t) = 2t\mathbf{i} + 3t^2\mathbf{j}$, so, by Theorem 11.3.3, the angle between $\mathbf{r}'(t)$ and \mathbf{i} is

$\theta(t) = \cos^{-1} \frac{\mathbf{r}'(t) \cdot \mathbf{i}}{\|\mathbf{r}'(t)\| \|\mathbf{i}\|} = \cos^{-1} \frac{2t}{\sqrt{4t^2 + 9t^4}} = \cos^{-1} \frac{2t}{|t|\sqrt{4 + 9t^2}}$. Hence $\lim_{t \rightarrow 0^-} \theta(t) = \lim_{t \rightarrow 0^-} \cos^{-1} \left(-\frac{2}{\sqrt{4 + 9t^2}} \right) = \cos^{-1}(-1) = \pi$ and $\lim_{t \rightarrow 0^+} \theta(t) = \lim_{t \rightarrow 0^+} \cos^{-1} \left(\frac{2}{\sqrt{4 + 9t^2}} \right) = \cos^{-1}(1) = 0$.

45. If $\mathbf{r}(t) = x(t)\mathbf{i} + y(t)\mathbf{j} + z(t)\mathbf{k}$ is smooth, then $\|\mathbf{r}'(t)\|$ is continuous and nonzero. Thus the angle between $\mathbf{r}'(t)$ and \mathbf{i} , given by $\cos^{-1}(x'(t)/\|\mathbf{r}'(t)\|)$, is a continuous function of t . Similarly, the angles between $\mathbf{r}'(t)$ and the vectors \mathbf{j} and \mathbf{k} are continuous functions of t .

46. Let $\mathbf{r}(t) = x(t)\mathbf{i} + y(t)\mathbf{j}$ and use the chain rule.

47. A vector-valued function whose graph is the triangle cannot be smooth, since there is an abrupt change of direction at each vertex. However, such a function can be differentiable: Let $f(x)$ be a differentiable function which is increasing for $0 \leq x \leq 1$ and satisfies $f(0) = 0$, $f(1) = 1$, and $f'(0) = f'(1) = 0$. For example, we could let

$f(x) = 3x^2 - 2x^3$. Then let $\mathbf{r}(t) = \begin{cases} \langle f(t), 0 \rangle & \text{if } 0 \leq t \leq 1; \\ \langle 1 - f(t-1), f(t-1) \rangle & \text{if } 1 < t \leq 2; \\ \langle 0, 1 - f(t-2) \rangle & \text{if } 2 < t \leq 3. \end{cases}$ It is easy to check that $\mathbf{r}(t)$ traces

out the triangle as t varies from 0 to 3 and that $\mathbf{r}'(t)$ is differentiable, with $\mathbf{r}'(t) = \mathbf{0}$ for $t = 0, 1, 2$, and 3.

Exercise Set 12.4

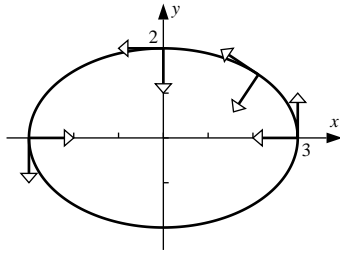
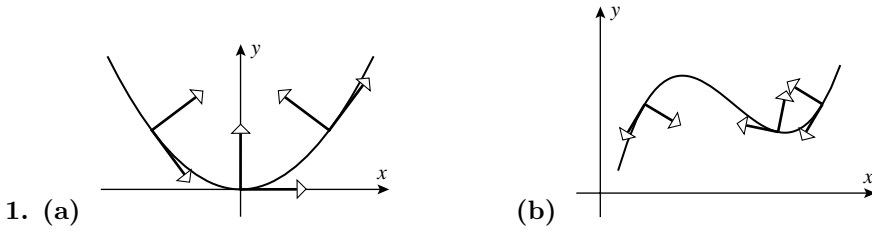

3. From the marginal note, the line is parametrized by normalizing \mathbf{v} , but $\mathbf{T}(t_0) = \mathbf{v}/\|\mathbf{v}\|$, so $\mathbf{r} = \mathbf{r}(t_0) + t\mathbf{v}$ becomes $\mathbf{r} = \mathbf{r}(t_0) + s\mathbf{T}(t_0)$.

4. $\mathbf{r}'(t)\big|_{t=1} = \langle 1, 2t \rangle\big|_{t=1} = \langle 1, 2 \rangle$, and $\mathbf{T}(1) = \left\langle \frac{1}{\sqrt{5}}, \frac{2}{\sqrt{5}} \right\rangle$, so the tangent line can be parametrized as $\mathbf{r} = \langle 1, 1 \rangle + s \left\langle \frac{1}{\sqrt{5}}, \frac{2}{\sqrt{5}} \right\rangle$, so $x = 1 + \frac{s}{\sqrt{5}}$, $y = 1 + \frac{2s}{\sqrt{5}}$.

5. $\mathbf{r}'(t) = 2t\mathbf{i} + \mathbf{j}$, $\|\mathbf{r}'(t)\| = \sqrt{4t^2 + 1}$, $\mathbf{T}(t) = (4t^2 + 1)^{-1/2}(2t\mathbf{i} + \mathbf{j})$, $\mathbf{T}'(t) = (4t^2 + 1)^{-1/2}(2\mathbf{i}) - 4t(4t^2 + 1)^{-3/2}(2t\mathbf{i} + \mathbf{j})$;
 $\mathbf{T}(1) = \frac{2}{\sqrt{5}}\mathbf{i} + \frac{1}{\sqrt{5}}\mathbf{j}$, $\mathbf{T}'(1) = \frac{2}{5\sqrt{5}}(\mathbf{i} - 2\mathbf{j})$, $\mathbf{N}(1) = \frac{1}{\sqrt{5}}\mathbf{i} - \frac{2}{\sqrt{5}}\mathbf{j}$.

6. $\mathbf{r}'(t) = t\mathbf{i} + t^2\mathbf{j}$, $\mathbf{T}(t) = (t^2 + t^4)^{-1/2}(t\mathbf{i} + t^2\mathbf{j})$, $\mathbf{T}'(t) = (t^2 + t^4)^{-1/2}(\mathbf{i} + 2t\mathbf{j}) - (t + 2t^3)(t^2 + t^4)^{-3/2}(t\mathbf{i} + t^2\mathbf{j})$;
 $\mathbf{T}(1) = \frac{1}{\sqrt{2}}\mathbf{i} + \frac{1}{\sqrt{2}}\mathbf{j}$, $\mathbf{T}'(1) = \frac{1}{2\sqrt{2}}(-\mathbf{i} + \mathbf{j})$, $\mathbf{N}(1) = -\frac{1}{\sqrt{2}}\mathbf{i} + \frac{1}{\sqrt{2}}\mathbf{j}$.

7. $\mathbf{r}'(t) = -5\sin t\mathbf{i} + 5\cos t\mathbf{j}$, $\|\mathbf{r}'(t)\| = 5$, $\mathbf{T}(t) = -\sin t\mathbf{i} + \cos t\mathbf{j}$, $\mathbf{T}'(t) = -\cos t\mathbf{i} - \sin t\mathbf{j}$; $\mathbf{T}(\pi/3) = -\frac{\sqrt{3}}{2}\mathbf{i} + \frac{1}{2}\mathbf{j}$,
 $\mathbf{T}'(\pi/3) = -\frac{1}{2}\mathbf{i} - \frac{\sqrt{3}}{2}\mathbf{j}$, $\mathbf{N}(\pi/3) = -\frac{1}{2}\mathbf{i} - \frac{\sqrt{3}}{2}\mathbf{j}$.

8. $\mathbf{r}'(t) = \frac{1}{t}\mathbf{i} + \mathbf{j}$, $\|\mathbf{r}'(t)\| = \frac{\sqrt{1+t^2}}{t}$, $\mathbf{T}(t) = (1+t^2)^{-1/2}(\mathbf{i} + t\mathbf{j})$, $\mathbf{T}'(t) = (1+t^2)^{-1/2}(\mathbf{j}) - t(1+t^2)^{-3/2}(\mathbf{i} + t\mathbf{j})$;
 $\mathbf{T}(e) = \frac{1}{\sqrt{1+e^2}}\mathbf{i} + \frac{e}{\sqrt{1+e^2}}\mathbf{j}$, $\mathbf{T}'(e) = \frac{1}{(1+e^2)^{3/2}}(-e\mathbf{i} + \mathbf{j})$, $\mathbf{N}(e) = -\frac{e}{\sqrt{1+e^2}}\mathbf{i} + \frac{1}{\sqrt{1+e^2}}\mathbf{j}$.

9. $\mathbf{r}'(t) = -4\sin t\mathbf{i} + 4\cos t\mathbf{j} + \mathbf{k}$, $\mathbf{T}(t) = \frac{1}{\sqrt{17}}(-4\sin t\mathbf{i} + 4\cos t\mathbf{j} + \mathbf{k})$, $\mathbf{T}'(t) = \frac{1}{\sqrt{17}}(-4\cos t\mathbf{i} - 4\sin t\mathbf{j})$, $\mathbf{T}(\pi/2) = -\frac{4}{\sqrt{17}}\mathbf{i} + \frac{1}{\sqrt{17}}\mathbf{k}$, $\mathbf{T}'(\pi/2) = -\frac{4}{\sqrt{17}}\mathbf{j}$, $\mathbf{N}(\pi/2) = -\mathbf{j}$.

10. $\mathbf{r}'(t) = \mathbf{i} + t\mathbf{j} + t^2\mathbf{k}$, $\mathbf{T}(t) = (1+t^2+t^4)^{-1/2}(\mathbf{i} + t\mathbf{j} + t^2\mathbf{k})$, $\mathbf{T}'(t) = (1+t^2+t^4)^{-1/2}(\mathbf{j} + 2t\mathbf{k}) - (t+2t^3)(1+t^2+t^4)^{-3/2}(\mathbf{i} + t\mathbf{j} + t^2\mathbf{k})$, $\mathbf{T}(0) = \mathbf{i}$, $\mathbf{T}'(0) = \mathbf{j} = \mathbf{N}(0)$.

11. $\mathbf{r}'(t) = e^t[(\cos t - \sin t)\mathbf{i} + (\cos t + \sin t)\mathbf{j} + \mathbf{k}]$, $\mathbf{T}(t) = \frac{1}{\sqrt{3}}[(\cos t - \sin t)\mathbf{i} + (\cos t + \sin t)\mathbf{j} + \mathbf{k}]$, $\mathbf{T}'(t) = \frac{1}{\sqrt{3}}[(-\sin t - \cos t)\mathbf{i} + (-\sin t + \cos t)\mathbf{j}]$, $\mathbf{T}(0) = \frac{1}{\sqrt{3}}\mathbf{i} + \frac{1}{\sqrt{3}}\mathbf{j} + \frac{1}{\sqrt{3}}\mathbf{k}$, $\mathbf{T}'(0) = \frac{1}{\sqrt{3}}(-\mathbf{i} + \mathbf{j})$, $\mathbf{N}(0) = -\frac{1}{\sqrt{2}}\mathbf{i} + \frac{1}{\sqrt{2}}\mathbf{j}$.

12. $\mathbf{r}'(t) = \sinh t \mathbf{i} + \cosh t \mathbf{j} + \mathbf{k}$, $\|\mathbf{r}'(t)\| = \sqrt{\sinh^2 t + \cosh^2 t + 1} = \sqrt{2} \cosh t$, $\mathbf{T}(t) = \frac{1}{\sqrt{2}}(\tanh t \mathbf{i} + \mathbf{j} + \operatorname{sech} t \mathbf{k})$, $\mathbf{T}'(t) = \frac{1}{\sqrt{2}}(\operatorname{sech}^2 t \mathbf{i} - \operatorname{sech} t \tanh t \mathbf{k})$, at $t = \ln 2$, $\tanh(\ln 2) = \frac{3}{5}$ and $\operatorname{sech}(\ln 2) = \frac{4}{5}$ so $\mathbf{T}(\ln 2) = \frac{3}{5\sqrt{2}}\mathbf{i} + \frac{1}{\sqrt{2}}\mathbf{j} + \frac{4}{5\sqrt{2}}\mathbf{k}$, $\mathbf{T}'(\ln 2) = \frac{4}{25\sqrt{2}}(4\mathbf{i} - 3\mathbf{k})$, $\mathbf{N}(\ln 2) = \frac{4}{5}\mathbf{i} - \frac{3}{5}\mathbf{k}$.
13. $\mathbf{r}'(t) = \cos t \mathbf{i} - \sin t \mathbf{j} + t \mathbf{k}$, $\mathbf{r}'(0) = \mathbf{i}$, $\mathbf{r}(0) = \mathbf{j}$, $\mathbf{T}(0) = \mathbf{i}$, so the tangent line has the parametrization $x = s$, $y = 1$, $z = 0$.
14. $\mathbf{r}(1) = \mathbf{i} + \mathbf{j} + \sqrt{8}\mathbf{k}$, $\mathbf{r}'(t) = \mathbf{i} + \mathbf{j} - \frac{t}{\sqrt{9-t^2}}\mathbf{k}$, $\mathbf{r}'(1) = \mathbf{i} + \mathbf{j} - \frac{1}{\sqrt{8}}\mathbf{k}$, $\|\mathbf{r}'(1)\| = \frac{\sqrt{17}}{\sqrt{8}}$, so the tangent line has parametrizations $\mathbf{r} = \mathbf{i} + \mathbf{j} + \sqrt{8}\mathbf{k} + t \left(\mathbf{i} + \mathbf{j} - \frac{1}{\sqrt{8}}\mathbf{k} \right) = \mathbf{i} + \mathbf{j} + \sqrt{8}\mathbf{k} + \frac{s\sqrt{8}}{\sqrt{17}} \left(\mathbf{i} + \mathbf{j} - \frac{1}{\sqrt{8}}\mathbf{k} \right)$.
15. $\mathbf{T} = \frac{3}{5} \cos t \mathbf{i} - \frac{3}{5} \sin t \mathbf{j} + \frac{4}{5} \mathbf{k}$, $\mathbf{N} = -\sin t \mathbf{i} - \cos t \mathbf{j}$, $\mathbf{B} = \mathbf{T} \times \mathbf{N} = \frac{4}{5} \cos t \mathbf{i} - \frac{4}{5} \sin t \mathbf{j} - \frac{3}{5} \mathbf{k}$. Check: $\mathbf{r}' = 3 \cos t \mathbf{i} - 3 \sin t \mathbf{j} + 4 \mathbf{k}$, $\mathbf{r}'' = -3 \sin t \mathbf{i} - 3 \cos t \mathbf{j}$, $\mathbf{r}' \times \mathbf{r}'' = 12 \cos t \mathbf{i} - 12 \sin t \mathbf{j} - 9 \mathbf{k}$, $\|\mathbf{r}' \times \mathbf{r}''\| = 15$, $(\mathbf{r}' \times \mathbf{r}'') / \|\mathbf{r}' \times \mathbf{r}''\| = \frac{4}{5} \cos t \mathbf{i} - \frac{4}{5} \sin t \mathbf{j} - \frac{3}{5} \mathbf{k} = \mathbf{B}$.
16. $\mathbf{T} = \frac{1}{\sqrt{2}}[(\cos t + \sin t)\mathbf{i} + (-\sin t + \cos t)\mathbf{j}]$, $\mathbf{N} = \frac{1}{\sqrt{2}}[(-\sin t + \cos t)\mathbf{i} - (\cos t + \sin t)\mathbf{j}]$, $\mathbf{B} = \mathbf{T} \times \mathbf{N} = -\mathbf{k}$. Check: $\mathbf{r}' = e^t(\cos t + \sin t)\mathbf{i} + e^t(\cos t - \sin t)\mathbf{j}$, $\mathbf{r}'' = 2e^t \cos t \mathbf{i} - 2e^t \sin t \mathbf{j}$, $\mathbf{r}' \times \mathbf{r}'' = -2e^{2t} \mathbf{k}$, $\|\mathbf{r}' \times \mathbf{r}''\| = 2e^{2t}$, $(\mathbf{r}' \times \mathbf{r}'') / \|\mathbf{r}' \times \mathbf{r}''\| = -\mathbf{k} = \mathbf{B}$.
17. $\mathbf{r}'(t) = t \sin t \mathbf{i} + t \cos t \mathbf{j}$, $\|\mathbf{r}'\| = |t|$. For $t > 0$, $\mathbf{T} = \sin t \mathbf{i} + \cos t \mathbf{j}$, $\mathbf{N} = \cos t \mathbf{i} - \sin t \mathbf{j}$; for $t < 0$, $\mathbf{T} = -\sin t \mathbf{i} - \cos t \mathbf{j}$, $\mathbf{N} = -\cos t \mathbf{i} + \sin t \mathbf{j}$. In either case, $\mathbf{B} = \mathbf{T} \times \mathbf{N} = -\mathbf{k}$. Check: $\mathbf{r}' = t \sin t \mathbf{i} + t \cos t \mathbf{j}$, $\mathbf{r}'' = (\sin t + t \cos t)\mathbf{i} + (\cos t - t \sin t)\mathbf{j}$, $\mathbf{r}' \times \mathbf{r}'' = -t^2 \mathbf{k}$, $\|\mathbf{r}' \times \mathbf{r}''\| = t^2$; for $t \neq 0$, $(\mathbf{r}' \times \mathbf{r}'') / \|\mathbf{r}' \times \mathbf{r}''\| = -\mathbf{k} = \mathbf{B}$.
18. $\mathbf{T} = (-a \sin t \mathbf{i} + a \cos t \mathbf{j} + c \mathbf{k}) / \sqrt{a^2 + c^2}$, $\mathbf{N} = -\cos t \mathbf{i} - \sin t \mathbf{j}$, $\mathbf{B} = \mathbf{T} \times \mathbf{N} = (c \sin t \mathbf{i} - c \cos t \mathbf{j} + a \mathbf{k}) / \sqrt{a^2 + c^2}$. Check: $\mathbf{r}' = -a \sin t \mathbf{i} + a \cos t \mathbf{j} + c \mathbf{k}$, $\mathbf{r}'' = -a \cos t \mathbf{i} - a \sin t \mathbf{j}$, $\mathbf{r}' \times \mathbf{r}'' = ca \sin t \mathbf{i} - ca \cos t \mathbf{j} + a^2 \mathbf{k}$, $\|\mathbf{r}' \times \mathbf{r}''\| = a\sqrt{a^2 + c^2}$, $(\mathbf{r}' \times \mathbf{r}'') / \|\mathbf{r}' \times \mathbf{r}''\| = \mathbf{B}$.
19. $\mathbf{r}(\pi/4) = \frac{\sqrt{2}}{2}\mathbf{i} + \frac{\sqrt{2}}{2}\mathbf{j} + \mathbf{k}$, $\mathbf{T} = -\sin t \mathbf{i} + \cos t \mathbf{j} = \frac{\sqrt{2}}{2}(-\mathbf{i} + \mathbf{j})$, $\mathbf{N} = -(\cos t \mathbf{i} + \sin t \mathbf{j}) = -\frac{\sqrt{2}}{2}(\mathbf{i} + \mathbf{j})$, $\mathbf{B} = \mathbf{k}$; the rectifying, osculating, and normal planes are given (respectively) by $x + y = \sqrt{2}$, $z = 1$, $-x + y = 0$.
20. $\mathbf{r}(0) = \mathbf{i} + \mathbf{j}$, $\mathbf{T} = \frac{1}{\sqrt{3}}(\mathbf{i} + \mathbf{j} + \mathbf{k})$, $\mathbf{N} = \frac{1}{\sqrt{2}}(-\mathbf{j} + \mathbf{k})$, $\mathbf{B} = \frac{1}{\sqrt{6}}(2\mathbf{i} - \mathbf{j} - \mathbf{k})$; the rectifying, osculating, and normal planes are given (respectively) by $-y + z = -1$, $2x - y - z = 1$, $x + y + z = 2$.
21. False. For example, if $\mathbf{r}(t) = \langle t, 0 \rangle$ then $\mathbf{T}(t) = \langle 1, 0 \rangle$ is parallel to $\mathbf{r}(t)$ for all $t > 0$.
22. False. For example, $\mathbf{r}(t) = \langle \cos t, -\sin t \rangle$ parametrizes the unit circle in a clockwise direction. We have $\mathbf{T}(t) = \langle -\sin t, -\cos t \rangle$ and $\mathbf{N}(t) = \langle -\cos t, \sin t \rangle$, so $\mathbf{T}(0) = \langle 0, -1 \rangle$, $\mathbf{N}(0) = \langle -1, 0 \rangle$, and the counterclockwise angle from $\mathbf{T}(0)$ to $\mathbf{N}(0)$ is $3\pi/2$, not $\pi/2$. (In fact the angle is $3\pi/2$ for all values of t .)
23. True. By Theorem 12.3.4(b), $\|\mathbf{r}'(s)\| = 1$ for all s , so Theorem 12.2.8 implies that $\mathbf{r}'(s)$ and $\mathbf{r}''(s)$ are orthogonal.
24. False. $\mathbf{B}(t)$ is the cross product of $\mathbf{T}(t)$ and $\mathbf{N}(t)$.
26. The formulas for the unit tangent, normal, and binormal vectors are simpler when a curve is parametrized by arc length. Compare equations (1) and (6), (2) and (7), and (11) and (12). In the next section, we will see further examples; e.g. compare Definition 12.5.1 and Theorem 12.5.2.

Exercise Set 12.5

1. $\kappa \approx \frac{1}{0.5} = 2.$
2. $\kappa \approx \frac{1}{4/3} = \frac{3}{4}.$
3. (a) At $x = 0$ the curvature of I has a large value, yet the value of II there is zero, so II is not the curvature of I; hence I is the curvature of II.

(b) I has points of inflection where the curvature is zero, but II is not zero there, and hence is not the curvature of I; so I is the curvature of II.
4. (a) II takes the value zero at $x = 0$, yet the curvature of I is large there; hence I is the curvature of II.

(b) I has constant zero curvature; II has constant, positive curvature; hence I is the curvature of II.
5. $\mathbf{r}'(t) = 2t\mathbf{i} + 3t^2\mathbf{j}$, $\mathbf{r}''(t) = 2\mathbf{i} + 6t\mathbf{j}$, $\kappa = \frac{\|\mathbf{r}'(t) \times \mathbf{r}''(t)\|}{\|\mathbf{r}'(t)\|^3} = \frac{6t^2}{(4t^2 + 9t^4)^{3/2}} = \frac{6}{|t|(4 + 9t^2)^{3/2}}.$
6. $\mathbf{r}'(t) = -4\sin t\mathbf{i} + \cos t\mathbf{j}$, $\mathbf{r}''(t) = -4\cos t\mathbf{i} - \sin t\mathbf{j}$, $\kappa = \frac{\|\mathbf{r}'(t) \times \mathbf{r}''(t)\|}{\|\mathbf{r}'(t)\|^3} = \frac{4}{(16\sin^2 t + \cos^2 t)^{3/2}}.$
7. $\mathbf{r}'(t) = 3e^{3t}\mathbf{i} - e^{-t}\mathbf{j}$, $\mathbf{r}''(t) = 9e^{3t}\mathbf{i} + e^{-t}\mathbf{j}$, $\kappa = \frac{\|\mathbf{r}'(t) \times \mathbf{r}''(t)\|}{\|\mathbf{r}'(t)\|^3} = \frac{12e^{2t}}{(9e^{6t} + e^{-2t})^{3/2}}.$
8. $\mathbf{r}'(t) = -3t^2\mathbf{i} + (1 - 2t)\mathbf{j}$, $\mathbf{r}''(t) = -6t\mathbf{i} - 2\mathbf{j}$, $\kappa = \frac{\|\mathbf{r}'(t) \times \mathbf{r}''(t)\|}{\|\mathbf{r}'(t)\|^3} = \frac{6|t^2 - t|}{(9t^4 + 4t^2 - 4t + 1)^{3/2}}.$
9. $\mathbf{r}'(t) = -4\sin t\mathbf{i} + 4\cos t\mathbf{j} + \mathbf{k}$, $\mathbf{r}''(t) = -4\cos t\mathbf{i} - 4\sin t\mathbf{j}$, $\kappa = \frac{\|\mathbf{r}'(t) \times \mathbf{r}''(t)\|}{\|\mathbf{r}'(t)\|^3} = \frac{4}{17}.$
10. $\mathbf{r}'(t) = \mathbf{i} + t\mathbf{j} + t^2\mathbf{k}$, $\mathbf{r}''(t) = \mathbf{j} + 2t\mathbf{k}$, $\kappa = \frac{\|\mathbf{r}'(t) \times \mathbf{r}''(t)\|}{\|\mathbf{r}'(t)\|^3} = \frac{\sqrt{t^4 + 4t^2 + 1}}{(t^4 + t^2 + 1)^{3/2}}.$
11. $\mathbf{r}'(t) = \sinh t\mathbf{i} + \cosh t\mathbf{j} + \mathbf{k}$, $\mathbf{r}''(t) = \cosh t\mathbf{i} + \sinh t\mathbf{j}$, $\kappa = \frac{\|\mathbf{r}'(t) \times \mathbf{r}''(t)\|}{\|\mathbf{r}'(t)\|^3} = \frac{1}{2\cosh^2 t}.$
12. $\mathbf{r}'(t) = \mathbf{j} + 2t\mathbf{k}$, $\mathbf{r}''(t) = 2\mathbf{k}$, $\kappa = \frac{\|\mathbf{r}'(t) \times \mathbf{r}''(t)\|}{\|\mathbf{r}'(t)\|^3} = \frac{2}{(4t^2 + 1)^{3/2}}.$
13. $\mathbf{r}'(t) = -3\sin t\mathbf{i} + 4\cos t\mathbf{j} + \mathbf{k}$, $\mathbf{r}''(t) = -3\cos t\mathbf{i} - 4\sin t\mathbf{j}$, $\mathbf{r}'(\pi/2) = -3\mathbf{i} + \mathbf{k}$, $\mathbf{r}''(\pi/2) = -4\mathbf{j}$; $\kappa = \frac{\|4\mathbf{i} + 12\mathbf{k}\|}{\|-3\mathbf{i} + \mathbf{k}\|^3} = \frac{2}{5}$, $\rho = 5/2.$
14. $\mathbf{r}'(t) = e^t\mathbf{i} - e^{-t}\mathbf{j} + \mathbf{k}$, $\mathbf{r}''(t) = e^t\mathbf{i} + e^{-t}\mathbf{j}$, $\mathbf{r}'(0) = \mathbf{i} - \mathbf{j} + \mathbf{k}$, $\mathbf{r}''(0) = \mathbf{i} + \mathbf{j}$; $\kappa = \frac{\|-\mathbf{i} + \mathbf{j} + 2\mathbf{k}\|}{\|\mathbf{i} - \mathbf{j} + \mathbf{k}\|^3} = \sqrt{2}/3$, $\rho = 3/\sqrt{2}.$
15. $\mathbf{r}'(t) = e^t(\cos t - \sin t)\mathbf{i} + e^t(\cos t + \sin t)\mathbf{j} + e^t\mathbf{k}$, $\mathbf{r}''(t) = -2e^t\sin t\mathbf{i} + 2e^t\cos t\mathbf{j} + e^t\mathbf{k}$, $\mathbf{r}'(0) = \mathbf{i} + \mathbf{j} + \mathbf{k}$, $\mathbf{r}''(0) = 2\mathbf{j} + \mathbf{k}$; $\kappa = \frac{\|-\mathbf{i} - \mathbf{j} + 2\mathbf{k}\|}{\|\mathbf{i} + \mathbf{j} + \mathbf{k}\|^3} = \sqrt{2}/3$, $\rho = 3/\sqrt{2}.$
16. $\mathbf{r}'(t) = \cos t\mathbf{i} - \sin t\mathbf{j} + t\mathbf{k}$, $\mathbf{r}''(t) = -\sin t\mathbf{i} - \cos t\mathbf{j} + \mathbf{k}$, $\mathbf{r}'(0) = \mathbf{i}$, $\mathbf{r}''(0) = -\mathbf{j} + \mathbf{k}$; $\kappa = \frac{\|-\mathbf{j} - \mathbf{k}\|}{\|\mathbf{i}\|^3} = \sqrt{2}$, $\rho = \sqrt{2}/2.$

17. $\mathbf{r}'(s) = \frac{1}{2} \cos\left(1 + \frac{s}{2}\right) \mathbf{i} - \frac{1}{2} \sin\left(1 + \frac{s}{2}\right) \mathbf{j} + \frac{\sqrt{3}}{2} \mathbf{k}$, $\|\mathbf{r}'(s)\| = 1$, so $\frac{d\mathbf{T}}{ds} = -\frac{1}{4} \sin\left(1 + \frac{s}{2}\right) \mathbf{i} - \frac{1}{4} \cos\left(1 + \frac{s}{2}\right) \mathbf{j}$, $\kappa = \left\| \frac{d\mathbf{T}}{ds} \right\| = \frac{1}{4}$.

18. $\mathbf{r}'(s) = -\sqrt{\frac{3-2s}{3}} s \mathbf{i} + \sqrt{\frac{2s}{3}} \mathbf{j}$, $\|\mathbf{r}'(s)\| = 1$, so $\frac{d\mathbf{T}}{ds} = \frac{1}{\sqrt{9-6s}} \mathbf{i} + \frac{1}{\sqrt{6s}} \mathbf{j}$, $\kappa = \left\| \frac{d\mathbf{T}}{ds} \right\| = \sqrt{\frac{1}{9-6s} + \frac{1}{6s}} = \sqrt{\frac{3}{2s(9-6s)}} = \frac{1}{\sqrt{2s(3-2s)}}$.

19. True, by Example 1 with $a = 2$.

20. False. For any line, $\mathbf{T}(s)$ is constant, so $\kappa(s) = \left\| \frac{d\mathbf{T}}{ds} \right\| = \|\mathbf{0}\| = 0$.

21. False. By equation (1), the curvature is $\|\mathbf{r}''(s)\|$, not $\|\mathbf{r}'(s)\|$. ($\|\mathbf{r}'(s)\|$ is always 1, if it exists.)

22. False. The radius of the osculating circle is the reciprocal of the curvature.

23. (a) $\mathbf{r}' = x'\mathbf{i} + y'\mathbf{j}$, $\mathbf{r}'' = x''\mathbf{i} + y''\mathbf{j}$, $\|\mathbf{r}' \times \mathbf{r}''\| = |x'y'' - x''y'|$, $\kappa = \frac{|x'y'' - y'x''|}{(x'^2 + y'^2)^{3/2}}$.

(b) Set $x = t$, $y = f(x) = f(t)$, $x' = 1$, $x'' = 0$, $y' = \frac{dy}{dx}$, $y'' = \frac{d^2y}{dx^2}$, $\kappa = \frac{|d^2y/dx^2|}{(1 + (dy/dx)^2)^{3/2}}$.

24. $\frac{dy}{dx} = \tan \phi$, $(1 + \tan^2 \phi)^{3/2} = (\sec^2 \phi)^{3/2} = |\sec \phi|^3$, $\kappa(x) = \frac{|y''|}{|\sec \phi|^3} = |y'' \cos^3 \phi|$.

25. $\kappa(x) = \frac{|\sin x|}{(1 + \cos^2 x)^{3/2}}$, $\kappa(\pi/2) = 1$.

26. $\kappa(x) = \frac{2 \sec^2 x |\tan x|}{(1 + \sec^4 x)^{3/2}}$, $\kappa(\pi/4) = \frac{4}{5\sqrt{5}}$.

27. $\kappa(x) = \frac{e^{-x}}{(1 + e^{-2x})^{3/2}}$, $\kappa(1) = \frac{e^{-1}}{(1 + e^{-2})^{3/2}}$.

28. By implicit differentiation, $dy/dx = 4x/y$, $d^2y/dx^2 = 36/y^3$ so $\kappa = \frac{36/|y|^3}{(1 + 16x^2/y^2)^{3/2}}$; if $(x, y) = (2, 5)$ then $\kappa = \frac{36/125}{(1 + 64/25)^{3/2}} = \frac{36}{89\sqrt{89}}$.

29. $x'(t) = 2t$, $y'(t) = 3t^2$, $x''(t) = 2$, $y''(t) = 6t$, $x'(1/2) = 1$, $y'(1/2) = 3/4$, $x''(1/2) = 2$, $y''(1/2) = 3$; $\kappa = 96/125$.

30. $x'(t) = 3e^{3t}$, $y'(t) = -e^{-t}$, $x''(t) = 9e^{3t}$, $y''(t) = e^{-t}$, $x'(0) = 3$, $y'(0) = -1$, $x''(0) = 9$, $y''(0) = 1$; $\kappa = 6/(5\sqrt{10})$.

31. $x'(t) = 1$, $y'(t) = -1/t^2$, $x''(t) = 0$, $y''(t) = 2/t^3$, $x'(1) = 1$, $y'(1) = -1$, $x''(1) = 0$, $y''(1) = 2$; $\kappa = 1/\sqrt{2}$.

32. $x'(t) = 4 \cos 2t$, $y'(t) = 3 \cos t$, $x''(t) = -8 \sin 2t$, $y''(t) = -3 \sin t$, $x'(\pi/2) = -4$, $y'(\pi/2) = 0$, $x''(\pi/2) = 0$, $y''(\pi/2) = -3$, $\kappa = 12/16^{3/2} = 3/16$.

33. (a) $\kappa(x) = \frac{|\cos x|}{(1 + \sin^2 x)^{3/2}}$, $\rho(x) = \frac{(1 + \sin^2 x)^{3/2}}{|\cos x|}$, $\rho(0) = \rho(\pi) = 1$.

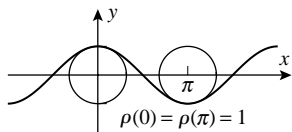

(b) $\kappa(t) = \frac{2}{(4 \sin^2 t + \cos^2 t)^{3/2}}$, $\rho(t) = \frac{1}{2}(4 \sin^2 t + \cos^2 t)^{3/2}$, $\rho(0) = 1/2$, $\rho(\pi/2) = 4$.

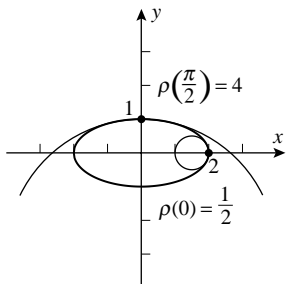

34. $x'(t) = -e^{-t}(\cos t + \sin t)$, $y'(t) = e^{-t}(\cos t - \sin t)$, $x''(t) = 2e^{-t} \sin t$, $y''(t) = -2e^{-t} \cos t$; using the formula of Exercise 23(a), $\kappa = \frac{1}{\sqrt{2}}e^t$.

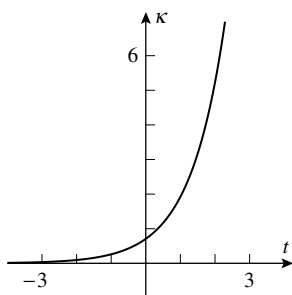

35. $y = f(x) = xe^{-x}$.

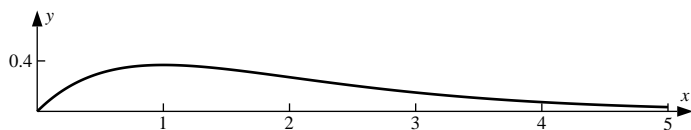

$$y = \kappa(x) = \frac{|x - 2|e^{-x}}{[1 + (1 - x)^2 e^{-2x}]^{3/2}}$$

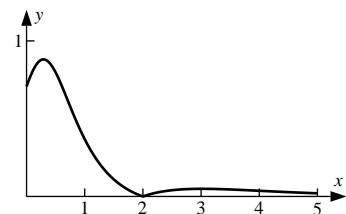

36. $y = f(x) = x^3 - x$.

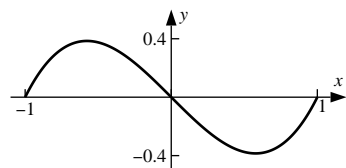

$$y = \kappa(x) = \frac{6|x|}{[1 + (3x^2 - 1)^2]^{3/2}}.$$

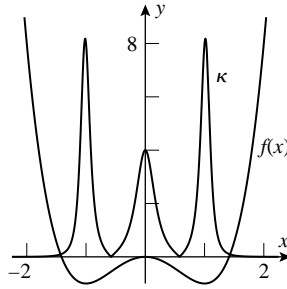
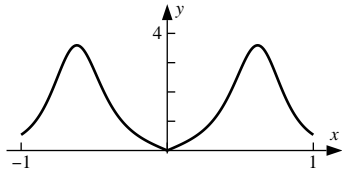

37. (a) $\kappa = \frac{|12x^2 - 4|}{[1 + (4x^3 - 4x)^2]^{3/2}}.$

(b)

(c) $f'(x) = 4x^3 - 4x = 0$ at $x = 0, \pm 1$, $f''(x) = 12x^2 - 4$, so extrema at $x = 0, \pm 1$, and $\rho = 1/4$ for $x = 0$ and $\rho = 1/8$ when $x = \pm 1$.

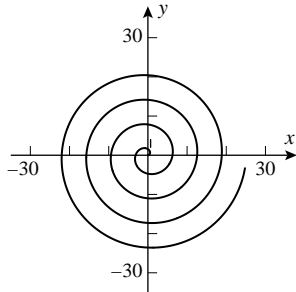

38. (a)

(c) $\kappa(t) = \frac{t^2 + 2}{(t^2 + 1)^{3/2}}.$

(d) $\lim_{t \rightarrow +\infty} \kappa(t) = 0.$

39. $\mathbf{r}'(\theta) = \left(-r \sin \theta + \cos \theta \frac{dr}{d\theta}\right) \mathbf{i} + \left(r \cos \theta + \sin \theta \frac{dr}{d\theta}\right) \mathbf{j};$

$$\mathbf{r}''(\theta) = \left(-r \cos \theta - 2 \sin \theta \frac{dr}{d\theta} + \cos \theta \frac{d^2r}{d\theta^2}\right) \mathbf{i} + \left(-r \sin \theta + 2 \cos \theta \frac{dr}{d\theta} + \sin \theta \frac{d^2r}{d\theta^2}\right) \mathbf{j};$$

$$\kappa = \frac{\left| r^2 + 2 \left(\frac{dr}{d\theta}\right)^2 - r \frac{d^2r}{d\theta^2} \right|}{\left[r^2 + \left(\frac{dr}{d\theta}\right)^2 \right]^{3/2}}.$$

40. Let $r = a$ be the circle, so that $dr/d\theta = 0$, and $\kappa(\theta) = \frac{1}{r} = \frac{1}{a}.$

41. $\kappa(\theta) = \frac{3}{2\sqrt{2}(1 + \cos \theta)^{1/2}}, \kappa(\pi/2) = \frac{3}{2\sqrt{2}}.$

42. $\kappa(\theta) = \frac{1}{\sqrt{5}e^{2\theta}}, \kappa(1) = \frac{1}{\sqrt{5}e^2}.$

43. $\kappa(\theta) = \frac{10 + 8 \cos^2 3\theta}{(1 + 8 \cos^2 3\theta)^{3/2}}, \kappa(0) = \frac{2}{3}.$

44. $\kappa(\theta) = \frac{\theta^2 + 2}{(\theta^2 + 1)^{3/2}}$, $\kappa(1) = \frac{3}{2\sqrt{2}}$.

45. Let $y = t$, then $x = \frac{t^2}{4p}$ and $\kappa(t) = \frac{1/|2p|}{[t^2/(4p^2) + 1]^{3/2}}$; $t = 0$ when $(x, y) = (0, 0)$ so $\kappa(0) = 1/|2p|$, $\rho = 2|p|$.

46. $\kappa(x) = \frac{e^x}{(1 + e^{2x})^{3/2}}$, $\kappa'(x) = \frac{e^x(1 - 2e^{2x})}{(1 + e^{2x})^{5/2}}$; $\kappa'(x) = 0$ when $e^{2x} = 1/2$, $x = -(\ln 2)/2$. By the first derivative test, $\kappa(-\frac{1}{2} \ln 2)$ is maximum so the point is $(-\frac{1}{2} \ln 2, 1/\sqrt{2})$.

47. Let $x = 3 \cos t$, $y = 2 \sin t$ for $0 \leq t < 2\pi$, $\kappa(t) = \frac{6}{(9 \sin^2 t + 4 \cos^2 t)^{3/2}}$ so $\rho(t) = \frac{1}{6}(9 \sin^2 t + 4 \cos^2 t)^{3/2} = \frac{1}{6}(5 \sin^2 t + 4)^{3/2}$ which, by inspection, is minimum when $t = 0$ or π . The radius of curvature is minimum at $(3, 0)$ and $(-3, 0)$.

48. $\mathbf{r}'(t) = -\sin t \mathbf{i} + \cos t \mathbf{j} - \sin t \mathbf{k}$, $\mathbf{r}''(t) = -\cos t \mathbf{i} - \sin t \mathbf{j} - \cos t \mathbf{k}$, $\|\mathbf{r}'(t) \times \mathbf{r}''(t)\| = \|- \mathbf{i} + \mathbf{k}\| = \sqrt{2}$, $\|\mathbf{r}'(t)\| = (1 + \sin^2 t)^{1/2}$; $\kappa(t) = \sqrt{2}/(1 + \sin^2 t)^{3/2}$, $\rho(t) = (1 + \sin^2 t)^{3/2}/\sqrt{2}$. The minimum value of ρ is $1/\sqrt{2}$; the maximum value is 2.

49. From Exercise 39: $dr/d\theta = ae^{a\theta} = ar$, $d^2r/d\theta^2 = a^2e^{a\theta} = a^2r$; $\kappa = 1/[\sqrt{1 + a^2}r]$.

50. Use implicit differentiation on $r^2 = a^2 \cos 2\theta$ to get $2r \frac{dr}{d\theta} = -2a^2 \sin 2\theta$, $r \frac{dr}{d\theta} = -a^2 \sin 2\theta$, and again to get $r \frac{d^2r}{d\theta^2} + \left(\frac{dr}{d\theta}\right)^2 = -2a^2 \cos 2\theta$ so $r \frac{d^2r}{d\theta^2} = -\left(\frac{dr}{d\theta}\right)^2 - 2a^2 \cos 2\theta = -\left(\frac{dr}{d\theta}\right)^2 - 2r^2$, thus $\left| r^2 + 2 \left(\frac{dr}{d\theta}\right)^2 - r \frac{d^2r}{d\theta^2} \right| = 3 \left[r^2 + \left(\frac{dr}{d\theta}\right)^2 \right]$, $\kappa = \frac{3}{[r^2 + (dr/d\theta)^2]^{1/2}}$; $\frac{dr}{d\theta} = -\frac{a^2 \sin 2\theta}{r}$ so $r^2 + \left(\frac{dr}{d\theta}\right)^2 = r^2 + \frac{a^4 \sin^2 2\theta}{r^2} = \frac{r^4 + a^4 \sin^2 2\theta}{r^2} = \frac{a^4 \cos^2 2\theta + a^4 \sin^2 2\theta}{r^2} = \frac{a^4}{r^2}$, hence $\kappa = \frac{3r}{a^2}$.

51. (a) $d^2y/dx^2 = 2$, $\kappa(\phi) = |2 \cos^3 \phi|$. (b) $dy/dx = \tan \phi = 1$, $\phi = \pi/4$, $\kappa(\pi/4) = |2 \cos^3(\pi/4)| = 1/\sqrt{2}$, $\rho = \sqrt{2}$.

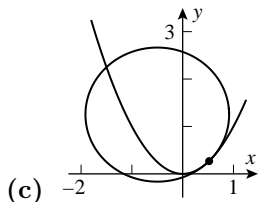

52. (a) $\left(\frac{5}{3}, 0\right)$, $\left(0, -\frac{5}{2}\right)$. (b) Clockwise. (c) It is a point, namely the center of the circle.

53. $\kappa = 0$ along $y = 0$; along $y = x^2$, $\kappa(x) = 2/(1 + 4x^2)^{3/2}$, $\kappa(0) = 2$. Along $y = x^3$, $\kappa(x) = 6|x|/(1 + 9x^4)^{3/2}$, $\kappa(0) = 0$.

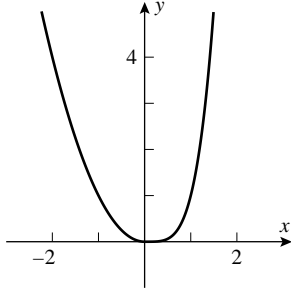

54. (a)

(b) For $y = x^2$, $\kappa(x) = \frac{2}{(1 + 4x^2)^{3/2}}$, so $\kappa(0) = 2$; for $y = x^4$, $\kappa(x) = \frac{12x^2}{(1 + 16x^6)^{3/2}}$ so $\kappa(0) = 0$. κ is not continuous at $x = 0$.

55. $\kappa = 1/r$ along the circle; along $y = ax^2$, $\kappa(x) = 2a/(1 + 4a^2x^2)^{3/2}$, $\kappa(0) = 2a$ so $2a = 1/r$, $a = 1/(2r)$.

56. $\kappa(x) = \frac{|y''|}{(1 + y'^2)^{3/2}}$ so the transition will be smooth if the values of y are equal, the values of y' are equal, and the values of y'' are equal at $x = 0$. If $y = e^x$, then $y' = y'' = e^x$; if $y = ax^2 + bx + c$, then $y' = 2ax + b$ and $y'' = 2a$. Equate y , y' , and y'' at $x = 0$ to get $c = 1$, $b = 1$, and $a = 1/2$.

57. Let $y(x) = \begin{cases} f(x) & \text{if } x \leq 0; \\ ax^2 + bx + c & \text{if } x > 0. \end{cases}$ Since $\kappa(x) = \frac{|y''|}{(1 + y'^2)^{3/2}}$, the transition will be smooth if y , y' , and y'' are all continuous at $x = 0$. This happens if $f(0) = c$, $f'(0) = b$, and $f''(0) = 2a$. So if we let $a = f''(0)/2$, $b = f'(0)$, and $c = f(0)$, the transition will be smooth. (Note that we don't need $f'''(x)$ to exist for all $x \leq 0$; it suffices to have $f''(x)$ continuous.)

58. The result follows immediately from the definitions $\mathbf{N} = \frac{\mathbf{T}'(s)}{\|\mathbf{T}'(s)\|}$ and $\kappa = \|\mathbf{T}'(s)\|$.

59. (a) $\mathbf{B} \cdot \frac{d\mathbf{B}}{ds} = 0$ because $\|\mathbf{B}(s)\| = 1$, so $\frac{d\mathbf{B}}{ds}$ is perpendicular to $\mathbf{B}(s)$.

(b) $\mathbf{B}(s) \cdot \mathbf{T}(s) = 0$, so $0 = \mathbf{B}(s) \cdot \frac{d\mathbf{T}}{ds} + \frac{d\mathbf{B}}{ds} \cdot \mathbf{T}(s)$. Since $\frac{d\mathbf{T}}{ds} = \kappa\mathbf{N}(s)$, $\mathbf{B}(s) \cdot \frac{d\mathbf{T}}{ds} = \kappa\mathbf{B}(s) \cdot \mathbf{N}(s) = 0$. Hence $\frac{d\mathbf{B}}{ds} \cdot \mathbf{T}(s) = 0$; thus $\frac{d\mathbf{B}}{ds}$ is perpendicular to $\mathbf{T}(s)$.

(c) $\frac{d\mathbf{B}}{ds}$ is perpendicular to both $\mathbf{B}(s)$ and $\mathbf{T}(s)$ but so is $\mathbf{N}(s)$, thus $\frac{d\mathbf{B}}{ds}$ is parallel to $\mathbf{N}(s)$ and hence a scalar multiple of $\mathbf{N}(s)$.

(d) If C lies in a plane, then $\mathbf{T}(s)$ and $\mathbf{N}(s)$ also lie in the plane; $\mathbf{B}(s) = \mathbf{T}(s) \times \mathbf{N}(s)$ so $\mathbf{B}(s)$ is always perpendicular to the plane. Since $\frac{d\mathbf{B}}{ds}$ exists at each point on the curve, \mathbf{B} is continuous. Since $\|\mathbf{B}\| = 1$, either $\mathbf{B} = \mathbf{k}$ for all s or $\mathbf{B} = -\mathbf{k}$ for all s ; in either case $\frac{d\mathbf{B}}{ds} = \mathbf{0}$.

60. $\frac{d\mathbf{N}}{ds} = \mathbf{B} \times \frac{d\mathbf{T}}{ds} + \frac{d\mathbf{B}}{ds} \times \mathbf{T} = \mathbf{B} \times (\kappa\mathbf{N}) + (-\tau\mathbf{N}) \times \mathbf{T} = \kappa\mathbf{B} \times \mathbf{N} - \tau\mathbf{N} \times \mathbf{T}$, but $\mathbf{B} \times \mathbf{N} = -\mathbf{T}$ and $\mathbf{N} \times \mathbf{T} = -\mathbf{B}$ so $\frac{d\mathbf{N}}{ds} = -\kappa\mathbf{T} + \tau\mathbf{B}$.

61. $\mathbf{r}''(s) = d\mathbf{T}/ds = \kappa\mathbf{N}$ so $\mathbf{r}'''(s) = \kappa d\mathbf{N}/ds + (d\kappa/ds)\mathbf{N}$ but $d\mathbf{N}/ds = -\kappa\mathbf{T} + \tau\mathbf{B}$ so $\mathbf{r}'''(s) = -\kappa^2\mathbf{T} + (d\kappa/ds)\mathbf{N} + \kappa\tau\mathbf{B}$, $\mathbf{r}'(s) \times \mathbf{r}''(s) = \mathbf{T} \times (\kappa\mathbf{N}) = \kappa\mathbf{T} \times \mathbf{N} = \kappa\mathbf{B}$, $[\mathbf{r}'(s) \times \mathbf{r}''(s)] \cdot \mathbf{r}'''(s) = -\kappa^3\mathbf{B} \cdot \mathbf{T} + \kappa(d\kappa/ds)\mathbf{B} \cdot \mathbf{N} + \kappa^2\tau\mathbf{B} \cdot \mathbf{B} = \kappa^2\tau$, $\tau = [\mathbf{r}'(s) \times \mathbf{r}''(s)] \cdot \mathbf{r}'''(s) / \kappa^2 = [\mathbf{r}'(s) \times \mathbf{r}''(s)] \cdot \mathbf{r}'''(s) / \|\mathbf{r}''(s)\|^2$ and $\mathbf{B} = \mathbf{T} \times \mathbf{N} = [\mathbf{r}'(s) \times \mathbf{r}''(s)] / \|\mathbf{r}''(s)\|$.

$$62. \text{ (a) } \mathbf{T}' = \frac{d\mathbf{T}}{dt} = \frac{d\mathbf{T}}{ds} \frac{ds}{dt} = (\kappa\mathbf{N})s' = \kappa s' \mathbf{N}, \mathbf{N}' = \frac{d\mathbf{N}}{dt} = \frac{d\mathbf{N}}{ds} \frac{ds}{dt} = (-\kappa\mathbf{T} + \tau\mathbf{B})s' = -\kappa s' \mathbf{T} + \tau s' \mathbf{B}.$$

$$\text{ (b) } \|\mathbf{r}'(t)\| = s' \text{ so } \mathbf{r}'(t) = s' \mathbf{T} \text{ and } \mathbf{r}''(t) = s'' \mathbf{T} + s' \mathbf{T}' = s'' \mathbf{T} + s'(\kappa s' \mathbf{N}) = s'' \mathbf{T} + \kappa(s')^2 \mathbf{N}.$$

$$\text{ (c) } \mathbf{r}'''(t) = s''' \mathbf{T} + s'' \mathbf{T}' + \kappa(s')^2 \mathbf{N}' + [2\kappa s' s'' + \kappa'(s')^2] \mathbf{N} = s'''(\kappa s' \mathbf{N}) + s'' \mathbf{T} + \kappa(s')^2(-\kappa s' \mathbf{T} + \tau s' \mathbf{B}) + [2\kappa s' s'' + \kappa'(s')^2] \mathbf{N} = [s''' - \kappa^2(s')^3] \mathbf{T} + [3\kappa s' s'' + \kappa'(s')^2] \mathbf{N} + \kappa \tau (s')^3 \mathbf{B}.$$

$$\text{ (d) } \mathbf{r}'(t) \times \mathbf{r}''(t) = s' s'' \mathbf{T} \times \mathbf{T} + \kappa(s')^3 \mathbf{T} \times \mathbf{N} = \kappa(s')^3 \mathbf{B}, [\mathbf{r}'(t) \times \mathbf{r}''(t)] \cdot \mathbf{r}'''(t) = \kappa^2 \tau (s')^6, \text{ so}$$

$$\tau = \frac{[\mathbf{r}'(t) \times \mathbf{r}''(t)] \cdot \mathbf{r}'''(t)}{\kappa^2 (s')^6} = \frac{[\mathbf{r}'(t) \times \mathbf{r}''(t)] \cdot \mathbf{r}'''(t)}{\|\mathbf{r}'(t) \times \mathbf{r}''(t)\|^2}.$$

$$63. \mathbf{r}' = 2\mathbf{i} + 2t\mathbf{j} + t^2\mathbf{k}, \mathbf{r}'' = 2\mathbf{j} + 2t\mathbf{k}, \mathbf{r}''' = 2\mathbf{k}, \mathbf{r}' \times \mathbf{r}'' = 2t^2\mathbf{i} - 4t\mathbf{j} + 4\mathbf{k}, \|\mathbf{r}' \times \mathbf{r}''\| = 2(t^2 + 2), \tau = 8/[2(t^2 + 2)]^2 = 2/(t^2 + 2)^2.$$

$$64. \mathbf{r}' = -a \sin t \mathbf{i} + a \cos t \mathbf{j} + c \mathbf{k}, \mathbf{r}'' = -a \cos t \mathbf{i} - a \sin t \mathbf{j}, \mathbf{r}''' = a \sin t \mathbf{i} - a \cos t \mathbf{j}, \mathbf{r}' \times \mathbf{r}'' = ac \sin t \mathbf{i} - ac \cos t \mathbf{j} + a^2 \mathbf{k}, \|\mathbf{r}' \times \mathbf{r}''\| = \sqrt{a^2(a^2 + c^2)}, \tau = a^2 c / [a^2(a^2 + c^2)] = c / (a^2 + c^2).$$

$$65. \mathbf{r}' = e^t \mathbf{i} - e^{-t} \mathbf{j} + \sqrt{2} \mathbf{k}, \mathbf{r}'' = e^t \mathbf{i} + e^{-t} \mathbf{j}, \mathbf{r}''' = e^t \mathbf{i} - e^{-t} \mathbf{j}, \mathbf{r}' \times \mathbf{r}'' = -\sqrt{2} e^{-t} \mathbf{i} + \sqrt{2} e^t \mathbf{j} + 2 \mathbf{k}, \|\mathbf{r}' \times \mathbf{r}''\| = \sqrt{2}(e^t + e^{-t}), \tau = (-2\sqrt{2})/[2(e^t + e^{-t})^2] = -\sqrt{2}/(e^t + e^{-t})^2.$$

$$66. \mathbf{r}' = (1 - \cos t) \mathbf{i} + \sin t \mathbf{j} + \mathbf{k}, \mathbf{r}'' = \sin t \mathbf{i} + \cos t \mathbf{j}, \mathbf{r}''' = \cos t \mathbf{i} - \sin t \mathbf{j}, \mathbf{r}' \times \mathbf{r}'' = -\cos t \mathbf{i} + \sin t \mathbf{j} + (\cos t - 1) \mathbf{k}, \|\mathbf{r}' \times \mathbf{r}''\| = \sqrt{\cos^2 t + \sin^2 t + (\cos t - 1)^2} = \sqrt{1 + 4 \sin^4(t/2)}, \tau = -1/[1 + 4 \sin^4(t/2)].$$

67. If the curvature κ has a maximum at P , then the curve lies outside of the osculating circle near P . If κ has a minimum at P , then the curve lies inside of the osculating circle near P . Otherwise the curve and the osculating circle cross at P . For example, the curvature of the ellipse in Example 4 has a maximum at $t = \pi/2$; as shown in Figure 12.5.5 the ellipse is outside of the osculating circle at that point. (By symmetry the same is true at $t = 3\pi/2$.) The curvature has a minimum at $t = 0$ and the ellipse is inside of the osculating circle there. (Also at $t = \pi$, by symmetry.) At other points the ellipse and the osculating circle cross. For example, the figure below shows them at $t = \pi/4$. (The osculating circle at this point has center $(-5\sqrt{2}/8, 5\sqrt{2}/12)$ and radius $13\sqrt{26}/24$.)

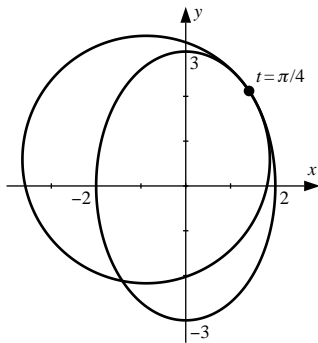

68. The radius of curvature is largest at $t = 0$, so the cardioid is straightest there. As t increases to π , the radius of curvature decreases; i.e. the curve bends more. At $t = \pi$ the cardioid has a cusp, at which point the radius of curvature is 0.

Exercise Set 12.6

$$1. \mathbf{v}(t) = -3 \sin t \mathbf{i} + 3 \cos t \mathbf{j}, \mathbf{a}(t) = -3 \cos t \mathbf{i} - 3 \sin t \mathbf{j}, \|\mathbf{v}(t)\| = \sqrt{9 \sin^2 t + 9 \cos^2 t} = 3, \mathbf{r}(\pi/3) = (3/2) \mathbf{i} + (3\sqrt{3}/2) \mathbf{j}, \mathbf{v}(\pi/3) = -(3\sqrt{3}/2) \mathbf{i} + (3/2) \mathbf{j}, \mathbf{a}(\pi/3) = -(3/2) \mathbf{i} - (3\sqrt{3}/2) \mathbf{j}.$$

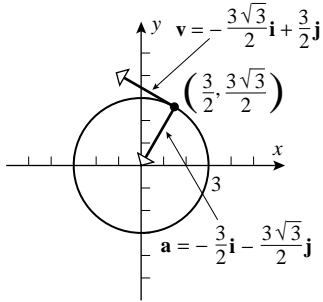

2. $\mathbf{v}(t) = \mathbf{i} + 2t\mathbf{j}$, $\mathbf{a}(t) = 2\mathbf{j}$, $\|\mathbf{v}(t)\| = \sqrt{1 + 4t^2}$, $\mathbf{r}(2) = 2\mathbf{i} + 4\mathbf{j}$, $\mathbf{v}(2) = \mathbf{i} + 4\mathbf{j}$, $\mathbf{a}(2) = 2\mathbf{j}$.

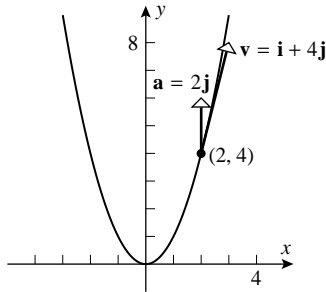

3. $\mathbf{v}(t) = e^t\mathbf{i} - e^{-t}\mathbf{j}$, $\mathbf{a}(t) = e^t\mathbf{i} + e^{-t}\mathbf{j}$, $\|\mathbf{v}(t)\| = \sqrt{e^{2t} + e^{-2t}}$, $\mathbf{r}(0) = \mathbf{i} + \mathbf{j}$, $\mathbf{v}(0) = \mathbf{i} - \mathbf{j}$, $\mathbf{a}(0) = \mathbf{i} + \mathbf{j}$.

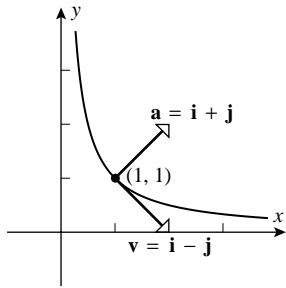

4. $\mathbf{v}(t) = 4\mathbf{i} - \mathbf{j}$, $\mathbf{a}(t) = \mathbf{0}$, $\|\mathbf{v}(t)\| = \sqrt{17}$, $\mathbf{r}(1) = 6\mathbf{i}$, $\mathbf{v}(1) = 4\mathbf{i} - \mathbf{j}$, $\mathbf{a}(1) = \mathbf{0}$.

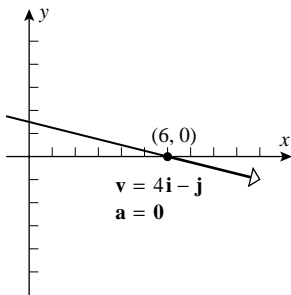

5. $\mathbf{v} = \mathbf{i} + t\mathbf{j} + t^2\mathbf{k}$, $\mathbf{a} = \mathbf{j} + 2t\mathbf{k}$; at $t = 1$, $\mathbf{v} = \mathbf{i} + \mathbf{j} + \mathbf{k}$, $\|\mathbf{v}\| = \sqrt{3}$, $\mathbf{a} = \mathbf{j} + 2\mathbf{k}$.

6. $\mathbf{r} = (1 + 3t)\mathbf{i} + (2 - 4t)\mathbf{j} + (7 + t)\mathbf{k}$, $\mathbf{v} = 3\mathbf{i} - 4\mathbf{j} + \mathbf{k}$, $\mathbf{a} = \mathbf{0}$; at $t = 2$, $\mathbf{v} = 3\mathbf{i} - 4\mathbf{j} + \mathbf{k}$, $\|\mathbf{v}\| = \sqrt{26}$, $\mathbf{a} = \mathbf{0}$.

7. $\mathbf{v} = -2\sin t\mathbf{i} + 2\cos t\mathbf{j} + \mathbf{k}$, $\mathbf{a} = -2\cos t\mathbf{i} - 2\sin t\mathbf{j}$; at $t = \pi/4$, $\mathbf{v} = -\sqrt{2}\mathbf{i} + \sqrt{2}\mathbf{j} + \mathbf{k}$, $\|\mathbf{v}\| = \sqrt{5}$, $\mathbf{a} = -\sqrt{2}\mathbf{i} - \sqrt{2}\mathbf{j}$.

8. $\mathbf{v} = e^t(\cos t + \sin t)\mathbf{i} + e^t(\cos t - \sin t)\mathbf{j} + \mathbf{k}$, $\mathbf{a} = 2e^t \cos t\mathbf{i} - 2e^t \sin t\mathbf{j}$; at $t = \pi/2$, $\mathbf{v} = e^{\pi/2}\mathbf{i} - e^{\pi/2}\mathbf{j} + \mathbf{k}$, $\|\mathbf{v}\| = (1 + 2e^\pi)^{1/2}$, $\mathbf{a} = -2e^{\pi/2}\mathbf{j}$.

9. (a) $\mathbf{v} = -aw \sin \omega t\mathbf{i} + bw \cos \omega t\mathbf{j}$, $\mathbf{a} = -aw^2 \cos \omega t\mathbf{i} - bw^2 \sin \omega t\mathbf{j} = -\omega^2\mathbf{r}$.

(b) From part (a), $\|\mathbf{a}\| = \omega^2\|\mathbf{r}\|$.

10. (a) $\mathbf{v} = 16\pi \cos \pi t \mathbf{i} - 8\pi \sin 2\pi t \mathbf{j}$, $\mathbf{a} = -16\pi^2 \sin \pi t \mathbf{i} - 16\pi^2 \cos 2\pi t \mathbf{j}$; at $t = 1$, $\mathbf{v} = -16\pi \mathbf{i}$, $\|\mathbf{v}\| = 16\pi$, $\mathbf{a} = -16\pi^2 \mathbf{j}$.

(b) $x = 16 \sin \pi t$, $y = 4 \cos 2\pi t = 4 \cos^2 \pi t - 4 \sin^2 \pi t = 4 - 8 \sin^2 \pi t$, $y = 4 - x^2/32$.

(c) $x(t)$ and $y(t)$ are periodic with periods 2 and 1, respectively, so after 2 s the particle retraces its path.

11. If $\mathbf{a} = \mathbf{0}$ then $x''(t) = y''(t) = z''(t) = 0$, so $x(t) = x_1 t + x_0$, $y(t) = y_1 t + y_0$, $z(t) = z_1 t + z_0$, the motion is along a straight line and has constant speed.

12. (a) If $\|\mathbf{r}\|$ is constant then so is $\|\mathbf{r}\|^2$, but then $x^2 + y^2 = c^2$ (2-space) or $x^2 + y^2 + z^2 = c^2$ (3-space), so the motion is along a circle or a sphere of radius c centered at the origin, and the velocity vector is always perpendicular to the position vector.

(b) If $\|\mathbf{v}\|$ is constant, then by the theorem $\mathbf{v}(t) \cdot \mathbf{a}(t) = 0$, so the velocity is always perpendicular to the acceleration.

13. $\mathbf{v} = (6/\sqrt{t})\mathbf{i} + (3/2)t^{1/2}\mathbf{j}$, $\|\mathbf{v}\| = \sqrt{36/t + 9t/4}$, $\frac{d}{dt}\|\mathbf{v}\| = \frac{-36/t^2 + 9/4}{2\sqrt{36/t + 9t/4}} = 0$ if $t = 4$ which yields a minimum by the first derivative test. The minimum speed is $3\sqrt{2}$ when $\mathbf{r} = 24\mathbf{i} + 8\mathbf{j}$.

14. $\mathbf{v} = (1 - 2t)\mathbf{i} - 2t\mathbf{j}$, $\|\mathbf{v}\| = \sqrt{(1 - 2t)^2 + 4t^2} = \sqrt{8t^2 - 4t + 1}$, $\frac{d}{dt}\|\mathbf{v}\| = \frac{8t - 2}{\sqrt{8t^2 - 4t + 1}} = 0$ if $t = \frac{1}{4}$ which yields a minimum by the first derivative test. The minimum speed is $1/\sqrt{2}$ when the particle is at $\mathbf{r} = \frac{3}{16}\mathbf{i} - \frac{1}{16}\mathbf{j}$.

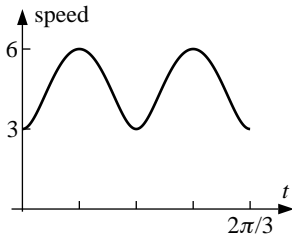

15. (a)

(b) $\mathbf{v} = 3 \cos 3t \mathbf{i} + 6 \sin 3t \mathbf{j}$, $\|\mathbf{v}\| = \sqrt{9 \cos^2 3t + 36 \sin^2 3t} = 3\sqrt{1 + 3 \sin^2 3t}$; by inspection, maximum speed is 6 and minimum speed is 3.

(d) By inspection, $\|\mathbf{v}\| = 3\sqrt{1 + 3 \sin^2 3t}$ is maximal when $\sin 3t = \pm 1$; this occurs first when $t = \pi/6$.

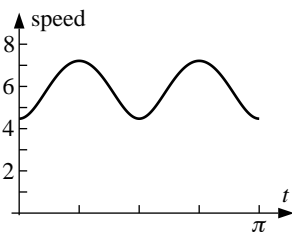

16. (a)

(d) $\mathbf{v} = -6 \sin 2t \mathbf{i} + 2 \cos 2t \mathbf{j} + 4\mathbf{k}$, $\|\mathbf{v}\| = \sqrt{36 \sin^2 2t + 4 \cos^2 2t + 16} = 2\sqrt{8 \sin^2 2t + 5}$; by inspection the maximum speed is $2\sqrt{13}$ and first occurs when $t = \pi/4$, the minimum speed is $2\sqrt{5}$ and first occurs when $t = 0$.

17. $\mathbf{v}(t) = -\sin t \mathbf{i} + \cos t \mathbf{j} + \mathbf{C}_1$, $\mathbf{v}(0) = \mathbf{j} + \mathbf{C}_1 = \mathbf{i}$, $\mathbf{C}_1 = \mathbf{i} - \mathbf{j}$, $\mathbf{v}(t) = (1 - \sin t)\mathbf{i} + (\cos t - 1)\mathbf{j}$; $\mathbf{r}(t) = (t + \cos t)\mathbf{i} + (\sin t - t)\mathbf{j} + \mathbf{C}_2$, $\mathbf{r}(0) = \mathbf{i} + \mathbf{C}_2 = \mathbf{j}$, $\mathbf{C}_2 = -\mathbf{i} + \mathbf{j}$ so $\mathbf{r}(t) = (t + \cos t - 1)\mathbf{i} + (\sin t - t + 1)\mathbf{j}$.

18. $\mathbf{v}(t) = t\mathbf{i} - e^{-t}\mathbf{j} + \mathbf{C}_1$, $\mathbf{v}(0) = -\mathbf{j} + \mathbf{C}_1 = 2\mathbf{i} + \mathbf{j}$; $\mathbf{C}_1 = 2\mathbf{i} + 2\mathbf{j}$, so $\mathbf{v}(t) = (t+2)\mathbf{i} + (2 - e^{-t})\mathbf{j}$; $\mathbf{r}(t) = (t^2/2 + 2t)\mathbf{i} + (2t + e^{-t})\mathbf{j} + \mathbf{C}_2$, $\mathbf{r}(0) = \mathbf{j} + \mathbf{C}_2 = \mathbf{i} - \mathbf{j}$, $\mathbf{C}_2 = \mathbf{i} - 2\mathbf{j}$ so $\mathbf{r}(t) = (t^2/2 + 2t + 1)\mathbf{i} + (2t + e^{-t} - 2)\mathbf{j}$.

19. $\mathbf{v}(t) = -\cos t\mathbf{i} + \sin t\mathbf{j} + e^t\mathbf{k} + \mathbf{C}_1$, $\mathbf{v}(0) = -\mathbf{i} + \mathbf{k} + \mathbf{C}_1 = \mathbf{k}$, so $\mathbf{C}_1 = \mathbf{i}$, $\mathbf{v}(t) = (1 - \cos t)\mathbf{i} + \sin t\mathbf{j} + e^t\mathbf{k}$; $\mathbf{r}(t) = (t - \sin t)\mathbf{i} - \cos t\mathbf{j} + e^t\mathbf{k} + \mathbf{C}_2$, $\mathbf{r}(0) = -\mathbf{j} + \mathbf{k} + \mathbf{C}_2 = -\mathbf{i} + \mathbf{k}$ so $\mathbf{C}_2 = -\mathbf{i} + \mathbf{j}$, $\mathbf{r}(t) = (t - \sin t - 1)\mathbf{i} + (1 - \cos t)\mathbf{j} + e^t\mathbf{k}$.

20. $\mathbf{v}(t) = -\frac{1}{t+1}\mathbf{j} + \frac{1}{2}e^{-2t}\mathbf{k} + \mathbf{C}_1$, $\mathbf{v}(0) = -\mathbf{j} + \frac{1}{2}\mathbf{k} + \mathbf{C}_1 = 3\mathbf{i} - \mathbf{j}$, so $\mathbf{C}_1 = 3\mathbf{i} - \frac{1}{2}\mathbf{k}$, $\mathbf{v}(t) = 3\mathbf{i} - \frac{1}{t+1}\mathbf{j} + \left(\frac{1}{2}e^{-2t} - \frac{1}{2}\right)\mathbf{k}$; $\mathbf{r}(t) = 3t\mathbf{i} - \ln(t+1)\mathbf{j} - \left(\frac{1}{4}e^{-2t} + \frac{1}{2}t\right)\mathbf{k} + \mathbf{C}_2$, $\mathbf{r}(0) = -\frac{1}{4}\mathbf{k} + \mathbf{C}_2 = 2\mathbf{k}$ so $\mathbf{C}_2 = \frac{9}{4}\mathbf{k}$, $\mathbf{r}(t) = 3t\mathbf{i} - \ln(t+1)\mathbf{j} + \left(\frac{9}{4} - \frac{1}{4}e^{-2t} - \frac{1}{2}t\right)\mathbf{k}$.

21. $\mathbf{v} = 3t^2\mathbf{i} + 2t\mathbf{j}$, $\mathbf{a} = 6t\mathbf{i} + 2\mathbf{j}$; $\mathbf{v} = 3\mathbf{i} + 2\mathbf{j}$ and $\mathbf{a} = 6\mathbf{i} + 2\mathbf{j}$ when $t = 1$, so $\cos \theta = (\mathbf{v} \cdot \mathbf{a}) / (\|\mathbf{v}\| \|\mathbf{a}\|) = 11 / \sqrt{130}$, $\theta \approx 15^\circ$.

22. $\mathbf{v} = e^t(\cos t - \sin t)\mathbf{i} + e^t(\cos t + \sin t)\mathbf{j}$, $\mathbf{a} = -2e^t \sin t\mathbf{i} + 2e^t \cos t\mathbf{j}$, $\mathbf{v} \cdot \mathbf{a} = 2e^{2t}$, $\|\mathbf{v}\| = \sqrt{2}e^t$, $\|\mathbf{a}\| = 2e^t$, $\cos \theta = (\mathbf{v} \cdot \mathbf{a}) / (\|\mathbf{v}\| \|\mathbf{a}\|) = 1/\sqrt{2}$, $\theta = 45^\circ$.

23. (a) Displacement = $\mathbf{r}_1 - \mathbf{r}_0 = 0.7\mathbf{i} + 2.7\mathbf{j} - 3.4\mathbf{k}$.

(b) $\Delta \mathbf{r} = \mathbf{r}_1 - \mathbf{r}_0$, so $\mathbf{r}_0 = \mathbf{r}_1 - \Delta \mathbf{r} = -0.7\mathbf{i} - 2.9\mathbf{j} + 4.8\mathbf{k}$.

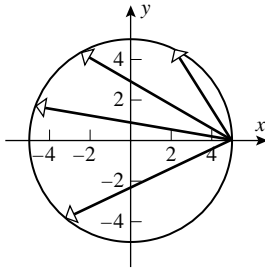

24. (a) (b) One revolution, or 10π .

25. $\Delta \mathbf{r} = \mathbf{r}(3) - \mathbf{r}(1) = 8\mathbf{i} + (26/3)\mathbf{j}$; $\mathbf{v} = 2t\mathbf{i} + t^2\mathbf{j}$, $s = \int_1^3 t\sqrt{4+t^2} dt = \frac{13\sqrt{13} - 5\sqrt{5}}{3}$.

26. $\Delta \mathbf{r} = \mathbf{r}(3\pi/2) - \mathbf{r}(0) = 3\mathbf{i} - 3\mathbf{j}$; $\mathbf{v} = -3\cos t\mathbf{i} - 3\sin t\mathbf{j}$, $s = \int_0^{3\pi/2} 3 dt = \frac{9\pi}{2}$.

27. $\Delta \mathbf{r} = \mathbf{r}(\ln 3) - \mathbf{r}(0) = 2\mathbf{i} - (2/3)\mathbf{j} + \sqrt{2}(\ln 3)\mathbf{k}$; $\mathbf{v} = e^t\mathbf{i} - e^{-t}\mathbf{j} + \sqrt{2}\mathbf{k}$, $s = \int_0^{\ln 3} (e^t + e^{-t}) dt = \frac{8}{3}$.

28. $\Delta \mathbf{r} = \mathbf{r}(\pi) - \mathbf{r}(0) = \mathbf{0}$; $\mathbf{v} = -2\sin 2t\mathbf{i} + 2\sin 2t\mathbf{j} - \sin 2t\mathbf{k}$, $\|\mathbf{v}\| = 3|\sin 2t|$, $s = \int_0^\pi 3|\sin 2t| dt = 6 \int_0^{\pi/2} \sin 2t dt = 6$.

29. In both cases, the equation of the path in rectangular coordinates is $x^2 + y^2 = 4$, the particles move counterclockwise around this circle; $\mathbf{v}_1 = -6\sin 3t\mathbf{i} + 6\cos 3t\mathbf{j}$ and $\mathbf{v}_2 = -4t\sin(t^2)\mathbf{i} + 4t\cos(t^2)\mathbf{j}$ so $\|\mathbf{v}_1\| = 6$ and $\|\mathbf{v}_2\| = 4t$.

30. Let $u = 1 - t^3$ to get $\mathbf{r}_1(u) = (3 + 2(1 - t^3))\mathbf{i} + (1 - t^3)\mathbf{j} + (1 - (1 - t^3))\mathbf{k} = (5 - 2t^3)\mathbf{i} + (1 - t^3)\mathbf{j} + t^3\mathbf{k} = \mathbf{r}_2(t)$, so both particles move along the same path; $\mathbf{v}_1 = 2\mathbf{i} + \mathbf{j} - \mathbf{k}$ and $\mathbf{v}_2 = -6t^2\mathbf{i} - 3t^2\mathbf{j} + 3t^2\mathbf{k}$ so $\|\mathbf{v}_1\| = \sqrt{6}$ and $\|\mathbf{v}_2\| = 3\sqrt{6}t^2$.

31. (a) $\mathbf{v} = -e^{-t}\mathbf{i} + e^t\mathbf{j}$, $\mathbf{a} = e^{-t}\mathbf{i} + e^t\mathbf{j}$; when $t = 0$, $\mathbf{v} = -\mathbf{i} + \mathbf{j}$, $\mathbf{a} = \mathbf{i} + \mathbf{j}$, $\|\mathbf{v}\| = \sqrt{2}$, $\mathbf{v} \cdot \mathbf{a} = 0$, $\mathbf{v} \times \mathbf{a} = -2\mathbf{k}$ so $a_T = 0$, $a_N = \sqrt{2}$.

(b) $a_T \mathbf{T} = \mathbf{0}$, $a_N \mathbf{N} = \mathbf{a} - a_T \mathbf{T} = \mathbf{i} + \mathbf{j}$. (c) $\kappa = 1/\sqrt{2}$.

32. (a) $\mathbf{v} = -2t \sin(t^2)\mathbf{i} + 2t \cos(t^2)\mathbf{j}$, $\mathbf{a} = [-4t^2 \cos(t^2) - 2 \sin(t^2)]\mathbf{i} + [-4t^2 \sin(t^2) + 2 \cos(t^2)]\mathbf{j}$; when $t = \sqrt{\pi}/2$, $\mathbf{v} = -\sqrt{\pi/2}\mathbf{i} + \sqrt{\pi/2}\mathbf{j}$, $\mathbf{a} = (-\pi/\sqrt{2} - \sqrt{2})\mathbf{i} + (-\pi/\sqrt{2} + \sqrt{2})\mathbf{j}$, $\|\mathbf{v}\| = \sqrt{\pi}$, $\mathbf{v} \cdot \mathbf{a} = 2\sqrt{\pi}$, $\mathbf{v} \times \mathbf{a} = \pi^{3/2}\mathbf{k}$ so $a_T = 2$, $a_N = \pi$.

(b) $a_T \mathbf{T} = -\sqrt{2}(\mathbf{i} - \mathbf{j})$, $a_N \mathbf{N} = \mathbf{a} - a_T \mathbf{T} = -(\pi/\sqrt{2})(\mathbf{i} + \mathbf{j})$. (c) $\kappa = 1$.

33. (a) $\mathbf{v} = (3t^2 - 2)\mathbf{i} + 2t\mathbf{j}$, $\mathbf{a} = 6t\mathbf{i} + 2\mathbf{j}$; when $t = 1$, $\mathbf{v} = \mathbf{i} + 2\mathbf{j}$, $\mathbf{a} = 6\mathbf{i} + 2\mathbf{j}$, $\|\mathbf{v}\| = \sqrt{5}$, $\mathbf{v} \cdot \mathbf{a} = 10$, $\mathbf{v} \times \mathbf{a} = -10\mathbf{k}$, so $a_T = 2\sqrt{5}$, $a_N = 2\sqrt{5}$.

(b) $a_T \mathbf{T} = \frac{2\sqrt{5}}{\sqrt{5}}(\mathbf{i} + 2\mathbf{j}) = 2\mathbf{i} + 4\mathbf{j}$, $a_N \mathbf{N} = \mathbf{a} - a_T \mathbf{T} = 4\mathbf{i} - 2\mathbf{j}$. (c) $\kappa = 2/\sqrt{5}$.

34. (a) $\mathbf{v} = e^t(-\sin t + \cos t)\mathbf{i} + e^t(\cos t + \sin t)\mathbf{j}$, $\mathbf{a} = -2e^t \sin t \mathbf{i} + 2e^t \cos t \mathbf{j}$; when $t = \pi/4$, $\mathbf{v} = \sqrt{2}e^{\pi/4}\mathbf{j}$, $\mathbf{a} = -\sqrt{2}e^{\pi/4}\mathbf{i} + \sqrt{2}e^{\pi/4}\mathbf{j}$, $\|\mathbf{v}\| = \sqrt{2}e^{\pi/4}$, $\mathbf{v} \cdot \mathbf{a} = 2e^{\pi/2}$, $\mathbf{v} \times \mathbf{a} = 2e^{\pi/2}\mathbf{k}$, so $a_T = \sqrt{2}e^{\pi/4}$, $a_N = \sqrt{2}e^{\pi/4}$.

(b) $a_T \mathbf{T} = \sqrt{2}e^{\pi/4}\mathbf{j}$, $a_N \mathbf{N} = \mathbf{a} - a_T \mathbf{T} = -\sqrt{2}e^{\pi/4}\mathbf{i}$. (c) $\kappa = \frac{1}{\sqrt{2}e^{\pi/4}}$.

35. (a) $\mathbf{v} = e^t\mathbf{i} - 2e^{-2t}\mathbf{j} + \mathbf{k}$, $\mathbf{a} = e^t\mathbf{i} + 4e^{-2t}\mathbf{j}$; when $t = 0$, $\mathbf{v} = \mathbf{i} - 2\mathbf{j} + \mathbf{k}$, $\mathbf{a} = \mathbf{i} + 4\mathbf{j}$, $\|\mathbf{v}\| = \sqrt{6}$, $\mathbf{v} \cdot \mathbf{a} = -7$, $\mathbf{v} \times \mathbf{a} = -4\mathbf{i} + \mathbf{j} + 6\mathbf{k}$ so $a_T = -7/\sqrt{6}$, $a_N = \sqrt{53}/6$.

(b) $a_T \mathbf{T} = -\frac{7}{6}(\mathbf{i} - 2\mathbf{j} + \mathbf{k})$, $a_N \mathbf{N} = \mathbf{a} - a_T \mathbf{T} = \frac{13}{6}\mathbf{i} + \frac{5}{3}\mathbf{j} + \frac{7}{6}\mathbf{k}$. (c) $\kappa = \frac{\sqrt{53}}{6\sqrt{6}}$.

36. (a) $\mathbf{v} = 3 \cos t \mathbf{i} - 2 \sin t \mathbf{j} - 2 \cos 2t \mathbf{k}$, $\mathbf{a} = -3 \sin t \mathbf{i} - 2 \cos t \mathbf{j} + 4 \sin 2t \mathbf{k}$; when $t = \pi/2$, $\mathbf{v} = -2\mathbf{j} + 2\mathbf{k}$, $\mathbf{a} = -3\mathbf{i}$, $\|\mathbf{v}\| = 2\sqrt{2}$, $\mathbf{v} \cdot \mathbf{a} = 0$, $\mathbf{v} \times \mathbf{a} = -6\mathbf{j} - 6\mathbf{k}$ so $a_T = 0$, $a_N = 3$.

(b) $a_T \mathbf{T} = \mathbf{0}$, $a_N \mathbf{N} = \mathbf{a} = -3\mathbf{i}$. (c) $\kappa = \frac{3}{8}$.

37. $\|\mathbf{v}\| = 4$, $\mathbf{v} \cdot \mathbf{a} = -12$, $\mathbf{v} \times \mathbf{a} = 8\mathbf{k}$ so $a_T = -3$, $a_N = 2$, $\mathbf{T} = -\mathbf{j}$, $\mathbf{N} = (\mathbf{a} - a_T \mathbf{T})/a_N = \mathbf{i}$.

38. $\|\mathbf{v}\| = 3$, $\mathbf{v} \cdot \mathbf{a} = 4$, $\mathbf{v} \times \mathbf{a} = 4\mathbf{i} - 3\mathbf{j} - 2\mathbf{k}$ so $a_T = 4/3$, $a_N = \sqrt{29}/3$, $\mathbf{T} = (1/3)(2\mathbf{i} + 2\mathbf{j} + \mathbf{k})$, $\mathbf{N} = (\mathbf{a} - a_T \mathbf{T})/a_N = (\mathbf{i} - 8\mathbf{j} + 14\mathbf{k})/(3\sqrt{29})$.

39. $a_T = \frac{d^2s}{dt^2} = \frac{d}{dt} \sqrt{t^2 + e^{-3t}} = \frac{2t - 3e^{-3t}}{2\sqrt{t^2 + e^{-3t}}}$ so when $t = 0$, $a_T = -\frac{3}{2}$.

40. $a_T = \frac{d^2s}{dt^2} = \frac{d}{dt} \sqrt{(4t-1)^2 + \cos^2 \pi t} = \frac{4(4t-1) - \pi \cos \pi t \sin \pi t}{\sqrt{(4t-1)^2 + \cos^2 \pi t}}$ so when $t = 1/4$, $a_T = -\frac{\pi}{\sqrt{2}}$.

41. $a_N = \kappa(ds/dt)^2 = (1/\rho)(ds/dt)^2 = (1/1)(2.9 \times 10^5)^2 = 8.41 \times 10^{10} \text{ km/s}^2$.

42. $\mathbf{a} = (d^2s/dt^2)\mathbf{T} + \kappa(ds/dt)^2\mathbf{N}$ where $\kappa = \frac{|d^2y/dx^2|}{[1 + (dy/dx)^2]^{3/2}}$. If $d^2y/dx^2 = 0$, then $\kappa = 0$ and $\mathbf{a} = (d^2s/dt^2)\mathbf{T}$ so \mathbf{a} is tangent to the curve.

43. $a_N = \kappa(ds/dt)^2 = [2/(1 + 4x^2)^{3/2}](3)^2 = 18/(1 + 4x^2)^{3/2}$.

44. $y = e^x$, $a_N = \kappa(ds/dt)^2 = [e^x/(1 + e^{2x})^{3/2}](2)^2 = 4e^x/(1 + e^{2x})^{3/2}$.

45. $\mathbf{a} = a_T \mathbf{T} + a_N \mathbf{N}$; by the Pythagorean Theorem $a_N = \sqrt{\|\mathbf{a}\|^2 - a_T^2} = \sqrt{9 - 9} = 0$.

46. As in Exercise 45, $\|\mathbf{a}\|^2 = a_T^2 + a_N^2$, $81 = 9 + a_N^2$, $a_N = \sqrt{72} = 6\sqrt{2}$.

47. True. By equation (1) the velocity vector is ds/dt multiplied by the unit tangent vector.
48. False. By equation (13) the normal scalar component of acceleration is the product of the curvature and the square of the speed.
49. False. Equations (10) and (11) imply that \mathbf{a} and \mathbf{v} are parallel, but they may point in opposite directions. For example, if $\mathbf{r}(t) = (\ln t)\mathbf{i} + (\sin(\ln t))\mathbf{j}$ then $\kappa(1) = 0$, $\mathbf{v}(1) = \mathbf{i} + \mathbf{j}$, and $\mathbf{a}(1) = -\mathbf{i} - \mathbf{j}$.
50. False. The distance traveled only equals the magnitude of the displacement if the particle travels in a straight line (without reversing direction) during the time interval.
51. From (14), $\|\mathbf{a}\|^2 = \mathbf{a} \cdot \mathbf{a} = (a_T\mathbf{T} + a_N\mathbf{N}) \cdot (a_T\mathbf{T} + a_N\mathbf{N}) = a_T^2(\mathbf{T} \cdot \mathbf{T}) + 2a_Ta_N(\mathbf{T} \cdot \mathbf{N}) + a_N^2(\mathbf{N} \cdot \mathbf{N}) = a_T^2 + a_N^2$, since \mathbf{T} and \mathbf{N} are orthogonal unit vectors. Hence $a_N^2 = \|\mathbf{a}\|^2 - a_T^2$. Since $a_N \geq 0$ (from equation (13)), $a_N = \sqrt{\|\mathbf{a}\|^2 - a_T^2}$.
52. Let $c = ds/dt$, $a_N = \kappa \left(\frac{ds}{dt} \right)^2$, $a_N = \frac{1}{1000}c^2$, so $c^2 = 1000a_N$, $c \leq 10\sqrt{10}\sqrt{1.5} \approx 38.73$ m/s.
53. 10 km/h is the same as $\frac{100}{36}$ m/s, so $\|\mathbf{F}\| = 500 \frac{1}{15} \left(\frac{100}{36} \right)^2 \approx 257.20$ N.
54. (a) $v_0 = 320$, $\alpha = 60^\circ$, $s_0 = 0$, so $x = 160t$, $y = 160\sqrt{3}t - 16t^2$.
- (b) $dy/dt = 160\sqrt{3} - 32t$, $dy/dt = 0$ when $t = 5\sqrt{3}$, so $y_{\max} = 160\sqrt{3}(5\sqrt{3}) - 16(5\sqrt{3})^2 = 1200$ ft.
- (c) $y = 16t(10\sqrt{3} - t)$, $y = 0$ when $t = 0$ or $10\sqrt{3}$, so $x_{\max} = 160(10\sqrt{3}) = 1600\sqrt{3}$ ft.
- (d) $\mathbf{v}(t) = 160\mathbf{i} + (160\sqrt{3} - 32t)\mathbf{j}$, $\mathbf{v}(10\sqrt{3}) = 160(\mathbf{i} - \sqrt{3}\mathbf{j})$, $\|\mathbf{v}(10\sqrt{3})\| = 320$ ft/s.
55. $v_0 = 80$, $\alpha = -60^\circ$, $s_0 = 168$ so $x = 40t$, $y = 168 - 40\sqrt{3}t - 16t^2$; $y = 0$ when $t = -7\sqrt{3}/2$ (invalid) or $t = \sqrt{3}$ so $x(\sqrt{3}) = 40\sqrt{3}$ ft.
56. $v_0 = 80$, $\alpha = 0^\circ$, $s_0 = 168$ so $x = 80t$, $y = 168 - 16t^2$; $y = 0$ when $t = -\sqrt{42}/2$ (invalid) or $t = \sqrt{42}/2$ so $x(\sqrt{42}/2) = 40\sqrt{42}$ ft.
57. $\alpha = 30^\circ$, $s_0 = 0$ so $x = \sqrt{3}v_0t/2$, $y = v_0t/2 - 16t^2$; $dy/dt = v_0/2 - 32t$, $dy/dt = 0$ when $t = v_0/64$ so $y_{\max} = v_0^2/256 = 2500$, $v_0 = 800$ ft/s.
58. $\alpha = 45^\circ$, $s_0 = 0$ so $x = \sqrt{2}v_0t/2$, $y = \sqrt{2}v_0t/2 - 4.9t^2$; $y = 0$ when $t = 0$ or $\sqrt{2}v_0/9.8$, so $x_{\max} = v_0^2/9.8 = 24,500$, $v_0 = 490$ m/s.
59. $v_0 = 800$, $s_0 = 0$, so $x = (800 \cos \alpha)t$, $y = (800 \sin \alpha)t - 16t^2 = 16t(50 \sin \alpha - t)$; $y = 0$ when $t = 0$ or $50 \sin \alpha$, so $x_{\max} = 40,000 \sin \alpha \cos \alpha = 20,000 \sin 2\alpha = 10,000$, $2\alpha = 30^\circ$ or 150° , $\alpha = 15^\circ$ or 75° .
60. (a) $v_0 = 5$, $\alpha = 0^\circ$, $s_0 = 4$ so $x = 5t$, $y = 4 - 16t^2$; $y = 0$ when $t = -1/2$ (invalid) or $1/2$ so it takes the ball $1/2$ s to hit the floor.
- (b) $\mathbf{v}(t) = 5\mathbf{i} - 32t\mathbf{j}$, $\mathbf{v}(1/2) = 5\mathbf{i} - 16\mathbf{j}$, $\|\mathbf{v}(1/2)\| = \sqrt{281}$ so the ball hits the floor with a speed of $\sqrt{281}$ ft/s.
- (c) $v_0 = 0$, $\alpha = -90^\circ$, $s_0 = 4$ so $x = 0$, $y = 4 - 16t^2$; $y = 0$ when $t = 1/2$ so both balls would hit the ground at the same instant.
61. (a) From (26), $\mathbf{r}(t) = (40 \cos 60^\circ)t\mathbf{i} + \left(4 + (40 \sin 60^\circ)t - \frac{1}{2}gt^2 \right)\mathbf{j} = 20t\mathbf{i} + (4 + 20\sqrt{3}t - 16t^2)\mathbf{j}$. When $x = 15$, $t = \frac{3}{4}$, and $y = 4 + 20\sqrt{3} \cdot \frac{3}{4} - 16 \left(\frac{3}{4} \right)^2 \approx 20.98$ ft, so the water clears the corner point A with 0.98 ft to spare.

(b) $y = 20$ when $16t^2 - 20\sqrt{3}t + 16 = 0$, $t = \frac{5\sqrt{3} \pm \sqrt{11}}{8}$, $t \approx 0.668$ (reject) or 1.497 , $x(1.497) \approx 29.942$ ft, so the water hits the roof.

(c) About $29.942 - 15 = 14.942$ ft.

62. $x = (v_0/2)t$, $y = 4 + (v_0\sqrt{3}/2)t - 16t^2$, solve $x = 15$, $y = 20$ simultaneously for v_0 and t , $v_0/2 = 15/t$, $t^2 = \frac{15}{16}\sqrt{3} - 1$, $t \approx 0.7898$, $v_0 \approx 30/0.7898 \approx 37.98$ ft/s.

63. (a) $x = (35\sqrt{2}/2)t$, $y = (35\sqrt{2}/2)t - 4.9t^2$, from Exercise 23(a) in Section 12.5 $\kappa = \frac{|x'y'' - x''y'|}{[(x')^2 + (y')^2]^{3/2}}$, $\kappa(0) = \frac{9.8}{35^2\sqrt{2}} = 0.004\sqrt{2} \approx 0.00565685$; $\rho = 1/\kappa \approx 176.78$ m.

(b) $y'(t) = 0$ when $t = \frac{25}{14}\sqrt{2}$, $y = \frac{125}{4}$ m.

64. (a) $\mathbf{a} = a_T\mathbf{T} + a_N\mathbf{N}$, $a_T = \frac{d^2s}{dt^2} = -7.5$ ft/s², $a_N = \kappa \left(\frac{ds}{dt}\right)^2 = \frac{1}{\rho}(132)^2 = \frac{132^2}{3000}$ ft/s², $\|\mathbf{a}\| = \sqrt{a_T^2 + a_N^2} = \sqrt{(7.5)^2 + \left(\frac{132^2}{3000}\right)^2} \approx 9.49$ ft/s².

(b) $\cos \theta = \frac{\mathbf{a} \cdot \mathbf{T}}{\|\mathbf{a}\|\|\mathbf{T}\|} = \frac{a_T}{\|\mathbf{a}\|} \approx -\frac{7.5}{9.49} \approx -0.79$, $\theta \approx 2.48$ radians $\approx 142^\circ$.

65. $s_0 = 0$ so $x = (v_0 \cos \alpha)t$, $y = (v_0 \sin \alpha)t - gt^2/2$.

(a) $dy/dt = v_0 \sin \alpha - gt$ so $dy/dt = 0$ when $t = (v_0 \sin \alpha)/g$, $y_{\max} = (v_0 \sin \alpha)^2/(2g)$.

(b) $y = 0$ when $t = 0$ or $(2v_0 \sin \alpha)/g$, so $x = R = (2v_0^2 \sin \alpha \cos \alpha)/g = (v_0^2 \sin 2\alpha)/g$ when $t = (2v_0 \sin \alpha)/g$; R is maximum when $2\alpha = 90^\circ$, $\alpha = 45^\circ$, and the maximum value of R is v_0^2/g .

66. The range is $(v_0^2 \sin 2\alpha)/g$ and the maximum range is v_0^2/g so $(v_0^2 \sin 2\alpha)/g = (3/4)v_0^2/g$, $\sin 2\alpha = 3/4$, $\alpha = (1/2)\sin^{-1}(3/4) \approx 24.3^\circ$ or $\alpha = (1/2)[180^\circ - \sin^{-1}(3/4)] \approx 65.7^\circ$.

67. $v_0 = 80$, $\alpha = 30^\circ$, $s_0 = 5$ so $x = 40\sqrt{3}t$, $y = 5 + 40t - 16t^2$.

(a) $y = 0$ when $t = (-40 \pm \sqrt{(40)^2 - 4(-16)(5)})/(-32) = (5 \pm \sqrt{30})/4$, reject $(5 - \sqrt{30})/4$ to get $t = (5 + \sqrt{30})/4 \approx 2.62$ s.

(b) $x \approx 40\sqrt{3}(2.62) \approx 181.5$ ft.

68. $v_0 = 70$, $\alpha = 60^\circ$, $s_0 = 5$ so $x = 35t$, $y = 5 + 35\sqrt{3}t - 16t^2$.

(a) $y = 0$ when $t = (-35\sqrt{3} \pm \sqrt{3 \cdot 35^2 + 320})/(-32) = (35\sqrt{3} \pm \sqrt{3995})/32$, reject $(35\sqrt{3} - \sqrt{3995})/32$ to get $t = (35\sqrt{3} + \sqrt{3995})/32 \approx 3.87$ s.

(b) $x \approx 35(3.87) \approx 135.4$ ft.

69. (a) $v_0(\cos \alpha)(2.9) = 259 \cos 23^\circ$ so $v_0 \cos \alpha \approx 82.21061$, $v_0(\sin \alpha)(2.9) - 16(2.9)^2 = -259 \sin 23^\circ$, so $v_0 \sin \alpha \approx 11.50367$; divide $v_0 \sin \alpha$ by $v_0 \cos \alpha$ to get $\tan \alpha \approx 0.139929$, thus $\alpha \approx 8^\circ$ and $v_0 \approx 82.21061/\cos 8^\circ \approx 83$ ft/s.

(b) From part (a), $x \approx 82.21061t$ and $y \approx 11.50367t - 16t^2$ for $0 \leq t \leq 2.9$; the distance traveled is $\int_0^{2.9} \sqrt{(dx/dt)^2 + (dy/dt)^2} dt \approx 268.76$ ft.

70. (a) $v_0 = v$, $s_0 = h$ so $x = (v \cos \alpha)t$, $y = h + (v \sin \alpha)t - \frac{1}{2}gt^2$. If $x = R$, then $(v \cos \alpha)t = R$, $t = \frac{R}{v \cos \alpha}$ but $y = 0$ for this value of t so $h + (v \sin \alpha)[R/(v \cos \alpha)] - \frac{1}{2}g[R/(v \cos \alpha)]^2 = 0$, $h + (\tan \alpha)R - g(\sec^2 \alpha)R^2/(2v^2) = 0$, $g(\sec^2 \alpha)R^2 - 2v^2(\tan \alpha)R - 2v^2h = 0$.

(b) $2g \sec^2 \alpha \tan \alpha R^2 + 2g \sec^2 \alpha R \frac{dR}{d\alpha} - 2v^2 \sec^2 \alpha R - 2v^2 \tan \alpha \frac{dR}{d\alpha} = 0$; if $\frac{dR}{d\alpha} = 0$ and $\alpha = \alpha_0$ when $R = R_0$, then $2g \sec^2 \alpha_0 \tan \alpha_0 R_0^2 - 2v^2 \sec^2 \alpha_0 R_0 = 0$, $g \tan \alpha_0 R_0 - v^2 = 0$, $\tan \alpha_0 = v^2/(gR_0)$.

(c) If $\alpha = \alpha_0$ and $R = R_0$, then from part (a) $g(\sec^2 \alpha_0)R_0^2 - 2v^2(\tan \alpha_0)R_0 - 2v^2h = 0$, but from part (b) $\tan \alpha_0 = v^2/(gR_0)$ so $\sec^2 \alpha_0 = 1 + \tan^2 \alpha_0 = 1 + v^4/(gR_0)^2$, thus $g[1 + v^4/(gR_0)^2]R_0^2 - 2v^2[v^2/(gR_0)]R_0 - 2v^2h = 0$, $gR_0^2 - v^4/g - 2v^2h = 0$, $R_0^2 = v^2(v^2 + 2gh)/g^2$, $R_0 = (v/g)\sqrt{v^2 + 2gh}$ and $\tan \alpha_0 = v^2/(v\sqrt{v^2 + 2gh}) = v/\sqrt{v^2 + 2gh}$, $\alpha_0 = \tan^{-1}(v/\sqrt{v^2 + 2gh})$.

71. The forces acting on the passenger are gravity and the normal and frictional forces exerted by the parts of the car that are in contact with the passenger. The total force is given by Newton's second law of motion:

$\mathbf{F} = m\mathbf{a} = ma_T\mathbf{T} + ma_N\mathbf{N} = m\frac{d^2s}{dt^2}\mathbf{T} + m\kappa\left(\frac{ds}{dt}\right)^2\mathbf{N}$. When the car is turning to the right (resp. left), $m\kappa\left(\frac{ds}{dt}\right)^2\mathbf{N}$ points right (resp. left), and the passenger feels a push in that direction caused by contact with

some part of the car to his left (resp. right). When the car is speeding up, $m\frac{d^2s}{dt^2}\mathbf{T}$ points forward and the

passenger feels a forward push from the back of the seat. When the car is slowing down, $m\frac{d^2s}{dt^2}\mathbf{T}$ points backward and the passenger feels a backward push from friction with the seat, or from the normal force of a seat belt or shoulder strap. On level ground, the net downward force is zero; the force of the seat pushing up on the passenger

exactly balances the force of gravity. But when the car goes over the top of a hill, $m\kappa\left(\frac{ds}{dt}\right)^2\mathbf{N}$ points down.

Since the force of gravity is unchanged, the force of the seat pushing up is diminished, and the passenger feels lighter. (The passenger doesn't feel the force of gravity directly, since it acts equally on all parts of the body.)

If we double the speed as a function of time, then $\frac{ds}{dt}$ and $\frac{d^2s}{dt^2}$ are doubled, so the tangential component of the force,

$m\frac{d^2s}{dt^2}$, is doubled and the normal component, $m\kappa\left(\frac{ds}{dt}\right)^2$, is quadrupled.

72. See discussion leading up to Formula (26).

Exercise Set 12.7

1. (a) From (15) and (6), at $t = 0$, $\mathbf{C} = \mathbf{v}_0 \times \mathbf{b}_0 - GM\mathbf{u} = v_0\mathbf{j} \times r_0v_0\mathbf{k} - GM\mathbf{u} = r_0v_0^2\mathbf{i} - GM\mathbf{i} = (r_0v_0^2 - GM)\mathbf{i}$.

(b) From (22), $r_0v_0^2 - GM = GM e$, so from (7) and (17), $\mathbf{v} \times \mathbf{b} = GM(\cos \theta \mathbf{i} + \sin \theta \mathbf{j}) + GM e \mathbf{i}$, and the result follows.

(c) From (10) it follows that \mathbf{b} is perpendicular to \mathbf{v} , and the result follows.

(d) From part (c) and (10), $\|\mathbf{v} \times \mathbf{b}\| = \|\mathbf{v}\|\|\mathbf{b}\| = vr_0v_0$. From part (b), $\|\mathbf{v} \times \mathbf{b}\| = GM\sqrt{(e + \cos \theta)^2 + \sin^2 \theta} = GM\sqrt{e^2 + 2e \cos \theta + 1}$. By (10) and part (c), $\|\mathbf{v} \times \mathbf{b}\| = \|\mathbf{v}\|\|\mathbf{b}\| = v(r_0v_0)$ thus $v = \frac{GM}{r_0v_0}\sqrt{e^2 + 2e \cos \theta + 1}$. From (22), $r_0v_0^2/(GM) = 1 + e$, $GM/(r_0v_0) = v_0/(1 + e)$ so $v = \frac{v_0}{1 + e}\sqrt{e^2 + 2e \cos \theta + 1}$.

(e) From (20) $r = \frac{k}{1 + e \cos \theta}$, so the minimum value of r occurs when $\theta = 0$ and the maximum value when $\theta = \pi$.

From part (d) $v = \frac{v_0}{1+e} \sqrt{e^2 + 2e \cos \theta + 1}$ so the minimum value of v occurs when $\theta = \pi$ and the maximum when $\theta = 0$.

2. At the end of the minor axis, $\cos \theta = -c/a = -e$, so $v = \frac{v_0}{1+e} \sqrt{e^2 + 2e(-e) + 1} = \frac{v_0}{1+e} \sqrt{1-e^2} = v_0 \sqrt{\frac{1-e}{1+e}}$.
3. v_{\max} occurs when $\theta = 0$ so $v_{\max} = v_0$; v_{\min} occurs when $\theta = \pi$, so $v_{\min} = \frac{v_0}{1+e} \sqrt{e^2 - 2e + 1} = v_{\max} \frac{1-e}{1+e}$, thus $v_{\max} = v_{\min} \frac{1+e}{1-e}$.
4. If the orbit is a circle then $e = 0$ so from Exercise 1(d), $v = v_0$ at all points on the orbit. Use (22) with $e = 0$ to get $v_0 = \sqrt{GM/r_0}$ so $v = \sqrt{GM/r_0}$.
5. (a) The results follow from formulae (1) and (7) of Section 10.6.
 - (b) r_{\min} and r_{\max} are extremes and occur at the same time as the extrema of $\|\mathbf{r}\|^2$, and hence at critical points of $\|\mathbf{r}\|^2$. Thus $\frac{d}{dt} \|\mathbf{r}\|^2 = \frac{d}{dt} (\mathbf{r} \cdot \mathbf{r}) = 2\mathbf{r} \cdot \mathbf{r}' = 0$, and hence \mathbf{r} and $\mathbf{v} = \mathbf{r}'$ are orthogonal.
 - (c) v_{\min} and v_{\max} are extremes and occur at the same time as the extrema of $\|\mathbf{v}\|^2$, and hence at critical points of $\|\mathbf{v}\|^2$. Thus $\frac{d}{dt} \|\mathbf{v}\|^2 = \frac{d}{dt} (\mathbf{v} \cdot \mathbf{v}) = 2\mathbf{v} \cdot \mathbf{v}' = 0$, and hence \mathbf{v} and $\mathbf{a} = \mathbf{v}'$ are orthogonal. By (5), \mathbf{a} is a scalar multiple of \mathbf{r} and thus \mathbf{v} and \mathbf{r} are orthogonal.
 - (d) From equation (2), $\mathbf{r} \times \mathbf{v} = \mathbf{b}$ and thus $\|\mathbf{b}\| = \|\mathbf{r} \times \mathbf{v}\| = \|\mathbf{r}\| \|\mathbf{v}\| \sin \theta$. When either \mathbf{r} or \mathbf{v} has an extremum, however, the angle $\theta = \pi/2$ and thus $\|\mathbf{b}\| = \|\mathbf{r}\| \|\mathbf{v}\|$. Finally, since \mathbf{b} is a constant vector, the maximum of \mathbf{r} occurs at the minimum of \mathbf{v} and vice versa, and thus $\|\mathbf{b}\| = r_{\max} v_{\min} = r_{\min} v_{\max}$.
6. From Exercise 5, $v_{\max} = \frac{r_{\max} v_{\min}}{r_{\min}} = \frac{a(1+e)v_{\min}}{a(1-e)} = v_{\min} \frac{1+e}{1-e}$.
7. $r_0 = 6440 + 200 = 6640$ km so $v = \sqrt{3.99 \times 10^5 / 6640} \approx 7.75$ km/s.
8. From Example 1, the orbit is 22,250 mi above the Earth, thus $v \approx \sqrt{\frac{1.24 \times 10^{12}}{26,250}} \approx 6873$ mi/h.
9. From (23) with $r_0 = 6440 + 300 = 6740$ km, $v_{\text{esc}} = \sqrt{\frac{2(3.99) \times 10^5}{6740}} \approx 10.88$ km/s.
10. From (29), $T = \frac{2\pi}{\sqrt{GM}} a^{3/2}$. But $T = 1$ yr = $365 \cdot 24 \cdot 3600$ s, thus $M = \frac{4\pi^2 a^3}{GT^2} \approx 1.99 \times 10^{30}$ kg.
11. (a) At perigee, $r = r_{\min} = a(1-e) = 238,900(1-0.055) \approx 225,760$ mi; at apogee, $r = r_{\max} = a(1+e) = 238,900(1+0.055) \approx 252,040$ mi. Subtract the sum of the radius of the Moon and the radius of the Earth to get minimum distance = $225,760 - 5080 = 220,680$ mi, and maximum distance = $252,040 - 5080 = 246,960$ mi.
 - (b) $T = 2\pi \sqrt{a^3/(GM)} = 2\pi \sqrt{(238,900)^3 / (1.24 \times 10^{12})} \approx 659$ hr ≈ 27.5 days.
12. (a) $r_{\min} = 6440 + 649 = 7,089$ km, $r_{\max} = 6440 + 4,340 = 10,780$ km so $a = (r_{\min} + r_{\max})/2 = 8934.5$ km.
 - (b) $e = (10,780 - 7,089) / (10,780 + 7,089) \approx 0.207$.
 - (c) $T = 2\pi \sqrt{a^3/(GM)} = 2\pi \sqrt{(8934.5)^3 / (3.99 \times 10^5)} \approx 8400$ s ≈ 140 min.

13. (a) $r_0 = 4000 + 180 = 4180$ mi, $v = \sqrt{\frac{GM}{r_0}} = \sqrt{1.24 \times 10^{12}/4180} \approx 17,224$ mi/h.

(b) $r_0 = 4180$ mi, $v_0 = \sqrt{\frac{GM}{r_0}} + 600$; $e = \frac{r_0 v_0^2}{GM} - 1 = 1200 \sqrt{\frac{r_0}{GM}} + (600)^2 \frac{r_0}{GM} \approx 0.071$; $r_{\max} = 4180(1 + 0.071)/(1 - 0.071) \approx 4819$ mi; the apogee altitude is about $4819 - 4000 = 819$ mi.

14. By equation (20), $r = \frac{k}{1 + e \cos \theta}$, where $k > 0$. By assumption, r is minimal when $\theta = 0$, hence $e \geq 0$.

Chapter 12 Review Exercises

- The line in 2-space through the point $(2, 0)$ and parallel to the vector $-3\mathbf{i} - 4\mathbf{j}$.
- The circle of radius 3 in the xy -plane, with center at the origin.
- An ellipse in the plane $z = -1$, center at $(0, 0, -1)$, major axis of length 6 parallel to x -axis, minor axis of length 4 parallel to y -axis.
- A parabola in the plane $x = -2$, vertex at $(-2, 0, -1)$, opening upward.
- (a) The line through the tips of \mathbf{r}_0 and \mathbf{r}_1 .
(b) The line segment connecting the tips of \mathbf{r}_0 and \mathbf{r}_1 .
(c) The line through the tip of \mathbf{r}_0 which is parallel to $\mathbf{r}'(t_0)$.
- Let $\mathbf{r} = x\mathbf{i} + y\mathbf{j} + z\mathbf{k}$, then $x^2 + z^2 = t^2(\sin^2 \pi t + \cos^2 \pi t) = t^2 = y^2$.

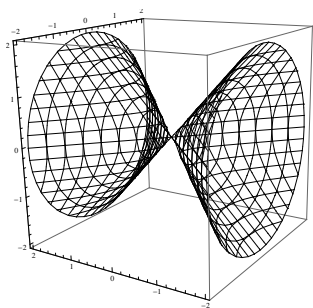

8. Let $x = t$, then $y = t^2$, $z = \pm \sqrt{4 - t^2/3 - t^4/6}$.

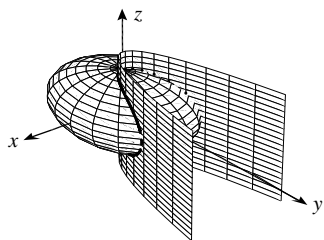

10. $\lim_{t \rightarrow 0} \left(e^{-t}\mathbf{i} + \frac{1 - \cos t}{t}\mathbf{j} + t^2\mathbf{k} \right) = \mathbf{i}$.

11. $\mathbf{r}'(t) = (1 - 2\sin 2t)\mathbf{i} - (2t + 1)\mathbf{j} + \cos t\mathbf{k}$, $\mathbf{r}'(0) = \mathbf{i} - \mathbf{j} + \mathbf{k}$ and $\mathbf{r}(0) = \mathbf{i}$, so the line is given by $x = 1 + t$, $y = -t$, $z = t$.

12. (a) $\mathbf{r}'(t) = 3\mathbf{r}'_1(t) + 2\mathbf{r}'_2(t), \mathbf{r}'(0) = \langle 3, 0, 3 \rangle + \langle 8, 0, 4 \rangle = \langle 11, 0, 7 \rangle.$

(b) $\mathbf{r}'(t) = \frac{1}{t+1}\mathbf{r}_1(t) + (\ln(t+1))\mathbf{r}'_1(t), \mathbf{r}'(0) = \mathbf{r}_1(0) = \langle -1, 1, 2 \rangle.$

(c) $\mathbf{r}' = \mathbf{r}_1 \times \mathbf{r}'_2 + \mathbf{r}'_1 \times \mathbf{r}_2, \mathbf{r}'(0) = \langle -1, 1, 2 \rangle \times \langle 4, 0, 2 \rangle + \langle 1, 2, 1 \rangle \times \langle 1, 0, 1 \rangle = \langle 0, 10, -2 \rangle.$

(d) $f'(t) = \mathbf{r}_1(t) \cdot \mathbf{r}'_2(t) + \mathbf{r}'_1(t) \cdot \mathbf{r}_2(t), f'(0) = 0 + 2 = 2.$

13. $(\sin t)\mathbf{i} - (\cos t)\mathbf{j} + \mathbf{C}.$

14. $\left\langle \frac{1}{3} \sin 3t, \frac{1}{3} \cos 3t \right\rangle \Big|_0^{\pi/3} = \langle 0, -2/3 \rangle.$

15. $\mathbf{y}(t) = \int \mathbf{y}'(t) dt = \frac{1}{3}t^3\mathbf{i} + t^2\mathbf{j} + \mathbf{C}, \mathbf{y}(0) = \mathbf{C} = \mathbf{i} + \mathbf{j}, \mathbf{y}(t) = \left(\frac{1}{3}t^3 + 1\right)\mathbf{i} + (t^2 + 1)\mathbf{j}.$

16. Let $\mathbf{r}(t) = x(t)\mathbf{i} + y(t)\mathbf{j}$, then $\frac{dx}{dt} = x(t), \frac{dy}{dt} = y(t), x(0) = x_0, y(0) = y_0$, so $x(t) = x_0e^t, y(t) = y_0e^t, \mathbf{r}(t) = e^t\mathbf{r}_0$.
If $\mathbf{r}(t)$ is a vector in 3-space then an analogous solution holds.

17. $\left(\frac{ds}{dt}\right)^2 = \left(\sqrt{2}e^{\sqrt{2}t}\right)^2 + \left(-\sqrt{2}e^{-\sqrt{2}t}\right)^2 + 4 = 8 \cosh^2(\sqrt{2}t), L = \int_0^{\sqrt{2} \ln 2} 2\sqrt{2} \cosh(\sqrt{2}t) dt = 2 \sinh(\sqrt{2}t) \Big|_0^{\sqrt{2} \ln 2} = 2 \sinh(2 \ln 2) = \frac{15}{4}.$

18. $\mathbf{r}'_1(t) = (-\ln 2)e^{t \ln 2}\mathbf{r}'(2 - e^{t \ln 2}), \mathbf{r}'_1(1) = -(2 \ln 2)\mathbf{r}'(0) = -(2 \ln 2)(3\mathbf{i} - \mathbf{j} + \mathbf{k}).$

19. $\mathbf{r} = \mathbf{r}_0 + t \vec{PQ} = (t-1)\mathbf{i} + (4-2t)\mathbf{j} + (3+2t)\mathbf{k}; \left\| \frac{d\mathbf{r}}{dt} \right\| = 3, \mathbf{r}(s) = \frac{s-3}{3}\mathbf{i} + \frac{12-2s}{3}\mathbf{j} + \frac{9+2s}{3}\mathbf{k}.$

20. $\mathbf{r}'(t) = \langle e^t(\cos t - \sin t), -e^t(\sin t + \cos t) \rangle, s(t) = \sqrt{2} \int_0^t e^\tau d\tau = \sqrt{2}(e^t - 1); e^t = (s + \sqrt{2})/\sqrt{2}, t = \ln\left(\frac{s + \sqrt{2}}{\sqrt{2}}\right),$
 $\mathbf{r}(s) = \left\langle \frac{s + \sqrt{2}}{\sqrt{2}} \cos \ln\left(\frac{s + \sqrt{2}}{\sqrt{2}}\right), -\frac{s + \sqrt{2}}{\sqrt{2}} \sin \ln\left(\frac{s + \sqrt{2}}{\sqrt{2}}\right) \right\rangle.$

22. $\frac{d\mathbf{r}}{dt} = \left\langle -2 \sin t, -2 \sin t + \frac{3}{\sqrt{5}} \cos t, -\sin t - \frac{6}{\sqrt{5}} \cos t \right\rangle, \left\| \frac{d\mathbf{r}}{dt} \right\|^2 = 9,$
 $\mathbf{r}(s) = \left\langle 2 \cos \frac{s}{3}, 2 \cos \frac{s}{3} + \frac{3}{\sqrt{5}} \sin \frac{s}{3}, \cos \frac{s}{3} - \frac{6}{\sqrt{5}} \sin \frac{s}{3} \right\rangle, \mathbf{T}(0) = \mathbf{r}'(0) = \left\langle 0, \frac{1}{\sqrt{5}}, -\frac{2}{\sqrt{5}} \right\rangle;$
 $\mathbf{r}''(s) = \left\langle -\frac{2}{9} \cos \frac{s}{3}, -\frac{2}{9} \cos \frac{s}{3} - \frac{1}{3\sqrt{5}} \sin \frac{s}{3}, -\frac{1}{9} \cos \frac{s}{3} + \frac{2}{3\sqrt{5}} \sin \frac{s}{3} \right\rangle, \mathbf{r}''(0) = \left\langle -\frac{2}{9}, -\frac{2}{9}, -\frac{1}{9} \right\rangle, \|\mathbf{r}''(0)\| = \frac{1}{3};$
 $\mathbf{N}(0) = \left\langle -\frac{2}{3}, -\frac{2}{3}, -\frac{1}{3} \right\rangle; \mathbf{B}(0) = \left\langle -\frac{\sqrt{5}}{3}, \frac{4\sqrt{5}}{15}, \frac{2\sqrt{5}}{15} \right\rangle.$

24. From Theorem 12.5.2b, $\kappa(0) = \|\mathbf{r}'(0) \times \mathbf{r}''(0)\|/\|\mathbf{r}'(0)\|^3 = \|2\mathbf{k}\|/\|\mathbf{i}\|^3 = 2.$

25. $\mathbf{r}'(t) = -2 \sin t \mathbf{i} + 3 \cos t \mathbf{j} - \mathbf{k}, \mathbf{r}'(\pi/2) = -2\mathbf{i} - \mathbf{k}, \mathbf{r}''(t) = -2 \cos t \mathbf{i} - 3 \sin t \mathbf{j}, \mathbf{r}''(\pi/2) = -3\mathbf{j}, \mathbf{r}'(\pi/2) \times \mathbf{r}''(\pi/2) = -3\mathbf{i} + 6\mathbf{k}$ and hence, by Theorem 12.5.2b, $\kappa(\pi/2) = \sqrt{45}/5^{3/2} = 3/5.$

26. $\mathbf{r}'(t) = \langle 2, 2e^{2t}, -2e^{-2t} \rangle, \mathbf{r}'(0) = \langle 2, 2, -2 \rangle, \mathbf{r}''(t) = \langle 0, 4e^{2t}, 4e^{-2t} \rangle, \mathbf{r}''(0) = \langle 0, 4, 4 \rangle,$ and, by Theorem 12.5.2b,
 $\kappa(0) = \|\langle 16, -8, 8 \rangle\|/(12)^{3/2} = \frac{8\sqrt{6}}{12\sqrt{12}} = \frac{1}{3}\sqrt{2}.$

27. By Exercise 23(b) of Section 12.5, $\kappa = |d^2y/dx^2|/[1 + (dy/dx)^2]^{3/2}$, but $d^2y/dx^2 = -\cos x = 0$ at $x = \pi/2$, so $\kappa = 0$.

28. $dy/dx = 1/x$, $d^2y/dx^2 = -1/x^2$, and, by Exercise 23(b) of Section 12.5, $\kappa(1) = \sqrt{2}/4$.

29. (a) Speed. (b) Distance traveled. (c) Distance of the particle from the origin.

30. (a) The tangent vector to the curve is always tangent to the sphere.

(b) $\|\mathbf{v}\| = \text{const}$, so $\mathbf{v} \cdot \mathbf{a} = 0$; the acceleration vector is always perpendicular to the velocity vector.

$$(c) \|\mathbf{r}(t)\|^2 = \left(1 - \frac{1}{4} \cos^2 t\right) (\cos^2 t + \sin^2 t) + \frac{1}{4} \cos^2 t = 1.$$

31. (a) $\|\mathbf{r}(t)\| = 1$, so, by Theorem 12.2.8, $\mathbf{r}'(t)$ is always perpendicular to the vector $\mathbf{r}(t)$. Then $\mathbf{v}(t) = R\omega(-\sin \omega t \mathbf{i} + \cos \omega t \mathbf{j})$, $v = \|\mathbf{v}(t)\| = R\omega$.

(b) $\mathbf{a} = -R\omega^2(\cos \omega t \mathbf{i} + \sin \omega t \mathbf{j})$, $a = \|\mathbf{a}\| = R\omega^2$, and $\mathbf{a} = -\omega^2 \mathbf{r}$ is directed toward the origin.

(c) The smallest positive value of t for which $\mathbf{r}(t) = \mathbf{r}(0)$ satisfies $\omega t = 2\pi$, so $T = t = \frac{2\pi}{\omega}$.

32. (a) $F = \|\mathbf{F}\| = m\|\mathbf{a}\| = mR\omega^2 = mR \frac{v^2}{R^2} = \frac{mv^2}{R}$.

(b) $R = 6440 + 3200 = 9640$ km, $6.43 = v = R\omega = 9640\omega$, $\omega = \frac{6.43}{9640} \approx 0.000667$, $a = R\omega^2 = v\omega = \frac{6.43^2}{9640} \approx 0.00429$ km/s², $\mathbf{a} = -a(\cos \omega t \mathbf{i} + \sin \omega t \mathbf{j}) \approx -0.00429[\cos(0.000667t)\mathbf{i} + \sin(0.000667t)\mathbf{j}]$ km/s².

(c) $F = ma \approx 60(0.00429)$ kg · km/s² = 0.2574 kN = 257.4 N.

33. (a) $\frac{d\mathbf{v}}{dt} = 2t^2\mathbf{i} + \mathbf{j} + \cos 2t\mathbf{k}$, $\mathbf{v}_0 = \mathbf{i} + 2\mathbf{j} - \mathbf{k}$, so $x'(t) = \frac{2}{3}t^3 + 1$, $y'(t) = t + 2$, $z'(t) = \frac{1}{2} \sin 2t - 1$, $x(t) = \frac{1}{6}t^4 + t$, $y(t) = \frac{1}{2}t^2 + 2t$, $z(t) = -\frac{1}{4} \cos 2t - t + \frac{1}{4}$, since $\mathbf{r}(0) = \mathbf{0}$. Hence $\mathbf{r}(t) = \left(\frac{1}{6}t^4 + t\right)\mathbf{i} + \left(\frac{1}{2}t^2 + 2t\right)\mathbf{j} - \left(\frac{1}{4} \cos 2t + t - \frac{1}{4}\right)\mathbf{k}$.

(b) $\left.\frac{ds}{dt}\right|_{t=1} = \|\mathbf{r}'(t)\| \Big|_{t=1} = \sqrt{(5/3)^2 + 9 + (1 - (\sin 2)/2)^2} \approx 3.475$.

34. $\|\mathbf{v}\|^2 = \mathbf{v}(t) \cdot \mathbf{v}(t)$, $2\|\mathbf{v}\| \frac{d}{dt} \|\mathbf{v}\| = 2\mathbf{v} \cdot \mathbf{a}$, $\frac{d}{dt} (\|\mathbf{v}\|) = \frac{1}{\|\mathbf{v}\|} (\mathbf{v} \cdot \mathbf{a})$.

35. From Table 12.7.1, $GM \approx 3.99 \times 10^5$ km³/s², and $r_0 = 6440 + 600 = 7040$ km, so $v_{\text{esc}} = \sqrt{\frac{2GM}{r_0}} \approx \sqrt{\frac{2 \cdot 3.99 \times 10^5}{7040}} \approx 10.65$ km/s.

36. The height $y(t)$ of the rocket satisfies $\tan \theta = y/b$, $y = b \tan \theta$, $v = \frac{dy}{dt} = \frac{dy}{d\theta} \frac{d\theta}{dt} = b \sec^2 \theta \frac{d\theta}{dt}$.

37. By equation (26) of Section 12.6, $\mathbf{r}(t) = (60 \cos \alpha)t\mathbf{i} + ((60 \sin \alpha)t - 16t^2 + 4)\mathbf{j}$, and the maximum height of the baseball occurs when $y'(t) = 0$, $60 \sin \alpha = 32t$, $t = \frac{15}{8} \sin \alpha$, so the ball clears the ceiling if $y_{\text{max}} = (60 \sin \alpha) \frac{15}{8} \sin \alpha - 16 \frac{15^2}{8^2} \sin^2 \alpha + 4 \leq 25$, $\frac{15^2 \sin^2 \alpha}{4} \leq 21$, $\sin^2 \alpha \leq \frac{28}{75}$. The ball hits the wall when $x = 60$, $t = \sec \alpha$, and $y(\sec \alpha) = 60 \sin \alpha \sec \alpha - 16 \sec^2 \alpha + 4$. Maximize the height $h(\alpha) = y(\sec \alpha) = 60 \tan \alpha - 16 \sec^2 \alpha + 4$, subject to the constraint $\sin^2 \alpha \leq \frac{28}{75}$. Then $h'(\alpha) = 60 \sec^2 \alpha - 32 \sec^2 \alpha \tan \alpha = 0$, $\tan \alpha = \frac{60}{32} = \frac{15}{8}$, so $\sin \alpha = \frac{15}{\sqrt{8^2 + 15^2}} = \frac{15}{17}$.

but for this value of α the constraint is not satisfied (the ball hits the ceiling). Hence the maximum value of h occurs at one of the endpoints of the α -interval on which the ball clears the ceiling, i.e. $[0, \sin^{-1} \sqrt{28/75}]$. Since $h'(0) = 60$, it follows that h is increasing throughout the interval, since $h' > 0$ inside the interval. Thus h_{\max} occurs when $\sin^2 \alpha = \frac{28}{75}$, $h_{\max} = 60 \tan \alpha - 16 \sec^2 \alpha + 4 = 60 \frac{\sqrt{28}}{\sqrt{47}} - 16 \frac{75}{47} + 4 = \frac{120\sqrt{329} - 1012}{47} \approx 24.78$ ft. Note: the possibility that the baseball keeps climbing until it hits the wall can be rejected as follows: if so, then $y'(t) = 0$ after the ball hits the wall, i.e. $t = \frac{15}{8} \sin \alpha$ occurs after $t = \sec \alpha$, hence $\frac{15}{8} \sin \alpha \geq \sec \alpha$, $15 \sin \alpha \cos \alpha \geq 8$, $15 \sin 2\alpha \geq 16$, impossible.

Chapter 12 Making Connections

1. (a) The given formulas imply that $\mathbf{N}(t) = \mathbf{B}(t) \times \mathbf{T}(t) = \frac{\mathbf{r}'(t) \times \mathbf{r}''(t)}{\|\mathbf{r}'(t) \times \mathbf{r}''(t)\|} \times \frac{\mathbf{r}'(t)}{\|\mathbf{r}'(t)\|}$.

(b) Since \mathbf{r}' is perpendicular to $\mathbf{r}' \times \mathbf{r}''$, Theorem 11.4.5a implies that $\|(\mathbf{r}'(t) \times \mathbf{r}''(t)) \times \mathbf{r}'(t)\| = \|\mathbf{r}'(t) \times \mathbf{r}''(t)\| \|\mathbf{r}'(t)\|$, and the result follows.

(c) (i) $\mathbf{r}'(t) = 2t\mathbf{i} + \mathbf{j}$, $\mathbf{r}'(1) = 2\mathbf{i} + \mathbf{j}$, $\mathbf{r}''(t) = 2\mathbf{i}$, $\mathbf{u} = 2\mathbf{i} - 4\mathbf{j}$, $\mathbf{N} = \frac{1}{\sqrt{5}}\mathbf{i} - \frac{2}{\sqrt{5}}\mathbf{j}$.

(ii) $\mathbf{r}'(t) = -4 \sin t \mathbf{i} + 4 \cos t \mathbf{j} + \mathbf{k}$, $\mathbf{r}'(\frac{\pi}{2}) = -4\mathbf{i} + \mathbf{k}$, $\mathbf{r}''(t) = -4 \cos t \mathbf{i} - 4 \sin t \mathbf{j}$, $\mathbf{r}''(\frac{\pi}{2}) = -4\mathbf{j}$, $\mathbf{u} = 17(-4\mathbf{j})$, $\mathbf{N} = -\mathbf{j}$.

2. (a) From Exercise 45 of Section 11.4, $(\mathbf{r}'(t) \times \mathbf{r}''(t)) \times \mathbf{r}'(t) = \|\mathbf{r}'(t)\|^2 \mathbf{r}''(t) - (\mathbf{r}'(t) \cdot \mathbf{r}''(t)) \mathbf{r}'(t) = \mathbf{u}(t)$, so $\mathbf{N}(t) = \mathbf{u}(t) / \|\mathbf{u}(t)\|$.

(b) (i) $\mathbf{r}'(t) = \cos t \mathbf{i} - \sin t \mathbf{j} + \mathbf{k}$, $\mathbf{r}''(t) = -\sin t \mathbf{i} - \cos t \mathbf{j}$, $\mathbf{u} = -2(\sin t \mathbf{i} + \cos t \mathbf{j})$, $\|\mathbf{u}\| = 2$, $\mathbf{N}(t) = -\sin t \mathbf{i} - \cos t \mathbf{j}$.

(ii) $\mathbf{r}'(t) = \mathbf{i} + 2t\mathbf{j} + 3t^2\mathbf{k}$, $\mathbf{r}''(t) = 2\mathbf{j} + 6t\mathbf{k}$, $\mathbf{u}(t) = -(4t + 18t^3)\mathbf{i} + (2 - 18t^4)\mathbf{j} + (6t + 12t^3)\mathbf{k}$,

$$\mathbf{N}(t) = \frac{1}{2\sqrt{81t^8 + 117t^6 + 54t^4 + 13t^2 + 1}} (-(4t + 18t^3)\mathbf{i} + (2 - 18t^4)\mathbf{j} + (6t + 12t^3)\mathbf{k}).$$

3. (a) $\mathbf{r}(t) = \int_0^t \cos\left(\frac{\pi u^2}{2}\right) du \mathbf{i} + \int_0^t \sin\left(\frac{\pi u^2}{2}\right) du \mathbf{j}$; $\left\|\frac{d\mathbf{r}}{dt}\right\|^2 = x'(t)^2 + y'(t)^2 = \cos^2\left(\frac{\pi t^2}{2}\right) + \sin^2\left(\frac{\pi t^2}{2}\right) = 1$ and $\mathbf{r}(0) = \mathbf{0}$.

(b) $\mathbf{r}'(s) = \cos\left(\frac{\pi s^2}{2}\right) \mathbf{i} + \sin\left(\frac{\pi s^2}{2}\right) \mathbf{j}$, $\mathbf{r}''(s) = -\pi s \sin\left(\frac{\pi s^2}{2}\right) \mathbf{i} + \pi s \cos\left(\frac{\pi s^2}{2}\right) \mathbf{j}$, $\kappa(s) = \|\mathbf{r}''(s)\| = \pi|s|$.

(c) $\kappa(s) \rightarrow +\infty$, so the spiral winds ever tighter.

4. Suppose that the roller coaster starts with the part of the Cornu spiral of Exercise 3 with $0 \leq t \leq t_0$, expanded by a factor of a . Let P be the point with $t = t_0$, where the spiral is joined to a circular arc of radius r and angle 2θ . (Here θ is $\pi/2$, $\pi/4$, and 0 for the 3 cases.) The figure shows the uphill half of the coaster. We will find the values of t_0 , a , and r in terms of θ , given that the slopes and curvatures of the spiral and arc match at P , and that the width of the roller coaster is 45 feet.

Since we've expanded the spiral by a factor of a , the parametric equations are $x(t) = a \int_0^t \cos\left(\frac{\pi u^2}{2}\right) du$, $y(t) = a \int_0^t \sin\left(\frac{\pi u^2}{2}\right) du$.

The arc length is also expanded by a factor of a , so $s = at$. So is the radius of curvature along the spiral, so the curvature is $1/a$ times that found in Exercise 3(b): $\kappa(t) = \pi t/a$ for $t \geq 0$.

Let $\phi(t)$ be the angle of inclination at a point on the spiral. By equation (8) of Section 12.5, $\kappa(t) = \frac{d\phi}{ds} = \frac{d\phi}{dt} \frac{dt}{ds} = \frac{1}{a} \frac{d\phi}{dt}$. Since $\phi(0) = 0$, $\phi(t_0) = \int_0^{t_0} \frac{d\phi}{dt} dt = \int_0^{t_0} a\kappa(t) dt = \int_0^{t_0} \pi t dt = \frac{\pi}{2} t_0^2$. From the figure, $\phi(t_0) = \pi - \theta$, so $\frac{\pi}{2} t_0^2 = \pi - \theta$ and $t_0 = \sqrt{2 - 2\theta/\pi}$.

Since the curvatures of the spiral and the arc at P must be equal, we have $1/r = \kappa(t_0) = \pi t_0/a$, so $a = \pi t_0 r$.

Next we find the width of the roller coaster. The horizontal distance from the center of the circular arc to P is $r \sin \theta$. The rightmost point on the spiral has $\phi(t) = \pi/2$, so $t = 1$, and its horizontal distance from P is $x(1) - x(t_0) = -a \int_1^{t_0} \cos\left(\frac{\pi u^2}{2}\right) du$. Hence the width of the roller coaster is $2 \left(r \sin \theta - a \int_1^{t_0} \cos\left(\frac{\pi u^2}{2}\right) du \right) = 2r \left(\sin \theta - \pi t_0 \int_1^{t_0} \cos\left(\frac{\pi u^2}{2}\right) du \right)$. This must be 45 feet, so $r = \frac{45}{2 \left(\sin \theta - \pi t_0 \int_1^{t_0} \cos\left(\frac{\pi u^2}{2}\right) du \right)}$.

We now have equations for t_0 , a , and r in terms of θ , and we can compute the height: The vertical distance between P and the center C of the circular arc is $r \cos \theta$, so the height of C is $y(t_0) - r \cos \theta$. The height of the top of the loop is $y(t_0) - r \cos \theta + r = r(1 - \cos \theta) + a \int_0^{t_0} \sin\left(\frac{\pi u^2}{2}\right) du$.

To summarize, given θ , we compute: $t_0 = \sqrt{2 - 2\theta/\pi}$, $r = \frac{45}{2 \left(\sin \theta - \pi t_0 \int_1^{t_0} \cos\left(\frac{\pi u^2}{2}\right) du \right)}$, $a = \pi t_0 r$, height $= r(1 - \cos \theta) + a \int_0^{t_0} \sin\left(\frac{\pi u^2}{2}\right) du$.

For the 3 cases, we find, using numerical integration:

semicircle:	$\theta = \pi/2$	$t_0 = 1$	$r = 45/2$	$a = 45\pi/2$	height ≈ 53.47871
quarter-circle:	$\theta = \pi/4$	$t_0 = \sqrt{3/2}$	$r \approx 22.07718$	$a \approx 84.94525$	height ≈ 60.97553
single point:	$\theta = 0$	$t_0 = \sqrt{2}$	$r \approx 20.17627$	$a \approx 89.64079$	height ≈ 64.00103

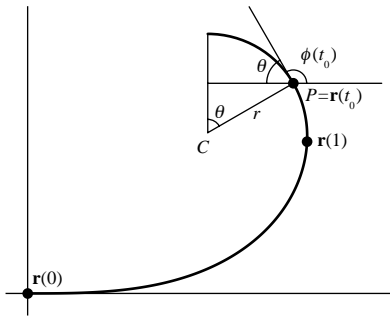

5. $\mathbf{r} = \left(a \cos \frac{s}{w} \right) \mathbf{i} + \left(a \sin \frac{s}{w} \right) \mathbf{j} + \frac{cs}{w} \mathbf{k}$, $\mathbf{r}' = -\left(\frac{a}{w} \sin \frac{s}{w} \right) \mathbf{i} + \left(\frac{a}{w} \cos \frac{s}{w} \right) \mathbf{j} + \frac{c}{w} \mathbf{k}$, $\mathbf{r}'' = -\left(\frac{a}{w^2} \cos \frac{s}{w} \right) \mathbf{i} - \left(\frac{a}{w^2} \sin \frac{s}{w} \right) \mathbf{j}$, $\mathbf{r}''' = \left(\frac{a}{w^3} \sin \frac{s}{w} \right) \mathbf{i} - \left(\frac{a}{w^3} \cos \frac{s}{w} \right) \mathbf{j}$, $\mathbf{r}' \times \mathbf{r}'' = \left(\frac{ac}{w^3} \sin \frac{s}{w} \right) \mathbf{i} - \left(\frac{ac}{w^3} \cos \frac{s}{w} \right) \mathbf{j} + \frac{a^2}{w^3} \mathbf{k}$, $(\mathbf{r}' \times \mathbf{r}'') \cdot \mathbf{r}''' = \frac{a^2 c}{w^6}$, $\|\mathbf{r}''(s)\| = \frac{a}{w^2}$, so $\tau = \frac{c}{w^2}$ and $\mathbf{B} = \left(\frac{c}{w} \sin \frac{s}{w} \right) \mathbf{i} - \left(\frac{c}{w} \cos \frac{s}{w} \right) \mathbf{j} + \frac{a}{w} \mathbf{k}$.

6. (a) $\|\mathbf{e}_r(t)\|^2 = \cos^2 \theta + \sin^2 \theta = 1$, so $\mathbf{e}_r(t)$ is a unit vector; $\mathbf{r}(t) = r(t)\mathbf{e}(t)$, so they have the same direction if $r(t) > 0$, opposite if $r(t) < 0$. $\mathbf{e}_\theta(t)$ is perpendicular to $\mathbf{e}_r(t)$ since $\mathbf{e}_r(t) \cdot \mathbf{e}_\theta(t) = 0$, and it will result from a counterclockwise rotation of $\mathbf{e}_r(t)$ provided $\mathbf{e}(t) \times \mathbf{e}_\theta(t) = \mathbf{k}$, which is true.

(b) $\frac{d}{dt} \mathbf{e}_r(t) = \frac{d\theta}{dt} (-\sin \theta \mathbf{i} + \cos \theta \mathbf{j}) = \frac{d\theta}{dt} \mathbf{e}_\theta(t)$ and $\frac{d}{dt} \mathbf{e}_\theta(t) = -\frac{d\theta}{dt} (\cos \theta \mathbf{i} + \sin \theta \mathbf{j}) = -\frac{d\theta}{dt} \mathbf{e}_r(t)$, so $\mathbf{v}(t) = \frac{d}{dt} \mathbf{r}(t) = \frac{d}{dt} (r(t)\mathbf{e}_r(t)) = r'(t)\mathbf{e}_r(t) + r(t)\frac{d\theta}{dt} \mathbf{e}_\theta(t)$.

(c) From part (b), $\mathbf{a} = \frac{d}{dt}\mathbf{v}(t) = r''(t)\mathbf{e}_r(t) + r'(t)\frac{d\theta}{dt}\mathbf{e}_\theta(t) + r'(t)\frac{d\theta}{dt}\mathbf{e}_\theta(t) + r(t)\frac{d^2\theta}{dt^2}\mathbf{e}_\theta(t) - r(t)\left(\frac{d\theta}{dt}\right)^2\mathbf{e}_r(t) =$

$$\left[\frac{d^2r}{dt^2} - r\left(\frac{d\theta}{dt}\right)^2\right]\mathbf{e}_r(t) + \left[r\frac{d^2\theta}{dt^2} + 2\frac{dr}{dt}\frac{d\theta}{dt}\right]\mathbf{e}_\theta(t).$$

Partial Derivatives

Exercise Set 13.1

- (a) $f(2, 1) = (2)^2(1) + 1 = 5$. (b) $f(1, 2) = (1)^2(2) + 1 = 3$. (c) $f(0, 0) = (0)^2(0) + 1 = 1$.
(d) $f(1, -3) = (1)^2(-3) + 1 = -2$. (e) $f(3a, a) = (3a)^2(a) + 1 = 9a^3 + 1$.
(f) $f(ab, a - b) = (ab)^2(a - b) + 1 = a^3b^2 - a^2b^3 + 1$.
- (a) $2t$ (b) $2x$ (c) $2y^2 + 2y$
- (a) $f(x + y, x - y) = (x + y)(x - y) + 3 = x^2 - y^2 + 3$. (b) $f(xy, 3x^2y^3) = (xy)(3x^2y^3) + 3 = 3x^3y^4 + 3$.
- (a) $(x/y) \sin(x/y)$ (b) $xy \sin(xy)$ (c) $(x - y) \sin(x - y)$
- $F(g(x), h(y)) = F(x^3, 3y + 1) = x^3 e^{x^3(3y+1)}$.
- $g(u(x, y), v(x, y)) = g(x^2y^3, \pi xy) = \pi xy \sin \left[(x^2y^3)^2 (\pi xy) \right] = \pi xy \sin (\pi x^5 y^7)$.
- (a) $t^2 + 3t^{10}$ (b) 0 (c) 3076
- $\sqrt{t} e^{-3 \ln(t^2+1)} = \frac{\sqrt{t}}{(t^2 + 1)^3}$.
- (a) 2.50 mg/L. (b) $C(100, t) = 20(e^{-0.2t} - e^{-t})$. (c) $C(x, 1) = 0.2x(e^{-0.2} - e^{-1})$.
- (a) $e^{-0.2t} - e^{-t} = e^{-0.1} - e^{-0.5}$ at $t \approx 6.007$, the medication remains effective for 5 and a half hours longer.
(b) The maximum concentration is about 10.6998 mg/L, at time $t \approx 2.0118$ hours.
- (a) $v = 7$ lies between $v = 5$ and $v = 15$, and $7 = 5 + 2 = 5 + \frac{2}{10}(15 - 5)$, so $WCI \approx 19 + \frac{2}{10}(13 - 19) = 19 - 1.2 = 17.8^\circ\text{F}$.
(b) $T = 28$ lies between $T = 25$ and $T = 30$, and $28 = 25 + 3 = 25 + \frac{3}{5}(30 - 25)$, so $WCI \approx 19 + \frac{3}{5}(25 - 19) = 19 + 3.6 = 22.6^\circ\text{F}$.
- (a) At $T = 35$, $14 = 5 + 9 = 5 + \frac{9}{10}(15 - 5)$, so $WCI \approx 31 + \frac{9}{10}(25 - 31) = 25.6^\circ\text{F}$.
(b) At $v = 15$, $32 = 30 + 2 = 30 + \frac{2}{5}(35 - 30)$, so $WCI \approx 19 + \frac{2}{5}(25 - 19) = 21.4^\circ\text{F}$.
- (a) At $v = 25$, $WCI = 16$, so $T = 30^\circ\text{F}$.

(b) At $v = 25$, $WCI = 6 = 3 + \frac{1}{2}(9 - 3)$, so $T \approx 20 + \frac{1}{2}(25 - 20) = 22.5^\circ\text{F}$.

14. (a) At $T = 25$, $WCI = 7$, so $v = 35$ mi/h.

(b) At $T = 30$, $WCI = 15 = 16 + \frac{1}{2}(14 - 16)$, so $v \approx 25 + \frac{1}{2}(35 - 25) = 30$ mi/h.

15. (a) The depression is $20 - 16 = 4$, so the relative humidity is 66%.

(b) The relative humidity $\approx 77 - (1/2)7 = 73.5\%$.

(c) The relative humidity $\approx 59 + (2/5)4 = 60.6\%$.

16. (a) 4°C .

(b) The relative humidity $\approx 62 - (1/4)9 = 59.75\%$.

(c) The relative humidity $\approx 77 + (1/5)(79 - 77) = 77.4\%$.

17. (a) 19 (b) -9 (c) 3 (d) $a^6 + 3$ (e) $-t^8 + 3$ (f) $(a + b)(a - b)^2b^3 + 3$

18. (a) $x^2(x + y)(x - y) + (x + y) = x^2(x^2 - y^2) + (x + y) = x^4 - x^2y^2 + x + y$.

(b) $(xz)(xy)(y/x) + xy = xy^2z + xy$.

19. $F(x^2, y + 1, z^2) = (y + 1)e^{x^2(y+1)z^2}$.

20. $g(x^2z^3, \pi xyz, xy/z) = (xy/z) \sin(\pi x^3yz^4)$.

21. (a) $f(\sqrt{5}, 2, \pi, -3\pi) = 80\sqrt{\pi}$. (b) $f(1, 1, \dots, 1) = \sum_{k=1}^n k = n(n + 1)/2$.

22. (a) $f(-2, 2, 0, \pi/4) = 1$. (b) $f(1, 2, \dots, n) = n(n + 1)(2n + 1)/6$, see Theorem 5.4.2(b), Section 5.4.

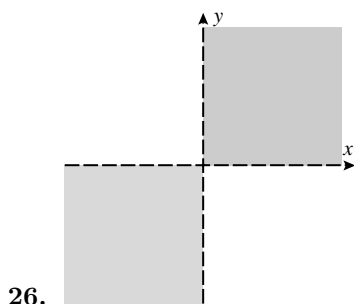
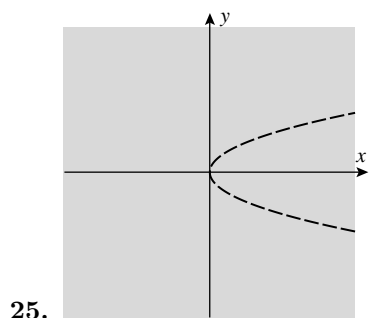
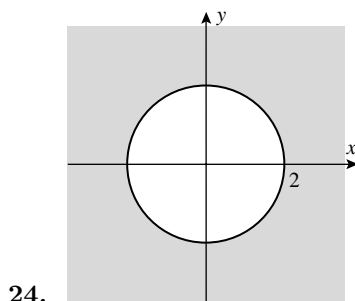
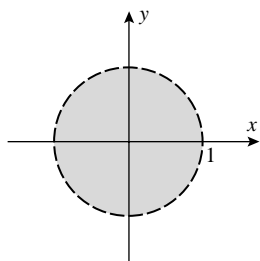

27. (a) All points in 2-space above or on the line $y = -2$.
 (b) All points in 3-space on or within the sphere $x^2 + y^2 + z^2 = 25$.
 (c) All points in 3-space.
28. (a) All points in 2-space on or between the vertical lines $x = \pm 2$.
 (b) All points in 2-space above the line $y = 2x$.
 (c) All points in 3-space not on the plane $x + y + z = 0$.
29. True; it is the intersection of the domain $[-1, 1]$ of $\sin^{-1} t$ and the domain $[0, +\infty)$ of \sqrt{t} .
30. False, the origin is not in the domain of the function.
31. False; z has no constraints so the domain is an infinite solid circular cylinder.
32. True; $f(x, y, z) = D$ yields the plane with normal vector $\mathbf{i} + 2\mathbf{j} + 3\mathbf{k}$ and which passes through $(D, 0, 0)$.

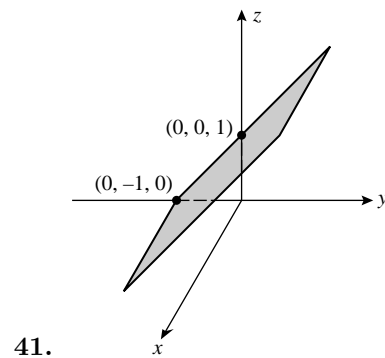
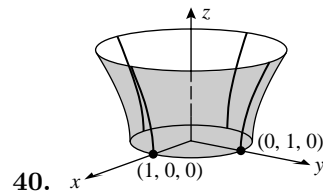
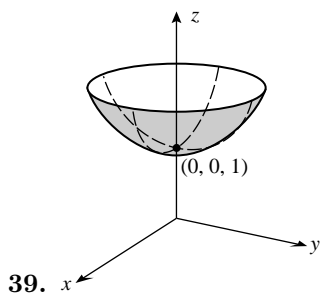
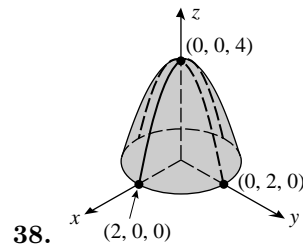
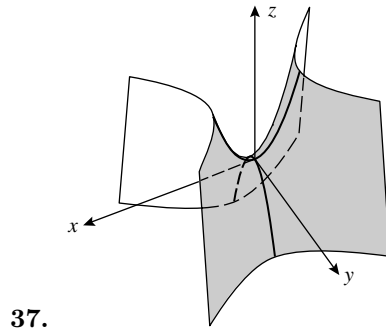
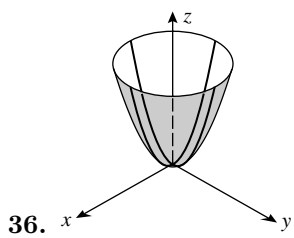
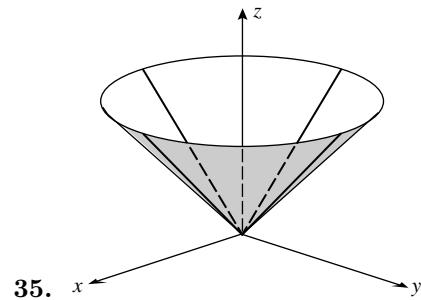
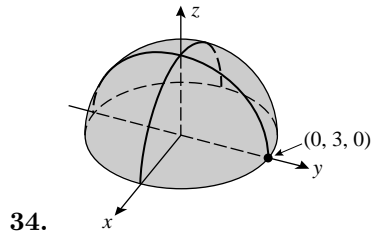
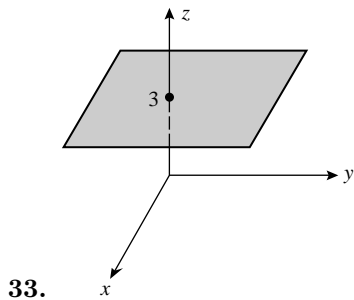

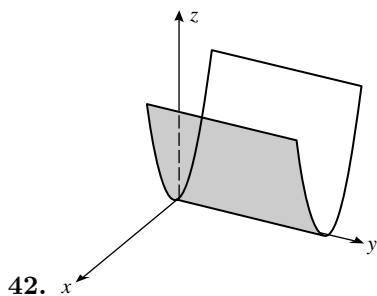
42. x

43. (a) Hyperbolas. (b) Parabolas. (c) Noncircular ellipses. (d) Lines.

44. (a) Lines. (b) Circles. (c) Hyperbolas. (d) Parabolas.

45. (a) $\approx \$130$. (b) $\approx \$275$ more.46. (a) $\approx \$55$. (b) $\approx \$250$ less.47. (a) $f(x, y) = 1 - x^2 - y^2$, because $f = c$ is a circle of radius $\sqrt{1 - c}$ (provided $c \leq 1$), and the radii in (a) decrease as c increases.(b) $f(x, y) = \sqrt{x^2 + y^2}$ because $f = c$ is a circle of radius c , and the radii increase uniformly.(c) $f(x, y) = x^2 + y^2$ because $f = c$ is a circle of radius \sqrt{c} and the radii in the plot grow like the square root function.

48. (a) III, because the surface has 9 peaks along the edges, three peaks to each edge.

(b) I, because in the first quadrant of the xy -plane, $z \geq 0$ for $x \geq y$, and $z \leq 0$ for $x \leq y$.(c) IV, because in the first quadrant of the xy -plane, $z \leq 0$ for $x \geq y$, and $z \geq 0$ for $x \leq y$.

(d) II, because the surface has four peaks.

49. (a) A (b) B (c) Increase. (d) Decrease. (e) Increase. (f) Decrease.

50. (a) Medicine Hat, since the contour lines are closer together near Medicine Hat than they are near Chicago.

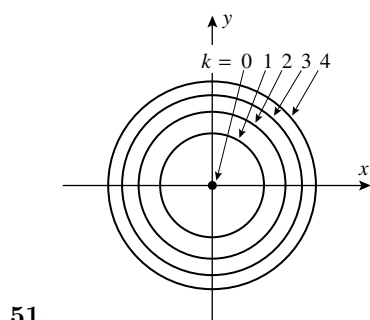
(b) The change in atmospheric pressure is about $\Delta p \approx 999 - 1010 = -11$, so the average rate of change is $\Delta p/1400 \approx -0.0079$.

51.

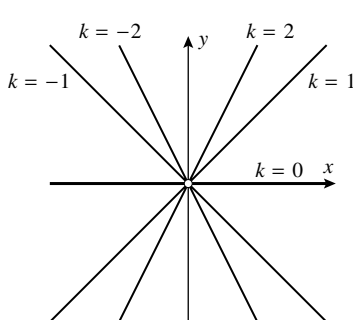

52.

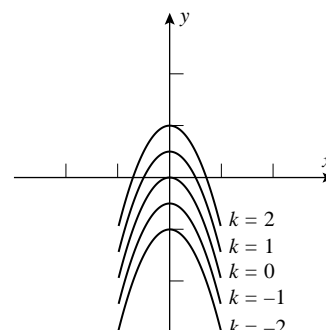

53.

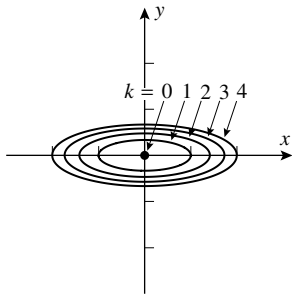

54.

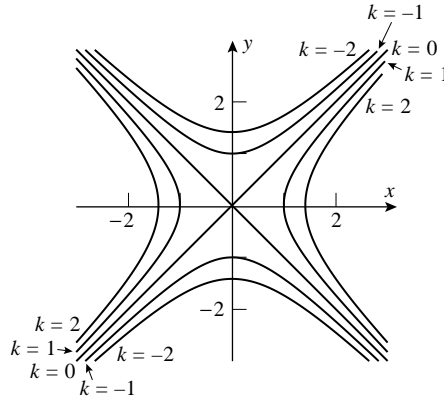

55.

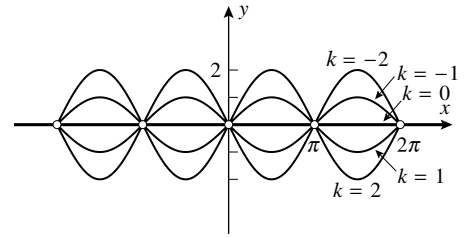

56.

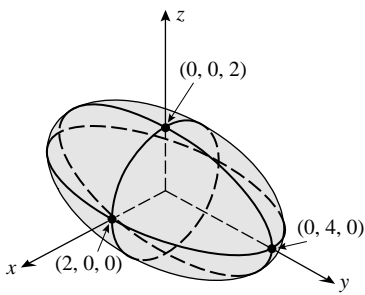

57.

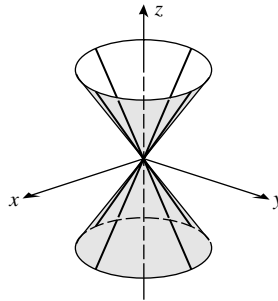

58.

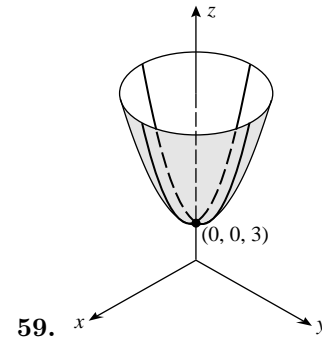

59.

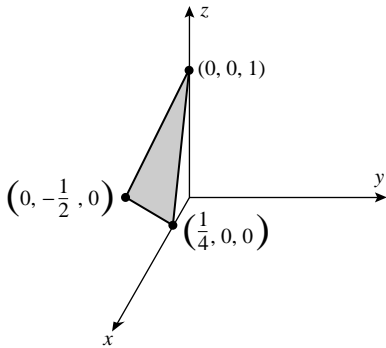

60.

61. Concentric spheres, common center at $(2,0,0)$.

62. Parallel planes, common normal $3\mathbf{i} - \mathbf{j} + 2\mathbf{k}$.

63. Concentric cylinders, common axis the y -axis.

64. Circular paraboloids, common axis the z -axis, all the same shape but with different vertices along z -axis.

65. (a) $f(-1, 1) = 0; x^2 - 2x^3 + 3xy = 0$. (b) $f(0, 0) = 0; x^2 - 2x^3 + 3xy = 0$.

(c) $f(2, -1) = -18; x^2 - 2x^3 + 3xy = -18$.

66. (a) $f(\ln 2, 1) = 2; ye^x = 2$. (b) $f(0, 3) = 3; ye^x = 3$. (c) $f(1, -2) = -2e; ye^x = -2e$.

67. (a) $f(1, -2, 0) = 5; x^2 + y^2 - z = 5$. (b) $f(1, 0, 3) = -2; x^2 + y^2 - z = -2$. (c) $f(0, 0, 0) = 0; x^2 + y^2 - z = 0$.

68. (a) $f(1, 0, 2) = 3; xyz + 3 = 3, xyz = 0$. (b) $f(-2, 4, 1) = -5; xyz + 3 = -5, xyz = -8$.

(c) $f(0, 0, 0) = 3; xyz = 0$.

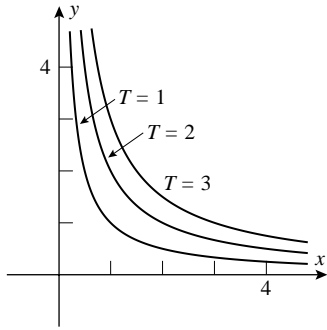

69. (a)

(b) At $(1, 4)$ the temperature is $T(1, 4) = 4$ so the temperature will remain constant along the path $xy = 4$.

70. $V = \frac{8}{\sqrt{16 + x^2 + y^2}}$, $x^2 + y^2 = \frac{64}{V^2} - 16$, the equipotential curves are circles.

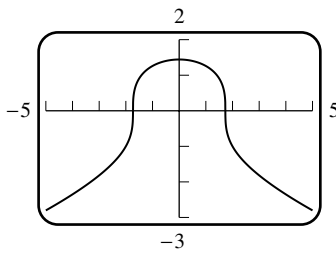
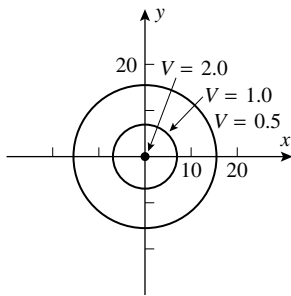

71. (a)

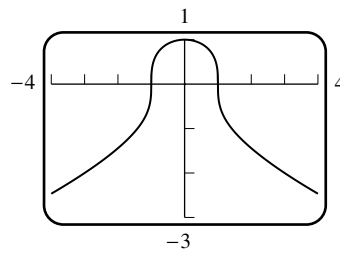

(b)

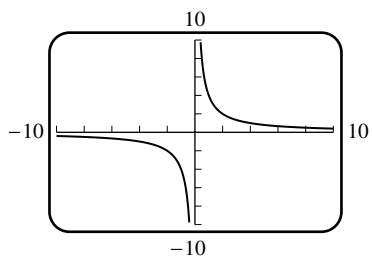

72. (a)

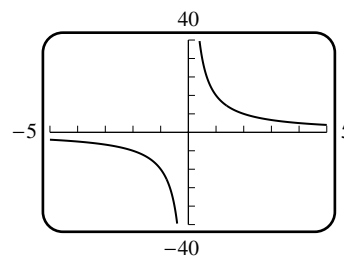

(b)

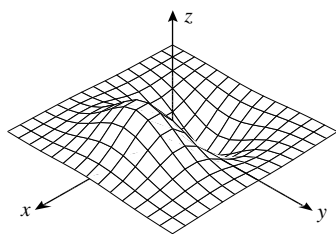

73. (a)

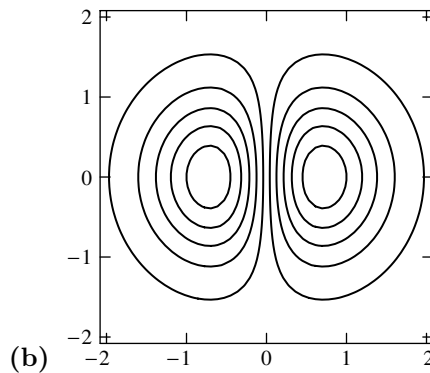

(b)

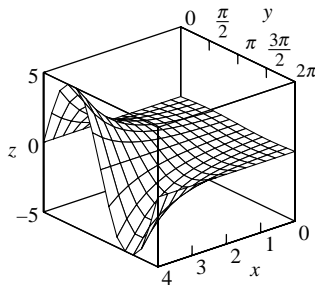

74. (a)

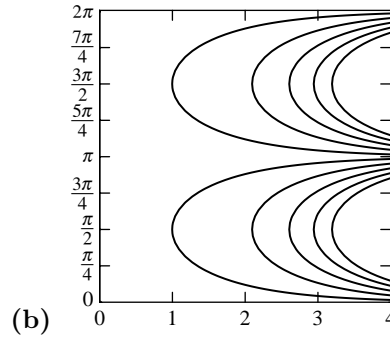

(b)

75. (a) The graph of g is the graph of f shifted one unit in the positive x -direction.

(b) The graph of g is the graph of f shifted one unit up the z -axis.

(c) The graph of g is the graph of f shifted one unit down the y -axis and then inverted with respect to the plane $z = 0$.

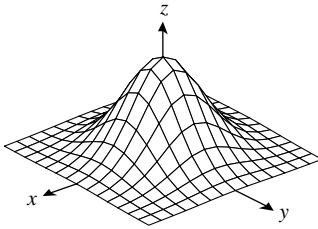

76. (a)

(b) If a is positive and increasing then the graph of g is more pointed, and in the limit as $a \rightarrow +\infty$ the graph approaches a 'spike' on the z -axis of height 1. As a decreases to zero the graph of g gets flatter until it finally approaches the plane $z = 1$.

Exercise Set 13.2

1. $\lim_{(x,y) \rightarrow (1,3)} (4xy^2 - x) = 4 \cdot 1 \cdot 3^2 - 1 = 35.$

2. $\lim_{(x,y) \rightarrow (0,0)} \frac{4x - y}{\sin y - 1} = \frac{4 \cdot 0 - 0}{\sin 0 - 1} = 0.$

3. $\lim_{(x,y) \rightarrow (-1,2)} \frac{xy^3}{x + y} = \frac{-1 \cdot 2^3}{-1 + 2} = -8.$

4. $\lim_{(x,y) \rightarrow (1,-3)} e^{2x-y^2} = e^{2 \cdot 1 - (-3)^2} = e^{-7}.$

5. $\lim_{(x,y) \rightarrow (0,0)} \ln(1 + x^2y^3) = \ln(1 + 0^2 \cdot 0^3) = 0.$

6. $\lim_{(x,y) \rightarrow (4,-2)} x \sqrt[3]{y^3 + 2x} = (-2) \cdot \sqrt[3]{(-2)^3 + 2 \cdot 4} = 0.$

7. (a) Along $x = 0$: $\lim_{(x,y) \rightarrow (0,0)} \frac{3}{x^2 + 2y^2} = \lim_{y \rightarrow 0} \frac{3}{2y^2}$ does not exist.

(b) Along $x = 0$: $\lim_{(x,y) \rightarrow (0,0)} \frac{x + y}{2x^2 + y^2} = \lim_{y \rightarrow 0} \frac{1}{y}$ does not exist.

8. (a) Along $y = 0$: $\lim_{x \rightarrow 0} \frac{x}{x^2} = \lim_{x \rightarrow 0} \frac{1}{x}$ does not exist, so the original limit does not exist.
- (b) Along $y = 0$: $\lim_{x \rightarrow 0} \frac{1}{x^2}$ does not exist, so the original limit does not exist.
9. Let $z = x^2 + y^2$, then $\lim_{(x,y) \rightarrow (0,0)} \frac{\sin(x^2 + y^2)}{x^2 + y^2} = \lim_{z \rightarrow 0^+} \frac{\sin z}{z} = 1$.
10. Let $z = x^2 + y^2$, then $\lim_{(x,y) \rightarrow (0,0)} \frac{1 - \cos(x^2 + y^2)}{x^2 + y^2} = \lim_{z \rightarrow 0^+} \frac{1 - \cos z}{z} = \lim_{z \rightarrow 0^+} \frac{\sin z}{1} = 0$.
11. Let $z = x^2 + y^2$, then $\lim_{(x,y) \rightarrow (0,0)} e^{-1/(x^2 + y^2)} = \lim_{z \rightarrow 0^+} e^{-1/z} = 0$.
12. With $z = x^2 + y^2$, $\lim_{z \rightarrow 0} \frac{1}{\sqrt{z}} e^{-1/\sqrt{z}}$; let $w = \frac{1}{\sqrt{z}}$, $\lim_{w \rightarrow +\infty} \frac{w}{e^w} = 0$.
13. $\lim_{(x,y) \rightarrow (0,0)} \frac{(x^2 + y^2)(x^2 - y^2)}{x^2 + y^2} = \lim_{(x,y) \rightarrow (0,0)} (x^2 - y^2) = 0$.
14. $\lim_{(x,y) \rightarrow (0,0)} \frac{(x^2 + 4y^2)(x^2 - 4y^2)}{x^2 + 4y^2} = \lim_{(x,y) \rightarrow (0,0)} (x^2 - 4y^2) = 0$.
15. Along $y = 0$: $\lim_{x \rightarrow 0} \frac{0}{3x^2} = \lim_{x \rightarrow 0} 0 = 0$; along $y = x$: $\lim_{x \rightarrow 0} \frac{x^2}{5x^2} = \lim_{x \rightarrow 0} 1/5 = 1/5$, so the limit does not exist.
16. Let $z = x^2 + y^2$, then $\lim_{(x,y) \rightarrow (0,0)} \frac{1 - x^2 - y^2}{x^2 + y^2} = \lim_{z \rightarrow 0^+} \frac{1 - z}{z} = +\infty$ so the limit does not exist.
17. $\lim_{(x,y,z) \rightarrow (2,-1,2)} \frac{xz^2}{\sqrt{x^2 + y^2 + z^2}} = \frac{2 \cdot 2^2}{\sqrt{2^2 + (-1)^2 + 2^2}} = \frac{8}{3}$.
18. $\lim_{(x,y,z) \rightarrow (2,0,-1)} \ln(2x + y - z) = \ln(2 \cdot 2 + 0 - (-1)) = \ln 5$.
19. Let $t = \sqrt{x^2 + y^2 + z^2}$, then $\lim_{(x,y,z) \rightarrow (0,0,0)} \frac{\sin(x^2 + y^2 + z^2)}{\sqrt{x^2 + y^2 + z^2}} = \lim_{t \rightarrow 0^+} \frac{\sin(t^2)}{t} = 0$.
20. With $t = \sqrt{x^2 + y^2 + z^2}$, $\lim_{t \rightarrow 0^+} \frac{\sin t}{t^2} = \lim_{t \rightarrow 0^+} \frac{\cos t}{2t} = +\infty$ so the limit does not exist.
21. $\frac{e^{\sqrt{x^2 + y^2 + z^2}}}{\sqrt{x^2 + y^2 + z^2}} = \frac{e^\rho}{\rho}$, so $\lim_{(x,y,z) \rightarrow (0,0,0)} \frac{e^{\sqrt{x^2 + y^2 + z^2}}}{\sqrt{x^2 + y^2 + z^2}} = \lim_{\rho \rightarrow 0^+} \frac{e^\rho}{\rho}$ does not exist.
22. $\lim_{(x,y,z) \rightarrow (0,0,0)} \tan^{-1} \left[\frac{1}{x^2 + y^2 + z^2} \right] = \lim_{\rho \rightarrow 0^+} \tan^{-1} \frac{1}{\rho^2} = \frac{\pi}{2}$.
23. $\lim_{r \rightarrow 0} r \ln r^2 = \lim_{r \rightarrow 0} (2 \ln r)/(1/r) = \lim_{r \rightarrow 0} (2/r)/(-1/r^2) = \lim_{r \rightarrow 0} (-2r) = 0$.
24. $y \ln(x^2 + y^2) = r \sin \theta \ln r^2 = 2r(\ln r) \sin \theta$, so $\lim_{(x,y) \rightarrow (0,0)} y \ln(x^2 + y^2) = \lim_{r \rightarrow 0^+} 2r(\ln r) \sin \theta = 0$.
25. $\frac{x^2 y^2}{\sqrt{x^2 + y^2}} = \frac{(r^2 \cos^2 \theta)(r^2 \sin^2 \theta)}{r} = r^3 \cos^2 \theta \sin^2 \theta$, so $\lim_{(x,y) \rightarrow (0,0)} \frac{x^2 y^2}{\sqrt{x^2 + y^2}} = 0$.

26. $\left| \frac{r^2 \cos \theta \sin \theta}{\sqrt{r^2 + 2r^2 \sin^2 \theta}} \right| \leq \frac{r^2}{\sqrt{r^2}} = r$ so $\lim_{(x,y) \rightarrow (0,0)} \left| \frac{xy}{x^2 + 2y^2} \right| = 0$.

27. $\left| \frac{\rho^3 \sin^2 \phi \cos \phi \sin \theta \cos \theta}{\rho^2} \right| \leq \rho$, so $\lim_{(x,y,z) \rightarrow (0,0,0)} \frac{xyz}{x^2 + y^2 + z^2} = 0$.

28. $\left| \frac{\sin x \sin y}{\sqrt{x^2 + 2y^2 + 3z^2}} \right| \leq \left| \frac{xy}{\sqrt{x^2 + y^2 + z^2}} \right| = \left| \frac{\rho^2 \sin^2 \phi \cos \theta \sin \theta}{\rho} \right| \leq \rho$, so $\lim_{(x,y,z) \rightarrow (0,0,0)} \frac{\sin x \sin y}{\sqrt{x^2 + 2y^2 + 3z^2}} = 0$.

29. True: contains no boundary points, therefore each point of D is an interior point.

30. False: $f(x, y) = xy/(x^2 + y^2)$ has limit zero along $x = 0$ as well as along $y = 0$, but not, if $m \neq 0$, along the line $y = mx$.

31. False: let $f(x, y) = -1$ for $x < 0$ and $f(x, y) = 1$ for $x \geq 0$ and let $g(x, y) = -f(x, y)$.

32. True; there is a $\delta > 0$ such that $|f(x)| > |L|/2$ if $0 < x < \delta$, so $\frac{x^2 + y^2}{|f(x^2 + y^2)|} \leq \frac{x^2 + y^2}{|L|/2} < \epsilon$ if $x^2 + y^2 < \delta$ and $x^2 + y^2 < |L|\epsilon/2$.

33. (a) No, since there seem to be points near $(0, 0)$ with $z = 0$ and other points near $(0, 0)$ with $z \approx 1/2$.

(b) $\lim_{x \rightarrow 0} \frac{mx^3}{x^4 + m^2x^2} = \lim_{x \rightarrow 0} \frac{mx}{x^2 + m^2} = 0$.

(c) $\lim_{x \rightarrow 0} \frac{x^4}{2x^4} = \lim_{x \rightarrow 0} 1/2 = 1/2$.

(d) A limit must be unique if it exists, so $f(x, y)$ cannot have a limit as $(x, y) \rightarrow (0, 0)$.

34. (a) Along $y = mx$: $\lim_{x \rightarrow 0} \frac{mx^4}{2x^6 + m^2x^2} = \lim_{x \rightarrow 0} \frac{mx^2}{2x^4 + m^2} = 0$; along $y = kx^2$: $\lim_{x \rightarrow 0} \frac{kx^5}{2x^6 + k^2x^4} = \lim_{x \rightarrow 0} \frac{kx}{2x^2 + k^2} = 0$.

(b) $\lim_{x \rightarrow 0} \frac{x^6}{2x^6 + x^6} = \lim_{x \rightarrow 0} \frac{1}{3} = \frac{1}{3} \neq 0$.

35. (a) We may assume that $a^2 + b^2 + c^2 > 0$, since we are dealing with a line (not just the point $(0, 0, 0)$). Assume first that $a \neq 0$. Then $\lim_{t \rightarrow 0} \frac{abct^3}{a^2t^2 + b^4t^4 + c^4t^4} = \lim_{t \rightarrow 0} \frac{abct}{a^2 + b^4t^2 + c^4t^2} = 0$. If, on the other hand, $a = 0$, the result is trivial, as the quotient is then zero.

(b) $\lim_{t \rightarrow 0} \frac{t^4}{t^4 + t^4 + t^4} = \lim_{t \rightarrow 0} 1/3 = 1/3$.

36. $\pi/2$ because $\frac{x^2 + 1}{x^2 + (y - 1)^2} \rightarrow +\infty$ as $(x, y) \rightarrow (0, 1)$.

37. $-\pi/2$ because $\frac{x^2 - 1}{x^2 + (y - 1)^2} \rightarrow -\infty$ as $(x, y) \rightarrow (0, 1)$.

38. With $z = x^2 + y^2$, $\lim_{z \rightarrow 0^+} \frac{\sin z}{z} = 1 = f(0, 0)$.

39. The required limit does not exist, so the singularity is not removable.

40. $\lim_{(x,y) \rightarrow (0,0)} f(x,y) = 0$ so the limit exists, and $f(0,0) = -4 \neq 0$, thus the singularity is removable.

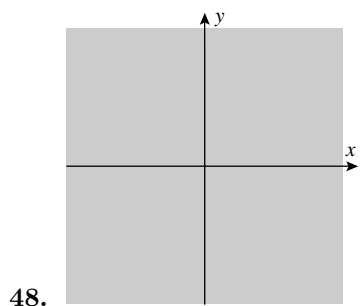
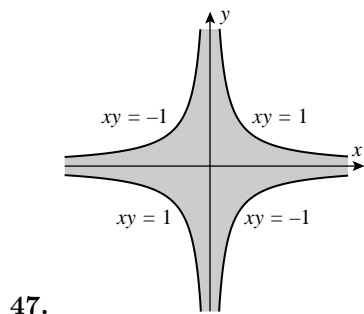
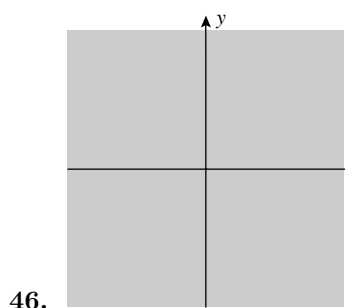
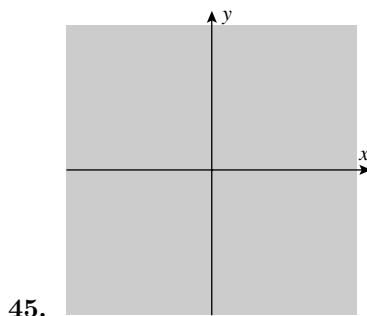
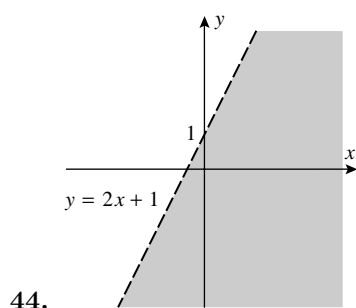
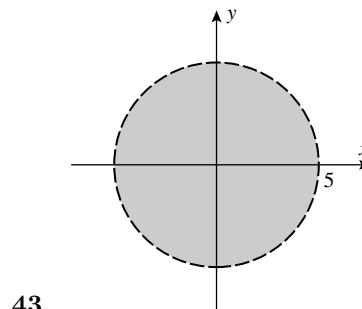
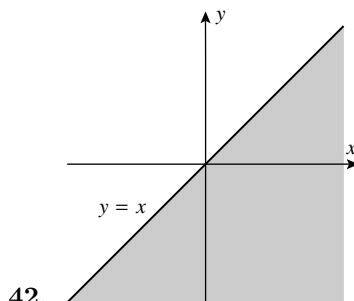
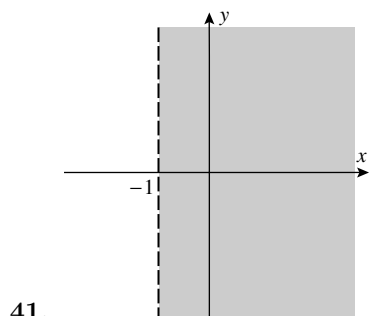

49. All of 3-space.

50. All points inside the sphere with radius 2 and center at the origin.

51. All points not on the cylinder $x^2 + z^2 = 1$.

52. All of 3-space.

Exercise Set 13.3

- (a) $9x^2y^2$ (b) $6x^3y$ (c) $9y^2$ (d) $9x^2$ (e) $6y$ (f) $6x^3$ (g) 36 (h) 12
- (a) $2e^{2x} \sin y$ (b) $e^{2x} \cos y$ (c) $2 \sin y$ (d) 0 (e) $\cos y$ (f) e^{2x} (g) 0 (h) 4
- $\frac{\partial z}{\partial x} = 18xy - 15x^4y$, $\frac{\partial z}{\partial y} = 9x^2 - 3x^5$.
- $f_x(x,y) = 20xy^4 - 6y^2 + 20x$, $f_y(x,y) = 40x^2y^3 - 12xy$.
- $\frac{\partial z}{\partial x} = 8(x^2 + 5x - 2y)^7(2x + 5)$, $\frac{\partial z}{\partial y} = -16(x^2 + 5x - 2y)^7$.

6. $f_x(x, y) = (-1)(xy^2 - x^2y)^{-2}(y^2 - 2xy)$, $f_y(x, y) = (-1)(xy^2 - x^2y)^{-2}(2xy - x^2)$.
7. $\frac{\partial}{\partial p}(e^{-7p/q}) = -7e^{-7p/q}/q$, $\frac{\partial}{\partial q}(e^{-7p/q}) = 7pe^{-7p/q}/q^2$.
8. $\frac{\partial}{\partial x}(xe^{\sqrt{15xy}}) = e^{\sqrt{15xy}} + xe^{\sqrt{15xy}} \frac{1}{2} \frac{1}{\sqrt{15xy}} 15y$, $\frac{\partial}{\partial y}(xe^{\sqrt{15xy}}) = xe^{\sqrt{15xy}} \frac{1}{2} \frac{1}{\sqrt{15xy}} 15x$.
9. $\frac{\partial z}{\partial x} = (15x^2y + 7y^2) \cos(5x^3y + 7xy^2)$, $\frac{\partial z}{\partial y} = (5x^3 + 14xy) \cos(5x^3y + 7xy^2)$.
10. $f_x(x, y) = -(2y^2 - 6xy^2) \sin(2xy^2 - 3x^2y^2)$, $f_y(x, y) = -(4xy - 6x^2y) \sin(2xy^2 - 3x^2y^2)$.
11. (a) $\frac{\partial z}{\partial x} = \frac{3}{2\sqrt{3x+2y}}$; slope = $\frac{3}{8}$. (b) $\frac{\partial z}{\partial y} = \frac{1}{\sqrt{3x+2y}}$; slope = $\frac{1}{4}$.
12. (a) $\frac{\partial z}{\partial x} = e^{-y}$; slope = 1. (b) $\frac{\partial z}{\partial y} = -xe^{-y} + 5$; slope = 2.
13. (a) $\frac{\partial z}{\partial x} = -4 \cos(y^2 - 4x)$; rate of change = $-4 \cos 7$. (b) $\frac{\partial z}{\partial y} = 2y \cos(y^2 - 4x)$; rate of change = $2 \cos 7$.
14. (a) $\frac{\partial z}{\partial x} = -\frac{1}{(x+y)^2}$; rate of change = $-\frac{1}{4}$. (b) $\frac{\partial z}{\partial y} = -\frac{1}{(x+y)^2}$; rate of change = $-\frac{1}{4}$.
15. $\partial z/\partial x =$ slope of line parallel to xz -plane = -4 ; $\partial z/\partial y =$ slope of line parallel to yz -plane = $1/2$.
16. Moving to the right from (x_0, y_0) decreases $f(x, y)$, so $f_x < 0$; moving up increases f , so $f_y > 0$.
17. (a) The right-hand estimate is $\partial r/\partial v \approx (222 - 197)/(85 - 80) = 5$; the left-hand estimate is $\partial r/\partial v \approx (197 - 173)/(80 - 75) = 4.8$; the average is $\partial r/\partial v \approx 4.9$.
- (b) The right-hand estimate is $\partial r/\partial \theta \approx (200 - 197)/(45 - 40) = 0.6$; the left-hand estimate is $\partial r/\partial \theta \approx (197 - 188)/(40 - 35) = 1.8$; the average is $\partial r/\partial \theta \approx 1.2$.
18. (a) The right-hand estimate is $\partial r/\partial v \approx (253 - 226)/(90 - 85) = 5.4$; the left-hand estimate is $(226 - 200)/(85 - 80) = 5.2$; the average is $\partial r/\partial v \approx 5.3$.
- (b) The right-hand estimate is $\partial r/\partial \theta \approx (222 - 226)/(50 - 45) = -0.8$; the left-hand estimate is $(226 - 222)/(45 - 40) = 0.8$; the average is $\partial r/\partial v \approx 0$.
19. III is a plane, and its partial derivatives are constants, so III cannot be $f(x, y)$. If I is the graph of $z = f(x, y)$ then (by inspection) f_y is constant as y varies, but neither II nor III is constant as y varies. Hence $z = f(x, y)$ has II as its graph, and as II seems to be an odd function of x and an even function of y , f_x has I as its graph and f_y has III as its graph.
20. The slope at P in the positive x -direction is negative, the slope in the positive y -direction is negative, thus $\partial z/\partial x < 0$, $\partial z/\partial y < 0$; the curve through P which is parallel to the x -axis is concave down, so $\partial^2 z/\partial x^2 < 0$; the curve parallel to the y -axis is concave down, so $\partial^2 z/\partial y^2 < 0$.
21. True: f is constant along the line $y = 2$ so $f_x(4, 2) = 0$.
22. True, $f(3, y) = y^2$, so $f_y(3, 4) = 8$.
23. True; z is a linear function of both x and y .

24. False; if so then $2y + 2 = \frac{\partial f_x}{\partial y} = \frac{\partial f_y}{\partial x} = 2y$, a contradiction.
25. $\partial z/\partial x = 8xy^3e^{x^2y^3}$, $\partial z/\partial y = 12x^2y^2e^{x^2y^3}$.
26. $\partial z/\partial x = -5x^4y^4 \sin(x^5y^4)$, $\partial z/\partial y = -4x^5y^3 \sin(x^5y^4)$.
27. $\partial z/\partial x = x^3/(y^{3/5} + x) + 3x^2 \ln(1 + xy^{-3/5})$, $\partial z/\partial y = -(3/5)x^4/(y^{8/5} + xy)$.
28. $\partial z/\partial x = ye^{xy} \sin(4y^2)$, $\partial z/\partial y = 8ye^{xy} \cos(4y^2) + xe^{xy} \sin(4y^2)$.
29. $\frac{\partial z}{\partial x} = -\frac{y(x^2 - y^2)}{(x^2 + y^2)^2}$, $\frac{\partial z}{\partial y} = \frac{x(x^2 - y^2)}{(x^2 + y^2)^2}$.
30. $\frac{\partial z}{\partial x} = \frac{xy^3(3x + 4y)}{2(x + y)^{3/2}}$, $\frac{\partial z}{\partial y} = \frac{x^2y^2(6x + 5y)}{2(x + y)^{3/2}}$.
31. $f_x(x, y) = (3/2)x^2y(5x^2 - 7)(3x^5y - 7x^3y)^{-1/2}$, $f_y(x, y) = (1/2)x^3(3x^2 - 7)(3x^5y - 7x^3y)^{-1/2}$.
32. $f_x(x, y) = -2y/(x - y)^2$, $f_y(x, y) = 2x/(x - y)^2$.
33. $f_x(x, y) = \frac{y^{-1/2}}{y^2 + x^2}$, $f_y(x, y) = -\frac{xy^{-3/2}}{y^2 + x^2} - \frac{3}{2}y^{-5/2} \tan^{-1}(x/y)$.
34. $f_x(x, y) = 3x^2e^{-y} + (1/2)x^{-1/2}y^3 \sec \sqrt{x} \tan \sqrt{x}$, $f_y(x, y) = -x^3e^{-y} + 3y^2 \sec \sqrt{x}$.
35. $f_x(x, y) = -(4/3)y^2 \sec^2 x (y^2 \tan x)^{-7/3}$, $f_y(x, y) = -(8/3)y \tan x (y^2 \tan x)^{-7/3}$.
36. $f_x(x, y) = 2y^2 \cosh \sqrt{x} \sinh(xy^2) \cosh(xy^2) + \frac{1}{2}x^{-1/2} \sinh \sqrt{x} \sinh^2(xy^2)$,
 $f_y(x, y) = 4xy \cosh \sqrt{x} \sinh(xy^2) \cosh(xy^2)$.
37. $f_x(x, y) = -2x$, $f_x(3, 1) = -6$; $f_y(x, y) = -21y^2$, $f_y(3, 1) = -21$.
38. $\partial f/\partial x = x^2y^2e^{xy} + 2xye^{xy}$, $\partial f/\partial x|_{(1,1)} = 3e$; $\partial f/\partial y = x^3ye^{xy} + x^2e^{xy}$, $\partial f/\partial y|_{(1,1)} = 2e$.
39. $\partial z/\partial x = x(x^2 + 4y^2)^{-1/2}$, $\partial z/\partial x|_{(1,2)} = 1/\sqrt{17}$; $\partial z/\partial y = 4y(x^2 + 4y^2)^{-1/2}$, $\partial z/\partial y|_{(1,2)} = 8/\sqrt{17}$.
40. $\partial w/\partial x = -x^2y \sin xy + 2x \cos xy$, $\frac{\partial w}{\partial x}(1/2, \pi) = -\pi/4$; $\partial w/\partial y = -x^3 \sin xy$, $\frac{\partial w}{\partial y}(1/2, \pi) = -1/8$.
41. (a) $2xy^4z^3 + y$ (b) $4x^2y^3z^3 + x$ (c) $3x^2y^4z^2 + 2z$ (d) $2y^4z^3 + y$ (e) $32z^3 + 1$ (f) 438
42. (a) $2xy \cos z$ (b) $x^2 \cos z$ (c) $-x^2y \sin z$ (d) $4y \cos z$ (e) $4 \cos z$ (f) 0
43. $f_x = 2z/x$, $f_y = z/y$, $f_z = \ln(x^2y \cos z) - z \tan z$.
44. $f_x = y^{-5/2}z \sec(xz/y) \tan(xz/y)$, $f_y = -xy^{-7/2}z \sec(xz/y) \tan(xz/y) - (3/2)y^{-5/2} \sec(xz/y)$,
 $f_z = xy^{-5/2} \sec(xz/y) \tan(xz/y)$.
45. $f_x = -y^2z^3/(1 + x^2y^4z^6)$, $f_y = -2xyz^3/(1 + x^2y^4z^6)$, $f_z = -3xy^2z^2/(1 + x^2y^4z^6)$.
46. $f_x = 4xyz \cosh \sqrt{z} \sinh(x^2yz) \cosh(x^2yz)$, $f_y = 2x^2z \cosh \sqrt{z} \sinh(x^2yz) \cosh(x^2yz)$,
 $f_z = 2x^2y \cosh \sqrt{z} \sinh(x^2yz) \cosh(x^2yz) + (1/2)z^{-1/2} \sinh \sqrt{z} \sinh^2(x^2yz)$.

47. $\partial w/\partial x = yze^z \cos xz$, $\partial w/\partial y = e^z \sin xz$, $\partial w/\partial z = ye^z(\sin xz + x \cos xz)$.

48. $\partial w/\partial x = 2x/(y^2 + z^2)$, $\partial w/\partial y = -2y(x^2 + z^2)/(y^2 + z^2)^2$, $\partial w/\partial z = 2z(y^2 - x^2)/(y^2 + z^2)^2$.

49. $\partial w/\partial x = x/\sqrt{x^2 + y^2 + z^2}$, $\partial w/\partial y = y/\sqrt{x^2 + y^2 + z^2}$, $\partial w/\partial z = z/\sqrt{x^2 + y^2 + z^2}$.

50. $\partial w/\partial x = 2y^3e^{2x+3z}$, $\partial w/\partial y = 3y^2e^{2x+3z}$, $\partial w/\partial z = 3y^3e^{2x+3z}$.

51. (a) e (b) $2e$ (c) e

52. (a) $2/\sqrt{7}$ (b) $4/\sqrt{7}$ (c) $1/\sqrt{7}$

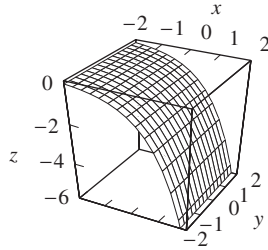
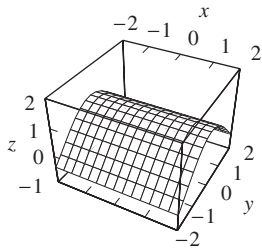

53.

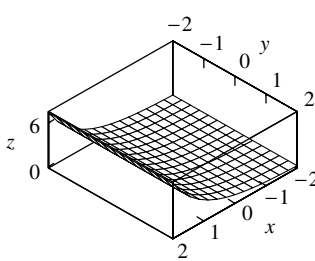
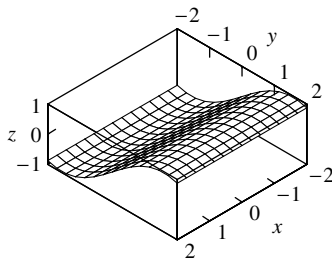

54.

55. $\partial z/\partial x = 2x + 6y(\partial y/\partial x) = 2x$, $\partial z/\partial x|_{(2,1)} = 4$.

56. $\partial z/\partial y = 6y$, $\partial z/\partial y|_{(2,1)} = 6$.

57. $\partial z/\partial x = -x(29 - x^2 - y^2)^{-1/2}$, $\partial z/\partial x|_{(4,3)} = -2$.

58. (a) $\partial z/\partial y = 8y$, $\partial z/\partial y|_{(-1,1)} = 8$. (b) $\partial z/\partial x = 2x$, $\partial z/\partial x|_{(-1,1)} = -2$.

59. (a) $\partial V/\partial r = 2\pi rh$. (b) $\partial V/\partial h = \pi r^2$. (c) $\partial V/\partial r|_{r=6, h=4} = 48\pi$. (d) $\partial V/\partial h|_{r=8, h=10} = 64\pi$.

60. (a) $\partial V/\partial s = \frac{\pi s d^2}{6\sqrt{4s^2 - d^2}}$. (b) $\partial V/\partial d = \frac{\pi d(8s^2 - 3d^2)}{24\sqrt{4s^2 - d^2}}$. (c) $\partial V/\partial s|_{s=10, d=16} = 320\pi/9$.

(d) $\partial V/\partial d|_{s=10, d=16} = 16\pi/9$.

61. (a) $P = 10T/V$, $\partial P/\partial T = 10/V$, $\partial P/\partial T|_{T=80, V=50} = 1/5 \text{ lb}/(\text{in}^2\text{K})$.

(b) $V = 10T/P$, $\partial V/\partial P = -10T/P^2$, if $V = 50$ and $T = 80$, then $P = 10(80)/(50) = 16$, $\partial V/\partial P|_{T=80, P=16} = -25/8(\text{in}^5/\text{lb})$.

62. (a) $\partial T/\partial x = 3x^2 + 1$, $\partial T/\partial x|_{(1,2)} = 4 \frac{^\circ\text{C}}{\text{cm}}$. (b) $\partial T/\partial y = 4y$, $\partial T/\partial y|_{(1,2)} = 8 \frac{^\circ\text{C}}{\text{cm}}$.

63. (a) $V = lwh$, $\partial V/\partial l = wh = 6$. (b) $\partial V/\partial w = lh = 15$. (c) $\partial V/\partial h = lw = 10$.

64. (a) $\partial A/\partial a = (1/2)b \sin \theta = (1/2)(10)(\sqrt{3}/2) = 5\sqrt{3}/2$.
 (b) $\partial A/\partial \theta = (1/2)ab \cos \theta = (1/2)(5)(10)(1/2) = 25/2$.
 (c) $b = (2A \csc \theta)/a$, $\partial b/\partial a = -(2A \csc \theta)/a^2 = -b/a = -2$.
65. $\partial V/\partial r = \frac{2}{3}\pi r h = \frac{2}{r}(\frac{1}{3}\pi r^2 h) = 2V/r$.
66. (a) $\partial z/\partial y = x^2$, $\partial z/\partial y|_{(1,3)} = 1$, $\mathbf{j} + \mathbf{k}$ is parallel to the tangent line so $x = 1$, $y = 3 + t$, $z = 3 + t$.
 (b) $\partial z/\partial x = 2xy$, $\partial z/\partial x|_{(1,3)} = 6$, $\mathbf{i} + 6\mathbf{k}$ is parallel to the tangent line so $x = 1 + t$, $y = 3$, $z = 3 + 6t$.
67. (a) $2x - 2z(\partial z/\partial x) = 0$, $\partial z/\partial x = x/z = \pm 3/(2\sqrt{6}) = \pm\sqrt{6}/4$.
 (b) $z = \pm\sqrt{x^2 + y^2 - 1}$, $\partial z/\partial x = \pm x/\sqrt{x^2 + y^2 - 1} = \pm\sqrt{6}/4$.
68. (a) $2y - 2z(\partial z/\partial y) = 0$, $\partial z/\partial y = y/z = \pm 4/(2\sqrt{6}) = \pm\sqrt{6}/3$.
 (b) $z = \pm\sqrt{x^2 + y^2 - 1}$, $\partial z/\partial y = \pm y/\sqrt{x^2 + y^2 - 1} = \pm\sqrt{6}/3$.
69. $\frac{3}{2}(x^2 + y^2 + z^2)^{1/2} \left(2x + 2z \frac{\partial z}{\partial x}\right) = 0$, $\partial z/\partial x = -x/z$; similarly, $\partial z/\partial y = -y/z$.
70. $\frac{4x - 3z^2(\partial z/\partial x)}{2x^2 + y - z^3} = 1$, $\frac{\partial z}{\partial x} = \frac{4x - 2x^2 - y + z^3}{3z^2}$; $\frac{1 - 3z^2(\partial z/\partial y)}{2x^2 + y - z^3} = 0$, $\frac{\partial z}{\partial y} = \frac{1}{3z^2}$.
71. $2x + z \left(xy \frac{\partial z}{\partial x} + yz\right) \cos xyz + \frac{\partial z}{\partial x} \sin xyz = 0$, $\frac{\partial z}{\partial x} = -\frac{2x + yz^2 \cos xyz}{xyz \cos xyz + \sin xyz}$;
 $z \left(xy \frac{\partial z}{\partial y} + xz\right) \cos xyz + \frac{\partial z}{\partial y} \sin xyz = 0$, $\frac{\partial z}{\partial y} = -\frac{xz^2 \cos xyz}{xyz \cos xyz + \sin xyz}$.
72. $e^{xy}(\cosh z) \frac{\partial z}{\partial x} + ye^{xy} \sinh z - z^2 - 2xz \frac{\partial z}{\partial x} = 0$, $\frac{\partial z}{\partial x} = \frac{z^2 - ye^{xy} \sinh z}{e^{xy} \cosh z - 2xz}$;
 $e^{xy}(\cosh z) \frac{\partial z}{\partial y} + xe^{xy} \sinh z - 2xz \frac{\partial z}{\partial y} = 0$, $\frac{\partial z}{\partial y} = -\frac{xe^{xy} \sinh z}{e^{xy} \cosh z - 2xz}$.
73. $(3/2)(x^2 + y^2 + z^2 + w^2)^{1/2} \left(2x + 2w \frac{\partial w}{\partial x}\right) = 0$, $\partial w/\partial x = -x/w$; similarly, $\partial w/\partial y = -y/w$ and $\partial w/\partial z = -z/w$.
74. $\partial w/\partial x = -4x/3$, $\partial w/\partial y = -1/3$, $\partial w/\partial z = (2x^2 + y - z^3 + 3z^2 + 3w)/3$.
75. $\frac{\partial w}{\partial x} = -\frac{yzw \cos xyz}{2w + \sin xyz}$, $\frac{\partial w}{\partial y} = -\frac{xzw \cos xyz}{2w + \sin xyz}$, $\frac{\partial w}{\partial z} = -\frac{xyw \cos xyz}{2w + \sin xyz}$.
76. $\frac{\partial w}{\partial x} = \frac{ye^{xy} \sinh w}{z^2 - e^{xy} \cosh w}$, $\frac{\partial w}{\partial y} = \frac{xe^{xy} \sinh w}{z^2 - e^{xy} \cosh w}$, $\frac{\partial w}{\partial z} = \frac{2zw}{e^{xy} \cosh w - z^2}$.
77. $f_x = e^{x^2}$, $f_y = -e^{y^2}$.
78. $f_x = ye^{x^2 y^2}$, $f_y = xe^{x^2 y^2}$.
79. $f_x = 2xy^3 \sin x^6 y^9$, $f_y = 3x^2 y^2 \sin x^6 y^9$.

80. $f_x = \sin(x - y)^3 - \sin(x + y)^3$, $f_y = -\sin(x - y)^3 - \sin(x + y)^3$.
81. (a) $-\frac{1}{4x^{3/2}} \cos y$ (b) $-\sqrt{x} \cos y$ (c) $-\frac{\sin y}{2\sqrt{x}}$ (d) $-\frac{\sin y}{2\sqrt{x}}$
82. (a) $8 + 84x^2y^5$ (b) $140x^4y^3$ (c) $140x^3y^4$ (d) $140x^3y^4$
83. (a) $6 \cos(3x^2 + 6y^2) - 36x^2 \sin(3x^2 + 6y^2)$ (b) $12 \cos(3x^2 + 6y^2) - 144y^2 \sin(3x^2 + 6y^2)$
(c) $-72xy \sin(3x^2 + 6y^2)$ (d) $-72xy \sin(3x^2 + 6y^2)$
84. (a) 0 (b) $4xe^{2y}$ (c) $2e^{2y}$ (d) $2e^{2y}$
85. $f_x = 8x - 8y^4$, $f_y = -32xy^3 + 35y^4$, $f_{xy} = f_{yx} = -32y^3$.
86. $f_x = x/\sqrt{x^2 + y^2}$, $f_y = y/\sqrt{x^2 + y^2}$, $f_{xy} = f_{yx} = -xy(x^2 + y^2)^{-3/2}$.
87. $f_x = e^x \cos y$, $f_y = -e^x \sin y$, $f_{xy} = f_{yx} = -e^x \sin y$.
88. $f_x = e^{x-y^2}$, $f_y = -2ye^{x-y^2}$, $f_{xy} = f_{yx} = -2ye^{x-y^2}$.
89. $f_x = 4/(4x - 5y)$, $f_y = -5/(4x - 5y)$, $f_{xy} = f_{yx} = 20/(4x - 5y)^2$.
90. $f_x = 2x/(x^2 + y^2)$, $f_y = 2y/(x^2 + y^2)$, $f_{xy} = -4xy/(x^2 + y^2)^2$.
91. $f_x = 2y/(x + y)^2$, $f_y = -2x/(x + y)^2$, $f_{xy} = f_{yx} = 2(x - y)/(x + y)^3$.
92. $f_x = 4xy^2/(x^2 + y^2)^2$, $f_y = -4x^2y/(x^2 + y^2)^2$, $f_{xy} = f_{yx} = 8xy(x^2 - y^2)/(x^2 + y^2)^3$.
93. (a) $\frac{\partial^3 f}{\partial x^3}$ (b) $\frac{\partial^3 f}{\partial y^2 \partial x}$ (c) $\frac{\partial^4 f}{\partial x^2 \partial y^2}$ (d) $\frac{\partial^4 f}{\partial y^3 \partial x}$
94. (a) f_{xyy} (b) f_{xxx} (c) f_{xyy} (d) f_{yyyx}
95. (a) $30xy^4 - 4$ (b) $60x^2y^3$ (c) $60x^3y^2$
96. (a) $120(2x - y)^2$ (b) $-240(2x - y)^2$ (c) $480(2x - y)$
97. (a) $f_{xyy}(0, 1) = -30$ (b) $f_{xxx}(0, 1) = -125$ (c) $f_{yyxx}(0, 1) = 150$
98. (a) $\frac{\partial^3 w}{\partial y^2 \partial x} = -e^y \sin x$, $\frac{\partial^3 w}{\partial y^2 \partial x} \Big|_{(\pi/4, 0)} = -1/\sqrt{2}$. (b) $\frac{\partial^3 w}{\partial x^2 \partial y} = -e^y \cos x$, $\frac{\partial^3 w}{\partial x^2 \partial y} \Big|_{(\pi/4, 0)} = -1/\sqrt{2}$.
99. (a) $f_{xy} = 15x^2y^4z^7 + 2y$. (b) $f_{yz} = 35x^3y^4z^6 + 3y^2$. (c) $f_{xz} = 21x^2y^5z^6$.
(d) $f_{zz} = 42x^3y^5z^5$. (e) $f_{zyy} = 140x^3y^3z^6 + 6y$. (f) $f_{xxy} = 30xy^4z^7$.
(g) $f_{zyx} = 105x^2y^4z^6$. (h) $f_{xxyz} = 210xy^4z^6$.
100. (a) $160(4x - 3y + 2z)^3$ (b) $-1440(4x - 3y + 2z)^2$ (c) $-5760(4x - 3y + 2z)$
101. (a) $z_x = 2x + 2y$, $z_{xx} = 2$, $z_y = -2y + 2x$, $z_{yy} = -2$; $z_{xx} + z_{yy} = 2 - 2 = 0$.
(b) $z_x = e^x \sin y - e^y \sin x$, $z_{xx} = e^x \sin y - e^y \cos x$, $z_y = e^x \cos y + e^y \cos x$, $z_{yy} = -e^x \sin y + e^y \cos x$; $z_{xx} + z_{yy} = e^x \sin y - e^y \cos x - e^x \sin y + e^y \cos x = 0$.

$$(c) \quad z_x = \frac{2x}{x^2 + y^2} - 2 \frac{y}{x^2} \frac{1}{1 + (y/x)^2} = \frac{2x - 2y}{x^2 + y^2}, \quad z_{xx} = -2 \frac{x^2 - y^2 - 2xy}{(x^2 + y^2)^2}, \quad z_y = \frac{2y}{x^2 + y^2} + 2 \frac{1}{x} \frac{1}{1 + (y/x)^2} = \frac{2y + 2x}{x^2 + y^2}, \quad z_{yy} = -2 \frac{y^2 - x^2 + 2xy}{(x^2 + y^2)^2}; \quad z_{xx} + z_{yy} = -2 \frac{x^2 - y^2 - 2xy}{(x^2 + y^2)^2} - 2 \frac{y^2 - x^2 + 2xy}{(x^2 + y^2)^2} = 0.$$

$$102. (a) \quad z_t = -e^{-t} \sin(x/c), \quad z_x = (1/c)e^{-t} \cos(x/c), \quad z_{xx} = -(1/c^2)e^{-t} \sin(x/c); \quad z_t - c^2 z_{xx} = -e^{-t} \sin(x/c) - c^2(-1/c^2)e^{-t} \sin(x/c) = 0.$$

$$(b) \quad z_t = -e^{-t} \cos(x/c), \quad z_x = -(1/c)e^{-t} \sin(x/c), \quad z_{xx} = -(1/c^2)e^{-t} \cos(x/c); \quad z_t - c^2 z_{xx} = -e^{-t} \cos(x/c) - c^2(-1/c^2)e^{-t} \cos(x/c) = 0.$$

$$103. \quad u_x = \omega \sin c\omega t \cos \omega x, \quad u_{xx} = -\omega^2 \sin c\omega t \sin \omega x, \quad u_t = c\omega \cos c\omega t \sin \omega x, \quad u_{tt} = -c^2 \omega^2 \sin c\omega t \sin \omega x; \quad u_{xx} - \frac{1}{c^2} u_{tt} = -\omega^2 \sin c\omega t \sin \omega x - \frac{1}{c^2}(-c^2)\omega^2 \sin c\omega t \sin \omega x = 0.$$

$$104. (a) \quad \partial u/\partial x = \partial v/\partial y = 2x, \quad \partial u/\partial y = -\partial v/\partial x = -2y.$$

$$(b) \quad \partial u/\partial x = \partial v/\partial y = e^x \cos y, \quad \partial u/\partial y = -\partial v/\partial x = -e^x \sin y.$$

$$(c) \quad \partial u/\partial x = \partial v/\partial y = 2x/(x^2 + y^2), \quad \partial u/\partial y = -\partial v/\partial x = 2y/(x^2 + y^2).$$

105. $\partial u/\partial x = \partial v/\partial y$ and $\partial u/\partial y = -\partial v/\partial x$ so $\partial^2 u/\partial x^2 = \partial^2 v/\partial x \partial y$, and $\partial^2 u/\partial y^2 = -\partial^2 v/\partial y \partial x$, $\partial^2 u/\partial x^2 + \partial^2 u/\partial y^2 = \partial^2 v/\partial x \partial y - \partial^2 v/\partial y \partial x$, if $\partial^2 v/\partial x \partial y = \partial^2 v/\partial y \partial x$ then $\partial^2 u/\partial x^2 + \partial^2 u/\partial y^2 = 0$; thus u satisfies Laplace's equation. The proof that v satisfies Laplace's equation is similar. Adding Laplace's equations for u and v gives Laplace's equation for $u + v$.

$$106. \quad \partial^2 R/\partial R_1^2 = -2R_2^2/(R_1 + R_2)^3, \quad \partial^2 R/\partial R_2^2 = -2R_1^2/(R_1 + R_2)^3, \quad (\partial^2 R/\partial R_1^2) (\partial^2 R/\partial R_2^2) = 4R_1^2 R_2^2 / (R_1 + R_2)^6 = \left[4 / (R_1 + R_2)^4 \right] [R_1 R_2 / (R_1 + R_2)]^2 = 4R^2 / (R_1 + R_2)^4.$$

$$107. \quad \partial f/\partial v = 8vw^3 x^4 y^5, \quad \partial f/\partial w = 12v^2 w^2 x^4 y^5, \quad \partial f/\partial x = 16v^2 w^3 x^3 y^5, \quad \partial f/\partial y = 20v^2 w^3 x^4 y^4.$$

$$108. \quad \partial w/\partial r = \cos st + ue^u \cos ur, \quad \partial w/\partial s = -rt \sin st, \quad \partial w/\partial t = -rs \sin st, \quad \partial w/\partial u = re^u \cos ur + e^u \sin ur.$$

$$109. \quad \partial f/\partial v_1 = 2v_1 / (v_3^2 + v_4^2), \quad \partial f/\partial v_2 = -2v_2 / (v_3^2 + v_4^2), \quad \partial f/\partial v_3 = -2v_3 (v_1^2 - v_2^2) / (v_3^2 + v_4^2)^2, \\ \partial f/\partial v_4 = -2v_4 (v_1^2 - v_2^2) / (v_3^2 + v_4^2)^2.$$

$$110. \quad \frac{\partial V}{\partial x} = 2xe^{2x-y} + e^{2x-y}, \quad \frac{\partial V}{\partial y} = -xe^{2x-y} + w, \quad \frac{\partial V}{\partial z} = w^2 e^{zw}, \quad \frac{\partial V}{\partial w} = wze^{zw} + e^{zw} + y.$$

$$111. (a) 0 \quad (b) 0 \quad (c) 0 \quad (d) 0 \quad (e) 2(1 + yw)e^{yw} \sin z \cos z \quad (f) 2xw(2 + yw)e^{yw} \sin z \cos z$$

$$112. 128, -512, 32, 64/3.$$

$$113. \quad \partial w/\partial x_i = -i \sin(x_1 + 2x_2 + \dots + nx_n).$$

$$114. \quad \partial w/\partial x_i = \frac{1}{n} \left(\sum_{k=1}^n x_k \right)^{(1/n)-1}.$$

$$115. (a) \quad xy\text{-plane, } f_x = 12x^2y + 6xy, \quad f_y = 4x^3 + 3x^2, \quad f_{xy} = f_{yx} = 12x^2 + 6x.$$

$$(b) \quad y \neq 0, f_x = 3x^2/y, \quad f_y = -x^3/y^2, \quad f_{xy} = f_{yx} = -3x^2/y^2.$$

116. (a) $x^2 + y^2 > 1$, (the exterior of the circle of radius 1 about the origin); $f_x = x/\sqrt{x^2 + y^2 - 1}$, $f_y = y/\sqrt{x^2 + y^2 - 1}$, $f_{xy} = f_{yx} = -xy(x^2 + y^2 - 1)^{-3/2}$.

(b) xy -plane, $f_x = 2x \cos(x^2 + y^3)$, $f_y = 3y^2 \cos(x^2 + y^3)$, $f_{xy} = f_{yx} = -6xy^2 \sin(x^2 + y^3)$.

$$117. f_x(2, -1) = \lim_{x \rightarrow 2} \frac{f(x, -1) - f(2, -1)}{x - 2} = \lim_{x \rightarrow 2} \frac{2x^2 + 3x + 1 - 15}{x - 2} = \lim_{x \rightarrow 2} (2x + 7) = 11 \text{ and}$$

$$f_y(2, -1) = \lim_{y \rightarrow -1} \frac{f(2, y) - f(2, -1)}{y + 1} = \lim_{y \rightarrow -1} \frac{8 - 6y + y^2 - 15}{y + 1} = \lim_{y \rightarrow -1} y - 7 = -8.$$

118. $f_x(x, y) = \frac{2}{3}(x^2 + y^2)^{-1/3}(2x) = \frac{4x}{3(x^2 + y^2)^{1/3}}$, $(x, y) \neq (0, 0)$; and by definition, $f_x(0, 0) = \lim_{h \rightarrow 0} \frac{((h)^2)^{2/3} - 0}{h} = 0$.

119. (a) $f_y(0, 0) = \left. \frac{d}{dy}[f(0, y)] \right|_{y=0} = \left. \frac{d}{dy}[y] \right|_{y=0} = 1$.

(b) If $(x, y) \neq (0, 0)$, then $f_y(x, y) = \frac{1}{3}(x^3 + y^3)^{-2/3}(3y^2) = \frac{y^2}{(x^3 + y^3)^{2/3}}$; $f_y(x, y)$ does not exist when $y \neq 0$ and $y = -x$.

Exercise Set 13.4

1. $f(x, y) \approx f(3, 4) + f_x(x - 3) + f_y(y - 4) = 5 + 2(x - 3) - (y - 4)$ and $f(3.01, 3.98) \approx 5 + 2(0.01) - (-0.02) = 5.04$.

2. $f(x, y) \approx f(-1, 2) + f_x(x + 1) + f_y(y - 2) = 2 + (x + 1) + 3(y - 2)$ and $f(-0.99, 2.02) \approx 2 + 0.01 + 3(0.02) = 2.07$.

3. $L(x, y, z) = f(1, 2, 3) + (x - 1) + 2(y - 2) + 3(z - 3)$, $f(1.01, 2.02, 3.03) \approx 4 + 0.01 + 2(0.02) + 3(0.03) = 4.14$.

4. $L(x, y, z) = f(2, 1, -2) - (x - 2) + (y - 1) - 2(z + 2)$, $f(1.98, 0.99, -1.97) \approx 0.02 - 0.01 - 2(0.03) = -0.05$.

5. Suppose $f(x, y) = c$ for all (x, y) . Then at (x_0, y_0) we have $\frac{f(x_0 + \Delta x, y_0) - f(x_0, y_0)}{\Delta x} = 0$ and hence $f_x(x_0, y_0)$ exists and is equal to 0 (Definition 13.3.1). A similar result holds for f_y . From equation (2), it follows that $\Delta f = 0$, and then by Definition 13.4.1 we see that f is differentiable at (x_0, y_0) . An analogous result holds for functions $f(x, y, z)$ of three variables.

6. Let $f(x, y) = ax + by + c$. Then $L(x, y) = f(x_0, y_0) + f_x(x_0, y_0)(x - x_0) + f_y(x_0, y_0)(y - y_0) = ax_0 + by_0 + c + a(x - x_0) + b(y - y_0) = ax + by + c$, so $L = f$ and thus E is zero. For three variables the proof is analogous.

7. $f_x = 2x, f_y = 2y, f_z = 2z$ so $L(x, y, z) = 0$, $E = f - L = x^2 + y^2 + z^2$, and $\lim_{(x,y,z) \rightarrow (0,0,0)} \frac{E(x, y, z)}{\sqrt{x^2 + y^2 + z^2}} = \lim_{(x,y,z) \rightarrow (0,0,0)} \sqrt{x^2 + y^2 + z^2} = 0$, so f is differentiable at $(0, 0, 0)$.

8. $f_x = 2xr(x^2 + y^2 + z^2)^{r-1}, f_y = 2yr(x^2 + y^2 + z^2)^{r-1}, f_z = 2zr(x^2 + y^2 + z^2)^{r-1}$, so the partials of f exist only if $r \geq 1$. If so then $L(x, y, z) = 0, E(x, y, z) = f(x, y, z)$ and $\frac{E(x, y, z)}{\sqrt{x^2 + y^2 + z^2}} = (x^2 + y^2 + z^2)^{r-1/2}$, so f is differentiable at $(0, 0, 0)$ if and only if $r \geq \max(1/2, 1) = 1$.

9. $dz = 7dx - 2dy$.

10. $dz = ye^{xy}dx + xe^{xy}dy$.

11. $dz = 3x^2y^2dx + 2x^3ydy$.

12. $dz = (10xy^5 - 2)dx + (25x^2y^4 + 4)dy$.
13. $dz = [y/(1 + x^2y^2)] dx + [x/(1 + x^2y^2)] dy$.
14. $dz = -3e^{-3x} \cos 6y dx - 6e^{-3x} \sin 6y dy$.
15. $dw = 8dx - 3dy + 4dz$.
16. $dw = yze^{xyz} dx + xze^{xyz} dy + xye^{xyz} dz$.
17. $dw = 3x^2y^2z dx + 2x^3yz dy + x^3y^2 dz$.
18. $dw = (8xy^3z^7 - 3y) dx + (12x^2y^2z^7 - 3x) dy + (28x^2y^3z^6 + 1) dz$.
19. $dw = \frac{yz}{1 + x^2y^2z^2} dx + \frac{xz}{1 + x^2y^2z^2} dy + \frac{xy}{1 + x^2y^2z^2} dz$.
20. $dw = \frac{1}{2\sqrt{x}} dx + \frac{1}{2\sqrt{y}} dy + \frac{1}{2\sqrt{z}} dz$.
21. $df = (2x + 2y - 4)dx + 2xdy$; $x = 1, y = 2, dx = 0.01, dy = 0.04$ so $df = 0.10$ and $\Delta f = 0.1009$.
22. $df = (1/3)x^{-2/3}y^{1/2}dx + (1/2)x^{1/3}y^{-1/2}dy$; $x = 8, y = 9, dx = -0.22, dy = 0.03$ so $df = -0.045$ and $\Delta f \approx -0.045613$.
23. $df = -x^{-2}dx - y^{-2}dy$; $x = -1, y = -2, dx = -0.02, dy = -0.04$ so $df = 0.03$ and $\Delta f \approx 0.029412$.
24. $df = \frac{y}{2(1 + xy)} dx + \frac{x}{2(1 + xy)} dy$; $x = 0, y = 2, dx = -0.09, dy = -0.02$ so $df = -0.09$ and $\Delta f \approx -0.098129$.
25. $df = 2y^2z^3dx + 4xyz^3dy + 6xy^2z^2dz$; $x = 1, y = -1, z = 2, dx = -0.01, dy = -0.02, dz = 0.02$ so $df = 0.96$ and $\Delta f \approx 0.97929$.
26. $df = \frac{yz(y+z)}{(x+y+z)^2} dx + \frac{xz(x+z)}{(x+y+z)^2} dy + \frac{xy(x+y)}{(x+y+z)^2} dz$; $x = -1, y = -2, z = 4, dx = -0.04, dy = 0.02, dz = -0.03$ so $df = 0.58$ and $\Delta f \approx 0.60529$.
27. False: Example 9, Section 13.3 gives such a function which is not even continuous at (x_0, y_0) , let alone differentiable.
28. False; only where f is continuous, since by Theorem 13.2.3 the condition given is equivalent to continuity.
29. True; indeed, by Theorem 13.4.4, f is differentiable.
30. True; from (9), it has normal vector $f_x(x_0, y_0)\mathbf{i} + f_y(x_0, y_0)\mathbf{j} - \mathbf{k}$ and passes through $(x_0, y_0, f(x_0, y_0))$.
31. Label the four smaller rectangles A, B, C, D starting with the lower left and going clockwise. Then the increase in the area of the rectangle is represented by B, C and D ; and the portions B and D represent the approximation of the increase in area given by the total differential.
32. $V + \Delta V = (\pi/3)4.05^2(19.95) \approx 109.0766250\pi$, $V = 320\pi/3$, $\Delta V \approx 2.40996\pi$; $dV = (2/3)\pi r h dr + (1/3)\pi r^2 dh$; $r = 4, h = 20, dr = 0.05, dh = -0.05$ so $dV = 2.4\pi$, and $\Delta V/dV \approx 1.00415$.
33. (a) $f(P) = 1/5, f_x(P) = -x/(x^2 + y^2)^{-3/2} \Big|_{(x,y)=(4,3)} = -4/125, f_y(P) = -y/(x^2 + y^2)^{-3/2} \Big|_{(x,y)=(4,3)} = -3/125, L(x, y) = \frac{1}{5} - \frac{4}{125}(x - 4) - \frac{3}{125}(y - 3)$.

$$(b) L(Q) - f(Q) = \frac{1}{5} - \frac{4}{125}(-0.08) - \frac{3}{125}(0.01) - 0.2023342382 \approx -0.0000142382, |PQ| = \sqrt{0.08^2 + 0.01^2} \approx 0.08062257748, |L(Q) - f(Q)|/|PQ| \approx 0.000176603.$$

$$34. (a) f(P) = 1, f_x(P) = 0.5, f_y(P) = 0.3, L(x, y) = 1 + 0.5(x - 1) + 0.3(y - 1).$$

$$(b) L(Q) - f(Q) = 1 + 0.5(0.05) + 0.3(-0.03) - 1.05^{0.5} 0.97^{0.3} \approx 0.00063, |PQ| = \sqrt{0.05^2 + 0.03^2} \approx 0.05831, |L(Q) - f(Q)|/|PQ| \approx 0.0107.$$

$$35. (a) f(P) = 0, f_x(P) = 0, f_y(P) = 0, L(x, y) = 0.$$

$$(b) L(Q) - f(Q) = -0.003 \sin(0.004) \approx -0.000012, |PQ| = \sqrt{0.003^2 + 0.004^2} = 0.005, |L(Q) - f(Q)|/|PQ| \approx 0.0024.$$

$$36. (a) f(P) = \ln 2, f_x(P) = 1, f_y(P) = 1/2, L(x, y) = \ln 2 + (x - 1) + \frac{1}{2}(y - 2).$$

$$(b) L(Q) - f(Q) = \ln 2 + 0.01 + (1/2)(0.02) - \ln 2.0402 \approx 0.0000993383, |PQ| = \sqrt{0.01^2 + 0.02^2} \approx 0.02236067978, |L(Q) - f(Q)|/|PQ| \approx 0.0044425.$$

$$37. (a) f(P) = 6, f_x(P) = 6, f_y(P) = 3, f_z(P) = 2, L(x, y, z) = 6 + 6(x - 1) + 3(y - 2) + 2(z - 3).$$

$$(b) L(Q) - f(Q) = 6 + 6(0.001) + 3(0.002) + 2(0.003) - 6.018018006 = -0.000018006, |PQ| = \sqrt{0.001^2 + 0.002^2 + 0.003^2} \approx 0.003741657387, |L(Q) - f(Q)|/|PQ| \approx -0.000481.$$

$$38. (a) f(P) = 0, f_x(P) = 1/2, f_y(P) = 1/2, f_z(P) = 0, L(x, y) = \frac{1}{2}(x + 1) + \frac{1}{2}(y - 1).$$

$$(b) L(Q) - f(Q) = 0, |L(Q) - f(Q)|/|PQ| = 0.$$

$$39. (a) f(P) = e, f_x(P) = e, f_y(P) = -e, f_z(P) = -e, L(x, y, z) = e + e(x - 1) - e(y + 1) - e(z + 1).$$

$$(b) L(Q) - f(Q) = e - 0.01e + 0.01e - 0.01e - 0.99e^{0.9999} = 0.99(e - e^{0.9999}), |PQ| = \sqrt{0.01^2 + 0.01^2 + 0.01^2} \approx 0.01732, |L(Q) - f(Q)|/|PQ| \approx 0.01554.$$

$$40. (a) f(P) = 0, f_x(P) = 1, f_y(P) = -1, f_z(P) = 1, L(x, y, z) = (x - 2) - (y - 1) + (z + 1).$$

$$(b) L(Q) - f(Q) = 0.02 + 0.03 - 0.01 - \ln 1.0403 \approx 0.00049086691, |PQ| = \sqrt{0.02^2 + 0.03^2 + 0.01^2} \approx 0.03742, |L(Q) - f(Q)|/|PQ| \approx 0.01312.$$

$$41. (a) \text{ Let } f(x, y) = e^x \sin y; f(0, 0) = 0, f_x(0, 0) = 0, f_y(0, 0) = 1, \text{ so } e^x \sin y \approx y.$$

$$(b) \text{ Let } f(x, y) = \frac{2x + 1}{y + 1}; f(0, 0) = 1, f_x(0, 0) = 2, f_y(0, 0) = -1, \text{ so } \frac{2x + 1}{y + 1} \approx 1 + 2x - y.$$

$$42. f(1, 1) = 1, f_x(x, y) = \alpha x^{\alpha-1} y^\beta, f_x(1, 1) = \alpha, f_y(x, y) = \beta x^\alpha y^{\beta-1}, f_y(1, 1) = \beta, \text{ so } x^\alpha y^\beta \approx 1 + \alpha(x - 1) + \beta(y - 1).$$

$$43. (a) \text{ Let } f(x, y, z) = xyz + 2, \text{ then } f_x = f_y = f_z = 1 \text{ at } x = y = z = 1, \text{ and } L(x, y, z) = f(1, 1, 1) + f_x(x - 1) + f_y(y - 1) + f_z(z - 1) = 3 + x - 1 + y - 1 + z - 1 = x + y + z.$$

$$(b) \text{ Let } f(x, y, z) = \frac{4x}{y + z}, \text{ then } f_x = 2, f_y = -1, f_z = -1 \text{ at } x = y = z = 1, \text{ and } L(x, y, z) = f(1, 1, 1) + f_x(x - 1) + f_y(y - 1) + f_z(z - 1) = 2 + 2(x - 1) - (y - 1) - (z - 1) = 2x - y - z + 2.$$

$$44. \text{ Let } f(x, y, z) = x^\alpha y^\beta z^\gamma, \text{ then } f_x = \alpha, f_y = \beta, f_z = \gamma \text{ at } x = y = z = 1, \text{ and } f(x, y, z) \approx f(1, 1, 1) + f_x(x - 1) + f_y(y - 1) + f_z(z - 1) = 1 + \alpha(x - 1) + \beta(y - 1) + \gamma(z - 1).$$

45. $L(x, y) = f(1, 1) + f_x(1, 1)(x - 1) + f_y(1, 1)(y - 1)$ and $L(1.1, 0.9) = 3.15 = 3 + 2(0.1) + f_y(1, 1)(-0.1)$ so $f_y(1, 1) = -0.05/(-0.1) = 0.5$.
46. $L(x, y) = 3 + f_x(0, -1)x - 2(y + 1)$, $3.3 = 3 + f_x(0, -1)(0.1) - 2(-0.1)$, so $f_x(0, -1) = 0.1/0.1 = 1$.
47. $x - y + 2z - 2 = L(x, y, z) = f(3, 2, 1) + f_x(3, 2, 1)(x - 3) + f_y(3, 2, 1)(y - 2) + f_z(3, 2, 1)(z - 1)$, so $f_x(3, 2, 1) = 1$, $f_y(3, 2, 1) = -1$, $f_z(3, 2, 1) = 2$ and $f(3, 2, 1) = L(3, 2, 1) = 1$.
48. $L(x, y, z) = x + 2y + 3z + 4 = (x - 0) + 2(y + 1) + 3(z + 2) - 4$, $f(0, -1, -2) = -4$, $f_x(0, -1, -2) = 1$, $f_y(0, -1, -2) = 2$, $f_z(0, -1, -2) = 3$.
49. $L(x, y) = f(x_0, y_0) + f_x(x_0, y_0)(x - x_0) + f_y(x_0, y_0)(y - y_0)$, $2y - 2x - 2 = x_0^2 + y_0^2 + 2x_0(x - x_0) + 2y_0(y - y_0)$, from which it follows that $x_0 = -1$, $y_0 = 1$.
50. $f(x, y) = x^2y$, so $f_x(x_0, y_0) = 2x_0y_0$, $f_y(x_0, y_0) = x_0^2$, and $L(x, y) = f(x_0, y_0) + 2x_0y_0(x - x_0) + x_0^2(y - y_0)$. But $L(x, y) = 8 - 4x + 4y$, hence $-4 = 2x_0y_0$, $4 = x_0^2$ and $8 = f(x_0, y_0) - 2x_0^2y_0 - x_0^2y_0 = -2x_0^2y_0$. Thus either $x_0 = -2$, $y_0 = 1$ from which it follows that $8 = -8$, a contradiction, or $x_0 = 2$, $y_0 = -1$, which is a solution since then $8 = -2x_0^2y_0 = 8$ is true.
51. $L(x, y, z) = f(x_0, y_0, z_0) + f_x(x_0, y_0, z_0)(x - x_0) + f_y(x_0, y_0, z_0)(y - y_0) + f_z(x_0, y_0, z_0)(z - z_0)$, $y + 2z - 1 = x_0y_0 + z_0^2 + y_0(x - x_0) + x_0(y - y_0) + 2z_0(z - z_0)$, so that $x_0 = 1$, $y_0 = 0$, $z_0 = 1$.
52. $L(x, y, z) = f(x_0, y_0, z_0) + f_x(x_0, y_0, z_0)(x - x_0) + f_y(x_0, y_0, z_0)(y - y_0) + f_z(x_0, y_0, z_0)(z - z_0)$. Then $x - y - z - 2 = x_0y_0z_0 + y_0z_0(x - x_0) + x_0z_0(y - y_0) + x_0y_0(z - z_0)$, hence $y_0z_0 = 1$, $x_0z_0 = -1$, $x_0y_0 = -1$, and $-2 = x_0y_0z_0 - 3x_0y_0z_0$, or $x_0y_0z_0 = 1$. Since now $x_0 = -y_0 = -z_0$, we must have $|x_0| = |y_0| = |z_0| = 1$ or else $|x_0y_0z_0| \neq 1$, impossible. Thus $x_0 = 1$, $y_0 = z_0 = -1$ (note that $(-1, 1, 1)$ is not a solution).
53. $A = xy$, $dA = ydx + xdy$, $dA/A = dx/x + dy/y$, $|dx/x| \leq 0.03$ and $|dy/y| \leq 0.05$, $|dA/A| \leq |dx/x| + |dy/y| \leq 0.08 = 8\%$.
54. $V = (1/3)\pi r^2 h$, $dV = (2/3)\pi r h dr + (1/3)\pi r^2 dh$, $dV/V = 2(dr/r) + dh/h$, $|dr/r| \leq 0.01$ and $|dh/h| \leq 0.04$, $|dV/V| \leq 2|dr/r| + |dh/h| \leq 0.06 = 6\%$.
55. $z = \sqrt{x^2 + y^2}$, $dz = \frac{x}{\sqrt{x^2 + y^2}}dx + \frac{y}{\sqrt{x^2 + y^2}}dy$, $\frac{dz}{z} = \frac{x}{x^2 + y^2}dx + \frac{y}{x^2 + y^2}dy = \frac{x^2}{x^2 + y^2} \left(\frac{dx}{x}\right) + \frac{y^2}{x^2 + y^2} \left(\frac{dy}{y}\right)$, $\left|\frac{dz}{z}\right| \leq \frac{x^2}{x^2 + y^2} \left|\frac{dx}{x}\right| + \frac{y^2}{x^2 + y^2} \left|\frac{dy}{y}\right|$, if $\left|\frac{dx}{x}\right| \leq r/100$ and $\left|\frac{dy}{y}\right| \leq r/100$, then $\left|\frac{dz}{z}\right| \leq \frac{x^2}{x^2 + y^2}(r/100) + \frac{y^2}{x^2 + y^2}(r/100) = \frac{r}{100}$ so the percentage error in z is at most about $r\%$.
56. (a) $z = \sqrt{x^2 + y^2}$, $dz = x(x^2 + y^2)^{-1/2} dx + y(x^2 + y^2)^{-1/2} dy$, $|dz| \leq x(x^2 + y^2)^{-1/2} |dx| + y(x^2 + y^2)^{-1/2} |dy|$; if $x = 3$, $y = 4$, $|dx| \leq 0.05$, and $|dy| \leq 0.05$ then $|dz| \leq (3/5)(0.05) + (4/5)(0.05) = 0.07$ cm.
- (b) $A = (1/2)xy$, $dA = (1/2)ydx + (1/2)x dy$, $|dA| \leq (1/2)y|dx| + (1/2)x|dy| \leq 2(0.05) + (3/2)(0.05) = 0.175$ cm².
57. $dT = \frac{\pi}{g\sqrt{L/g}}dL - \frac{\pi L}{g^2\sqrt{L/g}}dg$, $\frac{dT}{T} = \frac{1}{2} \frac{dL}{L} - \frac{1}{2} \frac{dg}{g}$; $|dL/L| \leq 0.005$ and $|dg/g| \leq 0.001$ so $|dT/T| \leq (1/2)(0.005) + (1/2)(0.001) = 0.003 = 0.3\%$.
58. $dP = (k/V)dT - (kT/V^2)dV$, $dP/P = dT/T - dV/V$; if $dT/T = 0.03$ and $dV/V = 0.05$ then $dP/P = -0.02$ so there is about a 2% decrease in pressure.
59. (a) $\left|\frac{d(xy)}{xy}\right| = \left|\frac{y dx + x dy}{xy}\right| = \left|\frac{dx}{x} + \frac{dy}{y}\right| \leq \left|\frac{dx}{x}\right| + \left|\frac{dy}{y}\right| \leq \frac{r}{100} + \frac{s}{100}$; $(r + s)\%$.

(b) $\left| \frac{d(x/y)}{x/y} \right| = \left| \frac{y dx - x dy}{xy} \right| = \left| \frac{dx}{x} - \frac{dy}{y} \right| \leq \left| \frac{dx}{x} \right| + \left| \frac{dy}{y} \right| \leq \frac{r}{100} + \frac{s}{100}; (r + s)\%.$

(c) $\left| \frac{d(x^2y^3)}{x^2y^3} \right| = \left| \frac{2xy^3 dx + 3x^2y^2 dy}{x^2y^3} \right| = \left| 2 \frac{dx}{x} + 3 \frac{dy}{y} \right| \leq 2 \left| \frac{dx}{x} \right| + 3 \left| \frac{dy}{y} \right| \leq 2 \frac{r}{100} + 3 \frac{s}{100}; (2r + 3s)\%.$

(d) $\left| \frac{d(x^3y^{1/2})}{x^3y^{1/2}} \right| = \left| \frac{3x^2y^{1/2} dx + (1/2)x^3y^{-1/2} dy}{x^3y^{1/2}} \right| = \left| 3 \frac{dx}{x} + \frac{1}{2} \frac{dy}{y} \right| \leq 3 \left| \frac{dx}{x} \right| + \frac{1}{2} \left| \frac{dy}{y} \right| \leq 3 \frac{r}{100} + \frac{1}{2} \frac{s}{100}; (3r + \frac{1}{2}s)\%.$

60. $R = 1/(1/R_1 + 1/R_2 + 1/R_3)$, $\partial R/\partial R_1 = \frac{1}{R_1^2(1/R_1 + 1/R_2 + 1/R_3)^2} = R^2/R_1^2$, similarly $\partial R/\partial R_2 = R^2/R_2^2$ and $\partial R/\partial R_3 = R^2/R_3^2$ so $\frac{dR}{R} = (R/R_1) \frac{dR_1}{R_1} + (R/R_2) \frac{dR_2}{R_2} + (R/R_3) \frac{dR_3}{R_3}$, $\left| \frac{dR}{R} \right| \leq (R/R_1) \left| \frac{dR_1}{R_1} \right| + (R/R_2) \left| \frac{dR_2}{R_2} \right| + (R/R_3) \left| \frac{dR_3}{R_3} \right| \leq (R/R_1)(0.10) + (R/R_2)(0.10) + (R/R_3)(0.10) = R(1/R_1 + 1/R_2 + 1/R_3)(0.10) = (1)(0.10) = 0.10 = 10\%.$

61. $dA = \frac{1}{2}b \sin \theta da + \frac{1}{2}a \sin \theta db + \frac{1}{2}ab \cos \theta d\theta$, $|dA| \leq \frac{1}{2}b \sin \theta |da| + \frac{1}{2}a \sin \theta |db| + \frac{1}{2}ab \cos \theta |d\theta| \leq \frac{1}{2}(50)(1/2)(1/2) + \frac{1}{2}(40)(1/2)(1/4) + \frac{1}{2}(40)(50) \left(\frac{\sqrt{3}}{2} \right) (\pi/90) = 35/4 + 50\pi\sqrt{3}/9 \approx 39 \text{ ft}^2.$

62. $V = \ell wh$, $dV = whd\ell + \ell hdw + \ell wd h$, $|dV/V| \leq |d\ell/\ell| + |dw/w| + |dh/h| \leq 3(r/100) = 3r\%.$

63. $f_x = 2x \sin y$, $f_y = x^2 \cos y$ are both continuous everywhere, so f is differentiable everywhere.

64. $f_x = y \sin z$, $f_y = x \sin z$, $f_z = xy \cos z$ are all continuous everywhere, so f is differentiable everywhere.

65. That f is differentiable means that $\lim_{(x,y) \rightarrow (x_0,y_0)} \frac{E_f(x,y)}{\sqrt{(x-x_0)^2 + (y-y_0)^2}} = 0$, where $E_f(x,y) = f(x,y) - L_f(x,y)$; here $L_f(x,y)$ is the linear approximation to f at (x_0,y_0) . Let f_x and f_y denote $f_x(x_0,y_0)$, $f_y(x_0,y_0)$ respectively. Then $g(x,y,z) = z - f(x,y)$, $L_f(x,y) = f(x_0,y_0) + f_x(x-x_0) + f_y(y-y_0)$, $L_g(x,y,z) = g(x_0,y_0,z_0) + g_x(x-x_0) + g_y(y-y_0) + g_z(z-z_0) = 0 - f_x(x-x_0) - f_y(y-y_0) + (z-z_0)$, and $E_g(x,y,z) = g(x,y,z) - L_g(x,y,z) = (z-f(x,y)) + f_x(x-x_0) + f_y(y-y_0) - (z-z_0) = f(x_0,y_0) + f_x(x_0,y_0)(x-x_0) + f_y(x_0,y_0)(y-y_0) - f(x,y) = -E_f(x,y)$. Thus $\frac{|E_g(x,y,z)|}{\sqrt{(x-x_0)^2 + (y-y_0)^2 + (z-z_0)^2}} \leq \frac{|E_f(x,y)|}{\sqrt{(x-x_0)^2 + (y-y_0)^2}}$, so $\lim_{(x,y,z) \rightarrow (x_0,y_0,z_0)} \frac{E_g(x,y,z)}{\sqrt{(x-x_0)^2 + (y-y_0)^2 + (z-z_0)^2}} = 0$ and g is differentiable at (x_0,y_0,z_0) .

66. The condition $\lim_{(\Delta x, \Delta y) \rightarrow (0,0)} \frac{\Delta f - f_x(x_0,y_0)\Delta x - f_y(x_0,y_0)\Delta y}{\sqrt{(\Delta x)^2 + (\Delta y)^2}} = 0$ is equivalent to $\lim_{(\Delta x, \Delta y) \rightarrow (0,0)} \epsilon(\Delta x, \Delta y) = 0$ which is equivalent to ϵ being continuous at $(0,0)$ with $\epsilon(0,0) = 0$. Since ϵ is continuous, f is differentiable.

Exercise Set 13.5

1. $\frac{dz}{dt} = \frac{\partial z}{\partial x} \frac{dx}{dt} + \frac{\partial z}{\partial y} \frac{dy}{dt} = 42t^{13}.$
2. $\frac{dz}{dt} = \frac{\partial z}{\partial x} \frac{dx}{dt} + \frac{\partial z}{\partial y} \frac{dy}{dt} = \frac{2(3 + t^{-1/3})}{3(2t + t^{2/3})}.$
3. $\frac{dz}{dt} = \frac{\partial z}{\partial x} \frac{dx}{dt} + \frac{\partial z}{\partial y} \frac{dy}{dt} = 3t^{-2} \sin(1/t).$

4. $\frac{dz}{dt} = \frac{\partial z}{\partial x} \frac{dx}{dt} + \frac{\partial z}{\partial y} \frac{dy}{dt} = \frac{1 - 2t^4 - 8t^4 \ln t}{2t\sqrt{1 + \ln t} - 2t^4 \ln t}.$
5. $\frac{dz}{dt} = \frac{\partial z}{\partial x} \frac{dx}{dt} + \frac{\partial z}{\partial y} \frac{dy}{dt} = -\frac{10}{3} t^{7/3} e^{1-t^{10/3}}.$
6. $\frac{dz}{dt} = \frac{\partial z}{\partial x} \frac{dx}{dt} + \frac{\partial z}{\partial y} \frac{dy}{dt} = (1 + t)e^t \cosh(te^t/2) \sinh(te^t/2).$
7. $\frac{dw}{dt} = \frac{\partial w}{\partial x} \frac{dx}{dt} + \frac{\partial w}{\partial y} \frac{dy}{dt} + \frac{\partial w}{\partial z} \frac{dz}{dt} = 165t^{32}.$
8. $\frac{dw}{dt} = \frac{\partial w}{\partial x} \frac{dx}{dt} + \frac{\partial w}{\partial y} \frac{dy}{dt} + \frac{\partial w}{\partial z} \frac{dz}{dt} = \frac{3 - (4/3)t^{-1/3} - 24t^{-7}}{3t - 2t^{2/3} + 4t^{-6}}.$
9. $\frac{dw}{dt} = \frac{\partial w}{\partial x} \frac{dx}{dt} + \frac{\partial w}{\partial y} \frac{dy}{dt} + \frac{\partial w}{\partial z} \frac{dz}{dt} = -2t \cos(t^2).$
10. $\frac{dw}{dt} = \frac{\partial w}{\partial x} \frac{dx}{dt} + \frac{\partial w}{\partial y} \frac{dy}{dt} + \frac{\partial w}{\partial z} \frac{dz}{dt} = \frac{1 - 512t^5 - 2560t^5 \ln t}{2t\sqrt{1 + \ln t} - 512t^5 \ln t}.$
11. $\frac{dw}{dt} = \frac{\partial w}{\partial x} \frac{dx}{dt} + \frac{\partial w}{\partial y} \frac{dy}{dt} + \frac{\partial w}{\partial z} \frac{dz}{dt} = 3264.$
12. $\frac{dw}{dt} = \frac{\partial w}{\partial x} \frac{dx}{dt} + \frac{\partial w}{\partial y} \frac{dy}{dt} + \frac{\partial w}{\partial z} \frac{dz}{dt} = 0.$
13. $\frac{dz}{dt} = \frac{\partial z}{\partial x} \frac{dx}{dt} + \frac{\partial z}{\partial y} \frac{dy}{dt} = 3(2t)_{t=2} - (3t^2)_{t=2} = 12 - 12 = 0.$
14. $\frac{dw}{dt} = \frac{\partial w}{\partial x} \frac{dx}{dt} + \frac{\partial w}{\partial y} \frac{dy}{dt} + \frac{\partial w}{\partial z} \frac{dz}{dt} = 1 + 2(\pi \cos \pi t)_{t=1} + 3(2t)_{t=1} = 1 - 2\pi + 6 = 7 - 2\pi.$
15. Let $z = xy$, and let $x = f(t)$ and $y = g(t)$. Then $z = f(t)g(t)$ and $(f(t)g(t))' = \frac{dz}{dt} = \frac{\partial z}{\partial x} \frac{dx}{dt} + \frac{\partial z}{\partial y} \frac{dy}{dt} = y \frac{dx}{dt} + x \frac{dy}{dt} = g(t)f'(t) + f(t)g'(t).$
16. Let $z = x^y$, and let $x = t$ and $y = t$. Then $z = t^t$ and $(t^t)' = \frac{dz}{dt} = \frac{\partial z}{\partial x} \frac{dx}{dt} + \frac{\partial z}{\partial y} \frac{dy}{dt} = yx^{y-1} \frac{dx}{dt} + (\ln x) x^y \frac{dy}{dt} = t \cdot t^{t-1} + (\ln t) t^t = t^t + (\ln t) t^t.$
17. $\partial z / \partial u = 24u^2v^2 - 16uv^3 - 2v + 3, \partial z / \partial v = 16u^3v - 24u^2v^2 - 2u - 3.$
18. $\partial z / \partial u = 2u/v^2 - u^2v \sec^2(u/v) - 2uv^2 \tan(u/v), \partial z / \partial v = -2u^2/v^3 + u^3 \sec^2(u/v) - 2u^2v \tan(u/v).$
19. $\partial z / \partial u = -\frac{2 \sin u}{3 \sin v}, \partial z / \partial v = -\frac{2 \cos u \cos v}{3 \sin^2 v}.$
20. $\partial z / \partial u = 3 + 3v/u - 4u, \partial z / \partial v = 2 + 3 \ln u + 2 \ln v.$
21. $\partial z / \partial u = e^u, \partial z / \partial v = 0.$
22. $\partial z / \partial u = -\sin(u - v) \sin(u^2 + v^2) + 2u \cos(u - v) \cos(u^2 + v^2),$
 $\partial z / \partial v = \sin(u - v) \sin(u^2 + v^2) + 2v \cos(u - v) \cos(u^2 + v^2).$

23. $\partial T/\partial r = 3r^2 \sin \theta \cos^2 \theta - 4r^3 \sin^3 \theta \cos \theta$, $\partial T/\partial \theta = -2r^3 \sin^2 \theta \cos \theta + r^4 \sin^4 \theta + r^3 \cos^3 \theta - 3r^4 \sin^2 \theta \cos^2 \theta$.

24. $dR/d\phi = 5e^{5\phi}$.

25. $\partial t/\partial x = (x^2 + y^2)/(4x^2y^3)$, $\partial t/\partial y = (y^2 - 3x^2)/(4xy^4)$.

26. $\partial w/\partial u = \frac{2v^2 [u^2v^2 - (u - 2v)^2]}{[u^2v^2 + (u - 2v)^2]^2}$, $\partial w/\partial v = \frac{u^2 [(u - 2v)^2 - u^2v^2]}{[u^2v^2 + (u - 2v)^2]^2}$.

27. $\partial z/\partial r = (dz/dx)(\partial x/\partial r) = 2r \cos^2 \theta / (r^2 \cos^2 \theta + 1)$, $\partial z/\partial \theta = (dz/dx)(\partial x/\partial \theta) = -2r^2 \sin \theta \cos \theta / (r^2 \cos^2 \theta + 1)$.

28. $\partial u/\partial x = (\partial u/\partial r)(dr/dx) + (\partial u/\partial t)(\partial t/\partial x) = (s^2 \ln t)(2x) + (rs^2/t)(y^3) = x(4y + 1)^2(1 + 2 \ln xy^3)$, $\partial u/\partial y = (\partial u/\partial s)(ds/dy) + (\partial u/\partial t)(\partial t/\partial y) = (2rs \ln t)(4) + (rs^2/t)(3xy^2) = 8x^2(4y + 1) \ln xy^3 + 3x^2(4y + 1)^2/y$.

29. $\partial w/\partial \rho = 2\rho(4 \sin^2 \phi + \cos^2 \phi)$, $\partial w/\partial \phi = 6\rho^2 \sin \phi \cos \phi$, $\partial w/\partial \theta = 0$.

30. $\frac{dw}{dx} = \frac{\partial w}{\partial x} + \frac{\partial w}{\partial y} \frac{dy}{dx} + \frac{\partial w}{\partial z} \frac{dz}{dx} = 3y^2z^3 + (6xyz^3)(6x) + 9xy^2z^2 \frac{1}{2\sqrt{x-1}} = 3(3x^2 + 2)^2(x-1)^{3/2} + 36x^2(3x^2 + 2)(x-1)^{3/2} + \frac{9}{2}x(3x^2 + 2)^2\sqrt{x-1} = \frac{3}{2}(3x^2 + 2)(39x^3 - 30x^2 + 10x - 4)\sqrt{x-1}$.

31. $-\pi$.

32. $351/2, -168$.

33. $\sqrt{3}e^{\sqrt{3}}, (2 - 4\sqrt{3})e^{\sqrt{3}}$.

34. 1161.

35. $A = \frac{1}{2}ab \sin \theta$, so $\frac{dA}{dt} = \frac{\partial A}{\partial a} \frac{da}{dt} + \frac{\partial A}{\partial b} \frac{db}{dt} + \frac{\partial A}{\partial \theta} \frac{d\theta}{dt}$. This gives us $0 = \frac{dA}{dt} = \frac{1}{2}b \sin \theta \frac{da}{dt} + \frac{1}{2}a \sin \theta \frac{db}{dt} + \frac{1}{2}ab \cos \theta \frac{d\theta}{dt}$. From here, $\frac{d\theta}{dt} = -(b \sin \theta \frac{da}{dt} + a \sin \theta \frac{db}{dt}) / (ab \cos \theta)$, and with the given values, $\frac{d\theta}{dt} = -\frac{9\sqrt{3}}{20} \approx -0.779423$ rad/s.

36. $V = IR$, so $\frac{dV}{dt} = \frac{\partial V}{\partial I} \frac{dI}{dt} + \frac{\partial V}{\partial R} \frac{dR}{dt} = R \frac{dI}{dt} + I \frac{dR}{dt}$. We also know that $R = \frac{R_1 R_2}{R_1 + R_2}$, which gives us $\frac{dR}{dt} = \frac{\partial R}{\partial R_1} \frac{dR_1}{dt} + \frac{\partial R}{\partial R_2} \frac{dR_2}{dt} = \frac{R_2^2}{(R_1 + R_2)^2} \frac{dR_1}{dt} + \frac{R_1^2}{(R_1 + R_2)^2} \frac{dR_2}{dt}$. With the given values, we get $\frac{dV}{dt} \approx 0.455$ V/s.

37. False; by themselves they have no meaning.

38. True; this is the chain rule.

39. False; consider $z = xy, x = t, y = t$; then $z = t^2$.

40. True; use the chain rule to differentiate both sides of the equation $f(t, t) = c$.

41. $F(x, y) = x^2y^3 + \cos y$, $\frac{dy}{dx} = -\frac{2xy^3}{3x^2y^2 - \sin y}$.

42. $F(x, y) = x^3 - 3xy^2 + y^3 - 5$, $\frac{dy}{dx} = -\frac{3x^2 - 3y^2}{-6xy + 3y^2} = \frac{x^2 - y^2}{2xy - y^2}$.

43. $F(x, y) = e^{xy} + ye^y - 1$, $\frac{dy}{dx} = -\frac{ye^{xy}}{xe^{xy} + ye^y + e^y}$.

$$44. F(x, y) = x - (xy)^{1/2} + 3y - 4, \quad \frac{dy}{dx} = -\frac{1 - (1/2)(xy)^{-1/2}y}{-(1/2)(xy)^{-1/2}x + 3} = \frac{2\sqrt{xy} - y}{x - 6\sqrt{xy}}.$$

$$45. \frac{\partial z}{\partial x} = \frac{2x + yz}{6yz - xy}, \quad \frac{\partial z}{\partial y} = \frac{xz - 3z^2}{6yz - xy}.$$

$$46. \ln(1 + z) + xy^2 + z - 1 = 0; \quad \frac{\partial z}{\partial x} = -\frac{y^2(1 + z)}{2 + z}, \quad \frac{\partial z}{\partial y} = -\frac{2xy(1 + z)}{2 + z}.$$

$$47. ye^x - 5 \sin 3z - 3z = 0; \quad \frac{\partial z}{\partial x} = -\frac{ye^x}{-15 \cos 3z - 3} = \frac{ye^x}{15 \cos 3z + 3}, \quad \frac{\partial z}{\partial y} = \frac{e^x}{15 \cos 3z + 3}.$$

$$48. \frac{\partial z}{\partial x} = -\frac{ze^{yz} \cos xz - ye^{xy} \cos yz}{ye^{xy} \sin yz + xe^{yz} \cos xz + ye^{yz} \sin xz}, \quad \frac{\partial z}{\partial y} = -\frac{ze^{xy} \sin yz - xe^{xy} \cos yz + ze^{yz} \sin xz}{ye^{xy} \sin yz + xe^{yz} \cos xz + ye^{yz} \sin xz}.$$

$$49. (a) \quad \frac{\partial z}{\partial x} = \frac{dz}{du} \frac{\partial u}{\partial x}, \quad \frac{\partial z}{\partial y} = \frac{dz}{du} \frac{\partial u}{\partial y}.$$

$$(b) \quad \frac{\partial^2 z}{\partial x^2} = \frac{dz}{du} \frac{\partial^2 u}{\partial x^2} + \frac{\partial}{\partial x} \left(\frac{dz}{du} \right) \frac{\partial u}{\partial x} = \frac{dz}{du} \frac{\partial^2 u}{\partial x^2} + \frac{d^2 z}{du^2} \left(\frac{\partial u}{\partial x} \right)^2;$$

$$\frac{\partial^2 z}{\partial y^2} = \frac{dz}{du} \frac{\partial^2 u}{\partial y^2} + \frac{\partial}{\partial y} \left(\frac{dz}{du} \right) \frac{\partial u}{\partial y} = \frac{dz}{du} \frac{\partial^2 u}{\partial y^2} + \frac{d^2 z}{du^2} \left(\frac{\partial u}{\partial y} \right)^2; \quad \frac{\partial^2 z}{\partial y \partial x} = \frac{dz}{du} \frac{\partial^2 u}{\partial y \partial x} + \frac{\partial}{\partial y} \left(\frac{dz}{du} \right) \frac{\partial u}{\partial x} = \frac{dz}{du} \frac{\partial^2 u}{\partial y \partial x} + \frac{d^2 z}{du^2} \frac{\partial u}{\partial x} \frac{\partial u}{\partial y}.$$

$$50. (a) \quad z = f(u), \quad u = x^2 - y^2; \quad \partial z / \partial x = (dz/du)(\partial u / \partial x) = 2xdz/du; \quad \partial z / \partial y = (dz/du)(\partial u / \partial y) = -2ydz/du, \quad y\partial z / \partial x + x\partial z / \partial y = 2xydz/du - 2xydz/du = 0.$$

$$(b) \quad z = f(u), \quad u = xy; \quad \frac{\partial z}{\partial x} = \frac{dz}{du} \frac{\partial u}{\partial x} = y \frac{dz}{du}, \quad \frac{\partial z}{\partial y} = \frac{dz}{du} \frac{\partial u}{\partial y} = x \frac{dz}{du}, \quad x \frac{\partial z}{\partial x} - y \frac{\partial z}{\partial y} = xy \frac{dz}{du} - xy \frac{dz}{du} = 0.$$

$$(c) \quad yz_x + xz_y = y(2x \cos(x^2 - y^2)) - x(2y \cos(x^2 - y^2)) = 0.$$

$$(d) \quad xz_x - yz_y = xye^{xy} - yxe^{xy} = 0.$$

$$51. \text{ Let } z = f(u) \text{ where } u = x + 2y; \text{ then } \partial z / \partial x = (dz/du)(\partial u / \partial x) = dz/du, \quad \partial z / \partial y = (dz/du)(\partial u / \partial y) = 2dz/du \text{ so } 2\partial z / \partial x - \partial z / \partial y = 2dz/du - 2dz/du = 0.$$

$$52. \text{ Let } z = f(u) \text{ where } u = x^2 + y^2; \text{ then } \partial z / \partial x = (dz/du)(\partial u / \partial x) = 2x dz/du, \quad \partial z / \partial y = (dz/du)(\partial u / \partial y) = 2ydz/du \text{ so } y \partial z / \partial x - x \partial z / \partial y = 2xydz/du - 2xydz/du = 0.$$

$$53. \quad \frac{\partial w}{\partial x} = \frac{dw}{du} \frac{\partial u}{\partial x} = \frac{dw}{du}, \quad \frac{\partial w}{\partial y} = \frac{dw}{du} \frac{\partial u}{\partial y} = 2 \frac{dw}{du}, \quad \frac{\partial w}{\partial z} = \frac{dw}{du} \frac{\partial u}{\partial z} = 3 \frac{dw}{du}, \text{ so } \frac{\partial w}{\partial x} + \frac{\partial w}{\partial y} + \frac{\partial w}{\partial z} = 6 \frac{dw}{du}.$$

$$54. \quad \partial w / \partial x = (dw/d\rho)(\partial \rho / \partial x) = (x/\rho)dw/d\rho, \text{ similarly } \partial w / \partial y = (y/\rho)dw/d\rho \text{ and } \partial w / \partial z = (z/\rho)dw/d\rho \text{ so } (\partial w / \partial x)^2 + (\partial w / \partial y)^2 + (\partial w / \partial z)^2 = (dw/d\rho)^2.$$

$$55. \quad z = f(u, v) \text{ where } u = x - y \text{ and } v = y - x, \quad \frac{\partial z}{\partial x} = \frac{\partial z}{\partial u} \frac{\partial u}{\partial x} + \frac{\partial z}{\partial v} \frac{\partial v}{\partial x} = \frac{\partial z}{\partial u} - \frac{\partial z}{\partial v} \text{ and } \frac{\partial z}{\partial y} = \frac{\partial z}{\partial u} \frac{\partial u}{\partial y} + \frac{\partial z}{\partial v} \frac{\partial v}{\partial y} = -\frac{\partial z}{\partial u} + \frac{\partial z}{\partial v} \text{ so } \frac{\partial z}{\partial x} + \frac{\partial z}{\partial y} = 0.$$

$$56. \text{ Let } w = f(r, s, t) \text{ where } r = x - y, \quad s = y - z, \quad t = z - x; \quad \partial w / \partial x = (\partial w / \partial r)(\partial r / \partial x) + (\partial w / \partial t)(\partial t / \partial x) = \partial w / \partial r - \partial w / \partial t, \text{ similarly } \partial w / \partial y = -\partial w / \partial r + \partial w / \partial s \text{ and } \partial w / \partial z = -\partial w / \partial s + \partial w / \partial t \text{ so } \partial w / \partial x + \partial w / \partial y + \partial w / \partial z = 0.$$

$$57. (a) \quad 1 = -r \sin \theta \frac{\partial \theta}{\partial x} + \cos \theta \frac{\partial r}{\partial x} \text{ and } 0 = r \cos \theta \frac{\partial \theta}{\partial x} + \sin \theta \frac{\partial r}{\partial x}; \text{ solve for } \partial r / \partial x \text{ and } \partial \theta / \partial x.$$

(b) $0 = -r \sin \theta \frac{\partial \theta}{\partial y} + \cos \theta \frac{\partial r}{\partial y}$ and $1 = r \cos \theta \frac{\partial \theta}{\partial y} + \sin \theta \frac{\partial r}{\partial y}$; solve for $\partial r / \partial y$ and $\partial \theta / \partial y$.

(c) $\frac{\partial z}{\partial x} = \frac{\partial z}{\partial r} \frac{\partial r}{\partial x} + \frac{\partial z}{\partial \theta} \frac{\partial \theta}{\partial x} = \frac{\partial z}{\partial r} \cos \theta - \frac{1}{r} \frac{\partial z}{\partial \theta} \sin \theta$, $\frac{\partial z}{\partial y} = \frac{\partial z}{\partial r} \frac{\partial r}{\partial y} + \frac{\partial z}{\partial \theta} \frac{\partial \theta}{\partial y} = \frac{\partial z}{\partial r} \sin \theta + \frac{1}{r} \frac{\partial z}{\partial \theta} \cos \theta$.

(d) Square and add the results of parts (a) and (b).

(e) From part (c), $\frac{\partial^2 z}{\partial x^2} = \frac{\partial}{\partial r} \left(\frac{\partial z}{\partial r} \cos \theta - \frac{1}{r} \frac{\partial z}{\partial \theta} \sin \theta \right) \frac{\partial r}{\partial x} + \frac{\partial}{\partial \theta} \left(\frac{\partial z}{\partial r} \cos \theta - \frac{1}{r} \frac{\partial z}{\partial \theta} \sin \theta \right) \frac{\partial \theta}{\partial x} =$
 $= \left(\frac{\partial^2 z}{\partial r^2} \cos \theta + \frac{1}{r^2} \frac{\partial z}{\partial \theta} \sin \theta - \frac{1}{r} \frac{\partial^2 z}{\partial r \partial \theta} \sin \theta \right) \cos \theta + \left(\frac{\partial^2 z}{\partial \theta \partial r} \cos \theta - \frac{\partial z}{\partial r} \sin \theta - \frac{1}{r} \frac{\partial^2 z}{\partial \theta^2} \sin \theta - \frac{1}{r} \frac{\partial z}{\partial \theta} \cos \theta \right) \left(-\frac{\sin \theta}{r} \right) =$
 $\frac{\partial^2 z}{\partial r^2} \cos^2 \theta + \frac{2}{r^2} \frac{\partial z}{\partial \theta} \sin \theta \cos \theta - \frac{2}{r} \frac{\partial^2 z}{\partial \theta \partial r} \sin \theta \cos \theta + \frac{1}{r^2} \frac{\partial^2 z}{\partial \theta^2} \sin^2 \theta + \frac{1}{r} \frac{\partial z}{\partial r} \sin^2 \theta$.

Similarly, from part (c), $\frac{\partial^2 z}{\partial y^2} = \frac{\partial^2 z}{\partial r^2} \sin^2 \theta - \frac{2}{r^2} \frac{\partial z}{\partial \theta} \sin \theta \cos \theta + \frac{2}{r} \frac{\partial^2 z}{\partial \theta \partial r} \sin \theta \cos \theta + \frac{1}{r^2} \frac{\partial^2 z}{\partial \theta^2} \cos^2 \theta + \frac{1}{r} \frac{\partial z}{\partial r} \cos^2 \theta$.

Add these to get $\frac{\partial^2 z}{\partial x^2} + \frac{\partial^2 z}{\partial y^2} = \frac{\partial^2 z}{\partial r^2} + \frac{1}{r^2} \frac{\partial^2 z}{\partial \theta^2} + \frac{1}{r} \frac{\partial z}{\partial r}$.

58. $z_x = \frac{-2y}{x^2 + y^2}$, $z_{xx} = \frac{4xy}{(x^2 + y^2)^2}$, $z_y = \frac{2x}{x^2 + y^2}$, $z_{yy} = -\frac{4xy}{(x^2 + y^2)^2}$, $z_{xx} + z_{yy} = 0$; $z = \tan^{-1} \frac{2r^2 \cos \theta \sin \theta}{r^2(\cos^2 \theta - \sin^2 \theta)} = \tan^{-1} \tan 2\theta = 2\theta + k\pi$ for some fixed k ; $z_r = 0$, $z_{\theta\theta} = 0$.

59. (a) By the chain rule, $\frac{\partial u}{\partial r} = \frac{\partial u}{\partial x} \cos \theta + \frac{\partial u}{\partial y} \sin \theta$ and $\frac{\partial v}{\partial \theta} = -\frac{\partial v}{\partial x} r \sin \theta + \frac{\partial v}{\partial y} r \cos \theta$, use the Cauchy-Riemann conditions $\frac{\partial u}{\partial x} = \frac{\partial v}{\partial y}$ and $\frac{\partial u}{\partial y} = -\frac{\partial v}{\partial x}$ in the equation for $\frac{\partial u}{\partial r}$ to get $\frac{\partial u}{\partial r} = \frac{\partial v}{\partial y} \cos \theta - \frac{\partial v}{\partial x} \sin \theta$ and compare to $\frac{\partial v}{\partial \theta}$ to see that $\frac{\partial u}{\partial r} = \frac{1}{r} \frac{\partial v}{\partial \theta}$. The result $\frac{\partial v}{\partial r} = -\frac{1}{r} \frac{\partial u}{\partial \theta}$ can be obtained by considering $\frac{\partial v}{\partial r}$ and $\frac{\partial u}{\partial \theta}$.

(b) $u_x = \frac{2x}{x^2 + y^2}$, $v_y = 2 \frac{1}{x} \frac{1}{1 + (y/x)^2} = \frac{2x}{x^2 + y^2} = u_x$; $u_y = \frac{2y}{x^2 + y^2}$, $v_x = -2 \frac{y}{x^2} \frac{1}{1 + (y/x)^2} = -\frac{2y}{x^2 + y^2} = -u_y$; $u = \ln r^2$, $v = 2\theta$, $u_r = 2/r$, $v_\theta = 2$, so $u_r = \frac{1}{r} v_\theta$, $u_\theta = 0$, $v_r = 0$, so $v_r = -\frac{1}{r} u_\theta$.

60. (a) $u_x = f'(x + ct)$, $u_{xx} = f''(x + ct)$, $u_t = cf'(x + ct)$, $u_{tt} = c^2 f''(x + ct)$; $u_{tt} = c^2 u_{xx}$.

(b) Substitute g for f and $-c$ for c in part (a).

(c) Since the sum of derivatives equals the derivative of the sum, the result follows from parts (a) and (b).

(d) $\sin t \sin x = \frac{1}{2}(-\cos(x + t) + \cos(x - t))$.

61. $\partial w / \partial \rho = (\sin \phi \cos \theta) \partial w / \partial x + (\sin \phi \sin \theta) \partial w / \partial y + (\cos \phi) \partial w / \partial z$,
 $\partial w / \partial \phi = (\rho \cos \phi \cos \theta) \partial w / \partial x + (\rho \cos \phi \sin \theta) \partial w / \partial y - (\rho \sin \phi) \partial w / \partial z$,
 $\partial w / \partial \theta = -(\rho \sin \phi \sin \theta) \partial w / \partial x + (\rho \sin \phi \cos \theta) \partial w / \partial y$.

62. (a) $\frac{\partial w}{\partial x} = \frac{\partial f}{\partial x} + \frac{\partial f}{\partial z} \frac{\partial z}{\partial x}$. (b) $\frac{\partial w}{\partial y} = \frac{\partial f}{\partial y} + \frac{\partial f}{\partial z} \frac{\partial z}{\partial y}$.

63. $w_r = e^r / (e^r + e^s + e^t + e^u)$, $w_{rs} = -e^r e^s / (e^r + e^s + e^t + e^u)^2$, $w_{rst} = 2e^r e^s e^t / (e^r + e^s + e^t + e^u)^3$, $w_{rstu} = -6e^r e^s e^t e^u / (e^r + e^s + e^t + e^u)^4 = -6e^{r+s+t+u} / e^{4u} = -6e^{r+s+t+u-4u}$.

64. $\partial w / \partial y_1 = a_1 \partial w / \partial x_1 + a_2 \partial w / \partial x_2 + a_3 \partial w / \partial x_3$, $\partial w / \partial y_2 = b_1 \partial w / \partial x_1 + b_2 \partial w / \partial x_2 + b_3 \partial w / \partial x_3$.

65. (a) $dw/dt = \sum_{i=1}^4 (\partial w/\partial x_i)(dx_i/dt)$. (b) $\partial w/\partial v_j = \sum_{i=1}^4 (\partial w/\partial x_i)(\partial x_i/\partial v_j)$ for $j = 1, 2, 3$.
66. Let $u = x_1^2 + x_2^2 + \dots + x_n^2$; then $w = u^k$, $\partial w/\partial x_i = ku^{k-1}(2x_i) = 2k x_i u^{k-1}$, $\partial^2 w/\partial x_i^2 = 2k(k-1)x_i u^{k-2}(2x_i) + 2ku^{k-1} = 4k(k-1)x_i^2 u^{k-2} + 2ku^{k-1}$ for $i = 1, 2, \dots, n$, so $\sum_{i=1}^n \partial^2 w/\partial x_i^2 = 4k(k-1)u^{k-2} \sum_{i=1}^n x_i^2 + 2kn u^{k-1} = 4k(k-1)u^{k-2}u + 2kn u^{k-1} = 2ku^{k-1}[2(k-1) + n]$, which is 0 if $k = 0$ or if $2(k-1) + n = 0$, $k = 1 - n/2$.
67. $dF/dx = (\partial F/\partial u)(du/dx) + (\partial F/\partial v)(dv/dx) = f(u)g'(x) - f(v)h'(x) = f(g(x))g'(x) - f(h(x))h'(x)$.
68. Represent the line segment C that joins A and B by $x = x_0 + (x_1 - x_0)t$, $y = y_0 + (y_1 - y_0)t$ for $0 \leq t \leq 1$. Let $F(t) = f(x_0 + (x_1 - x_0)t, y_0 + (y_1 - y_0)t)$ for $0 \leq t \leq 1$; then $f(x_1, y_1) - f(x_0, y_0) = F(1) - F(0)$. Apply the Mean Value Theorem to $F(t)$ on the interval $[0, 1]$ to get $[F(1) - F(0)]/(1 - 0) = F'(t^*)$, $F(1) - F(0) = F'(t^*)$ for some t^* in $(0, 1)$ so $f(x_1, y_1) - f(x_0, y_0) = F'(t^*)$. By the chain rule, $F'(t) = f_x(x, y)(dx/dt) + f_y(x, y)(dy/dt) = f_x(x, y)(x_1 - x_0) + f_y(x, y)(y_1 - y_0)$. Let (x^*, y^*) be the point on C for $t = t^*$ then $f(x_1, y_1) - f(x_0, y_0) = F'(t^*) = f_x(x^*, y^*)(x_1 - x_0) + f_y(x^*, y^*)(y_1 - y_0)$.
69. Let (a, b) be any point in the region, if (x, y) is in the region then by the result of Exercise 74 $f(x, y) - f(a, b) = f_x(x^*, y^*)(x - a) + f_y(x^*, y^*)(y - b)$, where (x^*, y^*) is on the line segment joining (a, b) and (x, y) . If $f_x(x, y) = f_y(x, y) = 0$ throughout the region then $f(x, y) - f(a, b) = (0)(x - a) + (0)(y - b) = 0$, $f(x, y) = f(a, b)$ so $f(x, y)$ is constant on the region.

Exercise Set 13.6

- $\nabla f(x, y) = (3y/2)(1 + xy)^{1/2}\mathbf{i} + (3x/2)(1 + xy)^{1/2}\mathbf{j}$, $\nabla f(3, 1) = 3\mathbf{i} + 9\mathbf{j}$, $D_{\mathbf{u}}f = \nabla f \cdot \mathbf{u} = 12/\sqrt{2} = 6\sqrt{2}$.
- $\nabla f(x, y) = 5 \cos(5x - 3y)\mathbf{i} - 3 \cos(5x - 3y)\mathbf{j}$, $\nabla f(3, 5) = 5\mathbf{i} - 3\mathbf{j}$, $D_{\mathbf{u}}f = \nabla f \cdot \mathbf{u} = -27/5$.
- $\nabla f(x, y) = [2x/(1 + x^2 + y)]\mathbf{i} + [1/(1 + x^2 + y)]\mathbf{j}$, $\nabla f(0, 0) = \mathbf{j}$, $D_{\mathbf{u}}f = -3/\sqrt{10}$.
- $\nabla f(x, y) = -[(c + d)y/(x - y)^2]\mathbf{i} + [(c + d)x/(x - y)^2]\mathbf{j}$, $\nabla f(3, 4) = -4(c + d)\mathbf{i} + 3(c + d)\mathbf{j}$, $D_{\mathbf{u}}f = -(7/5)(c + d)$.
- $\nabla f(x, y, z) = 20x^4y^2z^3\mathbf{i} + 8x^5yz^3\mathbf{j} + 12x^5y^2z^2\mathbf{k}$, $\nabla f(2, -1, 1) = 320\mathbf{i} - 256\mathbf{j} + 384\mathbf{k}$, $D_{\mathbf{u}}f = -320$.
- $\nabla f(x, y, z) = yze^{xz}\mathbf{i} + e^{xz}\mathbf{j} + (xye^{xz} + 2z)\mathbf{k}$, $\nabla f(0, 2, 3) = 6\mathbf{i} + \mathbf{j} + 6\mathbf{k}$, $D_{\mathbf{u}}f = 45/7$.
- $\nabla f(x, y, z) = \frac{2x}{x^2 + 2y^2 + 3z^2}\mathbf{i} + \frac{4y}{x^2 + 2y^2 + 3z^2}\mathbf{j} + \frac{6z}{x^2 + 2y^2 + 3z^2}\mathbf{k}$, $\nabla f(-1, 2, 4) = (-2/57)\mathbf{i} + (8/57)\mathbf{j} + (24/57)\mathbf{k}$, $D_{\mathbf{u}}f = -314/741$.
- $\nabla f(x, y, z) = yz \cos xyz\mathbf{i} + xz \cos xyz\mathbf{j} + xy \cos xyz\mathbf{k}$, $\nabla f(1/2, 1/3, \pi) = (\pi\sqrt{3}/6)\mathbf{i} + (\pi\sqrt{3}/4)\mathbf{j} + (\sqrt{3}/12)\mathbf{k}$, $D_{\mathbf{u}}f = (1 - \pi)/12$.
- $\nabla f(x, y) = 12x^2y^2\mathbf{i} + 8x^3y\mathbf{j}$, $\nabla f(2, 1) = 48\mathbf{i} + 64\mathbf{j}$, $\mathbf{u} = (4/5)\mathbf{i} - (3/5)\mathbf{j}$, $D_{\mathbf{u}}f = \nabla f \cdot \mathbf{u} = 0$.
- $\nabla f(x, y) = 27x^2\mathbf{i} - 6y^2\mathbf{j}$, $\nabla f(1, 0) = 27\mathbf{i}$, $\mathbf{u} = (1/\sqrt{2})\mathbf{i} + (1/\sqrt{2})\mathbf{j}$, $D_{\mathbf{u}}f = \nabla f \cdot \mathbf{u} = 27/\sqrt{2}$.
- $\nabla f(x, y) = (y^2/x)\mathbf{i} + 2y \ln x\mathbf{j}$, $\nabla f(1, 4) = 16\mathbf{i}$, $\mathbf{u} = (-\mathbf{i} + \mathbf{j})/\sqrt{2}$, $D_{\mathbf{u}}f = -8\sqrt{2}$.
- $\nabla f(x, y) = e^x \cos y\mathbf{i} - e^x \sin y\mathbf{j}$, $\nabla f(0, \pi/4) = (\mathbf{i} - \mathbf{j})/\sqrt{2}$, $\mathbf{u} = (5\mathbf{i} - 2\mathbf{j})/\sqrt{29}$, $D_{\mathbf{u}}f = 7/\sqrt{58}$.
- $\nabla f(x, y) = -[y/(x^2 + y^2)]\mathbf{i} + [x/(x^2 + y^2)]\mathbf{j}$, $\nabla f(-2, 2) = -(\mathbf{i} + \mathbf{j})/4$, $\mathbf{u} = -(\mathbf{i} + \mathbf{j})/\sqrt{2}$, $D_{\mathbf{u}}f = \sqrt{2}/4$.
- $\nabla f(x, y) = (e^y - ye^x)\mathbf{i} + (xe^y - e^x)\mathbf{j}$, $\nabla f(0, 0) = \mathbf{i} - \mathbf{j}$, $\mathbf{u} = (5\mathbf{i} - 2\mathbf{j})/\sqrt{29}$, $D_{\mathbf{u}}f = 7/\sqrt{29}$.

15. $\nabla f(x, y, z) = y\mathbf{i} + x\mathbf{j} + 2z\mathbf{k}$, $\nabla f(-3, 0, 4) = -3\mathbf{j} + 8\mathbf{k}$, $\mathbf{u} = (\mathbf{i} + \mathbf{j} + \mathbf{k})/\sqrt{3}$, $D_{\mathbf{u}}f = 5/\sqrt{3}$.
16. $\nabla f(x, y, z) = -x(x^2 + z^2)^{-1/2}\mathbf{i} + \mathbf{j} - z(x^2 + z^2)^{-1/2}\mathbf{k}$, $\nabla f(-3, 1, 4) = (3/5)\mathbf{i} + \mathbf{j} - (4/5)\mathbf{k}$, $\mathbf{u} = (2\mathbf{i} - 2\mathbf{j} - \mathbf{k})/3$, $D_{\mathbf{u}}f = 0$.
17. $\nabla f(x, y, z) = -\frac{1}{z+y}\mathbf{i} - \frac{z-x}{(z+y)^2}\mathbf{j} + \frac{y+x}{(z+y)^2}\mathbf{k}$, $\nabla f(1, 0, -3) = (1/3)\mathbf{i} + (4/9)\mathbf{j} + (1/9)\mathbf{k}$, $\mathbf{u} = (-6\mathbf{i} + 3\mathbf{j} - 2\mathbf{k})/7$, $D_{\mathbf{u}}f = -8/63$.
18. $\nabla f(x, y, z) = e^{x+y+3z}(\mathbf{i} + \mathbf{j} + 3\mathbf{k})$, $\nabla f(-2, 2, -1) = e^{-3}(\mathbf{i} + \mathbf{j} + 3\mathbf{k})$, $\mathbf{u} = (20\mathbf{i} - 4\mathbf{j} + 5\mathbf{k})/21$, $D_{\mathbf{u}}f = (31/21)e^{-3}$.
19. $\nabla f(x, y) = (y/2)(xy)^{-1/2}\mathbf{i} + (x/2)(xy)^{-1/2}\mathbf{j}$, $\nabla f(1, 4) = \mathbf{i} + (1/4)\mathbf{j}$, $\mathbf{u} = \cos\theta\mathbf{i} + \sin\theta\mathbf{j} = (1/2)\mathbf{i} + (\sqrt{3}/2)\mathbf{j}$, $D_{\mathbf{u}}f = 1/2 + \sqrt{3}/8$.
20. $\nabla f(x, y) = [2y/(x+y)^2]\mathbf{i} - [2x/(x+y)^2]\mathbf{j}$, $\nabla f(-1, -2) = -(4/9)\mathbf{i} + (2/9)\mathbf{j}$, $\mathbf{u} = \mathbf{j}$, $D_{\mathbf{u}}f = 2/9$.
21. $\nabla f(x, y) = 2\sec^2(2x+y)\mathbf{i} + \sec^2(2x+y)\mathbf{j}$, $\nabla f(\pi/6, \pi/3) = 8\mathbf{i} + 4\mathbf{j}$, $\mathbf{u} = (\mathbf{i} - \mathbf{j})/\sqrt{2}$, $D_{\mathbf{u}}f = 2\sqrt{2}$.
22. $\nabla f(x, y) = \cosh x \cosh y\mathbf{i} + \sinh x \sinh y\mathbf{j}$, $\nabla f(0, 0) = \mathbf{i}$, $\mathbf{u} = -\mathbf{i}$, $D_{\mathbf{u}}f = -1$.
23. $\nabla f(x, y) = y(x+y)^{-2}\mathbf{i} - x(x+y)^{-2}\mathbf{j}$, $\nabla f(1, 0) = -\mathbf{j}$, $\vec{PQ} = -2\mathbf{i} - \mathbf{j}$, $\mathbf{u} = (-2\mathbf{i} - \mathbf{j})/\sqrt{5}$, $D_{\mathbf{u}}f = 1/\sqrt{5}$.
24. $\nabla f(x, y) = -e^{-x} \sec y\mathbf{i} + e^{-x} \sec y \tan y\mathbf{j}$, $\nabla f(0, \pi/4) = \sqrt{2}(-\mathbf{i} + \mathbf{j})$, $\vec{PO} = -(\pi/4)\mathbf{j}$, $\mathbf{u} = -\mathbf{j}$, $D_{\mathbf{u}}f = -\sqrt{2}$.
25. $\nabla f(x, y) = \frac{ye^y}{2\sqrt{xy}}\mathbf{i} + \left(\sqrt{xy}e^y + \frac{xe^y}{2\sqrt{xy}}\right)\mathbf{j}$, $\nabla f(1, 1) = (e/2)(\mathbf{i} + 3\mathbf{j})$, $\mathbf{u} = -\mathbf{j}$, $D_{\mathbf{u}}f = -3e/2$.
26. $\nabla f(x, y) = -y(x+y)^{-2}\mathbf{i} + x(x+y)^{-2}\mathbf{j}$, $\nabla f(2, 3) = (-3\mathbf{i} + 2\mathbf{j})/25$, if $D_{\mathbf{u}}f = 0$ then \mathbf{u} and ∇f are orthogonal, by inspection $2\mathbf{i} + 3\mathbf{j}$ is orthogonal to $\nabla f(2, 3)$ so $\mathbf{u} = \pm(2\mathbf{i} + 3\mathbf{j})/\sqrt{13}$.
27. $\nabla f(2, 1, -1) = -\mathbf{i} + \mathbf{j} - \mathbf{k}$, $\vec{PQ} = -3\mathbf{i} + \mathbf{j} + \mathbf{k}$, $\mathbf{u} = (-3\mathbf{i} + \mathbf{j} + \mathbf{k})/\sqrt{11}$, $D_{\mathbf{u}}f = 3/\sqrt{11}$.
28. $\nabla f(-1, -2, 1) = 13\mathbf{i} + 5\mathbf{j} - 20\mathbf{k}$, $\mathbf{u} = -\mathbf{k}$, $D_{\mathbf{u}}f = 20$.
29. Solve the system $(3/5)f_x(1, 2) - (4/5)f_y(1, 2) = -5$, $(4/5)f_x(1, 2) + (3/5)f_y(1, 2) = 10$ for
 (a) $f_x(1, 2) = 5$. (b) $f_y(1, 2) = 10$. (c) $\nabla f(1, 2) = 5\mathbf{i} + 10\mathbf{j}$, $\mathbf{u} = (-\mathbf{i} - 2\mathbf{j})/\sqrt{5}$, $D_{\mathbf{u}}f = -5\sqrt{5}$.
30. $\nabla f(-5, 1) = -3\mathbf{i} + 2\mathbf{j}$, $\vec{PQ} = \mathbf{i} + 2\mathbf{j}$, $\mathbf{u} = (\mathbf{i} + 2\mathbf{j})/\sqrt{5}$, $D_{\mathbf{u}}f = 1/\sqrt{5}$.
31. f increases the most in the direction of III.
32. The contour lines are closer at P , so the function is increasing more rapidly there, hence ∇f is larger at P .
33. $\nabla z = -7y \cos(7y^2 - 7xy)\mathbf{i} + (14y - 7x) \cos(7y^2 - 7xy)\mathbf{j}$.
34. $\nabla z = (42/y) \cos(6x/y)\mathbf{i} - (42x/y^2) \cos(6x/y)\mathbf{j}$.
35. $\nabla z = -\frac{84y}{(6x-7y)^2}\mathbf{i} + \frac{84x}{(6x-7y)^2}\mathbf{j}$.
36. $\nabla z = \frac{48ye^{3y}}{(x+8y)^2}\mathbf{i} + \frac{6xe^{3y}(3x+24y-8)}{(x+8y)^2}\mathbf{j}$.

37. $\nabla w = -9x^8\mathbf{i} - 3y^2\mathbf{j} + 12z^{11}\mathbf{k}$.

38. $\nabla w = e^{8y} \sin 6z\mathbf{i} + 8xe^{8y} \sin 6z\mathbf{j} + 6xe^{8y} \cos 6z\mathbf{k}$.

39. $\nabla w = \frac{x}{x^2 + y^2 + z^2}\mathbf{i} + \frac{y}{x^2 + y^2 + z^2}\mathbf{j} + \frac{z}{x^2 + y^2 + z^2}\mathbf{k}$.

40. $\nabla w = e^{-5x} \sec(x^2yz) [(2xyz \tan(x^2yz) - 5)\mathbf{i} + x^2z \tan(x^2yz)\mathbf{j} + x^2y \tan(x^2yz)\mathbf{k}]$.

41. $\nabla f(x, y) = 10x\mathbf{i} + 4y^3\mathbf{j}$, $\nabla f(4, 2) = 40\mathbf{i} + 32\mathbf{j}$.

42. $\nabla f(x, y) = 10x \cos(x^2)\mathbf{i} - 3 \sin 3y\mathbf{j}$, $\nabla f(\sqrt{\pi}/2, 0) = 5\sqrt{\pi/2}\mathbf{i}$.

43. $\nabla f(x, y) = 3(2x + y)(x^2 + xy)^2\mathbf{i} + 3x(x^2 + xy)^2\mathbf{j}$, $\nabla f(-1, -1) = -36\mathbf{i} - 12\mathbf{j}$.

44. $\nabla f(x, y) = -x(x^2 + y^2)^{-3/2}\mathbf{i} - y(x^2 + y^2)^{-3/2}\mathbf{j}$, $\nabla f(3, 4) = -(3/125)\mathbf{i} - (4/125)\mathbf{j}$.

45. $\nabla f(x, y, z) = [y/(x + y + z)]\mathbf{i} + [y/(x + y + z) + \ln(x + y + z)]\mathbf{j} + [y/(x + y + z)]\mathbf{k}$, $\nabla f(-3, 4, 0) = 4\mathbf{i} + 4\mathbf{j} + 4\mathbf{k}$.

46. $\nabla f(x, y, z) = 3y^2z \tan^2 x \sec^2 x\mathbf{i} + 2yz \tan^3 x\mathbf{j} + y^2 \tan^3 x\mathbf{k}$, $\nabla f(\pi/4, -3) = 54\mathbf{i} - 6\mathbf{j} + 9\mathbf{k}$.

47. $f(1, 2) = 3$, level curve $4x - 2y + 3 = 3$, $2x - y = 0$; $\nabla f(x, y) = 4\mathbf{i} - 2\mathbf{j}$, $\nabla f(1, 2) = 4\mathbf{i} - 2\mathbf{j}$.

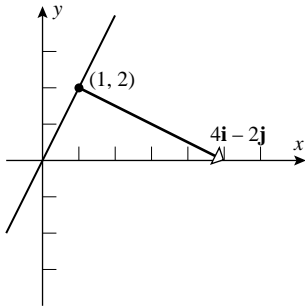

48. $f(-2, 2) = 1/2$, level curve $y/x^2 = 1/2$, $y = x^2/2$ for $x \neq 0$. $\nabla f(x, y) = -(2y/x^3)\mathbf{i} + (1/x^2)\mathbf{j}$, $\nabla f(-2, 2) = (1/2)\mathbf{i} + (1/4)\mathbf{j}$.

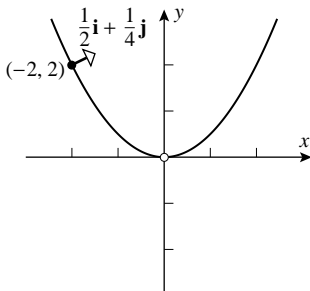

49. $f(-2, 0) = 4$, level curve $x^2 + 4y^2 = 4$, $x^2/4 + y^2 = 1$. $\nabla f(x, y) = 2x\mathbf{i} + 8y\mathbf{j}$, $\nabla f(-2, 0) = -4\mathbf{i}$.

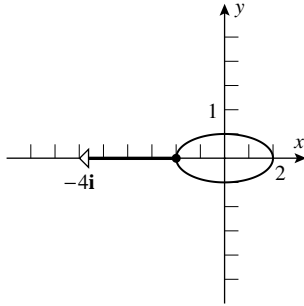

50. $f(2, -1) = 3$, level curve $x^2 - y^2 = 3$. $\nabla f(x, y) = 2xi - 2yj$, $\nabla f(2, -1) = 4i + 2j$.

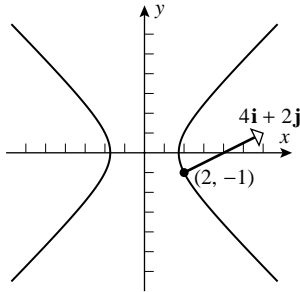

51. $\nabla f(x, y) = 8xyi + 4x^2j$, $\nabla f(1, -2) = -16i + 4j$ is normal to the level curve through P so $\mathbf{u} = \pm(-4i + j)/\sqrt{17}$.

52. $\nabla f(x, y) = (6xy - y)i + (3x^2 - x)j$, $\nabla f(2, -3) = -33i + 10j$ is normal to the level curve through P so $\mathbf{u} = \pm(-33i + 10j)/\sqrt{1189}$.

53. $\nabla f(x, y) = 12x^2y^2i + 8x^3yj$, $\nabla f(-1, 1) = 12i - 8j$, $\mathbf{u} = (3i - 2j)/\sqrt{13}$, $\|\nabla f(-1, 1)\| = 4\sqrt{13}$.

54. $\nabla f(x, y) = 3i - (1/y)j$, $\nabla f(2, 4) = 3i - (1/4)j$, $\mathbf{u} = (12i - j)/\sqrt{145}$, $\|\nabla f(2, 4)\| = \sqrt{145}/4$.

55. $\nabla f(x, y) = x(x^2 + y^2)^{-1/2}i + y(x^2 + y^2)^{-1/2}j$, $\nabla f(4, -3) = (4i - 3j)/5$, $\mathbf{u} = (4i - 3j)/5$, $\|\nabla f(4, -3)\| = 1$.

56. $\nabla f(x, y) = y(x + y)^{-2}i - x(x + y)^{-2}j$, $\nabla f(0, 2) = (1/2)i$, $\mathbf{u} = i$, $\|\nabla f(0, 2)\| = 1/2$.

57. $\nabla f(1, 1, -1) = 3i - 3j$, $\mathbf{u} = (i - j)/\sqrt{2}$, $\|\nabla f(1, 1, -1)\| = 3\sqrt{2}$.

58. $\nabla f(0, -3, 0) = (i - 3j + 4k)/6$, $\mathbf{u} = (i - 3j + 4k)/\sqrt{26}$, $\|\nabla f(0, -3, 0)\| = \sqrt{26}/6$.

59. $\nabla f(1, 2, -2) = (-i + j)/2$, $\mathbf{u} = (-i + j)/\sqrt{2}$, $\|\nabla f(1, 2, -2)\| = 1/\sqrt{2}$.

60. $\nabla f(4, 2, 2) = (i - j - k)/8$, $\mathbf{u} = (i - j - k)/\sqrt{3}$, $\|\nabla f(4, 2, 2)\| = \sqrt{3}/8$.

61. $\nabla f(x, y) = -2xi - 2yj$, $\nabla f(-1, -3) = 2i + 6j$, $\mathbf{u} = -(i + 3j)/\sqrt{10}$, $-\|\nabla f(-1, -3)\| = -2\sqrt{10}$.

62. $\nabla f(x, y) = ye^{xy}i + xe^{xy}j$; $\nabla f(2, 3) = e^6(3i + 2j)$, $\mathbf{u} = -(3i + 2j)/\sqrt{13}$, $-\|\nabla f(2, 3)\| = -\sqrt{13}e^6$.

63. $\nabla f(x, y) = -3\sin(3x - y)i + \sin(3x - y)j$, $\nabla f(\pi/6, \pi/4) = (-3i + j)/\sqrt{2}$, $\mathbf{u} = (3i - j)/\sqrt{10}$, $-\|\nabla f(\pi/6, \pi/4)\| = -\sqrt{5}$.

64. $\nabla f(x, y) = \frac{y}{(x + y)^2} \sqrt{\frac{x + y}{x - y}}i - \frac{x}{(x + y)^2} \sqrt{\frac{x + y}{x - y}}j$, $\nabla f(3, 1) = (\sqrt{2}/16)(i - 3j)$, $\mathbf{u} = -(i - 3j)/\sqrt{10}$, $-\|\nabla f(3, 1)\| = -\sqrt{5}/8$.

65. $\nabla f(5, 7, 6) = -i + 11j - 12k$, $\mathbf{u} = (i - 11j + 12k)/\sqrt{266}$, $-\|\nabla f(5, 7, 6)\| = -\sqrt{266}$.

66. $\nabla f(0, 1, \pi/4) = 2\sqrt{2}(\mathbf{i} - \mathbf{k})$, $\mathbf{u} = -(\mathbf{i} - \mathbf{k})/\sqrt{2}$, $-\|\nabla f(0, 1, \pi/4)\| = -4$.
67. False; actually they are equal: $D_{\mathbf{v}}(f) = \nabla f \cdot \mathbf{v}/\|\mathbf{v}\| = \nabla f \cdot 2\|\mathbf{u}\|/2 = D_{\mathbf{u}}(f)$.
68. True: let $\mathbf{u} = (x, x^2)$. Then $0 = Df_{\mathbf{u}} = f_x(0, 0) \cdot 1 + f_y(0, 0) \cdot 0 = f_x(0, 0)$.
69. False; $f(x, y) = x$ and $\mathbf{u} = \mathbf{j}$.
70. False, for example $f(x, y) = \sin x$, $(x_0, y_0) = (0, 0)$ and $(x_1, y_1) = (3\pi/2, 0)$.
71. $\nabla f(4, -5) = 2\mathbf{i} - \mathbf{j}$, $\mathbf{u} = (5\mathbf{i} + 2\mathbf{j})/\sqrt{29}$, $D_{\mathbf{u}}f = 8/\sqrt{29}$.
72. Let $\mathbf{u} = u_1\mathbf{i} + u_2\mathbf{j}$ where $u_1^2 + u_2^2 = 1$, but $D_{\mathbf{u}}f = \nabla f \cdot \mathbf{u} = u_1 - 2u_2 = -2$ so $u_1 = 2u_2 - 2$, $(2u_2 - 2)^2 + u_2^2 = 1$, $5u_2^2 - 8u_2 + 3 = 0$, $u_2 = 1$ or $u_2 = 3/5$ thus $u_1 = 0$ or $u_1 = -4/5$; $\mathbf{u} = \mathbf{j}$ or $\mathbf{u} = -\frac{4}{5}\mathbf{i} + \frac{3}{5}\mathbf{j}$.
73. (a) At $(1, 2)$ the steepest ascent seems to be in the direction $\mathbf{i} + \mathbf{j}$ and the slope in that direction seems to be $0.5/(\sqrt{2}/2) = 1/\sqrt{2}$, so $\nabla f \approx \frac{1}{2}\mathbf{i} + \frac{1}{2}\mathbf{j}$, which has the required direction and magnitude.

(b) The direction of $-\nabla f(4, 4)$ appears to be $-\mathbf{i} - \mathbf{j}$ and its magnitude appears to be $1/0.8 = 5/4$.

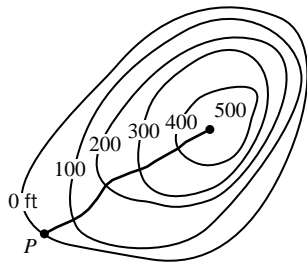
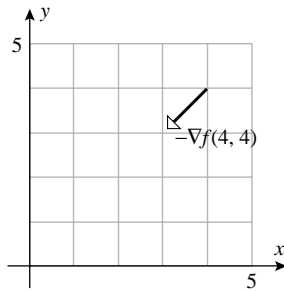

74. Depart from each contour line in a direction orthogonal to that contour line, as an approximation to the optimal path.
75. $\nabla z = 6x\mathbf{i} - 2y\mathbf{j}$, $\|\nabla z\| = \sqrt{36x^2 + 4y^2} = 6$ if $36x^2 + 4y^2 = 36$; all points on the ellipse $9x^2 + y^2 = 9$.
76. $\nabla z = 3\mathbf{i} + 2y\mathbf{j}$, $\|\nabla z\| = \sqrt{9 + 4y^2}$, so $\nabla\|\nabla z\| = \frac{4y}{\sqrt{9 + 4y^2}}\mathbf{j}$, and $\nabla\|\nabla z\| \Big|_{(x,y)=(5,2)} = \frac{8}{5}\mathbf{j}$.
77. $\mathbf{r} = t\mathbf{i} - t^2\mathbf{j}$, $d\mathbf{r}/dt = \mathbf{i} - 2t\mathbf{j} = \mathbf{i} - 4\mathbf{j}$ at the point $(2, -4)$, $\mathbf{u} = (\mathbf{i} - 4\mathbf{j})/\sqrt{17}$; $\nabla z = 2x\mathbf{i} + 2y\mathbf{j} = 4\mathbf{i} - 8\mathbf{j}$ at $(2, -4)$, hence $dz/ds = D_{\mathbf{u}}z = \nabla z \cdot \mathbf{u} = 36/\sqrt{17}$.
78. (a) $\nabla T(x, y) = \frac{y(1 - x^2 + y^2)}{(1 + x^2 + y^2)^2}\mathbf{i} + \frac{x(1 + x^2 - y^2)}{(1 + x^2 + y^2)^2}\mathbf{j}$, $\nabla T(1, 1) = (\mathbf{i} + \mathbf{j})/9$, $\mathbf{u} = (2\mathbf{i} - \mathbf{j})/\sqrt{5}$, $D_{\mathbf{u}}T = 1/(9\sqrt{5})$.
- (b) $\mathbf{u} = -(\mathbf{i} + \mathbf{j})/\sqrt{2}$, opposite to $\nabla T(1, 1)$.

79. (a) $\nabla V(x, y) = -2e^{-2x} \cos 2y\mathbf{i} - 2e^{-2x} \sin 2y\mathbf{j}$, $\mathbf{E} = -\nabla V(\pi/4, 0) = 2e^{-\pi/2}\mathbf{i}$.

(b) $V(x, y)$ decreases most rapidly in the direction of $-\nabla V(x, y)$ which is \mathbf{E} .

80. $\nabla z = -0.04x\mathbf{i} - 0.08y\mathbf{j}$, if $x = -20$ and $y = 5$ then $\nabla z = 0.8\mathbf{i} - 0.4\mathbf{j}$.

(a) $\mathbf{u} = -\mathbf{i}$ points due west, $D_{\mathbf{u}}z = -0.8$, the climber will descend because z is decreasing.

(b) $\mathbf{u} = (\mathbf{i} + \mathbf{j})/\sqrt{2}$ points northeast, $D_{\mathbf{u}}z = 0.2\sqrt{2}$, the climber will ascend at the rate of $0.2\sqrt{2}$ m per m of travel in the xy -plane.

(c) The climber will travel a level path in a direction perpendicular to $\nabla z = 0.8\mathbf{i} - 0.4\mathbf{j}$, by inspection $\pm(\mathbf{i} + 2\mathbf{j})/\sqrt{5}$ are unit vectors in these directions; $(\mathbf{i} + 2\mathbf{j})/\sqrt{5}$ makes an angle of $\tan^{-1}(1/2) \approx 27^\circ$ with the positive y -axis so $-(\mathbf{i} + 2\mathbf{j})/\sqrt{5}$ makes the same angle with the negative y -axis. The compass direction should be N 27° E or S 27° W.

81. Let \mathbf{u} be the unit vector in the direction of \mathbf{a} , then $D_{\mathbf{u}}f(3, -2, 1) = \nabla f(3, -2, 1) \cdot \mathbf{u} = \|\nabla f(3, -2, 1)\| \cos \theta = 5 \cos \theta = -5$, $\cos \theta = -1$, $\theta = \pi$ so $\nabla f(3, -2, 1)$ is oppositely directed to \mathbf{u} ; $\nabla f(3, -2, 1) = -5\mathbf{u} = -10/3\mathbf{i} + 5/3\mathbf{j} + 10/3\mathbf{k}$.

82. (a) $\nabla T(1, 1, 1) = (\mathbf{i} + \mathbf{j} + \mathbf{k})/8$, $\mathbf{u} = -(\mathbf{i} + \mathbf{j} + \mathbf{k})/\sqrt{3}$, $D_{\mathbf{u}}T = -\sqrt{3}/8$.

(b) $(\mathbf{i} + \mathbf{j} + \mathbf{k})/\sqrt{3}$. (c) $\sqrt{3}/8$.

83. (a) $\nabla r = \frac{x}{\sqrt{x^2 + y^2}}\mathbf{i} + \frac{y}{\sqrt{x^2 + y^2}}\mathbf{j} = \mathbf{r}/r$.

(b) $\nabla f(r) = \frac{\partial f(r)}{\partial x}\mathbf{i} + \frac{\partial f(r)}{\partial y}\mathbf{j} = f'(r)\frac{\partial r}{\partial x}\mathbf{i} + f'(r)\frac{\partial r}{\partial y}\mathbf{j} = f'(r)\nabla r$.

84. (a) $\nabla (re^{-3r}) = \frac{(1 - 3r)}{r}e^{-3r}\mathbf{r}$.

(b) $3r^2\mathbf{r} = \frac{f'(r)}{r}\mathbf{r}$ so $f'(r) = 3r^3$, $f(r) = \frac{3}{4}r^4 + C$, $f(2) = 12 + C = 1$, $C = -11$; $f(r) = \frac{3}{4}r^4 - 11$.

85. $\mathbf{u}_r = \cos \theta\mathbf{i} + \sin \theta\mathbf{j}$, $\mathbf{u}_\theta = -\sin \theta\mathbf{i} + \cos \theta\mathbf{j}$, $\nabla z = \frac{\partial z}{\partial x}\mathbf{i} + \frac{\partial z}{\partial y}\mathbf{j} = \left(\frac{\partial z}{\partial r} \cos \theta - \frac{1}{r} \frac{\partial z}{\partial \theta} \sin \theta\right)\mathbf{i} + \left(\frac{\partial z}{\partial r} \sin \theta + \frac{1}{r} \frac{\partial z}{\partial \theta} \cos \theta\right)\mathbf{j} = \frac{\partial z}{\partial r}(\cos \theta\mathbf{i} + \sin \theta\mathbf{j}) + \frac{1}{r} \frac{\partial z}{\partial \theta}(-\sin \theta\mathbf{i} + \cos \theta\mathbf{j}) = \frac{\partial z}{\partial r}\mathbf{u}_r + \frac{1}{r} \frac{\partial z}{\partial \theta}\mathbf{u}_\theta$.

86. (a) $\nabla(f + g) = (f_x + g_x)\mathbf{i} + (f_y + g_y)\mathbf{j} = (f_x\mathbf{i} + f_y\mathbf{j}) + (g_x\mathbf{i} + g_y\mathbf{j}) = \nabla f + \nabla g$.

(b) $\nabla(cf) = (cf_x)\mathbf{i} + (cf_y)\mathbf{j} = c(f_x\mathbf{i} + f_y\mathbf{j}) = c\nabla f$.

(c) $\nabla(fg) = (fg_x + g f_x)\mathbf{i} + (fg_y + g f_y)\mathbf{j} = f(g_x\mathbf{i} + g_y\mathbf{j}) + g(f_x\mathbf{i} + f_y\mathbf{j}) = f\nabla g + g\nabla f$.

(d) $\nabla(f/g) = \frac{gf_x - fg_x}{g^2}\mathbf{i} + \frac{gf_y - fg_y}{g^2}\mathbf{j} = \frac{g(f_x\mathbf{i} + f_y\mathbf{j}) - f(g_x\mathbf{i} + g_y\mathbf{j})}{g^2} = \frac{g\nabla f - f\nabla g}{g^2}$.

(e) $\nabla(f^n) = (nf^{n-1}f_x)\mathbf{i} + (nf^{n-1}f_y)\mathbf{j} = nf^{n-1}(f_x\mathbf{i} + f_y\mathbf{j}) = nf^{n-1}\nabla f$.

87. $\mathbf{r}'(t) = \mathbf{v}(t) = k(x, y)\nabla T = -8k(x, y)x\mathbf{i} - 2k(x, y)y\mathbf{j}$; $\frac{dx}{dt} = -8kx$, $\frac{dy}{dt} = -2ky$. Divide and solve to get $y^4 = 256x$; one parametrization is $x(t) = e^{-8t}$, $y(t) = 4e^{-2t}$.

88. $\mathbf{r}'(t) = \mathbf{v}(t) = k\nabla T = -2k(x, y)x\mathbf{i} - 4k(x, y)y\mathbf{j}$. Divide and solve to get $y = \frac{3}{25}x^2$; one parametrization is $x(t) = 5e^{-2t}$, $y(t) = 3e^{-4t}$.

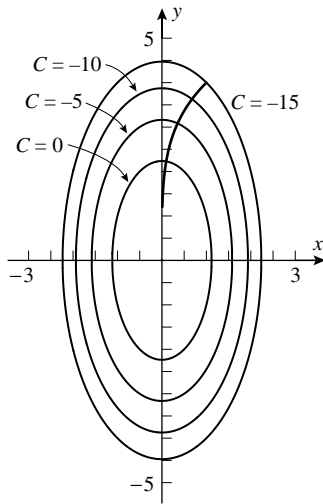

89.

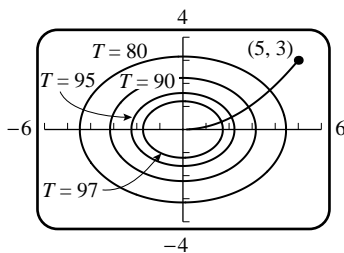

90.

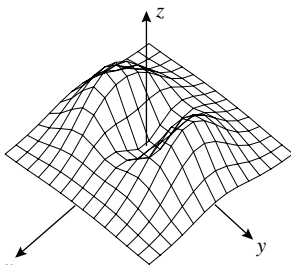

91. (a)

$$(c) \nabla f = [2x - 2x(x^2 + 3y^2)]e^{-(x^2+y^2)}\mathbf{i} + [6y - 2y(x^2 + 3y^2)]e^{-(x^2+y^2)}\mathbf{j}.$$

$$(d) \nabla f = \mathbf{0} \text{ if } x = y = 0 \text{ or } x = 0, y = \pm 1 \text{ or } x = \pm 1, y = 0.$$

$$92. dz/dt = (\partial z/\partial x)(dx/dt) + (\partial z/\partial y)(dy/dt) = (\partial z/\partial x\mathbf{i} + \partial z/\partial y\mathbf{j}) \cdot (dx/dt\mathbf{i} + dy/dt\mathbf{j}) = \nabla z \cdot \mathbf{r}'(t).$$

93. $\nabla f(x, y) = f_x(x, y)\mathbf{i} + f_y(x, y)\mathbf{j}$, if $\nabla f(x, y) = \mathbf{0}$ throughout the region then $f_x(x, y) = f_y(x, y) = 0$ throughout the region, the result follows from Exercise 69, Section 13.5.

94. Let \mathbf{u}_1 and \mathbf{u}_2 be nonparallel unit vectors for which the directional derivative is zero. Let \mathbf{u} be any other unit vector, then $\mathbf{u} = c_1\mathbf{u}_1 + c_2\mathbf{u}_2$ for some choice of scalars c_1 and c_2 , $D_{\mathbf{u}}f(x, y) = \nabla f(x, y) \cdot \mathbf{u} = c_1\nabla f(x, y) \cdot \mathbf{u}_1 + c_2\nabla f(x, y) \cdot \mathbf{u}_2 = c_1D_{\mathbf{u}_1}f(x, y) + c_2D_{\mathbf{u}_2}f(x, y) = 0$.

$$95. \nabla f(u, v, w) = \frac{\partial f}{\partial x}\mathbf{i} + \frac{\partial f}{\partial y}\mathbf{j} + \frac{\partial f}{\partial z}\mathbf{k} = \left(\frac{\partial f}{\partial u}\frac{\partial u}{\partial x} + \frac{\partial f}{\partial v}\frac{\partial v}{\partial x} + \frac{\partial f}{\partial w}\frac{\partial w}{\partial x}\right)\mathbf{i} + \left(\frac{\partial f}{\partial u}\frac{\partial u}{\partial y} + \frac{\partial f}{\partial v}\frac{\partial v}{\partial y} + \frac{\partial f}{\partial w}\frac{\partial w}{\partial y}\right)\mathbf{j} + \left(\frac{\partial f}{\partial u}\frac{\partial u}{\partial z} + \frac{\partial f}{\partial v}\frac{\partial v}{\partial z} + \frac{\partial f}{\partial w}\frac{\partial w}{\partial z}\right)\mathbf{k} = \frac{\partial f}{\partial u}\nabla u + \frac{\partial f}{\partial v}\nabla v + \frac{\partial f}{\partial w}\nabla w.$$

Exercise Set 13.7

1. (a) $f(x, y, z) = x^2 + y^2 + 4z^2$, $\nabla f = 2x\mathbf{i} + 2y\mathbf{j} + 8z\mathbf{k}$, $\nabla f(2, 2, 1) = 4\mathbf{i} + 4\mathbf{j} + 8\mathbf{k}$, $\mathbf{n} = \mathbf{i} + \mathbf{j} + 2\mathbf{k}$, $x + y + 2z = 6$.
- (b) $\mathbf{r}(t) = 2\mathbf{i} + 2\mathbf{j} + \mathbf{k} + t(\mathbf{i} + \mathbf{j} + 2\mathbf{k})$, $x(t) = 2 + t$, $y(t) = 2 + t$, $z(t) = 1 + 2t$.
- (c) $\cos \theta = \frac{\mathbf{n} \cdot \mathbf{k}}{\|\mathbf{n}\|} = \frac{\sqrt{2}}{\sqrt{3}}$, $\theta \approx 35.26^\circ$.
2. (a) $f(x, y, z) = xz - yz^3 + yz^2$, $\mathbf{n} = \nabla f(2, -1, 1) = \mathbf{i} + 3\mathbf{k}$; tangent plane $x + 3z = 5$.
- (b) Normal line $x = 2 + t$, $y = -1$, $z = 1 + 3t$.
- (c) $\cos \theta = \frac{\mathbf{n} \cdot \mathbf{k}}{\|\mathbf{n}\|} = \frac{3}{\sqrt{10}}$, $\theta \approx 18.43^\circ$.
3. $\nabla F = \langle 2x, 2y, 2z \rangle$, so $\mathbf{n} = \langle -6, 0, 8 \rangle$, so the tangent plane is given by $-6(x + 3) + 8(z - 4) = 0$ or $3x - 4z = -25$, normal line $x = -3 - 6t$, $y = 0$, $z = 4 + 8t$.
4. $\nabla F = \langle 2xy, x^2, -8z \rangle$, so $\mathbf{n} = \langle -6, 9, 16 \rangle$, so the tangent plane is given by $-6x + 9y + 16z = -5$, normal line $x = -3 - 6t$, $y = 1 + 9t$, $z = -2 + 16t$.
5. $\nabla F = \langle 2x - yz, -xz, -xy \rangle$, so $\mathbf{n} = \langle -18, 8, 20 \rangle$, so the tangent plane is given by $-18x + 8y + 20z = 152$, normal line $x = -4 - 18t$, $y = 5 + 8t$, $z = 2 + 20t$.
6. At P , $\partial z/\partial x = 4$ and $\partial z/\partial y = -6$, tangent plane $4x - 6y - z = 13$, normal line $x = 2 + 4t$, $y = -3 - 6t$, $z = 13 - t$.
7. At P , $\partial z/\partial x = 48$ and $\partial z/\partial y = -14$, tangent plane $48x - 14y - z = 64$, normal line $x = 1 + 48t$, $y = -2 - 14t$, $z = 12 - t$.
8. At P , $\partial z/\partial x = 14$ and $\partial z/\partial y = -2$, tangent plane $14x - 2y - z = 16$, normal line $x = 2 + 14t$, $y = 4 - 2t$, $z = 4 - t$.
9. At P , $\partial z/\partial x = 1$ and $\partial z/\partial y = -1$, tangent plane $x - y - z = 0$, normal line $x = 1 + t$, $y = -t$, $z = 1 - t$.
10. At P , $\partial z/\partial x = -1$ and $\partial z/\partial y = 0$, tangent plane $x + z = -1$, normal line $x = -1 - t$, $y = 0$, $z = -t$.
11. At P , $\partial z/\partial x = 0$ and $\partial z/\partial y = 3$, tangent plane $3y - z = -1$, normal line $x = \pi/6$, $y = 3t$, $z = 1 - t$.
12. At P , $\partial z/\partial x = 1/4$ and $\partial z/\partial y = 1/6$, tangent plane $3x + 2y - 12z = -30$, normal line $x = 4 + t/4$, $y = 9 + t/6$, $z = 5 - t$.
13. The tangent plane is horizontal if the normal $\partial z/\partial x\mathbf{i} + \partial z/\partial y\mathbf{j} - \mathbf{k}$ is parallel to \mathbf{k} which occurs when $\partial z/\partial x = \partial z/\partial y = 0$.
- (a) $\partial z/\partial x = 3x^2y^2$, $\partial z/\partial y = 2x^3y$; $3x^2y^2 = 0$ and $2x^3y = 0$ for all (x, y) on the x -axis or y -axis, and $z = 0$ for these points, the tangent plane is horizontal at all points on the x -axis or y -axis.
- (b) $\partial z/\partial x = 2x - y - 2$, $\partial z/\partial y = -x + 2y + 4$; solve the system $2x - y - 2 = 0$, $-x + 2y + 4 = 0$, to get $x = 0$, $y = -2$. $z = -4$ at $(0, -2)$, the tangent plane is horizontal at $(0, -2, -4)$.
14. $\partial z/\partial x = 6x$, $\partial z/\partial y = -2y$, so $6x_0\mathbf{i} - 2y_0\mathbf{j} - \mathbf{k}$ is normal to the surface at a point (x_0, y_0, z_0) on the surface. $6\mathbf{i} + 4\mathbf{j} - \mathbf{k}$ is normal to the given plane. The tangent plane and the given plane are parallel if their normals are parallel so $6x_0 = 6$, $x_0 = 1$ and $-2y_0 = 4$, $y_0 = -2$. $z = -1$ at $(1, -2)$, the point on the surface is $(1, -2, -1)$.
15. $\partial z/\partial x = -6x$, $\partial z/\partial y = -4y$ so $-6x_0\mathbf{i} - 4y_0\mathbf{j} - \mathbf{k}$ is normal to the surface at a point (x_0, y_0, z_0) on the surface. This normal must be parallel to the given line and hence to the vector $-3\mathbf{i} + 8\mathbf{j} - \mathbf{k}$ which is parallel to the line so $-6x_0 = -3$, $x_0 = 1/2$ and $-4y_0 = 8$, $y_0 = -2$. $z = -3/4$ at $(1/2, -2)$. The point on the surface is $(1/2, -2, -3/4)$.

16. $(3, 4, 5)$ is a point of intersection because it satisfies both equations. Both surfaces have $(3/5)\mathbf{i} + (4/5)\mathbf{j} - \mathbf{k}$ as a normal so they have a common tangent plane at $(3, 4, 5)$.
17. (a) $2t + 7 = (-1 + t)^2 + (2 + t)^2$, $t^2 = 1$, $t = \pm 1$ so the points of intersection are $(-2, 1, 5)$ and $(0, 3, 9)$.
- (b) $\partial z/\partial x = 2x$, $\partial z/\partial y = 2y$ so at $(-2, 1, 5)$ the vector $\mathbf{n} = -4\mathbf{i} + 2\mathbf{j} - \mathbf{k}$ is normal to the surface. $\mathbf{v} = \mathbf{i} + \mathbf{j} + 2\mathbf{k}$ is parallel to the line; $\mathbf{n} \cdot \mathbf{v} = -4$ so the cosine of the acute angle is $[\mathbf{n} \cdot (-\mathbf{v})]/(\|\mathbf{n}\| \|\mathbf{v}\|) = 4/(\sqrt{21}\sqrt{6}) = 4/(3\sqrt{14})$. Similarly, at $(0, 3, 9)$ the vector $\mathbf{n} = 6\mathbf{j} - \mathbf{k}$ is normal to the surface, $\mathbf{n} \cdot \mathbf{v} = 4$ so the cosine of the acute angle is $4/(\sqrt{37}\sqrt{6}) = 4/\sqrt{222}$.
18. $z = xf(u)$ where $u = x/y$, $\partial z/\partial x = xf'(u)\partial u/\partial x + f(u) = (x/y)f'(u) + f(u) = uf'(u) + f(u)$, $\partial z/\partial y = xf'(u)\partial u/\partial y = -(x^2/y^2)f'(u) = -u^2f'(u)$. If (x_0, y_0, z_0) is on the surface then, with $u_0 = x_0/y_0$, $[u_0f'(u_0) + f(u_0)]\mathbf{i} - u_0^2f'(u_0)\mathbf{j} - \mathbf{k}$ is normal to the surface so the tangent plane is $[u_0f'(u_0) + f(u_0)]x - u_0^2f'(u_0)y - z = [u_0f'(u_0) + f(u_0)]x_0 - u_0^2f'(u_0)y_0 - z_0 = \left[\frac{x_0}{y_0}f'(u_0) + f(u_0)\right]x_0 - \frac{x_0^2}{y_0^2}f'(u_0)y_0 - z_0 = x_0f(u_0) - z_0 = 0$, so all tangent planes pass through the origin.
19. False, they only need to be parallel.
20. False, $f_x(1, 1) = -1/2$, $f_y(1, 1) = 1/2$.
21. True, see Section 13.4 equation (15).
22. True, see equation (5) in Theorem 13.7.2.
23. Set $f(x, y, z) = z + x - z^4(y - 1)$, then $f(x, y, z) = 0$, $\mathbf{n} = \pm \nabla f(3, 5, 1) = \pm(\mathbf{i} - \mathbf{j} - 15\mathbf{k})$, unit vectors $\pm \frac{1}{\sqrt{227}}(\mathbf{i} - \mathbf{j} - 15\mathbf{k})$.
24. $f(x, y, z) = \sin xz - 4 \cos yz$, $\nabla f(\pi, \pi, 1) = -\mathbf{i} - \pi\mathbf{k}$; unit vectors $\pm \frac{1}{\sqrt{1 + \pi^2}}(\mathbf{i} + \pi\mathbf{k})$.
25. $f(x, y, z) = x^2 + y^2 + z^2$, if (x_0, y_0, z_0) is on the sphere then $\nabla f(x_0, y_0, z_0) = 2(x_0\mathbf{i} + y_0\mathbf{j} + z_0\mathbf{k})$ is normal to the sphere at (x_0, y_0, z_0) , the normal line is $x = x_0 + x_0t$, $y = y_0 + y_0t$, $z = z_0 + z_0t$ which passes through the origin when $t = -1$.
26. $f(x, y, z) = 2x^2 + 3y^2 + 4z^2$, if (x_0, y_0, z_0) is on the ellipsoid then $\nabla f(x_0, y_0, z_0) = 2(2x_0\mathbf{i} + 3y_0\mathbf{j} + 4z_0\mathbf{k})$ is normal there and hence so is $\mathbf{n}_1 = 2x_0\mathbf{i} + 3y_0\mathbf{j} + 4z_0\mathbf{k}$; \mathbf{n}_1 must be parallel to $\mathbf{n}_2 = \mathbf{i} - 2\mathbf{j} + 3\mathbf{k}$ which is normal to the given plane so $\mathbf{n}_1 = c\mathbf{n}_2$ for some constant c . Equate corresponding components to get $x_0 = c/2$, $y_0 = -2c/3$, and $z_0 = 3c/4$; substitute into the equation of the ellipsoid yields $2(c^2/4) + 3(4c^2/9) + 4(9c^2/16) = 9$, $c^2 = 108/49$, $c = \pm 6\sqrt{3}/7$. The points on the ellipsoid are $(3\sqrt{3}/7, -4\sqrt{3}/7, 9\sqrt{3}/14)$ and $(-3\sqrt{3}/7, 4\sqrt{3}/7, -9\sqrt{3}/14)$.
27. $f(x, y, z) = x^2 + y^2 - z^2$, if (x_0, y_0, z_0) is on the surface then $\nabla f(x_0, y_0, z_0) = 2(x_0\mathbf{i} + y_0\mathbf{j} - z_0\mathbf{k})$ is normal there and hence so is $\mathbf{n}_1 = x_0\mathbf{i} + y_0\mathbf{j} - z_0\mathbf{k}$; \mathbf{n}_1 must be parallel to $\overrightarrow{PQ} = 3\mathbf{i} + 2\mathbf{j} - 2\mathbf{k}$ so $\mathbf{n}_1 = c\overrightarrow{PQ}$ for some constant c . Equate components to get $x_0 = 3c$, $y_0 = 2c$ and $z_0 = 2c$ which when substituted into the equation of the surface yields $9c^2 + 4c^2 - 4c^2 = 1$, $c^2 = 1/9$, $c = \pm 1/3$ so the points are $(1, 2/3, 2/3)$ and $(-1, -2/3, -2/3)$.
28. $f_1(x, y, z) = 2x^2 + 3y^2 + z^2$, $f_2(x, y, z) = x^2 + y^2 + z^2 - 6x - 8y - 8z + 24$, $\mathbf{n}_1 = \nabla f_1(1, 1, 2) = 4\mathbf{i} + 6\mathbf{j} + 4\mathbf{k}$, $\mathbf{n}_2 = \nabla f_2(1, 1, 2) = -4\mathbf{i} - 6\mathbf{j} - 4\mathbf{k}$, $\mathbf{n}_1 = -\mathbf{n}_2$ so \mathbf{n}_1 and \mathbf{n}_2 are parallel. Note that $(1, 1, 2)$ lies on each of the two surfaces.
29. $\mathbf{n}_1 = 2\mathbf{i} - 2\mathbf{j} - \mathbf{k}$, $\mathbf{n}_2 = 2\mathbf{i} - 8\mathbf{j} + 4\mathbf{k}$, $\mathbf{n}_1 \times \mathbf{n}_2 = -16\mathbf{i} - 10\mathbf{j} - 12\mathbf{k}$ is tangent to the line, so $x(t) = 1 + 8t$, $y(t) = -1 + 5t$, $z(t) = 2 + 6t$.

30. $f(x, y, z) = \sqrt{x^2 + y^2} - z$, $\mathbf{n}_1 = \nabla f(4, 3, 5) = \frac{4}{5}\mathbf{i} + \frac{3}{5}\mathbf{j} - \mathbf{k}$, $\mathbf{n}_2 = \mathbf{i} + 2\mathbf{j} + 2\mathbf{k}$, $\mathbf{n}_1 \times \mathbf{n}_2 = (16\mathbf{i} - 13\mathbf{j} + 5\mathbf{k})/5$ is tangent to the line, $x(t) = 4 + 16t$, $y(t) = 3 - 13t$, $z(t) = 5 + 5t$. The point $(4, 3, 5)$ lies on both surfaces.
31. $f(x, y, z) = x^2 + z^2 - 25$, $g(x, y, z) = y^2 + z^2 - 25$, $\mathbf{n}_1 = \nabla f(3, -3, 4) = 6\mathbf{i} + 8\mathbf{k}$, $\mathbf{n}_2 = \nabla g(3, -3, 4) = -6\mathbf{j} + 8\mathbf{k}$, $\mathbf{n}_1 \times \mathbf{n}_2 = 48\mathbf{i} - 48\mathbf{j} - 36\mathbf{k}$ is tangent to the line, $x(t) = 3 + 4t$, $y(t) = -3 - 4t$, $z(t) = 4 - 3t$. The point $(3, -3, 4)$ lies on both surfaces.
32. (a) $f(x, y, z) = z - 8 + x^2 + y^2$, $g(x, y, z) = 4x + 2y - z$, $\mathbf{n}_1 = 4\mathbf{j} + \mathbf{k}$, $\mathbf{n}_2 = 4\mathbf{i} + 2\mathbf{j} - \mathbf{k}$, $\mathbf{n}_1 \times \mathbf{n}_2 = -6\mathbf{i} + 4\mathbf{j} - 16\mathbf{k}$ is tangent to the line, $x(t) = 3t$, $y(t) = 2 - 2t$, $z(t) = 4 + 8t$.
33. Use implicit differentiation to get $\partial z/\partial x = -c^2x/(a^2z)$, $\partial z/\partial y = -c^2y/(b^2z)$. At (x_0, y_0, z_0) , $z_0 \neq 0$, a normal to the surface is $-[c^2x_0/(a^2z_0)]\mathbf{i} - [c^2y_0/(b^2z_0)]\mathbf{j} - \mathbf{k}$ so the tangent plane is $-\frac{c^2x_0}{a^2z_0}x - \frac{c^2y_0}{b^2z_0}y - z = -\frac{c^2x_0^2}{a^2z_0} - \frac{c^2y_0^2}{b^2z_0} - z_0$, $\frac{x_0x}{a^2} + \frac{y_0y}{b^2} + \frac{z_0z}{c^2} = \frac{x_0^2}{a^2} + \frac{y_0^2}{b^2} + \frac{z_0^2}{c^2} = 1$.
34. $\partial z/\partial x = 2x/a^2$, $\partial z/\partial y = 2y/b^2$. At (x_0, y_0, z_0) the vector $(2x_0/a^2)\mathbf{i} + (2y_0/b^2)\mathbf{j} - \mathbf{k}$ is normal to the surface so the tangent plane is $(2x_0/a^2)x + (2y_0/b^2)y - z = 2x_0^2/a^2 + 2y_0^2/b^2 - z_0$, but $z_0 = x_0^2/a^2 + y_0^2/b^2$ so $(2x_0/a^2)x + (2y_0/b^2)y - z = 2z_0 - z_0 = z_0$, $2x_0x/a^2 + 2y_0y/b^2 = z + z_0$.
35. $\mathbf{n}_1 = f_x(x_0, y_0)\mathbf{i} + f_y(x_0, y_0)\mathbf{j} - \mathbf{k}$ and $\mathbf{n}_2 = g_x(x_0, y_0)\mathbf{i} + g_y(x_0, y_0)\mathbf{j} - \mathbf{k}$ are normal, respectively, to $z = f(x, y)$ and $z = g(x, y)$ at P ; \mathbf{n}_1 and \mathbf{n}_2 are perpendicular if and only if $\mathbf{n}_1 \cdot \mathbf{n}_2 = 0$, $f_x(x_0, y_0)g_x(x_0, y_0) + f_y(x_0, y_0)g_y(x_0, y_0) + 1 = 0$, $f_x(x_0, y_0)g_x(x_0, y_0) + f_y(x_0, y_0)g_y(x_0, y_0) = -1$.
36. $f_x = x/\sqrt{x^2 + y^2}$, $f_y = y/\sqrt{x^2 + y^2}$, $g_x = -x/\sqrt{x^2 + y^2}$, $g_y = -y/\sqrt{x^2 + y^2}$, $f_xg_x + f_yg_y = -(x^2 + y^2)/(x^2 + y^2) = -1$, so by Exercise 35 the normal lines are perpendicular.
37. $\nabla f = f_x\mathbf{i} + f_y\mathbf{j} + f_z\mathbf{k}$ and $\nabla g = g_x\mathbf{i} + g_y\mathbf{j} + g_z\mathbf{k}$ evaluated at (x_0, y_0, z_0) are normal, respectively, to the surfaces $f(x, y, z) = 0$ and $g(x, y, z) = 0$ at (x_0, y_0, z_0) . The surfaces are orthogonal at (x_0, y_0, z_0) if and only if $\nabla f \cdot \nabla g = 0$ so $f_xg_x + f_yg_y + f_zg_z = 0$.
38. $f(x, y, z) = x^2 + y^2 + z^2 - a^2 = 0$, $g(x, y, z) = z^2 - x^2 - y^2 = 0$, $f_xg_x + f_yg_y + f_zg_z = -4x^2 - 4y^2 + 4z^2 = 4g(x, y, z) = 0$.
39. $z = \frac{k}{xy}$; at a point $\left(a, b, \frac{k}{ab}\right)$ on the surface, $\left\langle -\frac{k}{a^2b}, -\frac{k}{ab^2}, -1 \right\rangle$ and hence $\langle bk, ak, a^2b^2 \rangle$ is normal to the surface so the tangent plane is $bkx + ak y + a^2b^2z = 3abk$. The plane cuts the x , y , and z -axes at the points $3a$, $3b$, and $\frac{3k}{ab}$, respectively, so the volume of the tetrahedron that is formed is $V = \frac{1}{3} \left(\frac{3k}{ab}\right) \left[\frac{1}{2}(3a)(3b)\right] = \frac{9}{2}k$, which does not depend on a and b .

Exercise Set 13.8

1. (a) Minimum at $(2, -1)$, no maxima. (b) Maximum at $(0, 0)$, no minima. (c) No maxima or minima.
2. (a) Maximum at $(-1, 5)$, no minima. (b) No maxima or minima. (c) No maxima or minima.
3. $f(x, y) = (x - 3)^2 + (y + 2)^2$, minimum at $(3, -2)$, no maxima.
4. $f(x, y) = -(x + 1)^2 - 2(y - 1)^2 + 4$, maximum at $(-1, 1)$, no minima.
5. $f_x = 6x + 2y = 0$, $f_y = 2x + 2y = 0$; critical point $(0, 0)$; $D = 8 > 0$ and $f_{xx} = 6 > 0$ at $(0, 0)$, relative minimum.
6. $f_x = 3x^2 - 3y = 0$, $f_y = -3x - 3y^2 = 0$; critical points $(0, 0)$ and $(-1, 1)$; $D = -9 < 0$ at $(0, 0)$, saddle point; $D = 27 > 0$ and $f_{xx} = -6 < 0$ at $(-1, 1)$, relative maximum.

7. $f_x = 2x - 2xy = 0$, $f_y = 4y - x^2 = 0$; critical points $(0,0)$ and $(\pm 2, 1)$; $D = 8 > 0$ and $f_{xx} = 2 > 0$ at $(0,0)$, relative minimum; $D = -16 < 0$ at $(\pm 2, 1)$, saddle points.
8. $f_x = 3x^2 - 3 = 0$, $f_y = 3y^2 - 3 = 0$; critical points $(-1, \pm 1)$ and $(1, \pm 1)$; $D = -36 < 0$ at $(-1, 1)$ and $(1, -1)$, saddle points; $D = 36 > 0$ and $f_{xx} = 6 > 0$ at $(1, 1)$, relative minimum; $D = 36 > 0$ and $f_{xx} = -36 < 0$ at $(-1, -1)$, relative maximum.
9. $f_x = y + 2 = 0$, $f_y = 2y + x + 3 = 0$; critical point $(1, -2)$; $D = -1 < 0$ at $(1, -2)$, saddle point.
10. $f_x = 2x + y - 2 = 0$, $f_y = x - 2 = 0$; critical point $(2, -2)$; $D = -1 < 0$ at $(2, -2)$, saddle point.
11. $f_x = 2x + y - 3 = 0$, $f_y = x + 2y = 0$; critical point $(2, -1)$; $D = 3 > 0$ and $f_{xx} = 2 > 0$ at $(2, -1)$, relative minimum.
12. $f_x = y - 3x^2 = 0$, $f_y = x - 2y = 0$; critical points $(0,0)$ and $(1/6, 1/12)$; $D = -1 < 0$ at $(0,0)$, saddle point; $D = 1 > 0$ and $f_{xx} = -1 < 0$ at $(1/6, 1/12)$, relative maximum.
13. $f_x = 2x - 2/(x^2y) = 0$, $f_y = 2y - 2/(xy^2) = 0$; critical points $(-1, -1)$ and $(1, 1)$; $D = 32 > 0$ and $f_{xx} = 6 > 0$ at $(-1, -1)$ and $(1, 1)$, relative minima.
14. $f_x = e^y = 0$ is impossible, no critical points.
15. $f_x = 2x = 0$, $f_y = 1 - e^y = 0$; critical point $(0, 0)$; $D = -2 < 0$ at $(0, 0)$, saddle point.
16. $f_x = y - 2/x^2 = 0$, $f_y = x - 4/y^2 = 0$; critical point $(1, 2)$; $D = 3 > 0$ and $f_{xx} = 4 > 0$ at $(1, 2)$, relative minimum.
17. $f_x = e^x \sin y = 0$, $f_y = e^x \cos y = 0$, $\sin y = \cos y = 0$ is impossible, no critical points.
18. $f_x = y \cos x = 0$, $f_y = \sin x = 0$; $\sin x = 0$ if $x = n\pi$ for $n = 0, \pm 1, \pm 2, \dots$ and $\cos x \neq 0$ for these values of x so $y = 0$; critical points $(n\pi, 0)$ for $n = 0, \pm 1, \pm 2, \dots$; $D = -1 < 0$ at $(n\pi, 0)$, saddle points.
19. $f_x = -2(x+1)e^{-(x^2+y^2+2x)} = 0$, $f_y = -2ye^{-(x^2+y^2+2x)} = 0$; critical point $(-1, 0)$; $D = 4e^2 > 0$ and $f_{xx} = -2e < 0$ at $(-1, 0)$, relative maximum.
20. $f_x = y - a^3/x^2 = 0$, $f_y = x - b^3/y^2 = 0$; critical point $(a^2/b, b^2/a)$; if $ab > 0$ then $D = 3 > 0$ and $f_{xx} = 2b^3/a^3 > 0$ at $(a^2/b, b^2/a)$, relative minimum; if $ab < 0$ then $D = 3 > 0$ and $f_{xx} = 2b^3/a^3 < 0$ at $(a^2/b, b^2/a)$, relative maximum.
21. $\nabla f = (4x - 4y)\mathbf{i} - (4x - 4y^3)\mathbf{j} = \mathbf{0}$ when $x = y$, $x = y^3$, so $x = y = 0$ or $x = y = \pm 1$. At $(0, 0)$, $D = -16$, a saddle point; at $(1, 1)$ and $(-1, -1)$, $D = 32 > 0$, $f_{xx} = 4$, a relative minimum.

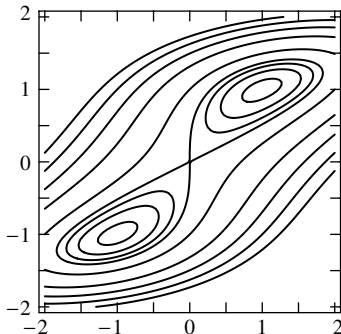

22. $\nabla f = (2y^2 - 2xy + 4y)\mathbf{i} + (4xy - x^2 + 4x)\mathbf{j} = \mathbf{0}$ when $2y^2 - 2xy + 4y = 0$, $4xy - x^2 + 4x = 0$, with solutions $(0, 0)$, $(0, -2)$, $(4, 0)$, $(4/3, -2/3)$. At $(0, 0)$, $D = -16$, a saddle point. At $(0, -2)$, $D = -16$, a saddle point. At $(4, 0)$, $D = -16$, a saddle point. At $(4/3, -2/3)$, $D = 16/3$, $f_{xx} = 4/3 > 0$, a relative minimum.

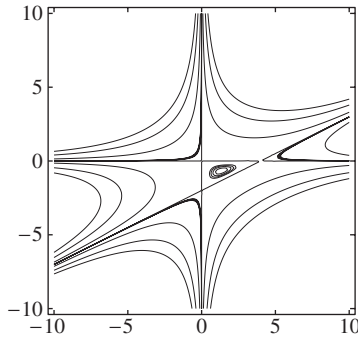

23. False, e.g. $f(x, y) = x$.
24. False; $f(x, y) = (x^2 + y^2 - 1/4)^2$, every point on $x^2 + y^2 = 1/4$ is a critical point of f .
25. True, Theorem 13.8.6.
26. True, Theorem 13.8.6.
27. (a) Critical point $(0,0)$; $D = 0$.
- (b) $f(0,0) = 0, x^4 + y^4 \geq 0$ so $f(x, y) \geq f(0,0)$, relative minimum.
28. (a) $f_x(x, y) = 4x^3, f_y(x, y) = -4y^3$, both equal zero only at $(0,0)$ where $D = 0$.
- (b) The trace of the surface $z = x^4 - y^4$ in the xz -plane has a relative minimum at the origin, whereas the trace in the yz -plane has a relative maximum there. Therefore, f has a saddle point at $(0,0)$.
29. (a) $f_x = 3e^y - 3x^2 = 3(e^y - x^2) = 0, f_y = 3xe^y - 3e^{3y} = 3e^y(x - e^{2y}) = 0, e^y = x^2$ and $e^{2y} = x, x^4 = x, x(x^3 - 1) = 0$ so $x = 0, 1$; critical point $(1,0)$; $D = 27 > 0$ and $f_{xx} = -6 < 0$ at $(1,0)$, relative maximum.
- (b) $\lim_{x \rightarrow -\infty} f(x,0) = \lim_{x \rightarrow -\infty} (3x - x^3 - 1) = +\infty$ so no absolute maximum.
30. $f_x = 8xe^y - 8x^3 = 8x(e^y - x^2) = 0, f_y = 4x^2e^y - 4e^{4y} = 4e^y(x^2 - e^{3y}) = 0, x^2 = e^y$ and $x^2 = e^{3y}, e^{3y} = e^y, e^{2y} = 1$, so $y = 0$ and $x = \pm 1$; critical points $(1,0)$ and $(-1,0)$. $D = 128 > 0$ and $f_{xx} = -16 < 0$ at both points so a relative maximum occurs at each one.
31. $f_x = y - 1 = 0, f_y = x - 3 = 0$; critical point $(3,1)$. Along $y = 0$: $u(x) = -x$; no critical points, along $x = 0$: $v(y) = -3y$; no critical points, along $y = -\frac{4}{5}x + 4$: $w(x) = -\frac{4}{5}x^2 + \frac{27}{5}x - 12$; critical point $(27/8, 13/10)$.

(x, y)	$(3, 1)$	$(0, 0)$	$(5, 0)$	$(0, 4)$	$(27/8, 13/10)$
$f(x, y)$	-3	0	-5	-12	-231/80

Absolute maximum value is 0, absolute minimum value is -12.

32. $f_x = y - 2 = 0, f_y = x = 0$; critical point $(0,2)$, but $(0,2)$ is not in the interior of R . Along $y = 0$: $u(x) = -2x$; no critical points, along $x = 0$: $v(y) = 0$; along $y = 4 - x$: $w(x) = 2x - x^2$; critical point $(1,3)$.

(x, y)	$(0, 0)$	$(0, 4)$	$(4, 0)$	$(1, 3)$
$f(x, y)$	0	0	-8	1

Absolute maximum value is 1, absolute minimum value is -8.

33. $f_x = 2x - 2 = 0$, $f_y = -6y + 6 = 0$; critical point $(1, 1)$. Along $y = 0$: $u_1(x) = x^2 - 2x$; critical point $(1, 0)$, along $y = 2$: $u_2(x) = x^2 - 2x$; critical point $(1, 2)$, along $x = 0$: $v_1(y) = -3y^2 + 6y$; critical point $(0, 1)$, along $x = 2$: $v_2(y) = -3y^2 + 6y$; critical point $(2, 1)$.

(x, y)	(1, 1)	(1, 0)	(1, 2)	(0, 1)	(2, 1)	(0, 0)	(0, 2)	(2, 0)	(2, 2)
$f(x, y)$	2	-1	-1	3	3	0	0	0	0

Absolute maximum value is 3, absolute minimum value is -1 .

34. $f_x = e^y - 2x = 0$, $f_y = xe^y - e^y = e^y(x - 1) = 0$; critical point $(1, \ln 2)$. Along $y = 0$: $u_1(x) = x - x^2 - 1$; critical point $(1/2, 0)$, along $y = 1$: $u_2(x) = ex - x^2 - e$; critical point $(e/2, 1)$, along $x = 0$: $v_1(y) = -e^y$; no critical points, along $x = 2$: $v_2(y) = e^y - 4$; no critical points.

(x, y)	(0, 0)	(0, 1)	(2, 1)	(2, 0)	(1, $\ln 2$)	(1/2, 0)	$(e/2, 1)$
$f(x, y)$	-1	$-e$	$e - 4$	-3	-1	$-3/4$	$e(e - 4)/4 \approx -0.87$

Absolute maximum value is $-3/4$, absolute minimum value is -3 .

35. $f_x = 2x - 1 = 0$, $f_y = 4y = 0$; critical point $(1/2, 0)$. Along $x^2 + y^2 = 4$: $y^2 = 4 - x^2$, $u(x) = 8 - x - x^2$ for $-2 \leq x \leq 2$; critical points $(-1/2, \pm\sqrt{15}/2)$.

(x, y)	(1/2, 0)	$(-1/2, \sqrt{15}/2)$	$(-1/2, -\sqrt{15}/2)$	(-2, 0)	(2, 0)
$f(x, y)$	$-1/4$	$33/4$	$33/4$	6	2

Absolute maximum value is $33/4$, absolute minimum value is $-1/4$.

36. $f_x = y^2 = 0$, $f_y = 2xy = 0$; no critical points in the interior of R . Along $y = 0$: $u(x) = 0$; along $x = 0$: $v(y) = 0$; along $x^2 + y^2 = 1$: $w(x) = x - x^3$ for $0 \leq x \leq 1$; critical point $(1/\sqrt{3}, \sqrt{2/3})$.

(x, y)	(0, 0)	(0, 1)	(1, 0)	$(1/\sqrt{3}, \sqrt{2/3})$
$f(x, y)$	0	0	0	$2\sqrt{3}/9$

Absolute maximum value is $\frac{2}{9}\sqrt{3}$, absolute minimum value is 0.

37. Maximize $P = xyz$ subject to $x + y + z = 48$, $x > 0$, $y > 0$, $z > 0$. $z = 48 - x - y$ so $P = xy(48 - x - y) = 48xy - x^2y - xy^2$, $P_x = 48y - 2xy - y^2 = 0$, $P_y = 48x - x^2 - 2xy = 0$. But $x \neq 0$ and $y \neq 0$ so $48 - 2x - y = 0$ and $48 - x - 2y = 0$; critical point $(16, 16)$. $P_{xx}P_{yy} - P_{xy}^2 > 0$ and $P_{xx} < 0$ at $(16, 16)$, relative maximum. $z = 16$ when $x = y = 16$, the product is maximum for the numbers 16, 16, 16.

38. Minimize $S = x^2 + y^2 + z^2$ subject to $x + y + z = 27$, $x > 0$, $y > 0$, $z > 0$. $z = 27 - x - y$ so $S = x^2 + y^2 + (27 - x - y)^2$, $S_x = 4x + 2y - 54 = 0$, $S_y = 2x + 4y - 54 = 0$; critical point $(9, 9)$; $S_{xx}S_{yy} - S_{xy}^2 = 12 > 0$ and $S_{xx} = 4 > 0$ at $(9, 9)$, relative minimum. $z = 9$ when $x = y = 9$, the sum of the squares is minimum for the numbers 9, 9, 9.

39. Maximize $w = xy^2z^2$ subject to $x + y + z = 5$, $x > 0$, $y > 0$, $z > 0$. $x = 5 - y - z$ so $w = (5 - y - z)y^2z^2 = 5y^2z^2 - y^3z^2 - y^2z^3$, $w_y = 10yz^2 - 3y^2z^2 - 2yz^3 = yz^2(10 - 3y - 2z) = 0$, $w_z = 10y^2z - 2y^3z - 3y^2z^2 = y^2z(10 - 2y - 3z) = 0$, $10 - 3y - 2z = 0$ and $10 - 2y - 3z = 0$; critical point when $y = z = 2$; $w_{yy}w_{zz} - w_{yz}^2 = 320 > 0$ and $w_{yy} = -24 < 0$ when $y = z = 2$, relative maximum. $x = 1$ when $y = z = 2$, xy^2z^2 is maximum at $(1, 2, 2)$.

40. Minimize $w = D^2 = x^2 + y^2 + z^2$ subject to $x^2 - yz = 5$. $x^2 = 5 + yz$ so $w = 5 + yz + y^2 + z^2$, $w_y = z + 2y = 0$, $w_z = y + 2z = 0$; critical point when $y = z = 0$; $w_{yy}w_{zz} - w_{yz}^2 = 3 > 0$ and $w_{yy} = 2 > 0$ when $y = z = 0$, relative minimum. $x^2 = 5$, $x = \pm\sqrt{5}$ when $y = z = 0$. The points $(\pm\sqrt{5}, 0, 0)$ are closest to the origin.

41. The diagonal of the box must equal the diameter of the sphere, thus we maximize $V = xyz$ or, for convenience, $w = V^2 = x^2y^2z^2$ subject to $x^2 + y^2 + z^2 = 4a^2$, $x > 0$, $y > 0$, $z > 0$; $z^2 = 4a^2 - x^2 - y^2$ hence $w = 4a^2x^2y^2 - x^4y^2 - x^2y^4$, $w_x = 2xy^2(4a^2 - 2x^2 - y^2) = 0$, $w_y = 2x^2y(4a^2 - x^2 - 2y^2) = 0$, $4a^2 - 2x^2 - y^2 = 0$ and $4a^2 - x^2 - 2y^2 = 0$; critical point $(2a/\sqrt{3}, 2a/\sqrt{3})$; $w_{xx}w_{yy} - w_{xy}^2 = \frac{4096}{27}a^8 > 0$ and $w_{xx} = -\frac{128}{9}a^4 < 0$ at $(2a/\sqrt{3}, 2a/\sqrt{3})$, relative maximum. $z = 2a/\sqrt{3}$ when $x = y = 2a/\sqrt{3}$, the dimensions of the box of maximum volume are $2a/\sqrt{3}, 2a/\sqrt{3}, 2a/\sqrt{3}$.
42. Maximize $V = xyz$ subject to $x + y + z = 129$, $x > 0$, $y > 0$, $z > 0$. $z = 129 - x - y$ so $V = 129xy - x^2y - xy^2$, $V_x = y(129 - 2x - y) = 0$, $V_y = x(129 - x - 2y) = 0$, $129 - 2x - y = 0$ and $129 - x - 2y = 0$; critical point $(43, 43)$; $V_{xx}V_{yy} - V_{xy}^2 = 7439 > 0$ and $V_{xx} = -86 < 0$ at $(43, 43)$, relative maximum. The maximum volume is $V = (43)(43)(43) = 79,507 \text{ cm}^3$.
43. Let x , y , and z be, respectively, the length, width, and height of the box. Minimize $C = 10(2xy) + 5(2xz + 2yz) = 10(2xy + xz + yz)$ subject to $xyz = 16$. $z = 16/(xy)$, so $C = 20(xy + 8/y + 8/x)$, $C_x = 20(y - 8/x^2) = 0$, $C_y = 20(x - 8/y^2) = 0$; critical point $(2, 2)$; $C_{xx}C_{yy} - C_{xy}^2 = 1200 > 0$ and $C_{xx} = 40 > 0$ at $(2, 2)$, relative minimum. $z = 4$ when $x = y = 2$. The cost of materials is minimum if the length and width are 2 ft and the height is 4 ft.
44. Maximize the profit $P = 500(y-x)(x-40) + [45,000 + 500(x-2y)](y-60) = 500(-x^2 - 2y^2 + 2xy - 20x + 170y - 5400)$. $P_x = 1000(-x + y - 10) = 0$, $P_y = 1000(-2y + x + 85) = 0$; critical point $(65, 75)$; $P_{xx}P_{yy} - P_{xy}^2 = 1,000,000 > 0$ and $P_{xx} = -1000 < 0$ at $(65, 75)$, relative maximum. The profit will be maximum when $x = 65$ and $y = 75$.
45. (a) $x = 0$: $f(0, y) = -3y^2$, minimum -3 , maximum 0 ; $x = 1$, $f(1, y) = 4 - 3y^2 + 2y$, $\frac{\partial f}{\partial y}(1, y) = -6y + 2 = 0$ at $y = 1/3$, minimum 3 , maximum $13/3$; $y = 0$, $f(x, 0) = 4x^2$, minimum 0 , maximum 4 ; $y = 1$, $f(x, 1) = 4x^2 + 2x - 3$, $\frac{\partial f}{\partial x}(x, 1) = 8x + 2 \neq 0$ for $0 < x < 1$, minimum -3 , maximum 3 .
- (b) $f(x, x) = 3x^2$, minimum 0 , maximum 3 ; $f(x, 1-x) = -x^2 + 8x - 3$, $\frac{d}{dx}f(x, 1-x) = -2x + 8 \neq 0$ for $0 < x < 1$, maximum 4 , minimum -3 .
- (c) $f_x(x, y) = 8x + 2y = 0$, $f_y(x, y) = -6y + 2x = 0$, solution is $(0, 0)$, which is not an interior point of the square, so check the sides: minimum -3 , maximum $13/3$.
46. Maximize $A = ab \sin \alpha$ subject to $2a + 2b = \ell$, $a > 0$, $b > 0$, $0 < \alpha < \pi$. $b = (\ell - 2a)/2$ so $A = (1/2)(\ell a - 2a^2) \sin \alpha$, $A_a = (1/2)(\ell - 4a) \sin \alpha$, $A_\alpha = (a/2)(\ell - 2a) \cos \alpha$; $\sin \alpha \neq 0$ so from $A_a = 0$ we get $a = \ell/4$ and then from $A_\alpha = 0$ we get $\cos \alpha = 0$, $\alpha = \pi/2$. $A_{aa}A_{\alpha\alpha} - A_{a\alpha}^2 = \ell^2/8 > 0$ and $A_{aa} = -2 < 0$ when $a = \ell/4$ and $\alpha = \pi/2$, the area is maximum.
47. Minimize $S = xy + 2xz + 2yz$ subject to $xyz = V$, $x > 0$, $y > 0$, $z > 0$ where x , y , and z are, respectively, the length, width, and height of the box. $z = V/(xy)$ so $S = xy + 2V/y + 2V/x$, $S_x = y - 2V/x^2 = 0$, $S_y = x - 2V/y^2 = 0$; critical point $(\sqrt[3]{2V}, \sqrt[3]{2V})$; $S_{xx}S_{yy} - S_{xy}^2 = 3 > 0$ and $S_{xx} = 2 > 0$ at this point so there is a relative minimum there. The length and width are each $\sqrt[3]{2V}$, the height is $z = \sqrt[3]{2V}/2$.
48. The altitude of the trapezoid is $x \sin \phi$ and the lengths of the lower and upper bases are, respectively, $27 - 2x$ and $27 - 2x + 2x \cos \phi$ so we want to maximize $A = (1/2)(x \sin \phi)[(27 - 2x) + (27 - 2x + 2x \cos \phi)] = 27x \sin \phi - 2x^2 \sin \phi + x^2 \sin \phi \cos \phi$. $A_x = \sin \phi(27 - 4x + 2x \cos \phi)$, $A_\phi = x(27 \cos \phi - 2x \cos \phi - x \sin^2 \phi + x \cos^2 \phi) = x(27 \cos \phi - 2x \cos \phi + 2x \cos^2 \phi - x)$. $\sin \phi \neq 0$ so from $A_x = 0$ we get $\cos \phi = (4x - 27)/(2x)$, $x \neq 0$ so from $A_\phi = 0$ we get $(27 - 2x + 2x \cos \phi) \cos \phi - x = 0$ which, for $\cos \phi = (4x - 27)/(2x)$, yields $4x - 27 - x = 0$, $x = 9$. If $x = 9$ then $\cos \phi = 1/2$, $\phi = \pi/3$. The critical point occurs when $x = 9$ and $\phi = \pi/3$; $A_{xx}A_{\phi\phi} - A_{x\phi}^2 = 729/2 > 0$ and $A_{xx} = -3\sqrt{3}/2 < 0$ there, the area is maximum when $x = 9$ and $\phi = \pi/3$.

49. (a) $\frac{\partial g}{\partial m} = \sum_{i=1}^n 2(mx_i + b - y_i)x_i = 2 \left(m \sum_{i=1}^n x_i^2 + b \sum_{i=1}^n x_i - \sum_{i=1}^n x_i y_i \right) = 0$ if $\left(\sum_{i=1}^n x_i^2 \right) m + \left(\sum_{i=1}^n x_i \right) b =$

$$\sum_{i=1}^n x_i y_i, \frac{\partial g}{\partial b} = \sum_{i=1}^n 2(mx_i + b - y_i) = 2 \left(m \sum_{i=1}^n x_i + bn - \sum_{i=1}^n y_i \right) = 0 \text{ if } \left(\sum_{i=1}^n x_i \right) m + nb = \sum_{i=1}^n y_i.$$

(b) $\sum_{i=1}^n (x_i - \bar{x})^2 = \sum_{i=1}^n (x_i^2 - 2\bar{x}x_i + \bar{x}^2) = \sum_{i=1}^n x_i^2 - 2\bar{x} \sum_{i=1}^n x_i + n\bar{x}^2 = \sum_{i=1}^n x_i^2 - \frac{2}{n} \left(\sum_{i=1}^n x_i \right)^2 + \frac{1}{n} \left(\sum_{i=1}^n x_i \right)^2 = \sum_{i=1}^n x_i^2 - \frac{1}{n} \left(\sum_{i=1}^n x_i \right)^2 \geq 0$ so $n \sum_{i=1}^n x_i^2 - \left(\sum_{i=1}^n x_i \right)^2 \geq 0$. This is an equality if and only if $\sum_{i=1}^n (x_i - \bar{x})^2 = 0$, which means $x_i = \bar{x}$ for each i .

(c) The system of equations $Am + Bb = C, Dm + Eb = F$ in the unknowns m and b has a unique solution provided $AE \neq BD$, and if so the solution is $m = \frac{CE - BF}{AE - BD}, b = \frac{F - Dm}{E}$, which after the appropriate substitution yields the desired result.

50. (a) $g_{mm} = 2 \sum_{i=1}^n x_i^2, g_{bb} = 2n, g_{mb} = 2 \sum_{i=1}^n x_i, D = g_{mm}g_{bb} - g_{mb}^2 = 4 \left[n \sum_{i=1}^n x_i^2 - \left(\sum_{i=1}^n x_i \right)^2 \right] > 0$ and $g_{mm} > 0$.

(b) $g(m, b)$ is of the second-degree in m and b so the graph of $z = g(m, b)$ is a quadric surface.

(c) The function $z = g(m, b)$, as a function of m and b , has only one critical point, found in Exercise 49, and tends to $+\infty$ as either $|m|$ or $|b|$ tends to infinity, since g_{mm} and g_{bb} are both positive. Thus the only critical point must be a minimum.

51. $n = 3, \sum_{i=1}^3 x_i = 3, \sum_{i=1}^3 y_i = 7, \sum_{i=1}^3 x_i y_i = 13, \sum_{i=1}^3 x_i^2 = 11, y = \frac{3}{4}x + \frac{19}{12}$.

52. $n = 4, \sum_{i=1}^4 x_i = 7, \sum_{i=1}^4 y_i = 4, \sum_{i=1}^4 x_i^2 = 21, \sum_{i=1}^4 x_i y_i = -2, y = -\frac{36}{35}x + \frac{14}{5}$.

53. $\sum_{i=1}^4 x_i = 10, \sum_{i=1}^4 y_i = 8.2, \sum_{i=1}^4 x_i^2 = 30, \sum_{i=1}^4 x_i y_i = 23, n = 4; m = 0.5, b = 0.8, y = 0.5x + 0.8$.

54. $\sum_{i=1}^5 x_i = 15, \sum_{i=1}^5 y_i = 15.1, \sum_{i=1}^5 x_i^2 = 55, \sum_{i=1}^5 x_i y_i = 39.8, n = 5; m = -0.55, b = 4.67, y = 4.67 - 0.55x$.

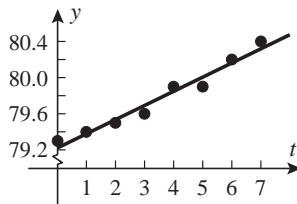

55. (a) $y \approx 79.225 + 0.1571t$.

(b)

(c) $y \approx 81.6$.

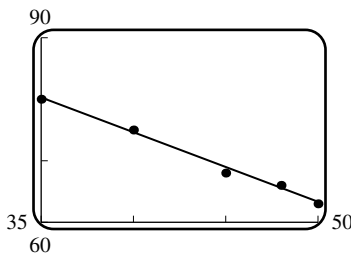

56. (a) $y \approx 119.84 - 1.13x$.

(b)

(c) About 52 units.

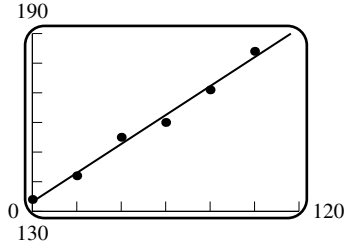

57. (a) $P = \frac{2798}{21} + \frac{171}{350}T$. (b) (c) $T \approx -272.7096^\circ \text{ C}$.

58. (a) For example, $z = y$.

(b) For example, on $0 \leq x \leq 1, 0 \leq y \leq 1$ let $z = \begin{cases} y & \text{if } 0 < x < 1, 0 < y < 1; \\ 1/2 & \text{if } x = 0, 1 \text{ or } y = 0, 1. \end{cases}$

59. $f(x_0, y_0) \geq f(x, y)$ for all (x, y) inside a circle centered at (x_0, y_0) by virtue of Definition 14.8.1. If r is the radius of the circle, then in particular $f(x_0, y_0) \geq f(x, y_0)$ for all x satisfying $|x - x_0| < r$ so $f(x, y_0)$ has a relative maximum at x_0 . The proof is similar for the function $f(x_0, y)$.

Exercise Set 13.9

1. (a) $xy = 4$ is tangent to the line, so the maximum value of f is 4.

(b) $xy = 2$ intersects the curve and so gives a smaller value of f .

(c) Maximize $f(x, y) = xy$ subject to the constraint $g(x, y) = x + y - 4 = 0, \nabla f = \lambda \nabla g, y\mathbf{i} + x\mathbf{j} = \lambda(\mathbf{i} + \mathbf{j})$, so solve the equations $y = \lambda, x = \lambda$ with solution $x = y = \lambda$, but $x + y = 4$, so $x = y = 2$, and the maximum value of f is $f = xy = 4$.

2. (a) $x^2 + y^2 = 25$ is tangent to the line at $(3, 4)$, so the minimum value of f is 25.

(b) A larger value of f yields a circle of a larger radius, and hence intersects the line.

(c) Minimize $f(x, y) = x^2 + y^2$ subject to the constraint $g(x, y) = 3x + 4y - 25 = 0, \nabla f = \lambda \nabla g, 2x\mathbf{i} + 2y\mathbf{j} = 3\lambda\mathbf{i} + 4\lambda\mathbf{j}$, so solve $2x = 3\lambda, 2y = 4\lambda$ and $3x + 4y - 25 = 0$; solution is $x = 3, y = 4$, minimum = 25.

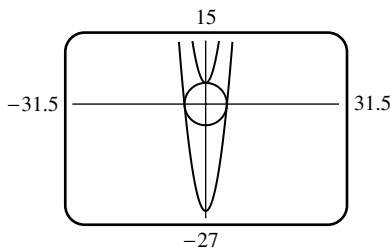

3. (a)

(b) One extremum at $(0, 5)$ and one at approximately $(\pm 5, 0)$, so minimum value -5 , maximum value ≈ 25 .

(c) Find the minimum and maximum values of $f(x, y) = x^2 - y$ subject to the constraint $g(x, y) = x^2 + y^2 - 25 = 0, \nabla f = \lambda \nabla g, 2x\mathbf{i} - \mathbf{j} = 2\lambda x\mathbf{i} + 2\lambda y\mathbf{j}$, so solve $2x = 2\lambda x, -1 = 2\lambda y, x^2 + y^2 - 25 = 0$. If $x = 0$ then $y = \pm 5, f = \mp 5$, and if $x \neq 0$ then $\lambda = 1, y = -1/2, x^2 = 25 - 1/4 = 99/4, f = 99/4 + 1/2 = 101/4$, so the maximum value of f is $101/4$ at $(\pm 3\sqrt{11}/2, -1/2)$ and the minimum value of f is -5 at $(0, 5)$.

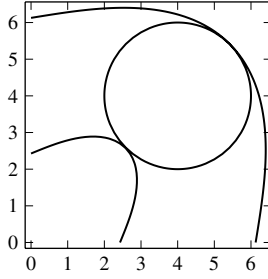

4. (a)

(b) $f \approx 15$.

(d) Set $f(x, y) = x^3 + y^3 - 3xy$, $g(x, y) = (x-4)^2 + (y-4)^2 - 4$; minimize f subject to the constraint $g = 0$: $\nabla f = \lambda g$, $(3x^2 - 3y)\mathbf{i} + (3y^2 - 3x)\mathbf{j} = 2\lambda(x-4)\mathbf{i} + 2\lambda(y-4)\mathbf{j}$, so solve (use a CAS) $3x^2 - 3y = 2\lambda(x-4)$, $3y^2 - 3x = 2\lambda(y-4)$ and $(x-4)^2 + (y-4)^2 - 4 = 0$; minimum value $f = 14.52$ at $(2.5858, 2.5858)$.

5. $y = 8x\lambda$, $x = 16y\lambda$; $y/(8x) = x/(16y)$, $x^2 = 2y^2$ so $4(2y^2) + 8y^2 = 16$, $y^2 = 1$, $y = \pm 1$. Test $(\pm\sqrt{2}, -1)$ and $(\pm\sqrt{2}, 1)$. $f(-\sqrt{2}, -1) = f(\sqrt{2}, 1) = \sqrt{2}$, $f(-\sqrt{2}, 1) = f(\sqrt{2}, -1) = -\sqrt{2}$. Maximum $\sqrt{2}$ at $(-\sqrt{2}, -1)$ and $(\sqrt{2}, 1)$, minimum $-\sqrt{2}$ at $(-\sqrt{2}, 1)$ and $(\sqrt{2}, -1)$.
6. $2x = 2x\lambda$, $-2y = 2y\lambda$, $x^2 + y^2 = 25$. If $x \neq 0$ then $\lambda = 1$ and $y = 0$ so $x^2 + 0^2 = 25$, $x = \pm 5$. If $x = 0$ then $0^2 + y^2 = 25$, $y = \pm 5$. Test $(\pm 5, 0)$ and $(0, \pm 5)$: $f(\pm 5, 0) = 25$, $f(0, \pm 5) = -25$, maximum 25 at $(\pm 5, 0)$, minimum -25 at $(0, \pm 5)$.
7. $12x^2 = 4x\lambda$, $2y = 2y\lambda$. If $y \neq 0$ then $\lambda = 1$ and $12x^2 = 4x$, $12x(x-1/3) = 0$, $x = 0$ or $x = 1/3$ so from $2x^2 + y^2 = 1$ we find that $y = \pm 1$ when $x = 0$, $y = \pm\sqrt{7}/3$ when $x = 1/3$. If $y = 0$ then $2x^2 + 0^2 = 1$, $x = \pm 1/\sqrt{2}$. Test $(0, \pm 1)$, $(1/3, \pm\sqrt{7}/3)$, and $(\pm 1/\sqrt{2}, 0)$. $f(0, \pm 1) = 1$, $f(1/3, \pm\sqrt{7}/3) = 25/27$, $f(1/\sqrt{2}, 0) = \sqrt{2}$, $f(-1/\sqrt{2}, 0) = -\sqrt{2}$. Maximum $\sqrt{2}$ at $(1/\sqrt{2}, 0)$, minimum $-\sqrt{2}$ at $(-1/\sqrt{2}, 0)$.
8. $1 = 2x\lambda$, $-3 = 6y\lambda$; $1/(2x) = -1/(2y)$, $y = -x$ so $x^2 + 3(-x)^2 = 16$, $x = \pm 2$. Test $(-2, 2)$ and $(2, -2)$. $f(-2, 2) = -9$, $f(2, -2) = 7$. Maximum 7 at $(2, -2)$, minimum -9 at $(-2, 2)$.
9. $2 = 2x\lambda$, $1 = 2y\lambda$, $-2 = 2z\lambda$; $1/x = 1/(2y) = -1/z$ thus $x = 2y$, $z = -2y$ so $(2y)^2 + y^2 + (-2y)^2 = 4$, $y^2 = 4/9$, $y = \pm 2/3$. Test $(-4/3, -2/3, 4/3)$ and $(4/3, 2/3, -4/3)$. $f(-4/3, -2/3, 4/3) = -6$, $f(4/3, 2/3, -4/3) = 6$. Maximum 6 at $(4/3, 2/3, -4/3)$, minimum -6 at $(-4/3, -2/3, 4/3)$.
10. $3 = 4x\lambda$, $6 = 8y\lambda$, $2 = 2z\lambda$; $3/(4x) = 3/(4y) = 1/z$ thus $y = x$, $z = 4x/3$, so $2x^2 + 4x^2 + (4x/3)^2 = 70$, $x^2 = 9$, $x = \pm 3$. Test $(-3, -3, -4)$ and $(3, 3, 4)$. $f(-3, -3, -4) = -35$, $f(3, 3, 4) = 35$. Maximum 35 at $(3, 3, 4)$, minimum -35 at $(-3, -3, -4)$.
11. $yz = 2x\lambda$, $xz = 2y\lambda$, $xy = 2z\lambda$; $yz/(2x) = xz/(2y) = xy/(2z)$ thus $y^2 = x^2$, $z^2 = x^2$ so $x^2 + x^2 + x^2 = 1$, $x = \pm 1/\sqrt{3}$. Test the eight possibilities with $x = \pm 1/\sqrt{3}$, $y = \pm 1/\sqrt{3}$, and $z = \pm 1/\sqrt{3}$ to find the maximum is $1/(3\sqrt{3})$ at $(1/\sqrt{3}, 1/\sqrt{3}, 1/\sqrt{3})$, $(1/\sqrt{3}, -1/\sqrt{3}, -1/\sqrt{3})$, $(-1/\sqrt{3}, 1/\sqrt{3}, -1/\sqrt{3})$, and $(-1/\sqrt{3}, -1/\sqrt{3}, 1/\sqrt{3})$; the minimum is $-1/(3\sqrt{3})$ at $(1/\sqrt{3}, 1/\sqrt{3}, -1/\sqrt{3})$, $(1/\sqrt{3}, -1/\sqrt{3}, 1/\sqrt{3})$, $(-1/\sqrt{3}, 1/\sqrt{3}, 1/\sqrt{3})$, and $(-1/\sqrt{3}, -1/\sqrt{3}, -1/\sqrt{3})$.
12. $4x^3 = 2\lambda x$, $4y^3 = 2\lambda y$, $4z^3 = 2\lambda z$; if x (or y or z) $\neq 0$ then $\lambda = 2x^2$ (or $2y^2$ or $2z^2$). Assume for the moment that $|x| \leq |y| \leq |z|$. Then:
 Case I: $x, y, z \neq 0$ so $\lambda = 2x^2 = 2y^2 = 2z^2$, $x = \pm y = \pm z$, $3x^2 = 1$, $x = \pm 1/\sqrt{3}$, $f(x, y, z) = 3/9 = 1/3$.
 Case II: $x = 0, y, z \neq 0$; then $y = \pm z$, $2y^2 = 1$, $y = \pm z = \pm 1/\sqrt{2}$, $f(x, y, z) = 2/4 = 1/2$.
 Case III: $x = y = 0, z \neq 0$; then $z^2 = 1$, $z = \pm 1$, $f(x, y, z) = 1$.
 Case IV: all other cases follow by symmetry.
- Thus f has a maximum value of 1 at $(0, 0, \pm 1)$, $(0, \pm 1, 0)$, and $(\pm 1, 0, 0)$ and a minimum value of $1/3$ at $(\pm 1/\sqrt{3}, \pm 1/\sqrt{3}, \pm 1/\sqrt{3})$.

13. False, it is a scalar.
14. False, they must be parallel, not necessarily equal.
15. False, there are three equations in three unknowns.
16. True, see the discussion before equation (3).
17. $f(x, y) = x^2 + y^2$; $2x = 2\lambda$, $2y = -4\lambda$; $y = -2x$ so $2x - 4(-2x) = 3$, $x = 3/10$. The point is $(3/10, -3/5)$.
18. $f(x, y) = (x - 4)^2 + (y - 2)^2$, $g(x, y) = y - 2x - 3$; $2(x - 4) = -2\lambda$, $2(y - 2) = \lambda$; $x - 4 = -2(y - 2)$, $x = -2y + 8$ so $y = 2(-2y + 8) + 3$, $y = 19/5$. The point is $(2/5, 19/5)$.
19. $f(x, y, z) = x^2 + y^2 + z^2$; $2x = \lambda$, $2y = 2\lambda$, $2z = \lambda$; $y = 2x$, $z = x$ so $x + 2(2x) + x = 1$, $x = 1/6$. The point is $(1/6, 1/3, 1/6)$.
20. $f(x, y, z) = (x - 1)^2 + (y + 1)^2 + (z - 1)^2$; $2(x - 1) = 4\lambda$, $2(y + 1) = 3\lambda$, $2(z - 1) = \lambda$; $x = 4z - 3$, $y = 3z - 4$ so $4(4z - 3) + 3(3z - 4) + z = 2$, $z = 1$. The point is $(1, -1, 1)$.
21. $f(x, y) = (x - 1)^2 + (y - 2)^2$; $2(x - 1) = 2x\lambda$, $2(y - 2) = 2y\lambda$; $(x - 1)/x = (y - 2)/y$, $y = 2x$ so $x^2 + (2x)^2 = 45$, $x = \pm 3$. $f(-3, -6) = 80$ and $f(3, 6) = 20$ so $(3, 6)$ is closest and $(-3, -6)$ is farthest.
22. $f(x, y, z) = x^2 + y^2 + z^2$; $2x = y\lambda$, $2y = x\lambda$, $2z = -2z\lambda$. If $z \neq 0$ then $\lambda = -1$ so $2x = -y$ and $2y = -x$, $x = y = 0$; substitute into $xy - z^2 = 1$ to get $z^2 = -1$ which has no real solution. If $z = 0$ then $xy - (0)^2 = 1$, $y = 1/x$, and also (from $2x = y\lambda$ and $2y = x\lambda$), $2x/y = 2y/x$, $y^2 = x^2$ so $(1/x)^2 = x^2$, $x^4 = 1$, $x = \pm 1$. Test $(1, 1, 0)$ and $(-1, -1, 0)$ to see that they are both closest to the origin.
23. $f(x, y, z) = x + y + z$, $x^2 + y^2 + z^2 = 25$ where x , y , and z are the components of the vector; $1 = 2x\lambda$, $1 = 2y\lambda$, $1 = 2z\lambda$; $1/(2x) = 1/(2y) = 1/(2z)$; $y = x$, $z = x$ so $x^2 + x^2 + x^2 = 25$, $x = \pm 5/\sqrt{3}$. $f(-5/\sqrt{3}, -5/\sqrt{3}, -5/\sqrt{3}) = -5\sqrt{3}$ and $f(5/\sqrt{3}, 5/\sqrt{3}, 5/\sqrt{3}) = 5\sqrt{3}$ so the vector is $5(\mathbf{i} + \mathbf{j} + \mathbf{k})/\sqrt{3}$.
24. $x^2 + y^2 = 25$ is the constraint; solve $8x - 4y = 2x\lambda$, $-4x + 2y = 2y\lambda$. If $x = 0$ then $y = 0$ and conversely; but $x^2 + y^2 = 25$, so x and y are nonzero. Thus $\lambda = (4x - 2y)/x = (-2x + y)/y$, so $0 = 2x^2 + 3xy - 2y^2 = (2x - y)(x + 2y)$, hence $y = 2x$ or $x = -2y$. If $y = 2x$ then $x^2 + (2x)^2 = 25$, $x = \pm\sqrt{5}$. If $x = -2y$ then $(-2y)^2 + y^2 = 25$, $y = \pm\sqrt{5}$. $T(-\sqrt{5}, -2\sqrt{5}) = T(\sqrt{5}, 2\sqrt{5}) = 0$ and $T(2\sqrt{5}, -\sqrt{5}) = T(-2\sqrt{5}, \sqrt{5}) = 125$. The highest temperature is 125 and the lowest is 0.
25. Minimize $f = x^2 + y^2 + z^2$ subject to $g(x, y, z) = x + y + z - 27 = 0$. $\nabla f = \lambda \nabla g$, $2x\mathbf{i} + 2y\mathbf{j} + 2z\mathbf{k} = \lambda\mathbf{i} + \lambda\mathbf{j} + \lambda\mathbf{k}$, solution $x = y = z = 9$, minimum value 243.
26. Maximize $f(x, y, z) = xyz^2$ subject to $g(x, y, z) = x + y + z - 5 = 0$, $\nabla f = \lambda \nabla g = \lambda(\mathbf{i} + \mathbf{j} + \mathbf{k})$, $\lambda = y^2 z^2 = 2xyz^2 = 2xy^2 z$, $\lambda = 0$ is impossible, hence $x, y, z \neq 0$, and $z = y = 2x$, $5x - 5 = 0$, $x = 1$, $y = z = 2$, maximum value 16 at $(1, 2, 2)$.
27. Minimize $f = x^2 + y^2 + z^2$ subject to $x^2 - yz = 5$, $\nabla f = \lambda \nabla g$, $2x = 2x\lambda$, $2y = -z\lambda$, $2z = -y\lambda$. If $\lambda \neq \pm 2$, then $y = z = 0$, $x = \pm\sqrt{5}$, $f = 5$; if $\lambda = \pm 2$ then $x = 0$, and since $-yz = 5$, $y = -z = \pm\sqrt{5}$, $f = 10$, thus the minimum value is 5 at $(\pm\sqrt{5}, 0, 0)$.
28. The diagonal of the box must equal the diameter of the sphere so maximize $V = xyz$ or, for convenience, maximize $f = V^2 = x^2 y^2 z^2$ subject to $g(x, y, z) = x^2 + y^2 + z^2 - 4a^2 = 0$, $\nabla f = \lambda \nabla g$, $2xy^2 z^2 = 2\lambda x$, $2x^2 yz^2 = 2\lambda y$, $2x^2 y^2 z = 2\lambda z$. Since $V \neq 0$ it follows that $x, y, z \neq 0$, hence $x = y = z$, $3x^2 = 4a^2$, $x = 2a/\sqrt{3}$, maximum volume $8a^3/(3\sqrt{3})$.
29. Let x , y , and z be, respectively, the length, width, and height of the box. Minimize $f(x, y, z) = 10(2xy) + 5(2xz + 2yz) = 10(2xy + xz + yz)$ subject to $g(x, y, z) = xyz - 16 = 0$, $\nabla f = \lambda \nabla g$, $20y + 10z = \lambda yz$, $20x + 10z = \lambda xz$, $10x + 10y = \lambda xy$. Since $V = xyz = 16$, $x, y, z \neq 0$, thus $\lambda z = 20 + 10(z/y) = 20 + 10(z/x)$, so $x = y$.

From this and $10x + 10y = \lambda xy$ it follows that $20 = \lambda x$, so $10z = 20x$, $z = 2x = 2y$, $V = 2x^3 = 16$ and thus $x = y = 2$ ft, $z = 4$ ft, $f(2, 2, 4) = 240$ cents.

30. (a) If $g(x, y) = x = 0$ then $8x + 2y = \lambda$, $-6y + 2x = 0$; but $x = 0$, so $y = \lambda = 0$, $f(0, 0) = 0$ maximum, $f(0, 1) = -3$, minimum. If $g(x, y) = x - 1 = 0$ then $8x + 2y = \lambda$, $-6y + 2x = 0$; but $x = 1$, so $y = 1/3$, $f(1, 1/3) = 13/3$ maximum, $f(1, 0) = 4$, $f(1, 1) = 3$ minimum. If $g(x, y) = y = 0$ then $8x + 2y = 0$, $-6y + 2x = \lambda$; but $y = 0$ so $x = \lambda = 0$, $f(0, 0) = 0$ minimum, $f(1, 0) = 4$, maximum. If $g(x, y) = y - 1 = 0$ then $8x + 2y = 0$, $-6y + 2x = \lambda$; but $y = 1$ so $x = -1/4$, no solution, $f(0, 1) = -3$ minimum, $f(1, 1) = 3$ maximum.

(b) If $g(x, y) = x - y = 0$ then $8x + 2y = \lambda$, $-6y + 2x = -\lambda$; but $x = y$ so solution $x = y = \lambda = 0$, $f(0, 0) = 0$ minimum, $f(1, 1) = 3$ maximum. If $g(x, y) = 1 - x - y = 0$ then $8x + 2y = -1$, $-6y + 2x = -1$; but $x + y = 1$ so solution is $x = -2/13$, $y = 3/2$ which is not on diagonal, $f(0, 1) = -3$ minimum, $f(1, 0) = 4$ maximum.

31. Maximize $A(a, b, \alpha) = ab \sin \alpha$ subject to $g(a, b, \alpha) = 2a + 2b - \ell = 0$, $\nabla_{(a,b,\alpha)} A = \lambda \nabla_{(a,b,\alpha)} g$, $b \sin \alpha = 2\lambda$, $a \sin \alpha = 2\lambda$, $ab \cos \alpha = 0$ with solution $a = b (= \ell/4)$, $\alpha = \pi/2$ maximum value if parallelogram is a square.

32. Minimize $f(x, y, z) = xy + 2xz + 2yz$ subject to $g(x, y, z) = xyz - V = 0$, $\nabla f = \lambda \nabla g$, $y + 2z = \lambda yz$, $x + 2z = \lambda xz$, $2x + 2y = \lambda xy$; $\lambda = 0$ leads to $x = y = z = 0$, impossible, so solve for $\lambda = 1/z + 2/x = 1/z + 2/y = 2/y + 2/x$, so $x = y = 2z$, $x^3 = 2V$, minimum value $3(2V)^{2/3}$.

33. (a) Maximize $f(\alpha, \beta, \gamma) = \cos \alpha \cos \beta \cos \gamma$ subject to $g(\alpha, \beta, \gamma) = \alpha + \beta + \gamma - \pi = 0$, $\nabla f = \lambda \nabla g$, $-\sin \alpha \cos \beta \cos \gamma = \lambda$, $-\cos \alpha \sin \beta \cos \gamma = \lambda$, $-\cos \alpha \cos \beta \sin \gamma = \lambda$ with solution $\alpha = \beta = \gamma = \pi/3$, maximum value $1/8$.

(b) For example, $f(\alpha, \beta) = \cos \alpha \cos \beta \cos(\pi - \alpha - \beta)$.

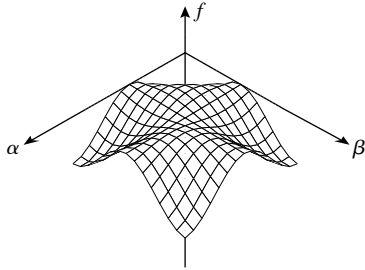

34. Find maxima and minima $z = x^2 + 4y^2$ subject to the constraint $g(x, y) = x^2 + y^2 - 1 = 0$, $\nabla z = \lambda \nabla g$, $2xi + 8yj = 2\lambda xi + 2\lambda yj$, solve $2x = 2\lambda x$, $8y = 2\lambda y$. If $y \neq 0$ then $\lambda = 4$, $x = 0$, $y^2 = 1$ and $z = x^2 + 4y^2 = 4$. If $y = 0$ then $x^2 = 1$ and $z = 1$, so the maximum height is obtained for $(x, y) = (0, \pm 1)$, $z = 4$ and the minimum height is $z = 1$ at $(\pm 1, 0)$.

Chapter 13 Review Exercises

1. (a) $f(\ln y, e^x) = e^{\ln y} \ln e^x = xy$.

(b) $f(r + s, rs) = e^{r+s} \ln(rs)$.

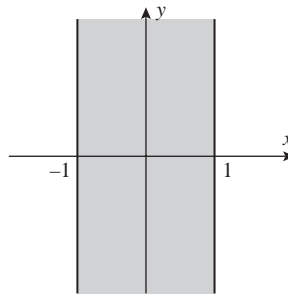
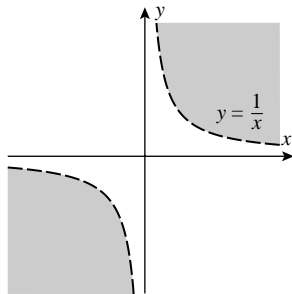

3. $z = \sqrt{x^2 + y^2} = c$ implies $x^2 + y^2 = c^2$, which is the equation of a circle; $x^2 + y^2 = c$ is also the equation of a circle (for $c > 0$).

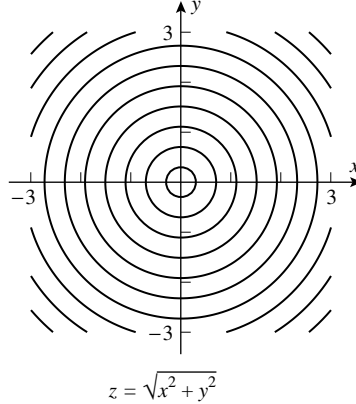
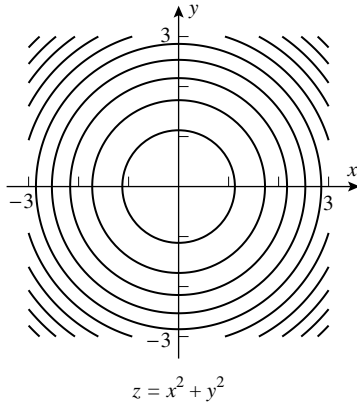

4. (b) $f(x, y, z) = z - x^2 - y^2$.
5. $x^4 - x + y - x^3y = (x^3 - 1)(x - y)$, limit = -1 , not defined on the line $y = x$ so not continuous at $(0, 0)$.
6. If $(x, y) \neq (0, 0)$, then $\frac{x^4 - y^4}{x^2 + y^2} = x^2 - y^2$, limit: $\lim_{(x,y) \rightarrow (0,0)} (x^2 - y^2) = 0$, continuous.
7. (a) They approximate the profit per unit of any additional sales of the standard or high-resolution monitors, respectively.
- (b) The rates of change with respect to the two directions x and y , and with respect to time.
9. (a) $P = \frac{10T}{V}$, $\frac{dP}{dt} = \frac{\partial P}{\partial T} \frac{dT}{dt} + \frac{\partial P}{\partial V} \frac{dV}{dt} = \frac{10}{V} \cdot 3 - \frac{10T}{V^2} \cdot 0 = \frac{30}{V} = \frac{30}{2.5} = 12 \text{ N}/(\text{m}^2 \text{ min}) = 12 \text{ Pa}/\text{min}$.
- (b) $\frac{dP}{dt} = \frac{\partial P}{\partial T} \frac{dT}{dt} + \frac{\partial P}{\partial V} \frac{dV}{dt} = \frac{10}{V} \cdot 0 - \frac{10T}{V^2} \cdot (-3) = \frac{30T}{V^2} = \frac{30 \cdot 50}{(2.5)^2} = 240 \text{ Pa}/\text{min}$.
10. (a) $z = 1 - y^2$, slope $= \frac{\partial z}{\partial y} = -2y = 4$. (b) $z = 1 - 4x^2$, $\frac{\partial z}{\partial x} = -8x = -8$.
11. $w_x = 2x \sec^2(x^2 + y^2) + \sqrt{y}$, $w_{xy} = 8xy \sec^2(x^2 + y^2) \tan(x^2 + y^2) + \frac{1}{2}y^{-1/2}$, $w_y = 2y \sec^2(x^2 + y^2) + \frac{1}{2}xy^{-1/2}$, $w_{yx} = 8xy \sec^2(x^2 + y^2) \tan(x^2 + y^2) + \frac{1}{2}y^{-1/2}$.
12. $\partial w / \partial x = \frac{1}{x - y} - \sin(x + y)$, $\partial^2 w / \partial x^2 = -\frac{1}{(x - y)^2} - \cos(x + y)$, $\partial w / \partial y = -\frac{1}{x - y} - \sin(x + y)$, $\partial^2 w / \partial y^2 = -\frac{1}{(x - y)^2} - \cos(x + y) = \partial^2 w / \partial x^2$.
13. $F_x = -6xz$, $F_{xx} = -6z$, $F_y = -6yz$, $F_{yy} = -6z$, $F_z = 6z^2 - 3x^2 - 3y^2$, $F_{zz} = 12z$, $F_{xx} + F_{yy} + F_{zz} = -6z - 6z + 12z = 0$.
14. $f_x = yz + 2x$, $f_{xy} = z$, $f_{xyz} = 1$, $f_{xyzx} = 0$; $f_z = xy - (1/z)$, $f_{zx} = y$, $f_{zxx} = 0$, $f_{zxxy} = 0$.
16. $\Delta w = (1.1)^2(-0.1) - 2(1.1)(-0.1) + (-0.1)^2(1.1) - 0 = 0.11$, $dw = (2xy - 2y + y^2)dx + (x^2 - 2x + 2yx)dy = -(-0.1) = 0.1$.
17. $dV = \frac{2}{3}xhdx + \frac{1}{3}x^2dh = \frac{2}{3}2(-0.1) + \frac{1}{3}(0.2) = -0.06667 \text{ m}^3$; $\Delta V = -0.07267 \text{ m}^3$.
18. $f_x\left(\frac{1}{3}, \pi\right) = \pi \cos \frac{\pi}{3} = \frac{\pi}{2}$, $f_y\left(\frac{1}{3}, \pi\right) = \frac{1}{3} \cos \frac{\pi}{3} = \frac{1}{6}$, so $L(x, y) = \frac{\sqrt{3}}{2} + \frac{\pi}{2}\left(x - \frac{1}{3}\right) + \frac{1}{6}(y - \pi)$.

19. $\frac{dz}{dt} = \frac{\partial z}{\partial x} \frac{dx}{dt} + \frac{\partial z}{\partial y} \frac{dy}{dt}$, so when $t = 0$, $4\left(-\frac{1}{2}\right) + 2\frac{dy}{dt} = 2$. Solve to obtain $\left.\frac{dy}{dt}\right|_{t=0} = 2$.
20. (a) $\frac{dy}{dx} = -\frac{6x - 5y + y \sec^2 xy}{-5x + x \sec^2 xy}$. (b) $\frac{dy}{dx} = -\frac{\ln y + \cos(x - y)}{x/y - \cos(x - y)}$.
21. $\frac{dy}{dx} = -\frac{f_x}{f_y}$, $\frac{d^2y}{dx^2} = -\frac{f_y(d/dx)f_x - f_x(d/dx)f_y}{f_y^2} = -\frac{f_y(f_{xx} + f_{xy}(dy/dx)) - f_x(f_{xy} + f_{yy}(dy/dx))}{f_y^2} =$
 $= -\frac{f_y(f_{xx} + f_{xy}(-f_x/f_y)) - f_x(f_{xy} + f_{yy}(-f_x/f_y))}{f_y^2} = \frac{-f_y^2 f_{xx} + 2f_x f_y f_{xy} - f_x^2 f_{yy}}{f_y^3}$.
22. (a) $\frac{d}{dt} \left(\frac{\partial z}{\partial x} \right) = \frac{\partial}{\partial x} \left(\frac{\partial z}{\partial x} \right) \frac{dx}{dt} + \frac{\partial}{\partial y} \left(\frac{\partial z}{\partial x} \right) \frac{dy}{dt} = \frac{\partial^2 z}{\partial x^2} \frac{dx}{dt} + \frac{\partial^2 z}{\partial y \partial x} \frac{dy}{dt}$ by the Chain Rule, and $\frac{d}{dt} \left(\frac{\partial z}{\partial y} \right) =$
 $\frac{\partial}{\partial x} \left(\frac{\partial z}{\partial y} \right) \frac{dx}{dt} + \frac{\partial}{\partial y} \left(\frac{\partial z}{\partial y} \right) \frac{dy}{dt} = \frac{\partial^2 z}{\partial x \partial y} \frac{dx}{dt} + \frac{\partial^2 z}{\partial y^2} \frac{dy}{dt}$.
- (b) $\frac{dz}{dt} = \frac{\partial z}{\partial x} \frac{dx}{dt} + \frac{\partial z}{\partial y} \frac{dy}{dt}$, $\frac{d^2z}{dt^2} = \frac{dx}{dt} \left(\frac{\partial^2 z}{\partial x^2} \frac{dx}{dt} + \frac{\partial^2 z}{\partial y \partial x} \frac{dy}{dt} \right) + \frac{\partial z}{\partial x} \frac{d^2x}{dt^2} + \frac{dy}{dt} \left(\frac{\partial^2 z}{\partial x \partial y} \frac{dx}{dt} + \frac{\partial^2 z}{\partial y^2} \frac{dy}{dt} \right) + \frac{\partial z}{\partial y} \frac{d^2y}{dt^2}$.
25. $\nabla f = \frac{y}{x+y} \mathbf{i} + \left(\ln(x+y) + \frac{y}{x+y} \right) \mathbf{j}$, so when $(x, y) = (-3, 5)$, $\frac{\partial f}{\partial u} = \nabla f \cdot \mathbf{u} = \left[\frac{5}{2} \mathbf{i} + \left(\ln 2 + \frac{5}{2} \right) \mathbf{j} \right] \cdot \left[\frac{3}{5} \mathbf{i} + \frac{4}{5} \mathbf{j} \right] =$
 $\frac{3}{2} + 2 + \frac{4}{5} \ln 2 = \frac{7}{2} + \frac{4}{5} \ln 2$.
26. (a) \mathbf{u} is a unit vector parallel to the gradient, so $\mathbf{u} = \frac{2}{5} \left(2\mathbf{i} + \frac{3}{2}\mathbf{j} \right) = \frac{4}{5} \mathbf{i} + \frac{3}{5} \mathbf{j}$. The maximum value is $\nabla f(0, 0) \cdot \mathbf{u} =$
 $\frac{8}{5} + \frac{9}{10} = \frac{5}{2}$.
- (b) The unit vector to give the minimum has the opposite sense of the vector in Part(a), so $\mathbf{u} = -\frac{4}{5} \mathbf{i} - \frac{3}{5} \mathbf{j}$ and
 $\nabla f(0, 0) \cdot \mathbf{u} = -\frac{5}{2}$.
27. Use the unit vectors $\mathbf{u} = \left\langle \frac{1}{\sqrt{2}}, \frac{1}{\sqrt{2}} \right\rangle$, $\mathbf{v} = \langle 0, -1 \rangle$, $\mathbf{w} = \left\langle -\frac{1}{\sqrt{5}}, -\frac{2}{\sqrt{5}} \right\rangle = -\frac{\sqrt{2}}{\sqrt{5}} \mathbf{u} + \frac{1}{\sqrt{5}} \mathbf{v}$, so that $D_{\mathbf{w}} f = -\frac{\sqrt{2}}{\sqrt{5}} D_{\mathbf{u}} f +$
 $\frac{1}{\sqrt{5}} D_{\mathbf{v}} f = -\frac{\sqrt{2}}{\sqrt{5}} 2\sqrt{2} + \frac{1}{\sqrt{5}} (-3) = -\frac{7}{\sqrt{5}}$.
28. (a) $\mathbf{n} = z_x \mathbf{i} + z_y \mathbf{j} - \mathbf{k} = 8\mathbf{i} + 8\mathbf{j} - \mathbf{k}$, tangent plane $8x + 8y - z = 4 + 8 \ln 2$, normal line $x(t) = 1 + 8t, y(t) =$
 $\ln 2 + 8t, z(t) = 4 - t$.
- (b) $\mathbf{n} = 3\mathbf{i} + 10\mathbf{j} - 14\mathbf{k}$, tangent plane $3x + 10y - 14z = 30$, normal line $x(t) = 2 + 3t, y(t) = 1 + 10t, z(t) = -1 - 14t$.
29. The origin is not such a point, so assume that the normal line at $(x_0, y_0, z_0) \neq (0, 0, 0)$ passes through the origin, then $\mathbf{n} = z_x \mathbf{i} + z_y \mathbf{j} - \mathbf{k} = -y_0 \mathbf{i} - x_0 \mathbf{j} - \mathbf{k}$; the line passes through the origin and is normal to the surface if it has the form $\mathbf{r}(t) = -y_0 t \mathbf{i} - x_0 t \mathbf{j} - t \mathbf{k}$ and $(x_0, y_0, z_0) = (x_0, y_0, 2 - x_0 y_0)$ lies on the line if $-y_0 t = x_0, -x_0 t = y_0, -t = 2 - x_0 y_0$, with solutions $x_0 = y_0 = -1, x_0 = y_0 = 1, x_0 = y_0 = 0$; thus the points are $(0, 0, 2), (1, 1, 1), (-1, -1, 1)$.
30. $\mathbf{n} = \frac{2}{3} x_0^{-1/3} \mathbf{i} + \frac{2}{3} y_0^{-1/3} \mathbf{j} + \frac{2}{3} z_0^{-1/3} \mathbf{k}$, tangent plane $x_0^{-1/3} x + y_0^{-1/3} y + z_0^{-1/3} z = x_0^{2/3} + y_0^{2/3} + z_0^{2/3} = 1$; intercepts are $x = x_0^{1/3}, y = y_0^{1/3}, z = z_0^{1/3}$, sum of squares of intercepts is $x_0^{2/3} + y_0^{2/3} + z_0^{2/3} = 1$.
31. The line is tangent to $6\mathbf{i} + 4\mathbf{j} + \mathbf{k}$, a normal to the surface is $\mathbf{n} = 18x\mathbf{i} + 8y\mathbf{j} - \mathbf{k}$, so solve $18x = 6k, 8y = 4k, -1 = k$; $k = -1, x = -1/3, y = -1/2, z = 2$.

32. Solve $(t - 1)^2/4 + 16e^{-2t} + (2 - \sqrt{t})^2 = 1$ for t to get $t = 1.833223, 2.839844$; the particle strikes the surface at the points $P_1(0.83322, 0.639589, 0.646034), P_2(1.83984, 0.233739, 0.314816)$. The velocity vectors are given by $\mathbf{v} = \frac{dx}{dt}\mathbf{i} + \frac{dy}{dt}\mathbf{j} + \frac{dz}{dt}\mathbf{k} = \mathbf{i} - 4e^{-t}\mathbf{j} - 1/(2\sqrt{t})\mathbf{k}$, and a normal to the surface is $\mathbf{n} = \nabla(x^2/4 + y^2 + z^2) = x/2\mathbf{i} + 2y\mathbf{j} + 2z\mathbf{k}$. At the points P_i these are $\mathbf{v}_1 = \mathbf{i} - 0.639589\mathbf{j} - 0.369286\mathbf{k}, \mathbf{v}_2 = \mathbf{i} - 0.233739\mathbf{j} - 0.296704\mathbf{k}; \mathbf{n}_1 = 0.41661\mathbf{i} + 1.27918\mathbf{j} + 1.29207\mathbf{k}$ and $\mathbf{n}_2 = 0.91992\mathbf{i} + 0.46748\mathbf{j} + 0.62963\mathbf{k}$ so $\cos^{-1}[(\mathbf{v}_i \cdot \mathbf{n}_i)/(\|\mathbf{v}_i\| \|\mathbf{n}_i\|)] = 112.3^\circ, 61.1^\circ$; the acute angles are $67.7^\circ, 61.1^\circ$.
33. $\nabla f = (2x + 3y - 6)\mathbf{i} + (3x + 6y + 3)\mathbf{j} = \mathbf{0}$ if $2x + 3y = 6, x + 2y = -1, x = 15, y = -8, D = 3 > 0, f_{xx} = 2 > 0$, so f has a relative minimum at $(15, -8)$.
34. $\nabla f = (2xy - 6x)\mathbf{i} + (x^2 - 12y)\mathbf{j} = \mathbf{0}$ if $2xy - 6x = 0, x^2 - 12y = 0$; if $x = 0$ then $y = 0$, and if $x \neq 0$ then $y = 3, x = \pm 6$, thus the gradient vanishes at $(0, 0), (-6, 3), (6, 3)$; $f_{xx} = 2y - 6, f_{yy} = -12, f_{xy} = 2x$, so $D = -24y + 72 - 4x^2$, so $(\pm 6, 3)$ are saddle points, and $(0, 0)$ is a relative maximum.
35. $\nabla f = (3x^2 - 3y)\mathbf{i} - (3x - y)\mathbf{j} = \mathbf{0}$ if $y = x^2, 3x = y$, so $x = y = 0$ or $x = 3, y = 9$; at $x = y = 0, D = -9$, saddle point; at $x = 3, y = 9, D = 9, f_{xx} = 18 > 0$, relative minimum.
36. $\nabla f = (8x - 12y)\mathbf{i} + (-12x + 18y)\mathbf{j} = \mathbf{0}$ if $y = \frac{2}{3}x; f_{xx} = 8, f_{xy} = -12, f_{yy} = 18, D = 0$, from which we can draw no conclusion. Upon inspection, however, $f(x, y) = (2x - 3y)^2$, so f has a relative (and an absolute) minimum of 0 at every point on the line $y = \frac{2}{3}x$, no relative maximum.
37. (a) $y^2 = 8 - 4x^2$, find extrema of $f(x) = x^2(8 - 4x^2) = -4x^4 + 8x^2$ defined for $-\sqrt{2} \leq x \leq \sqrt{2}$. Then $f'(x) = -16x^3 + 16x = 0$ when $x = 0, \pm 1, f''(x) = -48x^2 + 16$, so f has a relative maximum at $x = \pm 1, y = \pm 2$ and a relative minimum at $x = 0, y = \pm 2\sqrt{2}$. At the endpoints $x = \pm\sqrt{2}, y = 0$ we obtain the minimum $f = 0$ again.
- (b) $f(x, y) = x^2y^2, g(x, y) = 4x^2 + y^2 - 8 = 0, \nabla f = 2xy^2\mathbf{i} + 2x^2y\mathbf{j} = \lambda\nabla g = 8\lambda x\mathbf{i} + 2\lambda y\mathbf{j}$, so solve $2xy^2 = 8\lambda x, 2x^2y = 2\lambda y$. If $x = 0$ then $y = \pm 2\sqrt{2}$, and if $y = 0$ then $x = \pm\sqrt{2}$. In either case f has a relative and absolute minimum. Assume $x, y \neq 0$, then $y^2 = 4\lambda, x^2 = \lambda$, use $g = 0$ to obtain $x^2 = 1, x = \pm 1, y = \pm 2$, and $f = 4$ is a relative and absolute maximum at $(\pm 1, \pm 2)$.
38. Let the first octant corner of the box be (x, y, z) , so that $(x/a)^2 + (y/b)^2 + (z/c)^2 = 1$. Maximize $V = 8xyz$ subject to $g(x, y, z) = (x/a)^2 + (y/b)^2 + (z/c)^2 = 1$, solve $\nabla V = \lambda\nabla g$, or $8(yz\mathbf{i} + xz\mathbf{j} + xy\mathbf{k}) = (2\lambda x/a^2)\mathbf{i} + (2\lambda y/b^2)\mathbf{j} + (2\lambda z/c^2)\mathbf{k}, 8a^2yz = 2\lambda x, 8b^2xz = 2\lambda y, 8c^2xy = 2\lambda z$. For the maximum volume, $x, y, z \neq 0$; divide the first equation by the second to obtain $a^2y^2 = b^2x^2$; the first by the third to obtain $a^2z^2 = c^2x^2$, and finally $b^2z^2 = c^2y^2$. From $g = 1$ get $3(x/a)^2 = 1, x = \pm a/\sqrt{3}$, and then $y = \pm b/\sqrt{3}, z = \pm c/\sqrt{3}$. The dimensions of the box are $\frac{2a}{\sqrt{3}} \times \frac{2b}{\sqrt{3}} \times \frac{2c}{\sqrt{3}}$, and the maximum volume is $8abc/(3\sqrt{3})$.
39. Denote the currents I_1, I_2, I_3 by x, y, z respectively. Then minimize $F(x, y, z) = x^2R_1 + y^2R_2 + z^2R_3$ subject to $g(x, y, z) = x + y + z - I = 0$, so solve $\nabla F = \lambda\nabla g, 2xR_1\mathbf{i} + 2yR_2\mathbf{j} + 2zR_3\mathbf{k} = \lambda(\mathbf{i} + \mathbf{j} + \mathbf{k}), \lambda = 2xR_1 = 2yR_2 = 2zR_3$, so the minimum value of F occurs when $I_1 : I_2 : I_3 = \frac{1}{R_1} : \frac{1}{R_2} : \frac{1}{R_3}$.

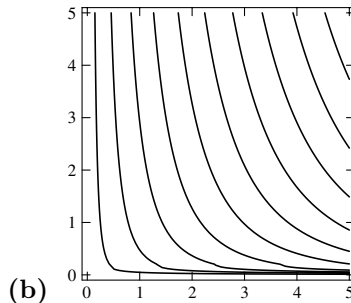
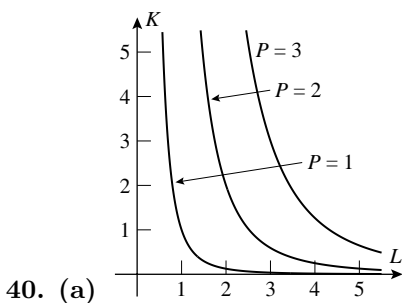

41. (a) $\partial P/\partial L = c\alpha L^{\alpha-1}K^\beta, \partial P/\partial K = c\beta L^\alpha K^{\beta-1}$.

(b) The rates of change of output with respect to labor and capital equipment, respectively.

(c) $K(\partial P/\partial K) + L(\partial P/\partial L) = c\beta L^\alpha K^\beta + c\alpha L^\alpha K^\beta = (\alpha + \beta)P = P$.

42. (a) Maximize $P = 1000L^{0.6}K^{0.4}$ subject to $50L + 100K = 200,000$ or $L + 2K = 4000$. $600\left(\frac{K}{L}\right)^{0.4} = \lambda$, $400\left(\frac{L}{K}\right)^{0.6} = 2\lambda$, $L + 2K = 4000$; so $\frac{2}{3}\left(\frac{L}{K}\right) = 2$, thus $L = 3K$, $L = 2400, K = 800, P(2400, 800) = 1000 \cdot 2400^{0.6} \cdot 800^{0.4} = 1000 \cdot 3^{0.6} \cdot 800 = 800,000 \cdot 3^{0.6} \approx \$1,546,545.64$.

(b) The value of labor is $50L = 120,000$ and the value of capital is $100K = 80,000$.

Chapter 13 Making Connections

1. $\frac{\partial z}{\partial r} = \frac{\partial z}{\partial x} \frac{\partial x}{\partial r} + \frac{\partial z}{\partial y} \frac{\partial y}{\partial r} = \cos \theta \frac{\partial z}{\partial x} + \sin \theta \frac{\partial z}{\partial y}$, multiply by r to get the first equation. $\frac{\partial z}{\partial \theta} = \frac{\partial z}{\partial x} \frac{\partial x}{\partial \theta} + \frac{\partial z}{\partial y} \frac{\partial y}{\partial \theta} = -r \sin \theta \frac{\partial z}{\partial x} + r \cos \theta \frac{\partial z}{\partial y} = -y \frac{\partial z}{\partial x} + x \frac{\partial z}{\partial y}$.

2. (a) $f(tx, ty) = 3t^2x^2 + t^2y^2 = t^2f(x, y); n = 2$.

(b) $f(tx, ty) = \sqrt{t^2x^2 + t^2y^2} = tf(x, y); n = 1$.

(c) $f(tx, ty) = t^3x^2y - 2t^3y^3 = t^3f(x, y); n = 3$.

(d) $f(tx, ty) = 5/(t^2x^2 + 2t^2y^2)^2 = t^{-4}f(x, y); n = -4$.

3. Suppose $g(\theta)$ exists such that $f(x, y) = r^n g(\theta)$ is homogeneous of degree n . Then $f(tx, ty) = (tr)^n g(\theta) = t^n [r^n g(\theta)] = t^n f(x, y)$. Conversely if $f(x, y)$ is homogeneous of degree n then let $g(\theta) = f(\cos \theta, \sin \theta)$. Then $f(x, y) = f(r \cos \theta, r \sin \theta) = r^n f(\cos \theta, \sin \theta) = r^n g(\theta)$; moreover, $g(\theta)$ has period 2π .

4. (a) If $f(u, v) = t^n f(x, y)$, then $\frac{\partial f}{\partial u} \frac{du}{dt} + \frac{\partial f}{\partial v} \frac{dv}{dt} = nt^{n-1} f(x, y)$, $x \frac{\partial f}{\partial u} + y \frac{\partial f}{\partial v} = nt^{n-1} f(x, y)$; let $t = 1$ to get $x \frac{\partial f}{\partial x} + y \frac{\partial f}{\partial y} = n f(x, y)$.

(b) Let $f(x, y)$ be homogeneous of degree n , so that $f(x, y) = r^n g(\theta)$, where g has period 2π . Then $f_x = nr^{n-1} g(\theta) \frac{x}{r} - r^n g'(\theta) \frac{y}{r^2}$, $f_y = nr^{n-1} g(\theta) \frac{y}{r} + r^n g'(\theta) \frac{x}{r^2}$, so

$$xf_x + yf_y = r^n (ng(\theta) \cos^2 \theta + ng(\theta) \sin^2 \theta - g'(\theta) [\cos \theta \sin \theta - \sin \theta \cos \theta]) = nr^n g(\theta) = n f(x, y).$$

(c) If $f(x, y) = 3x^2 + y^2$ then $xf_x + yf_y = 6x^2 + 2y^2 = 2f(x, y)$; if $f(x, y) = \sqrt{x^2 + y^2}$ then $xf_x + yf_y = x^2/\sqrt{x^2 + y^2} + y^2/\sqrt{x^2 + y^2} = \sqrt{x^2 + y^2} = f(x, y)$; if $f(x, y) = x^2y - 2y^3$ then $xf_x + yf_y = 3x^2y - 6y^3 = 3f(x, y)$; if $f(x, y) = \frac{5}{(x^2 + 2y^2)^2}$ then $xf_x + yf_y = x \frac{5(-2)2x}{(x^2 + 2y^2)^3} + y \frac{5(-2)4y}{(x^2 + 2y^2)^3} = -4f(x, y)$.

5. Write $f(x, y) = z(r, \theta)$ in polar form. From the hypotheses and Exercise 1 of this section we see that $r \frac{\partial z}{\partial r} - nz = 0$.

Divide by r^{n+1} to obtain $r^{-n} \frac{\partial z}{\partial r} - nr^{-n-1} z = 0$, $\frac{\partial}{\partial r}(r^{-n} z) = 0$. Thus $r^{-n} z$ is independent of r , say $r^{-n} z = g(\theta)$, $z = r^n g(\theta)$. From Exercise 3 it follows that f is homogeneous of degree n provided that g is 2π periodic; but this follows from the fact that z is defined in terms of sines and cosines.

Multiple Integrals

Exercise Set 14.1

- $$1. \int_0^1 \int_0^2 (x+3) dy dx = \int_0^1 (2x+6) dx = 7.$$
- $$2. \int_1^3 \int_{-1}^1 (2x-4y) dy dx = \int_1^3 4x dx = 16.$$
- $$3. \int_2^4 \int_0^1 x^2 y dx dy = \int_2^4 \frac{1}{3} y dy = 2.$$
- $$4. \int_{-2}^0 \int_{-1}^2 (x^2 + y^2) dx dy = \int_{-2}^0 (3 + 3y^2) dy = 14.$$
- $$5. \int_0^{\ln 3} \int_0^{\ln 2} e^{x+y} dy dx = \int_0^{\ln 3} e^x dx = 2.$$
- $$6. \int_0^2 \int_0^1 y \sin x dy dx = \int_0^2 \frac{1}{2} \sin x dx = \frac{1 - \cos 2}{2}.$$
- $$7. \int_{-1}^0 \int_2^5 dx dy = \int_{-1}^0 3 dy = 3.$$
- $$8. \int_4^6 \int_{-3}^7 dy dx = \int_4^6 10 dx = 20.$$
- $$9. \int_0^1 \int_0^1 \frac{x}{(xy+1)^2} dy dx = \int_0^1 \left(1 - \frac{1}{x+1}\right) dx = 1 - \ln 2.$$
- $$10. \int_{\pi/2}^{\pi} \int_1^2 x \cos xy dy dx = \int_{\pi/2}^{\pi} (\sin 2x - \sin x) dx = -2.$$
- $$11. \int_0^{\ln 2} \int_0^1 xy e^{y^2 x} dy dx = \int_0^{\ln 2} \frac{1}{2} (e^x - 1) dx = \frac{1 - \ln 2}{2}.$$
- $$12. \int_3^4 \int_1^2 \frac{1}{(x+y)^2} dy dx = \int_3^4 \left(\frac{1}{x+1} - \frac{1}{x+2}\right) dx = \ln(25/24).$$
- $$13. \int_{-1}^1 \int_{-2}^2 4xy^3 dy dx = \int_{-1}^1 0 dx = 0.$$
- $$14. \int_0^1 \int_0^1 \frac{xy}{\sqrt{x^2 + y^2 + 1}} dy dx = \int_0^1 [x(x^2 + 2)^{1/2} - x(x^2 + 1)^{1/2}] dx = \frac{1}{3}(3\sqrt{3} - 4\sqrt{2} + 1).$$

$$15. \int_0^1 \int_2^3 x \sqrt{1-x^2} dy dx = \int_0^1 x(1-x^2)^{1/2} dx = \frac{1}{3}.$$

$$16. \int_0^{\pi/2} \int_0^{\pi/3} (x \sin y - y \sin x) dy dx = \int_0^{\pi/2} \left(\frac{x}{2} - \frac{\pi^2}{18} \sin x \right) dx = \frac{\pi^2}{144}.$$

$$17. (a) \quad x_k^* = k/2 - 1/4, k = 1, 2, 3, 4; y_l^* = l/2 - 1/4, l = 1, 2, 3, 4, \iint_R f(x, y) dx dy \approx \sum_{k=1}^4 \sum_{l=1}^4 f(x_k^*, y_l^*) \Delta A_{kl} = \sum_{k=1}^4 \sum_{l=1}^4 \left[\left(\frac{k}{2} - \frac{1}{4} \right)^2 + \left(\frac{l}{2} - \frac{1}{4} \right)^2 \right] \left(\frac{1}{2} \right)^2 = \frac{37}{4}.$$

$$(b) \quad \int_0^2 \int_0^2 (x^2 + y) dx dy = \frac{28}{3}; \text{ the error is } \left| \frac{37}{4} - \frac{28}{3} \right| = \frac{1}{12}.$$

$$18. (a) \quad x_k^* = k/2 - 1/4, k = 1, 2, 3, 4; y_l^* = l/2 - 1/4, l = 1, 2, 3, 4, \iint_R f(x, y) dx dy \approx \sum_{k=1}^4 \sum_{l=1}^4 f(x_k^*, y_l^*) \Delta A_{kl} = \sum_{k=1}^4 \sum_{l=1}^4 \left[\left(\frac{k}{2} - \frac{1}{4} \right) - 2 \left(\frac{l}{2} - \frac{1}{4} \right) \right] \left(\frac{1}{2} \right)^2 = -4.$$

$$(b) \quad \int_0^2 \int_0^2 (x - 2y) dx dy = -4; \text{ the error is zero.}$$

19. The solid is a rectangular box with sides of length 1, 5, and 4, so its volume is $1 \cdot 5 \cdot 4 = 20$;

$$\int_0^5 \int_1^2 4 dx dy = \int_0^5 4x \Big|_{x=1}^2 dy = \int_0^5 4 dy = 20.$$

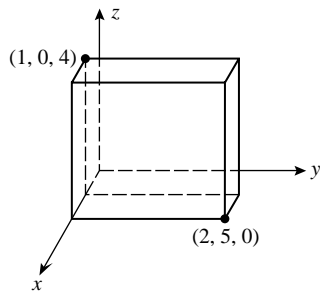

20. Two copies of the solid will fit together to form a rectangular box whose base is a square of side 1 and whose height is 2, so the solid's volume is $(1^2 \cdot 2)/2 = 1$;

$$\int_0^1 \int_0^1 (2 - x - y) dx dy = \int_0^1 \left[2x - \frac{1}{2}x^2 - xy \right]_{x=0}^1 dy = \int_0^1 \left(\frac{3}{2} - y \right) dy = \left[\frac{3}{2}y - \frac{1}{2}y^2 \right]_0^1 = 1.$$

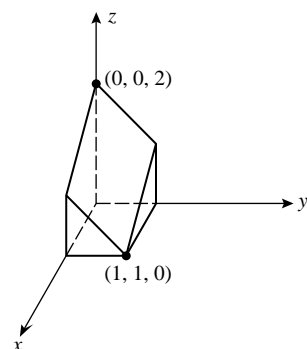

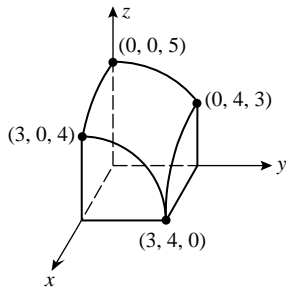

21.

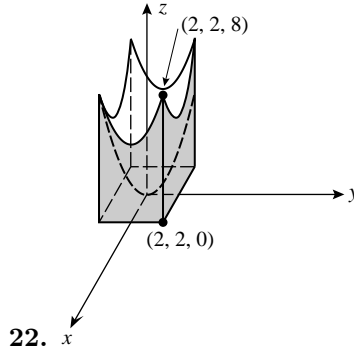

22.

23. False. ΔA_k represents the area of such a region.

24. True.
$$\iint_R f(x, y) dA = \int_1^4 \int_0^3 f(x, y) dy dx = \int_1^4 2x dx = x^2 \Big|_1^4 = 15.$$

25. False.
$$\iint_R f(x, y) dA = \int_1^5 \int_2^4 f(x, y) dy dx.$$

26. True, by equation (12).

27.
$$\iint_R f(x, y) dA = \int_a^b \left[\int_c^d g(x)h(y) dy \right] dx = \int_a^b g(x) \left[\int_c^d h(y) dy \right] dx = \left[\int_a^b g(x) dx \right] \left[\int_c^d h(y) dy \right].$$

28. The integral of $\tan x$ (an odd function) over the interval $[-1, 1]$ is zero, so the iterated integral is also zero.

29.
$$V = \int_3^5 \int_1^2 (2x + y) dy dx = \int_3^5 \left(2x + \frac{3}{2} \right) dx = 19.$$

30.
$$V = \int_1^3 \int_0^2 (3x^3 + 3x^2y) dy dx = \int_1^3 (6x^3 + 6x^2) dx = 172.$$

31.
$$V = \int_0^2 \int_0^3 x^2 dy dx = \int_0^2 3x^2 dx = 8.$$

32.
$$V = \int_0^3 \int_0^4 5 \left(1 - \frac{x}{3} \right) dy dx = \int_0^3 5 \left(4 - \frac{4x}{3} \right) dx = 30.$$

33.
$$\int_0^{1/2} \int_0^\pi x \cos(xy) \cos^2 \pi x dy dx = \int_0^{1/2} \cos^2 \pi x \sin(xy) \Big|_0^\pi dx = \int_0^{1/2} \cos^2 \pi x \sin \pi x dx = -\frac{1}{3\pi} \cos^3 \pi x \Big|_0^{1/2} = \frac{1}{3\pi}.$$

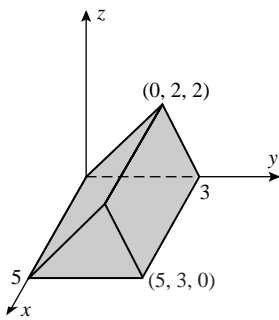

34. (a)

$$(b) V = \int_0^5 \int_0^2 y \, dy \, dx + \int_0^5 \int_2^3 (-2y + 6) \, dy \, dx = 10 + 5 = 15.$$

$$35. f_{\text{ave}} = \frac{1}{48} \int_0^6 \int_0^8 xy^2 \, dx \, dy = \frac{1}{48} \int_0^6 \left(\frac{1}{2} x^2 y^2 \right)_{x=0}^{x=8} dy = \frac{1}{48} \int_0^6 32y^2 \, dy = 48.$$

$$36. f_{\text{ave}} = \frac{1}{18} \int_0^6 \int_0^3 x^2 + 7y \, dx \, dy = \frac{1}{18} \int_0^6 \left(\frac{1}{3} x^3 + 7yx \right)_{x=0}^{x=3} dy = \frac{1}{18} \int_0^6 9 + 21y \, dy = 24.$$

$$37. f_{\text{ave}} = \frac{2}{\pi} \int_0^{\pi/2} \int_0^1 y \sin xy \, dx \, dy = \frac{2}{\pi} \int_0^{\pi/2} \left(-\cos xy \right)_{x=0}^{x=1} dy = \frac{2}{\pi} \int_0^{\pi/2} (1 - \cos y) \, dy = 1 - \frac{2}{\pi}.$$

$$38. f_{\text{ave}} = \frac{1}{3} \int_0^3 \int_0^1 x(x^2 + y)^{1/2} \, dx \, dy = \int_0^3 \frac{1}{9} [(1+y)^{3/2} - y^{3/2}] \, dy = \frac{2}{45} (31 - 9\sqrt{3}).$$

$$39. T_{\text{ave}} = \frac{1}{2} \int_0^1 \int_0^2 (10 - 8x^2 - 2y^2) \, dy \, dx = \frac{1}{2} \int_0^1 \left(\frac{44}{3} - 16x^2 \right) dx = \left(\frac{14}{3} \right)^\circ \text{C}.$$

$$40. f_{\text{ave}} = \frac{1}{A(R)} \int_a^b \int_c^d k \, dy \, dx = \frac{1}{A(R)} (b-a)(d-c)k = k.$$

$$41. 1.381737122$$

$$42. 2.230985141$$

43. The first integral equals $1/2$, the second equals $-1/2$. This does not contradict Theorem 14.1.3 because the integrand is not continuous at $(x, y) = (0, 0)$; if $f(x, y) = \frac{y-x}{(x+y)^3}$, then $\lim_{x \rightarrow 0} f(x, 0) = \lim_{x \rightarrow 0} \frac{-1}{x^2} \rightarrow -\infty$.

$$44. V = \int_0^1 \int_0^\pi xy^3 \sin(xy) \, dx \, dy = \int_0^1 \left[y \sin(xy) - xy^2 \cos(xy) \right]_{x=0}^{x=\pi} dy = \int_0^1 [y \sin(\pi y) - \pi y^2 \cos(\pi y)] \, dy = \left[\frac{3}{\pi^2} \sin(\pi y) - \frac{3}{\pi} y \cos(\pi y) - y^2 \sin(\pi y) \right]_0^1 = \frac{3}{\pi}.$$

45. If R is a rectangular region defined by $a \leq x \leq b$, $c \leq y \leq d$, then the volume given in equation (5) can be written as an iterated integral: $V = \iint_R f(x, y) \, dA = \int_a^b \left(\int_c^d f(x, y) \, dy \right) dx$. The inner integral, $\int_c^d f(x, y) \, dy$, is the area $A(x)$ of the cross-section with x -coordinate x of the solid enclosed between R and the surface $z = f(x, y)$. So $V = \int_a^b A(x) \, dx$, as found in Section 6.2.

Exercise Set 14.2

$$1. \int_0^1 \int_{x^2}^x xy^2 \, dy \, dx = \int_0^1 \frac{1}{3} (x^4 - x^7) \, dx = \frac{1}{40}.$$

$$2. \int_1^{3/2} \int_y^{3-y} y \, dx \, dy = \int_1^{3/2} (3y - 2y^2) \, dy = \frac{7}{24}.$$

$$3. \int_0^3 \int_0^{\sqrt{9-y^2}} y \, dx \, dy = \int_0^3 y \sqrt{9-y^2} \, dy = 9.$$

$$4. \int_{1/4}^1 \int_{x^2}^x \sqrt{x/y} \, dy \, dx = \int_{1/4}^1 \int_{x^2}^x x^{1/2} y^{-1/2} \, dy \, dx = \int_{1/4}^1 2(x - x^{3/2}) \, dx = \frac{13}{80}.$$

$$5. \int_{\sqrt{\pi}}^{\sqrt{2\pi}} \int_0^{x^3} \sin(y/x) \, dy \, dx = \int_{\sqrt{\pi}}^{\sqrt{2\pi}} [-x \cos(x^2) + x] \, dx = \frac{\pi}{2}.$$

$$6. \int_{-1}^1 \int_{-x^2}^{x^2} (x^2 - y) \, dy \, dx = \int_{-1}^1 2x^4 \, dx = \frac{4}{5}.$$

$$7. \int_0^1 \int_0^x y \sqrt{x^2 - y^2} \, dy \, dx = \int_0^1 \frac{1}{3} x^3 \, dx = \frac{1}{12}.$$

$$8. \int_1^2 \int_0^{y^2} e^{x/y^2} \, dx \, dy = \int_1^2 (e - 1) y^2 \, dy = \frac{7(e - 1)}{3}.$$

$$9. \text{(a)} \int_0^2 \int_0^{x^2} f(x, y) \, dy \, dx. \quad \text{(b)} \int_0^4 \int_{\sqrt{y}}^2 f(x, y) \, dx \, dy.$$

$$10. \text{(a)} \int_0^1 \int_{x^2}^{\sqrt{x}} f(x, y) \, dy \, dx. \quad \text{(b)} \int_0^1 \int_{y^2}^{\sqrt{y}} f(x, y) \, dx \, dy.$$

$$11. \text{(a)} \int_1^2 \int_{-2x+5}^3 f(x, y) \, dy \, dx + \int_2^4 \int_1^3 f(x, y) \, dy \, dx + \int_4^5 \int_{2x-7}^3 f(x, y) \, dy \, dx.$$

$$\text{(b)} \int_1^3 \int_{(5-y)/2}^{(y+7)/2} f(x, y) \, dx \, dy.$$

$$12. \text{(a)} \int_{-1}^1 \int_{-\sqrt{1-x^2}}^{\sqrt{1-x^2}} f(x, y) \, dy \, dx. \quad \text{(b)} \int_{-1}^1 \int_{-\sqrt{1-y^2}}^{\sqrt{1-y^2}} f(x, y) \, dx \, dy.$$

$$13. \text{(a)} \int_0^2 \int_0^{x^2} xy \, dy \, dx = \int_0^2 \frac{1}{2} x^5 \, dx = \frac{16}{3}.$$

$$\text{(b)} \int_1^3 \int_{(5-y)/2}^{(y+7)/2} xy \, dx \, dy = \int_1^3 (3y^2 + 3y) \, dy = 38.$$

$$14. \text{(a)} \int_0^1 \int_{x^2}^{\sqrt{x}} (x + y) \, dy \, dx = \int_0^1 \left(x^{3/2} + \frac{x}{2} - x^3 - \frac{x^4}{2} \right) dx = \frac{3}{10}.$$

$$\text{(b)} \int_{-1}^1 \int_{-\sqrt{1-x^2}}^{\sqrt{1-x^2}} x \, dy \, dx + \int_{-1}^1 \int_{-\sqrt{1-x^2}}^{\sqrt{1-x^2}} y \, dy \, dx = \int_{-1}^1 2x \sqrt{1-x^2} \, dx + 0 = 0.$$

$$15. \text{(a)} \int_4^8 \int_{16/x}^x x^2 \, dy \, dx = \int_4^8 (x^3 - 16x) \, dx = 576.$$

$$\text{(b)} \int_2^4 \int_{16/y}^8 x^2 \, dx \, dy + \int_4^8 \int_y^8 x^2 \, dx \, dy = \int_2^4 \left[\frac{512}{3} - \frac{4096}{3y^3} \right] dy + \int_4^8 \frac{512 - y^3}{3} dy = \frac{640}{3} + \frac{1088}{3} = 576.$$

$$16. \text{(a)} \int_0^1 \int_1^2 xy^2 \, dy \, dx + \int_1^2 \int_x^2 xy^2 \, dy \, dx = \int_0^1 7x/3 \, dx + \int_1^2 \frac{8x - x^4}{3} \, dx = \frac{7}{6} + \frac{29}{15} = \frac{31}{10}.$$

$$(b) \int_1^2 \int_0^y xy^2 dx dy = \int_1^2 \frac{1}{2} y^4 dy = \frac{31}{10}.$$

$$17. (a) \int_{-1}^1 \int_{-\sqrt{1-x^2}}^{\sqrt{1-x^2}} (3x-2y) dy dx = \int_{-1}^1 6x\sqrt{1-x^2} dx = 0.$$

$$(b) \int_{-1}^1 \int_{-\sqrt{1-y^2}}^{\sqrt{1-y^2}} (3x-2y) dx dy = \int_{-1}^1 -4y\sqrt{1-y^2} dy = 0.$$

$$18. (a) \int_0^5 \int_{5-x}^{\sqrt{25-x^2}} y dy dx = \int_0^5 (5x-x^2) dx = \frac{125}{6}.$$

$$(b) \int_0^5 \int_{5-y}^{\sqrt{25-y^2}} y dx dy = \int_0^5 y (\sqrt{25-y^2} - 5 + y) dy = \frac{125}{6}.$$

$$19. \int_0^4 \int_0^{\sqrt{y}} x(1+y^2)^{-1/2} dx dy = \int_0^4 \frac{1}{2} y(1+y^2)^{-1/2} dy = \frac{\sqrt{17}-1}{2}.$$

$$20. \int_0^{\pi} \int_0^x x \cos y dy dx = \int_0^{\pi} x \sin x dx = \pi.$$

$$21. \int_0^2 \int_{y^2}^{6-y} xy dx dy = \int_0^2 \frac{1}{2} (36y - 12y^2 + y^3 - y^5) dy = \frac{50}{3}.$$

$$22. \int_0^{\pi/4} \int_{\sin y}^{1/\sqrt{2}} x dx dy = \int_0^{\pi/4} \frac{1}{4} \cos 2y dy = \frac{1}{8}.$$

$$23. \int_0^1 \int_{x^3}^x (x-1) dy dx = \int_0^1 (-x^4 + x^3 + x^2 - x) dx = -\frac{7}{60}.$$

$$24. \int_0^{1/\sqrt{2}} \int_x^{2x} x^2 dy dx + \int_{1/\sqrt{2}}^1 \int_x^{1/x} x^2 dy dx = \int_0^{1/\sqrt{2}} x^3 dx + \int_{1/\sqrt{2}}^1 (x-x^3) dx = \frac{1}{8}.$$

$$25. \int_0^2 \int_0^{y^2} \sin(y^3) dx dy = \int_0^2 y^2 \sin(y^3) dy = \frac{1-\cos 8}{3}.$$

$$26. \int_0^1 \int_{e^x}^e x dy dx = \int_0^1 (ex - xe^x) dx = \frac{e}{2} - 1.$$

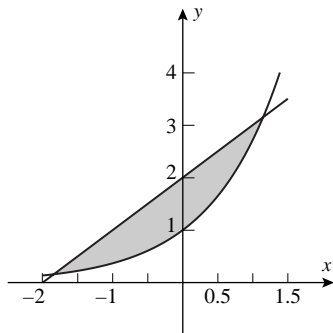

27. (a)

$$(b) (-1.8414, 0.1586), (1.1462, 3.1462).$$

$$(c) \iint_R x \, dA \approx \int_{-1.8414}^{1.1462} \int_{e^x}^{x+2} x \, dy \, dx = \int_{-1.8414}^{1.1462} x(x+2-e^x) \, dx \approx -0.4044.$$

$$(d) \iint_R x \, dA \approx \int_{0.1586}^{3.1462} \int_{y-2}^{\ln y} x \, dx \, dy = \int_{0.1586}^{3.1462} \left[\frac{\ln^2 y}{2} - \frac{(y-2)^2}{2} \right] dy \approx -0.4044.$$

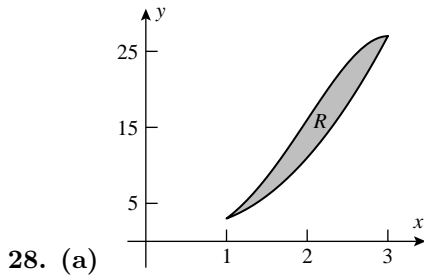

(b) $(1, 3), (3, 27)$.

$$(c) \int_1^3 \int_{3-4x+4x^2}^{4x^3-x^4} x \, dy \, dx = \int_1^3 x[(4x^3-x^4) - (3-4x+4x^2)] \, dx = \frac{224}{15}.$$

29. $A = \int_0^{\pi/4} \int_{\sin x}^{\cos x} dy \, dx = \int_0^{\pi/4} (\cos x - \sin x) \, dx = \sqrt{2} - 1.$

30. $A = \int_{-4}^1 \int_{3y-4}^{-y^2} dx \, dy = \int_{-4}^1 (-y^2 - 3y + 4) \, dy = \frac{125}{6}.$

31. $A = \int_{-3}^3 \int_{1-y^2/9}^{9-y^2} dx \, dy = \int_{-3}^3 8 \left(1 - \frac{y^2}{9} \right) dy = 32.$

32. $A = \int_0^1 \int_{\sinh x}^{\cosh x} dy \, dx = \int_0^1 (\cosh x - \sinh x) \, dx = 1 - e^{-1}.$

33. False. The expression on the right side doesn't make sense. To evaluate an integral of the form $\int_{x^2}^{2x} g(y) \, dy$, x must have a fixed value. But then we can't use x as a variable in defining $g(y) = \int_0^1 f(x, y) \, dx$.

34. True. This is Theorem 14.2.2(a).

35. False. For example, if $f(x, y) = x$ then $\iint_R f(x, y) \, dA = \int_{-1}^1 \int_{x^2}^1 x \, dy \, dx = \int_{-1}^1 xy \Big|_{y=x^2}^1 dx = \int_{-1}^1 x(1-x^2) \, dx = \left[\frac{1}{2}x^2 - \frac{1}{4}x^4 \right]_{-1}^1 = 0$, but $2 \int_0^1 \int_{x^2}^1 x \, dy \, dx = \int_0^1 xy \Big|_{y=x^2}^1 dx = \int_0^1 x(1-x^2) \, dx = \left[\frac{1}{2}x^2 - \frac{1}{4}x^4 \right]_0^1 = \frac{1}{4}.$

36. False. For example, if R is the square $0 \leq x \leq 1, 0 \leq y \leq 1$, then the area of R is 1, but $\iint_R xy \, dA = \int_0^1 \int_0^1 xy \, dy \, dx = \int_0^1 \frac{1}{2}xy^2 \Big|_{y=0}^1 dx = \int_0^1 \frac{1}{2}x \, dx = \frac{1}{4}x^2 \Big|_0^1 = \frac{1}{4}.$

37. $\int_0^4 \int_0^{6-3x/2} \left(3 - \frac{3x}{4} - \frac{y}{2} \right) dy \, dx = \int_0^4 \left[\left(3 - \frac{3x}{4} \right) \left(6 - \frac{3x}{2} \right) - \frac{1}{4} \left(6 - \frac{3x}{2} \right)^2 \right] dx = 12.$

$$38. \int_0^2 \int_0^{\sqrt{4-x^2}} \sqrt{4-x^2} \, dy \, dx = \int_0^2 (4-x^2) \, dx = \frac{16}{3}.$$

$$39. V = \int_{-3}^3 \int_{-\sqrt{9-x^2}}^{\sqrt{9-x^2}} (3-x) \, dy \, dx = \int_{-3}^3 (6\sqrt{9-x^2} - 2x\sqrt{9-x^2}) \, dx = 27\pi.$$

$$40. V = \int_0^1 \int_{x^2}^x (x^2 + 3y^2) \, dy \, dx = \int_0^1 (2x^3 - x^4 - x^6) \, dx = \frac{11}{70}.$$

$$41. V = \int_0^3 \int_0^2 (9x^2 + y^2) \, dy \, dx = \int_0^3 \left(18x^2 + \frac{8}{3}\right) \, dx = 170.$$

$$42. V = \int_{-1}^1 \int_{y^2}^1 (1-x) \, dx \, dy = \int_{-1}^1 \left(\frac{1}{2} - y^2 + \frac{y^4}{2}\right) \, dy = \frac{8}{15}.$$

$$43. V = \int_{-3/2}^{3/2} \int_{-\sqrt{9-4x^2}}^{\sqrt{9-4x^2}} (y+3) \, dy \, dx = \int_{-3/2}^{3/2} 6\sqrt{9-4x^2} \, dx = \frac{27\pi}{2}.$$

$$44. V = \int_0^3 \int_{y^2/3}^3 (9-x^2) \, dx \, dy = \int_0^3 \left(18 - 3y^2 + \frac{y^6}{81}\right) \, dy = \frac{216}{7}.$$

$$45. V = 4 \int_0^1 \int_0^{\sqrt{1-x^2}} (1-x^2-y^2) \, dy \, dx = \frac{8}{3} \int_0^1 (1-x^2)^{3/2} \, dx = \frac{\pi}{2}.$$

$$46. V = \int_0^2 \int_0^{\sqrt{4-x^2}} (x^2 + y^2) \, dy \, dx = \int_0^2 \left[x^2\sqrt{4-x^2} + \frac{1}{3}(4-x^2)^{3/2}\right] \, dx = 2\pi.$$

$$47. \int_0^{\sqrt{2}} \int_{y^2}^2 f(x, y) \, dx \, dy.$$

$$48. \int_0^8 \int_0^{x/2} f(x, y) \, dy \, dx.$$

$$49. \int_1^{e^2} \int_{\ln x}^2 f(x, y) \, dy \, dx.$$

$$50. \int_0^1 \int_{e^y}^e f(x, y) \, dx \, dy.$$

$$51. \int_0^{\pi/2} \int_0^{\sin x} f(x, y) \, dy \, dx.$$

$$52. \int_0^1 \int_{x^2}^{\sqrt{x}} f(x, y) \, dy \, dx.$$

$$53. \int_0^4 \int_0^{y/4} e^{-y^2} \, dx \, dy = \int_0^4 \frac{1}{4} y e^{-y^2} \, dy = \frac{1 - e^{-16}}{8}.$$

$$54. \int_0^1 \int_0^{2x} \cos(x^2) \, dy \, dx = \int_0^1 2x \cos(x^2) \, dx = \sin 1.$$

55. $\int_0^2 \int_0^{x^2} e^{x^3} dy dx = \int_0^2 x^2 e^{x^3} dx = \frac{e^8 - 1}{3}.$

56. $\int_0^{\ln 3} \int_{e^y}^3 x dx dy = \frac{1}{2} \int_0^{\ln 3} (9 - e^{2y}) dy = \frac{9 \ln 3 - 4}{2}.$

57. (a) $\int_0^4 \int_{\sqrt{x}}^2 \sin(\pi y^3) dy dx$; the inner integral is non-elementary.

$$\int_0^2 \int_0^{y^2} \sin(\pi y^3) dx dy = \int_0^2 y^2 \sin(\pi y^3) dy = -\frac{1}{3\pi} \cos(\pi y^3) \Big|_0^2 = 0.$$

(b) $\int_0^1 \int_{\sin^{-1} y}^{\pi/2} \sec^2(\cos x) dx dy$; the inner integral is non-elementary.

$$\int_0^{\pi/2} \int_0^{\sin x} \sec^2(\cos x) dy dx = \int_0^{\pi/2} \sec^2(\cos x) \sin x dx = \tan 1.$$

58. $V = 4 \int_0^2 \int_0^{\sqrt{4-x^2}} (x^2 + y^2) dy dx = 4 \int_0^2 \left(x^2 \sqrt{4-x^2} + \frac{1}{3}(4-x^2)^{3/2} \right) dx =$
 $= \int_0^{\pi/2} \left(\frac{64}{3} + \frac{64}{3} \sin^2 \theta - \frac{128}{3} \sin^4 \theta \right) d\theta = \frac{64}{3} \frac{\pi}{2} + \frac{64}{3} \frac{\pi}{4} - \frac{128}{3} \frac{\pi}{2} \cdot \frac{3}{4} = 8\pi$ (by substituting $x = 2 \sin \theta$).

59. The region is symmetric with respect to the y -axis, and the integrand is an odd function of x , hence the answer is zero.

60. This is the volume in the first octant under the surface $z = \sqrt{1 - x^2 - y^2}$, so $1/8$ of the volume of the sphere of radius 1, thus $\frac{\pi}{6}$.

61. Area of triangle is $1/2$, so $f_{\text{ave}} = 2 \int_0^1 \int_x^1 \frac{1}{1+x^2} dy dx = 2 \int_0^1 \left[\frac{1}{1+x^2} - \frac{x}{1+x^2} \right] dx = \frac{\pi}{2} - \ln 2.$

62. Area $= \int_0^2 (3x - x^2 - x) dx = \frac{4}{3}$, so $f_{\text{ave}} = \frac{3}{4} \int_0^2 \int_x^{3x-x^2} (x^2 - xy) dy dx = \frac{3}{4} \int_0^2 \left(-2x^3 + 2x^4 - \frac{x^5}{2} \right) dx = -\frac{3}{4} \frac{8}{15} = -\frac{2}{5}.$

63. $T_{\text{ave}} = \frac{1}{A(R)} \iint_R (5xy + x^2) dA$. The diamond has corners $(\pm 2, 0), (0, \pm 4)$ and thus has area $A(R) = 4 \cdot \frac{1}{2} (4) = 16$. Since $5xy$ is an odd function of x (as well as y), $\iint_R 5xy dA = 0$. Since x^2 is an even function of both x and y , $T_{\text{ave}} = \frac{1}{16} \iint_R x^2 dA = \frac{1}{4} \int_0^2 \int_0^{4-2x} x^2 dy dx = \frac{1}{4} \int_0^2 (4-2x)x^2 dx = \frac{1}{4} \left[\frac{4}{3} x^3 - \frac{1}{2} x^4 \right]_0^2 = \left(\frac{2}{3} \right) \text{C}.$

64. The area of the lens is $\pi R^2 = 4\pi$ and the average thickness T_{ave} is $T_{\text{ave}} = \frac{4}{4\pi} \int_0^2 \int_0^{\sqrt{4-x^2}} \left(1 - \frac{x^2 + y^2}{4} \right) dy dx =$
 $\frac{1}{\pi} \int_0^2 \frac{1}{6} (4-x^2)^{3/2} dx = \frac{8}{3\pi} \int_0^{\pi/2} \sin^4 \theta d\theta = \frac{8}{3\pi} \frac{1}{2} \cdot \frac{3}{4} \frac{\pi}{2} = \frac{1}{2}$ in (by substituting $x = 2 \cos \theta$).

65. $y = \sin x$ and $y = x/2$ intersect at $x = 0$ and $x = a \approx 1.895494$, so $V = \int_0^a \int_{x/2}^{\sin x} \sqrt{1+x+y} dy dx \approx 0.676089.$

67. See Example 7. Given an iterated integral $\int_c^d \int_{h_1(y)}^{h_2(y)} f(x, y) dx dy$, draw the type II region R defined by $c \leq y \leq d$, $h_1(y) \leq x \leq h_2(y)$. If R is also a type I region, try to determine the numbers a and b and functions $g_1(x)$ and $g_2(x)$ such that R is also described by $a \leq x \leq b$, $g_1(x) \leq y \leq g_2(x)$. Then $\int_c^d \int_{h_1(y)}^{h_2(y)} f(x, y) dx dy = \int_a^b \int_{g_1(x)}^{g_2(x)} f(x, y) dy dx$. This isn't always possible: R may not be a type I region. Even if it is, it may not be possible to find formulas for $g_1(x)$ and $g_2(x)$.

Exercise Set 14.3

1. $\int_0^{\pi/2} \int_0^{\sin \theta} r \cos \theta dr d\theta = \int_0^{\pi/2} \frac{1}{2} \sin^2 \theta \cos \theta d\theta = \frac{1}{6}$.
2. $\int_0^{\pi} \int_0^{1+\cos \theta} r dr d\theta = \int_0^{\pi} \frac{1}{2} (1 + \cos \theta)^2 d\theta = \frac{3\pi}{4}$.
3. $\int_0^{\pi/2} \int_0^{a \sin \theta} r^2 dr d\theta = \int_0^{\pi/2} \frac{a^3}{3} \sin^3 \theta d\theta = \frac{2}{9} a^3$.
4. $\int_0^{\pi/6} \int_0^{\cos 3\theta} r dr d\theta = \int_0^{\pi/6} \frac{1}{2} \cos^2 3\theta d\theta = \frac{\pi}{24}$.
5. $\int_0^{\pi} \int_0^{1-\sin \theta} r^2 \cos \theta dr d\theta = \int_0^{\pi} \frac{1}{3} (1 - \sin \theta)^3 \cos \theta d\theta = 0$.
6. $\int_0^{\pi/2} \int_0^{\cos \theta} r^3 dr d\theta = \int_0^{\pi/2} \frac{1}{4} \cos^4 \theta d\theta = \frac{3\pi}{64}$.
7. $A = \int_0^{2\pi} \int_0^{1-\cos \theta} r dr d\theta = \int_0^{2\pi} \frac{1}{2} (1 - \cos \theta)^2 d\theta = \frac{3\pi}{2}$.
8. $A = 4 \int_0^{\pi/2} \int_0^{\sin 2\theta} r dr d\theta = 2 \int_0^{\pi/2} \sin^2 2\theta d\theta = \frac{\pi}{2}$.
9. $A = \int_{\pi/4}^{\pi/2} \int_{\sin 2\theta}^1 r dr d\theta = \int_{\pi/4}^{\pi/2} \frac{1}{2} (1 - \sin^2 2\theta) d\theta = \frac{\pi}{16}$.
10. $A = 2 \int_0^{\pi/3} \int_{\sec \theta}^2 r dr d\theta = \int_0^{\pi/3} (4 - \sec^2 \theta) d\theta = \frac{4\pi}{3} - \sqrt{3}$.
11. $A = \int_{\pi/6}^{5\pi/6} \int_2^{4 \sin \theta} f(r, \theta) r dr d\theta$.

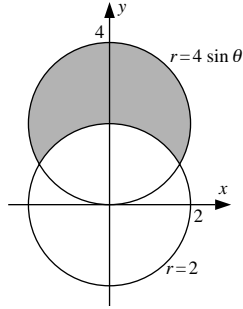

12. $A = \int_{\pi/2}^{3\pi/2} \int_{1+\cos\theta}^1 f(r, \theta) r \, dr \, d\theta.$

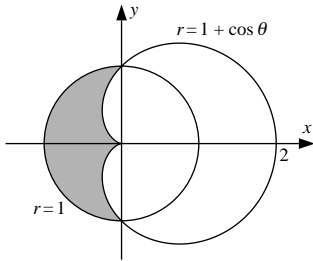

13. $V = 8 \int_0^{\pi/2} \int_1^3 r \sqrt{9-r^2} \, dr \, d\theta.$

14. $V = 2 \int_0^{\pi/2} \int_0^{2\sin\theta} r^2 \, dr \, d\theta.$

15. $V = 2 \int_0^{\pi/2} \int_0^{\cos\theta} (1-r^2)r \, dr \, d\theta.$

16. $V = 4 \int_0^{\pi/2} \int_1^3 \, dr \, d\theta.$

17. $V = 8 \int_0^{\pi/2} \int_1^3 r \sqrt{9-r^2} \, dr \, d\theta = \frac{128}{3} \sqrt{2} \int_0^{\pi/2} \, d\theta = \frac{64}{3} \sqrt{2} \pi.$

18. $V = 2 \int_0^{\pi/2} \int_0^{2\sin\theta} r^2 \, dr \, d\theta = \frac{16}{3} \int_0^{\pi/2} \sin^3 \theta \, d\theta = \frac{32}{9}.$

19. $V = 2 \int_0^{\pi/2} \int_0^{\cos\theta} (1-r^2)r \, dr \, d\theta = \frac{1}{2} \int_0^{\pi/2} (2\cos^2\theta - \cos^4\theta) \, d\theta = \frac{5\pi}{32}.$

20. $V = 4 \int_0^{\pi/2} \int_1^3 \, dr \, d\theta = 8 \int_0^{\pi/2} \, d\theta = 4\pi.$

21. $V = \int_0^{\pi/2} \int_0^{3\sin\theta} r^2 \sin\theta \, dr \, d\theta = 9 \int_0^{\pi/2} \sin^4 \theta \, d\theta = \frac{27\pi}{16}.$

22. $V = 4 \int_0^{\pi/2} \int_{2\cos\theta}^2 \sqrt{4-r^2} \, r \, dr \, d\theta + 4 \int_{\pi/2}^{\pi} \int_0^2 \sqrt{4-r^2} \, r \, dr \, d\theta = \int_0^{\pi/2} \frac{32}{3} (1-\cos^2\theta)^{3/2} \theta \, d\theta + \int_{\pi/2}^{\pi} \frac{32}{3} \, d\theta = \frac{64}{9} + \frac{16\pi}{3}.$

$$23. \int_0^{2\pi} \int_0^3 \sin(r^2)r \, dr \, d\theta = \frac{1}{2}(1 - \cos 9) \int_0^{2\pi} d\theta = \pi(1 - \cos 9).$$

$$24. \int_0^{\pi/2} \int_0^3 r\sqrt{9-r^2} \, dr \, d\theta = 9 \int_0^{\pi/2} d\theta = \frac{9\pi}{2}.$$

$$25. \int_0^{\pi/4} \int_0^2 \frac{1}{1+r^2} r \, dr \, d\theta = \frac{1}{2} \ln 5 \int_0^{\pi/4} d\theta = \frac{\pi}{8} \ln 5.$$

$$26. \int_{\pi/4}^{\pi/2} \int_0^{2\cos\theta} 2r^2 \sin\theta \, dr \, d\theta = \frac{16}{3} \int_{\pi/4}^{\pi/2} \cos^3\theta \sin\theta \, d\theta = \frac{1}{3}.$$

$$27. \int_0^{\pi/2} \int_0^1 r^3 \, dr \, d\theta = \frac{1}{4} \int_0^{\pi/2} d\theta = \frac{\pi}{8}.$$

$$28. \int_0^{2\pi} \int_0^2 e^{-r^2} r \, dr \, d\theta = \frac{1}{2}(1 - e^{-4}) \int_0^{2\pi} d\theta = (1 - e^{-4})\pi.$$

$$29. \int_0^{\pi/2} \int_0^{2\cos\theta} r^2 \, dr \, d\theta = \frac{8}{3} \int_0^{\pi/2} \cos^3\theta \, d\theta = \frac{16}{9}.$$

$$30. \int_0^{\pi/2} \int_0^1 \cos(r^2)r \, dr \, d\theta = \frac{1}{2} \sin 1 \int_0^{\pi/2} d\theta = \frac{\pi}{4} \sin 1.$$

$$31. \int_0^{\pi/2} \int_0^a \frac{r}{(1+r^2)^{3/2}} \, dr \, d\theta = \frac{\pi}{2} \left(1 - \frac{1}{\sqrt{1+a^2}}\right).$$

$$32. \int_0^{\pi/4} \int_0^{\sec\theta \tan\theta} r^2 \, dr \, d\theta = \frac{1}{3} \int_0^{\pi/4} \sec^3\theta \tan^3\theta \, d\theta = \frac{2(\sqrt{2}+1)}{45}.$$

$$33. \int_0^{\pi/4} \int_0^2 \frac{r}{\sqrt{1+r^2}} \, dr \, d\theta = \frac{\pi}{4}(\sqrt{5}-1).$$

$$34. \int_{\pi/2}^{3\pi/2} \int_0^4 3r^2 \cos\theta \, dr \, d\theta = \int_{\pi/2}^{3\pi/2} 64 \cos\theta \, d\theta = -128.$$

35. True. It can be defined by the inequalities $0 \leq \theta \leq 2\pi$, $0 \leq r \leq 2$.

36. False. The volume is $\iint_R f(r, \theta) \, dA$. The extra factor r isn't introduced until we write this as an iterated integral as in Theorem 14.3.3.

37. False. The integrand in the iterated integral should be multiplied by r : $\iint_R f(r, \theta) \, dA = \int_0^{\pi/2} \int_1^2 f(r, \theta) r \, dr \, d\theta$.

38. False. The region is described by $0 \leq \theta \leq \pi$, $0 \leq r \leq \sin\theta$, so $A = \int_0^\pi \int_0^{\sin\theta} r \, dr \, d\theta$.

$$39. V = \int_0^{2\pi} \int_0^a hr \, dr \, d\theta = \int_0^{2\pi} h \frac{a^2}{2} \, d\theta = \pi a^2 h.$$

$$40. V = \int_0^{2\pi} \int_0^R D(r)r \, dr \, d\theta = \int_0^{2\pi} \int_0^R ke^{-r} r \, dr \, d\theta = -2\pi k(1+r)e^{-r} \Big|_0^R = 2\pi k[1 - (R+1)e^{-R}].$$

$$41. \int_{\tan^{-1}(1/3)}^{\tan^{-1}(2)} \int_0^2 r^3 \cos^2 \theta \, dr \, d\theta = 4 \int_{\tan^{-1}(1/3)}^{\tan^{-1}(2)} \cos^2 \theta \, d\theta = 2 \int_{\tan^{-1}(1/3)}^{\tan^{-1}(2)} (1 + \cos(2\theta)) \, d\theta = \left[2\theta + 2 \cos \theta \sin \theta \right]_{\tan^{-1}(1/3)}^{\tan^{-1}(2)} = 2 \tan^{-1}(2) + 2 \cdot \frac{1}{\sqrt{5}} \cdot \frac{2}{\sqrt{5}} - 2 \tan^{-1}(1/3) - 2 \cdot \frac{3}{\sqrt{10}} \cdot \frac{1}{\sqrt{10}} = 2 (\tan^{-1}(2) - \tan^{-1}(1/3)) + \frac{1}{5} = 2 \tan^{-1}(1) + \frac{1}{5} = \frac{\pi}{2} + \frac{1}{5}.$$

$$42. A = \int_0^\phi \int_0^{2a \sin \theta} r \, dr \, d\theta = 2a^2 \int_0^\phi \sin^2 \theta \, d\theta = a^2 \phi - \frac{1}{2} a^2 \sin 2\phi.$$

$$43. (a) V = 8 \int_0^{\pi/2} \int_0^a \frac{c}{a} (a^2 - r^2)^{1/2} r \, dr \, d\theta = -\frac{4c}{3a} \pi (a^2 - r^2)^{3/2} \Big|_0^a = \frac{4}{3} \pi a^2 c.$$

$$(b) V \approx \frac{4}{3} \pi (6378.1370)^2 6356.5231 \text{ km}^3 \approx 1.0831682 \cdot 10^{12} \text{ km}^3 = 1.0831682 \cdot 10^{21} \text{ m}^3.$$

$$44. V = 2 \int_0^{\pi/2} \int_0^{a \sin \theta} \frac{c}{a} (a^2 - r^2)^{1/2} r \, dr \, d\theta = \frac{2}{3} a^2 c \int_0^{\pi/2} (1 - \cos^3 \theta) \, d\theta = \frac{(3\pi - 4)a^2 c}{9}.$$

$$45. A = 4 \int_0^{\pi/4} \int_0^{a\sqrt{2 \cos 2\theta}} r \, dr \, d\theta = 4a^2 \int_0^{\pi/4} \cos 2\theta \, d\theta = 2a^2.$$

$$46. A = \int_{\pi/6}^{\pi/4} \int_{\sqrt{8 \cos 2\theta}}^{4 \sin \theta} r \, dr \, d\theta + \int_{\pi/4}^{\pi/2} \int_0^{4 \sin \theta} r \, dr \, d\theta = \int_{\pi/6}^{\pi/4} (8 \sin^2 \theta - 4 \cos 2\theta) \, d\theta + \int_{\pi/4}^{\pi/2} 8 \sin^2 \theta \, d\theta = \frac{4\pi}{3} + 2\sqrt{3} - 2.$$

Exercise Set 14.4

$$1. z = \sqrt{9 - y^2}, z_x = 0, z_y = -y/\sqrt{9 - y^2}, z_x^2 + z_y^2 + 1 = 9/(9 - y^2), S = \int_0^2 \int_{-3}^3 \frac{3}{\sqrt{9 - y^2}} \, dy \, dx = \int_0^2 3\pi \, dx = 6\pi.$$

$$2. z = 8 - 2x - 2y, z_x^2 + z_y^2 + 1 = 4 + 4 + 1 = 9, S = \int_0^4 \int_0^{4-x} 3 \, dy \, dx = \int_0^4 3(4 - x) \, dx = 24.$$

$$3. z^2 = 4x^2 + 4y^2, 2z z_x = 8x \text{ so } z_x = 4x/z; \text{ similarly } z_y = 4y/z \text{ so } z_x^2 + z_y^2 + 1 = (16x^2 + 16y^2)/z^2 + 1 = 5, S = \int_0^1 \int_{x^2}^x \sqrt{5} \, dy \, dx = \sqrt{5} \int_0^1 (x - x^2) \, dx = \frac{\sqrt{5}}{6}.$$

$$4. z_x = 2, z_y = 2y, z_x^2 + z_y^2 + 1 = 5 + 4y^2, S = \int_0^1 \int_0^y \sqrt{5 + 4y^2} \, dx \, dy = \int_0^1 y \sqrt{5 + 4y^2} \, dy = \frac{27 - 5\sqrt{5}}{12}.$$

$$5. z^2 = x^2 + y^2, z_x = x/z, z_y = y/z, z_x^2 + z_y^2 + 1 = (x^2 + y^2)/z^2 + 1 = 2, S = \iint_R \sqrt{2} \, dA = 2 \int_0^{\pi/2} \int_0^{2 \cos \theta} \sqrt{2} r \, dr \, d\theta = 4\sqrt{2} \int_0^{\pi/2} \cos^2 \theta \, d\theta = \sqrt{2}\pi.$$

$$6. z_x = -2x, z_y = -2y, z_x^2 + z_y^2 + 1 = 4x^2 + 4y^2 + 1, S = \iint_R \sqrt{4x^2 + 4y^2 + 1} \, dA = \int_0^{2\pi} \int_0^1 r \sqrt{4r^2 + 1} \, dr \, d\theta = \frac{1}{12} (5\sqrt{5} - 1) \int_0^{2\pi} d\theta = \frac{\pi}{6} (5\sqrt{5} - 1).$$

$$7. z_x = y, z_y = x, z_x^2 + z_y^2 + 1 = x^2 + y^2 + 1, S = \iint_R \sqrt{x^2 + y^2 + 1} \, dA = \int_0^{\pi/6} \int_0^3 r \sqrt{r^2 + 1} \, dr \, d\theta = \frac{1}{3} (10\sqrt{10} - 1) \int_0^{\pi/6} d\theta = \frac{\pi}{18} (10\sqrt{10} - 1).$$

8. $z_x = x, z_y = y, z_x^2 + z_y^2 + 1 = x^2 + y^2 + 1, S = \iint_R \sqrt{x^2 + y^2 + 1} dA = \int_0^{2\pi} \int_0^{\sqrt{8}} r \sqrt{r^2 + 1} dr d\theta = \frac{26}{3} \int_0^{2\pi} d\theta = \frac{52\pi}{3}.$
9. On the sphere, $z_x = -x/z$ and $z_y = -y/z$ so $z_x^2 + z_y^2 + 1 = (x^2 + y^2 + z^2)/z^2 = 16/(16 - x^2 - y^2)$. The planes $z = 1$ and $z = 2$ intersect the sphere along the circles $x^2 + y^2 = 15$ and $x^2 + y^2 = 12$, so $S = \iint_R \frac{4}{\sqrt{16 - x^2 - y^2}} dA = \int_0^{2\pi} \int_{\sqrt{12}}^{\sqrt{15}} \frac{4r}{\sqrt{16 - r^2}} dr d\theta = 4 \int_0^{2\pi} d\theta = 8\pi.$
10. On the sphere, $z_x = -x/z$ and $z_y = -y/z$ so $z_x^2 + z_y^2 + 1 = (x^2 + y^2 + z^2)/z^2 = 8/(8 - x^2 - y^2)$; the cone cuts the sphere in the circle $x^2 + y^2 = 4$; $S = \int_0^{2\pi} \int_0^2 \frac{2\sqrt{2}r}{\sqrt{8 - r^2}} dr d\theta = (8 - 4\sqrt{2}) \int_0^{2\pi} d\theta = 8(2 - \sqrt{2})\pi.$

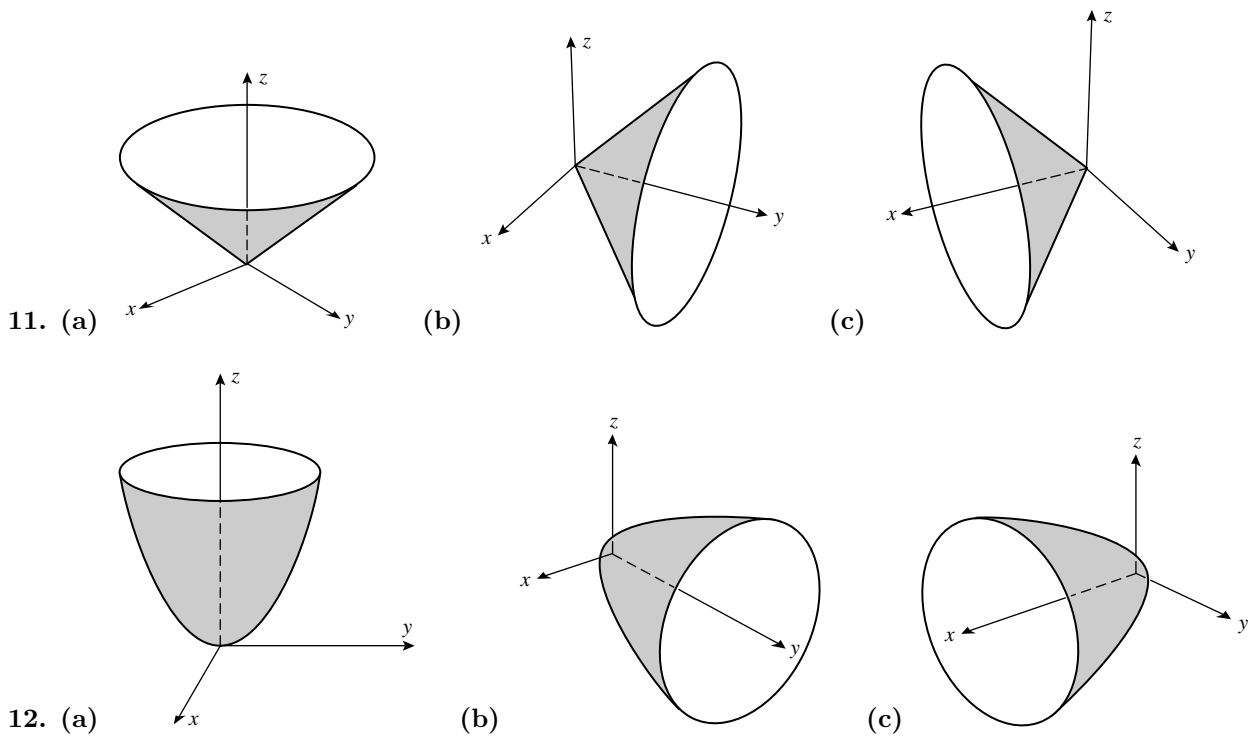

13. (a) $x = u, y = v, z = \frac{5}{2} + \frac{3}{2}u - 2v.$ (b) $x = u, y = v, z = u^2.$

14. (a) $x = u, y = v, z = \frac{v}{1 + u^2}.$ (b) $x = u, y = v, z = \frac{1}{3}v^2 - \frac{5}{3}.$

15. (a) $x = \sqrt{5} \cos u, y = \sqrt{5} \sin u, z = v; 0 \leq u \leq 2\pi, 0 \leq v \leq 1.$

(b) $x = 2 \cos u, y = v, z = 2 \sin u; 0 \leq u \leq 2\pi, 1 \leq v \leq 3.$

16. (a) $x = u, y = 1 - u, z = v; -1 \leq v \leq 1$ (b) $x = u, y = 5 + 2v, z = v; 0 \leq u \leq 3.$

17. $x = u, y = \sin u \cos v, z = \sin u \sin v.$

18. $x = u, y = e^u \cos v, z = e^u \sin v.$

19. $x = r \cos \theta, y = r \sin \theta, z = \frac{1}{1 + r^2}.$

20. $x = r \cos \theta, y = r \sin \theta, z = e^{-r^2}$.
21. $x = r \cos \theta, y = r \sin \theta, z = 2r^2 \cos \theta \sin \theta$.
22. $x = r \cos \theta, y = r \sin \theta, z = r^2(\cos^2 \theta - \sin^2 \theta)$.
23. $x = r \cos \theta, y = r \sin \theta, z = \sqrt{9 - r^2}; r \leq \sqrt{5}$.
24. $x = r \cos \theta, y = r \sin \theta, z = r; r \leq 3$.
25. $x = \frac{1}{2}\rho \cos \theta, y = \frac{1}{2}\rho \sin \theta, z = \frac{\sqrt{3}}{2}\rho$.
26. $x = 3 \cos \theta, y = 3 \sin \theta, z = 3 \cot \phi$.
27. $z = x - 2y$; a plane.
28. $y = x^2 + z^2, 0 \leq y \leq 4$; part of a circular paraboloid.
29. $(x/3)^2 + (y/2)^2 = 1; 2 \leq z \leq 4$; part of an elliptic cylinder.
30. $z = x^2 + y^2; 0 \leq z \leq 4$; part of a circular paraboloid.
31. $(x/3)^2 + (y/4)^2 = z^2; 0 \leq z \leq 1$; part of an elliptic cone.
32. $x^2 + (y/2)^2 + (z/3)^2 = 1$; an ellipsoid.
33. (a) I: $x = r \cos \theta, y = r \sin \theta, z = r, 0 \leq r \leq 2$; II: $x = u, y = v, z = \sqrt{u^2 + v^2}; 0 \leq u^2 + v^2 \leq 4$.
34. (a) I: $x = r \cos \theta, y = r \sin \theta, z = r^2, 0 \leq r \leq \sqrt{2}$; II: $x = u, y = v, z = u^2 + v^2; u^2 + v^2 \leq 2$.
35. (a) $0 \leq u \leq 3, 0 \leq v \leq \pi$. (b) $0 \leq u \leq 4, -\pi/2 \leq v \leq \pi/2$.
36. (a) $0 \leq u \leq 6, -\pi \leq v \leq 0$. (b) $0 \leq u \leq 5, \pi/2 \leq v \leq 3\pi/2$.
37. (a) $0 \leq \phi \leq \pi/2, 0 \leq \theta \leq 2\pi$. (b) $0 \leq \phi \leq \pi, 0 \leq \theta \leq \pi$.
38. (a) $\pi/2 \leq \phi \leq \pi, 0 \leq \theta \leq 2\pi$. (b) $0 \leq \theta \leq \pi/2, 0 \leq \phi \leq \pi/2$.
39. $u = 1, v = 2, \mathbf{r}_u \times \mathbf{r}_v = -2\mathbf{i} - 4\mathbf{j} + \mathbf{k}; 2x + 4y - z = 5$.
40. $u = 1, v = 2, \mathbf{r}_u \times \mathbf{r}_v = -4\mathbf{i} - 2\mathbf{j} + 8\mathbf{k}; 2x + y - 4z = -6$.
41. $u = 0, v = 1, \mathbf{r}_u \times \mathbf{r}_v = 6\mathbf{k}; z = 0$.
42. $\mathbf{r}_u \times \mathbf{r}_v = 2\mathbf{i} - \mathbf{j} - 3\mathbf{k}; 2x - y - 3z = -4$.
43. $\mathbf{r}_u \times \mathbf{r}_v = \frac{1}{\sqrt{2}}\mathbf{i} - \frac{1}{\sqrt{2}}\mathbf{j} + \frac{1}{2}\mathbf{k}; x - y + \frac{1}{\sqrt{2}}z = \frac{\pi\sqrt{2}}{8}$.
44. $\mathbf{r}_u \times \mathbf{r}_v = 2\mathbf{i} - \ln 2 \mathbf{k}; 2x - (\ln 2)z = 0$.
45. $\mathbf{r}_u = \cos v \mathbf{i} + \sin v \mathbf{j} + 2u \mathbf{k}, \mathbf{r}_v = -u \sin v \mathbf{i} + u \cos v \mathbf{j}, \|\mathbf{r}_u \times \mathbf{r}_v\| = u\sqrt{4u^2 + 1}; S = \int_0^{2\pi} \int_1^2 u\sqrt{4u^2 + 1} du dv = \frac{\pi}{6}(17\sqrt{17} - 5\sqrt{5})$.

46. $\mathbf{r}_u = \cos v \mathbf{i} + \sin v \mathbf{j} + \mathbf{k}$, $\mathbf{r}_v = -u \sin v \mathbf{i} + u \cos v \mathbf{j}$, $\|\mathbf{r}_u \times \mathbf{r}_v\| = \sqrt{2}u$; $S = \int_0^{\pi/2} \int_0^{2v} \sqrt{2} u \, du \, dv = \frac{\sqrt{2}}{12} \pi^3$.

47. False. For example, if $f(x, y) = 1$ then the surface has the same area as R , $\iint_R dA$, not $\iint_R \sqrt{2} \, dA$.

48. True. $\mathbf{q} \times \mathbf{r} = \left\langle -\frac{\partial z}{\partial x}, -\frac{\partial z}{\partial y}, 1 \right\rangle$, so $\iint_R \|\mathbf{q} \times \mathbf{r}\| \, dA = \iint_R \sqrt{\left(\frac{\partial z}{\partial x}\right)^2 + \left(\frac{\partial z}{\partial y}\right)^2 + 1} \, dA = S$, by equation (2).

49. True, as explained before Definition 14.4.1.

50. True. $\|\langle 1, 0, a \rangle \times \langle 0, 1, b \rangle\| = \|\langle -a, -b, 1 \rangle\| = \sqrt{a^2 + b^2 + 1} = \sqrt{\left(\frac{\partial z}{\partial x}\right)^2 + \left(\frac{\partial z}{\partial y}\right)^2 + 1}$, so the area of the surface is $\iint_R \sqrt{\left(\frac{\partial z}{\partial x}\right)^2 + \left(\frac{\partial z}{\partial y}\right)^2 + 1} \, dA = \iint_R \|\langle 1, 0, a \rangle \times \langle 0, 1, b \rangle\| \, dA = \|\langle 1, 0, a \rangle \times \langle 0, 1, b \rangle\| \cdot \iint_R dA = \|\langle 1, 0, a \rangle \times \langle 0, 1, b \rangle\| \cdot (\text{area of } R)$.

51. $\mathbf{r}(u, v) = a \cos u \sin v \mathbf{i} + a \sin u \sin v \mathbf{j} + a \cos v \mathbf{k}$, $\|\mathbf{r}_u \times \mathbf{r}_v\| = a^2 \sin v$, $S = \int_0^\pi \int_0^{2\pi} a^2 \sin v \, du \, dv = 2\pi a^2 \int_0^\pi \sin v \, dv = 4\pi a^2$.

52. $\mathbf{r} = r \cos u \mathbf{i} + r \sin u \mathbf{j} + v \mathbf{k}$, $\|\mathbf{r}_u \times \mathbf{r}_v\| = r$; $S = \int_0^h \int_0^{2\pi} r \, du \, dv = 2\pi r h$.

53. $z_x = \frac{h}{a} \frac{x}{\sqrt{x^2 + y^2}}$, $z_y = \frac{h}{a} \frac{y}{\sqrt{x^2 + y^2}}$, $z_x^2 + z_y^2 + 1 = \frac{h^2 x^2 + h^2 y^2}{a^2(x^2 + y^2)} + 1 = \frac{a^2 + h^2}{a^2}$, $S = \int_0^{2\pi} \int_0^a \frac{\sqrt{a^2 + h^2}}{a} r \, dr \, d\theta = \frac{1}{2} a \sqrt{a^2 + h^2} \int_0^{2\pi} d\theta = \pi a \sqrt{a^2 + h^2}$.

54. (a) Revolving a point $(a_0, 0, b_0)$ of the xz -plane around the z -axis generates a circle, an equation of which is $\mathbf{r} = a_0 \cos u \mathbf{i} + a_0 \sin u \mathbf{j} + b_0 \mathbf{k}$, $0 \leq u \leq 2\pi$. A point on the circle $(x - a)^2 + z^2 = b^2$ which generates the torus can be written $\mathbf{r} = (a + b \cos v) \mathbf{i} + b \sin v \mathbf{k}$, $0 \leq v \leq 2\pi$. Set $a_0 = a + b \cos v$ and $b_0 = a + b \sin v$ and use the first result: any point on the torus can thus be written in the form $\mathbf{r} = (a + b \cos v) \cos u \mathbf{i} + (a + b \cos v) \sin u \mathbf{j} + b \sin v \mathbf{k}$, which yields the result.

55. $\mathbf{r}_u = -(a + b \cos v) \sin u \mathbf{i} + (a + b \cos v) \cos u \mathbf{j}$, $\mathbf{r}_v = -b \sin v \cos u \mathbf{i} - b \sin v \sin u \mathbf{j} + b \cos v \mathbf{k}$, $\|\mathbf{r}_u \times \mathbf{r}_v\| = b(a + b \cos v)$; $S = \int_0^{2\pi} \int_0^{2\pi} b(a + b \cos v) \, du \, dv = 4\pi^2 ab$.

56. $\|\mathbf{r}_u \times \mathbf{r}_v\| = \sqrt{u^2 + 1}$; $S = \int_0^{4\pi} \int_0^5 \sqrt{u^2 + 1} \, du \, dv = 4\pi \int_0^5 \sqrt{u^2 + 1} \, du \approx 174.7199011$.

57. $z = -1$ when $v \approx 0.27955$, $z = 1$ when $v \approx 2.86204$, $\|\mathbf{r}_u \times \mathbf{r}_v\| = |\cos v|$; $S \approx \int_0^{2\pi} \int_{0.27955}^{2.86204} |\cos v| \, dv \, du \approx 9.099$.

58. (a) $x = v \cos u$, $y = v \sin u$, $z = f(v)$, for example. (b) $x = v \cos u$, $y = v \sin u$, $z = 1/v^2$.

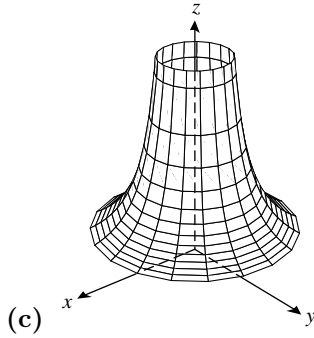

59. $\left(\frac{x}{a}\right)^2 + \left(\frac{y}{b}\right)^2 + \left(\frac{z}{c}\right)^2 = 1$, ellipsoid.
60. $\left(\frac{x}{a}\right)^2 + \left(\frac{y}{b}\right)^2 - \left(\frac{z}{c}\right)^2 = 1$, hyperboloid of one sheet.
61. $-\left(\frac{x}{a}\right)^2 - \left(\frac{y}{b}\right)^2 + \left(\frac{z}{c}\right)^2 = 1$, hyperboloid of two sheets.

Exercise Set 14.5

1. $\int_{-1}^1 \int_0^2 \int_0^1 (x^2 + y^2 + z^2) dx dy dz = \int_{-1}^1 \int_0^2 (1/3 + y^2 + z^2) dy dz = \int_{-1}^1 (10/3 + 2z^2) dz = 8.$
2. $\int_{1/3}^{1/2} \int_0^\pi \int_0^1 zx \sin xy dz dy dx = \int_{1/3}^{1/2} \int_0^\pi \frac{1}{2} x \sin xy dy dx = \int_{1/3}^{1/2} \frac{1}{2} (1 - \cos \pi x) dx = \frac{1}{12} + \frac{\sqrt{3}-2}{4\pi}.$
3. $\int_0^2 \int_{-1}^{y^2} \int_{-1}^z yz dx dz dy = \int_0^2 \int_{-1}^{y^2} (yz^2 + yz) dz dy = \int_0^2 \left(\frac{1}{3}y^7 + \frac{1}{2}y^5 - \frac{1}{6}y\right) dy = \frac{47}{3}.$
4. $\int_0^{\pi/4} \int_0^1 \int_0^{x^2} x \cos y dz dx dy = \int_0^{\pi/4} \int_0^1 x^3 \cos y dx dy = \int_0^{\pi/4} \frac{1}{4} \cos y dy = \frac{\sqrt{2}}{8}.$
5. $\int_0^3 \int_0^{\sqrt{9-z^2}} \int_0^x xy dy dx dz = \int_0^3 \int_0^{\sqrt{9-z^2}} \frac{1}{2} x^3 dx dz = \int_0^3 \frac{1}{8} (81 - 18z^2 + z^4) dz = \frac{81}{5}.$
6. $\int_1^3 \int_x^{x^2} \int_0^{\ln z} xe^y dy dz dx = \int_1^3 \int_x^{x^2} (xz - x) dz dx = \int_1^3 \left(\frac{1}{2}x^5 - \frac{3}{2}x^3 + x^2\right) dx = \frac{118}{3}.$
7. $\int_0^2 \int_0^{\sqrt{4-x^2}} \int_{-5+x^2+y^2}^{3-x^2-y^2} x dz dy dx = \int_0^2 \int_0^{\sqrt{4-x^2}} [2x(4-x^2) - 2xy^2] dy dx = \int_0^2 \frac{4}{3} x(4-x^2)^{3/2} dx = \frac{128}{15}.$
8. $\int_1^2 \int_z^2 \int_0^{\sqrt{3}y} \frac{y}{x^2 + y^2} dx dy dz = \int_1^2 \int_z^2 \frac{\pi}{3} dy dz = \int_1^2 \frac{\pi}{3} (2-z) dz = \frac{\pi}{6}.$
9. $\int_0^\pi \int_0^1 \int_0^{\pi/6} xy \sin yz dz dy dx = \int_0^\pi \int_0^1 x[1 - \cos(\pi y/6)] dy dx = \int_0^\pi (1 - 3/\pi)x dx = \frac{\pi(\pi-3)}{2}.$
10. $\int_{-1}^1 \int_0^{1-x^2} \int_0^y y dz dy dx = \int_{-1}^1 \int_0^{1-x^2} y^2 dy dx = \int_{-1}^1 \frac{1}{3} (1-x^2)^3 dx = \frac{32}{105}.$

$$11. \int_0^{\sqrt{2}} \int_0^x \int_0^{2-x^2} xyz \, dz \, dy \, dx = \int_0^{\sqrt{2}} \int_0^x \frac{1}{2} xy(2-x^2)^2 \, dy \, dx = \int_0^{\sqrt{2}} \frac{1}{4} x^3(2-x^2)^2 \, dx = \frac{1}{6}.$$

$$12. \int_{\pi/6}^{\pi/2} \int_y^{\pi/2} \int_0^{xy} \cos(z/y) \, dz \, dx \, dy = \int_{\pi/6}^{\pi/2} \int_y^{\pi/2} y \sin x \, dx \, dy = \int_{\pi/6}^{\pi/2} y \cos y \, dy = \frac{5\pi - 6\sqrt{3}}{12}.$$

$$13. \int_0^3 \int_1^2 \int_{-2}^1 \frac{\sqrt{x+z^2}}{y} \, dz \, dy \, dx \approx 9.425.$$

$$14. 8 \int_0^1 \int_0^{\sqrt{1-x^2}} \int_0^{\sqrt{1-x^2-y^2}} e^{-x^2-y^2-z^2} \, dz \, dy \, dx \approx 2.381.$$

$$15. V = \int_0^4 \int_0^{(4-x)/2} \int_0^{(12-3x-6y)/4} dz \, dy \, dx = \int_0^4 \int_0^{(4-x)/2} \frac{1}{4}(12-3x-6y) \, dy \, dx = \int_0^4 \frac{3}{16}(4-x)^2 \, dx = 4.$$

$$16. V = \int_0^1 \int_0^{1-x} \int_0^{\sqrt{y}} dz \, dy \, dx = \int_0^1 \int_0^{1-x} \sqrt{y} \, dy \, dx = \int_0^1 \frac{2}{3}(1-x)^{3/2} \, dx = \frac{4}{15}.$$

$$17. V = 2 \int_0^2 \int_{x^2}^4 \int_0^{4-y} dz \, dy \, dx = 2 \int_0^2 \int_{x^2}^4 (4-y) \, dy \, dx = 2 \int_0^2 \left(8-4x^2 + \frac{1}{2}x^4\right) \, dx = \frac{256}{15}.$$

$$18. V = \int_0^1 \int_0^y \int_0^{\sqrt{1-y^2}} dz \, dx \, dy = \int_0^1 \int_0^y \sqrt{1-y^2} \, dx \, dy = \int_0^1 y\sqrt{1-y^2} \, dy = \frac{1}{3}.$$

19. The projection of the curve of intersection onto the xy -plane is $x^2 + y^2 = 1$,

$$(a) \int_{-1}^1 \int_{-\sqrt{1-x^2}}^{\sqrt{1-x^2}} \int_{4x^2+y^2}^{4-3y^2} f(x, y, z) \, dz \, dy \, dx. \quad (b) \int_{-1}^1 \int_{-\sqrt{1-y^2}}^{\sqrt{1-y^2}} \int_{4x^2+y^2}^{4-3y^2} f(x, y, z) \, dz \, dx \, dy.$$

20. The projection of the curve of intersection onto the xy -plane is $2x^2 + y^2 = 4$,

$$(a) \int_{-\sqrt{2}}^{\sqrt{2}} \int_{-\sqrt{4-2x^2}}^{\sqrt{4-2x^2}} \int_{3x^2+y^2}^{8-x^2-y^2} f(x, y, z) \, dz \, dy \, dx. \quad (b) \int_{-2}^2 \int_{-\sqrt{(4-y^2)/2}}^{\sqrt{(4-y^2)/2}} \int_{3x^2+y^2}^{8-x^2-y^2} f(x, y, z) \, dz \, dx \, dy.$$

$$21. \text{ Let } f(x, y, z) = 1 \text{ in Exercise 19(a). } V = \int_{-1}^1 \int_{-\sqrt{1-x^2}}^{\sqrt{1-x^2}} \int_{4x^2+y^2}^{4-3y^2} dz \, dy \, dx = 4 \int_0^1 \int_0^{\sqrt{1-x^2}} \int_{4x^2+y^2}^{4-3y^2} dz \, dy \, dx.$$

$$22. \text{ Let } f(x, y, z) = 1 \text{ in Exercise 20(a). } V = \int_{-\sqrt{2}}^{\sqrt{2}} \int_{-\sqrt{4-2x^2}}^{\sqrt{4-2x^2}} \int_{3x^2+y^2}^{8-x^2-y^2} dz \, dy \, dx = 4 \int_0^{\sqrt{2}} \int_0^{\sqrt{4-2x^2}} \int_{3x^2+y^2}^{8-x^2-y^2} dz \, dy \, dx.$$

$$23. V = 2 \int_{-3}^3 \int_0^{\sqrt{9-x^2}/3} \int_0^{x+3} dz \, dy \, dx.$$

$$24. V = 8 \int_0^1 \int_0^{\sqrt{1-x^2}} \int_0^{\sqrt{1-x^2}} dz \, dy \, dx.$$

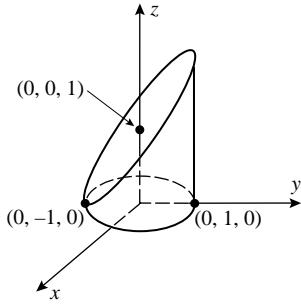

25. (a)

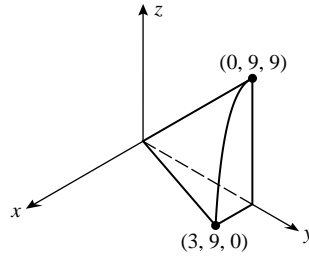

(b)

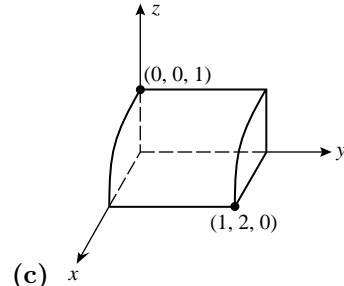

(c)

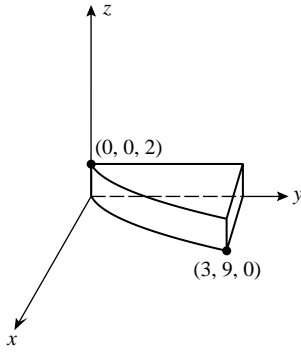

26. (a)

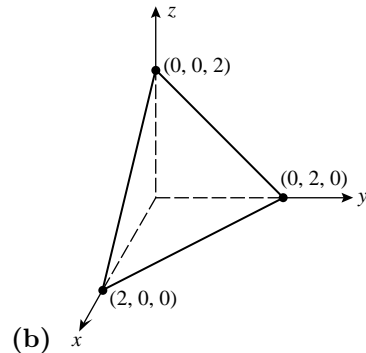

(b)

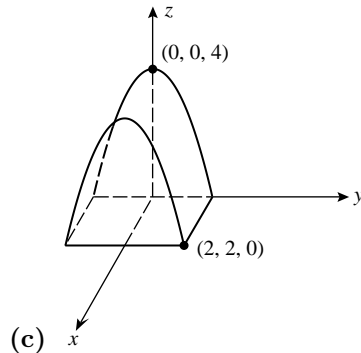

(c)

27. True, by changing the order of integration in Theorem 14.5.1.

28. False. For example, consider the simple xy -solid G defined by $-1 \leq x \leq 1$, $-1 \leq y \leq 1$, $0 \leq z \leq x^2 + y^2$. Cross-sections of G parallel to the xy -plane with $z > 0$ are neither type I nor type II regions, so the triple integral over G can't be expressed as an integral whose outermost integration is performed with respect to z . (As shown in Theorem 14.5.2, the triple integral can be expressed as an iterated integral whose innermost integration is performed with respect to z .)

29. False. The middle integral (with respect to y) should be $\int_0^{\sqrt{1-x^2}}$.

30. False. For example, let G be described by $0 \leq x \leq 1$, $0 \leq y \leq 1$, $0 \leq z \leq 1$, and let $f(x, y, z) = 2x$. Then

$$\iiint_G 2x \, dV = \int_0^1 \int_0^1 \int_0^1 2x \, dz \, dy \, dx = \int_0^1 \int_0^1 2x \, dy \, dx = \int_0^1 2x \, dx = x^2 \Big|_0^1 = 1 = \text{volume of } G.$$

$$31. \int_a^b \int_c^d \int_k^\ell f(x)g(y)h(z) \, dz \, dy \, dx = \int_a^b \int_c^d f(x)g(y) \left[\int_k^\ell h(z) \, dz \right] \, dy \, dx = \left[\int_a^b f(x) \left[\int_c^d g(y) \, dy \right] \, dx \right] \left[\int_k^\ell h(z) \, dz \right] = \left[\int_a^b f(x) \, dx \right] \left[\int_c^d g(y) \, dy \right] \left[\int_k^\ell h(z) \, dz \right].$$

$$32. (a) \left[\int_{-1}^1 x \, dx \right] \left[\int_0^1 y^2 \, dy \right] \left[\int_0^{\pi/2} \sin z \, dz \right] = (0)(1/3)(1) = 0.$$

$$(b) \left[\int_0^1 e^{2x} \, dx \right] \left[\int_0^{\ln 3} e^y \, dy \right] \left[\int_0^{\ln 2} e^{-z} \, dz \right] = [(e^2 - 1)/2](2)(1/2) = (e^2 - 1)/2.$$

$$33. V = \int_0^1 \int_0^{1-x} \int_0^{1-x-y} dz \, dy \, dx = 1/6, \quad f_{\text{ave}} = 6 \int_0^1 \int_0^{1-x} \int_0^{1-x-y} (x + y + z) \, dz \, dy \, dx = \frac{3}{4}.$$

34. The integrand is an odd function of each of x, y , and z , so the average is zero.

35. The volume $V = \frac{3\pi}{\sqrt{2}}$, and thus

$$r_{\text{ave}} = \frac{\sqrt{2}}{3\pi} \iiint_G \sqrt{x^2 + y^2 + z^2} dV = \frac{\sqrt{2}}{3\pi} \int_{-1/\sqrt{2}}^{1/\sqrt{2}} \int_{-\sqrt{1-2x^2}}^{\sqrt{1-2x^2}} \int_{5x^2+5y^2}^{6-7x^2-y^2} \sqrt{x^2 + y^2 + z^2} dz dy dx \approx 3.291.$$

36. $V = 1, d_{\text{ave}} = \frac{1}{V} \int_0^1 \int_0^1 \int_0^1 \sqrt{(x-z)^2 + (y-z)^2 + z^2} dx dy dz \approx 0.771.$

37. (a) $\int_0^a \int_0^{b(1-x/a)} \int_0^{c(1-x/a-y/b)} dz dy dx, \int_0^b \int_0^{a(1-y/b)} \int_0^{c(1-x/a-y/b)} dz dx dy,$
 $\int_0^c \int_0^{a(1-z/c)} \int_0^{b(1-x/a-z/c)} dy dx dz, \int_0^a \int_0^{c(1-x/a)} \int_0^{b(1-x/a-z/c)} dy dz dx, \int_0^c \int_0^{b(1-z/c)} \int_0^{a(1-y/b-z/c)} dx dy dz,$
 $\int_0^b \int_0^{c(1-y/b)} \int_0^{a(1-y/b-z/c)} dx dz dy.$

(b) Use the first integral in part (a) to get $\int_0^a \int_0^{b(1-x/a)} c \left(1 - \frac{x}{a} - \frac{y}{b}\right) dy dx = \int_0^a \frac{1}{2} bc \left(1 - \frac{x}{a}\right)^2 dx = \frac{1}{6} abc.$

38. $V = 8 \int_0^a \int_0^{b\sqrt{1-x^2/a^2}} \int_0^{c\sqrt{1-x^2/a^2-y^2/b^2}} dz dy dx = 8 \int_0^a \int_0^{b\sqrt{1-x^2/a^2}} c \sqrt{1 - \frac{x^2}{a^2} - \frac{y^2}{b^2}} dy dx =$
 $= \frac{8c}{b} \int_0^a \int_0^{b\sqrt{1-x^2/a^2}} \sqrt{b^2 \left(1 - \frac{x^2}{a^2}\right) - y^2} dy dx =$
 $= \frac{8c}{b} \int_0^a \left[\frac{y}{2} \sqrt{b^2 \left(1 - \frac{x^2}{a^2}\right) - y^2} + \frac{b^2}{2} \left(1 - \frac{x^2}{a^2}\right) \sin^{-1} \frac{y}{\sqrt{b^2 \left(1 - \frac{x^2}{a^2}\right)}} \right]_{y=0}^{b\sqrt{1-x^2/a^2}} dx =$
 $= \frac{8c}{b} \int_0^a \frac{b^2}{2} \left(1 - \frac{x^2}{a^2}\right) \frac{\pi}{2} dx = 2\pi bc \int_0^a \left(1 - \frac{x^2}{a^2}\right) dx = 2\pi bc \left[x - \frac{x^3}{3a^2} \right]_0^a = \frac{4\pi abc}{3},$ by Endpaper Integral Table Formula 74.

39. (a) $\int_0^2 \int_0^{\sqrt{4-x^2}} \int_0^5 f(x, y, z) dz dy dx$ (b) $\int_0^9 \int_0^{3-\sqrt{x}} \int_y^{3-\sqrt{x}} f(x, y, z) dz dy dx$

(c) $\int_0^2 \int_0^{4-x^2} \int_y^{8-y} f(x, y, z) dz dy dx$

40. (a) $\int_0^3 \int_0^{\sqrt{9-x^2}} \int_0^{\sqrt{9-x^2-y^2}} f(x, y, z) dz dy dx$ (b) $\int_0^4 \int_0^{x/2} \int_0^2 f(x, y, z) dz dy dx$

(c) $\int_0^2 \int_0^{4-x^2} \int_{x^2}^{4-y} f(x, y, z) dz dy dx$

41. See discussion after Theorem 14.5.2.

Exercise Set 14.6

1. $\int_0^{2\pi} \int_0^1 \int_0^{\sqrt{1-r^2}} zr dz dr d\theta = \int_0^{2\pi} \int_0^1 \frac{1}{2}(1-r^2)r dr d\theta = \int_0^{2\pi} \frac{1}{8} d\theta = \frac{\pi}{4}.$

2. $\int_0^{\pi/2} \int_0^{\cos \theta} \int_0^{r^2} r \sin \theta dz dr d\theta = \int_0^{\pi/2} \int_0^{\cos \theta} r^3 \sin \theta dr d\theta = \int_0^{\pi/2} \frac{1}{4} \cos^4 \theta \sin \theta d\theta = \frac{1}{20}.$

$$3. \int_0^{\pi/2} \int_0^{\pi/2} \int_0^1 \rho^3 \sin \phi \cos \phi \, d\rho \, d\phi \, d\theta = \int_0^{\pi/2} \int_0^{\pi/2} \frac{1}{4} \sin \phi \cos \phi \, d\phi \, d\theta = \int_0^{\pi/2} \frac{1}{8} \, d\theta = \frac{\pi}{16}.$$

$$4. \int_0^{2\pi} \int_0^{\pi/4} \int_0^{a \sec \phi} \rho^2 \sin \phi \, d\rho \, d\phi \, d\theta = \int_0^{2\pi} \int_0^{\pi/4} \frac{1}{3} a^3 \sec^3 \phi \sin \phi \, d\phi \, d\theta = \int_0^{2\pi} \frac{1}{6} a^3 \, d\theta = \frac{\pi a^3}{3}.$$

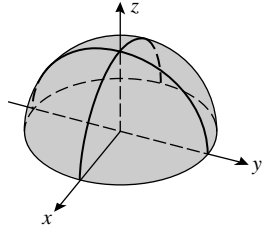

5. $f(r, \theta, z) = z$

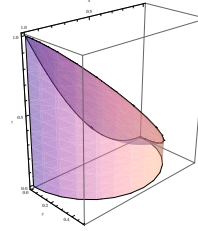

6. $f(r, \theta, z) = \sin \theta$

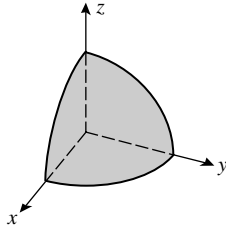

7. $f(\rho, \theta, \phi) = \rho \cos \phi$

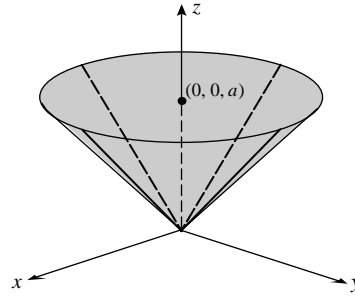

8. $f(\rho, \theta, \phi) = 1$

$$9. V = \int_0^{2\pi} \int_0^3 \int_{r^2}^9 r \, dz \, dr \, d\theta = \int_0^{2\pi} \int_0^3 r(9 - r^2) \, dr \, d\theta = \int_0^{2\pi} \frac{81}{4} \, d\theta = \frac{81\pi}{2}.$$

$$10. V = \int_0^{2\pi} \int_0^{1/\sqrt{2}} \int_r^{\sqrt{1-r^2}} r \, dz \, dr \, d\theta = \int_0^{2\pi} \int_0^{1/\sqrt{2}} r\sqrt{1-r^2} - r^2 \, dr \, d\theta = \int_0^{2\pi} \frac{1}{6}(2 - \sqrt{2}) \, d\theta = \frac{\pi}{3}(2 - \sqrt{2}).$$

11. $r^2 + z^2 = 20$ intersects $z = r^2$ in a circle of radius 2; the volume consists of two portions, one inside the cylinder $r = 2$ and one outside that cylinder:

$$V = \int_0^{2\pi} \int_0^2 \int_{-\sqrt{20-r^2}}^{r^2} r \, dz \, dr \, d\theta + \int_0^{2\pi} \int_2^{\sqrt{20}} \int_{-\sqrt{20-r^2}}^{\sqrt{20-r^2}} r \, dz \, dr \, d\theta = \int_0^{2\pi} \int_0^2 r(r^2 + \sqrt{20-r^2}) \, dr \, d\theta + \int_0^{2\pi} \int_2^{\sqrt{20}} 2r\sqrt{20-r^2} \, dr \, d\theta = \frac{4}{3}(10\sqrt{5} - 13) \int_0^{2\pi} d\theta + \frac{128}{3} \int_0^{2\pi} d\theta = \frac{152}{3}\pi + \frac{80}{3}\pi\sqrt{5}.$$

12. $z = hr/a$ intersects $z = h$ in a circle of radius a , $V = \int_0^{2\pi} \int_0^a \int_{hr/a}^h r \, dz \, dr \, d\theta = \int_0^{2\pi} \int_0^a \frac{h}{a}(ar - r^2) \, dr \, d\theta = \int_0^{2\pi} \frac{1}{6} a^2 h \, d\theta = \frac{\pi a^2 h}{3}.$

$$13. V = \int_0^{2\pi} \int_0^{\pi/3} \int_0^4 \rho^2 \sin \phi \, d\rho \, d\phi \, d\theta = \int_0^{2\pi} \int_0^{\pi/3} \frac{64}{3} \sin \phi \, d\phi \, d\theta = \frac{32}{3} \int_0^{2\pi} d\theta = \frac{64\pi}{3}.$$

$$14. V = \int_0^{2\pi} \int_0^{\pi/4} \int_1^2 \rho^2 \sin \phi \, d\rho \, d\phi \, d\theta = \int_0^{2\pi} \int_0^{\pi/4} \frac{7}{3} \sin \phi \, d\phi \, d\theta = \frac{7}{6}(2 - \sqrt{2}) \int_0^{2\pi} d\theta = \frac{7\pi}{3}(2 - \sqrt{2}).$$

15. In spherical coordinates the sphere and the plane $z = a$ are $\rho = 2a$ and $\rho = a \sec \phi$, respectively. They intersect at $\phi = \pi/3$, $V = \int_0^{2\pi} \int_0^{\pi/3} \int_0^{a \sec \phi} \rho^2 \sin \phi \, d\rho \, d\phi \, d\theta + \int_0^{2\pi} \int_{\pi/3}^{\pi/2} \int_0^{2a} \rho^2 \sin \phi \, d\rho \, d\phi \, d\theta =$

$$= \int_0^{2\pi} \int_0^{\pi/3} \frac{1}{3} a^3 \sec^3 \phi \sin \phi \, d\phi \, d\theta + \int_0^{2\pi} \int_{\pi/3}^{\pi/2} \frac{8}{3} a^3 \sin \phi \, d\phi \, d\theta = \frac{1}{2} a^3 \int_0^{2\pi} d\theta + \frac{4}{3} a^3 \int_0^{2\pi} d\theta = \frac{11\pi a^3}{3}.$$

$$16. V = \int_0^{2\pi} \int_{\pi/4}^{\pi/2} \int_0^3 \rho^2 \sin \phi \, d\rho \, d\phi \, d\theta = \int_0^{2\pi} \int_{\pi/4}^{\pi/2} 9 \sin \phi \, d\phi \, d\theta = \frac{9\sqrt{2}}{2} \int_0^{2\pi} d\theta = 9\sqrt{2}\pi.$$

$$17. \int_0^{\pi/2} \int_0^a \int_0^{a^2-r^2} r^3 \cos^2 \theta \, dz \, dr \, d\theta = \int_0^{\pi/2} \int_0^a (a^2 r^3 - r^5) \cos^2 \theta \, dr \, d\theta = \frac{1}{12} a^6 \int_0^{\pi/2} \cos^2 \theta \, d\theta = \frac{\pi a^6}{48}.$$

$$18. \int_0^\pi \int_0^{\pi/2} \int_0^1 e^{-\rho^3} \rho^2 \sin \phi \, d\rho \, d\phi \, d\theta = \frac{1}{3} (1 - e^{-1}) \int_0^\pi \int_0^{\pi/2} \sin \phi \, d\phi \, d\theta = \frac{\pi}{3} (1 - e^{-1}).$$

$$19. \int_0^{\pi/2} \int_0^{\pi/4} \int_0^{\sqrt{8}} \rho^4 \cos^2 \phi \sin \phi \, d\rho \, d\phi \, d\theta = \frac{32\pi}{15} (2\sqrt{2} - 1).$$

$$20. \int_0^{2\pi} \int_0^\pi \int_0^3 \rho^3 \sin \phi \, d\rho \, d\phi \, d\theta = 81\pi.$$

21. False. The factor r^2 should be just r .

22. True. If G is the spherical wedge then the volume of G is $\iiint_G 1 \, dV = \int_{\theta_1}^{\theta_2} \int_{\phi_1}^{\phi_2} \int_{\rho_1}^{\rho_2} \rho^2 \sin \phi \, d\rho \, d\phi \, d\theta$, by equation (9).

23. True. The region is described by $0 \leq \phi \leq \pi/4$, $0 \leq \theta \leq 2\pi$, $1 \leq \rho \leq 3$, so the volume is $\iiint_G 1 \, dV = \int_0^{\pi/4} \int_0^{2\pi} \int_1^3 \rho^2 \sin \phi \, d\rho \, d\theta \, d\phi$.

24. False. The “ $\sin \theta$ ” and “ $\cos \theta$ ” in the iterated integral are reversed.

$$25. \text{(a)} \int_{-2}^2 \int_1^4 \int_{\pi/6}^{\pi/3} \frac{r \tan^3 \theta}{\sqrt{1+z^2}} \, d\theta \, dr \, dz = \left(\int_{-2}^2 \frac{1}{\sqrt{1+z^2}} \, dz \right) \left(\int_1^4 r \, dr \right) \left(\int_{\pi/6}^{\pi/3} \tan^3 \theta \, d\theta \right) = \\ = 2 \ln(2 + \sqrt{5}) \cdot \frac{15}{2} \cdot \left(\frac{4}{3} - \frac{1}{2} \ln 3 \right) = \frac{5}{2} (8 - 3 \ln 3) \ln(2 + \sqrt{5}) \approx 16.97774195.$$

(b) G is the cylindrical wedge $\pi/6 \leq \theta \leq \pi/3$, $1 \leq r \leq 4$, $-2 \leq z \leq 2$. Since $dx \, dy \, dz = dV = r \, d\theta \, dr \, dz$, the integrand in rectangular coordinates is $\frac{1}{r} \cdot \frac{r \tan^3 \theta}{\sqrt{1+z^2}} = \frac{(y/x)^3}{\sqrt{1+z^2}}$, so $f(x, y, z) = \frac{y^3}{x^3 \sqrt{1+z^2}}$.

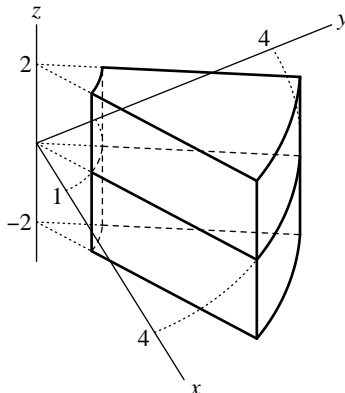

$$26. \int_0^{\pi/2} \int_0^{\pi/4} \frac{1}{18} \cos^{37} \theta \cos \phi \, d\phi \, d\theta = \frac{\sqrt{2}}{36} \int_0^{\pi/2} \cos^{37} \theta \, d\theta = \frac{4,294,967,296}{755,505,013,725} \sqrt{2} \approx 0.008040.$$

$$27. \text{(a)} \quad V = 2 \int_0^{2\pi} \int_0^a \int_0^{\sqrt{a^2-r^2}} r \, dz \, dr \, d\theta = \frac{4\pi a^3}{3}. \quad \text{(b)} \quad V = \int_0^{2\pi} \int_0^\pi \int_0^a \rho^2 \sin \phi \, d\rho \, d\phi \, d\theta = \frac{4\pi a^3}{3}.$$

$$28. \text{(a)} \quad \int_0^2 \int_0^{\sqrt{4-x^2}} \int_0^{\sqrt{4-x^2-y^2}} xyz \, dz \, dy \, dx = \int_0^2 \int_0^{\sqrt{4-x^2}} \frac{1}{2} xy(4-x^2-y^2) \, dy \, dx = \frac{1}{8} \int_0^2 x(4-x^2)^2 \, dx = \frac{4}{3}.$$

$$\text{(b)} \quad \int_0^{\pi/2} \int_0^2 \int_0^{\sqrt{4-r^2}} r^3 z \sin \theta \cos \theta \, dz \, dr \, d\theta = \int_0^{\pi/2} \int_0^2 \frac{1}{2} (4r^3 - r^5) \sin \theta \cos \theta \, dr \, d\theta = \frac{8}{3} \int_0^{\pi/2} \sin \theta \cos \theta \, d\theta = \frac{4}{3}.$$

$$\text{(c)} \quad \int_0^{\pi/2} \int_0^{\pi/2} \int_0^2 \rho^5 \sin^3 \phi \cos \phi \sin \theta \cos \theta \, d\rho \, d\phi \, d\theta = \int_0^{\pi/2} \int_0^{\pi/2} \frac{32}{3} \sin^3 \phi \cos \phi \sin \theta \cos \theta \, d\phi \, d\theta = \frac{8}{3} \int_0^{\pi/2} \sin \theta \cos \theta \, d\theta = \frac{4}{3}.$$

$$29. \quad V = \int_0^{\pi/2} \int_{\pi/6}^{\pi/3} \int_0^2 \rho^2 \sin \phi \, d\rho \, d\phi \, d\theta = \int_0^{\pi/2} \int_{\pi/6}^{\pi/3} \frac{8}{3} \sin \phi \, d\phi \, d\theta = \frac{4}{3} (\sqrt{3} - 1) \int_0^{\pi/2} d\theta = \frac{2\pi}{3} (\sqrt{3} - 1).$$

$$30. \text{(a)} \quad \text{The sphere and cone intersect in a circle of radius } \rho_0 \sin \phi_0, \quad V = \int_{\theta_1}^{\theta_2} \int_0^{\rho_0 \sin \phi_0} \int_{r \cot \phi_0}^{\sqrt{\rho_0^2 - r^2}} r \, dz \, dr \, d\theta = \int_{\theta_1}^{\theta_2} \int_0^{\rho_0 \sin \phi_0} \left(r \sqrt{\rho_0^2 - r^2} - r^2 \cot \phi_0 \right) dr \, d\theta = \int_{\theta_1}^{\theta_2} \frac{1}{3} \rho_0^3 (1 - \cos^3 \phi_0 - \sin^3 \phi_0 \cot \phi_0) \, d\theta = \frac{1}{3} \rho_0^3 (1 - \cos^3 \phi_0 - \sin^2 \phi_0 \cos \phi_0) (\theta_2 - \theta_1) = \frac{1}{3} \rho_0^3 (1 - \cos \phi_0) (\theta_2 - \theta_1).$$

(b) From part (a), the volume of the solid bounded by $\theta = \theta_1$, $\theta = \theta_2$, $\phi = \phi_1$, $\phi = \phi_2$, and $\rho = \rho_0$ is $\frac{1}{3} \rho_0^3 (1 - \cos \phi_2) (\theta_2 - \theta_1) - \frac{1}{3} \rho_0^3 (1 - \cos \phi_1) (\theta_2 - \theta_1) = \frac{1}{3} \rho_0^3 (\cos \phi_1 - \cos \phi_2) (\theta_2 - \theta_1)$, so the volume of the spherical wedge between $\rho = \rho_1$ and $\rho = \rho_2$ is $\Delta V = \frac{1}{3} \rho_2^3 (\cos \phi_1 - \cos \phi_2) (\theta_2 - \theta_1) - \frac{1}{3} \rho_1^3 (\cos \phi_1 - \cos \phi_2) (\theta_2 - \theta_1) = \frac{1}{3} (\rho_2^3 - \rho_1^3) (\cos \phi_1 - \cos \phi_2) (\theta_2 - \theta_1)$.

(c) $\frac{d}{d\phi} \cos \phi = -\sin \phi$ so from the Mean-Value Theorem $\cos \phi_2 - \cos \phi_1 = -(\phi_2 - \phi_1) \sin \phi^*$ where ϕ^* is between ϕ_1 and ϕ_2 . Similarly $\frac{d}{d\rho} \rho^3 = 3\rho^2$ so $\rho_2^3 - \rho_1^3 = 3\rho^{*2} (\rho_2 - \rho_1)$ where ρ^* is between ρ_1 and ρ_2 . Thus $\cos \phi_1 - \cos \phi_2 = \sin \phi^* \Delta \phi$ and $\rho_2^3 - \rho_1^3 = 3\rho^{*2} \Delta \rho$ so $\Delta V = \rho^{*2} \sin \phi^* \Delta \rho \Delta \phi \Delta \theta$.

31. The fact that none of the limits involves θ means that the solid is obtained by rotating a region in the xz -plane about the z -axis, between two angles θ_1 and θ_2 . If the integral is expressed in cylindrical coordinates, then the plane region must be either a type I region or a type II region (with the role of y replaced by z); see Definition 14.2.1. If the integral is expressed in spherical coordinates, then the plane region may be a simple polar region (with the roles of θ and r replaced by ϕ and ρ); see Definition 14.3.1. Or it may be described by inequalities of the form $\rho_1 \leq \rho \leq \rho_2$, $\phi_1(\rho) \leq \phi \leq \phi_2(\rho)$ for some numbers $\rho_1 \leq \rho_2$ and functions $\phi_1(\rho) \leq \phi_2(\rho)$.

Exercise Set 14.7

$$1. \quad \frac{\partial(x, y)}{\partial(u, v)} = \begin{vmatrix} 1 & 4 \\ 3 & -5 \end{vmatrix} = -17.$$

$$2. \frac{\partial(x, y)}{\partial(u, v)} = \begin{vmatrix} 1 & 4v \\ 4u & -1 \end{vmatrix} = -1 - 16uv.$$

$$3. \frac{\partial(x, y)}{\partial(u, v)} = \begin{vmatrix} \cos u & -\sin v \\ \sin u & \cos v \end{vmatrix} = \cos u \cos v + \sin u \sin v = \cos(u - v).$$

$$4. \frac{\partial(x, y)}{\partial(u, v)} = \begin{vmatrix} \frac{2(v^2 - u^2)}{(u^2 + v^2)^2} & -\frac{4uv}{(u^2 + v^2)^2} \\ \frac{4uv}{(u^2 + v^2)^2} & \frac{2(v^2 - u^2)}{(u^2 + v^2)^2} \end{vmatrix} = 4/(u^2 + v^2)^2.$$

$$5. x = \frac{2}{9}u + \frac{5}{9}v, y = -\frac{1}{9}u + \frac{2}{9}v; \frac{\partial(x, y)}{\partial(u, v)} = \begin{vmatrix} 2/9 & 5/9 \\ -1/9 & 2/9 \end{vmatrix} = \frac{1}{9}.$$

$$6. x = \ln u, y = uv; \frac{\partial(x, y)}{\partial(u, v)} = \begin{vmatrix} 1/u & 0 \\ v & u \end{vmatrix} = 1.$$

$$7. x = \frac{\sqrt{u+v}}{\sqrt{2}}, y = \frac{\sqrt{v-u}}{\sqrt{2}}; \frac{\partial(x, y)}{\partial(u, v)} = \begin{vmatrix} \frac{1}{2\sqrt{2}\sqrt{u+v}} & \frac{1}{2\sqrt{2}\sqrt{u+v}} \\ -\frac{1}{2\sqrt{2}\sqrt{v-u}} & \frac{1}{2\sqrt{2}\sqrt{v-u}} \end{vmatrix} = \frac{1}{4\sqrt{v^2 - u^2}}.$$

$$8. x = \frac{u^{3/2}}{v^{1/2}}, y = \frac{v^{1/2}}{u^{1/2}}; \frac{\partial(x, y)}{\partial(u, v)} = \begin{vmatrix} \frac{3u^{1/2}}{2v^{1/2}} & -\frac{u^{3/2}}{2v^{3/2}} \\ -\frac{v^{1/2}}{2u^{3/2}} & \frac{1}{2u^{1/2}v^{1/2}} \end{vmatrix} = \frac{1}{2v}.$$

$$9. \frac{\partial(x, y, z)}{\partial(u, v, w)} = \begin{vmatrix} 3 & 1 & 0 \\ 1 & 0 & -2 \\ 0 & 1 & 1 \end{vmatrix} = 5.$$

$$10. \frac{\partial(x, y, z)}{\partial(u, v, w)} = \begin{vmatrix} 1-v & -u & 0 \\ v-vw & u-uw & -uv \\ vw & uw & uv \end{vmatrix} = u^2v.$$

$$11. y = v, x = \frac{u}{y} = \frac{u}{v}, z = w - x = w - \frac{u}{v}; \frac{\partial(x, y, z)}{\partial(u, v, w)} = \begin{vmatrix} 1/v & -u/v^2 & 0 \\ 0 & 1 & 0 \\ -1/v & u/v^2 & 1 \end{vmatrix} = \frac{1}{v}.$$

$$12. x = \frac{v+w}{2}, y = \frac{u-w}{2}, z = \frac{u-v}{2}; \frac{\partial(x, y, z)}{\partial(u, v, w)} = \begin{vmatrix} 0 & 1/2 & 1/2 \\ 1/2 & 0 & -1/2 \\ 1/2 & -1/2 & 0 \end{vmatrix} = -\frac{1}{4}.$$

13. False. It is the area of the parallelogram.

14. False. If the mapping is not one-to-one, then the integral may be larger than the area. For example, let $x = u$, $y = (v - 3)^2$. Then R is the rectangle $0 \leq x \leq 2$, $0 \leq y \leq 4$, with area 8, but $\frac{\partial(x, y)}{\partial(u, v)} = \begin{vmatrix} 1 & 0 \\ 0 & 2(v - 3) \end{vmatrix} = 2(v - 3)$,

$$\text{so } \int_1^5 \int_0^2 \left| \frac{\partial(x, y)}{\partial(u, v)} \right| du dv = \int_1^5 \int_0^2 2|v - 3| du dv = \int_1^5 4|v - 3| dv = \int_1^3 4(3 - v) dv + \int_3^5 4(v - 3) dv = (12v - 2v^2) \Big|_1^3 + (2v^2 - 12v) \Big|_3^5 = 8 + 8 = 16.$$

15. False. The Jacobian is $\frac{\partial(x, y)}{\partial(u, v)} = \begin{vmatrix} \cos \theta & -r \sin \theta \\ \sin \theta & r \cos \theta \end{vmatrix} = r(\cos^2 \theta + \sin^2 \theta) = r$.

16. True. See the solution of Exercise 14.7.48(b).

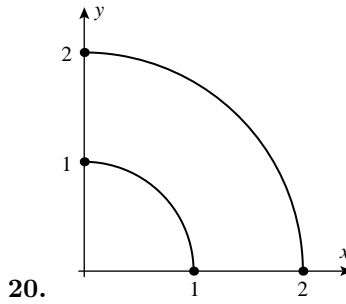
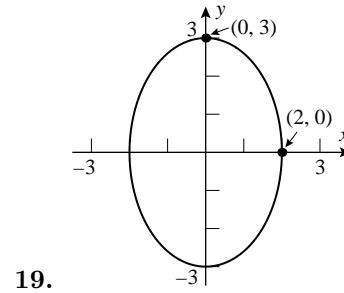
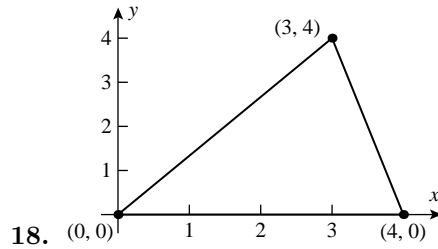
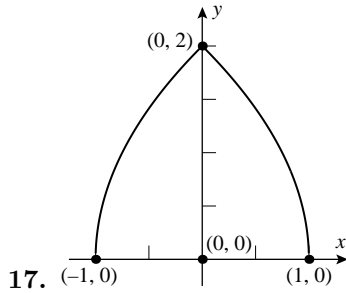

21. $x = \frac{1}{5}u + \frac{2}{5}v, y = -\frac{2}{5}u + \frac{1}{5}v, \frac{\partial(x, y)}{\partial(u, v)} = \frac{1}{5}; \frac{1}{5} \iint_S \frac{u}{v} dA_{uv} = \frac{1}{5} \int_1^3 \int_1^4 \frac{u}{v} du dv = \frac{3}{2} \ln 3.$

22. $x = \frac{1}{2}u + \frac{1}{2}v, y = \frac{1}{2}u - \frac{1}{2}v, \frac{\partial(x, y)}{\partial(u, v)} = -\frac{1}{2}; \frac{1}{2} \iint_S ve^{uv} dA_{uv} = \frac{1}{2} \int_1^4 \int_0^1 ve^{uv} du dv = \frac{1}{2}(e^4 - e - 3).$

23. $x = u + v, y = u - v, \frac{\partial(x, y)}{\partial(u, v)} = -2;$ the boundary curves of the region S in the uv -plane are $v = 0, v = u,$ and $u = 1$ so $2 \iint_S \sin u \cos v dA_{uv} = 2 \int_0^1 \int_0^u \sin u \cos v dv du = 1 - \frac{1}{2} \sin 2.$

24. $x = \sqrt{v/u}, y = \sqrt{uv}$ so, from Example 3, $\frac{\partial(x, y)}{\partial(u, v)} = -\frac{1}{2u};$ the boundary curves of the region S in the uv -plane are $u = 1, u = 3, v = 1,$ and $v = 4$ so $\iint_S uv^2 \left(\frac{1}{2u}\right) dA_{uv} = \frac{1}{2} \int_1^4 \int_1^3 v^2 du dv = 21.$

25. $x = 3u, y = 4v, \frac{\partial(x, y)}{\partial(u, v)} = 12;$ S is the region in the uv -plane enclosed by the circle $u^2 + v^2 = 1.$ Use polar coordinates to obtain $\iint_S 12\sqrt{u^2 + v^2}(12) dA_{uv} = 144 \int_0^{2\pi} \int_0^1 r^2 dr d\theta = 96\pi.$

26. $x = 2u, y = v, \frac{\partial(x, y)}{\partial(u, v)} = 2;$ S is the region in the uv -plane enclosed by the circle $u^2 + v^2 = 1.$ Use polar coordinates to obtain $\iint_S e^{-(4u^2 + 4v^2)}(2) dA_{uv} = 2 \int_0^{2\pi} \int_0^1 re^{-4r^2} dr d\theta = \frac{\pi}{2}(1 - e^{-4}).$

27. Let S be the region in the uv -plane bounded by $u^2 + v^2 = 1,$ so $u = 2x, v = 3y, x = u/2, y = v/3, \frac{\partial(x, y)}{\partial(u, v)} =$

$$\left| \begin{array}{cc} 1/2 & 0 \\ 0 & 1/3 \end{array} \right| = 1/6, \text{ use polar coordinates to get } \frac{1}{6} \iint_S \sin(u^2 + v^2) dA_{uv} = \frac{1}{6} \int_0^{\pi/2} \int_0^1 r \sin r^2 dr d\theta =$$

$$= \frac{\pi}{24} (-\cos r^2) \Big|_0^1 = \frac{\pi}{24} (1 - \cos 1).$$

28. $u = x/a, v = y/b, x = au, y = bv; \frac{\partial(x, y)}{\partial(u, v)} = ab; A = ab \int_0^{2\pi} \int_0^1 r dr d\theta = \pi ab.$

29. $x = u/3, y = v/2, z = w, \frac{\partial(x, y, z)}{\partial(u, v, w)} = 1/6; S$ is the region in uvw -space enclosed by the sphere $u^2 + v^2 + w^2 = 36$,
so $\iiint_S \frac{u^2}{9} \frac{1}{6} dV_{uvw} = \frac{1}{54} \int_0^{2\pi} \int_0^\pi \int_0^6 (\rho \sin \phi \cos \theta)^2 \rho^2 \sin \phi d\rho d\phi d\theta = \frac{1}{54} \int_0^{2\pi} \int_0^\pi \int_0^6 \rho^4 \sin^3 \phi \cos^2 \theta d\rho d\phi d\theta =$
 $\frac{192\pi}{5}.$

30. Let G_1 be the region $u^2 + v^2 + w^2 \leq 1$, with $x = au, y = bv, z = cw, \frac{\partial(x, y, z)}{\partial(u, v, w)} = abc$; then use spherical coordinates in uvw -space: $\iiint_{G_1} (y^2 + z^2) dV_{xyz} = abc \iiint_{G_1} (b^2 v^2 + c^2 w^2) dV_{uvw} = \int_0^{2\pi} \int_0^\pi \int_0^1 abc (b^2 \sin^2 \phi \sin^2 \theta +$
 $c^2 \cos^2 \phi) \rho^4 \sin \phi d\rho d\phi d\theta = \int_0^{2\pi} \frac{abc}{15} (4b^2 \sin^2 \theta + 2c^2) d\theta = \frac{4}{15} \pi abc (b^2 + c^2).$

31. $u = \theta = \begin{cases} \cot^{-1}(x/y) & \text{if } y \neq 0 \\ 0 & \text{if } y = 0, x > 0 \\ \pi & \text{if } y = 0, x < 0 \end{cases}, v = r = \sqrt{x^2 + y^2}.$ Other answers are possible.

32. $u = r = \sqrt{x^2 + y^2}, v = \frac{1}{2} + \frac{\theta}{\pi} = \begin{cases} \frac{1}{2} + \frac{1}{\pi} \tan^{-1}(y/x) & \text{if } x \neq 0 \\ 1 & \text{if } x = 0, y > 0 \\ 0 & \text{if } x = 0, y < 0 \end{cases}.$ Other answers are possible.

33. $u = \frac{3}{7}x - \frac{2}{7}y, v = -\frac{1}{7}x + \frac{3}{7}y.$ Other answers are possible.

34. $u = -x + \frac{4}{3}y, v = y.$ Other answers are possible.

35. Let $u = y - 4x, v = y + 4x$, then $x = \frac{1}{8}(v - u), y = \frac{1}{2}(v + u)$ so $\frac{\partial(x, y)}{\partial(u, v)} = -\frac{1}{8}; \frac{1}{8} \iint_S \frac{u}{v} dA_{uv} = \frac{1}{8} \int_2^5 \int_0^2 \frac{u}{v} du dv =$
 $\frac{1}{4} \ln \frac{5}{2}.$

36. Let $u = y + x, v = y - x$, then $x = \frac{1}{2}(u - v), y = \frac{1}{2}(u + v)$ so $\frac{\partial(x, y)}{\partial(u, v)} = \frac{1}{2}; -\frac{1}{2} \iint_S uv dA_{uv} = -\frac{1}{2} \int_0^2 \int_0^1 uv du dv =$
 $-\frac{1}{2}.$

37. Let $u = x - y, v = x + y$, then $x = \frac{1}{2}(v + u), y = \frac{1}{2}(v - u)$ so $\frac{\partial(x, y)}{\partial(u, v)} = \frac{1}{2}$; the boundary curves of the region S in the uv -plane are $u = 0, v = u$, and $v = \pi/4$; thus $\frac{1}{2} \iint_S \frac{\sin u}{\cos v} dA_{uv} = \frac{1}{2} \int_0^{\pi/4} \int_0^v \frac{\sin u}{\cos v} du dv = \frac{1}{2} \left[\ln(\sqrt{2} + 1) - \frac{\pi}{4} \right].$

38. Let $u = y - x, v = y + x$, then $x = \frac{1}{2}(v - u), y = \frac{1}{2}(u + v)$ so $\frac{\partial(x, y)}{\partial(u, v)} = -\frac{1}{2}$; the boundary curves of the region S in the uv -plane are $v = -u, v = u, v = 1$, and $v = 4$; thus $\frac{1}{2} \iint_S e^{u/v} dA_{uv} = \frac{1}{2} \int_1^4 \int_{-v}^v e^{u/v} du dv = \frac{15}{4}(e - e^{-1})$.

39. Let $u = \frac{y}{x}, v = \frac{x}{y^2}$, then $x = \frac{1}{u^2v}, y = \frac{1}{uv}$ so $\frac{\partial(x, y)}{\partial(u, v)} = \frac{1}{u^4v^3}$; $\iint_S \frac{1}{u^4v^3} dA_{uv} = \int_1^4 \int_1^2 \frac{1}{u^4v^3} du dv = \frac{35}{256}$.

40. Let $x = 3u, y = 2v, \frac{\partial(x, y)}{\partial(u, v)} = 6$; S is the region in the uv -plane enclosed by the circle $u^2 + v^2 = 1$, so $\iint_R (9 - x - y) dA = \iint_S 6(9 - 3u - 2v) dA_{uv} = 6 \int_0^{2\pi} \int_0^1 (9 - 3r \cos \theta - 2r \sin \theta) r dr d\theta = 54\pi$.

41. $x = u, y = \frac{w}{u}, z = v + \frac{w}{u}, \frac{\partial(x, y, z)}{\partial(u, v, w)} = -\frac{1}{u}$; $\iiint_S \frac{v^2w}{u} dV_{uvw} = \int_2^4 \int_0^1 \int_1^3 \frac{v^2w}{u} du dv dw = 2 \ln 3$.

42. $u = xy, v = yz, w = xz, 1 \leq u \leq 2, 1 \leq v \leq 3, 1 \leq w \leq 4, x = \sqrt{uw/v}, y = \sqrt{uv/w}, z = \sqrt{vw/u}, \frac{\partial(x, y, z)}{\partial(u, v, w)} = \frac{1}{2\sqrt{uvw}} V = \iiint_G dV = \int_1^2 \int_1^3 \int_1^4 \frac{1}{2\sqrt{uvw}} dw dv du = 4(\sqrt{2} - 1)(\sqrt{3} - 1)$.

43. (b) $\frac{\partial(x, y)}{\partial(u, v)} \cdot \frac{\partial(u, v)}{\partial(x, y)} = \begin{vmatrix} x_u & x_v \\ y_u & y_v \end{vmatrix} \cdot \begin{vmatrix} u_x & u_y \\ v_x & v_y \end{vmatrix} = \begin{vmatrix} x_u u_x + x_v v_x & x_u u_y + x_v v_y \\ y_u u_x + y_v v_x & y_u u_y + y_v v_y \end{vmatrix} = \begin{vmatrix} x_x & x_y \\ y_x & y_y \end{vmatrix} = \begin{vmatrix} 1 & 0 \\ 0 & 1 \end{vmatrix} = 1$.

44. $\frac{\partial(u, v)}{\partial(x, y)} = 3xy^4 = 3v$ so $\frac{\partial(x, y)}{\partial(u, v)} = \frac{1}{3v}$; $\frac{1}{3} \iint_S \frac{\sin u}{v} dA_{uv} = \frac{1}{3} \int_1^2 \int_\pi^{2\pi} \frac{\sin u}{v} du dv = -\frac{2}{3} \ln 2$.

45. $\frac{\partial(u, v)}{\partial(x, y)} = 8xy$ so $\frac{\partial(x, y)}{\partial(u, v)} = \frac{1}{8xy}$; $xy \left| \frac{\partial(x, y)}{\partial(u, v)} \right| = xy \cdot \frac{1}{8xy} = \frac{1}{8}$ so $\frac{1}{8} \iint_S dA_{uv} = \frac{1}{8} \int_9^{16} \int_1^4 du dv = \frac{21}{8}$.

46. $\frac{\partial(u, v)}{\partial(x, y)} = -2(x^2 + y^2)$, so $\frac{\partial(x, y)}{\partial(u, v)} = -\frac{1}{2(x^2 + y^2)}$; $(x^4 - y^4)e^{xy} \left| \frac{\partial(x, y)}{\partial(u, v)} \right| = \frac{x^4 - y^4}{2(x^2 + y^2)} e^{xy} = \frac{1}{2}(x^2 - y^2)e^{xy} = \frac{1}{2}ve^u$, so $\frac{1}{2} \iint_S ve^u dA_{uv} = \frac{1}{2} \int_3^4 \int_1^3 ve^u du dv = \frac{7}{4}(e^3 - e)$.

47. Set $u = x + y + 2z, v = x - 2y + z, w = 4x + y + z$, then $\frac{\partial(u, v, w)}{\partial(x, y, z)} = \begin{vmatrix} 1 & 1 & 2 \\ 1 & -2 & 1 \\ 4 & 1 & 1 \end{vmatrix} = 18$, and $V = \iiint_R dx dy dz = \int_{-6}^6 \int_{-2}^2 \int_{-3}^3 \frac{\partial(x, y, z)}{\partial(u, v, w)} du dv dw = 6 \cdot 4 \cdot 12 \cdot \frac{1}{18} = 16$.

48. (a) $\frac{\partial(x, y, z)}{\partial(r, \theta, z)} = \begin{vmatrix} \cos \theta & -r \sin \theta & 0 \\ \sin \theta & r \cos \theta & 0 \\ 0 & 0 & 1 \end{vmatrix} = r$.

(b) $\frac{\partial(x, y, z)}{\partial(\rho, \phi, \theta)} = \begin{vmatrix} \sin \phi \cos \theta & \rho \cos \phi \cos \theta & -\rho \sin \phi \sin \theta \\ \sin \phi \sin \theta & \rho \cos \phi \sin \theta & \rho \sin \phi \cos \theta \\ \cos \phi & -\rho \sin \phi & 0 \end{vmatrix} = \rho^2 \sin \phi$.

49. The main motivation is to change the region of integration to one that has a simple description in either rectangular, polar, cylindrical, or spherical coordinates.
50. First consider the case in which R is defined by $a \leq u(x, y) \leq b$, $c \leq v(x, y) \leq d$, for some functions u and v . If we can solve for x and y in terms of u and v , then we can write $\iint_R f(x, y) dA_{xy} = \iint_S f(x(u, v), y(u, v)) \left| \frac{\partial(x, y)}{\partial(u, v)} \right| dA_{uv}$, where S is the rectangle $a \leq u \leq b$, $c \leq v \leq d$. For the more general case in which the boundary curves of R are level curves of more than 2 functions, we can pick 2 of these functions, say $u(x, y)$ and $v(x, y)$, try to solve for x and y in terms of u and v , and rewrite all of the inequalities in terms of u and v . This gives a region S in the uv -plane, with one boundary curve which is a horizontal line segment and one which is a vertical line segment. If we are very lucky, the other boundary curves may also be fairly simple and we may be able to compute the resulting integral over S . See Examples 2 and 3.

Exercise Set 14.8

1. $M = \int_0^1 \int_0^{\sqrt{x}} (x + y) dy dx = \frac{13}{20}$, $M_x = \int_0^1 \int_0^{\sqrt{x}} (x + y)y dy dx = \frac{3}{10}$, $M_y = \int_0^1 \int_0^{\sqrt{x}} (x + y)x dy dx = \frac{19}{42}$,
 $\bar{x} = \frac{M_y}{M} = \frac{190}{273}$, $\bar{y} = \frac{M_x}{M} = \frac{6}{13}$; the mass is $\frac{13}{20}$ and the center of gravity is at $\left(\frac{190}{273}, \frac{6}{13}\right)$.
2. $M = \int_0^\pi \int_0^{\sin x} y dy dx = \frac{\pi}{4}$, $\bar{x} = \frac{\pi}{2}$ from the symmetry of the density and the region, $M_x = \int_0^\pi \int_0^{\sin x} y^2 dy dx = \frac{4}{9}$, $\bar{y} = \frac{M_x}{M} = \frac{16}{9\pi}$; mass $\frac{\pi}{4}$, center of gravity $\left(\frac{\pi}{2}, \frac{16}{9\pi}\right)$.
3. $M = \int_0^{\pi/2} \int_0^a r^3 \sin \theta \cos \theta dr d\theta = \frac{a^4}{8}$, $\bar{x} = \bar{y}$ from the symmetry of the density and the region,
 $M_y = \int_0^{\pi/2} \int_0^a r^4 \sin \theta \cos^2 \theta dr d\theta = \frac{a^5}{15}$, $\bar{x} = \frac{8a}{15}$; mass $\frac{a^4}{8}$, center of gravity $\left(\frac{8a}{15}, \frac{8a}{15}\right)$.
4. $M = \int_0^\pi \int_0^1 r^3 dr d\theta = \frac{\pi}{4}$, $\bar{x} = 0$ from the symmetry of density and region, $M_x = \int_0^\pi \int_0^1 r^4 \sin \theta dr d\theta = \frac{2}{5}$,
 $\bar{y} = \frac{8}{5\pi}$; mass $\frac{\pi}{4}$, center of gravity $\left(0, \frac{8}{5\pi}\right)$.
5. $M = \iint_R \delta(x, y) dA = \int_0^1 \int_0^1 |x + y - 1| dx dy = \int_0^1 \left[\int_0^{1-x} (1 - x - y) dy + \int_{1-x}^1 (x + y - 1) dy \right] dx = \frac{1}{3}$. $\bar{x} =$
 $3 \int_0^1 \int_0^1 x \delta(x, y) dy dx = 3 \int_0^1 \left[\int_0^{1-x} x(1 - x - y) dy + \int_{1-x}^1 x(x + y - 1) dy \right] dx = \frac{1}{2}$. By symmetry, $\bar{y} = \frac{1}{2}$ as
 well; center of gravity $\left(\frac{1}{2}, \frac{1}{2}\right)$.
6. $\bar{x} = \frac{1}{M} \iint_G x \delta(x, y) dA$, and the integrand is an odd function of x while the region is symmetric with respect to the y -axis, thus $\bar{x} = 0$; likewise $\bar{y} = 0$.
7. $V = 1$, $\bar{x} = \int_0^1 \int_0^1 \int_0^1 x dz dy dx = \frac{1}{2}$, similarly $\bar{y} = \bar{z} = \frac{1}{2}$; centroid $\left(\frac{1}{2}, \frac{1}{2}, \frac{1}{2}\right)$.
8. $V = \pi r^2 h = 2\pi$, $\bar{x} = \bar{y} = 0$ by symmetry, $\iiint_G z dz dy dx = \int_0^2 \int_0^{2\pi} \int_0^1 r z dr d\theta dz = 2\pi$, centroid = $(0, 0, 1)$.

9. True. This is the definition of “centroid”; see Section 6.7.
10. False. For example, suppose the lamina is the annulus $1 \leq r \leq 2$ with constant density 1. The centroid is the origin, which is not part of the annulus, so the density is 0 there. But the mass is not 0.
11. False. The coordinates are the first moments about the y - and x -axes, divided by the mass.
12. False. Density in 3-space has units of mass per unit volume.
13. Let $x = r \cos \theta$, $y = r \sin \theta$, and $dA = r dr d\theta$ in formulas (11) and (12).
14. $\bar{x} = 0$ from the symmetry of the region, $A = \int_0^{2\pi} \int_0^{a(1+\sin \theta)} r dr d\theta = \frac{3\pi a^2}{2}$, $\bar{y} = \frac{1}{A} \int_0^{2\pi} \int_0^{a(1+\sin \theta)} r^2 \sin \theta dr d\theta = \frac{2}{3\pi a^2} \cdot \frac{5\pi a^3}{4} = \frac{5a}{6}$; centroid $\left(0, \frac{5a}{6}\right)$.
15. $\bar{x} = \bar{y}$ from the symmetry of the region, $A = \int_0^{\pi/2} \int_0^{\sin 2\theta} r dr d\theta = \frac{\pi}{8}$, $\bar{x} = \frac{1}{A} \int_0^{\pi/2} \int_0^{\sin 2\theta} r^2 \cos \theta dr d\theta = \frac{8}{\pi} \cdot \frac{16}{105} = \frac{128}{105\pi}$; centroid $\left(\frac{128}{105\pi}, \frac{128}{105\pi}\right)$.
16. $\bar{x} = 0$ from the symmetry of the region, $A = \frac{1}{2}\pi(b^2 - a^2)$, $\bar{y} = \frac{1}{A} \int_0^\pi \int_a^b r^2 \sin \theta dr d\theta = \frac{1}{A} \frac{2}{3}(b^3 - a^3) = \frac{4(b^3 - a^3)}{3\pi(b^2 - a^2)}$; centroid $\left(0, \frac{4(b^3 - a^3)}{3\pi(b^2 - a^2)}\right)$.
17. $\bar{y} = 0$ from the symmetry of the region, $A = \frac{1}{2}\pi a^2$, $\bar{x} = \frac{1}{A} \int_{-\pi/2}^{\pi/2} \int_0^a r^2 \cos \theta dr d\theta = \frac{1}{A} \frac{2}{3}a^3 = \frac{4a}{3\pi}$; centroid $\left(\frac{4a}{3\pi}, 0\right)$.
18. $\bar{x} = 3/2$ and $\bar{y} = 1$ from the symmetry of the region, $\iint_R x dA = \bar{x}A = \frac{3}{2} \cdot 6 = 9$, $\iint_R y dA = \bar{y}A = 1 \cdot 6 = 6$.
19. $\bar{x} = \bar{y} = \bar{z}$ from the symmetry of the region, $V = 1/6$, $\bar{x} = \frac{1}{V} \int_0^1 \int_0^{1-x} \int_0^{1-x-y} x dz dy dx = 6 \cdot \frac{1}{24} = \frac{1}{4}$; centroid $\left(\frac{1}{4}, \frac{1}{4}, \frac{1}{4}\right)$.
20. The solid is described by $-1 \leq y \leq 1, 0 \leq z \leq 1 - y^2, 0 \leq x \leq 1 - z$; $V = \int_{-1}^1 \int_0^{1-y^2} \int_0^{1-z} dx dz dy = \frac{4}{5}$, $\bar{x} = \frac{1}{V} \int_{-1}^1 \int_0^{1-y^2} \int_0^{1-z} x dx dz dy = \frac{5}{14}$, $\bar{y} = 0$ by symmetry, $\bar{z} = \frac{1}{V} \int_{-1}^1 \int_0^{1-y^2} \int_0^{1-z} z dx dz dy = \frac{2}{7}$; the centroid is $\left(\frac{5}{14}, 0, \frac{2}{7}\right)$.
21. $\bar{x} = 1/2$ and $\bar{y} = 0$ from the symmetry of the region, $V = \int_0^1 \int_{-1}^1 \int_{y^2}^1 dz dy dx = \frac{4}{3}$, $\bar{z} = \frac{1}{V} \iiint_G z dV = \frac{3}{4} \cdot \frac{4}{5} = \frac{3}{5}$; centroid $\left(\frac{1}{2}, 0, \frac{3}{5}\right)$.

22. $\bar{x} = \bar{y}$ from the symmetry of the region, $V = \int_0^2 \int_0^2 \int_0^{xy} dz dy dx = 4$, $\bar{x} = \frac{1}{V} \iiint_G x dV = \frac{1}{4} \cdot \frac{16}{3} = \frac{4}{3}$,
 $\bar{z} = \frac{1}{V} \iiint_G z dV = \frac{1}{4} \cdot \frac{32}{9} = \frac{8}{9}$; centroid $\left(\frac{4}{3}, \frac{4}{3}, \frac{8}{9}\right)$.

23. $\bar{x} = \bar{y} = \bar{z}$ from the symmetry of the region, $V = \pi a^3/6$, $\bar{x} = \frac{1}{V} \int_0^a \int_0^{\sqrt{a^2-x^2}} \int_0^{\sqrt{a^2-x^2-y^2}} x dz dy dx =$
 $\frac{1}{V} \int_0^a \int_0^{\sqrt{a^2-x^2}} x \sqrt{a^2-x^2-y^2} dy dx = \frac{1}{V} \int_0^{\pi/2} \int_0^a r^2 \sqrt{a^2-r^2} \cos \theta dr d\theta = \frac{6}{\pi a^3} \cdot \frac{\pi a^4}{16} = \frac{3a}{8}$; this gives us the
centroid $\left(\frac{3a}{8}, \frac{3a}{8}, \frac{3a}{8}\right)$.

24. $\bar{x} = \bar{y} = 0$ from the symmetry of the region, $V = 2\pi a^3/3$, $\bar{z} = \frac{1}{V} \int_{-a}^a \int_{-\sqrt{a^2-x^2}}^{\sqrt{a^2-x^2}} \int_0^{\sqrt{a^2-x^2-y^2}} z dz dy dx =$
 $\frac{1}{V} \int_{-a}^a \int_{-\sqrt{a^2-x^2}}^{\sqrt{a^2-x^2}} \frac{1}{2}(a^2-x^2-y^2) dy dx = \frac{1}{V} \int_0^{2\pi} \int_0^a \frac{1}{2}(a^2-r^2)r dr d\theta = \frac{3}{2\pi a^3} \cdot \frac{\pi a^4}{4} = \frac{3a}{8}$; centroid $\left(0, 0, \frac{3a}{8}\right)$.

25. $M = \int_0^a \int_0^a \int_0^a (a-x) dz dy dx = \frac{a^4}{2}$, $\bar{y} = \bar{z} = \frac{a}{2}$ from the symmetry of density and region,
 $\bar{x} = \frac{1}{M} \int_0^a \int_0^a \int_0^a x(a-x) dz dy dx = \frac{2}{a^4} \cdot \frac{a^5}{6} = \frac{a}{3}$; mass $\frac{a^4}{2}$, center of gravity $\left(\frac{a}{3}, \frac{a}{2}, \frac{a}{2}\right)$.

26. $M = \int_{-a}^a \int_{-\sqrt{a^2-x^2}}^{\sqrt{a^2-x^2}} \int_0^h (h-z) dz dy dx = \frac{\pi}{2} a^2 h^2$, $\bar{x} = \bar{y} = 0$ from the symmetry of density and region, $\bar{z} =$
 $\frac{1}{M} \iiint_G z(h-z) dV = \frac{2}{\pi a^2 h^2} \cdot \frac{\pi a^2 h^3}{6} = \frac{h}{3}$; mass $\frac{\pi a^2 h^2}{2}$, center of gravity $\left(0, 0, \frac{h}{3}\right)$.

27. $M = \int_{-1}^1 \int_0^1 \int_0^{1-y^2} yz dz dy dx = \frac{1}{6}$, $\bar{x} = 0$ by the symmetry of density and region, $\bar{y} = \frac{1}{M} \iiint_G y^2 z dV =$
 $6 \cdot \frac{8}{105} = \frac{16}{35}$, $\bar{z} = \frac{1}{M} \iiint_G yz^2 dV = 6 \cdot \frac{1}{12} = \frac{1}{2}$; mass $\frac{1}{6}$, center of gravity $\left(0, \frac{16}{35}, \frac{1}{2}\right)$.

28. $M = \int_0^3 \int_0^{9-x^2} \int_0^1 xz dz dy dx = \frac{81}{8}$, $\bar{x} = \frac{1}{M} \iiint_G x^2 z dV = \frac{8}{81} \cdot \frac{81}{5} = \frac{8}{5}$, $\bar{y} = \frac{1}{M} \iiint_G xyz dV = \frac{8}{81} \cdot \frac{243}{8} = 3$,
 $\bar{z} = \frac{1}{M} \iiint_G xz^2 dV = \frac{8}{81} \cdot \frac{27}{4} = \frac{2}{3}$; mass $\frac{81}{8}$, center of gravity $\left(\frac{8}{5}, 3, \frac{2}{3}\right)$.

29. (a) $M = \int_0^1 \int_0^1 k(x^2 + y^2) dy dx = \frac{2k}{3}$, $\bar{x} = \bar{y}$ from the symmetry of density and region,
 $\bar{x} = \frac{1}{M} \iint_R kx(x^2 + y^2) dA = \frac{3}{2k} \cdot \frac{5k}{12} = \frac{5}{8}$; center of gravity $\left(\frac{5}{8}, \frac{5}{8}\right)$.

(b) $\bar{y} = 1/2$ from the symmetry of density and region, $M = \int_0^1 \int_0^1 kx dy dx = \frac{k}{2}$, $\bar{x} = \frac{1}{M} \iint_R kx^2 dA = \frac{2}{k} \cdot \frac{k}{3} = \frac{2}{3}$,
center of gravity $\left(\frac{2}{3}, \frac{1}{2}\right)$.

30. (a) $\bar{x} = \bar{y} = \bar{z}$ from the symmetry of density and region, $M = \int_0^1 \int_0^1 \int_0^1 k(x^2 + y^2 + z^2) dz dy dx = k$, $\bar{x} = \frac{1}{M} \iiint_G kx(x^2 + y^2 + z^2) dV = \frac{1}{k} \cdot \frac{7k}{12} = \frac{7}{12}$; center of gravity $\left(\frac{7}{12}, \frac{7}{12}, \frac{7}{12}\right)$.

(b) $\bar{x} = \bar{y} = \bar{z}$ from the symmetry of density and region, $M = \int_0^1 \int_0^1 \int_0^1 k(x + y + z) dz dy dx = \frac{3k}{2}$, $\bar{x} = \frac{1}{M} \iiint_G kx(x + y + z) dV = \frac{2}{3k} \cdot \frac{5k}{6} = \frac{5}{9}$; center of gravity $\left(\frac{5}{9}, \frac{5}{9}, \frac{5}{9}\right)$.

31. $V = \iiint_G dV = \int_0^\pi \int_0^{\sin x} \int_0^{1/(1+x^2+y^2)} dz dy dx \approx 0.666633$, $\bar{x} = \frac{1}{V} \iiint_G x dV \approx 1.177406$, $\bar{y} = \frac{1}{V} \iiint_G y dV \approx 0.353554$, $\bar{z} = \frac{1}{V} \iiint_G z dV \approx 0.231557$.

32. (b) Use polar coordinates for x and y to get $V = \iiint_G dV = \int_0^{2\pi} \int_0^a \int_0^{1/(1+r^2)} r dz dr d\theta = \pi \ln(1 + a^2)$, $\bar{z} = \frac{1}{V} \iiint_G z dV = \frac{a^2}{2(1 + a^2) \ln(1 + a^2)}$. Thus $\lim_{a \rightarrow 0^+} \bar{z} = \frac{1}{2}$; $\lim_{a \rightarrow +\infty} \bar{z} = 0$. Also, $\lim_{a \rightarrow 0^+} \bar{z} = \frac{1}{2}$; $\lim_{a \rightarrow +\infty} \bar{z} = 0$.

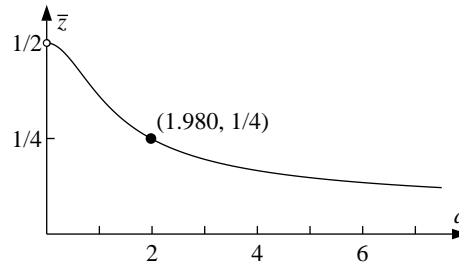

(c) Solve $\bar{z} = 1/4$ for a to obtain $a \approx 1.980291$.

33. $M = \int_0^{2\pi} \int_0^3 \int_r^3 (3 - z)r dz dr d\theta = \int_0^{2\pi} \int_0^3 \frac{1}{2}r(3 - r)^2 dr d\theta = \frac{27}{8} \int_0^{2\pi} d\theta = \frac{27\pi}{4}$.

34. $M = \int_0^{2\pi} \int_0^a \int_0^h kzr dz dr d\theta = \int_0^{2\pi} \int_0^a \frac{1}{2}kh^2r dr d\theta = \frac{1}{4}ka^2h^2 \int_0^{2\pi} d\theta = \frac{\pi ka^2h^2}{2}$.

35. $M = \int_0^{2\pi} \int_0^\pi \int_0^a k\rho^3 \sin \phi d\rho d\phi d\theta = \int_0^{2\pi} \int_0^\pi \frac{1}{4}ka^4 \sin \phi d\phi d\theta = \frac{1}{2}ka^4 \int_0^{2\pi} d\theta = \pi ka^4$.

36. $M = \int_0^{2\pi} \int_0^\pi \int_1^2 \rho \sin \phi d\rho d\phi d\theta = \int_0^{2\pi} \int_0^\pi \frac{3}{2} \sin \phi d\phi d\theta = 3 \int_0^{2\pi} d\theta = 6\pi$.

37. $\bar{x} = \bar{y} = 0$ from the symmetry of the region, $V = \int_0^{2\pi} \int_0^1 \int_{r^2}^{\sqrt{2-r^2}} r dz dr d\theta = \int_0^{2\pi} \int_0^1 (r\sqrt{2-r^2} - r^3) dr d\theta = \frac{\pi}{6}(8\sqrt{2} - 7)$, $\bar{z} = \frac{1}{V} \int_0^{2\pi} \int_0^1 \int_{r^2}^{\sqrt{2-r^2}} zr dz dr d\theta = \frac{6}{(8\sqrt{2} - 7)\pi} \cdot \frac{7\pi}{12} = \frac{7}{16\sqrt{2} - 14}$; centroid $\left(0, 0, \frac{7}{16\sqrt{2} - 14}\right)$.

38. $\bar{x} = \bar{y} = 0$ from the symmetry of the region, $V = 8\pi/3$, $\bar{z} = \frac{1}{V} \int_0^{2\pi} \int_0^2 \int_r^2 zr dz dr d\theta = \frac{3}{8\pi} \cdot 4\pi = \frac{3}{2}$; centroid $\left(0, 0, \frac{3}{2}\right)$.

39. $\bar{y} = 0$ from the symmetry of the region, $V = 2 \int_0^{\pi/2} \int_0^{2 \cos \theta} \int_0^{r^2} r \, dz \, dr \, d\theta = 3\pi/2$,
 $\bar{x} = \frac{2}{V} \int_0^{\pi/2} \int_0^{2 \cos \theta} \int_0^{r^2} r^2 \cos \theta \, dz \, dr \, d\theta = \frac{4}{3\pi}(\pi) = 4/3$, $\bar{z} = \frac{1}{V} \int_0^{\pi/2} \int_0^{2 \cos \theta} \int_0^{r^2} zr \, dz \, dr \, d\theta = \frac{4}{3\pi}(5\pi/6) = 10/9$;
centroid $(4/3, 0, 10/9)$.
40. $M = \int_0^{\pi/2} \int_0^{2 \cos \theta} \int_0^{4-r^2} zr \, dz \, dr \, d\theta = \int_0^{\pi/2} \int_0^{2 \cos \theta} \frac{1}{2}r(4-r^2)^2 \, dr \, d\theta = \frac{16}{3} \int_0^{\pi/2} (1-\sin^6 \theta) \, d\theta = (16/3)(11\pi/32) = 11\pi/6$.
41. $\bar{x} = \bar{y} = \bar{z}$ from the symmetry of the region, $V = \pi a^3/6$, $\bar{z} = \frac{1}{V} \int_0^{\pi/2} \int_0^{\pi/2} \int_0^a \rho^3 \cos \phi \sin \phi \, d\rho \, d\phi \, d\theta = \frac{6}{\pi a^3} \cdot \frac{\pi a^4}{16} = \frac{3a}{8}$; centroid $\left(\frac{3a}{8}, \frac{3a}{8}, \frac{3a}{8}\right)$.
42. $\bar{x} = \bar{y} = 0$ from the symmetry of the region, $V = \int_0^{2\pi} \int_0^{\pi/3} \int_0^4 \rho^2 \sin \phi \, d\rho \, d\phi \, d\theta = \frac{64\pi}{3}$,
 $\bar{z} = \frac{1}{V} \int_0^{2\pi} \int_0^{\pi/3} \int_0^4 \rho^3 \cos \phi \sin \phi \, d\rho \, d\phi \, d\theta = \frac{3}{64\pi} \cdot 48\pi = \frac{9}{4}$; centroid $\left(0, 0, \frac{9}{4}\right)$.
43. $M = \int_0^{2\pi} \int_0^{\pi/4} \int_0^1 \rho^3 \sin \phi \, d\rho \, d\phi \, d\theta = \int_0^{2\pi} \int_0^{\pi/4} \frac{1}{4} \sin \phi \, d\phi \, d\theta = \frac{1}{8}(2 - \sqrt{2}) \int_0^{2\pi} d\theta = \frac{\pi}{4}(2 - \sqrt{2})$.
44. $\bar{x} = \bar{y} = 0$ from the symmetry of density and region, $M = \int_0^{2\pi} \int_0^1 \int_0^{1-r^2} (r^2 + z^2)r \, dz \, dr \, d\theta = \frac{\pi}{4}$, $\bar{z} = \frac{1}{M} \int_0^{2\pi} \int_0^1 \int_0^{1-r^2} z(r^2 + z^2)r \, dz \, dr \, d\theta = \frac{4}{\pi} \cdot \frac{11\pi}{120} = \frac{11}{30}$; center of gravity $\left(0, 0, \frac{11}{30}\right)$.
45. $\bar{x} = \bar{y} = 0$ from the symmetry of density and region, $M = \int_0^{2\pi} \int_0^1 \int_0^r zr \, dz \, dr \, d\theta = \frac{\pi}{4}$,
 $\bar{z} = \frac{1}{M} \int_0^{2\pi} \int_0^1 \int_0^r z^2r \, dz \, dr \, d\theta = \frac{4}{\pi} \cdot \frac{2\pi}{15} = \frac{8}{15}$; center of gravity $\left(0, 0, \frac{8}{15}\right)$.
46. $\bar{x} = \bar{y} = 0$ from the symmetry of density and region, $M = \int_0^{2\pi} \int_0^{\pi/2} \int_0^a k\rho^3 \sin \phi \, d\rho \, d\phi \, d\theta = \frac{\pi ka^4}{2}$, $\bar{z} = \frac{1}{M} \int_0^{2\pi} \int_0^{\pi/2} \int_0^a k\rho^4 \sin \phi \cos \phi \, d\rho \, d\phi \, d\theta = \frac{2}{\pi ka^4} \cdot \frac{\pi ka^5}{5} = \frac{2a}{5}$; center of gravity $\left(0, 0, \frac{2a}{5}\right)$.
47. $\bar{x} = \bar{z} = 0$ from the symmetry of the region, $V = 54\pi/3 - 16\pi/3 = 38\pi/3$, $\bar{y} = \frac{1}{V} \int_0^{\pi} \int_0^{\pi} \int_2^3 \rho^3 \sin^2 \phi \sin \theta \, d\rho \, d\phi \, d\theta = \frac{1}{V} \int_0^{\pi} \int_0^{\pi} \frac{65}{4} \sin^2 \phi \sin \theta \, d\phi \, d\theta = \frac{1}{V} \int_0^{\pi} \frac{65\pi}{8} \sin \theta \, d\theta = \frac{3}{38\pi} \cdot \frac{65\pi}{4} = \frac{195}{152}$; centroid $\left(0, \frac{195}{152}, 0\right)$.
48. $M = \int_0^{2\pi} \int_0^{\pi} \int_0^R \delta_0 e^{-(\rho/R)^3} \rho^2 \sin \phi \, d\rho \, d\phi \, d\theta = \int_0^{2\pi} \int_0^{\pi} \frac{1}{3}(1 - e^{-1})R^3 \delta_0 \sin \phi \, d\phi \, d\theta = \frac{4\pi}{3}(1 - e^{-1})\delta_0 R^3$.
49. $I_x = \int_0^a \int_0^b y^2 \delta \, dy \, dx = \frac{\delta ab^3}{3}$, $I_y = \int_0^a \int_0^b x^2 \delta \, dy \, dx = \frac{\delta a^3 b}{3}$, $I_z = I_x + I_y = \frac{\delta ab(a^2 + b^2)}{3}$.
50. $I_x = \int_0^{2\pi} \int_0^a r^3 \sin^2 \theta \, \delta \, dr \, d\theta = \frac{\delta \pi a^4}{4}$; $I_y = \int_0^{2\pi} \int_0^a r^3 \cos^2 \theta \, \delta \, dr \, d\theta = \frac{\delta \pi a^4}{4} = I_x$; $I_z = I_x + I_y = \frac{\delta \pi a^4}{2}$.

51. $I_z = \int_0^{2\pi} \int_0^a \int_0^h r^2 \delta r dz dr d\theta = \delta \int_0^{2\pi} \int_0^a \int_0^h r^3 dz dr d\theta = \frac{1}{2} \delta \pi a^4 h.$

52. $I_y = \int_0^{2\pi} \int_0^a \int_0^h (r^2 \cos^2 \theta + z^2) \delta r dz dr d\theta = \delta \int_0^{2\pi} \int_0^a (hr^3 \cos^2 \theta + \frac{1}{3} h^3 r) dr d\theta =$
 $= \delta \int_0^{2\pi} \left(\frac{1}{4} a^4 h \cos^2 \theta + \frac{1}{6} a^2 h^3 \right) d\theta = \delta \left(\frac{\pi}{4} a^4 h + \frac{\pi}{3} a^2 h^3 \right).$

53. $I_z = \int_0^{2\pi} \int_{a_1}^{a_2} \int_0^h r^2 \delta r dz dr d\theta = \delta \int_0^{2\pi} \int_{a_1}^{a_2} \int_0^h r^3 dz dr d\theta = \frac{1}{2} \delta \pi h (a_2^4 - a_1^4).$

54. $I_z = \int_0^{2\pi} \int_0^\pi \int_0^a (\rho^2 \sin^2 \phi) \delta \rho^2 \sin \phi d\rho d\phi d\theta = \delta \int_0^{2\pi} \int_0^\pi \int_0^a \rho^4 \sin^3 \phi d\rho d\phi d\theta = \frac{8}{15} \delta \pi a^5.$

55. (a) The solid generated by R_k as it revolves about L is a cylinder of height Δy_k and radius $x_k^* + \frac{1}{2} \Delta x_k$ from which a cylinder of height Δy_k and radius $x_k^* - \frac{1}{2} \Delta x_k$ has been removed, so its volume is $\pi(x_k^* + \frac{1}{2} \Delta x_k)^2 \Delta y_k - \pi(x_k^* - \frac{1}{2} \Delta x_k)^2 \Delta y_k = 2\pi x_k^* \Delta x_k \Delta y_k = 2\pi x_k^* \Delta A_k.$

(b) From part (a), $V = \iint_R 2\pi x dA = 2\pi \iint_R x dA.$ From equation (13), this equals $2\pi \cdot \bar{x} \cdot [\text{area of } R].$

56. (a) $V = \left[\frac{1}{2} \pi a^2 \right] \left[2\pi \left(a + \frac{4a}{3\pi} \right) \right] = \frac{1}{3} \pi (3\pi + 4) a^3.$

(b) The distance between the centroid and the line is $\frac{\sqrt{2}}{2} \left(a + \frac{4a}{3\pi} \right),$ so $V = \left[\frac{1}{2} \pi a^2 \right] \left[2\pi \frac{\sqrt{2}}{2} \left(a + \frac{4a}{3\pi} \right) \right] =$
 $\frac{1}{6} \sqrt{2} \pi (3\pi + 4) a^3.$

57. $\bar{x} = k$ so $V = \pi ab \cdot 2\pi k = 2\pi^2 abk.$

58. $\bar{y} = 4$ from the symmetry of the region; $A = \int_{-2}^2 \int_{x^2}^{8-x^2} dy dx = \frac{64}{3}.$ So $V = \frac{64}{3} \cdot 2\pi \cdot 4 = \frac{512\pi}{3}.$

59. The region generates a cone of volume $\frac{1}{3} \pi ab^2$ when it is revolved about the x -axis, the area of the region is $\frac{1}{2} ab$ so $\frac{1}{3} \pi ab^2 = \frac{1}{2} ab \cdot 2\pi \bar{y}, \bar{y} = \frac{b}{3}.$ A cone of volume $\frac{1}{3} \pi a^2 b$ is generated when the region is revolved about the y -axis so $\frac{1}{3} \pi a^2 b = \frac{1}{2} ab \cdot 2\pi \bar{x}, \bar{x} = \frac{a}{3}.$ The centroid is $\left(\frac{a}{3}, \frac{b}{3} \right).$

60. The centroid of the circle which generates the tube travels a distance $s = \int_0^{4\pi} \sqrt{\sin^2 t + \cos^2 t + \frac{1}{16}} dt = \sqrt{17} \pi,$
 so $V = \pi \left(\frac{1}{2} \right)^2 \sqrt{17} \pi = \frac{\sqrt{17} \pi^2}{4}.$

61. It is the point P in the plane of the lamina such that the lamina will balance on any knife-edge passing through $P.$ (If P is in the lamina, then the lamina will also balance on a point of support at $P.$)

Chapter 14 Review Exercises

$$3. \text{ (a) } \iint_R dA \quad \text{(b) } \iiint_G dV \quad \text{(c) } \iint_R \sqrt{\left(\frac{\partial z}{\partial x}\right)^2 + \left(\frac{\partial z}{\partial y}\right)^2 + 1} dA$$

$$4. \text{ (a) } x = a \sin \phi \cos \theta, y = a \sin \phi \sin \theta, z = a \cos \phi, 0 \leq \theta \leq 2\pi, 0 \leq \phi \leq \pi.$$

$$\text{(b) } x = a \cos \theta, y = a \sin \theta, z = z, 0 \leq \theta \leq 2\pi, 0 \leq z \leq h.$$

$$5. \int_0^1 \int_{1-\sqrt{1-y^2}}^{1+\sqrt{1-y^2}} f(x, y) dx dy$$

$$6. \int_0^2 \int_x^{2x} f(x, y) dy dx + \int_2^3 \int_x^{6-x} f(x, y) dy dx$$

7. (a) The transformation sends $(1, 0)$ to (a, c) and $(0, 1)$ to (b, d) . There are two possibilities: either $(a, c) = (2, 1)$ and $(b, d) = (1, 2)$ or $(a, c) = (1, 2)$ and $(b, d) = (2, 1)$. So either $a = 2, b = 1, c = 1, d = 2$ or $a = 1, b = 2, c = 2, d = 1$.

(b) For either transformation in part (a), $\left| \frac{\partial(x, y)}{\partial(u, v)} \right| = 3$, so the area is $\iint_R dA = \int_0^1 \int_0^1 \left| \frac{\partial(x, y)}{\partial(u, v)} \right| du dv = \int_0^1 \int_0^1 3 du dv = 3$. The diagonals of R cut it into 4 congruent right triangles. One of these has vertices $(0, 0)$, $\left(\frac{3}{2}, \frac{3}{2}\right)$, and $(2, 1)$, so its bases have lengths $\frac{3}{2}\sqrt{2}$ and $\frac{1}{2}\sqrt{2}$ and its area is $\frac{1}{2} \cdot \frac{3}{2}\sqrt{2} \cdot \frac{1}{2}\sqrt{2} = \frac{3}{4}$; hence R has area $4 \cdot \frac{3}{4} = 3$.

8. If $0 < x, y < \pi$ then $0 < \sin \sqrt{xy} \leq 1$, with equality only on the hyperbola $xy = \pi^2/4$, so $0 = \int_0^\pi \int_0^\pi 0 dy dx < \int_0^\pi \int_0^\pi \sin \sqrt{xy} dy dx < \int_0^\pi \int_0^\pi 1 dy dx = \pi^2$.

$$9. \int_{1/2}^1 2x \cos(\pi x^2) dx = \frac{1}{\pi} \sin(\pi x^2) \Big|_{1/2}^1 = -\frac{1}{\sqrt{2}\pi}.$$

$$10. \int_0^2 \frac{x^2}{2} e^{y^3} \Big|_{x=-y}^{2y} dy = \frac{3}{2} \int_0^2 y^2 e^{y^3} dy = \frac{1}{2} e^{y^3} \Big|_0^2 = \frac{1}{2} (e^8 - 1).$$

$$11. \int_0^1 \int_{2y}^2 e^x e^y dx dy$$

$$12. \int_0^\pi \int_0^x \frac{\sin x}{x} dy dx$$

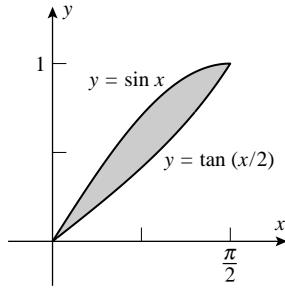

13.

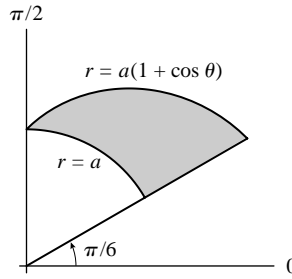

14.

$$15. \quad 2 \int_0^8 \int_0^{y^{1/3}} x^2 \sin y^2 dx dy = \frac{2}{3} \int_0^8 y \sin y^2 dy = -\frac{1}{3} \cos y^2 \Big|_0^8 = \frac{1}{3}(1 - \cos 64) \approx 0.20271.$$

$$16. \quad \int_0^{\pi/2} \int_0^2 (4 - r^2)r dr d\theta = 2\pi.$$

$$17. \quad \sin 2\theta = 2 \sin \theta \cos \theta = \frac{2xy}{x^2 + y^2}, \text{ and } r = 2a \sin \theta \text{ is the circle } x^2 + (y - a)^2 = a^2, \text{ so } \int_0^a \int_{a - \sqrt{a^2 - x^2}}^{a + \sqrt{a^2 - x^2}} \frac{2xy}{x^2 + y^2} dy dx = \int_0^a x \left[\ln(a + \sqrt{a^2 - x^2}) - \ln(a - \sqrt{a^2 - x^2}) \right] dx = a^2.$$

$$18. \quad \int_{\pi/4}^{\pi/2} \int_0^2 4r^2(\cos \theta \sin \theta) r dr d\theta = -4 \cos 2\theta \Big|_{\pi/4}^{\pi/2} = 4.$$

$$19. \quad \int_0^2 \int_{(y/2)^{1/3}}^{2-y/2} dx dy = \int_0^2 \left(2 - \frac{y}{2} - \left(\frac{y}{2}\right)^{1/3} \right) dy = \left(2y - \frac{y^2}{4} - \frac{3}{2} \left(\frac{y}{2}\right)^{4/3} \right) \Big|_0^2 = \frac{3}{2}.$$

$$20. \quad A = 6 \int_0^{\pi/6} \int_0^{\cos 3\theta} r dr d\theta = 3 \int_0^{\pi/6} \cos^2 3\theta d\theta = \frac{\pi}{4}.$$

$$21. \quad \int_0^{2\pi} \int_0^2 \int_{r^4}^{16} r^2 \cos^2 \theta r dz dr d\theta = \int_0^{2\pi} \cos^2 \theta d\theta \int_0^2 r^3(16 - r^4) dr = 32\pi.$$

$$22. \quad \int_0^{\pi/2} \int_0^{\pi/2} \int_0^1 \frac{1}{1 + \rho^2} \rho^2 \sin \phi d\rho d\phi d\theta = \left(1 - \frac{\pi}{4}\right) \frac{\pi}{2} \int_0^{\pi/2} \sin \phi d\phi = \left(1 - \frac{\pi}{4}\right) \frac{\pi}{2} (-\cos \phi) \Big|_0^{\pi/2} = \left(1 - \frac{\pi}{4}\right) \frac{\pi}{2}.$$

$$23. \quad (a) \quad \int_0^{2\pi} \int_0^{\pi/3} \int_0^a (\rho^2 \sin^2 \phi) \rho^2 \sin \phi d\rho d\phi d\theta = \int_0^{2\pi} \int_0^{\pi/3} \int_0^a \rho^4 \sin^3 \phi d\rho d\phi d\theta.$$

$$(b) \quad \int_0^{2\pi} \int_0^{\sqrt{3}a/2} \int_{r/\sqrt{3}}^{\sqrt{a^2 - r^2}} r^2 dz r dr d\theta = \int_0^{2\pi} \int_0^{\sqrt{3}a/2} \int_{r/\sqrt{3}}^{\sqrt{a^2 - r^2}} r^3 dz dr d\theta.$$

$$(c) \quad \int_{-\sqrt{3}a/2}^{\sqrt{3}a/2} \int_{-\sqrt{(3a^2/4) - x^2}}^{\sqrt{(3a^2/4) - x^2}} \int_{\sqrt{x^2 + y^2}/\sqrt{3}}^{\sqrt{a^2 - x^2 - y^2}} (x^2 + y^2) dz dy dx.$$

$$24. \quad (a) \quad \int_0^4 \int_{-\sqrt{4x-x^2}}^{\sqrt{4x-x^2}} \int_{x^2+y^2}^{4x} dz dy dx \quad (b) \quad \int_{-\pi/2}^{\pi/2} \int_0^{4 \cos \theta} \int_{r^2}^{4r \cos \theta} r dz dr d\theta$$

$$25. \quad V = \int_0^{2\pi} \int_0^{a/\sqrt{3}} \int_{\sqrt{3}r}^a r dz dr d\theta = 2\pi \int_0^{a/\sqrt{3}} r(a - \sqrt{3}r) dr = \frac{\pi a^3}{9}.$$

26. The intersection of the two surfaces projects onto the yz -plane as $2y^2 + z^2 = 1$, so

$$V = 4 \int_0^{1/\sqrt{2}} \int_0^{\sqrt{1-2y^2}} \int_{y^2+z^2}^{1-y^2} dx dz dy = 4 \int_0^{1/\sqrt{2}} \int_0^{\sqrt{1-2y^2}} (1-2y^2-z^2) dz dy = 4 \int_0^{1/\sqrt{2}} \frac{2}{3}(1-2y^2)^{3/2} dy = \frac{\sqrt{2}\pi}{4}.$$

27. The triangular region R is described by $0 \leq x \leq 1$, $-x \leq y \leq x$. Hence $S = \iint_R \sqrt{z_x^2 + z_y^2 + 1} dA = \int_0^1 \int_{-x}^x \sqrt{(4x)^2 + 3^2 + 1} dy dx = \int_0^1 \int_{-x}^x \sqrt{16x^2 + 10} dy dx = \int_0^1 2x\sqrt{16x^2 + 10} dx = \frac{1}{24}(16x^2 + 10)^{3/2} \Big|_0^1 = \frac{1}{12}(13\sqrt{26} - 5\sqrt{10}) \approx 4.20632$.

28. $\|\mathbf{r}_u \times \mathbf{r}_v\| = \sqrt{2u^2 + 2v^2 + 4}$, $S = \iint_{u^2+v^2 \leq 4} \sqrt{2u^2 + 2v^2 + 4} dA = \int_0^{2\pi} \int_0^2 \sqrt{2r^2 + 4} r dr d\theta = \frac{8\pi}{3}(3\sqrt{3} - 1)$.

29. $(\mathbf{r}_u \times \mathbf{r}_v) \Big|_{\substack{u=1 \\ v=2}} = \langle -2, -4, 1 \rangle$, tangent plane $2x + 4y - z = 5$.

30. $u = -3, v = 0$, $(\mathbf{r}_u \times \mathbf{r}_v) \Big|_{\substack{u=-3 \\ v=0}} = \langle -18, 0, -3 \rangle$, tangent plane $6x + z = -9$.

32. $x = \frac{1}{10}u + \frac{3}{10}v$ and $y = -\frac{3}{10}u + \frac{1}{10}v$, hence $|J(u, v)| = \left| \left(\frac{1}{10} \right)^2 + \left(\frac{3}{10} \right)^2 \right| = \frac{1}{10}$, and $\iint_R \frac{x-3y}{(3x+y)^2} dA = \frac{1}{10} \int_1^3 \int_0^4 \frac{u}{v^2} du dv = \frac{1}{10} \int_1^3 \frac{1}{v^2} dv \int_0^4 u du = \frac{1}{10} \frac{2}{3} 8 = \frac{8}{15}$.

33. (a) Add u and w to get $x = \ln(u+w) - \ln 2$; subtract w from u to get $y = \frac{1}{2}u - \frac{1}{2}w$, substitute these values into $v = y + 2z$ to get $z = -\frac{1}{4}u + \frac{1}{2}v + \frac{1}{4}w$. Hence $x_u = \frac{1}{u+w}$, $x_v = 0$, $x_w = \frac{1}{u+w}$; $y_u = \frac{1}{2}$, $y_v = 0$, $y_z = -\frac{1}{2}$; $z_u = -\frac{1}{4}$, $z_v = \frac{1}{2}$, $z_w = \frac{1}{4}$, and thus $\frac{\partial(x, y, z)}{\partial(u, v, w)} = \frac{1}{2(u+w)}$.

(b) $V = \iiint_G dV = \int_1^3 \int_1^2 \int_0^4 \frac{1}{2(u+w)} dw dv du = \frac{1}{2}(7 \ln 7 - 5 \ln 5 - 3 \ln 3) = \frac{1}{2} \ln \frac{823543}{84375} \approx 1.139172308$.

34. $V = \frac{4}{3}\pi a^3$, $\bar{d} = \frac{3}{4\pi a^3} \iiint_{\rho \leq a} \rho dV = \frac{3}{4\pi a^3} \int_0^\pi \int_0^{2\pi} \int_0^a \rho^3 \sin \phi d\rho d\theta d\phi = \frac{3}{4\pi a^3} \cdot 2 \cdot 2\pi \cdot \frac{a^4}{4} = \frac{3}{4}a$.

35. $A = \int_{-4}^4 \int_{y^2/4}^{2+y^2/8} dx dy = \int_{-4}^4 \left(2 - \frac{y^2}{8} \right) dy = \frac{32}{3}$; $\bar{y} = 0$ by symmetry;
 $\int_{-4}^4 \int_{y^2/4}^{2+y^2/8} x dx dy = \int_{-4}^4 \left(2 + \frac{1}{4}y^2 - \frac{3}{128}y^4 \right) dy = \frac{256}{15}$, $\bar{x} = \frac{3}{32} \frac{256}{15} = \frac{8}{5}$; centroid $\left(\frac{8}{5}, 0 \right)$.

36. $A = \pi ab/2$, $\bar{x} = 0$ by symmetry, $\int_{-a}^a \int_0^{b\sqrt{1-x^2/a^2}} y dy dx = \frac{1}{2} \int_{-a}^a b^2 \left(1 - \frac{x^2}{a^2} \right) dx = \frac{2ab^2}{3}$, centroid $\left(0, \frac{4b}{3\pi} \right)$.

37. $V = \frac{1}{3}\pi a^2 h$, $\bar{x} = \bar{y} = 0$ by symmetry, $\int_0^{2\pi} \int_0^a \int_0^{h-rh/a} rz dz dr d\theta = \pi \int_0^a rh^2 \left(1 - \frac{r}{a} \right)^2 dr = \frac{\pi a^2 h^2}{12}$, centroid $\left(0, 0, \frac{h}{4} \right)$.

$$\begin{aligned}
38. V &= \int_{-2}^2 \int_{x^2}^4 \int_0^{4-y} dz dy dx = \int_{-2}^2 \int_{x^2}^4 (4-y) dy dx = \int_{-2}^2 \left(8 - 4x^2 + \frac{1}{2}x^4\right) dx = \frac{256}{15}, \int_{-2}^2 \int_{x^2}^4 \int_0^{4-y} y dz dy dx = \\
&\int_{-2}^2 \int_{x^2}^4 (4y - y^2) dy dx = \int_{-2}^2 \left(\frac{1}{3}x^6 - 2x^4 + \frac{32}{3}\right) dx = \frac{1024}{35}, \int_{-2}^2 \int_{x^2}^4 \int_0^{4-y} z dz dy dx = \int_{-2}^2 \int_{x^2}^4 \frac{1}{2}(4-y)^2 dy dx = \\
&\int_{-2}^2 \left(-\frac{x^6}{6} + 2x^4 - 8x^2 + \frac{32}{3}\right) dx = \frac{2048}{105}, \bar{x} = 0 \text{ by symmetry, centroid } \left(0, \frac{12}{7}, \frac{8}{7}\right).
\end{aligned}$$

Chapter 14 Making Connections

$$\begin{aligned}
1. (a) I^2 &= \left[\int_0^{+\infty} e^{-x^2} dx\right] \left[\int_0^{+\infty} e^{-y^2} dy\right] = \int_0^{+\infty} \left[\int_0^{+\infty} e^{-x^2} dx\right] e^{-y^2} dy = \int_0^{+\infty} \int_0^{+\infty} e^{-x^2} e^{-y^2} dx dy = \\
&= \int_0^{+\infty} \int_0^{+\infty} e^{-(x^2+y^2)} dx dy.
\end{aligned}$$

$$(b) I^2 = \int_0^{\pi/2} \int_0^{+\infty} e^{-r^2} r dr d\theta = \frac{1}{2} \int_0^{\pi/2} d\theta = \frac{\pi}{4}.$$

$$(c) \text{ Since } I > 0, I = \sqrt{\frac{\pi}{4}} = \frac{\sqrt{\pi}}{2}.$$

2. The two quarter-circles with center at the origin and of radius A and $\sqrt{2}A$ lie inside and outside of the square with corners $(0, 0)$, $(A, 0)$, (A, A) , $(0, A)$, so the following inequalities hold:

$$\int_0^{\pi/2} \int_0^A \frac{1}{(1+r^2)^2} r dr d\theta \leq \int_0^A \int_0^A \frac{1}{(1+x^2+y^2)^2} dx dy \leq \int_0^{\pi/2} \int_0^{\sqrt{2}A} \frac{1}{(1+r^2)^2} r dr d\theta.$$

The integral on the left can be evaluated as $\frac{\pi A^2}{4(1+A^2)}$ and the integral on the right equals $\frac{2\pi A^2}{4(1+2A^2)}$. Since both of these quantities tend to $\frac{\pi}{4}$ as $A \rightarrow +\infty$, it follows by sandwiching that $\int_0^{+\infty} \int_0^{+\infty} \frac{1}{(1+x^2+y^2)^2} dx dy = \frac{\pi}{4}$.

$$3. (a) 1.173108605 \quad (b) \int_0^{\pi} \int_0^1 r e^{-r^4} dr d\theta = \pi \int_0^1 r e^{-r^4} dr \approx 1.173108605.$$

4. (a) At any point outside the closed sphere $\{x^2 + y^2 + z^2 \leq 1\}$ the integrand is negative, so to maximize the integral it suffices to include all points inside the sphere; hence the maximum value is taken on the region $G = \{x^2 + y^2 + z^2 \leq 1\}$.

$$(b) 1.675516$$

$$(c) \int_0^{2\pi} \int_0^{\pi} \int_0^1 (1-\rho^2)\rho^2 \sin \phi d\rho d\phi d\theta = \frac{8\pi}{15}.$$

5. (a) Let S_1 be the set of points (x, y, z) which satisfy the equation $x^{2/3} + y^{2/3} + z^{2/3} = a^{2/3}$, and let S_2 be the set of points (x, y, z) where $x = a(\sin \phi \cos \theta)^3$, $y = a(\sin \phi \sin \theta)^3$, $z = a \cos^3 \phi$, $0 \leq \phi \leq \pi$, $0 \leq \theta < 2\pi$. If (x, y, z) is a point of S_2 then $x^{2/3} + y^{2/3} + z^{2/3} = a^{2/3}[(\sin \phi \cos \theta)^3 + (\sin \phi \sin \theta)^3 + \cos^3 \phi] = a^{2/3}$, so (x, y, z) belongs to S_1 . If (x, y, z) is a point of S_1 then $x^{2/3} + y^{2/3} + z^{2/3} = a^{2/3}$. Let $x_1 = x^{1/3}$, $y_1 = y^{1/3}$, $z_1 = z^{1/3}$, $a_1 = a^{1/3}$. Then $x_1^2 + y_1^2 + z_1^2 = a_1^2$, so in spherical coordinates $x_1 = a_1 \sin \phi \cos \theta$, $y_1 = a_1 \sin \phi \sin \theta$, $z_1 = a_1 \cos \phi$, with $\theta = \tan^{-1} \left(\frac{y_1}{x_1}\right) = \tan^{-1} \left(\frac{y}{x}\right)^{1/3}$, $\phi = \cos^{-1} \frac{z_1}{a_1} = \cos^{-1} \left(\frac{z}{a}\right)^{1/3}$. Then $x = x_1^3 = a_1^3 (\sin \phi \cos \theta)^3 = a(\sin \phi \cos \theta)^3$, similarly $y = a(\sin \phi \sin \theta)^3$, $z = a \cos^3 \phi$ so (x, y, z) belongs to S_2 . Thus $S_1 = S_2$.

$$(b) \text{ Let } a = 1 \text{ and } \mathbf{r} = (\cos \theta \sin \phi)^3 \mathbf{i} + (\sin \theta \sin \phi)^3 \mathbf{j} + \cos^3 \phi \mathbf{k}, \text{ then } S = 8 \int_0^{\pi/2} \int_0^{\pi/2} \|\mathbf{r}_\theta \times \mathbf{r}_\phi\| d\phi d\theta =$$

$$72 \int_0^{\pi/2} \int_0^{\pi/2} \sin \theta \cos \theta \sin^4 \phi \cos \phi \sqrt{\cos^2 \phi + \sin^2 \phi \sin^2 \theta \cos^2 \theta} d\theta d\phi \approx 4.4506.$$

$$6. \frac{\partial(x, y, z)}{\partial(\rho, \phi, \theta)} = \begin{vmatrix} \sin^3 \phi \cos^3 \theta & 3\rho \sin^2 \phi \cos \phi \cos^3 \theta & -3\rho \sin^3 \phi \cos^2 \theta \sin \theta \\ \sin^3 \phi \sin^3 \theta & 3\rho \sin^2 \phi \cos \phi \sin^3 \theta & 3\rho \sin^3 \phi \sin^2 \theta \cos \theta \\ \cos^3 \phi & -3\rho \cos^2 \phi \sin \phi & 0 \end{vmatrix} = 9\rho^2 \cos^2 \theta \sin^2 \theta \cos^2 \phi \sin^5 \phi, \text{ so}$$

$$V = 9 \int_0^{2\pi} \int_0^{\pi} \int_0^a \rho^2 \cos^2 \theta \sin^2 \theta \cos^2 \phi \sin^5 \phi d\rho d\phi d\theta = \frac{4}{35} \pi a^3.$$

Topics in Vector Calculus

Exercise Set 15.1

- (a) III, because the vector field is independent of y and the direction is that of the negative x -axis for negative x , and positive for positive.

(b) IV, because the y -component is constant, and the x -component varies periodically with x .
- (a) I, since the vector field is constant.

(b) II, since the vector field points away from the origin.
- (a) True. (b) True. (c) True.
- (a) False, the lengths are equal to 1. (b) False, the y -component is zero. (c) False, the x -component is zero.

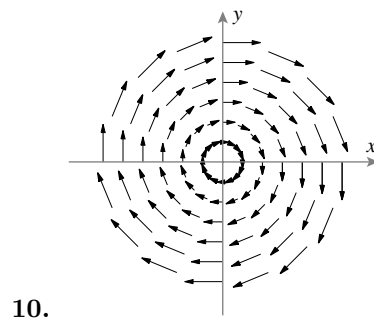
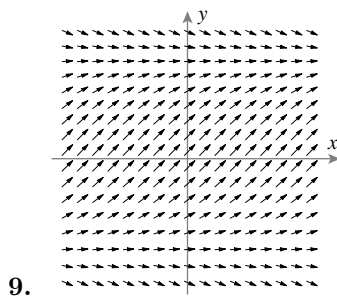
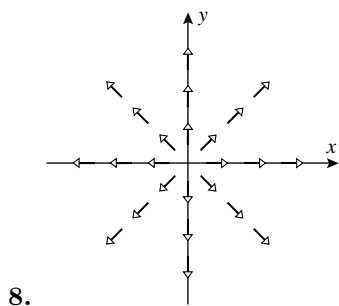
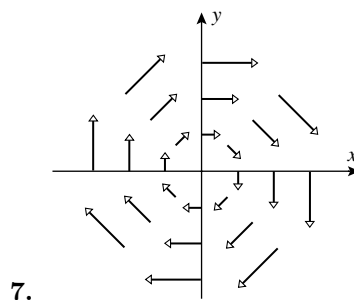
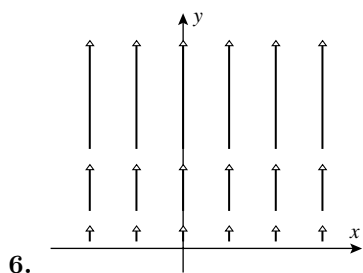
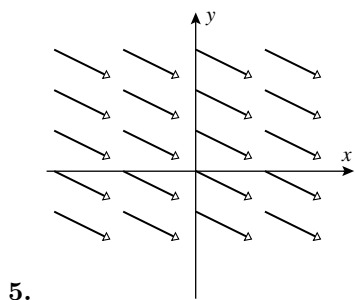

- False, the \mathbf{k} -component is nonzero.
- False, the power of $\|\mathbf{r}\|$ should be 3.
- True (this example is the curl of \mathbf{F}).
- False, ϕ is the divergence of \mathbf{F} .

15. (a) $\nabla\phi = \phi_x\mathbf{i} + \phi_y\mathbf{j} = \frac{y}{1+x^2y^2}\mathbf{i} + \frac{x}{1+x^2y^2}\mathbf{j} = \mathbf{F}$, so \mathbf{F} is conservative for all x, y .
- (b) $\nabla\phi = \phi_x\mathbf{i} + \phi_y\mathbf{j} + \phi_z\mathbf{k} = 2x\mathbf{i} - 6y\mathbf{j} + 8z\mathbf{k} = \mathbf{F}$ so \mathbf{F} is conservative for all x, y and z .
16. (a) $\nabla\phi = \phi_x\mathbf{i} + \phi_y\mathbf{j} = (6xy - y^3)\mathbf{i} + (4y + 3x^2 - 3xy^2)\mathbf{j} = \mathbf{F}$, so \mathbf{F} is conservative for all x, y .
- (b) $\nabla\phi = \phi_x\mathbf{i} + \phi_y\mathbf{j} + \phi_z\mathbf{k} = (\sin z + y \cos x)\mathbf{i} + (\sin x + z \cos y)\mathbf{j} + (x \cos z + \sin y)\mathbf{k} = \mathbf{F}$, so \mathbf{F} is conservative for all x, y , and z .
17. $\operatorname{div} \mathbf{F} = 2x + y$, $\operatorname{curl} \mathbf{F} = z\mathbf{i}$.
18. $\operatorname{div} \mathbf{F} = z^3 + 8y^3x^2 + 10zy$, $\operatorname{curl} \mathbf{F} = 5z^2\mathbf{i} + 3xz^2\mathbf{j} + 4xy^4\mathbf{k}$.
19. $\operatorname{div} \mathbf{F} = 0$, $\operatorname{curl} \mathbf{F} = (40x^2z^4 - 12xy^3)\mathbf{i} + (14y^3z + 3y^4)\mathbf{j} - (16xz^5 + 21y^2z^2)\mathbf{k}$.
20. $\operatorname{div} \mathbf{F} = ye^{xy} + \sin y + 2 \sin z \cos z$, $\operatorname{curl} \mathbf{F} = -xe^{xy}\mathbf{k}$.
21. $\operatorname{div} \mathbf{F} = \frac{2}{\sqrt{x^2 + y^2 + z^2}}$, $\operatorname{curl} \mathbf{F} = \mathbf{0}$.
22. $\operatorname{div} \mathbf{F} = \frac{1}{x} + xze^{xyz} + \frac{x}{x^2 + z^2}$, $\operatorname{curl} \mathbf{F} = -xye^{xyz}\mathbf{i} + \frac{z}{x^2 + z^2}\mathbf{j} + yze^{xyz}\mathbf{k}$.
23. $\nabla \cdot (\mathbf{F} \times \mathbf{G}) = \nabla \cdot (-(z + 4y^2)\mathbf{i} + (4xy + 2xz)\mathbf{j} + (2xy - x)\mathbf{k}) = 4x$.
24. $\nabla \cdot (\mathbf{F} \times \mathbf{G}) = \nabla \cdot ((x^2yz^2 - x^2y^2)\mathbf{i} - xy^2z^2\mathbf{j} + xy^2z\mathbf{k}) = -xy^2$.
25. $\nabla \cdot (\nabla \times \mathbf{F}) = \nabla \cdot (-\sin(x - y)\mathbf{k}) = 0$.
26. $\nabla \cdot (\nabla \times \mathbf{F}) = \nabla \cdot (-ze^{yz}\mathbf{i} + xe^{xz}\mathbf{j} + 3e^y\mathbf{k}) = 0$.
27. $\nabla \times (\nabla \times \mathbf{F}) = \nabla \times (xz\mathbf{i} - yz\mathbf{j} + y\mathbf{k}) = (1 + y)\mathbf{i} + x\mathbf{j}$.
28. $\nabla \times (\nabla \times \mathbf{F}) = \nabla \times ((x + 3y)\mathbf{i} - y\mathbf{j} - 2xy\mathbf{k}) = -2x\mathbf{i} + 2y\mathbf{j} - 3\mathbf{k}$.
31. Let $\mathbf{F} = f\mathbf{i} + g\mathbf{j} + h\mathbf{k}$; $\operatorname{div} (k\mathbf{F}) = k\frac{\partial f}{\partial x} + k\frac{\partial g}{\partial y} + k\frac{\partial h}{\partial z} = k \operatorname{div} \mathbf{F}$.
32. Let $\mathbf{F} = f\mathbf{i} + g\mathbf{j} + h\mathbf{k}$; $\operatorname{curl} (k\mathbf{F}) = k\left(\frac{\partial h}{\partial y} - \frac{\partial g}{\partial z}\right)\mathbf{i} + k\left(\frac{\partial f}{\partial z} - \frac{\partial h}{\partial x}\right)\mathbf{j} + k\left(\frac{\partial g}{\partial x} - \frac{\partial f}{\partial y}\right)\mathbf{k} = k \operatorname{curl} \mathbf{F}$.
33. Let $\mathbf{F} = f(x, y, z)\mathbf{i} + g(x, y, z)\mathbf{j} + h(x, y, z)\mathbf{k}$ and $\mathbf{G} = P(x, y, z)\mathbf{i} + Q(x, y, z)\mathbf{j} + R(x, y, z)\mathbf{k}$, then
 $\operatorname{div} (\mathbf{F} + \mathbf{G}) = \left(\frac{\partial f}{\partial x} + \frac{\partial P}{\partial x}\right) + \left(\frac{\partial g}{\partial y} + \frac{\partial Q}{\partial y}\right) + \left(\frac{\partial h}{\partial z} + \frac{\partial R}{\partial z}\right) = \left(\frac{\partial f}{\partial x} + \frac{\partial g}{\partial y} + \frac{\partial h}{\partial z}\right) + \left(\frac{\partial P}{\partial x} + \frac{\partial Q}{\partial y} + \frac{\partial R}{\partial z}\right) = \operatorname{div} \mathbf{F} + \operatorname{div} \mathbf{G}$.
34. Let $\mathbf{F} = f(x, y, z)\mathbf{i} + g(x, y, z)\mathbf{j} + h(x, y, z)\mathbf{k}$ and $\mathbf{G} = P(x, y, z)\mathbf{i} + Q(x, y, z)\mathbf{j} + R(x, y, z)\mathbf{k}$, then
 $\operatorname{curl} (\mathbf{F} + \mathbf{G}) = \left[\frac{\partial}{\partial y}(h + R) - \frac{\partial}{\partial z}(g + Q)\right]\mathbf{i} + \left[\frac{\partial}{\partial z}(f + P) - \frac{\partial}{\partial x}(h + R)\right]\mathbf{j} + \left[\frac{\partial}{\partial x}(g + Q) - \frac{\partial}{\partial y}(f + P)\right]\mathbf{k}$; expand and rearrange terms to get $\operatorname{curl} \mathbf{F} + \operatorname{curl} \mathbf{G}$.
35. Let $\mathbf{F} = f\mathbf{i} + g\mathbf{j} + h\mathbf{k}$; $\operatorname{div} (\phi\mathbf{F}) = \left(\phi\frac{\partial f}{\partial x} + \frac{\partial \phi}{\partial x}f\right) + \left(\phi\frac{\partial g}{\partial y} + \frac{\partial \phi}{\partial y}g\right) + \left(\phi\frac{\partial h}{\partial z} + \frac{\partial \phi}{\partial z}h\right) = \phi\left(\frac{\partial f}{\partial x} + \frac{\partial g}{\partial y} + \frac{\partial h}{\partial z}\right) + \left(\frac{\partial \phi}{\partial x}f + \frac{\partial \phi}{\partial y}g + \frac{\partial \phi}{\partial z}h\right) = \phi \operatorname{div} \mathbf{F} + \nabla\phi \cdot \mathbf{F}$.

36. Let $\mathbf{F} = f\mathbf{i} + g\mathbf{j} + h\mathbf{k}$; $\text{curl}(\phi\mathbf{F}) = \left[\frac{\partial}{\partial y}(\phi h) - \frac{\partial}{\partial z}(\phi g) \right] \mathbf{i} + \left[\frac{\partial}{\partial z}(\phi f) - \frac{\partial}{\partial x}(\phi h) \right] \mathbf{j} + \left[\frac{\partial}{\partial x}(\phi g) - \frac{\partial}{\partial y}(\phi f) \right] \mathbf{k}$; use the product rule to expand each of the partial derivatives, rearrange to get $\phi \text{curl} \mathbf{F} + \nabla\phi \times \mathbf{F}$.

37. Let $\mathbf{F} = f\mathbf{i} + g\mathbf{j} + h\mathbf{k}$; $\text{div}(\text{curl} \mathbf{F}) = \frac{\partial}{\partial x} \left(\frac{\partial h}{\partial y} - \frac{\partial g}{\partial z} \right) + \frac{\partial}{\partial y} \left(\frac{\partial f}{\partial z} - \frac{\partial h}{\partial x} \right) + \frac{\partial}{\partial z} \left(\frac{\partial g}{\partial x} - \frac{\partial f}{\partial y} \right) = \frac{\partial^2 h}{\partial x \partial y} - \frac{\partial^2 g}{\partial x \partial z} + \frac{\partial^2 f}{\partial y \partial z} - \frac{\partial^2 h}{\partial y \partial x} + \frac{\partial^2 g}{\partial z \partial x} - \frac{\partial^2 f}{\partial z \partial y} = 0$, assuming equality of mixed second partial derivatives, which follows from the continuity assumptions.

38. $\text{curl}(\nabla\phi) = \left(\frac{\partial^2 \phi}{\partial y \partial z} - \frac{\partial^2 \phi}{\partial z \partial y} \right) \mathbf{i} + \left(\frac{\partial^2 \phi}{\partial z \partial x} - \frac{\partial^2 \phi}{\partial x \partial z} \right) \mathbf{j} + \left(\frac{\partial^2 \phi}{\partial x \partial y} - \frac{\partial^2 \phi}{\partial y \partial x} \right) \mathbf{k} = \mathbf{0}$, assuming equality of mixed second partial derivatives, which follows from the continuity assumptions.

39. $\nabla \cdot (k\mathbf{F}) = k\nabla \cdot \mathbf{F}$, $\nabla \cdot (\mathbf{F} + \mathbf{G}) = \nabla \cdot \mathbf{F} + \nabla \cdot \mathbf{G}$, $\nabla \cdot (\phi\mathbf{F}) = \phi\nabla \cdot \mathbf{F} + \nabla\phi \cdot \mathbf{F}$, $\nabla \cdot (\nabla \times \mathbf{F}) = 0$.

40. $\nabla \times (k\mathbf{F}) = k\nabla \times \mathbf{F}$, $\nabla \times (\mathbf{F} + \mathbf{G}) = \nabla \times \mathbf{F} + \nabla \times \mathbf{G}$, $\nabla \times (\phi\mathbf{F}) = \phi\nabla \times \mathbf{F} + \nabla\phi \times \mathbf{F}$, $\nabla \times (\nabla\phi) = \mathbf{0}$.

41. (a) $\text{curl} \mathbf{r} = 0\mathbf{i} + 0\mathbf{j} + 0\mathbf{k} = \mathbf{0}$.

$$(b) \nabla\|\mathbf{r}\| = \nabla\sqrt{x^2 + y^2 + z^2} = \frac{x}{\sqrt{x^2 + y^2 + z^2}}\mathbf{i} + \frac{y}{\sqrt{x^2 + y^2 + z^2}}\mathbf{j} + \frac{z}{\sqrt{x^2 + y^2 + z^2}}\mathbf{k} = \frac{\mathbf{r}}{\|\mathbf{r}\|}.$$

42. (a) $\text{div} \mathbf{r} = 1 + 1 + 1 = 3$.

$$(b) \nabla \frac{1}{\|\mathbf{r}\|} = \nabla(x^2 + y^2 + z^2)^{-1/2} = -\frac{x\mathbf{i} + y\mathbf{j} + z\mathbf{k}}{(x^2 + y^2 + z^2)^{3/2}} = -\frac{\mathbf{r}}{\|\mathbf{r}\|^3}.$$

43. (a) $\nabla f(r) = f'(r)\frac{\partial r}{\partial x}\mathbf{i} + f'(r)\frac{\partial r}{\partial y}\mathbf{j} + f'(r)\frac{\partial r}{\partial z}\mathbf{k} = f'(r)\nabla r = \frac{f'(r)}{r}\mathbf{r}$.

$$(b) \text{div}[f(r)\mathbf{r}] = f(r)\text{div} \mathbf{r} + \nabla f(r) \cdot \mathbf{r} = 3f(r) + \frac{f'(r)}{r}\mathbf{r} \cdot \mathbf{r} = 3f(r) + rf'(r).$$

44. (a) $\text{curl}[f(r)\mathbf{r}] = f(r)\text{curl} \mathbf{r} + \nabla f(r) \times \mathbf{r} = f(r)\mathbf{0} + \frac{f'(r)}{r}\mathbf{r} \times \mathbf{r} = \mathbf{0} + \mathbf{0} = \mathbf{0}$.

$$(b) \nabla^2 f(r) = \text{div}[\nabla f(r)] = \text{div} \left[\frac{f'(r)}{r}\mathbf{r} \right] = \frac{f'(r)}{r}\text{div} \mathbf{r} + \nabla \frac{f'(r)}{r} \cdot \mathbf{r} = 3\frac{f'(r)}{r} + \frac{rf''(r) - f'(r)}{r^3}\mathbf{r} \cdot \mathbf{r} = 2\frac{f'(r)}{r} + f''(r).$$

45. $f(r) = 1/r^3$, $f'(r) = -3/r^4$, $\text{div}(\mathbf{r}/r^3) = 3(1/r^3) + r(-3/r^4) = 0$.

46. Multiply $3f(r) + rf'(r) = 0$ through by r^2 to obtain $3r^2f(r) + r^3f'(r) = 0$, $d[r^3f(r)]/dr = 0$, $r^3f(r) = C$, $f(r) = C/r^3$, so $\mathbf{F} = C\mathbf{r}/r^3$ (an inverse-square field).

47. (a) At the point (x, y) the slope of the line along which the vector $-y\mathbf{i} + x\mathbf{j}$ lies is $-x/y$; the slope of the tangent line to C at (x, y) is dy/dx , so $dy/dx = -x/y$.

$$(b) ydy = -xdx, y^2/2 = -x^2/2 + K_1, x^2 + y^2 = K.$$

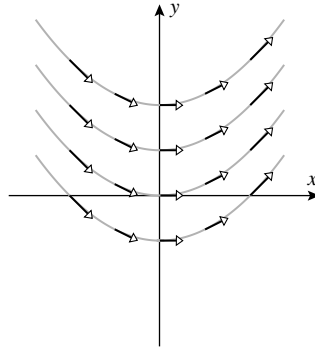

48. $dy/dx = x$, $y = x^2/2 + K$.

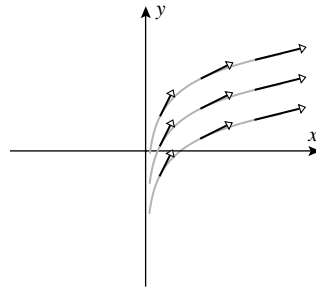

49. $dy/dx = 1/x$, $y = \ln x + K$.

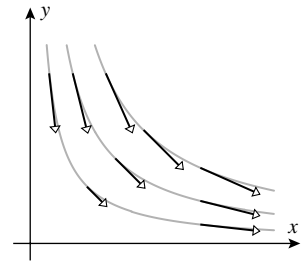

50. $dy/dx = -y/x$, $(1/y)dy = (-1/x)dx$, $\ln y = -\ln x + K_1$, $y = e^{K_1}e^{-\ln x} = K/x$.

Exercise Set 15.2

1. (a) $\int_C ds = \text{length of line segment} = 1$. (b) 0, because $\sin xy = 0$ along C .

2. (a) $\int_C ds = \text{length of line segment} = 2$. (b) 0, because x is constant and $dx = 0$.

3. Since \mathbf{F} and \mathbf{r} are parallel, $\mathbf{F} \cdot \mathbf{r} = \|\mathbf{F}\|\|\mathbf{r}\|$, and since \mathbf{F} is constant, $\int_C \mathbf{F} \cdot d\mathbf{r} = \int_C d(\mathbf{F} \cdot \mathbf{r}) = \int_C d(\|\mathbf{F}\|\|\mathbf{r}\|) = \sqrt{2} \int_{-4}^4 \sqrt{2} dt = 16$.

4. $\int_C \mathbf{F} \cdot \mathbf{r} = 0$, since \mathbf{F} is perpendicular to the curve.

5. By inspection the tangent vector in part (a) is given by $\mathbf{T} = \mathbf{j}$, so $\mathbf{F} \cdot \mathbf{T} = \mathbf{F} \cdot \mathbf{j} = \sin x$ on C . But $x = -\pi/2$ on C , thus $\sin x = -1$, $\mathbf{F} \cdot \mathbf{T} = -1$ and $\int_C \mathbf{F} \cdot d\mathbf{r} = \int_C (-1) ds$.

6. (a) Let α be the angle between \mathbf{F} and \mathbf{T} . Since $\|\mathbf{F}\| = 1$, $\cos \alpha = \|\mathbf{F}\|\|\mathbf{T}\| \cos \alpha = \mathbf{F} \cdot \mathbf{T}$, and $\int_C \mathbf{F} \cdot \mathbf{T} ds =$

$\int_C \cos \alpha(s) ds$. From Figure 15.2.12(b) it is apparent that α is close to zero on most of the parabola, thus $\cos \alpha \approx 1$ though $\cos \alpha \leq 1$. Hence $\int_C \cos \alpha(s) ds \leq \int_C ds$ and the first integral is close to the second.

(b) From Example 8(b) $\int_C \cos \alpha ds = \int_C \mathbf{F} \cdot d\mathbf{r} \approx 5.83629$, and $\int_C ds = \int_{-1}^2 \sqrt{1 + (2t)^2} dt \approx 6.125726619$.

7. $\int_C \mathbf{F} \cdot d\mathbf{r} = \int_4^5 (8 \cdot 0 + 8 \cdot 1) dt = 8$.

8. $\int_C \mathbf{F} \cdot d\mathbf{r} = \int_1^4 (2 \cdot 1 + 5 \cdot 0) dt = 6$.

9. $\int_C \mathbf{F} \cdot d\mathbf{r} = \int_4^{11} (0 \cdot 0 + 2(-2) \cdot 1) dt = -28$.

10. $\int_C \mathbf{F} \cdot d\mathbf{r} = \int_{-1}^6 (-8(-t) \cdot (-1) + 3(0) \cdot 0) dt = -140$.

11. (a) $ds = \sqrt{\left(\frac{dx}{dt}\right)^2 + \left(\frac{dy}{dt}\right)^2} dt$, so $\int_0^1 (2t - \sqrt{t^2})\sqrt{4 + 4t^2} dt = \int_0^1 2t\sqrt{1 + t^2} dt = \frac{2}{3}(1 + t^2)^{3/2} \Big|_0^1 = \frac{2}{3}(2\sqrt{2} - 1)$.

(b) $\int_0^1 (2t - \sqrt{t^2})2 dt = 1$. (c) $\int_0^1 (2t - \sqrt{t^2})2t dt = \frac{2}{3}$.

12. (a) $\int_0^1 t(3t^2)(6t^3)^2 \sqrt{1 + 36t^2 + 324t^4} dt = \frac{864}{5}$. (b) $\int_0^1 t(3t^2)(6t^3)^2 dt = \frac{54}{5}$.

(c) $\int_0^1 t(3t^2)(6t^3)^2 6t dt = \frac{648}{11}$. (d) $\int_0^1 t(3t^2)(6t^3)^2 18t^2 dt = 162$.

13. (a) $C : x = t, y = t, 0 \leq t \leq 1; \int_0^1 6t dt = 3$.

(b) $C : x = t, y = t^2, 0 \leq t \leq 1; \int_0^1 (3t + 6t^2 - 2t^3) dt = 3$.

(c) $C : x = t, y = \sin(\pi t/2), 0 \leq t \leq 1; \int_0^1 [3t + 2 \sin(\pi t/2) + \pi t \cos(\pi t/2) - (\pi/2) \sin(\pi t/2) \cos(\pi t/2)] dt = 3$.

(d) $C : x = t^3, y = t, 0 \leq t \leq 1; \int_0^1 (9t^5 + 8t^3 - t) dt = 3$.

14. (a) $C : x = t, y = t, z = t, 0 \leq t \leq 1; \int_0^1 (t + t - t) dt = \frac{1}{2}$.

(b) $C : x = t, y = t^2, z = t^3, 0 \leq t \leq 1; \int_0^1 (t^2 + t^3(2t) - t(3t^2)) dt = -\frac{1}{60}$.

(c) $C : x = \cos \pi t, y = \sin \pi t, z = t, 0 \leq t \leq 1; \int_0^1 (-\pi \sin^2 \pi t + \pi t \cos \pi t - \cos \pi t) dt = -\frac{\pi}{2} - \frac{2}{\pi}$.

15. False, a line integral is independent of the orientation of the curve.

16. False, it's a scalar.

17. True, see (26).

18. True, since ∇f is normal to C ; see (30).

$$19. \int_0^3 \frac{\sqrt{1+t}}{1+t} dt = \int_0^3 (1+t)^{-1/2} dt = 2.$$

$$20. \sqrt{5} \int_0^1 \frac{1+2t}{1+t^2} dt = \sqrt{5}(\pi/4 + \ln 2).$$

$$21. \int_0^1 3(t^2)(t^2)(2t^3/3)(1+2t^2) dt = 2 \int_0^1 t^7(1+2t^2) dt = 13/20.$$

$$22. \frac{\sqrt{5}}{4} \int_0^{2\pi} e^{-t} dt = \sqrt{5}(1 - e^{-2\pi})/4.$$

$$23. \int_0^{\pi/4} (8 \cos^2 t - 16 \sin^2 t - 20 \sin t \cos t) dt = 1 - \pi.$$

$$24. \int_{-1}^1 \left(\frac{2}{3}t - \frac{2}{3}t^{5/3} + t^{2/3} \right) dt = 6/5.$$

$$25. C : x = (3-t)^2/3, y = 3-t, 0 \leq t \leq 3; \int_0^3 \frac{1}{3}(3-t)^2 dt = 3.$$

$$26. C : x = t^{2/3}, y = t, -1 \leq t \leq 1; \int_{-1}^1 \left(\frac{2}{3}t^{2/3} - \frac{2}{3}t^{1/3} + t^{7/3} \right) dt = 4/5.$$

$$27. C : x = \cos t, y = \sin t, 0 \leq t \leq \pi/2; \int_0^{\pi/2} (-\sin t - \cos^2 t) dt = -1 - \pi/4.$$

$$28. C : x = 3-t, y = 4-3t, 0 \leq t \leq 1; \int_0^1 (-37 + 41t - 9t^2) dt = -39/2.$$

$$29. \int_0^1 (-3)e^{3t} dt = 1 - e^3.$$

$$30. \int_0^{\pi/2} (\sin^2 t \cos t - \sin^2 t \cos t + t^4(2t)) dt = \frac{\pi^6}{192}.$$

$$31. (a) \int_0^{\ln 2} (e^{3t} + e^{-3t}) \sqrt{e^{2t} + e^{-2t}} dt = \frac{63}{64}\sqrt{17} + \frac{1}{4} \ln(4 + \sqrt{17}) - \frac{1}{4} \tanh^{-1} \left(\frac{1}{17}\sqrt{17} \right).$$

$$(b) \int_0^{\pi/2} [e^t \sin t \cos t - (\sin t - t) \sin t + (1+t^2)] dt = \frac{1}{24}\pi^3 + \frac{1}{5}e^{\pi/2} + \frac{1}{4}\pi + \frac{6}{5}.$$

$$32. (a) \int_0^{\pi/2} \cos^{21} t \sin^9 t \sqrt{(-3 \cos^2 t \sin t)^2 + (3 \sin^2 t \cos t)^2} dt = 3 \int_0^{\pi/2} \cos^{22} t \sin^{10} t dt = \frac{61,047}{4,294,967,296}\pi.$$

$$(b) \int_1^e \left(t^5 \ln t + 7t^2(2t) + t^4(\ln t)\frac{1}{t} \right) dt = \frac{5}{36}e^6 + \frac{59}{16}e^4 - \frac{491}{144}.$$

33. (a) $C_1 : (0, 0)$ to $(1, 0); x = t, y = 0, 0 \leq t \leq 1, C_2 : (1, 0)$ to $(0, 1); x = 1 - t, y = t, 0 \leq t \leq 1, C_3 : (0, 1)$ to $(0, 0); x = 0, y = 1 - t, 0 \leq t \leq 1, \int_0^1 (0)dt + \int_0^1 (-1)dt + \int_0^1 (0)dt = -1.$

(b) $C_1 : (0, 0)$ to $(1, 0); x = t, y = 0, 0 \leq t \leq 1, C_2 : (1, 0)$ to $(1, 1); x = 1, y = t, 0 \leq t \leq 1, C_3 : (1, 1)$ to $(0, 1); x = 1 - t, y = 1, 0 \leq t \leq 1, C_4 : (0, 1)$ to $(0, 0); x = 0, y = 1 - t, 0 \leq t \leq 1, \int_0^1 (0)dt + \int_0^1 (-1)dt + \int_0^1 (-1)dt + \int_0^1 (0)dt = -2.$

34. (a) $C_1 : (0, 0)$ to $(1, 1); x = t, y = t, 0 \leq t \leq 1, C_2 : (1, 1)$ to $(2, 0); x = 1 + t, y = 1 - t, 0 \leq t \leq 1, C_3 : (2, 0)$ to $(0, 0); x = 2 - 2t, y = 0, 0 \leq t \leq 1, \int_0^1 (0)dt + \int_0^1 2dt + \int_0^1 (0)dt = 2.$

(b) $C_1 : (-5, 0)$ to $(5, 0); x = t, y = 0, -5 \leq t \leq 5, C_2 : x = 5 \cos t, y = 5 \sin t, 0 \leq t \leq \pi, \int_{-5}^5 (0)dt + \int_0^\pi (-25)dt = -25\pi.$

35. $C_1 : x = t, y = z = 0, 0 \leq t \leq 1, \int_0^1 0 dt = 0; C_2 : x = 1, y = t, z = 0, 0 \leq t \leq 1, \int_0^1 (-t) dt = -\frac{1}{2}; C_3 : x = 1, y = 1, z = t, 0 \leq t \leq 1, \int_0^1 3 dt = 3; \int_C x^2 z dx - yx^2 dy + 3 dz = 0 - \frac{1}{2} + 3 = \frac{5}{2}.$

36. $C_1 : (0, 0, 0)$ to $(1, 1, 0); x = t, y = t, z = 0, 0 \leq t \leq 1, C_2 : (1, 1, 0)$ to $(1, 1, 1); x = 1, y = 1, z = t, 0 \leq t \leq 1, C_3 : (1, 1, 1)$ to $(0, 0, 0); x = 1 - t, y = 1 - t, z = 1 - t, 0 \leq t \leq 1, \int_0^1 (-t^3)dt + \int_0^1 3 dt + \int_0^1 -3dt = -1/4.$

37. $\int_0^\pi (0)dt = 0.$

38. $\int_0^1 (e^{2t} - 4e^{-t})dt = e^2/2 + 4e^{-1} - 9/2.$

39. $\int_0^1 e^{-t}dt = 1 - e^{-1}$

40. $\int_0^{\pi/2} (7 \sin^2 t \cos t + 3 \sin t \cos t)dt = 23/6.$

41. Represent the circular arc by $x = 3 \cos t, y = 3 \sin t, 0 \leq t \leq \pi/2. \int_C x\sqrt{y}ds = 9\sqrt{3} \int_0^{\pi/2} \sqrt{\sin t} \cos t dt = 6\sqrt{3}.$

42. $\delta(x, y) = k\sqrt{x^2 + y^2}$ where k is the constant of proportionality,

$$\int_C k\sqrt{x^2 + y^2}ds = k \int_0^1 e^t(\sqrt{2}e^t) dt = \sqrt{2}k \int_0^1 e^{2t} dt = (e^2 - 1)k/\sqrt{2}.$$

43. $\int_C \frac{kx}{1 + y^2}ds = 15k \int_0^{\pi/2} \frac{\cos t}{1 + 9 \sin^2 t} dt = 5k \tan^{-1} 3.$

44. $\delta(x, y, z) = kz$ where k is the constant of proportionality, $\int_C kz ds = \int_1^4 k(4\sqrt{t})(2 + 1/t) dt = 136k/3.$

45. $C : x = t^2, y = t, 0 \leq t \leq 1; W = \int_0^1 3t^4 dt = 3/5.$

46. $W = \int_1^3 (t^2 + 1 - 1/t^3 + 1/t) dt = 92/9 + \ln 3.$

47. $W = \int_0^1 (t^3 + 5t^6) dt = 27/28.$

48. $C_1 : (0, 0, 0) \text{ to } (1, 3, 1); x = t, y = 3t, z = t, 0 \leq t \leq 1, C_2 : (1, 3, 1) \text{ to } (2, -1, 4); x = 1 + t, y = 3 - 4t, z = 1 + 3t, 0 \leq t \leq 1, W = \int_0^1 (4t + 8t^2) dt + \int_0^1 (-11 - 17t - 11t^2) dt = -37/2.$

49. $C : x = 4 \cos t, y = 4 \sin t, 0 \leq t \leq \pi/2, \int_0^{\pi/2} \left(-\frac{1}{4} \sin t + \cos t \right) dt = 3/4.$

50. $C_1 : (0, 3) \text{ to } (6, 3); x = 6t, y = 3, 0 \leq t \leq 1, C_2 : (6, 3) \text{ to } (6, 0); x = 6, y = 3 - 3t, 0 \leq t \leq 1, \int_0^1 \frac{6}{36t^2 + 9} dt + \int_0^1 \frac{-12}{36 + 9(1-t)^2} dt = \frac{1}{3} \tan^{-1} 2 - \frac{2}{3} \tan^{-1}(1/2).$

51. Represent the parabola by $x = t, y = t^2, 0 \leq t \leq 2. \int_C 3x ds = \int_0^2 3t \sqrt{1 + 4t^2} dt = (17\sqrt{17} - 1)/4.$

52. Represent the semicircle by $x = 2 \cos t, y = 2 \sin t, 0 \leq t \leq \pi. \int_C x^2 y ds = \int_0^{\pi} 16 \cos^2 t \sin t dt = 32/3.$

53. (a) $2\pi rh = 2\pi(1)2 = 4\pi.$

(b) $S = \int_C z(t) dt$, since the average height is 2.

(c) $C : x = \cos t, y = \sin t, 0 \leq t \leq 2\pi; S = \int_0^{2\pi} (2 + (1/2) \sin 3t) dt = 4\pi.$

54. $C : x = a \cos t, y = -a \sin t, 0 \leq t \leq 2\pi, \int_C \frac{x dy - y dx}{x^2 + y^2} = \int_0^{2\pi} \frac{-a^2 \cos^2 t - a^2 \sin^2 t}{a^2} dt = -\int_0^{2\pi} dt = -2\pi.$

55. $W = \int_C \mathbf{F} \cdot d\mathbf{r} = \int_0^1 (\lambda t^2(1-t), t - \lambda t(1-t)) \cdot (1, \lambda - 2\lambda t) dt = -\lambda/12, W = 1 \text{ when } \lambda = -12.$

56. The force exerted by the farmer is $\mathbf{F} = \left(150 + 20 - \frac{1}{10}z\right) \mathbf{k} = \left(170 - \frac{3}{4\pi}t\right) \mathbf{k}$, so $\mathbf{F} \cdot d\mathbf{r} = \left(170 - \frac{1}{10}z\right) dz$, and $W = \int_0^{60} \left(170 - \frac{1}{10}z\right) dz = 10,020 \text{ foot-pounds.}$ Note that the functions $x(z), y(z)$ are irrelevant.

57. (a) From (8), $\Delta s_k = \int_{t_{k-1}}^{t_k} \|\mathbf{r}'(t)\| dt$, thus $m\Delta t_k \leq \Delta s_k \leq M\Delta t_k$ for all k . Obviously $\Delta s_k \leq M(\max \Delta t_k)$, and since the right side of this inequality is independent of k , it follows that $\max \Delta s_k \leq M(\max \Delta t_k)$. Similarly $m(\max \Delta t_k) \leq \max \Delta s_k$.

(b) This follows from $\max \Delta t_k \leq \frac{1}{m} \max \Delta s_k$ and $\max \Delta s_k \leq M \max \Delta t_k$.

Exercise Set 15.3

1. $\partial x/\partial y = 0 = \partial y/\partial x$, conservative so $\partial\phi/\partial x = x$ and $\partial\phi/\partial y = y$, $\phi = x^2/2 + k(y)$, $k'(y) = y$, $k(y) = y^2/2 + K$, $\phi = x^2/2 + y^2/2 + K$.
2. $\partial(3y^2)/\partial y = 6y = \partial(6xy)/\partial x$, conservative so $\partial\phi/\partial x = 3y^2$ and $\partial\phi/\partial y = 6xy$, $\phi = 3xy^2 + k(y)$, $6xy + k'(y) = 6xy$, $k'(y) = 0$, $k(y) = K$, $\phi = 3xy^2 + K$.
3. $\partial(x^2y)/\partial y = x^2$ and $\partial(5xy^2)/\partial x = 5y^2$, not conservative.
4. $\partial(e^x \cos y)/\partial y = -e^x \sin y = \partial(-e^x \sin y)/\partial x$, conservative so $\partial\phi/\partial x = e^x \cos y$ and $\partial\phi/\partial y = -e^x \sin y$, $\phi = e^x \cos y + k(y)$, $-e^x \sin y + k'(y) = -e^x \sin y$, $k'(y) = 0$, $k(y) = K$, $\phi = e^x \cos y + K$.
5. $\partial(\cos y + y \cos x)/\partial y = -\sin y + \cos x = \partial(\sin x - x \sin y)/\partial x$, conservative so $\partial\phi/\partial x = \cos y + y \cos x$ and $\partial\phi/\partial y = \sin x - x \sin y$, $\phi = x \cos y + y \sin x + k(y)$, $-x \sin y + \sin x + k'(y) = \sin x - x \sin y$, $k'(y) = 0$, $k(y) = K$, $\phi = x \cos y + y \sin x + K$.
6. $\partial(x \ln y)/\partial y = x/y$ and $\partial(y \ln x)/\partial x = y/x$, not conservative.
7. (a) Let $C : x(t) = 1 + 2t, y = 4 - 3t, 0 \leq t \leq 1$. Then $I = \int_C (2xy^3 dx + (1 + 3x^2y^2) dy) = \int_0^1 [2(1+2t)(4-3t)^3]2 + (1 + 3(1+2t)^2(4-3t)^2)(-3)]dt = -58$.
 (b) Let $C_1 : x(t) = 1, y(t) = 4 - 3t, 0 \leq t \leq 1$ and $C_2 : x(t) = 2t - 1, y = 1, 1 \leq t \leq 2$. Then $I_1 = \int_0^1 [(1 + 3(4-3t)^2)(-3)]dt = -66$ and $I_2 = \int_1^2 2(2t-1)2 dt = 8$, so $I = I_1 + I_2 = -66 + 8 = -58$.
8. (a) $\partial(y \sin x)/\partial y = \sin x = \partial(-\cos x)/\partial x$, independent of path.
 (b) $C_1 : x = \pi t, y = 1 - 2t, 0 \leq t \leq 1; \int_0^1 (\pi \sin \pi t - 2\pi t \sin \pi t + 2 \cos \pi t)dt = 0$.
 (c) $\partial\phi/\partial x = y \sin x$ and $\partial\phi/\partial y = -\cos x$, $\phi = -y \cos x + k(y)$, $-\cos x + k'(y) = -\cos x$, $k'(y) = 0$, $k(y) = K$, $\phi = -y \cos x + K$. Let $K = 0$ to get $\phi(\pi, -1) - \phi(0, 1) = (-1) - (-1) = 0$.
9. $\partial(3y)/\partial y = 3 = \partial(3x)/\partial x$, $\phi = 3xy$, $\phi(4, 0) - \phi(1, 2) = -6$.
10. $\partial(e^x \sin y)/\partial y = e^x \cos y = \partial(e^x \cos y)/\partial x$, $\phi = e^x \sin y$, $\phi(1, \pi/2) - \phi(0, 0) = e$.
11. $\partial(2xe^y)/\partial y = 2xe^y = \partial(x^2e^y)/\partial x$, $\phi = x^2e^y$, $\phi(3, 2) - \phi(0, 0) = 9e^2$.
12. $\partial(3x - y + 1)/\partial y = -1 = \partial[-(x + 4y + 2)]/\partial x$, $\phi = 3x^2/2 - xy + x - 2y^2 - 2y$, $\phi(0, 1) - \phi(-1, 2) = 11/2$.
13. $\partial(2xy^3)/\partial y = 6xy^2 = \partial(3x^2y^2)/\partial x$, $\phi = x^2y^3$, $\phi(-1, 0) - \phi(2, -2) = 32$.
14. $\partial(e^x \ln y - e^y/x)/\partial y = e^x/y - e^y/x = \partial(e^x/y - e^y \ln x)/\partial x$, $\phi = e^x \ln y - e^y \ln x$, $\phi(3, 3) - \phi(1, 1) = 0$.
15. $\phi = x^2y^2/2$, $W = \phi(0, 0) - \phi(1, 1) = -1/2$.
16. $\phi = x^2y^3$, $W = \phi(4, 1) - \phi(-3, 0) = 16$.
17. $\phi = e^{xy}$, $W = \phi(2, 0) - \phi(-1, 1) = 1 - e^{-1}$.
18. $\phi = e^{-y} \sin x$, $W = \phi(-\pi/2, 0) - \phi(\pi/2, 1) = -1 - 1/e$.
19. False, the integral must be zero for *all* closed curves C .

20. True, Theorem 15.3.3.

21. True; if $\nabla\phi$ is constant then ϕ is linear.

22. True, Theorem 15.3.3.

23. $\partial(e^y + ye^x)/\partial y = e^y + e^x = \partial(xe^y + e^x)/\partial x$ so \mathbf{F} is conservative, $\phi(x, y) = xe^y + ye^x$ so $\int_C \mathbf{F} \cdot d\mathbf{r} = \phi(0, \ln 2) - \phi(1, 0) = \ln 2 - 1$.

24. $\partial(2xy)/\partial y = 2x = \partial(x^2 + \cos y)/\partial x$ so \mathbf{F} is conservative, $\phi(x, y) = x^2y + \sin y$ so $\int_C \mathbf{F} \cdot d\mathbf{r} = \phi(\pi, \pi/2) - \phi(0, 0) = \pi^3/2 + 1$.

25. $\mathbf{F} \cdot d\mathbf{r} = [(e^y + ye^x)\mathbf{i} + (xe^y + e^x)\mathbf{j}] \cdot [(\pi/2)\cos(\pi t/2)\mathbf{i} + (1/t)\mathbf{j}] dt = \left(\frac{\pi}{2}\cos(\pi t/2)(e^y + ye^x) + (xe^y + e^x)/t\right) dt$, so $\int_C \mathbf{F} \cdot d\mathbf{r} = \int_1^2 \left(\frac{\pi}{2}\cos(\pi t/2)\left(t + (\ln t)e^{\sin(\pi t/2)}\right) + \left(\sin(\pi t/2) + \frac{1}{t}e^{\sin(\pi t/2)}\right)\right) dt = \ln 2 - 1 \approx -0.306853$.

26. $\mathbf{F} \cdot d\mathbf{r} = (2t^2 \cos(t/3) + [t^2 + \cos(t \cos(t/3))](\cos(t/3) - (t/3) \sin(t/3))) dt$, so

$$\int_C \mathbf{F} \cdot d\mathbf{r} = \int_0^\pi (2t^2 \cos(t/3) + [t^2 + \cos(t \cos(t/3))](\cos(t/3) - (t/3) \sin(t/3))) dt = 1 + \pi^3/2.$$

27. No; a closed loop can be found whose tangent everywhere makes an angle $< \pi$ with the vector field, so the line integral $\int_C \mathbf{F} \cdot d\mathbf{r} > 0$, and by Theorem 15.3.2 the vector field is not conservative.

28. The vector field is constant, say $\mathbf{F} = a\mathbf{i} + b\mathbf{j}$, so let $\phi(x, y) = ax + by$ and \mathbf{F} is conservative.

29. Let $\mathbf{r}(t)$ be a parametrization of the circle C . Then by Theorem 15.3.2(b), $\int_C \mathbf{F} d\mathbf{r} = \int_C \mathbf{F} \cdot \mathbf{r}'(t) dt = 0$. Let $h(t) = \mathbf{F}(x, y) \cdot \mathbf{r}'(t)$. Then h is continuous. We must find two points at which $h = 0$. If $h(t) = 0$ everywhere on the circle, then we are done; otherwise there are points at which h is nonzero, say $h(t_1) > 0$. Then there is a small interval around t_1 on which the integral of h is positive. (Let $\epsilon = h(t_1)/2$. Since $h(t)$ is continuous there exists $\delta > 0$ such that for $|t - t_1| < \delta$, $h(t) > \epsilon/2$. Then $\int_{t_1-\delta}^{t_1+\delta} h(t) dt \geq (2\delta)\epsilon/2 > 0$.) Since $\int_C h = 0$, there are points on the circle where $h < 0$, say $h(t_2) < 0$. Now consider the parametrization $h(\theta)$, $0 \leq \theta \leq 2\pi$. Let $\theta_1 < \theta_2$ correspond to the points above where $h > 0$ and $h < 0$. Then by the Intermediate Value Theorem on $[\theta_1, \theta_2]$ there must be a point where $h = 0$, say $h(\theta_3) = 0$, $\theta_1 < \theta_3 < \theta_2$. To find a second point where $h = 0$, assume that h is a periodic function with period 2π (if need be, extend the definition of h). Then $h(t_2 - 2\pi) = h(t_2) < 0$. Apply the Intermediate Value Theorem on $[t_2 - 2\pi, t_1]$ to find an additional point θ_4 at which $h = 0$. The reader should prove that θ_3 and θ_4 do indeed correspond to distinct points on the circle.

30. The function $\mathbf{F} \cdot \mathbf{r}'(t)$ is not necessarily continuous since the tangent to the square has obvious discontinuities. For a counterexample to the result, let the square have vertices at $(0, 0), (0, 1), (1, 1), (1, 0)$. Let $\Phi(x, y) = xy + x + y$ and let $\mathbf{F} = \nabla\Phi = (y+1)\mathbf{i} + (x+1)\mathbf{j}$. Then \mathbf{F} is conservative, but on the bottom side of the square, where $y = 0$, $\mathbf{F} \cdot \mathbf{r}' = -\mathbf{F} \cdot \mathbf{j} = -x - 1 \leq -1 < 0$. On the top edge $\mathbf{F} \cdot \mathbf{r}' = \mathbf{F} \cdot \mathbf{j} = x + 1 \geq 1 > 0$. Similarly for the other two sides of the square. Thus at no point is $\mathbf{F} \cdot \mathbf{r}' = 0$.

31. If \mathbf{F} is conservative, then $\mathbf{F} = \nabla\phi = \frac{\partial\phi}{\partial x}\mathbf{i} + \frac{\partial\phi}{\partial y}\mathbf{j} + \frac{\partial\phi}{\partial z}\mathbf{k}$ and hence $f = \frac{\partial\phi}{\partial x}, g = \frac{\partial\phi}{\partial y}$, and $h = \frac{\partial\phi}{\partial z}$. Thus $\frac{\partial f}{\partial y} = \frac{\partial^2\phi}{\partial y\partial x}$ and $\frac{\partial g}{\partial x} = \frac{\partial^2\phi}{\partial x\partial y}, \frac{\partial f}{\partial z} = \frac{\partial^2\phi}{\partial z\partial x}$ and $\frac{\partial h}{\partial x} = \frac{\partial^2\phi}{\partial x\partial z}, \frac{\partial g}{\partial z} = \frac{\partial^2\phi}{\partial z\partial y}$ and $\frac{\partial h}{\partial y} = \frac{\partial^2\phi}{\partial y\partial z}$. The result follows from the equality of mixed second partial derivatives.

32. Let $f(x, y, z) = yz, g(x, y, z) = xz, h(x, y, z) = yx^2$, then $\partial f/\partial z = y, \partial h/\partial x = 2xy \neq \partial f/\partial z$, thus by Exercise 31, $\mathbf{F} = f\mathbf{i} + g\mathbf{j} + h\mathbf{k}$ is not conservative, and by Theorem 15.3.2, $\int_C yz \, dx + xz \, dy + yx^2 \, dz$ is not independent of the path.

33. $\frac{\partial}{\partial y}(h(x)[x \sin y + y \cos y]) = h(x)[x \cos y - y \sin y + \cos y], \frac{\partial}{\partial x}(h(x)[x \cos y - y \sin y]) = h(x) \cos y + h'(x)[x \cos y - y \sin y]$, equate these two partial derivatives to get $(x \cos y - y \sin y)(h'(x) - h(x)) = 0$ which holds for all x and y if $h'(x) = h(x), h(x) = Ce^x$ where C is an arbitrary constant.

34. (a) $\frac{\partial}{\partial y} \frac{cx}{(x^2 + y^2)^{3/2}} = -\frac{3cxy}{(x^2 + y^2)^{5/2}} = \frac{\partial}{\partial x} \frac{cy}{(x^2 + y^2)^{3/2}}$ when $(x, y) \neq (0, 0)$, so by Theorem 15.3.3, \mathbf{F} is conservative. Set $\partial\phi/\partial x = cx/(x^2 + y^2)^{-3/2}$, then $\phi(x, y) = -c(x^2 + y^2)^{-1/2} + k(y), \partial\phi/\partial y = cy/(x^2 + y^2)^{-3/2} + k'(y)$, so $k'(y) = 0$. Thus $\phi(x, y) = -\frac{c}{(x^2 + y^2)^{1/2}}$ is a potential function.

(b) $\text{curl } \mathbf{F} = \mathbf{0}$ is similar to part (a), so \mathbf{F} is conservative. Let $\phi(x, y, z) = \int \frac{cx}{(x^2 + y^2 + z^2)^{3/2}} \, dx = -c(x^2 + y^2 + z^2)^{-1/2} + k(y, z)$. As in part (a), $\partial k/\partial y = \partial k/\partial z = 0$, so $\phi(x, y, z) = -c/(x^2 + y^2 + z^2)^{1/2}$ is a potential function for \mathbf{F} .

35. (a) See Exercise 34, $c = 1$; $W = \int_P^Q \mathbf{F} \cdot d\mathbf{r} = \phi(3, 2, 1) - \phi(1, 1, 2) = -\frac{1}{\sqrt{14}} + \frac{1}{\sqrt{6}}$.

(b) C begins at $P(1, 1, 2)$ and ends at $Q(3, 2, 1)$ so the answer is again $W = -\frac{1}{\sqrt{14}} + \frac{1}{\sqrt{6}}$.

(c) The circle is not specified, but cannot pass through $(0, 0, 0)$, so Φ is continuous and differentiable on the circle. Start at any point P on the circle and return to P , so the work is $\Phi(P) - \Phi(P) = 0$. C begins at, say, $(3, 0)$ and ends at the same point so $W = 0$.

36. (a) $\mathbf{F} \cdot d\mathbf{r} = \left(y \frac{dx}{dt} - x \frac{dy}{dt}\right) dt$ for points on the circle $x^2 + y^2 = 1$, so $C_1 : x = \cos t, y = \sin t, 0 \leq t \leq \pi$, $\int_{C_1} \mathbf{F} \cdot d\mathbf{r} = \int_0^\pi (-\sin^2 t - \cos^2 t) dt = -\pi$, $C_2 : x = \cos t, y = -\sin t, 0 \leq t \leq \pi$, $\int_{C_2} \mathbf{F} \cdot d\mathbf{r} = \int_0^\pi (\sin^2 t + \cos^2 t) dt = \pi$.

(b) $\frac{\partial f}{\partial y} = \frac{x^2 - y^2}{(x^2 + y^2)^2}, \frac{\partial g}{\partial x} = -\frac{y^2 - x^2}{(x^2 + y^2)^2} = \frac{\partial f}{\partial y}$.

(c) The circle about the origin of radius 1, which is formed by traversing C_1 and then traversing C_2 in the reverse direction, does not lie in an open simply connected region inside which \mathbf{F} is continuous, since \mathbf{F} is not defined at the origin, nor can it be defined there in such a way as to make the resulting function continuous there.

37. If C is composed of smooth curves C_1, C_2, \dots, C_n and curve C_i extends from (x_{i-1}, y_{i-1}) to (x_i, y_i) then $\int_C \mathbf{F} \cdot d\mathbf{r} = \sum_{i=1}^n \int_{C_i} \mathbf{F} \cdot d\mathbf{r} = \sum_{i=1}^n [\phi(x_i, y_i) - \phi(x_{i-1}, y_{i-1})] = \phi(x_n, y_n) - \phi(x_0, y_0)$, where (x_0, y_0) and (x_n, y_n) are the endpoints of C .

38. $\int_{C_1} \mathbf{F} \cdot d\mathbf{r} + \int_{-C_2} \mathbf{F} \cdot d\mathbf{r} = 0$, but $\int_{-C_2} \mathbf{F} \cdot d\mathbf{r} = -\int_{C_2} \mathbf{F} \cdot d\mathbf{r}$ so $\int_{C_1} \mathbf{F} \cdot d\mathbf{r} = \int_{C_2} \mathbf{F} \cdot d\mathbf{r}$, thus $\int_C \mathbf{F} \cdot d\mathbf{r}$ is independent of path.

39. Let C_1 be an arbitrary piecewise smooth curve from (a, b) to a point (x, y_1) in the disk, and C_2 the vertical line segment from (x, y_1) to (x, y) . Then $\phi(x, y) = \int_{C_1} \mathbf{F} \cdot d\mathbf{r} + \int_{C_2} \mathbf{F} \cdot d\mathbf{r} = \int_{(a,b)}^{(x,y_1)} \mathbf{F} \cdot d\mathbf{r} + \int_{C_2} \mathbf{F} \cdot d\mathbf{r}$. The first

term does not depend on y ; hence $\frac{\partial \phi}{\partial y} = \frac{\partial}{\partial y} \int_{C_2} \mathbf{F} \cdot d\mathbf{r} = \frac{\partial}{\partial y} \int_{C_2} f(x, y)dx + g(x, y)dy$. However, the line integral with respect to x is zero along C_2 , so $\frac{\partial \phi}{\partial y} = \frac{\partial}{\partial y} \int_{C_2} g(x, y) dy$. Express C_2 as $x = x, y = t$ where t varies from y_1 to y , then $\frac{\partial \phi}{\partial y} = \frac{\partial}{\partial y} \int_{y_1}^y g(x, t) dt = g(x, y)$.

Exercise Set 15.4

- $\iint_R (2x - 2y)dA = \int_0^1 \int_0^1 (2x - 2y)dy dx = 0$; for the line integral, on $x = 0, y^2 dx = 0, x^2 dy = 0$; on $y = 0, y^2 dx = x^2 dy = 0$; on $x = 1, y^2 dx + x^2 dy = dy$; and on $y = 1, y^2 dx + x^2 dy = dx$, hence $\oint_C y^2 dx + x^2 dy = \int_0^1 dy + \int_1^0 dx = 1 - 1 = 0$.
- $\iint_R (1 - 1)dA = 0$; for the line integral let $x = \cos t, y = \sin t, \oint_C y dx + x dy = \int_0^{2\pi} (-\sin^2 t + \cos^2 t)dt = 0$.
- $\int_{-2}^4 \int_1^2 (2y - 3x)dy dx = 0$.
- $\int_0^{2\pi} \int_0^3 (1 + 2r \sin \theta)r dr d\theta = 9\pi$.
- $\int_0^{\pi/2} \int_0^{\pi/2} (-y \cos x + x \sin y)dy dx = 0$.
- $\iint_R (\sec^2 x - \tan^2 x)dA = \iint_R dA = \pi$.
- $\iint_R [1 - (-1)]dA = 2 \iint_R dA = 8\pi$.
- $\int_0^1 \int_{x^2}^x (2x - 2y)dy dx = 1/30$.
- $\iint_R \left(-\frac{y}{1+y} - \frac{1}{1+y} \right) dA = - \iint_R dA = -4$.
- $\int_0^{\pi/2} \int_0^4 (-r^2)r dr d\theta = -32\pi$.
- $\iint_R \left(-\frac{y^2}{1+y^2} - \frac{1}{1+y^2} \right) dA = - \iint_R dA = -1$.
- $\iint_R (\cos x \cos y - \cos x \cos y)dA = 0$.
- $\int_0^1 \int_{x^2}^{\sqrt{x}} (y^2 - x^2)dy dx = 0$.

14. (a) $\int_0^2 \int_{x^2}^{2x} (-6x + 2y) dy dx = -56/15.$ (b) $\int_0^2 \int_{x^2}^{2x} 6y dy dx = 64/5.$

15. False, Green's Theorem applies to closed curves in the plane.

16. False, the first partial derivatives need not even exist.

17. True, it is the area of the region bounded by C .

18. True by Green's Theorem.

19. (a) $C : x = \cos t, y = \sin t, 0 \leq t \leq 2\pi; \oint_C (e^{\sin t}(-\sin t) + \sin t \cos t e^{\cos t}) dt \approx -3.550999378;$
 $\iint_R \left[\frac{\partial}{\partial x}(ye^x) - \frac{\partial}{\partial y}e^y \right] dA = \iint_R [ye^x - e^y] dA = \int_0^{2\pi} \int_0^1 [r \sin \theta e^{r \cos \theta} - e^{r \sin \theta}] r dr d\theta \approx -3.550999378.$

(b) $C_1 : x = t, y = t^2, 0 \leq t \leq 1; \int_{C_1} [e^y dx + ye^x dy] = \int_0^1 [e^{t^2} + 2t^3 e^t] dt \approx 2.589524432,$

$C_2 : x = t^2, y = t, 0 \leq t \leq 1; \int_{C_2} [e^y dx + ye^x dy] = \int_0^1 [2te^t + te^{t^2}] dt = \frac{e+3}{2} \approx 2.859140914.$

$\int_{C_1} - \int_{C_2} \approx -0.269616482; \iint_R = \int_0^1 \int_{x^2}^{\sqrt{x}} [ye^x - e^y] dy dx \approx -0.269616482.$

20. (a) $\oint_C x dy = \int_0^{2\pi} ab \cos^2 t dt = \pi ab.$ (b) $\oint_C -y dx = \int_0^{2\pi} ab \sin^2 t dt = \pi ab.$

21. $A = \frac{1}{2} \oint_C -y dx + x dy = \frac{1}{2} \int_0^{2\pi} (3a^2 \sin^4 \phi \cos^2 \phi + 3a^2 \cos^4 \phi \sin^2 \phi) d\phi = \frac{3}{2} a^2 \int_0^{2\pi} \sin^2 \phi \cos^2 \phi d\phi =$
 $= \frac{3}{8} a^2 \int_0^{2\pi} \sin^2 2\phi d\phi = 3\pi a^2/8.$

22. $C_1 : (0, 0) \text{ to } (a, 0); x = at, y = 0, 0 \leq t \leq 1, C_2 : (a, 0) \text{ to } (0, b); x = a - at, y = bt, 0 \leq t \leq 1, C_3 :$
 $(0, b) \text{ to } (0, 0); x = 0, y = b - bt, 0 \leq t \leq 1, A = \oint_C x dy = \int_0^1 (0) dt + \int_0^1 ab(1-t) dt + \int_0^1 (0) dt = \frac{1}{2} ab.$

23. $C_1 : (0, 0) \text{ to } (a, 0); x = at, y = 0, 0 \leq t \leq 1, C_2 : (a, 0) \text{ to } (a \cos t_0, b \sin t_0); x = a \cos t, y = b \sin t, 0 \leq t \leq t_0,$
 $C_3 : (a \cos t_0, b \sin t_0) \text{ to } (0, 0); x = -a(\cos t_0)t, y = -b(\sin t_0)t, -1 \leq t \leq 0, A = \frac{1}{2} \oint_C -y dx + x dy = \frac{1}{2} \int_0^1 (0) dt +$
 $\frac{1}{2} \int_0^{t_0} ab dt + \frac{1}{2} \int_{-1}^0 (0) dt = \frac{1}{2} ab t_0.$

24. $C_1 : (0, 0) \text{ to } (a, 0); x = at, y = 0, 0 \leq t \leq 1, C_2 : (a, 0) \text{ to } (a \cosh t_0, b \sinh t_0); x = a \cosh t, y = b \sinh t, 0 \leq t \leq t_0,$
 $C_3 : (a \cosh t_0, b \sinh t_0) \text{ to } (0, 0); x = -a(\cosh t_0)t, y = -b(\sinh t_0)t, -1 \leq t \leq 0, A = \frac{1}{2} \oint_C -y dx + x dy =$
 $\frac{1}{2} \int_0^1 (0) dt + \frac{1}{2} \int_0^{t_0} ab dt + \frac{1}{2} \int_{-1}^0 (0) dt = \frac{1}{2} ab t_0.$

25. $\text{curl } \mathbf{F}(x, y, z) = (g_x - f_y)\mathbf{k}$, since f and g are independent of z . Thus $\iint_R \text{curl } \mathbf{F} \cdot \mathbf{k} dA = \iint_R (g_x - f_y) dA =$
 $\int_C f(x, y) dx + g(x, y) dy = \int_C \mathbf{F} \cdot d\mathbf{r}$ by Green's Theorem.

26. The boundary of the region R in Figure Ex-22 is $C = C_1 - C_2$, so by Green's Theorem, $\int_{C_1} \mathbf{F} \cdot d\mathbf{r} - \int_{C_2} \mathbf{F} \cdot d\mathbf{r} = \int_{C_1 - C_2} \mathbf{F} \cdot d\mathbf{r} = \int_C \mathbf{F} \cdot d\mathbf{r} = 0$, since $f_y = g_x$. Thus $\int_{C_1} = \int_{C_2}$.

27. Let C_1 denote the graph of $g(x)$ from left to right, and C_2 the graph of $f(x)$ from left to right. On the vertical sides $x = \text{const}$, and so $dx = 0$ there. Thus the area between the curves is $A(R) = \iint_R dA = - \int_C y dx = - \int_{C_1} g(x) dx + \int_{C_2} f(x) dx = - \int_a^b g(x) dx + \int_a^b f(x) dx = \int_a^b (f(x) - g(x)) dx$.

28. Let $A(R_1)$ denote the area of the region R_1 bounded by C and the lines $y = y_0, y = y_1$ and the y -axis. Then by Formula (6) $A(R_1) = \int_C x dy$, since the integrals on the top and bottom are zero ($dy = 0$ there), and $x = 0$ on the y -axis. Similarly, $A(R_2) = \int_{-C} y dx = - \int_C y dx$, where R_2 is the region bounded by $C, x = x_0, x = x_1$ and the x -axis.

(a) R_1 (b) R_2 (c) $\int_C y dx + x dy = A(R_1) + A(R_2) = x_1 y_1 - x_0 y_0$.

(d) Let $\phi(x, y) = xy$. Then $\nabla \phi \cdot d\mathbf{r} = y dx + x dy$ and thus by the Fundamental Theorem $\int_C y dx + x dy = \phi(x_1, y_1) - \phi(x_0, y_0) = x_1 y_1 - x_0 y_0$.

(e) $\int_{t_0}^{t_1} x(t) \frac{dy}{dt} dt = x(t_1)y(t_1) - x(t_0)y(t_0) - \int_{t_0}^{t_1} y(t) \frac{dx}{dt} dt$ which is equivalent to $\int_C y dx + x dy = x_1 y_1 - x_0 y_0$.

29. $W = \iint_R y dA = \int_0^\pi \int_0^5 r^2 \sin \theta dr d\theta = 250/3$.

30. We cannot apply Green's Theorem on the region enclosed by the closed curve C , since \mathbf{F} does not have first order partial derivatives at the origin. However, the curve C_{x_0} , consisting of $y = x_0^3/4, x_0 \leq x \leq 2; x = 2, x_0^3/4 \leq y \leq 2; \text{ and } y = x^3/4, x_0 \leq x \leq 2$ encloses a region R_{x_0} in which Green's Theorem does hold, and

$$W = \oint_C \mathbf{F} \cdot d\mathbf{r} = \lim_{x_0 \rightarrow 0^+} \oint_{C_{x_0}} \mathbf{F} \cdot d\mathbf{r} = \lim_{x_0 \rightarrow 0^+} \iint_{R_{x_0}} \nabla \cdot \mathbf{F} dA = \lim_{x_0 \rightarrow 0^+} \int_{x_0}^2 \int_{x_0^3/4}^{x^3/4} \left(\frac{1}{2} x^{-1/2} - \frac{1}{2} y^{-1/2} \right) dy dx = \lim_{x_0 \rightarrow 0^+} \left(-\frac{18}{35} \sqrt{2} - \frac{\sqrt{2}}{4} x_0^3 + x_0^{3/2} + \frac{3}{14} x_0^{7/2} - \frac{3}{10} x_0^{5/2} \right) = -\frac{18}{35} \sqrt{2}.$$

31. $\oint_C y dx - x dy = \iint_R (-2) dA = -2 \int_0^{2\pi} \int_0^{a(1+\cos \theta)} r dr d\theta = -3\pi a^2$.

32. $\bar{x} = \frac{1}{A} \iint_R x dA$, but $\oint_C \frac{1}{2} x^2 dy = \iint_R x dA$ from Green's Theorem so $\bar{x} = \frac{1}{A} \oint_C \frac{1}{2} x^2 dy = \frac{1}{2A} \oint_C x^2 dy$. Similarly, $\bar{y} = -\frac{1}{2A} \oint_C y^2 dx$.

33. $A = \int_0^1 \int_{x^3}^x dy dx = \frac{1}{4}$; $C_1 : x = t, y = t^3, 0 \leq t \leq 1, \int_{C_1} x^2 dy = \int_0^1 t^2 (3t^2) dt = \frac{3}{5}$, $C_2 : x = t, y = t, 0 \leq t \leq 1; \int_{C_2} x^2 dy = \int_0^1 t^2 dt = \frac{1}{3}, \oint_C x^2 dy = \int_{C_1} - \int_{C_2} = \frac{3}{5} - \frac{1}{3} = \frac{4}{15}, \bar{x} = \frac{8}{15}, \int_C y^2 dx = \int_0^1 t^6 dt - \int_0^1 t^2 dt = \frac{1}{7} - \frac{1}{3} = -\frac{4}{21}, \bar{y} = \frac{8}{21}$, centroid $\left(\frac{8}{15}, \frac{8}{21} \right)$.

34. $A = \frac{a^2}{2}$; $C_1 : x = t, y = 0, 0 \leq t \leq a$, $C_2 : x = a - t, y = t, 0 \leq t \leq a$; $C_3 : x = 0, y = a - t, 0 \leq t \leq a$; $\int_{C_1} x^2 dy = 0$, $\int_{C_2} x^2 dy = \int_0^a (a - t)^2 dt = \frac{a^3}{3}$, $\int_{C_3} x^2 dy = 0$, $\oint_C x^2 dy = \int_{C_1} + \int_{C_2} + \int_{C_3} = \frac{a^3}{3}$, $\bar{x} = \frac{a}{3}$; $\int_C y^2 dx = 0 - \int_0^a t^2 dt + 0 = -\frac{a^3}{3}$, $\bar{y} = \frac{a}{3}$, centroid $(\frac{a}{3}, \frac{a}{3})$.

35. $\bar{x} = 0$ from the symmetry of the region, $C_1 : (a, 0)$ to $(-a, 0)$ along $y = \sqrt{a^2 - x^2}$; $x = a \cos t, y = a \sin t, 0 \leq t \leq \pi$, $C_2 : (-a, 0)$ to $(a, 0)$; $x = t, y = 0, -a \leq t \leq a$, $A = \pi a^2 / 2$, $\bar{y} = -\frac{1}{2A} \left[\int_0^\pi -a^3 \sin^3 t dt + \int_{-a}^a (0) dt \right] = -\frac{1}{\pi a^2} \left(-\frac{4a^3}{3} \right) = \frac{4a}{3\pi}$; centroid $(0, \frac{4a}{3\pi})$.

36. $A = \frac{ab}{2}$; $C_1 : x = t, y = 0, 0 \leq t \leq a$, $C_2 : x = a, y = t, 0 \leq t \leq b$; $C_3 : x = a - at, y = b - bt, 0 \leq t \leq 1$; $\int_{C_1} x^2 dy = 0$, $\int_{C_2} x^2 dy = \int_0^b a^2 dt = ba^2$, $\int_{C_3} x^2 dy = \int_0^1 a^2(1 - t)^2(-b) dt = -\frac{ba^2}{3}$, $\oint_C x^2 dy = \int_{C_1} + \int_{C_2} + \int_{C_3} = \frac{2ba^2}{3}$, $\bar{x} = \frac{2a}{3}$; $\int_C y^2 dx = 0 + 0 - \int_0^1 ab^2(1 - t)^2 dt = -\frac{ab^2}{3}$, $\bar{y} = \frac{b}{3}$, centroid $(\frac{2a}{3}, \frac{b}{3})$.

37. From Green's Theorem, the given integral equals $\iint_R (1 - x^2 - y^2) dA$ where R is the region enclosed by C . The value of this integral is maximum if the integration extends over the largest region for which the integrand $1 - x^2 - y^2$ is nonnegative so we want $1 - x^2 - y^2 \geq 0, x^2 + y^2 \leq 1$. The largest region is that bounded by the circle $x^2 + y^2 = 1$ which is the desired curve C .

38. (a) $C : x = a + (c - a)t, y = b + (d - b)t, 0 \leq t \leq 1$, $\int_C -y dx + x dy = \int_0^1 (ad - bc) dt = ad - bc$.

(b) Let C_1, C_2 , and C_3 be the line segments from (x_1, y_1) to (x_2, y_2) , (x_2, y_2) to (x_3, y_3) , and (x_3, y_3) to (x_1, y_1) , then if C is the entire boundary consisting of C_1, C_2 , and C_3 . $A = \frac{1}{2} \int_C -y dx + x dy = \frac{1}{2} \sum_{i=1}^3 \int_{C_i} -y dx + x dy = \frac{1}{2} [(x_1 y_2 - x_2 y_1) + (x_2 y_3 - x_3 y_2) + (x_3 y_1 - x_1 y_3)]$.

(c) $A = \frac{1}{2} [(x_1 y_2 - x_2 y_1) + (x_2 y_3 - x_3 y_2) + \dots + (x_n y_1 - x_1 y_n)]$.

(d) $A = \frac{1}{2} [(0 - 0) + (6 + 8) + (0 + 2) + (0 - 0)] = 8$.

39. $\int_C \mathbf{F} \cdot d\mathbf{r} = \int_C (x^2 + y) dx + (4x - \cos y) dy = 3 \iint_R dA = 3(25 - 2) = 69$.

40. $\int_C \mathbf{F} \cdot d\mathbf{r} = \int_C (e^{-x} + 3y) dx + x dy = -2 \iint_R dA = -2[\pi(4)^2 - \pi(2)^2] = -24\pi$.

Exercise Set 15.5

1. R is the annular region between $x^2 + y^2 = 1$ and $x^2 + y^2 = 4$;

$$\iint_\sigma z^2 dS = \iint_R (x^2 + y^2) \sqrt{\frac{x^2}{x^2 + y^2} + \frac{y^2}{x^2 + y^2} + 1} dA = \sqrt{2} \iint_R (x^2 + y^2) dA = \sqrt{2} \int_0^{2\pi} \int_1^2 r^3 dr d\theta = \frac{15}{2} \pi \sqrt{2}$$

2. $z = 1 - x - y$, R is the triangular region enclosed by $x + y = 1$, $x = 0$ and $y = 0$;

$$\iint_{\sigma} xy \, dS = \iint_R xy\sqrt{3} \, dA = \sqrt{3} \int_0^1 \int_0^{1-x} xy \, dy \, dx = \frac{\sqrt{3}}{24}.$$

3. Let $\mathbf{r}(u, v) = \cos u \mathbf{i} + v \mathbf{j} + \sin u \mathbf{k}$, $0 \leq u \leq \pi$, $0 \leq v \leq 1$. Then $\mathbf{r}_u = -\sin u \mathbf{i} + \cos u \mathbf{k}$, $\mathbf{r}_v = \mathbf{j}$, $\mathbf{r}_u \times \mathbf{r}_v = -\cos u \mathbf{i} - \sin u \mathbf{k}$, $\|\mathbf{r}_u \times \mathbf{r}_v\| = 1$, $\iint_{\sigma} x^2 y \, dS = \int_0^1 \int_0^{\pi} v \cos^2 u \, du \, dv = \pi/4$.

4. $z = \sqrt{4 - x^2 - y^2}$, R is the circular region enclosed by $x^2 + y^2 = 3$; $\iint_{\sigma} (x^2 + y^2)z \, dS =$

$$= \iint_R (x^2 + y^2)\sqrt{4 - x^2 - y^2} \sqrt{\frac{x^2}{4 - x^2 - y^2} + \frac{y^2}{4 - x^2 - y^2} + 1} \, dA = \iint_R 2(x^2 + y^2) \, dA = 2 \int_0^{2\pi} \int_0^{\sqrt{3}} r^3 \, dr \, d\theta = 9\pi.$$

5. If we use the projection of σ onto the xz -plane then $y = 1 - x$ and R is the rectangular region in the xz -plane enclosed by $x = 0$, $x = 1$, $z = 0$ and $z = 1$; $\iint_{\sigma} (x - y - z) \, dS = \iint_R (2x - 1 - z)\sqrt{2} \, dA = \sqrt{2} \int_0^1 \int_0^1 (2x - 1 - z) \, dz \, dx = -\sqrt{2}/2$.

6. R is the triangular region enclosed by $2x + 3y = 6$, $x = 0$, and $y = 0$; $\iint_{\sigma} (x + y) \, dS = \iint_R (x + y)\sqrt{14} \, dA = \sqrt{14} \int_0^3 \int_0^{(6-2x)/3} (x + y) \, dy \, dx = 5\sqrt{14}$.

7. There are six surfaces, parametrized by projecting onto planes:

$\sigma_1 : z = 0$; $0 \leq x \leq 1$, $0 \leq y \leq 1$ (onto xy -plane), $\sigma_2 : x = 0$; $0 \leq y \leq 1$, $0 \leq z \leq 1$ (onto yz -plane),

$\sigma_3 : y = 0$; $0 \leq x \leq 1$, $0 \leq z \leq 1$ (onto xz -plane), $\sigma_4 : z = 1$; $0 \leq x \leq 1$, $0 \leq y \leq 1$ (onto xy -plane),

$\sigma_5 : x = 1$; $0 \leq y \leq 1$, $0 \leq z \leq 1$ (onto yz -plane), $\sigma_6 : y = 1$; $0 \leq x \leq 1$, $0 \leq z \leq 1$ (onto xz -plane).

By symmetry the integrals over σ_1, σ_2 and σ_3 are equal, as are those over σ_4, σ_5 and σ_6 , and $\iint_{\sigma_1} (x + y + z) \, dS = \int_0^1 \int_0^1 (x + y) \, dx \, dy = 1$; $\iint_{\sigma_4} (x + y + z) \, dS = \int_0^1 \int_0^1 (x + y + 1) \, dx \, dy = 2$, thus, $\iint_{\sigma} (x + y + z) \, dS = 3 \cdot 1 + 3 \cdot 2 = 9$.

8. Let $\mathbf{r}(\phi, \theta) = a \sin \phi \cos \theta \mathbf{i} + a \sin \phi \sin \theta \mathbf{j} + a \cos \phi \mathbf{k}$, $0 \leq \theta \leq 2\pi$, $0 \leq \phi \leq \pi$; $\|\mathbf{r}_{\phi} \times \mathbf{r}_{\theta}\| = a^2 \sin \phi$, $x^2 + y^2 = a^2 \sin^2 \phi$, $\iint_{\sigma} f(x, y, z) = \int_0^{2\pi} \int_0^{\pi} a^4 \sin^3 \phi \, d\phi \, d\theta = \frac{8}{3}\pi a^4$.

9. True by definition of the integral.

10. False, it could be more on one part and less on another; or $f = 1 + g$ where the integral of g is zero.

11. False, it's the total mass of the lamina.

12. True, Theorem 15.5.3.

13. (a) The integral is improper because the function $z(x, y)$ is not differentiable when $x^2 + y^2 = 1$.

- (b) Fix r_0 , $0 < r_0 < 1$. Then $z + 1 = \sqrt{1 - x^2 - y^2} + 1$, and $\iint_{\sigma_{r_0}} (z + 1) \, dS =$

$$\begin{aligned}
 &= \iint_{\sigma_{r_0}} (\sqrt{1-x^2-y^2} + 1) \sqrt{1 + \frac{x^2}{1-x^2-y^2} + \frac{y^2}{1-x^2-y^2}} dx dy = \int_0^{2\pi} \int_0^{r_0} (\sqrt{1-r^2} + 1) \frac{1}{\sqrt{1-r^2}} r dr d\theta = \\
 &= 2\pi \left(1 + \frac{1}{2}r_0^2 - \sqrt{1-r_0^2} \right), \text{ and, after passing to the limit as } r_0 \rightarrow 1, \iint_{\sigma} (z+1) dS = 3\pi.
 \end{aligned}$$

(c) Let $\mathbf{r}(\phi, \theta) = \sin \phi \cos \theta \mathbf{i} + \sin \phi \sin \theta \mathbf{j} + \cos \phi \mathbf{k}$, $0 \leq \theta \leq 2\pi$, $0 \leq \phi \leq \pi/2$; $\|\mathbf{r}_\phi \times \mathbf{r}_\theta\| = \sin \phi$, $\iint_{\sigma} (1 + \cos \phi) dS = \int_0^{2\pi} \int_0^{\pi/2} (1 + \cos \phi) \sin \phi d\phi d\theta = 2\pi \int_0^{\pi/2} (1 + \cos \phi) \sin \phi d\phi = 3\pi$.

14. (a) The function $z(x, y)$ is not differentiable at the origin (in fact it's partial derivatives are unbounded there).

(b) R is the circular region enclosed by $x^2 + y^2 = 1$; $\iint_{\sigma} \sqrt{x^2 + y^2 + z^2} dS = \iint_R \sqrt{2(x^2 + y^2)} \sqrt{\frac{x^2}{x^2 + y^2} + \frac{y^2}{x^2 + y^2} + 1} dA = \lim_{r_0 \rightarrow 0^+} 2 \iint_{R'} \sqrt{x^2 + y^2} dA$, where R' is the annular region enclosed by $x^2 + y^2 = 1$ and $x^2 + y^2 = r_0^2$ with r_0 slightly larger than 0 because $\sqrt{\frac{x^2}{x^2 + y^2} + \frac{y^2}{x^2 + y^2} + 1}$ is not defined for $x^2 + y^2 = 0$, so $\iint_{\sigma} \sqrt{x^2 + y^2 + z^2} dS = \lim_{r_0 \rightarrow 0^+} 2 \int_0^{2\pi} \int_{r_0}^1 r^2 dr d\theta = \lim_{r_0 \rightarrow 0^+} \frac{4\pi}{3} (1 - r_0^3) = \frac{4\pi}{3}$.

(c) The cone is contained in the locus of points satisfying $\phi = \pi/4$, so it can be parametrized with spherical coordinates ρ, θ : $\mathbf{r}(\rho, \theta) = \frac{1}{\sqrt{2}}\rho \cos \theta \mathbf{i} + \frac{1}{\sqrt{2}}\rho \sin \theta \mathbf{j} + \frac{1}{\sqrt{2}}\rho \mathbf{k}$, $0 \leq \theta \leq 2\pi$, $r < \rho \leq \sqrt{2}$. Then $\mathbf{r}_\rho = \frac{1}{\sqrt{2}} \cos \theta \mathbf{i} + \frac{1}{\sqrt{2}} \sin \theta \mathbf{j} + \frac{1}{\sqrt{2}} \mathbf{k}$, $\mathbf{r}_\theta = -\frac{1}{\sqrt{2}}\rho \sin \theta \mathbf{i} + \frac{1}{\sqrt{2}}\rho \cos \theta \mathbf{j}$, $\mathbf{r}_\rho \times \mathbf{r}_\theta = \frac{\rho}{2} (-\cos \theta \mathbf{i} - \sin \theta \mathbf{j} + \mathbf{k})$ and $\|\mathbf{r}_\rho \times \mathbf{r}_\theta\| = \frac{1}{\sqrt{2}}\rho$, and thus $\iint_{\sigma_r} f(x, y, z) dS = \lim_{r \rightarrow 0} \int_0^{2\pi} \int_r^{\sqrt{2}} \rho \frac{1}{\sqrt{2}} \rho d\rho d\theta = \lim_{r \rightarrow 0} 2\pi \frac{1}{\sqrt{2}} \frac{1}{3} \rho^3 \Big|_r^{\sqrt{2}} = \lim_{r \rightarrow 0} \frac{\sqrt{2}}{3} (2\sqrt{2} - r^3) \pi = \frac{4\pi}{3}$.

15. (a) Subdivide the right hemisphere $\sigma \cap \{x > 0\}$ into patches, each patch being as small as desired (i). For each patch there is a corresponding patch on the left hemisphere $\sigma \cap \{x < 0\}$ which is the reflection through the yz -plane. Condition (ii) now follows.

(b) Use the patches in Part (a) and the function $f(x, y, z) = x^n$ to define the sum in Definition 15.5.1. The patches of the sum divide into two classes, each the negative of the other since n is odd. Thus the sum adds to zero. Since x^n is a continuous function the limit exists and must also be zero, $\int_{\sigma} x^n dS = 0$.

16. Since g is independent of x it is convenient to say that g is an even function of x , and hence $f(x, y)g(x, y)$ is a continuous odd function of x . Following the argument in Exercise 15, the sum again breaks into two classes, consisting of pairs of patches with the opposite sign. Thus the sum is zero and $\int_{\sigma} fg dS = 0$.

17. (a) Permuting the variables x, y, z by sending $x \rightarrow y \rightarrow z \rightarrow x$ will leave the integrals equal, through symmetry in the variables.

(b) $\iint_{\sigma} (x^2 + y^2 + z^2) dS =$ surface area of sphere, so each integral contributes one third, i.e. $\iint_{\sigma} x^2 dS = \frac{1}{3} \left[\iint_{\sigma} x^2 dS + \iint_{\sigma} y^2 dS + \iint_{\sigma} z^2 dS \right]$.

(c) Since σ has radius 1, $\iint_{\sigma} dS$ is the surface area of the sphere, which is 4π , therefore $\iint_{\sigma} x^2 dS = \frac{4}{3}\pi$.

18. $\iint_{\sigma} (x-y)^2 dS = \iint_{\sigma} x^2 dS - \iint_{\sigma} 2xy dS + \iint_{\sigma} y^2 dS = \frac{4}{3}\pi + 0 + \frac{4}{3}\pi = \frac{8}{3}\pi$. The middle integral is zero by Exercise 15 as the integrand is an odd function of x .

19. (a) $\frac{\sqrt{29}}{16} \int_0^6 \int_0^{(12-2x)/3} xy(12-2x-3y) dy dx$.

(b) $\frac{\sqrt{29}}{4} \int_0^3 \int_0^{(12-4z)/3} yz(12-3y-4z) dy dz$.

(c) $\frac{\sqrt{29}}{9} \int_0^3 \int_0^{6-2z} xz(12-2x-4z) dx dz$.

20. (a) $a \int_0^a \int_0^{\sqrt{a^2-x^2}} x dy dx$ (b) $a \int_0^a \int_0^{\sqrt{a^2-z^2}} z dy dz$ (c) $a \int_0^a \int_0^{\sqrt{a^2-z^2}} \frac{xz}{\sqrt{a^2-x^2-z^2}} dx dz$

21. $18\sqrt{29}/5$.

22. $a^4/3$.

23. $\int_0^4 \int_1^2 y^3 z \sqrt{4y^2+1} dy dz$; $\frac{1}{2} \int_0^4 \int_1^4 xz \sqrt{1+4x} dx dz$.

24. $a \int_0^9 \int_{a/\sqrt{5}}^{a/\sqrt{2}} \frac{x^2 y}{\sqrt{a^2-y^2}} dy dx$, $a \int_{a/\sqrt{2}}^{2a/\sqrt{5}} \int_0^9 x^2 dx dz$

25. $391\sqrt{17}/15 - 5\sqrt{5}/3$.

26. The region $R: 3x^2+2y^2=5$ is symmetric in y . The integrand is $x^2yz dS = x^2y(5-3x^2-2y^2)\sqrt{1+36x^2+16y^2} dy dx$, which is odd in y , hence $\iint_{\sigma} x^2yz dS = 0$.

27. $z = \sqrt{4-x^2}$, $\frac{\partial z}{\partial x} = -\frac{x}{\sqrt{4-x^2}}$, $\frac{\partial z}{\partial y} = 0$; $\iint_{\sigma} \delta_0 dS = \delta_0 \iint_R \sqrt{\frac{x^2}{4-x^2}+1} dA = 2\delta_0 \int_0^4 \int_0^1 \frac{1}{\sqrt{4-x^2}} dx dy = \frac{4}{3}\pi\delta_0$.

28. $z = \frac{1}{2}(x^2+y^2)$, R is the circular region enclosed by $x^2+y^2=8$; $\iint_{\sigma} \delta_0 dS = \delta_0 \iint_R \sqrt{x^2+y^2+1} dA = \delta_0 \int_0^{2\pi} \int_0^{\sqrt{8}} \sqrt{r^2+1} r dr d\theta = \frac{52}{3}\pi\delta_0$.

29. $z = 4-y^2$, R is the rectangular region enclosed by $x=0$, $x=3$, $y=0$ and $y=3$; $\iint_{\sigma} y dS = \iint_R y\sqrt{4y^2+1} dA = \int_0^3 \int_0^3 y\sqrt{4y^2+1} dy dx = \frac{1}{4}(37\sqrt{37}-1)$.

30. R is the annular region enclosed by $x^2+y^2=1$ and $x^2+y^2=16$; $\iint_{\sigma} x^2 z dS =$

$$= \iint_R x^2 \sqrt{x^2 + y^2} \sqrt{\frac{x^2}{x^2 + y^2} + \frac{y^2}{x^2 + y^2} + 1} dA = \sqrt{2} \iint_R x^2 \sqrt{x^2 + y^2} dA = \sqrt{2} \int_0^{2\pi} \int_1^4 r^4 \cos^2 \theta dr d\theta = \frac{1023\sqrt{2}}{5} \pi.$$

31. $M = \iint_{\sigma} \delta(x, y, z) dS = \iint_{\sigma} \delta_0 dS = \delta_0 \iint_{\sigma} dS = \delta_0 S.$

32. $\delta(x, y, z) = |z|$; use $z = \sqrt{a^2 - x^2 - y^2}$, let R be the circular region enclosed by $x^2 + y^2 = a^2$, and σ the hemisphere above R . By the symmetry of both the surface and the density function with respect to the xy -plane we have

$$M = 2 \iint_{\sigma} z dS = 2 \iint_R \sqrt{a^2 - x^2 - y^2} \sqrt{\frac{x^2}{a^2 - x^2 - y^2} + \frac{y^2}{a^2 - x^2 - y^2} + 1} dA = \lim_{r_0 \rightarrow a^-} 2a \iint_{R_{r_0}} dA$$

where R_{r_0} is the circular region with radius r_0 that is slightly less than a . But $\iint_{R_{r_0}} dA$ is simply the area of the circle with radius r_0 so $M = \lim_{r_0 \rightarrow a^-} 2a(\pi r_0^2) = 2\pi a^3.$

33. By symmetry $\bar{x} = \bar{y} = 0$. $\iint_{\sigma} dS = \iint_R \sqrt{x^2 + y^2 + 1} dA = \int_0^{2\pi} \int_0^{\sqrt{8}} \sqrt{r^2 + 1} r dr d\theta = \frac{52\pi}{3}$, $\iint_{\sigma} z dS =$

$$\iint_R z \sqrt{x^2 + y^2 + 1} dA = \frac{1}{2} \iint_R (x^2 + y^2) \sqrt{x^2 + y^2 + 1} dA = \frac{1}{2} \int_0^{2\pi} \int_0^{\sqrt{8}} r^3 \sqrt{r^2 + 1} dr d\theta = \frac{596\pi}{15}$$

$\bar{z} = \frac{596\pi/15}{52\pi/3} = \frac{149}{65}$. The centroid is $(\bar{x}, \bar{y}, \bar{z}) = (0, 0, 149/65)$.

34. By symmetry $\bar{x} = \bar{y} = 0$. $\iint_{\sigma} dS = \iint_R \frac{2}{\sqrt{4 - x^2 - y^2}} dA = 2 \int_0^{2\pi} \int_0^{\sqrt{3}} \frac{r}{\sqrt{4 - r^2}} dr d\theta = 4\pi$, $\iint_{\sigma} z dS =$

$$\iint_R 2 dA = (2)(\text{area of circle of radius } \sqrt{3}) = 6\pi$$
, so $\bar{z} = \frac{6\pi}{4\pi} = \frac{3}{2}$. The centroid is $(\bar{x}, \bar{y}, \bar{z}) = (0, 0, 3/2)$.

35. $\partial \mathbf{r} / \partial u = \cos v \mathbf{i} + \sin v \mathbf{j} + 3\mathbf{k}$, $\partial \mathbf{r} / \partial v = -u \sin v \mathbf{i} + u \cos v \mathbf{j}$, $\|\partial \mathbf{r} / \partial u \times \partial \mathbf{r} / \partial v\| = \sqrt{10}u$; $3\sqrt{10} \iint_R u^4 \sin v \cos v dA =$

$$3\sqrt{10} \int_0^{\pi/2} \int_1^2 u^4 \sin v \cos v du dv = 93/\sqrt{10}.$$

36. $\partial \mathbf{r} / \partial u = \mathbf{j}$, $\partial \mathbf{r} / \partial v = -2 \sin v \mathbf{i} + 2 \cos v \mathbf{k}$, $\|\partial \mathbf{r} / \partial u \times \partial \mathbf{r} / \partial v\| = 2$; $8 \iint_R \frac{1}{u} dA = 8 \int_0^{2\pi} \int_1^3 \frac{1}{u} du dv = 16\pi \ln 3$.

37. $\partial \mathbf{r} / \partial u = \cos v \mathbf{i} + \sin v \mathbf{j} + 2u\mathbf{k}$, $\partial \mathbf{r} / \partial v = -u \sin v \mathbf{i} + u \cos v \mathbf{j}$, $\|\partial \mathbf{r} / \partial u \times \partial \mathbf{r} / \partial v\| = u\sqrt{4u^2 + 1}$; $\iint_R u dA =$

$$= \int_0^{\pi} \int_0^{\sin v} u du dv = \pi/4.$$

38. $\partial \mathbf{r} / \partial u = 2 \cos u \cos v \mathbf{i} + 2 \cos u \sin v \mathbf{j} - 2 \sin u \mathbf{k}$, $\partial \mathbf{r} / \partial v = -2 \sin u \sin v \mathbf{i} + 2 \sin u \cos v \mathbf{j}$; $\|\partial \mathbf{r} / \partial u \times \partial \mathbf{r} / \partial v\| = 4 \sin u$;

$$4 \iint_R e^{-2 \cos u} \sin u dA = 4 \int_0^{2\pi} \int_0^{\pi/2} e^{-2 \cos u} \sin u du dv = 4\pi(1 - e^{-2}).$$

39. $\partial z / \partial x = -2xe^{-x^2 - y^2}$, $\partial z / \partial y = -2ye^{-x^2 - y^2}$, $(\partial z / \partial x)^2 + (\partial z / \partial y)^2 + 1 = 4(x^2 + y^2)e^{-2(x^2 + y^2)} + 1$; use polar

coordinates to get $M = \int_0^{2\pi} \int_0^3 r^2 \sqrt{4r^2 e^{-2r^2} + 1} dr d\theta \approx 57.895751$.

$$40. \text{ (b) } A = \iint_{\sigma} dS = \int_0^{2\pi} \int_{-1}^1 \frac{1}{2} \sqrt{40u \cos(v/2) + u^2 + 4u^2 \cos^2(v/2) + 100} du dv \approx 62.93768644; \bar{x} = \frac{1}{A} \iint_{\sigma} x dS \approx 0.016302; \bar{y} = \bar{z} = 0 \text{ by symmetry.}$$

Exercise Set 15.6

- (a) Zero. (b) Zero. (c) Positive. (d) Negative. (e) Zero. (f) Zero.
- 0; the vector field is constant, so when we compute the flux, for any given contribution on one face of the cube, we will get the same contribution with a minus sign on the opposite face. (Whatever "flows in" on one side "flows out" on the opposite, so the total flux is 0.)
- The vector field is constant $-5\mathbf{i}$ on a square like this, $\mathbf{n} = \mathbf{i}$, so $\iint_R \mathbf{F} \cdot \mathbf{n} dS = -5A(R) = -80$.
- $\mathbf{n} = -\mathbf{j}$, so $\mathbf{F} \cdot \mathbf{n} = -1$, $\iint_R \mathbf{F} \cdot \mathbf{n} dS = -A(R) = -25$.
- $\mathbf{n} = \mathbf{k}$, so $\mathbf{F} \cdot \mathbf{n} = 5$, so the flux is $5A(R) = 5 \cdot 6 = 30$.
- $\mathbf{n} = \mathbf{j}$, so $\mathbf{F} \cdot \mathbf{n} = 3$, so the flux is $3A(R) = 3 \cdot 25\pi = 75\pi$.
- $\mathbf{n} = \mathbf{k}$, so $\mathbf{F} \cdot \mathbf{n} = 8$, so the flux is $8A(R) = 8 \cdot 25\pi = 200\pi$.
- (a) $\mathbf{n} = -\cos v\mathbf{i} - \sin v\mathbf{j}$. (b) Inward, by inspection.
- $\mathbf{n} = \mathbf{k}$, so $\mathbf{F} \cdot \mathbf{n} = x$, $\iint_R \mathbf{F} \cdot \mathbf{n} dS = \int_0^2 \int_0^2 x dx dy = 4$.
- $\mathbf{n} = \mathbf{k}$, so $\mathbf{F} \cdot \mathbf{n} = 2x$, $\iint_R \mathbf{F} \cdot \mathbf{n} dS = \int_0^3 \int_0^2 2x dx dy = 12$.
- $\mathbf{n} = -z_x\mathbf{i} - z_y\mathbf{j} + \mathbf{k}$, $\iint_R \mathbf{F} \cdot \mathbf{n} dS = \iint_R (2x^2 + 2y^2 + 2(1 - x^2 - y^2)) dS = \int_0^{2\pi} \int_0^1 2r dr d\theta = 2\pi$.
- $\mathbf{n} = -\mathbf{j}$, so $\mathbf{F} \cdot \mathbf{n} = -(x + e^{-1})$, $\iint_R \mathbf{F} \cdot \mathbf{n} dS = -\int_0^4 \int_0^2 x + e^{-1} dx dz = -8 - 8/e$.
- R is the annular region enclosed by $x^2 + y^2 = 1$ and $x^2 + y^2 = 4$; $\iint_{\sigma} \mathbf{F} \cdot \mathbf{n} dS =$

$$= \iint_R \left(-\frac{x^2}{\sqrt{x^2 + y^2}} - \frac{y^2}{\sqrt{x^2 + y^2}} + 2z \right) dA = \iint_R \sqrt{x^2 + y^2} dA = \int_0^{2\pi} \int_1^2 r^2 dr d\theta = \frac{14\pi}{3}$$
- R is the circular region enclosed by $x^2 + y^2 = 4$; $\iint_{\sigma} \mathbf{F} \cdot \mathbf{n} dS = \iint_R (2y^2 - 1) dA = \int_0^{2\pi} \int_0^2 (2r^2 \sin^2 \theta - 1) r dr d\theta = 4\pi$.

15. R is the circular region enclosed by $x^2 + y^2 - y = 0$; $\iint_{\sigma} \mathbf{F} \cdot \mathbf{n} dS = \iint_R (-x) dA = 0$ since the region R is symmetric across the y -axis.

16. With $z = \frac{1}{2}(6 - 6x - 3y)$, R is the triangular region enclosed by $2x + y = 2$, $x = 0$, and $y = 0$; $\iint_{\sigma} \mathbf{F} \cdot \mathbf{n} dS = \iint_R \left(3x^2 + \frac{3}{2}yx + zx\right) dA = 3 \iint_R x dA = 3 \int_0^1 \int_0^{2-2x} x dy dx = 1$.

17. $\partial \mathbf{r} / \partial u = \cos v \mathbf{i} + \sin v \mathbf{j} - 2u \mathbf{k}$, $\partial \mathbf{r} / \partial v = -u \sin v \mathbf{i} + u \cos v \mathbf{j}$, $\partial \mathbf{r} / \partial u \times \partial \mathbf{r} / \partial v = 2u^2 \cos v \mathbf{i} + 2u^2 \sin v \mathbf{j} + u \mathbf{k}$;
 $\iint_R (2u^3 + u) dA = \int_0^{2\pi} \int_1^2 (2u^3 + u) du dv = 18\pi$.

18. $\partial \mathbf{r} / \partial u = \mathbf{k}$, $\partial \mathbf{r} / \partial v = -2 \sin v \mathbf{i} + \cos v \mathbf{j}$, $\partial \mathbf{r} / \partial u \times \partial \mathbf{r} / \partial v = -\cos v \mathbf{i} - 2 \sin v \mathbf{j}$; $\iint_R (2 \sin^2 v - e^{-\sin v} \cos v) dA = \int_0^{2\pi} \int_0^5 (2 \sin^2 v - e^{-\sin v} \cos v) du dv = 10\pi$.

19. $\partial \mathbf{r} / \partial u = \cos v \mathbf{i} + \sin v \mathbf{j} + 2 \mathbf{k}$, $\partial \mathbf{r} / \partial v = -u \sin v \mathbf{i} + u \cos v \mathbf{j}$, $\partial \mathbf{r} / \partial u \times \partial \mathbf{r} / \partial v = -2u \cos v \mathbf{i} - 2u \sin v \mathbf{j} + u \mathbf{k}$; $\iint_R u^2 dA = \int_0^{\pi} \int_0^{\sin v} u^2 du dv = 4/9$.

20. $\partial \mathbf{r} / \partial u = 2 \cos u \cos v \mathbf{i} + 2 \cos u \sin v \mathbf{j} - 2 \sin u \mathbf{k}$, $\partial \mathbf{r} / \partial v = -2 \sin u \sin v \mathbf{i} + 2 \sin u \cos v \mathbf{j}$; $\partial \mathbf{r} / \partial u \times \partial \mathbf{r} / \partial v = 4 \sin^2 u \cos v \mathbf{i} + 4 \sin^2 u \sin v \mathbf{j} + 4 \sin u \cos u \mathbf{k}$; $\iint_R 8 \sin u dA = 8 \int_0^{2\pi} \int_0^{\pi/3} \sin u du dv = 8\pi$.

21. In each part, divide σ into the six surfaces

- $\sigma_1 : x = -1$ with $|y| \leq 1$, $|z| \leq 1$, and $\mathbf{n} = -\mathbf{i}$, $\sigma_2 : x = 1$ with $|y| \leq 1$, $|z| \leq 1$, and $\mathbf{n} = \mathbf{i}$,
- $\sigma_3 : y = -1$ with $|x| \leq 1$, $|z| \leq 1$, and $\mathbf{n} = -\mathbf{j}$, $\sigma_4 : y = 1$ with $|x| \leq 1$, $|z| \leq 1$, and $\mathbf{n} = \mathbf{j}$,
- $\sigma_5 : z = -1$ with $|x| \leq 1$, $|y| \leq 1$, and $\mathbf{n} = -\mathbf{k}$, $\sigma_6 : z = 1$ with $|x| \leq 1$, $|y| \leq 1$, and $\mathbf{n} = \mathbf{k}$,

(a) $\iint_{\sigma_1} \mathbf{F} \cdot \mathbf{n} dS = \iint_{\sigma_1} dS = 4$, $\iint_{\sigma_2} \mathbf{F} \cdot \mathbf{n} dS = \iint_{\sigma_2} dS = 4$, and $\iint_{\sigma_i} \mathbf{F} \cdot \mathbf{n} dS = 0$ for $i = 3, 4, 5, 6$, so $\iint_{\sigma} \mathbf{F} \cdot \mathbf{n} dS = 4 + 4 + 0 + 0 + 0 + 0 = 8$.

(b) $\iint_{\sigma_1} \mathbf{F} \cdot \mathbf{n} dS = \iint_{\sigma_1} dS = 4$, similarly $\iint_{\sigma_i} \mathbf{F} \cdot \mathbf{n} dS = 4$ for $i = 2, 3, 4, 5, 6$, so $\iint_{\sigma} \mathbf{F} \cdot \mathbf{n} dS = 4 + 4 + 4 + 4 + 4 + 4 = 24$.

(c) $\iint_{\sigma_1} \mathbf{F} \cdot \mathbf{n} dS = -\iint_{\sigma_1} dS = -4$, $\iint_{\sigma_2} \mathbf{F} \cdot \mathbf{n} dS = 4$, similarly $\iint_{\sigma_i} \mathbf{F} \cdot \mathbf{n} dS = -4$ for $i = 3, 5$ and $\iint_{\sigma_i} \mathbf{F} \cdot \mathbf{n} dS = 4$ for $i = 4, 6$, so $\iint_{\sigma} \mathbf{F} \cdot \mathbf{n} dS = -4 + 4 - 4 + 4 - 4 + 4 = 0$.

22. Decompose σ into a top σ_1 (the disk) and a bottom σ_2 (the portion of the paraboloid). Then $\mathbf{n}_1 = \mathbf{k}$, $\iint_{\sigma_1} \mathbf{F} \cdot \mathbf{n}_1 dS = -\iint_{\sigma_1} y dS = -\int_0^{2\pi} \int_0^1 r^2 \sin \theta dr d\theta = 0$, $\mathbf{n}_2 = (2x\mathbf{i} + 2y\mathbf{j} - \mathbf{k})/\sqrt{1 + 4x^2 + 4y^2}$, $\iint_{\sigma_2} \mathbf{F} \cdot \mathbf{n}_2 dS = \iint_{\sigma_2} \frac{y(2x^2 + 2y^2 + 1)}{\sqrt{1 + 4x^2 + 4y^2}} dS = 0$, because the surface σ_2 is symmetric with respect to the xy -plane and the integrand is an odd function of y . Thus the flux is 0.
23. False, the Möbius strip is not orientable.
24. False, the flux is a scalar.
25. False, the value can be zero if as much liquid passes in the negative direction as in the positive.
26. True, it is $\iint_{\sigma} \mathbf{n} \cdot \mathbf{n} dS = \iint_{\sigma} dS = A(\sigma)$.
27. The surface is parametrized by $x = u \cos v, y = u \sin v, z = u, 1 \leq u \leq 2, 0 \leq v \leq 2\pi$. $\frac{\partial \mathbf{r}}{\partial u} \times \frac{\partial \mathbf{r}}{\partial v} = -(u \cos v \mathbf{i} + u \sin v \mathbf{j} - u \mathbf{k})$; $\iint_{\sigma} \mathbf{F} \cdot \mathbf{n} dS = \iint_R u (\cos v + \sin v - 1) dA = \int_0^{2\pi} \int_1^2 (\cos v + \sin v - 1) u du dv = -3\pi$.
28. The surface is parametrized by $x = 4 \cos u, y = 4 \sin u, z = v, 0 \leq u \leq 2\pi, -2 \leq v \leq 2$. $\frac{\partial \mathbf{r}}{\partial u} \times \frac{\partial \mathbf{r}}{\partial v} = (4 \cos u \mathbf{i} + 4 \sin u \mathbf{j})$; $\iint_{\sigma} \mathbf{F} \cdot \mathbf{n} dS = \iint_R 12 \cos u + 28 \sin u dA = \int_0^{2\pi} \int_{-2}^2 12 \cos u + 28 \sin u dv du = 0$.
29. (a) $\mathbf{n} = \frac{1}{\sqrt{3}}[\mathbf{i} + \mathbf{j} + \mathbf{k}]$, $V = \int_{\sigma} \mathbf{F} \cdot \mathbf{n} dS = \int_0^1 \int_0^{1-x} (2x - 3y + 1 - x - y) dy dx = 0 \text{ m}^3/\text{s}$.
- (b) $m = 0 \cdot 806 = 0 \text{ kg/s}$.
30. (a) Let $x = 3 \sin \phi \cos \theta, y = 3 \sin \phi \sin \theta, z = 3 \cos \phi$, $\mathbf{n} = \sin \phi \cos \theta \mathbf{i} + \sin \phi \sin \theta \mathbf{j} + \cos \phi \mathbf{k}$, so $V = \int_{\sigma} \mathbf{F} \cdot \mathbf{n} dS = \iint_A 9 \sin \phi (-3 \sin^2 \phi \sin \theta \cos \theta + 3 \sin \phi \cos \phi \sin \theta + 9 \sin \phi \cos \phi \cos \theta) dA = \int_0^{2\pi} \int_0^3 3 \sin \phi \cos \theta (-\sin \phi \sin \theta + 4 \cos \phi) r dr d\theta = 0 \text{ m}^3$.
- (b) $\frac{dm}{dt} = 0 \cdot 1060 = 0 \text{ kg/s}$.
31. (a) $G(x, y, z) = x - g(y, z)$, $\nabla G = \mathbf{i} - \frac{\partial g}{\partial y} \mathbf{j} - \frac{\partial g}{\partial z} \mathbf{k}$, apply Theorem 15.6.3: $\iint_{\sigma} \mathbf{F} \cdot \mathbf{n} dS = \iint_R \mathbf{F} \cdot \left(\mathbf{i} - \frac{\partial x}{\partial y} \mathbf{j} - \frac{\partial x}{\partial z} \mathbf{k} \right) dA$, if σ is oriented by front normals, and $\iint_{\sigma} \mathbf{F} \cdot \mathbf{n} dS = \iint_R \mathbf{F} \cdot \left(-\mathbf{i} + \frac{\partial x}{\partial y} \mathbf{j} + \frac{\partial x}{\partial z} \mathbf{k} \right) dA$, if σ is oriented by back normals, where R is the projection of σ onto the yz -plane.
- (b) R is the semicircular region in the yz -plane enclosed by $z = \sqrt{1 - y^2}$ and $z = 0$; $\iint_{\sigma} \mathbf{F} \cdot \mathbf{n} dS = \iint_R (-y -$

$$2yz + 16z)dA = \int_{-1}^1 \int_0^{\sqrt{1-y^2}} (-y - 2yz + 16z)dz dy = \frac{32}{3}.$$

32. (a) $G(x, y, z) = y - g(x, z)$, $\nabla G = -\frac{\partial g}{\partial x} \mathbf{i} + \mathbf{j} - \frac{\partial g}{\partial z} \mathbf{k}$, apply Theorem 15.6.3: $\iint_R \mathbf{F} \cdot \left(\frac{\partial y}{\partial x} \mathbf{i} - \mathbf{j} + \frac{\partial y}{\partial z} \mathbf{k} \right) dA$, σ oriented by left normals, and $\iint_R \mathbf{F} \cdot \left(-\frac{\partial y}{\partial x} \mathbf{i} + \mathbf{j} - \frac{\partial y}{\partial z} \mathbf{k} \right) dA$, σ oriented by right normals, where R is the projection of σ onto the xz -plane.

(b) R is the semicircular region in the xz -plane enclosed by $z = \sqrt{1-x^2}$ and $z = 0$; $\iint_{\sigma} \mathbf{F} \cdot \mathbf{n} dS = \iint_R (-2x^2 + (x^2 + z^2) - 2z^2)dA = -\int_{-1}^1 \int_0^{\sqrt{1-x^2}} (x^2 + z^2)dz dx = -\frac{\pi}{4}.$

33. (a) On the sphere, $\|\mathbf{r}\| = a$ so $\mathbf{F} = a^k \mathbf{r}$ and $\mathbf{F} \cdot \mathbf{n} = a^k \mathbf{r} \cdot (\mathbf{r}/a) = a^{k-1} \|\mathbf{r}\|^2 = a^{k-1} a^2 = a^{k+1}$, hence $\iint_{\sigma} \mathbf{F} \cdot \mathbf{n} dS = a^{k+1} \iint_{\sigma} dS = a^{k+1} (4\pi a^2) = 4\pi a^{k+3}.$

(b) If $k = -3$, then $\iint_{\sigma} \mathbf{F} \cdot \mathbf{n} dS = 4\pi.$

34. Let $\mathbf{r} = \sin u \cos v \mathbf{i} + \sin u \sin v \mathbf{j} + \cos u \mathbf{k}$, $\mathbf{r}_u \times \mathbf{r}_v = \sin^2 u \cos v \mathbf{i} + \sin^2 u \sin v \mathbf{j} + \sin u \cos u \mathbf{k}$, $\mathbf{F} \cdot (\mathbf{r}_u \times \mathbf{r}_v) = a^2 \sin^3 u \cos^2 v + \frac{1}{a} \sin^3 u \sin^2 v + a \sin u \cos^3 u,$

$$\iint_{\sigma} \mathbf{F} \cdot \mathbf{n} dS = \int_0^{2\pi} \int_0^{\pi} \left(a^2 \sin^3 u \cos^2 v + \frac{1}{a} \sin^3 u \sin^2 v + a \sin u \cos^3 u \right) du dv = \frac{4}{3a} \int_0^{\pi} (a^3 \cos^2 v + \sin^2 v) dv = \frac{4\pi}{3} \left(a^2 + \frac{1}{a} \right) = 3\pi \text{ if } a = \frac{1}{2}, \frac{-1 \pm \sqrt{33}}{4}.$$

35. Let $\mathbf{r} = a \sin u \cos v \mathbf{i} + a \sin u \sin v \mathbf{j} + a \cos u \mathbf{k}$, $\mathbf{r}_u \times \mathbf{r}_v = a^2 \sin^2 u \cos v \mathbf{i} + a^2 \sin^2 u \sin v \mathbf{j} + a^2 \sin u \cos u \mathbf{k}$, $\mathbf{F} \cdot (\mathbf{r}_u \times \mathbf{r}_v) = \left(\frac{6}{a} + 1 \right) a^3 \sin^3 u \cos^2 v - 4a^4 \sin^3 u \sin^2 v + a^5 \sin u \cos^2 u,$

$$\iint_{\sigma} \mathbf{F} \cdot \mathbf{n} dS = \int_0^{2\pi} \int_0^{\pi} \left(\left(\frac{6}{a} + 1 \right) a^3 \sin^3 u \cos^2 v - 4a^4 \sin^3 u \sin^2 v + a^5 \sin u \cos^2 u \right) du dv = \frac{4}{3} a^2 (6 + a - 4a^2 + a^3) \pi = 0 \text{ if } a = -1, 2, 3. \text{ We discard } a = -1 \text{ because } a \text{ is the radius of the sphere.}$$

Exercise Set 15.7

1. $\sigma_1 : x = 0, \mathbf{F} \cdot \mathbf{n} = -x = 0, \iint_{\sigma_1} (0) dA = 0,$ $\sigma_2 : x = 1, \mathbf{F} \cdot \mathbf{n} = x = 1, \iint_{\sigma_2} (1) dA = 1,$

$\sigma_3 : y = 0, \mathbf{F} \cdot \mathbf{n} = -y = 0, \iint_{\sigma_3} (0) dA = 0,$ $\sigma_4 : y = 1, \mathbf{F} \cdot \mathbf{n} = y = 1, \iint_{\sigma_4} (1) dA = 1,$

$\sigma_5 : z = 0, \mathbf{F} \cdot \mathbf{n} = -z = 0, \iint_{\sigma_5} (0) dA = 0,$ $\sigma_6 : z = 1, \mathbf{F} \cdot \mathbf{n} = z = 1, \iint_{\sigma_6} (1) dA = 1.$

$$\iint_{\sigma} \mathbf{F} \cdot \mathbf{n} = 3; \iiint_G \operatorname{div} \mathbf{F} dV = \iiint_G 3 dV = 3.$$

2. Let $\mathbf{r} = \sin u \cos v \mathbf{i} + \sin u \sin v \mathbf{j} + \cos u \mathbf{k}$, $\mathbf{r}_u \times \mathbf{r}_v = \sin^2 u \cos v \mathbf{i} + \sin^2 u \sin v \mathbf{j} + \sin u \cos u \mathbf{k}$, $\mathbf{F} \cdot (\mathbf{r}_u \times \mathbf{r}_v) = 5 \sin^2 u \sin v + 7 \sin u \cos u$,

$$\iint_{\sigma} \mathbf{F} \cdot \mathbf{n} dS = \int_0^{2\pi} \int_0^{\pi} 5 \sin^2 u \sin v + 7 \sin u \cos u du dv = 0; \quad \iiint_G \operatorname{div} \mathbf{F} dV = \iiint_G 0 dV = 0.$$

3. $\sigma_1 : z = 1, \mathbf{n} = \mathbf{k}, \mathbf{F} \cdot \mathbf{n} = z^2 = 1, \iint_{\sigma_1} (1) dS = \pi$, $\sigma_2 : \mathbf{n} = 2x\mathbf{i} + 2y\mathbf{j} - \mathbf{k}, \mathbf{F} \cdot \mathbf{n} = 4x^2 - 4x^2y^2 - x^4 -$

$$3y^4, \iint_{\sigma_2} \mathbf{F} \cdot \mathbf{n} dS = \int_0^{2\pi} \int_0^1 [4r^2 \cos^2 \theta - 4r^4 \cos^2 \theta \sin^2 \theta - r^4 \cos^4 \theta - 3r^4 \sin^4 \theta] r dr d\theta = \frac{\pi}{3};$$

$$\iint_{\sigma} \mathbf{F} \cdot \mathbf{n} dS = \frac{4\pi}{3}; \quad \iiint_G \operatorname{div} \mathbf{F} dV = \iiint_G (2+z) dV = \int_0^{2\pi} \int_0^1 \int_{r^2}^1 (2+z) dz r dr d\theta = 4\pi/3.$$

4. $\sigma_1 : x = 0, \mathbf{F} \cdot \mathbf{n} = -xy = 0, \iint_{\sigma_1} (0) dA = 0$, $\sigma_2 : x = 2, \mathbf{F} \cdot \mathbf{n} = xy = 2y, \iint_{\sigma_2} (2y) dA = 8$,

$$\sigma_3 : y = 0, \mathbf{F} \cdot \mathbf{n} = -yz = 0, \iint_{\sigma_3} (0) dA = 0, \quad \sigma_4 : y = 2, \mathbf{F} \cdot \mathbf{n} = yz = 2z, \iint_{\sigma_4} (2z) dA = 8,$$

$$\sigma_5 : z = 0, \mathbf{F} \cdot \mathbf{n} = -xz = 0, \iint_{\sigma_5} (0) dA = 0, \quad \sigma_6 : z = 2, \mathbf{F} \cdot \mathbf{n} = xz = 2x, \iint_{\sigma_6} (2x) dA = 8.$$

$$\iint_{\sigma} \mathbf{F} \cdot \mathbf{n} = 24; \quad \iiint_G \operatorname{div} \mathbf{F} dV = \iiint_G (y+z+x) dV = 24.$$

5. False, it equates a surface integral with a volume integral.

6. True, the integral of a positive function is positive.

7. True, see the subsection "Sources and Sinks".

8. False, see Theorem 15.7.2.

9. G is the rectangular solid; $\iiint_G \operatorname{div} \mathbf{F} dV = \int_0^2 \int_0^1 \int_0^3 (2x-1) dx dy dz = 12$.

10. G is the spherical solid enclosed by σ ; $\iiint_G \operatorname{div} \mathbf{F} dV = \iiint_G 0 dV = 0$, $\iiint_G dV = 0$.

11. G is the cylindrical solid; $\iiint_G \operatorname{div} \mathbf{F} dV = 3 \iiint_G dV = (3)(\text{volume of cylinder}) = (3)[\pi a^2(1)] = 3\pi a^2$.

12. G is the solid bounded by $z = 1-x^2-y^2$ and the xy -plane; $\iiint_G \operatorname{div} \mathbf{F} dV = 3 \iiint_G dV = 3 \int_0^{2\pi} \int_0^1 \int_0^{1-r^2} r dz dr d\theta = \frac{3\pi}{2}$.

13. G is the cylindrical solid; $\iiint_G \operatorname{div} \mathbf{F} dV = 3 \iiint_G (x^2 + y^2 + z^2) dV = 3 \int_0^{2\pi} \int_0^2 \int_0^3 (r^2 + z^2) r dz dr d\theta = 180\pi$.

14. G is the tetrahedron; $\iiint_G \operatorname{div} \mathbf{F} dV = \iiint_G x dV = \int_0^1 \int_0^{1-x} \int_0^{1-x-y} x dz dy dx = \frac{1}{24}$.

15. G is the hemispherical solid bounded by $z = \sqrt{4 - x^2 - y^2}$ and the xy -plane; $\iiint_G \operatorname{div} \mathbf{F} dV = 3 \iiint_G (x^2 + y^2 + z^2) dV = 3 \int_0^{2\pi} \int_0^{\pi/2} \int_0^2 \rho^4 \sin \phi d\rho d\phi d\theta = \frac{192\pi}{5}$.

16. G is the hemispherical solid; $\iiint_G \operatorname{div} \mathbf{F} dV = 5 \iiint_G z dV = 5 \int_0^{2\pi} \int_0^{\pi/2} \int_0^a \rho^3 \sin \phi \cos \phi d\rho d\phi d\theta = \frac{5\pi a^4}{4}$.

17. G is the conical solid; $\iiint_G \operatorname{div} \mathbf{F} dV = 2 \iiint_G (x + y + z) dV = 2 \int_0^{2\pi} \int_0^1 \int_r^1 (r \cos \theta + r \sin \theta + z) r dz dr d\theta = \frac{\pi}{2}$.

18. G is the solid bounded by $z = 2x$ and $z = x^2 + y^2$; $\iiint_G \operatorname{div} \mathbf{F} dV = \iiint_G dV = 2 \int_0^{\pi/2} \int_0^{2 \cos \theta} \int_{r^2}^{2r \cos \theta} r dz dr d\theta = \frac{\pi}{2}$.

19. From the examples we see that we need to integrate the divergence of the vector field over the whole volume. The former is $\operatorname{div} \mathbf{F} = 4x^2$. Finding the volume is more difficult. We are looking for all the points in the x - y plane that lie above the plane $z = 0$, and that lie i) underneath the surface $z = 4 - x^2$, (this surface passes through the parabola $z = 4 - x^2$ in the x - z plane and has no restriction on y); and ii) lie underneath the plane $z = 5 - y$ together with the condition $y \geq 0$. First we observe that $-2 \leq x \leq 2$. Given such a value of x , we note that $0 \leq y \leq 5$. Finally, $0 \leq z \leq \min(5 - y, 4 - x^2)$. And which is the minimum? We check the boundary, where one z equals the other z , i.e. $4 - x^2 = 5 - y$, or the parabola $y = x^2 + 1$ in the x - y plane. Thus

$$\iiint_G \operatorname{div} \mathbf{F} dV = 4 \iiint_G x^2 dV = \int_{-2}^2 \int_0^{1+x^2} \int_0^{4-x^2} 4x^2 dz dy dx + \int_{-2}^2 \int_{x^2+1}^5 \int_0^{5-y} 4x^2 dz dy dx = \frac{4608}{35}$$

20. $\iint_{\sigma} \mathbf{r} \cdot \mathbf{n} dS = \iiint_G \operatorname{div} \mathbf{r} dV = 3 \iiint_G dV = 3 \operatorname{vol}(G)$.

21. $\iint_{\sigma} \mathbf{F} \cdot \mathbf{n} dS = 3[\pi(3^2)(5)] = 135\pi$.

22. $\iint_{\sigma} \mathbf{F} \cdot \mathbf{n} dS = \iiint_G \operatorname{div} \mathbf{F} dV = \iiint_G 0 dV = 0$; since the vector field is constant, the same amount enters as leaves.

23. (a) $\mathbf{F} = x\mathbf{i} + y\mathbf{j} + z\mathbf{k}$, $\operatorname{div} \mathbf{F} = 3$. (b) $\mathbf{F} = -x\mathbf{i} - y\mathbf{j} - z\mathbf{k}$, $\operatorname{div} \mathbf{F} = -3$.

24. (a) The flux through any cylinder whose axis is the z -axis is positive by inspection; by the Divergence Theorem, this says that the divergence cannot be negative at the origin, else the flux through a small enough cylinder would also be negative (impossible), hence the divergence at the origin must be ≥ 0 .

(b) Similar to part (a), ≤ 0 .

25. $0 = \iiint_R \operatorname{div} \mathbf{F} dV = \iint_{\sigma} \mathbf{F} \cdot \mathbf{n} dS$. Let σ_1 denote that part of σ on which $\mathbf{F} \cdot \mathbf{n} > 0$ and let σ_2 denote the part

where $\mathbf{F} \cdot \mathbf{n} < 0$. If $\iint_{\sigma_1} \mathbf{F} \cdot \mathbf{n} > 0$ then the integral over σ_2 is negative (and equal in magnitude). Thus the boundary between σ_1 and σ_2 is infinite, hence \mathbf{F} and \mathbf{n} are perpendicular on an infinite set.

26. No; the argument in Exercise 25 rests on the assumption that $\mathbf{F} \cdot \mathbf{n}$ is continuous, which may not be true on a cube because the tangent jumps from one value to the next. Let $\phi(x, y, z) = xy + xz + yz + x + y + z$, so $\mathbf{F} = \nabla\phi = (y + z + 1)\mathbf{i} + (x + z + 1)\mathbf{j} + (x + y + 1)\mathbf{k}$. On each side of the cube we must show $\mathbf{F} \cdot \mathbf{n} \neq 0$. On the face where $x = 0$, for example, $\mathbf{F} \cdot \mathbf{n} = -(y + z + 1) \leq -1 < 0$, and on the face where $x = 1$, $\mathbf{F} \cdot \mathbf{n} = y + z + 1 \geq 1 > 0$. The other faces can be treated in a similar manner.

$$27. \iint_{\sigma} \text{curl } \mathbf{F} \cdot \mathbf{n} \, dS = \iiint_G \text{div}(\text{curl } \mathbf{F}) \, dV = \iiint_G (0) \, dV = 0.$$

$$28. \iint_{\sigma} \nabla f \cdot \mathbf{n} \, dS = \iiint_G \text{div}(\nabla f) \, dV = \iiint_G \nabla^2 f \, dV.$$

$$29. \iint_{\sigma} (f\nabla g) \cdot \mathbf{n} \, dS = \iiint_G \text{div}(f\nabla g) \, dV = \iiint_G (f\nabla^2 g + \nabla f \cdot \nabla g) \, dV \text{ by Exercise 31, Section 15.1.}$$

$$30. \iint_{\sigma} (f\nabla g) \cdot \mathbf{n} \, dS = \iiint_G (f\nabla^2 g + \nabla f \cdot \nabla g) \, dV \text{ by Exercise 29; } \iint_{\sigma} (g\nabla f) \cdot \mathbf{n} \, dS = \iiint_G (g\nabla^2 f + \nabla g \cdot \nabla f) \, dV \text{ by interchanging } f \text{ and } g; \text{ subtract to obtain the result.}$$

$$31. \text{ Since } \mathbf{v} \text{ is constant, } \nabla \cdot \mathbf{v} = \mathbf{0}. \text{ Let } \mathbf{F} = f\mathbf{v}; \text{ then } \text{div } \mathbf{F} = (\nabla f)\mathbf{v} \text{ and by the Divergence Theorem } \iint_{\sigma} f\mathbf{v} \cdot \mathbf{n} \, dS = \iiint_G \text{div } \mathbf{F} \, dV = \iiint_G (\nabla f) \cdot \mathbf{v} \, dV.$$

$$32. \text{ Let } \mathbf{r} = u\mathbf{i} + v\mathbf{j} + w\mathbf{k} \text{ so that, for } \mathbf{r} \neq \mathbf{0}, \mathbf{F}(x, y, z) = \mathbf{r}/\|\mathbf{r}\|^k = \frac{u}{(u^2 + v^2 + w^2)^{k/2}}\mathbf{i} + \frac{v}{(u^2 + v^2 + w^2)^{k/2}}\mathbf{j} + \frac{w}{(u^2 + v^2 + w^2)^{k/2}}\mathbf{k}. \text{ Now } \frac{\partial \mathbf{F}_1}{\partial u} = \frac{u^2 + v^2 + w^2 - ku^2}{(u^2 + v^2 + w^2)^{(k/2)+1}}; \text{ similarly for } \partial \mathbf{F}_2 / \partial v, \partial \mathbf{F}_3 / \partial w, \text{ so that}$$

$$\text{div } \mathbf{F} = \frac{3(u^2 + v^2 + w^2) - k(u^2 + v^2 + w^2)}{(u^2 + v^2 + w^2)^{(k/2)+1}} = 0 \text{ if and only if } k = 3.$$

33. $\text{div } \mathbf{F} = 0$; no sources or sinks.

34. $\text{div } \mathbf{F} = y - x$; sources where $y > x$, sinks where $y < x$.

35. $\text{div } \mathbf{F} = 3x^2 + 3y^2 + 3z^2$; sources at all points except the origin, no sinks.

36. $\text{div } \mathbf{F} = 3(x^2 + y^2 + z^2 - 1)$; sources outside the sphere $x^2 + y^2 + z^2 = 1$, sinks inside the sphere $x^2 + y^2 + z^2 = 1$.

37. Let σ_1 be the portion of the paraboloid $z = 1 - x^2 - y^2$ for $z \geq 0$, and σ_2 the portion of the plane $z = 0$ for $x^2 + y^2 \leq 1$.

$$\text{Then } \iint_{\sigma_1} \mathbf{F} \cdot \mathbf{n} \, dS = \iint_R \mathbf{F} \cdot (2x\mathbf{i} + 2y\mathbf{j} + \mathbf{k}) \, dA = \int_{-1}^1 \int_{-\sqrt{1-x^2}}^{\sqrt{1-x^2}} (2x[x^2y - (1 - x^2 - y^2)^2] + 2y(y^3 - x) + (2x + 2 - 3x^2 - 3y^2)) \, dy \, dx = 3\pi/4; z = 0 \text{ and } \mathbf{n} = -\mathbf{k} \text{ on } \sigma_2 \text{ so } \mathbf{F} \cdot \mathbf{n} = 1 - 2x, \iint_{\sigma_2} \mathbf{F} \cdot \mathbf{n} \, dS = \iint_{\sigma_2} (1 - 2x) \, dS = \pi. \text{ Thus}$$

$$\iint_{\sigma} \mathbf{F} \cdot \mathbf{n} \, dS = 3\pi/4 + \pi = 7\pi/4. \text{ But } \text{div } \mathbf{F} = 2xy + 3y^2 + 3, \text{ so } \iiint_G \text{div } \mathbf{F} \, dV = \int_{-1}^1 \int_{-\sqrt{1-x^2}}^{\sqrt{1-x^2}} \int_0^{1-x^2-y^2} (2xy + 3y^2 + 3) \, dz \, dy \, dx = 7\pi/4.$$

Exercise Set 15.8

- If σ is oriented with upward normals then C consists of three parts parametrized as $C_1 : \mathbf{r}(t) = (1-t)\mathbf{i} + t\mathbf{j}$ for $0 \leq t \leq 1$, $C_2 : \mathbf{r}(t) = (1-t)\mathbf{j} + t\mathbf{k}$ for $0 \leq t \leq 1$, $C_3 : \mathbf{r}(t) = t\mathbf{i} + (1-t)\mathbf{k}$ for $0 \leq t \leq 1$. $\int_{C_1} \mathbf{F} \cdot d\mathbf{r} = \int_{C_2} \mathbf{F} \cdot d\mathbf{r} = \int_{C_3} \mathbf{F} \cdot d\mathbf{r} = \int_0^1 (3t-1)dt = \frac{1}{2}$, so $\oint_C \mathbf{F} \cdot d\mathbf{r} = \frac{1}{2} + \frac{1}{2} + \frac{1}{2} = \frac{3}{2}$. $\text{curl } \mathbf{F} = \mathbf{i} + \mathbf{j} + \mathbf{k}$, $z = 1 - x - y$, R is the triangular region in the xy -plane enclosed by $x + y = 1$, $x = 0$, and $y = 0$; $\iint_{\sigma} (\text{curl } \mathbf{F}) \cdot \mathbf{n} dS = 3 \iint_R dA = (3)(\text{area of } R) = (3) \left[\frac{1}{2}(1)(1) \right] = \frac{3}{2}$.
- If σ is oriented with upward normals then C can be parametrized as $\mathbf{r}(t) = \cos t \mathbf{i} + \sin t \mathbf{j} + \mathbf{k}$ for $0 \leq t \leq 2\pi$. $\oint_C \mathbf{F} \cdot d\mathbf{r} = \int_0^{2\pi} (\sin^2 t \cos t - \cos^2 t \sin t) dt = 0$; $\text{curl } \mathbf{F} = \mathbf{0}$ so $\iint_{\sigma} (\text{curl } \mathbf{F}) \cdot \mathbf{n} dS = \iint_{\sigma} 0 dS = 0$.
- If σ is oriented with upward normals then C can be parametrized as $\mathbf{r}(t) = a \cos t \mathbf{i} + a \sin t \mathbf{j}$ for $0 \leq t \leq 2\pi$. $\oint_C \mathbf{F} \cdot d\mathbf{r} = \int_0^{2\pi} 0 dt = 0$; $\text{curl } \mathbf{F} = \mathbf{0}$ so $\iint_{\sigma} (\text{curl } \mathbf{F}) \cdot \mathbf{n} dS = \iint_{\sigma} 0 dS = 0$.
- If σ is oriented with upward normals then C can be parametrized as $\mathbf{r}(t) = 3 \cos t \mathbf{i} + 3 \sin t \mathbf{j}$ for $0 \leq t \leq 2\pi$. $\oint_C \mathbf{F} \cdot d\mathbf{r} = \int_0^{2\pi} (9 \sin^2 t + 9 \cos^2 t) dt = 9 \int_0^{2\pi} dt = 18\pi$. $\text{curl } \mathbf{F} = -2\mathbf{i} + 2\mathbf{j} + 2\mathbf{k}$, R is the circular region in the xy -plane enclosed by $x^2 + y^2 = 9$; $\iint_{\sigma} (\text{curl } \mathbf{F}) \cdot \mathbf{n} dS = \iint_R (-4x + 4y + 2) dA = \int_0^{2\pi} \int_0^3 (-4r \cos \theta + 4r \sin \theta + 2) r dr d\theta = 18\pi$.
- Take σ as the part of the plane $z = 0$ for $x^2 + y^2 \leq 1$ with $\mathbf{n} = \mathbf{k}$; $\text{curl } \mathbf{F} = -3y^2 \mathbf{i} + 2z \mathbf{j} + 2\mathbf{k}$, $\iint_{\sigma} (\text{curl } \mathbf{F}) \cdot \mathbf{n} dS = 2 \iint_{\sigma} dS = (2)(\text{area of circle}) = (2)[\pi(1)^2] = 2\pi$.
- $\text{curl } \mathbf{F} = x\mathbf{i} + (x-y)\mathbf{j} + 6xy^2\mathbf{k}$; $\iint_{\sigma} (\text{curl } \mathbf{F}) \cdot \mathbf{n} dS = \iint_R (x-y-6xy^2) dA = \int_0^1 \int_0^3 (x-y-6xy^2) dy dx = -30$.
- C is the boundary of R and $\text{curl } \mathbf{F} = 2\mathbf{i} + 3\mathbf{j} + 4\mathbf{k}$, so $\oint_C \mathbf{F} \cdot d\mathbf{r} = \iint_R \text{curl } \mathbf{F} \cdot \mathbf{n} dS = \iint_R 4x + 6y + 4 dA = 4(\text{area of } R) = 16\pi$.
- $\text{curl } \mathbf{F} = -4\mathbf{i} - 6\mathbf{j} + 6y\mathbf{k}$, $z = y/2$ oriented with upward normals, R is the triangular region in the xy -plane enclosed by $x + y = 2$, $x = 0$, and $y = 0$; $\iint_{\sigma} (\text{curl } \mathbf{F}) \cdot \mathbf{n} dS = \iint_R (3 + 6y) dA = \int_0^2 \int_0^{2-x} (3 + 6y) dy dx = 14$.
- $\text{curl } \mathbf{F} = x\mathbf{k}$, take σ as part of the plane $z = y$ oriented with upward normals, R is the circular region in the xy -plane enclosed by $x^2 + y^2 - y = 0$; $\iint_{\sigma} (\text{curl } \mathbf{F}) \cdot \mathbf{n} dS = \iint_R x dA = \int_0^{\pi} \int_0^{\sin \theta} r^2 \cos \theta dr d\theta = 0$.
- $\text{curl } \mathbf{F} = -y\mathbf{i} - z\mathbf{j} - x\mathbf{k}$, $z = 1 - x - y$ oriented with upward normals, R is the triangular region in the xy -plane

enclosed by $x + y = 1$, $x = 0$ and $y = 0$; $\iint_{\sigma} (\text{curl } \mathbf{F}) \cdot \mathbf{n} dS = \iint_R (-y - z - x) dA = - \iint_R dA = -\frac{1}{2}(1)(1) = -\frac{1}{2}$.

11. $\text{curl } \mathbf{F} = \mathbf{i} + \mathbf{j} + \mathbf{k}$, take σ as the part of the plane $z = 0$ with $x^2 + y^2 \leq a^2$ and $\mathbf{n} = \mathbf{k}$; $\iint_{\sigma} (\text{curl } \mathbf{F}) \cdot \mathbf{n} dS = \iint_{\sigma} dS = \text{area of circle} = \pi a^2$.

12. $\text{curl } \mathbf{F} = \mathbf{i} + \mathbf{j} + \mathbf{k}$, take σ as the part of the plane $z = 1/\sqrt{2}$ with $x^2 + y^2 \leq 1/2$ and $\mathbf{n} = \mathbf{k}$; $\iint_{\sigma} (\text{curl } \mathbf{F}) \cdot \mathbf{n} dS = \iint_{\sigma} dS = \text{area of circle} = \frac{\pi}{2}$.

13. True, Theorem 15.8.1.

14. False, Green's Theorem is a special case of Stokes's Theorem.

15. False, the circulation is $\int_C \mathbf{F} \cdot \mathbf{T} ds$.

16. True, Theorem 15.8.1.

17. (a) Take σ as the part of the plane $2x + y + 2z = 2$ in the first octant, oriented with downward normals; $\text{curl } \mathbf{F} = -x\mathbf{i} + (y-1)\mathbf{j} - \mathbf{k}$, $\oint_C \mathbf{F} \cdot \mathbf{T} ds = \iint_{\sigma} (\text{curl } \mathbf{F}) \cdot \mathbf{n} dS = \iint_R \left(x - \frac{1}{2}y + \frac{3}{2}\right) dA = \int_0^1 \int_0^{2-2x} \left(x - \frac{1}{2}y + \frac{3}{2}\right) dy dx = \frac{3}{2}$.

(b) At the origin $\text{curl } \mathbf{F} = -\mathbf{j} - \mathbf{k}$ and with $\mathbf{n} = \mathbf{k}$, $\text{curl } \mathbf{F}(0, 0, 0) \cdot \mathbf{n} = (-\mathbf{j} - \mathbf{k}) \cdot \mathbf{k} = -1$.

(c) The rotation of \mathbf{F} has its maximum value at the origin about the unit vector in the same direction as $\text{curl } \mathbf{F}(0, 0, 0)$ so $\mathbf{n} = -\frac{1}{\sqrt{2}}\mathbf{j} - \frac{1}{\sqrt{2}}\mathbf{k}$.

18. (a) Using the hint, the orientation of the curve C with respect to the surface σ_1 is the opposite of the orientation of C with respect to the surface σ_2 . Thus in the expressions $\iint_{\sigma_1} (\text{curl } \mathbf{F}) \cdot \mathbf{n} dS = \int_C \mathbf{F} \cdot \mathbf{T} dS$ and $\iint_{\sigma_2} (\text{curl } \mathbf{F}) \cdot \mathbf{n} dS = \oint_C \mathbf{F} \cdot \mathbf{T} dS$, the two line integrals have oppositely oriented tangents \mathbf{T} . Hence $\iint_{\sigma} (\text{curl } \mathbf{F}) \cdot \mathbf{n} dS = \iint_{\sigma_1} (\text{curl } \mathbf{F}) \cdot \mathbf{n} dS + \iint_{\sigma_2} (\text{curl } \mathbf{F}) \cdot \mathbf{n} dS = 0$.

(b) The flux of the curl field through the boundary of a solid is zero.

19. (a) The flow is independent of z and has no component in the direction of \mathbf{k} , and so by inspection the only nonzero component of the curl is in the direction of \mathbf{k} . However both sides of (9) are zero, as the flow is orthogonal to the curve C_a . Thus the curl is zero.

(b) Since the flow appears to be tangential to the curve C_a , it seems that the right hand side of (9) is nonzero, and thus the curl is nonzero, and points in the positive z -direction.

20. (a) The only nonzero vector component of the vector field is in the direction of \mathbf{i} , and it increases with y and is independent of x . Thus the curl of F is nonzero, and points in the positive z -direction. Alternatively, let $\mathbf{F} = f\mathbf{i}$, and let C be the circle of radius ϵ with positive orientation. Then $\mathbf{T} = -\sin\theta\mathbf{i} + \cos\theta\mathbf{j}$, and $\oint_C \mathbf{F} \cdot \mathbf{T} ds = -\epsilon \int_0^{2\pi} f(\epsilon, \theta) \sin\theta d\theta = -\epsilon \int_0^\pi f(\epsilon, \theta) \sin\theta d\theta - \epsilon \int_{-\pi}^0 f(\epsilon, \theta) \sin\theta d\theta = -\epsilon \int_0^\pi (f(\epsilon, \theta) - f(\epsilon, -\theta)) \sin\theta d\theta < 0$, because from the picture $f(\epsilon, \theta) > f(\epsilon, -\theta)$ for $0 < \theta < \pi$. Thus, from (9), the curl is nonzero and points in the negative z -direction.

(b) By inspection the vector field is constant, and thus its curl is zero.

21. Since \mathbf{F} is conservative, if C is any closed curve then $\int_C \mathbf{F} \cdot d\mathbf{r} = 0$. But $\int_C \mathbf{F} \cdot d\mathbf{r} = \int_C \mathbf{F} \cdot \mathbf{T} ds$ from (30) of Section 15.2. In equation (9) the direction of \mathbf{n} is arbitrary, so for any fixed curve C_a the integral $\int_{C_a} \mathbf{F} \cdot \mathbf{T} ds = 0$. Thus $\text{curl } \mathbf{F}(P_0) \cdot \mathbf{n} = 0$. But \mathbf{n} is arbitrary, so we conclude that $\text{curl } \mathbf{F} = \mathbf{0}$.

22. Since $\oint_C \mathbf{E} \cdot \mathbf{r} d\mathbf{r} = \iint_\sigma \text{curl } \mathbf{E} \cdot \mathbf{n} dS$, it follows that $\iint_\sigma \text{curl } \mathbf{E} \cdot \mathbf{n} dS = -\iint_\sigma \frac{\partial \mathbf{B}}{\partial t} \cdot \mathbf{n} dS$. This relationship holds for any surface σ , hence $\text{curl } \mathbf{E} = -\frac{\partial \mathbf{B}}{\partial t}$.

23. Parametrize C by $x = \cos t, y = \sin t, 0 \leq t \leq 2\pi$. But $\mathbf{F} = x^2y\mathbf{i} + (y^3 - x)\mathbf{j} + (2x - 1)\mathbf{k}$ along C so $\oint_C \mathbf{F} \cdot d\mathbf{r} = -5\pi/4$. Since $\text{curl } \mathbf{F} = (-2z - 2)\mathbf{j} + (-1 - x^2)\mathbf{k}$, $\iint_\sigma (\text{curl } \mathbf{F}) \cdot \mathbf{n} dS = \iint_R (\text{curl } \mathbf{F}) \cdot (2x\mathbf{i} + 2y\mathbf{j} + \mathbf{k}) dA = \int_{-1}^1 \int_{-\sqrt{1-x^2}}^{\sqrt{1-x^2}} [2y(2x^2 + 2y^2 - 4) - 1 - x^2] dy dx = -5\pi/4$.

Chapter 15 Review Exercises

2. (b) $c \frac{\mathbf{r} - \mathbf{r}_0}{\|\mathbf{r} - \mathbf{r}_0\|^3}$. (c) $c \frac{(x - x_0)\mathbf{i} + (y - y_0)\mathbf{j} + (z - z_0)\mathbf{k}}{\sqrt{(x - x_0)^2 + (y - y_0)^2 + (z - z_0)^2}}$

3. $\mathbf{v} = (1 - x)\mathbf{i} + (2 - y)\mathbf{j}$, $\|\mathbf{v}\| = \sqrt{(1 - x)^2 + (2 - y)^2}$, $\mathbf{u} = \frac{1}{\|\mathbf{v}\|} \mathbf{v} = \frac{1 - x}{\sqrt{(1 - x)^2 + (2 - y)^2}} \mathbf{i} + \frac{2 - y}{\sqrt{(1 - x)^2 + (2 - y)^2}} \mathbf{j}$.

4. $\frac{-2y}{(x - y)^2} \mathbf{i} + \frac{2x}{(x - y)^2} \mathbf{j}$.

5. $\mathbf{i} + \mathbf{j} + \mathbf{k}$.

6. $\text{div } \mathbf{F} = \frac{y^2 - x^2}{(x^2 + y^2)^2} + \frac{x^2 - y^2}{(x^2 + y^2)^2} + \frac{1}{(x^2 + y^2)} = \frac{1}{x^2 + y^2}$, the level surface of $\text{div } \mathbf{F} = 1$ is the cylinder about the z -axis of radius 1.

7. (a) $\int_a^b \left[f(x(t), y(t)) \frac{dx}{dt} + g(x(t), y(t)) \frac{dy}{dt} \right] dt$. (b) $\int_a^b f(x(t), y(t)) \sqrt{x'(t)^2 + y'(t)^2} dt$.

8. (a) $M = \int_C \delta(x, y, z) ds$. (b) $L = \int_C ds$.

11. $s = \theta, x = \cos \theta, y = \sin \theta, \int_0^{2\pi} (\cos \theta - \sin \theta) d\theta = 0$, also follows from odd function rule.

$$12. \int_0^{2\pi} [\cos t(-\sin t) + t \cos t - 2 \sin^2 t] dt = 0 + 0 - 2\pi = -2\pi.$$

$$13. \int_1^2 \left(\frac{t}{2t} - 2\frac{2t}{t} \right) dt = \int_1^2 \left(-\frac{7}{2} \right) dt = -\frac{7}{2}.$$

$$14. \mathbf{r}(t) = t\mathbf{i} + t^2\mathbf{j}, W = \int_C \mathbf{F} \cdot \mathbf{r} = \int_0^1 [(t^2)^2 + t(t^2)(2t)] dt = \frac{3}{5}.$$

$$16. \text{By the Fundamental Theorem of Line Integrals, } \int_C \nabla f \cdot d\mathbf{r} = f(1, 2, -1) - f(0, 0, 0) = -4.$$

$$17. \text{(a) If } h(x)\mathbf{F} \text{ is conservative, then } \frac{\partial}{\partial y}(yh(x)) = \frac{\partial}{\partial x}(-2xh(x)), \text{ or } h(x) = -2h(x) - 2xh'(x) \text{ which has the general solution } x^3h(x)^2 = C_1, h(x) = Cx^{-3/2}, \text{ so } C\frac{y}{x^{3/2}}\mathbf{i} - C\frac{2}{x^{1/2}}\mathbf{j} \text{ is conservative, with potential function } \phi = -2Cy/\sqrt{x}.$$

$$\text{(b) If } g(y)\mathbf{F}(x, y) \text{ is conservative then } \frac{\partial}{\partial y}(yg(y)) = \frac{\partial}{\partial x}(-2xg(y)), \text{ or } g(y) + yg'(y) = -2g(y), \text{ with general solution } g(y) = C/y^3, \text{ so } \mathbf{F} = C\frac{1}{y^2}\mathbf{i} - C\frac{2x}{y^3}\mathbf{j} \text{ is conservative, with potential function } Cx/y^2.$$

$$18. \text{(a) } f_y - g_x = e^{xy} + xye^{xy} - e^{xy} - xye^{xy} = 0 \text{ so the vector field is conservative.}$$

$$\text{(b) } \phi_x = ye^{xy} - 1, \phi = e^{xy} - x + k(x), \phi_y = xe^{xy}, \text{ let } k(x) = 0; \phi(x, y) = e^{xy} - x.$$

$$\text{(c) } W = \int_C \mathbf{F} \cdot d\mathbf{r} = \phi(x(8\pi), y(8\pi)) - \phi(x(0), y(0)) = \phi(8\pi, 0) - \phi(0, 0) = -8\pi.$$

$$21. \text{Let } O \text{ be the origin, } P \text{ the point with polar coordinates } \theta = \alpha, r = f(\alpha), \text{ and } Q \text{ the point with polar coordinates } \theta = \beta, r = f(\beta). \text{ Let } C_1 : O \text{ to } P; x = t \cos \alpha, y = t \sin \alpha, 0 \leq t \leq f(\alpha), -y \frac{dx}{dt} + x \frac{dy}{dt} = 0; C_2 : P \text{ to } Q; x = f(t) \cos t, y = f(t) \sin t, \alpha \leq \theta \leq \beta, -y \frac{dx}{dt} + x \frac{dy}{dt} = f(t)^2; C_3 : Q \text{ to } O; x = -t \cos \beta, y = -t \sin \beta, -f(\beta) \leq t \leq 0, -y \frac{dx}{dt} + x \frac{dy}{dt} = 0. A = \frac{1}{2} \oint_C -y dx + x dy = \frac{1}{2} \int_{\alpha}^{\beta} f(t)^2 dt; \text{ set } t = \theta \text{ and } r = f(\theta) = f(t), A = \frac{1}{2} \int_{\alpha}^{\beta} r^2 d\theta.$$

$$22. \text{(a) } \int_C f(x) dx + g(y) dy = \iint_R \left(\frac{\partial}{\partial x} g(y) - \frac{\partial}{\partial y} f(x) \right) dA = 0.$$

$$\text{(b) } W = \int_C \mathbf{F} \cdot d\mathbf{r} = \int_C f(x) dx + g(y) dy = 0, \text{ so the work done by the vector field around any simple closed curve is zero. The field is conservative.}$$

$$23. \iint_{\sigma} f(x, y, z) dS = \iint_R f(x(u, v), y(u, v), z(u, v)) \|\mathbf{r}_u \times \mathbf{r}_v\| du dv.$$

$$24. \text{Cylindrical coordinates } \mathbf{r}(\theta, z) = \cos \theta \mathbf{i} + \sin \theta \mathbf{j} + z \mathbf{k}, 0 \leq \theta \leq 2\pi, 0 \leq z \leq 1, \mathbf{r}_{\theta} = -\sin \theta \mathbf{i} + \cos \theta \mathbf{j}, \mathbf{r}_z = \mathbf{k}, \|\mathbf{r}_{\theta} \times \mathbf{r}_z\| = \|\mathbf{r}_{\theta}\| \|\mathbf{r}_z\| \sin(\pi/2) = 1; \text{ by Theorem 15.5.1, } \iint_{\sigma} z dS = \int_0^{2\pi} \int_0^1 z dz d\theta = \pi.$$

25. Yes; by imagining a normal vector sliding around the surface it is evident that the surface has two sides.

$$27. \mathbf{r} = x\mathbf{i} + y\mathbf{j} + (1 - x^2 - y^2)\mathbf{k}, \mathbf{r}_x \times \mathbf{r}_y = 2x\mathbf{i} + 2y\mathbf{j} + \mathbf{k}, \mathbf{F} = x\mathbf{i} + y\mathbf{j} + 2z\mathbf{k}, \Phi = \iint_R \mathbf{F} \cdot (\mathbf{r}_x \times \mathbf{r}_y) dA = \iint_R (2x^2 + 2y^2 + 2(1 - x^2 - y^2)) dA = 2A = 2\pi.$$

$$28. \mathbf{r} = \sin \phi \cos \theta \mathbf{i} + \sin \phi \sin \theta \mathbf{j} + \cos \phi \mathbf{k}, \frac{\partial \mathbf{r}}{\partial \phi} \times \frac{\partial \mathbf{r}}{\partial \theta} = \sin^2 \phi \cos \theta \mathbf{i} + \sin^2 \phi \sin \theta \mathbf{j} + \sin \phi \cos \phi \mathbf{k}, \Phi = \iint_{\sigma} \mathbf{F} \cdot \left(\frac{\partial \mathbf{r}}{\partial \phi} \times \frac{\partial \mathbf{r}}{\partial \theta} \right) dA = \int_0^{2\pi} \int_0^{\pi} (\sin^3 \phi \cos^2 \theta + 2 \sin^3 \phi \sin^2 \theta + 3 \sin \phi \cos^2 \phi) d\phi d\theta = 8\pi. \text{ We can also obtain this result by the Divergence Theorem, simply by multiplying 6 (the constant divergence of the vector field) with } 4\pi/3 \text{ (the volume of the unit sphere).}$$

$$30. D_{\mathbf{n}}\phi = \mathbf{n} \cdot \nabla \phi, \text{ so } \iint_{\sigma} D_{\mathbf{n}}\phi dS = \iint_{\sigma} \mathbf{n} \cdot \nabla \phi dS = \iiint_G \nabla \cdot (\nabla \phi) dV = \iiint_G \left[\frac{\partial^2 \phi}{\partial x^2} + \frac{\partial^2 \phi}{\partial y^2} + \frac{\partial^2 \phi}{\partial z^2} \right] dV.$$

$$31. \text{ By Exercise 30, } \iint_{\sigma} D_{\mathbf{n}}f dS = - \iiint_G [f_{xx} + f_{yy} + f_{zz}] dV = -6 \iiint_G dV = -6 \text{vol}(G) = -8\pi.$$

$$32. C \text{ is defined by } \mathbf{r}(\theta) = \cos \theta \mathbf{i} + \sin \theta \mathbf{j} + \mathbf{k}, 0 \leq \theta \leq 2\pi, \mathbf{r}'(\theta) = -\sin \theta \mathbf{i} + \cos \theta \mathbf{j}, \mathbf{T} = -\sin \theta \mathbf{i} + \cos \theta \mathbf{j}. \text{ By Stokes' Theorem } \iint_{\sigma} (\text{curl } \mathbf{F}) \cdot \mathbf{n} dS = \int_C \mathbf{F} \cdot \mathbf{T} ds = \int_0^{2\pi} -\sin \theta (1 - \sin \theta) + \cos \theta (\cos \theta + 1) d\theta = 2\pi.$$

33. A computation of $\text{curl } \mathbf{F}$ shows that $\text{curl } \mathbf{F} = \mathbf{0}$ if and only if the three given equations hold. Moreover the equations hold if \mathbf{F} is conservative, so it remains to show that \mathbf{F} is conservative if $\text{curl } \mathbf{F} = \mathbf{0}$. Let C be any simple closed curve in the region. Since the region is simply connected, there is a piecewise smooth, oriented surface σ in the region with boundary C . By Stokes' Theorem, $\oint_C \mathbf{F} \cdot d\mathbf{r} = \iint_{\sigma} (\text{curl } \mathbf{F}) \cdot \mathbf{n} dS = \iint_{\sigma} 0 dS = 0$. By the 3-space analog of Theorem 15.3.2, \mathbf{F} is conservative.

$$34. \text{ (a) Conservative, } \phi(x, y, z) = xz^2 - e^{-y}. \quad \text{(b) Not conservative, } f_y \neq g_x.$$

$$35. \text{ (a) Conservative, } \phi(x, y, z) = -\cos x + yz. \quad \text{(b) Not conservative, } f_z \neq h_x.$$

$$36. \text{ (a) } \mathbf{F}(x, y, z) = \frac{qQ(x\mathbf{i} + y\mathbf{j} + z\mathbf{k})}{4\pi\epsilon_0(x^2 + y^2 + z^2)^{3/2}}.$$

$$\text{(b) } \mathbf{F} = \nabla \phi, \text{ where } \phi = -\frac{qQ}{4\pi\epsilon_0(x^2 + y^2 + z^2)^{1/2}}, \text{ so } W = \phi(3, 1, 5) - \phi(3, 0, 0) = \frac{qQ}{4\pi\epsilon_0} \left(\frac{1}{3} - \frac{1}{\sqrt{35}} \right).$$

Chapter 15 Making Connections

1. Using Newton's Second Law of Motion followed by Theorem 12.6.2 we have $\text{Work} = \int_C \mathbf{F} \cdot \mathbf{T} ds = \int_C m \mathbf{a} \cdot \mathbf{T} ds = m \int_C \left[\frac{d^2 s}{dt^2} \mathbf{T} + \kappa \left(\frac{ds}{dt} \right)^2 \mathbf{N} \right] \cdot \mathbf{T} ds$. But $\mathbf{N} \cdot \mathbf{T} = 0$ and $v = \frac{ds}{dt}$ so $\int_C \mathbf{F} \cdot \mathbf{T} ds = m \int_C \frac{d^2 s}{dt^2} ds = m \int_C \left(\frac{dv}{dt} \right) ds = m \int_a^b v(t) \left(\frac{dv}{dt} \right) dt = m \int_a^b \frac{d}{dt} \left(\frac{1}{2} (v(t))^2 \right) dt = \frac{1}{2} m [v(b)]^2 - \frac{1}{2} m [v(a)]^2$, which is the change in kinetic energy of the particle.

2. Work performed with a 'constrained' motion and under the influence of \mathbf{F} is equal to $\int_C (\mathbf{F} + \mathbf{S}) \cdot d\mathbf{r} = \int_C \mathbf{F} \cdot d\mathbf{r} =$

$\int_C \mathbf{F} \cdot \mathbf{T} ds$, because $\int_C \mathbf{S} \cdot d\mathbf{r} = 0$ by normality of \mathbf{S} and C . Now proceed as in Exercise 1.

3. $\int_C \mathbf{F} \cdot d\mathbf{r} = \int_{t_0}^{t_1} \nabla \phi(x, y, z) \cdot \langle x'(t), y'(t), z'(t) \rangle dt = \phi(x(t_1), y(t_1), z(t_1)) - \phi(x(t_0), y(t_0), z(t_0))$, which is the change in potential energy of the particle, or the negative of the kinetic energy of the particle. Note that we have used Theorem 15.3.3. For constrained motions the following calculations apply: $\text{work} = \int_C (\mathbf{F} + \mathbf{S}) \cdot d\mathbf{r} = \int_C \mathbf{F} \cdot d\mathbf{r}$ and continue as before.

4. The equation of motion can be expressed with $\mathbf{r}(t) = x(t)\mathbf{i} + y(t)\mathbf{j}$, with $x''(t) = 0, y''(t) = -g$. Integrating, we get (recall child starts at rest, so $(x(0), y(0)) = (x_0, y_0), (x'(0), y'(0)) = (0, 0)$), $\mathbf{r}'(t) = -gt\mathbf{j}, \mathbf{r}(t) = x_0\mathbf{i} + (y_0 - gt^2/2)\mathbf{j}$. So the motion ends when $y_0 = gt^2/2, t = \sqrt{2y_0/g}$. Finally, from the picture $y_0 = \ell \sin \theta$, so $t = \sqrt{2\ell \sin \theta/g}, v = gt = \sqrt{2g\ell \sin \theta}$.

Graphing Functions Using Calculators and Computer Algebra Systems

Exercise Set A

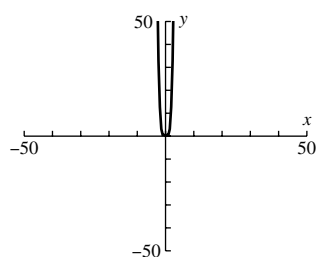

1. (a)

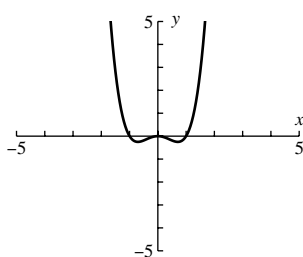

(b)

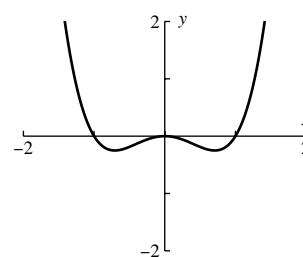

(c)

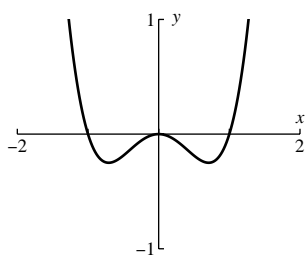

(d)

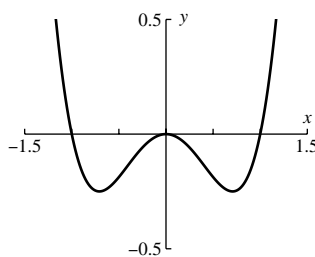

(e)

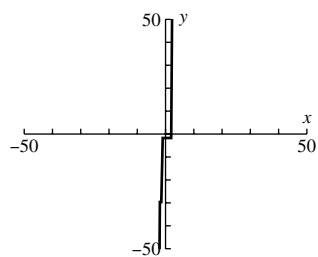

2. (a)

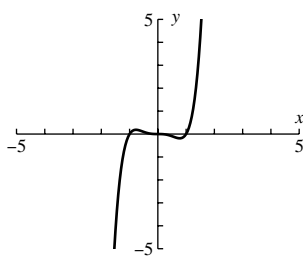

(b)

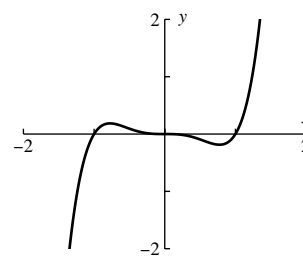

(c)

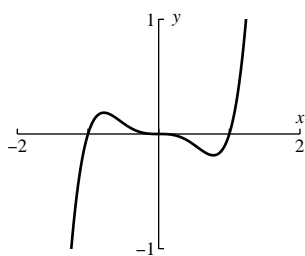

(d)

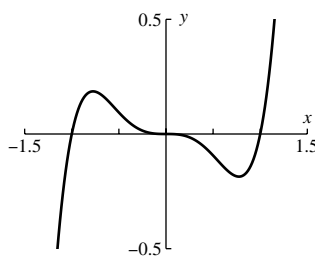

(e)

3. (a) Only two points of the graph, $(-1, 13)$ and $(1, 13)$, are in the window.

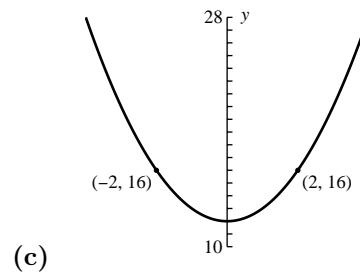
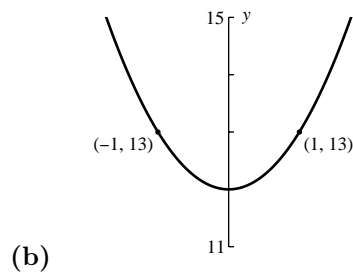
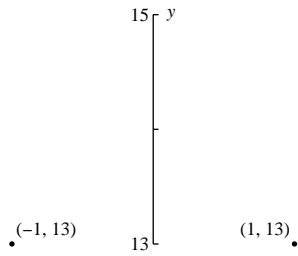

(d) This graph uses the window $[-4, 4] \times [-4, 28]$.

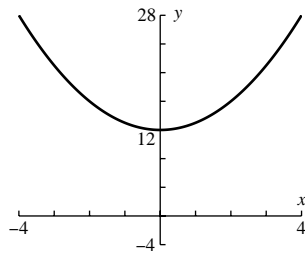

4. (a) Only two points of the graph, $(-1, -13)$ and $(1, -13)$, are in the window.

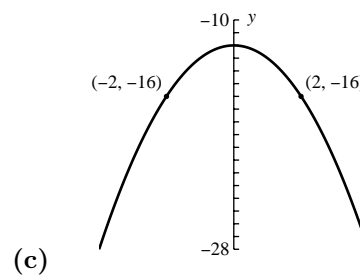
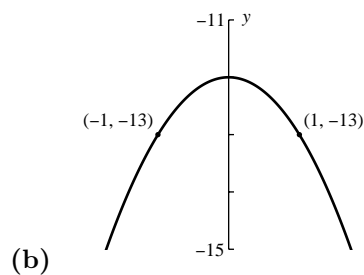
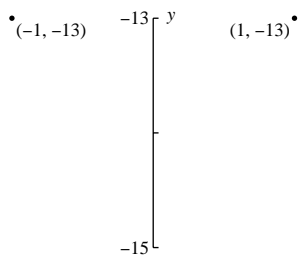

(d) This graph uses the window $[-4, 4] \times [-28, 4]$.

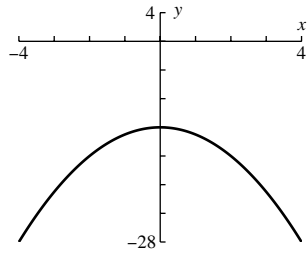

5. The domain is $[-\sqrt{8}, \sqrt{8}]$ and the range is $[0, 4]$. The graph below uses the window $[-3, 3] \times [-1, 5]$.

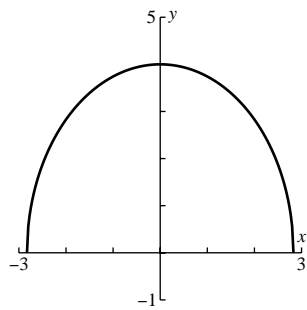

6. The domain is $[-3, 1]$ and the range is $[0, 2]$. The graph below uses the window $[-3.5, 1.5] \times [-.5, 2.5]$.

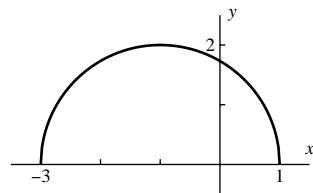

7.

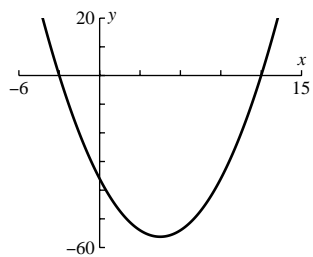

8.

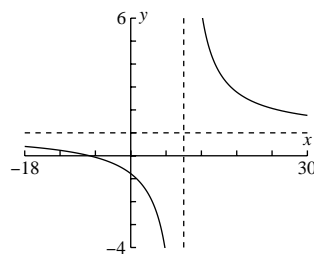

9.

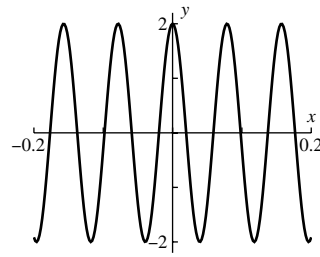

10.

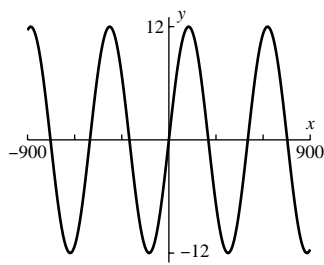

11.

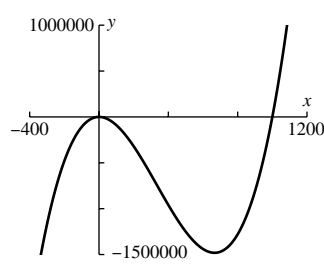

12.

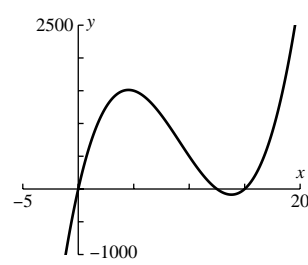

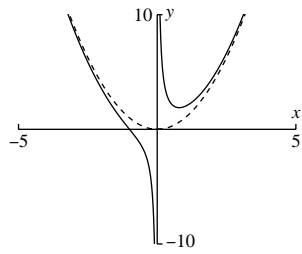

13.

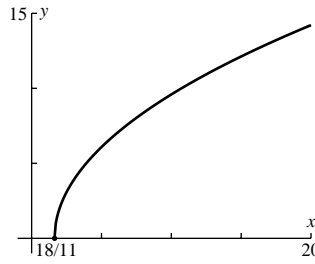

14.

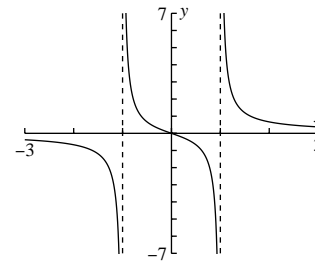

15.

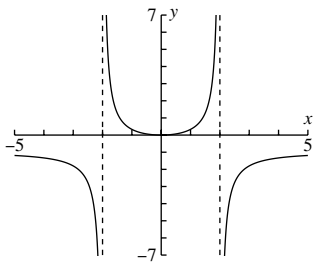

16.

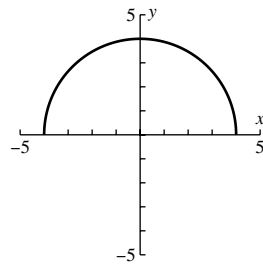

17. (a) $f(x) = \sqrt{16 - x^2}$

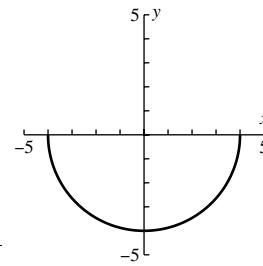

(b) $f(x) = -\sqrt{16 - x^2}$

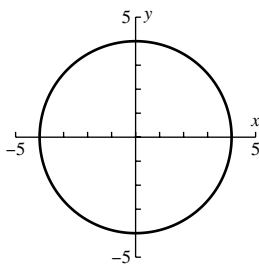

(c)

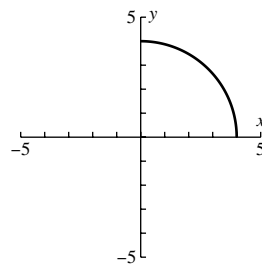

(d)

(e) No; it fails the vertical line test.

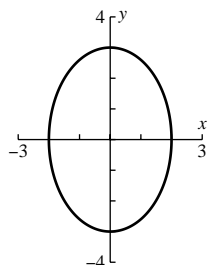

18. (a) $y = \pm \frac{3}{2} \sqrt{4 - x^2}$

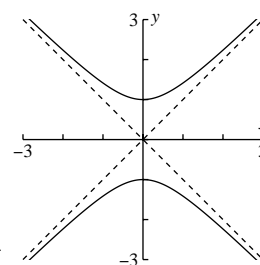

(b) $y = \pm \sqrt{x^2 + 1}$

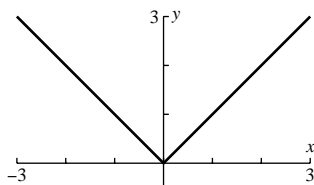

19. (a)

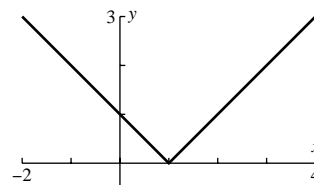

(b)

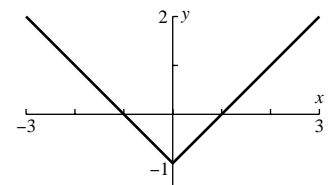

(c)

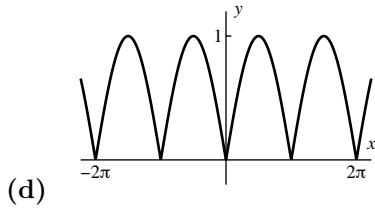

(d)

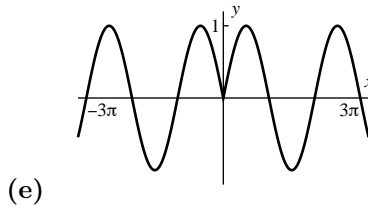

(e)

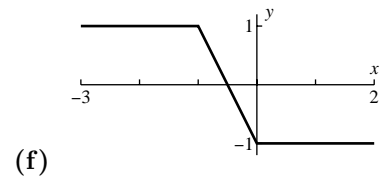

(f)

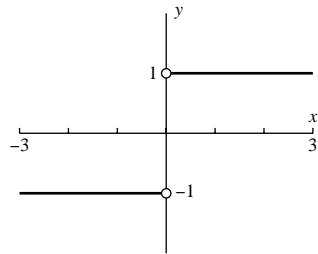

20.

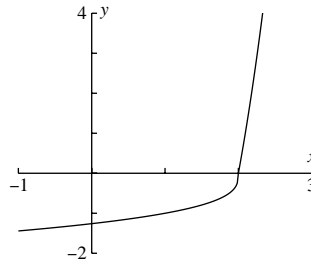

21.

22. It is difficult to show all parts of the function in one window, so 3 different views are shown below:

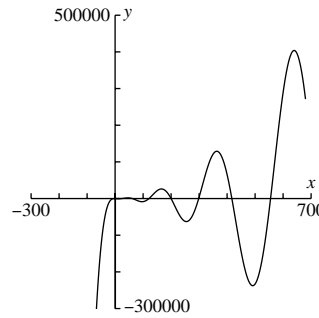
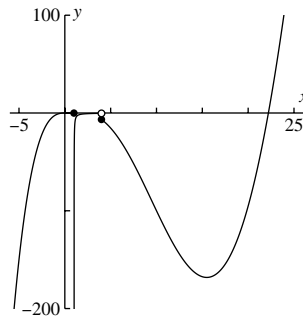
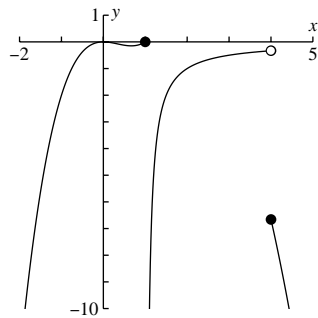

23. (a) The two graphs should be identical:

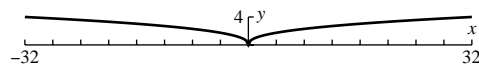

(b) The two graphs should be identical:

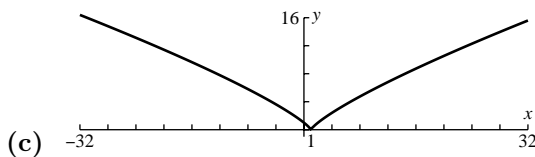
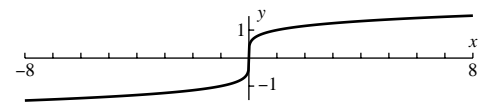

(c)

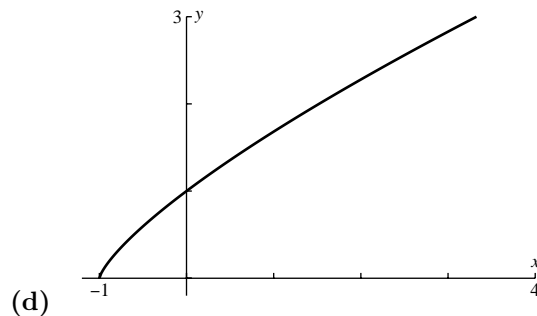

(d)

24. The graph is shown below. If your calculator leaves out the middle part of the graph of $y = (x^2 - 4)^{2/3}$, it is because it is rounding off the exponent $2/3$ to some value with an even denominator. Suppose, for example, that a calculator rounds $2/3$ to $0.66667 = 66667/100000$. For x between -2 and 2 , $x^2 - 4$ is negative, and so $y = (x^2 - 4)^{66667/100000}$ is not defined.

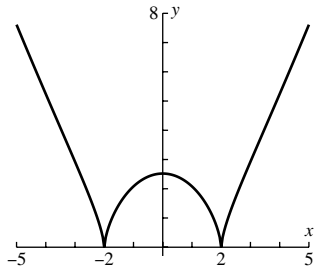

25. (a) Positive values of c make the parabola open upward; negative values make it open downward. Large values (positive or negative) make it pointier.

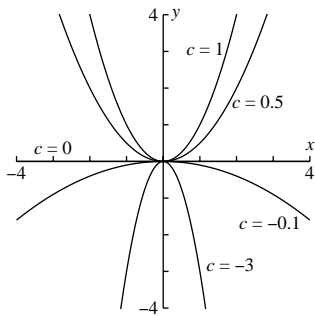

- (b) The parabola keeps the same shape, but its vertex is moved to $(-c/2, -c^2/4)$.

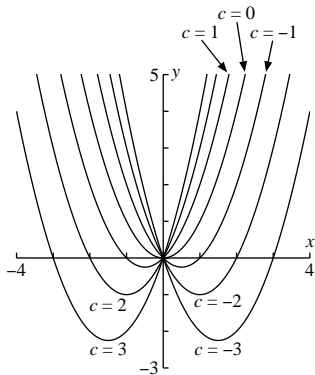

- (c) The parabola keeps the same shape, but is translated vertically.

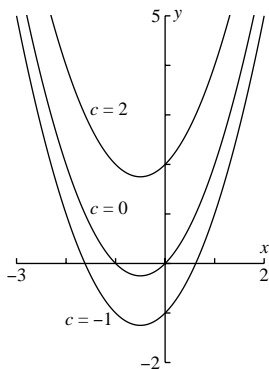

26. (a) $y = \sqrt{x(x-1)(x-2)}$ or $y = -\sqrt{x(x-1)(x-2)}$. The graph is the first one shown in part (b).

(b) Whenever $0 < a < b$, the graph consists of a finite loop with $0 \leq x \leq a$ and an infinite part with $x \geq b$. If we multiply both a and b by a positive number s , then the new graph is obtained from the original by expanding

it horizontally by a factor of s and vertically by a factor of $s^{3/2}$. To see this, let $f(x) = \pm\sqrt{x(x-a)(x-b)}$ and $g(x) = \pm\sqrt{x(x-as)(x-bs)}$; then $g(x) = \pm\sqrt{s^3 \frac{x}{s} (\frac{x}{s} - a) (\frac{x}{s} - b)} = s^{3/2} f(\frac{x}{s})$. (For example, compare the graphs below for $a = 1, b = 2$ and for $a = 4, b = 8$.) So the shape of the graph is mainly determined by the ratio b/a . When b/a is large, the loop is almost symmetrical across the line $x = a/2$, and is approximately an ellipse. When b/a is slightly larger than 1, the loop is not symmetric across a vertical line, and has almost a corner at $x = a$, where it almost touches the infinite piece of the graph.

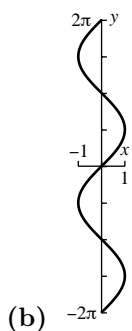
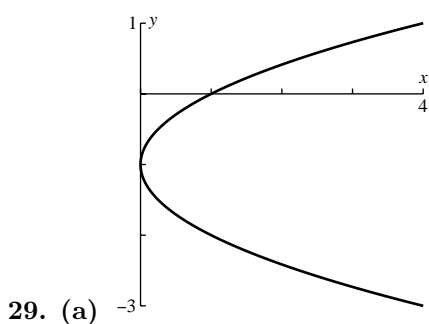
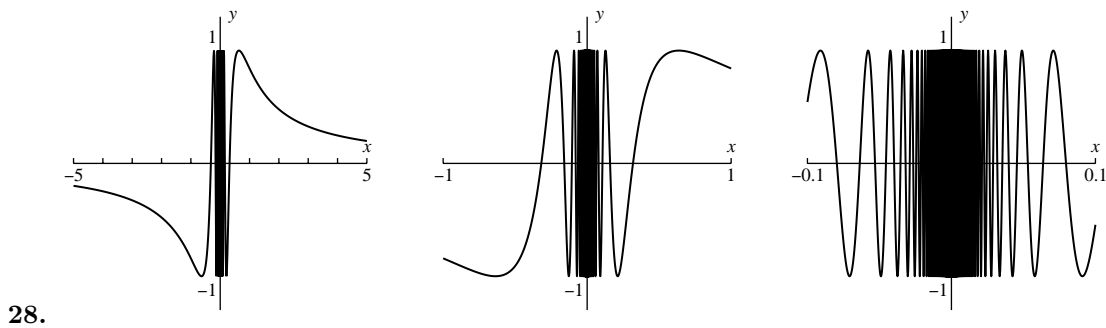
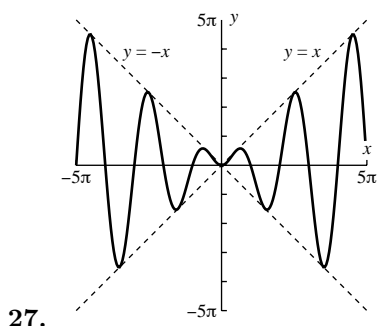
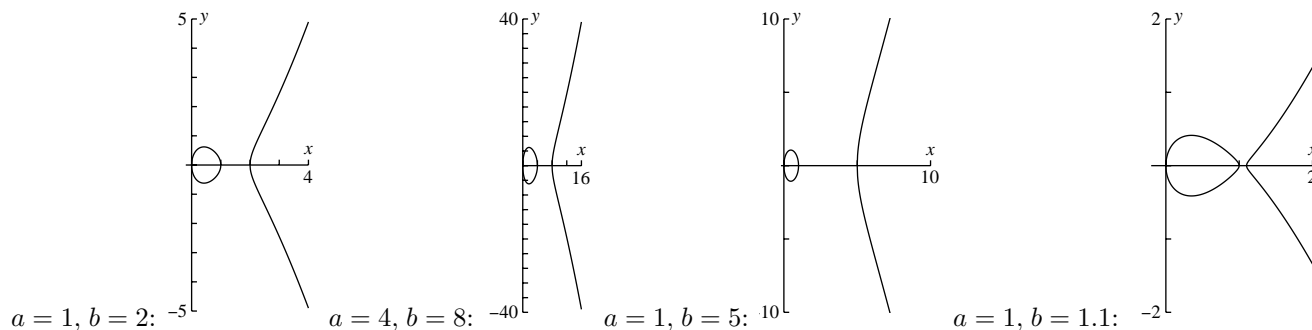

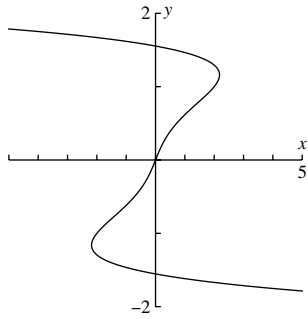

30. (a)

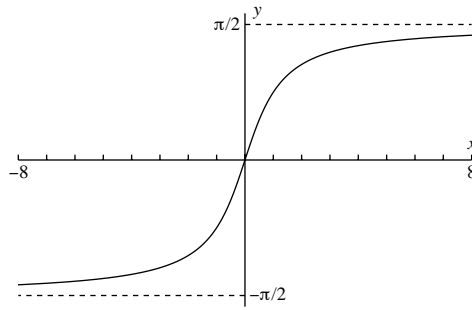

(b)

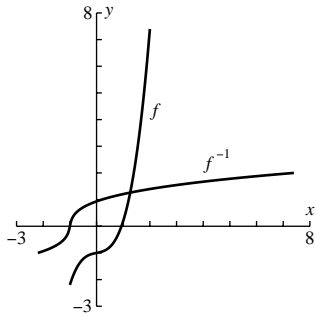

31.

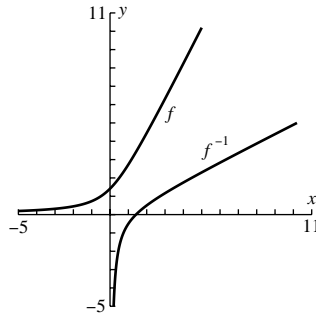

32.

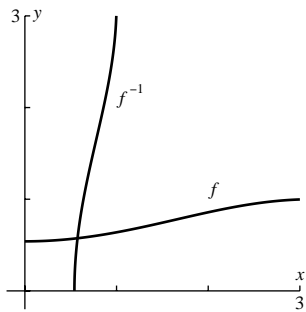

33.

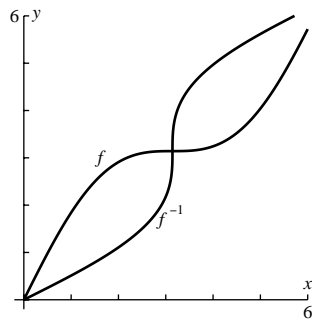

34.

35. (a) One possible answer is $x = 4 \cos t, y = 3 \sin t$.

(b) One possible answer is $x = -1 + 4 \cos t, y = 2 + 3 \sin t$.

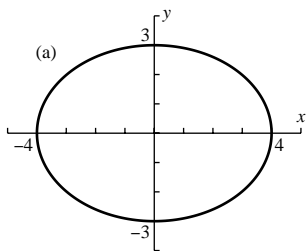

(c)

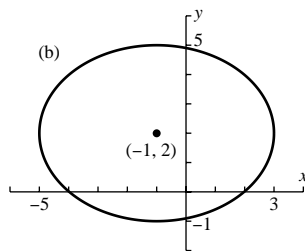

Trigonometry Review

Exercise Set B

1. (a) $5\pi/12$ (b) $13\pi/6$ (c) $\pi/9$ (d) $23\pi/30$
2. (a) $7\pi/3$ (b) $\pi/12$ (c) $5\pi/4$ (d) $11\pi/12$
3. (a) 12° (b) $(270/\pi)^\circ$ (c) 288° (d) 540°
4. (a) 18° (b) $(360/\pi)^\circ$ (c) 72° (d) 210°

5.

	$\sin \theta$	$\cos \theta$	$\tan \theta$	$\csc \theta$	$\sec \theta$	$\cot \theta$
(a)	$\sqrt{21}/5$	$2/5$	$\sqrt{21}/2$	$5/\sqrt{21}$	$5/2$	$2/\sqrt{21}$
(b)	$3/4$	$\sqrt{7}/4$	$3/\sqrt{7}$	$4/3$	$4/\sqrt{7}$	$\sqrt{7}/3$
(c)	$3/\sqrt{10}$	$1/\sqrt{10}$	3	$\sqrt{10}/3$	$\sqrt{10}$	$1/3$

6.

	$\sin \theta$	$\cos \theta$	$\tan \theta$	$\csc \theta$	$\sec \theta$	$\cot \theta$
(a)	$1/\sqrt{2}$	$1/\sqrt{2}$	1	$\sqrt{2}$	$\sqrt{2}$	1
(b)	$3/5$	$4/5$	$3/4$	$5/3$	$5/4$	$4/3$
(c)	$1/4$	$\sqrt{15}/4$	$1/\sqrt{15}$	4	$4/\sqrt{15}$	$\sqrt{15}$

7. $\sin \theta = 3/\sqrt{10}$, $\cos \theta = 1/\sqrt{10}$. 8. $\sin \theta = \sqrt{5}/3$, $\tan \theta = \sqrt{5}/2$.

9. $\tan \theta = \sqrt{21}/2$, $\csc \theta = 5/\sqrt{21}$. 10. $\cot \theta = \sqrt{15}$, $\sec \theta = 4/\sqrt{15}$.

11. Let x be the length of the side adjacent to θ , then $\cos \theta = x/6 = 0.3$, $x = 1.8$.

12. Let x be the length of the hypotenuse, then $\sin \theta = 2.4/x = 0.8$, $x = 2.4/0.8 = 3$.

13.

	θ	$\sin \theta$	$\cos \theta$	$\tan \theta$	$\csc \theta$	$\sec \theta$	$\cot \theta$
(a)	225°	$-1/\sqrt{2}$	$-1/\sqrt{2}$	1	$-\sqrt{2}$	$-\sqrt{2}$	1
(b)	-210°	$1/2$	$-\sqrt{3}/2$	$-1/\sqrt{3}$	2	$-2/\sqrt{3}$	$-\sqrt{3}$
(c)	$5\pi/3$	$-\sqrt{3}/2$	$1/2$	$-\sqrt{3}$	$-2/\sqrt{3}$	2	$-1/\sqrt{3}$
(d)	$-3\pi/2$	1	0	$-$	1	$-$	0

14.	θ	$\sin \theta$	$\cos \theta$	$\tan \theta$	$\csc \theta$	$\sec \theta$	$\cot \theta$
(a)	330°	$-1/2$	$\sqrt{3}/2$	$-1/\sqrt{3}$	-2	$2/\sqrt{3}$	$-\sqrt{3}$
(b)	-120°	$-\sqrt{3}/2$	$-1/2$	$\sqrt{3}$	$-2/\sqrt{3}$	-2	$1/\sqrt{3}$
(c)	$9\pi/4$	$1/\sqrt{2}$	$1/\sqrt{2}$	1	$\sqrt{2}$	$\sqrt{2}$	1
(d)	-3π	0	-1	0	$-$	-1	$-$

15.	$\sin \theta$	$\cos \theta$	$\tan \theta$	$\csc \theta$	$\sec \theta$	$\cot \theta$
(a)	$4/5$	$3/5$	$4/3$	$5/4$	$5/3$	$3/4$
(b)	$-4/5$	$3/5$	$-4/3$	$-5/4$	$5/3$	$-3/4$
(c)	$1/2$	$-\sqrt{3}/2$	$-1/\sqrt{3}$	2	$-2\sqrt{3}$	$-\sqrt{3}$
(d)	$-1/2$	$\sqrt{3}/2$	$-1/\sqrt{3}$	-2	$2/\sqrt{3}$	$-\sqrt{3}$
(e)	$1/\sqrt{2}$	$1/\sqrt{2}$	1	$\sqrt{2}$	$\sqrt{2}$	1
(f)	$1/\sqrt{2}$	$-1/\sqrt{2}$	-1	$\sqrt{2}$	$-\sqrt{2}$	-1

16.	$\sin \theta$	$\cos \theta$	$\tan \theta$	$\csc \theta$	$\sec \theta$	$\cot \theta$
(a)	$1/4$	$\sqrt{15}/4$	$1/\sqrt{15}$	4	$4/\sqrt{15}$	$\sqrt{15}$
(b)	$1/4$	$-\sqrt{15}/4$	$-1/\sqrt{15}$	4	$-4/\sqrt{15}$	$-\sqrt{15}$
(c)	$3/\sqrt{10}$	$1/\sqrt{10}$	3	$\sqrt{10}/3$	$\sqrt{10}$	$1/3$
(d)	$-3/\sqrt{10}$	$-1/\sqrt{10}$	3	$-\sqrt{10}/3$	$-\sqrt{10}$	$1/3$
(e)	$\sqrt{21}/5$	$-2/5$	$-\sqrt{21}/2$	$5/\sqrt{21}$	$-5/2$	$-2/\sqrt{21}$
(f)	$-\sqrt{21}/5$	$-2/5$	$\sqrt{21}/2$	$-5/\sqrt{21}$	$-5/2$	$2/\sqrt{21}$

17. (a) $x = 3 \sin 25^\circ \approx 1.2679$. (b) $x = 3 / \tan(2\pi/9) \approx 3.5753$.

18. (a) $x = 2 / \sin 20^\circ \approx 5.8476$. (b) $x = 3 / \cos(3\pi/11) \approx 4.5811$.

19.	$\sin \theta$	$\cos \theta$	$\tan \theta$	$\csc \theta$	$\sec \theta$	$\cot \theta$
(a)	$a/3$	$\sqrt{9-a^2}/3$	$a/\sqrt{9-a^2}$	$3/a$	$3/\sqrt{9-a^2}$	$\sqrt{9-a^2}/a$
(b)	$a/\sqrt{a^2+25}$	$5/\sqrt{a^2+25}$	$a/5$	$\sqrt{a^2+25}/a$	$\sqrt{a^2+25}/5$	$5/a$
(c)	$\sqrt{a^2-1}/a$	$1/a$	$\sqrt{a^2-1}$	$a/\sqrt{a^2-1}$	a	$1/\sqrt{a^2-1}$

20. (a) $\theta = 3\pi/4 \pm 2n\pi$ and $\theta = 5\pi/4 \pm 2n\pi$, $n = 0, 1, 2, \dots$

(b) $\theta = 5\pi/4 \pm 2n\pi$ and $\theta = 7\pi/4 \pm 2n\pi$, $n = 0, 1, 2, \dots$

21. (a) $\theta = 3\pi/4 \pm n\pi$, $n = 0, 1, 2, \dots$

(b) $\theta = \pi/3 \pm 2n\pi$ and $\theta = 5\pi/3 \pm 2n\pi$, $n = 0, 1, 2, \dots$

22. (a) $\theta = 7\pi/6 \pm 2n\pi$ and $\theta = 11\pi/6 \pm 2n\pi$, $n = 0, 1, 2, \dots$

(b) $\theta = \pi/3 \pm n\pi$, $n = 0, 1, 2, \dots$

23. (a) $\theta = \pi/6 \pm n\pi$, $n = 0, 1, 2, \dots$

(b) $\theta = 4\pi/3 \pm 2n\pi$ and $\theta = 5\pi/3 \pm 2n\pi$, $n = 0, 1, 2, \dots$

24. (a) $\theta = 3\pi/2 \pm 2n\pi$, $n = 0, 1, 2, \dots$

(b) $\theta = \pi \pm 2n\pi$, $n = 0, 1, 2, \dots$

25. (a) $\theta = 3\pi/4 \pm n\pi$, $n = 0, 1, 2, \dots$

(b) $\theta = \pi/6 \pm n\pi$, $n = 0, 1, 2, \dots$

26. (a) $\theta = 2\pi/3 \pm 2n\pi$ and $\theta = 4\pi/3 \pm 2n\pi$, $n = 0, 1, 2, \dots$

(b) $\theta = 7\pi/6 \pm 2n\pi$ and $\theta = 11\pi/6 \pm 2n\pi$, $n = 0, 1, 2, \dots$

27. (a) $\theta = \pi/3 \pm 2n\pi$ and $\theta = 2\pi/3 \pm 2n\pi$, $n = 0, 1, 2, \dots$

(b) $\theta = \pi/6 \pm 2n\pi$ and $\theta = 11\pi/6 \pm 2n\pi$, $n = 0, 1, 2, \dots$

28. $\sin \theta = -3/5$, $\cos \theta = -4/5$, $\tan \theta = 3/4$, $\csc \theta = -5/3$, $\sec \theta = -5/4$, $\cot \theta = 4/3$.

29. $\sin \theta = 2/5$, $\cos \theta = -\sqrt{21}/5$, $\tan \theta = -2/\sqrt{21}$, $\csc \theta = 5/2$, $\sec \theta = -5/\sqrt{21}$, $\cot \theta = -\sqrt{21}/2$.

30. (a) $\theta = \pi/2 \pm 2n\pi$, $n = 0, 1, 2, \dots$ (b) $\theta = \pm 2n\pi$, $n = 0, 1, 2, \dots$ (c) $\theta = \pi/4 \pm n\pi$, $n = 0, 1, 2, \dots$

(d) $\theta = \pi/2 \pm 2n\pi$, $n = 0, 1, 2, \dots$ (e) $\theta = \pm 2n\pi$, $n = 0, 1, 2, \dots$ (f) $\theta = \pi/4 \pm n\pi$, $n = 0, 1, 2, \dots$

31. (a) $\theta = \pm n\pi$, $n = 0, 1, 2, \dots$ (b) $\theta = \pi/2 \pm n\pi$, $n = 0, 1, 2, \dots$ (c) $\theta = \pm n\pi$, $n = 0, 1, 2, \dots$

(d) $\theta = \pm n\pi$, $n = 0, 1, 2, \dots$ (e) $\theta = \pi/2 \pm n\pi$, $n = 0, 1, 2, \dots$ (f) $\theta = \pm n\pi$, $n = 0, 1, 2, \dots$

32. Construct a right triangle with one angle equal to 17° , measure the lengths of the sides and hypotenuse and use formula (6) for $\sin \theta$ and $\cos \theta$ to approximate $\sin 17^\circ$ and $\cos 17^\circ$.

33. (a) $s = r\theta = 4(\pi/6) = 2\pi/3$ cm. (b) $s = r\theta = 4(5\pi/6) = 10\pi/3$ cm.

34. $r = s/\theta = 7/(\pi/3) = 21/\pi$. 35. $\theta = s/r = 2/5$.

36. $\theta = s/r$ so $A = \frac{1}{2}r^2\theta = \frac{1}{2}r^2(s/r) = \frac{1}{2}rs$.

37. (a) $2\pi r = R(2\pi - \theta)$, $r = \frac{2\pi - \theta}{2\pi}R$.

(b) $h = \sqrt{R^2 - r^2} = \sqrt{R^2 - (2\pi - \theta)^2 R^2 / (4\pi^2)} = \frac{\sqrt{4\pi\theta - \theta^2}}{2\pi}R$.

38. The circumference of the circular base is $2\pi r$. When cut and flattened, the cone becomes a circular sector of radius L . If θ is the central angle that subtends the arc of length $2\pi r$, then $\theta = (2\pi r)/L$ so the area S of the sector is $S = (1/2)L^2(2\pi r/L) = \pi rL$ which is the lateral surface area of the cone.

39. Let h be the altitude as shown in the figure, then $h = 3 \sin 60^\circ = 3\sqrt{3}/2$ so $A = \frac{1}{2}(3\sqrt{3}/2)(7) = 21\sqrt{3}/4$.

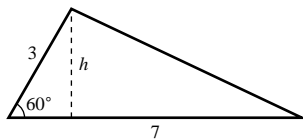

40. Draw the perpendicular from vertex C as shown in the figure, then $h = 9 \sin 30^\circ = 9/2$, $a = h / \sin 45^\circ = 9\sqrt{2}/2$, $c_1 = 9 \cos 30^\circ = 9\sqrt{3}/2$, $c_2 = a \cos 45^\circ = 9/2$, $c_1 + c_2 = 9(\sqrt{3} + 1)/2$, angle $C = 180^\circ - (30^\circ + 45^\circ) = 105^\circ$.

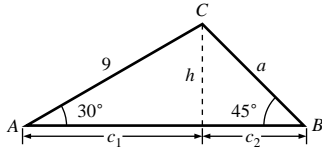

41. Let x be the distance above the ground, then $x = 10 \sin 67^\circ \approx 9.2$ ft.
 42. Let x be the height of the building, then $x = 120 \tan 76^\circ \approx 481$ ft.
 43. From the figure, $h = x - y$ but $x = d \tan \beta$, $y = d \tan \alpha$ so $h = d(\tan \beta - \tan \alpha)$.

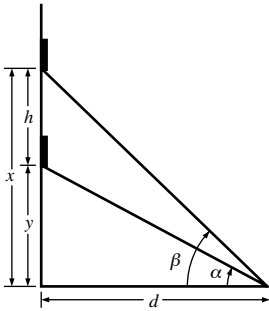

44. From the figure, $d = x - y$ but $x = h \cot \alpha$, $y = h \cot \beta$ so $d = h(\cot \alpha - \cot \beta)$, $h = \frac{d}{\cot \alpha - \cot \beta}$.

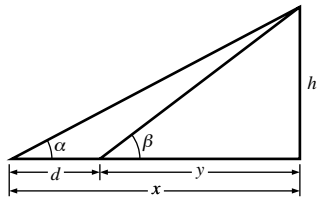

45. (a) $\sin 2\theta = 2 \sin \theta \cos \theta = 2(\sqrt{5}/3)(2/3) = 4\sqrt{5}/9$.
 (b) $\cos 2\theta = 2 \cos^2 \theta - 1 = 2(2/3)^2 - 1 = -1/9$.
 46. (a) $\sin(\alpha - \beta) = \sin \alpha \cos \beta - \cos \alpha \sin \beta = (3/5)(1/\sqrt{5}) - (4/5)(2/\sqrt{5}) = -1/\sqrt{5}$.
 (b) $\cos(\alpha + \beta) = \cos \alpha \cos \beta - \sin \alpha \sin \beta = (4/5)(1/\sqrt{5}) - (3/5)(2/\sqrt{5}) = -2/(5\sqrt{5})$.
 47. $\sin 3\theta = \sin(2\theta + \theta) = \sin 2\theta \cos \theta + \cos 2\theta \sin \theta = (2 \sin \theta \cos \theta) \cos \theta + (\cos^2 \theta - \sin^2 \theta) \sin \theta = 2 \sin \theta \cos^2 \theta + \sin \theta \cos^2 \theta - \sin^3 \theta = 3 \sin \theta \cos^2 \theta - \sin^3 \theta$; similarly, $\cos 3\theta = \cos^3 \theta - 3 \sin^2 \theta \cos \theta$.
 48. $\frac{\cos \theta \sec \theta}{1 + \tan^2 \theta} = \frac{\cos \theta \sec \theta}{\sec^2 \theta} = \frac{\cos \theta}{\sec \theta} = \frac{\cos \theta}{(1/\cos \theta)} = \cos^2 \theta$.
 49. $\frac{\cos \theta \tan \theta + \sin \theta}{\tan \theta} = \frac{\cos \theta(\sin \theta / \cos \theta) + \sin \theta}{\sin \theta / \cos \theta} = 2 \cos \theta$.
 50. $2 \csc 2\theta = \frac{2}{\sin 2\theta} = \frac{2}{2 \sin \theta \cos \theta} = \left(\frac{1}{\sin \theta}\right) \left(\frac{1}{\cos \theta}\right) = \csc \theta \sec \theta$.
 51. $\tan \theta + \cot \theta = \frac{\sin \theta}{\cos \theta} + \frac{\cos \theta}{\sin \theta} = \frac{\sin^2 \theta + \cos^2 \theta}{\sin \theta \cos \theta} = \frac{1}{\sin \theta \cos \theta} = \frac{2}{2 \sin \theta \cos \theta} = \frac{2}{\sin 2\theta} = 2 \csc 2\theta$.

52. $\frac{\sin 2\theta}{\sin \theta} - \frac{\cos 2\theta}{\cos \theta} = \frac{\sin 2\theta \cos \theta - \cos 2\theta \sin \theta}{\sin \theta \cos \theta} = \frac{\sin \theta}{\sin \theta \cos \theta} = \sec \theta.$

53. $\frac{\sin \theta + \cos 2\theta - 1}{\cos \theta - \sin 2\theta} = \frac{\sin \theta + (1 - 2 \sin^2 \theta) - 1}{\cos \theta - 2 \sin \theta \cos \theta} = \frac{\sin \theta(1 - 2 \sin \theta)}{\cos \theta(1 - 2 \sin \theta)} = \tan \theta.$

54. Using (47), $2 \sin 2\theta \cos \theta = 2(1/2)(\sin \theta + \sin 3\theta) = \sin \theta + \sin 3\theta.$

55. Using (47), $2 \cos 2\theta \sin \theta = 2(1/2)[\sin(-\theta) + \sin 3\theta] = \sin 3\theta - \sin \theta.$

56. $\tan(\theta/2) = \frac{\sin(\theta/2)}{\cos(\theta/2)} = \frac{2 \sin^2(\theta/2)}{2 \sin(\theta/2) \cos(\theta/2)} = \frac{1 - \cos \theta}{\sin \theta}.$

57. $\tan(\theta/2) = \frac{\sin(\theta/2)}{\cos(\theta/2)} = \frac{2 \sin(\theta/2) \cos(\theta/2)}{2 \cos^2(\theta/2)} = \frac{\sin \theta}{1 + \cos \theta}.$

58. From (52), $\cos(\pi/3 + \theta) + \cos(\pi/3 - \theta) = 2 \cos(\pi/3) \cos \theta = 2(1/2) \cos \theta = \cos \theta.$

59. From the figures, area = $\frac{1}{2}hc$ but $h = b \sin A$, so area = $\frac{1}{2}bc \sin A$. The formulas area = $\frac{1}{2}ac \sin B$ and area = $\frac{1}{2}ab \sin C$ follow by drawing altitudes from vertices B and C , respectively.

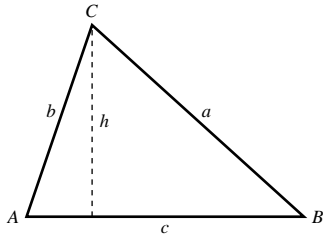

60. From right triangles ADC and BDC , $h_1 = b \sin A = a \sin B$ so $a/\sin A = b/\sin B$. From right triangles AEB and CEB , $h_2 = c \sin A = a \sin C$ so $a/\sin A = c/\sin C$, thus $a/\sin A = b/\sin B = c/\sin C$.

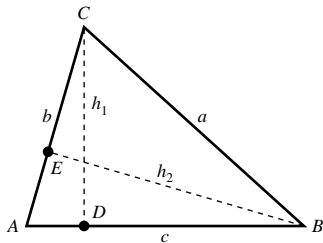

61. (a) $\sin(\pi/2 + \theta) = \sin(\pi/2) \cos \theta + \cos(\pi/2) \sin \theta = (1) \cos \theta + (0) \sin \theta = \cos \theta.$

(b) $\cos(\pi/2 + \theta) = \cos(\pi/2) \cos \theta - \sin(\pi/2) \sin \theta = (0) \cos \theta - (1) \sin \theta = -\sin \theta.$

(c) $\sin(3\pi/2 - \theta) = \sin(3\pi/2) \cos \theta - \cos(3\pi/2) \sin \theta = (-1) \cos \theta - (0) \sin \theta = -\cos \theta.$

(d) $\cos(3\pi/2 + \theta) = \cos(3\pi/2) \cos \theta - \sin(3\pi/2) \sin \theta = (0) \cos \theta - (-1) \sin \theta = \sin \theta.$

62. $\tan(\alpha + \beta) = \frac{\sin(\alpha + \beta)}{\cos(\alpha + \beta)} = \frac{\sin \alpha \cos \beta + \cos \alpha \sin \beta}{\cos \alpha \cos \beta - \sin \alpha \sin \beta}$, divide numerator and denominator by $\cos \alpha \cos \beta$ and use $\tan \alpha = \frac{\sin \alpha}{\cos \alpha}$ and $\tan \beta = \frac{\sin \beta}{\cos \beta}$ to get (38); $\tan(\alpha - \beta) = \tan(\alpha + (-\beta)) = \frac{\tan \alpha + \tan(-\beta)}{1 - \tan \alpha \tan(-\beta)} = \frac{\tan \alpha - \tan \beta}{1 + \tan \alpha \tan \beta}$ because $\tan(-\beta) = -\tan \beta.$

63. (a) Add (34) and (36) to get $\sin(\alpha - \beta) + \sin(\alpha + \beta) = 2 \sin \alpha \cos \beta$, so $\sin \alpha \cos \beta = (1/2)[\sin(\alpha - \beta) + \sin(\alpha + \beta)]$.
 (b) Subtract (35) from (37). (c) Add (35) and (37).
64. (a) From (47), $\sin \frac{A+B}{2} \cos \frac{A-B}{2} = \frac{1}{2}(\sin B + \sin A)$, so $\sin A + \sin B = 2 \sin \frac{A+B}{2} \cos \frac{A-B}{2}$.
 (b) Use (49). (c) Use (48).
65. $\sin \alpha + \sin(-\beta) = 2 \sin \frac{\alpha - \beta}{2} \cos \frac{\alpha + \beta}{2}$, but $\sin(-\beta) = -\sin \beta$, so $\sin \alpha - \sin \beta = 2 \cos \frac{\alpha + \beta}{2} \sin \frac{\alpha - \beta}{2}$.
66. (a) From (34), $C \sin(\alpha + \phi) = C \sin \alpha \cos \phi + C \cos \alpha \sin \phi$ so $C \cos \phi = 3$ and $C \sin \phi = 5$, square and add to get $C^2(\cos^2 \phi + \sin^2 \phi) = 9 + 25$, $C^2 = 34$. If $C = \sqrt{34}$ then $\cos \phi = 3/\sqrt{34}$ and $\sin \phi = 5/\sqrt{34}$ so ϕ is the first-quadrant angle for which $\tan \phi = 5/3$. $3 \sin \alpha + 5 \cos \alpha = \sqrt{34} \sin(\alpha + \phi)$.
 (b) Follow the procedure of part (a) to get $C \cos \phi = A$ and $C \sin \phi = B$, $C = \sqrt{A^2 + B^2}$, $\tan \phi = B/A$ where the quadrant in which ϕ lies is determined by the signs of A and B because $\cos \phi = A/C$ and $\sin \phi = B/C$, so $A \sin \alpha + B \cos \alpha = \sqrt{A^2 + B^2} \sin(\alpha + \phi)$.
67. Consider the triangle having a , b , and d as sides. The angle formed by sides a and b is $\pi - \theta$ so from the law of cosines, $d^2 = a^2 + b^2 - 2ab \cos(\pi - \theta) = a^2 + b^2 + 2ab \cos \theta$, $d = \sqrt{a^2 + b^2 + 2ab \cos \theta}$.
68. (a) Angle of inclination = $\tan^{-1}(1/2) \approx 27^\circ$.
 (b) $\tan^{-1}(-1) = -45^\circ$ so angle of inclination = $180^\circ - 45^\circ = 135^\circ$.
 (c) Angle of inclination = $\tan^{-1} 2 \approx 63^\circ$.
 (d) $\tan^{-1}(-57) \approx -89^\circ$ so angle of inclination $\approx 180^\circ - 89^\circ = 91^\circ$.
69. (a) $\tan^{-1}(-1/2) \approx -27^\circ$ so angle of inclination $\approx 180^\circ - 27^\circ = 153^\circ$.
 (b) Angle of inclination = $\tan^{-1} 1 = 45^\circ$.
 (c) $\tan^{-1}(-2) \approx -63^\circ$ so angle of inclination $\approx 180^\circ - 63^\circ = 117^\circ$.
 (d) Angle of inclination = $\tan^{-1} 57 \approx 89^\circ$.
70. (a) $y = -\frac{\sqrt{3}}{3}x + \frac{2}{3}$, $\tan^{-1}\left(-\frac{\sqrt{3}}{3}\right) = -30^\circ$, so angle of inclination = $180^\circ - 30^\circ = 150^\circ$.
 (b) $y = 4x - 7$. Angle of inclination = $\tan^{-1} 4 \approx 76^\circ$.
71. (a) Angle of inclination = $\tan^{-1} \sqrt{3} = 60^\circ$.
 (b) $y = -2x - 5$. $\tan^{-1}(-2) \approx -63^\circ$ so angle of inclination $\approx 180^\circ - 63^\circ = 117^\circ$.

Solving Polynomial Equations

Exercise Set C

1. (a) $q(x) = x^2 + 4x + 2, r(x) = -11x + 6.$

(b) $q(x) = 2x^2 + 4, r(x) = 9.$

(c) $q(x) = x^3 - x^2 + 2x - 2, r(x) = 2x + 1.$

2. (a) $q(x) = 2x^2 - x + 2, r(x) = 5x + 5.$

(b) $q(x) = x^3 + 3x^2 - x + 2, r(x) = 3x - 1.$

(c) $q(x) = 5x^3 - 5, r(x) = 4x^2 + 10.$

3. (a) $q(x) = 3x^2 + 6x + 8, r(x) = 15.$

(b) $q(x) = x^3 - 5x^2 + 20x - 100, r(x) = 504.$

(c) $q(x) = x^4 + x^3 + x^2 + x + 1, r(x) = 0.$

4. (a) $q(x) = 2x^2 + x - 1, r(x) = 0.$

(b) $q(x) = 2x^3 - 5x^2 + 3x - 39, r(x) = 147.$

(c) $q(x) = x^6 + x^5 + x^4 + x^3 + x^2 + x + 1, r(x) = 2.$

5.

x	0	1	-3	7
$p(x)$	-4	-3	101	5001

6.

x	1	-1	3	-3	7	-7	21	-21
$p(x)$	-24	-12	12	0	420	-168	10416	-7812

7. (a) $q(x) = x^2 + 6x + 13, r = 20.$ (b) $q(x) = x^2 + 3x - 2, r = -4.$

8. (a) $q(x) = x^4 - x^3 + x^2 - x + 1, r = -2.$ (b) $q(x) = x^4 + x^3 + x^2 + x + 1, r = 0.$

9. Assume $r = a/b$ where a and b are integers with $a > 0$:

(a) b divides 1, $b = \pm 1$; a divides 24, $a = 1, 2, 3, 4, 6, 8, 12, 24$;
the possible candidates are $\{\pm 1, \pm 2, \pm 3, \pm 4, \pm 6, \pm 8, \pm 12, \pm 24\}.$

(b) b divides 3 so $b = \pm 1, \pm 3$; a divides -10 so $a = 1, 2, 5, 10$;

the possible candidates are $\{\pm 1, \pm 2, \pm 5, \pm 10, \pm 1/3, \pm 2/3, \pm 5/3, \pm 10/3\}$.

(c) b divides 1 so $b = \pm 1$; a divides 17 so $a = 1, 17$;

the possible candidates are $\{\pm 1, \pm 17\}$.

10. An integer zero c divides -21 , so $c = \pm 1, \pm 3, \pm 7, \pm 21$ are the only possibilities; substitution of these candidates shows that the integer zeros are $-7, -1, 3$.

11. $(x + 1)(x - 1)(x - 2)$

12. $(x + 2)(3x + 1)(x - 2)$

13. $(x + 3)^3(x + 1)$

14. $(x - 1)(2x + 3)(x^2 + 3)$

15. $(x + 3)(x + 2)(x + 1)^2(x - 3)$

17. -3 is the only real root.

18. $x = -3/2, 2 \pm \sqrt{3}$ are the real roots.

19. $x = -2, -2/3, -1 \pm \sqrt{3}$ are the real roots.

20. $-2, -1, 1/2, 3$.

21. $-2, 2, 3$ are the only real roots.

23. If $x - 1$ is a factor then $p(1) = 0$, so $k^2 - 7k + 10 = 0$, $k^2 - 7k + 10 = (k - 2)(k - 5)$, so $k = 2, 5$.

24. $(-3)^7 = -2187$, so -3 is a root and thus by Theorem C.4, $x + 3$ is a factor of $x^7 + 2187$.

25. If the side of the cube is x then $x^2(x - 3) = 196$; the only real root of this equation is $x = 7$ cm.

26. (a) If $x - x^3 = 1$ then $x^3 - x + 1 = 0$. The only candidates for a rational root are 1 and -1 , neither of which is a root.

(b) Let $f(x) = x^3 - x + 1$. Since $f(-2) = -5 < 0$ and $f(-1) = 1 > 0$, there is a real root x between -2 and -1 . (In fact, $x \approx -1.3247$.)

27. Use the Factor Theorem with x as the variable and y as the constant c .

(a) For any positive integer n the polynomial $x^n - y^n$ has $x = y$ as a root.

(b) For any positive even integer n the polynomial $x^n - y^n$ has $x = -y$ as a root.

(c) For any positive odd integer n the polynomial $x^n + y^n$ has $x = -y$ as a root.