

تم تحميل هذا الملف من موقع المناهج الإماراتية



موقع
المناهج الإماراتية

www.alManahj.com/ae

* للحصول على أوراق عمل لجميع الصفوف وجميع المواد اضغط هنا

<https://almanahj.com/ae>

* للحصول على أوراق عمل لجميع مواد KG1 اضغط هنا

<https://almanahj.com/ae/21>

* للحصول على جميع أوراق KG1 في مادة لغة عربية ولجميع الفصول, اضغط هنا

<https://almanahj.com/ae/21arabic>

* للحصول على أوراق عمل لجميع مواد KG1 في مادة لغة عربية الخاصة بـ الفصل الأول اضغط هنا

<https://almanahj.com/ae/21arabic1>

* لتحميل كتب جميع المواد في جميع الفصول للـ KG1 اضغط هنا

<https://almanahj.com/ae/grade21>

للحصول على جميع روابط الصفوف على تلغرام وفيسبوك من قنوات وصفحات: اضغط هنا

https://t.me/UAElinks_bot



لون واكتب

الخَرَكَات

الكسرة

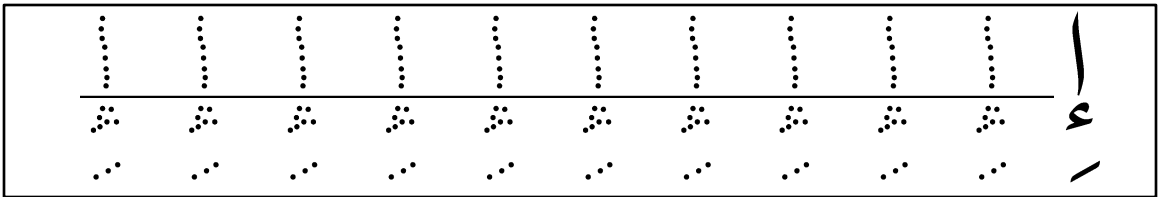
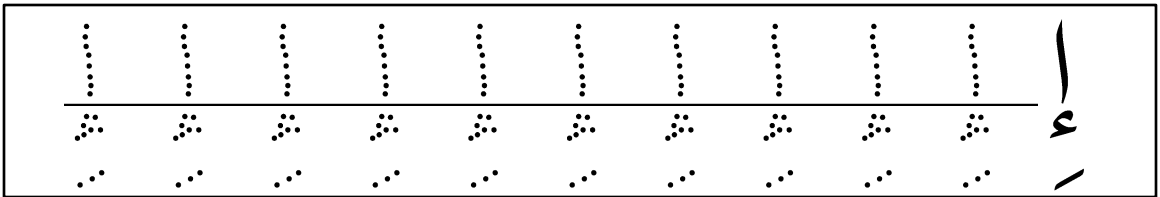
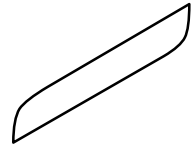
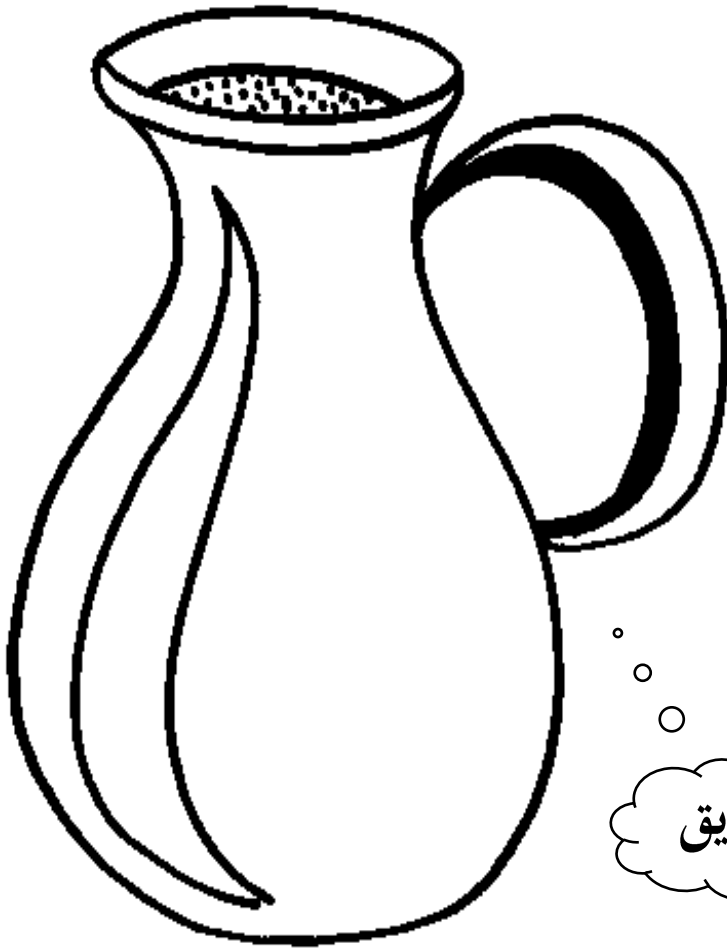

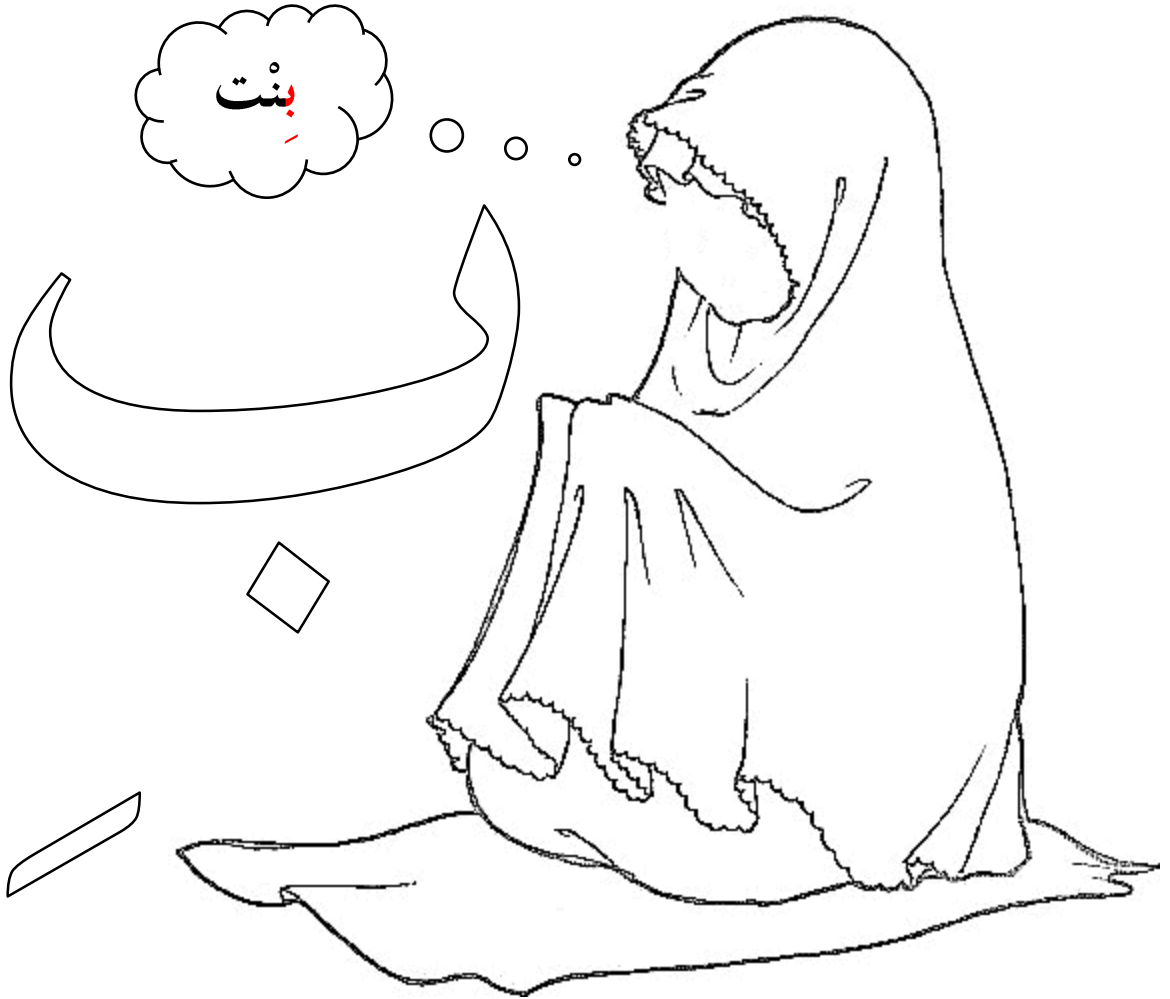

ب ب ب ب ب ب ب

ب ب ب ب ب ب ب

تمساح

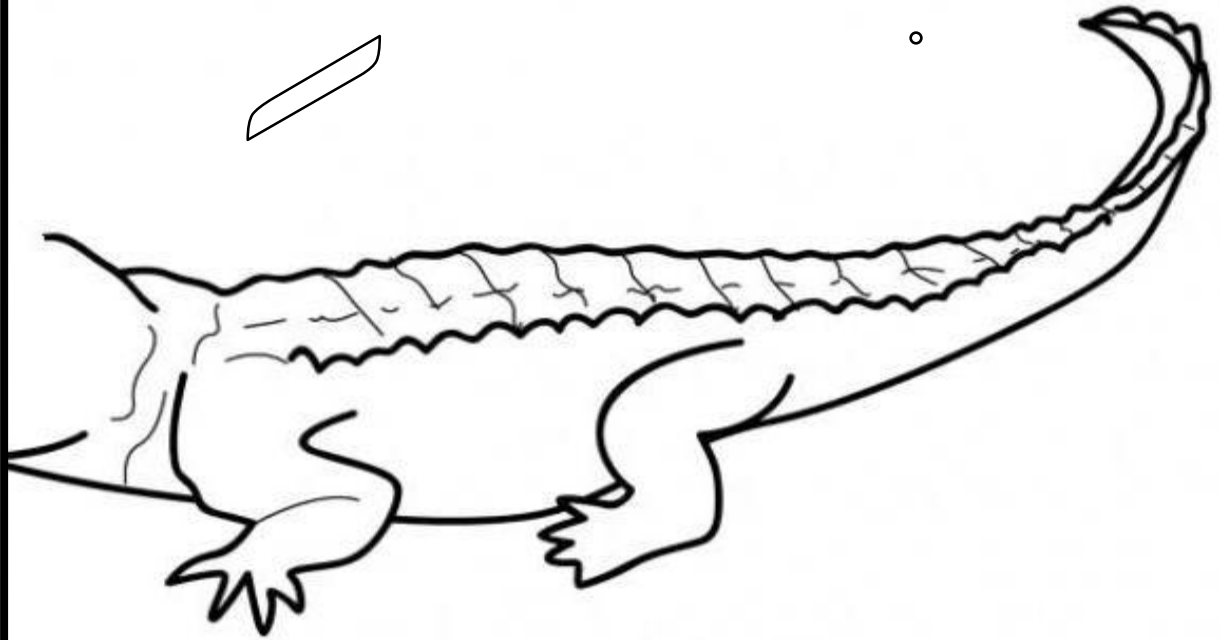
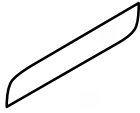
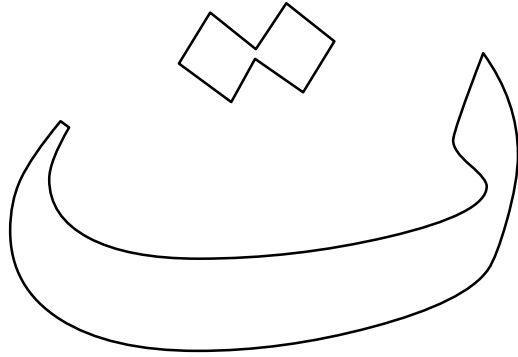

ت ت ت ت ت ت ت

ت ت ت ت ت ت ت

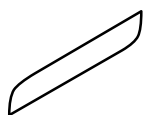
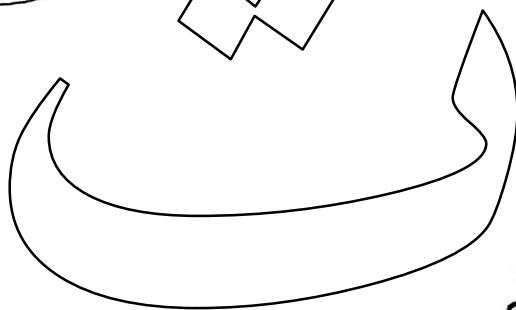

ث ث ث ث ث ث ث

ث ث ث ث ث ث ث

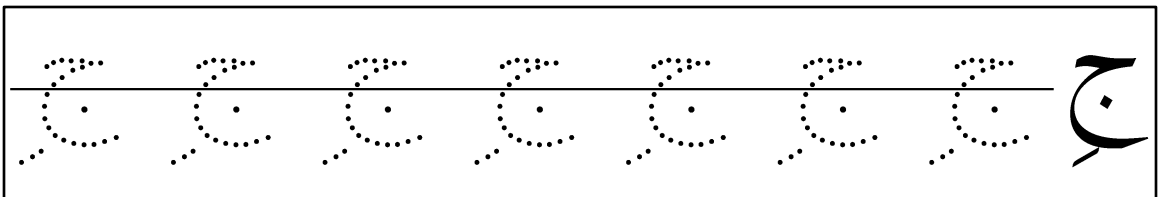
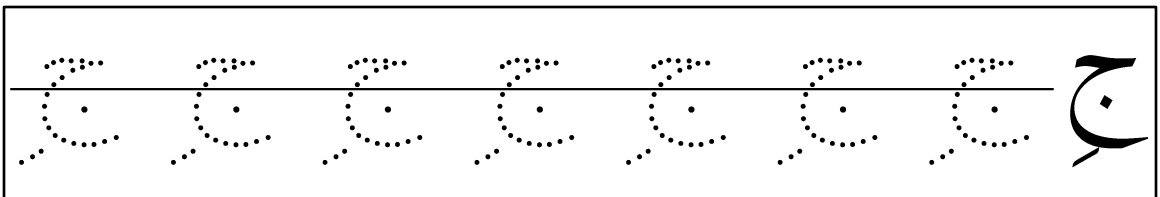
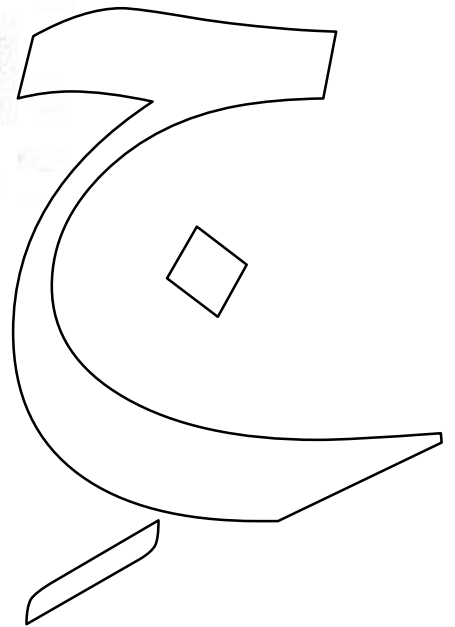
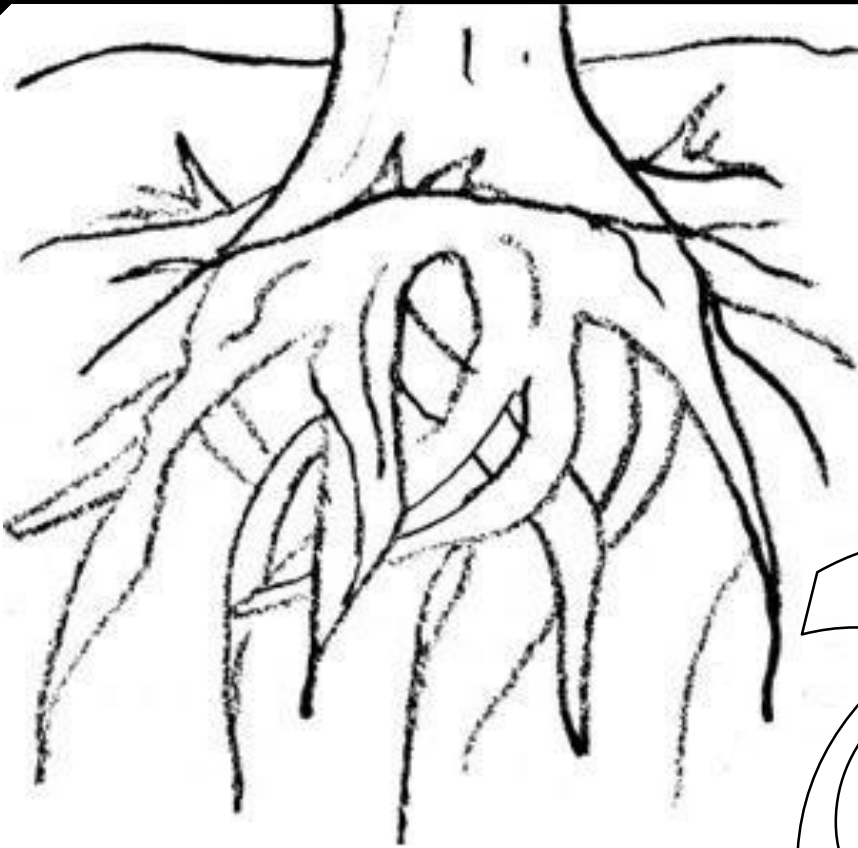

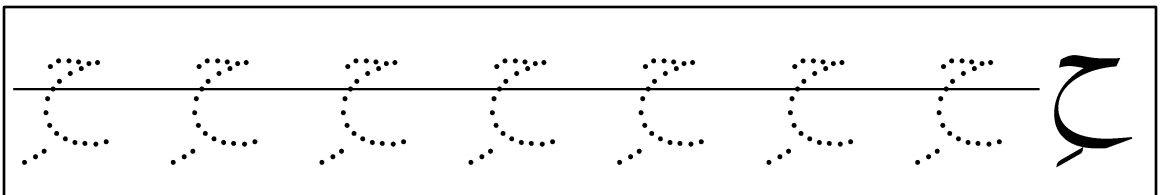
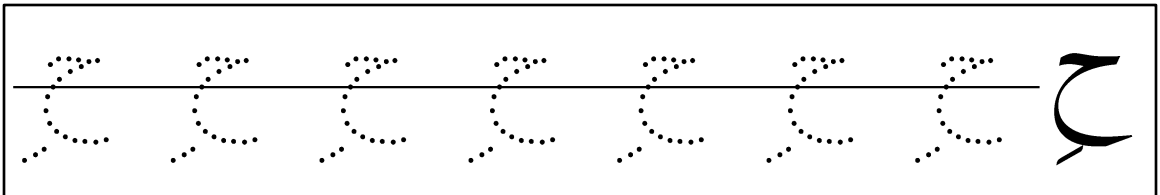
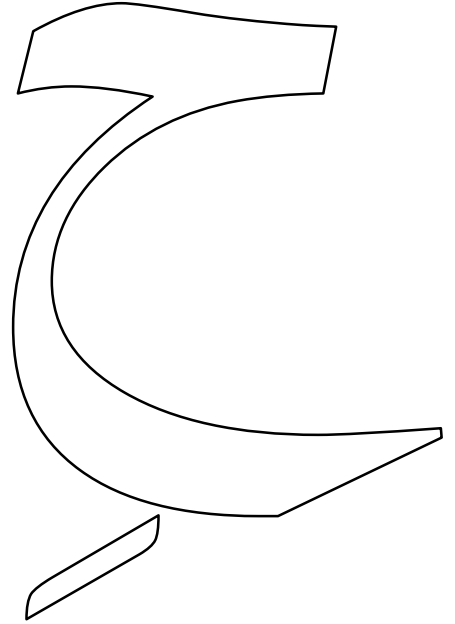

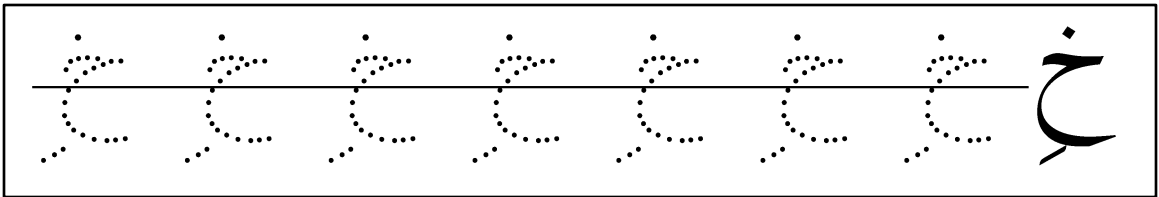
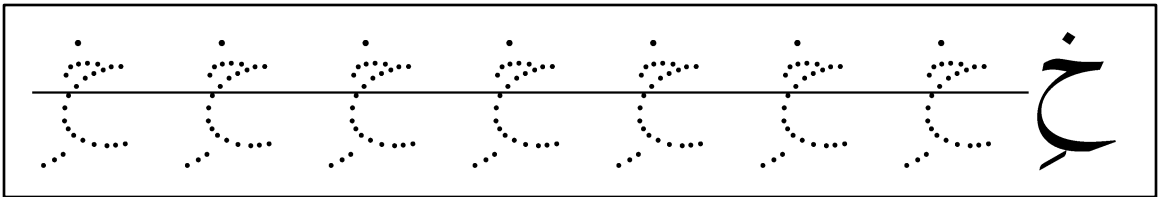
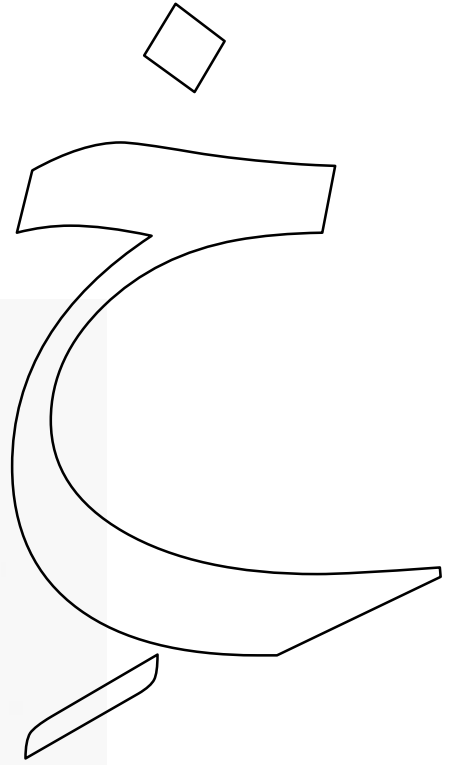
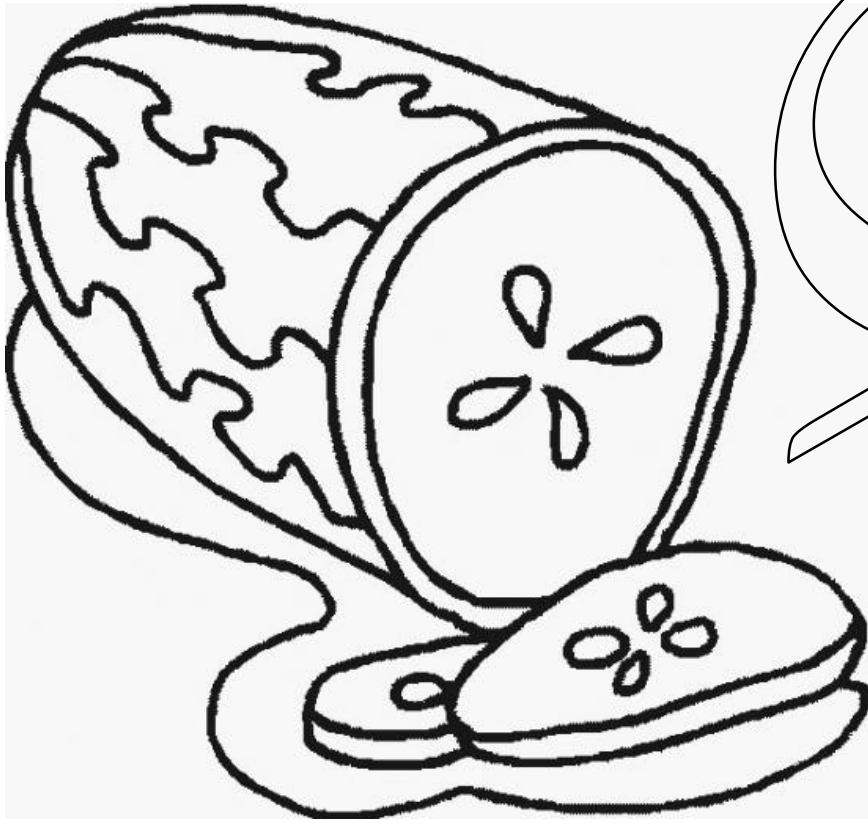

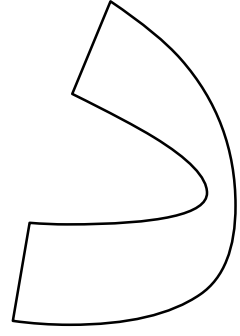

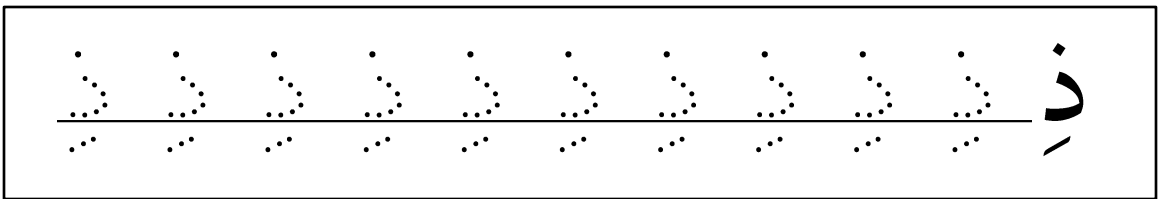
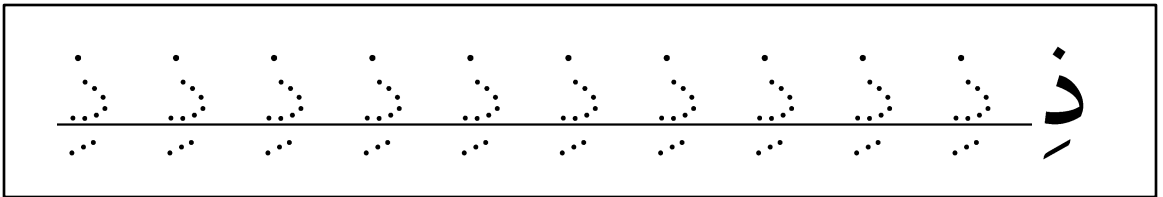
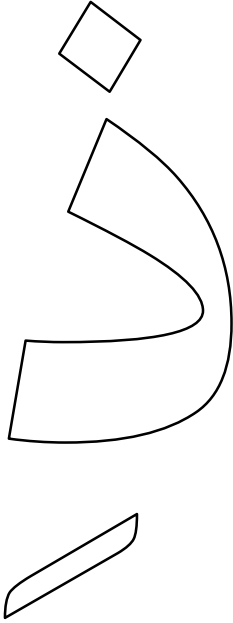
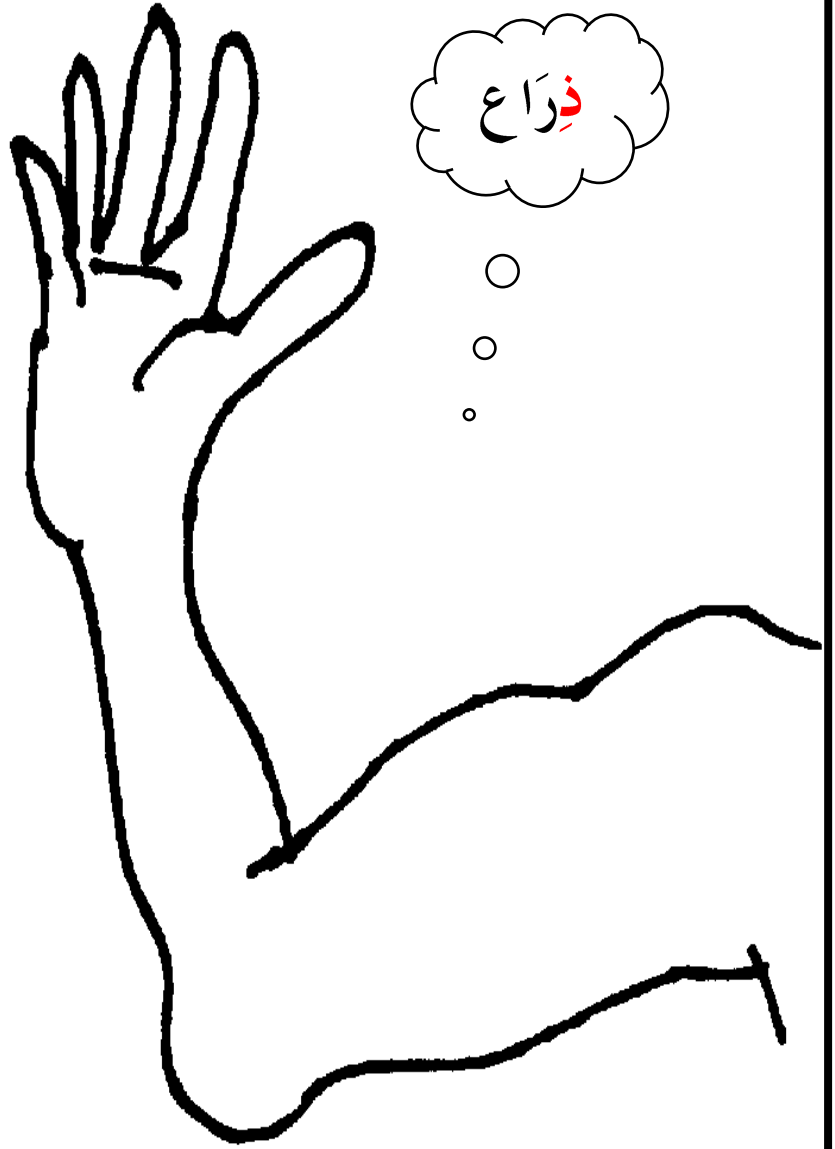

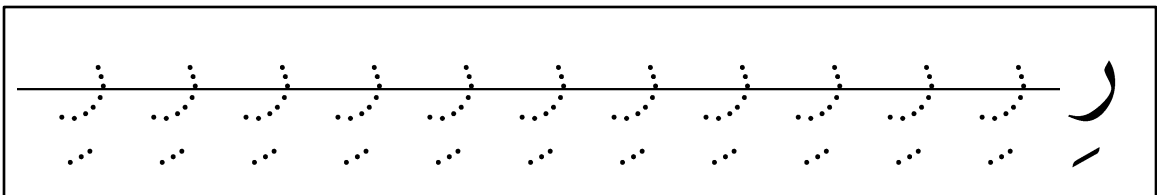
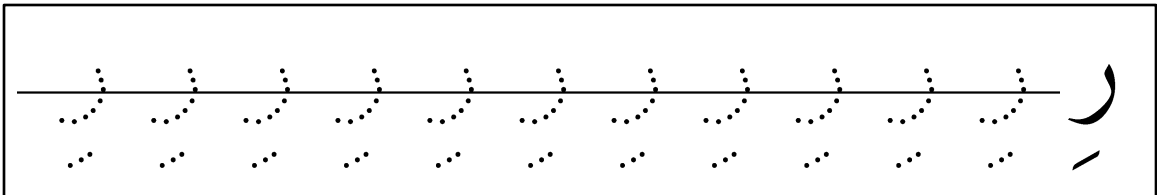
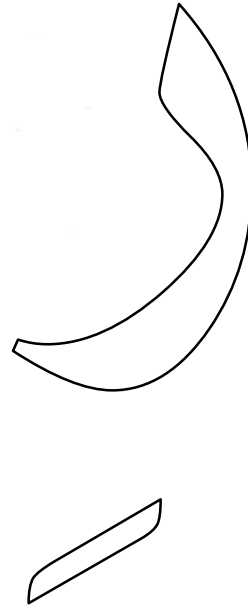

زِيَارَةُ الْمَرِيضِ



ز ز ز ز ز ز ز ز ز ز

ز ز ز ز ز ز ز ز ز ز

6

س

س

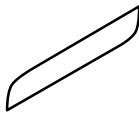

س س س س س س س

س س س س س س س

شِتا

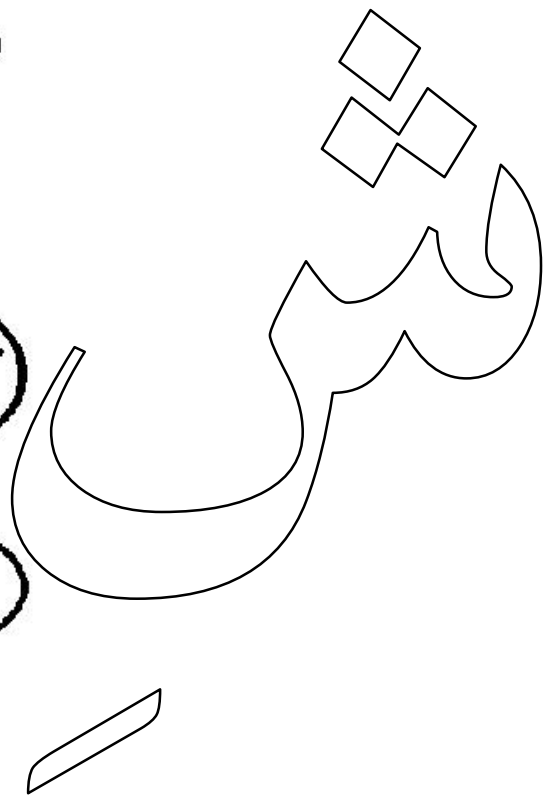

شِتا شِتا شِتا شِتا شِتا شِتا

شِتا شِتا شِتا شِتا شِتا شِتا

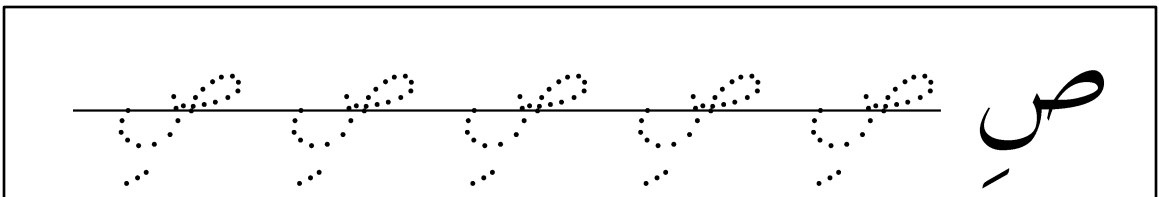
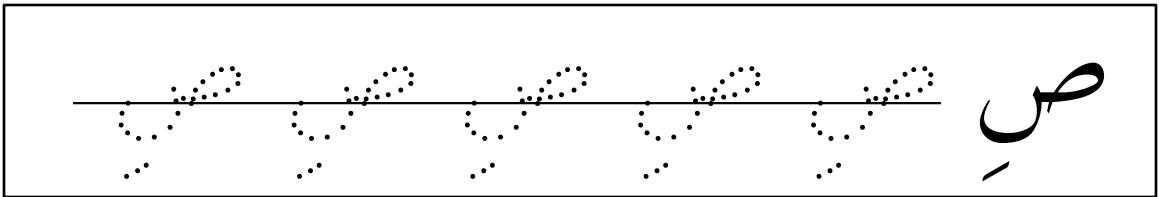
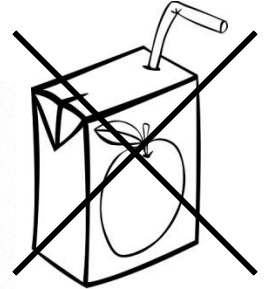
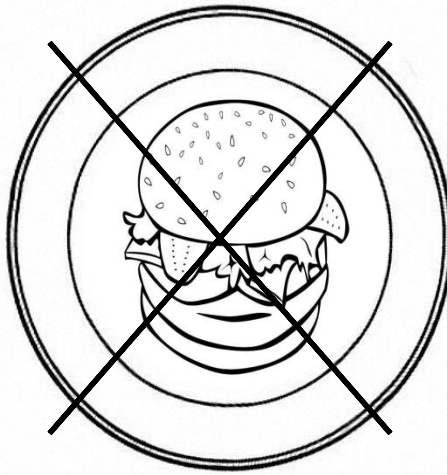
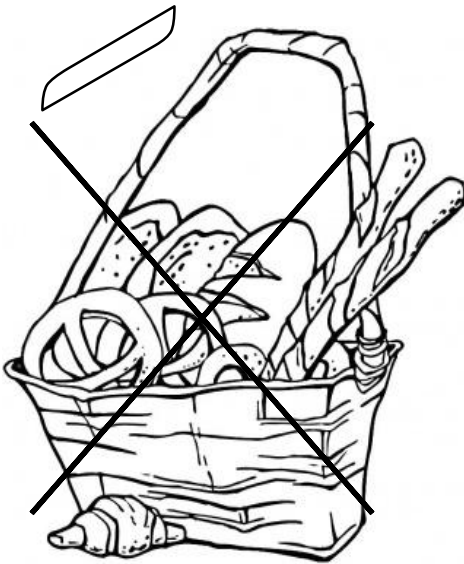
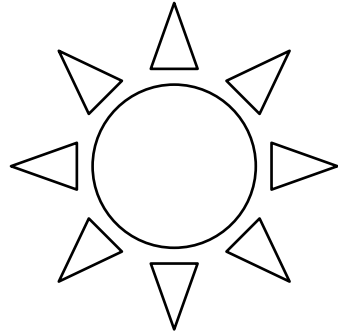
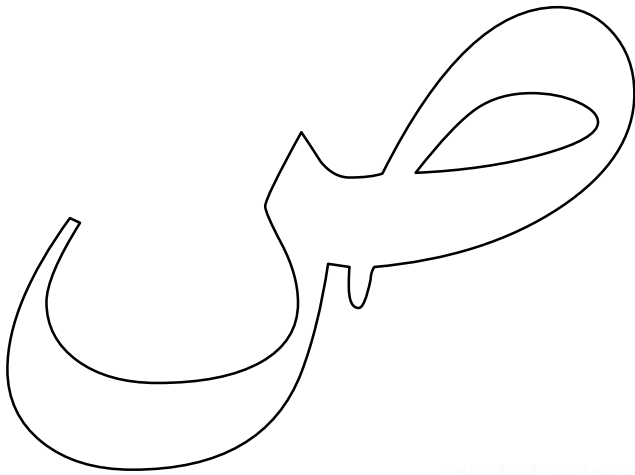



ض

ض ض ض ض ض

ض

ض ض ض ض ض

ط

ط

طفل



ط ط ط ط ط ط ط ط ط ط

ط ط ط ط ط ط ط ط ط ط

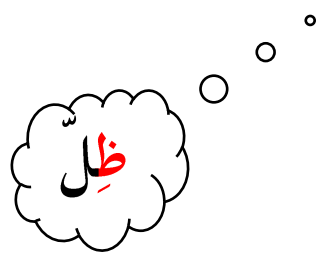
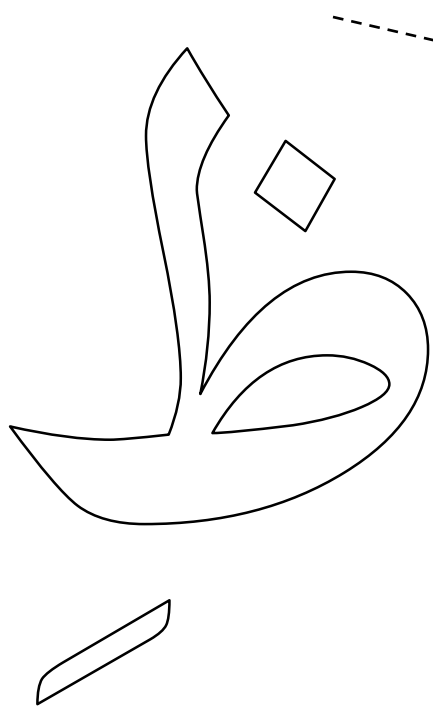

ظِ ظِ ظِ ظِ ظِ ظِ ظِ ظِ ظِ

ظِ ظِ ظِ ظِ ظِ ظِ ظِ ظِ

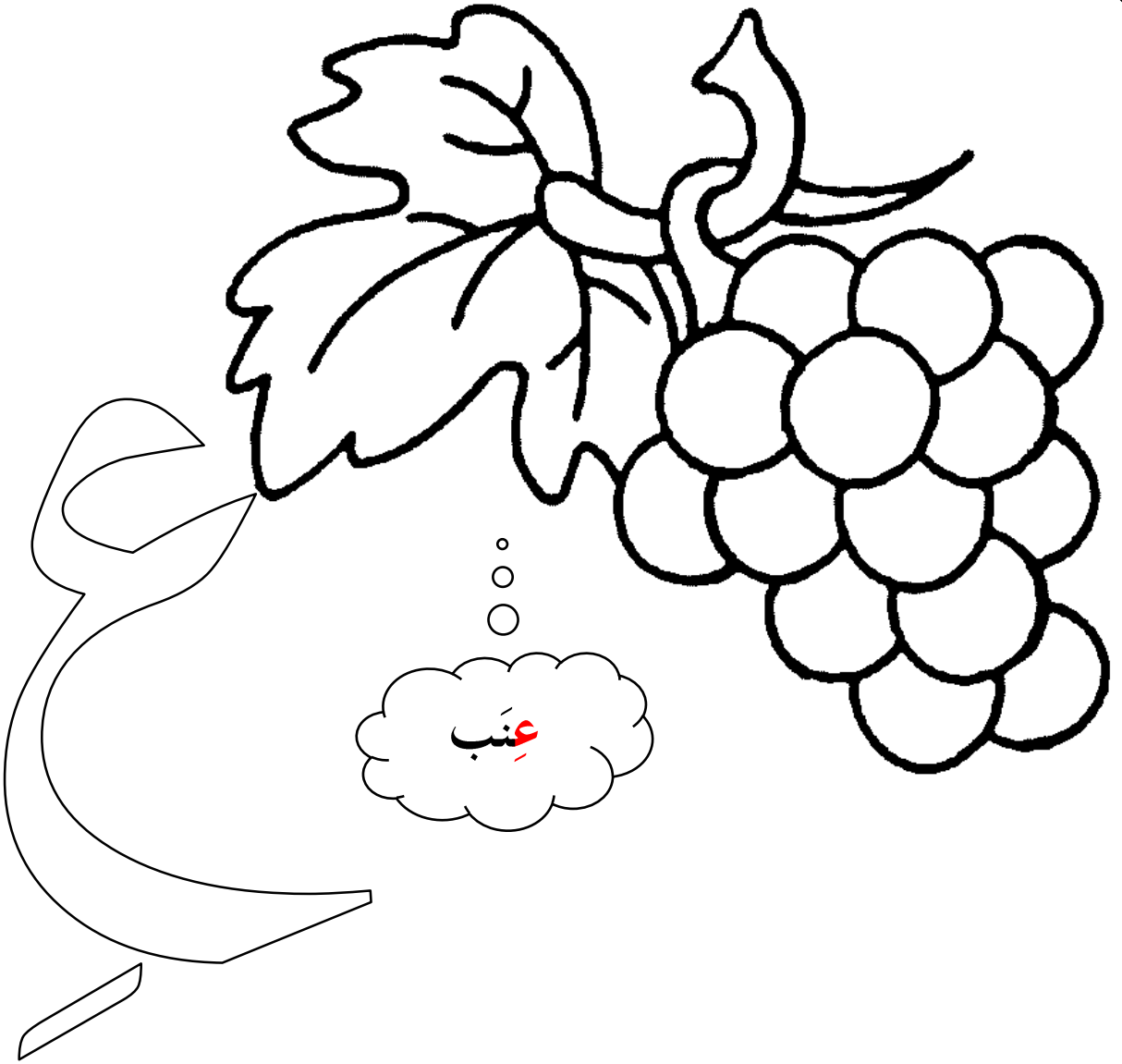

سنب سنب سنب سنب سنب سنب سنب سنب سنب

سنب سنب سنب سنب سنب سنب سنب سنب سنب

غلاف

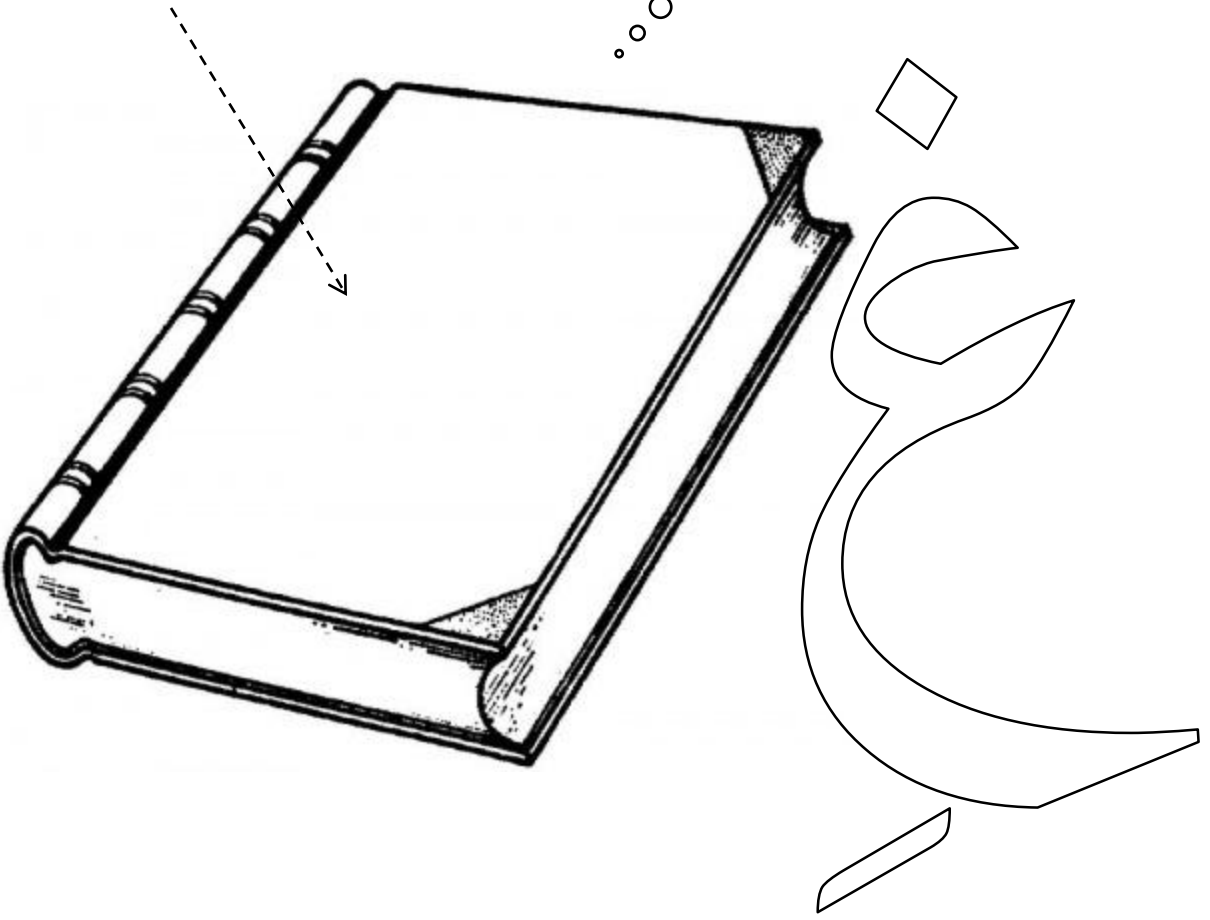

غلاف غلاف غلاف غلاف غلاف غلاف غلاف غلاف

غلاف غلاف غلاف غلاف غلاف غلاف غلاف غلاف

؟ الله أين

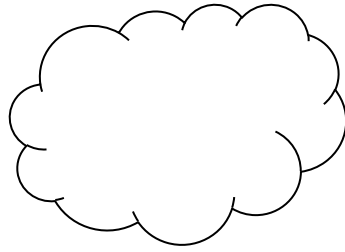
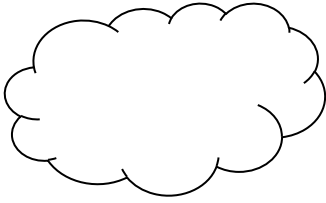

في السماء

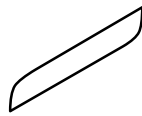
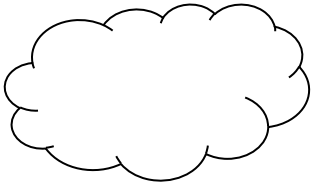
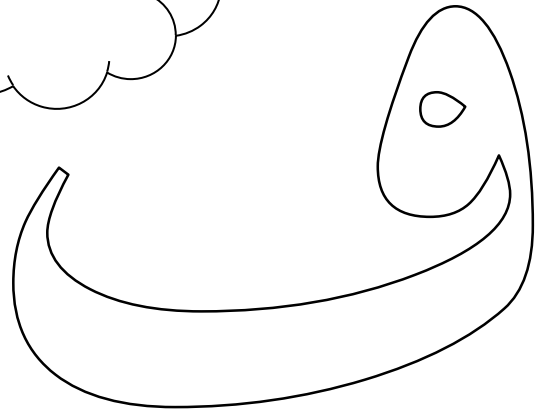

فِ فِ فِ فِ فِ فِ فِ

فِ فِ فِ فِ فِ فِ فِ

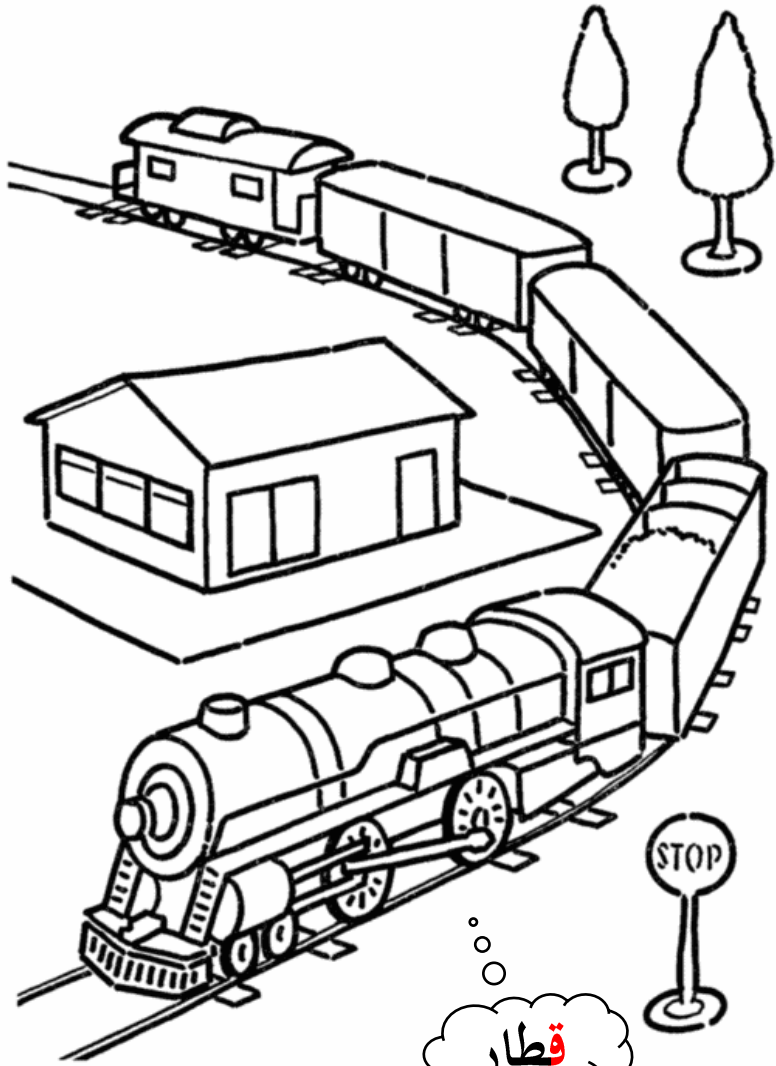
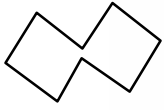
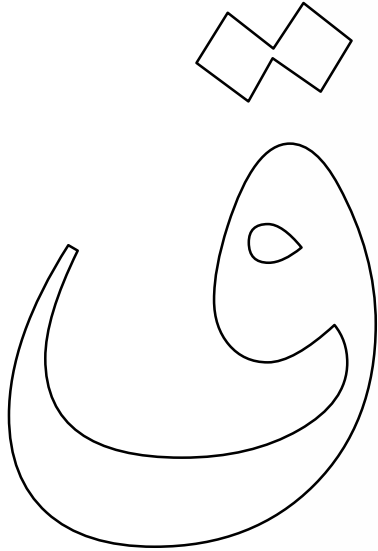

قطار

ق ق ق ق ق ق ق ق ق ق

ق ق ق ق ق ق ق ق ق ق

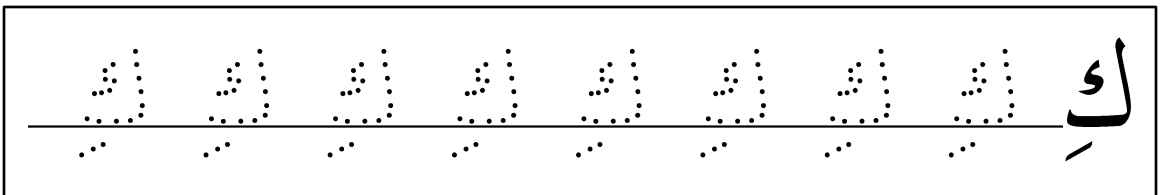
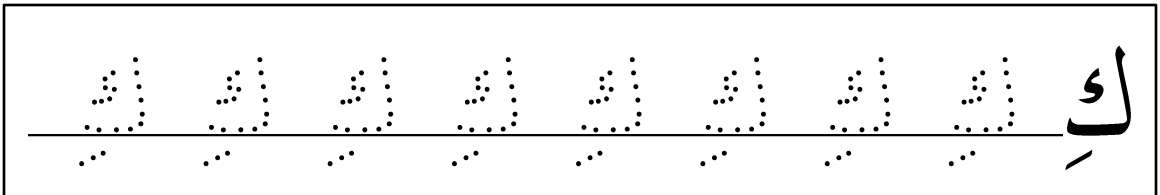
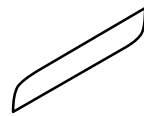
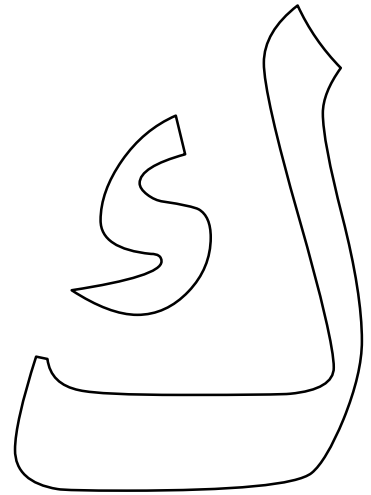
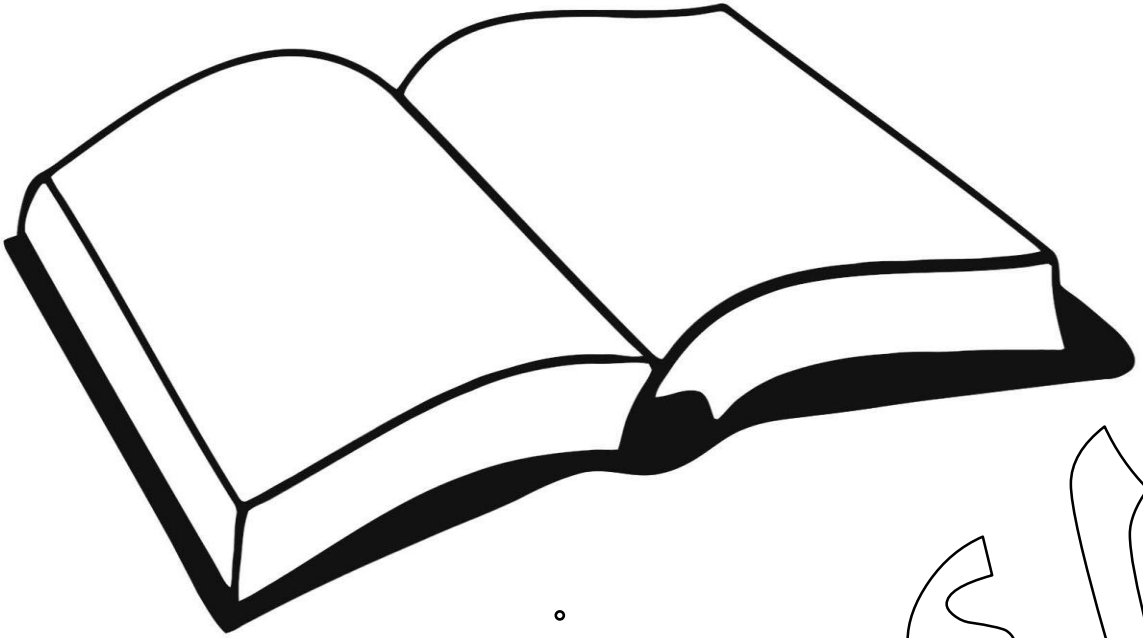

لسان

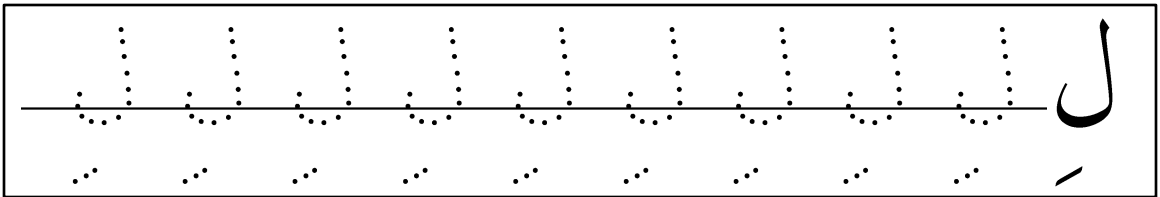
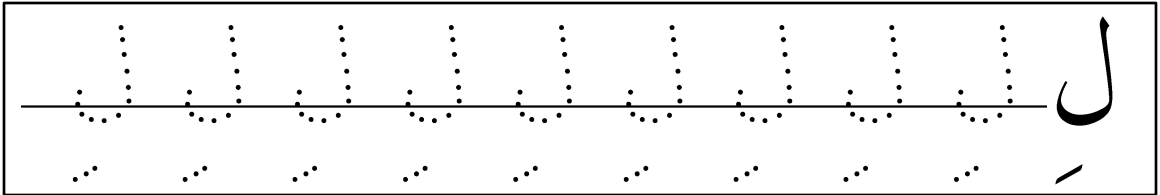
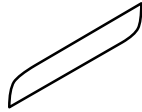
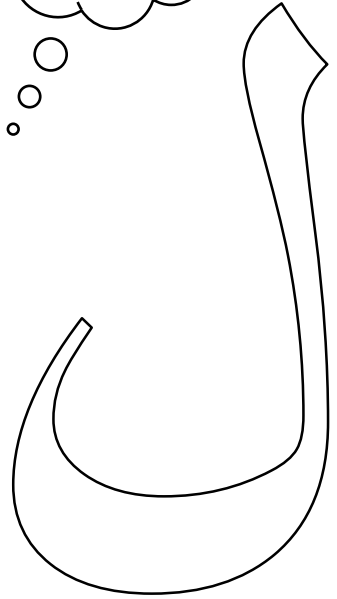
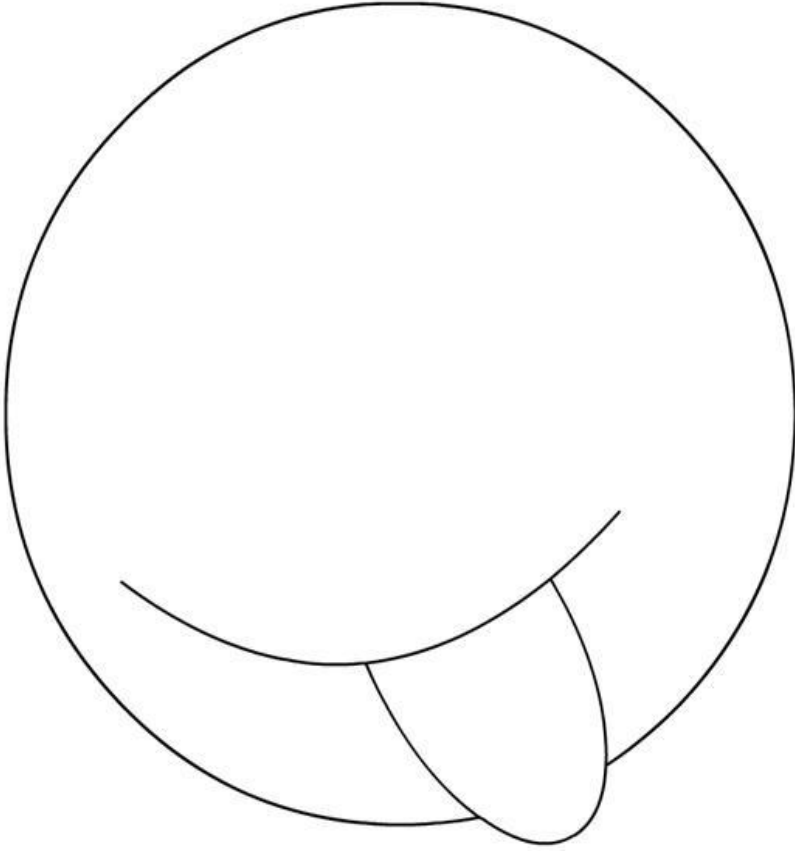

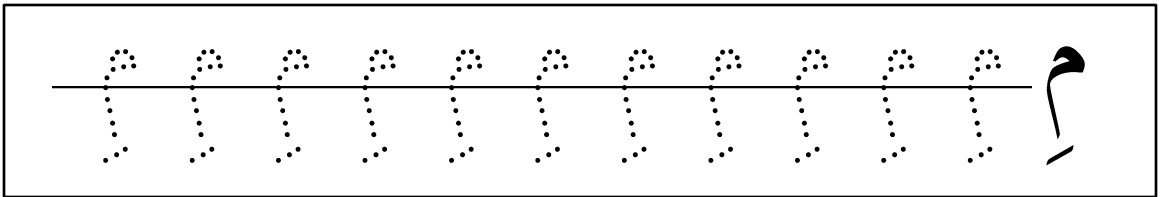
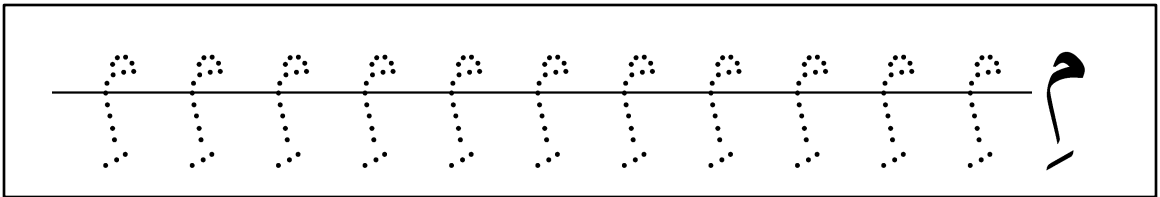
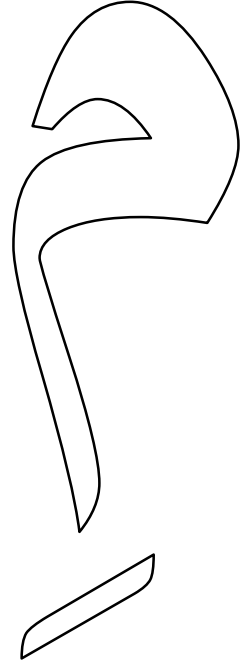
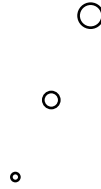
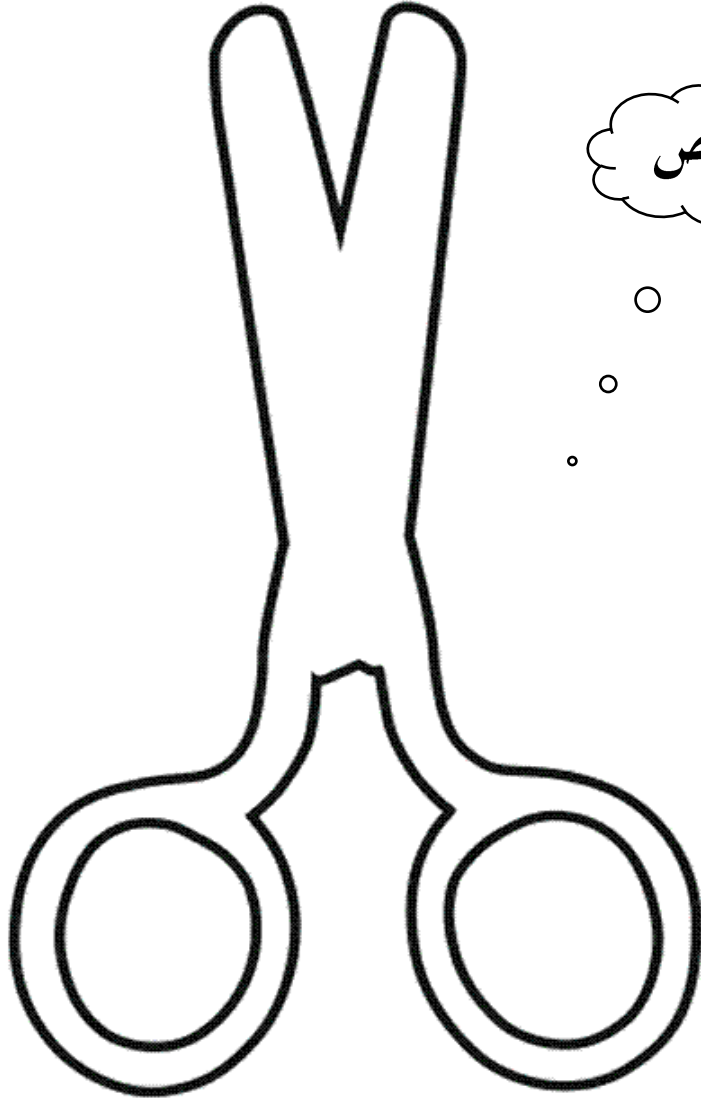

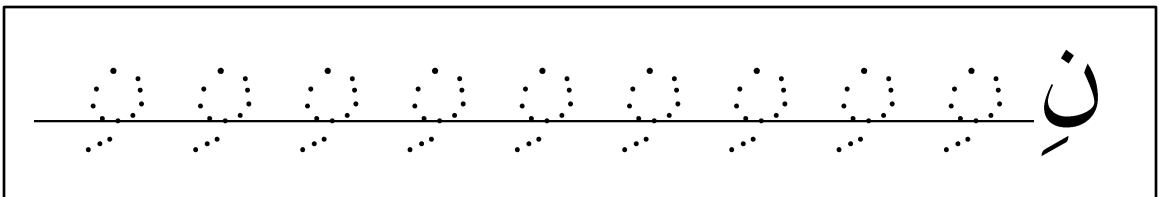
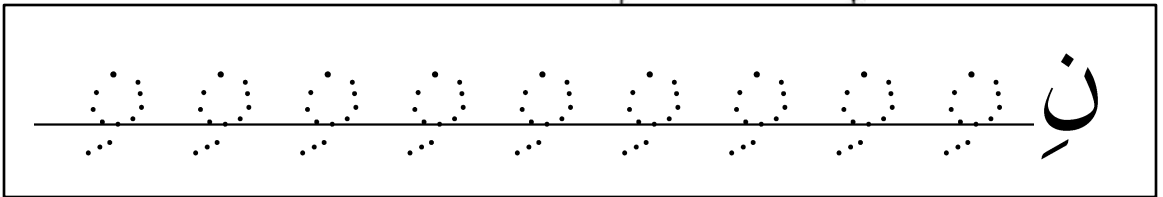
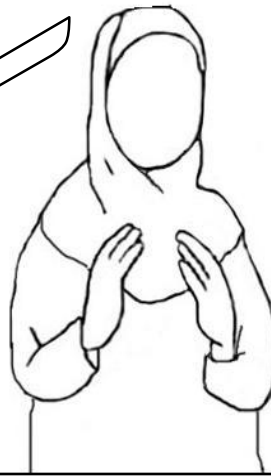
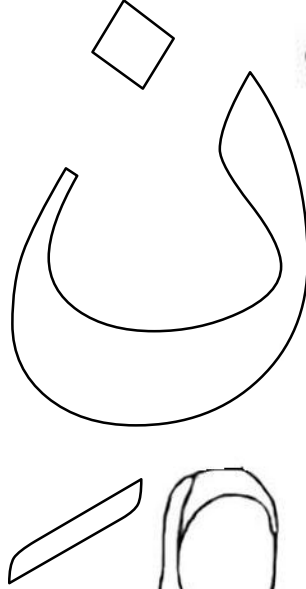

هلال

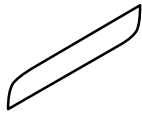
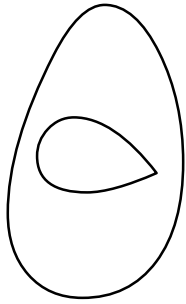

هلال

هلال

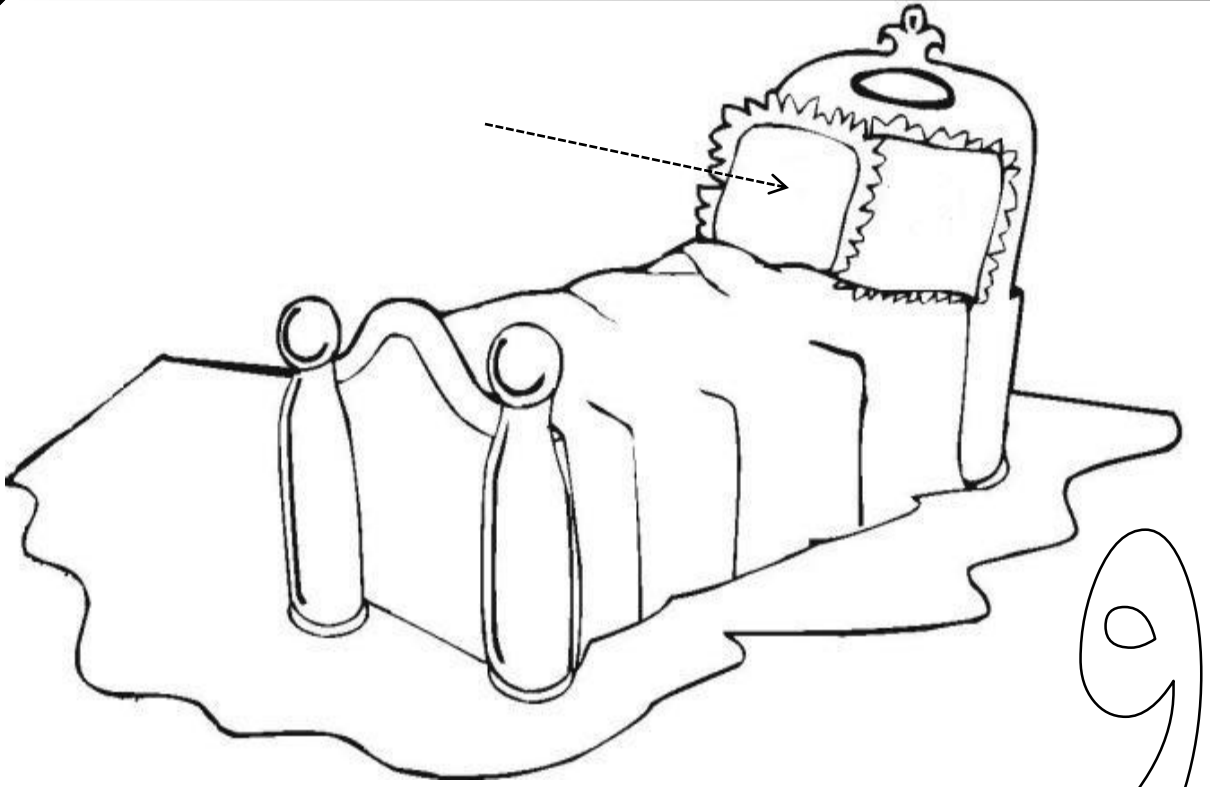

وسادة

