

# Super Help for Parade 1



Let's  
learn  
together  
unit 4, 5,  
6, 7, 8  
and 9...

Grade 1

# Unit 4 : My Clothes

---

- Match:



Unit 4 : My Clothes

---



- Count. Write. How many?

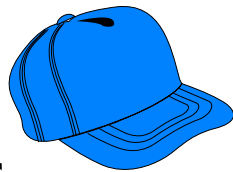
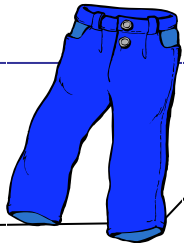

Unit 4 : My Clothes



- Count and write:



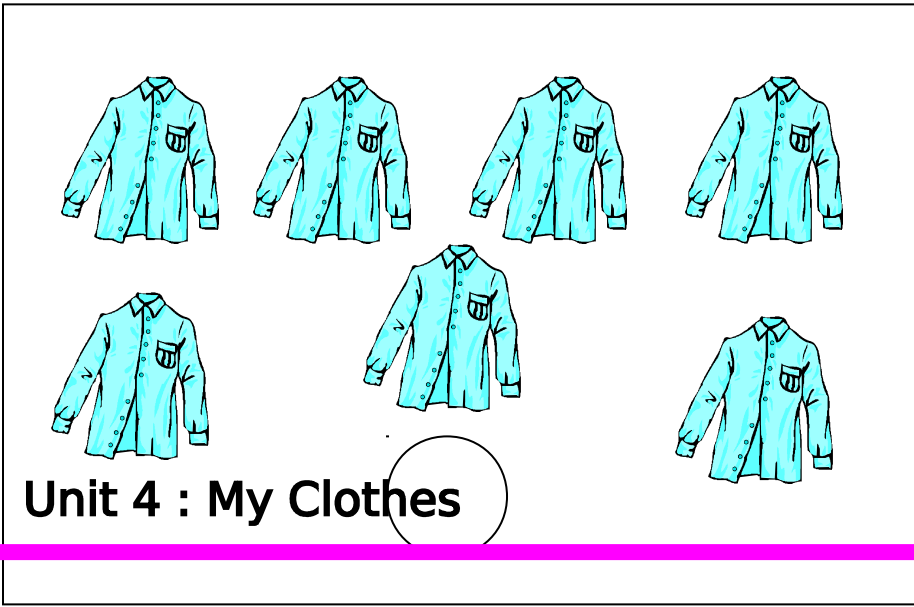
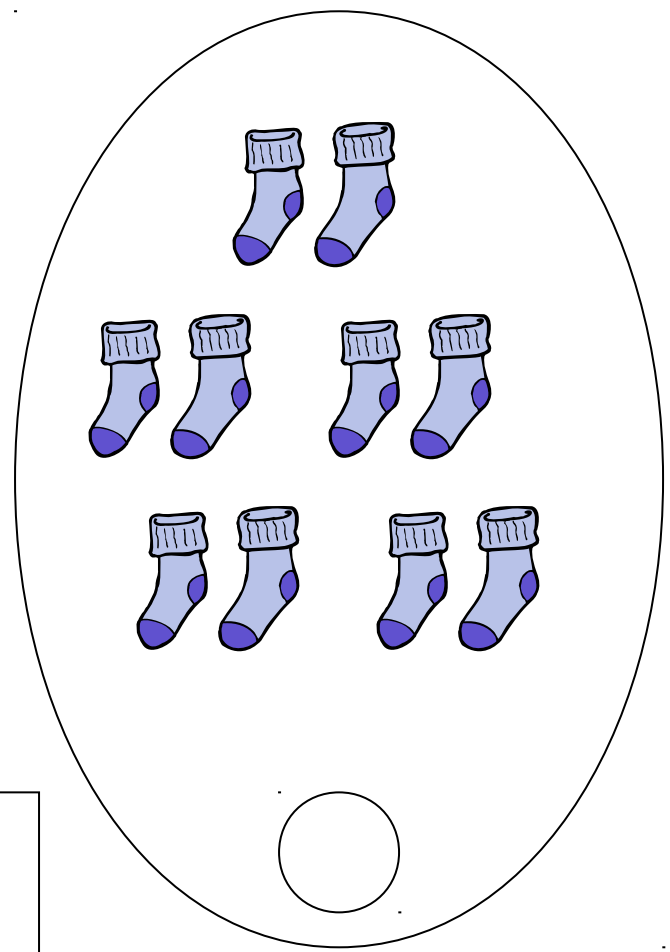
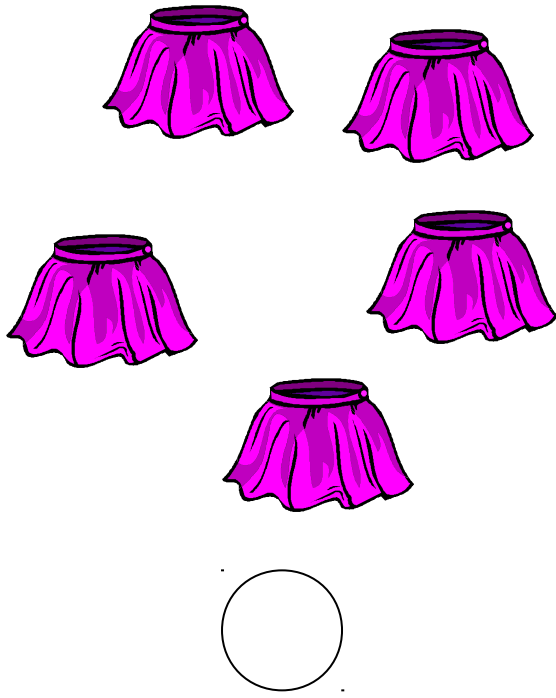

**Unit 4 : My Clothes**

**- Color:            1= purple            2= orange            3= red**



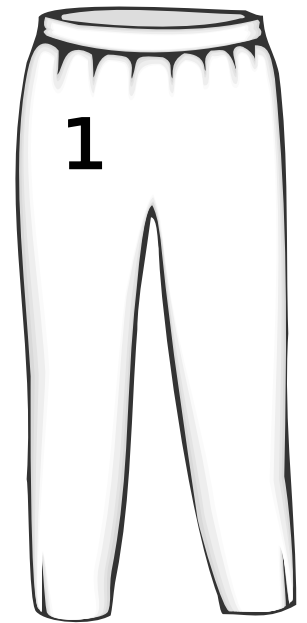
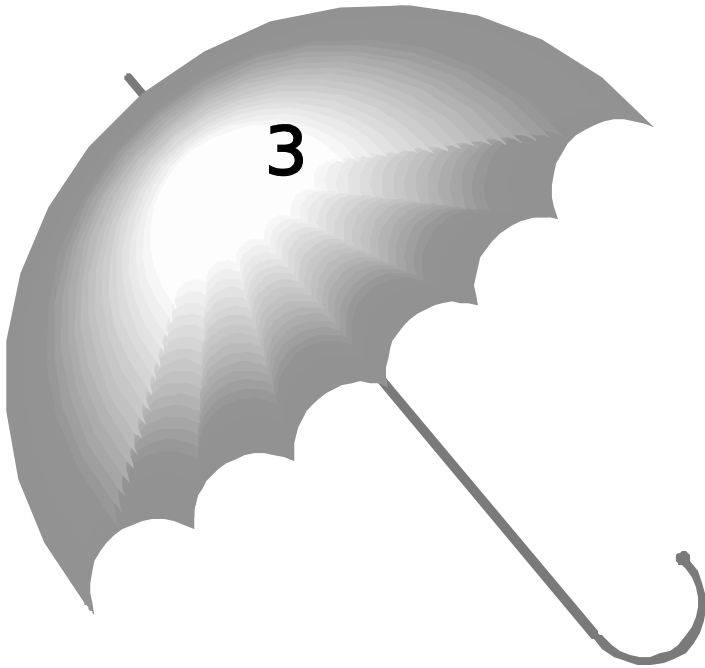
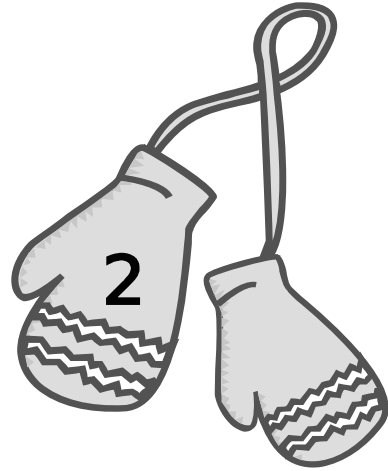
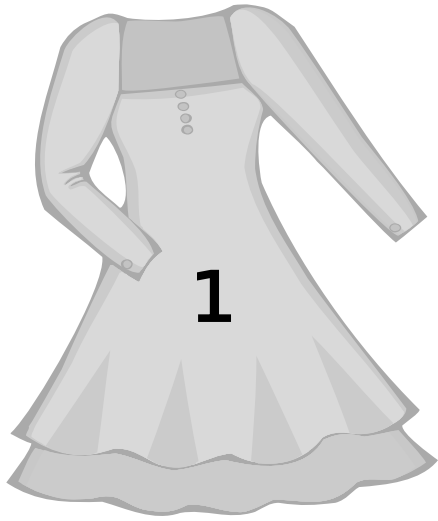

## Unit 4 : My Clothes



Read and circle:

- Circle the rectangle:

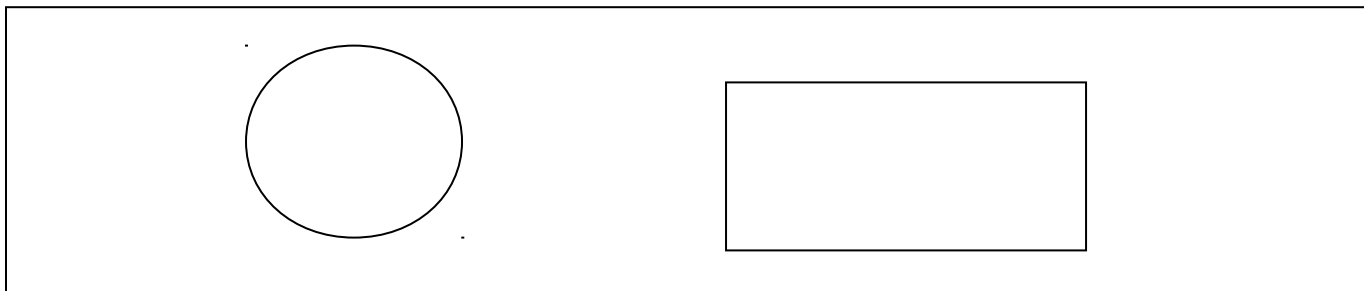

- Circle the triangle:

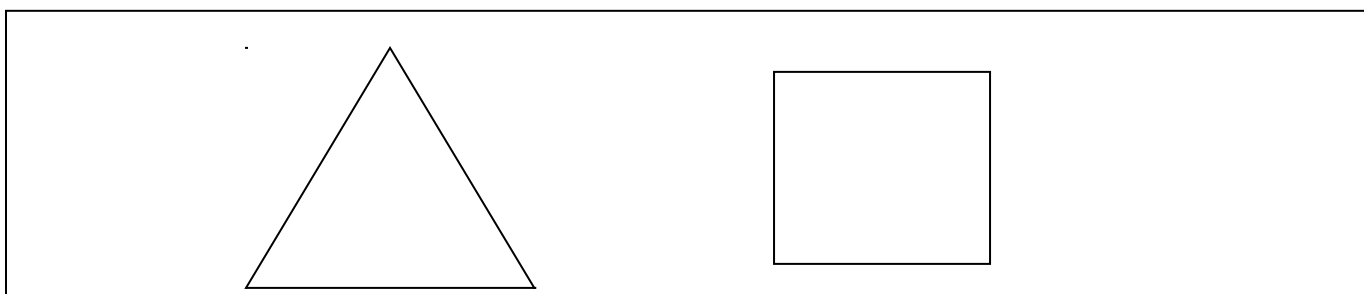

- Circle the jacket:



## Unit 4 : My Clothes

- Write the missing letter:



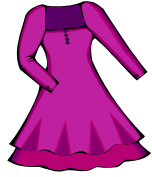

dr.....ss

shor.....



.....ocks



pa.....ts

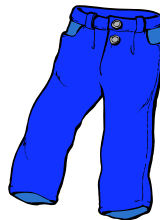

## Unit 5 : My Toys

- Color:

1= pink

2= white

3= yellow



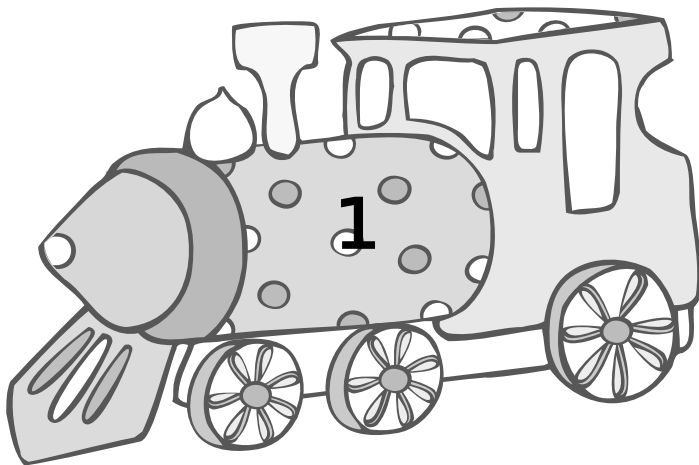
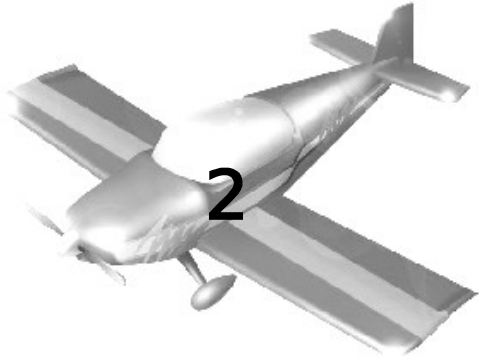

## Unit 5 : My Toys

- Count. Color:

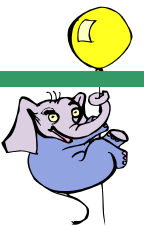



7

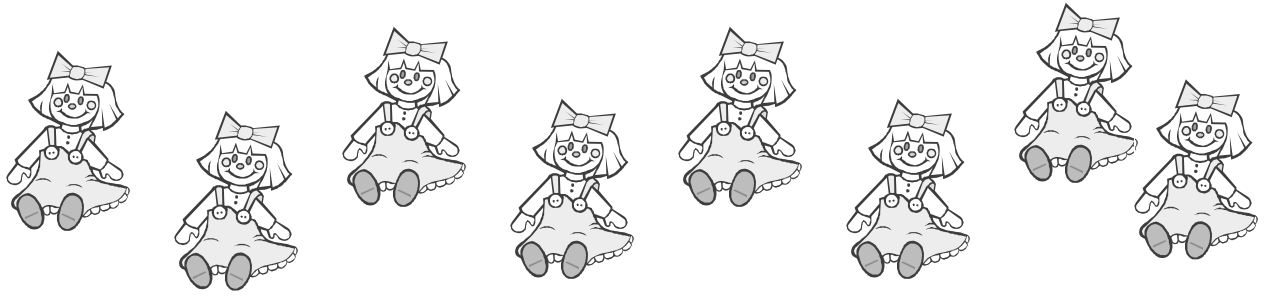

4

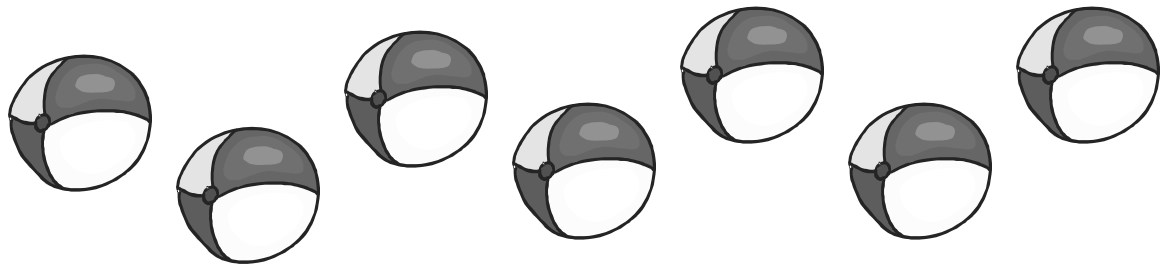

6

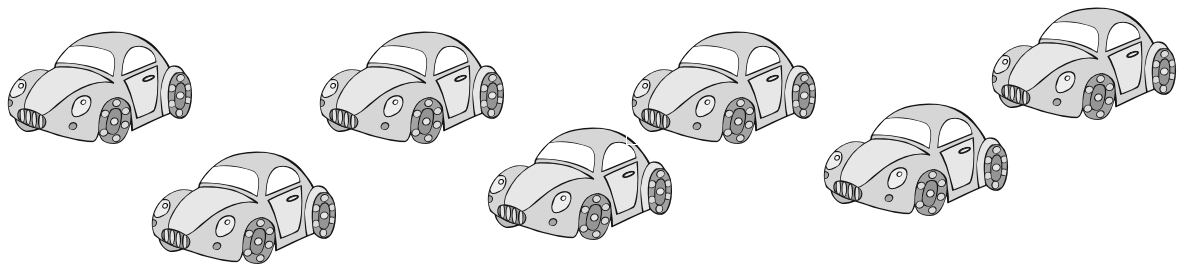

## Unit 5 : My Toys

- Read and match:

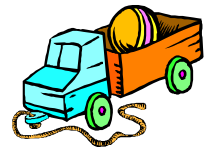
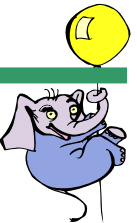

1. doll

2. ball

3. boat

4. car

5. truck

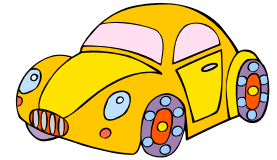
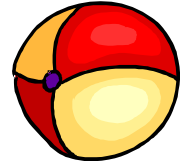

Unit 5 : My Toys

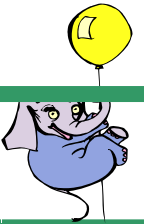

- Write the missing letter:

tra.....n

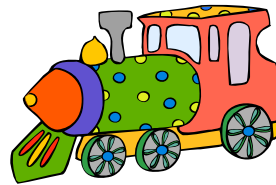

gam.....



.....histle

## Unit 6 : Helpers

---

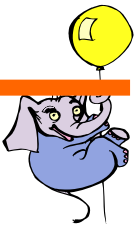

- Match:

---

1.

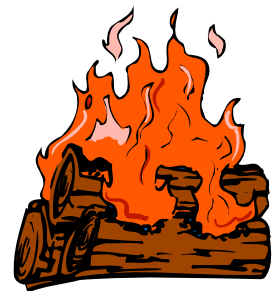

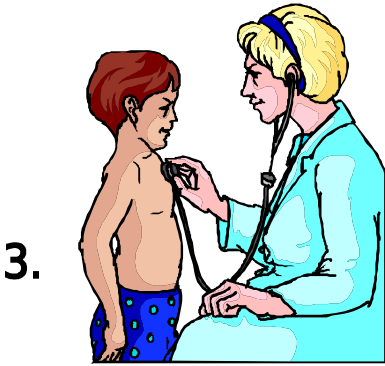
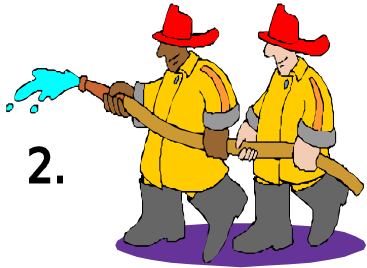

## Unit 6 : Helpers

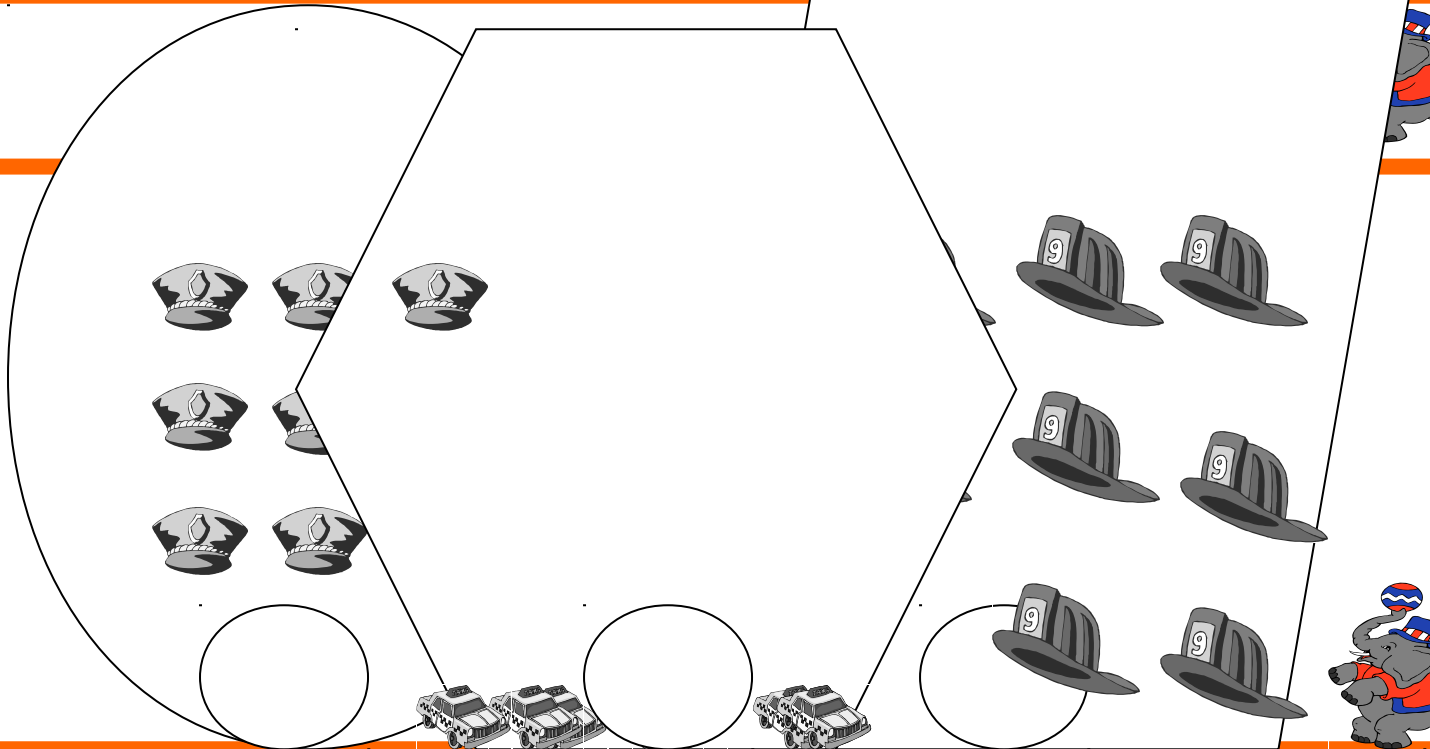

## Unit 6 : Helpers

---

- Match and color:

**1. taxi**

10



2. dentist

3. bus

4. nurse

5. ten

Unit 6 : Helpers



- Read and circle:

- Circle the taxi:

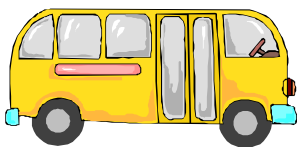

- Circle the firefighter:

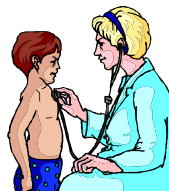

- Circle the dentist:



- Circle 8 circles:

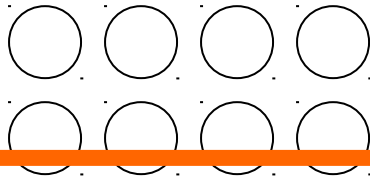

## Unit 6 : Helpers

Write the missing letter:



n.....rse

ta.....i



b.....s



do.....tor



