

Molecular Markers

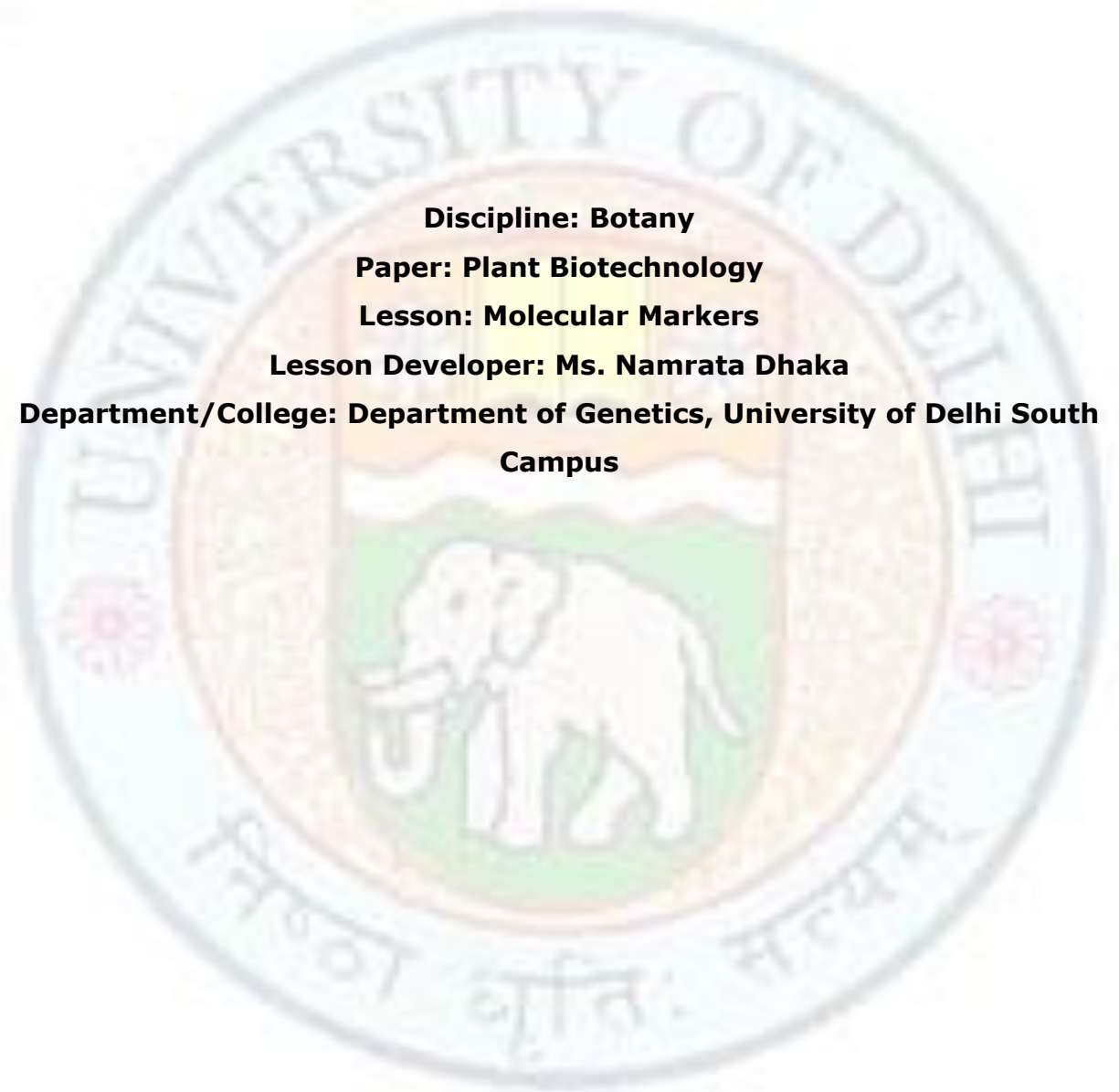

Discipline: Botany

Paper: Plant Biotechnology

Lesson: Molecular Markers

Lesson Developer: Ms. Namrata Dhaka

**Department/College: Department of Genetics, University of Delhi South
Campus**

Learning Outcomes

After reading this chapter, the readers should be able to understand the following:

- What are molecular markers?
- The basic terminology used with reference to markers like – polymorphism, dominant/codominant markers, indels, SNPs etc.
- Different types of marker systems.
- Hybridization based and PCR based markers.
- The principle, methodology and relative advantages and disadvantages of five most commonly used type of molecular markers – RFLP, RAPD, AFLP, SSR and SNP.
- Application of molecular markers, especially in context of plant breeding.



Table of Contents

Chapter: Molecular Markers

- **Introduction**
 - **Advantages of molecular markers over morphological and biochemical markers**
 - **How can we visualize DNA?**
 - **Types of molecular markers**
 - **Restriction Fragment Length Polymorphism (RFLP)**
 - Principle
 - Discovery
 - Method
 - Advantages
 - Disadvantages
 - **Random Amplified Polymorphic DNA (RAPD)**
 - Principle
 - Discovery
 - Method
 - Advantages
 - Disadvantages
 - **Amplified Fragment Length Polymorphism (AFLP)**
 - Principle
 - Discovery
 - Method
 - Advantages
 - Disadvantages
 - **Simple Sequence Repeats (SSR)**
 - Principle
 - Discovery
 - Method
 - Advantages
 - Disadvantages
 - **Single Nucleotide Polymorphism (SNP)**

Molecular Markers

- **Principle**
- **Method**
- **Advantages**
- **Disadvantages**
- **Comparison of different molecular marker systems**
- **Applications of molecular markers**
 - **Mapping genes of interest**
 - **Marker assisted breeding**
 - **Assessment of genetic diversity**
 - **DNA fingerprinting**
- **Summary**
- **Exercise/ Practice**
- **Glossary**
- **References/ Bibliography/ Further Reading**

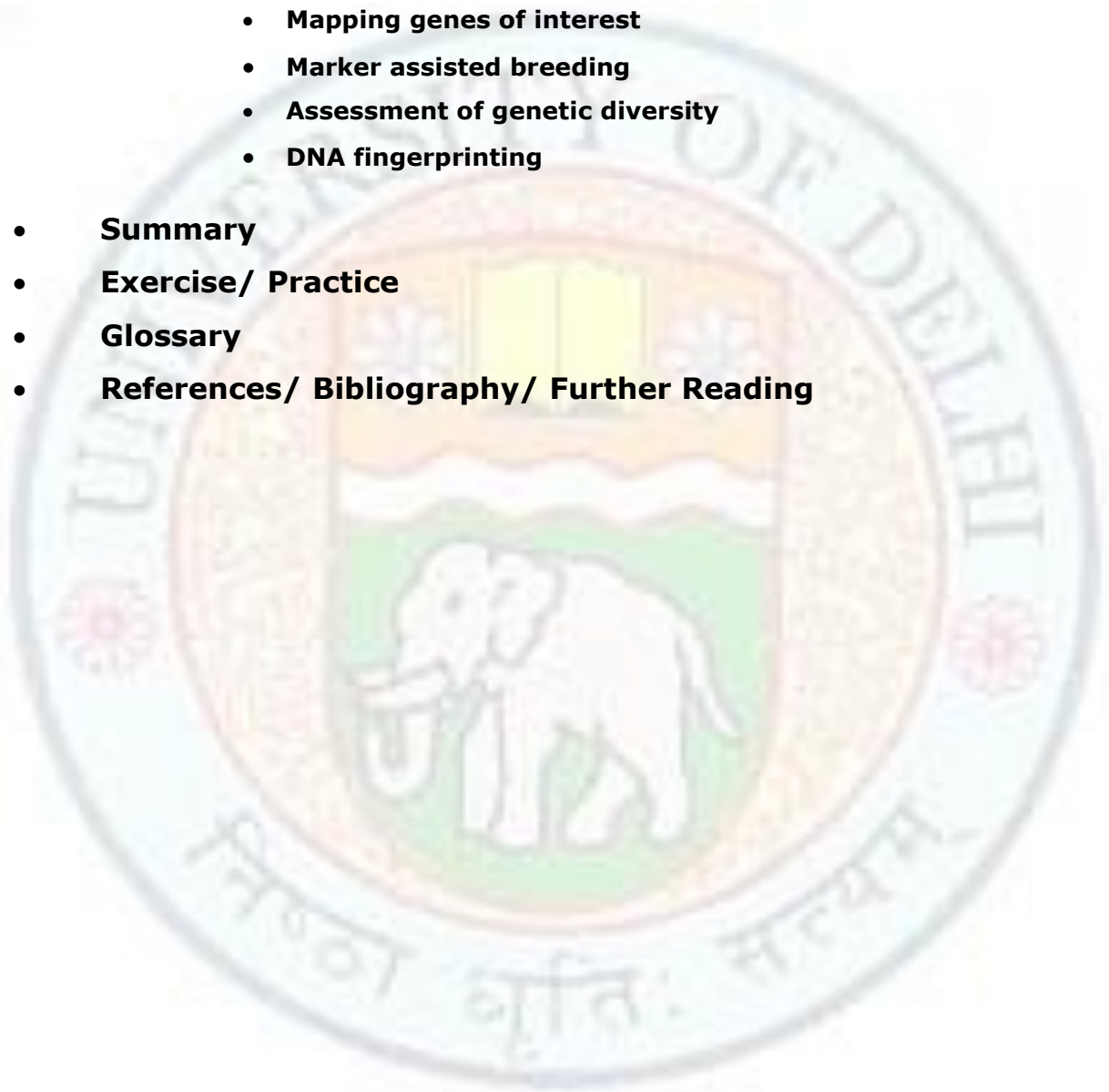

Introduction

Often, you may have come across a situation where a passer-by asks you the way to reach a particular location. The way you generally answer them is through the help of certain landmarks and directions. For example, you may answer somewhat in this manner - you say, go straight take left from the school building, go straight till the traffic light signal, take right and then take a second right from under the flyover and if you go straight a little further, you shall reach your destination. In this case, you have used 'school building', 'traffic light signal' and 'flyover' as landmarks to help the passer-by to reach his destination. In a similar way, in biology, one may define such landmarks called as 'markers' to characterize individuals or differentiate between any two individuals, for various research purposes especially plant and animal breeding, human genetics and forensics.

The question that arises next is – what are we actually trying to 'mark' with these 'markers'? Markers are basically used to find the locations of genes of interests. The exact purpose and the overall methodology employing the markers to find a desired gene in any organism vary according to the different research goals. We shall discuss ahead, what are the various applications of markers.

Taking the concept ahead, the next question that may arise in your mind is what is the exact nature of these markers? What are they actually – chemicals, molecules or any other attribute? Practically, any trait which exhibits variation between individuals can be used as a marker. Markers may be -

- Morphological – Any trait visible to naked eye, example, plant height, flower color, fruit shape and so on.
- Biochemical – Allozymes (isozymes) which are structurally different forms of the same enzyme.
- Molecular – DNA markers. (allozymes are proteins, they may also be grouped as molecular markers but these days, the term 'molecular markers' is synonymously used for DNA markers and therefore allozymes are separately referred to as biochemical markers). These DNA markers are essentially nothing but the landmarks on the genome of an individual, which can be visualized through various techniques to detect differences between small stretches of DNA of any two individuals.

Advantages of molecular markers over morphological and biochemical markers

- Molecular markers are abundant while biochemical markers are very few and morphological markers still fewer in number and insufficient for using for breeding purposes.
- Morphological and biochemical markers are subject to variation due to environmental factors while molecular markers are not.
- Biochemical markers may show tissue specificity while molecular markers show no such bias.
- Morphological markers are affected by epistasis while molecular markers are not.
- Molecular markers can exhibit high polymorphism compared to the other types of markers.

In this chapter, we shall focus on the DNA markers, also referred to as molecular markers and try to understand their nature, various techniques applied to generate markers and their advantages and disadvantages and applications of molecular markers.

How can we visualize DNA?

Since molecular markers are derived from DNA and the purpose of developing markers is to look at differences between individuals, species or populations, it is essential to be able to visualize DNA, only then can we infer the genotype of an organism and compare it with that of the others.

A simple way in which we can do this is depicted in the figure ahead. The genomic DNA of an organism can be extracted using specific protocols. From the total genomic DNA, a small stretch of DNA can be amplified and visualized by loading the amplified product onto agarose gels to determine the differences between any two or more genotypes. The details of various techniques that allow this to be done are given ahead in the chapter.

Molecular Markers

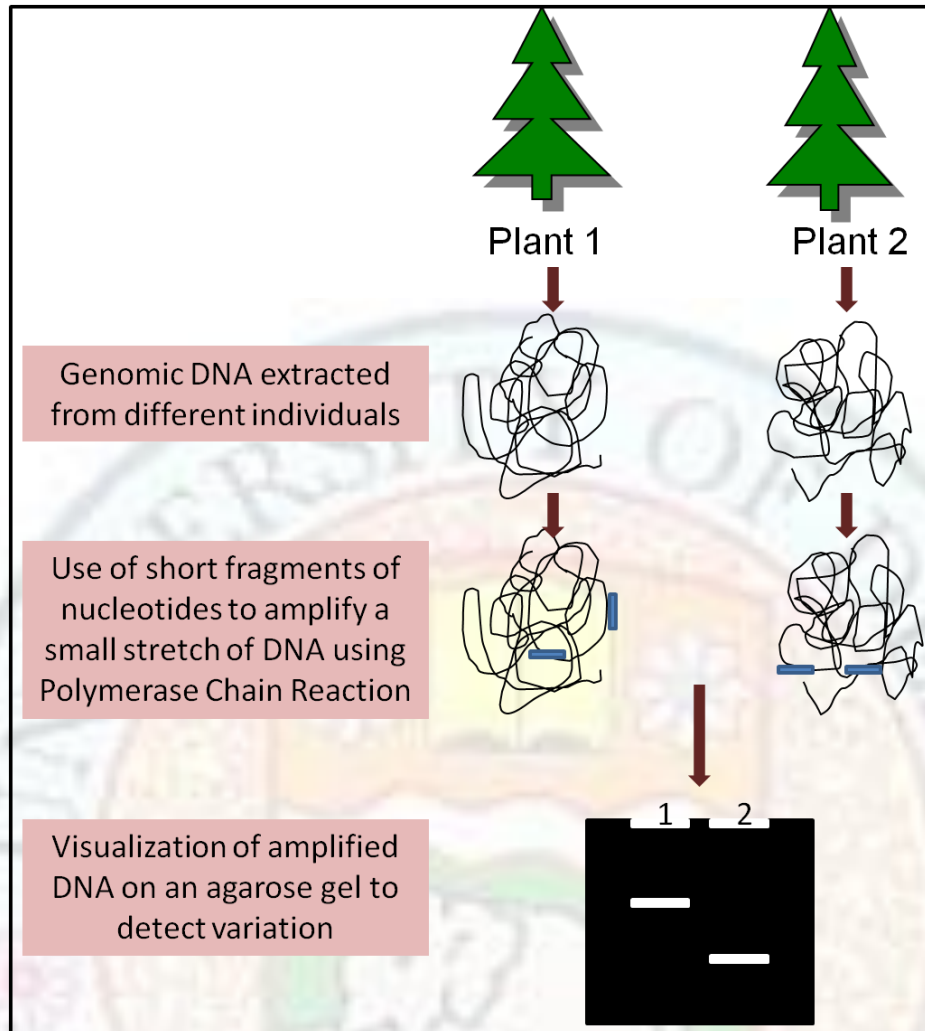

Figure: Overview of steps involved in detecting the genotype of plants with respect to PCR based molecular markers.

Source: Author

Visit page

<http://www.dnalc.org/resources/animations/dna-barcoding.html>

THE BASIS FOR DEVELOPING MOLECULAR MARKERS IS GENETIC DIVERSITY

Molecular markers are designed to capture mutations in the DNA sequences. What is the nature of genetic variation created by mutations? These nucleotide changes may be limited to a single base or to a larger stretch of DNA.

Consider the following sentences.

1. THE CAT RAN **VERY** FAST.
2. THE CAT RAN **VERY VERY** FAST.
3. THE CAT RAN FAST.
4. THE CAT RAN **EXTREMELY** FAST.

1. and 2. – An extra word is added (**INSERTION**).

1. and 3. – A word is omitted (**DELETION**).

1. and 4. – A different word is incorporated (**SUBSTITUTION**).

All the sentences essentially state the same fact but they have some changes which make them different from each other.

Similar may be the case with nucleotide sequence changes, for example,

INSERTION

.....AATCGGGCCTAAGCTAGCCTAA.....

.....AATCGGGCCTAAT**T**GCTAGCCTAA..... SINGLE BASE INSERTION

.....AATCGGGCCTAAT**TAA**GCTAGCCTAA..... REPEAT UNIT INSERTION

DELETION

.....AATCGGGCCTAAGCTAGCCTAA.....

.....AATCGGGCCT**AG**CTAGCCTAA..... SINGLE BASE DELETION

.....AATCGGGC**CG**CTAGCCTAA..... REPEAT UNIT DELETION

SUBSTITUTION

.....AATCGGGCCTAAGCTAGCCTAA.....

.....AATCGGGCCTA**C**GCTAGCCTAA.....

IMPORTANT TERMS TO KNOW IN ORDER TO UNDERSTAND MOLECULAR MARKERS

Polymorphism

A marker is polymorphic if it shows different profiles in different individuals otherwise it is monomorphic (not polymorphic). For example, in the gel picture shown ahead, individuals 1 and 3 are polymorphic while individuals 1 and 2 are not polymorphic.

Allele

Alleles are alternative forms of a gene. A diploid organism is homozygous for a particular gene if it contains the same alleles for a gene e.g. AA or aa and heterozygous if it contains different alleles e.g. Aa.

Length/presence – absence polymorphism

If polymorphism is visualized as differences in size of the bands as obtained after gel electrophoresis, it is length polymorphism. It usually results due to large insertions or deletions. If polymorphism results due to either absence or presence of band, it is the latter kind of polymorphism. This may result due to point mutations which cause failure of primer binding and PCR amplification.

Codominant or dominant

A marker is called codominant if it can differentiate between homozygotes and heterozygotes and dominant if it is unable to do so. For example a length polymorphism, as shown below in the figure (a), shows a codominant marker. Both types of alleles are detected as bands of different length. While (b) shows a dominant marker which exhibits presence – absence polymorphism. Here only one type of allele can be amplified while the other cannot be amplified therefore; we cannot distinguish between homozygotes and heterozygotes.

Molecular Markers

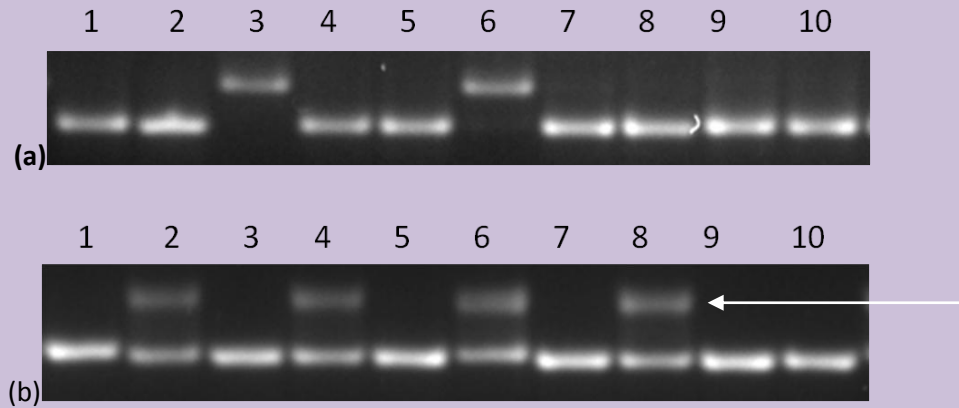

Figure: Agarose gel electrophoresis profile of two different molecular markers used to test 10 different individuals. (a) a codominant marker, (b) a dominant marker (see arrow). The lower band in this case is a monomorphic band that has amplified in all the individuals.

Source: Author

Types of molecular markers

With rapid advancements in the field of molecular biology today, there are a great number of the types of molecular markers available. If all are simply listed, the beginners might feel inundated with numerous techniques available. Therefore, it is best to understand the types of markers as based on the classification based on their methodology.

Molecular Markers

First generation markers (Based on hybridization)	Second generation markers (Based on PCR)	Third generation markers (Based on DNA Sequencing)
<ul style="list-style-type: none"> • Restriction Fragment Length Polymorphism (RFLP) 	<ul style="list-style-type: none"> • Random Amplified Polymorphic DNA (RAPD) • Amplified Fragment Length Polymorphism (AFLP) • Simple sequence repeat (microsatellite) (SSR) • Variable number tandem repeat (minisatellite) (VNTR) • Sequence characterised amplification region (SCAR) etc. 	<ul style="list-style-type: none"> • Single nucleotide polymorphism (SNP)

Figure: Types of molecular markers based on chronology of different types of technique for marker detection.

Source: Author

Molecular markers may be broadly classified into three categories in the chronological order of their development.

- First Generation of markers was the hybridization based markers. These are so called because the DNA profile is visualized through hybridization of DNA with radioactively labeled probes of known sequence.
- The second generation of markers were the PCR based markers, as their assay was carried out through amplification using either arbitrary or sequence specific primers.
- The third generation markers are the most recent ones, called as SNPs. Their detection requires sequence information. With the advancement in the field of DNA sequencing, SNPs have become very popular in the last few years.

Some of the above mentioned markers have been explained ahead in detail.

1. Restriction Fragment Length Polymorphism (RFLP)

Principle

The restriction enzymes recognize and cut DNA at specific sites called restriction sites. Polymorphism can be detected if there is any variation in any two individuals at the restriction sites of any particular restriction enzyme. Such polymorphism can be visualized as variation in length after cutting the DNA with the enzyme and carrying out Southern blotting.

Discovery

RFLP was the first molecular marker system to be used. Its application was first shown by Botstein et al., in 1980 for linkage mapping in humans. Later, it was a widely accepted system for use in plants.

Method

RFLP analysis involves digestion of DNA by restriction enzyme followed by separation of the fragments using agarose gel electrophoresis and detection by Southern hybridization using a labeled probe.

Molecular Markers

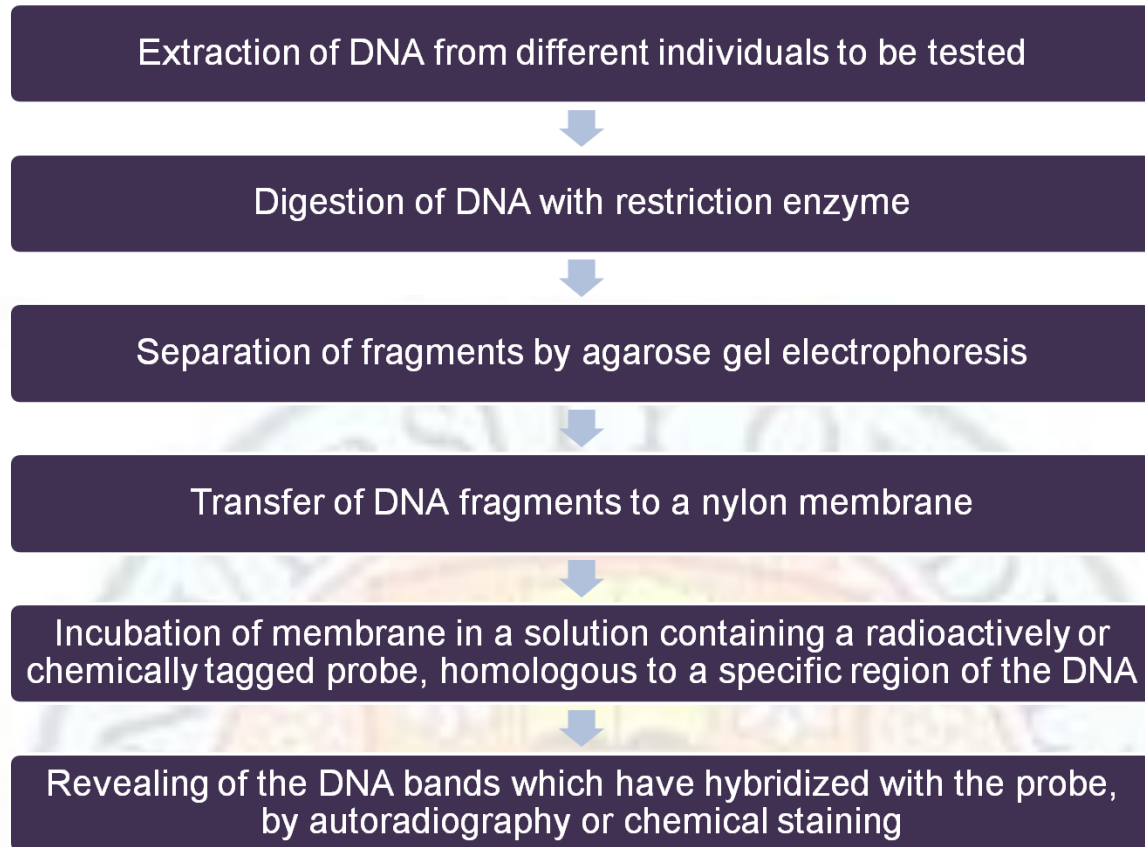

Figure: Overview of different steps involved in RFLP analysis.

Source: Author

Visit page

<http://www.dnai.org/>

<https://www.youtube.com/watch?v=Z1rkIKPv81E>

Molecular Markers

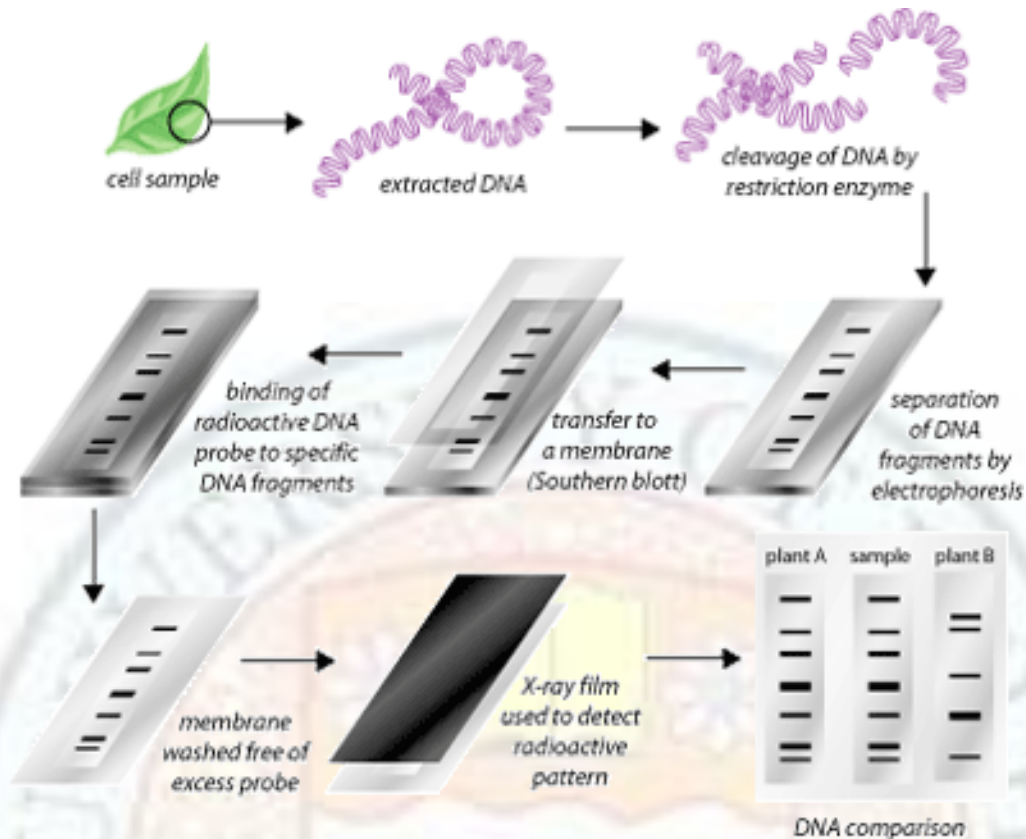

Figure: Method of RFLP analysis

Source: <http://www.scq.ubc.ca/dna-fingerprinting-in-the-standardization-of-herbs-and-nutraceuticals/>

As discussed before, DNA sequence may be altered in different individuals due to mutations. Even single nucleotide changes can alter the restriction sites (new restriction sites can be created and the older ones can be disrupted). Therefore, the patterns of restriction digestion can be different in different individuals, resulting in detection of polymorphism. Also, large insertions and deletions (also called Indels) can occur which cause length polymorphism.

Molecular Markers

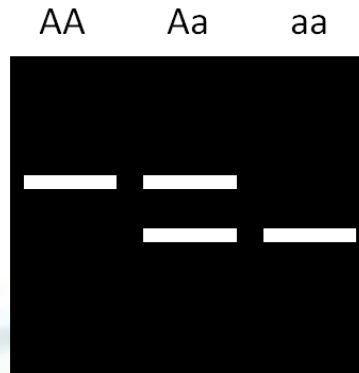

Figure: An example of pattern of southern hybridization generated after the RFLP process, in case where a single probe is used for DNA of three different plants. First lane shows that the individual is homozygous for the larger size allele. Third lane shows individual homozygous for the smaller allele and the second lane shows the heterozygous condition.

Source: Author

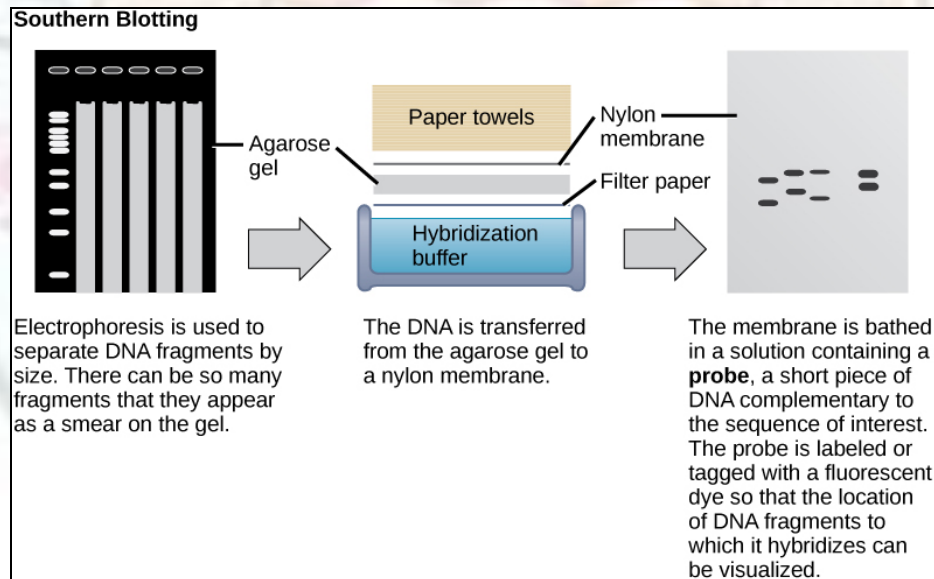

Figure: Steps involved in Southern hybridization

Source: <http://cnx.org/content/m44552/latest/?collection=col11448/1.9>

Molecular Markers

Advantages

- It is a codominant marker.
- The results are highly reproducible.

Disadvantages

- The process is long and tedious.
- Large amount of DNA is required.
- Use of radioactively labeled probes.

These disadvantages can be overcome using PCR based markers.

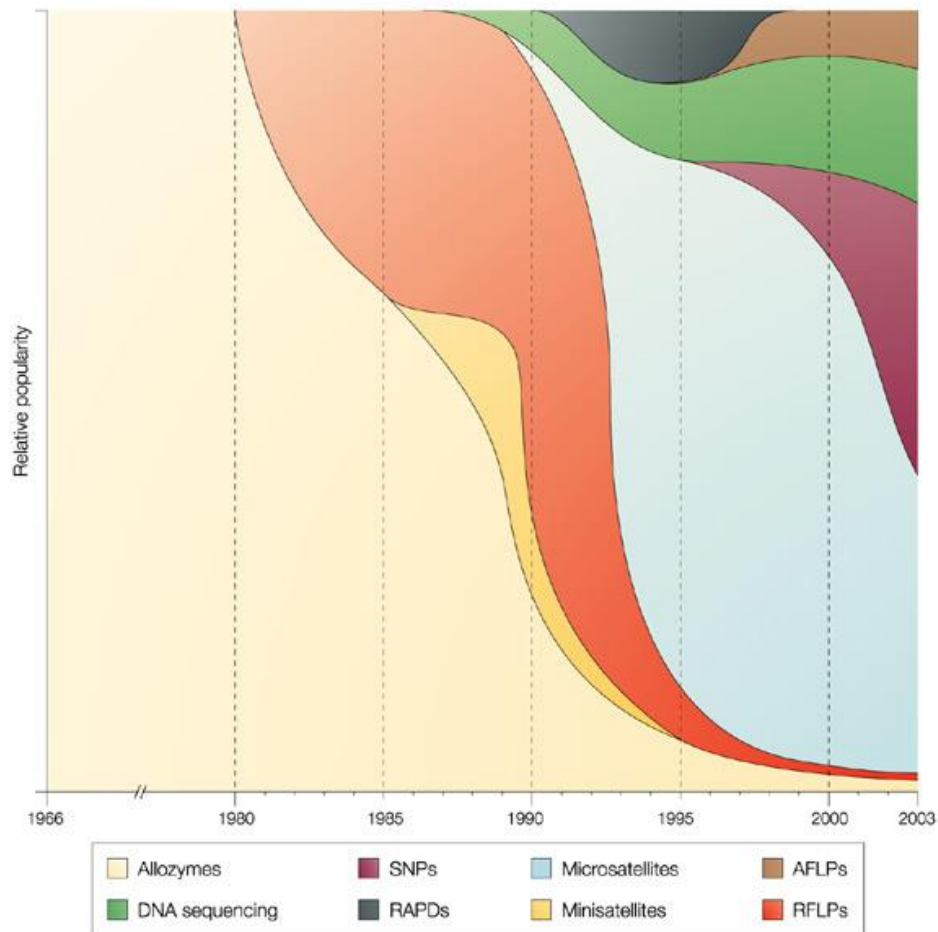

Figure: Image showing changing relative importance of different types of molecular markers with time.

Source: Schlötterer, Christian. "The evolution of molecular markers—just a matter of fashion?" *Nature Reviews Genetics* 5.1 (2004): 63-69.

Molecular Markers

Polymerase Chain Reaction

It is a technique used for *in vitro* amplification of specific DNA sequences using a small stretch (generally 18 – 25 nucleotides long) of complimentary oligonucleotides called primers. Amplification of a desired region of the genomic DNA can be carried out in an exponential manner.

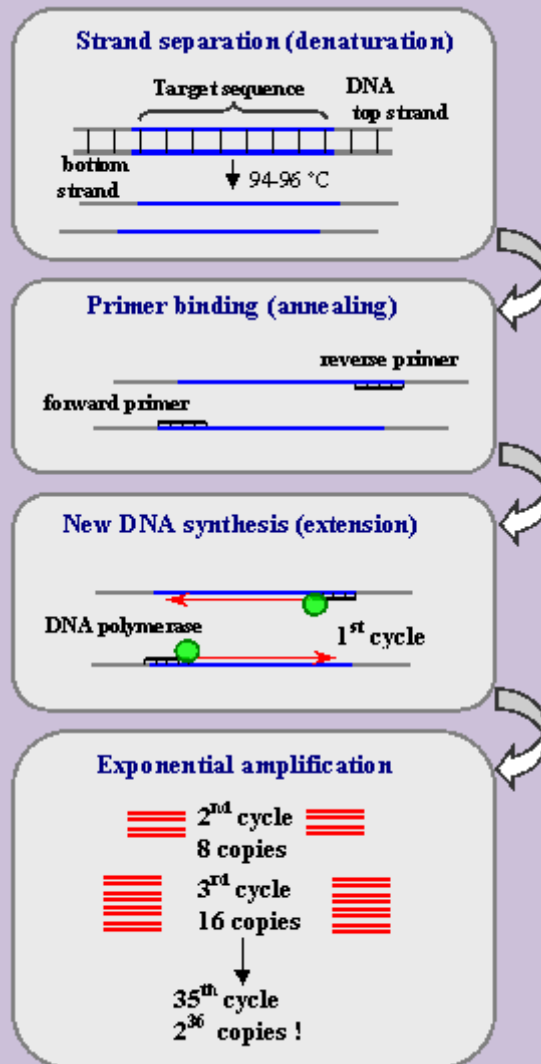

Figure: Steps in a Polymerase Chain Reaction

Source:

<http://www.ncbi.nlm.nih.gov/projects/genome/probe/doc/TechPCR.shtml>

Visit following pages for more details about PCR

<http://www.dnalc.org/resources/3d/19-polymerase-chain-reaction.html>

PCR virtual lab -

<http://learn.genetics.utah.edu/content/labs/pcr/>

2. Random Amplified Polymorphic DNA (RAPD)

Principle

If the length of primers used for PCR, is shorter (9-10nt) than that normally used (18-25nt) and their sequence is arbitrary and the amplification is not done under stringent conditions, several loci are amplified which are unique for a genotype and can be used for detection of polymorphism.

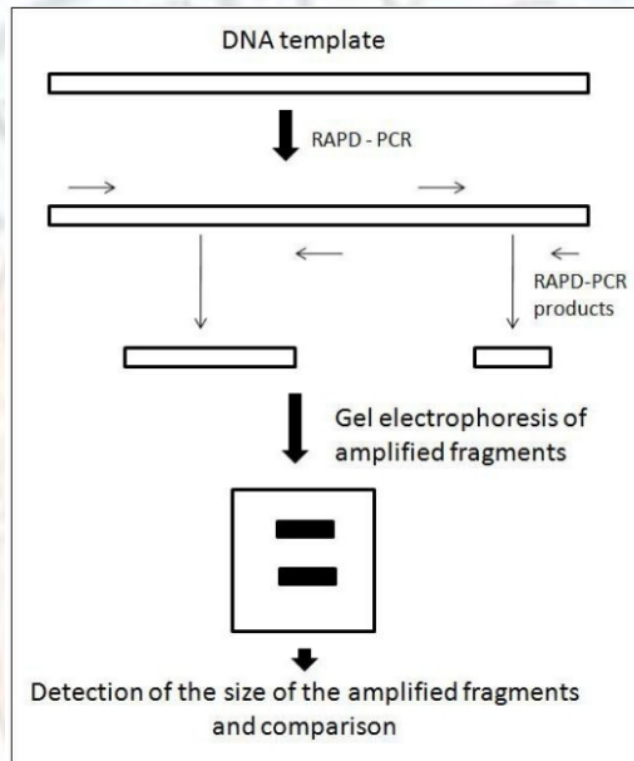

Figure: Principle of RAPD analysis

Source: http://openi.nlm.nih.gov/detailedresult.php?img=2885095_ijms-11-02079f4&req=4

Arif, Ibrahim A., et al. "A brief review of molecular techniques to assess plant diversity." *International journal of molecular sciences* 11.5 (2010): 2079-2096.

Discovery

It was first shown by Welsh and McClelland in 1990.

Molecular Markers

Method

For RAPD analysis, PCR is carried out using short (generally around 10 nucleotides long) arbitrary (any random sequence) primers. They serve as both forward and reverse primer and amplify many genomic fragments simultaneously. Amplified fragments usually range from 500 base pair to 5 kb. They can be separated and visualized using agarose gel electrophoresis.

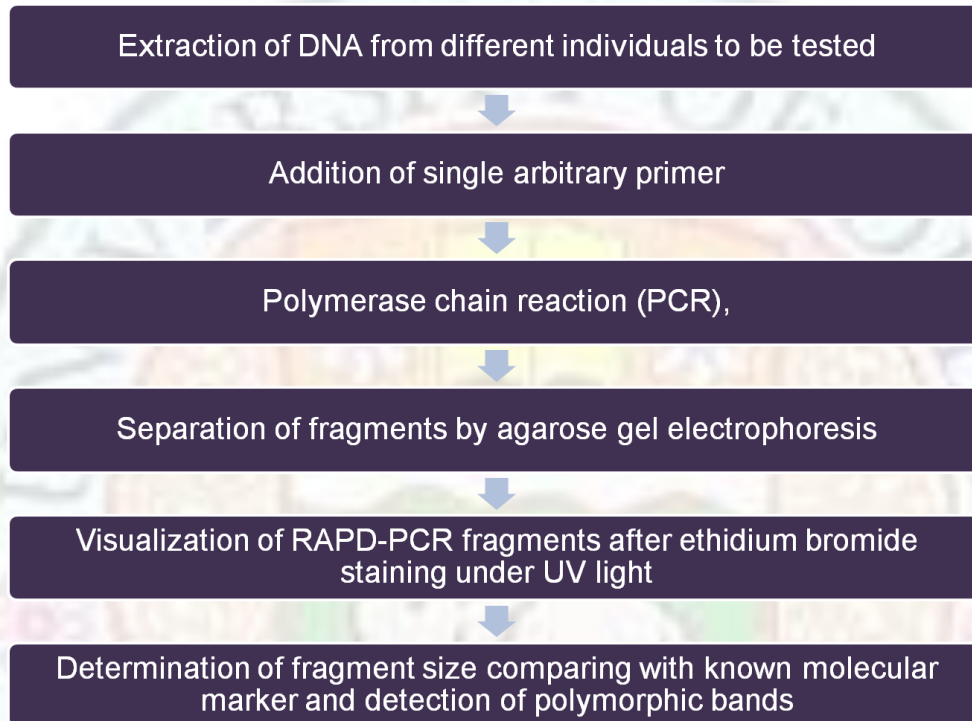

Figure: Steps in RAPD analysis.

Source: Author

Advantages

- The method is quick and easy.
- Amount of DNA required is very less.
- No prior sequence information is needed.
- Many polymorphic markers can be generated with a single primer.

Disadvantages

- Reproducibility is low as the results vary greatly with different reaction conditions because the conditions used for PCR, like annealing temperatures, random primers and concentration of reagents etc. is not stringent.
- They are dominant markers.

3. Amplified Fragment Length Polymorphism (AFLP)

Principle

Polymorphism originating from two sources is captured – first by difference in restriction sites of enzymes and second by difference in hybridization sites of arbitrary bases.

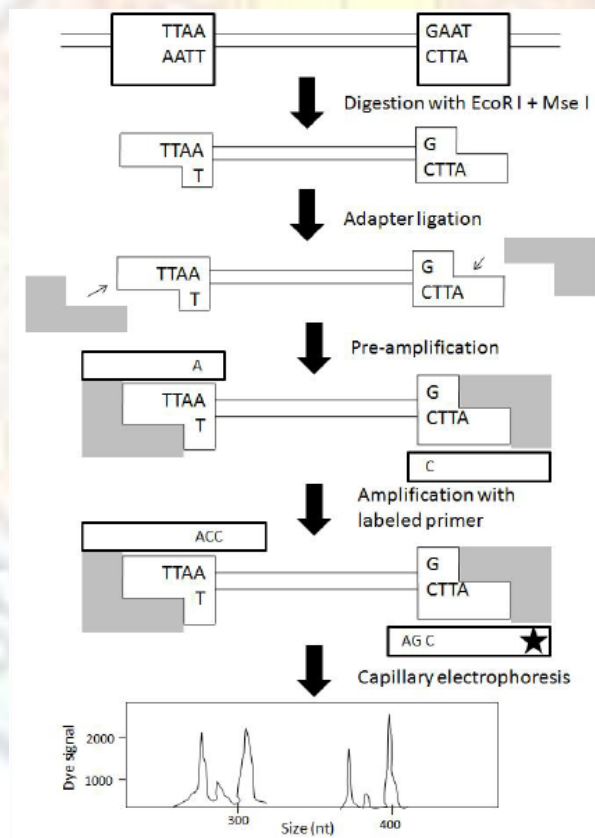

Figure: Principle behind AFLP analysis

Source: Arif, Ibrahim A., et al. "A brief review of molecular techniques to assess plant diversity." *International journal of molecular sciences* 11.5 (2010): 2079-2096.

Molecular Markers

Discovery

This method was first shown by Vos et al., in 1995.

Method

This marker system combines the use of restriction enzymes and PCR. The AFLP fragments are obtained by digestion of DNA with restriction enzymes followed by the ligation of digested products with oligonucleotide adapters of known sequences and their subsequent amplification by PCR. The amplified products may be 80 to 500 bp in size.

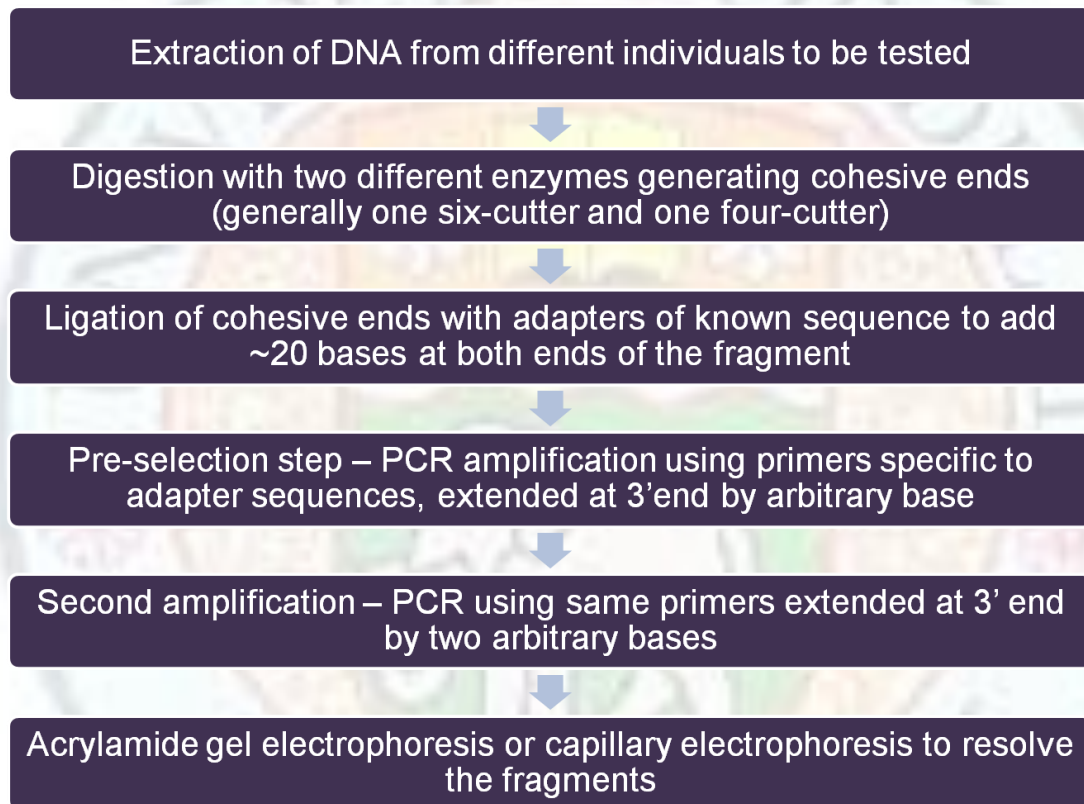

Figure: Steps involved in AFLP analysis

Source: Author

Molecular Markers

AFLP procedure

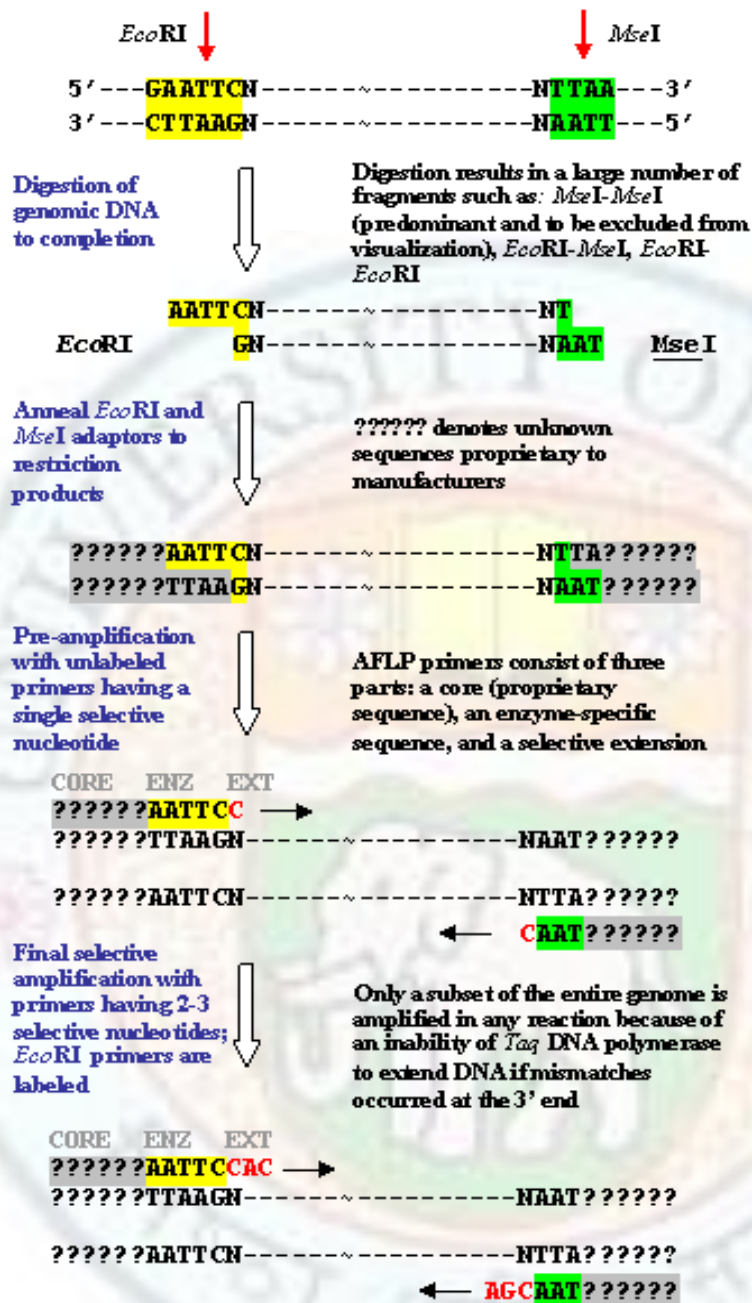

Figure: Detailed workflow of AFLP marker genotyping

Source: <http://www.ncbi.nlm.nih.gov/projects/genome/probe/doc/TechAFLP.shtml>

Advantages

A large number of polymorphic fragments can be obtained in a single experiment.

Disadvantages

- The process is complex as compared to the more advanced techniques of marker development (discussed ahead)
- The fragments are mostly scored as dominant markers.

4. Simple Sequence Repeats (SSR)

Principle

Microsatellites or SSR are tandem repeats of 1 – 6 nucleotides. For example, (A)_n, (AT)_n, (ATG)_n, (GATT)_n, (CTACG)_n, (TACGAC)_n, and so on. They are abundant in genomes of all organisms. The sequence of unique flanking regions of SSR can be used to design primers and carry out PCR to amplify SSR containing sequences. The polymorphism can be detected by agarose gel electrophoresis if differences are large enough (agarose gels can detect differences greater than 10 base pair), or polyacrylamide gel electrophoresis or capillary electrophoresis (sensitive enough to detect differences as low as 1 to 2 bases).

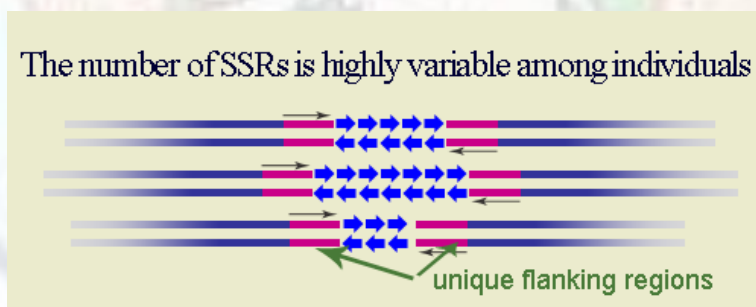

Figure: Principle behind SSR marker development

Source: <http://www.ncbi.nlm.nih.gov/projects/genome/probe/doc/TechSTS.shtml>

Discovery

SSRs were first used as markers for use in genetic mapping in humans (Litt and Luty, 1989; Weber and May, 1989).

Molecular Markers

Method

Development of primers flanking the SSR region in a particular sequence



Extraction of DNA from different individuals to be tested



Amplification of DNA using SSR primers



Gel or capillary electrophoresis to resolve amplified products

Figure: Steps involved in development of SSR marker.

Source: Author

Molecular Markers



Figure: Steps in development of SSR markers (a) Sequences of genes are obtained from various databases or by carrying out *de novo* sequencing, (b) The sequences are tested to look for SSR. This may be done using various softwares, (c) Primers are designed specific to flanking regions of SSR. This may be done manually or various softwares are available for designing primers. (d) PCR amplification is carried out and finally (e) Amplified products are resolved. The gel picture shows the result of screening eight different DNA samples, 1 to 8, using a SSR marker (M is size marker 100 bp ladder.). For this SSR marker, individuals 1, 3, 5 and 6 are of one genotype and rest is of the other type.

Source: Author

Advantages

- They are usually codominant.
- The method is easy and quick.
- Automation can be done using fluorescently labeled primers which allow detection by a technique called capillary electrophoresis, thus omitting the use of agarose or polyacrylamide gels.
- Low amount of DNA is required.
- Reproducibility is high.
- These markers can be easily exchanged between different laboratories.

Disadvantages

The cost of development of SSR markers is high if sequence information of any organism is not already available.

5. Single Nucleotide Polymorphism (SNP)

Principle

Single nucleotide polymorphism or SNPs are single base substitutions. SNP is the most abundant type of molecular marker in all organisms (for example, one SNP about every 20 bp in wheat in some regions of the genome). If SNPs can be detected between any two individuals, they can be used as molecular markers.

Molecular Markers

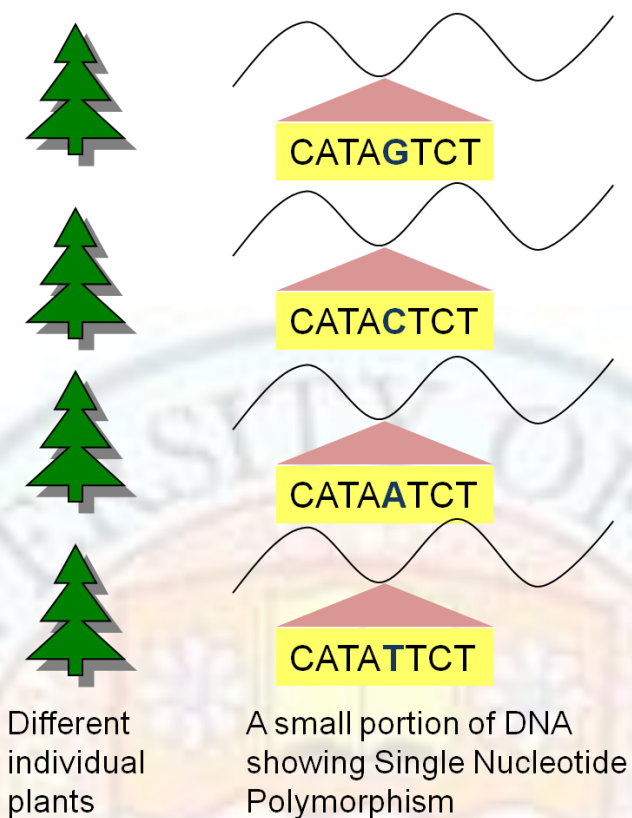

Figure: A cartoon showing a SNP among four different individual plants in a small segment of DNA.

Source: Author

Method

SNPs may be detected using many different techniques. An easy way of detection is available when SNP causes variation in the restriction site of an enzyme. In such a case, difference in the recognition of template DNA of different individuals, by the restriction enzyme, may lead to different patterns of bands when DNA is digested, resulting in polymorphism. (There are several advanced techniques to detect SNPs. The readers should refer to 'References and Further Reading' to know the details of the techniques).

Molecular Markers

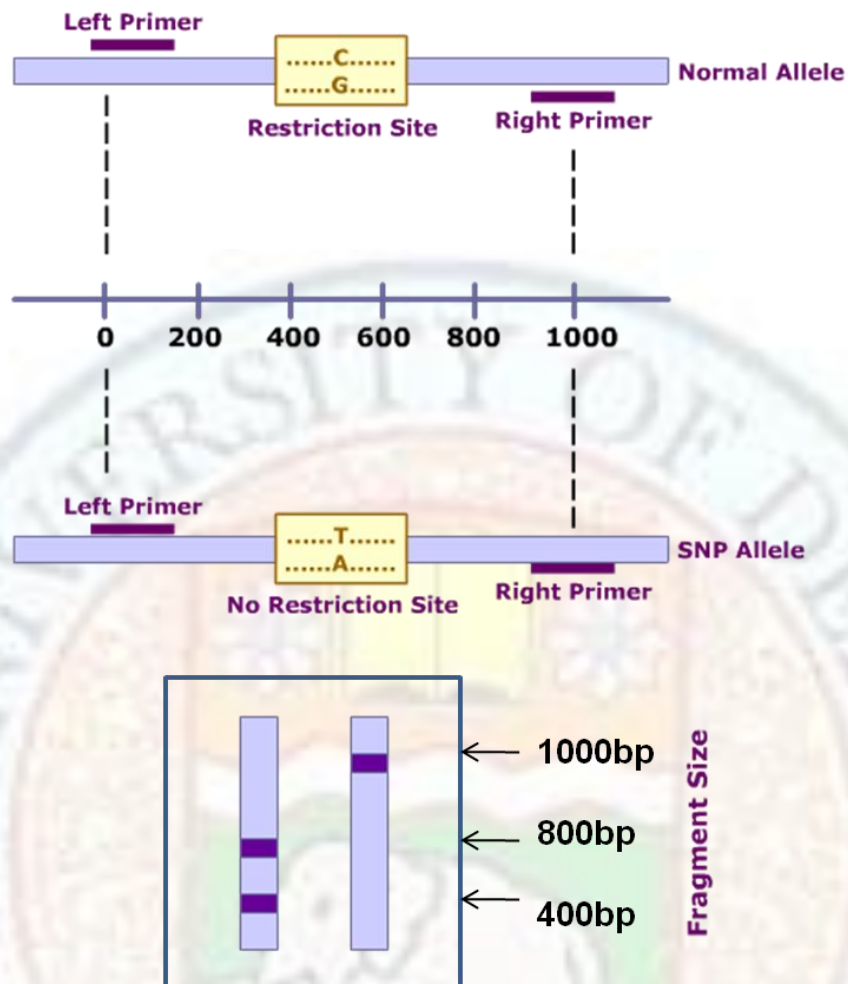

Figure: Detection of SNP using variation with a restriction site.

Source: Author

Advantages

- SNPs are abundant in genomes so one can generate a large number of molecular markers
- There are many methods available for detection of SNPs and they can be automated.

Disadvantages

- The costs for marker development and genotyping are very high.
- Technical expertise is required.

Comparison of different molecular marker systems

	RFLP	RAPD	AFLP	SSR	SNP
Polymorphism	Low-medium	Medium-high	High	High	Extremely high
Dominance	Co-dominant	Dominant	Dominant/co-dominant	Co-dominant	Co-dominant/dominant
Amount of DNA required	High	Low	High	Low	Low
DNA sequence required	No	No	No	Yes/No	Yes
PCR based	No	Yes	Yes	Yes	Yes
Radioactive detection	Yes	No	Yes/No	No	No
Cost	Medium	Low	Medium	Low/high	High
Automation	No	No	No	No/yes	Yes
Reproducibility	High	Low	High	High	High

Figure: Table of comparison of different molecular markers

Source: Author

Applications of molecular markers

1. Mapping genes of interest

Polymorphic markers are used for construction of linkage maps based on recombination frequencies between markers. A genetic map identifies linear arrangement of molecular markers on a chromosome. It is assembled from meiotic recombination data between the markers. These maps can be used for isolation of genes of interest, using different methods like QTL (Quantitative Trait Loci) mapping and GWAS (Genome Wide Association Studies).

Molecular Markers

Biparental linkage mapping

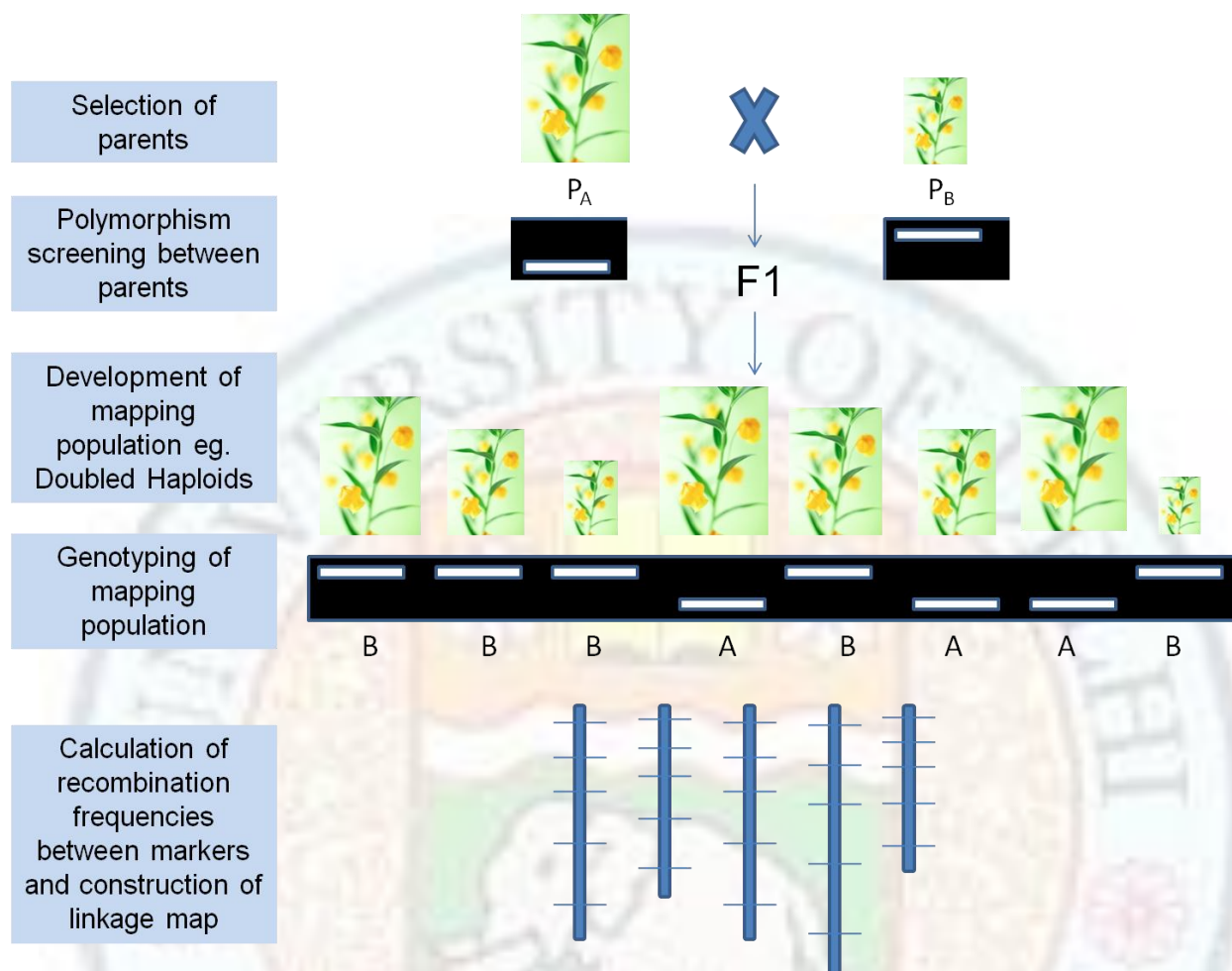
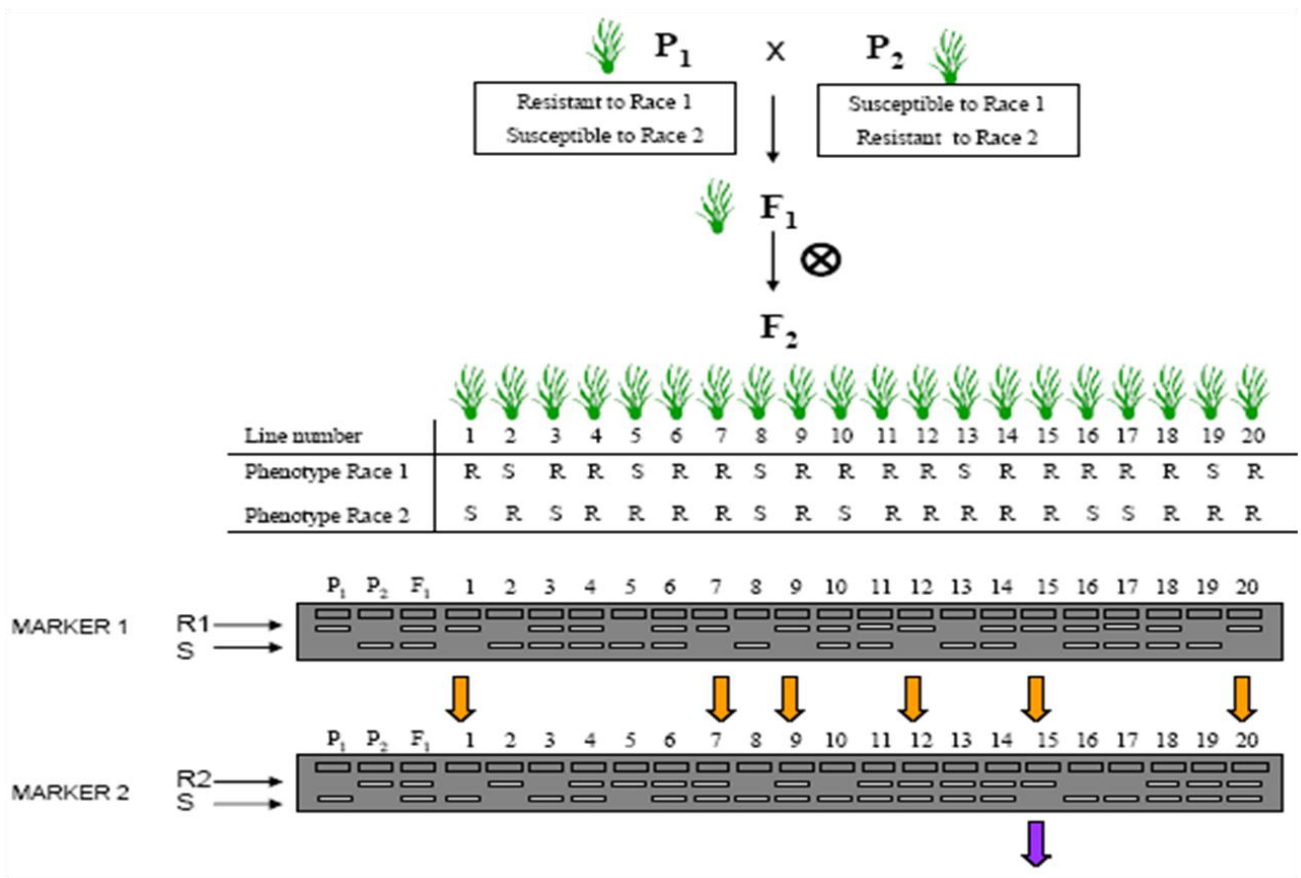

Figure: Steps involved in construction of linkage maps using a mapping population derived from F_1 hybrid of two parents. Two parents are selected for construction of a mapping population. They are screened with a number of molecular markers to find markers which are polymorphic. A mapping population is developed by crossing the parents followed by harvesting microspores from F_1 plants and doing haploid culture to raise a population of doubled haploids (for details refer to Chapter Tissue Culture Applications – Part II). The mapping population thus derived is genotyped with the polymorphic markers to construct a linkage map.

Source: Author

2. Marker assisted breeding

If markers are found genetically linked to a trait of interest, plant breeders can use them to select varieties or individuals which contain desirable traits.



Marker assisted pyramiding of two disease resistance genes. Homozygotes can be selected from F2 population.

Figure: An example of using marker assisted breeding to select plants from a small population that carry two resistance genes. Here, two different plants are shown which have resistance to two different races of a pathogen. These two plants are crossed to get a F2 population. Some of the individuals in this F2 population are expected to contain both these genes. This can be checked through genotyping with markers which are closely linked with the resistant trait. (For a detailed explanation, the reader should follow the link given below.

Source:

http://www.knowledgebank.irri.org/ricebreedingcourse/Marker_assisted_breeding.htm

3. Assessment of genetic diversity

Molecular markers can be used to determine genetic relationship between individuals, varieties or populations. This may be used to study phylogenetic relationships or in breeding programs.

4. DNA fingerprinting

A 'DNA fingerprint' basically means a specific pattern of molecular marker profile, specific to an individual. This is important for forensic studies and for germplasm conservation.

Visit page -

<http://www.britannica.com/EBchecked/topic/167155/DNA-fingerprinting>

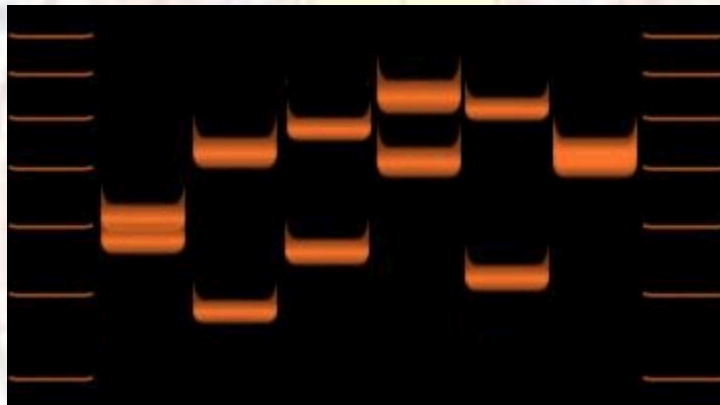

Figure: A profile of VNTR (Variable Number of Tandem Repeats) experiment of six different individuals

Source: "D1S80Demo" by Pale Whale Gail, Wikimedia Commons -

<http://commons.wikimedia.org/wiki/File:D1S80Demo.gif#mediaviewer/File:D1S80Demo.gif>

Molecular Markers

Summary

Molecular markers are segments of DNA, harboring any kind of variation that can be used to differentiate any two individuals, species or populations. They are preferred over morphological or biochemical markers as they are far more abundant and polymorphic. Variation in the DNA sequence is the basis of development of molecular markers. This variation can be due to insertion or deletion of one or more bases or single base substitutions.

Molecular markers may be hybridization based or PCR based. RFLP were the first molecular markers to be used. The method of RFLP analysis is based on restriction digestion followed by resolving of digestion products and their subsequent hybridization with a labeled probe. RFLP provides co-dominant markers but the procedure is very tedious and involves radioactive detection. Today, there are many PCR – based markers available which are far more convenient to use, and have therefore replaced RFLP analysis.

The PCR – based markers were the second generation markers that were developed initially were those which did not require sequence information of an organism and involved arbitrary primers, as is the case in RAPD. RAPD and AFLP marker systems are PCR based markers which detect multi-locus polymorphism. But RAPD has low reproducibility and AFLP involves a complex procedure of both PCR amplification and hybridization. Therefore, their use is limited to species in which sequencing information is not available.

In species where sequencing information is available or can be generated *de novo* by various recent techniques, third generation markers are preferred. These are SSRs and SNPs. SSRs are repeats in the DNA ranging from mono- to hex nucleotide. They are easy to detect, are highly variable and mostly co-dominant. SNPs are also good source of markers as they are the most abundant type of polymorphisms in the genome. They are also co-dominant in nature. The only limitation at present in use of SNPs is the high cost of development and assay.

These above mentioned marker systems can be considered as representative marker systems to discuss molecular markers, as they are most frequently used. There are also other marker systems available.

Molecular markers are used for a variety of purposes, the main being their use in plant breeding. They can be used for assessing genetic diversity between different plants, construction of linkage maps for different crops and carry out marker assisted breeding.

Molecular Markers

DNA fingerprinting is an important application of molecular markers, which, apart from plant breeding, is very useful in germplasm conservation and forensics.



Molecular Markers

Exercises

- What do you understand by the term 'molecular marker'?
- Why are molecular markers preferred over morphological markers?
- What kind of molecular markers were the first to be used?
- What is the difference between dominant and co-dominant markers?
- Given below is the result of genotyping of a mapping population of a plant using SSR marker. Lane 1 shows Parent 1 (P1) and Lane 2 show Parent 2 (P2). Lanes 3 – 24 show different individuals of the F2 population derived from P 1 and P 2. If P1 has genotype 'AA' for this marker and P2 has genotype 'aa', answer the following
 - a. What is the genotype of each of the individuals 3 to 24?
 - b. Are they homozygous or heterozygous?
 - c. What kind of polymorphism is observed here?

1 2 3 4 5 6 7 8 9 10 11 12 13 14 15 16 17 18 19 20 21 22 23 24

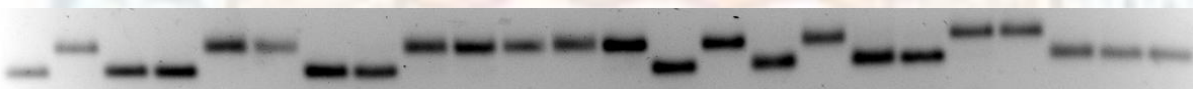

- Why does RAPD marker show low reproducibility? Why are they still useful?
- What method can be followed for SSR marker development?
- Explain a way in which SNP can be detected.
- Discuss the applications of molecular markers in plant breeding.
- How can molecular markers be used in forensics?

Glossary

Adapter: A synthetic oligonucleotide with a cohesive end that can be used to join a blunt end of DNA with a cohesive end of another.

Agarose: A neutral, linear sulfated polysaccharide that is used for electrophoresis.

Agarose gel: A polysaccharide matrix that is used to separate nucleic acid molecules according to their size.

Allele: Alternative forms of a gene.

Amplification: An increase in the number of DNA molecules by *in vitro* activity of polymerase using synthetic oligonucleotides.

Base pair: Any hydrogen – bonded pair of purine – pyrimidine bases in a nucleic acid molecule.

Capillary electrophoresis: Separation of charged molecules in silica capillaries using electro-osmotic flow.

Digestion: Enzymatic hydrolysis of covalent bonds in a macromolecule.

DNA Fingerprinting: A technique for generating a pattern of DNA showing DNA polymorphism. RFLP, microsatellites or minisatellites (VNTR) are generally used to generate a DNA fingerprint.

DNA sequencing: Methods to determine the sequence of bases in a DNA molecule.

Electrophoresis: A method to separate molecules in an electric field according to their net charge, shape and size.

Epitasis: Mode of gene interaction where one gene may affect the expression of another.

Genome: The entire set of hereditary material in an organism.

Kilo base (kb): One thousand base pairs.

Labeling: Introduction of radioactive or non-radioactive atoms in to the target molecules to enable their detection.

Molecular Markers

Ladder: A mixture of DNA molecules that allow determination of molecular weight of unknown DNA molecules, within a size range, when run on electrophoresis gels.

Linkage map: A linear arrangement of molecular markers according to the recombination frequencies between them.

Phylogenetic analysis: Study of the evolutionary relationships in a group of individuals, species or populations.

Primer: A short oligonucleotide complementary to a sequence in a larger nucleic acid molecule (template), which serves as a substrate for DNA polymerase in an *in vitro* reaction.

Restriction enzyme: A bacterial enzyme that recognizes specific sites in DNA and cuts the DNA molecule into separate fragments.

Variable Number of Tandem Repeats (VNTR): DNA region composed of tandemly repeated short sequences (11-60bp), which varies within population.



References

- Acquaah, George. *Principles of plant genetics and breeding*. John Wiley & Sons, 2009.
- Allard, Robert Wayne. *Principles of plant breeding*. John Wiley & Sons, 1999.
- Arif, Ibrahim A., et al. "A brief review of molecular techniques to assess plant diversity." *International journal of molecular sciences* 11.5 (2010): 2079-2096.
- Henry, Robert J., ed. *Plant genotyping: the DNA fingerprinting of plants*. CABI, 2001.
- Jones, Neil, et al. "Markers and mapping revisited: finding your gene." *New Phytologist* 183.4 (2009): 935-966.
- Weising, Kurt, et al. *DNA fingerprinting in plants: principles, methods, and applications*. CRC press, 2005.
- White, T. L., W. T. Adams, and D. B. Neale. "Genetic markers-morphological, biochemical and molecular markers." *Forest genetics* (2007): 53-74.
- Rademaker, J. L. W., et al. "DNA markers: protocols, applications and overviews." *DNA markers: protocols, applications, and overviews* (1997).
- Schlötterer, Christian. "The evolution of molecular markers—just a matter of fashion?" *Nature Reviews Genetics* 5.1 (2004): 63-69.

Web links

- http://www.pomics.com/Pradeep_2_4_2009_141_162.pdf
- http://www.ccmb.res.in/staff/Aggarwal/pap_36.pdf
- <http://www.adfg.alaska.gov/static/fishing/PDFs/research/geneconservation/snp/schlotterer2004.pdf>
- <http://www.ncbi.nlm.nih.gov/projects/genome/probe/doc/TechRFLP.shtml>
- http://www.plantsciences.ucdavis.edu/bit150/DN_Lecture/Neale_chapter4.pdf
- <http://www.ncbi.nlm.nih.gov/projects/genome/probe/doc/TechRFLP.shtml>

Molecular Markers

<http://www.dnalc.org/resources/animations/pcr.html>

http://www.knowledgebank.irri.org/ricebreedingcourse/Marker_assisted_breeding.htm

