



Discipline: Botany

Paper: Plant Biotechnology

National Coordinator: Prof. S.C. Bhatla

Lesson: Introduction to Recombinant DNA Technology

Lesson Developer: Ms. Manisha Sharma, UDSC

Department/College: Genetics

Table of Contents

Introduction to recombinant DNA technology

- **What is recombinant DNA?**
- **But first, what is DNA?**
- **History – Early experiments in recombinant DNA technology**
- **Applications of recombinant DNA technology**
 - **Pharmaceutical uses**
 - **Vaccines**
 - **Diagnostic testing**
 - **Gene therapy**
 - **Monoclonal antibodies**
 - **DNA fingerprinting**
 - **Food additives**
 - **Agricultural uses**
 - **Animal husbandry**
- **Summary**
- **Questions**
- **Glossary**
- **References**
- **Web links**

Learning outcomes

- After reading this article, the reader should have understood how a genetically modified organism is created.
- The reader should be able to differentiate between recombinant DNA and the process of genetic recombination.
- The reader should have known the history and major accomplishments which have led to the initiation of recombinant DNA technology.
- The reader should be able to identify how and in what fields recombinant DNA technology is being used today and the major areas of focus where this technology is being developed.

Introduction

What is recombinant DNA?

Recombinant DNA, or rDNA, as the name suggests, is comprised of two or more pieces of DNA molecules that have been combined together to form a single molecule.

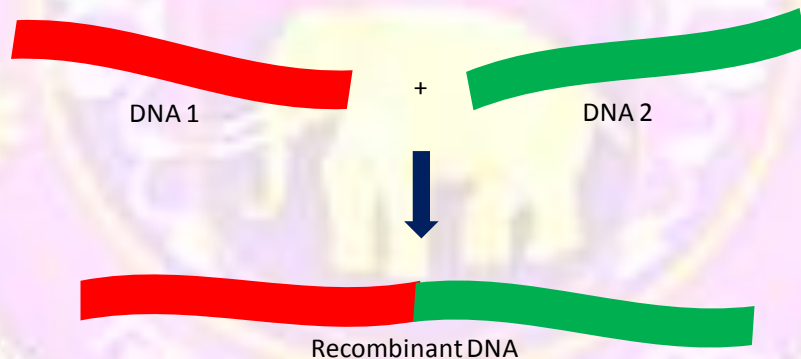

Figure: Diagrammatic representation of two DNA molecules that join together to form a recombinant DNA molecule.

Source: Developed by author

Generally, creation of a recombinant DNA molecule involves two steps:

- In the first step, DNA from two or more sources containing a gene or any other fragment of interest are cut at specific points/sites.

Introduction to recombinant DNA technology

- In the second step, the cut DNA sequences are joined together in a controlled manner to create a recombinant DNA molecule.

A gene is the basic physical and functional unit of heredity in any living organism. It is the coding sequence of DNA that contains information to make proteins in a cell.

Recombinant DNA molecules are also known as chimeric DNA, because they are hybrid DNA molecules which have been engineered from at least two different sources, like the mythical chimera.

An organism, if its genome has been altered using recombinant DNA technology is known as a transgenic or genetically modified (GM) organism. A transgenic organism is created either by combining DNA from different genomes or by inserting foreign DNA into the host organism's genome. The transgene should be introgressed into the germ line of the organism and is stably inherited by its progeny.

Proteins that are produced in a genetically modified organism due to the expression of a recombinant DNA are known as recombinant proteins.

But first, what is DNA?

- DNA (deoxyribonucleic acid) is the repository of genetic information that we inherit from our parents. It decides how we turn out to be as an organism, e.g. the colour of our skin, our height, curly or straight hair, even in plants whether they have rounded or pointed leaves, etc. DNA is involved in the creation, development as well as maintenance of normal body function of all organisms.
- All organisms except some viruses have DNA as their genetic material.
- DNA is a nucleic acid made up of long strands of sugar, phosphate and nitrogenous bases.
- The nitrogenous bases can further be of four types – adenine (A), guanine (G), thymine (T) or cytosine (C). Adenine and guanine are purines and thymine and cytosine are pyrimidines.

Introduction to recombinant DNA technology

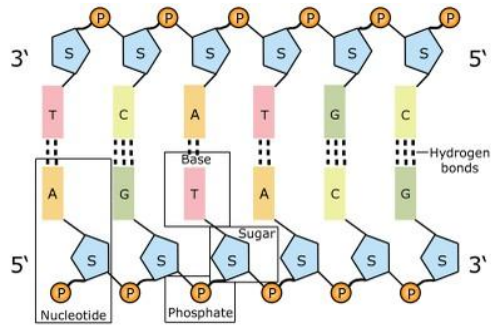
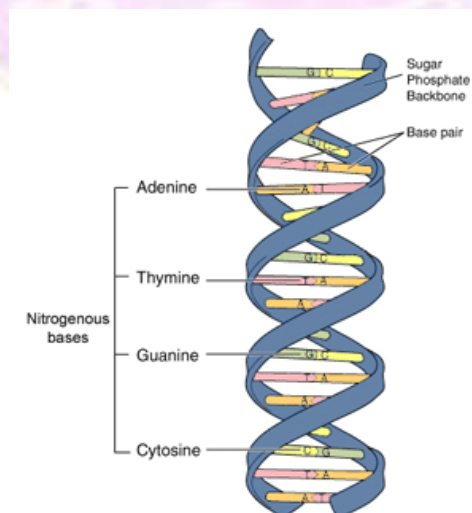

Figure: DNA is composed of sugar, phosphate and nitrogenous bases. Two DNA strands are connected by hydrogen bonds between the bases.

Source: <http://www2.le.ac.uk/departments/genetics/vgec/schoolscolleges/topics/dna-genes-chromosomes>

- Nitrogenous bases on two separate DNA strands interact with each other to form two kinds of hydrogen bonds or H-bonds, i.e., a double bond between bases A and T and a triple bond between bases G and C. The two strands form a helical ladder-like structure, known as the DNA 'double helix'.

The three dimensional DNA double helix structure was proposed in 1953 by American biologist James Watson and English physicist Francis Crick. Their proposition was based on the reasoning given by Austrian biochemist Erwin Chargaff that $A = T$ and $C = G$ and the crucial X-ray crystallographic evidence provided by English researchers Rosalind Franklin and Maurice Wilkins.



Introduction to recombinant DNA technology

Figure: DNA double helix showing base pairs.

Source: <http://www2.le.ac.uk/departments/genetics/vgec/highereducation/topics/dnageneschromosomes>

For further information, read <http://www.nature.com/scitable/topicpage/discovery-of-dna-structure-and-function-watson-397>.

- Just imagine what a mind-boggling number of combinations of the 4 bases can be linked together to create an infinitely long DNA ladder.



Figure: Hydrogen bonding between the two strands of DNA in a double helix.

Source: Developed by author

- The combination in which the 4 bases are linked together in a DNA strand is known as the DNA sequence, such as the sequence of the DNA strand 1 in the above image would be read as ATGAACTGC.



Figure: Electron micrograph of DNA.

Source: modified from <http://www.biologydiscussion.com/essays/molecular-biology/dna-and-importance-of-proteins-molecular-biology/1874>

- Don't you think the underlying basis of the enormous diversity of living organisms that we have on our planet could be due to differences in the DNA sequences of all these organisms?

Introduction to recombinant DNA technology



Figure: Difference in the appearance of the two cats is because of differences in their DNA.

Sources: <http://www.irregularwebcomic.net/3007.html>, <http://pictures-of-cats.org/ragamuffin-cat.html>

- In the cells of all living organisms, DNA passes on the genetic information in the form of mRNA through a process known as transcription. The mRNA then translates this information by synthesis of proteins, another important constituent of all organisms. This process is known as the 'central dogma' of molecular biology.

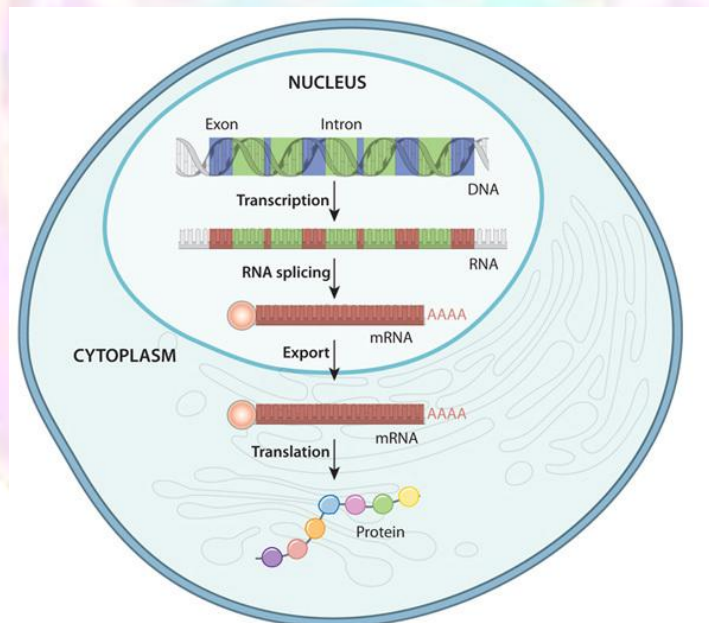

Figure: The central dogma of molecular biology shows the flow of genetic information within a biological system.

Source: <http://news.genius.com/Varenka-lorenzi-ryan-l-earley-matthew-s-grober-differential-responses-of-brain-gonad-and-muscle-steroid-levels-to-changes-in-social-status-and-sex-in-a-sequential-and-bidirectional-hermaphroditic-fish-annotated#note-1476806>

Introduction to recombinant DNA technology

Suppose we have a method to change the DNA sequence of an organism, we can infer that it can alter the proteins that this organism synthesizes.

Let's visualize a hypothetical scenario where by altering our own DNA sequence through introduction of some novel DNA sequence into our own DNA, we could redesign the protein that forms our hair colour, so that it is black in the day and fluorescent pink at night. Are we talking about some futuristic sci-fi movie? Probably, we can bring about this change using a technique known as recombinant DNA technology.

History – early experiments in recombinant DNA technology

A study of the history of recombinant DNA technology is necessary to understand how genetically engineered organisms were created in the first place. Recombinant DNA technology originated in the late 1960s and early 1970s, but it is still one of the most frequently used genetic technologies worldwide. The basic principle of recombination, where cells repair DNA breaks by reuniting or recombining the broken pieces, had been discovered much earlier.

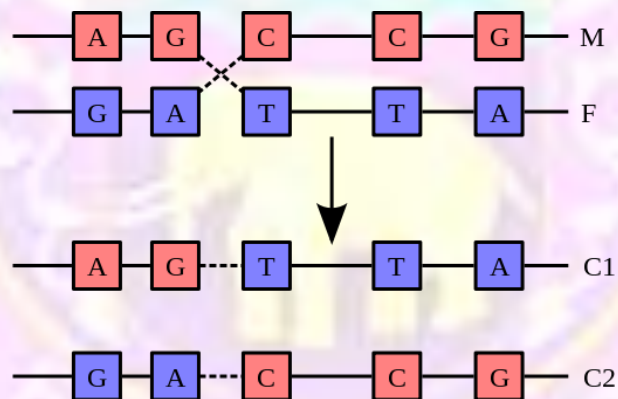

Figure: DNA recombination where the parental chromosome (M, F) break and re-joins resulting in the new set of chromosomes (C1, C2) that harbour a fragment of DNA from both the parents.

Source: http://commons.wikimedia.org/wiki/File:Chromosomal_Recombination.svg

Thus, discovery of recombinant DNA technology involved identification of the key ingredients necessary for recombination, deciphering the function of these raw biological ingredients, and then recreating the recombination process in the laboratory itself.

Recombinant DNA technology and genetic or DNA or chromosomal recombination are two separate processes. Recombinant DNA is artificially created through experiments in a laboratory. Genetic recombination is a natural biological process of breaking and rejoining DNA sequences in all living organisms.

The story begins in the year 1869, when a Swiss physiological chemist Friedrich Miescher set out to characterize the protein components of human leukocytes (white blood cells), but instead isolated what he termed as nuclein (later named as 'nucleic acid' and finally, 'DNA') inside the nuclei of leukocytes.

Miescher's work was long forgotten except for a few scientists like the Russian biochemist Phoebus Levene, who was investigating the chemical nature of nuclein. In 1919, Levene proposed the 'polynucleotide' model which said that nucleic acids were composed of a series of nucleotides. Further, each nucleotide was composed of one nitrogenous base, a sugar molecule and a phosphate group.

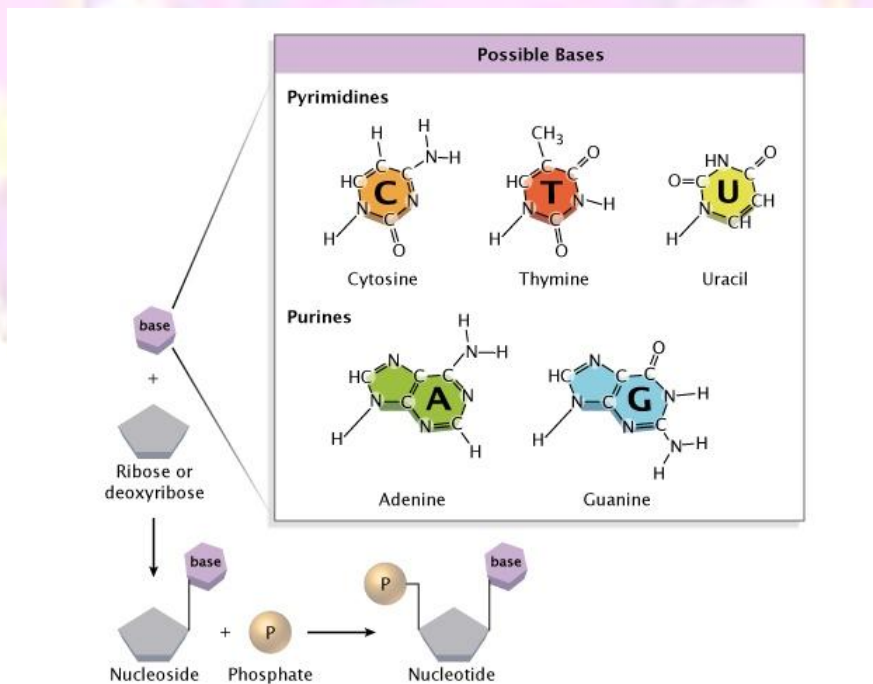

Figure: The chemical structure of a nucleotide.

Source: <http://www.nature.com/scitable/topicpage/discovery-of-dna-structure-and-function-watson-397>

Introduction to recombinant DNA technology

In another unrelated experiment in 1928, an English microbiologist Frederick Griffith was studying two strains of the bacterium *Streptococcus pneumoniae*, out of which the highly virulent S strain was responsible for a pneumonia epidemic in London, and showed that a chemical component released from the virulent S cells was transferred into the non-virulent R cells, turning them virulent. This uptake of foreign DNA from the environment is known as genetic transformation.

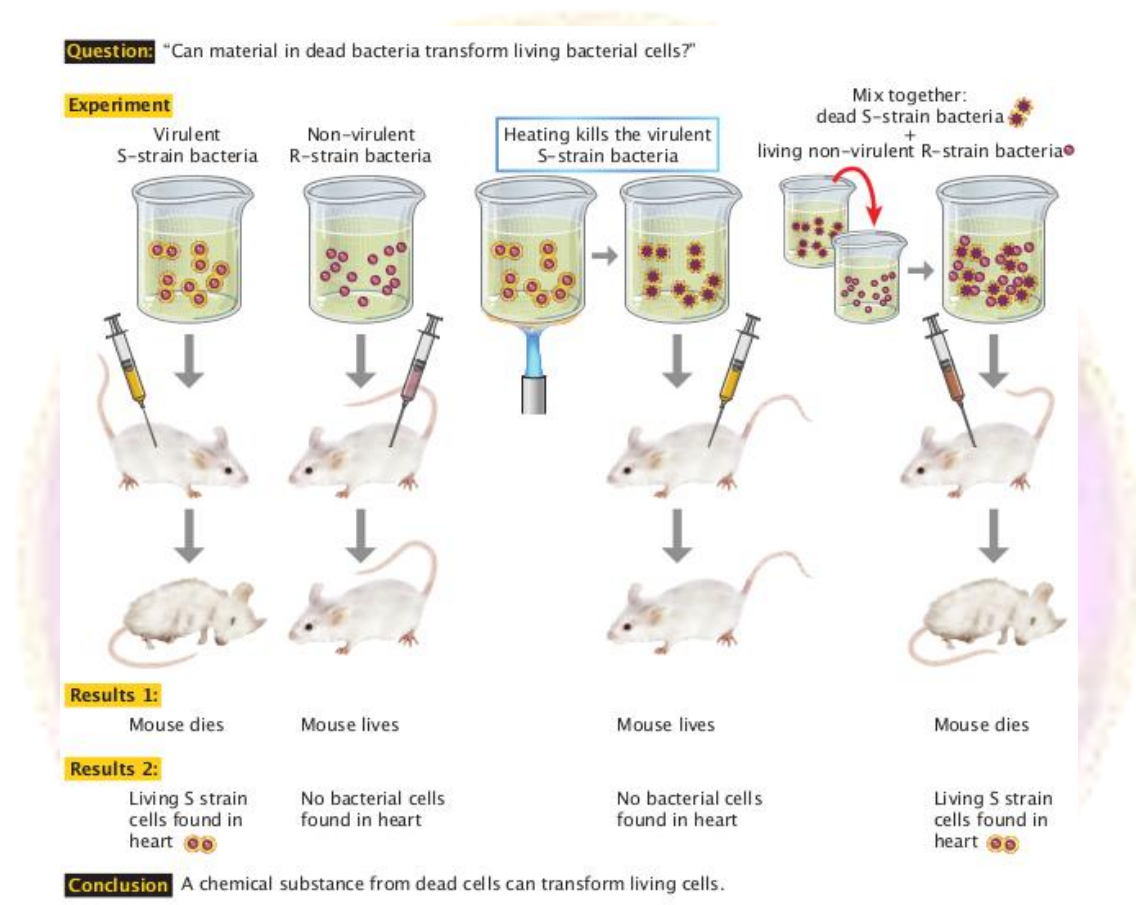

Figure: Griffith's experiments on pneumococci.

Source: <http://www.nature.com/scitable/topicpage/isolating-hereditary-material-frederick-griffith-oswald-avery-336>

More than a decade later, in 1944, researcher Oswald Avery and his colleagues Colin MacLeod and Maclyn McCarty at the Rockefeller University in New York, suggested that the transforming molecule in Griffith's experiment was DNA.

Introduction to recombinant DNA technology

Question: What is the material that transforms cells? Is it protein, RNA, or DNA?

Experiment

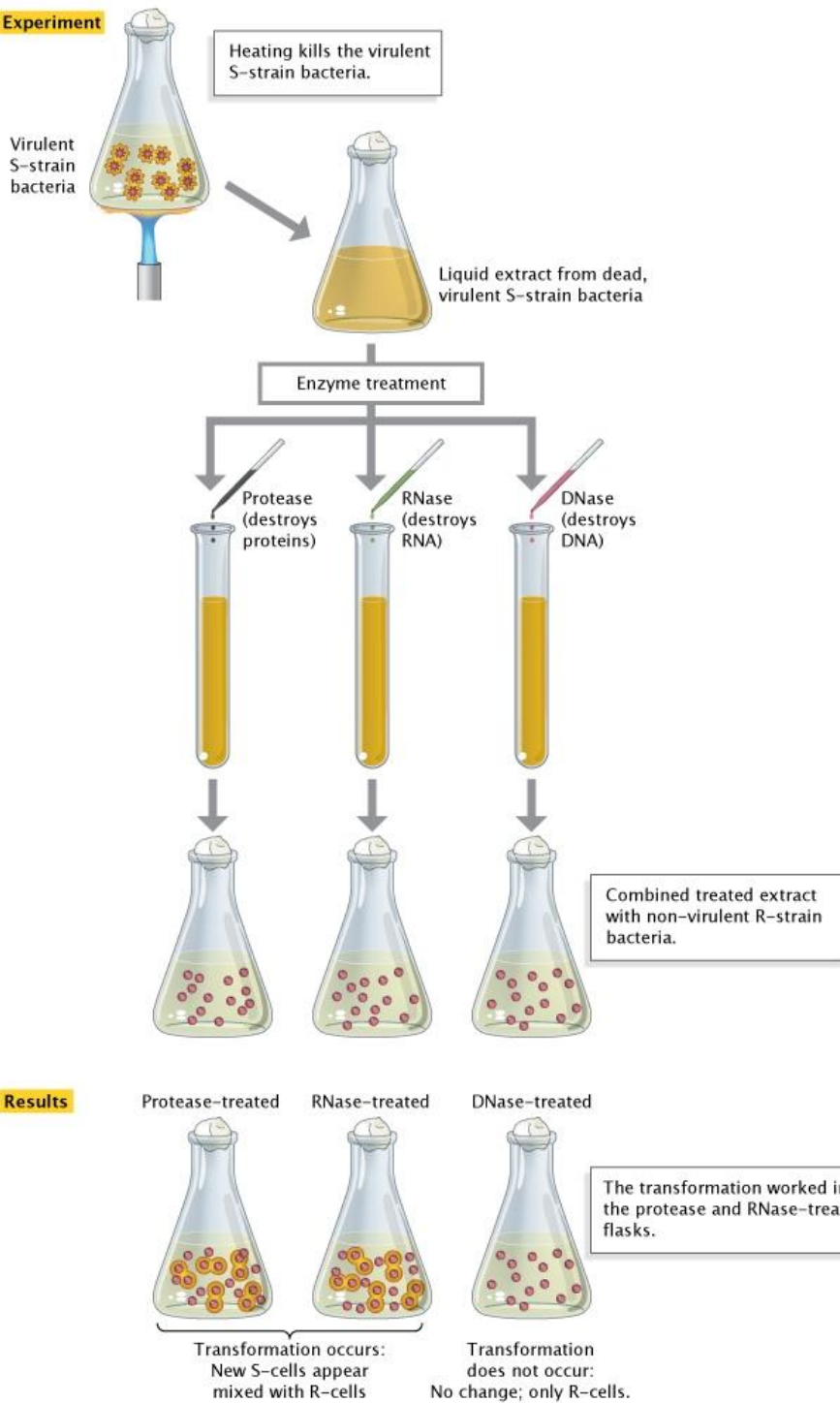

Results

Conclusion DNA is the molecule responsible for transformation.

Figure: DNA is identified as the transforming molecule.

Source: <http://www.nature.com/scitable/topicpage/isolating-hereditary-material-frederick-griffith-oswald-avery-336>

Introduction to recombinant DNA technology

One could draw the conclusion from Griffith's and Avery's work that DNA is the hereditary material that changes the genetic constitution and phenotype of an organism, but this proposition was rejected at that time because protein was favoured as the genetic material.

Variation in nucleotide composition of DNA among species was demonstrated in 1950 by an Austrian biochemist, Erwin Chargaff. He also established the 'Chargaff's rule' – the total amount of purines is equal to the total amount of pyrimidines in a DNA molecule, or $A = T$ and $G = C$.

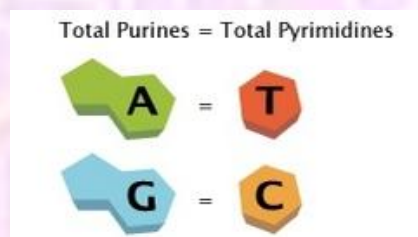

Figure: Chargaff's rule.

Source: <http://www.nature.com/scitable/topicpage/discovery-of-dna-structure-and-function-watson-397>

In the year 1952, Alfred Hershey and Martha Chase proved that protein is not the genetic material, and just a year later, the structure of DNA was elucidated by Watson and Crick, and it was concluded that DNA is the hereditary material. The Nobel Prize in Physiology or Medicine 1969 was awarded jointly to Max Delbrück, Alfred D. Hershey and Salvador E. Luria "for their discoveries concerning the replication mechanism and the genetic structure of viruses" (http://www.nobelprize.org/nobel_prizes/medicine/laureates/1969/).

Arthur Kornberg and his colleagues in 1956 identified and partially purified the enzyme DNA polymerase I of *Escherichia coli*. It was a remarkable enzyme that could incorporate deoxyribonucleotides into DNA *in vitro*, and is still used to produce labelled DNA probes. Using this enzyme, one could create copies of DNA outside an intact cell, and the genetic specificity could be maintained. The Nobel Prize in Physiology or Medicine 1959 was awarded jointly to Severo Ochoa and Arthur Kornberg "for their discovery of the mechanisms in the biological synthesis of ribonucleic acid and deoxyribonucleic acid" (http://www.nobelprize.org/nobel_prizes/medicine/laureates/1959/).

Introduction to recombinant DNA technology

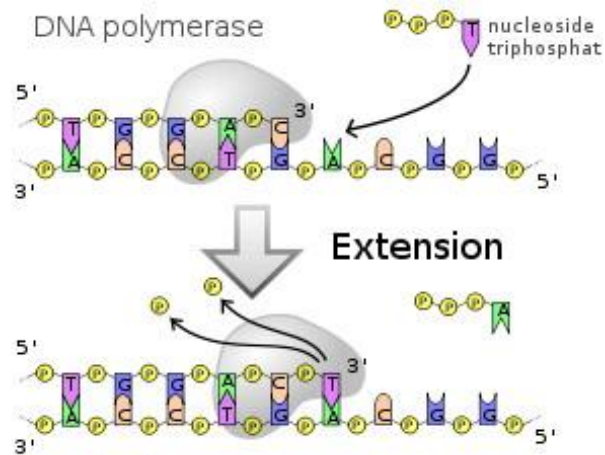

Figure: DNA polymerase functions in DNA replication.

Source: <http://www.virology.ws/2009/05/10/the-error-prone-ways-of-rna-synthesis/>

By the 1960s, it was known that the DNA sequence of each gene specifies the amino acid sequence of the protein, and mRNA acts as the intermediate molecule in this process. But the question was – how just four nitrogenous bases code for all the 20 known amino acids. In 1961, a research team comprising of Francis Crick, Leslie Barnett, Sydney Brenner and Richard Watts-Tobin discovered that the genetic code is a triplet. The Nobel Prize in Physiology or Medicine 1962 was awarded jointly to Francis Harry Compton Crick, James Dewey Watson and Maurice Hugh Frederick Wilkins “for their discoveries concerning the molecular structure of nucleic acids and its significance for information transfer in living material” (http://www.nobelprize.org/nobel_prizes/medicine/laureates/1962/). In 1966, Marshall W. Nirenberg, Har Gobind Khorana and Robert W. Holley cracked the genetic code and deciphered the codons for amino acids, and were jointly awarded the Nobel Prize for Physiology or Medicine in 1968

(http://www.nobelprize.org/nobel_prizes/medicine/laureates/1968/).

Introduction to recombinant DNA technology

		Second position					
		U	C	A	G		
U	UUU	<i>phe</i>	UCU	UAU	<i>tyr</i>	UGU	<i>cys</i>
	UUC		UCC	UAC		UGC	
	UUA		UCA	UAA	Stop	UGA	Stop
	UUG		UCG	UAG	Stop	UGG	<i>trp</i>
C	CUU	<i>leu</i>	CCU	CAU	<i>his</i>	CGU	
	CUC		CCC	CAC		CGC	<i>arg</i>
	CUA		CCA	CAA	<i>gln</i>	CGA	
	CUG		CCG	CAG		CGG	
A	AUU		ACU	AAU	<i>asn</i>	AGU	<i>ser</i>
	AUC	<i>ile</i>	ACC	AAC		AGC	
	AUA		ACA	AAA	<i>lys</i>	AGA	<i>arg</i>
	AUG	<i>met</i>	ACG	AAG		AGG	
G	GUU		GCU	GAU	<i>asp</i>	GGU	
	GUC	<i>val</i>	GCC	GAC		GGC	<i>gly</i>
	GUA		GCA	GAA	<i>glu</i>	GGA	
	GUG		GCG	GAG		GGG	

Initiation
 Termination

Figure: The genetic code.

Source: <http://biomocnews.blogspot.in/2012/10/daily-newsletter-october-29-2012-ground.html>

These classic experiments certainly proved that DNA as the genetic material could be transferred into cells, but the question was whether this DNA could be isolated from the cells and modified before reintroduction into the cells. In this period of time, a lot was known about genes and DNA, but the experimental techniques of that generation were not sophisticated enough to allow the study of genes and its manipulation in greater detail.

In 1961, Julius Marmur and Paul Doty discovered the optimal conditions for DNA renaturation, where high temperature was required to prevent the binding between non-complementary strands and to ensure the proper pairing between complementary strands, which paved the way for making nucleic acid hybridisation reactions specific and feasible.

By the 1960s, it was known to biologists that DNA recombination occurs inside cells, which obviously implies that enzymes that break and join DNA should be present inside

Introduction to recombinant DNA technology

the cell, and the search for these cut-and-paste enzymes started. The first breakthrough came in 1967 when American biologist Martin Gellert and his colleagues from the National Institutes of Health purified and characterised an enzyme from *E. coli* that could join, or recombine DNA fragments by forming phosphodiester bonds between DNA ends held by hydrogen-bond pairing in a double-stranded configuration. They called this enzyme 'DNA-joining enzyme', now known as DNA ligase, which acts as 'glue' to join short strands of DNA during replication.

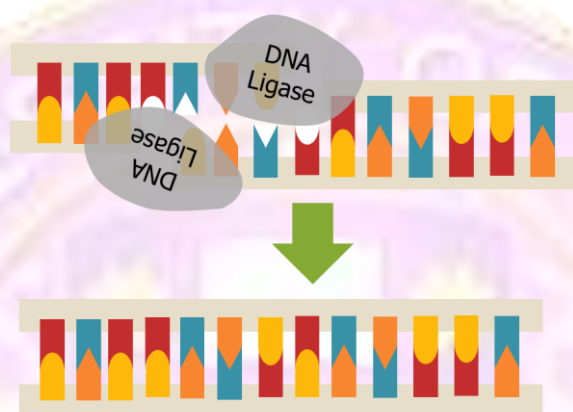

Figure: Two DNA fragments are joined by DNA ligase.

Source: http://en.wikibooks.org/wiki/Structural_Biochemistry/DNA_Repair

A second major milestone was crossed in the year 1962 with the discovery of enzymes that digest DNA into separate fragments. A Swiss microbiologist Werner Arber (with Stuart Linn) discovered restriction enzymes from *E. coli*, one of the most important tools in recombinant DNA technology, which cleave DNA at specific restriction sites in the genome. In 1970, microbiologists Hamilton Smith and Kent Wilcox isolated restriction enzymes from another bacterial species, *Haemophilus influenzae*. The experimental use of restriction enzymes as a way to cut DNA molecules was first demonstrated in 1971 by John Hopkins biochemist Daniel Nathans and his graduate student Kathleen Danna, who used it to digest DNA of the eukaryotic virus SV40, and the unique linear digested fragments were separated by gel electrophoresis, a technique by which nucleic acids are resolved on the basis of their size.

Introduction to recombinant DNA technology

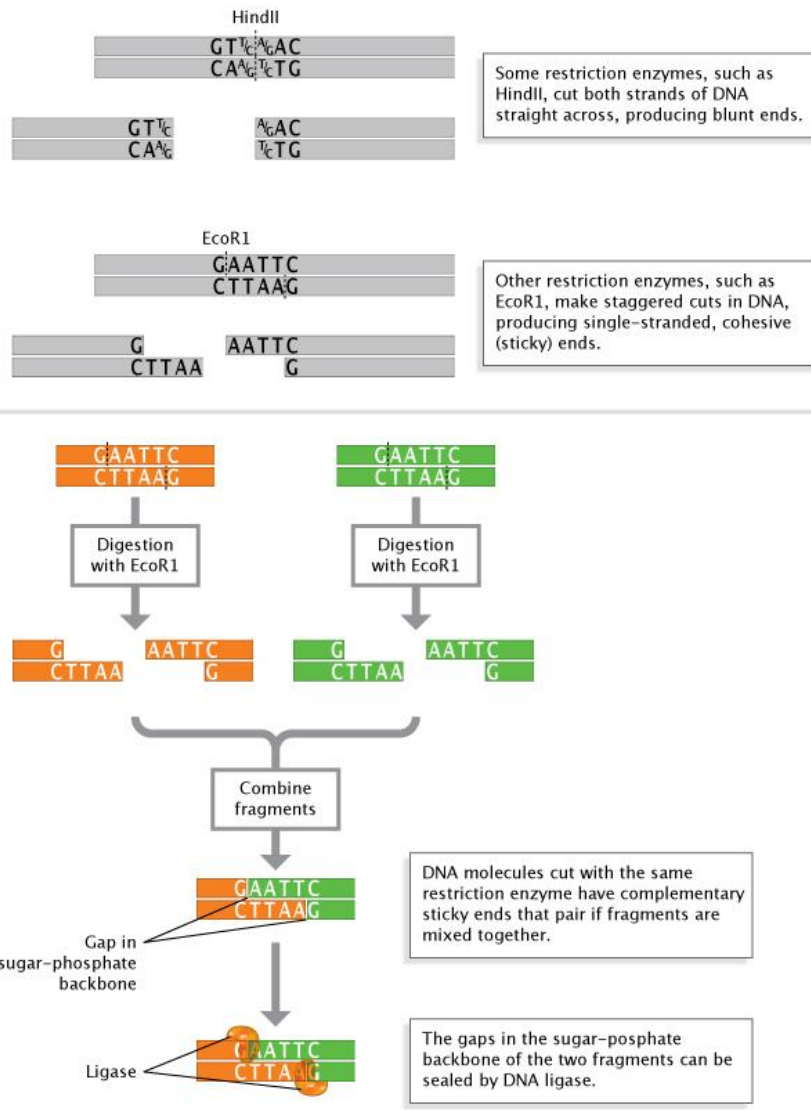

Figure: DNA fragments cut by restriction enzymes and joined by DNA ligase.

Source: <http://www.nature.com/scitable/topicpage/restriction-enzymes-545>

Introduction to recombinant DNA technology

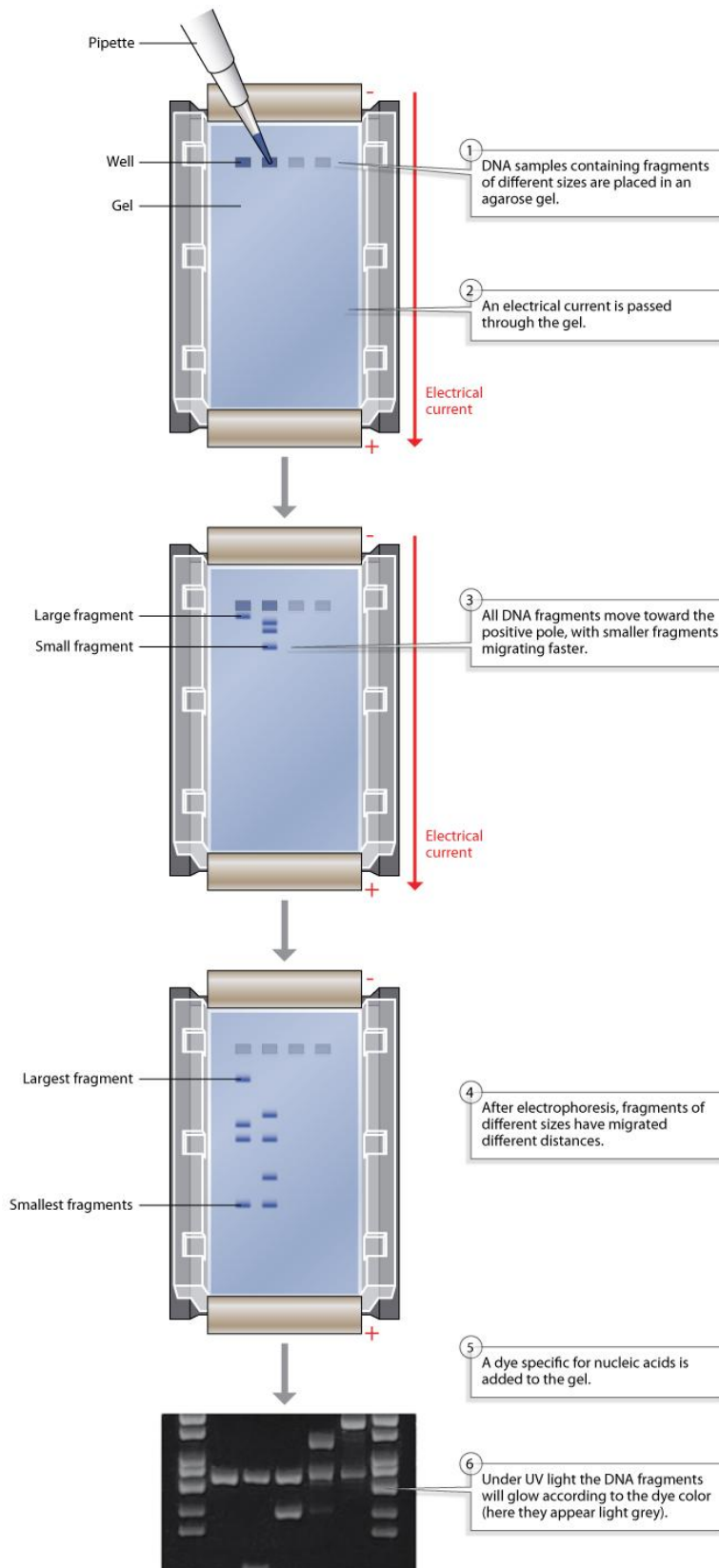

Figure: Gel electrophoresis for the separation of nucleic acids on the basis of size.

Source: <http://www.nature.com/scitable/topicpage/restriction-enzymes-545#>

Introduction to recombinant DNA technology

This technique could also be used for DNA sequence characterization. Edwin Southern in 1975 devised a technique known as Southern blotting to transfer separated DNA fragments from a gel to a solid membrane. This membrane could then be used for hybridisation with radioactive or chemically labelled DNA or RNA probes with known base sequence. This helps in distinctly identifying the complementary DNA sequences among all the separated fragments on the membrane due to the position where the probe is bound detected by autoradiography. This can in turn help to identify the location of the sequence of interest in the genome.

Werner Arber, Daniel Nathans and Hamilton O. Smith were jointly awarded the Nobel Prize in Physiology or Medicine in 1978 for the discovery of restriction enzymes and their applications to problems of molecular genetics (http://www.nobelprize.org/nobel_prizes/medicine/laureates/1978/).



Introduction to recombinant DNA technology

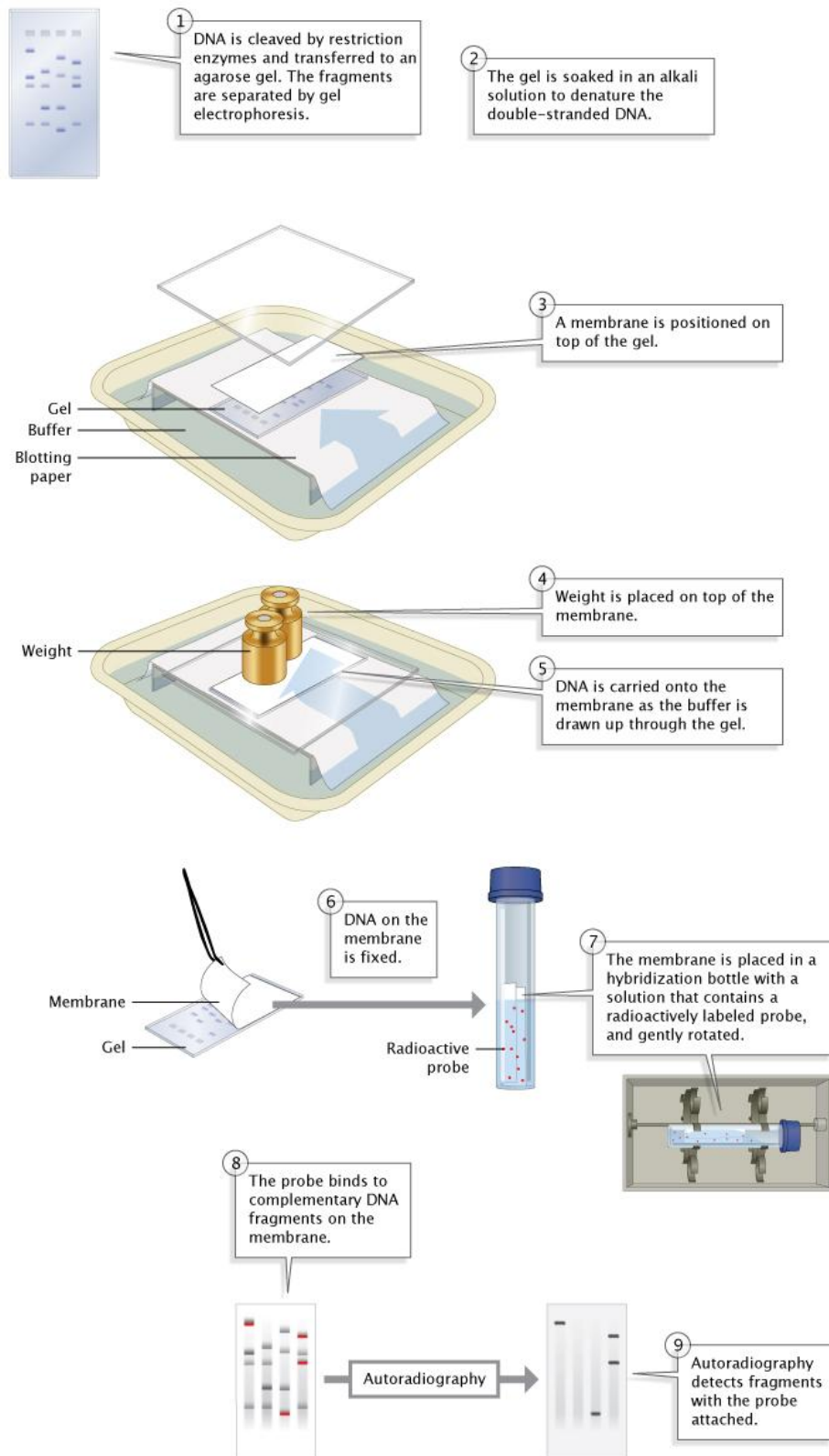

Figure: Detection of specific DNA sequences using radioactive probes on a Southern blot.

Source: <http://www.nature.com/scitable/topicpage/restriction-enzymes-545#>

Introduction to recombinant DNA technology

Two Stanford University researchers Janet Mertz and Ronald Davis in 1972 discovered *EcoRI*, an enzyme that cuts DNA in a staggered fashion yielding fragments with single stranded overhanging ends known as cohesive or sticky ends. Since then this enzyme has been extensively used in molecular biology to generate two fragments with complementary sticky ends that could be further joined together and sealed by DNA ligase to yield a recombinant DNA molecule.

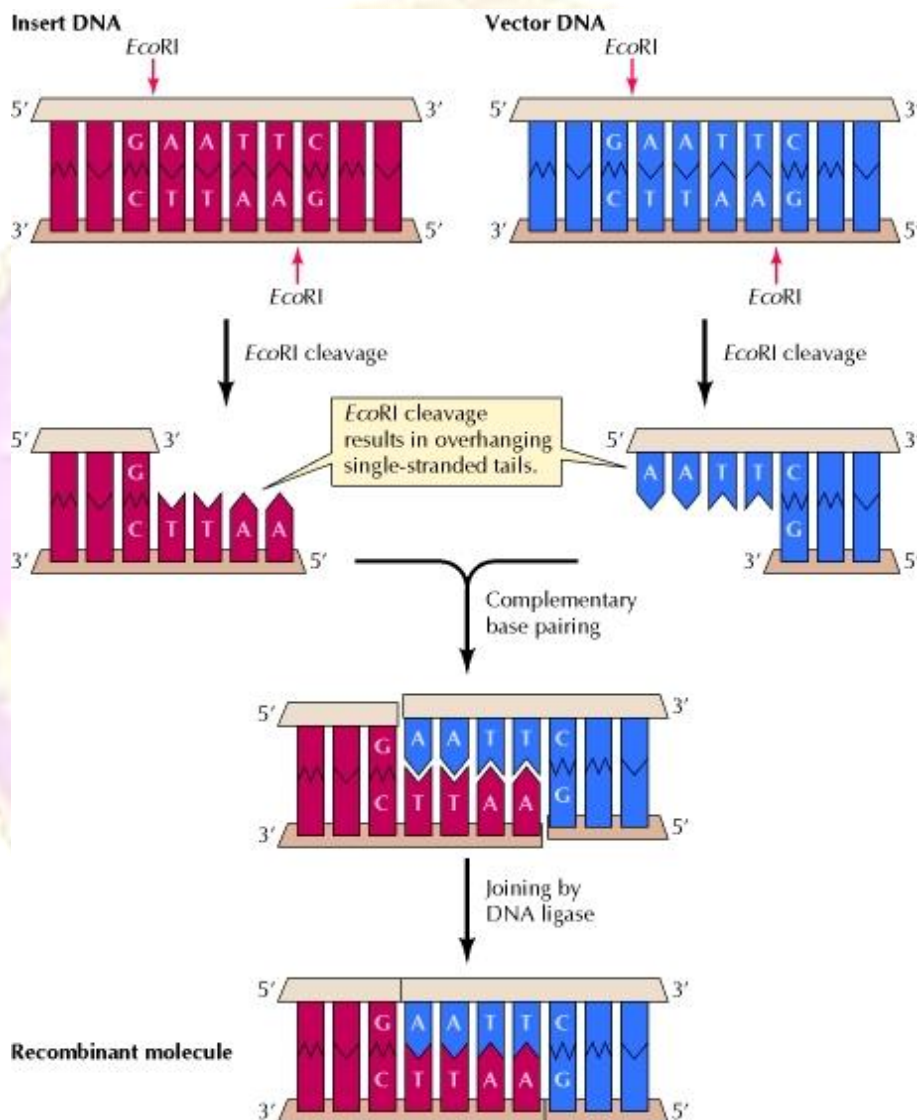

Figure: DNA digested with the enzyme *EcoRI* yields the digested fragments with sticky ends.

Source: <http://mcdevittapbio.wikispaces.com/Chapter+20+Study+Notes+-+Grace+Estampa>

Introduction to recombinant DNA technology

In 1972-1973, two groups at Stanford University, one comprising Stanley Cohen and his colleague Annie Chang, in collaboration with Herbert Boyer and Robert Helling at the University of California in San Francisco constructed hybrid bacterial plasmids and the other group of Paul Berg and colleagues constructed hybrid λ phage sequence into tumour virus SV40 *in vitro* and developed 'transformation' methods, independently. Later, hybrid plasmids and viruses developed were used as vectors for introduction of foreign DNA into bacteria and mammalian cells, respectively, using this method. Hence, the first DNA cloning strategies had been developed.

Plasmid Insertion

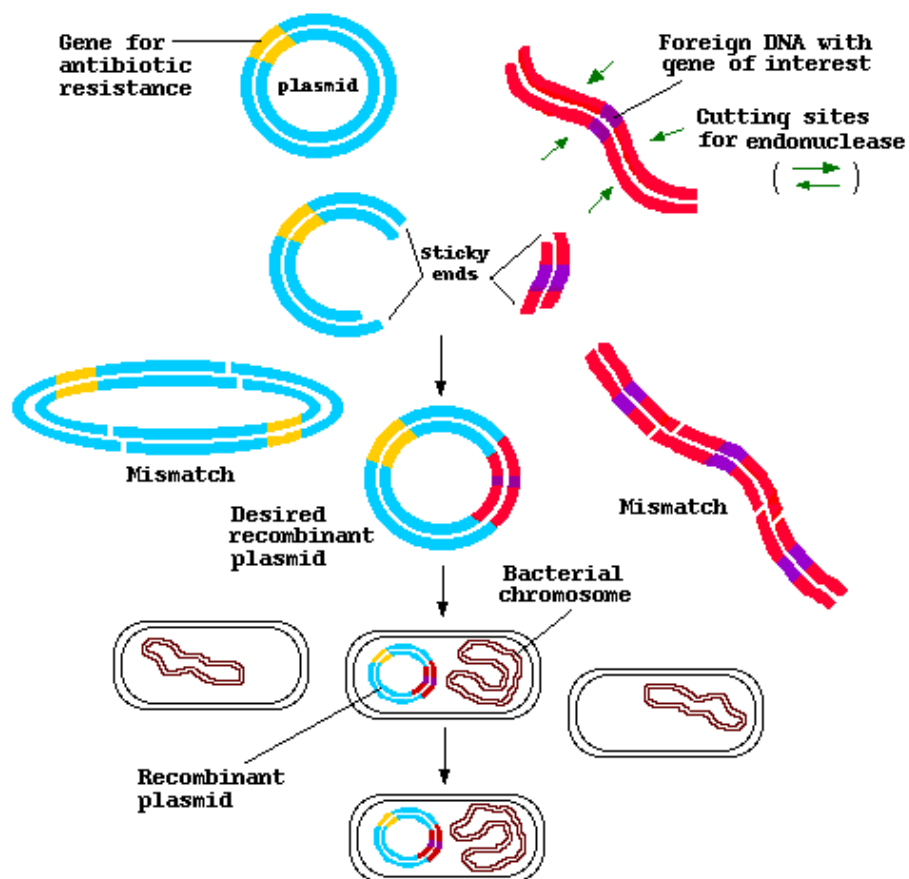

Figure: Transformation of bacterium with the recombinant plasmid.

Source: <http://whaleandwasp.wikispaces.com/Part+1-DNA+Cloning,+Recombinant+DNA,+Genetic+Engineering>

Introduction to recombinant DNA technology

Once gene modification was possible, researchers wanted the laborious process of DNA analysis to become simpler by discovering strategies to read nucleotide sequences directly, rather than taking the indirect route of protein or RNA sequencing or genetic analysis. In the years 1973-1977, two rapid DNA sequencing methods were developed. Allan Maxam and Walter Gilbert developed a method in 1973 known as wandering-spot analysis. But it was a time-consuming and labour-intensive technique which soon grew out of favour with the discovery of the chain-termination or dideoxy sequencing method in 1977, also known as Sanger sequencing, named after its developer, the English biochemist Frederick Sanger. This technique is still one of the most popular methods for DNA sequencing.

The Nobel Prize in Chemistry 1980 was divided, one half awarded to Paul Berg "for his fundamental studies of the biochemistry of nucleic acids, with particular regard to recombinant-DNA", the other half jointly to Walter Gilbert and Frederick Sanger "for their contributions concerning the determination of base sequences in nucleic acids" (http://www.nobelprize.org/nobel_prizes/chemistry/laureates/1980/).

For further information, visit <http://www.nature.com/scitable/topicpage/the-order-of-nucleotides-in-a-gene-6525806>.



Introduction to recombinant DNA technology

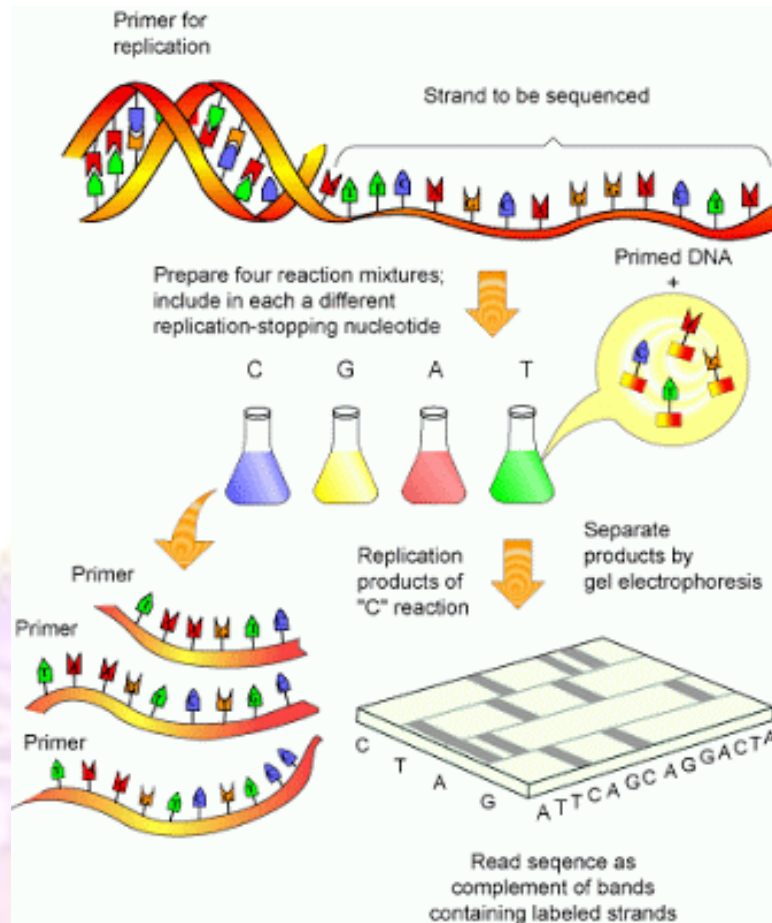

Figure: Sanger sequencing workflow.

Source: <http://medicalab.blogspot.in/2012/08/nxg-technologies-in-dna-sequencing-intro.html>

Introduction to recombinant DNA technology

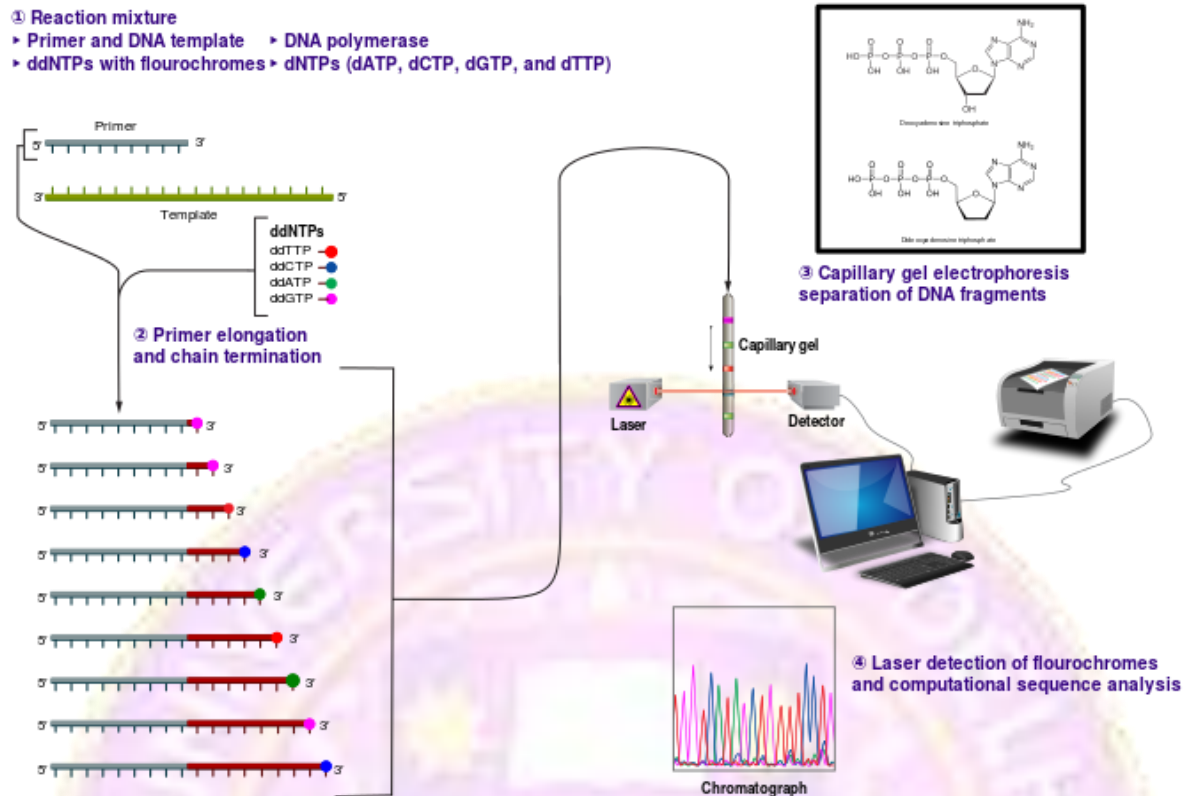

Figure: A pictorial representation of DNA sequencing by Sanger's sequencing method.

Source: <http://commons.wikimedia.org/wiki/File:Sanger-sequencing.svg>

Another revolution in recombinant DNA technology came in 1985 with the advent of a technique to rapidly amplify very minute quantities of DNA for use in cloning, developing expression constructs and to introduce mutations into genes, known as the polymerase chain reaction (PCR). Interestingly, the brainwave to put all the ingredients for DNA synthesis in a single tube and replicate the template DNA occurred to its inventor Kary Mullis while on a late night drive along the coast of California, and the technique was born without which no molecular biology laboratory functions today. The Nobel Prize in Chemistry 1993 was awarded "for contributions to the developments of methods within DNA-based chemistry" jointly with one half to Kary B. Mullis "for his invention of the polymerase chain reaction (PCR) method" and with one half to Michael Smith "for his fundamental contributions to the establishment of oligonucleotide-based, site-directed mutagenesis and its development for protein studies" (http://www.nobelprize.org/nobel_prizes/chemistry/laureates/1993/).

Introduction to recombinant DNA technology

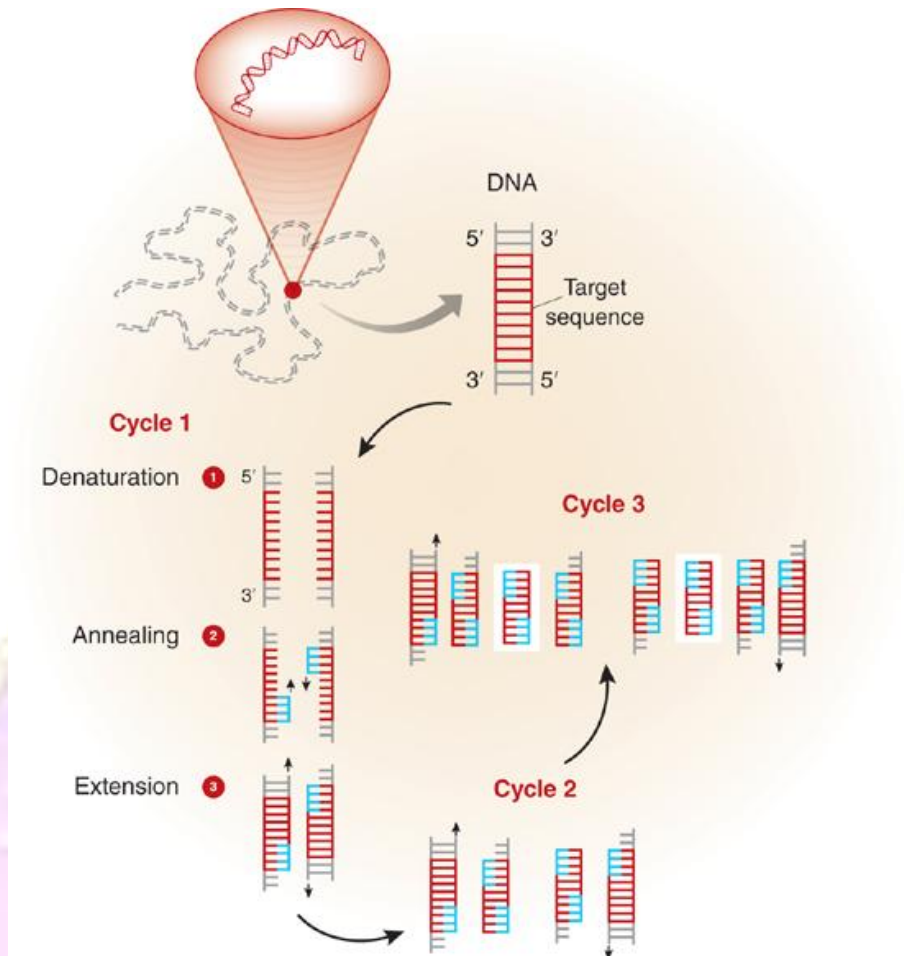

Figure: The polymerase chain reaction.

Source: http://www.nature.com/jid/journal/v133/n3/fig_tab/jid20131f1.html#figure-title

Now that the techniques to introduce modified DNA into live cells had been developed, creation of the first mammalian transgenic organism was only one step ahead.

Applications of recombinant DNA technology

The first transgenic animals to be developed were mice in the early 1980s. In 1981, Franklin Constantini and Elizabeth Lacy of the University of Oxford created transgenic mice by introducing rabbit DNA fragments into its germ-line cells. In another piece of work, Richard Palmiter of the University of Washington in collaboration with Ralph Brinster of the University of Pennsylvania transferred a foreign gene into the embryo of a mouse to create transgenic mice in 1982.

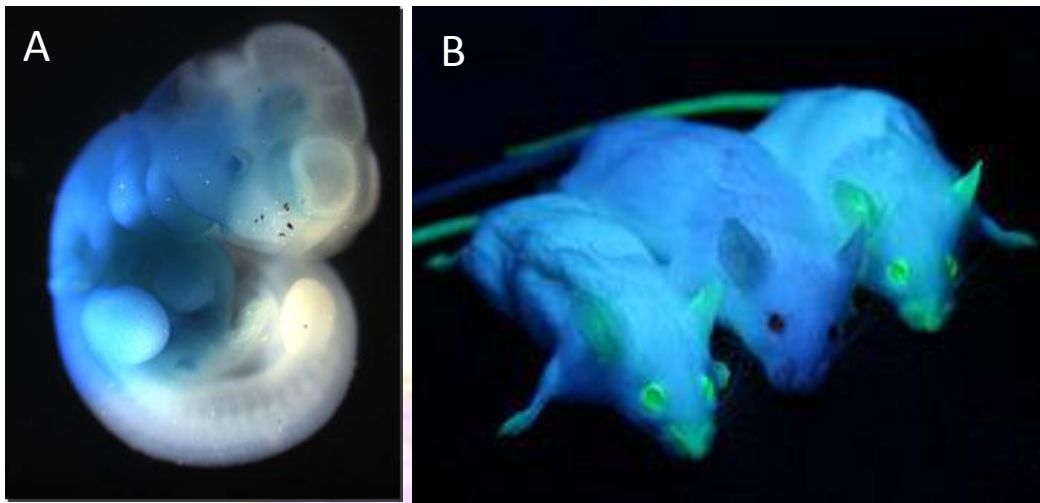

Figure: (A) Transgenic mouse embryo. (B) Three mice, one in the centre is the wild type and the other two have been transformed with green fluorescent protein and glow green under blue light.

Source: http://en.wikipedia.org/wiki/Genetically_modified_mouse,
<http://www.albany.edu/genomics/mouse-production.html>



Introduction to recombinant DNA technology

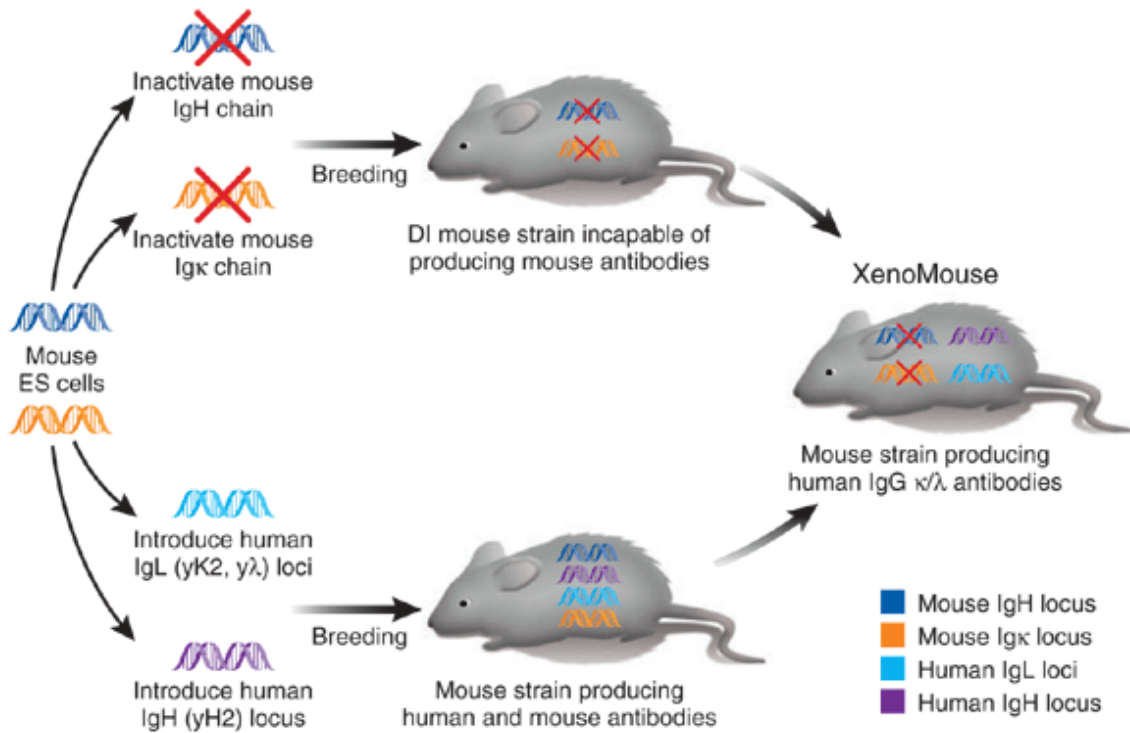

Figure: Transgenic XenoMouse strains that produce recombinant human antibodies instead of mouse antibodies.

Source: http://www.nature.com/nbt/journal/v25/n10/fig_tab/nbt1337_F1.html

Introduction to recombinant DNA technology

Around the same time, two American scientists Allan C. Spradling and Gerald M. Rubin at the Carnegie Institution for Science developed transgenic fruitflies.

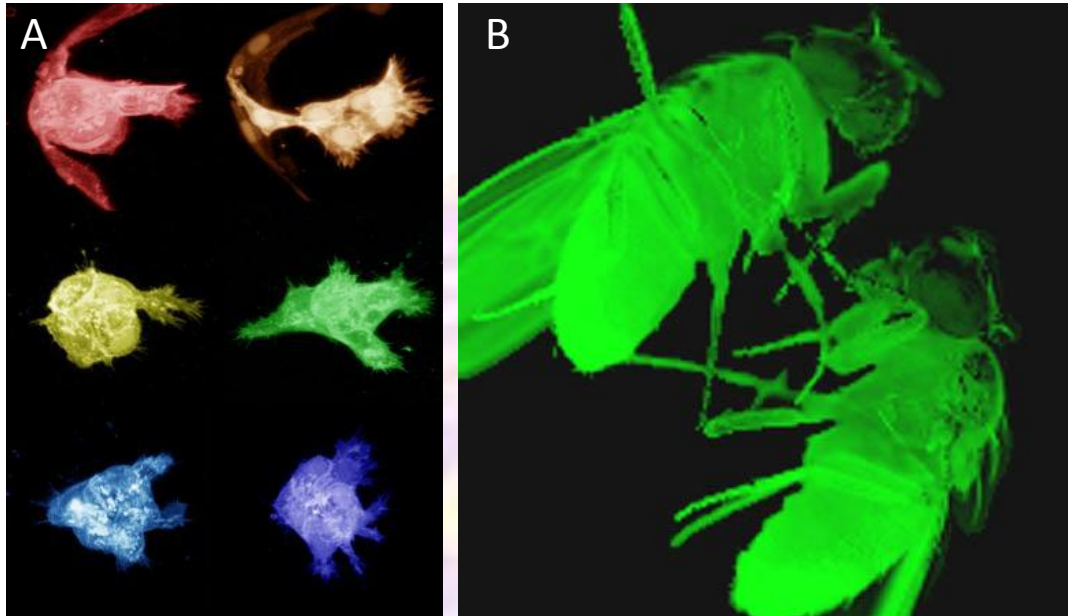

Figure: (A) Genetically engineered fruitflies that move towards light. (B) Recombinant flies, a gene from fireflies has been inserted to make them glow – creating neon flies!!

Source: <http://www.biotechniques.com/news/Light-moves-fruit-fly-cells/biotechniques-296670.html>, <http://whyfiles.org/coolimages/index.html%3Fid=1095691116.html>

Since then, the use of recombinant DNA technology in the field of biotechnology, medicine and research has seen phenomenal growth, impacting all walks of life. Recombinant proteins are usually synthesised in bacteria, yeast, insects, mammalian cells, transgenic plants and animals. Each of the system has its own pros and cons for the synthesis of the recombinant proteins.

Pharmaceutical uses

The first commercially available therapeutic recombinant protein is the insulin use for the treatment of insulin-dependent diabetes. It was first approved by USFDA in 1982. For the production of the recombinant insulin human *insulin* gene was inserted into the *E.coli* genetic material. For further information visit <http://www.nlm.nih.gov/exhibition/fromdnatobeer/exhibition-interactive/recombinant->

Introduction to recombinant DNA technology

[DNA/recombinant-dna-technology-alternative.html](http://www.dnalc.org/view/15505-DNA/recombinant-dna-technology-alternative.html), <http://www.dnalc.org/view/15505-Synthesizing-human-insulin-using-recombinant-DNA-3D-animation-with-no-audio.html>.

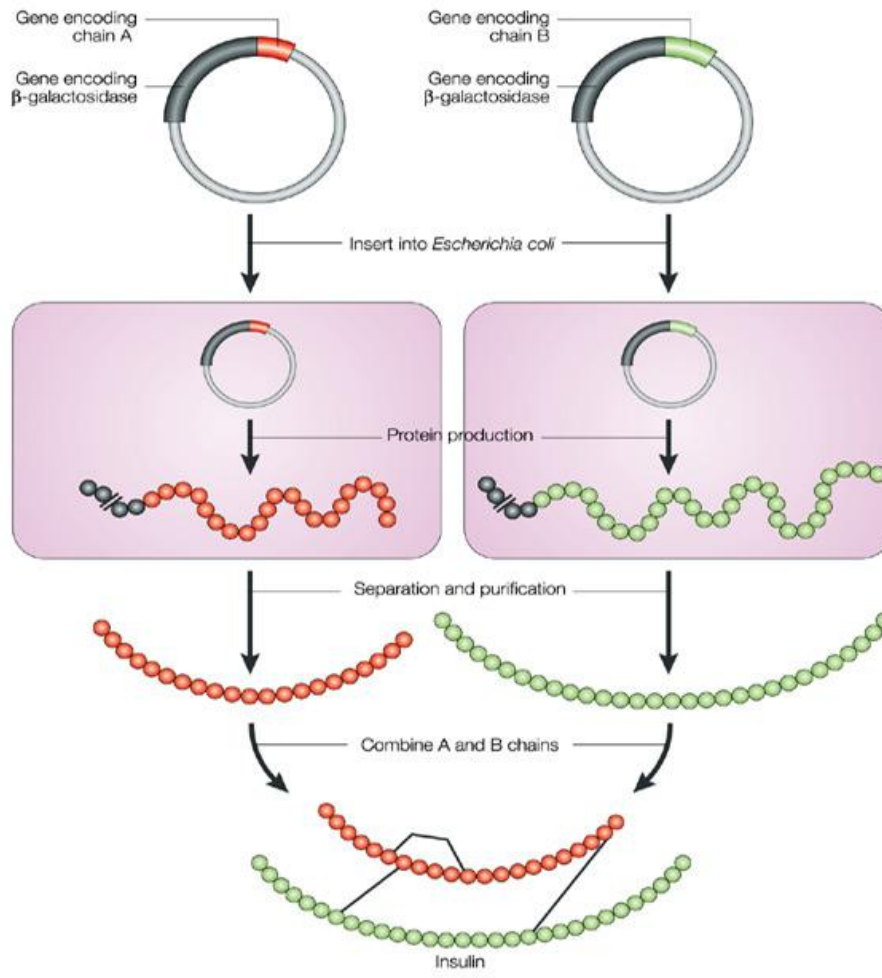

Figure: Production of recombinant insulin in bacteria.

Source: http://www.nature.com/nrd/journal/v2/n9/fig_tab/nrd1179_F1.html

Human growth hormone (HGH) or somatotropin is used to treat growth hormone deficiency in children and in Turner syndrome. Earlier, it was obtained in small amounts only from pituitary glands of cadavers which led to patients developing Creutzfeldt-Jacob disease. Recombinant HGH was first developed in 1986 using transgenic tobacco and has gained regulatory approval worldwide for therapeutic use.

Blood clotting factor VIII from the blood of human donors was used to treat the bleeding disorder haemophilia, which led to the risk of transmitting blood borne infectious diseases, hence recombinant proteins are used now.

Introduction to recombinant DNA technology

Interferons are antiviral proteins used for the the treatment of certain types of cancers and skin conditions. Recombinant interferons are produced in *E. coli*.

Vaccines

Recombinant hepatitis B vaccine to control hepatitis B infection was developed using a recombinant strain of yeast *Saccharomyces cerevisiae* that produces a hepatitis B virus surface antigen (HbsAg) in bulk, and is approved for use. A similar vaccine that is produced in transgenic tomato and induces an immune response in mice when injected into them is still under development.

Vaccines against AIDS are also being developed in the same manner.

For further information, visit <http://www.nature.com/scitable/topicpage/genetically-modified-organisms-gmos-transgenic-crops-and-732>.

Diagnostic testing

The antibody test (ELISA or western blot) and DNA test (using reverse transcriptase polymerase chain reaction or RT-PCR) used for the diagnosis of HIV infection have been developed using recombinant DNA technology.

DNA probes and PCR are now also used to detect diseases such as cancer, foot and mouth disease, tuberculosis, Lyme disease, cystic fibrosis, muscular dystrophy, Huntington's disease and fragile X syndrome.

Gene therapy

In this technique, DNA of patients lacking a sequence for the production of some essential proteins is modified by introducing the desired gene sequence into its genome. Gene therapy has been used to treat patients with deficiency in production of the enzyme adenosine deaminase (ADA) and melanoma (a virulent skin cancer).

Monoclonal antibodies

These are produced using hybridoma technology, where normal lymphocytes (B-cells or plasma cells) that produce antibodies are fused to myelonema cells (tumour cells), to produce an indefinite cell culture with an infinite supply of desired antibodies, which can be used to raise vaccines against human, animal and plant pathogens.

Introduction to recombinant DNA technology

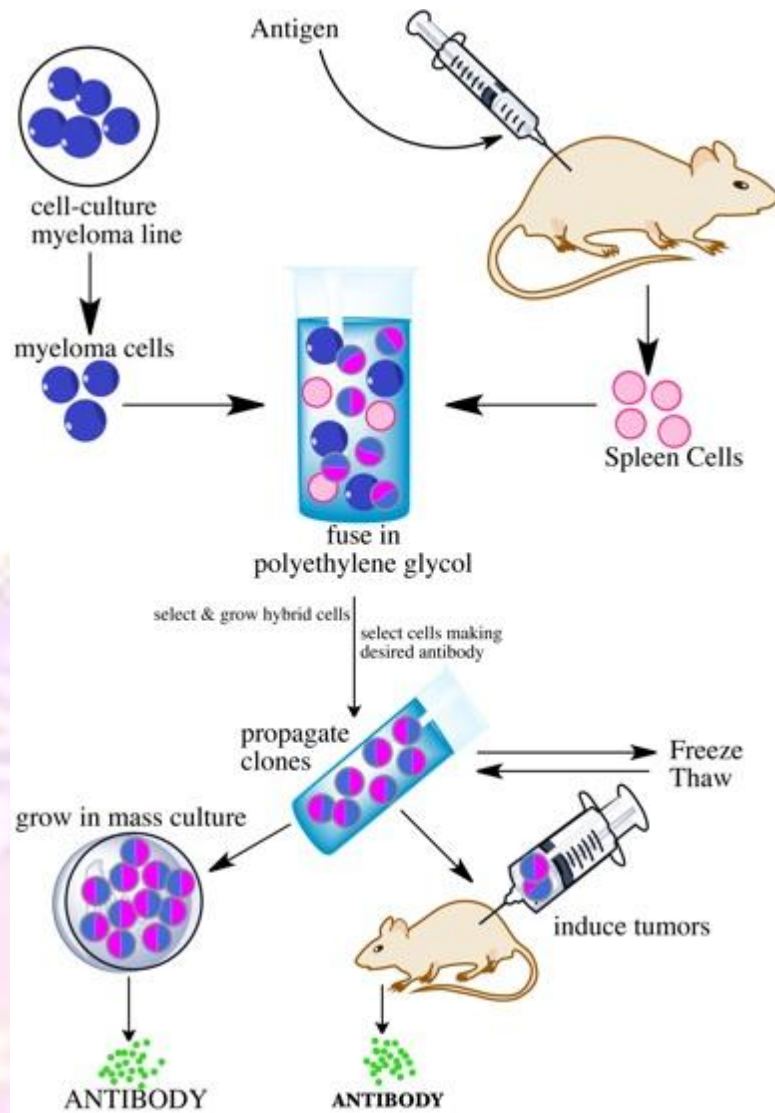

Figure: Preparation of monoclonal antibodies. Antigen is injected into mouse and after few weeks, spleen is removed and plasma cells are extracted. The mouse's spleen cells are fused with myeloma cells to create hybrid cells called hybridoma cells. Each hybridoma cell indefinitely produces identical antibodies.

Source: http://en.wikibooks.org/wiki/Structural_Biochemistry/Proteins/Sources_of_production_of_Monoclonal_antibody

DNA fingerprinting

This technology to match or find out variations among DNA sequences of individuals is commonly used in forensics for the identification of criminal suspects.

Introduction to recombinant DNA technology

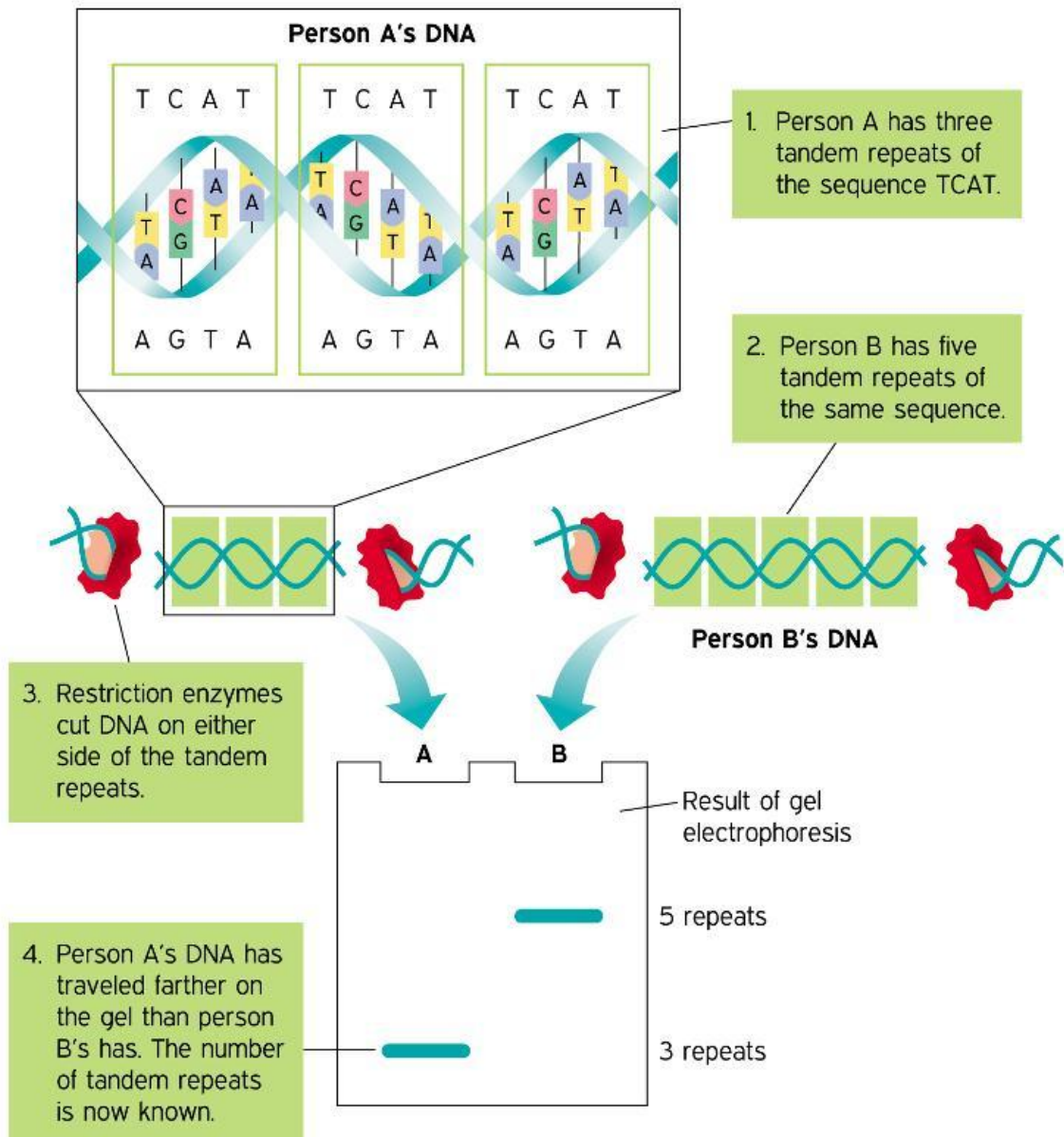

Figure: Schematic workflow of DNA fingerprinting used to distinguish between different people.

Source: http://www.mediahex.com/DNA_Fingerprinting

Food additives

In 1990, recombinant enzyme chymosin produced in *E. coli*, used to manufacture cheese, was granted 'generally-recognised-as-safe' (GRAS) status by USFDA, and today, it is used to make 60% of the hard cheese in U.S.

Agricultural uses

Introduction to recombinant DNA technology

The major objective of growing transgenic crops is enhancement in yield, which leads to increased profitability by reducing the cost of food and drug production, and hence, greater food security.

Pest and disease resistant transgenic crops are being developed to reduce yield loss and herbicide tolerant crops are being developed to eliminate weed competition from the crop plant.

- Glyphosate herbicide (Roundup) tolerant soybean, maize/corn, sorghum, canola, alfalfa and cotton that express glyphosate tolerant proteins are commercially available.
- Bt corn resistant to European corn borer insect pest, Bt cotton resistant to bollworm and Bt brinjal resistant to brinjal fruit and shoot borer express the insecticidal protein Cry1Ab from the bacterium *Bacillus thuringiensis* (the word Bt is an acronym derived from the name of this bacterium). Bt corn and Bt cotton are commercially available while Bt Brinjal awaits commercial release in India.



Figure: Non Bt brinjal is infested with pests, compared to Bt brinjal that is not infested by pests, and hence does not need pesticide sprays.

Source: <http://gmopundit.blogspot.in/2012/02/ngo-gmo-ogm-indian-pm-indicates-foreign.html>

Introduction to recombinant DNA technology

- Plum resistant to plum pox virus caused by insertion of viral coat protein (CP) gene is commercially available.

Plants with enhanced nutrient composition are used for improvement of food quality.

- Fatty acid composition of canola oil was altered by increasing laurate levels by inserting the gene for ACP thioesterase synthesis from California bay tree and is commercially available.
- Nutrient content of rice was enhanced by introgression of three genes for the production of beta-carotene, a precursor to vitamin A in rice endosperm in order to reduce vitamin A deficiency. It is known as Golden Rice but is not commercially available yet due to pending regulatory issues.



Figure: A Wild type rice. B Golden rice modified for the synthesis of beta carotene.

Source: <http://www.goldenrice.org/>

Plants that have been engineered to synthesise vaccines against human pathogens are being developed.

- Transgenic tobacco is being developed to create HbsAg vaccine against Hepatitis B infection.
- Transgenic maize expressing fusion protein (F) from Newcastle disease virus (NDV) is being used to develop oral vaccines.

Plants that show delayed fruit ripening were developed for better transport, reduced spoilage during storage due to rotting and increased shelf life. One such example is the Flavr Savr tomato that was approved for commercial use.

Introduction to recombinant DNA technology

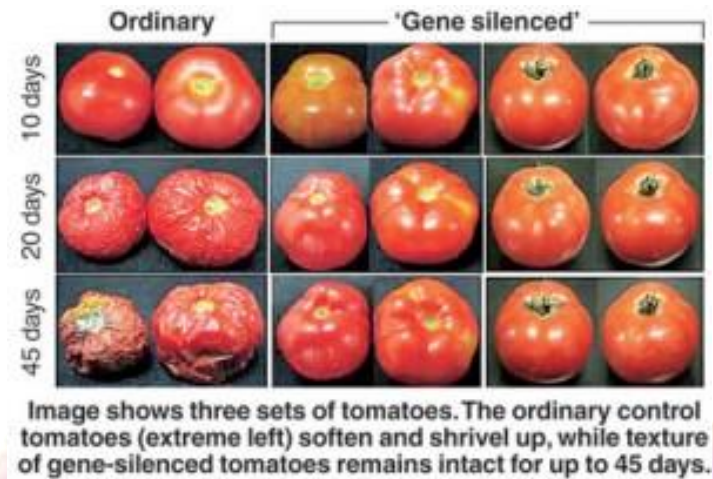

Figure: GM tomato remains fresh for 35 days longer than regular tomato.

Source: Prof. Asis Datta, Distinguished Emeritus Scientist, National Institute of Plant Genome Research.

Other objectives are to create plants with shorter maturation time to reduce the time needed for crop harvest, development of plants resistant to abiotic stresses such as aluminium, boron, heavy metals, salt, drought, frost, extreme heat, etc. and plants with the capability to fix nitrogen in order to utilise nutrient-deficient marginal lands where crop plants are not able to grow and enhance agricultural yield.

Animal husbandry

The advantage of producing transgenic animals is that the transgene conferring the desired trait to the animal will be inherited by its offspring generation after generation. The first mammal to be cloned from an adult somatic cell in the year 1996 was a female domestic sheep known as Dolly at the Roslin Institute, University of Edinburgh, Scotland.

You would be interested to know about the first and only transgenic animal commercially available in the United States to the general public, a zebrafish harbouring green fluorescent protein (gfp), producing multicoloured fish of various hues such as fluorescent green, fluorescent yellow and fluorescent purple, commonly known as GloFish.

Introduction to recombinant DNA technology



Figure: Transgenic animals – GloFish.

Source: <http://www.nature.com/scitable/topicpage/recombinant-dna-technology-and-transgenic-animals-34513>

Other than ornamental use, the major goal of developing transgenic animals is increased food productivity.

- Enhanced nutrition for public health – Transgenic pigs with enhanced levels of omega-3 fatty acids, whose consumption is known to reduce coronary heart disease, have been developed to improve nutritional quality of pork.
- Increased feed utilisation – The EnviroPig™ which express salivary phytase, lead to reduction in the water and production cost for the animals, increase in milk, meat and manure and environmental conservation due to decreased land and water usage.



Figure: Enviropigs create less pollution than regular pigs.

Source: <http://tucsoncitizen.com/morque/2008/11/17/102661-brasher-enviropigs-can-t-go-to-market-yet/>

- Addition of bovine growth hormone to cows could lead to enhanced milk production and transfer of genes for beneficial 'nutriceutical' proteins could lead to improved milk composition.



Figure: Transgenic piglets that produce 70% more milk than non transgenic piglets.

Source: <http://www.nature.com/scitable/knowledge/library/transgenic-animals-in-agriculture-105646080>

- Improved growth rate and carcass composition – Transgenic Coho salmon that grow larger and mature faster due to the presence of type 1 growth factor are being developed to improve the protein intake in human diet. Insertion of low-density lipoprotein (LDL) receptor gene and hormones like leptin would decrease fat and cholesterol in animal products.

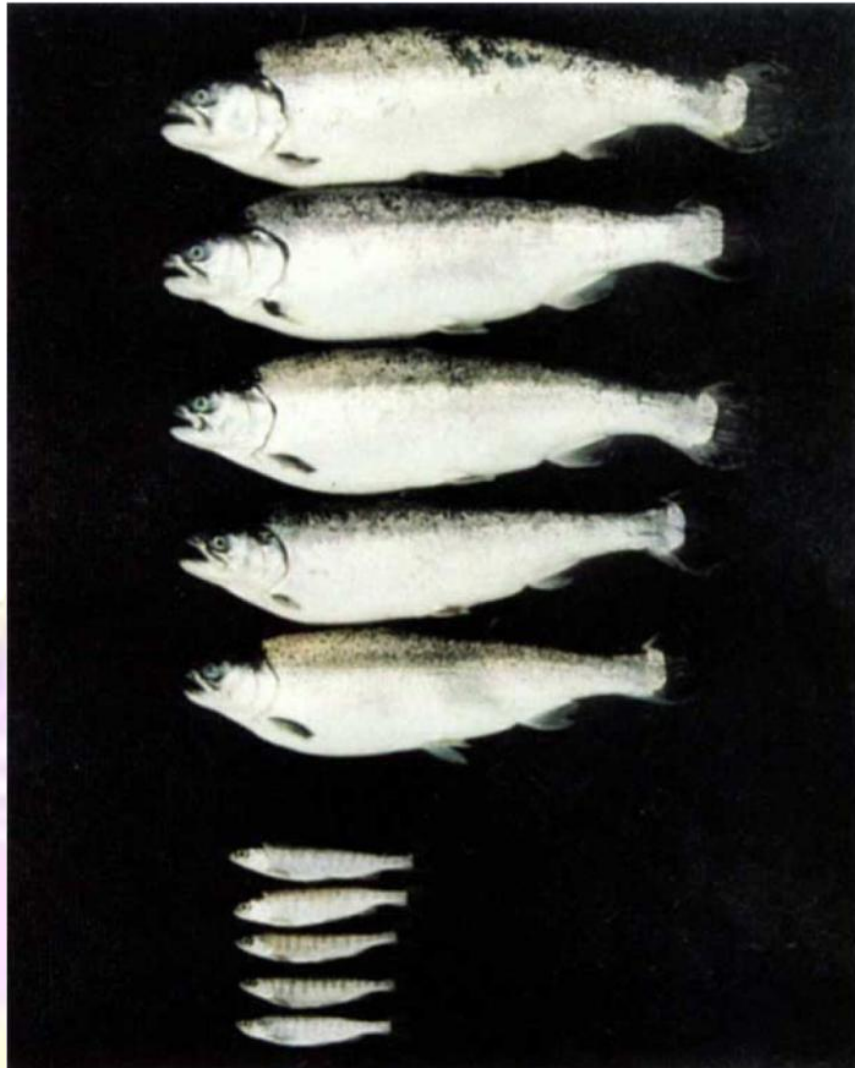

Figure: GM Coho salmon (top) grow larger than non-transgenic Coho salmon (bottom).

Source: <http://www.nature.com/scitable/content/non-transgenic-bottom-and-transgenic-top-coho-99253>

- Increasing disease resistance in animals – Transgenic cattle were shown to have increased resistance towards mad cow disease and mastitis.
- Transgenic livestock with enhanced fecundity and reproductive performance would increase food security.
- Improved colour, yield, quality of hair, fiber and wool produced by transgenic animals are the major areas of research. Spider silk has been produced using the milk of transgenic goats.

Summary

Recombinant DNA technology, the technique to create recombinant organisms by combining two DNA fragments of interest has been here since the last 40 years, and advances in this field are reported everyday due to its uses in modern medicine, improvement of public health, eradication of hunger and conservation of natural resources. Although recombinant DNA technology is steadily gaining popularity and its applications are ever increasing as the knowledge of the function of genes continues to increase, these techniques have failed to capture widespread acceptance among the masses due to personal or religious perceptions, ethical beliefs and environmental concerns. Adequate research to analyse the risks and safety concerns are needed before any GM organisms are made commercially available. However, its benefit to mankind as a source to eradicate hunger and disease worldwide should not be ignored.

Questions

1. What is recombinant DNA technology?
2. What is a genetically modified organism?
3. What is the central dogma of molecular biology?
4. Who discovered the structure of DNA? Give a description of the structure of DNA.
5. What is the role of restriction enzymes and ligases in DNA cloning?
6. Give a few examples of the therapeutic uses of recombinant DNA technology.
7. What are Bt crops?
8. Give a few examples of transgenic animals.
9. What is golden rice?
10. What is the purpose of creating transgenic plants and animals?

Glossary

Central dogma – The process of passing on information from DNA to mRNA and then to proteins is known as the central dogma of molecular biology.

Introduction to recombinant DNA technology

Cloning – The process of creating a genetically identical organism. In nature, it happens through asexual reproduction.

DNA - DNA (deoxyribonucleic acid) is the repository of genetic information that we inherit from our parents.

DNA ligase – The enzyme that could join, or recombine DNA fragments by forming phosphodiester bonds between DNA ends held by hydrogen-bond pairing in a double-stranded configuration during replication.

Gene - A gene is the basic physical and functional unit of heredity in any living organism. It is the coding sequence of DNA that is transcribed and contains information to make proteins in a cell.

Genetically modified organism - An organism, if its genome has been altered using recombinant DNA technology, either by combining DNA from different genomes or by inserting foreign DNA into its genome and the transgene is introgressed into the germ line of the organism and is stably inherited by its progeny, is known as a transgenic or genetically modified (GM) organism.

Molecular cloning – The process of creating multiple identical copies of any DNA fragment, usually involving recombinant DNA technology.

Recombinant DNA - Recombinant DNA, or recombinant DNA, as the name suggests, is comprised of two or more pieces of DNA molecules that have been combined together to form a single molecule.

Replication – The process by which one DNA molecule makes a duplicate copy of itself inside the cell.

Restriction enzyme – The enzymes that cleave DNA at specific restriction sites in the genome.

Transcription – The process by which a DNA molecule is copied into RNA inside the cell.

Translation – The process by which the mRNA codes for a protein inside the cell.

References

1. Molecular Biology, 2nd edition. David Clark
2. Gene cloning and DNA analysis – An Introduction. 6th edition. T.A. Brown

Introduction to recombinant DNA technology

3. Molecular Biology of the cell. 5th edition. Bruce Alberts, Alexander Johnson, Julian Lewis, Martin Raff, Keith Roberts, Peter Walter
4. Molecular Cloning: A laboratory manual. 4th edition. Michael R. Green and Joseph Sambrook

Web links

- <http://www.nature.com/scitable/topicpage/recombinant-dna-technology-and-transgenic-animals-34513>
- <http://www.nature.com/scitable/topicpage/discovery-of-dna-structure-and-function-watson-397>
- <http://www.nature.com/scitable/topicpage/isolating-hereditary-material-frederick-griffith-oswald-avery-336>
- <http://www.nature.com/scitable/topicpage/restriction-enzymes-545>
- <http://www.nature.com/scitable/topicpage/genetically-modified-organisms-gmos-transgenic-crops-and-732>
- <http://www.nature.com/scitable/knowledge/library/transgenic-animals-in-agriculture-105646080>

