

## The Application of the Refractory Carbides and Borides to Aluminum Reduction Cells

C. E. RANSLEY

The British Aluminium Co. Ltd., Gerrards Cross, Bucks., England

### Abstract

This paper describes the long-range work initiated by The British Aluminium Co. (and developed in association with the Kaiser Aluminum & Chemical Corp.) on the application of the carbides and borides of the transition elements to cathode construction in aluminum reduction cells. Titanium and zirconium borides and carbide/boride mixtures are particularly suitable for this purpose, and the project has required the preparation and fabrication of these materials in the form of massive pieces of a closely controlled quality. It has been found possible to produce these at an acceptable cost. By the use of these materials the cathode voltage drop can be considerably reduced, and various new types of cell structure become feasible. The cell lining, for example, can be made electrically neutral; under these conditions flux absorption is markedly less than in orthodox cells. A further advantage is that magnetic fields can be virtually eliminated. Some results on full production cells presently in operation are reported.

### Introduction

It is remarkable how little the cell used in the Hall-Héroult electrolytic process for aluminum has changed in the 70 years of its existence. It has increased in size from 4–6 kA in 1890 to 100 kA or more today, and a major modification to the system occurred when the Soderberg continuous electrode was introduced in the 1920's, but the cell itself still remains as a shallow carbon-lined container, thermally insulated at the sides and bottom, contained in a steel box structure. The cathodic connection is made by burying iron bars in the bottom and thus making an indirect contact with a pool, or "pad," of molten aluminum which rests on the floor and constitutes the active cathode. The electrolyte used is also still the cryolite-calcium fluoride-alumina fusion developed in the early days of the process and has only changed slightly in respect to the optimum operating composition.

Since the voltage efficiency of modern cells is only 40% and the over-

all energy efficiency about 35%,<sup>1</sup> there is clearly considerable scope for improvement in cell design, particularly as recent increases in cell amperage have led to a situation in which the dissipation of heat from the structure has constituted one of the major problems, at least with Soderberg anodes. The obvious remedy for this is to reduce the ohmic resistance of the cell; the various possibilities have been discussed in many papers (e.g., refs. 1, 2) and include (1) reduction in current density, (2) reduction in interpolar distance (working distance), (3) use of an electrolyte with a higher electrical conductivity, and (4) reduction in ohmic resistances occurring externally to the flux path.

Factors (1) and (2) are strongly interrelated with current efficiency and will be discussed later. Some feasible modifications of electrolyte composition in accordance with (3) have been mentioned by Lewis.<sup>2</sup>

Although the voltage losses external to the cell are not unimportant, they are normally small compared with those occurring in the anode and cathode structures. Thus the anode drop may vary between 0.7 and 0.25 v depending on the type of anode. Various figures have been published for the voltage drop in the cathode (i.e., between the cathode bus bar and the metal pad), but it is normally in the range 0.40 to 0.75 v. For 40 kA cells, the drop is often at the lower end of this range, i.e., 0.40–0.50 v. The resistance causing this drop arises mainly within the box structure and from the conduction sequence (a) steel cathode bar, (b) iron/carbon interface, (c) spreading resistance in the carbon floor, and (d) interface carbon/molten aluminum pad. The highest individual drop is probably (d) due to the formation of carbides and other compounds at the surface of the lining, combined with the deposition of high-alumina sludges in this area.

One factor which has a very important effect on the economics of cell operation is the life of the lining. Although the precise mechanism is not understood, penetration of the cathode by flux and sodium takes place, and is accompanied by expansion, graphitization of the carbon, and aluminization of the steel bars. Lifting of the cathode occurs, followed by final failure due to the cell "going to iron," or to the development of an actual leak. These effects become more pronounced as the amperage increases above 40 kA. It can be conjectured that the fact that the cell bottom is actively cathodic, with an appreciable potential drop through the thickness, contributes to the penetration of flux constituents into the structure. It is also evident that the generation of heat within the cathode itself may well be a contributory factor in its final deterioration, since the voltage drop in it is substantial compared with the ohmic drop in the molten flux itself (e.g., 0.5 compared with

1.5–2), temperature measurements at the center of large 100 kA cathodes show that the cathodes can run very hot indeed.

These considerations lead to speculation as to whether any improvement in the cathode construction of the cell can be effected. In theory this is perfectly feasible since it can be shown quite readily<sup>3</sup> that the voltage drop incurred in passing electric current through a conductor of optimum dimensions and with a normal Lorenz function with respect to thermal and electrical conductivity, when the ends are maintained at 20 and 960°C, is of the order of 0.18–0.19 v. This suggests that if an appropriate material could be found the cathode voltage drop might be reduced to less than half the existing value.

Another marked deficiency in the present carbon cathode arrangement must be emphasized. This is that electrolysis on a bare carbon cathode takes place with only a very low current efficiency;<sup>1</sup> sodium is produced which penetrates the carbon rapidly and causes disintegration. This effect is even more pronounced with other alkali ions, e.g., from potassium-containing electrolytes. Because of this behavior, a carbon cathode cannot be worked efficiently at an appreciable angle to the horizontal, but must be operated so that it is covered by a metal pad; also, to allow for surface tension effects, this pad must be of an appreciable thickness, say 2 in. or more. It is for this reason that the Hall cell has retained its classical form, with its attendant disadvantages of large floor area requirements and restriction in operating conditions.

#### Development of New Materials for Cathode Construction

More than ten years ago, work was initiated in the laboratories of The British Aluminium Co. on the development of materials for the specific purpose of improving the cathode performance of the Hall cell. This project owed its origin to an observation during the use of titanium carbide crucibles in an investigation on the purification of aluminum by an evaporating process. The carbide was found to be strongly wetted by the molten metal; this property, in combination with other characteristics such as good electrical conductivity and low solubility in the metal, suggested that it might prove suitable for use in a cell, either as a direct lead into a metal pad or as a sloping cathode without the deficiencies of carbon as outlined earlier. Further work showed that in fact the carbides and borides of certain of the transition elements, and particularly those of titanium and zirconium, have properties which make them highly suitable for this application. A number of patents have been published,<sup>4</sup> and others are pending, covering the use of such compounds.

Since 1956 a long-term project has been carried on by The British Aluminium Co. in close association with the Kaiser Aluminum & Chemical Corp. of the United States and has been taken to industrial cell status by both these concerns.

Many important properties are required of a good cathode material. The degree to which the carbides and borides of the transition elements (we may conveniently adopt the term RHM, or refractory hard metals, for this class of compounds) fulfill these requirements is discussed below. Before doing this, however, one essential, if obvious, point must be emphasized. This is that the selected material must be capable of being fabricated into the required form at a cost which is an economic one in relation to the overall cost of the cell and any productive advantage that may result from its use.

#### Production of Carbide and Boride Powders and Bodies

When the project on the application of these materials to reduction cells was in its early stages, the carbides of titanium and zirconium, and more particularly their borides, were only available in very restricted quantities and were also extremely expensive. Titanium carbide was used to some extent in bonded tungsten carbide products, but the unbonded materials were only produced on a laboratory basis, in the form of very small compacts. The progress of the whole project was, therefore, dependent upon the development of methods for the preparation, and fabrication into relatively massive pieces, of these materials; there was thus an obvious interaction between material availability and cell investigation which added to the difficulty of the overall development.

The processes used for the production of the various carbides and borides of interest in cell applications are essentially similar. The most important compounds are those of titanium and zirconium; the production procedures may be illustrated by reference to titanium.

Titanium carbide is readily produced by the direct reduction of titanium dioxide by carbon:

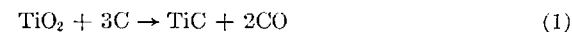

The reaction proceeds rapidly at temperatures of the order of 2000–2500°C, but back reaction can occur during cooling down from the reduction temperature and rapid cooling is required. Methods and apparatus for carrying out this process have been described in an early patent.<sup>5</sup>

The boride can be manufactured by a similar reaction; e.g.,

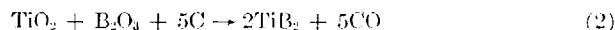

or by using intermediate products:

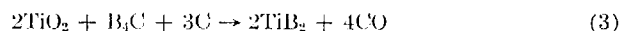

All reactions are capable of yielding readily powdered products suitable for final fabrication into massive pieces for cell use. Both hot pressing and cold pressing followed by sintering can be used for fabrication, and it has proved possible to develop very satisfactory procedures for the manufacture of compacts of the sizes required. Much of the experimental work on cell structures has utilized cylindrical rods 2 and 3 in. diam up to 26 in. long and many hundreds of these have been produced on pilot scale plant without any serious technical difficulties. Rods of even larger dimensions are also being made at the present time.

It has been one of the principal objectives of this work to make these refractory compounds available as quite massive engineering materials, and sufficient experience has now been gained to demonstrate that they can be manufactured at a reasonable cost, e.g., \$5.00 per lb of fabricated compact, such that the proposed cell projects become economically feasible.

### Properties of Compacted Carbides and Borides

Although porous RHM bodies have considerable possibilities in cell applications, it has been shown that relatively dense materials (e.g., with densities in excess of 90% theoretical) are advantageous in many respects. A gas permeability test shows that such bodies become virtually impermeable when the density exceeds 92–93%, and this has important effects on the behavior in certain methods of utilization. Electrodes with densities of better than 95% are now used in certain cell applications.

The properties of such materials have been studied in considerable detail. Minor impurities have a profound effect on the sintering behavior of the pressed powder and on the properties of the final compact, and a close control on composition has to be maintained in order to obtain materials which are suitable for use under the onerous conditions of cell operation. This has necessitated the development of new analytical procedures and also methods of cutting and examining these very hard substances, e.g., by metallographic techniques. The properties which are most important are electrical resistivity, strength, solubility in

molten metal and flux and corrosion resistance; these have been studied in the titanium and zirconium carbides and borides and in the carbide/boride systems with appropriate support from micrographic, x-ray diffraction, and electron microscope examination. It is expected that the detailed results of this work will ultimately be published in subsequent papers from the laboratories of both The British Aluminium Co. and the Kaiser Aluminum & Chemical Corp. For the purpose of the present introductory paper it will be sufficient to quote some typical properties of the titanium compounds.

### Electrical Resistivity

The resistivity of  $\text{TiB}_2$  is dependent on its purity but at room temperature normally lies in the range of 10–30  $\mu\text{ohm cm}$ . The resistivity of  $\text{TiC}$  is appreciably higher than that of the boride and is approximately 70  $\mu\text{ohm cm}$  at room temperature. The variations of resistance with

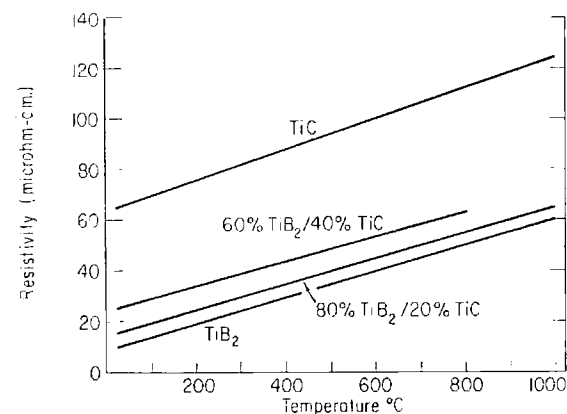

Fig. 1. Electrical resistivity of titanium carbide, titanium boride, and some mixtures over the temperature range of 20 to 1000°C.

temperature in the range of 20 to 1000°C for both the carbide and boride and some of their mixtures are shown in Figure 1. There is only a limited mutual intersolubility of the compounds at the two extremes of the system, and the effect of composition on resistivity is thus nearly linear.

### Thermal Conductivity

The thermal conductivity of a relatively pure  $TiB_2$ , hot pressed to a density of about 90% theoretical, has been measured by the National Physical Laboratory with the results given in Table I.\*

TABLE I  
Thermal Conductivity of  $TiB_2$

Temp., °C	50	100	200	400	600	800	1000
Thermal conductivity, cgs	0.141	0.140	0.138	0.138	0.129	0.119	0.107

These results given in Table I thus indicate a thermal conductivity of the same order as iron and a negative temperature coefficient similar to that shown by metals.

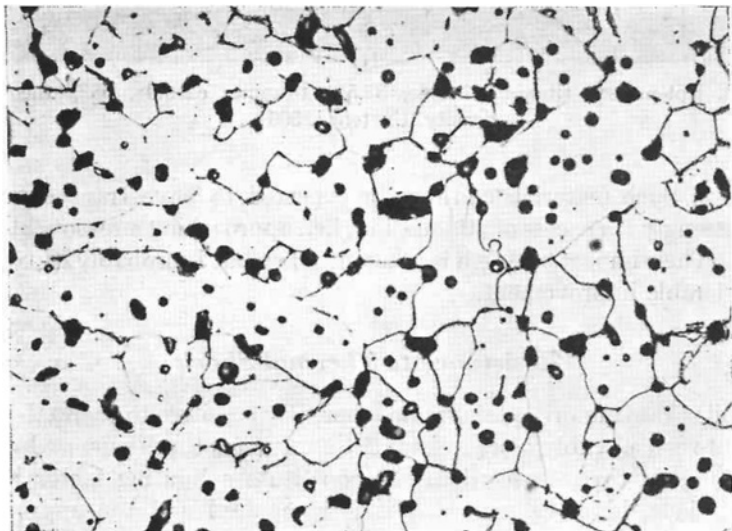

Fig. 2. Hot-pressed titanium boride, 94% theoretical density. Etched. 500 $\times$ .

### Mechanical Properties

The transverse rupture strength of these materials is very sensitive to residual porosity and final grain size. The structure of a relatively pure  $TiB_2$  and of a  $TiB_2/TiC$  "alloy" showing the occurrence of  $TiC$  as a secondary phase are illustrated by the photomicrographs, Figures

\* These data are due to Dr. R. W. Powell of the National Physical Laboratory, Teddington, Middlesex, England.

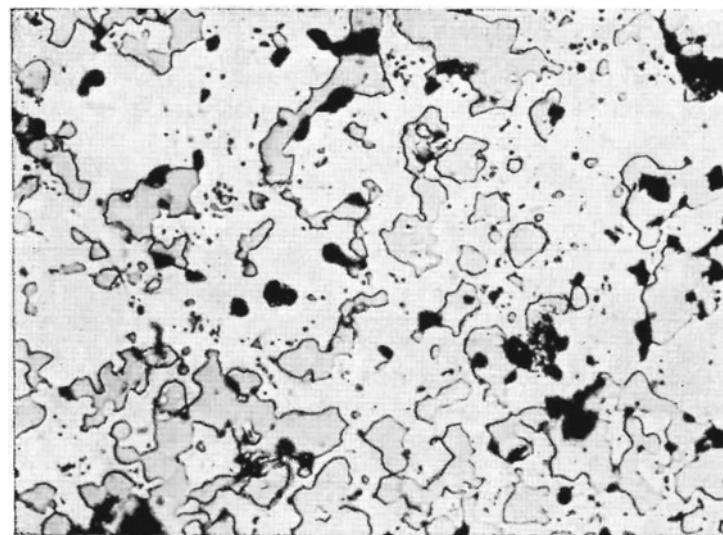

Fig. 3. Hot-pressed titanium boride, 37.5% titanium carbide, 95% theoretical density. Unetched. 500 $\times$ .

2 and 3. Such materials can now be expected to have transverse rupture strengths in excess of 20 tons/in.<sup>2</sup>, i.e., approaching a reasonable cast iron. Their impact strength is inherently low but is probably capable of considerable improvement.

### Resistance to Thermal Shock

While these materials tend to be inherently sensitive to thermal shock, they are considerably more resistant<sup>6</sup> than is sometimes supposed. Their deficiency in this respect does not constitute a limiting factor in cell applications, however, provided it is recognized and the appropriate steps are taken to avoid drastic conditions, particularly in the starting up of cells.

### Solubility in Molten Aluminum and Cryolite Fluxes

Detailed measurements have been made of the solubility of titanium carbide, carbon, titanium boride, and carbide/boride mixtures in molten aluminum over a wide temperature range (800 to 1600°C); these results will be published in the later paper. In the case of pure  $TiB_2$ , however, it has been found from experiments on the dissolution of hot-

## NEW PROCESSES AND MATERIALS

pressed compacts in molten aluminum under high vacuum or inert gas atmosphere conditions that the normal solubility product law:

$$[\text{Ti}] \times [\text{B}]^2 = \text{constant} \quad (5)$$

is obeyed quite closely over the important temperature range, i.e., 850 to 1100°C (see Table II).

TABLE II  
Solubility Product: Titanium and Boron in Aluminum

Temp., °C	$[\text{Ti}] \times [\text{B}]^2$ , wt-%	$[\text{Ti}]$ for stoichiometric soln., wt-%
850	$2 \times 10^{-9}$	0.002 <sub>6</sub>
970	$1 \times 10^{-8}$	0.004
1100	$6 \times 10^{-8}$	0.008

At the normal cell temperature of 970°C the equilibrium solubility of  $\text{TiB}_2$  is thus very low. It must also be pointed out that the introduction of titanium and boron from sources other than the electrodes (e.g., by the addition of very small quantities of borax to the flux) will result in a back reaction of the solution process and this can be used, if required, to control the rate of solution of the electrodes. Titanium is normally present in commercial purity aluminum, and this assists in slowing down the rate of solution of the boride. In fact, it has been found that in commercial cells fully equipped with boride electrodes, the erosion of the electrodes within the metal pad is so slow that it can



Fig. 4. Durability of RHM electrodes under cell conditions. Left: 2½ in. diam rod after 267 days of service. Right: unused rod.

## ALUMINUM

be discounted from the point of view of life. This is illustrated by Figure 4 which shows the appearance of the end of a boride rod after 267 days of operation in a 10-kA experimental cell; an unused electrode is shown for comparison, and the degree of erosion has clearly been quite negligible in this time.

Under cathodic conditions the rate of dissolution of these materials in molten cryolite fluxes has also been shown to be negligible. They are also found to be very resistant to the attack of other alkali ions and in particular to potassium which, as already mentioned, has an extremely

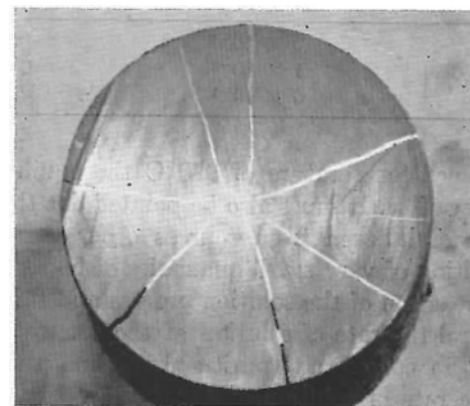

Fig. 5. Cross section of 2 in. diam titanium boride rod after only 6 days of cell operation, showing cracking and aluminum penetration of unsuitable material.

disruptive effect on carbon. Their suitability for cathode construction in cells can thus be readily demonstrated, and it is possible to contemplate their use either as current leads to a molten aluminum pad, or alternatively, as cathode plates which allow the electrolytically separated metal to drain down to a selected region of the cell.

It must be emphasized, however, that it is necessary to exercise a very close control over the chemical composition of these materials in order to insure an adequate quality for this application. Unsuitable materials are rapidly penetrated and disrupted in use; the type of cracking which occurs, which can sometimes be misinterpreted as thermal shock, is illustrated in Figure 5. Useful guidance as to the suitability of material can be obtained by a simple immersion test in aluminum at about 970°C, preferably in vacuum or neutral gas, but confirmation under actual cell conditions is undoubtedly necessary also.

### Resistance to Corrosion

Obviously where the cathodic elements emerge from the cell at an elevated temperature, a good resistance to oxidation and to the corrosive environment of the cell is essential. The rate of oxidation of titanium carbide shows a marked peak at about 450°C and at this temperature there is no protective film formation; the resistance improves again at higher temperatures, where an adherent film of rutile is formed.<sup>7</sup> Zirconium carbide shows similar behavior, and these carbides must be protected if used under conditions where this type of oxidation can occur.

The borides are very much more resistant to oxidation and will stand prolonged exposure at temperatures above 600°C without excessive deterioration. Carbide/boride mixtures also have good properties in this respect. When the cell electrodes are housed entirely within the structure of the cell, oxidation resistance is, of course, not important, since the conditions at the cathode are normally highly reducing.

### Cell Structures

A wide range of cell structures is feasible when these refractory compounds are used as cathodic elements. Some of those illustrated in published patents<sup>4</sup> are shown in Figures 6 to 11, and can be divided into two broad groups in which the elements are used (a) as current leads direct into the metal pad, as shown in Figures 7 to 10; (b) as sloping cathode plates or other surfaces which allow the aluminum to drain to a lower part of the cell, as shown in Figure 11.

In the present paper it is intended to deal primarily with the current lead applications, since this type of cell has been studied to a much greater extent than the sloping cathode type. Very interesting results have been obtained on the latter, however, and the potential advantages of such cells are undoubtedly considerable.

### Candle Lead Cell

Before giving closer attention to the current lead cell, reference should be made to the very simple cell modification which is illustrated in Figure 6. This consists of the insertion of relatively short leads (or "candles") into a standard carbon cathode without any other alterations to the cell; this has the advantage that it can be applied to any type of existing cell.

It has already been pointed out that the most important component in the voltage drop between the metal pad and the cathode bus bar is

ALUMINUM

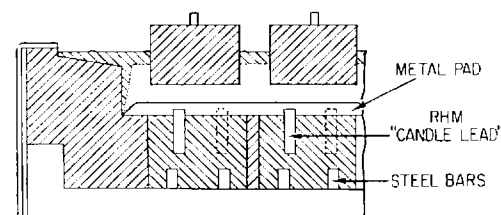

Fig. 6. Use of RHM candle leads in conventional cathode.

that at the pad/carbon lining interface; this arises as a result of compound formation at the carbon surface and also because high-alumina sludge tends to be deposited at the interface. The degree of sludging can vary widely and can thus lead to considerable fluctuations in the current distribution and also in the overall cathode voltage drop. Laboratory tests showed that the high resistance layer could be partially short-circuited by the use of short RHM candles or rods inserted into the cell lining and left protruding 1 to 2 in. into the metal pad; subsequent cell tests have demonstrated that such leads have beneficial effects.

In the case of prebaked carbon linings, a convenient technique for installing the leads is to drill slightly undersized holes in the blocks before assembly or in the finished cell bottom, which are honed out so that the RHM rods are a sliding fit; the rods are covered with pitch and then driven into the holes. The bores are preferably located so that they are uniformly distributed over the bottom of the cell and the lower ends of the candles are in close proximity to the iron cathode bars.

In a preliminary trial with a small prebaked anode cell, normally rated at 16 kA, the candles consisted of 24 hot-pressed titanium carbide rods 2 in. in diameter and 7 in. long, uniformly distributed over the floor and arranged so that 1¼ in. of the rods projected above the carbon cathode. The lining of the cell was constructed with prebaked cathode blocks 14 in. thick; the steel cathode bars were 2¼ in. wide and 4¼ in. deep and were accommodated in slots cut in the bottom of the blocks. The modified cell was compared with an entirely similar cell, not equipped with candles, which was run in series with it.

The cells were closely observed over a period of approximately three months. The flux bath used was normal cryolite containing 6–10% calcium fluoride and was operated with an excess of aluminum fluoride over the normal cryolite ratio; the candle and control cells averaged 6.8 and 6.5% excess  $AlF_3$  over the test period. Extensive routine measurements were made of the voltage drops in the cell, the flux and metal pad

temperatures, and current efficiency. It was found that the average cathode voltage drop in the control cell over the three-month period was 0.58 v, the individual values varying between 0.41 and 0.81 v. The corresponding average cathode drop on the candle cell was 0.38 v, with a range of only 0.30 to 0.46 v. The results of the temperature measurements, again averaged over the whole period, were as given in Table III.

TABLE III  
Temperature Measurements

	Control cell, °C	RHM candle cell, °C
Flux	964	960
Metal pad	953	943

The average current efficiencies of the two cells were 89.8 and 90.8% for the control and modified cell, respectively; the higher efficiency of the latter can be ascribed to the fact that at the same overall cell voltage, its working distance was increased to maintain the heat input into the cell.

This simple cell modification has also been tested under full production conditions, e.g., in 40 kA Soderberg cells. In one arrangement which was tried, the inserts consisted of hot-pressed titanium boride bars 2 in. in diameter and 9-9½ in. long, which were left protruding 1½ in. above the cathode. Only 27 electrodes were used in this case, because of the higher conductivity of the titanium boride compared with the carbide used in the test described above. A strict comparison was again made with a control cell, and over a test period of five months the average cathode voltage drop of the modified cell was 0.2 v less than that of the control. The current efficiency was also about 2% higher.

A striking feature in the performance of these candle lead cells is the constancy of the cathode voltage loss, particularly under cold or sludgy conditions, by comparison with the widely fluctuating values observed in orthodox cells. This suggests that the candles also result in the maintenance of a more uniform current distribution in the cathode, and this factor may partially account for the improvement in current efficiency which is found.

The metal tapped from the cell equipped with titanium boride leads analyzed 0.007% titanium, 0.001% boron compared with 0.0045% titanium, 0.0002% boron in the metal from the orthodox cell. If pure

titanium carbide leads are used, the titanium content may be as much as 0.02% higher than in a normal furnace and the life of the inserts is then relatively short.

### Current Lead Cells

The cells indicated diagrammatically in Figures 7 to 10 all incorporate RHM leads to establish a direct electrical connection from the cathode bus bar to the molten metal pad. Such connections may obviously be of widely different types; for many purposes rods 3 in. or more in diameter provide a convenient arrangement. The current-carrying capacity of such rods is approximately 500 A/in.<sup>2</sup> (77.5 A/cm<sup>2</sup>) cross section, although the actual value is naturally dependent upon the composition of the RHM material and the way in which it is used. Figure 11 is a cell with sloping cathode plates.

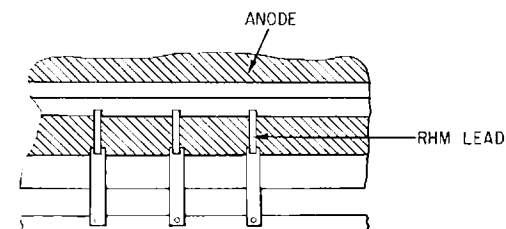

Fig. 7. Cell with bottom-entering leads.

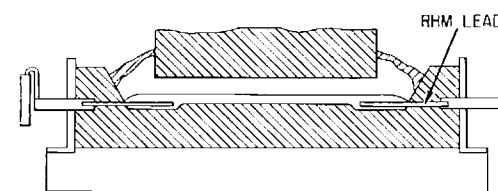

Fig. 8. Cell with side-entering leads.

By means of the cathode structures shown it is possible to reduce the total cathode voltage drop to about 0.2 v, or even less if there is a considerable abstraction of heat from the cell. This low voltage can only be achieved if low resistance contacts are made both to the metal pad and between the RHM electrode and the conductor leading to the negative bus bar. The contact to the pad is automatically insured by the wetting of the RHM electrode by the molten metal. The connection to

NEW PROCESSES AND MATERIALS

ALUMINUM

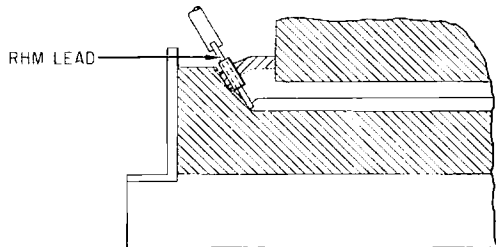

Fig. 9. Cell with leads through crust (side-channel arrangement).

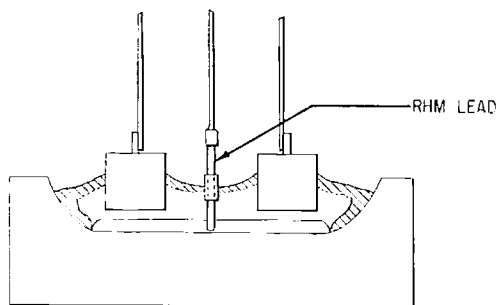

Fig. 10. Cell with leads through crust (center-channel arrangement).

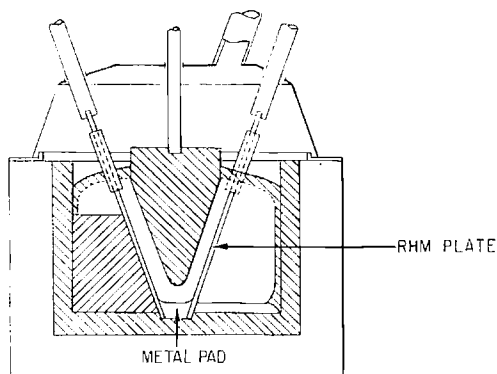

Fig. 11. Cell with sloping cathode plates.

the "cold" end of the electrode may be made in various ways, and the choice of the type of joint depends primarily on the temperature at which it is to operate; successful joints can be made, for example, to aluminum, copper, and steel.

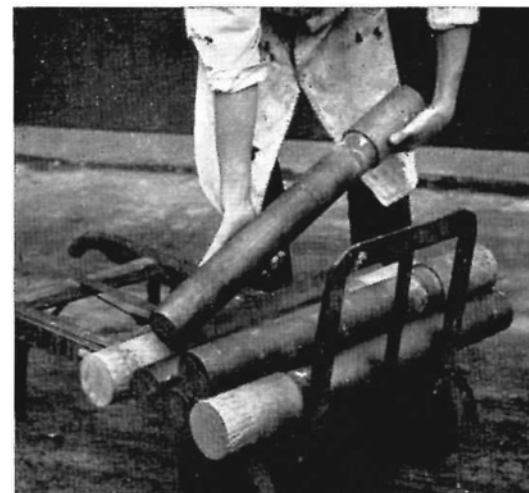

Fig. 12. Refractory hard metal electrodes capped with aluminum for cell use.

A convenient procedure for making the joint is to cast a fairly short aluminum cap on the end of the rod. In order to insure adequate wetting between the cap and the rod, it is necessary to take special precautions in the casting operation. One method described in a patent<sup>8</sup> is to prepare the surface of the RHM material by etching and nickel plating; the aluminum is then cast around it in a reducing or nonoxidizing atmosphere. The cap can be readily welded to an appropriate conductor for completing the connection to the cathode bus bar.

Figure 12 shows a number of "capped" electrodes ready for welding and final assembly in cells.

**Built-in RHM Electrodes**

Figures 7 and 8 illustrates two cell structures in which the RHM electrodes are inserted through the floor and walls, respectively, of the electrolysis chamber. Both arrangements are feasible and have been subjected to full-scale testing.

Some details of the performance of experimental cells operated with RHM leads arranged as in Figure 8 are given in a French patent<sup>9</sup> assigned to the Kaiser Aluminum & Chemical Corp. This gives data on the performance of cells of approximately 10 kA rating which were operated under conditions of maximum cell output. Some results given in the patent relate to the operation of three types of prebaked anode cells:



1. An orthodox cell with a standard carbon lining provided with the usual complement of steel cathode bars. This was run with a normal cryolite flux containing 7–8% calcium fluoride.

2. A cell with an identical structure to cell 1 which was operated with a flux modified by the substitution of 5% lithium for the equivalent sodium fluoride, and containing only a low calcium fluoride content.

3. A cell of the same overall dimensions with the floor of the bath cavity constructed of carbon and the sidewalls of silicon carbide brick,

and equipped with horizontal RHM rods projecting through the walls into the metal pad. Two of these cells were operated on the lithium-containing flux in the same way as cell 2.

The cells were operated under closely controlled conditions to compare the separate effects of (a) the change in flux composition and (b) the modification to the structure, on the cell output. The results obtained are summarized in Table IV.

The data indicate a gain in cell output of approximately 12% as a result of the lithium addition to the flux. The modification of the cell structure by the introduction of the RHM leads and the use of silicon carbide sidewalls increased this gain to about 37%, with no decrease in power efficiency. The marked reduction in the cathode voltage drop will be noted.

#### Use of Top-Entry Electrodes

A further cell construction is that in which the RHM leads are introduced into the bath cavity through the top, i.e., through the flux crust. Two possible arrangements are shown in Figures 9 and 10.

In Figure 9, the electrodes are inserted through the crust near the sidewalls. This method of construction has the very considerable advantage that it permits a ready conversion of some types of existing cells (e.g., those installations in which the cells are arranged in a side-by-side pattern). In prebaked cells, this modification permits the cell to be "worked" along the center channel as is often the present practice.

An alternative construction, which is immediately adaptable to prebaked anode cells, is to locate the electrodes in a row down the center channel as indicated in Figure 10. The electrodes are suspended by hangers, which are clamped to a cathode beam running the length of the furnace, and the anodes can then be arranged symmetrically down each side and be connected to anode bus bars running parallel with it. If the series is arranged so that the current is introduced and led out from the same end of the cell (i.e., the current flows in opposite directions in the anode and cathode bus bars) it is possible to reduce magnetic effects in the bath to a minimum. This factor is of considerable importance in large cells, e.g., 100 kA or more.

It is clearly an advantage in both top-entry types of cell that the cathode electrodes can be removed and renewed if required while the cell is running. Rather severe corrosion conditions occur in the crust zone, but RHM materials show a remarkably good resistance to attack under these conditions; this resistance can be enhanced by suitable protective measures, e.g., the use of ceramic sheaths.

TABLE IV  
Operational Data on Prebaked Anode Experimental Cells<sup>a</sup>

	Orthodox cell carbon lining no Li	Orthodox cell carbon lining Li	Orthodox cell carbon lining no Li	Modified cell A RHM leads, SiC sidewalls Li	Modified cell B RHM leads, SiC sidewalls Li
Period, days	252.6	251.4	140.6	144.5	143
Total production, lb	37,677	41,738	19,606	27,754	27,135
lb Al/cell day	148	166	139.5	191.9	189.5
Increase in production, %	—	12	—	37.8	36
Current, amp	9,716	10,783	9,366	11,895	11,806
Increase in current, %	—	11	—	27	26
Overall cell voltage	5.18	5.11	5.07	5.46	5.02
Cathode/anode voltage	4.01	4.13	3.93	4.73	4.27
Current density, amp/in. <sup>2</sup>	7.6	8.5	7.35	9.35	9.3
Bath temperature, °C	974	961	974	941	946
Flux ratio NaF/AlF <sub>3</sub>	1.39	1.42	1.49	1.32	1.32
Solidification temp. flux, °C	965	942	963	937	937
CaF <sub>2</sub> content, %	7.7	2.8	7.48	2.42	2.5
LiF content, %	—	4.93	—	4.97	4.97
Mean Al <sub>2</sub> O <sub>3</sub> content, %	3.0	2.1	3.76	2.48	2.49
Working (interpolar) distance, in.	2.08	2.12	2.09	2.02	2.05
Carbon ratio, lb C/lb Al	0.473	0.450	0.482	0.407	0.423
Current efficiency, %	86	86.8	84.7	90.9	90.5
kw-hr/lb Al	8.12	7.95	8.17	8.12	7.49
Cathode drop, v	0.68	0.457	0.679	0.269	0.208
Flux depth, in.	6.6	6.9	6.7	6.4	6.4
Metal depth, in.	5.4	5	5.3	5.2	6.1

<sup>a</sup> See ref. 9.

Top-entry lead cells have been operated under commercial conditions with considerable success. They are very stable in operation and show a high current and energy efficiency. The cathode voltage drop in such cells remains at about 0.2 v throughout life.

### Future Development

In this brief survey of the application of refractory hard metal compounds to aluminum reduction cells, one or two examples have been given of feasible cell structures; work is still proceeding on the refinement of these and other designs. It is emphasized, however, that the trials on some types of cell have been extended to commercial scale operations and a considerable background has now been built up. For example, cells are now being operated without any detailed supervision by laboratory personnel. Starting procedures have been worked out which are quite straightforward and avoid any damage to the RHM electrodes. At the same time, it must be remembered that in comparison with the many years of design and operational experience behind the orthodox Hall cell, these cells are still very new, and there is undoubtedly still much to be learned about the optimum conditions under which they should be run.

One of the major drawbacks to the Hall cell process is the high capital cost of installation, which has been variously estimated from \$700–1000 per annual ton of capacity.<sup>2,10</sup> The plants now in commission thus represent a very large investment which cannot be readily discarded. Any improvement in the present basic process is thus doubly advantageous. It is hoped that the developments described in this paper will contribute significantly to the general efficiency of cell operations. In addition to the direct saving of voltage and the increased electrical efficiency that is possible, the use of RHM materials should result in the more satisfactory operation of very large cells, which are undoubtedly more economical in labor.

The expected increase in electrical efficiency can be utilized in two ways:

1. By a decrease in the energy consumption per pound of metal. This aspect is more important in European operations where the availability of power is the main limitation on output.

2. By an increase in metal output from a given size of cell. This is an important criterion in North American plants where plenty of power is available and increased production from an existing facility is required.

Present indications are that an improvement of up to 15% may be achieved. The cost of RHM materials is obviously an important factor to be considered, but it is expected that considerable reductions in costs can be achieved in this direction. The cost of cell construction must also be taken into account. The use of RHM current leads or cathodes automatically entails that the cell floor does not have to fulfill its traditional role of current conduction and the bath container can therefore be constructed cheaply with a homogeneous lining backed, if required, by thermal insulation. The inner lining may still be of carbon, either rammed or prebaked, but this may be graded to have a maximum resistance to flux and metal penetration without regard to its electrical conductivity. The evidence now available shows that the absorption of flux in linings used under these conditions is much less than in normal cells. Materials other than carbon are feasible and are under investigation. Experimental cells have been operated, for example, with such diverse linings as highly fired alumina and solidified flux, i.e., in a simple steel box filled with solid flux.

The author wishes to emphasize that this project has entailed the closest cooperation by colleagues at the laboratories and works of The British Aluminium Co. and also by the Kaiser Aluminum & Chemical Corp., which he is glad to acknowledge. Further publications dealing with various aspects of the development are planned.

### References

1. Pearson, T. G., *The Chemical Background of the Aluminium Industry*, Royal Inst. Chem. Lectures, Monographs and Reports, No. 3, London, 1956.
2. Lewis, R. A., *Chem. Eng. Prog.*, **56**, 78 (1960).
3. Seager, G. C., this Vol., p. 131.
4. Brit. Pats. 784,695, 784,696, 802,471, 802,905.
5. British Pat. 804,242.
6. Blum, A., and J. H. Wieliczko, *Planseeber. Pulvermet.*, **9**, No. 1/2, 77 (1961).
7. Macdonald, N. F., and C. E. Ransley, *Powder Met.*, **3**, 172 (1959).
8. British Pat. 825,443.
9. French Pat. 1,227,482.
10. *Materials Survey, Aluminum*, Business and Defense Services Administration, U. S. Dept. Comm., Washington, 1956.

### Discussion

**E. A. Hollingshead** (*Aluminium Labs., Arvida, Quebec*): In an industrial cell with boride bars introduced through the lining, what length of rod and current density in the rod is visualized?

**C. E. Ransley**: A 3 in. diam rod carries 4000 amp. The length will depend on cell construction.

**E. A. Hollingshead**: Is the claimed total cathode voltage drop of about 0.2 v measured from the aluminum layer to the metal conductor adjacent to the cold end of the boride rod?

## NEW PROCESSES AND MATERIALS

**C. E. Ransley:** The voltage drop is from the metal pad to the main bus.

**E. A. Hollingshead:** With the conventional carbon lining, the voltage drop between the aluminum and the carbon is said to be an appreciable part of the total cathode voltage drop. Has this been measured directly? If so, would the author indicate how it was measured and what typical results were for old and new linings?

**C. E. Ransley:** The drop has not been measured directly. It has been inferred from calculation.

**R. A. Lewis (Kaiser Aluminum & Chemical Corp., Permanente, Calif.):** We have had limited experience in measurement using graphite rods buried in the lining just below the carbon floor. Our numbers bear out the findings reported in an earlier paper that about half the cathode voltage drop is in the area of the metal pad-carbon junction.

**E. A. Hollingshead:** In the case of top-entry RHM leads, could the author recommend a specific refractory for the protective sheath?

**C. E. Ransley:** A sheath is not necessary under all conditions. The problem is currently under investigation.

**J. P. Givry (Pechiney, Saint-Jean-de-Maurienne, France):** In Table IV, cell *B* has a lower energy consumption than cell *A* and the orthodox cell for the same anode-cathode distance the same current density (i.e., voltage drop in the bath about the same, cathodic voltage drop about the same). The total voltage drop is different by 0.46 v. Why?

**R. A. Lewis:** The higher voltage of cell *A* was actually because the cathode bus was modified during the early stage of operation, resulting in an abnormally high external voltage loss of 0.3–0.4 v higher than in the other cells. This abnormally high external voltage was included in the total cell voltage. To place all of the cells on the same basis, this abnormally high external voltage loss for cell *A* should have been subtracted from the cell *A* total cell voltage.

**A. E. Masson (Ugine, Paris, France):** Did you try boride bars with a density lower than 90% of the theoretical which, I believe, have a better resistance to thermal shock than a dense product?

**C. E. Ransley:** Yes, we have tried low densities. In fact, we have tried quite a range of densities.

**J. P. Givry:** We do not agree that magnetic effects will be reduced to a minimum with top-entry leads. There will be very important horizontal currents flowing in the metal pad and a very great magnetic field caused by the current flow from one cell to the other.

**C. E. Ransley:** There is a heavy horizontal current flow in the metal pad, but the currents in the anode and cathode bus bars above the cell flow in opposite directions and thus cancel. The effect of the current in the main bus bars between cells can readily be neutralized by a proper cell line arrangement.

**M. B. Dell (Alcoa, New Kensington Research Labs., Pa.):** What factors have been found to limit the life of cells having RHM elements?

**C. E. Ransley:** Our general experience on commercial cells has been too short for us to distinguish whether bars are the limiting factor in life expectancy.

**Gilkie (National Carbon):** Is your figure of \$5.00 per lb for the RHM bars cost or market price?

**C. E. Ransley:** This is thought to be a feasible market price. Our own figures on the cost of production are such that we do not think there should be any difficulty in achieving this target price.