

## THE EFFECT OF MAGNESIUM SUPPLY ON THE QUALITY OF ALUMINUM MELTS

Heather Drieling, D. Corleen Chesonis

Alcoa Technical Center; 100 Technical Drive; Alcoa Center, PA, 15069, USA

Keywords: Aluminum-Magnesium Alloys, Oxidation, Metal Cleanliness

### Abstract

Domestic aluminum producers are increasingly turning to alternate suppliers of alloying materials in order to lower costs and meet demand. Occasionally, problems arise due to this practice. One Alcoa facility had just such an issue with magnesium supply. The effects of magnesium concentration, temperature, and time on oxidation rate are quite well documented. This paper will present a comparison between the effects of commercially pure magnesium sources on a continuous casting process. Metal cleanliness data using LiMCA and PoDFA will be presented as well as TGA results, SEM, and visual documentation. Significant differences in oxidation behavior were observed among the three magnesium sources that were evaluated.

### Introduction

Domestic aluminum producers are under constant pressure to reduce production costs. The cost of alloying materials is a significant part of the overall conversion costs on some alloys. New alternate suppliers for these alloying materials are being researched and employed. One Alcoa facility that had an issue with magnesium supply has a continuous casting production line that runs predominately 5xxx series alloys.

This plant changed magnesium suppliers to lower alloying cost. They changed from long time supplier Brand X to Brand Y. The plant started noticing serious recovery issues on the high magnesium alloy casting line. Recovery dropped by 40% on alloys containing greater than 4% Mg and by 10% on alloys containing less than 4% Mg. Oxides built up in the process during normal casting operations at a rate much greater than normal. Visible oxides were present on the metal in the troughing. The filtration system itself was operating correctly but the amount of oxides before filtration was unacceptable and they were able to overwhelm the filtration system over time.

There are certain things that manufacturers do to reduce the formation of magnesium oxides or to lessen their impact on the process. These include lower magnesium content if possible, temperature control, better furnace practices, barriers on troughing, minimizing turbulence, and furnace combustion control. All of these procedures were part of normal practice at this facility and this facility had been casting these types of alloys for a number of years. Processing parameters were revisited and determined to be best practice and yet they were not successful in controlling the oxidation.

Root cause analysis was conducted and it pointed to the magnesium supply. Since the new supplier had been approved for use by normal testing methods and no other plant had reported a problem, a significant amount of testing was required to prove this theory.

### Experimental Apparatus and Procedure

LiMCA was used to test the cleanliness of molten aluminum before any filtration or degassing. PoDFA samples were also taken during each furnace directly downstream of the LiMCA before the degasser. Figure 1 shows a schematic of the casting line and measurement location.

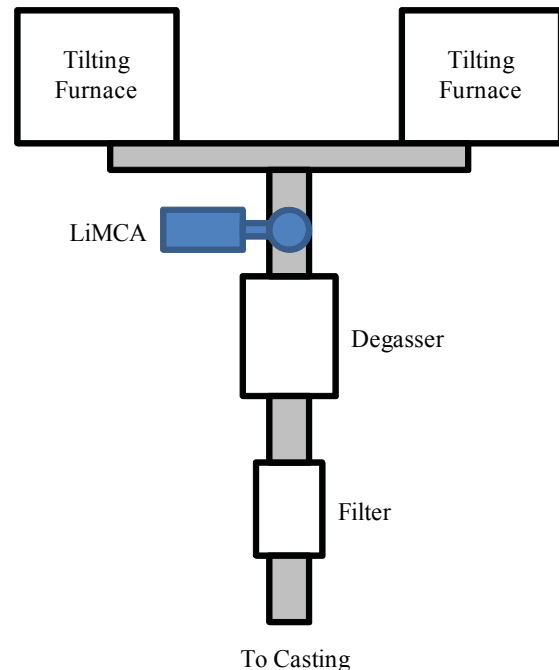

Figure 1. Measurement location at casting line.

Each furnace load that was tested was a 100% pure metal charge from the smelter. No scrap material was used in any of the charges. Each run consisted of two furnaces from each of three magnesium suppliers. Furnaces were alloyed and treated as normal except for the magnesium source for each run. Fresh filters were installed and furnaces were drained and scraped out before each run. Magnesium ingots of various sizes were used where available. The three suppliers used were Brand X the original supplier, Brand Y the new supplier, and Brand Z an additional supplier used at some other plants.

Brands X and Y had small and large ingots tested. Brand Z only had large ingots tested. Where smaller additions were needed during the large ingot trial smaller pieces from that manufacturer were used except in the case of Brand Z where only the large size was available and Brand X was used to make up the smaller alloy corrections.

Furnaces were processed and cast using normal procedures except in the case of the first furnace of Brand X where the furnace sat alloyed for 4 hours prior to the start of the test due to mechanical problems on the caster. All furnaces were tested using similar alloys with approximately 5% Mg.

### Metal Cleanliness Measurements – LiMCA

LiMCA measurements are shown in Figures 2 through 5 as normalized R values. These values were calculated by setting the highest cast-average N20 value equal to 100 and multiplying all other inclusion concentrations by the ratio (100/maximum N20). R20, R30, R50, and R100 represent the relative concentrations of particles larger than 20, 30, 50, and 100  $\mu\text{m}$ , respectively.

Inclusion concentrations were measured by LiMCA II [1]. LiMCA operates based on the Coulter counter principle. Metal is cycled in and out of a glass probe through a small orifice close to 300  $\mu\text{m}$  in size. Non-metallic inclusions passing through the orifice produce a change in the voltage between electrodes situated inside and outside of the glass probe. The inclusion size range covered by LiMCA is 20 to 300  $\mu\text{m}$ . Particles smaller than 20  $\mu\text{m}$  cannot be distinguished from electrical noise.

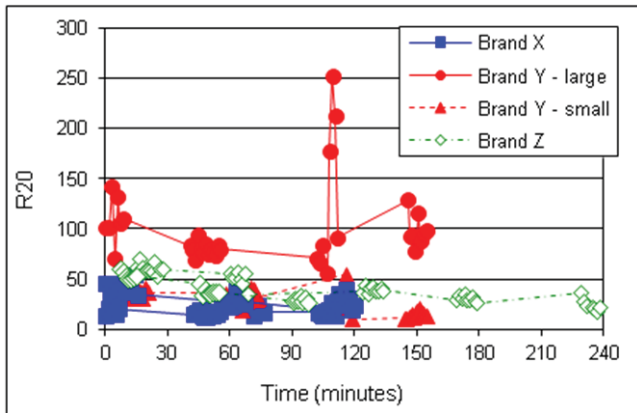

Figure 2. LiMCA R20 before degassing and filtration.

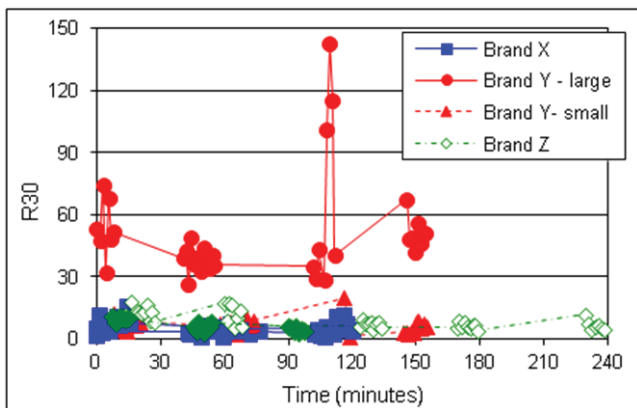

Figure 3. LiMCA R30 before degassing and filtration.

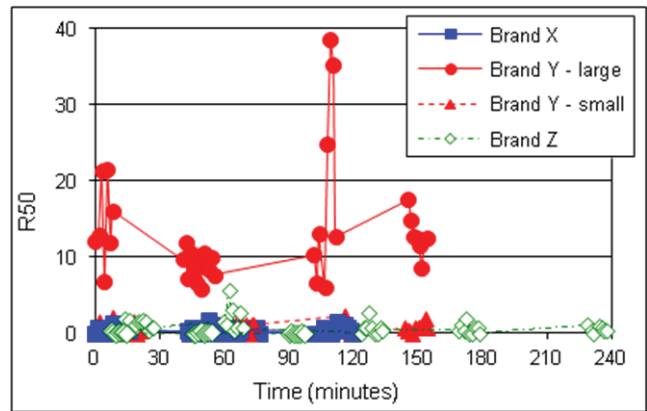

Figure 4. LiMCA R50 before degassing and filtration.

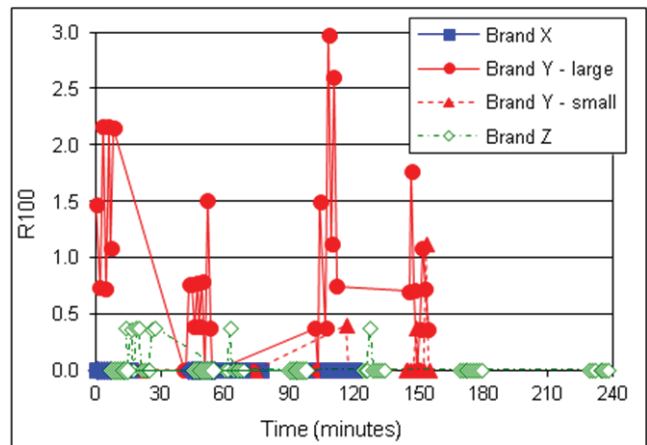

Figure 5. LiMCA R100 before degassing and filtration.

The LiMCA data shows a significant difference between Brand Y and the two other suppliers. According to this data the small size Brand Y magnesium should perform considerably better than the large size. In practice, the rapid breakaway oxidation occurred no matter what size of Brand Y magnesium was used. An indication of this can be seen in the R100 plot (Figure 5), where significant concentrations of particles larger than 100  $\mu\text{m}$  were observed late in the test on small Brand Y. It is important to note that the first furnace of Brand X sat for an additional 4 hours before the start of casting because of mechanical difficulties with the casting machine. Despite the extended hold, metal from this Mg source remained relatively clean.

### Metal Cleanliness Measurements – PoDFA

PoDFA samples [2] were taken simultaneously with LiMCA after 50% tilt of the furnace. Results of the metallographic analysis are shown in Figure 6. Carbide concentrations were removed from the counts because this casting plant is located at a smelter and carbides were common to all samples. PoDFA inclusion counts are reported in relative  $\text{mm}^2/\text{kg}$  and oxide films are in relative number/kg. Each value was multiplied by an offset factor to obtain the relative values.

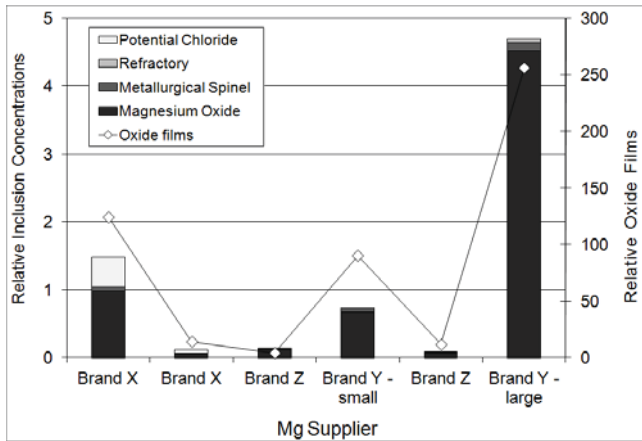

Figure 6. Relative PoDFA results without carbides.

Even though the first furnace of Brand X sat for 4 hours before the cast, both Brand X furnaces had less oxide growth on the troughs and in the spout than either of the other materials. This indicates that, even though there were more oxides present in the first Brand X furnace because of the long hold, the oxide was in the amorphous form and did not exhibit exponential growth. Observations of recoveries and visual interpretation of oxide growth in the trough showed Brand X performing the best followed by Brand Z then Brand Y. Oxide films for brand Y were much greater than for Brand Z and the Brand X furnace that did not have an extended hold.

### Bench Scale Oxidation Testing

To better understand the problem, lab scale testing was performed to see if the breakaway oxide growth could be measured more accurately. Thermogravimetric analysis (TGA) was conducted on samples of 5% Mg alloy from the three suppliers. Chips from the samples were heated to 700C and held over time in normal atmospheric conditions. The weight gain of each sample was measured and the results are shown in Figure 7. Temperature profiles are the top three bars that rise immediately to 700C and hold. The weight gains are the three sloped lines.

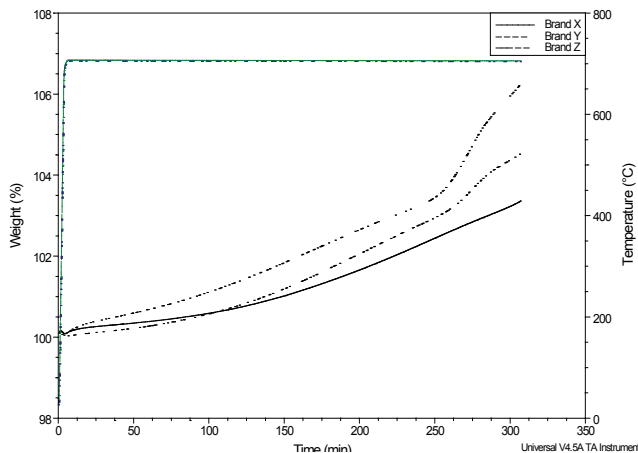

Figure 7. TGA curves for 5% Mg in aluminum.

Brand Y exhibits exponential oxide growth much more quickly than Brand X. Brand Z is in the middle of the others. The shift

between amorphous MgO film and the crystalline form happens much sooner in the Brand Y. The graph in Figure 8 from Cochran et al [3] fits extremely well with these TGA results and with what was observed during processing.

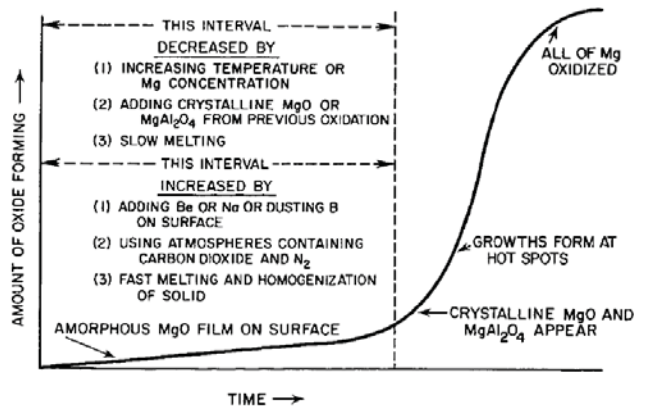
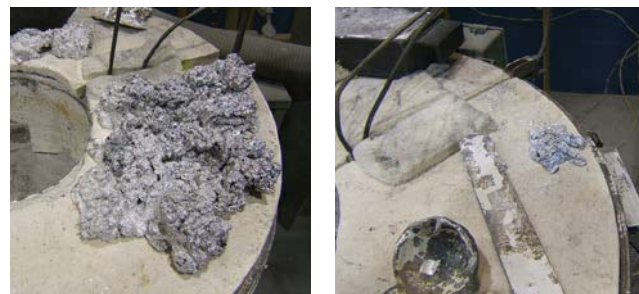

Figure 8. Oxidation behavior of Al-Mg alloys [3].

The difference in oxidation behavior was also shown in a simple 5 hour 5% growth test. This test was done using 5% Mg in pure aluminum held at 675C for 5 hours. This was done using small size pieces of both Brand Y and Brand X. The furnace was electrically heated under normal atmospheric conditions. The molten aluminum (approximately 100 lbs) was skimmed and then the pure magnesium was added and stirred. The metal was allowed to sit with no further disruption for 5 hours, at which time the pictures in Figure 9 were taken. The furnaces were skimmed and the amount of dross on each is shown in Figure 10. This test is very simple to perform, but it provides important information about a sample of magnesium for very little expenditure.



Brand Y Brand X  
Figure 9. Surface of metal after 5 hour oxidation test.



Brand Y Brand X  
Figure 10. Dross from 5 hour oxidation test.



### SEM / EDS Analysis

Some of the breakaway oxidation from a furnace charge made with Brand Y was taken from the top of the metal in the trough and sent for SEM analysis. The oxides had a fibrous appearance as shown in Figure 11. No product used in this process contained any type of MgO fibers so it was suspected that these fibers must originate from the Mg used to alloy the metal. Oxides collected from the surface of the troughs using Brand X did not exhibit this fibrous appearance.

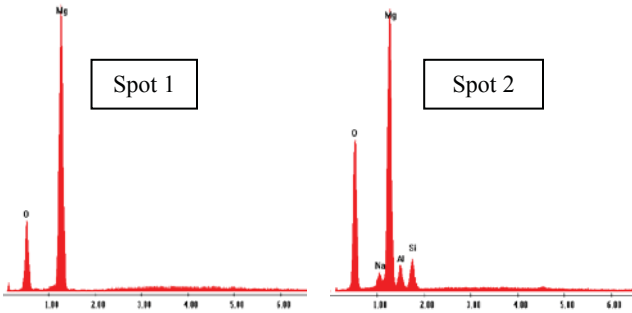
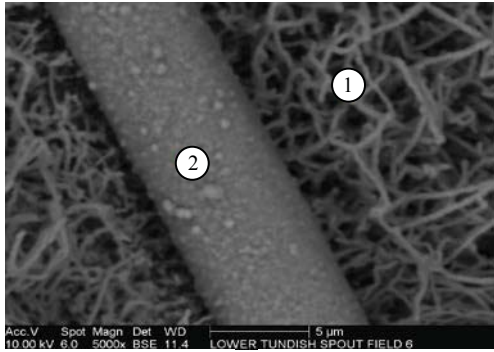

Figure 11. SEM analysis of oxides from trough using Brand Y.

SEM analysis was also done to compare the surface of the three types of pure magnesium ingot. The surface of the Brand Y magnesium was covered with MgO fibers similar to those seen in the breakaway oxidation on the molten alloy. This is seen in Figure 12. The surfaces of Brands X and Z did not contain any of these fibers and are seen in Figures 13 and 14. The scale bar on all three pictures is 20 µm.

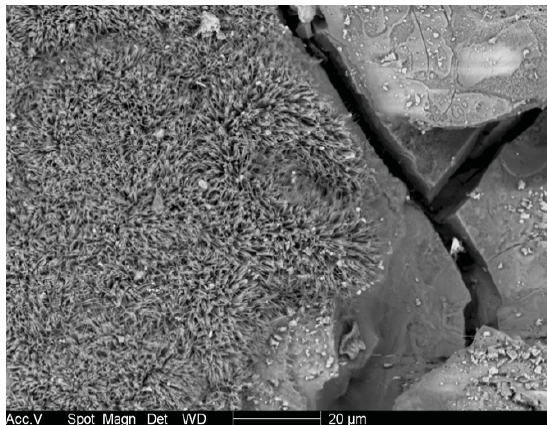

Figure 12. Surface of Brand Y pure Mg.

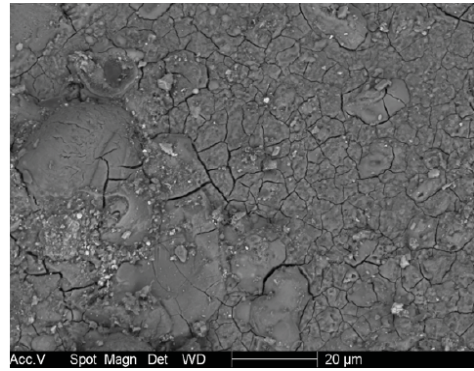

Figure 13. Surface of Brand X pure Mg.

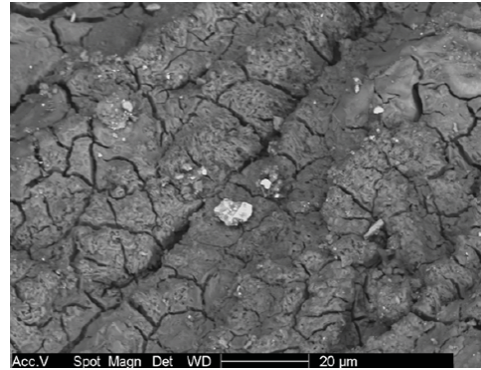

Figure 14. Surface of Brand Z pure Mg.

### Cause of MgO Growth

To determine the cause of the breakaway oxidation, trace element analysis was done using Glow Discharge Mass Spectrometry (GDMS). Using GDMS, some differences among the suppliers were observed as shown in Table I.

Table I. Chemical Analysis of Mg Sources

Sample ID	Brand X small	Brand X Large	Brand Y Small	Brand Y Large	Brand Z large
Element	ppm wt	ppm wt	ppm wt	ppm wt	ppm wt
Be	< 0.005	< 0.005	< 0.005	0.009	< 0.005
Na	4	4	14	9.1	2.2
P	6.1	20	12	22	7.5
S	8	54	31	29	41
Cl	0.72	27	0.62	0.97	47
K	0.48	3.5	0.26	0.3	0.15
Ca	0.97	1.9	0.11	< 0.05	47
La	< 0.005	< 0.005	0.75	26	0.01
Ce	< 0.005	< 0.005	1.5	73	0.02
Pr	< 0.005	< 0.005	0.18	7.4	< 0.005
Nd	< 0.005	< 0.005	0.48	18	< 0.005
Pb	< 0.01	0.86	2.9	0.62	23

Differences were noticed in calcium levels among the various suppliers, with Brand Y containing less Ca than Brands X and Z. Since it is well known that calcium can have an impact on delaying oxidation of Al-Mg alloys [4], this was explored using the 5% Mg for 5 hour growth test. The results are shown in Figure 15. There was no significant impact on oxidation using 5

ppm Ca. Only when 15 ppm of Ca was added to the melt did a significant reduction in oxidation occur.

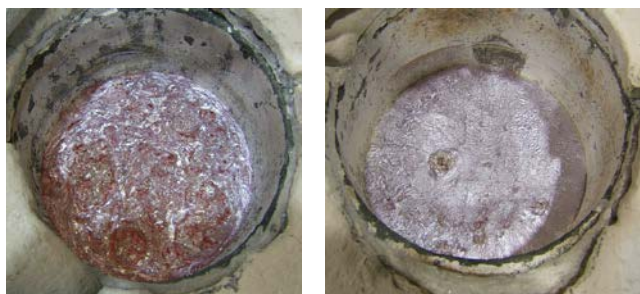

Brand Y + 5 ppm Ca      Brand Y + 15 ppm Ca  
Figure 15. Oxide growth after 5 hour oxidation test with 5 and 15 ppm Ca added.

In addition to Ca, differences were noticed in certain lanthanide levels among the suppliers. Since it is suspected that certain components of misch metal (La, Ce, Pr, Nd) can have an impact on oxidation of Al-Mg alloys, this would be worth further exploration.

### Oxide “Seeds”

When Brand Y magnesium was cut and polished, seeds were visible in the SEM analysis of the metal as shown in Figure 16.

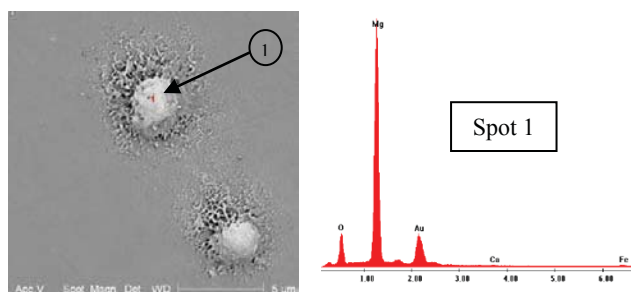

Figure 16. Oxide seeds in Brand Y magnesium.

These seeds would oxidize further when left in a normal atmosphere for several days. The results of this oxidation are shown in Figure 17.

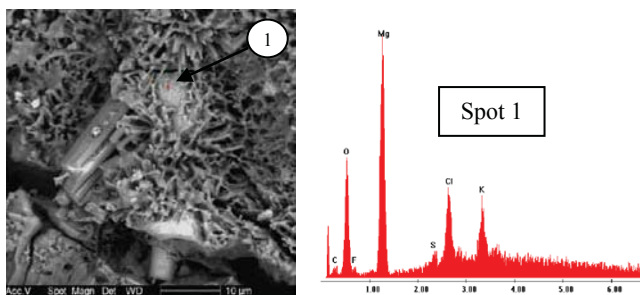

Figure 17. Oxide seeds after several days of exposure to normal atmosphere.

Brand X magnesium did not have any of these seeds visible in the multiple samples that were examined. These seeds are also worthy of further exploration.

### Conclusion

There are numerous factors concerning production and processing methods that can contribute to the differences observed in the magnesium supplies. None of the previous work on oxidation of Al-Mg alloys has stressed magnesium raw material source as a contributor to the growth of magnesium oxides in aluminum alloys. Since this was the largest uncontrollable factor contributing to magnesium oxidation at this particular plant, changes had to be made. Because of this issue, sensitive plants now have a robust magnesium qualification procedure. The original qualification procedure consisted of chemistry testing, magnesium ingot oxide surface thickness measurements, and slice tests to look for inclusions. Now TGA and 5 hour 5% oxide growth tests have been added as a standard approval requirement.

### Acknowledgements

The authors would like to thank Mike Easley for the SEM work, Paula Kolek for the TGA analysis, Jeff Shaw for the growth tests, and Kevin Condlin and Bill Welsch for the plant support.

### References

1. J.-P. Martin, R. Hachey, and F. Painchaud, “On-line Metal Cleanliness Determination in Molten Aluminium Alloys Using the LiMCA II Analyser,” *Light Metals 1994*, ed. U. Mannweiler (Warrendale, PA: The Minerals, Metals & Materials Society, 1994), pp. 915-920.
2. D. Doutre, B. Gariépy, J.-P. Martin, and G. Dubé, “Aluminium Cleanliness: Methods and Applications in Process Development and Quality Control,” *Light Metals 1985*, ed. H. O. Bohner (Warrendale, PA: The Minerals, Metals & Materials Society, 1985), pp. 1179-1195.
3. C. N. Cochran, D. L. Belitskus, and D. L. Kinosz, “Oxidation of Aluminum-Magnesium Melts in Air, Oxygen, Flue Gas, and Carbon Dioxide,” *Metallurgical Transactions B*, Volume 8B, June 1977, pp. 323-332.
4. D. H. DeYoung, W. F. McGinnis, R. T. Richter, and J. J. Wiesner, “Aluminum Alloys Having Improved Cast Surface Quality,” Patent WO2002030822 A2, Filed 2001, Granted 2002.