

Light Metals 2014

**CAST SHOP FOR ALUMINUM
PRODUCTION**

General Cast Shop

SESSION CHAIR

Pete Forakis

Emirates Aluminum

Abu Dhabi, United Arab Emirates

DEVELOPMENT AND DEMONSTRATION OF A MOLTEN METAL COOLING TROUGH TO IMPROVE CASTHOUSE PERFORMANCE

André Larouche¹, Frédéric Borel², Jean Crépeau³

¹Rio Tinto Alcan, Arvida Research and Development Center, 1955, Mellon Boulevard, Jonquière, Québec, Canada, G7S 4K8

²Rio Tinto Alcan, Smelter Technology, 725 rue Aristide Bergès - BP 7 - 38341 Voreppe Cedex - France

³Rio Tinto Alcan, Technology and Equipment Sales, 1188 Sherbrooke Street West, Montréal, Québec, Canada, H3A 3G2

Keywords: Molten metal, Temperature, Control, Cooling, Casthouse layout

Abstract

The management of casting temperature is an important aspect in today's casthouses. For example, in ingot remelt casthouses, non-alloyed and non-treated aluminum will translate into higher temperatures in the furnaces and hence, possibly into longer cycle times, lower casting speeds and limited mold life.

This paper presents a new patent pending technology [1] that allows cooling molten metal directly into the trough while casting is underway, thus reducing or eliminating the previously mentioned drawbacks. Heat extraction in the cooling trough can be controlled according to the molten metal temperature in the furnace and the molten metal flow rate.

This innovative approach gives the opportunity for a more efficient use of equipment and a potential reduction of the equipment needed (i.e. number of furnaces) to meet casthouse productivity. Furthermore, this innovative technology offers alternatives for smaller footprint casthouses where molten metal could be cast directly from the transport crucibles. This paper also presents the work that was done using smelter simulation software to assess the concept of smaller compact ingot remelt casthouses.

Introduction

Due to continuous creeping activities and more efficient cell technologies, there is a trend towards accelerated molten metal flux in the smelter that results in higher molten metal temperature delivered to the casthouse. In such circumstances (for example, pure aluminum production), molten metal temperature is generally too high to start the cast immediately after the skimming operation. This situation causes longer delays in furnace preparation and subsequent productivity concerns.

To remedy this situation, typical solutions such as furnace door opening, longer holding time, lower casting speed, and even melting of good sellable ingots to lower the melt temperature can be applied. However, these corrective actions lead to longer cycle times and consequently to a less productive casthouse. Furthermore, those corrective actions lower the temperature in the furnace, and generally, molten metal inside the furnace has to be reheated during the cast to maintain the casting target temperature, thus leading to higher energy consumption.

Table 1 shows the theoretical energy consumption of various casthouse layouts (pure aluminum production) assuming that the cast starts immediately after the skimming operation, whatever the furnace temperature is at that time. The target casting temperature (710 °C) would be achieved using a dedicated in-line molten metal cooling device. The energy consumption shown in Table 1 includes furnace energy losses (i.e., from furnace walls and due to

air infiltration) during scrap charging, siphoning, skimming, and casting. Scrap melting is assumed to be done using the molten metal superheat only. Burner efficiency, at low fire, is taken into account in the heat balance. Table 1 shows that, in most cases, the energy consumption should be near zero or very low as the sensible energy and latent heat contained in the molten metal are high enough to keep the molten metal temperature above the casting temperature during all or almost all the cast.

In the aluminum industry, typical remelt casthouse energy consumption can be evaluated to 300 MJ/mt or higher depending on the quality of the operations [2, 3]. The ability to cool the metal in-line would generate major operational expense reductions, greenhouse gas reduction as well as increase the overall casthouse efficiency by reducing downtime (Table 1).

As the advantages of in-line cooling of molten metal are numerous and have an important effect on operational and capital expenses, a full-scale laboratory demonstration unit was developed at the Arvida Research and Development Center of Rio Tinto Alcan. This paper presents the main results of this new patent pending technology.

Table 1. Theoretical furnace energy consumption for various casthouse layouts assuming a dedicated in-line molten metal cooling device

Crucible temperature (°C)	Furnace capacity (mt)	Ingot chain throughput (mt/h)	Internal Scrap rate (%)	Energy Consumption (MJ/mt)	Furnace temp. after skimming (°C)	Save downtime (min)
850	100	25	2	0	766	44
850	100	25	4	80,7	718	0
850	50	15	2	0	778	57
850	50	15	4	78,3	730	0
900	100	25	2	0	814	101
900	100	25	4	0	764	41
900	50	15	2	0	826	115
900	50	15	4	0	776	55

Thermal prerequisite for an in-line cooling trough

Table 1 shows the molten metal temperature in the furnace after skimming. Assuming a casting temperature of 710 °C, the temperature drop within an in-line cooling trough would have to be in the range of 50-100 °C. Using these values and the ingot chain throughput, the heat transfer removal rate for such equipment should be in the range of 200 to 700 kW. The heat transfer rate in a standard insulated trough (from furnace to ingot chain) is typically of the order of 75 to 100 kW. Using the heat extraction given above, the overall thermal conductance between the molten metal in a cooling trough and the ambient temperature must range between 54 and 175 W/m²K (considering a 25-cm metal head and a 10-m long trough). For comparison, the heat transfer coefficient, for a standard trough, ranges between 5 and 10 W/m²K.

The heat transfer rate of the in-line cooling trough must then be almost an order of magnitude greater than that of a standard trough. This represents a real challenge in terms of material and temperature management. Figure 1 shows the thermal conductance of different materials in a standard trough. The radiative thermal conductance is high, but is associated with only approximately 25% of the overall trough surface. The thermal conductance of the refractory, the insulation and the air cooling are the limiting values to reach an overall thermal conductance of 50-175 W/m²K, as described above. The conductance of the three above-mentioned materials has to be increased to cool the molten metal.

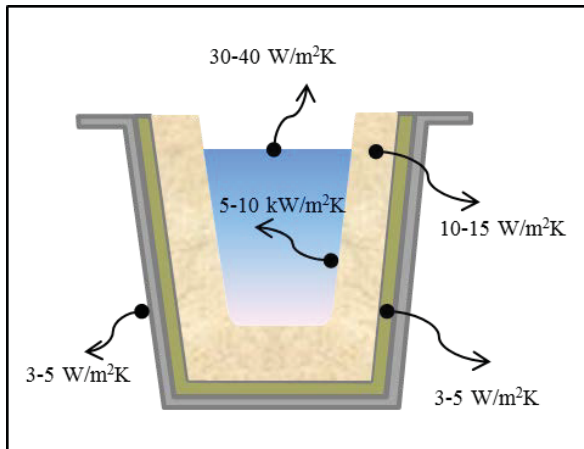

Figure 1. Thermal conductance associated with a standard trough.

Various non-reactive, thermally conductive refractory materials already exist on the market. Their thermal conductivity varies between 10 and 200 W/mK compared with standard insulating refractory having a typical conductivity between 0.5-0.7 W/mK. These high conductivity materials can safely be used as the lining for molten metal application. Air cooling can be easily replaced by water cooling because it has at least two order of magnitude higher heat transfer coefficient than air cooling.

The standard insulating material or board should be replaced with a material that has the following characteristics:

- High thermal conductance when needed (start of cast when the metal is hot in the furnace).
- Lower thermal conductance when required (at the end of the cast, as the metal in the furnace is colder or when the molten metal temperature in the furnace does not require extra cooling).
- Keeps tight contact between the refractory and the cooling jacket through time and space to avoid air gap thermal resistance, which dramatically reduces heat transfer.
- Is non-reactive at elevated temperature.

All those characteristics can be met when using a fluidized bed between the conductive refractory and the cooling jacket.

The thermal conductance of a typical fluidized bed ranges between 150-400 W/m²K [4]. These values meet the high conductivity requirement. Lower thermal conductance, inside the bed, can be met by reducing or shutting off the fluidization air.

When the fluidizing air is totally shut off, the bed particles stop to move and the heat transfer decreases, as the contact between

particles is not perfect due to the presence of air between them. The necessary tight contact between the refractory and the cooling jacket is obtained via the movement of the particles from one side to the other, which is the main characteristic of the fluidized bed.

The chosen fluidized bed material is non-reactive at elevated temperature, and no chemical reaction can occur between the air, particle, refractory or cooling jacket.

Using an appropriate refractory material, a fluidized bed media and water cooling and assemble those with an appropriate design, the global conductance range described above can be met to effectively reduce the molten metal temperature.

Main characteristics of the in-line cooling trough

The following operational aspects were considered in the development of the first laboratory full-scale unit:

- Fully instrumented (pressure gage, thermocouple, flow meter).
- Leakage detection (water and molten metal).
- Design to avoid condensation on metal surfaces.
- Freezing line must always be located in the fluidized bed.
- Avoid additional or more difficult tasks performed by the operators.
- Temperature drop within the cooling trough must be controlled within a range specified by the casthouse layout and operation.
- Outside shell temperature must be below the temperature level that can harm operators.
- Easily retrofitted to standard trough line.

The freezing line location is an important safety aspect. Figure 2 shows the thermal gradient, inside the cooling trough, when the fluidized bed is off. As one can see, the freeze line (660 °C) is located inside the fluidized bed for safe operation. When the fluidizing air is activated, the bed particle temperature always lies in between the refractory temperature and the coolant sleeve temperature. This temperature is way below the aluminum melting point.

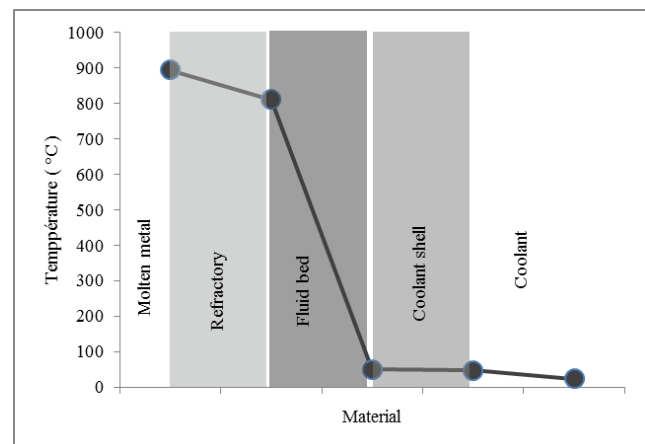

Figure 2. Thermal gradient inside the cooling trough without fluidization.

The overall dimension of a section of the cooling trough is shown in Figure 3 along with a conventional trough section. One can see that the width of the cooling trough is only 20% larger than that of

a conventional trough, which allows a safe and ergonomic operation (skimming). Pre-heating of the refractory is necessary before casting to reduce the initial molten metal heat loss due to the higher conductivity of the refractory. All the external services (electricity, air, water) are hidden below the trough, for safety and ease of operation.

As previously described, the molten metal temperature in the furnace varies during a cast due to wall heat losses or air infiltration. Variations in molten metal temperature, upon casting, can also occur from cast-to-cast due to different crucible temperatures. Hence, the molten metal temperature drop, inside the cooling trough, has to be controlled between limits that are related to the layout of the casthouse.

This control is performed using two process parameters. The first one consists in the utilization of several independent fluidized sections. Each section can be independently shut off to reach minimal heat extraction in this particular section as already explained. Heat extraction can then be smoothly varied from the lowest heat extraction rate (all sections closed) to the highest heat extraction rate (all sections opened). The number of independent sections can be chosen in order to meet the required precision for the casting temperature, which for ingot casting can be in the range of $\pm 5^\circ\text{C}$. The second parameter to control the temperature drop is the fluidization air flow rate that can be varied in each section to change the effective thermal conductance of the bed [4].

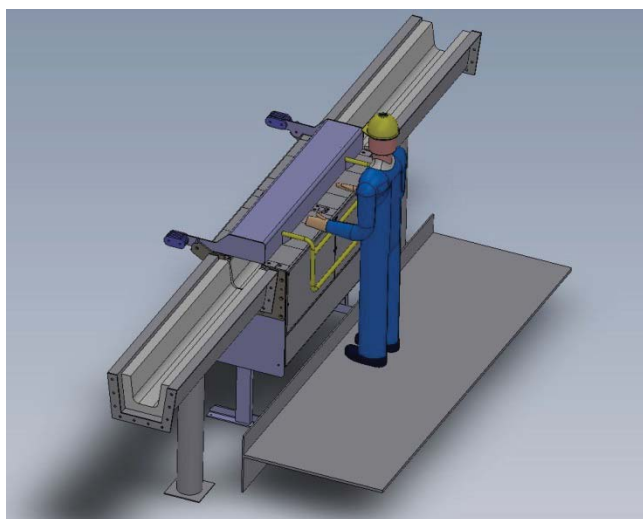

Figure 3. Schematic of the cooling trough installed between two standard trough sections.

Experimental results

A cooling trough section was developed at Rio Tinto Alcan Arvida Research and Development Center. The cooling trough is fed by a casting furnace allowing circulation of the molten metal for several hours at a flow rate of 13 t/hr. This flow rate is representative of an ingot chain caster (15-27 t/hr). Several trials were conducted to assess the thermal performance of the cooling trough as well as its robustness and ease of operation.

For these laboratory trials, the temperature drop or heat extraction rate was controlled manually without feedback control from the furnace casting temperature. The furnace temperature was set at 780°C and kept constant over time. The cooling trough was fully

instrumented with thermocouples inside the refractory, fluidized bed, water inlet and outlet, and molten metal inlet and outlet. The air and water flow rates were measured, and manual valves were used to control the air and water flow rates. The laboratory version of the cooling trough was not equipped with any top cover heater, but gas fire burners were used to preheat the refractory.

Table 2 shows the range of temperature drop observed with the demonstration unit for various operating conditions. Note that, in this table, the air and water flow rates are divided by the nominal flow rate. The maximum temperature drop of the laboratory cooling trough is much higher than that of a conventional well insulated trough (1°C/m). The minimum temperature drop is slightly higher than a conventional trough due to the less effective insulation of the particles at rest in the bed compared with the insulating board. It can be seen, in Table 2, that only a few meters of cooling section are needed to decrease the temperature by about 50°C in a modern 27 mt/h ingot chain caster.

The water flow rate does not affect the control of the temperature drop within the flow rate tested. This is due to the fact that the main thermal resistance within the cooling trough is the fluidized bed. Nevertheless, the water flow rate has to be set to a proper value in order to avoid excessive water temperature.

Figures 4 and 5 show the effect of the air flow rate and percentage of fluidized sections on the temperature drop within the cooling trough. In Figure 4, all the fluidized sections were opened. The range of temperature drop shown in Table 2 is wide enough to be able to control the casting temperature with the desired accuracy whatever the furnace temperature.

Table 2. Temperature drop within the cooling trough (excluding top radiative losses) for various operating conditions

Trial #	Air Flow rate	Water flow rate	ΔT
	(-)	(-)	($^\circ\text{C/m}$)
1	0,0	1,0	5,6
2	1,0	1,0	14
3	1,0	3,2	14
4	1,0	0,6	12,2

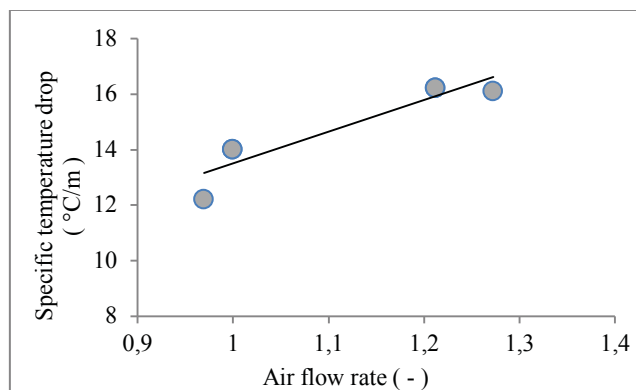

Figure 4. Effect of air fluidization flow rate on specific temperature drop.

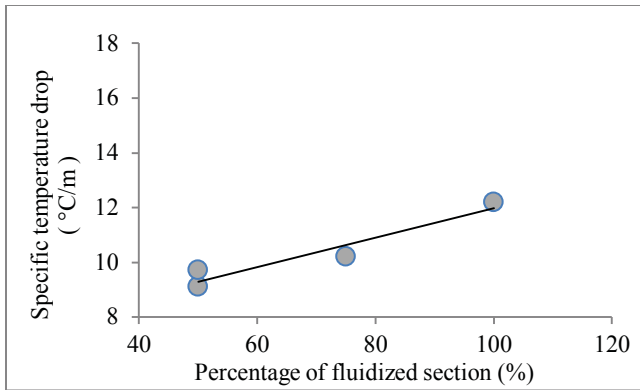

Figure 5. Effect of % of fluidized sections on specific temperature drop.

In order to illustrate the response time of the cooling trough, Figure 6 shows the variation of water temperature differential (outlet – inlet) and the refractory temperature when the fluidizing air flow rate is suddenly increased. One can see that the response time is approximately five minutes. This is fast enough to compensate for any furnace temperature variations, which are very slow during casting. The small drop in water temperature differential, observed at the end of the transition, is caused by the decrease in energy level of the refractory and bed media which is temporarily absorbed by the water.

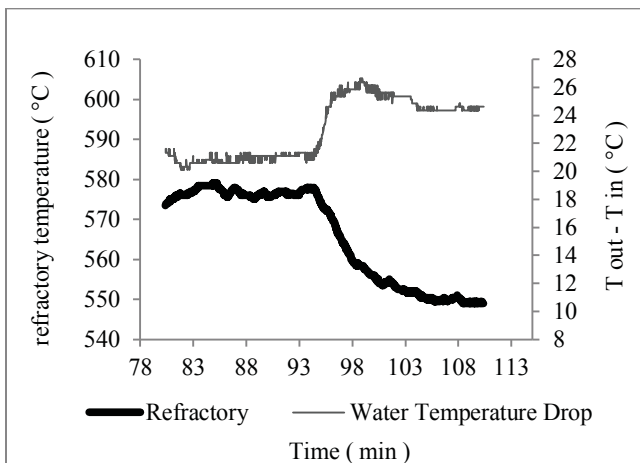

Figure 6. Temperature drop evolution after a sudden increase in the fluidizing air flow rate.

Application of cooling trough

The cooling trough technology may be applied to remelt casthouses or for value added low alloyed products such as lithographic, anodizing, foil or even electrical wire where a tight control of the casting temperature is required. The main benefits of such a technology are numerous:

- Increase of mold life due to constant and adequate casting temperature.
- Increase of casting speed as casting temperature can be reduced and tightly controlled.
- Reduction of furnace energy consumption and greenhouse gas, as no re-heating of molten metal is necessary while casting.

- Easier smelter creeping program as the pressure on the casthouse molten metal temperature management is reduced.
- Open opportunities for ‘almost’ continuous furnace operation in a remelt casthouse, as no cooling time is required.

All these benefits would increase the overall equipment efficiency towards more productive and less expensive casthouses.

In-line cooling of molten metal also opens new horizons for greenfield remelt casthouse layout. As metal could be cooled down rapidly in a trough, one can imagine that casting directly from the transport crucible and just keeping few furnaces for scrap melting purposes would greatly reduce capital expenses for the new casthouses while keeping all the advantages already described.

A modern remelt ingot casthouse uses typically two furnaces per ingot caster. A cooling trough could reduce the number of furnaces and reduce energy consumption, maintenance and operating cost. A more compacted arrangement of three furnaces linked to two ingot chains is already proposed [5].

The ARENA simulation software was used with a specific RTA/Smelter Technology library in order to design a casthouse having fewer furnaces and using crucibles and cooling troughs to cast the metal.

This library aims at modeling the metal flow of a smelter, containing modules representing pot line tapping groups, metal ladle transport vehicles, ladle cleaning, furnaces, casting pits and ingot lines. It covers the required product mix, furnace charging times, metal preparation times, equipment reliability, etc. Metal temperature management is also taken into account in the library: metal in ladles, furnace temperature, and casting temperature range.

The dimensioning criteria used in the library are:

- The percentage of shifts with reduction backlog (ladles not yet filled at the end of shift).
- The transport vehicle occupation rate.
- The catch up capacity in two downgraded modes (one without a furnace and the other without a production unit).

A smelter configuration was modeled, producing around 690 KT per year. The casthouse initial “classical” design includes five 30 tons/hour ingot lines and eight 100-ton furnaces (see Figure 7):

- One “duo”: two furnaces connected to an ingot line.
- Two “three furnaces - two ingot lines” groups [5].

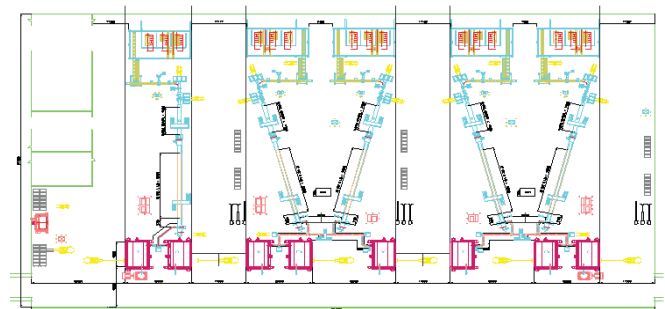

Figure 7. Diagram of initial casthouse configuration.

The cooling trough influence is evaluated by comparison between operating with or without temperature constraints at the beginning of casting. When using the cooling trough, waiting times are removed, and the smelter metal flow is modified. By studying the metal temperature in furnaces at cast start, the model shows that the cooling trough has to deal with a maximum temperature drop of 100 °C.

The results given by the model show that part of the furnaces can be replaced by tilting tables pouring directly in the troughs. A correctly dimensioned configuration consists in replacing five out of the eight furnaces by tilting tables, leaving only one furnace in each of the casting groups: the “duo” and the two “three furnaces two lines” (Figure 8). The use of furnaces is mandatory because of remelt metal management. The size and number of furnaces must take into account the percentage of solid scrap charge to be melted.

Further studies will be necessary to optimize the detailed operating procedures. Overall, the introduction of the cooling trough in a remelt casthouse configuration may represent a significant potential for capital and operational expense reductions for a greenfield operation.

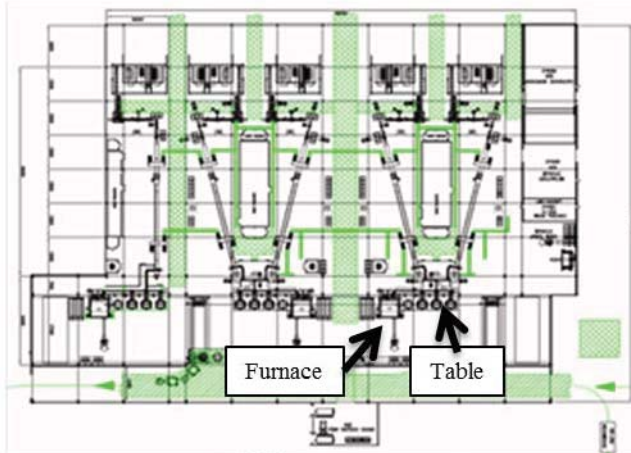

Figure 8. Possible casthouse configuration.

Conclusion

A new patent pending technology [1], an in-line cooling trough for molten metal was developed by Rio Tinto Alcan. A full-scale laboratory unit was trialed. The cooling performance of the in-line cooling trough is approximately one order of magnitude higher than that of a standard trough and can be adjusted depending on the casting furnace temperature, casting temperature and casting throughput. In the context of a pure remelt ingot casthouse or low alloyed value added production, this new technology opens the possibility for near zero energy consumption, reduction of greenhouse gases and a major reduction of the cycle time, hence a much higher overall equipment efficiency and efficient casthouses. New horizons for smaller and more compact casthouses with lower capital and operational expenses can also be foreseeing using in-line temperature control. This technology can be easily retrofitted to standard trough lines, and can be fully automated to control the casting temperature and does not require any additional operation for employees.

Acknowledgments

The authors wish to thank Rio Tinto Alcan for permission to publish the present paper. Special thanks are given to Messrs. Joseph Langlais, Serge Lavoie, Éric Hébert, Dany Jean and Serge Munger, as well as the many other researchers and technicians involved in all of Rio Tinto Alcan, for their active contribution in the development of the cooling trough.

References

1. International Patent Application No. PCT/CA2013/050120.
2. P. Koltun, A. Tharumarajah and J. Grandfield, “Greenhouse emissions in primary aluminium smelter cast houses - A life cycle analysis”, (Paper presented at the Aluminium Cast House Technology, 11th Australasian Conference and Exhibition, Surfers Paradise, QLD, Australia, 13 September 2009) 27-34.
3. Australian Commonwealth Government, “Energy efficiency best practice in the Australian aluminium industry”, (Industry, Science and Resources, Energy Efficiency Best Practice Program, May 2000).
4. D. Kunii, O. Levenspiel, *Fluidization Engineering*, (Boston, Second Edition, Butterworth-Heinmann Editor, 1991), 313-336.
5. J. Berlioux, J.-L. Baudrenghien, A. Bourgier, “New casthouse smelter layout for the production of small non-alloyed ingots: Three furnaces/two lines”, (Paper presented at TMS 2011, Annual Meeting of and Exhibition, San Diego, CA, TMS, 23 February 2011), 635-639.