

# FUNCTIONAL PROGRAMMING



A SIMPLE STEP-BY-STEP  
APPROACH TO LEARNING  
FUNCTIONAL PROGRAMMING

# SIMPLIFIED

ALVIN  
ALEXANDER

# **Functional Programming, Simplified**

**(Scala edition)**

# Table of Contents

- [Copyright](#)
- [Introduction\(or, Why I Wrote This Book\)](#)
- [Who This Book is For](#)
- [Goals, Part 1: “Soft” Goals of This Book](#)
- [Goals, Part 2: Concrete Goals](#)
- [Goals, Part 3: A Disclaimer](#)
- [Question Everything](#)
- [Rules for Programming in this Book](#)
- [One Rule for Reading this Book](#)
- [What is “Functional Programming”?](#)
- [What is This Lambda You Speak Of?](#)
- [The Benefits of Functional Programming](#)
- [Disadvantages of Functional Programming](#)
- [The “Great FP Terminology Barrier”](#)
- [Pure Functions](#)
- [Grandma’s Cookies \(and Pure Functions\)](#)
- [Benefits of Pure Functions](#)
- [Pure Functions and I/O](#)
- [Pure Function Signatures Tell All](#)
- [Functional Programming as Algebra](#)
- [A Note About Expression-Oriented Programming](#)
- [Functional Programming is Like Unix Pipelines](#)
- [Functions Are Variables, Too](#)
- [Using Methods As If They Were Functions](#)
- [How to Write Functions That Take Functions as Input Parameters](#)
- [How to Write a ‘map’ Function](#)
- [How to Use By-Name Parameters](#)
- [Functions Can Have Multiple Parameter Groups](#)
- [Partially-Applied Functions \(and Currying\)](#)
- [Recursion: Introduction](#)
- [Recursion: Motivation](#)
- [Recursion: Let’s Look at Lists](#)
- [Recursion: How to Write a ‘sum’ Function](#)
- [Recursion: How Recursive Function Calls Work](#)
- [Visualizing the Recursive sum Function](#)

- [Recursion: A Conversation Between Two Developers](#)
- [Recursion: Thinking Recursively](#)
- [JVM Stacks and Stack Frames](#)
- [A Visual Look at Stacks and Frames](#)
- [Tail-Recursive Algorithms](#)
- [A First Look at “State”](#)
- [A Functional Game \(With a Little Bit of State\)](#)
- [A Quick Review of Case Classes](#)
- [Update as You Copy, Don’t Mutate](#)
- [A Quick Review of for Expressions](#)
- [How to Write a Class That Can Be Used in a for Expression](#)
- [Creating a Sequence Class to be Used in a for Comprehension](#)
- [Making Sequence Work in a Simple for Loop](#)
- [How To Make Sequence Work as a Single Generator in a for Expression](#)
- [Enabling Filtering in a for Expression](#)
- [How to Enable the Use of Multiple Generators in a for Expression](#)
- [A Summary of the for Expression Lessons](#)
- [Pure Functions Tell No Lies](#)
- [Functional Error Handling](#)
- [Embrace The Idioms!](#)
- [What to Think When You See That Opening Curly Brace](#)
- [A Quick Review of How flatMap Works](#)
- [Option Naturally Leads to flatMap](#)
- [flatMap Naturally Leads to for](#)
- [for Expressions are Better Than getOrElse](#)
- [Recap: Option -> flatMap -> for](#)
- [A Note About Things That Can Be Mapped Over](#)
- [Starting to Glue Functions Together](#)
- [The “Bind” Concept](#)
- [Getting Close to Using bind in for Expressions](#)
- [Using a “Wrapper” Class in a for Expression](#)
- [Making Wrapper More Generic](#)
- [Changing “new Wrapper” to “Wrapper”](#)
- [A Quick Note About Case Classes and Companion Objects](#)
- [Using bind in a for Expression](#)
- [How Debuggable, f, g, and h Work](#)
- [A Generic Version of Debuggable](#)
- [One Last Debuggable: Using List Instead of String](#)
- [Key Points About Monads](#)

- [Signpost: Where We're Going Next](#)
- [Introduction: The IO Monad](#)
- [How to Use an IO Monad](#)
- [Assigning a for Expression to a Function](#)
- [The IO Monad and a for Expression That Uses Recursion](#)
- [Diving Deeper Into the IO Monad](#)
- [I'll Come Back to the IO Monad](#)
- [Functional Composition](#)
- [An Introduction to Handling State](#)
- [Handling State Manually](#)
- [Getting State Working in a for Expression](#)
- [Handling My Golfing State with a State Monad](#)
- [The State Monad Source Code](#)
- [Signpost: Getting IO and State Working Together](#)
- [Trying to Write a for Expression with IO and State](#)
- [Seeing the Problem: Trying to Use State and IO Together](#)
- [Solving the Problem with Monad Transformers](#)
- [Beginning the Process of Understanding StateT](#)
- [Getting Started: We're Going to Need a Monad Trait](#)
- [Now We Can Create StateT](#)
- [Using StateT in a for Expression](#)
- [Trying to Combine IO and StateT in a for Expression](#)
- [Fixing the IO Functions With Monadic Lifting](#)
- [A First IO/StateT for Expression](#)
- [The Final IO/StateT for Expression](#)
- [Summary of the StateT Lessons](#)
- [Signpost: Modeling the world with Scala/FP](#)
- [What is a Domain Model?](#)
- [A Review of OOP Data Modeling](#)
- [Modeling the "Data" Portion of the Pizza POS System with Scala/FP](#)
- [First Attempts to Organize Pure Functions](#)
- [Implementing FP Behavior with Modules](#)
- [Implementing the Pizza POS System Using a Modular Approach](#)
- [The "Functional Objects" Approach](#)
- [Demonstrating the "Functional Objects" Approach](#)
- [Summary of the Domain Modeling Approaches](#)
- [ScalaCheck 1: Introduction](#)
- [ScalaCheck 2: A More-Complicated Example](#)
- [The Problem with the IO Monad](#)

- [Signpost: Type Classes](#)
- [Type Classes 101: Introduction](#)
- [Type Classes 102: The Pizza Class](#)
- [Type Classes 103: The Cats Library](#)
- [Lenses, to Simplify “Update as You Copy”](#)
- [Signpost: Concurrency](#)
- [Concurrency and Mutability Don’t Mix](#)
- [Scala Concurrency Tools](#)
- [Akka Actors](#)
- [Akka Actor Examples](#)
- [Scala Futures](#)
- [A Second Futures Example](#)
- [Key Points About Futures](#)
- [To Be Continued](#)
- [Appendices](#)
- [Explaining Scala’s val Function Syntax](#)
- [The Differences Between val and def When Creating Functions](#)
- [Recursion is Great, But ...](#)
- [for expression translation examples](#)
- [A Review of Case Classes](#)
- [Algebraic Data Types](#)
- [A Review of Anonymous Functions](#)
- [On Using def vs val To Define Abstract Members in Traits](#)

# Copyright

Copyright 2017 [Alvin J. Alexander](#)

All rights reserved. No part of this book may be reproduced without prior written permission from the author.

Disclaimer: This book is presented solely for educational purposes, and it's also a work in progress. While best efforts have been used in preparing this book, the author makes no representations or warranties of any kind and assume no liabilities of any kind with respect to the accuracy or completeness of the contents, and specifically disclaim any implied warranties of merchantability or fitness of use for a particular purpose. The author shall not be held liable or responsible to any person or entity with respect to any loss or incidental or consequential damages caused, or alleged to have been caused, directly or indirectly, by the information or programs contained herein. Any use of this information is at your own risk. The advice and strategies contained herein may not be suitable for your situation.

Version 0.1.5, published October 17, 2017

# Introduction(or, Why I Wrote This Book)

The short version of “Why I wrote this book” is that I found that trying to learn functional programming in Scala to be really hard, and I want to try to improve that situation.

The longer answer goes like this ...



## My programming background

My degree is in aerospace engineering, so the only programming class I took in college was a FORTRAN class I was forced to take. After college I was one of the youngest people at the aerospace company I worked at, which meant that I'd have to maintain the software applications our group used. As a result, I became interested in programming, after which I quickly became interested in (a) "How can I write code faster?", and then (b) "How can I write maintainable code?"

After that I taught myself how to program in C by reading the classic book, [The C Programming Language](#) by Kernighan and Ritchie, quickly followed by learning Object-Oriented Programming (OOP) with C++ and Java. That was followed by investigating other programming languages, including Perl, PHP, Ruby, Python, and more.

Despite having exposure to all of these languages, I didn't know anything about Functional Programming (FP) until I came across [Google's Guava project](#), which includes FP libraries for Java collections. Then, when I learned [Scala](#) and came to understand the methods in the Scala collections' classes, I saw that immutable values and pure functions had some really nice benefits, so I set out to learn more about this thing called *Functional Programming*.

## Trying to learn FP with Scala

As I tried to learn about FP in Scala, I found that there weren't any FP books or blogs that I liked — certainly nothing that catered to my “I've never heard of FP until recently” background. Everything I read was either (a) dry and theoretical, or (b) quickly jumped into topics I couldn't understand. It seemed like people enjoyed writing words “monad” and “functor” and then watching me break out in a cold sweat.

As I googled “scala fp” like a madman, I found a few useful blog posts here and there about functional programming in Scala — what I'll call “Scala/FP” in this book — but those were too disconnected. One article covered Topic A, another covered Topic Z, and they were written by different authors with different experiences, so it was hard to find my way from A to Z. Besides being disjointed, they were often incomplete, or maybe they just assumed that I had some piece of knowledge that I didn't really have.

Another stumbling block is that experienced FP developers use generic types *a lot*. Conversely, I only rarely used generics. They also use the word “easy” when describing their code, as though saying “easy” is some sort of Jedi mind trick. For instance, this code — which I'll break down as you go through this book — was introduced with the text, “it's very easy to access and modify state”:

```
def updateHealth(delta: Int): Game[Int] =
  StateT[IO, GameState, Int] { (s: GameState) =>

    val newHealth = s.player.health + delta
    IO((s.copy(player = s.player.copy(health = newHealth)), newHealth))

  }
```

I don't know about you, but the first time I saw that code, the word *easy* is not what came to mind. What came to my mind were things like, “PHP is easy. Using setter methods to modify state is easy. Whatever that is ... that's not easy.”

Another problem with almost all of the Scala/FP resources is that they don't discuss functional input/output (I/O), or how to work with user interfaces. In this book I don't shy away from those topics: I write what I know about both of them.

## Learning Haskell to learn FP

In the end, the only way I could learn FP was to buy four [Haskell](#) books, take a few weeks off from my regular work, and teach myself Haskell. Because Haskell is a “pure” FP language — and because most experienced Scala/FP developers spoke glowingly about Haskell — I assumed that by learning Haskell I could learn FP.

That turned out to be true. In Haskell the only way you can write code is by using FP concepts, so you can’t bail out and take shortcuts when things get difficult. Because everything in Haskell is immutable, I was forced to learn about topics like recursion that I had avoided for most of my programming life. In the *beginning* this made things more difficult, but in the *end* I learned about the benefits of the new approaches I was forced to learn.

Once I understood Haskell, I went back to the Scala resources that I didn’t like before and suddenly they made sense(!). But again, this only happened *after I took the time to learn Haskell*, a language I didn’t plan on using in my work.

## The purpose of this book

Therefore, my reasons for writing this book are:

- To save you the time of having to try to understand many different, unorganized, inconsistent Scala/FP blog posts
- To save you the time of “having to learn Haskell to learn FP” (and then having to translate that Haskell knowledge back to Scala)
- To try to make learning Scala/FP as simple as possible

Don't get my statements about Haskell wrong: In the end, Haskell turned out to be a really interesting and even fun programming language. If I knew more about its libraries, or if it ran on the JVM and I could use the wealth of existing JVM libraries out there, I'd be interested in trying to use it.

As a potential benefit of this book, if you already know Scala/OOP and are interested in learning Haskell, you can learn Scala/FP from this book, and then you'll find it much easier to understand Haskell.

# Who This Book is For

I kept several audiences in mind as I wrote this book:

1. Developers who want a simple introduction to functional programming in Scala
2. Developers who are interested in writing “better” code
3. Parallel/concurrent application developers
4. “Big data” application developers
5. (Possibly) Upperclass college students

Here’s a quick look at why I say that I wrote this book for these people.

## **1) Developers who want a simple introduction to FP**

First, because this book started as a series of small notes I made for myself as I learned Scala/FP, it's safe to say that I wrote it for someone like me who has worked with OOP in Java, but has only a limited FP background. Specifically, this is someone who became interested in Scala because of its clean, modern syntax, and now wants a “simple but thorough” introduction to functional programming in Scala.

Because I've also written programs in C, C++, Perl, Python, Ruby, and a few other programming languages, it's safe to say that this book is written with these programmers in mind as well.

## 2) Those interested in writing “better” code

At specific points in this book — such as (a) when writing about pure functions, (b) using `val` and not `var`, and (c) avoiding the use of `null` values — I also wrote this book for any developer that wants to write better code, where I define “better” as safer, easier to test, and more error-free. Even if you decide not to write 100% pure FP code, many FP techniques in this book show how you can make your functions safer from bugs.

As a personal note, an ongoing theme in my programming life is that I want to be able to write applications faster, without sacrificing quality and maintainability. A selling point of FP is that it enables you to write safe functions — *pure* functions that rely only on their inputs to produce their outputs — that you can combine together to safely create larger applications.

### 3) Parallel/concurrent developers

Quiz: How many cores are in your smartphone? (This question is a tip of the cap to Derek Wyatt, who wrote about CPU cores and smartphones in his book, [Akka Concurrency](#)).

In addition to writing safer code, the “killer app” for FP since about 2005 is that CPUs aren’t constantly doubling in speed any more. (See Herb Sutter’s 2005 article, [The Free Lunch is Over](#).) Because of this, CPU designers are adding more cores to CPUs to get more overall CPU cycles/second. Therefore, if you want your apps to run as fast as possible, it will help to use *concurrent programming* techniques to put all of those cores to use, and the best way we know how to do that today is to use FP.

Two of my favorite ways of writing parallel/concurrent applications involve using Scala futures and the [Akka](#) messaging/actors framework. Not surprisingly, FP works extremely well with both of these approaches.



## 4) Big data app developers

More recently, Dean Wampler gave a presentation titled, [“Copious Data: The ‘Killer App’ for Functional Programming”](#). My experience with Big Data applications is limited to [processing large Apache access log records with Spark](#), but I can confirm that the code I wrote was a lot like algebra, where I passed data into pure functions and then used only the results from those functions. My code had no dependence on “side effects,” such as using mutable variables or managing state.

## 5) Upperclass college students

As I wrote in the [Scala Cookbook](#), because of its “power user” features, I don’t think Scala is a good first language for a programmer to learn, and as a result of that, a book about Scala/FP is also not a good first programming book to read.

That being said, I hope this will be a good first FP book to read *after* a college student has experience with languages like C, Java, and Scala.

## **Caution: Not for FP experts**

Finally, as a result of the people I *have* written this book for, it should come as no surprise that this book is *not* written for FP experts and theorists. I offer no new theory in this book; I just try to explain functional programming using the Scala programming language in the simplest way I can.

# Goals, Part 1: “Soft” Goals of This Book

Going through the thought process of “Why do I want to write a book about Scala/FP?” led me to develop my goals for this book. They are:

1. To introduce functional programming in Scala in a simple but thorough way, as though you and I are having a conversation.
2. To present the solutions in a systematic way. I want to introduce the material in the order in which I think you’ll run into problems as you learn Scala/FP. In this way I can break down complex code into smaller pieces so you can see how the larger solution is built from the smaller pieces.
3. To discuss the motivation and benefits of FP features. For me it wasn’t always clear *why* certain things in FP are better, so I’ll keep coming back to these two points.
4. I want to save you the time and effort of having to learn Haskell (or some other language) in order to learn FP.
5. I want to help you learn to “Think in FP.” (More on this shortly.)

In general, I want to help you start writing FP code without having to learn a lot of mathematics, background theory, and technical jargon like that shown in Figure [fig:fpTerminologyBarrier].

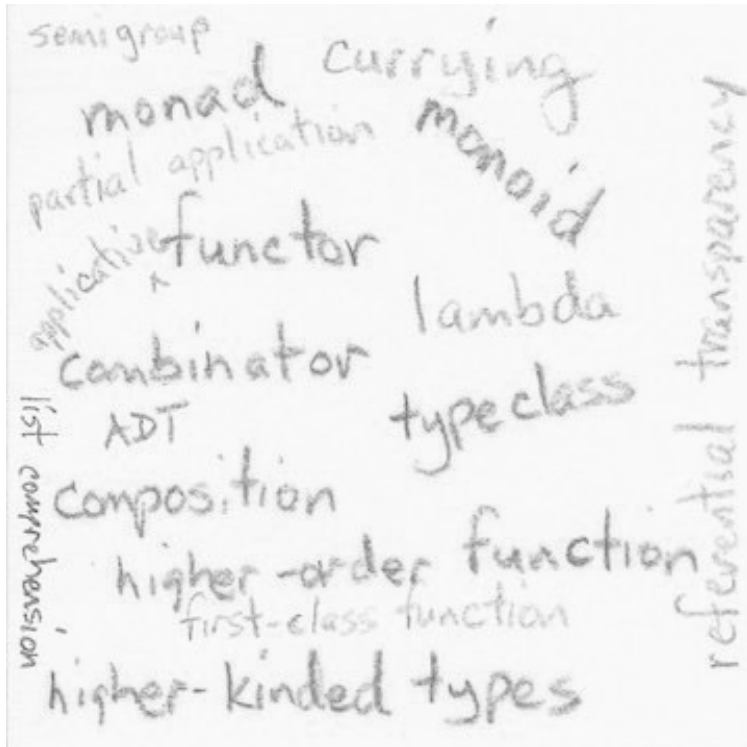

Examples of the “FP terminology barrier”

I refer to this as the “FP Terminology Barrier,” and I’ll discuss it more in an upcoming lesson.

## A word of caution: “The Learning Cliff”

When I took a thermodynamics class in college, I learned the quote I shared at the beginning of this chapter:

“One learns by doing the thing.”

For me, this is a reminder that sometimes the only way you can learn something is to work on it with your hands. Until that first thermodynamics class I never really had to *do the thing* — work all of the exercises — to learn the material, but in that class I found out the hard way that there are times when I really have to dig in and “do the thing to learn the thing.”

### ***Aside: Working hard to learn something new***

If you’ve read the book, [Einstein: His Life and Universe](#), by Walter Isaacson, you know that Albert Einstein had to essentially go back to school and learn a *lot* of math so he could turn the Theory of Special Relativity into the Theory of General Relativity.

He published the “Einstein field equations” (shown in Figure [fig:einsteinFieldEquations]) in 2015, and there’s no way that Einstein could have developed these equations without buckling down and taking the time to learn the necessary math. (Lesson: Even one of the smartest people in the history of Earth had to work hard to learn something new, with a huge payoff in the end.)

$$R_{\mu\nu} - \frac{1}{2}R g_{\mu\nu} + \Lambda g_{\mu\nu} = \frac{8\pi G}{c^4} T_{\mu\nu}$$

The Einstein field equations

## More on Point #7: Thinking in FP

In this book I hope to change the way you think about programming problems. As at least one functional developer has said, when you “Think in FP,” you see an application as (a) data flowing into the application, (b) being transformed by a series of transformer functions, and (c) producing an output.

The first lessons in this book are aimed at helping you to “Think in FP” — to see your applications in this way, as a series of data flows and transformers.

Another important part of “Thinking in FP” is that you’ll find that FP *function signatures* are very important — much more important than they are in OOP code. I cover this in depth in the lesson, “Pure Function Signatures Tell All.”

## Summary

In summary, my goals for this book are:

1. To introduce functional programming in Scala in a simple, thorough way.
2. To present the solutions in a systematic way.
3. To discuss the motivation and benefits of FP features.
4. To save you the time and effort of having to learn another programming language in order to understand Scala/FP.
5. In general, to help you “Think in FP.”

An important part of the learning process is having a “Question Everything” spirit, and I’ll cover that next.



## Goals, Part 2: Concrete Goals

After I released an early version of this book, I realized that I should state my goals for it more clearly; I don't want you to buy or read a book that doesn't match what you're looking for. More accurately, I don't want you to be disappointed in the book because your expectations are different than what I deliver. Therefore, I want to state some very clear and measurable goals by which you can judge whether or not you want to buy this book.

A first concrete goal is this: If you have a hard time understanding the book, [Functional Programming in Scala](#), I want to provide the background material that can help make it easier to understand. That book is very good, but it's also a thin, densely-packed book, so if there are a few Scala features you don't know, you can get lost.

Second, the [Introduction to Functional Game Programming](#) talk at the 2014 LambdaConf was a big influence on me. I remember going to that talk and thinking, "Wow, I thought I knew Scala and a little bit about functional programming, but I have no idea what this guy is talking about." Therefore, a second concrete goal is to make all of that talk and its associated code understandable to someone who has zero to little background in functional programming. The talk covers the `IO`, `State`, and `StateT` monads, and other FP features like *lenses*, so this is actually a pretty big goal.

A third, slightly-less concrete goal is that if you have no background in FP, I want to make Scala/FP libraries like [Cats](#) and [Scalaz](#) more understandable. That is, if you were to look at those libraries without any sort of FP background, I suspect you'd be as lost as I was at that 2014 LambdaConf talk. But if you read this book, I think you'll understand enough Scala/FP concepts that you'll be able to understand what those libraries are trying to achieve.

A fourth concrete goal is to provide you with all of the background knowledge you need — anonymous functions, type signatures, `for` expressions, classes that implement `map` and `flatMap`, etc. — so you can better understand the 128,000 *monad* tutorials that [Google currently lists in their search results](#).

## Goals, Part 3: A Disclaimer

As a bit of a warning, I want to be clear that this book is *very different* than the [Scala Cookbook](#). The essence of the Cookbook is, “Here’s a common problem, and here’s a solution to that problem,” i.e., a series of recipes.

This book is completely different.

## The “reporter” metaphor

I liken this book to being a reporter who goes to a foreign country that very few people seem to know about. Out of curiosity about what he has read and seen, the intrepid reporter goes to this foreign land to learn more about it. Nobody knows how the story is going to end, but the reporter promises to report the truth as he sees and understands it.

On his journey through this new land the reporter jots down many notes, especially as he has a few “Aha!” moments when he grasps new concepts. Over time he tries to organize his notes so he can present them in a logical order, trying to translate what he has seen into English (and Scala) as simply and accurately as he can. In the end there’s no promise that the reporter is going to *like* what he sees, but he promises to report everything as clearly as he can.

## **A reporter is not a salesman**

To be clear, there's no promise of a happy ending in this story. The reporter isn't trying to sell you on moving to this new land. Instead of trying to *sell* you, the reporter aims to report what he sees as accurately as possible, hoping that — armed with this new knowledge — in the end you'll decide what's in your own best interests. Maybe you'll decide to move to this land, maybe you won't, but at least you'll be well-armed in making your decision.

## **A personal experience**

As an example of how I think about this, many years ago I came close to moving to Santa Fe, New Mexico. As soon as I visited the town, I immediately fell in love with the plaza area, the food, and the architecture of the homes. But after thinking about the pros and cons more seriously, I decided not to move there. Instead, I decided to just vacation there from time to time, and also take home some nice souvenirs when I find them.

The same is true about this book: you may decide to move to this new land, or you may decide that you just like a few souvenirs. That choice is yours. My goal is to report what I find, as simply and accurately as I can.

# Question Everything

A Golden Rule of this book is to always ask, “*Why?*” By this I mean that you should question everything I present. Ask yourself, “Why is this FP approach better than what I do in my OOP code?” To help develop this spirit, let’s take a little look at what FP is, and then see what questions you might have about it.

## What is FP?

I'll describe FP more completely in the "What is Functional Programming?" lesson, but for the moment let's use the following definition of FP:

- FP applications consist of only immutable values and pure functions.
- *Pure function* means that (a) a function's output depends only on its input parameters, and (b) functions have no side effects, such as reading user input or writing output to a screen, disk, web service, etc.

While I'm intentionally keeping that definition short, it's a way that people commonly describe FP, essentially the FP [elevator pitch](#).

# What questions come to mind?

Given that description, what questions come to mind about FP?

Some of my first questions were:

- How can you possibly write an application without reading input or writing output?
- Regarding I/O:
  - How do I write database code?
  - How do I write RESTful code?
  - How do I write GUI code?
- If all variables are immutable, how do I handle changes in my code?
  - For instance, if I'm writing an order-entry system for a pizza store, what do I do when the customer wants to change their pizza crust or toppings in the middle of entering an order?

If you have a little more exposure to FP than I did, you might ask:

- Why is recursion better? Is it *really* better? Why can't I just use var fields inside my functions, as long as I don't share those vars outside the function scope?
- Is "Functional I/O" really better than "Traditional I/O"?

A little later you might ask:

- Are there certain applications where the FP approach is better? Or worse?



## Decide for yourself what's better

*Critical thinking* is an important part of being a scientist or engineer, and I always encourage you to think that way:

Is the approach I'm looking at better or worse than other options? If so, why?

When doing this I encourage you not to make any snap judgments. Just because you don't like something *initially* doesn't mean that thing is bad or wrong.

## The best idea wins

With critical thinking you also need to tune out the people who yell the loudest. Just because they're loud, that doesn't mean they're right. Just focus on which ideas are the best.

In my book, [A Survival Guide for New Consultants](#), I share this quote from [famed physicist Richard Feynman](#):

“The best idea wins.”

He wrote that in one of his books, where he shared an experience of how Neils Bohr would seek out a very young Feynman during the creation of the first atomic bomb. Bohr felt that the other scientists on the project were “Yes men” who would agree with anything he said, while Feynman was young, curious, and unintimidated. Because Feynman was only interested in learning and in trying to come up with the best solutions, he would tell Bohr exactly what he thought about each idea, and Bohr sought him out as a sounding board.

Feynman meant that you have to be able to have good, honest conversations with people about your ideas, and at the end of the day you have to put your ego aside, and the team should go forward with the best idea, no matter where it came from.

This goes back to my point: Don't blindly listen to people, especially the people who yell the loudest or those who can profit from selling you an idea. Put your critical thinking hat on, and make your own decisions.

## A quick aside: Imperative programming

In the next sections I'll use the term "Imperative programming," so I first want to give you a definition of what it means.

With a few minor changes, [Wikipedia offers this description](#): "*Imperative programming* is a programming paradigm that uses statements that change a program's state. It consists of a series of commands for the computer to perform. It focuses on describing the details of *how* a program operates."

[This Quora page](#) adds: "Imperative programming involves writing your program as a series of instructions (statements) that actively modify memory (variables, arrays). It focuses on 'how,' in the sense that you express the logic of your program based on how the computer would execute it."

If you've ever disassembled a JVM *.class* file with `javap -c` to see code like this:

```
public void main(java.lang.String[]);
  Code:
    0: aload_0
    1: aload_1
    2: invokestatic #60
    5: return
```

That's the extreme of what they're referring to: imperative programming at a very low level. This code tells the JVM *exactly* how it needs to solve the problem at hand.

## A critical thinking exercise

To start putting your critical thinking skill to work, I'm going to show you two versions of the same algorithm. As you see the two algorithms, I want you to jot down any questions you have about the two.

First, here's an imperative version of a sum method:

```
def sum(ints: List[Int]): Int = {  
  var sum = 0  
  for (i <- ints) {  
    sum += i  
  }  
  sum  
}
```

This code modifies a var field within a for loop — a common pattern in imperative programming.

Next, here's a Scala/FP version of that same method:

```
def sum(xs: List[Int]): Int = xs match {  
  case Nil => 0  
  case x :: tail => x + sum(tail)  
}
```

Notice that this method uses a match expression, has no var fields, and it makes a recursive call to sum in the last line of the method body.

Given those two versions of the same algorithm, what questions come to your mind?

### *My questions*

The questions you have will depend on your experience. If you're new to Scala/FP your first question might be, "How does that second method even work?" (Don't worry, I'll explain it more in the lessons on writing recursive functions.)

I remember that some of my first questions were:

- What's wrong with the imperative approach? Who cares if I use a var field

in a for loop inside a function? How does that affect anything else?

- Will the recursive function blow the stack with large lists?
- Is one approach faster or slower than the other?
- Thinking in the long term, is one approach more maintainable than the other?
- What if I want to write a “parallel” version of a sum algorithm (to take advantage of multiple cores); is one approach better than the other?

That’s the sort of thinking I want you to have when you’re reading this book: Question everything. If you think something is better, be honest; *why* do you think it’s better? If you think it’s worse, why is it worse?

In the pragmatic world I live in, if you can’t convince yourself that a feature is better than what you already know, the solution is simple: Don’t use it.

As I learned FP, some of it was so different from what I was used to, I found that *questioning everything* was the only way I could come to accept it.

## We write what we want, not how to do it

As another example of having a questioning attitude, early in my FP learning process I read quotes from experienced FP developers like this:

“In FP we don’t tell the computer *how* to do things, we just tell it *what* we want.”

When I read this my first thought was pretty close to, “What does that mean? You talk to the computer?”

I couldn’t figure out what they meant, so I kept questioning that statement. Were they being serious, or was this just some sort of FP [koan](#), trying to get you interested in the topic with a mysterious statement? It felt like they were trying to sell me something, but I was open to trying to understand their point.

After digging into the subject, I finally decided that the main thing they were referring to is that they don’t write imperative code with `for` loops. That is, they don’t write code like this:

```
def double(ints: List[Int]): List[Int] = {
  val buffer = new scala.collection.mutable.ListBuffer[Int]()
  for (i <- ints) {
    buffer += i * 2
  }
  buffer.toList
}

val newNumbers = double(oldNumbers)
```

Instead, they they write code like this:

```
val newNumbers = oldNumbers.map(_ * 2)
```

With a `for` loop you tell the compiler the exact steps you want it to follow to create the new list, but with FP you say, “I don’t care how `map` is implemented, I trust that it’s implemented well, and what I want is a new list with the doubled value of every element in the original list.”

In this example, questioning the “We write what we want” statement is a relatively minor point, but (a) I want to encourage a curious, questioning attitude, and (b) I know that you’ll eventually see that statement somewhere, and

I wanted to explain what it means.

In his book [Programming Erlang](#), Joe Armstrong notes that when he was first taught object-oriented programming (OOP), he felt that there was something wrong with it, but because everyone else was “Going OOP,” he felt compelled to go with the crowd. Paraphrasing his words, if you’re going to work as a professional programmer and put your heart and soul into your work, make sure you believe in the tools you use.

## What's next?

In the next lesson I'm going to provide a few programming *rules* that I'll follow in this book. While I'm generally not much of a "rules" person, I've found that in this case, having a few simple rules makes it easier to learning functional programming in Scala.



# Rules for Programming in this Book

Alright, that's enough of the "preface" material, let's get on with the book!

As I wrote earlier, I want to spare you the route I took of, "You Have to Learn Haskell to Learn Scala/FP," *but*, I need to say that I did learn a valuable lesson by taking that route:

It's extremely helpful to completely forget about several pieces of the Scala programming language as you learn FP in Scala.

Assuming that you come from an "imperative" and OOP background as I did, your attempts to learn Scala/FP will be hindered because *it is* possible to write both imperative code and FP code in Scala. Because you *can* write in both styles, what happens is that when things in FP start to get difficult, it's easy for an OOP developer to turn back to what they already know.

To learn Scala/FP the best thing you can do is *forget* that the imperative options even exist. I promise you — Scout's Honor — this will accelerate your Scala/FP learning process.

## The rules

To accelerate your Scala/FP learning process, this book uses the following programming “rules”:

1. There will be no `null` values in this book. We’ll intentionally forget that there is even a `null` keyword in Scala.
2. Only *pure functions* will be used in this book.
3. This book will only use immutable values (`val`) for all fields. There are no `var` fields in pure FP code, so I won’t use them in this book, unless I’m trying to explain a point.
4. Whenever you use an `if`, you must always also use an `else`. Functional programming uses only *expressions*, not *statements*.
5. We won’t create “classes” that encapsulate data and behavior. Instead we’ll create data structures and write pure functions that operate on those data structures.

## The rules are for your benefit (really)

These rules are inspired by what I learned from working with Haskell. In Haskell the only way you can *possibly* write code is by writing pure functions and using immutable values, and when those *really are your only choices*, your brain quits fighting the system. Instead of going back to things you're already comfortable with, you think, "Hmm, somehow other people have solved this problem using only immutable values, and I can, too." When your thinking gets to that point, your understanding of FP will rapidly progress.

If you're new to FP those rules may feel limiting — and you may be wondering how you can possibly get *anything* done — but if you follow these rules you'll find that they lead you to a different way of thinking about programming problems. *Because* of these rules your mind will naturally gravitate towards FP solutions to problems.

For instance, because you can't use a `var` field to initialize a mutable variable before a `for` loop, your mind will naturally think, "Hmm, what can I do here? Ah, yes, I can use recursion, or maybe a built-in collections method to solve this problem." Conversely, if you let yourself reach for that `var` field, you'll never come to this other way of thinking.

## Not a rule, but a note: using ???

While I'm writing about what aspects of the Scala language I *won't* use in this book, it's also worth noting that I will often use the Scala ??? syntax when I first sketch a function's signature. For example, when I first start writing a function named `createWorldPeace`, I'll start to sketch the signature like this:

```
def createWorldPeace = ???
```

I mention this because if you haven't seen this syntax before you may wonder why I'm using it. The reason I use it is because it's perfectly legal Scala code; that line of code will compile just fine. Go ahead and paste that code into the REPL and you'll see that it compiles just like this:

```
scala> def createWorldPeace = ???
createWorldPeace: Nothing
```

However, while that code does *compile*, you'll see a long error message that begins like this if you try to *call* the `createWorldPeace` function:

```
scala.NotImplementedError: an implementation is missing
```

I wrote about the ??? syntax in a blog post titled, [What does '???' mean in Scala?](#), but in short, Martin Odersky, creator of the Scala language, added it to Scala for teaching cases just like this. The ??? syntax just means, "The body of this function is TBD."

If you're interested in how language designers add features to a programming language, that blog post has a link to a really interesting discussion started by Mr. Odersky. He begins the thread by stating, "If people don't hold me back I'm going to add this (???) to Predef," and then the rest of the thread is an interesting back-and-forth discussion about the pros and cons of adding this feature to the Scala language, and possibly using other names for it, such as using `TODO` instead of ???.

## Summary

In summary, the rules we'll follow in this book are:

1. There will be no `null` values.
2. Only *pure functions* will be used.
3. Immutable values will be used for all fields.
4. Whenever you use an `if`, you must always also use an `else`.
5. We won't create "classes" that encapsulate data and behavior.

# One Rule for Reading this Book

In addition to the rules for *programming* in this book, there's one rule for *reading* this book:

If you already understand the material in a lesson, move on to the next lesson.

Because I try to thoroughly cover everything you might possibly need to know leading up to advanced topics like monads, there will probably be some lessons you don't need to read. For instance, you may already know that you can use functions as variables, how to write functions that have multiple parameter groups, etc.

Therefore, there's one simple rule for reading this book: If you already understand a topic — move on! (You can always come back and read it later if you feel like there's something you missed.)

# What is “Functional Programming”?

# Defining Functional Programming

It's surprisingly hard to find a consistent definition of *functional programming*. As just one example, some people say that functional programming (FP) is about writing *pure functions* — which is a good start — but then they add something else like, “The programming language must be lazy.” Really? Does a programming language really have to be lazy (non-strict) to be FP? (The correct answer is “no.”)

I share links to many definitions at the end of this lesson, but I think you can define FP with just two statements:

1. FP is about writing software applications using only pure functions.
2. When writing FP code you only use immutable values — `val` fields in Scala.

And when I say “only” in those sentences, I mean *only*.

You can combine those two statements into this simple definition:

Functional programming is a way of writing software applications using only pure functions and immutable values.

Of course that definition includes the term “pure functions,” which I haven't defined yet, so let me fix that.



## A working definition of pure function

I provide a complete description of pure functions in the “Pure Functions” lesson, but for now, I just want to provide a simple working definition of the term.

A *pure function* can be defined like this:

- The output of a pure function depends only on (a) its input parameters and (b) its internal algorithm.
  - This is unlike an OOP method, which can depend on other fields in the same class as the method.
- A pure function has no side effects, meaning that it does not read anything from the outside world or write anything to the outside world.
  - It does not read from a file, web service, UI, or database, and does not write anything either.
- As a result of those first two statements, if a pure function is called with an input parameter  $x$  an infinite number of times, it will always return the same result  $y$ .
  - For instance, any time a “string length” function is called with the string “Alvin”, the result will always be 5.

As a few examples, Java and Scala functions like these are pure functions:

- `String` uppercase and lowercase methods
- `List` methods like `max`, `min`
- `Math.sin(a)`, `Math.cos(a)`

In fact, because the Java `String` class and Scala `List` class are both immutable, all of their methods act just like pure functions.

Even complex algorithms like checksums, encodings, and encryption algorithms

follow these principles: given the same inputs an infinite number of times, they always return the same result.

Conversely, functions like these are *not* pure functions:

- `System.currentTimeMillis`
- Random class methods like `next`, `nextInt`
- I/O methods in classes like `File` and `HttpURLConnection` that read and write data

The first two examples yield different results almost every time they are called, and I/O functions are impure because they have *side effects* — they communicate with the outside world to send and receive data.

## Note 1: Higher-Order Functions are a great FP language feature

If you're not familiar with the term Higher-Order Function (HOF), it basically means that (a) you can treat a function as a value (`val`) — just like you can treat a `String` as a value — and (b) you can pass that value into other functions.

In writing good FP code, you pass one function to another so often that I'm tempted to add HOFs as a requirement of my FP definition. But in the end, you can write FP code in languages that don't support HOFs, including Java. Of course that will be painful and probably very verbose, but you can do it.

Therefore, I don't include HOFs in my definition of functional programming. In the end, HOFs are a *terrific* FP language feature, and they make Scala a *much* better FP language than Java, but it's still just a *language feature*, not a part of the core definition of functional programming.

## **Note 2: Recursion is a by-product**

Sometimes you'll see a definition of FP that states, "Recursion is a requirement of functional programming." While it's true that pure FP languages use recursion, the need for recursion is a *by-product* of the definition of FP.

Once you dig into FP, you'll see that if you only use pure functions and immutable values, the *only* way you can do things like "calculate the sum of a list" is to use recursion. Therefore, it's a result of my definition, not a part of the definition.

(I discuss this more in the recursion lessons.)

## Proof: Wikipedia's FP definition

When you google “functional programming definition,” the first link that currently shows up is from Wikipedia, and [their definition of FP](#) backs up my statements. The first line of their definition begins like this:

“In computer science, functional programming is a programming paradigm — a style of building the structure and elements of computer programs — that treats computation as the evaluation of mathematical functions and avoids changing-state and mutable data.”

So, yes, FP is made of (a) pure functions and (b) immutable data. (Their “mathematical functions” are equivalent to my pure functions.)

As proof for another assertion I made earlier, that Wikipedia page also elaborates on features that make an FP language easier to use — such as being able to treat functions as values — where they state, “Programming in a functional style can also be accomplished in languages that are not specifically designed for functional programming.” (Think Java.)

## Proof: A wonderful quote from Mary Rose Cook

When I first started learning FP, I was aware that pure functions were important, but this point was really driven home when I came across an article titled [A Practical Introduction to Functional Programming](#) by [Mary Rose Cook](#).

Ms. Cook used to work at the [Recurse Center](#) (formerly known as “Hacker School”) and now works at [Makers Academy](#), and in her “Practical Introduction to FP” essay, she refers to using only pure functions as a *Guide Rope* to learning FP:

“When people talk about functional programming, they mention a dizzying number of ‘functional’ characteristics. They mention immutable data, first class functions, and tail call optimisation. These are *language features* that aid functional programming.”

“They mention mapping, reducing, pipelining, recursing, currying and the use of higher order functions. These are *programming techniques* used to write functional code.”

“They mention parallelization, lazy evaluation, and determinism. These are advantageous properties of functional programs.”

“Ignore all that. Functional code is characterised by one thing: *the absence of side effects*. It (a pure function) doesn’t rely on data outside the current function, and it doesn’t change data that exists outside the current function. Every other ‘functional’ thing can be derived from this property. Use it as a guide rope as you learn.”

When she writes about the “absence of side effects,” she’s referring to building

applications from pure functions.

Her guide rope statement is so good, it bears repeating:

“Functional code is characterised by one thing: the absence of side effects.”

When I first read this quote, the little light bulb went on over my head and I began focusing even more on writing *only* pure functions.

If you think about it, this statement means exactly what I wrote at the beginning of this lesson:

Functional programming is a way of writing software applications using only pure functions and immutable values.

## That's great ... but why immutable values?

At this point you might be saying, “Okay, I buy the ‘pure functions’ portion of your definition, but what does *immutable values* have to do with this? Why can't my variables be mutable, i.e., why can't I use var?”

### *The best FP code is like algebra*

I dig into this question in the “FP is Like Algebra” lesson, but the short answer here is this:

The best FP code is like algebra, and in algebra you never re-use variables. And not re-using variables has many benefits.

For example, in Scala/FP you write code that looks like this:

```
val a = f(x)
val b = g(a)
val c = h(b)
```

When you write simple expressions like this, both you and the compiler are free to rearrange the code. For instance, because `a` will always be *exactly* the same as `f(x)`, you can replace `a` with `f(x)` at any point in your code.

The opposite of this is also true: `a` can always be replaced with `f(x)`. Therefore, this equation:

```
val b = g(a)
```

is exactly the same as this equation:

```
val b = g(f(x))
```

Continuing along this line of thinking, because `b` is *exactly* equivalent to `g(f(x))`, you can also state `c` differently. This equation:

```
val c = h(b)
```

is exactly the same as this equation:

```
val c = h(g(f(x)))
```



From a programming perspective, knowing that you can *always* replace the immutable values  $a$  and  $b$  with their equivalent functions (and vice-versa) is extremely important. If  $a$  and  $b$  had been defined as `var` fields, I couldn't make the substitutions that I did. That's because with mutable variables you can't be certain that later in your program  $a$  is still  $f(x)$ , and  $b$  is still  $g(a)$ . However, because the fields *are* immutable, you can make these algebraic substitutions.

### ***FP code is easier to reason about***

Furthermore, because  $a$  and  $b$  can never change, the code is easier to reason about. With `var` fields you always have to have a background thread running in your brain, "Is  $a$  reassigned somewhere else? Keep an eye out for it." But with FP code you never have to think, "I wonder if  $a$  was reassigned anywhere?" That thought never comes to mind.  $a$  is the same as  $f(x)$ , and that's all there is to it, end of story. They are completely interchangeable, just like the algebra you knew in high school.

To put this another way, in algebra you never reassign variables, so it's obvious that the third line here is a mistake:

```
a = f(x)
b = g(a)
a = h(y)    # d'oh -- `a` is reassigned!
c = i(a, b)
```

Clearly no mathematician would ever do that, and because FP code is like algebra, no FP developer would ever do that either.

### ***Another good reason to use immutable values***

Another good reason to use only immutable values is that mutable variables (`var` fields) don't work well with parallel/concurrent applications. Because concurrency is becoming more important as computers have more CPUs that have more cores, I discuss this in the "Benefits of Functional Programming" and "Concurrency" lessons.

As programmers gain more experience with FP, their code tends to look more like this expression:

```
val c = h(g(f(x)))
```

While that's cool — and it's also something that your brain becomes more comfortable with over time — it's also a style that makes it harder for new FP developers to understand. Therefore, in this book I write most code in the simple style first:

```
val a = f(x)
val b = g(a)
val c = h(b)
```

and then conclude with the reduced form at the end:

```
val c = h(g(f(x)))
```

As that shows, when functions are pure and variables are immutable, the code is like algebra. This is the sort of thing we did in high school, and it was all very logical. (FP developers refer to this sort of thing as “evaluation” and “substitution.”)

## Summary

In this lesson, I defined functional programming like this:

Functional programming is a way of writing software applications using only pure functions and immutable values.

To support that, I also defined *pure function* like this:

- The output of a pure function depends only on (a) its input parameters and (b) its internal algorithm.
- A pure function has no side effects, meaning that it does not read anything from the outside world or write anything to the outside world.
- As a result of those first two statements, if a pure function is called with an input parameter  $x$  an infinite number of times, it will always return the same result  $y$ .

I noted that higher-order functions (HOFs) are a terrific FP language feature, and also stated that recursion is a by-product of the definition of FP.

I also briefly discussed some of the benefits of immutable values (and FP in general):

- The best FP code is like algebra
- Pure functions and immutable values are easier to reason about
- Without much support (yet), I stated that immutable values make parallel/concurrent programming easier

## See also

- [A Postfunctional Language](#), a scala-lang.org post by Martin Odersky
- The docs.scala-lang.org definition of [functional style](#)
- [The Wikipedia definition of FP](#)
- [The Clojure definition of FP](#)
- [The Haskell definition of FP](#)
- [The “Creative Clojure” website agrees with my definition of functional programming](#)
- [Information about FP in the \*Real World Haskell\* book](#)
- Here’s the [msdn.microsoft.com definition of FP](#)
- [The definition of functional programming on c2.com](#)
- [A practical introduction to functional programming](#)
- [An intro to FP on the “Learn You a Haskell for Great Good” website](#)
- [Stack Exchange thread](#)
- [Why do immutable objects enable functional programming?](#)
- Also, see the “Benefits of Functional Programming” lesson and the concurrency lessons in this book

**What is This Lambda You Speak Of?**

## Goals

Once you get into FP, you'll quickly start hearing the terms "lambda" and "lambda calculus." The goal of this chapter is to provide background information on where those names come from, and what they mean.

## The short story

For those who don't like history, this is the shortest possible "history of functional programming" I can provide that explains where the terms lambda and lambda calculus come from.

### *Lambda*

Back in the 1930s, [Alonzo Church](#) was studying mathematics at Princeton University and began using the Greek symbol  $\lambda$  — "lambda" — to describe ideas he had about these things called *functions*. Because his work preceded the [development of the first electronic, general-purpose computer](#) by at least seven years, you can imagine him writing that symbol on chalkboards to describe his concept of functions.

So, historically speaking, that's the short story of where the term "lambda" comes from: it's just a symbol that Mr. Church chose when he first defined the concept of a function.

Fast-forward to today, and these days the name lambda is generally used to refer to anonymous functions. That's all it means, and it bears highlighting:

In modern functional programming, lambda means "anonymous function."

If you're familiar with other programming languages, you may know that [Python](#) and [Ruby](#) use the keyword `lambda` to define anonymous functions.

### *The term lambda calculus*

As an aerospace engineer, I always thought the name "calculus" referred to the form of mathematics that has to do with infinitesimal changes and derivatives, but the name calculus also has a broader meaning. The word calculus can mean "a formal system," and indeed, that's [how Wikipedia defines lambda calculus](#):

"Lambda calculus (also written as  $\lambda$ -calculus) is a formal

system in mathematical logic for expressing computation based on function abstraction and application using variable binding and substitution.”

So we have:

- lambda means “anonymous function,” and
- calculus means “a formal system”

Therefore, the term *lambda calculus* refers to “a formal way to think about functions.”

That same Wikipedia link states this:

“Lambda calculus provides a theoretical framework for describing functions and their evaluation. Although it is a mathematical abstraction rather than a programming language, it forms the basis of almost all functional programming languages today.”

When I first started learning about functional programming, I found these terms to be a little intimidating, but as with most FP terms, they’re just uncommon words for talking about “functions and their evaluation.”

If you’re interested in the deeper history of FP, including a guy named Haskell Curry, the relationship between FORTRAN and FP, and languages like Lisp, Haskell, Scala, and Martin Odersky’s work that led to the creation of Scala, continue reading the next section. Otherwise feel free to move on to the next chapter.



## The Longer Story (History)

For many more details about the history of functional programming, including the invention of the lambda calculus, more details about the  $\lambda$  symbol, several key people in the FP history, and languages like Lisp, Haskell, and Scala, see [the online version of this chapter](#).

(I try to make it an interesting read, and it begins like this: Back in the 1930s — 80+ years ago — gasoline cost 17 cents a gallon, World War II hadn't started yet (not until 1939, officially), the United States was in the midst of the Great Depression (1929-1939), and a man by the name of Alonzo Church was studying mathematics at Princeton University along with other legendary figures like Alan Turing, ([who finished his PhD under Church](#)) and John von Neumann.)

# The Benefits of Functional Programming

As I write about the benefits of functional programming in this chapter, I need to separate my answers into two parts. First, there are the benefits of *functional programming in general*. Second, there are more specific benefits that come from using *functional programming in Scala*. I'll look at both of these in these chapter.

## Benefits of functional programming in general

Experienced functional programmers make the following claims about functional programming, regardless of the language they use:

1. Pure functions are easier to reason about
2. Testing is easier, and pure functions lend themselves well to techniques like property-based testing
3. Debugging is easier
4. Programs are more bulletproof
5. Programs are written at a higher level, and are therefore easier to comprehend
6. Function signatures are more meaningful
7. Parallel/concurrent programming is easier

I'll discuss these benefits in this chapter, and then offer further proof of them as you go through this book.

## Benefits of functional programming in Scala

On top of those benefits of functional programming in general, Scala/FP offers these additional benefits:

1. Being able to (a) treat functions as values and (b) use anonymous functions

makes code more concise, and still readable

2. Scala syntax generally makes function signatures easy to read
3. The Scala collections' classes have a very functional API
4. Scala runs on the JVM, so you can still use the wealth of JVM-based libraries and tools with your Scala/FP applications

In the rest of this chapter I'll explore each of these benefits.

# 1) Pure functions are easier to reason about

The book, [Real World Haskell](#), states, “Purity makes the job of understanding code easier.” I’ve found this to be true for a variety of reasons.

First, pure functions *are* easier to reason about because you know that they can’t do certain things, such as talk to the outside world, have hidden inputs, or modify hidden state. Because of this, you’re guaranteed that their function signatures tell you (a) exactly what’s going into each function, and (b) coming out of each function.

In his book, [Clean Code](#), Robert Martin writes:

“The ratio of time spent reading (code) versus writing is well over 10 to 1 ... (therefore) making it easy to read makes it easier to write.”

I suspect that this ratio is lower with FP. Because pure functions are easier to reason about:

- I spend less time “reading” them.
- I can keep fewer details in my brain for every function that I read.

This is what functional programmers refer to as “a higher level of abstraction.”

Because I can read pure functions faster and use less brain memory per function, I can keep more overall logic in my brain at one time.

## 2) Testing is easier, and pure functions lend themselves well to techniques like property-based testing

As I show in the [Scala Cookbook](#), it's easier to test pure functions because you don't have to worry about them dealing with hidden state and side effects. What this means is that in imperative code you may have a method like this:

```
def doSomethingHidden(o: Order, p: Pizza): Unit ...
```

You can't tell much about what that method does by looking at its signature, but — because it returns nothing (`Unit`) — presumably it (a) modifies those variables, (b) changes some hidden state, or (c) interacts with the outside world.

When methods modify hidden state, you end up having to write long test code like this:

```
test("test hidden stuff that has side effects") {
  setUpPizzaState(p)
  setUpOrderState(o, p)
  doSomethingHidden(o, p)
  val result = getTheSideEffectFromThatMethod()
  assertEquals(result, expectedResult)
}
```

In FP you *can't* have code like that, so testing is simpler, like this:

```
test("test obvious stuff") {
  val result = doSomethingObvious(x, y, z)
  test(result, expectedResult)
}
```

### ***Proofs***

Beyond making unit testing easier, because functional code is like algebra it also makes it easier to use a form of testing known as *property-based testing*.

I write more about this in the lesson on using [ScalaCheck](#), but the main point is that because the outputs of your functions depend only on their inputs, you can define “properties” of your functions, and then ScalaCheck “attacks” your functions with a large range of inputs.

With a few minor edits, [the property-based testing page on the ScalaTest website](#)

states:

“... a *property* is a high-level specification of behavior that should hold for a range of data points. For example, a property might state, ‘The size of a list returned from a method should always be greater than or equal to the size of the list passed to that method.’ This property should hold no matter what list is passed.”

“The difference between a traditional unit test and a property is that unit tests traditionally verify behavior based on specific data points ... for example, a unit test might pass three or four specific lists to a method that takes a list and check that the results are as expected. A property, by contrast, describes at a high level the preconditions of the method under test and specifies some aspect of the result that should hold no matter what valid list is passed.”

### 3) Debugging is easier

Because pure functions depend only on their input parameters to produce their output, debugging applications written with pure functions is easier. Of course it's possible to still make a mistake when you write a pure function, but once you have a stack trace or debug output, all you have to do is follow the values to see what went wrong. Because the functions are pure, you don't have to worry about what's going on in the rest of the application, you just have to know the inputs that were given to the pure function that failed.

In [Masterminds of Programming](#), Paul Hudak, a co-creator of the Haskell language, states, "I've always felt that the 'execution trace' method of debugging in imperative languages was broken ... in all my years of Haskell programming, I have never in fact used Buddha, or GHC's debugger, or any debugger at all ... I find that testing works just fine; test small pieces of code using [QuickCheck](#) or a similar tool to make things more rigorous, and then — the key step — simply study the code to see why things don't work the way I expect them to. I suspect that a lot of people program similarly, otherwise there would be a lot more research on Haskell debuggers ..."

[ScalaCheck](#) is a property-based testing framework for Scala that was inspired by Haskell's QuickCheck.

## 4) Programs are more bulletproof

People that are smarter than I am can make the mathematical argument that *complete FP applications* are more bulletproof than other applications. Because there are fewer “moving parts” — mutable variables and hidden state — in FP applications, mathematically speaking, the overall application is less complex. This is true for simple applications, and the gap gets larger in parallel and concurrent programming (as you’ll see in a later section in this chapter).

The way I can explain this is to share an example of my own bad code. A few years ago I started writing [a football game for Android devices](#) (American football), and it has a lot of *state* to consider. On every play there is state like this:

- What quarter is it?
- How much time is left in the quarter?
- What is the score?
- What down is it?
- What distance is needed to make a first down?
- Much more ...

Here’s a small sample of the now-embarrassing `public static` fields that I globally mutate in that application:

```
// stats for human
public static int numRunsByHuman          = 0;
public static int numPassAttemptsByHuman  = 0;
public static int numPassCompletionsByHuman = 0;
public static int numInterceptionsThrownByHuman = 0;
public static int numRunningYardsByHuman  = 0;
public static int numPassingYardsByHuman  = 0;
public static int numFumblesByHuman       = 0;
public static int numFirstDownRunsByHuman = 0;
public static int numFirstDownPassesByHuman = 0;
```

When I wrote this code I thought, “I’ve written Java Swing (GUI) code since the 1990s, and Android code for a few years. I’m working by myself on this, I don’t



have to worry about team communication. I know what I'm doing, what could possibly go wrong?"

In short, although a football game is pretty simple compared to a business application, it still has a lot of "state" that you have to maintain. And when you're mutating that global state from several different places, well, it turns out that sometimes the computer gets an extra play, sometimes time doesn't run off the clock, etc.

Skipping all of my imperative state-related bugs ... once I learned how to handle state in FP applications, I gave up trying to fix those bugs, and I'm now rewriting the core of the application in an FP style.

As you'll see in this book, the solution to this problem is to pass the state around as a value, such as a case class or a Map. In this case I might call it `GameState`, and it would have fields like `quarter`, `timeRemaining`, `down`, etc.

A second argument about FP applications being more bulletproof is that because they are built from all of these little pure functions that are known to work extraordinarily well, the overall application itself must be safer. For instance, if 80% of the application is written with well-tested pure functions, you can be very confident in that code; you know that it will never have the mutable state bugs like the ones in my football game. (And if somehow it does, the problem is easier to find and fix.)

As an analogy, one time I had a house built, and I remember that the builder was very careful about the 2x4's that were used to build the framework of the house. He'd line them up and then say, "You do *not* want that 2x4 in your house," and he would pick up a bent or cracked 2x4 and throw it off to the side. In the same way that he was trying to build the framework of the house with wood that was clearly the best, we use pure functions to build the best possible core of our applications.

Yes, I know that programmers don't like it when I compare building a house to writing an application. But some analogies do fit.

## 5) Programs are written at a higher level, and are therefore easier to comprehend

In the same way that pure functions are easier to reason about, overall FP applications are also easier to reason about. For example, I find that my FP code is more concise than my imperative and OOP code, and it's also still very readable. In fact, I think it's more readable than my older code.

Some of the features that make FP code more concise and still readable are:

- The ability to treat functions as values
- The ability to pass those values into other functions
- Being able to write small snippets of code as anonymous functions
- Not having to create deep hierarchies of classes (that sometimes feel “artificial”)
- Most FP languages are “low ceremony” languages, meaning that they require less boilerplate code than other languages

If you want to see what I mean by FP languages being “low ceremony,” here's [a good example of OCaml](#), and this page shows [examples of Haskell's syntax](#).

In my experience, when I write Scala/FP code that I'm comfortable with today, I have always been able to read it at a later time. And as I mentioned when writing about the benefits of pure functions, “concise and readable” means that I can keep more code in my head at one time.

I emphasize that Scala/FP code is *concise and readable* because sometimes “more concise” code can create a maintenance problem. I remember that a friend who didn't like Perl once described [Perl](#) code as, “Write once, read forever.” Because the syntax could get so complex, he couldn't modify his own code a few weeks after writing it because he couldn't remember how each little syntactical nuance worked. I have the same problem writing complex regular

expressions. If I don't document them when I create them, I can never tell how they work when I look at them later.

(Personally I like the non-OO parts of Perl, and have written [over 150 Perl tutorials](#).)

## 6) Pure function signatures are meaningful

When learning FP, another big “lightbulb going on over my head” moment came when I saw that my function signatures were suddenly much more meaningful than my imperative and OOP method signatures.

Because non-FP methods can have side effects — which are essentially *hidden* inputs and outputs of those methods — their function signatures often don’t mean that much. For example, what do you think this imperative method does:

```
def doSomething(): Unit { code here ...
```

The correct answer is, “*Who knows?*” Because it takes no input parameters and returns nothing, there’s no way to guess from the signature what this method does.

In contrast, because pure functions depend only on their input parameters to produce their output, their function signatures are extremely meaningful — a contract, even.

I write more about this in the upcoming lesson, “Pure Functions Tell All.”

## 7) Parallel programming

While writing parallel and concurrent applications is considered a “killer app” that helped spur renewed interest in FP, I have written my parallel/concurrent apps (like [Sarah](#)) primarily using Akka Actors and Scala Futures, so I can only speak about them: they’re awesome tools. I wrote about them in the [Scala Cookbook](#) and on my website ([alvinalexander.com](http://alvinalexander.com)), so please search those resources for “actors” and “futures” to find examples.

Therefore, to support the claims that FP is a great tool for writing parallel/concurrent applications, I’m going to include quotes here from other resources. As you’ll see, the recurring theme in these quotes is, “Because FP only has immutable values, you can’t possibly have the race conditions that are so difficult to deal with in imperative code.”

The first quote comes from an article titled, [“Functional Programming for the Rest of Us,”](#):

“A functional program is ready for concurrency without any further modifications. You never have to worry about deadlocks and race conditions because you don’t need to use locks. No piece of data in a functional program is modified twice by the same thread, let alone by two different threads. That means you can easily add threads without ever giving conventional problems that plague concurrency applications a second thought.”

The author goes on to add the information shown in Figure [fig:benefitsFpConcurrencyStory].

The concurrency story doesn't stop here. If your application is inherently single threaded the compiler can still optimize functional programs to run on multiple CPUs. Take a look at the following code fragment:

```
String s1 = somewhatLongOperation1();
String s2 = somewhatLongOperation2();
String s3 = concatenate(s1, s2);
```

In a functional language the compiler could analyze the code, classify the functions that create strings *s1* and *s2* as potentially time consuming operations, and run them concurrently. This is impossible to do in an imperative language because each function may modify state outside of its scope and the function following it may depend on it. In functional languages automatic analysis of functions and finding

A compiler can optimize functional programs to run on multiple cores

[The Clojure.org website](#) adds the statements in Figure [fig:concurrencyBenniesClojure] about how Clojure and FP help with concurrency.

## Concurrency and the multi-core future

- Immutability makes much of the problem go away
  - Share freely between threads
- But changing state a reality for simulations and for in-program proxies to the outside world
- Locking is too hard to get right over and over again
- Clojure's software transactional memory and agent systems do the hard part

Concurrency benefits from the Clojure website

Page 17 of the book, [Haskell, the Craft of Functional Programming](#), states, “Haskell programs are easy to parallelize, and to run efficiently on multicore hardware, because there is no state to be shared between different threads.”

In [this article on the ibm.com website](#), Neal Ford states, “Immutable objects are also automatically thread-safe and have no synchronization issues. They can never exist in unknown or undesirable state because of an exception.”

In the pragprom.com article, [Functional Programming Basics](#), Robert C. Martin extrapolates from four cores to a future with 131,072 processors when he writes:

“Honestly, we programmers can barely get two Java threads to cooperate ... Clearly, if the value of a memory location, once initialized, does not change during the course of a program execution, then there’s nothing for the 131072 processors to compete over. You don’t need semaphores if you don’t have side effects! You can’t have concurrent update problems if you don’t update! ... So that’s the big deal about functional languages; and it is one big fricking deal. There is a freight train barreling down the tracks towards us, with multi-core emblazoned on it; and you’d better be ready by the time it gets here.”

With a slight bit of editing, an article titled, [The Downfall of Imperative Programming](#) states:

“Did you notice that in the definition of a *data race* there’s always talk of mutation? Any number of threads may *read* a memory location without synchronization, but if even one of them *mutates* it, you have a race. And that is the downfall of imperative programming: Imperative programs will always be vulnerable to data races because they contain mutable variables.”

[id Software](#) co-founder and technical director John Carmack states:

“Programming in a functional style makes the state presented to your code explicit, which makes it much easier to reason about, and, in a completely pure system, makes thread race conditions impossible.”

Writing [Erlang](#) code is similar to using the [Akka](#) actors library in Scala. The Erlang equivalent to an Akka actor is a “process,” and in his book, [Programming Erlang](#), Joe Armstrong writes:

“Processes share no data with other processes. This is the reason why we can easily distribute Erlang programs over multicores or networks.”

For a final quote, “The Trouble with Shared State” section on [this medium.com article](#) states, “In fact, if you’re using shared state and that state is reliant on sequences which vary depending on indeterministic factors, for all intents and purposes, the output is impossible to predict, and that means it’s impossible to properly test or fully understand. As Martin Odersky puts it:”

non-determinism = parallel processing + mutable state

The author follows that up with an understatement: “Program determinism is usually a desirable property in computing.”

## ***Deterministic algorithms and concurrency***

### *Deterministic algorithms*

If you’re not familiar with the term *deterministic algorithm*, [Wikipedia defines it](#) like this: “In computer science, a deterministic algorithm is an algorithm which, given a particular input, will always produce the same output, with the underlying machine always passing through the same sequence of states.”

(As you’ll soon see, this is basically the definition of a pure function.)

Conversely, a *nondeterministic algorithm* is like asking a user to ask the person next to them what their favorite color is: you’re never guaranteed to get the same answer. If you’re trying to do something like sort a list of numbers, you *really* want a deterministic solution.

### *Parallel, Concurrent*

[Yossi Kreinin created the image](#) shown in Figure [fig:diffsConcurrentParallel] to



help explain the differences between the meanings of “concurrent” and “parallel”.

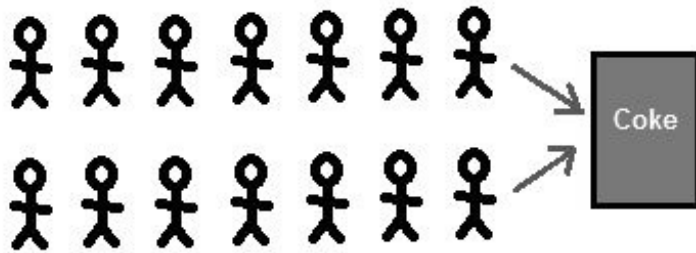

Concurrent: 2 queues, 1 vending machine

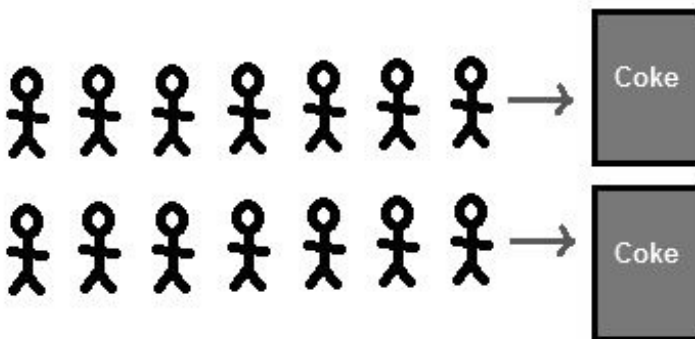

Parallel: 2 queues, 2 vending machines

The difference between concurrent and parallel

His image is based on a diagram in this article by [Erlang programmer Joe Armstrong](#). Mr. Armstrong offers this summary in his post:

- Concurrent = Two queues and one coffee machine
- Parallel = Two queues and two coffee machines

I tend to use the two terms interchangeably, but I will be more precise with my language in the “Concurrency” lessons in this book.

## **8) Scala/FP benefit: The ability to treat functions as values**

I've already written a little about higher-order functions (HOFs), and I write more about them later in this book, so I won't belabor this point: the fact that Scala lets you (a) treat functions as values, (b) pass functions as parameters into other functions, and (c) write concise anonymous functions, are all features that make Scala a better functional programming language than another language (such as Java) that does not have these features.

## 9) Scala/FP benefit: Syntax makes function signatures easy to read

In my opinion, the Scala method syntax is about as simple as you can make method signatures, especially signatures that support generic types. This simplicity usually makes method signatures easy to read.

For instance, it's easy to tell that this method takes a `String` and returns an `Int`:

```
def foo(s: String): Int = ???
```

These days I prefer to use *explicit* return types on my methods, such as the `Int` in this example. I've found that showing the explicit type makes them easier to read later, when I'm in maintenance mode.

If you prefer methods with *implicit return types* you can write that same method like this, which is also clear and concise:

```
def foo(s: String) = ???
```

Even when you need to use generic type parameters — which make any method harder to read — Scala method signatures are still fairly easy to read:

```
def foo[A, B](a: A): B = ???
```

It's hard to make generic types much easier than that.

## **10) Scala/FP benefit: The collections classes have a functional API**

When I first came to Scala from Java, the Scala collections API was a real surprise, and not in a pleasant way. *But*, once I had that “Aha!” moment and realized how they work, I saw what a great benefit they are. Having all of those standard functional methods eliminates almost every need for custom for loops.

The important benefit of this is that these standard methods make my code more consistent and concise. These days I write almost 100% fewer custom for loops, and that’s good for me — and anyone who has to read my code.

## 11) Scala/FP benefit: Code runs on the JVM

Because the Scala compiler generates Java bytecode that runs on the JVM, and because Scala supports both the FP and OOP models, you can still use all of those thousands of Java/JVM libraries that have been created in the last twenty years in your Scala/FP applications. Even if those libraries aren't "Pure FP," at least you can still use them without having to "reinvent the wheel" and write a new library from scratch.

In fact, not only can you use the wealth of existing JVM libraries, you can also use all of your favorite JVM tools in general:

- Build tools like Ant, Maven, Gradle, and SBT
- Test tools like JUnit, TestNG, and mock frameworks
- Continuous integration tools
- Debugging and logging frameworks
- Profiling tools
- More ...

These libraries and tools are a great strength of the JVM. If you ask experienced FP developers why they're using Scala rather than Haskell or another FP language, "libraries, tools, and JVM" is the usual answer.

## One more thing ...

On a personal note, a big early influence for me — before I knew about any of these benefits — was seeing people like Martin Odersky, Jonas Bonér, Bill Venners, and other leading Scala programmers use and promote an FP style. Because Scala supports both OOP and FP, it's not like they had to sell anyone on FP in order to get us to use Scala. (As a former business owner, I feel like I'm always on the lookout for people who are trying to “sell” me something.)

I don't know if they use FP 100% of the time, but what influenced me is that they started using FP and then they never said, “You know what? FP isn't that good after all. I'm going back to an imperative style.”

In the 2016 version of [Programming in Scala](#), Martin Odersky's biography states, “He works on programming languages and systems, more specifically on the topic of how to combine object-oriented and functional programming.” Clearly FP is important to him (as is finding the best ways to merge FP and OOP concepts).

## Summary

In summary, the benefits of “functional programming in general” are:

1. Pure functions are easier to reason about
2. Testing is easier, and pure functions lend themselves well to techniques like property-based testing
3. Debugging is easier
4. Programs are more bulletproof
5. Programs are written at a higher level, and are therefore easier to comprehend
6. Function signatures are more meaningful
7. Parallel/concurrent programming is easier

On top of those benefits, “functional programming in Scala” offers these additional benefits:

1. Being able to (a) treat functions as values and (b) use anonymous functions makes code more concise, and still readable
2. Scala syntax generally makes function signatures easy to read
3. The Scala collections’ classes have a very functional API
4. Scala runs on the JVM, so you can still use the wealth of JVM-based libraries and tools with your Scala/FP applications

## **What's next**

In this chapter I tried to share an honest assessment of the benefits of functional programming. In the next chapter I'll try to provide an honest assessment of the potential drawbacks and disadvantages of functional programming.



## See Also

Quotes in this chapter came from the following sources:

- [Real World Haskell](#)
- [Clean Code](#)
- [Masterminds of Programming](#)
- [Scala Cookbook](#)
- [The ScalaCheck website](#)
- [Property-based-testing on the ScalaTest website](#)
- [Functional Programming for the Rest of Us](#)
- [Yossi Kreinin's parallel vs concurrent image](#)
- [Joe Armstrong's parallel vs concurrent article](#)
- [The Clojure.org "rationale" page](#)
- [Haskell, the Craft of Functional Programming](#)
- [The Downfall of Imperative Programming](#) on fpcomplete.com
- [The Akka website](#)
- [Programming Erlang](#)
- "The Trouble with Shared State" section of [this medium.com article](#)
- [Deterministic algorithms on Wikipedia](#)
- I found John Carmack's quote in [this reprinted article on gamasutra.com](#)

You can also search my [alvinalexander.com](#) website for [examples of Akka and](#)

[Scala Futures.](#)

# Disadvantages of Functional Programming

In the last chapter I looked at the benefits of functional programming, and as I showed, there are quite a few. In this chapter I'll look at the potential drawbacks of FP.

Just as I did in the previous chapter, I'll first cover the “drawbacks of functional programming *in general*”:

1. Writing pure functions is easy, but combining them into a complete application is where things get hard
2. The advanced math terminology (monad, monoid, functor, etc.) makes FP intimidating
3. For many people, recursion doesn't feel natural
4. Because you can't mutate existing data, you instead use a pattern that I call, “Update as you copy”
5. Pure functions and I/O don't really mix
6. Using only immutable values and recursion can potentially lead to performance problems, including RAM use and speed

After that I'll look at the more-specific “drawbacks of functional programming in Scala”:

1. You can mix FP and OOP styles
2. Scala doesn't have a standard FP library

# 1) Writing pure functions is easy, but combining them into a complete application is where things get hard

Writing a pure function is generally fairly easy. Once you can define your type signature, pure functions are easier to write because of the absence of mutable variables, hidden inputs, hidden state, and I/O. For example, the `determinePossiblePlays` function in this code:

```
val possiblePlays = OffensiveCoordinator.determinePossiblePlays(gameState)
```

is a pure function, and behind it are thousands of lines of other functional code. Writing all of these pure functions took time, but it was never difficult. All of the functions follow the same pattern:

1. Data comes into the function
2. Apply an algorithm (to *transform* the data)
3. Transformed data comes out of the function

That being said, the part that *is* hard is, “How do I glue all of these pure functions together in an FP style?” That question can lead to the code I showed in the first chapter:

```
def updateHealth(delta: Int): Game[Int] = StateT[IO, GameState, Int]
  { (s: GameState) =>

    val newHealth = s.player.health + delta
      IO((s.copy(player = s.player.copy(health = newHealth)), newHealth))

  }
```

As you may be aware, when you first start programming in a pure FP style, gluing pure functions together to create a complete FP application is one of the biggest stumbling blocks you’ll encounter.

## **2) Advanced math terminology makes FP intimidating**

I don't know about you, but when I first heard terms like combinator, monoid, monad, and functor, I had no idea what people were talking about. And I've been paid to write software since the 1990s.

As I discuss in the next chapter, terms like this are intimidating, and that “fear factor” becomes a barrier to learning FP.

Because I cover this topic in the next chapter, I won't write any more about it here.

### 3) For many people, recursion doesn't feel natural

One reason I may not have known about those mathematical terms is because my degree is in aerospace engineering, not computer science. Possibly for the same reason, I *knew* about recursion, but never had to use it. That is, until I became serious about writing pure FP code.

As I wrote in the “What is FP?” chapter, the thing that happens when you use only pure functions and immutable values is that you *have* to use recursion. In pure FP code you no longer use var fields with for loops, so the only way to loop over elements in a collection is to use recursion.

Fortunately, you can learn how to write recursive code. If there's a secret to the process, it's in learning how to “think in recursion.” Once you gain that mindset and see that there are patterns to recursive algorithms, you'll find that recursion gets much easier, even natural.

Two paragraphs ago I wrote, “the only way to loop over elements in a collection is to use recursion,” but that isn't 100% true. In addition to gaining a “recursive thinking” mindset, here's another Scala/FP secret: once you understand the Scala collections' methods, you won't need to use recursion as often as you think. In the same way that collections' methods are replacements for custom for loops, they're also replacements for many custom recursive algorithms. Once you're comfortable with the collections' methods, you'll find that you reach for them before you reach for recursion.

## 4) Because you can't mutate existing data, you instead use a pattern that I call, "Update as you copy"

For over 20 years I've written imperative code where it was easy — and extraordinarily common — to mutate existing data. For instance, once upon a time I had a niece named "Emily Maness":

```
val emily = Person("Emily", "Maness")
```

Then one day she got married and her last name became "Wells", so it seemed logical to update her last name, like this:

```
emily.setLastName("Wells")
```

*In FP you don't do this.* You don't mutate existing objects.

Instead, what you do is (a) you copy an existing object to a new object, and then as a copy of the data is flowing from the old object to the new object, you (b) update any fields you want to change by providing new values for those fields, such as the `lastName` field in Figure [fig:updateAsYouCopyEmily].

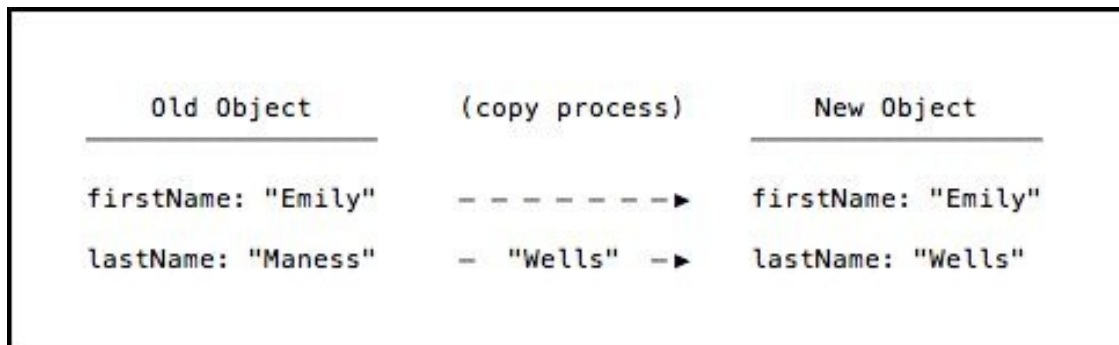

Results of the "update as you copy" concept

The way you "update as you copy" in Scala/FP is with the copy method that comes with *case classes*. First, you start with a case class:

```
case class Person (firstName: String, lastName: String)
```

Then, when your niece is born, you write code like this:

```
val emily1 = Person("Emily", "Maness")
```

Later, when she gets married and changes her last name, you write this:

```
val emily2 = emily1.copy(lastName = "Wells")
```

After that line of code, `emily2.lastName` has the value `Wells`.

Note: I intentionally use the variable names `emily1` and `emily2` in this example to make it clear that you never change the original variable. In FP you constantly create intermediate variables like `name1` and `name2` during the “update as you copy” process, but there are FP techniques that make those intermediate variables transparent. I show those techniques in lessons later in this book.

### ***“Update as you copy” gets worse with nested objects***

The “Update as you copy” technique isn’t too hard when you’re working with this simple `Person` object, but think about this: What happens when you have nested objects, such as a `Family` that has a `Person` who has a `Seq[CreditCard]`, and that person wants to add a new credit card, or update an existing one? (This is like an Amazon Prime member who adds a family member to their account, and that person has one or more credit cards.) Or what if the nesting of objects is even deeper?

In short, this is a real problem that results in some nasty-looking code, and it gets uglier with each nested layer. Fortunately, other FP developers ran into this problem long before I did, and they came up with ways to make this process easier. I cover this problem and its solution in the “Lens” lesson later in this book.



## 5) Pure functions and I/O don't really mix

As I wrote in the “What is Functional Programming” lesson, a *pure function* is a function (a) whose output depends only on its input, and (b) has no side effects. Therefore, by definition, any function that deals with these things is *impure*:

- File I/O
- Database I/O
- Internet I/O
- Any sort of UI/GUI input
- Any function that mutates variables
- Any function that uses “hidden” variables

Given this situation, a great question is, “How can an FP application possibly work without these things?”

The short answer is what I wrote in the Scala Cookbook: you write as much of your application's code in an FP style as you can, and then you write a thin I/O layer around the outside of the FP code, like putting “I/O icing” around an “FP cake,” as shown in Figure [fig:disadvantagesPureFpCore].

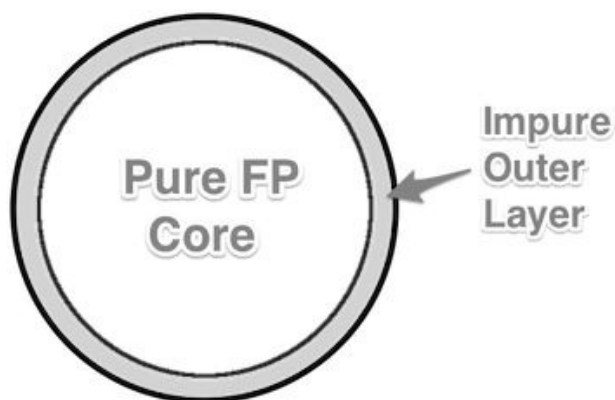

A thin, impure I/O layer around a pure core

## *Pure and impure functions*

In reality, no programming language is really “pure,” at least not by my definition. (Several FP experts say the same thing.) [Wikipedia lists Haskell as a “pure” FP language](#), and the way Haskell handles I/O equates to this Scala code:

```
def getCurrentTime(): IO[String] = ???
```

The short explanation of this code is that Haskell has an `IO` type that you *must* use as a wrapper when writing I/O functions. This is enforced by the Haskell compiler.

For example, `getLine` is a Haskell function that reads a line from STDIN, and returns a type that equates to `IO[String]` in Scala. Any time a Haskell function returns something wrapped in an `IO`, like `IO[String]`, that function can only be used in certain places within a Haskell application.

If that sounds hard core and limiting, it is. But it turns out to be a good thing.

Some people imply that this `IO` wrapper makes those functions pure, but in my opinion, this isn't true. At first I thought I was confused about this — that I didn't understand something — and then I read [this quote from Martin Odersky on scala-lang.org](#):

“The IO monad does not make a function pure. It just makes it obvious that it's impure.”

For the moment you can think of an `IO` instance as being like a Scala `Option`. More accurately, you can think of it as being an `Option` that always returns a `Some[YourDataTypeHere]`, such as a `Some[Person]` or a `Some[String]`.

As you can imagine, just because you wrap a `String` that you get from the outside world inside of a `Some`, that doesn't mean the `String` won't vary. For instance, if you prompt me for my name, I might reply “Al” or “Alvin,” and if you prompt my niece for her name, she'll reply “Emily,” and so on. I think you'll agree that `Some[Al]`, `Some[Alvin]`, and `Some[Emily]` are different values.

Therefore, even though (a) the return type of Haskell I/O functions must be

wrapped in the IO type, and (b) the Haskell compiler only permits IO types to be in certain places, they are *impure* functions: they can return a different value each time they are called.

## 6) Using only immutable values and recursion can lead to performance problems, including RAM use and speed

An author can get himself into trouble for stating that one programming paradigm can use more memory or be slower than other approaches, so let me begin this section by being very clear:

*When you first write a simple (“naive”) FP algorithm, it is possible — just possible — that the immutable values and data-copying I mentioned earlier can create a performance problem.*

I demonstrate an example of this problem in a blog post on [Scala Quicksort algorithms](#). In that article I show that the basic (“naive”) recursive quickSort algorithm found in the “Scala By Example” PDF uses about 660 MB of RAM while sorting an array of ten million integers, and is four times slower than using the `scala.util.Sorting.quickSort` method.

Having said that, it’s important to note how `scala.util.Sorting.quickSort` works. In Scala 2.12, it passes an `Array[Int]` directly to `java.util.Arrays.sort(int[])`. The way that sort method works varies by Java version, but Java 8 calls a sort method in `java.util.DualPivotQuicksort`. The code in that method (and one other method it calls) is at least 300 lines long, and is *much* more complex than the simple/naive quickSort algorithm I show.

Therefore, while it’s true that the “simple, naive” quickSort algorithm in the “Scala By Example” PDF has those performance problems, I need to be clear that I’m comparing (a) a very simple algorithm that you might initially write, to (b) a much larger, performance-optimized algorithm.

## 7) Scala/FP drawback: You can mix FP and OOP styles

If you're an FP purist, a drawback to using *functional programming in Scala* is that Scala supports both OOP and FP, and therefore it's possible to mix the two coding styles in the same code base.

While that is a *potential* drawback, many years ago when I worked with a technology known as [Function Point Analysis](#) — totally unrelated to functional programming — I learned of a philosophy called “House Rules” that eliminates this problem. With House Rules, the developers get together and agree on a programming style. Once a consensus is reached, that's the style that you use. Period.

As a simple example of this, when I owned a computer programming consulting company, the first developers I hired wanted a Java coding style that looks like this:

```
public void doSomething()
{
    doX();
    doY();
}
```

As shown, they wanted curly braces on their own lines, and the code was indented four spaces. I doubt that everyone on the team loved that style, but once we agreed on it, that was it.

I think you can use the House Rules philosophy to state what parts of the Scala language your organization will use in your applications. For instance, if you want to use a strict “Pure FP” style, use the rules I set forth in this book. You can always change the rules later, but it's important to start with something.

There are two ways to look at the fact that Scala supports both OOP and FP. As mentioned, in the first view, FP purists see this as a drawback.

But in a second view, people interested in using both paradigms within one language see this as a benefit. For example, Joe Armstrong has written that Erlang processes — which are the equivalent of Akka actors — can be written in an imperative style. Messages between processes are immutable, but the code

within each process is single-threaded and can therefore be imperative. If a language only supports FP, the code in each process (actor) would have to be pure functional code, when that isn't strictly necessary.

In the 2016 version of [Programming in Scala](#), Martin Odersky's biography states, "He works on programming languages and systems, more specifically on the topic of how to combine object-oriented and functional programming." Trying to merge the two styles appears to be an important goal for Mr. Odersky.

Personally, I like Scala's support of both the OOP and FP paradigms because it lets me use whatever style best fits the problem at hand. (In a terrific addition to this, adding Akka to the equation lets me use Scala the way other programmers use Erlang.)

## 8) Scala/FP drawback: Scala doesn't have a standard FP library

Another potential drawback to *functional programming in Scala* is that there isn't a built-in library to support certain FP techniques. For instance, if you want to use an IO data type as a wrapper around your impure Scala/FP functions, there isn't one built into the standard Scala libraries.

To deal with this problem, independent libraries like [Scalaz](#), [Cats](#), and others have been created. But, while these solutions are built into a language like Haskell, they're third-party libraries in Scala.

## “Should I use FP *everywhere*?”

After I listed all of the benefits of functional programming in the previous chapter, I asked the question, “Should I write *all* of my code in an FP style?” At that time you might have thought, “Of course! This FP stuff sounds great!”

Now that you’ve seen some of the drawbacks of FP, I think I can provide a better answer.

### ***1a) GUIs and Pure FP are not a good fit***

The first part of my answer is that I like to write Android apps, and I also enjoy writing Java Swing and JavaFX code, and the interface between (a) those frameworks and (b) your custom code isn’t a great fit for FP.

As one example of what I mean, in [an Android football game](#) I work on in my spare time, the OOP game framework I use provides an update method that I’m supposed to override to update the screen:

```
@Override
public void update(GameView gameView) {
    // my custom code here ...
}
```

Inside that method I have a lot of imperative GUI-drawing code that currently creates the UI shown in Figure [fig:disadvantagesXoplayAndroid].





The UI for my “XO Play” application

There isn't a place for FP code at this point. The framework expects me to update the pixels on the screen within this method, and if you've ever written anything like a video game, you know that to achieve the best performance — and avoid screen flickering — it's generally best to update only the pixels that need to be changed. So this really is an “update” method, as opposed to a

“completely redraw the screen” method.

Other “thick client,” GUI frameworks like Swing and JavaFX have similar interfaces, where they are OOP and imperative by design.

Figure [fig:disadvantagesSwingTabbedPane] shows an example of a little text editor I wrote and named “[AlPad](#),” and its major feature is that it lets me easily add and remove tabs to keep little notes organized.

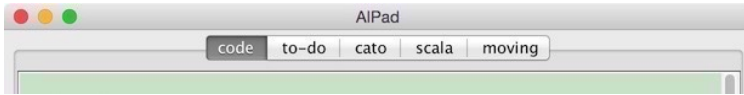

A few tabs in my “AlPad” application

The way you write Swing code like this is that you first create a `JTabbedPane`:

```
JTabbedPane tabbedPane = new JTabbedPane();
```

Once created, you keep that tabbed pane alive for the entire life of the application. Then when you later want to add a new tab, you *mutate* the `JTabbedPane` instance like this:

```
tabbedPane.addTab(  
    "to-do",  
    null,  
    newPanel,  
    "to-do");
```

That’s the way GUI code usually works: you create components and then mutate them during the life of the application to create the desired user interface. The same is true for other Swing components, like `JFrame`, `JList`, `JTable`, etc.

Because these frameworks are OOP and imperative by nature, this interface point is where FP typically doesn’t fit.

When you’re working with these frameworks you have to conform to their styles at this interface point, but there’s nothing to keep you from writing the rest of your code in an FP style. In my Android football game I have a function call that looks like this:

```
val possiblePlays = OffensiveCoordinator.determinePossiblePlays(gameState)
```

In that code, `determinePossiblePlays` is a pure function, and behind it are several thousand lines of other pure functions. So while the GUI code has to

conform to the Android game framework I'm using, the decision-making portion of my app — the “business logic” — is written in an FP style.

## ***1b) Caveats to what I just wrote***

Having stated that, let me add a few caveats.

First, *Web* applications are completely different than *thick client* (Swing, JavaFX) applications. In a thick client project, the entire application is typically written in one large codebase that results in a binary executable that users install on their computers. Eclipse, IntelliJ IDEA, and NetBeans are examples of this.

Conversely, the web applications I've written in the last few years use (a) one of many JavaScript-based technologies for the UI, and (b) [the Play Framework](#) on the server side. With Web applications like this, you have impure data coming into your Scala/Play application through data mappings and REST functions, and you probably also interact with impure database calls and impure network/internet I/O, but just like my football game, the “logic” portion of your application can be written with pure functions.

Second, the concept of [Functional-Reactive Programming](#) (FRP) combines FP techniques with GUI programming. The [RxJava](#) project includes this description:

“RxJava is a Java VM implementation of [Reactive Extensions](#): a library for composing asynchronous and event-based programs by using observable sequences ... It extends the Observer Pattern to support sequences of data/events and adds operators that allow you to compose sequences together *declaratively* while abstracting away concerns about things like low-level threading, synchronization, thread-safety and concurrent data structures.”

(Note that [declarative programming](#) is the opposite of [imperative programming](#).)

The [ReactiveX.io website](#) states:

“ReactiveX is a combination of the best ideas from the Observer pattern, the Iterator pattern, and functional programming.”

This short RxScala example [from the RxScala website](#) gives you a taste of the concept:

```
object Transforming extends App {  
  /**  
   * Asynchronously calls 'customObservableNonBlocking'  
   * and defines a chain of operators to apply to the  
   * callback sequence.  
   */  
  def simpleComposition()  
  {  
    AsyncObservable.customObservableNonBlocking()  
      .drop(10)  
      .take(5)  
      .map(stringValue => stringValue + "_xform")  
      .subscribe(s => println("onNext => " + s))  
  }  
  
  simpleComposition()  
}
```

This code does the following:

1. Using an “observable,” it receives a stream of String values. Given that stream of values, it ...
2. Drops the first ten values
3. “Takes” the next five values
4. Appends the string `_xform` to the end of each of those five values
5. Outputs those resulting values with `println`

As this example shows, the code that receives the stream of values is written in a functional style, using methods like `drop`, `take`, and `map`, combining them into a chain of calls, one after the other.

If you'd like to learn more about this topic, the RxScala project [is located here](#), and Netflix's "[Reactive Programming in the Netflix API with RxJava](#)" [blog post](#) is a good start.

## 2) Pragmatism (*the best tool for the job*)

I tend to be a pragmatist more than a purist, so when I need to get something done, I want to use the best tool for the job.

For instance, when I first started working with Scala and needed a way to stub out new SBT projects, I wrote a Unix shell script. Because this was for my personal use and I only work on Mac and Unix systems, creating a shell script was *by far* the simplest way to create a standard set of subdirectories and a *build.sbt* file.

Conversely, if I also programmed on Microsoft Windows or Linux systems, or if I had been interested in creating a more robust solution like the [Lightbend Activator](#), I might have written a Scala/FP application, but I didn't have those motivating factors. For my needs, writing that shell script was the most pragmatic solution to the problem.

Another way to think about this is instead of asking, "Is FP the right tool for every application I need to write?," go ahead and ask that question with a different technology. For instance, you can ask, "Should I use *Akka actors* to write every application?" If you're familiar with Akka, I think you'll agree that writing an Akka application to create a few subdirectories and a *build.sbt* file would be overkill — even though Akka is a terrific tool for other applications.

## Summary

In summary, potential drawbacks of *functional programming in general* are:

1. Writing pure functions is easy, but combining them into a complete application is where things get hard.
2. The advanced math terminology (monad, monoid, functor, etc.) makes FP intimidating.
3. For many people, recursion doesn't feel natural.
4. Because you can't mutate existing data, you instead use a pattern that I call, "Update as you copy."
5. Pure functions and I/O don't really mix.
6. Using only immutable values and recursion can potentially lead to performance problems, including RAM use and speed.

Potential drawbacks of *"functional programming in Scala"* are:

1. You can mix FP and OOP styles.
2. Scala doesn't have a standard FP library.

## **What's next**

Having covered the benefits and drawbacks of functional programming, in the next chapter I want to help “free your mind,” as Morpheus might say. That chapter is on something I call, “The Great FP Terminology Barrier,” and how to break through that barrier.

## See also

- My [Scala Quicksort algorithms](#) blog post
- Information about my [“AlPad” text editor](#)
- [“Reactive Extensions” on reactivex.io](#)
- Wikipedia’s definition of [declarative programming](#)
- Wikipedia’s definition of [imperative programming](#)
- [The RxScala project](#)
- Netflix’s [“Reactive Programming in the Netflix API with RxJava” blog post](#)



# **The “Great FP Terminology Barrier”**

## A short excursion to ... The Twilight Zone

Hello, Rod Serling of [The Twilight Zone](#) here. AI will be back shortly, but for now, let me take you to another place and time ... an alternate universe ...

In this alternate universe you are born a few years earlier, and one day you find yourself writing some code. One week, you create a `List` class, and then a few days after that you find yourself writing the same for loops over and over again to iterate over list elements. Recognizing a pattern and also wanting to be DRY (“Don’t Repeat Yourself”), you create a cool new method on the `List` class to replace those repetitive for loops:

```
val xs = List(1, 2, 3).applyAFunctionToEveryElement(_ * 2)
```

You originally named this method, “apply a function to every element *and return a value for each element*,” but after deciding that was way too long for a function name, you shortened it to `applyAFunctionToEveryElement`.

But the problem with this shorter name is that it’s not technically accurate. Because you are applying a function to each element and then returning the corresponding result for each element, you need a better name. But what name is accurate — and concise?

Pulling out your handy thesaurus, you come up with possible method names like these:

- apply
- convert
- evolve
- transform
- transmute
- metamorphose

As you try to settle on which of these names is best, your mathematics buddy

peers over your shoulder and asks, “What are you doing?” After you explain what you’re working on, he says, “Oh, cool. In mathematics we call that sort of thing ‘map.’” Then he pats you on the back, wishes you luck, and goes back to doing whatever it is that mathematicians do.

While some of the names you’ve come up with are good, this brief talk with your friend makes you think that it might be good to be consistent with mathematics. After all, you want mathematicians and scientists to use your programming language, so you decide to name your new method `map`:

```
val xs = List(1, 2, 3).map(_ * 2)
```

“Whoa,” you think to yourself, “that looks cool. I’ll bet there are zillions of functions that people can pass into `map` to achieve all kinds of cool things. And then I can use phrases like ‘map over a list.’” Things are taking shape.

## map as a general concept

As you think about your invention, it occurs to you that there are at least a few different data types in the world that can be mapped over ... not just lists, but hashmaps, too. Shoot, you can even think of a `String` as a `Seq[Char]`, and then even that can be mapped over. In time you realize that *any* collection whose elements can be iterated over can implement your new map function.

As this thought hits you, you realize that a logical thing to do is to create a trait that declares a map method. Then all of these other collections can extend that trait and implement their own map methods. With this thought, you begin sketching a new trait:

```
trait ThingsThatCanBeMappedOver {  
    // extending classes need to implement this  
    def map[A, B](f: A => B): TODO[B]  
}
```

You realize that the map function signature isn't quite right — you're going to have to invent some other things to make this work — but never mind those details for now, you're on a roll.

With that trait, you can now implement your `List` class like this:

```
class List extends ThingsThatCanBeMappedOver {  
    ...  
}
```

As you write that first line of code you realize that the trait name `ThingsThatCanBeMappedOver` isn't quite right. It's accurate, but a little long and perhaps unprofessional. You start to pull out your thesaurus again, but that act makes you think of your math buddy; what would he call this trait? It occurs to you that he would be comfortable writing code like this:

```
class List extends Map {  
    ...  
}
```

and as a result, you decide to call your new trait `Map`:

```
trait Map {
```

```
// extending classes need to implement this
def map[A, B](f: A => B): TODO[B]
}
```

There, that looks professional, and math-y like, too. Now you just have to figure out the correct function signature, and possibly implement a default method body.

Sadly, just at that moment, Rod Serling returns you to this version of planet Earth ...

## And the moral is ...

In this version of Earth's history, someone beat you to the invention of “things that can be mapped over,” and for some reason — possibly because they had a mathematics background — they made this declaration:

“Things that can be mapped over shall be called ... *Functor*.”

Huh?

History did not record whether the [Ballmer Peak](#), caffeine, or other chemicals were involved in that decision.

In this book, when I use the phrase, “Functional Programming Terminology Barrier,” this is the sort of thing I'm referring to. If a normal human being had discovered this technique, they might have come up with a name like `ThingsThatCanBeMappedOver`, but a mathematician discovered it and came up with the name, “Functor.”

Moral: A lot of FP terminology comes from mathematics. Don't let it get you down.

## A few more FP terms

As a few more examples of the *terminology barrier* I'm referring to, here are some other terms you'll run into as you try to learn functional programming:

Term	Definition
combinator	Per the <a href="#">Haskell wiki</a> , this has two meanings, but the common meaning is, "a style of organizing libraries centered around the idea of combining things." This refers to being able to combine functions together like a Unix command pipeline, i.e., <code>ps aux   grep root   wc -l</code> .
higher-order function	A function that takes other functions as parameters, or whose result is a function. ( <a href="http://docs.scala-lang.org">docs.scala-lang.org</a> )
lambda	Another word for "anonymous function."

As these examples show, when you get into FP you'll start seeing new terminology, and oftentimes they aren't terms that you need to know for other forms of programming. For instance, I taught Java and OOP classes for five years, and I didn't know these words at that time.

A common theme is that these terms generally come from mathematics fields like [category theory](#). Personally, I like math, so this is good for me. When someone uses a term like "[Combinatory Logic](#)," I think, "Oh, cool, what's that? Is it something that can make me a better programmer?"

However, a bad thing about it is that it's easy to get lost in the terminology. If you've ever been lost in a forest, the feeling is just like that.

As I write later in this book, I personally wasted a lot of time wondering, “What is *currying*? Why does everyone write about it so much?” That was a real waste of time.

I’ll say this more than once in this book: the best thing you can do to learn FP is to write code using only pure functions and immutable values, and see where that leads you. If you place those restrictions on yourself, you’ll eventually come up with the same inventions that mathematicians have come up with — and you might have simpler names for all of the terms.

“Mathematicians have big, scary words like ‘identity’ and ‘associativity’ and ‘commutativity’ to talk about this stuff — it’s their shorthand.”

~ From the book, [Coders at Work](#)



## **More terms coming ...**

The key point of this lesson is that there's generally no need to worry about a lot of mathematical and FP jargon, especially when you're first getting started. As I found out through my own experience, all this terminology does is create a learning barrier.

That being said, one *good* thing about terminology is that it lets us know that we're all talking about the same thing. Therefore, I'll introduce new terms as they naturally come up in the learning process.

## See also

- The [mathematical definition of “map” on Wikipedia](#)
- The [definition of “category theory” on Wikipedia](#)
- [Higher-order functions](#) on scala-lang.org
- The [Ballmer Peak](#)

# Pure Functions

# Goals

This lesson has two main goals:

1. Properly define the term “pure function.”
2. Show a few examples of pure functions.

It also tries to simplify the pure function definition, and shares a tip on how to easily identify many impure functions.

## Introduction

As I mentioned in the “What is Functional Programming?” chapter, I define functional programming (FP) like this:

*Functional programming* is a way of writing software applications using only pure functions and immutable values.

Because that definition uses the term “pure functions,” it’s important to understand what a pure function is. I gave a partial definition of pure functions in that chapter, and now I’ll provide a more complete definition.

## Definition of “pure function”

Just like the term *functional programming*, different people will give you different definitions of a pure function. I provide links to some of those at the end of this lesson, but skipping those for now, [Wikipedia defines a pure function](#) like this:

1. The function always evaluates to the same result value given the same argument value(s). It cannot depend on any hidden state or value, and it cannot depend on any I/O.
2. Evaluation of the result does not cause any semantically observable side effect or output, such as mutation of mutable objects or output to I/O devices.

That’s good, but I prefer to reorganize those statements like this:

1. A pure function depends only on (a) its declared input parameters and (b) its algorithm to produce its result. A pure function has no “back doors,” which means:
  1. Its result can’t depend on *reading* any hidden value outside of the function scope, such as another field in the same class or global variables.
  2. It cannot *modify* any hidden fields outside of the function scope, such as other mutable fields in the same class or global variables.
  3. It cannot depend on any external I/O. It can’t rely on input from files, databases, web services, UIs, etc; it can’t produce output, such as writing to a file, database, or web service, writing to a screen, etc.
2. A pure function does not modify its input parameters.

This can be summed up concisely with this definition:

*A pure function* is a function that depends *only* on its declared input parameters and its algorithm to produce its output. It does

not read any other values from “the outside world” — the world outside of the function’s scope — and it does not modify any values in the outside world.

## **A mantra for writing pure functions**

Once you've seen a formal pure function definition like that, I prefer this short mantra:

Output depends *only* on input.

Even though that isn't 100% accurate (because it doesn't address side effects), I prefer it because it's short and easy to remember. In this book I'll generally just write, "Output depends only on input" when referring to pure functions.



## The universe of a pure function

Another way to state this is that the universe of a pure function is only the input it receives, and the output it produces, as shown in Figure [fig:universeOfAPureFunction].

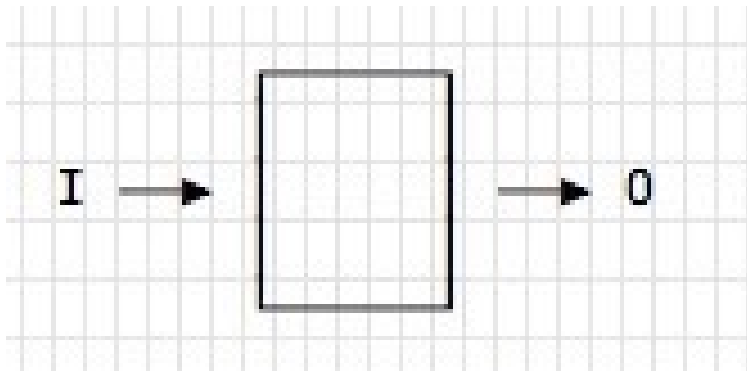

The entire universe of a pure function

If it seems like I'm emphasizing this point a lot, it's because I am(!). One of the most important concepts of functional programming is that FP applications are built almost entirely with pure functions, and pure functions are very different than what I used to write in my OOP career.

A great benefit of pure functions is that when you're writing them you don't have to think about anything else; all you have to think about is the universe of this function, which is what's coming into the function body from the outside world; what happens inside the function body; and what information you send back into the outside world.

## Examples of pure and impure functions

Given the definition of pure functions and these simpler mantras, let's look at some examples of *pure* and *impure* functions.

### *Examples of pure functions*

Mathematical functions are great examples of pure functions because it's pretty obvious that "output depends only on input." Methods like these in [scala.math](https://docs.scala-lang.org/stdlib/math-comparisons.html) are all pure functions:

- abs
- ceil
- max
- min

I refer to these as "methods" because they are defined using `def` in the package object `math`. However, these methods work just like functions, so I also refer to them as pure functions.

Because a Scala `String` is immutable, every method available to a `String` is a pure function, including:

- `charAt`
- `isEmpty`
- `length`
- `substring`

Many methods that are available on Scala's collections' classes fit the definition of a pure function, including the common ones:

- `drop`

- filter
- map
- reduce

## ***Examples of impure functions***

Conversely, the following functions are *impure*.

Going right back to the collections' classes, the `foreach` method is impure. `foreach` is used only for its side effects, which you can tell by looking at its signature on the [Seq class](#):

```
def foreach(f: (A) => Unit): Unit
```

Date and time related methods like `getDayOfWeek`, `getHour`, and `getMinute` are all impure because their output depends on something other than their inputs. Their results rely on some form of hidden I/O.

Methods on the `scala.util.Random` class like `nextInt` are also impure because their output depends on something other than their inputs.

In general, impure functions do one or more of these things:

- Read hidden inputs (variables not explicitly passed in as function input parameters)
- Write hidden outputs
- Mutate the parameters they are given
- Perform some sort of I/O with the outside world

## Tip: Telltale signs of impure functions

By looking at function signatures *only*, there are two ways you can identify many impure functions:

- They don't have any input parameters
- They don't return anything (or they return `Unit` in Scala, which is the same thing)

For example, here's the signature for the `println` method of [the Scala Predef object](#):

```
def println(x: Any): Unit  
-----
```

Because `println` is such a commonly-used method, you already know that it writes information to the outside world, but if you didn't know that, its `Unit` return type would be a terrific hint of that behavior. It doesn't return anything, so it *must* be mutating something or interacting with the outside world.

Similarly when you look at Scala's "read\*" methods you'll see that a method like `readLine` takes no input parameters, which is also a giveaway that it is impure:

```
def readLine(): String  
--
```

Because it takes no input parameters, the mantra, "Output depends only on input" clearly can't apply to it.

Simply stated:

- *If a function has no input parameters*, how can its output depend on its input?
- *If a function has no result*, it must have side effects: mutating variables, or performing some sort of I/O.

While this is an easy way to spot many impure functions, other impure methods

can have both (a) input parameters and (b) a non-Unit return type, but still be impure because they read variables outside of their scope, mutate variables outside of their scope, or perform I/O.

## Summary

As you saw in this lesson, this is my formal definition of a pure function:

*A pure function* is a function that depends *only* on its declared inputs and its internal algorithm to produce its output. It does not read any other values from “the outside world” — the world outside of the function’s scope — and it does not modify any values in the outside world.

Once you understand the complete definition, I prefer the short mantra:

Output depends *only* on input.

or this more accurate statement:

1. Output depends only on input
2. No side effects

## See also

- [The Wikipedia definition of a pure function](#)
- Wikipedia has [a good discussion on “pure functions” on their Functional Programming page](#)
- [The wolfram.com definition of a pure function](#)
- [The schoolofhaskell.com definition of a pure function](#)
- [The ocaml.org definition of a pure function](#)

# Grandma's Cookies (and Pure Functions)

To help explain pure functions, I'd like to share a little story ...

Once upon a time I was a freshman in college, and my girlfriend's grandmother sent her a tin full of cookies. I don't remember if there were different kinds of cookies in the package or not — all I remember is the chocolate chip cookies. Whatever her grandmother did to make those cookies, the dough was somehow more white than any other chocolate chip cookie I had ever seen before. They also tasted terrific, and I ate most of them.

Some time after this, my girlfriend — who would later become my wife — asked her grandmother how she made the chocolate chip cookies. Grandmother replied, "I just mix together some flour, butter, eggs, sugar, and chocolate chips, shape the dough into little cookies, and bake them at 350 degrees for 10 minutes." (There were a few more ingredients, but I don't remember them all.)

Later that day, my girlfriend and I tried to make a batch of cookies according to her grandmother's instructions, but no matter how hard we tried, they always turned out like normal cookies. Somehow we were missing something.



## Digging into the mystery

Perplexed by this mystery — and hungry for a great cookie — I snuck into grandmother’s recipe box late one night. Looking under “Chocolate Chip Cookies,” I found these comments:

```
/**
 * Mix together some flour, butter, eggs, sugar,
 * and chocolate chips. Shape the dough into
 * little cookies, and bake them at 350 degrees
 * for 10 minutes.
 */
```

“Huh,” I thought, “that’s just what she told us.”

I started to give up on my quest after reading the comments, but the desire for a great cookie spurred me on. After thinking about it for a few moments, I realized that I could decompile grandmother’s `makeCookies` recipe to see what it showed. When I did that, this is what I found:

```
def makeCookies(ingredients: List[Ingredient]): Batch[Cookie] = {
  val cookieDough = mix(ingredients)
  val betterCookieDough = combine(cookieDough, love)
  val cookies = shapeIntoLittleCookies(betterCookieDough)
  bake(cookies, 350.DegreesFahrenheit, 10.Minutes)
}
```

“Aha,” I thought, “here’s some code I can dig into.”

Looking at the first line, the function declaration seems fine:

```
def makeCookies(ingredients: List[Ingredient]): Batch[Cookie] = {
```

Whatever `makeCookies` does, as long as it’s a pure function — where its output depends only on its declared inputs — its signature states that it transforms a list of ingredients into a batch of cookies. Sounds good to me.

The first line inside the function says that `mix` is some sort of algorithm that transforms ingredients into `cookieDough`:

```
val cookieDough = mix(ingredients)
```

Assuming that `mix` is a pure function, this looks good.

The next line looks okay:

```
val betterCookieDough = combine(cookieDough, love)
```

Whoa. Hold on just a minute ... now I'm confused. What is `love`? Where does `love` come from?

Looking back at the function signature:

```
def makeCookies(ingredients: List[Ingredient]): Batch[Cookie] = {
```

clearly `love` is not defined as a function input parameter. Somehow `love` snuck into this function. That's when it hit me:

“Aha! `makeCookies` is not a pure function!”

Taking a deep breath to get control of myself, I looked at the last two lines of the function, and with the *now-major* assumption that `shapeIntoLittleCookies` and `bake` are pure functions, those lines look fine:

```
val cookies = shapeIntoLittleCookies(betterCookieDough)
bake(cookies, 350.DegreesFahrenheit, 10.Minutes)
```

“I don't know where `love` comes from,” I thought, “but clearly, it is a problem.”

## Hidden inputs and free variables

In regards to the `makeCookies` function, you'll hear functional programmers say a couple of things about `love`:

- `love` is a *hidden input* to the function
- `love` is a “free variable”

These statements essentially mean the same thing, so I prefer the first statement: to think of `love` as being a hidden input into the function. It wasn't passed in as a function input parameter, it came from ... well ... it came from somewhere else ... the ether.

## Functions as factories

Imagine that `makeCookies` is the only function you have to write today — this function is *your* entire scope for today. When you do that, it feels like someone teleported `love` right into the middle of your workspace. There you were, minding your own business, writing a function whose output depends only on its inputs, and then — Bam! — `love` is thrown right into the middle of your work.

Put another way, if `makeCookies` is the entire scope of what you should be thinking about right now, using `love` feels like you just accessed a global variable, doesn't it?

With pure functions I like to think of input parameters as coming into a function's front door, and its results going out its back door, just like a black box, or a factory, as shown in Figure [fig:cookieFactory].

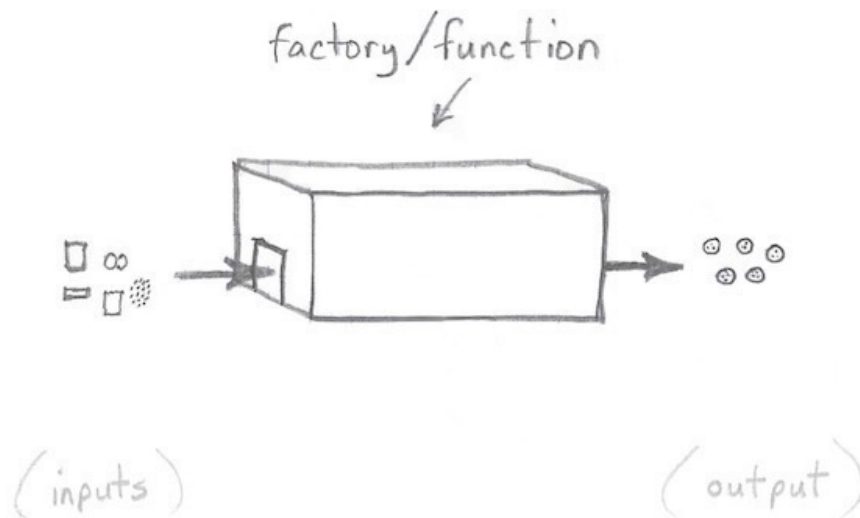

Thinking of a pure function as a factory with two doors

But in the case of `makeCookies` it's as though `love` snuck in through a side door, as shown in Figure [fig:cookieFactorySideDoor].

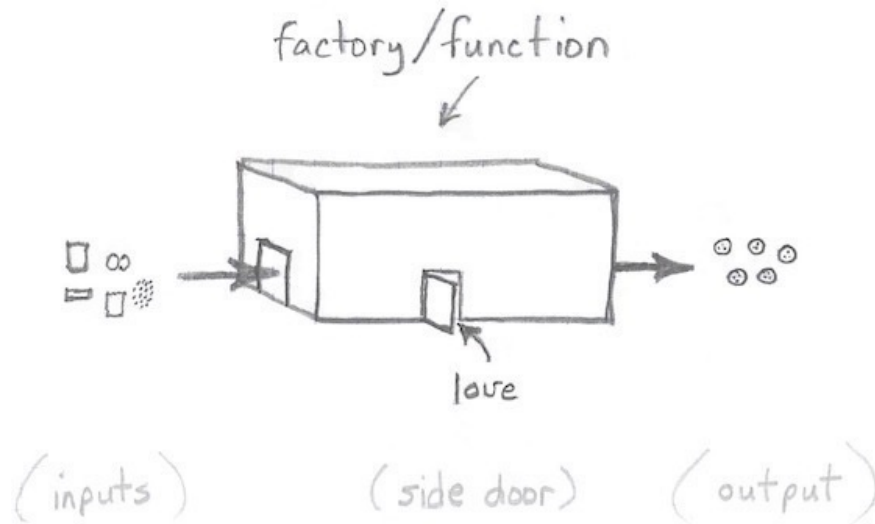

Impure functions use side doors

While you might think it's okay for things like love to slip in a side door, [if you spend any time in Alaska](#) you'll learn not to leave your doors open, because you never know what might walk in, as shown in Figure [fig:cookieFactorySideDoorBear].

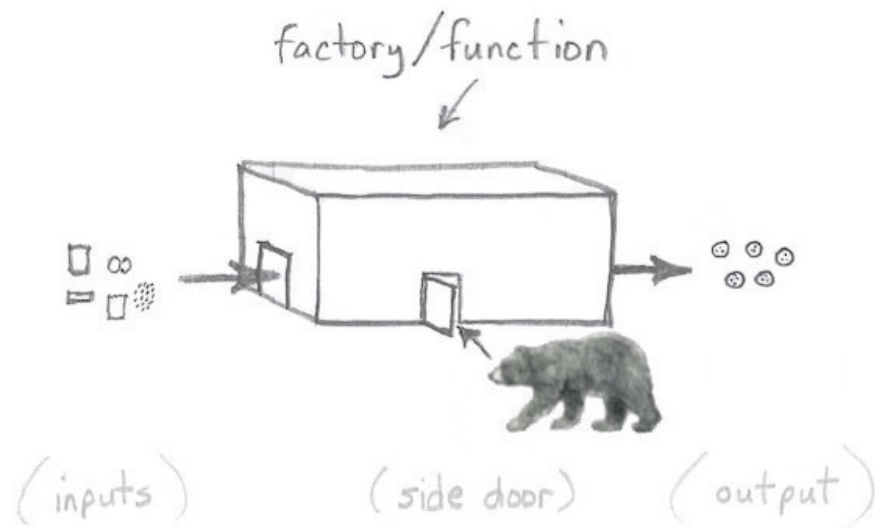

Bad things can happen when you use side doors

## Free variables

When I wrote about hidden inputs I also mentioned the term “free variable,” so let’s look at its meaning. Ward Cunningham’s [c2.com website](#) defines a free variable like this:

“A *free variable* is a variable used within a function, which is neither a formal parameter to the function nor defined in the function’s body.”

That sounds exactly like something you just heard, right? As a result, I prefer to use the less formal term, “hidden input.”

## What happens when hidden inputs change?

If Scala required us to mark impure functions with an `impure` annotation, `makeCookies` would be declared like this as a warning to all readers that, “Output depends on something other than input”:

```
@impure  
def makeCookies ...
```

And because `makeCookies` is an impure function, a good question to ask right now is:

“What happens when `love` changes?”

The answer is that because `love` comes into the function through a side door, it can change the `makeCookies` result without you ever knowing why you can get different results when you call it. (Or why my cookies never turn out right.)

## Unit tests and purity

I like to “speak in source code” as much as possible, and a little code right now can show what a significant problem hidden inputs are, such as when you write a unit test for an impure method like `makeCookies`.

If you’re asked to write a [ScalaTest](#) unit test for `makeCookies`, you might write some code like this:

```
test("make a batch of chocolate chip cookies") {
  val ingredients = List(
    Flour(3.Cups),
    Butter(1.Cup),
    Egg(2),
    Sugar(1.Cup),
    ChocolateChip(2.Cups)
  )
  val batchOfCookies = GrandmasRecipes.makeCookies(ingredients)
  assert(cookies.count == 12)
  assert(cookies.taste == Taste.JustLikeGrandmasCookies)
  assert(cookies.doughColor == Color.WhiterThanOtherCookies)
}
```

If you ran this test once it might work fine, you *might* get the expected results. But if you run it several times, you might get different results each time.

That’s a big problem with `makeCookies` using `love` as a hidden input: when you’re writing black-box testing code, you have no idea that `makeCookies` has a hidden dependency on `love`. All you’ll know is that sometimes the test succeeds, and other times it fails.

Put a little more technically:

- `love`’s state affects the result of `makeCookies`
- As a black-box consumer of this function, there’s no way for you to know that `love` affects `makeCookies` by looking at its method signature

If you have the source code for `makeCookies` and can perform white-box testing, you *can* find out that `love` affects its result, but that’s a big thing about functional programming: you never have to look at the source code of a pure function to see if it has hidden inputs or hidden outputs.



I've referred to hidden inputs quite a bit so far, but hidden outputs — mutating hidden variables or writing output — are also a problem of impure functions.

## Problems of the impure world

However, now that I do have the `makeCookies` source code, several questions come to mind:

- Does `love` have a default value?
- How is `love` set before you call `makeCookies`?
- What happens if `love` is not set?

Questions like these are problems of *impure* functions in general, and *hidden inputs* in particular. Fortunately you don't have to worry about these problems when you write pure functions.

When you write parallel/concurrent applications, the problem of hidden inputs becomes even worse. Imagine how hard it would be to solve the problem if `love` is set on a separate thread.

## The moral of this story

Every good story should have a moral, and I hope you see what a problem this is. In my case, I still don't know how to make cookies like my wife's grandmother did. (I lay in bed at night wondering, what is love? Where does love come from?)

In terms of writing rock-solid code, the moral is:

- `love` is a hidden input to `makeCookies`
- `makeCookies` output does not depend solely on its declared inputs
- You may get a different result every time you call `makeCookies` with the same inputs
- You can't just read the `makeCookies` signature to know its dependencies

Programmers also say that `makeCookies` depends on the *state* of `love`. Furthermore, with this coding style it's also likely that `love` is a mutable var.

My apologies to my wife's grandmother for using her in this example. She was the most organized person I ever met, and I'm sure that if she was a programmer, she would have written pure functions. And her cookies are sorely missed.

## **What's next**

Given all of this talk about pure functions, the next lesson answers the important question, “What are the benefits of pure functions?”

## See also

- [The Wikipedia definition of a pure function](#)
- Wikipedia has [a good discussion on “pure functions” on their Functional Programming page](#)
- My unit test was written using [ScalaTest](#).
- When you need to use specific *quantities* in Scala applications, [Squants](#) offers a DSL similar to what I showed in these examples.

# Benefits of Pure Functions

The goal of this lesson is simple: to list and explain the benefits of writing pure functions.

## Benefits of pure functions

My favorite benefits of pure functions are:

- They're easier to reason about
- They're easier to combine
- They're easier to test
- They're easier to debug
- They're easier to parallelize

FP developers talk about other benefits of writing pure functions. For instance, [Venkat Subramaniam](#) adds these benefits:

- They are idempotent
- They offer referential transparency
- They are memoizable
- They can be lazy

In this lesson I'll examine each of these benefits.

## **Pure functions are easier to reason about**

Pure functions are easier to reason about than impure functions, and I cover this in detail in the lesson, “Pure Function Signatures Tell All.” The key point is that because a pure function has no side effects or hidden I/O, you can get a terrific idea of what it does just by looking at its signature.



## Pure functions are easier to combine

Because “output depends only on input,” pure functions are easy to combine together into simple solutions. For example, you’ll often see FP code written as a chain of function calls, like this:

```
val x = doThis(a).thenThis(b)
        .andThenThis(c)
        .doThisToo(d)
        .andFinallyThis(e)
```

This capability is referred to as *functional composition*. I’ll demonstrate more examples of it throughout this book.

As you’ll see in the “FP is Like Unix Pipelines” lesson, Unix pipelines are easy to create because most Unix commands are like pure functions: they read input and produce transformed output based only on the inputs and the algorithm you supply.

## **Pure functions are easier to test**

As I showed in the [“Benefits of Functional Programming” chapter](#), pure functions are easier to test than impure functions. I expand on this in several other lessons in this book, including the lessons on property-based testing.

## Pure functions are easier to debug

In the [“Benefits of Functional Programming” chapter](#) I wrote that on a large scale, FP *applications* are easier to debug. In the small scale, pure functions are also easier to debug than their impure counterparts. Because the output of a pure function depends only on the function’s input parameters and your algorithm, you don’t need to look outside the function’s scope to debug it.

## Pure functions are easier to parallelize

I wrote in the [“Benefits of Functional Programming” chapter](#) that it’s easier to write parallel/concurrent applications with FP. Because all of those same reasons apply here I won’t repeat them, but I will show one example of how a compiler can optimize code within a pure function.

I’m not a compiler writer, so I’ll begin with this statement from the [“pure functions” section of the Wikipedia functional programming page](#):

“If there is no data dependency between two pure expressions, then their order can be reversed, or they can be performed in parallel and they cannot interfere with one another (in other terms, the evaluation of any pure expression is thread-safe).”

As an example of what that means, in this code:

```
val x = f(a)
val y = g(b)
val z = h(c)
val result = x + y + z
```

there are no data dependencies between the first three expressions, so they can be executed in any order. The only thing that matters is that they are executed before the assignment to `result`. If the compiler/interpreter wants to run those expressions in parallel, it can do that and then merge their values in the final expression. This can happen because (a) the functions are pure, and (b) there are no dependencies between the expressions.

That same Wikipedia page also states:

“If the entire language does not allow side-effects, then any evaluation strategy can be used; this gives the compiler freedom to reorder or combine the evaluation of expressions in a program (for example, using deforestation).”

The 2006 article, [Functional Programming for the Rest Of Us](#), includes a quote

similar to these Wikipedia quotes. It states, “An interesting property of functional languages is that they can be reasoned about mathematically. Since a functional language is simply an implementation of a formal system, all mathematical operations that could be done on paper still apply to the programs written in that language. The compiler could, for example, convert pieces of code into equivalent but more efficient pieces with a mathematical proof that two pieces of code are equivalent. Relational databases have been performing these optimizations for years. There is no reason the same techniques can’t apply to regular software.”

## Pure functions are idempotent

I don't use the word "idempotent" too often, so I'll quote from Venkat Subramaniam's [explanation of the benefit of idempotence in regards to pure functions](#) (with a few minor edits by me):

The word *idempotent* has a few different meanings ... a function or operation is idempotent if the result of executing it multiple times for a given input is the same as executing it only once for the same input. If we know that an operation is idempotent, we can run it as many times as we like ... it's safe to retry.

In a related definition, in [A practical introduction to functional programming](#), Mary Rose Cook states:

A process is *deterministic* if repetitions yield the same result every time.

The terms *idempotent* and *deterministic* are similar to a favorite phrase of mine: if you call a pure function with the same input(s) an infinite number of times, you will always get the same result.

Honestly, with these definitions it feels like I'm writing, "A benefit of pure functions is that they are pure functions." My only reason for keeping this section is so that you have some exposure to the terms *idempotent* and *deterministic*.

This demonstrates that like many other uncommon phrases in functional programming, you can understand a *concept* long before you know that someone created a label for that concept.

## Pure functions offer referential transparency

Referential transparency (RT) is another technical term that you'll hear in the FP world. It's similar to idempotency, and refers to what you (and a compiler) can do because your functions are pure.

If you like algebra, you'll like RT. It's said that an expression is *referentially transparent* if it can be replaced by its resulting value without changing the behavior of the program.

For instance, assume that  $x$  and  $y$  are immutable values within some scope of an application, and within that scope they're used to form this expression:

```
x + y
```

Then you can assign this expression to a third variable  $z$ :

```
val z = x + y
```

Now, throughout the given scope of your program, anywhere the expression  $x + y$  is used, it can be replaced by  $z$  without affecting the result of the program (and vice-versa).

Note that although I state that  $x$  and  $y$  are immutable values, they can also be the result of pure functions. For instance, `hello.length + world.length` will always be `10`. This result could be assigned to  $z$ , and then  $z$  could be used everywhere instead of this expression. In Scala this looks like this:

```
val x = "hello".length // 5
val y = "world".length // 5
val z = x + y          // 10
```

Because all of those values are immutable, you can use  $z$  anywhere you might use  $x+y$ , and in fact, in this example you can replace  $z$  with `10` anywhere, and your program will run exactly the same.

In FP we say things like, “`10` cannot be reduced any more.”  
(More on this later.)

Conversely, if  $x$  or  $y$  was an impure function, such as a “get the current time”

function,  $z$  could not be a reliable replacement for  $x + y$  at different points in the application.



## Pure functions are memoizable

Because a pure function always returns the same result when given the same inputs, a compiler (or your application) can also use caching optimizations, such as *memoization*.

[Wikipedia defines memoization like this:](#)

“Memoization is an optimization technique used primarily to speed up computer programs by storing the results of expensive function calls and returning the cached result when the same inputs occur again.”

For example, I previously noted that my Android football game has this function call:

```
val possiblePlays = OffensiveCoordinator.determinePossiblePlays(gameState)
```

The `determinePossiblePlays` function currently has several thousand lines of pure functions behind it, and over time it's only going to get more complicated. Although this function doesn't currently use memoization, it would be fairly simple to create a cache for it, so that each time it received the same `gameState` it would return the same result.

The cache could be implemented as a `Map`, with a type of `Map[GameState, Seq[OffensivePlay]]`. Then when `determinePossiblePlays` receives a `GameState` instance, it could perform a fast lookup in this cache.

While those statements are true, I don't want to oversimplify this too much. `determinePossiblePlays` makes decisions based on many `GameState` factors, including two important (a) game score and (b) time remaining. Those two variables would have to be factors in any cache.

## **Pure functions can be lazy**

*Laziness* is a major feature of the Haskell language, where everything is lazy (lazily evaluated). In Scala I primarily use laziness with large data sets and streams — i.e., impure functions — so I haven't personally taken advantage of this benefit yet.

## A quote from a Haskell co-creator

As a final note, here's a quote from the book, [Masterminds of Programming](#), which discusses some of the benefits I just described:

When asked, “What are the advantages of writing in a language without side effects?” Simon Peyton Jones, co-creator of Haskell, replied, “You only have to reason about values and not about state. If you give a function the same input, it'll give you the same output, every time. This has implications for reasoning, for compiling, for parallelism.”

## Summary

In this lesson I wrote about the benefits of pure functions. My favorite benefits are:

- They're easier to reason about
- They're easier to combine
- They're easier to test
- They're easier to debug
- They're easier to parallelize

Other FP developers write about these benefits of pure functions:

- They are idempotent
- They offer referential transparency
- They are memoizable
- They can be lazy

## See also

- Wikipedia has [a good discussion on the benefits of “pure functions” on their Functional Programming page](#)
- [The Haskell.org definition of referential transparency](#)
- Stack Exchange provides [a definition of referential transparency](#)
- Stack Overflow says, [Don’t worry about the term RT, it’s for pointy-headed purists](#)
- Venkat Subramaniam’s post on [the benefits of pure functions](#)
- If you like debates on the precise meaning of technical terms, reddit.com has a thread titled, [Purity and referential transparency are different](#)

# Pure Functions and I/O

## Goal

The goal of this lesson is to answer the question, “Because pure functions can’t have I/O, how can an FP application possibly get anything done if all of its functions are pure functions?”

## So how do you do anything with functional programming?

Given my pure function mantra, “Output depends only on input,” a logical question at this point is:

“How do I get anything done if I can’t read any inputs or write any outputs?”

Great question!

The answer is that you violate the “Write Only Pure Functions” rule! It seems like many other resources go through great lengths to avoid answering that question, but I just gave you that answer fairly early in this book. (You’re welcome.)

The general idea is that you write as much of your application as possible in an FP style, and then handle the UI and all forms of input/output (I/O) (such as Database I/O, Web Service I/O, File I/O, etc.) in the best way possible for your current programming language and tools.

In Scala the percentage of your code that’s considered impure I/O will vary, depending on the application type, but will probably be in this range:

- On the low end, it will be about the same as a language like Java. So if you were to write an application in Java and 20% of it was going to be impure I/O code and 80% of it would be other stuff, in FP that “other stuff” will be pure functions. This assumes that you treat your UI, File I/O, Database I/O, Web Services I/O, and any other conceivable I/O the same way that you would in Java, without trying to “wrap” that I/O code in “functional wrappers.” (More on this shortly.)
- On the high end, it will approach 100%, where that percentage relies on two things. First, you wrap all of your I/O code in functional wrappers. Second, your definition of “pure function” is looser than my definition.



## I/O wrapper's code

I don't mean to make a joke or be facetious in that second statement. It's just that some people may try to tell you that by putting a wrapper layer around I/O code, the *impure* I/O function somehow becomes *pure*. Maybe somewhere in some mathematical sense that is correct, I don't know. Personally, I don't buy that.

Let me explain what I'm referring to.

Imagine that in Scala you have a function that looks like this:

```
def promptUserForUsername: String = ???
```

Clearly this function is intended to reach out into the outside world and prompt a user for a username. You can't tell *how* it does that, but the function name and the fact that it returns a `String` gives us that impression.

Now, as you might expect, every user of an application (like Facebook or Twitter) should have a unique username. Therefore, any time this function is called, it will return a different result. By stating that (a) the function gets input from a user, and (b) it can return a different result every time it's called, this is clearly not a *pure* function. It is *impure*.

However, now imagine that this same function returns a `String` that is wrapped in another type that I'll name `IO`:

```
def promptUserForUsername: IO[String] = ???
```

Notice that this a little like using the `Option/Some/None` pattern in Scala.

### ***What's the benefit?***

That's interesting, but what does this do for us?

Personally, I think it has one main benefit: I can glance at this function signature, and know that it deals with I/O, and therefore it's an impure function. In this particular example I can also infer that from the function name, but what if the function was named differently?:

```
def getUsername: IO[String] = ???
```

In this case `getUsername` is a little more ambiguous, so if it just returned `String`, I wouldn't know exactly how it got that `String`. But when I see that a `String` is wrapped with `IO`, I know that this function interacts with the outside world to get that `String`. That's pretty cool.

## ***Does using `IO` make a function pure?***

But this is where it gets interesting: some people state that wrapping `promptUserForUsername`'s return type with `IO` makes it a pure function.

I am not that person.

The way I look at it, the first version of `promptUserForUsername` returned `String` values like these:

```
"alvin"  
"kim"  
"xena"
```

and now the second version of `promptUserForUsername` returns that same infinite number of different strings, but they're wrapped in the `IO` type:

```
IO("alvin")  
IO("kim")  
IO("xena")
```

Does that somehow make `promptUserForUsername` a pure function? I sure don't think so. It still interacts with the outside world, and it can still return a different value every time it's called, so by definition it's still an impure function.

I emphasize this point because you may read that Haskell's `IO` monad makes I/O pure. However, as Martin Odersky states in [this Google Groups Scala debate](#):

“The `IO` monad does not make a function pure. It just makes it obvious that it's impure.”

## Summary

As I showed in this lesson, when you need to write I/O code in functional programming languages, the solution is to violate the “Only Write Pure Functions” rule. The general idea is that you write as much of your application as possible in an FP style, and then handle the UI, Database I/O, Web Service I/O, and File I/O in the best way possible for your current programming language and tools.

I also showed that wrapping your I/O functions in an `IO` type doesn't make a function pure, but it is a great way to add something to your function's type signature to let every know, “This function deals with I/O.” When a function returns a type like `IO[String]` you can be very sure that it reached into the outside world to get that `String`, and when it returns `IO[Unit]`, you can be sure that it wrote something to the outside world.

## **What's next**

So far I've covered a lot of background material about pure functions, and in the next lesson I share something that was an important discovery for me: The signatures of pure functions are much more meaningful than the signatures of impure functions.

## See also

- The [this Google Groups Scala debate](#) where Martin Odersky states, “The IO monad does not make a function pure. It just makes it obvious that it’s impure.”
- For more details about the IO monad in Haskell, see the “I/O in Haskell” section in [the longer, online version of this lesson](#).

# Pure Function Signatures Tell All

One thing you'll find in FP is that the signatures of pure functions tell you a lot about what those functions do. In fact, it turns out that the signatures of functions in FP applications are *much* more important than they are in OOP applications. As you'll see in this lesson:

Because pure functions have no side effects, their outputs depend only on their inputs, and all FP values are immutable, pure function signatures tell you exactly what the function does.

## OOP function signatures

When writing OOP applications I never gave much thought to method signatures. When working on development teams I always thought, “Meh, let me see the method source code so I can figure out what it *really* does.” I remember one time a junior developer wrote what should have been a simple Java “setter” method named `setFoo`, and its source code looked something like this:

```
public void setFoo(int foo) {  
    this.foo = foo;  
    makeAMeal(foo);  
    foo++;  
    washTheDishes(foo);  
    takeOutTheTrash();  
}
```

In reality I don’t remember everything that setter method did, but I clearly remember the `foo++` part, and then saw that it used the `foo` and `foo++` values in other method calls. A method that —according to its signature— appeared to be a simple setter method was in fact much, much more than that.

I hope you see the problem here: there’s no way to know what’s *really* happening inside an impure function without looking at its source code.

Therefore, the first moral of this story is that because OOP methods *can* have side effects, I grew to only trust methods from certain people.

The second moral is that this situation can’t happen with pure functions (certainly not as blatantly as this example).

## Signatures of pure functions

The signatures of pure functions in Scala/FP have much more meaning than OOP functions because:

- They have no side effects
- Their output depends only on their inputs
- All values are immutable

To understand this, let's play a simple game.



## A game called, “What can this pure function possibly do?”

As an example of this — and as a first thought exercise — look at this function signature and ask yourself, “If `F00` is a pure function, what can it possibly do?”:

```
def F00(s: String): Int = ???
```

Ignore the name `F00`; I gave the function a meaningless name so you’d focus only on the rest of the type signature to figure out what this function can possibly do.

To solve this problem, let’s walk through some preliminary questions:

- Can this function read user input? It can’t have side effects, so, no.
- Can it write output to a screen? It can’t have side effects, so, no.
- Can it write (or read) information to (or from) a file, database, web service, or any other external data source? No, no, no, and no.

So what can it do?

If you said that there’s an excellent chance that this function does one of the following things, pat yourself on the back:

- Converts a `String` to an `Int`
- Determines the length of the input string
- Calculates a hashcode or checksum for the string

Because of the rules of pure functions, those are the only types of things this function can do. The `Int` result *must* depend on the `String` input. Output depends only on input.

## A second game example

Here's a second example that shows how the signatures of pure functions tell you a lot about what a function does. Given this simple class:

```
case class Person[name: String]
```

What can a pure function with this signature possibly do?:

```
def F00(people: Seq[Person], n: Int): Person = ???
```

I'll pause to let you think about it ...

By looking only at the function signature, you can guess that the function probably returns the Nth element of the given `List[Person]`.

That's pretty cool. Because it's a pure function you know that the `Person` value that's returned must be coming from the `Seq[Person]` that was passed in.

As an additional exercise, if I remove the `n` input parameter from the function:

```
def F00(people: Seq[Person]): Person = ???
```

Can you guess what this function can do?

(Pause to let you think ...)

My best guesses are:

- It's a `head` function
- It's a `tail` function (that returns only the last element)
- It's a Frankenstein's Monster function that builds one `Person` from many `Persons`

## A third game example

Here's a different variation of the "What can this pure function possibly do?" game. Imagine that you have the beginning of a function signature, where the input parameters are defined, but the return type is undefined:

```
def foo(s: String, i: Int) ...
```

Given only this information, can you answer the "What can this function possibly do?" question? That is, can you answer that question if you don't know what the function's return type is?

(Another pause to let you think ...)

The answer is "no." Even though `foo` is a pure function, you can't tell what it does until you see its return type. But ...

Even though you can't tell *exactly* what it does, you can guess a little bit. For example, because output depends only on input, these return types are all allowed by the definition of a pure function:

```
def foo1(s: String, i: Int): Char = ???  
def foo2(s: String, i: Int): String = ???  
def foo3(s: String, i: Int): Int = ???  
def foo4(s: String, i: Int): Seq[String] = ???
```

Even though you can't tell what this function does without seeing its return type, I find this game fascinating. Where OOP method signatures had no meaning to me, I can make some really good guesses about what FP method signatures are trying to tell me — even when the function name is meaningless.

## Trying to play the game with an impure method

Let's look at one last example. What can this method possibly do?:

```
def foo(p: Person): Unit = ...
```

Because it returns `Unit` (nothing), it *must* have a side effect of some sort. You can't know what those side effects are, but you can guess that it may do any or all of these things:

- Write to `STDOUT`
- Write to a file
- Write to a database
- Write to a web service
- Update some other variable(s) with the data in `p`
- Mutate the data in `p`
- Ignore `p` and do something totally unexpected

As you can see, trying to understand what an impure method can possibly do is much more complicated than trying to understand what a pure function can possibly do. As a result of this, I came to understand this phrase:

Pure function signatures tell all.

## Summary

As shown in this lesson, when a method has side effects there's no telling what it does, but when a function is pure its signature lets you make very strong guesses at what it does — even when you can't see the function name.

The features that make this possible are:

- The output of a pure function depends only on its inputs
- Pure functions have no side effects
- All values are immutable

## **What's next**

Now that I've written several small lessons about pure functions, the next two lessons will show how combining pure functions into applications feels both like (a) algebra and (b) Unix pipelines.

# Functional Programming as Algebra

## Introduction

I like to start most lessons with a relevant quote, and this one comes from the book, [Land of Lisp](#):

“Some advanced Lispsers will cringe when someone says that a function ‘returns a value.’ This is because Lisp derives from something called lambda calculus, which is a fundamental programming-like algebra developed by Alonzo Church. In the lambda calculus you ‘run’ a program by performing substitution rules on the starting program to determine the result of a function. Hence, the result of a set of functions just sort of magically appears by performing substitutions; never does a function consciously ‘decide’ to return a value. Because of this, Lisp purists prefer to say that a function ‘evaluates to a result.’”

Here’s another quote, from the book, [Thinking Functionally with Haskell](#):

“FP has a simple mathematical basis that supports equational reasoning about the properties of programs.”

Because of functional programming’s main features — pure functions and immutable values — writing FP code is like writing algebraic equations. Because I always liked algebra and thought it was simple, this made FP appealing to me.

I’ll demonstrate what I mean in this lesson.

## Goals

The first goal of this lesson is to give some examples of how FP code is like algebra.

A second goal of this lesson is to keep building an “FP way of thinking” about programming problems. The mindset of this lesson is that each pure function you write is like writing an algebraic equation, and then gluing those functions together to create a program is like combining a series of algebraic equations together to solve a math problem.

As the first quote I shared states, when you begin to think about your functions as “evaluating to a result,” you’ll be in a state of mind where you’re thinking about solving problems and writing your code as being like writing algebraic equations, and that’s a good thing.



## Background: Algebra as a reason for “Going FP”

Hopefully you’ll find your own reasons for “Going FP,” but for me the lightbulb went on over my head when I realized that FP let me look at my code this way. Gluing pure functions together felt like combining a series of algebraic equations together — i.e., algebraic substitution — and because I like algebra, this was a good thing.

Before learning FP, my background was in OOP. I first learned and then taught Java and OOP in the 1990s and early 2000s, and with that background I always looked at problems from the eyes of an OOP developer. OOP never made me see writing code as being like writing mathematical expressions. I always thought, “Okay, these things here are my objects (`Pizza`, `Topping`, `Order`), these are their behaviors (`addTopping`), and they hide their internal workings from other objects.”

But since learning FP I now see my code as being more like algebra, and it’s a very different perspective. I clearly remember my first thought when I saw the connection between FP and algebra:

“Whoa ... if my function’s output depends solely on its input, well, shoot, I can always write *one* pure function. If I can write one pure function, then I can write another, and then another. And then once they’re all working I can glue them together to form a complete solution, like a series of equations. And since they’re all pure functions they can’t really fail — especially not because of hidden state issues — at least not if I test them properly.”

Sometimes programming can get a little overwhelming when you think about writing an entire application, but when I realized that I can always write one pure function, that gave me a tremendous sense of confidence.

As a programming tip, when you’re writing a pure function, think of that function as your world, your only concern in the

entire world. Because “output depends only on input,” all you have to think about is that some inputs are coming into your function (your world), and all you need to do is create an algorithm to transform those inputs into the desired result.

## Background: Defining algebra

It's important to understand what "algebra" is so you can really internalize this lesson. Unfortunately, trying to find a good definition of algebra is difficult because many people go right from the word "algebra" to "mathematics," and that's not what I have in mind. [This informal definition of algebra by Daniel Eklund](#) fits my way of thinking a little better:

For purposes of simplicity, let us define algebra to be two things: 1) a SET of objects (not "objects" as in object-oriented), and 2) the OPERATIONS used on those objects to create new objects from that set.

As emphasized, the key words in that sentence are *set* and *operations*. Mr. Eklund goes on to define "numeric algebra":

In the case of *numeric algebra* — informally known as high-school algebra — the SET is the set of numbers (whether they be natural, rational, real, or complex) and the OPERATIONS used on these objects can be (but definitely not limited to be) addition or multiplication. The *algebra of numbers* is therefore the study of this set, and the laws by which these operators generate (or don't generate) new members from this set.

As an example, a *set* of [natural numbers](#) is [0,1,2 ... infinity]. *Operations* on that set can be add, subtract, and multiply, and new members are generated using these operators, such as  $1 + 2$  yielding 3.

Mr. Eklund goes on to define other types of algebras, but for our purposes I'll just share one more sentence:

The key thing to realize here is that an algebra lets us talk about the objects and the operations abstractly, and to consider the laws that these operations obey as they operate on the

underlying set.

In Scala/FP, the “objects” Mr. Eklund refers to can be thought of as the built-in Scala types and the custom types you create, and the “operations” can be thought of as the pure functions you write that work with those types.

For instance, in a pizza store application, the “set” might include types like Pizza, Topping, Customer, and Order. To find the operations that work with that set, you have to think about the problem domain. In a pizza store you add toppings to a pizza that a customer wants, and then you can add one or more pizzas to an order for that customer. The types are your set (the nouns), and the functions you create define the only possible operations (verbs) that can manipulate that set.

Given that discussion, a Scala trait for a Pizza type might look like this:

```
trait Pizza {  
  def setCrustSize(s: CrustSize): Pizza  
  def setCrustType(t: CrustType): Pizza  
  def addTopping(t: Topping): Pizza  
  def removeTopping(t: Topping): Pizza  
  def getToppings(): Seq[Topping]  
}
```

In the same way that 1 is a natural number and can work with operations like *add* and *subtract*, Pizza is a type and can work with the operations (methods) it defines.

## From algebra to FP

If you haven't worked with algebra in a while, it may help to see a few algebraic functions as a refresher:

```
f(x) = x + 1  
f(x,y) = x + y  
f(a,b,c,x) = a * x^2 + b*x + c
```

It's easy to write those algebraic equations as pure functions in Scala/FP.

Assuming that all the values are integers, they can be written as these functions in Scala:

```
def f(x: Int) = x + 1  
def f(x: Int, y: Int) = x + y  
def f(a: Int, b: Int, c: Int, x: Int) = a*x*x + b*x + c
```

These are pure functions (“output depends only on input”) that use only immutable values. This shows one way that FP is like algebra, by starting with algebraic functions and then writing the Scala/FP versions of those functions.

## From FP to algebra

Similarly I can start with Scala/FP code and show how it looks like algebraic equations. For example, take a look at these Scala expressions:

```
val emailDoc = getEmailFromServer(src)
val emailAddr = getAddr(emailDoc)
val domainName = getDomainName(emailAddr)
```

You can see how that code is like algebra if I add comments to it:

```
val emailDoc = getEmailFromServer(src)    // val b = f(a)
val emailAddr = getAddr(emailDoc)        // val c = g(b)
val domainName = getDomainName(emailAddr) // val d = h(c)
```

No matter what these functions do behind the scenes, they are essentially algebraic expressions, so you can reduce them just like you reduce mathematical expressions. Using simple substitution, the first two expressions can be combined to yield this:

```
val emailAddr = getAddr(getEmailFromServer(src))
val domainName = getDomainName(emailAddr)
```

Then those two expressions can be reduced to this:

```
val domainName = getDomainName(getAddr(getEmailFromServer(src)))
```

If you look at the comments I added to the code, you'll see that I started with this:

```
val b = f(a)
val c = g(b)
val d = h(c)
```

and reduced it to this:

```
val d = h(g(f(a)))
```

I can make these substitutions because the code is written as a series of expressions that use pure functions.

You can write the code in the three lines, or perform the substitutions to end up with just one line. Either approach is valid, and equal. What makes this possible is that other than `getEmailFromServer(src)`, which is presumably an impure

function, the code:

- Only uses pure functions (no side effects)
- Only uses immutable values

When your code is written like that, it really is just a series of algebraic equations.

## Benefit: Algebra is predictable

A great thing about algebra is that the results of algebraic equations are incredibly predictable. For example, if you have a `double` function like this:

```
def double(i: Int) = i * 2
```

you can then call it with the number 1 an infinite number of times and it will always return 2. That may seem obvious, but hey, it's how algebra works.

Because of this, you know that these things will *always* happen:

```
println(double(1)) // prints 2
println(double(2)) // "    4
println(double(3)) // "    6
```

And you also know that this can *never* happen:

```
println(double(1)) // prints 5 (can never happen)
println(double(1)) // prints 17 (can never happen)
```

With pure functions you can never have two different return values for the same input value(s). This can't happen with pure functions, and it can't happen with algebra, either.



## A game: What can possibly go wrong?

A great thing about thinking about your code as algebra is that you can look at one of your pure functions and ask, “What can possibly go wrong with this function?” When you do so, I hope that trying to find any problems with it will be very difficult. After thinking about it long and hard I hope you get to the point of saying, “Well, I guess the JVM could run out of RAM (but that doesn’t have anything directly to do with my function).”

My point is that because it’s isolated from the rest of the world, it should be a real struggle to think about how your pure function can possibly fail. When you’re writing OOP code you have to concern yourself that “output *does not* only depend on input,” which means that you have to think about everything else in the application that can fail or be a problem — i.e., things like (a) state of the application outside the function’s scope, and (b) variables being mutated while you’re trying to use them — but with FP code you don’t have those concerns.

For example, imagine that you’re writing a multi-threaded imperative application, you’ve been given a list of users, and the purpose of your function is to sort that list of users. There are a lot of ways to sort lists, so that isn’t hard, but what happens to your code if that list of users is mutated by another thread while your function is trying to sort the list? For instance, imagine that 20 users are removed from the list while you’re trying to sort it; what will happen to your function?

You can demonstrate this problem for yourself. Remembering that Scala Array elements can be mutated, imagine that you have an `Array[String]` like this:

```
// 1 - a mutable sequence to work with
val arr = Array("one", "two", "three", "four", "five")
```

Then imagine that you begin printing the length of each string in a different thread, like this:

```
// 2 - start printing the numbers in a different thread
val thread = new Thread {
  override def run {
    printStringLength(arr)
  }
}
thread.start
```

If you now mutate the array like this:

```
// 3 - mutate the sequence to see how that other thread works
Thread.sleep(100)
arr(3) = null
```

you can easily generate a `NullPointerException` if your `printStringLength` method looks like this:

```
def printStringLength(xs: Seq[String]) {
  for (x <- xs) {
    println(x.length)
    Thread.sleep(200)
  }
}
```

Conversely, it's impossible to replicate this example if you use a Scala `Vector` or `List`. Because these sequences are immutable, you can't accidentally mutate a sequence in one thread while it's being used in another.

## Transform as you copy, don't mutate

In my previous Java/OOP life I mutated variables all the time. That's how I did almost everything, and frankly, I didn't know there was another way. I knew that a Java String was immutable, but based on my OOP thinking, I thought this was more of a pain than anything that was actually helpful to me.

But when you think of your code as algebra, you realize that mutating a variable has nothing to do with algebra. For instance, I never had a math instructor who said, "Okay,  $x$  is currently 10, but let's go ahead and add 1 to it so  $x$  is now 11." Instead what they said is, "Okay, we have  $x$ , which is 10, and what we'll do is add 1 to it to get a new value  $y$ ":

```
x = 10
y = x + 1
```

In FP code you do the same thing. You never mutate  $x$ , but instead you use it as a foundation to create a new value. In Scala, you typically do this using the case class copy method.

### *The case class copy method*

When you use a Scala *case class* you automatically get a copy method that supports this "transform as you copy" algebraic philosophy.

A simple way to demonstrate this is to show what happens when a person changes their name. I'll demonstrate this with two variations of a Person class, first showing an OOP/imperative approach, and then showing an FP/algebraic approach.

With OOP code, when Jonathan Stuart Leibowitz changes his name to Jon Stewart, you write code like this:

```
// oop design
class Person(var name: String)

// create an instance with the original name
var p = new Person("Jonathan Stuart Leibowitz")

// change the name by mutating the instance
p.name = "Jon Stewart"
```

In my OOP life I wrote code like that all the time and never gave it a second thought. But you just don't do that sort of thing in algebra. Instead, what you do in FP/algebraic code is this:

```
// fp design
case class Person(name: String)

// create an instance with the original name
val p = Person("Jonathan Stuart Leibowitz")

// create a new instance with the "update as you copy" approach
val p2 = p.copy(name = "Jon Stewart")
```

The FP approach uses the copy method to create a new value p2 from the original p, resulting in p2.name being “Jon Stewart.”

Mathematically, the last two lines of the FP approach are similar to this:

```
val p = a
val p2 = p + b
```

It's good to see the case class copy approach now, because (a) it's a Scala/FP idiom, and (b) we're going to use it a lot in this book.

As I mentioned earlier, I *never* thought of my OOP code as having the slightest thing to do with algebra. Now I think of it that way all the time, and that thought process is the result of writing pure functions and using only immutable variables.

## Later in this book: Algebraic Data Types

Another way that FP relates to algebra is with a concept known as Algebraic Data Types, or ADTs. Don't worry about that name, ADT is a simple concept. For example, this code is an ADT:

```
sealed trait Bool
case object True extends Bool
case object False extends Bool
```

This code from the book, [Beginning Scala](#), is also an ADT:

```
sealed trait Shape
case class Circle(radius: Double) extends Shape
case class Square(length: Double) extends Shape
case class Rectangle(h: Double, w: Double) extends Shape
```

I don't want to get into this in much detail right now, I just want to let you know that there's more algebra later in this book. The "algebra" in ADTs is described on [the Haskell wiki](#) like this:

“Algebraic” refers to the property that an Algebraic Data Type is created by “algebraic” operations. The “algebra” here is “sums” and “products” (of types).

Again, don't fear the term; it's another complicated-sounding term for a simple concept, as shown in these examples.

## Summary

In this lesson I tried to show a few ways that functional programming is like algebra. I showed how simple algebraic functions can be written as pure functions in Scala, and I showed how a series of Scala expressions looks just like a series of algebraic functions. I also demonstrated how a series of expressions can be reduced using simple algebraic substitution. I also noted that in the future you'll learn about a term named Algebraic Data Types.

The intent of this lesson is to help you keep building an “FP way of thinking” about programming problems. If you write your code using only pure functions and immutable variables, your code will natural migrate towards this algebraic way of thinking:

Pure Functions + Immutable Values == Algebra

Who knows, you may even start saying that your functions “evaluate to a result.”

## See Also

- [What the Heck are Algebraic Data Types](#), the Daniel Eklund paper
- [Algebraic Data Type on Wikipedia](#)
- [The Algebra of Algebraic Data Types](#)
- [Algebraic Data Type on the Haskell wiki](#)

# **A Note About Expression-Oriented Programming**



## Goals

This chapter isn't a *lesson* so much as it is an observation — a short note that the FP code I'm writing in this book also falls into a category known as *Expression-Oriented Programming*, or EOP.

In fact, because Pure FP code is more strict than EOP, FP is a superset of EOP. As a result, we just happen to be writing EOP code while we're writing Scala/FP code.

Therefore, my goals for this lesson are:

- To show the difference between *statements* and *expressions*
- To briefly explain and demonstrate EOP
- To note that all “Pure FP” code is also EOP code

(I wrote about EOP in the [Scala Cookbook](#), so I'll keep this discussion short.)

## Statements and expressions

When you write pure functional code, you write a series of expressions that combine pure functions. In addition to this code conforming to an FP style, the style also fits the definition of “Expression-Oriented Programming,” or EOP. This means that every line of code returns a result (“evaluates to a result”), and is therefore an *expression* rather than a *statement*.

As noted in the quote at the beginning of this chapter, statements do not return results, and are executed solely for their side effects.

An *expression* has the form:

```
val resultingValue = somePureFunction(someImmutableValues)
```

Contrast that with the OOP “statement-oriented code” I used to write:

```
order.calculateTaxes()  
order.updatePrices()
```

Those two lines of code are *statements* because they don’t have a return value; they’re just executed for their side effects.

In FP and EOP you write those same statements as expressions, like this:

```
val tax = calculateTax(order)  
val price = calculatePrice(order)
```

While that may seem like a minor change, the effect on your overall coding style is huge. Writing code in an EOP style is essentially a gateway to writing in an FP style.

## A key point

A key point of this lesson is that when you see statements like this:

```
order.calculateTaxes()  
order.updatePrices()
```

you should think, “Ah, these are *statements* that are called for their side effects. This is imperative code, not FP code.”

## Scala supports EOP (and FP)

Scala provides strong support for FP code, and therefore, EOP code. As I noted in the [Scala Cookbook](#), these are obviously *expressions*:

```
val x = 2 + 2
val doubles = List(1,2,3,4,5).map(_ * 2)
```

But it's a little less obvious that the if/then construct can also be used to write expressions:

```
val greater = if (a > b) a else b
```

The match construct also evaluates to a result, and is used to write expressions:

```
val evenOrOdd = i match {
  case 1 | 3 | 5 | 7 | 9 => println("odd")
  case 2 | 4 | 6 | 8 | 10 => println("even")
}
```

And try/catch blocks are also used to write expressions:

```
def toInt(s: String): Int = {
  try {
    s.toInt
  } catch {
    case _ : Throwable => 0
  }
}
```

## Summary

When every line of code has a return value, it's said that you are writing *expressions*, and using an EOP style. In contrast, *statements* are lines of code that do not have return values, and are executed for their side effects. When you see statements in code you should think, "This is imperative code, not FP code."

As noted in this lesson, because EOP is a subset of an FP style, when you write Scala/FP code you are also writing EOP code.

## **What's next**

Given this background, the next lesson shows how writing Unix pipeline commands also fits an EOP style, and in fact, an FP style.

# **Functional Programming is Like Unix Pipelines**

## Goals

The primary goal of this lesson is to show that you can think of writing functional programs as being like writing Unix pipeline commands. Stated another way, if you've written Unix pipeline commands before, you have probably written code in a functional style, whether you knew it or not.

As a second, smaller goal, I want to demonstrate a few ways that you can look at your code visually to help you "Think in FP."

Note: This section is written for Unix and Linux users. If you don't know Unix, (a) I highly recommend learning it, and (b) you may want to (sadly) skip this section, as it may not make much sense unless you know the Unix commands that I show.



## Discussion

One way to think about FP is that it's like writing Unix/Linux pipeline commands, i.e., a series of two or more commands that you combine at the Unix command line to get a desired result.

For example, imagine that your boss comes to you and says, “I need a script that will tell me how many unique users are logged into a Unix system at any given time.” How would you solve this problem?

Knowing Unix, you know that the `who` command shows the users that are currently logged in. So you know that you want to start with `who` — that's your data source. To make things interesting, let's assume that `who` doesn't support any command-line arguments, so all you can do is run `who` without arguments to generate a list of users logged into your system, like this:

```
$ who
al      console  Oct 10 10:01
joe     ttys000  Oct 10 10:44
tallman ttys001  Oct 10 11:05
joe     ttys002  Oct 10 11:47
```

`who`'s output is well structured and consistent. It shows the username in the first column, the “console” they're logged in on in the second column, and the date and time they logged in on in the last columns.

Some Unix systems may show the IP address the user is logged in from. I left that column off of these examples to keep things simple.

If you didn't have to automate this solution, you could solve the problem by looking at the unique usernames in the first column. In this case there are four lines of output, but only three of the usernames are unique — `al`, `joe`, and `tallman` — so the answer to your boss's question is that there are three unique users logged into the system at the moment.

Now that you know how to solve the problem manually, the question becomes, how do you automate this solution?

## An algorithm

The solution's algorithm appears to be:

- Run the `who` command
- Create a list of usernames from the first column
- Get only the unique usernames from that list
- Count the size of that list

In Unix that algorithm translates to chaining these commands together:

- Start with `who` as the data source
- Use a command like `cut` to create the list of usernames
- Use `uniq` to get only the unique usernames from that list
- Use `wc -l` to count those unique usernames

## Implementing the algorithm

A solution for the first two steps is to create this simple Unix pipeline:

```
who | cut -d' ' -f1
```

That `cut` command can be read as, “Using a blank space as the field separator (`-d`), print the first field (`-f1`) of every row of the data stream from STDIN to STDOUT.” That pipeline command results in this output:

```
al
joe
tallman
joe
```

Notice what I did here: I combined two Unix commands to get a desired result. If you think of the `who` command as providing a list of strings, you can think of the `cut` command as being a pure function: it takes a list of strings as an input parameter, runs a transformation algorithm on that incoming data, and produces an output list of strings. It doesn’t use anything but the incoming data and its algorithm to produce its result.

As a quick aside, the signature for a Scala `cut` function that works like the Unix `cut` command might be written like this:

```
def cut(strings: Seq[String],
        delimiter: String,
        field: Int): Seq[String] = ???
```

Getting back to the problem at hand, my current pipeline command generates this output:

```
al
joe
tallman
joe
```

and I need to transform that data into a “number of unique users.”

To finish solving the problem, all I need to do is to keep combining more pure functions — er, Unix commands — to get the desired answer. That is, I need to keep transforming the data to get it into the format I want.

The next thing I need to do is reduce that list of *all users* down to a list of *unique users*. I do that by adding the `uniq` command to the end of the current pipeline:

```
who | cut -d ' ' -f1 | uniq
```

`uniq` transforms its STDIN to this STDOUT:

```
al  
joe  
tallman
```

Now all I have to do to get the number of unique users is count the number of lines that are in the stream with `wc -l`:

```
who | cut -d ' ' -f1 | uniq | wc -l
```

That produces this output:

```
3
```

Whoops. What's that 3 doing way over there to the right? I want to think of my result as being an `Int` value, but this is more like a `String` with a bunch of leading spaces. What to do?

Well, it's Unix, so all I have to do is add another command to the pipeline to transform this string-ish result to something that works more like an integer.

There are many ways to handle this, but I know that the Unix `tr` command is a nice way to remove blank spaces, so I add it to the end of the current pipeline:

```
who | cut -d ' ' -f1 | uniq | wc -l | tr -d ' '
```

That gives me the final, desired answer:

```
3
```

That looks more like an integer, and it won't cause any problem if I want to use this result as an input to some other command that expects an integer value (with no leading blank spaces).

If you've never used the `tr` command before, it stands for *translate*, and I wrote [a few tr command examples](#) many years ago.

## The solution as a shell script

Now that I have a solution as a Unix pipeline, I can convert it into a little shell script. For the purposes of this lesson, I'll write it in a verbose manner rather than as a pipeline:

```
WHO=`who`
RES1=`echo $WHO | cut -d' ' -f1`
RES2=`echo $RES1 | uniq`
RES3=`echo $RES2 | wc -l`
RES4=`echo $RES3 | tr -d ' '`
echo $RES4
```

Hmm, that looks suspiciously like a series of *expressions*, followed by a print statement, doesn't it? Some equivalent Scala code might look like this:

```
val who: Seq[String] = getUsers // an impure function
val res1 = cut(who, " ", 1)
val res2 = uniq(res1)
val res3 = countLines(res2)
val res4 = trim(res3)
println(res4) // a statement
```

## Combining simple expressions

I usually write “one expression at a time” code like this when I first start solving a problem, and eventually see that I can combine the expressions. For example, because the first and last lines of code are impure functions I might want to leave them alone, but what about these remaining lines?:

```
val res1 = cut(who, " ", 1)
val res2 = uniq(res1)
val res3 = countLines(res2)
val res4 = trim(res3)
```

In the first line, because `cut` is a pure function, `res1` and `cut(who, " ", 1)` will always be equivalent, so I can eliminate `res1` as an intermediate value:

```
val res2 = uniq(cut(who, " ", 1))
val res3 = countLines(res2)
val res4 = trim(res3)
```

Next, because `res2` is always equivalent to the right side of its expression, I can eliminate `res2` as an intermediate value:

```
val res3 = countLines(uniq(cut(who, " ", 1)))
```

```
val res4 = trim(res3)
```

Then I eliminate `res3` for the same reason:

```
val res4 = trim(countLines(uniq(cut(who, " ", 1))))
```

Because there are no more intermediate values, it makes sense to rename `res4`:

```
val result = trim(countLines(uniq(cut(who, " ", 1))))
```

If you want, you can write the entire original series of expressions and statements — including `getUsers` and the `println` statement — like this:

```
println(trim(countLines(uniq(cut(getUsers, " ", 1)))))
```

As a recap, I started with this:

```
val who: Seq[String] = getUsers
val res1 = cut(who, " ", 1)
val res2 = uniq(res1)
val res3 = countLines(res2)
val res4 = trim(res3)
println(res4)
```

and ended up with this:

```
println(trim(countLines(uniq(cut(getUsers, " ", 1)))))
```

The thing that enables this transformation is that all of those expressions in the middle of the original code are pure function calls.

That code shows the Scala equivalent of the Unix pipeline solution:

```
who | cut -d' ' -f1 | uniq | wc -l | tr -d ' '
```

I find solutions like this amusing, because condensed Scala code like this tends to look like Lisp code. To read the code, you start at the inside (with `getUsers`), and work your way out (to `cut`, then `uniq`, etc.).

As a final note, you don't have to use this condensed style. Use whatever style you're comfortable with.

## How is this like functional programming?

“That’s great,” you say, “but how is this like functional programming?”

Well, when you think of the `who` command as generating a list of strings (`Seq[String]`), you can then think of `cut`, `uniq`, `wc`, and `tr` as being a series of transformer functions, because they transform the input they’re given into a different type of output, as shown in Figure [fig:unixPipelines1].

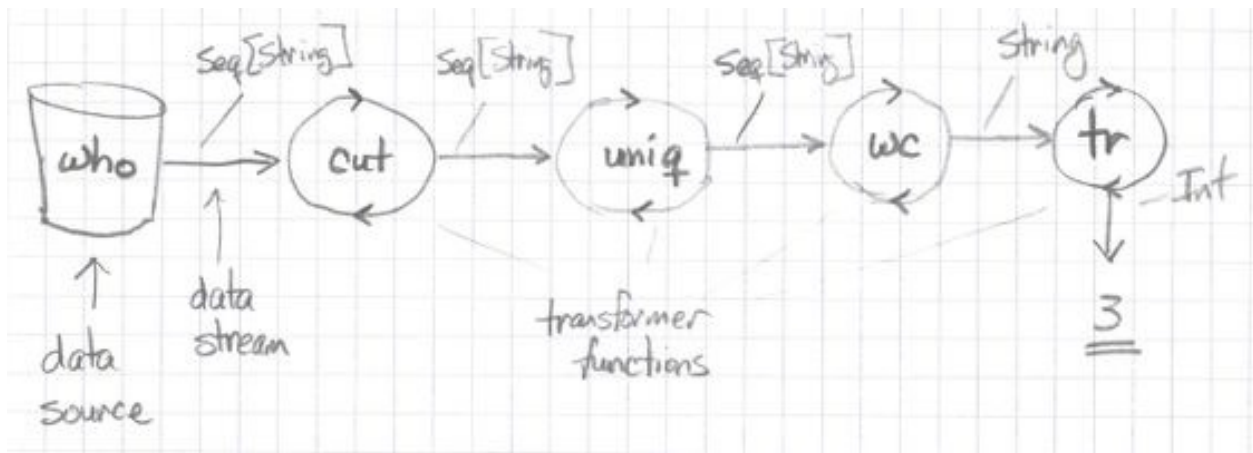

Unix commands transform their input into their output

Looking at just the `wc` command — and thinking of it as a pure function — you can think of it as taking a `Seq[String]` as its first input parameter, and when it’s given the `-l` argument, it returns the number of lines that it counts in that `Seq`.

In these ways the `wc` command is a pure function:

- It takes a `Seq[String]` as input
- It does not rely on any other state or hidden values
- It does not read or write to any files
- It does not alter the state of anything else in the universe
- Its output depends only on its input

- Given the same input at various points in time, it always returns the same value

The one thing that `wc` did that I didn't like is that it left-pads its output with blank spaces, so I used the `tr` command just like the `wc` command to fix that problem: as a pure function.

A nice way to think of this code is like this:

Input -> Transformer -> Transformer ... Transformer-> Output

With that thought, this example looks as shown in Figure [fig:unixPipelines2].

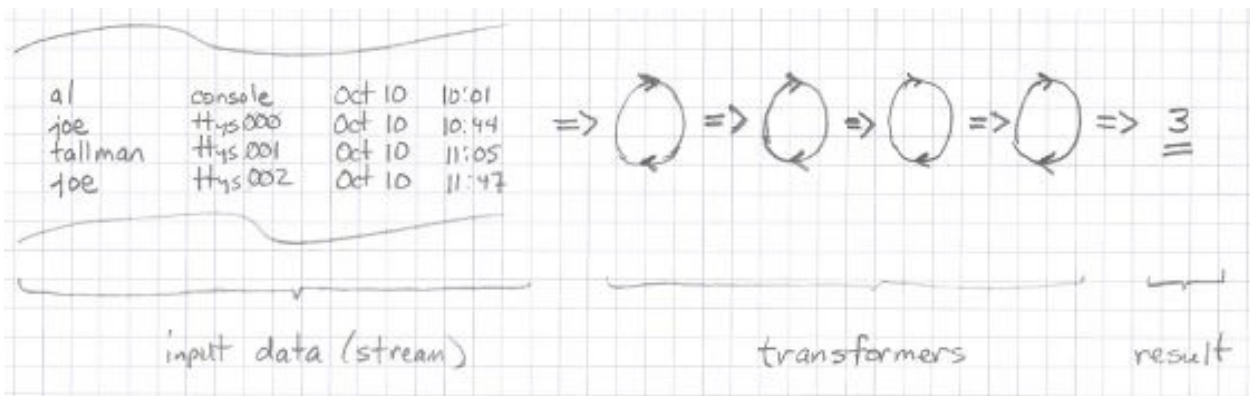

Using a series of transformers in a pipeline to solve a problem

Note a few key properties in all of this. First, data flows in only one direction, as shown in Figure [fig:unixPipelinesDataFlow].

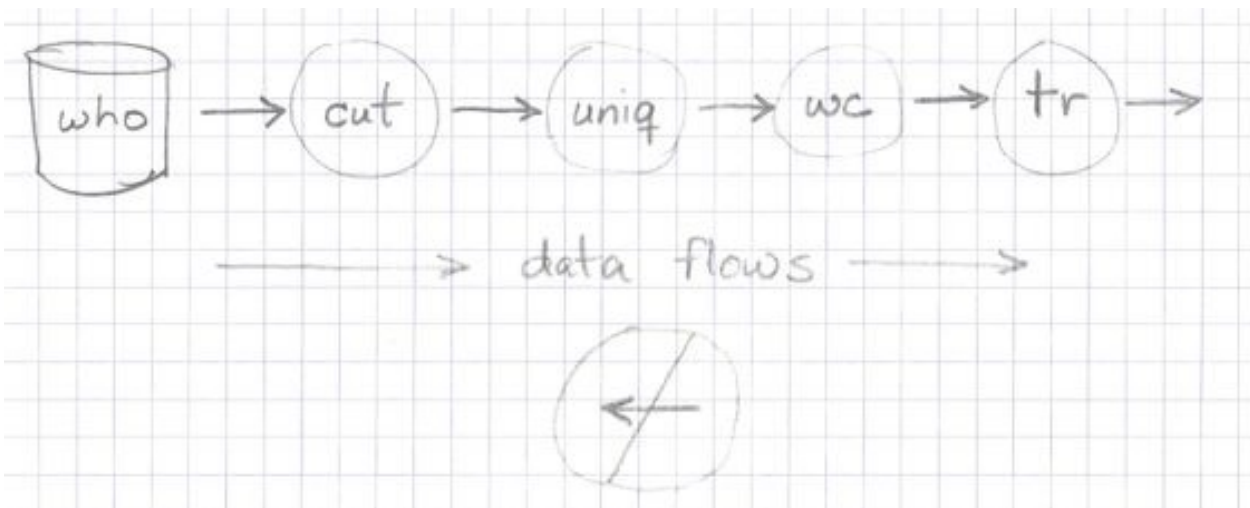



Pipeline data flows in only one direction

Second, Figure [fig:unixPipelineDataNotModified] shows that the input data a function is given is never modified.

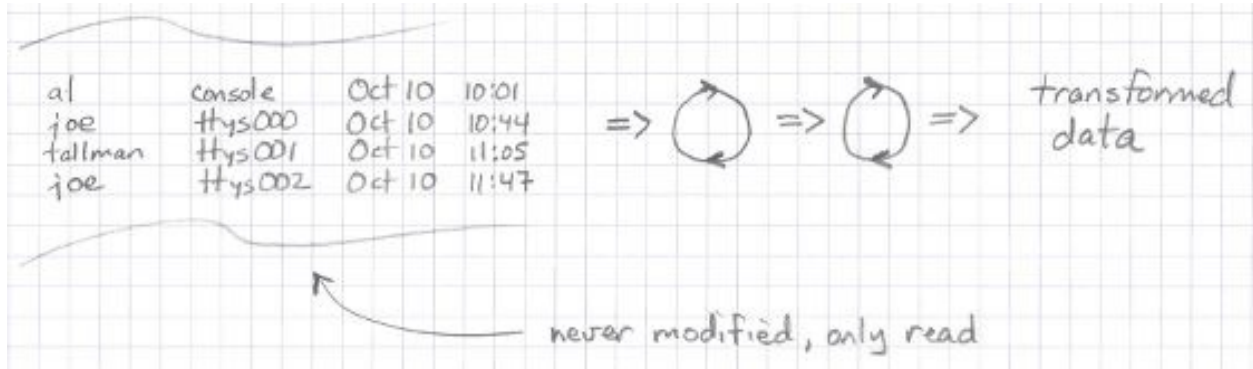

Data is never modified

Finally, as shown in Figure [fig:unixFunctionsEntranceExit], you can think of functions as having an *entrance* and an *exit*, but there are no side doors or windows for data to slip in or out.

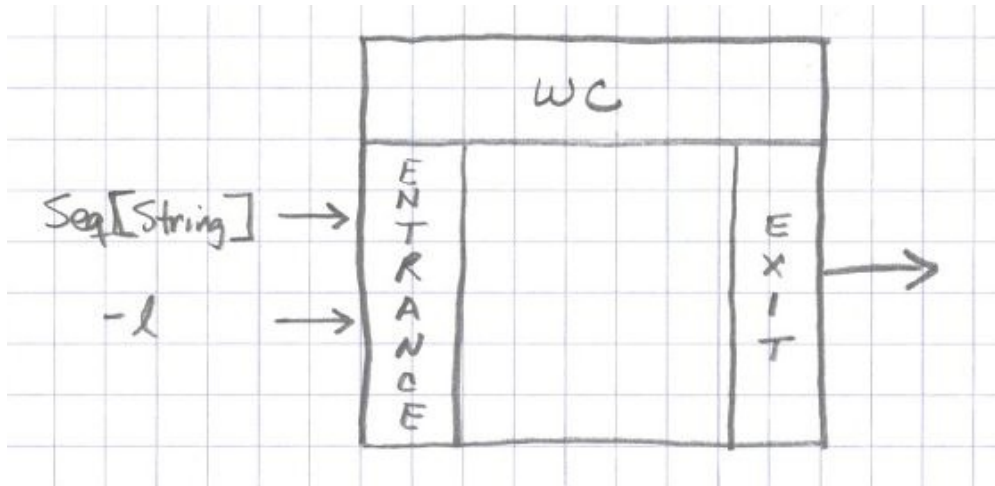

Pure functions have one entrance and one exit

These are all important properties of pure functions (and Unix commands).

## Pipelines as combinators

There's another interesting point about this example in regards to FP. When I combine these commands together like this:

```
who | cut -d' ' -f1 | uniq | wc -l | tr -d ' '
```

I create what's called in Unix a *pipeline* or *command pipeline*. In FP we call that same thing a *combinator*. That is, I combined the three commands — pure functions — together to get the data I wanted.

If I had structured my Scala code differently I could have made it look like this:

```
who.cut(delimiter=" ", field=1)
  .uniq
  .wc(lines = true)
  .tr(find=" ", replace="")
```

I'll add a more formal definition of “combinator” later in this book, but in general, when you see code like this — a chain of functions applied to some initial data — this is what most people think when they use the term “combinator.” This is another case where an FP term sounds scary, but remember that whenever you hear the term “combinator” you can think “Unix pipeline.”

## Look back at how you thought about that problem

At this point it's worth taking a moment to think about the thought process involved in solving this problem. If you look back at how it was solved, our thinking followed these steps:

- We started with the problem statement: wanting to know how many users are logged into the system.
- We thought about what data source had the information we needed, in this case the output of the `who` command.
- At this point I should note that implicit in my own thinking is that I knew the *structure* of the data I'd get from the `who` command. That is, as an experienced Unix user I knew that `who` returns a list of users, with each user login session printed on a new line.
- Depending on your thought process you may have thought of the `who` output as a multiline `String` or as a `List` (or more generally as a `Seq` in Scala). Either thought is fine.
- Because you knew the structure of the `who` data, and you know your Unix commands, you knew that you could apply a sequence of standard commands to the `who` data to get the number of unique users.
- You may or may not have known beforehand that the `wc -l` output is padded with blank spaces. I did not.

### *The functional programming thought process*

The reason I mention this thought process is because that's what the functional programming thought process is like:

- You start with a problem to solve.
- You either know where the data source is, or you figure it out.
- Likewise, the data is either in a known format, or in a format you need to

learn.

- You clearly define the output you want in the problem statement.
- You apply a series of pure functions to the input data source(s) to transform the data into a new structure.
- If all of the functions that you need already exist, you use them; otherwise you write new pure functions to transform the data as needed.

Note the use of the word *apply* in this discussion. Functional programmers like to say that they *apply* functions to input data to get a desired output. As you saw, using the word “apply” in the previous discussion was quite natural.

## More exercises

If you'd like to test that process with some more examples, here are a few more exercises you can work with to get the hang of an FP style of problem-solving:

- Write a pipeline to show the number of processes owned by the root user.
- Write a pipeline to show the number of open network connections. (Tip: I use `netstat` as the data source.)
- Use the `lsof` command to show what computers your computer is currently connected to.
- Write a pipeline command to show which processes are consuming the most RAM on your computer.
- Write a command to find the most recent `.gitignore` file on your computer.

## Data flow diagrams

Besides demonstrating how writing Unix pipeline commands are like writing FP code (and vice-versa), I'm also trying to demonstrate "The FP Thought Process." Because "output depends only on input," FP lends itself to something that used to be called "Data Flow Diagrams" — or DFDs — back in the old days.

There's a formal notation for DFDs, but I don't care for it. (There are actually several formal notations.) If I was going to sketch out the solution to the last problem, I'd draw it like the image in Figure [fig:unixDfdSketch].

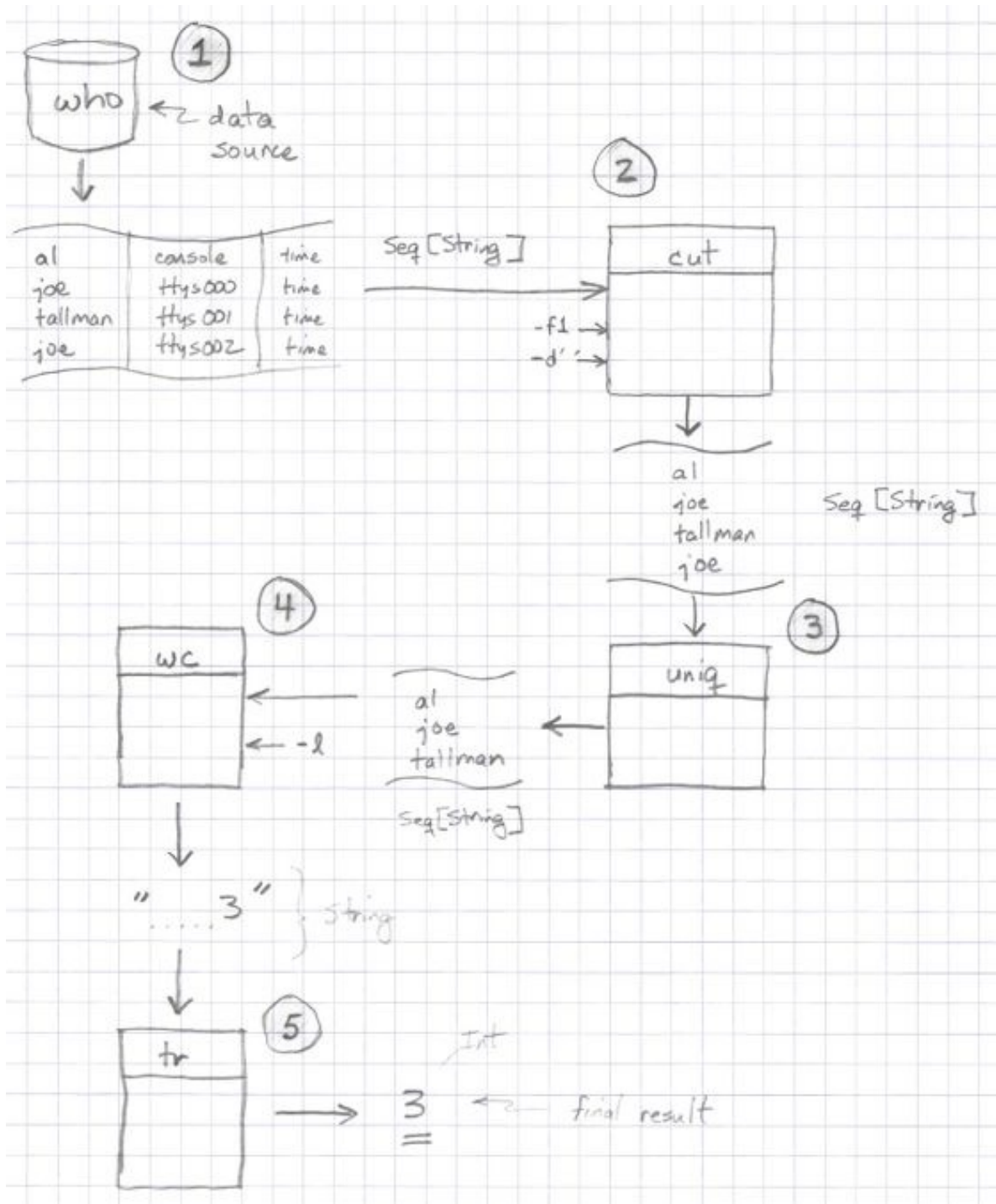

A DFD-like sketch of the pipeline solution

Because I'm using my own graphical drawing language here, I'll note that at the moment:

- I prefer to draw *data flows* as streams (simple tables).

- I like to annotate streams with their data types.
- I like to draw functions as rectangles (because of the whole front-door/back-door, entrance/exit concept).

I'm not suggesting that you have to draw out every problem and solution like this, but if you're working on a hard problem, this can be helpful.

### ***“Conservation of data”***

If I'm working on a difficult problem, or trying to explain a solution to other people, I like to draw visual diagrams like that. The book, [Complete Systems Analysis](#), by Robertson and Robertson, defines something else that they call a “Rule of Data Conservation,” which they state like this:

“Each process (function) in the data flow diagram must be able to produce the output *data flows* from its input.”

Using their diagramming process, the data that flows from the who command would be described like this:

Who = Username + Terminal + Date + Time

If you take the time to draw the data flows like this, it's possible to make sure that the “Rule of Data Conservation” is satisfied — at least assuming that you know each function's algorithm.

### ***“Black holes and miracles”***

A set of Power Point slides I found at DePaul.edu makes the following interesting observations about data flows:

- Data stays at rest unless moved by a process
- Processes cannot consume or create data
  - Must have at least 1 input data flow (to avoid miracles)
  - Must have at least 1 output data flow (to avoid black holes)



Just substitute “function” for “process” in their statements, and I really like those last two lines — avoiding *black holes* and *miracles* — as they apply to writing pure functions.

## **One caveat about this lesson**

In this lesson I tried to show how writing Unix pipeline commands is like writing FP code. One part I didn't show is a program that runs continuously until the user selects a "Quit" option. But fear not, I'll show this in an upcoming lesson, I just need to provide a little more background information, including covering topics like recursive programming.

## Summary

As I mentioned at the beginning, my main goal for this lesson is to demonstrate that writing Unix pipeline commands is like writing functional code. Just like functional programming, when you write Unix pipeline commands:

- You have data sources, or inputs, that bring external data into your application.
- Unix commands such as `cut`, `uniq`, etc., are like pure functions. They take in immutable inputs, and generate output based only on those inputs and their algorithms.
- You combine Unix commands with pipelines in the same way that you use FP functions as “combinators.”

# **Functions Are Variables, Too**

# Goals

The goal of this lesson is to show that in a good FP language like [Scala](#), you can use functions as values. In the same way that you create and use `String` and `Int` values, you can use a function:

```
val name = "Al"           // string value
val weight = 222         // int value
val double = (i: Int) => i * 2 // function value
```

To support this goal, this lesson shows:

- How to define a function as a `val`
- The “implicit” form of the `val` function syntax
- How to pass a function to another function
- Other ways to treat functions as values

## Scala's `val` function syntax

Understanding Scala's `val` function syntax is important because you'll see function signatures in a variety of places, including:

- When you define `val` functions
- When you define function input parameters (i.e., when one function takes another function as an input parameter)
- When you're reading the Scaladoc for almost every method in the Scala collections classes
- In the REPL output

You'll see examples of most of these in this lesson.

## Formalizing some definitions

Before getting into this lesson, it will help to make sure that I'm formal about how I use certain terminology. For instance, given this expression:

```
val x = 42
```

it's important to be clear about these things:

1. Technically, `x` is a *variable*, a specific type of variable known as an *immutable variable*. Informally, I prefer to refer to `x` as a "value," as in saying, "`x` is an integer value." I prefer this because `x` is declared as a `val` field; it's bound to the `Int` value 42, and that can never change. But to be consistent with (a) other programming resources as well as (b) algebraic terminology, I'll refer to `x` as a *variable* in this lesson.

[Wikipedia states](#) that in algebra, "a variable is an alphabetic character representing a number, called the value of the variable, which is either arbitrary or not fully specified or unknown." So in this way, referring to `x` as a variable is consistent with algebraic terms.

1. `x` has a *type*. In this case the type isn't shown explicitly, but we know that the type is an `Int`. I could have also defined it like this:

```
val x: Int = 42
```

But because programmers and the Scala compiler know that 42 is an `Int`, it's convenient to use the shorter form.

1. Variables themselves have *values*, and in this example the variable `x` has the value 42. (As you can imagine, it might be confusing if I wrote, "The value `x` has the value 42.")

I'm formalizing these definitions now because as you're about to see, these terms also apply to creating functions: functions also have variable names, types, and values.

## Function literals

If you haven't heard of the term "function literal" before, it's important to know that in this example:

```
xs.map(x => x * 2)
```

this part of the code is a *function literal*:

```
x => x * 2
```

It's just like saying that this is a *string literal*:

```
"hello, world"
```

I mention this because ...



## Function literals can be assigned to variables

In functional programming languages, function literals can be assigned to variable names. In Scala this means:

- You can define a function literal and assign it to a `val` field, which creates an immutable variable
- You give that variable a name, just like any other `val` field
- A function variable has a value, which is the code in its function body
- A function variable has a *type* — more on this shortly
- You can pass a function around to other functions, just like any other `val`
- You can store a function in a collection, such as a `Map`
- In general, you use a function variable just like any other variable

## The val function syntax

In the “Explaining the val Function Syntax” appendix, I show two different ways to define functions using vals in Scala. In this lesson I’ll use only the following approach, which shows the “*implicit* return type” syntax:

```
val isEven = (i: Int) => i % 2 == 0
```

In this case “implicit” means that this function doesn’t *explicitly* state that it returns a Boolean value; both you and the compiler can infer that by looking at the function body.

Scala also has a val function syntax where you *explicitly* declare the function’s return type, and I show that in the appendix.

I discuss the implicit syntax in detail in the appendix, but Figure [fig:functionImplicitReturnTypeSyntax] shows a quick look at what each of those fields means.

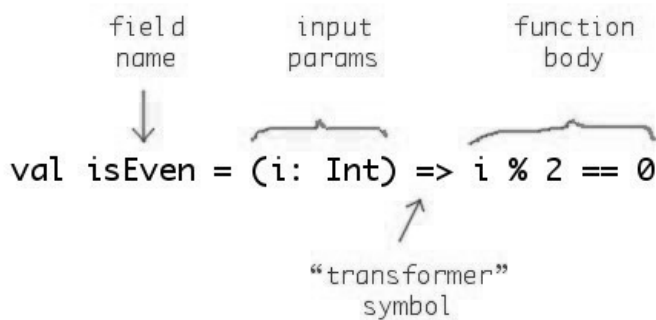

Scala’s implicit return type syntax for functions

If that syntax looks a little unusual, fear not, I show more examples of it in this lesson and in the appendices.

***Other ways to write this function***

This function body is a short way of saying that it returns `true` if the `Int` it is given is an even number, otherwise it returns `false`. If you don't like the way that code reads, it may help to put curly braces around the function body:

```
val isEven = (i: Int) => { i % 2 == 0 }
```

Or you can make the if/else condition more obvious:

```
val isEven = (i: Int) => if (i % 2 == 0) true else false
```

You can also put curly braces around that function body:

```
val isEven = (i: Int) => { if (i % 2 == 0) true else false }
```

Finally, if you prefer a *really* long form, you can write `isEven` like this:

```
val isEven = (i: Int) => {  
  if (i % 2 == 0) {  
    true  
  } else {  
    false  
  }  
}
```

Note: I only show this last version to show an example of a multi-line function body. I don't recommend writing short functions like this.

If you were going to explain any of these functions to another person, a good explanation would be like this:

“The function `isEven` transforms the input `Int` into a `Boolean` value based on its algorithm, which in this case is `i % 2 == 0`.”

When you read that sentence, it becomes clear that the `Boolean` return value is implied (implicit). I know that when I look at the code I have to pause for a moment before thinking, “Ah, it has a `Boolean` return type,” because it takes a moment for my brain to evaluate the function body to determine its return type. Therefore, even though it's more verbose, I generally prefer to write functions that explicitly specify their return type, because then I don't have to read the function body to determine the return type.

In my opinion, if (a) you have to read a function's body to determine its return type while (b) what you're really trying to do is understand some other block of

code — such as when you're debugging a problem — then (c) this forces you to think about low-level details that aren't important to the problem at hand. That's just my opinion, but it's what I've come to believe; I'd rather just glance at the function's type signature.

Stated another way, it's often easier to *write* functions that don't declare their return types, but it's harder to *maintain* them.

# The general implicit val function syntax

You can come to understand the implicit val function syntax by pasting a few functions into the Scala REPL. For instance, when you paste this function into the REPL:

```
val isEven = (i: Int) => i % 2 == 0
```

you'll see that the REPL responds by showing that isEven is an instance of something called <function1>:

```
scala> val isEven = (i: Int) => i % 2 == 0
isEven: Int => Boolean = <function1>
```

And when you paste a function that takes two input parameters into the REPL:

```
val sum = (a: Int, b: Int) => a + b
```

you'll see that it's an instance of <function2>:

```
scala> val sum = (a: Int, b: Int) => a + b
sum: (Int, Int) => Int = <function2>
```

When I line up the REPL output for those two examples, like this:

```
isEven: Int          => Boolean = <function1>
sum:    (Int, Int) => Int      = <function2>
```

you can begin to see that the general form for the way the REPL displays function variables is this:

```
variableName: type = value
```

You can see this more clearly when I highlight the function types and values. This is the REPL output for isEven:

```
isEven: Int => Boolean = <function1>
-----
name      type          value
```

and this is the output for the sum function:

```
sum:    (Int, Int) => Int = <function2>
-----
name      type          value
```

The type of the `isEven` function can be read as, “Transforms an `Int` value into a `Boolean` value,” and the `sum` function can be read as, “Takes two `Int` input parameters and transforms them into an `Int`.”

Cool FP developers generally don't say, “a function returns a result.” They say things like, “a function transforms its inputs into an output value.” Or, as it's stated in the [Land of Lisp](#) book, Lisp purists prefer to say that “a function *evaluates* to a result.” This may seem like a minor point, but I find that using phrases like this helps my brain to think of my code as being a combination of algebraic functions (or equations) — and that's a good way to think.

## What <function1> and <function2> mean

In the “Explaining the val Function Syntax” appendix I write more about this topic, but in short, the output <function1> indicates that `isEven` is an instance of [the Function1 trait](#) (meaning that it has one input parameter), and <function2> means that `sum` is an instance of [the Function2 trait](#) (meaning that it has two input parameters). The actual “value” of a function is the full body of the function, but rather than show all of that, the REPL uses <function1> and <function2> to show that `isEven` and `sum` are instances of these types.

As I discuss in that appendix, behind the scenes the Scala compiler converts this function:

```
val sum = (a: Int, b: Int) => a + b
```

into code that looks a lot like this:

```
val sum = new Function2[Int, Int, Int] {  
  def apply(a: Int, b: Int): Int = a + b  
}
```

I don't want to get too hung up on these details right now, but this is where the `Function2` reference comes from. For more information on this topic, see the “Explaining the val Function Syntax” appendix.

## Passing functions into other functions

A great thing about functional programming is that you can pass functions around just like other variables, and the most obvious thing this means is that you can pass one function into another. A good way to demonstrate this is with the methods in the Scala collections classes.

For example, given this list of integers (`List[Int]`):

```
val ints = List(1,2,3,4)
```

and these two functions that take `Int` parameters:

```
val isEven = (i: Int) => i % 2 == 0
val double = (i: Int) => i * 2
```

you can see that `isEven` works great with the `List` class `filter` method:

```
scala> ints.filter(isEven)
res0: List[Int] = List(2, 4)
```

and the `double` function works great with the `map` method:

```
scala> ints.map(double)
res1: List[Int] = List(2, 4, 6, 8)
```

Passing functions into other functions like this is what functional programming is all about.

### ***How this works (the short answer)***

In the upcoming lessons on Higher-Order Functions (HOFs) I show how to *write* methods like `map` and `filter`, but here's a short discussion of how the process of passing one function into another function (or method) works.

Technically `filter` is written as a method that takes a function as an input parameter. Any function it accepts must (a) take an element of the *type* contained in the collection, and (b) return a `Boolean` value. Because in this example `filter` is invoked on `ints` — which is a `List[Int]` — it expects a function that takes an `Int` and returns a `Boolean`. Because `isEven` transforms an `Int` to a `Boolean`, it works great with `filter` for this collection.



## A look at the Scaladoc

The `filter` method Scaladoc is shown in Figure [fig:scaladocListFilter]. Notice how it takes a predicate which has the generic type `A` as its input parameter, and it returns a `List` of the same generic type `A`. It's defined this way because `filter` doesn't *transform* the list elements, it just filters out the ones you don't want.

```
def filter(p: (A) => Boolean): List[A]
```

Selects all elements of this traversable collection which satisfy a predicate.

---

<b>p</b>	the predicate used to test elements.
<b>returns</b>	a new traversable collection consisting of all elements of this traversable collection that satisfy the given predicate <code>p</code> . The order of the elements is preserved.

The `filter` method of Scala's `List` class

As shown in Figure [fig:scaladocListMap], `map` also takes a function that works with generic types. In my example, because `ints` is a `List[Int]`, you can think of the generic type `A` in the image as an `Int`. Because `map` is intended to let you *transform* data, the generic type `B` can be any type. In my example, `double` is a function that takes an `Int` and returns an `Int`, so it works great with `map`.

```
def map[B](f: (A) => B): List[B]
```

[use case]  
Builds a new collection by applying a function to all elements of this list.

---

<b>B</b>	the element type of the returned collection.
<b>f</b>	the function to apply to each element.
<b>returns</b>	a new list resulting from applying the given function <code>f</code> to each element of this list and collecting the results.

The `map` method of Scala's `List` class

I explain this in more detail in upcoming lessons, but the important point for this lesson is that you *can* pass a function variable into another function.

## Because functions are variables ...

Because functions are variables, you can do all sorts of things with them. For instance, if you define two functions like this:

```
val double = (i: Int) => i * 2
val triple = (i: Int) => i * 3
```

you can have fun and store them in a Map:

```
val functions = Map(
  "2x" -> double,
  "3x" -> triple
)
```

If you put that code into the REPL, you'll have two functions stored as values inside a Map.

Now that they're in there, you can pass the Map around as desired, and then later on get references to the functions using the usual Map approach, i.e., by supplying their key values. For example, this is how you get a reference to the double function that's stored in the Map:

```
scala> val dub = functions("2x")
d: Int => Int = <function1>
```

This is just like getting a String or an Int or any other reference out of a Map — you specify the key that corresponds to the value.

Now that you have a reference to the original double function, you can invoke it:

```
scala> dub(2)
res0: Int = 4
```

You can do the same things with the other function I put in the Map:

```
scala> val trip = functions("3x")
t: Int => Int = <function1>

scala> trip(2)
res1: Int = 6
```

These examples show how to create functions as variables, store them in a Map, get them out of the Map, and then use them.

## ***The point of this example***

Besides showing how to put function variables into Maps, a key point of this example is: in Scala you can use a function variable just like a `String` variable or an `Int` variable. The sooner you begin treating functions as variables in your own code, the further you'll be down the path of becoming a great functional programmer.

## ***Exercise***

Given what I've shown so far, this request may be a bit of an advanced exercise, but ... here's that Map example again:

```
val functions = Map(  
  "2x" -> double,  
  "3x" -> triple  
)
```

Given that Map, sketch its data type here:

As an example of what I'm looking for, this Map:

```
val m = Map("age" -> 42)
```

has a data type of:

```
Map[String, Int]
```

That's what I'm looking for in this exercise: the *type* of the Map named `functions`.

## ***Solution to the exercise***

If you pasted the Map code into the REPL, you saw its output:

```
Map[String, Int => Int] = Map(2x -> <function1>, 3x -> <function1>)
```

The first part of that output shows the Map's data type:

```
Map[String, Int => Int]
```

The data type for the Map's *key* is `String`, and the type for its *value* is shown as `Int => Int`. That's how you write the *type* for a function that transforms a

single `Int` input parameter to a resulting `Int` value. As you know from the previous discussion, this means that it's an instance of the `Function1` trait.

As a second example, if the `Map` was holding a function that took two `Int`'s as input parameters and returns an `Int` — such as the earlier `sum` function — its type would be shown like this:

```
Map[(Int, Int) => Int]
```

That would be a `Function2` instance, because it takes two input parameters.

## Examples of val functions

To help you get comfortable with the “implicit return type” version of the val function syntax, here are the functions I showed in this lesson:

```
val isEven = (i: Int) => i % 2 == 0
val sum = (a: Int, b: Int) => a + b
val double = (i: Int) => i * 2
val triple = (i: Int) => i * 3
```

And here are a few more functions that show different input parameter types:

```
val strlen = (s: String) => s.length
val concat = (a: String, b: String) => a + b

case class Person(firstName: String, lastName: String)
val fullName = (p: Person) => s"${p.firstName} ${p.lastName}"
```

## Summary

Here's a summary of what I showed in this lesson:

- Function literals can be assigned to `val` fields to create function variables
- To be consistent with algebra and other FP resources, I refer to these fields are *variables* rather than *values*
- Examples of the `val` function syntax
- A function is an instance of a `FunctionN` trait, such as `Function1` or `Function2`
- What various function type signatures look like in the REPL
- How to pass a function into another function
- How to treat a function as a variable by putting it in a `Map`
- That, in general, you can use a function variable just like any other variable

In regards to `val` function signatures, understanding them is important because you'll see them in many places, including function literals, the Scaladoc, REPL output, and other developer's code. You'll also need to know this syntax so you can write your own functions that take other functions as input parameters.

## What's next

The next lesson shows that you can use `def` methods just like `val` functions. That's important because most developers prefer to use the `def` method syntax to define their algorithms.

## See also

- Scala's [Function1 trait](#)
- The online version of [Explaining the val Function Syntax](#)



# **Using Methods As If They Were Functions**

# Goals

As shown in Figure [fig:useMethodsLikeFuncsListMapScaladoc], have you noticed that the Scaladoc for the `List` class `map` method clearly shows that it takes a *function*?

```
def map[B](f: (A) => B): List[B]
  [use case]
  Builds a new collection by applying a function to all elements of this list.

```

---

**B** the element type of the returned collection.  
**f** the function to apply to each element.  
**returns** a new list resulting from applying the given function `f` to each element of this list and collecting the results.

The `map` method of Scala's `List` class

But despite that, you can somehow pass it a *method* and it still works, as shown in this code:

```
// [1] create a method
scala> def doubleMethod(i: Int) = i * 2
doubleMethod: (i: Int)Int

// [2] supply the method where a function is expected
scala> List(1,2,3).map(doubleMethod)
res0: List[Int] = List(2, 4, 6)
```

The intent of this lesson is to provide an explanation of how this works, and because it works, how it affects your Scala/FP code.

## Motivation

I think it's safe to say that most Scala/FP developers prefer to define their "functions" using the `def` keyword. But because the result isn't 100% exactly the same as writing a `val` function, it can be important to understand the differences between the two approaches, which I do in this lesson.

## A def method is not a val (Part 1)

From the previous lessons, you know that this example creates an instance of the `Function1` trait:

```
scala> val isEven = (i: Int) => i % 2 == 0
isEven: Int => Boolean = <function1>
```

However, when you write the same algorithm using `def`, the REPL output shows that you create something else:

```
scala> def isEven(i: Int) = i % 2 == 0
isEven: (i: Int)Boolean
```

The REPL output for the two examples is clearly different. This is because a `val` function is an instance of a `Function0` to `Function22` trait, but a `def` method is ... well ... when you're not working in the REPL — when you're writing a real application — it's a method that needs to be defined inside of a class, object, or trait.

### A deeper look

You can see the differences between `def` methods and `val` functions even more clearly by working with the Scala compiler at the command line. First, create a file named *Methods.scala* and put this code in it:

```
class Methods {
  def sum(a: Int, b: Int) = a + b
}
```

When you compile that code with `scalac`:

```
$ scalac Methods.scala
```

and then run `javap` on the resulting *Methods.class* file you'll see this output:

```
$ javap Methods
Compiled from "Methods.scala"
public class Methods {
    public int sum(int, int);
    public Methods();
}
```

`sum` is clearly a method in the class named `Methods`. Conversely, if you create a

`sum2` *function* in that same class, like this:

```
class Methods {  
  def sum(a: Int, b: Int) = a + b  
  val sum2 = (a: Int, b: Int) => a + b  
}
```

and then compile it with `scalac` and examine the bytecode again with `javap`, you'll see that a `val` function creates something completely different:

```
public Function2<Object, Object, Object> sum2();
```

(I edited that output slightly to make it more clear.)

This lesson explores these differences, particularly from the point of view of using `def` methods just as though they are real `val` functions.

## A def method is not a variable (Part 2)

In addition to showing that `def` methods are different than `val` functions, the REPL also shows that a method is not a variable that you can pass around. That is, you know that you can assign an `Int` to a variable name:

```
scala> val x = 1
x: Int = 1
```

and then show information about that variable:

```
scala> x
res0: Int = 1
```

You can also define a *function* and assign it to a variable:

```
scala> val double = (i: Int) => i * 2
double: Int => Int = <function1>
```

and then show information about it:

```
scala> double
res1: Int => Int = <function1>
```

But if you define a method using `def`:

```
scala> def triple(i: Int) = i * 3
triple: (i: Int)Int
```

and then try to show that method's “variable,” what you'll actually get is an error:

```
scala> triple
<console>:12: error: missing arguments for method triple;
follow this method with `_' if you want to treat it as a partially applied function
  triple
  ^
```

The REPL shows this error because the `triple` method is not a variable in the same way that an `Int` or a function is a variable.

Not yet, anyway. Very shortly I'll demonstrate how you can *manually* create a variable from a method.

## Recap

The reason I show these examples is to demonstrate that until you do something like passing a method into a function, a `def` method is not the same as a `val` function. Despite that, we know that somehow you *can* later treat a method as a function.

Which leads to the next question ...

## How is it that I can use a method like a function?

The answer of why you can use a method like a function is hinted at in Version 2.9 of *The Scala Language Specification*:

*“Eta-expansion converts an expression of `method` type to an equivalent expression of `function` type.”*

What that means is that when the Scala compiler is given these two lines of code:

```
def isEven(i: Int) = i % 2 == 0 // define a method
val evens = nums.filter(isEven) // pass the method into a function
```

it uses this “Eta Expansion” capability to automatically convert the *method* `isEven` into a *function* — a true `Function1` instance — so it can be passed into `filter`.

This happens automatically during the compilation process, so you generally don’t even have to think about. In fact, I used Scala for almost a year before I thought, “Hey, how is this even working?”



## How to manually convert a method to a function

To give you an idea of how Eta Expansion works, let's use the earlier `triple` example. I first defined this method:

```
scala> def triple(i: Int) = i * 3
triple: (i: Int)Int
```

and then when I tried to show its value in the REPL, I got this error:

```
scala> triple
<console>:12: error: missing arguments for method triple;
follow this method with `_' if you want to treat it as a
partially applied function
    triple
     ^
```

The error message states that you can follow this method with an underscore to treat the method as a *partially applied function*. That's true, and I demonstrate it in the next lesson. But for this lesson, the important thing to know is that *when you do this, you create a function from your method*.

To demonstrate this, go ahead and do what the error message says. Follow the method name with an underscore, and also assign that result to a variable name:

```
scala> val tripleFn = triple _
tripleFn: Int => Int = <function1>
```

Notice that the signature of this result is `Int => Int`. This means that `tripleFn` is a function that takes one `Int` as an input parameter, and returns an `Int` result. The REPL output also shows that `tripleFn` has a value `<function1>`, which means that it's an instance of the `Function1` trait. Because it's now a real function, you can display its value in the REPL:

```
scala> tripleFn
res0: Int => Int = <function1>
```

This new function works just like the method works, taking an `Int` input parameter and returning an `Int` result:

```
scala> tripleFn(1)
res0: Int = 3
```

As you'd expect, this manually-created function works just fine with the `map`

method of a List[Int]:

```
// create a List[Int]
scala> val x = List(1,2,3)
x: List[Int] = List(1, 2, 3)

// pass in the `tripleFn` function
scala> x.map(tripleFn)
res1: List[Int] = List(3, 6, 9)
```

This is a short example of what Eta Expansion does for you behind the scenes, during the compilation process.

The key point of these examples is (a) this is how things work behind the scenes, and (b) this process happens automatically when you pass a `def` method into a function that expects a *function* input parameter. Eta Expansion also lets you use `def` methods just like they are functions in many other situations.

It's hard to really “prove” in the REPL that this is what happens because I don't know of any way to disable Eta Expansion. While you can't prove it in the REPL, you can show what happens behind the scenes with the Scala compiler at the command line. If you start with this class:

```
class EtaExpansionTest {
    def double(i: Int) = i * 2
    def foo = {
        val xs = List(1,2,3)
        xs.map(double)    // pass the `double` method into `map`
    }
}
```

and then compile it with this command:

```
$ scalac -Xprint:all Methods.scala
```

you'll see a *lot* of output, and if you take the time to dig through that output, you'll be amazed at what the compiler does to the `xs.map(double)` code by the time it's done with it. I won't go into all of that here, but if you're interested in how this process works, I encourage you to dig into that output.

## In some places it doesn't happen automatically

In the previous lesson I showed that you can define functions and then store them in a Map. Can you do the same thing with methods?

Well, if you define two methods like this:

```
def double(i: Int) = i * 2
def triple(i: Int) = i * 3
```

and then try to store them in a Map, like this:

```
val functions = Map(
  "2x" -> double,
  "3x" -> triple
)
```

you'll get the following error messages:

```
<console>:13: error: missing arguments for method double;
follow this method with `_' if you want to treat it as a
partially applied function
    "2x" -> double,
           ^
<console>:14: error: missing arguments for method triple;
follow this method with `_' if you want to treat it as a
partially applied function
    "3x" -> triple
           ^
```

Prior to this lesson those errors might have been a head-scratcher, but now you know how to solve this problem — how to manually convert the methods into functions by following the *method* invocations with an underscore:

```
val functions = Map(
  "2x" -> double _,
  "3x" -> triple _
)
```

As before, that syntax converts the *double* and *triple methods* into *functions*, and then everything works as shown in the previous lesson. In this case that means that you can get a function back out of the Map and use it:

```
scala> val dub = functions("2x")
dub: Int => Int = <function1>

scala> dub(3)
res0: Int = 6
```

## Why this lesson is important

The reason I showed everything in this lesson is because most developers prefer the `def` method syntax over the `val` function syntax. Given the choice to write an algorithm using either approach, developers seem to prefer the `def` approach, and I believe that's because the `def` syntax is easier to read.

Because of this, in the rest of this book I'll often write `def` methods and refer to them as functions. Technically this isn't accurate, but because (a) methods can be used just like functions, and (b) I don't want to have to keep writing, "*A method that acts like a function,*" I will now start using this terminology.

## Summary

Here's a summary of what I showed in this lesson:

- The Scaladoc for collections methods like `map` and `filter` show that they take *functions* as input parameters.
- Despite that, somehow you can pass *methods* into them.
- The reason that works is called “Eta Expansion.”
- I showed how to manually convert a method to a function (using the partially-applied function approach).
- As a result of Eta Expansion, you can use `def` to define methods, and then generally treat them in the same way that you use `val` functions.

## What's next

In this lesson I showed that you can generally treat a `def` method just like a `val` function, and not have to worry about the differences between the two. I also showed that if the compiler doesn't take care of that process for you automatically, you can handle it manually.

In the next lesson you'll see how to write functions that take other functions as input parameters. With this background, you know that this also means that those functions will be able to take methods as input parameters as well.

# **How to Write Functions That Take Functions as Input Parameters**

## Motivation and Goals

The topic I'm about to cover is a big part of functional programming: *power programming* that's made possible by passing functions to other functions to get work done.

So far I've shown I've shown how to be a *consumer* of functions that take other functions as input parameters, that is, a consumer of *Higher Order Functions* (HOFs) like `map` and `filter`. In this lesson I'm going to show how to be the *producer* of HOFs, i.e., the writer of HOF APIs.

Therefore, the primary goal of this lesson is to show how to write functions that take other functions as input parameters. To do that I'll show:

- The syntax you use to define function input parameters
- Many examples of that syntax
- How to execute a function once you have a reference to it

As a beneficial side effect of this lesson, you'll be able to read the source code and Scaladoc for other HOFs, and you'll be able to understand the function signatures they're looking for.



# Terminology

Before we start, here are a few notes about the terminology I'll use in this lesson.

1. I use the acronym "FIP" to stand for "function input parameter." This isn't an industry standard, but because I use the term so often, I think the acronym makes the text easier to read.
2. As shown already, I'll use "HOF" to refer to "Higher Order Function."
3. As discussed in the previous lesson, because `def` methods are easier to read than `val` functions, from now on I'll write `def` methods and refer to them as "functions," even though that terminology isn't 100% accurate.

# Introduction

In the previous lesson I showed this function:

```
def isEven(i: Int) = i % 2 == 0
```

I then showed that `isEven` works great when you pass it into the `List` class `filter` method:

```
scala> val list = List.range(0, 10)
list: List[Int] = List(0, 1, 2, 3, 4, 5, 6, 7, 8, 9)

scala> val evens = list.filter(isEven)
evens: List[Int] = List(0, 2, 4, 6, 8)
```

The key points of this are:

- The `filter` method accepts a function as an input parameter.
- The functions you pass into `filter` must match the type signature that `filter` expects, i.e., the FIP you pass in must accept an input parameter of the type stored in the list and return a `Boolean`.

## Understanding `filter`'s Scaladoc

The Scaladoc shows the type of functions `filter` accepts, which you can see in Figure [fig:scaladocFunctionsFilterAccepts].

```
def filter(p: (A) => Boolean): List[A]
  Selects all elements of this traversable collection which satisfy a predicate.
```

---

<b>p</b>	the predicate used to test elements.
<b>returns</b>	a new traversable collection consisting of all elements of this traversable collection that satisfy the given predicate p. The order of the elements is preserved.

The Scaladoc shows the type of functions `filter` accepts

The Scaladoc text shows that `filter` takes a *predicate*, which is just a function that returns a `Boolean` value.

This part of the Scaladoc:

```
p: (A) => Boolean
```

means that `filter` takes a function input parameter which it names `p`, and `p` must transform a generic input `A` to a resulting `Boolean` value. In my example, where `list` has the type `List[Int]`, you can replace the generic type `A` with `Int`, and read that signature like this:

```
p: (Int) => Boolean
```

Because `isEven` has this type — it transforms an input `Int` into a resulting `Boolean` — it can be used with `filter`.

## *A lot of functionality with a little code*

The `filter` example shows that with HOFs you can accomplish a lot of work with a little bit of code. If `List` didn't have the `filter` method, you'd have to write a custom method like this to do the same work:

```
// what you'd have to do if `filter` didn't exist
def getEvens(list: List[Int]): List[Int] = {
  val tmpArray = ArrayBuffer[Int]()
  for (elem <- list) {
    if (elem % 2 == 0) tmpArray += elem
  }
  tmpArray.toList
}

val result = getEvens(list)
```

Compare all of that imperative code to this equivalent functional code:

```
val result = list.filter(_ % 2 == 0)
```

As you can see, this is a great advantage of functional programming. The code is much more concise, and it's also easier to comprehend.

As FP developers like to say, you don't tell the computer specifically “how” to do something — you don't specify the nitty-gritty details inside a custom `for` loop. Instead, in your FP code you express a thought like, “I want to create a filtered version of this list with this little algorithm.” When you do that, and you have good FP language to work with, you write your

code at a much higher programming level.

## **“Common control patterns”**

In many situations Scala/FP code can be easier to understand than imperative code. That’s because a great benefit of Scala/FP is that methods like `filter`, `map`, `head`, `tail`, etc., are all standard, built-in functions, so once you learn them you don’t have to write custom `for` loops any more. As an added benefit, you also don’t have to read other developers’ custom `for` loops.

I say this a lot, but we humans can only keep so much in our brains at one time. Concise, readable code is simpler for your brain and better for your productivity.

I know that when you first come to Scala all of these methods on the collections classes don’t feel like a benefit, they feel overwhelming. But once you realize that almost *every* `for` loop you’ve ever written falls into neat categories like `map`, `filter`, `reduce`, etc., you also realize what a great benefit these methods are. (And you’ll reduce the amount of custom `for` loops you write by at least 90%.)

Here’s what Martin Odersky wrote about this in his book, [Programming in Scala](#):

“You can use functions within your code to factor out common control patterns, and you can take advantage of higher-order functions in the Scala library to reuse control patterns that are common across all programmers’ code.”

Given this background and these advantages, let’s see how to write functions that take other functions as input parameters.

## Defining functions that take functions as parameters

To define a function that takes another function as an input parameter, all you have to do is define the signature of the function you want to accept.

To demonstrate this, I'll define a function named `sayHello` that takes a function as an input parameter. I'll name the input parameter `callback`, and also say that `callback` must have no input parameters and must return nothing. This is the Scala syntax that matches those requirements:

```
def sayHello(callback: () => Unit) {  
    callback()  
}
```

In this code, `callback` is an input parameter, and more specifically it is a *function input parameter* (or FIP). Notice how it's defined with this syntax:

```
callback: () => Unit
```

Here's how this works:

- `callback` is the name I give to the input parameter. In this case `callback` is a function I want to accept.
- The `callback` signature specifies the *type* of function I want to accept.
- The `()` portion of `callback`'s signature (on the left side of the `=>` symbol) states that it takes no input parameters.
- The `Unit` portion of the signature (on the right side of the `=>` symbol) indicates that the `callback` function should return nothing.
- When `sayHello` is called, its function body is executed, and the `callback()` line inside the body invokes the function that is passed in.

Figure [fig:howSayHelloAndCallbackWork] reiterates those points.

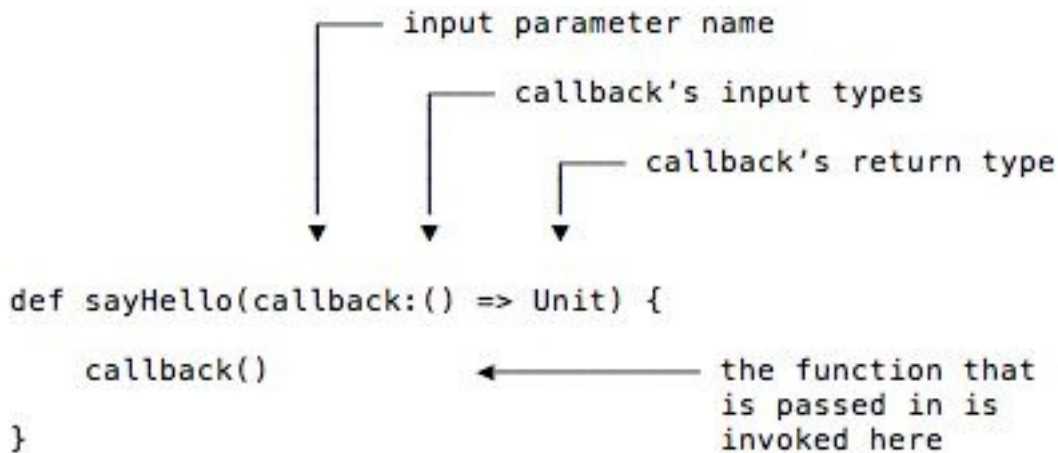

How sayHello and callback work.

Now that I've defined sayHello, I'll create a function to match callback's signature so I can test it. The following function takes no input parameters and returns nothing, so it matches callback's type signature:

```
def helloA1(): Unit = { println("Hello, A1") }
```

Because the signatures match, I can pass helloA1 into sayHello, like this:

```
sayHello(helloA1)
```

The REPL demonstrates how all of this works:

```
scala> def sayHello(callback:() => Unit) {
  |     callback()
  | }
sayHello: (callback: () => Unit)Unit

scala> def helloA1(): Unit = { println("Hello, A1") }
helloA1: ()Unit

scala> sayHello(helloA1)
Hello, A1
```

If you've never done this before, congratulations. You just defined a function named sayHello that takes another function as an input parameter, and then invokes that function when it's called.

It's important to know that the beauty of this approach is not that sayHello can take *one* function as an input parameter; the beauty is that it can take *any* function that matches callback's signature. For instance, because this next

function takes no input parameters and returns nothing, it also works with sayHello:

```
def holaLorenzo(): Unit = { println("Hola, Lorenzo") }
```

Here it is in the REPL:

```
scala> sayHello(holaLorenzo)
Hola, Lorenzo
```

This is a good start. Let's build on it by defining functions that can take more complicated functions as input parameters.

# The general syntax for defining function input parameters

I defined `sayHello` like this:

```
def sayHello(callback: () => Unit)
```

Inside of that, the `callback` function signature looks like this:

```
callback: () => Unit
```

I can explain this syntax by showing a few more examples. Imagine that we're defining a new version of `callback`, and this new version takes a `String` and returns an `Int`. That signature looks like this:

```
callback: (String) => Int
```

Next, imagine that you want to create a different version of `callback`, and this one should take two `Int` parameters and return an `Int`. Its signature looks like this:

```
callback: (Int, Int) => Int
```

As you can infer from these examples, the general syntax for defining function input parameter type signatures is:

```
variableName: (parameterTypes ...) => returnType
```

With `sayHello`, this is how the values line up:

<b>General</b>	<b>sayHello</b>	<b>Notes</b>
variableName	callback	The name you give the FIP
parameterTypes	()	The FIP takes no input parameters
returnType	Unit	The FIP returns nothing

## *Naming your function input parameters*

I find that the parameter name `callback` is good when you first start writing



HOFs. Of course you can name it anything you want, and other interesting names at first are `aFunction`, `theFunction`, `theExpectedFunction`, or maybe even `fip`. But from now on I'll make this name shorter and generally refer to the FIPs in my examples as just `f`, like this:

```
sayHello(f: () => Unit)
foo(f:(String) => Int)
bar(f:(Int, Int) => Int)
```



get, they always follow this same general syntax:

```
variableName: (parameterTypes ...) => returnType
```

For example, all of these FIP signatures follow the same pattern:

```
f: () => Unit  
f: String => Int  
f: (String) => Int  
f: (Int, Int) => Int  
f: (Person) => String  
f: (Person) => (String, String)  
f: (String, Int, Double) => Seq[String]  
f: List[Person] => Person
```

## A note about “type signatures”

I’m being a little loose with my verbiage here, so let me tighten it up for a moment. When I say that this is a “type signature”:

```
f: String => Int
```

that isn’t 100% accurate. The *type signature* of the function is really just this part:

```
String => Int
```

Therefore, being 100% accurate, these are the type signatures I just showed:

```
() => Unit  
String => Int  
(String) => Int  
(Int, Int) => Int  
(Person) => String  
(Person) => (String, String)  
(String, Int, Double) => Seq[String]  
List[Person] => Person
```

This may seem like a picky point, but because FP developers talk about type signatures all the time, I wanted to show the precise definition.

It’s common in FP to think about types a *lot* in your code. You might say that you “think in types.”

## A function that takes an Int parameter

Now let's look at a few more FIPs, with each example building on the one before it. First, here's a function named `runAFunction` that defines a FIP whose signature states that it takes an `Int` and returns nothing:

```
def runAFunction(f: Int => Unit): Unit = {  
  f(42)  
}
```

The function body says, "Whatever function you give to me, I'm going to pass the `Int` value 42 into it." This isn't terribly useful or functional, but it's a start.

Next, let's define a function that matches `f`'s type signature. The following `printIntPlus1` function takes an `Int` parameter and returns nothing, so it matches:

```
def printIntPlus1 (i: Int): Unit = { println(i+1) }
```

Now you can pass `printIntPlus1` into `runAFunction`:

```
runAFunction(printIntPlus1)
```

Because `printIntPlus1` is invoked inside `runAFunction` with the value 42, this prints 43. Here's what it all looks like in the REPL:

```
scala> def runAFunction(f: Int => Unit): Unit = {  
  |   f(42)  
  | }  
runAFunction: (f: Int => Unit)Unit  
  
scala> def printIntPlus1 (i: Int): Unit = { println(i+1) }  
printIntPlus1: (i: Int)Unit  
  
scala> runAFunction(printIntPlus1)  
43
```

Here's a second function that takes an `Int` and returns nothing:

```
def printIntPlus10(i: Int) { println(i+10) }
```

When you pass `printIntPlus10` into `runAFunction`, you'll see that it also works, printing 52:

```
runAFunction(printIntPlus10) // prints 52
```

## ***The power of the technique***

Although these examples don't do too much yet, you can see the power of HOFs:

You can easily swap in interchangeable algorithms.

As long as the signature of the function you pass in matches the signature that's expected, your algorithms can do anything you want. This is comparable to swapping out algorithms in the [OOP Strategy design pattern](#).

Let's keep building on this...

## Taking a function parameter along with other parameters

Here's a function named `executeNTimes` that has two input parameters: a function, and an `Int`:

```
def executeNTimes(f: () => Unit, n: Int) {  
  for (i <- 1 to n) f()  
}
```

As the code shows, `executeNTimes` executes the `f` function `n` times. To test this, define a function that matches `f`'s signature:

```
def helloWorld(): Unit = { println("Hello, world") }
```

and then pass this function into `executeNTimes` along with an `Int`:

```
scala> executeNTimes(helloWorld, 3)  
Hello, world  
Hello, world  
Hello, world
```

As expected, `executeNTimes` executes the `helloWorld` function three times. Cool.

## More parameters, everywhere

Next, here's a function named `executeAndPrint` that takes a function and two `Int` parameters, and returns nothing. It defines the FIP `f` as a function that takes two `Int` values and returns an `Int`:

```
def executeAndPrint(f: (Int, Int) => Int, x: Int, y: Int): Unit = {  
    val result = f(x, y)  
    println(result)  
}
```

`executeAndPrint` passes the two `Int` parameters it's given into the FIP it's given in this line of code:

```
val result = f(x, y)
```

Except for the fact that this function doesn't have a return value, this example shows a common FP technique:

- Your function takes a FIP.
- It takes other parameters that work with that FIP.
- You apply the FIP (`f`) to the parameters as needed, and return a value. (Or, in this example of a function with a side effect, you print something.)

To demonstrate `executeAndPrint`, let's create some functions that match `f`'s signature. Here are a couple of functions take two `Int` parameters and return an `Int`:

```
def sum(x: Int, y: Int) = x + y  
def multiply(x: Int, y: Int) = x * y
```

Now you can call `executeAndPrint` with these functions as the first parameter and whatever `Int` values you want to supply as the second and third parameters:

```
executeAndPrint(sum, 3, 11)    // prints 14  
executeAndPrint(multiply, 3, 9) // prints 27
```

Let's keep building on this...



## Taking multiple functions as input parameters

Now let's define a function that takes (a) multiple FIPs and (b) other parameters to feed those FIPs. Let's define a function like this:

- It takes one function parameter that expects two Ints, and returns an Int
- It takes a second function parameter with the same signature
- It takes two other Int parameters
- The Ints will be passed to the two FIPs
- It will return the results from the first two functions as a tuple — a `Tuple2`, to be specific

Since I learned FP, I like to think in terms of “Function signatures first,” so here's a function signature that matches those bullet points:

```
def execTwoFunctions(f1:(Int, Int) => Int,
                    f2:(Int, Int) => Int,
                    a: Int,
                    b: Int): Tuple2[Int, Int] = ???
```

Given that signature, can you imagine what the function body looks like?

(I'll pause for a moment to let you think about that.)

Here's what the complete function looks like:

```
def execTwoFunctions(f1: (Int, Int) => Int,
                    f2: (Int, Int) => Int,
                    a: Int,
                    b: Int): Tuple2[Int, Int] = {
  val result1 = f1(a, b)
  val result2 = f2(a, b)
  (result1, result2)
}
```

That's a verbose (clear) solution to the problem. You can shorten that three-line function body to just this, if you prefer:

```
(f1(a,b), f2(a,b))
```

Now you can test this new function with the trusty `sum` and `multiply` functions:

```
def sum(x: Int, y: Int) = x + y
def multiply(x: Int, y: Int) = x * y
```

Using these functions as input parameters, you can test `execTwoFunctions`:

```
val results = execTwoFunctions(sum, multiply, 2, 10)
```

The REPL shows the results:

```
scala> val results = execTwoFunctions(sum, multiply, 2, 10)
results: (Int, Int) = (12,20)
```

I hope these examples give you a taste for not only how to write HOFs, but the power of using them in your own code.

Okay, that's enough examples for now. I'll cover two more topics before finishing this lesson, and then in the next lesson you can see how to write a `map` function with everything I've shown so far.

## The FIP syntax is just like the val function syntax

A nice thing about Scala is that once you know how things work, you can see the consistency of the language. For example, the syntax that you use to define FIPs is the same as the “explicit return type” (ERT) syntax that you use to define functions.

I show the ERT syntax in detail in a blog post titled, [“Explaining Scala’s val Function Syntax.”](#)

What I mean by this is that when I define this function:

```
sampleFunction(f: (Int, Int) => Int)
```

the part of this code that defines the FIP signature is exactly the same as the ERT signature for the sum function that I define in that blog post:

```
val sum: (Int, Int) => Int = (a, b) => a + b
```

You can see what I mean if you line the two functions up, as shown in Figure [fig:fipSigSameAsSumErt].

```
sampleFunction(f: (Int, Int) => Int)
-----

val sum: (Int, Int) => Int = (a, b) => a + b
-----
```

The FIP signature is exactly the same as the ERT signature for the sum function.

Once you understand the FIP type signature syntax, it becomes easier to read things like (a) the ERT function syntax and (b) the Scaladoc for HOFs.

# The general thought process of designing HOFs

Personally, I'm rarely smart enough to see exactly what I want to do with all of my code beforehand. Usually I *think* I know what I want to do, and then as I start coding I realize that I really want something else. Because of this, my usual thought process when it comes to writing HOFs looks like this:

1. I write some code
2. I write more code
3. I realize that I'm starting to duplicate code
4. Knowing that duplicating code is bad, I start to refactor the code

Actually, I have this same thought process whether I'm writing OOP code or FP code, but the difference is in *what I do next*.

With OOP, what I might do at this point is to start creating class hierarchies. For instance, if I was working on some sort of tax calculator in the United States, I might create a class hierarchy like this:

```
trait StateTaxCalculator
class AlabamaStateTaxCalculator extends StateTaxCalculator ...
class AlaskaStateTaxCalculator extends StateTaxCalculator ...
class ArizonaStateTaxCalculator extends StateTaxCalculator ...
```

Conversely, in FP my approach is to first define an HOF like this:

```
def calculateStateTax(f: Double => Double, personsIncome: Double): Double = ...
```

Then I define a series of functions I can pass into that HOF, like this:

```
def calculateAlabamaStateTax(income: Double): Double = ...
def calculateAlaskaStateTax(income: Double): Double = ...
def calculateArizonaStateTax(income: Double): Double = ...
```

As you can see, that's a very different implementation process.

Note: I have no idea whether I'd approach these problems *exactly* as shown. I just want to demonstrate the difference in

the general thought process between the two approaches, and in that regard — creating a class hierarchy versus a series of functions with a main HOF — I think this example shows that.

To summarize this, the thought process, “I need to refactor this code to keep it DRY,” is the same in both OOP and FP, but the way you refactor the code is very different.

## Summary

A function that takes another function as an input parameter is called a “Higher Order Function,” or HOF. This lesson showed how to write HOFs in Scala, including showing the syntax for function input parameters (FIPs) and how to execute a function that is received as an input parameter.

As the lesson showed, the general syntax for defining a function as an input parameter is:

```
variableName: (parameterTypes ...) => returnType
```

Here are some examples of the syntax for FIPs that have different types and numbers of arguments:

```
def exec(f:() => Unit) = ??? // note: i don't show the function body
                          // for any of these examples

def exec(f: (String) => Int)
def exec(f: String => Int) // parentheses not needed
def exec(f: (Int) => Int)
def exec(f: (Double) => Double)
def exec(f: (Person) => String)
def exec(f: (Int) => Int, a: Int, b: Int)
def exec(f: (Pizza, Order) => Double)
def exec(f: (Pizza, Order, Customer, Discounts) => Currency)
def exec(f1: (Int) => Int, f2:(Double) => Unit, s: String)
```

## **What's next**

In this lesson I showed how to write HOFs. In the next lesson we'll put this knowledge to work by writing a complete map function that uses the techniques shown in this lesson.

# How to Write a 'map' Function

In the previous lesson you saw how to write higher-order functions (HOFs). In this lesson you'll use that knowledge to write a `map` function that takes a FIP and a `List`.



## Writing a map function

Imagine a world in which you know of the concept of “mapping,” but sadly a `map` method isn’t built into Scala’s `List` class. Further imagine that you’re not worried about *all* lists, you just want a `map` function for a `List[Int]`.

Knowing that life is better with `map`, you sit down to write your own `map` method.

## First steps

As I got better at FP, I came to learn that my first actions in writing most functions are:

1. Accurately state the problem as a sentence
2. Sketch the function signature

I'll follow that approach to solve this problem.

### *Accurately state the problem*

For the first step, I'll state the problem like this:

I want to write a map function that can be used to apply other functions to each element in a `List[Int]` that it's given.

### *Sketch the function signature*

My second step is to sketch a function signature that matches that statement. A blank canvas is always hard to look at, so I start with the obvious; I want a map function:

```
def map
```

Looking back at the problem statement, what do I know? Well, first, I know that map is going to take a function as an input parameter, and it's also going to take a `List[Int]`. Without thinking too much about the input parameters just yet, I can sketch this:

```
def map(f: (?) => ?, list: List[Int]): ???
```

Knowing how map works, I know that it should return a `List` that contains the same number of elements that are in the input `List`. For the moment, the important part about this is that this means that map will return a `List` of some sort:

```
def map(f: (?) => ?, list: List[Int]): List...  
-----
```

Given how `map` works — it applies a function to every element in the input list — the *type* of the output `List` can be anything: a `List[Double]`, `List[Float]`, `List[Foo]`, etc. This tells me that the `List` that `map` returns needs to be a generic type, so I add that at the end of the function declaration:

```
def map(f: (?) => ?, list: List[Int]): List[A]  
-----
```

Because of Scala's syntax, I need to add the generic type before the function signature as well:

```
def map[A](f: (?) => ?, list: List[Int]): List[A]  
---
```

A great thing about going through that thought process is that it tells me everything I need to know about the signature for the function input parameter `f`:

- Because `f`'s input parameter will come from the `List[Int]`, the parameter type must be `Int`
- Because the overall `map` function returns a `List` of the generic type `A`, `f` must also return the generic type `A`

The first statement lets me make this change to the definition of `f`:

```
def map[A](f: (Int) => ?, list: List[Int]): List[A]  
---
```

and the second statement lets me make this change:

```
def map[A](f: (Int) => A, list: List[Int]): List[A]  
-
```

When I define a FIP that has only one input parameter I can leave the parentheses off, so if you prefer that syntax, the finished function signature looks like this:

```
def map[A](f: Int => A, list: List[Int]): List[A]
```

Cool. That seems right. Now let's work on the function body.

## The map function body

A map function works on every element in a list, and because I haven't covered recursion yet, this means that we're going to need a for loop to loop over every element in the input list.

Because I know that map returns a list that has one element for each element in the input list, I further know that this loop is going to be a for/yield loop without any filters:

```
def map[A](f: (Int) => A, list: List[Int]): List[A] = {  
  for {  
    x <- list  
  } yield ???  
}
```

The only question now is, what exactly should the loop *yield*?

(I'll pause for a moment here to let you think about that.)

The answer is that the for loop should `yield` the result of applying the input function `f` to the current element in the loop. Therefore, I can finish the `yield` expression like this:

```
def map[A](f: (Int) => A, list: List[Int]): List[A] = {  
  for {  
    x <- list  
  } yield f(x) //<-- apply 'f' to each element 'x'  
}
```

And that is the solution for the problem that was stated.

You can use the REPL to confirm that this solution works as desired. First, paste the map function into the REPL. Then create a list of integers:

```
scala> val nums = List(1,2,3)  
nums: List[Int] = List(1, 2, 3)
```

Next, write a function that matches the signature map expects:

```
scala> def double(i: Int): Int = i * 2  
double: (i: Int)Int
```

Then you can use map to apply `double` to each element in `nums`:

```
scala> map(double, nums)
res0: List[Int] = List(2, 4, 6)
```

The map function works.

## Bonus: Make it generic

I started off by making `map` work only for a `List[Int]`, but at this point it's easy to make it work for any `List`. This is because there's nothing inside the `map` function body that depends on the given `List` being a `List[Int]`:

```
// nothing here that's specific to an Int
for {
  x <- list
} yield f(x)
```

That's as “generic” as code gets; there are no `Int` references in there. Therefore, you can make `map` work with generic types by replacing each `Int` reference in the function signature with a generic type. Because this type appears before the other generic type in the function signature, I'll first convert the old `A`'s to `B`'s:

```
def map[B](f: (Int) => B, list: List[Int]): List[B] = ...
      -           -           -
```

Then I replace the `Int` references with `A`, and put an `A` in the opening brackets, resulting in this signature:

```
def map[A,B](f: (A) => B, list: List[A]): List[B] = {
      -           -           -
```

If you want to take this even further, there's also nothing in this code that depends on the input “list” being a `List`. Because `map` works its way from the first element in the list to the last element, it doesn't matter if the `Seq` is an `IndexedSeq` or a `LinearSeq`, so you can use the parent `Seq` class here instead of `List`:

```
def map[A,B](f: (A) => B, list: Seq[A]): Seq[B] = {
      -           -           -
```

With this new signature, the complete, generic `map` function looks like this:

```
def map[A,B](f: (A) => B, list: Seq[A]): Seq[B] = {
  for {
    x <- list
  } yield f(x)
}
```

I hope you enjoyed that process. It's a good example of how I design functions these days, starting with the signature first, then implementing the function body,

then adding generic types where it makes sense.

## **Exercise: Write a `filter` function**

Now that you've seen how to write a `map` function, I encourage you to take the time to write a `filter` function. Because `filter` doesn't return a sequence that's the same size as the input sequence, its algorithm will be a little different, but it still needs to return a sequence in the end.



## What's next

Where this lesson provides a detailed example of how to write a function that takes other functions as an input parameter, the next lesson will show how to write functions that take “blocks of code” as input parameters. That technique and syntax is similar to what I just showed, but the “use case” for this other technique — known as “by-name parameters” — is a little different.

After that lesson, I'll demonstrate how to combine these techniques with a Scala feature that lets a function have multiple input parameter groups.

# How to Use By-Name Parameters

## Introduction

In previous lessons I showed how to pass a function into another function. I showed *how* to do that (the syntax), and I also showed *why* to do that (to easily pass in new algorithms).

While that's a great feature, sometimes you just want to write a function that takes a more general "block of code." I typically do this when I'm writing a custom control structure, and as it turns out, it's also common technique in FP.

In Scala we say that a function that defines an input parameter like this is a "by-name" parameter, which is also referred to as a "call by-name" parameter.

# Goals

My goals for this lesson are to show:

- The differences between by-value and by-name parameters
- The by-name syntax
- How to use by-name parameters
- Examples of when they are appropriate
- A comparison of by-name parameters and higher-order functions

## Background: By-value parameters

If you define a Person class like this:

```
case class Person(var name: String)
```

and then pass it into a Scala function, it's said to be a "call by-value" argument. You can read more about this [on Wikipedia's "evaluation strategy" page](#), but in short, the way I think of this is that the function receives a pointer to the object that's passed in.

This has a few repercussions. First, it means that there's no copy of the object. Under the covers, the function essentially receives a pointer that says, "You can find this Person instance at so-and-so memory address in the computer's RAM."

Second, if the object has mutable fields, the function can mutate those fields. When a function receives a Person instance and the name field is a var, the function can change the name:

```
def changeName(p: Person) = {  
  p.name = "Al"  
}
```

This change affects the Person instance that was passed in.

In regards to the name "by-value," the book, [Programming Scala](#), makes this statement:

"Typically, parameters to functions are by-value parameters; that is, the value of the parameter is determined before it is passed to the function."

In Scala the term "call by-value" means that the value is either:

- A primitive value (like an Int) that can't be changed
- A pointer to an object (like Person)

## Background: By-name parameters

“By-name” parameters are quite different than by-value parameters. Rob Norris, (aka, “tpolecat”) [makes the observation](#) that you can think about the two types of parameters like this:

- A *by-value* parameter is like receiving a `val` field; its body is evaluated once, when the parameter is bound to the function.
- A *by-name* parameter is like receiving a `def` method; its body is evaluated whenever it is used inside the function.

Those statements aren’t 100% accurate, but they are decent analogies to start with.

A little more accurately, the book [Scala Puzzlers](#) says that by-name parameters are “evaluated only when they are referenced inside the function.” The Scala Language Specification adds this:

This (by-name) indicates that the argument is not evaluated at the point of function application, but instead is evaluated at each use within the function.

[According to Wikipedia](#) these terms date back to a language named [ALGOL 60](#) (yes, the year 1960). But for me, the term “by-name” isn’t very helpful. When you look at those quotes from the Puzzlers book and the Language Specification, you see that they both say, “a by-name parameter is only evaluated when it’s accessed inside a function.” Therefore, I find that the following names are more accurate and meaningful than “by-name”:

- Call on access
- Evaluate on access
- Evaluate on use
- Evaluate when accessed

- Evaluate when referenced

However, because I can't change the universe, I'll continue to use the terms "by-name" and "call by-name" in this lesson, but I wanted to share those alternate names, which I think are more meaningful.

## Example: Creating a timer

That's enough background about the names. Let's look at some code that shows how to create a by-name parameter, and what it gives you.

On Unix systems you can run a `time` command (`timex` on some systems) to see how long commands take to execute:

```
$ time find . -name "*.scala"
```

That command returns the results of the `find` command it was given, along with the time it took to run. The `time` portion of the output looks like this:

```
real  0m4.351s
user  0m0.491s
sys   0m1.341s
```

This is cool, and it can be a helpful way to troubleshoot performance problems. Seeing how cool it is, you decide that you'd like to create a similar "timer" method in Scala.

### *Designing a Scala timer*

Thinking in advance about how your new `timer` function should work, you decide that a nice API will let you write code like this:

```
val (result, time) = timer(someLongRunningAlgorithm)
```

and this:

```
val (result, time) = timer {
  ...
  ...
}
```

As shown, a `timer` like this gives you both the result of the algorithm and the time it took to run.

### *Trying to define a function signature*

Having seen how to define signatures for function input parameters (FIPs) in the previous lessons, you realize that you know how to write a `timer` ... or at least

you think you can.

The problem you run into right away is, “Just what is that algorithm that’s being passed in?” It could look like this:

```
def timer(f:(Int) => Int) ...
```

or this:

```
def timer(f:(Double) => Double) ...
```

or anything else:

```
def timer(f:() => Unit) ...
def timer(f:(Person) => String) ...
def timer(f:(Pizza, Order) => Double) ...
def timer(f:(Pizza, Order, Customer, Discounts) => Currency) ...
```

“Hmm,” you begin thinking, “this is quite a problem ...” in fact, I can’t use generic types to solve this problem.

Fortunately the Scala creators gave us a nice solution for problems like these.

## ***By-name syntax***

The solution for situations like this is to use Scala’s by-name syntax. It’s similar to defining FIPs, but it also makes it possible to solve problems like this. The general syntax for defining a by-name parameter looks like this:

```
def timer(blockOfCode: => theReturnType) ...
```

If you look back at the function input parameter examples, you’ll see that the by-name syntax is similar to this example:

```
def timer(f:() => Unit) ...
```

The main difference is that with the by-name syntax, you leave off the ( ) after the input parameter.

Therefore, to create a `timer` that can accept a block of code that returns any type, you make the return type generic. I can sketch the `timer` signature like this:

```
def timer[A](blockOfCode: => A) = ???
```



With that signature in hand, I can then complete the `timer` function like this:

```
def timer[A](blockOfCode: => A) = {  
  val startTime = System.nanoTime  
  val result = blockOfCode  
  val stopTime = System.nanoTime  
  val delta = stopTime - startTime  
  (result, delta/10000000d)  
}
```

As shown, the `timer` method uses the by-name syntax to accept a block of code as an input parameter. Inside the `timer` function there are three lines of code that deal with determining how long the `blockOfCode` takes to run, with this line sandwiched in between those time-related expressions:

```
  val result = blockOfCode
```

That line (a) executes `blockOfCode` and (b) assigns its return value to `result`. Because `blockOfCode` is defined to return a generic type (`A`), it may return `Unit`, an `Int`, a `Seq[Person]`, a `Map[Person, Seq[Person]]`, whatever.

Now you can use the `timer` function for all sorts of things. It can be used for something that isn't terribly useful, like this:

```
scala> val (result, time) = timer(println("Hello"))  
Hello  
result: Unit = ()  
time: Double = 0.160
```

It can be used for an algorithm that reads a file and returns an iterator:

```
scala> def readFile(filename: String) = io.Source.fromFile(filename).getLines  
readFile: (filename: String)Iterator[String]  
  
scala> val (result, time) = timer(readFile("/etc/passwd"))  
result: Iterator[String] = non-empty iterator  
time: Double = 32.119
```

Or it can be used for just about anything else:

```
val (result, time) = timer{ aLongRunningAlgorithmThatReturnsSomething }
```

***“When is my code block run?”***

A great question right now is, “When are my by-name parameters executed?”

In the case of the `timer` function, it executes the `blockOfCode` when the second

line of the function is reached. But if that doesn't satisfy your curious mind, you can create another example like this:

```
def test[A](codeBlock: => A) = {  
  println("before 1st codeBlock")  
  val a = codeBlock  
  println(a)  
  Thread.sleep(10)  
  
  println("before 2nd codeBlock")  
  val b = codeBlock  
  println(b)  
  Thread.sleep(10)  
  
  println("before 3rd codeBlock")  
  val c = codeBlock  
  println(c)  
}
```

After you paste that code into the Scala REPL, you can then test it like this:

```
scala> test( System.currentTimeMillis )
```

That line of code will produce output like this:

```
before 1st codeBlock  
1480206447942  
before 2nd codeBlock  
1480206447954  
before 3rd codeBlock  
1480206447966
```

As that output shows, the block of code that's passed in is executed each time it's referenced inside the function.

## Another example: A Swing utility

As another example of how I use this technique, when I was writing a lot of Swing (GUI) code with Scala, I wrote this `invokeLater` function to accept blocks of code that should be run on the JVM's Event Dispatch Thread (EDT):

```
def invokeLater(codeBlock: => Unit) {
  SwingUtilities.invokeLater(new Runnable() {
    def run() {
      codeBlock
    }
  })
}
```

If you haven't used Swing before, it's important to make sure that any code that updates the UI is run on the EDT, and this function simplifies that process.

`invokeLater` defines `codeBlock` as a by-name input parameter, and `codeBlock` is expected to return `Unit` (nothing). I define it like that because every block of code it accepts is intended to update the Swing GUI, which means that each code block is used to achieve that side effect.

As an example, here are two calls I make to `invokeLater` from my [Sarah application](#):

```
invokeLater(mainFrame.setSarahIsSleeping())
invokeLater(mainFrame.setSarahIsListening())
```

In these examples, `mainFrame.setSarahIsSleeping()` and `mainFrame.setSarahIsListening()` are both function calls, and those functions update Sarah's Swing GUI.

In those examples I pass functions into `invokeLater`, but I can pass a block of code into it as well:

```
invokeLater {
  val controller = mainController.getMainFrameController()
  controller.setBackground(SARAH_IS_SLEEPING_COLOR)
}
```

Either approach — passing in a function, or passing in a block of code — is valid.

# Why have by-name parameters?

[Programming in Scala](#), written by Martin Odersky and Bill Venners, provides a great example of why by-name parameters were added to Scala. Their example goes like this:

1. Imagine that Scala does not have an `assert` function, and you want one.
2. You attempt to write one using function input parameters, like this:

```
def myAssert(predicate: () => Boolean) =  
  if (assertionsEnabled && !predicate())  
    throw new AssertionError
```

That code uses the FIP techniques I showed in previous lessons, and assuming that the variable `assertionsEnabled` is in scope, it will compile just fine. The problem is that when you go to use it, you have to write code like this:

```
myAssert(() => 5 > 3)
```

Because `myAssert` states that `predicate` is a function that takes no input parameters and returns a `Boolean`, that's how you have to write this line of code. It works, but it's not pleasing to the eye.

The solution is to change `predicate` to be a by-name parameter:

```
def byNameAssert(predicate: => Boolean) =  
  if (assertionsEnabled && !predicate)  
    throw new AssertionError
```

With that simple change, you can now write assertions like this:

```
byNameAssert(5 > 3)
```

That's much more pleasing to look at than this:

```
myAssert(() => 5 > 3)
```

[Programming in Scala](#) states that this is the primary use case for by-name parameters:

The result is that using `byNameAssert` looks exactly like using a

built-in control structure.

If you want to experiment with this code, here's the source code for a small but complete test class I created from their example:

```
object ByNameTests extends App {  
  var assertionsEnabled = true  
  
  def myAssert(p: () => Boolean) =  
    if (assertionsEnabled && !p())  
      throw new AssertionError  
  
  myAssert(() => 5 > 3)  
  
  def byNameAssert(p: => Boolean) =  
    if (assertionsEnabled && !p)  
      throw new AssertionError  
  
  byNameAssert(5 > 3)  
}
```

As you can see from that code, there's only a small syntactical difference between (a) defining a FIP that takes no input parameters and (b) a by-name parameter:

```
p: () => Boolean    // a function input parameter  
p: => Boolean      // a by-name parameter
```

As you can also tell from these two lines:

```
myAssert(() => 5 > 3)  
byNameAssert(5 > 3)
```

you need to call them differently.

# Summary

This lesson showed:

- The differences between by-value and by-name parameters
- Examples of the by-name syntax
- How to use by-name parameters in your functions
- Examples of when by-name parameters are appropriate
- Some comparisons of by-name parameters and higher-order functions

## See also

- On StackOverflow, Daniel Sobral has a nice answer to a question about [the difference between  \$\(f: A \Rightarrow B\)\$  and  \$\(f: \(\) \Rightarrow A\)\$](#)
- [Scala Puzzlers comments about function input parameters](#)
- [Evaluation strategy on Wikipedia](#)

# **Functions Can Have Multiple Parameter Groups**



# Introduction

Scala lets you create functions that have multiple input parameter groups, like this:

```
def foo(a: Int, b: String)(c: Double) ...
```

Because I knew very little about FP when I first started working with Scala, I originally thought this was just some sort of syntactic nicety. But then I learned that one cool thing this does is that it enables you to write your own control structures. For instance, you can write your own `while` loop, and I show how to do that in this lesson.

Beyond that, the book [Scala Puzzlers](#) states that being able to declare multiple parameter groups gives you these additional benefits (some of which are advanced and I rarely use):

- They let you have both implicit and non-implicit parameters
- They facilitate type inference
- A parameter in one group can use a parameter from a previous group as a default value

I demonstrate each of these features in this lesson, and show how multiple parameter groups are used to create partially-applied functions in the next lesson.

# Goals

The goals of this lesson are:

- Show how to write and use functions that have multiple input parameter groups
- Demonstrate how this helps you create your own control structures, which in turn can help you write your own DSLs
- Show some other potential benefits of using multiple input parameter groups

## First example

Defining a function with multiple parameter groups is one of the easier things in this book. Instead of writing a “normal” add function with one parameter group like this:

```
def add(a: Int, b: Int, c: Int) = a + b + c
```

just put your function’s input parameters in different groups, with each group surrounded by parentheses:

```
def sum(a: Int)(b: Int)(c: Int) = a + b + c
```

After that, you can call sum like this:

```
scala> sum(1)(2)(3)
res0: Int = 6
```

That’s all there is to the basic technique. The rest of this lesson shows the advantages that come from using this approach.

### *A few notes about this technique*

When you write sum with three input parameter groups like this, you can’t call it with three parameters in one group:

```
scala> sum(1,2,3)
<console>:12: error: too many arguments for method
sum: (a: Int)(b: Int)(c: Int)Int
    sum(1,2,3)
      ^
```

You must supply the input parameters in three separate input lists.

Another thing to note is that each parameter group can have multiple input parameters:

```
def doFoo(firstName: String, lastName: String)(age: Int) = ???
```

## How to write your own control structures

To show the kind of things you can do with multiple parameter groups, let's build a control structure of our own. To do this, imagine for a moment that you don't like the built-in Scala `while` loop — or maybe you want to add some functionality to it — so you want to create your own `whilst` loop, which you can use like this:

```
var i = 0
whilst (i < 5) {
  println(i)
  i += 1
}
```

A thing that your eyes will soon learn to see when looking at code like this is that `whilst` *must* be defined to have two parameter groups. The first parameter group contains `i < 5`. Note that this expression yields a `Boolean` value. This tells you that `whilst` must be defined so that its first parameter group expects a `Boolean` parameter.

The second parameter group is the block of code enclosed in curly braces immediately after that. These two groups are highlighted in Figure [fig:twoParamGroups].

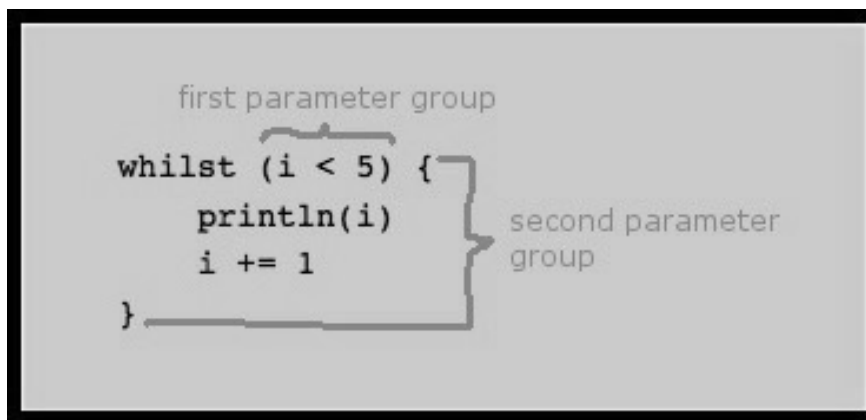

The second parameter group is enclosed in the curly braces.

You'll see this pattern *a lot* in Scala/FP code, so it helps to get used to it. I demonstrate more examples in this chapter, but the lesson for the moment is that when you see code like this, you should think:

- I see a function named `whilst` that has two parameter groups.
- The first parameter group must evaluate to a `Boolean` value.
- The second parameter group is probably defined as a by-name parameter. This specific block of code returns nothing (`Unit`), because the last expression in the code block (`i += 1`) returns nothing.

## ***How to create whilst***

To create the `whilst` control structure, define it as a function that takes two parameter groups. As mentioned, the first parameter group must evaluate to a `Boolean` value, and the second group takes a block of code that evaluates to `Unit`; the user wants to run this block of code in a loop as long as the first parameter group evaluates to `true`.

When I write functions the first thing I like to do is sketch the function's signature, and the previous paragraph tells me that `whilst`'s signature should look like this:

```
def whilst(testCondition: => Boolean)(codeBlock: => Unit) = ???
```

The two parameters groups are highlighted in Figure [fig:twoParamGroupsInWhilst].

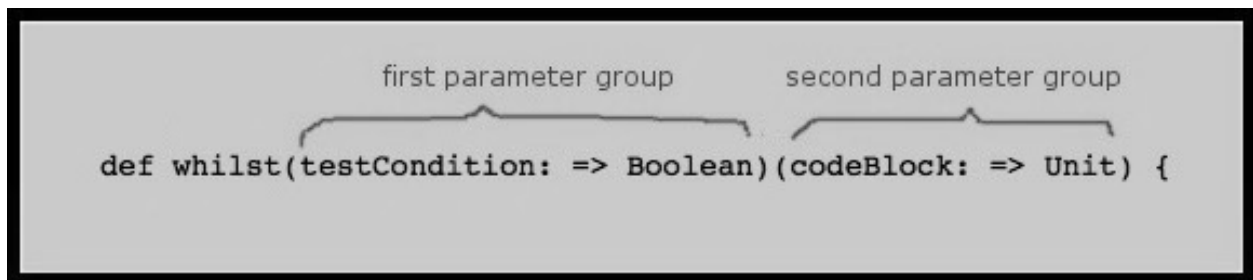

The two parameter groups in `whilst`'s function signature.

## ***Using by-name parameters***

Notice that both parameter groups use *by-name* parameters. The first parameter (`testCondition`) needs to be a by-name parameter because it specifies a test condition that will repeatedly be tested inside the function. If this *wasn't* a by-

name parameter, the `i < 5` code shown here:

```
var i = 0
while (i < 5) ...
```

would immediately be translated by the compiler into this:

```
while (0 < 5) ...
```

and then that code would be further “optimized” into this:

```
while (true) ...
```

If this happens, the `while` function would receive `true` for its first parameter, and the loop will run forever. This would be bad.

But when `testCondition` is defined as a by-name parameter, the `i < 5` code block is passed into `while` without being evaluated, which is what we desire.

Using a by-name parameter in the *last* parameter group when creating control structures is a common pattern in Scala/FP. This is because (as I just showed) a by-name parameter lets the consumer of your control structure pass in a block of code to solve their problem, typically enclosed in curly braces, like this:

```
customControlStructure(...) {
  // custom code block here
  ...
  ...
}
```

## ***The final code***

So far, I showed that the `while` signature begins like this:

```
def while(testCondition: => Boolean)(codeBlock: => Unit) = ???
```

In FP, the proper way to implement `while`'s body is with recursion, but because I haven't covered that yet, I'm going to cheat here and implement `while` with an inner `while` loop. Admittedly that's some serious cheating, but for the purposes of this lesson I'm not really interested in `while`'s body; I'm interested in its signature, along with what this general approach lets you accomplish.

Therefore, having defined `while`'s signature, this is what `while` looks like as a wrapper around a `while` loop:

```
def whilst(testCondition: => Boolean)(codeBlock: => Unit) {
  while (testCondition) {
    codeBlock
  }
}
```

Note that `whilst` doesn't return anything. That's *implied* by the current function signature, and you can make it more explicit by adding a `Unit` return type to the function signature:

```
def whilst(testCondition: => Boolean)(codeBlock: => Unit): Unit = {
  -----
}
```

I prefer this style of coding, and with that change, the final `whilst` function looks like this:

```
def whilst(testCondition: => Boolean)(codeBlock: => Unit): Unit = {
  while (testCondition) {
    codeBlock
  }
}
```

## ***Using whilst***

Because I cheated with the function body, that's all there is to writing `whilst`. Now you can use it anywhere you would use `while`. This is one possible example:

```
var i = 1
whilst(i < 5) {
  println(i)
  i += 1
}
```

## Exercise: Write a control structure using three parameter groups

The `whilst` example shows how to write a custom control structure using two parameter groups. It also shows a common pattern:

- Use one or more parameter groups to break the input parameters into different “compartments”
- Specifically define the parameter in the last parameter group as a by-name parameter so the function can accept a custom block of code

Control structures can have more than two parameter lists. As an exercise, imagine that you want to create a control structure that makes it easy to execute a condition if two test conditions are both true. Imagine the control structure is named `ifBothTrue`, and it will be used like this:

```
ifBothTrue(age > 18)(numAccidents == 0) {  
    println("Discount!")  
}
```

Just by looking at that code, you should be able to answer these questions:

- How many input parameter groups does `ifBothTrue` have?
- What is the type of the first group?
- What is the type of the second group?
- What is the type of the third group?

Sketch the signature of the `ifBothTrue` function. Start by sketching *only* the function signature, as I did with the `whilst` example:

Once you’re confident that you have the correct function signature, sketch the function body here:

### ***Solution***



In this case, because `ifBothTrue` takes two test conditions followed by a block of code, and it doesn't return anything, its signature looks like this:

```
def ifBothTrue(test1: => Boolean)
  (test2: => Boolean)
  (codeBlock: => Unit): Unit = ???
```

Because the code block should only be run if both test conditions are true, the complete function should be written like this:

```
def ifBothTrue(test1: => Boolean)
  (test2: => Boolean)
  (codeBlock: => Unit): Unit = {
  if (test1 && test2) {
    codeBlock
  }
}
```

You can test `ifBothTrue` with code like this:

```
val age = 19
val numAccidents = 0
ifBothTrue(age > 18)(numAccidents == 0) { println("Discount!") }
```

## Benefit: Using implicit values

A nice benefit of multiple input parameter groups comes when you use them with *implicit* parameters. This can help to simplify code when a resource is needed, but passing that resource explicitly to a function makes the code harder to read.

To demonstrate how this works, here's a function that uses multiple input parameter groups:

```
def printIntIfTrue(a: Int)(implicit b: Boolean) = if (b) println(a)
```

Notice that the `Boolean` in the second parameter group is tagged as an *implicit* value — but don't worry about that just yet. For the moment, just note that if you paste this function into the REPL and then call it with an `Int` and a `Boolean`, it does what it looks like it should do, printing the `Int` when the `Boolean` is `true`:

```
scala> printIntIfTrue(42)(true)
42
```

Given that background, let's see what that `implicit` keyword on the second parameter does for us.

### *Using implicit values*

Because `b` is defined as an *implicit* value in the *last* parameter group, if there is an implicit `Boolean` value in scope when `printIntIfTrue` is invoked, `printIntIfTrue` will use that `Boolean` without you having to explicitly provide it.

You can see how this works in the REPL. First, as an intentional error, try to call `printIntIfTrue` without a second parameter:

```
scala> printIntIfTrue(1)
<console>:12: error: could not find implicit value for parameter b: Boolean
  printIntIfTrue(1)
                   ^
```

Of course that fails because `printIntIfTrue` requires a `Boolean` value in its second parameter group. Next, let's see what happens if we define a regular `Boolean` in the current scope:

```
scala> val boo = true
boo: Boolean = true

scala> printIntIfTrue(1)
<console>:12: error: could not find implicit value for parameter b: Boolean
    printIntIfTrue(1)
                   ^
```

Calling `printIntIfTrue` still fails, as expected. Now notice what happens when `boo` is defined as an implicit `Boolean` value:

```
scala> implicit val boo = true
boo: Boolean = true

scala> printIntIfTrue(33)
33
```

`printIntIfTrue` works with only one parameter!

This works because:

1. The `Boolean` parameter in `printIntIfTrue`'s last parameter group is tagged with the `implicit` keyword
2. `boo` is declared to be an implicit `Boolean` value

The way this works is like this:

1. The Scala compiler knows that `printIntIfTrue` is defined to have two parameter groups.
2. It also knows that the second parameter group declares an implicit `Boolean` parameter.
3. When `printIntIfTrue(33)` is called, only one parameter group is supplied.
4. At this point Scala knows that one of two things must now be true. Either (a) there better be an implicit `Boolean` value in the current scope, in which case Scala will use it as the second parameter, or (b) Scala will throw the compiler error shown earlier.

Because `boo` is an implicit `Boolean` value and it's in the current scope, the Scala compiler reaches out and automatically uses it as the input parameter for the second parameter group. That is, `boo` is used just as though it had been passed in explicitly.

## ***The benefit***

If that code looks too “magical,” I’ll say two things about this technique:

- It works really well in certain situations
- Don’t overuse it, because when it’s used wrongly it makes code hard to understand and maintain (which is pretty much an anti-pattern)

An area where this technique works really well is when you need to refer to a shared resource several times, and you want to keep your code clean. For instance, if you need to reference a database connection several times in your code, using an implicit connection can clean up your code. It tends to be obvious that an implicit connection is hanging around, and of course database access code isn’t going to work without a connection.

## ***An implicit execution context***

A similar “shared resource” example is when you need an *execution context* in scope when you’re writing multi-threaded code with the Akka library. For example, with Akka you usually create an implicit ActorSystem like this early in your code:

```
implicit val actorSystem = ActorSystem("FutureSystem")
```

Then, at one or more places later in your code you can create a Future like this, and the Future “just works”:

```
val future = Future {  
  1 + 1  
}
```

The reason this Future works is because it’s written with an implicit input parameter in its last parameter group, like the `printIntIfTrue` function. If you dig through the Akka source code you’ll see that Future’s `apply` method is written like this:

```
def apply [T] (body: => T)(implicit executor: ExecutionContext) ...  
-----
```

As that shows, the executor parameter in the last parameter group is an implicit value of the `ExecutionContext` type. Because an ActorSystem is an

instance of an `ExecutionContext`, when you define the `ActorSystem` as being `implicit`, like this:

```
implicit val actorSystem = ActorSystem("FutureSystem")
-----
```

`Future`'s `apply` method can find it and “pull it in” automatically. This makes the `Future` code more readable. If `Future` didn't use an `implicit` value, each invocation of a new `Future` would have to look something like this:

```
val future = Future(actorSystem) {
  code to run here ...
}
```

That's not too bad with just one `Future`, but more complicated code is definitely cleaner without it repeatedly referencing the `actorSystem`.

If you're new to Akka Actors, my article, [A simple working Akka Futures example](#), explains everything I just wrote about actors, futures, execution contexts, and actor systems.

## Limits on implicit parameters

[The Scala language specification](#) tells us these things about implicit parameters:

- A method or constructor can have only one implicit parameter list, and it must be the last parameter list given
- If there are several eligible arguments which match the implicit parameter's type, a most specific one will be chosen using the rules of static overloading resolution

I'll show some of what this means in the following “implicit parameter FAQs”.

### ***FAQ: Can you use `implicit` more than once in your parameter lists?***

No, you can't. This code will not compile:

```
def printIntIfTrue(implicit a: Int)(implicit b: Boolean) = if (b) println(a)
```

The REPL shows the error message you'll get:

```
scala> def printIntIfTrue(implicit a: Int)(implicit b: Boolean) = if (b) println(a)
<console>:1: error: '=' expected but '(' found.
def printIntIfTrue(implicit a: Int)(implicit b: Boolean) = if (b) println(a)
                                ^
```

### ***FAQ: Does the `implicit` have to be in the last parameter list?***

Yes. This code, with an `implicit` in the first list, won't compile:

```
def printIntIfTrue(implicit b: Boolean)(a: Int) = if (b) println(a)
```

The REPL shows the compiler error:

```
scala> def printIntIfTrue(implicit b: Boolean)(a: Int) = if (b) println(a)
<console>:1: error: '=' expected but '(' found.
def printIntIfTrue(implicit b: Boolean)(a: Int) = if (b) println(a)
                                ^
```

### ***FAQ: What happens when multiple implicit values are in scope and***

## *can match the parameter?*

In theory, as the Specification states, “a most specific one will be chosen using the rules of static overloading resolution.” In practice, if you find that you’re getting anywhere near this situation, I wouldn’t use implicit parameters.

A simple way to show how this fails is with this series of expressions:

```
def printIntIfTrue(a: Int)(implicit b: Boolean) = if (b) println(a)
implicit val x = true
implicit val y = false
printIntIfTrue(42)
```

When you get to that last expression, can you guess what will happen?

The answer is that the compiler has no idea which `Boolean` should be used with the implicit parameter, so it bails out with this error message:

```
scala> printIntIfTrue(42)
<console>:14: error: ambiguous implicit values:
  both value x of type => Boolean
  and value y of type => Boolean
  match expected type Boolean
    printIntIfTrue(42)
                      ^
```

This is a simple example of how using implicit parameters can create a problem.

## Using default values

As the [Scala Puzzlers](#) book notes, you can supply default values for input parameters when using multiple parameter groups, in a manner similar to using one parameter group. Here I specify default values for the parameters a and b:

```
scala> def f2(a: Int = 1)(b: Int = 2) = { a + b }  
f2: (a: Int)(b: Int)Int
```

That part is easy, but the “magic” in this recipe is knowing that you need to supply empty parentheses when you want to use the default values:

```
scala> f2  
<console>:13: error: missing argument list for method f2  
Unapplied methods are only converted to functions when a  
function type is expected. You can make this conversion explicit  
by writing `f2 _` or `f2(_)(_)` instead of `f2`.  
      f2  
      ^
```

```
scala> f2()()  
res0: Int = 3
```

```
scala> f2(10)()  
res1: Int = 12
```

```
scala> f2()(10)  
res2: Int = 11
```

As the Puzzlers book also notes, a parameter in the second parameter group can use a parameter from the first parameter group as a default value. In this next example I assign a to be the default value for the parameter b:

```
def f2(a: Int = 1)(b: Int = a) = { a + b }
```

The REPL shows that this works as expected:

```
scala> def f2(a: Int = 1)(b: Int = a) = { a + b }  
f2: (a: Int)(b: Int)Int
```

```
scala> f2()()  
res0: Int = 2
```

```
scala> f2(10)()  
res1: Int = 20
```

I haven't had a need for these techniques yet, but in case you ever need them, there you go.



## Summary

In this lesson I covered the following:

- I showed how to write functions that have multiple input parameter groups.
- I showed how to call functions that have multiple input parameter groups.
- I showed to write your own control structures, such as `whilst` and `ifBothTrue`. The keys to this are (a) using multiple parameter groups and (b) accepting a block of code as a by-name parameter in the last parameter group.
- I showed how to use `implicit` parameters, and possible pitfalls of using them.
- I showed how to use default values with multiple parameter groups.

## **What's next**

The next lesson expands on this lesson by showing what “Currying” is, and by showing how multiple parameter groups work with partially-applied functions.

## See Also

- My article, [How to use the using control structure from Beginning Scala](#)
- [Joshua Suereth's scala-arm project](#) is similar to the using control structure
- The Scala “Breaks” control structure is created using the techniques shown in this lesson, and I describe it in my article, [How to use break and continue in Scala](#)

# Partially-Applied Functions (and Currying)

## Motivation

My motivations for writing this lesson are a little different than usual. Typically I think, “You’ll want to know this feature so you can use it like \_\_\_,” but the first motivation for this lesson goes like this: You’ll want to know about the concept of “currying” because experienced FP developers mention it quite a bit, especially if they have Haskell programming experience. (I did mention that Haskell was named after Haskell *Curry*, didn’t I?)

A second motivation is that the concept of currying is related to the multiple parameter groups I showed in the previous lesson come from.

That being said, the *primary motivation* for writing this lesson is that having multiple parameter groups make it a little easier to create *partially-applied functions*, and these can be useful in your FP code.

I’ll cover all of these topics in this lesson.

# Goals

Given that introduction, the goals of this lesson are:

- Provide a definition of *currying*
- Show how to create partially-applied functions from functions that have (a) multiple parameter groups or (b) single parameter groups

I'll also show how to create “curried” functions from regular functions, and show how Scala gets these features to work with the JVM.

# Currying

When I first got started in FP, I got lost in some of its nomenclature, and “currying” was a particularly deep rabbit’s hole of “Time in My Life I Wish I Had Spent Differently.”

All that the theory of *currying* means is that a function that takes *multiple* arguments can be translated into a series of function calls that each take a *single* argument. In pseudocode, this means that an expression like this:

```
result = f(x)(y)(z)
```

is mathematically the same as something like this:

```
f1 = f(x)
f2 = f1(y)
result = f2(z)
```

That’s all it means. [The Wikipedia page on Currying](#) describes currying like this:

In mathematics and computer science, currying is the technique of translating the evaluation of a function that takes multiple arguments into evaluating a sequence of functions, each with a single argument.

They later state:

There are analytical techniques that can only be applied to functions with a single argument. Practical functions frequently take more arguments than this.

## ***What this means***

In my daily working life, this theory usually isn’t important. It’s one of those things that’s “nice to know,” but the important things are (a) how this impacted the design of the Scala language, and (b) what you can do because of this theory.

In Scala this seems to fit most naturally with functions that have multiple input

parameters groups, and I'll demonstrate that in this lesson.

Terminology note: In the remainder of this lesson I'll occasionally use the acronym "PAF" to mean "partially-applied function."

# Partially-applied functions

To understand PAFs, I'll start with two definitions from [this online JavaScript course](#):

1. *Application*: The process of applying a function to its arguments in order to produce a return value.

As in algebra, in FP you say that “a function is applied to its arguments,” so “Application” in this context can also be called “Full Application,” or “Complete Application.”

1. *Partial Application*: This is the process of applying a function to *some* of its arguments. A partially-applied function gets returned for later use. In other words, a PAF is a function that takes a function with multiple parameters and returns a function with fewer parameters.

The best way to explain PAFs is with examples, so let's look at a few.



## Example 1 (partially-applied functions)

The following example shows how PAFs work. In the first step, you define a function with multiple parameter groups:

```
scala> def plus(a: Int)(b: Int) = a + b
plus: (a: Int)(b: Int)Int
```

Next, rather than giving the function all of the parameters in the two parameter groups it specifies, you give it (a) the parameter for the first group (a), and (b) a placeholder for the parameter in the second list, the ubiquitous underscore character:

```
scala> def plus2 = plus(2)(_)
plus2: Int => Int
```

The REPL output shows that this creates a new function named `plus2` which has the type `Int => Int`. This means that `plus2` takes an `Int` as input, and returns an `Int` as a result.

At this point you can think of `plus2` as looking like this:

```
def plus(b: Int) = 2 + b
```

What's happened is that `plus2` has been “seeded” with the initial `Int` value 2, and now it's just sitting there, waiting for another `Int` value that it can add to it. Let's give it another 2:

```
scala> plus2(2)
res0: Int = 4
```

Here's what it looks like when you give it a 3:

```
scala> plus2(3)
res1: Int = 5
```

As this shows, `plus2` gladly adds 2 to any `Int` it is given.

Before I move on to the next example, notice that you can create `plus2` in either of these ways:

```
def plus2 = plus(2)(_)
def plus2 = plus(2)_
```

I prefer the first syntax, but some people prefer the second approach.

## Example 2 (partially-applied functions)

The general benefit that this approach gives you is that it's a way to create specialized methods from more general methods. I demonstrate this in the [Scala Cookbook](#), and I'll share a variation of that example here.

When you're emitting HTML from Scala code, a wrap function that adds a prefix and a suffix to an HTML snippet can be really useful:

```
def wrap(prefix: String)(html: String)(suffix: String) = {
  prefix + html + suffix
}
```

You can use that function to do something like this, where I wrap a string in opening and closing `<div>` tags:

```
val hello = "Hello, world"
val result = wrap("<div>")(hello)("</div>")
```

Of course that `<div>` tag can be more complicated, such as specifying a CSS class or id, but I'm keeping this simple.

It turns out that `wrap` is a really nice, *general* function, so you can wrap text in DIV tags, P tags, SPAN tags, etc. But if you're going to be wrapping a lot of strings with DIV tags, what you probably want is a more specific `wrapWithDiv` function. This is a great time to use a partially-applied function, because that's what they do: they let you create a *specific* function from a *general* function:

```
val wrapWithDiv = wrap("<div>")(_: String)("</div>")
```

Now you can call `wrapWithDiv`, just passing it the HTML you want to wrap:

```
scala> wrapWithDiv("<p>Hello, world</p>")
res0: String = <div><p>Hello, world</p></div>

scala> wrapWithDiv("<img src=\""/images/foo.png\" />")
res1: String = <div></div>
```

Of course you can still call the original `wrap` function:

```
wrap("<pre>", "val x = 1", "</pre>")
```

You can also create other, more-specific functions:

```
val wrapWithPre = wrap("<pre>")(_: String)("</pre>")
```

Besides the unique syntax, the important point is that you make a more specific function by “seeding” the more general function with one or more initial parameters. That is, you *partially apply* parameters to the general function to create the specific function.

## ***Handling the missing parameter***

As I showed in that example, it’s necessary to specify the *type* of the missing parameter, as I did in this code:

```
val wrapWithDiv = wrap("<div>")(_: String)("</div>")
-----
```

If you don’t specify the type, you’ll get a compiler error that looks like this:

```
scala> val wrapWithDiv = wrap("<div>")(_)("</div>")
<console>:11: error: missing parameter type for
expanded function ((x$1) => wrap("<div>")(x$1)("</div>"))
  val wrapWithDiv = wrap("<div>")(_)("</div>")
                                ^
```

## Summary: Partially-applied functions

As a summary, PAFs give you this capability:

- You write a general function
- You create a specific function from the general function
- You still have access to both functions, and you kept your code “DRY” — you didn’t copy and paste code to make the new function

## Creating curried functions from regular functions

As a fun example of some things you can do with PAFs, the [“partially-applied functions” section of the \*Scala Exercises website\*](#) demonstrates that you can create curried functions from “normal” Scala functions. For instance, you can start with a normal, one-parameter group function like this:

```
def add(x: Int, y: Int) = x + y
```

Then they show that you can create a `Function2` instance from `add` by adding an underscore after it, like this:

```
scala> val addFunction = add _  
addFunction: (Int, Int) => Int = <function2>
```

After that, they prove that it’s a `Function2` instance like this:

```
(add _).isInstanceOf[Function2[_, _, _]]
```

Finally, they create a “curried” function from that `Function2` instance:

```
val addCurried = (add _).curried
```

Now you can use the new curried function like this:

```
addCurried(1)(2)
```

As this shows, calling the `curried` method on the `add` function instance creates a new function that has two parameter groups. (So, a curried function can be thought of as a function with multiple parameter groups.)

You can also create a partially-applied function from the curried function, like this:

```
val addCurriedTwo = addCurried(2)    // create a PAF  
addCurriedTwo(10)                   // use the PAF
```

The technique of converting a `def` method into a true function uses a Scala technology known as “Eta Expansion,” which I discuss in the *Using Methods As If They Were Functions* lesson.

***See it in the REPL***

You can see how all of those steps work by pasting the code into the REPL:

```
scala> def add(x: Int, y: Int) = x + y
add: (x: Int, y: Int)Int

scala> (add _).isInstanceOf[Function2[_, _, _]]
res0: Boolean = true

scala> val addCurried = (add _).curried
addCurried: Int => (Int => Int) = <function1>

scala> addCurried(1)(2)
res1: Int = 3

scala> val addCurriedTwo = addCurried(2)
addCurriedTwo: Int => Int = <function1>

scala> addCurriedTwo(10)
res2: Int = 12
```

Personally, I mostly use curried functions to create control structures, as I demonstrated with `whilst` and `ifBothTrue` in the previous lesson. (So, at the moment, this is a technique I know about, but have not used.)

## Partially-applied functions without multiple parameter groups

So far I've shown that you can create a partially-applied function with functions that have multiple parameter groups, but because Scala is really convenient, you can create PAFs with single parameter group functions as well.

To demonstrate this, first define a function as usual, with one parameter group:

```
def wrap(prefix: String, html: String, suffix: String) = {  
    prefix + html + suffix  
}
```

Then create a PAF by applying the first and third parameters, but not the second:

```
val wrapWithDiv = wrap("<div>", _: String, "</div>")
```

The `wrapWithDiv` function you create in this manner works the same as the `wrapWithDiv` function created in the previous example:

```
scala> val wrapWithDiv = wrap("<div>", _: String, "</div>")  
wrapWithDiv: String => String = <function1>  
  
scala> wrapWithDiv("Hello, world")  
res1: String = <div>Hello, world</div>
```



## Extra credit: How can all of this work with the JVM?

If you're interested in how things work under the covers, a good question at this point is, "How can this stuff possibly work with the JVM?" The JVM certainly wasn't written to account for things like currying and PAFs, so how does any of this work?

A short answer is that (a) the Scala compiler "uncurries" your code, and (b) you can see this during the compilation process. For example, write a little Scala class like this:

```
class Currying {
  def f1(a: Int, b: Int) = { a + b } // 1 param group
  def f2(a: Int)(b: Int) = { a + b } // 2 param groups
}
```

Then compile that class with this command:

```
$ scalac -Xprint:all Currying.scala
```

if you dig through the end of that output, you'll see that the Scala compiler has an "uncurry" phase. A short version of the tail end of the compiler output looks like this:

```
[[syntax trees at end of typer]] // Currying.scala
package <empty> {
  class Currying extends scala.AnyRef {
    def <init>(): Currying = {
      Currying.super.<init>();
      ()
    };
    def f1(a: Int, b: Int): Int = a.+(b);
    def f2(a: Int)(b: Int): Int = a.+(b)
  }
}

.
.
.

[[syntax trees at end of uncurry]] // Currying.scala
package <empty> {
  class Currying extends Object {
    def <init>(): Currying = {
      Currying.super.<init>();
      ()
    };
    def f1(a: Int, b: Int): Int = a.+(b);
    def f2(a: Int, b: Int): Int = a.+(b)
  }
}
```

```
}
```

As that output shows, I wrote the two functions `f1` and `f2` differently, but after the compiler's "uncurry" phase they end up looking the same.

Things might look more interesting in the output if I had created a partially-applied function, but I'll leave that as an exercise for the reader.

## Currying vs partially-applied functions

The concepts of currying and partially-applied functions are related, but they aren't exactly the same. As I wrote at the beginning, currying is defined like this:

A function that takes multiple arguments can be translated into a series of function calls that each take a single argument.

This is particularly important in a language like Haskell, where all functions are technically curried functions. In Scala this is generally a theoretical thing that's good to know about, and it's good to know that you can create a curried function from a normal function, but these aren't "core" features you absolutely need to know to write code in Scala.

A partially-applied function on the other hand is a function that you manually create by supplying fewer parameters than the initial function defines. As I showed in this lesson, you can create the PAF `plus2` like this:

```
def plus(a: Int)(b: Int) = a + b
def plus2 = plus(2)(_)
```

So, both concepts are related to multiple parameter groups, but in general, I use PAFs more often than I concern myself with curried functions.

## **Don't get bogged down in terminology**

As I mentioned at the beginning of this lesson, don't get bogged down in the precise meaning of things like "curried functions." It is good to know how multiple input parameter groups work because it's a technique that is used a lot in Scala/FP, but don't get lost in worrying about the exact meaning of currying like I did. Understanding how multiple parameter groups work is the important thing.

## Summary

This lesson covered the following topics:

- It provides a definition of *currying*
- It shows how to create partially-applied functions from functions that have (a) multiple parameter groups or (b) single parameter groups

It also shows how to create “curried” functions from regular functions, and provided a little look at how Scala gets these features to work with the JVM.

## What's next

I've covered a lot of Scala/FP background material so far, but occasionally I had to mix in a few var fields in my examples because that's the only way to solve certain problems with the tools I've shown so far.

Well, no more of that.

In the next few lessons things are going to be fun, as I get to cover *recursion*. Once you understand recursive calls, I think you'll find that they're a natural way to think about writing iterative algorithms.

Once I cover recursion you'll then be very close to handling many more FP concepts, the first of which will be how to handle "state" in FP applications. But to handle state in an FP manner, you'll need to know how to write recursive functions ...

## See Also

Here are a few more resources related to currying and partially-applied functions.

- Daniel Westheide's article, [Currying and Partially Applied Functions](#) is a good resource.

These discussions on StackOverflow and StackExchange also provide a little more insight:

- [With curried functions you get easier reuse of more abstract functions, since you get to specialize.](#)
- [“It's common to mistake partial function application for currying ... I've almost never seen anyone use currying in practice. Partial function application on the other hand is quite useful in many languages.”](#)
- [“There is a slight difference between currying and partial application, although they're closely related; since they're often mixed together, I'll deal with both terms.”](#)

# Recursion: Introduction

As you may have noticed from this book's index, you're about to jump into a series of lessons on recursive programming. I separated this text into a series of small lessons to make the content easier to read initially, and then easier to refer to later.

Please note that some of these lessons may be overkill for some people. Many people find recursive programming to be difficult, so I demonstrate it in several different ways. I start by reviewing the `List` class, then show a straightforward, "Here's how to write a recursive function" lesson. After that I add a few more lessons to explain recursion in different ways.

If at any point you feel like you understand how to write recursive functions, feel free to skip any or all of these lessons. You can always come back to them later if you need to.



# Recursion: Motivation

## What is recursion?

Before getting into the motivation to use recursion, a great question is, “What is recursion?”

Simply stated, a *recursive function* is a function that calls itself. That’s it.

As you’ll see in this lesson, a common use of recursive functions is to iterate over the elements in a list.

## Why do I need to write recursive functions?

The next question that usually comes up right about now is, “Why do I need to write recursive functions? Why can’t I use for loops to iterate over lists?”

The short answer is that algorithms that use for loops require the use of var fields, [and as you know from our rules](#), functional programmers don’t use var fields.

(Read on for the longer answer.)

## If you had var fields

Of course if you *could* use mutable variables in your programming language, you might write a “sum the integers in a list” algorithm like this:

```
def sum(xs: List[Int]): Int = {  
  var sum = 0  
  for (x <- xs) {  
    sum += x  
  }  
  sum  
}
```

That algorithm uses a `var` field named `sum` and a `for` loop to iterate through every element in the given list to calculate the sum of those integers. From an imperative programming standpoint, there’s nothing wrong with this code. I wrote imperative code like this in Java for more than fifteen years.

But from a functional programmer’s point of view, there are several problems with this code.

### ***Problem 1: We can only keep so much in our brains***

One problem is that reading a lot of custom `for` loops dulls your brain.

As an OOP/imperative programmer I never noticed it, but if you *think about the way you thought* when you read that function, one of the first things you thought is, “Hmm, here’s a `var` field named `sum`, so Al is probably going to modify that field in the rest of the algorithm.” Then you thought, “Okay, here’s a `for` loop ... he’s looping over `xs` ... ah, yes, he’s using `+=`, so this really is a ‘sum’ loop, so that variable name makes sense.” Once you learn FP — or even if you just learn the methods available on Scala collections classes — you realize *that’s a lot of thinking* about a little custom `for` loop.

If you’re like me a few years ago, you may be thinking that what I just wrote is overkill. You probably look at mutable variables and `for` loops all the time. But studies show that we can only keep *just so much* information in our brains at one time, therefore:

- The less information we *have* to keep in there is a win, and

- Boilerplate for loop code is a waste of our brain's RAM

Maybe this seems like a small win at the moment, but speaking from my own experience, anything I can do to keep my brain's RAM free for important things is a win.

### ***Problem #2: It's not algebraic***

Another problem is that this code doesn't look or feel like algebra. I discussed this in the [“Functional Programming is Like Algebra” lesson](#), so I won't repeat that discussion here.

### ***Problem #3: There are no var fields in FP***

Of course from our perspective as functional programmers, the *huge* problem with this code is that it requires a *var* field, and Scala/FP developers don't use those. A *var* field is a crutch, and the best thing you can do to expedite your FP education is to completely forget that they exist.

In my own FP experience, I learned that there's a different way to solve iterative problems once I let go of *var* fields and *for* loops.

## What to do?

Because we can't use var fields, we need to look at a different tool to solve problems like this. That tool is *recursion*.

If you're like me, at first you'll *need* to write recursive functions (because that's all you can do), but after a while you'll *want* to write recursive functions.

# **Recursion: Let's Look at Lists**

## Visualizing lists

Because the `List` data structure — and the *head* and *tail* components of a `List` — are so important to recursion, it helps to visualize what a list and its head and tail components look like. Figure [fig:headTailWorm] shows one way to visualize a `List`.



One way to visualize the head and tail elements of a list.

This creative imagery comes from [the online version of “Learn You a Haskell for Great Good”](#), and it does a great job of imprinting the concept of head and tail components of a list into your brain. As shown, the “head” component is simply the first element in the list, and the “tail” is the rest of the list.

A slightly more technical way to visualize the head and tail of a list is shown in Figure [fig:visualizeListMoreTech].



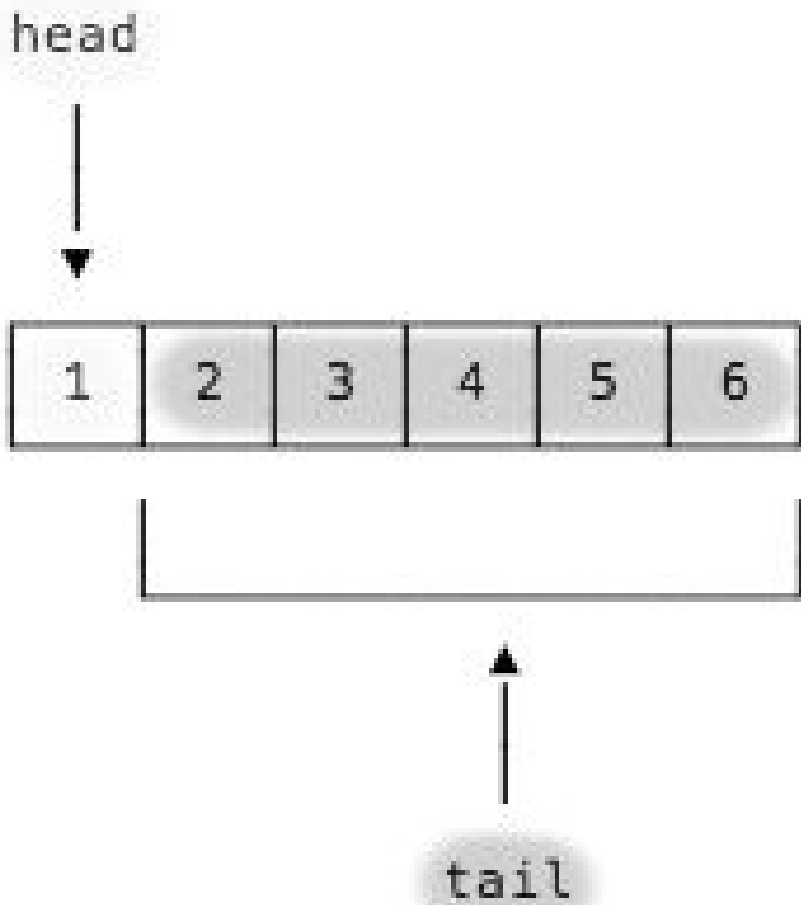

A slightly more technical way to visualize a list.

An even more accurate way to show this is with a `Nil` value in the very last position, as shown in Figure [fig:visualizeListNilElement], because that's what it really looks like.

head

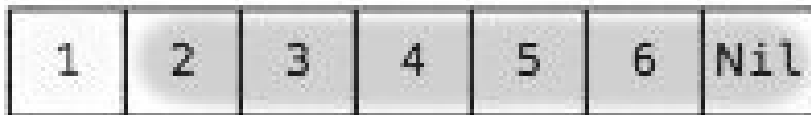

tail

A more accurate way to visualize a list.

## Linked lists and “cons” cells

To be clear, the `List` that I’m talking about is a *linked list* — [scala.collection.immutable.List](https://docs.scala-lang.org/overviews/collections/immutable.html#lists), which is the default list you get if you type `List` in your IDE or the REPL. This `List` is a series of cells, where each cell contains two things: (a) a value, and (b) a pointer to the next cell. This is shown in Figure [fig:linkedListDepiction].

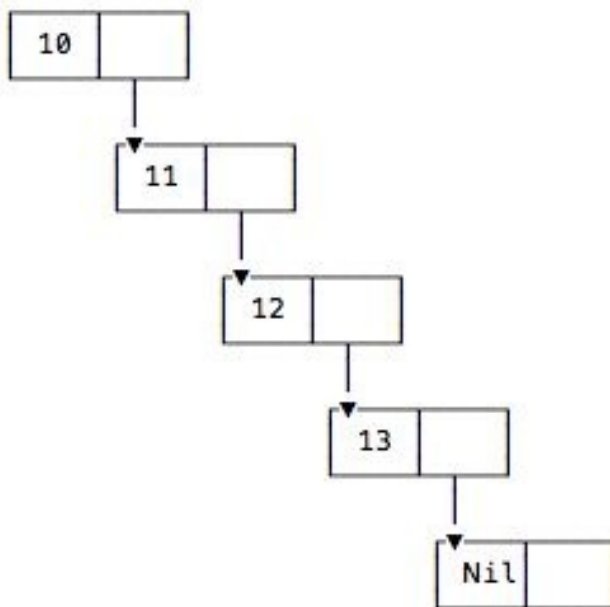

A linked list contains a value and a pointer to the next cell.

As shown, the last cell in a linked list contains the `Nil` value. The `Nil` in the last cell is *very* important: it’s how your recursive Scala code will know when it has reached the end of a `List`.

When drawing a list like this, Figure [fig:headElemOfAList] clearly shows the head element.

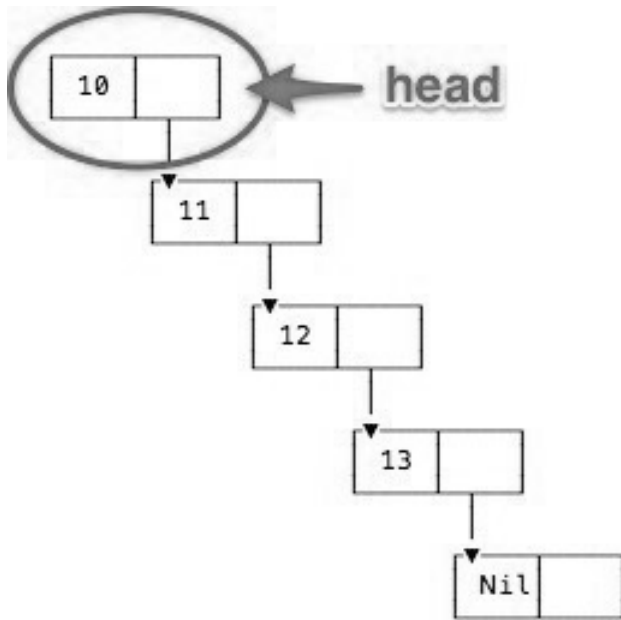

The head element of a list.

Figure [fig:tailElemsOfAList] shows the tail elements of a list.

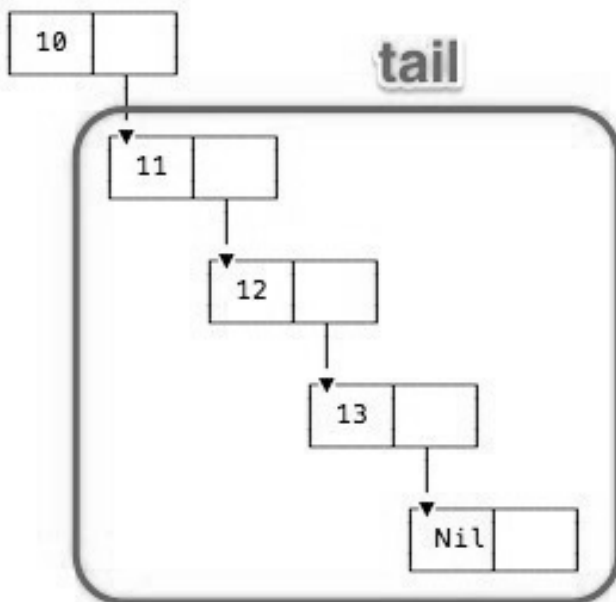

The tail elements of a list

Just like Haskell — and Lisp before it — the default Scala `List` works with these head and tail components, and I'll use them extensively in the examples that follow.

For historical reasons these cells are known as “cons cells.” That name comes from Lisp, and if you like history, you can [read more about it on Wikipedia](#).

## Note 1: The empty List

As a first note about Lists, a List with no elements in it is an *empty list*. An empty List contains only one cell, and that cell contains a Nil element, as shown in Figure [fig:theNilList].



A list with no elements contains only one cell, which contains a Nil element

You can create an empty List[Int] in Scala in two ways:

```
scala> val empty1: List[Int] = List()  
empty: List[Int] = List()
```

```
scala> val empty2: List[Int] = Nil  
empty: List[Int] = List()
```

```
scala> empty1 == empty2  
res0: Boolean = true
```

As those examples show:

```
List() == Nil
```

## Note 2: Several ways to create Lists

There are several ways to create *non-empty* Lists in Scala, but for the most part I'll use two approaches. First, here's a technique you're probably already familiar with:

```
val list = List(1,2,3)
```

Second, this is an approach you may not have seen yet:

```
val list = 1 :: 2 :: 3 :: Nil
```

These two techniques result in the exact same `List[Int]`, which you can see in the REPL:

```
scala> val list1 = List(1,2,3)
list: List[Int] = List(1, 2, 3)

scala> val list2 = 1 :: 2 :: 3 :: Nil
list: List[Int] = List(1, 2, 3)

scala> list1 == list2
res1: Boolean = true
```

The second approach is known as using “cons cells.” As you can see, it's a very literal approach to creating a List, where you specify each element in the List, including the `Nil` element in the last position. If you forget the `Nil` element at the end, the Scala compiler will bark at you:

```
scala> val list = 1 :: 2 :: 3
<console>:10: error: value :: is not a member of Int
      val list = 1 :: 2 :: 3
                   ^
```

I show this because it's important — very important — to know that the last element in a List *must* be the `Nil` element. (I like to say that the `Nil` element is to a List as a caboose is to a train.) We're going to take advantage of this knowledge as we write our first recursive function.

# Recursion: How to Write a 'sum' Function

With all of the images of the previous lesson firmly ingrained in your brain, let's write a sum function using recursion!



## Source code

The source code for this lesson is at this Github URL:

- [github.com/alvinj/RecursiveSum](https://github.com/alvinj/RecursiveSum)

## Sketching the sum function signature

Given a `List` of integers, such as this one:

```
val list = List(1, 2, 3, 4)
```

let's start tackling the problem in the usual way, by thinking, "Write the function signature first."

What do we know about the sum function we want to write? Well, we know a couple of things:

- It will take a list of integers as input
- Because it returns a sum of those integers, the function will return a single value, an `Int`

Armed with only those two pieces of information, I can sketch the function signature like this:

```
def sum(list: List[Int]): Int = ???
```

## The sum function body

When thinking about the function body, a functional programmer will think of a “sum” algorithm as follows:

1. If the sum function is given an empty list of integers, it should return 0. (Because the sum of nothing is zero.)
2. Otherwise, if the list is *not* empty, the result of the function is the combination of (a) the value of its head element (1, in this case), and (b) the sum of the remaining elements in the list (2, 3, 4).

A slight restatement of that second sentence is:

“The sum of a list of integers is the sum of the *head* element, plus the sum of the *tail* elements.”

Thinking about a `List` in terms of its head and tail elements is a standard way of thinking when writing recursive functions.

Now that we have a little idea of how to *think* about the problem recursively, let’s see how to implement those sentences in Scala code.

## Implementing the first sentence in code

The first sentence above states:

If the `sum` function is given an empty list of integers, it should return `0`.

Recursive Scala functions are often implemented using `match` expressions. Using (a) that information, and (b) remembering that an empty list contains only the `Nil` element, you can start writing the body of the `sum` function like this:

```
def sum(list: List[Int]): Int = list match {  
  case Nil => 0
```

This is a Scala way of saying, “If the `List` is empty, return `0`.” If you’re comfortable with `match` expressions and the `List` class, I think you’ll agree that this makes sense.

### ***Note 1: Using `return`***

If you prefer using `return` statements at this point in your Scala career, you can write that code like this:

```
def sum(list: List[Int]): Int = list match {  
  case Nil => return 0
```

Because a pure function doesn’t “return” a value as much as it “evaluates” to a result, you’ll want to quickly drop `return` from your vocabulary, but ... I also understand that using `return` can help when you first start writing recursive functions.

### ***Note 2: Using `if/then` instead***

You can also write this function using an `if/then` expression, but because you’ll often use *pattern matching* with recursive algorithms, I use a `match` expression here.

### ***Note 3: Can also use `List()`***

Because `Nil` is equivalent to `List()`, you can also write that case expression like this:

```
case List() => 0
```

However, most functional programmers use `Nil`, and I'll continue to use `Nil` in this lesson.

## Implementing the second sentence in code

That case expression is a Scala/FP implementation of the first sentence, so let's move on to the second sentence.

The second sentence says, “If the list is *not* empty, the result of the algorithm is the combination of (a) the value of its head element, and (b) the sum of its tail elements.”

To split the list into head and tail components, I start writing the second case expression like this:

```
case head :: tail => ???
```

If you know your case expressions, you know that if `sum` is given a list like `List(1, 2, 3, 4)`, this pattern has the result of assigning `head` to the value `1`, and assigning `tail` the value `List(2, 3, 4)`:

```
head = 1  
tail = List(2, 3, 4)
```

This case expression is a start, but how do we finish it? Again I go back to the second sentence:

If the list is *not* empty, the result of the algorithm is the combination of (a) the value of its head element, and (b) the sum of the tail elements.

The “value of its head element” is easy to add to the case expression:

```
case head :: tail => head ...
```

But then what? As the sentence says, “the value of its head element, and the sum of the tail elements,” which tells us we’ll be adding *something* to `head`:

```
case head :: tail => head + ???
```

What are we adding to `head`? *The sum of the list’s tail elements*. Hmm, now how can we get the sum of a list of tail elements? How about this:

```
case head :: tail => head + sum(tail)
```

Whoa. That code is a straightforward implementation of the sentence, isn't it?

(I'll pause here to let that sink in.)

If you combine this new case expression with the existing code, you get the following sum function:

```
def sum(list: List[Int]): Int = list match {  
  case Nil => 0  
  case head :: tail => head + sum(tail)  
}
```

And that is a recursive “sum the integers in a List” function in Scala/FP. No var's, no for loop.

## A note on those names

If you're new to case expressions, it's important to note that the `head` and `tail` variable names in the second case expression can be anything you want. I wrote it like this:

```
case head :: tail => head + sum(tail)
```

but I could have written this:

```
case h :: t => h + sum(t)
```

or this:

```
case x :: xs => x + sum(xs)
```

This last example uses variable names that are commonly used with FP, lists, and recursive programming. When working with a list, a single element is often referred to as `x`, and multiple elements are referred to as `xs`. It's a way of indicating that `x` is singular and `xs` is plural, like referring to a single “pizza” or multiple “pizzas.” With lists, the head element is definitely singular, while the tail can contain one or more elements. I'll generally use this naming convention in this book.



## Proof that sum works

To demonstrate that sum works, you can clone my [RecursiveSum project on Github](#) — which uses [ScalaTest](#) to test sum — or you can copy the following source code that extends a Scala App to test sum:

```
object RecursiveSum extends App {  
  def sum(list: List[Int]): Int = list match {  
    case Nil => 0  
    case x :: xs => x + sum(xs)  
  }  
  
  val list = List(1, 2, 3, 4)  
  val sum = sum(list)  
  println(sum)  
}
```

When you run this application you should see the output, 10. If so, congratulations on your first recursive function!

“That’s great,” you say, “but how exactly did that end up printing 10?”

To which I say, “Excellent question. Let’s dig into that!”

As I’ve noted before, I tend to write verbose code that’s hopefully easy to understand, especially in books, but you can shrink the last three lines of code to this, if you prefer:

```
println(sum(List(1,2,3,4)))
```

# Recursion: How Recursive Function Calls Work

An important point to understand about recursive function calls is that just as they “wind up” as they are called repeatedly, they “unwind” rapidly when the function’s end condition is reached.

In the case of the `sum` function, the end condition is reached when the `Nil` element in a `List` is reached. When `sum` gets to the `Nil` element, this pattern of the `match` expression is matched:

```
case Nil => 0
```

Because this line simply returns `0`, there are no more recursive calls to `sum`. This is a typical way of ending the recursion when operating on all elements of a `List` in recursive algorithms.

## Lists end with Nil

As I wrote in the earlier List lesson, a literal way to create a List is like this:

```
1 :: 2 :: 3 :: 4 :: Nil
```

This is a reminder that with any Scala List you are guaranteed that the last List element is Nil. Therefore, if your algorithm is going to operate on the entire list, you should use:

```
case Nil => ???
```

as your function's end condition.

This is the first clue about how the unfolding process works.

Note 1: This is a feature of the Scala List class. You'll have to change the approach if you work with other sequential collection classes like Vector, ArrayBuffer, etc. (More on this later in the book.)

Note 2: Examples of functions that work on every element in a list are map, filter, foreach, sum, product, and many more. Examples of functions that *don't* operate on every list element are take and takeWhile.

## Understanding how the sum example ran

A good way to understand how the sum function example ran is to add `println` statements inside the case expressions.

First, change the sum function to look like this:

```
def sum(list: List[Int]): Int = list match {
  case Nil => {
    println("case1: Nil was matched")
    0
  }
  case head :: tail => {
    println(s"case2: head = $head, tail = $tail")
    head + sum(tail)
  }
}
```

Now when you run it again with a `List(1, 2, 3, 4)` as its input parameter, you'll see this output:

```
case2: head = 1, tail = List(2, 3, 4)
case2: head = 2, tail = List(3, 4)
case2: head = 3, tail = List(4)
case2: head = 4, tail = List()
case1: Nil was matched
```

That output shows that `sum` is called repeatedly until the list is reduced to `List()` (which is the same as `Nil`). When `List()` is passed to `sum`, the first case is matched and the recursive calls to `sum` come to an end. (I'll demonstrate this visually in the next lesson.)

The book, [Land of Lisp](#) states, "recursive functions are list eaters," and this output shows why that statement is true.

## How the recursion works (“going down”)

Keeping in mind that `List(1, 2, 3, 4)` is the same as `1::2::3::4::Nil`, you can read the output like this:

1. The first time `sum` is called, the match expression sees that the given `List` doesn't match the `Nil` element, so control flows to the second case statement.
2. The second case statement matches the `List` pattern, then splits the incoming list of `1::2::3::4::Nil` into (a) a head element of `1` and
  1. the remainder of the list, `2::3::4::Nil`. The remainder — the tail — is then passed into another `sum` function call.
3. A new instance of `sum` receives the list `2::3::4::Nil`. It sees that this list does not match the `Nil` element, so control flows to the second case statement.
4. That statement matches the `List` pattern, then splits the list into a head element of `2` and a tail of `3::4::Nil`. The tail is passed as an input parameter to another `sum` call.
5. A new instance of `sum` receives the list `3::4::Nil`. This list does not match the `Nil` element, so control passes to the second case statement.
6. The list matches the pattern of the second case statement, which splits the list into a head element of `3` and a tail of `4::Nil`. The tail is passed as an input parameter to another `sum` call.
7. A new instance of `sum` receives the list `4::Nil`, sees that it does not match `Nil`, and passes control to the second case statement.
8. The list matches the pattern of the second case statement. The list is split into a head element of `4` a tail of `Nil`. The tail is passed to another `sum` function call.
9. The new instance of `sum` receives `Nil` as an input parameter, and sees that it

*does* match the `Nil` pattern in the first case expression. At this point the first case expression is evaluated.

10. The first case expression returns the value `0`. This marks the end of the recursive calls.

At this point — when the first case expression of this `sum` instance returns `0` — all of the recursive calls “unwind” until the very first `sum` instance returns its answer to the code that called it.

## How the unwinding works (“coming back up”)

That description gives you an idea of how the recursive sum function calls work until they reach the end condition. Here’s a description of what happens *after* the end condition is reached:

1. The last sum instance — the one that received `List()` — returns `0`. This happens because `List()` matches `Nil` in the first case expression.
2. This returns control to the previous sum instance. The second case expression of that sum function has return `4 + sum(Nil)` as its return value. This is reduced to return `4 + 0`, so this instance returns `4`. (I didn’t use a return statement in the code, but it’s easier to read this now if I say “return.”)
3. Again, this returns control to the previous sum instance. That sum instance has return `3 + sum(List(4))` as the result of its second case expression. You just saw that `sum(List(4))` returns `4`, so this case expression evaluates to return `3 + 4`, or `7`.
4. Control is returned to the previous sum instance. Its second case expression has return `2 + sum(List(3,4))` as its result. You just saw that `sum(List(3,4))` returns `7`, so this expression evaluates to return `2 + 7`, or `9`.
5. Finally, control is returned to the original sum function call. Its second case expression is return `1 + sum(List(2,3,4))`. You just saw that `sum(List(2,3,4))` returns `9`, so this call is reduced to return `1 + 9`, or `10`. This value is returned to whatever code called the first sum instance.

## Initial visuals of how the recursion works

One way to visualize how the recursive sum function calls work — the “going down” part — is shown in Figure [fig:recursionGoingDown].

```
sum(List(1,2,3,4))
  -> sum(List(2,3,4))
    -> sum(List(3,4))
      -> sum(List(4))
        -> sum(List())
```

How the original sum call leads to another, then to another ...

After that, when the end condition is reached, the “coming back up” part — what I call the unwinding process — is shown in Figure [fig:recursionUnwinding].

```
        -> sum( Nil )    // return 0
      -> sum( List(4) )  // return 4 + sum( List() )    => return 4 + 0 => 4
    -> sum( List(3,4) ) // return 3 + sum( List(4) )    => return 3 + 4 => 7
  -> sum( List(2,3,4) ) // return 2 + sum( List(3, 4) )    => return 2 + 7 => 9
sum( List(1,2,3,4) )   // return 1 + sum( List(2, 3, 4) ) => return 1 + 9 => 10
```

How sum function calls unwind, starting with the last sum call

If this isn't clear, fear not, in the next lesson I'll show a few more visual examples of how this works.



# Visualizing the Recursive sum Function

Another way to view recursion is with visual diagrams. To demonstrate this, I'll use the rectangular symbol shown in Figure [fig:rectFunctionSymbol] to represent a function.

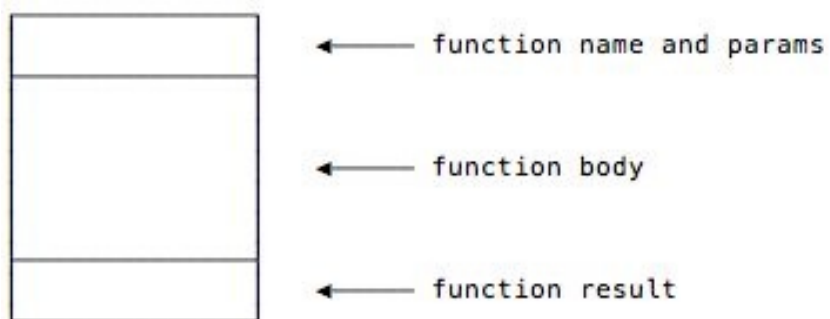

This rectangular symbol will be used to represent functions in this lesson

## The first step

Using that symbol and a list with only three elements, Figure [fig:the1stSumCall] shows a representation of the first sum function call.

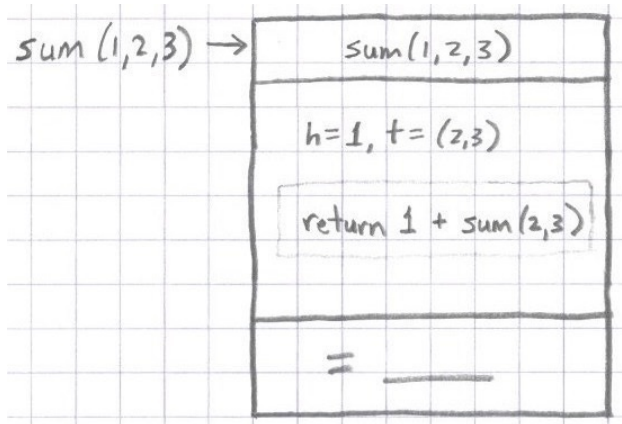

A visual representation of the first sum call

The top cell in the rectangle indicates that this first instance of sum is called with the parameters 1, 2, 3. Note that I'm leaving the "List" name off of these diagrams to make them more readable.

The body of the function is shown in the middle region of the symbol, and it's shown as return 1 + sum(2, 3). As I mentioned before, you don't normally use the return keyword with Scala/FP functions, but in this case it makes the diagram more clear.

In the bottom region of the symbol I've left room for the final return value of the function. At this time we don't know what the function will return, so for now I just leave that spot empty.

## The next steps

For the next step of the diagram, assume that the first sum function call receives the parameter list (1, 2, 3), and its body now calls a new instance of sum with the input parameter sum(2, 3) (or sum(List(2, 3)), if you prefer). You can imagine the second case expression separating the List into head and tail elements, as shown in Figure [fig:the2ndSumCall].

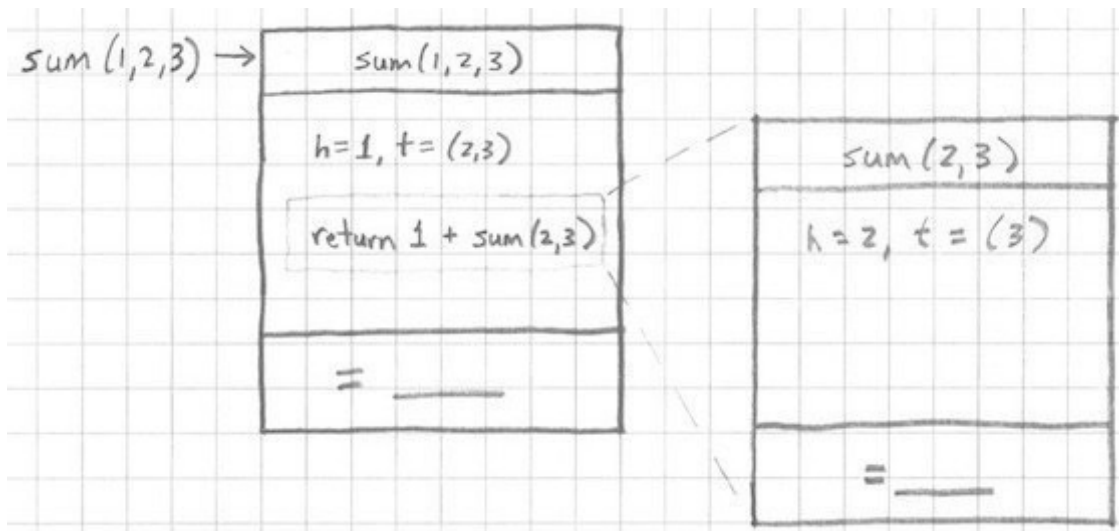

The first sum function invokes a second sum function call

Then this sum instance makes a recursive call to another sum instance, as shown in Figure [fig:the2ndSumCallsThe3rd].

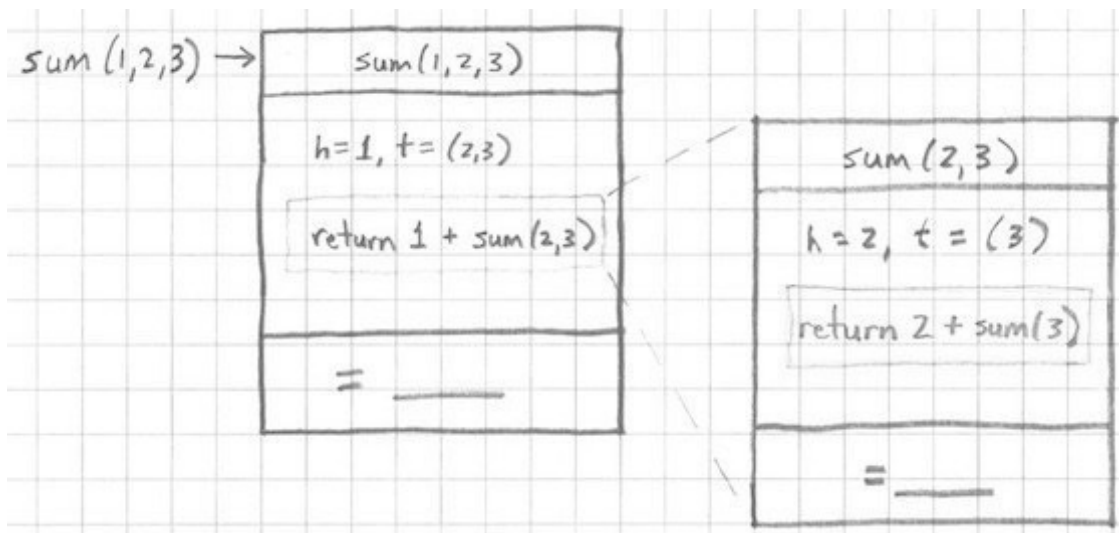

The second sum function call begins to invoke the third sum instance

Again I leave the return value of this function empty because I don't know what it will be until its sum call returns.

It's important to be clear that these two function calls are completely different instances of sum. They have their own input parameter lists, local variables, and return values. It's just as if you had two different functions, one named

sum3elements and one named sum2elements, as shown in Figure [fig:justLikeCallingDiffFunction].

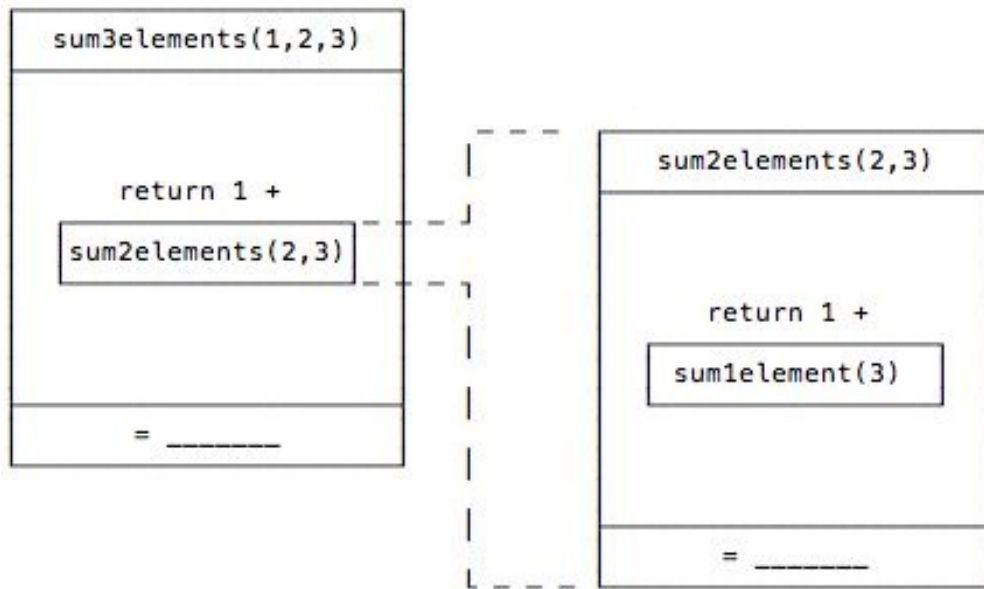

One sum function calling another sum instance is just like calling a different function

Just as the variables inside of `sum3elements` and `sum2elements` have completely different scope, the variables in two different instances of `sum` also have completely different scope.

Getting back to the `sum` example, you can now imagine that the next step will proceed just like the previous one, as shown in Figure [fig:the3rdSumCall].

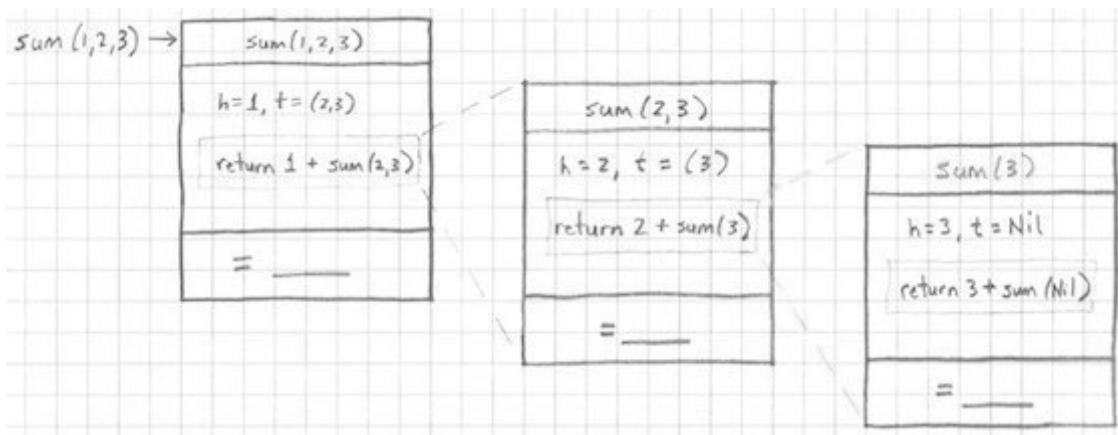

The third `sum` function has now been called

## The last recursive sum call

Now we're at the point where we make the last recursive call to sum. In this case, because 3 was the last integer in the list, a new instance of sum is called with the Nil value. This is shown in Figure [fig:nilPassedIntoLastSumCall].

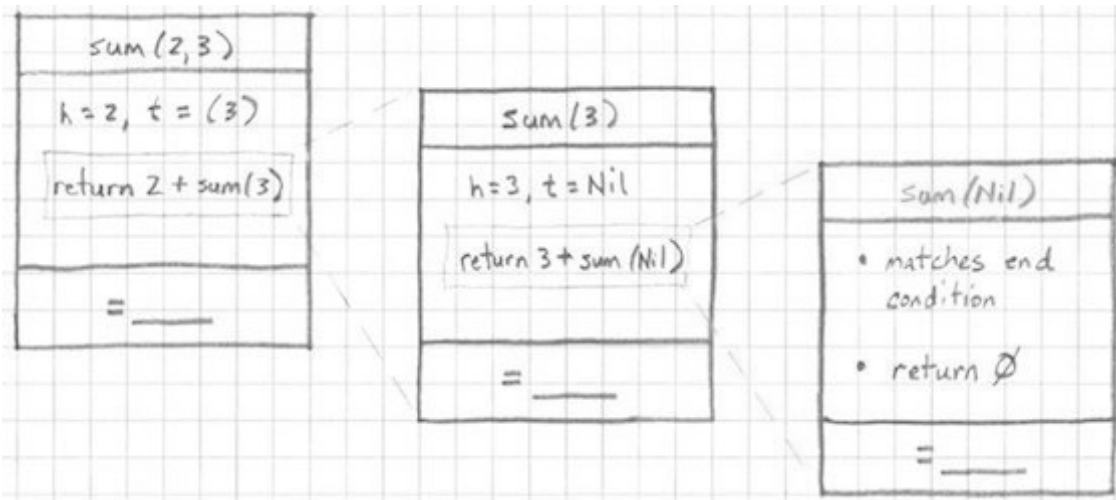

Nil is passed into the final sum function call

With this last sum call, the Nil input parameter matches the first case expression, and that expression simply returns  $\emptyset$ . So now we can fill in the return value for this function, as shown in Figure [fig:returnValLastCallIs0].

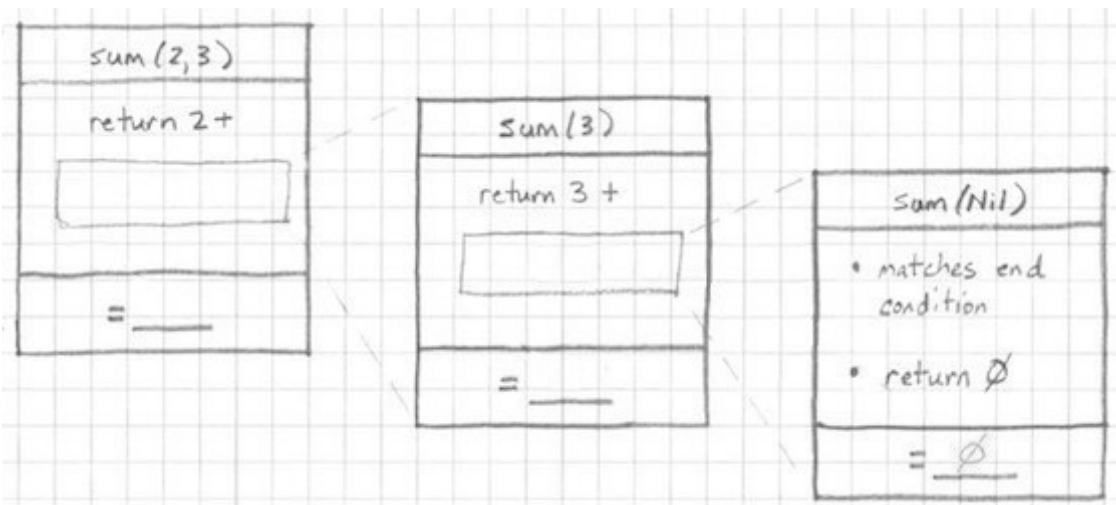

The return value of the last sum call is  $\emptyset$

Now this sum instance returns  $\emptyset$  back to the previous sum instance, as shown in

Figure [fig:return0To3rdSumCall].

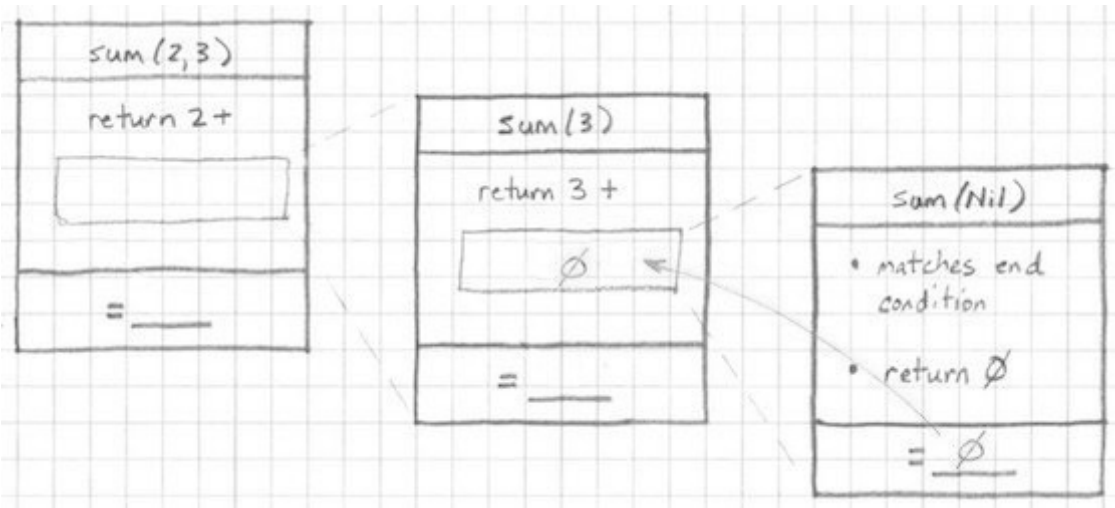

$\emptyset$  is returned back to the previous sum call

The result of this function call is  $3 + \emptyset$  (which is 3), so you can fill in its return value, and then flow it back to the previous sum call. This is shown in Figure [fig:the3rdSumCallReturns].

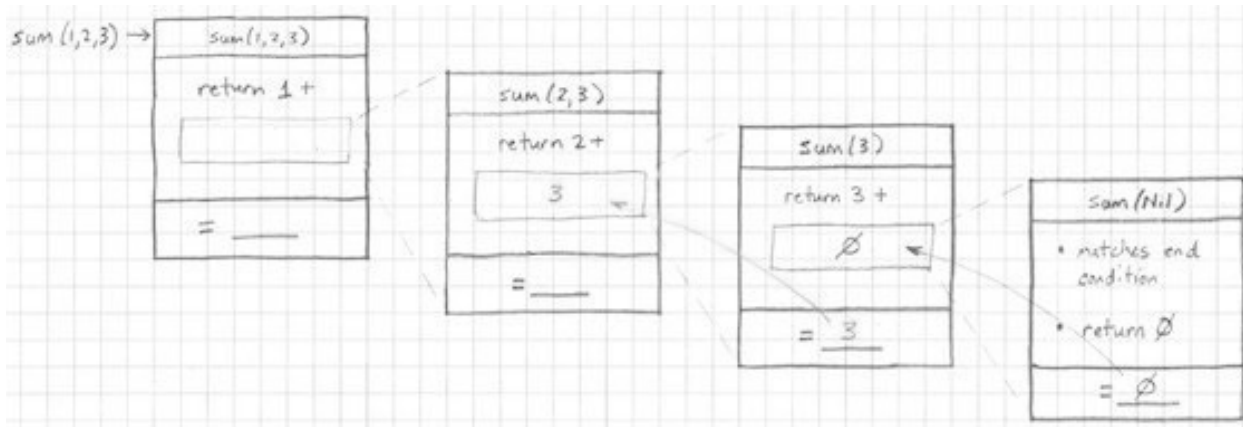

The third sum call returns to the second

The result of this function call is  $2 + 3$  (5), so that result can flow back to the previous function call, as shown in Figure [fig:the2ndSumCallReturns].

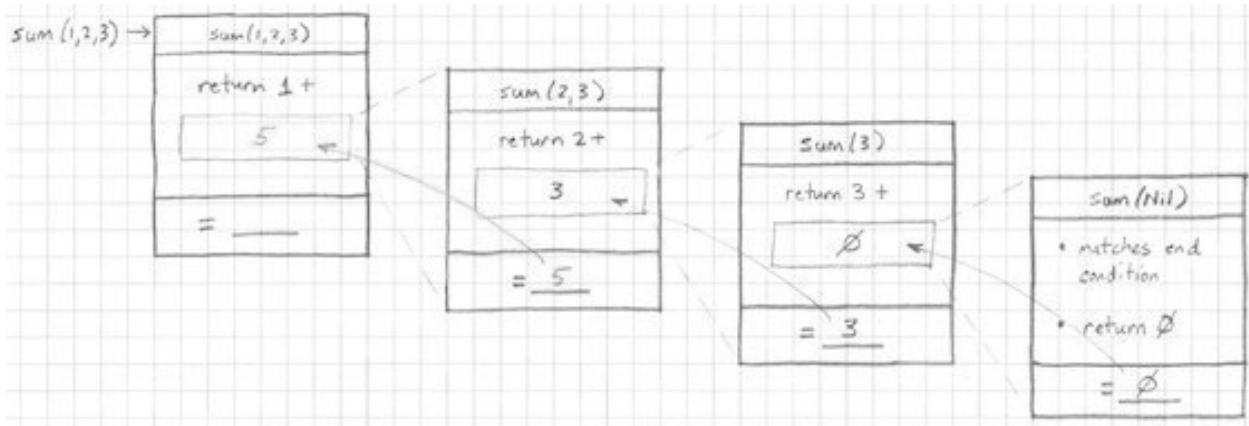

The second sum call returns to the first

Finally, the result of this sum instance is  $1 + 5$  (6). This was the first sum function call, so it returns the value 6 back to whoever called it, as shown in Figure [fig:the1stSumCallReturns].

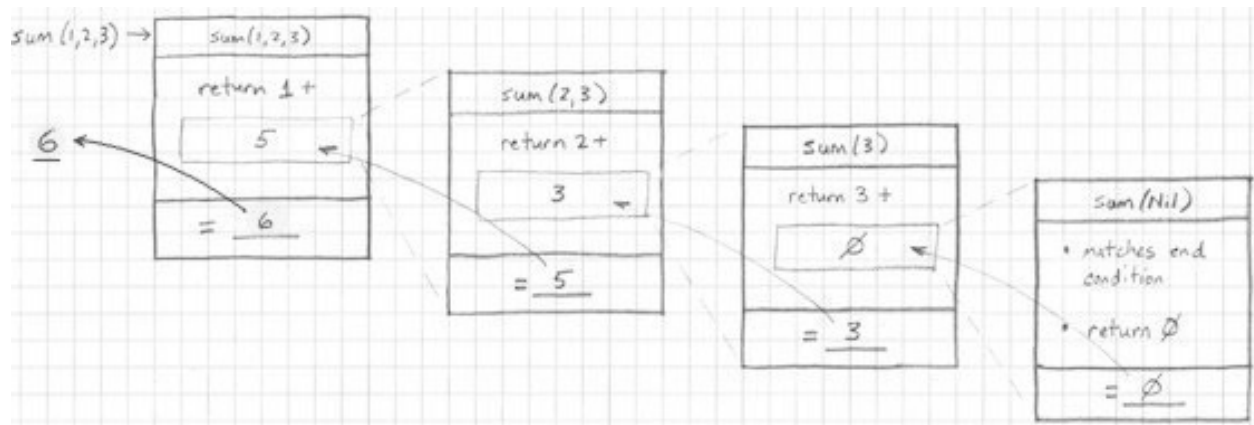

The first sum call returns to the final result

## Other visualizations

There are other ways to draw recursive function calls. Another nice approach is to use a modified version of a UML “[Sequence Diagram](#),” as shown in Figure [fig:sumFunctionCallsAsSequenceDiagram]. Note that in this diagram “time” flows from the top to the bottom.

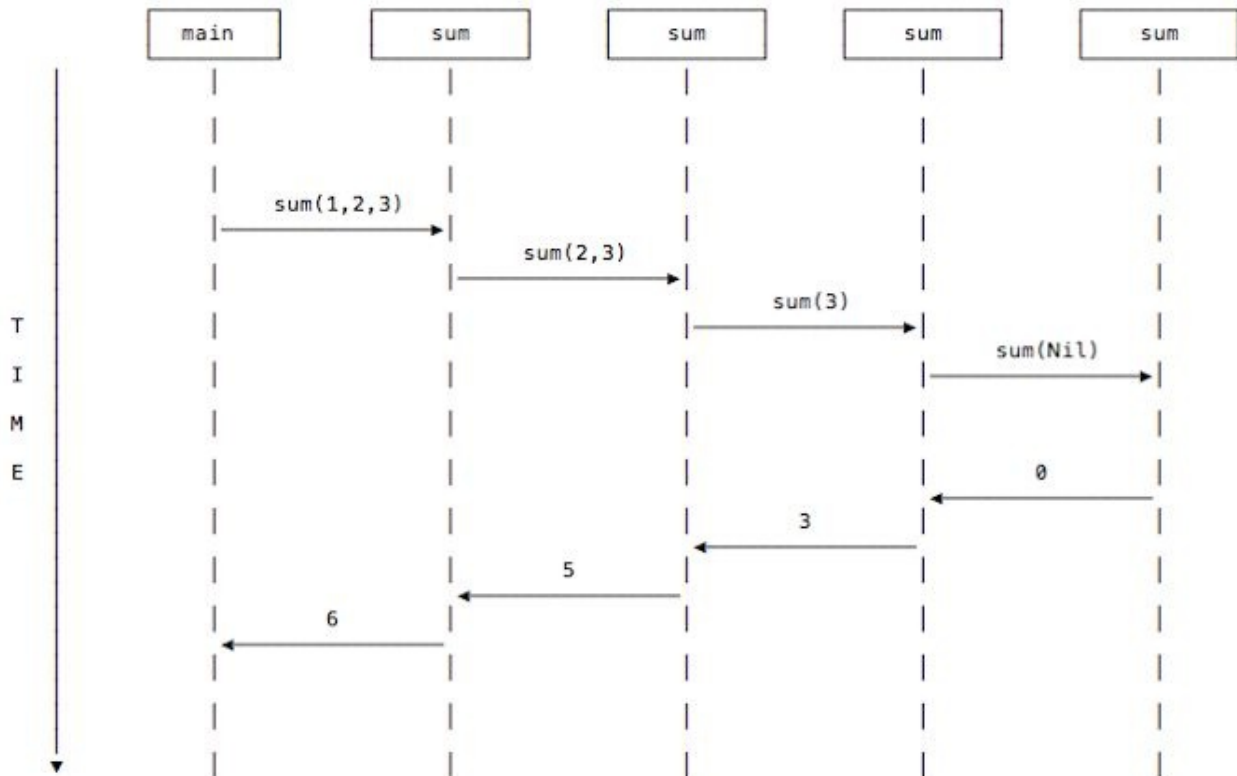

The sum function calls can be shown using a UML Sequence Diagram

This diagram shows that the main method calls sum with the parameter `List(1, 2, 3)`, where I again leave off the `List` part; it calls `sum(2, 3)`, and so on, until the `Nil` case is reached, at which point the return values flow back from right to left, eventually returning 6 back to the main method.

You can write the return values like that, or with some form of the function’s equation, as shown in Figure [fig:writingFunctionReturnValuesAsEquations].



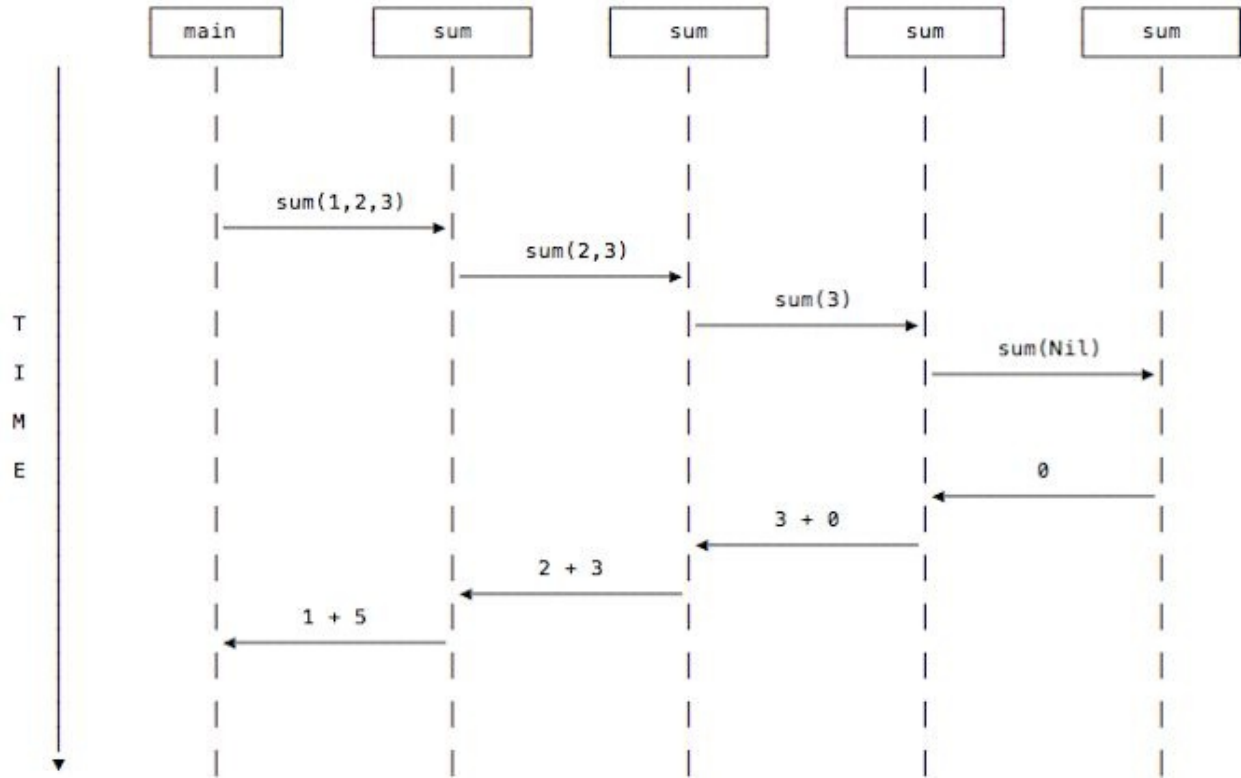

Writing the function return values as equations

Personally, I use whatever diagram seems to help the most.

## Summary

Those are some visual examples of how recursive function calls work. If you find yourself struggling to understand how recursion works, I hope these diagrams are helpful.

# Recursion: A Conversation Between Two Developers

As an homage to one of my favorite Lisp books — an early version of what is now [The Little Schemer](#) — this lesson shows a little question and answer interaction that you can imagine happening between two Scala programmers.

Given this sum function:

```
def sum(list: List[Int]): Int = list match {  
  case Nil => 0  
  case x :: xs => x + sum(xs)  
}
```

I hope this “conversation” will help drive home some of the points about how recursion works:

Person 1	Person 2
What is this? <code>val x = List(1, 2, 3, 4)</code>	An expression that defines a <code>List[Int]</code> , which in this case contains the integers 1 through 4. The expression binds that list to the variable <code>x</code> .
And what is this? <code>x.head</code>	The first element of the list <code>x</code> , which is 1.
How about this? <code>x.tail</code>	That’s the remaining elements in the list <code>x</code> , which is <code>List(2, 3, 4)</code> .
How about this: <code>x.tail.head</code>	It is the number 2.

How did you come up with that?	<code>x.tail</code> is <code>List(2, 3, 4)</code> , and <code>List(2, 3, 4).head</code> is the first element of that list, or 2.
How about this: <code>x.tail.tail</code>	That's <code>List(3, 4)</code> .
Explain, please.	<code>x.tail</code> is <code>List(2, 3, 4)</code> , and then <code>List(2, 3, 4).tail</code> is <code>List(3, 4)</code> .
Are you ready for more?	Yes, please.
Given the definition of our <code>sum</code> function, explain the first step in: <code>sum(List(1, 2, 3))</code> .	The <code>sum</code> function receives <code>List(1, 2, 3)</code> . This does not match the <code>Nil</code> case, but does match the second case, where <code>x</code> is assigned to 1 and <code>xs</code> is <code>List(2, 3)</code> .
Then what happens?	A new instance of <code>sum</code> is called with the parameter <code>List(2, 3)</code> .
And then?	A new instance of <code>sum</code> receives the input parameter <code>List(2, 3)</code> . This does not match the <code>Nil</code> case, but does match the second case, where <code>x</code> is assigned to 2 and <code>xs</code> is <code>List(3)</code> .
Please continue.	<code>sum</code> is called with the parameter <code>List(3)</code> .
Go on.	A new instance of <code>sum</code> receives <code>List(3)</code> . This does not match the <code>Nil</code> case, but does match the second

	case, where <code>x</code> is assigned to 3 and <code>xs</code> is <code>List()</code> .
Don't stop now.	<code>sum</code> is called with the parameter <code>List()</code> .
What happens inside this instance of <code>sum</code> ?	It receives <code>List()</code> . This is the same as <code>Nil</code> , so it matches the first case.
Cool. Something different. Now what happens?	That case returns <code>0</code> .
Ah, finally a return value!	You're telling me.
Okay, so now what happens?	This ends the recursion, and then the recursive calls unwind, as described in the previous lesson.

# **Recursion: Thinking Recursively**

## Goal

This lesson has one primary goal: to show that the thought process followed in writing the sum function follows a common recursive programming “pattern.” Indeed, when you write recursive functions you’ll generally follow the three-step process shown in this lesson.

I don’t want to make this too formulaic, but the reality is that if you follow these three steps in your thinking, it will make it easier to write recursive functions, especially when you first start.

## The general recursive thought process (the “three steps”)

As I mentioned in the previous lessons, when I sit down to write a recursive function, I think of three things:

- What is the function signature?
- What is the end condition for this algorithm?
- What is the actual algorithm? For example, if I’m processing all of the elements in a `List`, what does my algorithm do when the function receives a non-empty `List`?

Let’s take a deep dive into each step in the process to make more sense of these descriptions.



## Step 1: What is the function signature?

Once I know that I'm going to write a recursive function, the first thing I ask myself is, "What is the signature of this function?"

If you can describe the function verbally, you should find that you know (a) the parameters that will be passed into the function and (b) what the function will return. In fact, if you *don't* know these things, you're probably not ready to write the function yet.

### *The sum function*

In the sum function the algorithm is to add all of the integers in a given list together to return a single integer result. Therefore, because I know the function takes a list of integers as its input, I can start sketching the function signature like this:

```
def sum(list: List[Int]) ...
```

Because the description also tells me that the function returns an `Int` result, I add the function's return type:

```
def sum(list: List[Int]): Int = ???
```

This is the Scala way to say that "the sum function takes a list of integers and returns an integer result," which is what I want. In FP, sketching the function signature is often half of the battle, so this is actually a big step.

## Step 2: How will this algorithm end?

The next thing I usually think about is, “How will this algorithm end? What is its end condition?”

Because a recursive function like `sum` keeps calling itself over and over, it's of the utmost importance that there is an end case. If a recursive algorithm doesn't have an end condition, it will keep calling itself as fast as possible until either (a) your program crashes with a `StackOverflowError`, or (b) your computer's CPU gets extraordinarily hot. Therefore, I offer this tip:

Always have an end condition, and write it as soon as possible.

In the `sum` algorithm you know that you have a `List`, and you want to march through the entire `List` to add up the values of all of its elements. You may not know it at this point in your recursive programming career, but right away this statement is a big hint about the end condition. Because (a) you know that you're working with a `List`, (b) you want to operate on the entire `List`, and (c) a `List` ends with the `Nil` element, (d) you can begin to write the end condition case expression like this:

```
case Nil => ???
```

To be clear, this end condition is correct because you're working with a `List`, and you know that the algorithm will operate on the entire `List`. Because the `Nil` element is to a `List` as a caboose is to a train, you're guaranteed that it's always the last element of the `List`.

Note: If your algorithm will not work on the entire `List`, the end condition will be different than this.

Now the next question is, “What should this end condition return?”

A key here is that the function signature states that it returns an `Int`. Therefore, you know that this end condition must return an `Int` of some sort. But what `Int`? Because this is a “sum” algorithm, you also know that you don't want to return anything that will affect the sum. Hmmm ... what `Int` can you return when the `Nil` element is reached that won't affect the sum?

The answer is 0.

(More on this shortly.)

Given that answer, I can update the first case condition:

```
def sum(list: List[Int]): Int = list match {  
  case Nil => 0  
  case ???  
}
```

That condition states that if the function receives an empty `List` — denoted by `Nil` — the function will return 0.

Now we're ready for the third step.

I'll expand more on the point of returning 0 in this algorithm in the coming lessons, but for now it may help to know that there's a mathematical theory involved in this decision. What's happening here is that you're returning something known as an "identity" element for the current data set and algorithm. As a quick demonstration of what I'm talking about, here are a few other *identity* elements for different data sets and algorithms:

1) Imagine that you want to write a "product" algorithm for a list of integers. What would you return for the end condition in this case? The correct answer is 1. This is because the product involves multiplying all elements of the list, and multiplying any number by 1 gives you the original number, so this doesn't affect the final result in any way.

2) Imagine that you're writing a concatenation algorithm for a `List[String]`. What would you return for the end condition in this case? The correct answer is , an empty `String` (because once again, it does not affect the final result).

## Step 3: What is the algorithm?

Now that you've defined the function signature and the end condition, the final question is, "What is the algorithm at hand?"

When your algorithm will operate on all of the elements in a `List` and the first case condition handles the "empty list" case, this question becomes, "What should my function do when it receives a *non-empty List*?"

The answer for a "sum" function is that it should add all of the elements in the list. (Similarly, the answer for a "product" algorithm is that it should multiply all of the list elements.)

### *The sum algorithm*

At this point I go back to the original statement of the sum algorithm:

"The sum of a list of integers is the sum of the *head* element, plus the sum of the *tail* elements."

Because the first case expression handles the "empty list" case, you know that the second case condition should handle the case of the non-empty list. A common way to write the *pattern* for this case expression is this:

```
case head :: tail => ???
```

This pattern says, "head will be bound to the value of the first element in the `List`, and `tail` will contain all of the remaining elements in the `List`."

Because my description of the algorithm states that the sum is "the sum of the *head* element, plus the sum of the *tail* elements," I start to write a case expression, starting by adding the head element:

```
case head :: tail => head + ???
```

and then I write this code to represent "the sum of the tail elements":

```
case head :: tail => head + sum(tail)
```

That is a Scala/FP recursive way of expressing the thought, “The sum of a list of integers is the sum of the *head* element, plus the sum of the *tail* elements.”

(I described that thought process in detail in the previous lessons, so I won't repeat all of that thought process here.)

Now that we have the function signature, the end condition, and the main algorithm, we have the completed function:

```
def sum(list: List[Int]): Int = list match {  
  case Nil => 0  
  case head :: tail => head + sum(tail)  
}
```

### ***Naming conventions***

As I noted in the previous lessons, when FP developers work with lists, they often prefer to use the variable name *x* to refer to a single element and *xs* to refer to multiple elements, so this function is more commonly written with these variable names:

```
def sum(list: List[Int]): Int = list match {  
  case Nil => 0  
  case x :: xs => x + sum(xs)  
}
```

(But you don't have to use those names; use whatever is easiest for you to read.)

## The last two steps are iterative

In practice, the first step — sketching the function signature — is almost always the first step in the process. As I mentioned, it's hard to write a function if you don't know what the inputs and output will be.

But the last two steps — defining the end condition, and writing the algorithm — are interchangeable, and even iterative. For instance, if you're working on a `List` and you want to do something for *every* element in the list, you know the end condition will occur when you reach the `Nil` element. But if you're not going to operate on the entire list, or if you're working with something other than a `List`, it can help to bounce back and forth between the end case and the main algorithm until you come to the solution.

Note that the sum algorithm I've shown specifically works on a Scala `List`, which ends with a `Nil` element. It will not work with other sequences like `Vector`, `ArrayBuffer`, `ListBuffer`, or other sequences that do not have a `Nil` value as the last element in the sequence. I discuss the handling of those other sequences later in the book.

## Summary

When I sit down to write a recursive function, I generally think of three things:

- What is the function signature?
- What is the end condition for this algorithm?
- What is the main algorithm?

To solve the problem I almost always write the function signature first, and after that I usually write the end condition next, though the last two steps can also be an iterative process.

## What's next

Now that you've seen this "general pattern" of writing recursive functions, the next two lessons are exercises that give you a taste of how to use the patterns to write your own recursive functions.

First, I'll have you write another recursive function to operate on all of the elements in a `List`, and then you'll work on a recursive algorithm that operates on only a subset of a `List`.



# JVM Stacks and Stack Frames

For functions without deep levels of recursion, there's nothing wrong with the algorithms shown in the previous lessons. I use this simple, basic form of recursion when I know that I'm working with limited data sets. But in applications where you don't know how much data you might be processing, it's important that your recursive algorithms are *tail-recursive*, otherwise you'll get a nasty `StackOverflowError`.

For instance, if you run the `sum` function from the previous lessons with a larger list, like this:

```
object RecursiveSum extends App {  
  def sum(list: List[Int]): Int = list match {  
    case Nil => 0  
    case x :: xs => x + sum(xs)  
  }  
  
  val list = List.range(1, 10000) // MUCH MORE DATA  
  val x = sum(list)  
  println(x)  
}
```

you'll get a `StackOverflowError`, which is *really* counter to our desire to write great, bulletproof, functional programs.

The actual number of integers in a list needed to produce a `StackOverflowError` with this function will depend on the java command-line settings you use, but [the last time I checked](#) the default Java stack size it was 1,024 kb — yes, 1,024 *kilobytes* — just over one million *bytes*. That's not much RAM to work with. I write more about this at the end of this lesson, including how to change the default stack size with the java command's `-Xss` parameter.

I'll cover tail recursion in an upcoming lesson, but in this lesson I want to discuss the JVM stack and stack frames. If you're not already familiar with these

concepts, this discussion will help you understand what's happening here. It can also help you debug "stack traces" in general.

## What is a “Stack”?

To understand the potential “stack overflow” problem of recursive algorithms, you need to understand what happens when you write recursive algorithms.

The first thing to know is that in all computer programming languages there is this thing called “the stack,” also known as the “call stack.”

### *Official Java/JVM “stack” definition*

[Oracle provides the following description of the stack and stack frames](#) as they relate to the JVM:

“Each JVM thread has a private Java virtual machine stack, created at the same time as the thread. A JVM stack stores frames, also called “stack frames”. A JVM stack is analogous to the stack of a conventional language such as C — it holds local variables and partial results, and plays a part in method invocation and return.”

Therefore, you can visualize that a single stack has a pile of stack frames that look like Figure [fig:aSingleStack].

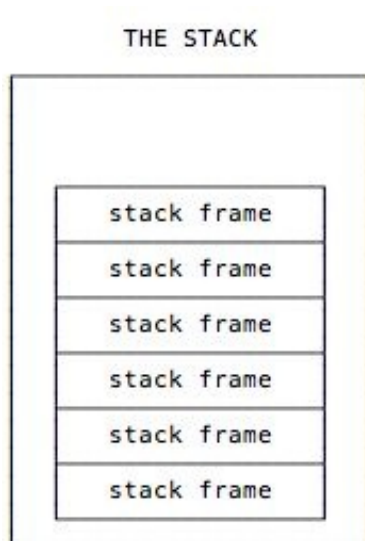

A single stack has a pile of stack frames.

As that quote mentions, each thread has its own stack, so in a multi-threaded application there are multiple stacks, and each stack has its own stack of frames, as shown in Figure [fig:multipleStacks].

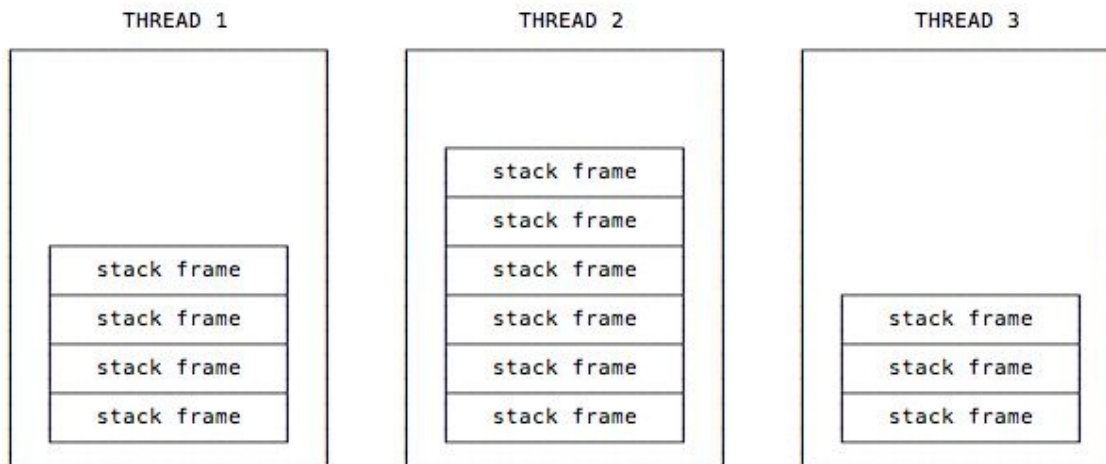

Each thread has its own stack.

## ***The Java stack***

To explain the stack a little more, all of the following quoted text comes from the free, online version of a book titled, [Inside the Java Virtual Machine](#), by Bill Venner. (I edited the text slightly to include only the portions relevant to stacks and stack frames.)

“When a new thread is launched, the JVM creates a new stack for the thread. A Java stack stores a thread’s state in discrete frames. *The JVM only performs two operations directly on Java stacks: it pushes and pops frames.*”

“The method that is currently being executed by a thread is the thread’s current method. The stack frame for the current method is the current frame. The class in which the current method is defined is called the current class, and the current class’s constant pool is the current constant pool. As it executes a method, the JVM keeps track of the current class and current constant pool. When the JVM encounters instructions that operate on data stored in the stack frame, it performs those operations on the current frame.”

*“When a thread invokes a Java method, the JVM creates and pushes a new frame onto the thread’s stack. This new frame then becomes the current frame. As the method executes, it uses the frame to store parameters, local variables, intermediate computations, and other data.”*

As the previous paragraph implies, each instance of a method has its own stack frame. Therefore, when you see the term “stack frame,” you can think, “all of the stuff a method instance needs.”

## What is a “Stack Frame”?

[The same chapter in that book](#) describes the “stack frame” as follows: “The stack frame has three parts: local variables, operand stack, and frame data.”

You can visualize that as shown in Figure [fig:stackFrameDetails].

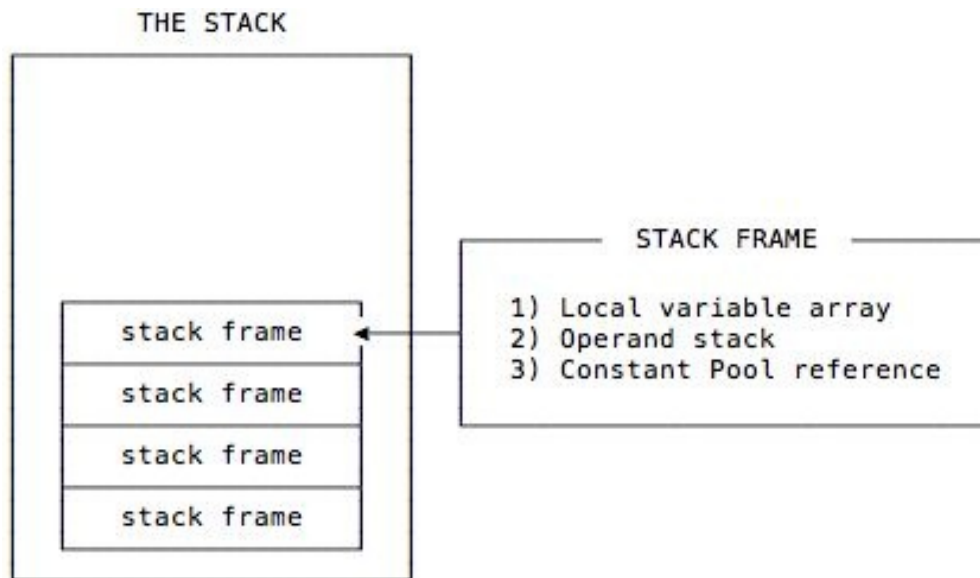

Each stack frame has three parts.

The book continues:

“The sizes of the local variables and operand stack, which are measured in *words*, depend upon the needs of each individual method. These sizes are determined at compile time and included in the class file data for each method.”

That’s important: *the size of a stack frame varies depending on the local variables and operand stack*. The book describes that size like this:

“When the JVM invokes a method, it checks the class data to determine the number of words required by the method in the local variables and operand stack. It creates a stack frame of the proper size for the method and pushes it onto the stack.”

***Word size, operand stack, and constant pool***

These descriptions introduce the phrases word size, operand stack, and constant pool. Here are definitions of those terms:

First, *word size* is a unit of measure. From [Chapter 5 of the same book](#), the word size can vary in JVM implementations, but it must be at least 32 bits so it can hold a value of type long or double.

Next, the *operand stack* is defined [here on oracle.com](#), but as a word of warning, that definition gets into machine code very quickly. For instance, it shows how two integers are added together with the `iadd` instruction. You are welcome to dig into those details, but for our purposes, a simple way to think about the operand stack is that it's memory (RAM) that is used as a working area inside a stack frame.

The Java *Run-Time Constant Pool* is defined at [this oracle.com page](#), which states, "A run-time constant pool ... contains several kinds of constants, ranging from numeric literals known at compile-time, to method and field references that must be resolved at run-time. The run-time constant pool serves a function similar to that of a symbol table for a conventional programming language, although it contains a wider range of data than a typical symbol table."

## Summary to this point

I can summarize what we've learned about stacks and stack frames like this:

- Each JVM thread has a private stack, created at the same time as the thread.
- A stack stores frames, also called “stack frames.”
- A stack frame is created every time a new method is called.

We can also say this about what happens when a Java/Scala/JVM method is invoked:

- When a method is invoked, a new stack frame is created to contain information about that method.
- Stack frames can have different sizes, depending on the method's parameters, local variables, and algorithm.
- As the method is executed, the code can only access the values in the current stack frame, which you can visualize as being the top-most stack frame.

As it relates to recursion, that last point is important. As a function like our `sum` function works on a list, such as `List(1, 2, 3)`, information about that instance of `sum` is in the top-most stack frame, and that instance of `sum` can't see the data of other instances of the `sum` function. This is how what appears to be a single, local variable — like the values `head` and `tail` inside of `sum` — can seemingly have many different values at the same time.



## One last resource on the stack and recursion

Not to belabor the point, but I want to share one last description of the stack (and the heap) that has specific comments about recursion. The discussion in Figure [fig:seriousStackSpace] comes from a book named [Algorithms](#), by Sedgewick and Wayne.

### SERIOUS STACK SPACE

Normally a computer allocates two areas of memory for a program: the stack and the heap.

The stack is used to store information about method calls. When a piece of code calls a method, information about the call is placed on the stack. When the method returns, that information is popped off the stack, so the program can resume execution just after the point where it called the method. [The stack is the same kind of stack described in Chapter 5.] The list of methods that were called to get to a particular point of execution is called the *call stack*.

The heap is another piece of memory that the program can use to create variables and perform calculations.

Typically the stack is much smaller than the heap. The stack usually is large enough for normal programs because your code typically doesn't include methods calling other methods to a very great depth. However, recursive algorithms can sometimes create extremely deep call stacks and exhaust the stack space, causing the program to crash.

For this reason, it's important to evaluate the maximum depth of recursion that a recursive algorithm requires in addition to studying its run time and memory requirements.

A discussion of the JVM stack and heap.

There are two important lines in this description that relate to recursive algorithms:

- “When the method returns, that information is popped off the stack, so the program can resume execution just after the point where it called the method.”
- “recursive algorithms can sometimes create extremely deep call stacks and exhaust the stack space.”

## Analysis

From all of these discussions I hope you can see the potential problem of recursive algorithms:

- When a recursive function calls itself, information for the new instance of the function is pushed onto the stack.
- Each time the function calls itself, another copy of the function information is pushed onto the stack. Because of this, a new stack frame is needed for each level in the recursion.
- As a result, more and more memory that is allocated to the stack is consumed as the function recurses. If the `sum` function calls itself a million times, a million stack frames are created.

# A Visual Look at Stacks and Frames

Given the background information of the previous lesson, let's take a visual look at how the JVM stack and stack frames work by going back to our recursive sum function from the previous lesson.

Before the sum function is initially called, the only thing on the call stack is the application's main method, as shown in Figure [fig:mainOnStack].

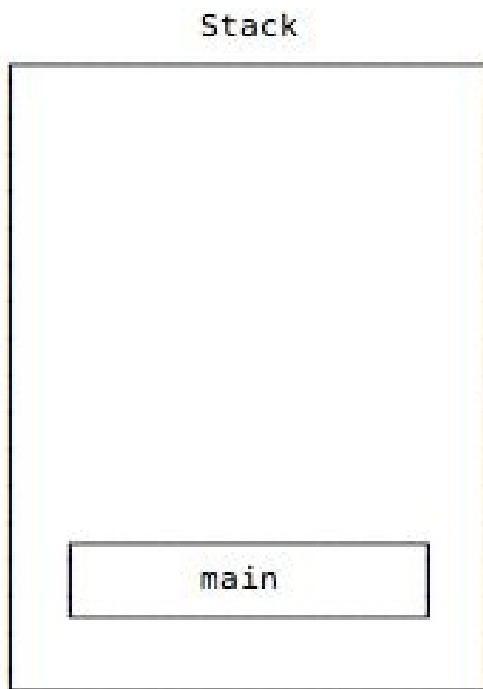

`main` is the only thing on the call stack before `sum` is called.

Then `main` calls `sum` with `List(1, 2, 3)`, which I show in Figure [fig:firstSumCall] without the "List" to keep things simple.

## Stack

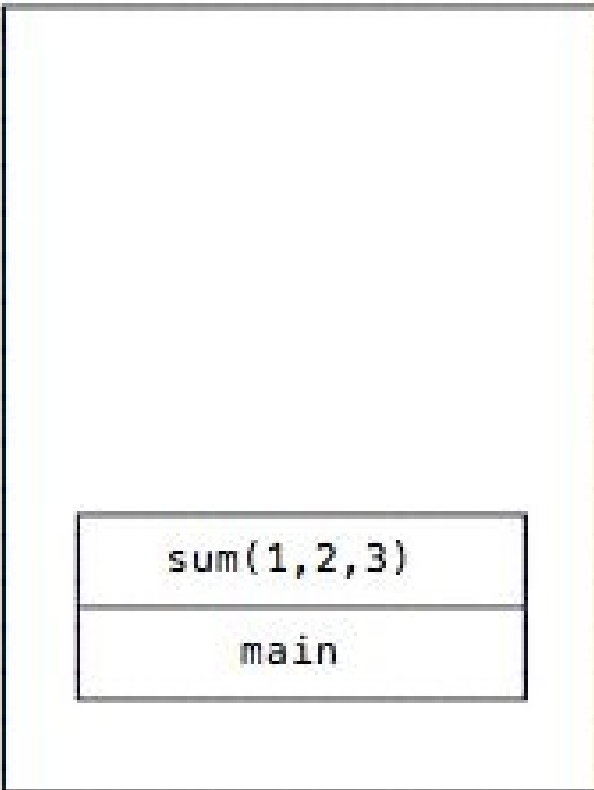

The first `sum` call is added to the stack.

The data that's given to `sum` matches its second case expression, and in my pseudocode, that expression evaluates to this:

```
return 1 + sum(2,3)
```

Next, when a new instance of `sum` is called with `List(2,3)`, the stack looks as shown in Figure [fig:theSecondSumCall].

## Stack

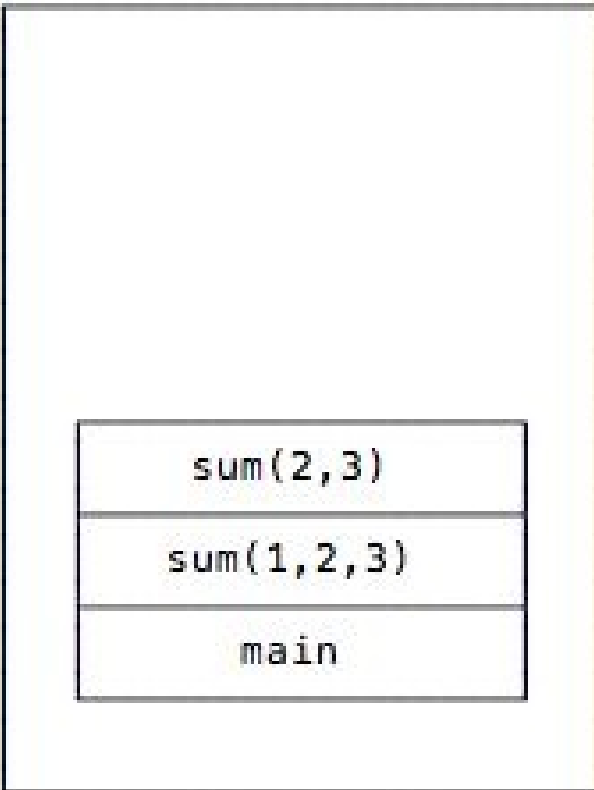

The second sum call is added to the stack.

Again the second case expression is matched inside of sum, and it evaluates to this:

```
return 2 + sum(3)
```

When a new instance of sum is called with the input parameter `List(3)`, the stack looks like Figure [fig:theThirdSumCall].

## Stack

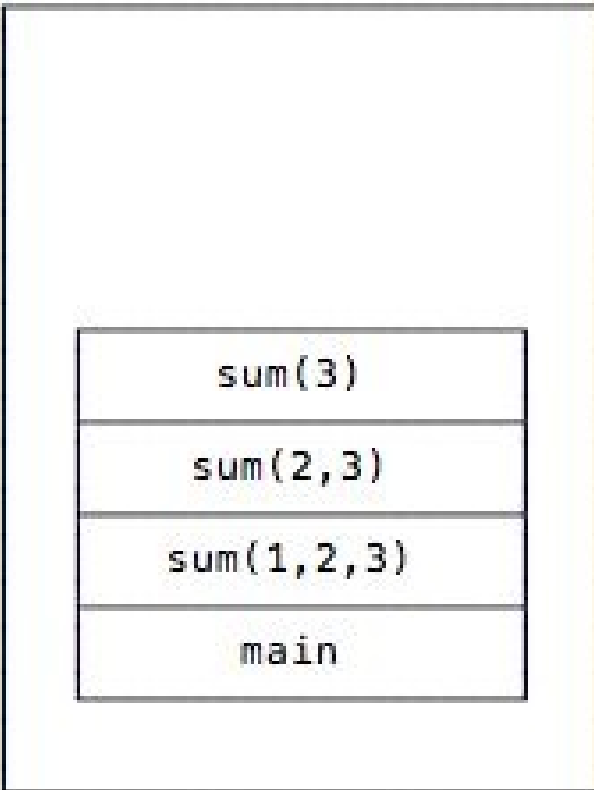

The third `sum` call is added to the stack.

Again the second case expression is matched, and that code evaluates to this:

```
return 3 + sum(Nil)
```

Finally, another instance of `sum` is called with the input parameter `List()` — also known as `Nil` — and the stack now looks like Figure [fig:theFinalSumCall].

## Stack

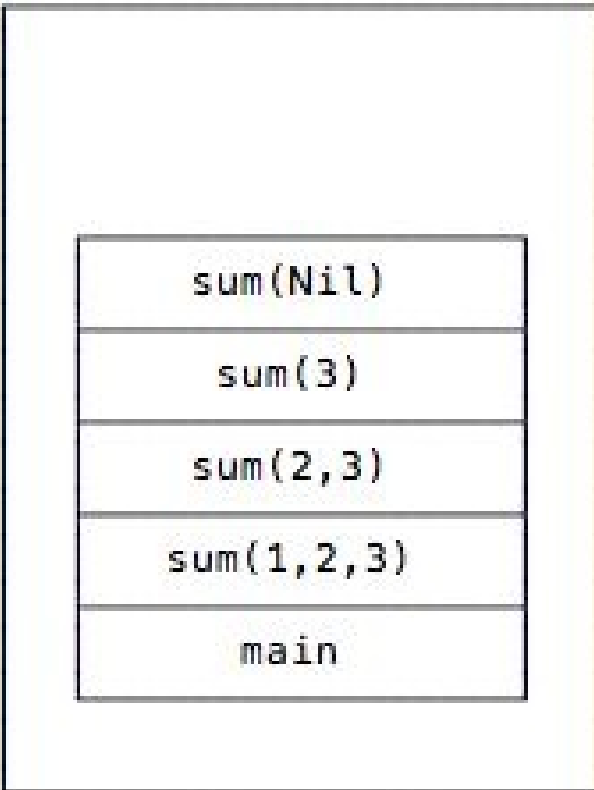

The final `sum` call is added to the stack.

This time, when `sum(Nil)` is called, the first case expression is matched:

```
case Nil => 0
```

That pattern match causes this `sum` instance to return `0`, and when it does, the call stack unwinds and the stack frames are popped off of the stack, as shown in the series of images in Figure [fig:callStackUnwinding222].

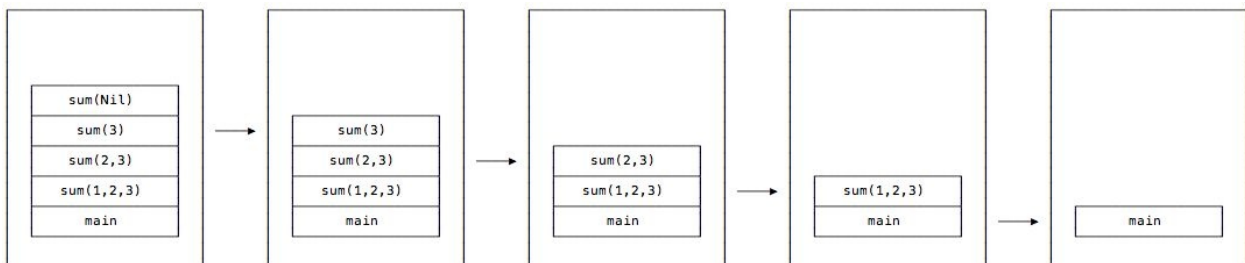

The unwinding of the call stack.

In this process, as each sum call returns, its frame is popped off of the stack, and when the recursion completely ends, the main method is the only frame left on the call stack. (The value 6 is also returned by the first sum invocation to the place where it was called in the main method.)

I hope that gives you a good idea of how recursive function calls are pushed-on and popped-off the JVM call stack.



## Manually dumping the stack with the sum example

If you want to explore this in code, you can also see the series of sum stack calls by modifying the sum function. To do this, add a couple of lines of code to the Nil case to print out stack trace information when that case is reached:

```
def sum(list: List[Int]): Int = list match {
  case Nil => {
    // this manually creates a stack trace
    val stackTraceAsArray = Thread.currentThread.getStackTrace
    stackTraceAsArray.foreach(println)
    // return 0 as before
    0
  }
  case x :: xs => x + sum(xs)
}
```

Now, if you call sum with a list that goes from 1 to 5:

```
val list = List.range(1, 5)
sum(list)
```

you'll get this output when the Nil case is reached:

```
java.lang.Thread.getStackTrace(Thread.java:1588)
recursion.SumWithStackDump$.sum(SumWithStackDump.scala:19)
recursion.SumWithStackDump$.sum(SumWithStackDump.scala:19)
recursion.SumWithStackDump$.sum(SumWithStackDump.scala:19)
recursion.SumWithStackDump$.sum(SumWithStackDump.scala:19)
recursion.SumWithStackDump$.sum(SumWithStackDump.scala:19)
```

While that output isn't too exciting, it shows that when the stack dump is manually triggered when the Nil case is reached, the sum function is on the stack five times. You can verify that this is correct by repeating the test with a List that has three elements, in which case you'll see the sum function referenced only three times in the output:

```
java.lang.Thread.getStackTrace(Thread.java:1588)
recursion.SumWithStackDump$.sum(SumWithStackDump.scala:13)
recursion.SumWithStackDump$.sum(SumWithStackDump.scala:19)
recursion.SumWithStackDump$.sum(SumWithStackDump.scala:19)
```

Clearly the sum function is being added to the stack over and over again, once for each call.

I encourage you to try this on your own to become comfortable

with what's happening.

## **Summary: Our current problem with “basic recursion”**

I hope this little dive into the JVM stack and stack frames helps to explain our current problem with “basic recursion.” As mentioned, if I try to pass a `List` with 10,000 elements into the current recursive `sum` function, it will generate a `StackOverflowError`. Because we’re trying to write bulletproof programs, this isn’t good.

## What's next

Now that we looked at (a) basic recursion with the sum function, (b) how that works with stacks and stack frames in the last two lessons, and (c) how basic recursion can throw a `StackOverflowError` with large data sets, the next lesson shows how to fix these problems with something called “tail recursion.”

# Tail-Recursive Algorithms

## Goals

The main goal of this lesson is to solve the problem shown in the previous lessons: Simple recursion creates a series of stack frames, and for algorithms that require deep levels of recursion, this creates a `StackOverflowError` (and crashes your program).

## “Tail recursion” to the rescue

Although the previous lesson showed that algorithms with deep levels of recursion can crash with a `StackOverflowError`, all is not lost. With Scala you can work around this problem by making sure that your recursive functions are written in a tail-recursive style.

A *tail-recursive function* is just a function whose *very last action* is a call to itself. When you write your recursive function in this way, the Scala compiler can optimize the resulting JVM bytecode so that the function requires only one stack frame — as opposed to one stack frame for each level of recursion!

[On Stack Overflow](#), Martin Odersky explains tail-recursion in Scala:

“Functions which call themselves as their last action are called tail-recursive. The Scala compiler detects tail recursion and replaces it with a jump back to the beginning of the function, after updating the function parameters with the new values ... as long as the last thing you do is calling yourself, it’s automatically tail-recursive (i.e., optimized).”

## But that sum function looks tail-recursive to me ...

“Hmm,” you might say, “if I understand Mr. Odersky’s quote, the sum function you wrote at the end of the last lesson (shown in Figure [fig:sumsLastAction]) sure looks tail-recursive to me.”

```
// note: this code won't compile yet
@tailrec
private def sumWithAccumulator(list: List[Int], accumulator: Int): Int = list match {
  case Nil => 0
  case x :: xs => x + sum(xs)
}
```

The call to sum appears to be the last action.

“Isn’t the ‘last action’ a call to itself, making it tail-recursive?”

If that’s what you’re thinking, fear not, that’s an easy mistake to make. But the answer is no, this function is not tail-recursive. Although `sum(tail)` is at the end of the second case expression, you have to think like a compiler here, and when you do that you’ll see that the last two actions of this function are:

1. Call `sum(xs)`
2. When that function call returns, add its value to `x` and return that result

When I make that code more explicit and write it as a series of one-line statements, you see that it looks like this:

```
val s = sum(xs)
val result = x + s
return result
```

As shown, the last calculation that happens before the return statement is that the sum of `x` and `s` is calculated. If you’re not 100% sure that you believe that, there are a few ways you can prove it to yourself.

### ***1) Proving it with the previous “stack trace” example***

One way to “prove” that the sum algorithm is not tail-recursive is with the “stack



trace” output from the previous lesson. The JVM output shows the sum method is called once for each step in the recursion, so it’s clear that the JVM feels the need to create a new instance of sum for each element in the collection.

## 2) Proving it with the *@tailrec* annotation

A second way to prove that sum isn’t tail-recursive is to attempt to tag the function with a Scala annotation named *@tailrec*. This annotation won’t compile unless the function is tail-recursive. (More on this later in this lesson.)

If you attempt to add the *@tailrec* annotation to sum:

```
// need to import tailrec before using it
import scala.annotation.tailrec

@tailrec
def sum(list: List[Int]): Int = list match {
  case Nil => 0
  case x :: xs => x + sum(xs)
}
```

the scalac compiler (or your IDE) will show an error message like this:

```
Sum.scala:10: error: could not optimize @tailrec annotated method sum:
it contains a recursive call not in tail position
def sum(list: List[Int]): Int = list match {
                                ^
```

This is another way to “prove” that the Scala compiler doesn’t think sum is tail-recursive.

## So, how do I write a tail-recursive function?

Now that you know the current approach isn't tail-recursive, the question becomes, "How do I make it tail-recursive?"

A common pattern used to make a recursive function that "accumulates a result" into a tail-recursive function is to follow these steps:

1. Keep the original function signature the same (i.e., `sum`'s signature).
2. Create a second function by (a) copying the original function, (b) giving it a new name, (c) making it `private`, (d) giving it a new "accumulator" input parameter, and (e) adding the `@tailrec` annotation to it.
3. Modify the second function's algorithm so it uses the new accumulator. (More on this shortly.)
4. Call the second function from inside the first function. When you do this you give the second function's accumulator parameter a "seed" value (a little like the *identity* value I wrote about in the previous lessons).

Let's jump into an example to see how this works.

## Example: How to make sum tail-recursive

### 1) Leave the original function signature the same

To begin the process of converting the recursive sum function into a *tail-recursive* sum algorithm, leave the external signature of `sum` the same as it was before:

```
def sum(list: List[Int]): Int = ...
```

### 2) Create a second function

Now create the second function by copying the first function, giving it a new name, marking it `private`, giving it a new “accumulator” parameter, and adding the `@tailrec` annotation to it. The highlights in Figure [fig:startingSecondFunction] show the changes.

```
// note: this code won't compile yet
@tailrec
private def sumWithAccumulator(list: List[Int], accumulator: Int): Int = list match {
  case Nil => 0
  case x :: xs => x + sum(xs)
}
```

Starting to create the second function.

This code won't compile as shown, so I'll fix that next.

Before moving on, notice that the data type for the accumulator (`Int`) is the same as the data type held in the `List` that we're iterating over.

### 3) Modify the second function's algorithm

The third step is to modify the algorithm of the newly-created function to use the accumulator parameter. The easiest way to explain this is to show the code for the solution, and then explain the changes. Here's the source code:

```
@tailrec
private def sumWithAccumulator(list: List[Int], accumulator: Int): Int = {
  list match {
    case Nil => accumulator
    case x :: xs => sumWithAccumulator(xs, accumulator + x)
  }
}
```

Here's a description of how that code works:

- I marked it with `@tailrec` so the compiler can help me by verifying that my code truly is tail-recursive.
- `sumWithAccumulator` takes two parameters, `list: List[Int]`, and `accumulator: Int`.
- The first parameter is the same list that the `sum` function receives.
- The second parameter is new. It's the "accumulator" that I mentioned earlier.
- The inside of the `sumWithAccumulator` function looks similar. It uses the same match/case approach that the original `sum` method used.
- Rather than returning `0`, the first case statement returns the accumulator value when the `Nil` pattern is matched. (More on this shortly.)
- The second case expression is tail-recursive. When this case is matched it immediately calls `sumWithAccumulator`, passing in the `xs` (tail) portion of `list`. What's different here is that the second parameter is the sum of the accumulator and the head of the current list, `x`.
- Where the original `sum` method passed itself the tail of `xs` and then later added that result to `x`, this new approach keeps track of the accumulator (total sum) value as each recursive call is made.

The result of this approach is that the "last action" of the `sumWithAccumulator` function is this call:

```
sumWithAccumulator(xs, accumulator + x)
```

Because this last action really is a call back to the same function, the JVM can optimize this code as Mr. Odersky described earlier.

#### ***4) Call the second function from the first function***

The fourth step in the process is to modify the original function to call the new function. Here's the source code for the new version of `sum`:

```
def sum(list: List[Int]): Int = sumWithAccumulator(list, 0)
```

Here's a description of how it works:

- The `sum` function signature is the same as before. It accepts a `List[Int]` and returns an `Int` value.
- The body of `sum` is just a call to the `sumWithAccumulator` function. It passes the original `list` to that function, and also gives its `accumulator` parameter an initial seed value of `0`.

Note that this “seed” value is the same as the *identity* value I wrote about in the previous recursion lessons. In those lessons I noted:

- The identity value for a sum algorithm is `0`.
- The identity value for a product algorithm is `1`.
- The identity value for a string concatenation algorithm is `.`

#### ***A few notes about sum***

Looking at `sum` again:

```
def sum(list: List[Int]): Int = sumWithAccumulator(list, 0)
```

a few key points about it are:

- Other programmers will call `sum`. It's the “Public API” portion of the solution.
- It has the same function signature as the previous version of `sum`. The benefit of this is that other programmers won't have to provide the initial seed value. In fact, they won't know that the internal algorithm uses a seed value. All they'll see is `sum`'s signature:

```
def sum(list: List[{}Int{}]): Int
```

## A slightly better way to write sum

Tail-recursive algorithms that use accumulators are typically written in the manner shown, with one exception: Rather than mark the new accumulator function as `private`, most Scala/FP developers like to put that function *inside* the original function as a way to limit its scope.

When doing this, the thought process is, “Don’t expose the scope of `sumWithAccumulator` unless you want other functions to call it.”

When you make this change, the final code looks like this:

```
// tail-recursive solution
def sum(list: List[Int]): Int = {
  @tailrec
  def sumWithAccumulator(list: List[Int], currentSum: Int): Int = {
    list match {
      case Nil => currentSum
      case x :: xs => sumWithAccumulator(xs, currentSum + x)
    }
  }
  sumWithAccumulator(list, 0)
}
```

Feel free to use either approach. (Don’t tell anyone, but I prefer the first approach; I think it reads more easily.)

## A note on variable names

If you don't like the name `accumulator` for the new parameter, it may help to see the function with a different name. For a “sum” algorithm a name like `runningTotal` or `currentSum` may be more meaningful:

```
// tail-recursive solution
def sum(list: List[Int]): Int = {
  @tailrec
  def sumWithAccumulator(list: List[Int], currentSum: Int): Int = {
    list match {
      case Nil => currentSum
      case x :: xs => sumWithAccumulator(xs, currentSum + x)
    }
  }
  sumWithAccumulator(list, 0)
}
```

I encourage you to use whatever name makes sense to you. I prefer `currentSum` for this algorithm, but you'll often hear this approach referred to as using an “accumulator,” which is why I used that name first.



## Proving that this is tail-recursive

You can follow my earlier efforts to demonstrate that this function really is tail-recursive, but at this point I'm satisfied with one proof: When you compile this code with the `@tailrec` annotation, the compiler doesn't give you an error message like it did before.

# Summary

In this lesson I:

- Defined tail recursion
- Introduced the `@tailrec` annotation
- Showed how to write a tail-recursive function
- Showed a formula you can use to convert a simple recursive function to a tail-recursive function

## What's next

This lesson covered the basics of converting a simple recursive function into a tail-recursive function. I'm usually not smart enough to write a tail-recursive function right away, so I usually write my algorithms using simple recursion, then convert them to use tail-recursion.

To help in your efforts, the next lesson will show more examples of tail-recursive for different types of algorithms.

## See also

- [My list of Scala recursion examples](#)
- [Martin Odersky explaining tail recursion on Stack Overflow](#)

# A First Look at “State”

In the next lesson I’m going to start writing a little command-line game, but before I get into that I want to discuss the general concept of handling “state” in software applications.

Every non-trivial application maintains some sort of *state*. For instance, the state of a word processing application is the current document, along with whether the document has been saved or not (whether the document is “clean” or “dirty”). Similarly, the state of a spreadsheet application is the spreadsheet and its clean/dirty state. Web versions of these applications have additional state, such as who the current user is, when they logged in, what their IP address is, etc.

Even voice applications like Siri and Amazon Echo have state. As I learned in writing [SARAH](#), one thing you need to do is to maintain speaking/listening state, otherwise the computer will hear itself talking, then respond to itself, eventually kicking off an endless loop.

Siri and others are also gaining a concept that I call *context*, or the “context of a conversation,” which also requires state management. Imagine asking Siri to order a pizza. It will respond by asking what toppings you want, where you want to order the pizza from, how you want to pay, etc. This is “conversational state.”

## Handling state in a game

In my spare time I work on developing an Android football game where I play against a computer opponent. If you know American Football (as opposed to what we Americans call “soccer”), in between each play you can think of the state of a football game as having these attributes:

- Which team has the ball (you are on offense or defense)
- Current field position
- Down and distance (such as “1st and 10”)
- Current score
- Time remaining

There are more state variables than this, but I’m keeping this example simple.

In Scala you might model this game state like this:

```
case class GameState (  
  iHaveTheBall: Boolean,  
  fieldPosition: Int,  
  down: Int,  
  distance: Int,  
  myScore: Int,  
  computerScore: Int,  
  timeRemaining: Int  
)
```

On the first play of the game the initial state might look like this:

```
GameState (  
  iHaveTheBall: true,  
  fieldPosition: 25,  
  down: 1,  
  distance: 10,  
  myScore: 0,  
  computerScore: 0,  
  timeRemaining: 3600  
)
```

Then, after the next play the state might look like this:

```
GameState (  
  iHaveTheBall: true,  
  fieldPosition: 29,  
  down: 2,  
  distance: 6,  
  myScore: 0,  
  computerScore: 0,  
  timeRemaining: 3536  
)
```

A football game typically has about 150 plays, so in my game there is a `GameState` instance for each of those plays.

### ***Why state is important***

State is important for many reasons, not the least of which is to know when the game is over and who won. An important part about state in my football game is that I use it to help the computer make decisions about what plays it calls.

When the computer is playing on offense it uses a function that looks like this:

```
val possiblePlays: List[OffensivePlay] =  
  OffensiveCoordinator.determinePossiblePlays(gameState)
```

The `determinePossiblePlays` function is a pure function. I pass `GameState` into it, and with thousands of lines of purely functional code behind it, it returns a list of all the possible plays that the algorithms believe make sense for the state that was passed in.

For instance, if it's fourth down and goal at the opponent's one-yard line with five seconds left in the game and the computer is down 21-17, it's smart enough to know that it needs to try to score a touchdown rather than kick a field goal. This is what I mean by "state" in the context of a football game.

As the game gets smarter I also maintain a history of all previously-called plays, so the computer can adjust its play calls based on the player's tendencies.

## More state

As you can imagine, a point of sales application for a pizza store will have state that includes:

- The number and types of pizzas ordered
- Customer contact information
- Customer payment information
- The date and time of the order
- Who took the order
- More ...

Once you begin to think about it this way, you'll see that every application maintains state of some sort.



## State and functional programming

As I mentioned, my football game has about 150 `GameState` instances for every game. In the context of functional programming, this raises an interesting question: In Scala/FP I can only have `val` instances, so how can I possibly create 150 new variables for each game? Put another way, if you assume that I keep all of the plays in a `List`, the question becomes, “How do I append `GameState` values to an immutable `List`?”

Questions like this bring you to a key point I got to when I was learning FP:

- How am I supposed to handle I/O, which by its very nature is impure?
- How am I supposed to handle state?

In the next lesson I’ll show one way to handle state in a simple game by building on what you just learned in the previous lessons: recursion.

# **A Functional Game (With a Little Bit of State)**

## Introduction

Now that I've given you a little background about “state”, let's build a simple game that requires us to use state. I'll build the game using recursion, and also *immutable state* — something I had never heard of when I first starting writing the [Scala Cookbook](#).

# Goals

Here are my goals for this lesson:

- To write our first functional application
- Show a first example of how to handle “state” in a Scala/FP application

## Source code

The best way to understand this lesson is to have its source code open in an IDE as you read it. The source code is available at this URL:

- [github.com/alvinj/FPCoinFlipGame](https://github.com/alvinj/FPCoinFlipGame)

Some of this project's code contains some wide lines that are hard to read in a book. You'll really want to check the code out of Github to see it properly.

## Coin Flip: A simple FP game

To get started using state in a Scala application, I'll build a little game you can play at the command line. The application will flip a coin (a virtual coin), and as the player, your goal is to guess whether the result is heads or tails. The computer will keep track of the total number of flips and the number of correct guesses.

When you start the game, you'll see this command-line prompt:

```
(h)eads, (t)ails, or (q)uit: _
```

This is how the application prompts you for your guess. Enter h for heads, t for tails, or q to quit the game. If you enter h or t, the application will flip a virtual coin, then let you know if your guess was correct or not.

As an example of how it works, I just played the game and made four guesses, and the input/output of that session looks like this:

```
(h)eads, (t)ails, or (q)uit: h
Flip was Heads. #Flips: 1, #Correct: 1

(h)eads, (t)ails, or (q)uit: h
Flip was Tails. #Flips: 2, #Correct: 1

(h)eads, (t)ails, or (q)uit: h
Flip was Heads. #Flips: 3, #Correct: 2

(h)eads, (t)ails, or (q)uit: t
Flip was Tails. #Flips: 4, #Correct: 3

(h)eads, (t)ails, or (q)uit: q

=== GAME OVER ===
#Flips: 4, #Correct: 3
```

Admittedly this isn't the most exciting game in the world, but it turns out to be a nice way to learn how to handle immutable state in a Scala/FP application.

One note before proceeding: The input/output in this game will *not* be handled in a functional way. I'll cover that in a future lesson.

On to the game!

## Coin Flip game state

Let's analyze how this game works:

- The computer is going to flip a virtual coin.
- You're going to guess whether that result is heads or tails.
- You can play the game for as many flips as you want.
- After each flip the output will look like this:

Flip was Tails. #Flips: 4, #Correct: 2

These statements tell us a few things about the game state:

- We need to track how many coin flips there are.
- We need to track how many guesses the player made correctly.

I could track more information, such as the history of the guess for each coin flip and the actual value, but to keep it simple, all I want to do at this time is to track (a) the number of flips, and (b) the number of correct guesses. As a result, a first stab at modeling the game state looks like this:

```
case class GameState (  
    numFlips: Int,  
    numCorrectGuesses: Int  
)
```

# Game pseudocode

Next, let's start working on the game code.

You know you're going to need some sort of main loop, and in the imperative world, pseudocode for that loop looks like this:

```
var input = ""
while (input != "q") {
  // prompt the player to select heads, tails, or quit
  // get the player's input
  if (input == "q") {
    print the game summary
    quit
  }
  // flip the coin
  // see if the player guessed correctly
  // print the #flips and #correct
}
```



## I/O functions

That's not how I'll write the loop, but it does give me an idea of some I/O functions I'm going to need. From that pseudocode it looks like I'm going to need these functions:

- A “show prompt” function
- A “get user input” function
- A function to print the number of flips and correct answers

These functions have nothing to do with FP — they're impure I/O functions that connect our application to the outside world — so I'll write them in the “usual way”. Here's the “show prompt” function:

```
def showPrompt: Unit = { print("\n(h)eads, (t)ails, or (q)uit: ") }
```

Next, here's the “get user input” function:

```
def getUserInput = readLine.trim.toUpperCase
```

Prior to Scala 2.11.0, `readLine` was made available to you without an `import` statement via Scala's `Predef` object, but since then it's available at `scala.io.StdIn.readLine`. Also, notice that I convert all input to uppercase to make it easier to work with later.

Next, while the game is being played I want to print output like this:

```
Flip was Tails. #Flips: 4, #Correct: 3
```

and when the game is over I want to print this output:

```
=== GAME OVER ===  
#Flips: 4, #Correct: 3
```

To accommodate these needs I create these functions:

```
def printableFlipResult(flip: String) = flip match {
```

```
    case "H" => "Heads"
    case "T" => "Tails"
}

def printGameState(printableResult: String, gameState: GameState): Unit = {
    print(s"Flip was $printableResult. ")
    printGameState(gameState)
}

def printGameState(gameState: GameState): Unit = {
    println(s"#Flips: ${gameState.numFlips}, #Correct: ${gameState.numCorrect}")
}

def printGameOver: Unit = println("\n=== GAME OVER ===")
```

Note that the `printGameState` functions take the `GameState` as an input parameter, and use its fields to print the output. The assumption is that these functions always receive the latest, up-to-date `GameState` instance.

If you know Scala, that's all fairly standard "print this out" and "read this in" code.

## Writing a coin toss function

When you look back at this piece of the original pseudocode:

```
// flip the coin
```

you'll see that one more thing I can get out of the way before writing the main loop is a function to simulate a coin toss.

A simple way to simulate a coin toss is to use a random number generator and limit the generator to return values of 0 and 1, where 0 means “heads” and 1 mean “tails.” This is how you limit Scala’s `Random.nextInt` method to yield only 0 or 1:

```
val r = new scala.util.Random
r.nextInt(2)
```

The `r.nextInt(2)` code tells `nextInt` to return integer values that are less than 2, i.e., 0 and 1.

Knowing that, I can write a coin flip function like this:

```
// returns "H" for heads, "T" for tails
def tossCoin(r: Random) = {
  val i = r.nextInt(2)
  i match {
    case 0 => "H"
    case 1 => "T"
  }
}
```

With these functions out of the way, let's get to the main part of the lesson: how to write the main loop of the program with an immutable game state.

## Writing the main loop in FP style

So now we need a “loop” ... how can we write one in an FP style? Using the tools we know so far, the best way to handle this is with our new friend, recursion. Because you may have never done this before, let me add a few important notes:

- With recursion the main loop is going to call itself repeatedly (recursively)
- Because the game state needs to be updated as the game goes along, a `GameState` instance needs to be passed into each recursive call
- Because each instance of the loop will simulate the flip of a coin, and because the `tossCoin` function requires a `scala.util.Random` instance, it's also best to pass a `Random` instance into each recursive call as well

Given that background, I can start writing some code. First, here's the `GameState` I showed earlier:

```
case class GameState (  
    numFlips: Int,  
    numCorrectGuesses: Int  
)
```

Next, I know I'm going to need (a) a Scala App, (b) initial `GameState` and `Random` instances, and (c) some sort of `mainLoop` call to get things started. I also know that `mainLoop` will take the `GameState` and `Random` instances, which leads me to this code:

```
object CoinFlip extends App {  
    val s = GameState(0, 0)  
    val r = new Random  
    mainLoop(s, r)  
}
```

Next, I can sketch the `mainLoop` function like this:

```
@tailrec  
def mainLoop(gameState: GameState, random: Random) {  
    // a) prompt the user for input  
    // b) get the user's input  
    // c) flip the coin  
    // d) compare the flip result to the user's input  
    // e) write the output  
    // f) if the user didn't type 'h', loop again:
```

```
    mainLoop(newGameState, random)  
}
```

If you feel like you understand what I've sketched in this `mainLoop` code, I encourage you to set this book aside and work on filling out `mainLoop`'s body on your own, using (a) the I/O functions I showed earlier and (b) any other code you might need. That's all that needs to be done now: fill out the body, and figure out where the recursive `mainLoop` call (or calls) need to be made.

## Writing the skeleton code

The next thing I did to solve this problem was to stub out the following skeleton code:

```
object CoinFlip extends App {

  val r = Random
  val s = GameState(0, 0)
  mainLoop(s, r)

  @tailrec
  def mainLoop(gameState: GameState, random: Random) {

    // a) prompt the user for input
    showPrompt()

    // b) get the user's input
    val userInput = getUserInput()

    userInput match {
      case "H" | "T" => {
        // c) flip the coin
        val coinTossResult = tossCoin(random)
        val newNumFlips = gameState.numFlips + 1

        // d) compare the flip result to the user's input
        if (userInput == coinTossResult) {
          // they guessed right
          // e) write the output
          // f) if the user didn't type 'h', loop again:
          mainLoop(newGameState, random)
        } else {
          // they guessed wrong
          // e) write the output
          // f) if the user didn't type 'h', loop again:
          mainLoop(newGameState, random)
        }
      }
      case _ => {
        // assume they type 'Q'
        println("\n=== GAME OVER ===")
        printGameState(gameState)
        // we return out of the recursion here
      }
    }
  }
}
```

That code is slightly different than my pseudocode, but it's in the ballpark.

Now all I need to do is finish off the 'e' and 'f' portions of the algorithm. I'll show those sections in the completed code that follows.

## The complete source code

The following source code shows the first cut of my solution for this application.

First, I put all of my “utility” functions in a separate object named `CoinFlipUtils`, in a file named `CoinFlipUtils.scala`:

```
package com.alvinalexander.coinflip.v1

import scala.util.Random
import scala.io.StdIn.readLine

object CoinFlipUtils {

  def showPrompt(): Unit = { print("\n(h)eads, (t)ails, or (q)uit: ") }

  def getUserInput(): String = readLine.trim.toUpperCase

  def printableFlipResult(flip: String): String = flip match {
    case "H" => "Heads"
    case "T" => "Tails"
  }

  def printGameState(
    printableFlipResult: String,
    gameState: GameState): Unit =
  {
    print(s"Flip was $printableFlipResult. ")
    printGameState(gameState)
  }

  def printGameState(gameState: GameState): Unit = {
    println(s"#Flips: ${gameState.numFlips}, #Correct:
      ${gameState.numCorrect}")
  }

  def printGameOver(): Unit = println("\n=== GAME OVER ===")

  // returns "H" for heads, "T" for tails
  def tossCoin(r: Random): String = {
    val i = r.nextInt(2)
    i match {
      case 0 => "H"
      case 1 => "T"
    }
  }
}
```

I did that to keep the code organized, and also to keep my next file smaller. Here’s the source code for `CoinFlip.scala`, which primarily consists of the `mainLoop`:

```
package com.alvinalexander.coinflip.v1
```

```

import CoinFlipUtils._
import scala.annotation.tailrec
import scala.util.Random

case class GameState(numFlips: Int, numCorrect: Int)

object CoinFlip extends App {

  val r = Random
  val s = GameState(0, 0)
  mainLoop(s, r)

  @tailrec
  def mainLoop(gameState: GameState, random: Random) {

    showPrompt()
    val userInput = getUserInput()

    // handle the result
    userInput match {
      case "H" | "T" => {
        val coinTossResult = tossCoin(random)
        val newNumFlips = gameState.numFlips + 1
        if (userInput == coinTossResult) {
          val newNumCorrect = gameState.numCorrect + 1
          val newGameState = gameState.copy(
            numFlips = newNumFlips,
            numCorrect = newNumCorrect
          )
          printGameState(
            printableFlipResult(coinTossResult), newGameState
          )
          mainLoop(newGameState, random)
        } else {
          val newGameState = gameState.copy(numFlips = newNumFlips)
          printGameState(
            printableFlipResult(coinTossResult), newGameState
          )
          mainLoop(newGameState, random)
        }
      }
      case _ => {
        printGameOver()
        printGameState(gameState)
        // return out of the recursion here
      }
    }
  }
}

```

There are a few ways to shorten and refactor that code, but it gives you an idea of what needs to be done for this game.

### ***When the user's guess is correct***

Note that when the user's guess matches the coin flip, I use this code:



```
val newNumCorrect = gameState.numCorrect + 1
val newGameState = gameState.copy(numFlips = newNumFlips, numCorrect = newNumCorrect)
printGameState(printableFlipResult(coinTossResult), newGameState)
mainLoop(newGameState, random)
```

The key here is that when the user's guess is correct I need to create a new GameState and pass that new instance into the next mainLoop call. I show that code in a long form, but I can remove the newNumCorrect temporary variable:

```
val newGameState = gameState.copy(
    numFlips = newNumFlips,
    numCorrect = gameState.numCorrect + 1
)
printGameState(printableFlipResult(coinTossResult), newGameState)
mainLoop(newGameState, random)
```

### ***When the user's guess is incorrect***

In the case where the user's guess is incorrect, I only need to update numFlips when creating a new GameState instance, so that block of code looks like this:

```
val newGameState = gameState.copy(numFlips = newNumFlips)
printGameState(printableFlipResult(coinTossResult), newGameState)
mainLoop(newGameState, random)
```

### ***When the user wants to quit the game***

In the case where the user enters anything other than H or T, I assume they want to quit the game, so I call these procedures:

```
printGameOver()
printGameState(gameState)
```

At this point I don't call mainLoop any more, so the recursion ends, all of the recursive calls unwind, and the game ends.

## Summary

At the beginning of this lesson I noted that the goals for this lesson were:

- To write our first functional application
- Show a first example of how to handle “state” in an FP application

A few important parts about this lesson that you may not have seen before in traditional imperative code are:

- The use of an explicit GameState variable
- Using recursion as a way of looping
- The recursion let us define the GameState instance as an immutable val field

## Exercises

1. Modify the game so you can play a new game by pressing 'n'
2. After adding the ability to play a new game, modify the program to keep a history of all previously-played games

## See also

- [The Procedure Syntax section of the Scala Style Guide](#)
- [A bug entry about deprecating the Procedure syntax](#)
- [How to prompt users for input from Scala shell scripts tutorial](#)

# **A Quick Review of Case Classes**

## Goals

In this book I generally assume that you know the basics of the Scala programming language, but because case classes are so important to *functional programming in Scala* it's worth a quick review of what case classes are — the features they provide, and the benefits of those features.

## Discussion

As opposed to a “regular” Scala `class`, a case class generates a lot of code for you, with the following benefits:

- An `apply` method is generated, so you don’t need to use the `new` keyword to create a new instance of the class.
- *Accessor* methods are generated for each constructor parameter, because case class constructor parameters are public `val` fields by default.
- (You won’t use `var` fields in this book, but if you did, *mutator* methods would also be generated for constructor parameters declared as `var`.)
- An `unapply` method is generated, which makes it easy to use case classes in `match` expressions. This is huge for Scala/FP.
- As you’ll see in the next lesson, a `copy` method is generated. I never use this in Scala/OOP code, you’ll use it all the time in Scala/FP.
- `equals` and `hashCode` methods are generated, which lets you compare objects and easily use them as keys in maps (and sets).
- A default `toString` method is generated, which is helpful for debugging.

## A quick demo

To demonstrate how case classes work, here are a few examples that show each of these features and benefits in action.

### *No need for new*

When you define a class as a case class, you don't have to use the `new` keyword to create a new instance:

```
scala> case class Person(name: String, relation: String)
defined class Person

// "new" not needed before Person
scala> val christina = Person("Christina", "niece")
christina: Person = Person(Christina,niece)
```

This is a nice convenience when writing Scala/OOP code, but it's a *terrific* feature when writing Scala/FP code, as you'll see throughout this book.

### *No mutator methods*

Case class constructor parameters are `val` by default, so an *accessor* method is generated for each parameter, but mutator methods are not generated:

```
scala> christina.name
res0: String = Christina

// can't mutate the `name` field
scala> christina.name = "Fred"
<console>:10: error: reassignment to val
      christina.name = "Fred"
                ^
```

### *unapply method*

Because an `unapply` method is automatically created for a case class, it works well when you need to extract information in `match` expressions, as shown here:

```
scala> christina match { case Person(n, r) => println(n, r) }
(Christina,niece)
```

Conversely, if you try to use a regular Scala class in a `match` expression like this, you'll quickly see that it won't compile. You'll see many more uses of case



classes with match expressions in this book because *pattern matching* is a BIG feature of Scala/FP.

A class that defines an unapply method is called an *extractor*, and unapply methods enable match/case expressions.

### ***copy method***

A case class also has a built-in copy method that is extremely helpful when you need to clone an object and change one or more of the fields during the cloning process:

```
scala> case class BaseballTeam(name: String, lastWorldSeriesWin: Int)
defined class BaseballTeam

scala> val cubs1908 = BaseballTeam("Chicago Cubs", 1908)
cubs1908: BaseballTeam = BaseballTeam(Chicago Cubs,1908)

scala> val cubs2016 = cubs1908.copy(lastWorldSeriesWin = 2016)
cubs2016: BaseballTeam = BaseballTeam(Chicago Cubs,2016)
```

I refer to this process as “update as you copy,” and this is such a big Scala/FP feature that I cover it in depth in the next lesson.

### ***equals and hashCode methods***

Case classes also have generated equals and hashCode methods, so instances can be compared:

```
scala> val hannah = Person("Hannah", "niece")
hannah: Person = Person(Hannah,niece)

scala> christina == hannah
res1: Boolean = false
```

These methods also let you easily use your objects in collections like sets and maps.

### ***toString methods***

Finally, case classes also have a default toString method implementation, which at the very least is helpful when debugging code:

```
scala> christina
```

```
res0: Person = Person(Christina,niece)
```

For more details on case classes, see the “Generating Boilerplate Code with Case Classes” chapter in the [Scala Cookbook](#).

## Summary

In this lesson I showed that the following methods are automatically created when you declare a class as a case class:

- apply
- unapply
- accessor methods are created for each constructor parameter
- copy
- equals and hashCode
- toString

These built-in methods make case classes easier to use in a functional programming style.

## What's next

I thought it was worth this quick review of Scala case classes because the next thing we're going to do is dive into the case class copy method. Because you don't mutate objects in FP, you need to do something else to create updated instances of objects when things change, and the way you do this in Scala/FP is with the copy method.

# Update as You Copy, Don't Mutate

[UpdateAsYouCopy]

## Goals

In functional programming you don't modify (mutate) existing objects, you create new objects with updated fields based on existing objects. For instance, last year my niece's name was "Emily Maness," so I could have created a Person instance to represent her, like this:

```
val emily = Person("Emily", "Maness")
```

Then she got married, and her last name became "Wells." In an imperative programming language you would just change her last name, like this:

```
emily.setLastName("Wells")
```

But in FP you don't do this, you don't mutate existing objects. Instead, what you do is (a) you copy the existing object to a new object, and (b) during the copy process you update any fields you want to change by supplying their new values.

The way you do this in Scala/FP is with the copy method that comes with the Scala *case class*. This lesson shows a few examples of how to use copy, including how to use it with nested objects.

## Source code

So you can follow along, the source code for this lesson is available at [github.com/alvinj/FpUpdateAsYouCopy](https://github.com/alvinj/FpUpdateAsYouCopy)

## Basic copy

When you're working with a simple object it's easy to use copy. Given a case class like this:

```
case class Person (firstName: String, lastName: String)
```

if you want to update a person's last name, you just "update as you copy," like this:

```
val emily1 = Person("Emily", "Maness")
val emily2 = emily1.copy(lastName = "Wells")
```

As shown, in simple situations like this all you have to do to use copy is:

- Make sure your class is a case class.
- Create an initial object (`emily1`), as usual.
- When a field in that object needs to be updated, use `copy` to create a new object (`emily2`) from the original object, and specify the name of the field to be changed, along with its new value.

When you're updating one field, that's all you have to do. (That's also all you have to do to update multiple fields, as I'll show shortly.)

### *The original instance is unchanged*

An important point to note about this is that the first instance remains unchanged. You can verify that by running a little App like this:

```
object CopyTest1 extends App {
  println("--- Before Copy ---")
  val emily1 = Person("Emily", "Maness")
  println(s"emily1 = $emily1")

  // emily got married
  println("\n--- After Copy ---")
  val emily2 = emily1.copy(lastName = "Wells")
  println(s"emily1 = $emily1")
  println(s"emily2 = $emily2")
}
```



The output of CopyTest1 looks as follows, showing that the original emily1 instance is unchanged after the copy:

```
--- Before Copy ---
emily1 = Person(Emily,Maness)

--- After Copy ---
emily1 = Person(Emily,Maness)
emily2 = Person(Emily,Wells)
```

What happens in practice is that you discard the original object, so thinking about the old instance isn't typically an issue; I just want to mention it. (You'll see more examples of how this works as we go along.)

In practice you also won't use intermediate variables with names like emily1, emily2, etc. We just need to do that now, until we learn a few more things.

## Updating several attributes at once

It's also easy to update multiple fields at one time using `copy`. For instance, had `Person` been defined like this:

```
case class Person (  
  firstName: String,  
  lastName: String,  
  age: Int  
)
```

you could create an instance like this:

```
val emily1 = Person("Emily", "Maness", 25)
```

and then create a new instance by updating several parameters at once, like this:

```
// emily is married, and a year older  
val emily2 = emily1.copy(lastName = "Wells", age = 26)
```

That's all you have to do to update two or more fields in a simple case class.

## Copying nested objects

As shown, using copy with simple case classes is straightforward. But when a case class contains other case classes, and those contain more case classes, things get more complicated and the required code gets more verbose.

For instance, let's say that you have a case class hierarchy like this:

```
case class BillingInfo(
  creditCards: Seq[CreditCard]
)

case class Name(
  firstName: String,
  mi: String,
  lastName: String
)

case class User(
  id: Int,
  name: Name,
  billingInfo: BillingInfo,
  phone: String,
  email: String
)

case class CreditCard(
  name: Name,
  number: String,
  month: Int,
  year: Int,
  cvv: String
)
```

Visually the relationship between these classes looks like Figure [fig:umlRelationshipBetweenClasses].

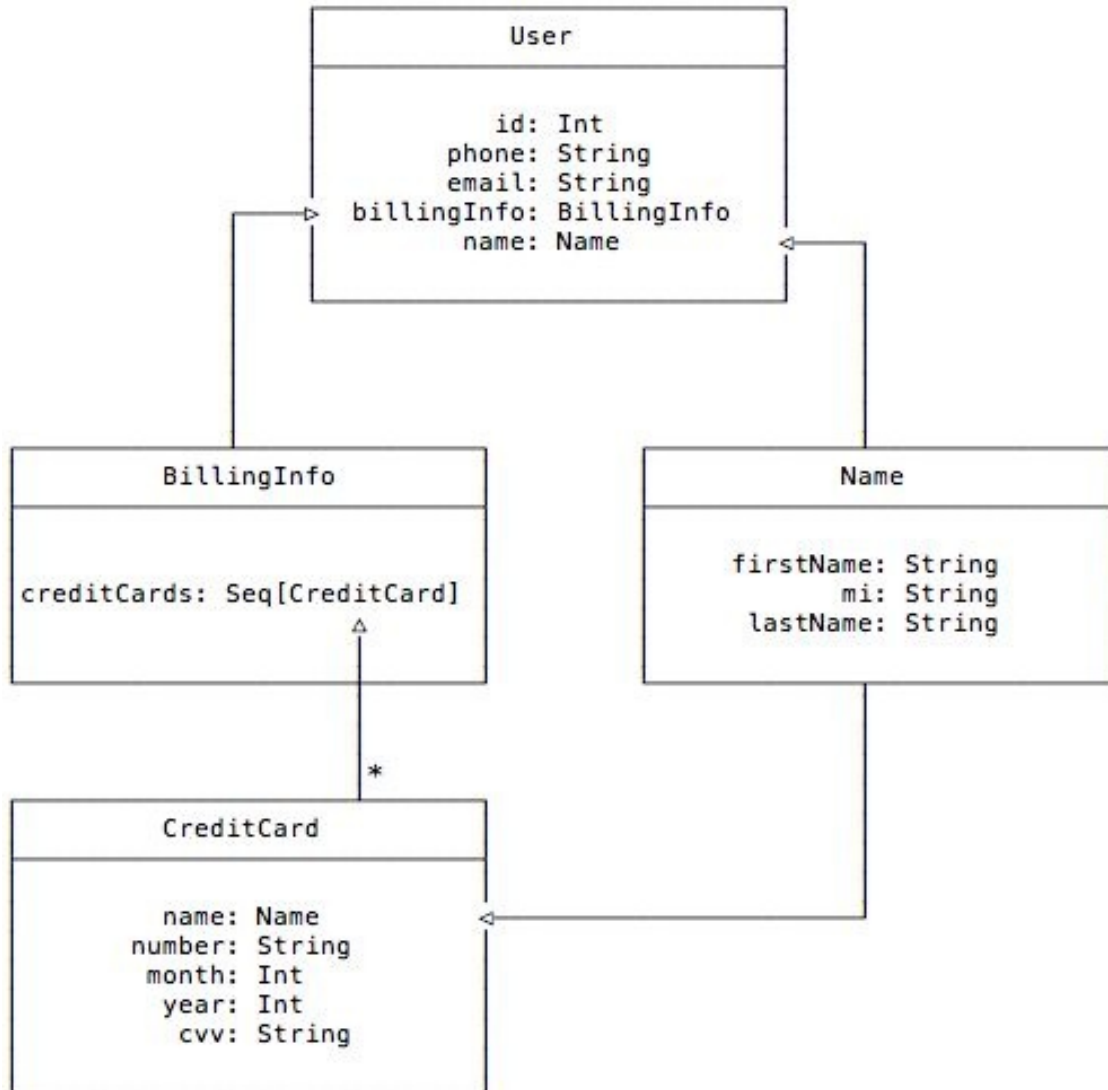

The visual relationship between the classes

Notice a few things about this code:

- User has fields of type Name and BillingInfo
- CreditCard also has a field of the Name type

Despite a little complexity, creating an initial instance of User with this hierarchy is straightforward:

```

object NestedCopy1 extends App {
  val hannahsName = Name(
    firstName = "Hannah",
  
```

```

        mi = "C",
        lastName = "Jones"
    )

    // create a user
    val hannah1 = User(
        id = 1,
        name = hannahsName,
        phone = "907-555-1212",
        email = "hannah@hannahjones.com",
        billingInfo = BillingInfo(
            creditCards = Seq(
                CreditCard(
                    name = hannahsName,
                    number = "1111111111111111",
                    month = 3,
                    year = 2020,
                    cvv = "123"
                )
            )
        )
    )
}

```

So far, so good. Now let's take a look at what you have to do when a few of the fields need to be updated.

### ***Updating the phone number***

First, let's suppose that Hannah moves. I kept the address out of the model to keep things relatively simple, but let's suppose that her phone number needs to be updated. Because the phone number is stored as a top-level field in `User`, this is a simple copy operation:

```

// hannah moved, update the phone number
val hannah2 = hannah1.copy(phone = "720-555-1212")

```

### ***Updating the last name***

Next, suppose that a little while later Hannah gets married and we need to update her last name. In this case you need to reach down into the `Name` instance of the `User` object and update the `lastName` field. I'll do this in a two-step process to keep it clear.

First, create a copy of the name field, changing `lastName` during the copy process:

```

// hannah got married, update her last name
val newName = hannah2.name.copy(lastName = "Smith")

```

If you print `newName` at this point, you'll see that it is "Hannah C Smith."

Now that you have this `newName` instance, the second step is to create a new "Hannah" instance with this new Name. You do that by (a) calling `copy` on the `hannah2` instance to make a new `hannah3` instance, and (b) within `copy` you bind the `name` field to `newName`:

```
val hannah3 = hannah2.copy(name = newName)
```

## ***Updating the credit card***

Suppose you also need to update the "Hannah" instance with new credit card information. To do this you follow the same pattern as before. First, you create a new `CreditCard` instance from the existing instance. Because the `creditCards` field inside the `billingInfo` instance is a `Seq`, you need to reference the first credit card instance while making the copy. That is, you reference `creditCards(0)`:

```
val oldCC = hannah3.billingInfo.creditCards(0)
val newCC = oldCC.copy(name = newName)
```

Because (a) `BillingInfo` takes a `Seq[CreditCard]`, and (b) there's only one credit card, I make a new `Seq[CreditCard]` like this:

```
val newCCs = Seq(newCC)
```

With this new `Seq[CreditCard]` I create a new "Hannah" instance by copying `hannah3` to `hannah4`, updating the `BillingInfo` during the copy process:

```
val hannah4 = hannah3.copy(billingInfo = BillingInfo(newCCs))
```

Put together, those lines of code look like this:

```
val oldCC = hannah3.billingInfo.creditCards(0)
val newCC = oldCC.copy(name = newName)
val newCCs = Seq(newCC)
val hannah4 = hannah3.copy(billingInfo = BillingInfo(newCCs))
```

You can shorten that code if you want, but I show the individual steps so it's easier to read.

These examples show how the "update as you copy" process works with nested objects in Scala/FP. (More on this after the attribution.)

## ***Attribution***

The examples I just showed are a simplification of the code and description found at these URLs:

- [The “koffio-lenses” example on GitHub](#)
- [The KOFF.io “Lens in Scala” tutorial](#)

## Lenses

As you saw, the “update as you copy” technique gets more complicated when you deal with real-world, nested objects, and the deeper the nesting gets, the more complicated the problem becomes. But fear not: there are Scala/FP libraries that make this easier. The general idea of these libraries is known as a “lens” (or “lenses”), and they make copying nested objects much simpler. I cover lenses in a lesson later in this book.



## Summary

Here's a summary of what I just covered:

- Because functional programmers don't mutate objects, when an object needs to be updated it's necessary to follow a pattern which I describe as "update as you copy".
- The way you do this in Scala is with the copy method, which comes with Scala case classes.
- As you can imagine, from here on out you're going to be using case classes more than you'll use the default Scala class. The copy method is just one reason for this, but it's a good reason. (You'll see even more reasons to use case classes as you go along.)

## **What's Next**

As mentioned, I write about lenses later in the book, when we get to a point where we have to “update as you copy” complicated objects.

But for now the next thing we need to dig into is for comprehensions. Once I cover those, you'll be close to being able to write small, simple, functional applications with everything I've covered so far.

## See Also

- The source code for this lesson is available at [at this Github repository](#)
- Alessandro Lacava has [some notes about case classes](#), including a little about copy, currying, and arity
- [The “koffio-lenses” example on GitHub](#)
- [The KOFF.io “Lens in Scala” tutorial](#)

# **A Quick Review of for Expressions**

## Goals

The goal of this lesson is to review at a high level how for loops work in Scala. This is necessary because Scala/FP developers *really* take advantage of advanced Scala for loop features.

As an example of what I mean, the goal of the next few lessons is to explain what's happening in this for loop:

```
def stackManip: State[Stack, Int] = for {  
  _ <- push(3)  
  a <- pop  
  b <- pop  
} yield(b)
```

If you already understand what's happening in that code, feel free to skip over these lessons; otherwise, read on.

# Introduction

If you're used to using the `for` loop in Java, Scala's `for` loop can work similar to it, but it can also be used in a different manner.

A *very* different manner.

And Scala/FP developers use it in this other manner.

A lot.

For instance, some experienced Scala/FP developers say that this is a “simple” use of a `for` loop in a functional style:

```
def stackManip: State[Stack, Int] = for {  
  _ <- push(3)  
  a <- pop  
  b <- pop  
} yield(b)
```

If you're used to traditional `for` loops in languages like C and Java, whatever is happening in this “loop” can be quite a surprise.

## *A peek into what's happening*

Let me explain a little of what's happening: This code is working with a stack, and a `push` function is pushing the number 3 onto a pre-existing stack, and then the next two lines `pop` values off of the stack. But even knowing that, a few questions come to mind:

- If a `push` function pushes a number onto a stack, where exactly is that stack?
- A `push` function normally doesn't return anything meaningful, so how is it being used as a *generator* in a `for` loop? And what is that underscore character doing on the left side of the `push` expression?
- Assuming that those `pop` functions are popping data off of a stack, again I ask, where is that stack?

In this lesson we'll starting digging into how the Scala for expression works. Knowing how it works is a prerequisite for understanding how this `stackManip` method works, and how `for` is used in many Scala/FP situations.

## **New rule: No more “for loop”**

Hmmm ... if you go back and look at that code again, is it really a “loop”? No, not really. However that code works, all it seems to do is to perform three operations on a stack. This thought leads us to a new rule:

For a variety of reasons — including the fact that this code isn’t really a *loop* but something called a *comprehension* — I will no longer use the term “for loop.” From now on, I’ll refer to this construct as a “for comprehension” or “for expression.”

I can explain this name by once again taking a short look back at history and mathematics.

To be consistent with the historical references I’m about to share, I’ll use the term “for comprehension” in this lesson, but in the remainder of this book I’ll use the term “for expression,” which is more commonly used.



## for comprehension history

As a quick historical tidbit, the name “comprehension” comes from both Haskell and mathematics, with mathematics preceding Haskell by some large number of years. The book, [Haskell, the Craft of Functional Programming](#), provides this introduction:

“One of the features of a functional language is the *list comprehension* notation, which has no parallels in other paradigms.”

[Learn You a Haskell for Great Good](#) states:

“List comprehensions are a way to filter, transform, and combine lists. They’re very similar to the mathematical concept of [set comprehensions](#). Set comprehensions are normally used for building sets out of other sets.”

If you’ve used the Scala for/yield expression at all, you know that it meets this definition. Indeed, you’ll find the for construct described on a page on the official Scala website titled [Sequence Comprehensions](#). There they state:

“Comprehensions have the form for (enumerators) yield e, where enumerators refers to a semicolon-separated list of enumerators. An enumerator is either a generator which introduces new variables, or it is a filter.”

These definitions lead us to the for comprehension concepts of *generators*, *filters*, and *definitions*.

# Generators, filters, and definitions

A Scala for comprehension can contain the following three types of expressions:

- Generators
- Filters
- Definitions

These are shown in the following source code snippet from the book, [Programming in Scala](#):

```
for {  
  p <- persons           // generator  
  n = p.name             // definition  
  if (n startsWith "To") // filter  
} yield
```

Let's look at short, formal definitions for each of these elements.

## ***Generators***

*Generators* have this general form:

```
pattern <- expression
```

In simple cases this results in an assignment, like this:

```
p <- persons
```

In this expression the value `p` iterates over all of the elements contained in `persons`. Generators can be more complicated than this, but this is their most simple and common use.

There are three more things to know about generators:

- Every for comprehension begins with a generator
- for comprehensions can have multiple generators
- The left side of a generator can also be a pattern:

```
def getTheSquirrel = for {  
  (dog, cat, squirrel) <- getAnimalsOutOfLaundryRoom  
} yield squirrel
```

## ***Definitions***

for comprehension *definitions* have this general form:

```
pattern = expression
```

A definition binds the pattern `pattern` on the left to the value of `expression` on the right.

In the original example in this lesson:

```
n = p.name
```

the variable `n` is bound to the value `p.name`. That statement has the same effect as writing this code outside of a for comprehension:

```
val n = p.name
```

## ***Filters***

for comprehension *filters* have this general form:

```
if (expression)
```

In this code `expression` must have the type `Boolean`.

A filter drops all elements from the iteration for which `expression` returns `false`, so in this code:

```
if (n startsWith "To")
```

any value `n` that does not start with the string `To` will be dropped during the iteration process. (Stated the other way, any value `n` that begins with the string `To` will be retained during the iteration process.)

## An example

Here's an example of each of these features in a Scala for comprehension:

```
case class Person(firstName: String, lastName: String)

val people = List(
  Person("barney", "rubble"),
  Person("fred", "flintstone")
)

val namesStartingWithB = for {
  p <- people           // generator
  fname = p.firstName  // definition
  if (fname startsWith "b") // filter
} yield fname.toUpperCase
```

If you put that code in the Scala REPL, you can then run this statement to see the expected result:

```
scala> namesStartingWithB.foreach(println)
BARNEY
```

## Summary

What you started to see in this lesson is that Scala for loops are much more than “loops.” They’re based on mathematical set comprehensions, and they are a way to “filter, transform, and combine lists.”

You also saw that a Scala for comprehension can contain the following three types of expressions:

- Generators
- Filters
- Definitions

## **What's next**

This lesson provides a quick review of the basic features of for comprehensions as background for the next lesson, where you'll learn how to write your own custom collection class to work in a for comprehension.

## See also

- [set comprehensions on Wikipedia](#)
- [Sequence comprehensions on scala-lang.org](#)
- [Haskell, the Craft of Functional Programming](#)
- [Learn You a Haskell for Great Good](#) states:
- [Programming in Scala](#)

# How to Write a Class That Can Be Used in a for Expression

As a reminder, the reason for the next several lessons on for expressions is so that you can get to a point where you can understand the following code:

```
def stackManip: State[Stack, Int] = for {  
  _ <- push(3)  
  a <- pop  
  b <- pop  
} yield(b)
```

To make this code easier to understand — or understandable at all, depending on your background — let's start digging into how the Scala for expression works.



## How for expressions work

The book, [Programming in Scala](#), co-written by Scala creator Martin Odersky, is the definitive reference for the Scala programming language, and Section 23.6 of that book, “Generalizing for,” describes the *translation rules* for how the Scala compiler converts (a) the for expressions you write into (b) a series of method calls that may include `map`, `flatMap`, `foreach`, and `withFilter`.

Very importantly, just as for expressions are compiled into these four functions, the opposite is also true: if you write a class that implements these functions, it can be used inside a for expression.

## Rules about how these functions enable for

In the next several lessons I'll show how to write your own custom data types that can be used in `for` expressions. To do this you need to know the rules that govern how a `for` expression is enabled by these functions. [Programming in Scala](#) gives us these translation rules:

1. If a custom data type defines a `foreach` method, it allows `for` *loops* (both with single and multiple generators). (Note the emphasis on the word “loops” in that definition. This refers to the simple Java-style use of a `for` loop, i.e., `for (i <- ints) println(i)`.)
2. If a data type defines only `map`, it can be used in `for` expressions consisting of a single generator.
3. If it defines `flatMap` as well as `map`, it allows `for` expressions consisting of multiple generators.
4. If it defines `withFilter`, it allows `for` filter expressions starting with an `if` within the `for` expression.

While a `for` expression technically doesn't require specific signatures for each of these methods, if you want your custom class to work well with a `for` expression it should generally implement those methods with the signatures shown in this example class:

```
abstract class CustomClass[A] {  
  def map[B](f: A => B): CustomClass[B]  
  def flatMap[B](f: A => CustomClass[B]): CustomClass[B]  
  def withFilter(p: A => Boolean): CustomClass[A]  
  def foreach(b: A => Unit): Unit  
}
```

If those type signatures don't make sense just yet, fear not, I'll cover them in the next few lessons.

And now — because we're at a point where we *really* need to know how `for` expressions work — in the next few lessons I'll demonstrate how to satisfy these rules as we build a custom class that can be used inside a Scala `for` expression.

# Creating a Sequence Class to be Used in a for Comprehension

The best way I know to demonstrate how the Scala for expression works is for us to build our own collection class.

To keep things simple I'm going to create a custom class as a “wrapper” around an existing Scala collection class. The reason for this is that I want you to focus on the effects that writing `map`, `flatMap`, `withFilter`, and `foreach` methods have on how the class works in a for expression — not on writing the gory internals of a collection class.

## A Sequence class

I always like to “begin with the end in mind” and picture how I want to use a class *before* I create it — i.e., its API — and to that end, this is how I want to use a custom class that I’m going to name Sequence:

```
val strings = Sequence("one", "two")
val nums = Sequence(1, 2, 3, 4, 5)
val peeps = Sequence(
    Person("Bert"),
    Person("Ernie"),
    Person("Grover")
)
```

From that code you can see that Sequence will be able to work with generic data types: it will be able to contain a series of String, Int, Person, and other data types.

Given those lines of code, you can infer some initial requirements about the Sequence class:

- Sequence either needs to be a case class, or it needs to have a companion object that implements an apply method, because I want to be able to create new Sequence instances without needing the new keyword.
- Because the class will be used as a container for generic elements, I’ll define the class to take a generic type.
- Because Sequence instances can be created with a variable number of initial elements, the Sequence class constructor will be defined to accept a “varargs” parameter.

I’ll create this class in a series of steps over the next several lessons.

## Create a case class named Sequence

The first step is to create a class named Sequence. I'm going to make it a case class so I can write code like this:

```
val strings = Sequence(1, 2, 3)
```

If I didn't use a case class (or an apply method in a companion object) I'd have to write "new Sequence", like this:

```
val strings = new Sequence("one", "two")
```

Therefore, I start by creating a case class named Sequence:

```
case class Sequence ...
```

## Sequence will be a container for generic elements

Next, I know that I want Sequence to contain elements of different types, so I expand that definition to say that Sequence will be a container of generic types:

```
case class Sequence[A] ...
```

## Sequence's constructor will take a variable number of input parameters

Next, I know that the Sequence constructor will have one parameter, and that parameter can be assigned to a variable number of elements, so I expand the definition to this:

```
case class Sequence[A](initialElems: A*) ...
```

If you're not familiar with using a *varargs* parameter, the *\** after the *A* is what lets you pass a variable number of elements into the Sequence constructor:

```
val a = Sequence(1,2)
val b = Sequence(1,2,3)
val c = Sequence('a', 'b', 'c', 'd', 'e')
```

Later in the Sequence class code you'll see how to handle a variable number of input elements.

### *If you have a hard time with generics*

If you have a hard time using generic types, it can help to remove the generic type *A* and use *Int* instead:

```
case class Sequence(initialElems: Int*) ...
```

With this code you only have to think about Sequence being a container for integers, so combined with the varargs constructor parameter, new instances of Sequence can be created like this:

```
val a = Sequence(1,2)
val b = Sequence(3,5,7,11,13,17,23)
```

Feel free to write your own code using *Int* rather than *A*, though I'll use *A* in the rest of this lesson:

```
case class Sequence[A](initialElems: A*) ...
```

## Sequence will be backed by a Scala collection class

As I mentioned at the beginning of this lesson, to keep this code from getting too complicated I'm going to implement Sequence as a wrapper around a Scala collection class. I originally wrote this lesson using a custom linked list class, but with that approach there was a lot of code that was unrelated to for expressions, so I opted to take this simpler approach.

The following code shows what I have in mind:

```
case class Sequence[A](initialElems: A*) {  
    // this is a book, don't do this at home  
    private val elems = scala.collection.mutable.ArrayBuffer[A]()  
  
    // initialize  
    elems ++= initialElems  
}
```

I make ArrayBuffer private in this code so no consumers of my class can see how it's implemented.

### *Scala constructors*

If you haven't use a Scala constructor in a while, remember that everything inside the body of a class that isn't a method is executed when a new instance of the class is created. Therefore, this line of code:

```
elems ++= initialElems
```

is executed when a new class instance is created. For example, when you create a new Sequence like this:

```
val ints = Sequence(1, 2, 3)
```

the int values 1, 2, and 3 are added to the elems variable when the class is first created.

If you need to brush up on how Scala class constructors work, see Chapter 4 of the [Scala Cookbook](#).



## ***About +=***

If you're not used to the += method, this line of code:

```
elems += initialElems
```

works just like this for loop:

```
for {  
  e <- initialElems  
} elems += e
```

## Summary

If you want to test this code before moving on to the next lesson, paste it into the Scala REPL and then create new sequences like these:

```
val strings = Sequence("a", "b", "c")
val nums = Sequence(1, 2, 3, 4, 5)
```

you'll see that they're created properly:

```
scala> val strings = Sequence("a", "b", "c")
strings: Sequence[String] = Sequence(WrappedArray(a, b, c))
```

```
scala> val nums = Sequence(1, 2, 3, 4, 5)
nums: Sequence[Int] = Sequence(WrappedArray(1, 2, 3, 4, 5))
```

Notice that `strings` has the type `Sequence[String]`, and `nums` has the type `Sequence[Int]`. That's generics at work.

Don't worry about the data on the right side of the `=` showing `Sequence(WrappedArray(...))`. That's just an artifact of taking a `varargs` constructor parameter.

## **What's next**

Now that I have a simple Sequence class to work with, I'll start to make it work with for expressions in the next lesson.

## See also

- My article, [How to create Scala methods that take variable-arguments \(varargs\) fields](#)
- [How to create an Array whose size can change \(ArrayBuffer\)](#)
- [How to delete Array and ArrayBuffer elements in Scala](#)

# Making Sequence Work in a Simple for Loop

So far I have this Sequence class:

```
case class Sequence[A](initialElems: A*) {  
    private val elems = scala.collection.mutable.ArrayBuffer[A]()  
    // initialize  
    elems ++= initialElems  
}
```

With that code I can create new Sequence instances like this:

```
val strings = Sequence("a", "b", "c")  
val nums = Sequence(1, 2, 3, 4, 5)
```

Next, I'll modify Sequence so I can use it as a generator in a for loop.

Note: I intentionally use the word “loop” in this lesson because all I'm trying to do is to loop over the elements in the Sequence, like a Java for loop. I'm specifically *not* trying to write for/yield expressions.

## Trying to use Sequence in a simple for loop

To get started, let's see what happens if I try to use a Sequence in a simple for loop. When I paste these two lines of code into the Scala REPL:

```
val ints = Sequence(1, 2, 3)
for (i <- ints) println(i)
```

I see this error after the for loop:

```
scala> for (i <- ints) println(i)
<console>:14: error: value foreach is not a member of Sequence[Int]
    for (i <- ints) println(i)
                ^
```

The bad news is that Sequence won't work in a simple for loop. But the good news is that the Scala compiler error tells me what's wrong:

```
"value foreach is not a member of Sequence[Int]"
```

## How to modify Sequence so it can be used as a for loop generator

The error message tells me that this for loop won't work because Sequence doesn't have a foreach method, so I'll go ahead and implement one.

Because (a) Sequence uses an ArrayBuffer behind the scenes, and (b) I'm not concerned with *how* I implement the foreach method, I'll just piggyback on the ArrayBuffer's foreach method:

```
def foreach(block: A => Unit): Unit = {
  elems.foreach(block)
}
```

(As I mentioned in the last lesson, for the purposes of understanding how the for expression works I don't care *how* I implement a foreach method, I just want to create one as simply as possible to see if that lets me use Sequence inside of for.)

Adding foreach makes my complete Sequence class look like this:

```
case class Sequence[A](initialElems: A*) {
  private val elems = scala.collection.mutable.ArrayBuffer[A]()

  // initialize
  elems ++= initialElems

  def foreach(block: A => Unit): Unit = {
    elems.foreach(block)
  }
}
```

When I paste that class into the REPL, and then paste this code in as well:

```
val ints = Sequence(1,2,3)
for (i <- ints) println(i)
```

I see that Sequence now works as a for loop generator:

```
scala> for (i <- ints) println(i)
1
2
3
```

Excellent. Let's move on to the next step.



## Exercises

1. If you don't like the way I implemented `foreach`, go ahead and implement it however you'd like. I recommend using recursion!

# How To Make Sequence Work as a Single Generator in a for Expression

Getting Sequence to work as a generator in a simple for loop was cool, but does adding foreach let Sequence also work when I add yield? Let's see.

When I paste this code into the REPL:

```
val ints = Sequence(1,2,3)

for {
  i <- ints
} yield i*2
```

I see this error message:

```
scala> for {
  |   i <- ints
  | } yield i*2
<console>:15: error: value map is not a member of Sequence[Int]
      i <- ints
      ^
```

Sadly, Sequence won't currently work with for/yield, but again the REPL tells us why:

```
error: value map is not a member of Sequence[Int]
```

That error tells us that Sequence needs a map method for this to work. Great — let's create one.

## Adding a map method to Sequence

Again I'm going to cheat to create a simple solution, this time using `ArrayBuffer`'s `map` method inside `Sequence`'s `map` method:

```
def map[B](f: A => B): Sequence[B] = {  
  val abMap: ArrayBuffer[B] = elems.map(f)  
  Sequence(abMap: _*)  
}
```

This `map` method does the following:

- It takes a function input parameter that transforms a type `A` to a type `B`.
- When it's finished, `map` returns a `Sequence[B]`.
- In the first line of the function I show `abMap: ArrayBuffer[B]` to be clear that `elems.map(f)` returns an `ArrayBuffer`. As usual, showing the type isn't necessary, but I think it helps to make this step clear.
- In the second line inside the function I use the `:_*` syntax to create a new `Sequence` and return it.

### About the `:_*` syntax

If you haven't seen the `abMap: _*` syntax before, the `:_*` part of the code is a way to adapt a collection to work with a `varargs` parameter. Recall that the `Sequence` constructor is defined to take a `varargs` parameter, as shown in Figure [fig:sequenceTakesVarargsParam].

```
case class Sequence[A](initialElems: A*)  
                        ↑  
                        |  
                        varargs param
```

The `Sequence` constructor takes a `varargs` input parameter.

For more information on this syntax, see my tutorial, [Scala's missing splat operator](#).

# The complete Sequence class

This is what the Sequence class looks like when I add the map method to it:

```
case class Sequence[A](initialElems: A*) {  
  private val elems = scala.collection.mutable.ArrayBuffer[A]()  
  
  // initialize  
  elems ++= initialElems  
  
  def map[B](f: A => B): Sequence[B] = {  
    val abMap = elems.map(f)  
    new Sequence(abMap: _*)  
  }  
  
  def foreach(block: A => Unit): Unit = {  
    elems.foreach(block)  
  }  
}
```

## Does for/yield work now?

Now when I go back and try to use the for/yield expression I showed earlier, I find that it compiles and runs just fine:

```
scala> val ints = Sequence(1,2,3)
ints: Sequence[Int] = Sequence(WrappedArray(1, 2, 3))

scala> for {
  |   i <- ints
  | } yield i*2
res0: Sequence[Int] = Sequence(ArrayBuffer(2, 4, 6))
```

## An important point

One point I need to make clear is that this `for/yield` expression works solely because of the `map` method; it has nothing to do with the `foreach` method. You can demonstrate this in at least two ways. First, if you remove the `foreach` method from the `Sequence` class you'll see that this `for` expression still works.

Second, if you create a little test class with this code in it, and then compile it with `scalac -Xprint:parse`, you'll see that the Scala compiler converts this `for` expression:

```
for {  
  i <- ints  
} yield i*2
```

into this `map` expression:

```
ints.map((i) => i.$times(2))
```

To be very clear, defining a `foreach` method in `Sequence` enables this `for` loop:

```
for (i <- ints) println(i)
```

and defining a `map` method in `Sequence` enables this `for` expression:

```
for {  
  i <- ints  
} yield i*2
```

## Summary

I can summarize what I accomplished in this lesson and the previous lesson with these lines of code:

```
// (1) works because `foreach` is defined
for (p <- peeps) println(p)

// (2) `yield` works because `map` is defined
val res: Sequence[Int] = for {
  i <- ints
} yield i * 2
res.foreach(println) // verify the result
```

## **What's next?**

This is a good start. Next up, I'll modify Sequence so I can use it with filtering clauses in for expressions.



# Enabling Filtering in a for Expression

Next, let's see if we can use a *filtering* clause inside of a for expression with the sequence code we have so far.

## Trying to use a filter

When I paste the current Sequence class and this code into the Scala REPL:

```
val ints = Sequence(1,2,3,4,5)

val res = for {
  i <- ints
  if i > 2
} yield i*2
```

I see the following error message:

```
<console>:14: error: value filter is not a member of Sequence[Int]
    i <- ints
      ^
```

Again the bad news is that I can't use a filtering clause like `if i > 2`, and the good news is that the REPL tells me why it won't work. So let's fix this problem.

## Before we continue ...

One note before we continue: I ran this example with the Scala 2.11.7 REPL, and that error message isn't 100% accurate. As I mentioned a few lessons ago, the current rule for how to get a custom collection class to work in a `for` expression is this:

- If a class defines `withFilter`, it allows for filter expressions starting with an `if` within the `for` expression

In versions of Scala up to 2.7 the `filter` error message shown in the REPL was correct, but starting with Scala 2.8 the preferred solution is to implement a `withFilter` method rather than a `filter` method. Therefore, in the following code I'll implement `withFilter`.

I'll write more about this shortly, but for the purposes of this lesson you can think of `withFilter` as being just like a `filter` method.

## Writing with `filter`'s type signature

At this point a good question is, “How does a `filter` method work?”

Figure [fig:scaladocFilterList295] shows the Scaladoc for the `filter` method of the `Scala List` class.

```
def filter(p: (A) => Boolean): List[A]
  Selects all elements of this traversable collection which satisfy a predicate.
```

---

<b>p</b>	the predicate used to test elements.
<b>returns</b>	a new traversable collection consisting of all elements of this traversable collection that satisfy the given predicate p. The order of the elements is preserved.

The Scaladoc for the `filter` method of the `Scala List` class.

By looking at that figure — and from your knowledge of the Scala collection methods — you know these things about how a typical `filter` method works:

1. It takes a function input parameter (FIP). That FIP must be able to be applied to the type of elements in the collection, and must return a `Boolean` value.
2. `filter` loops over the elements in its collection, and returns a new collection that contains the elements for which the passed-in function evaluates to `true`.

For instance, you can pass the anonymous function `_ > 2` into a `List[Int]`:

```
scala> val res = List(1,2,3,4,5).filter(_ > 2)
res: List[Int] = List(3, 4, 5)
```

1. Unlike `map`, `filter` doesn't *transform* elements in the collection, it just returns a subset of the elements in the collection. For instance, when `_ > 2` is applied, all elements in the collection that are greater than 2 are returned. This tells us that `filter`'s return type will be the same as the elements `Sequence` contains.

Put together, these bullet points tell us that a `filter` method for `Sequence` will have this type signature:

```
def filter(p: A => Boolean): Sequence[A] = ???
```

In that code, `p` stands for the predicate that `filter` takes as an input parameter. Because `Sequence` contains elements of type `A`, the predicate transforms that type to a `Boolean`, and `filter` returns a `Sequence[A]`.

When that method body is implemented you'll be able to write code like this:

```
val ints = Sequence(1,2,3,4,5).filter(i > 2)
```

Because Scala for expressions prefer `withFilter`, I'll go ahead and rename `filter` to `withFilter` at this point:

```
def withFilter(p: A => Boolean): Sequence[A] = ???
```

Given this type signature, all I need to do now is implement `withFilter`'s body.

## Implementing withFilter's body

As with `foreach` and `map`, I'll implement `withFilter`'s body by calling a method on `Sequence`'s private `ArrayBuffer`. Because in the real world there are differences in how a true `withFilter` method works, the easiest thing to do here is to call `filter`, so I'll do that:

```
def withFilter(p: A => Boolean): Sequence[A] = {  
  val tmpArrayBuffer = elems.filter(p)  
  Sequence(tmpArrayBuffer: _*)  
}
```

When I add this code to the existing implementation of the `Sequence` class I get this:

```
case class Sequence[A](initialElems: A*) {  
  private val elems = scala.collection.mutable.ArrayBuffer[A]()  
  elems += initialElems  
  
  def withFilter(p: A => Boolean): Sequence[A] = {  
    val tmpArrayBuffer = elems.filter(p)  
    Sequence(tmpArrayBuffer: _*)  
  }  
  
  def map[B](f: A => B): Sequence[B] = {  
    val abMap = elems.map(f)  
    new Sequence(abMap: _*)  
  }  
  
  def foreach(block: A => Unit): Unit = {  
    elems.foreach(block)  
  }  
}
```

Will this let us use a filtering clause in a `for` expression? Let's see.

When I paste the `Sequence` class source code into the REPL and then paste in this code:

```
val ints = Sequence(1,2,3,4,5)  
  
val res = for {  
  i <- ints  
  if i > 2  
} yield i*2
```

I see the following result:

```
scala> val res = for {  
  |   i <- ints  
  |   if i > 2  
  | } yield i*2  
res: Sequence[Int] = Sequence(ArrayBuffer(6, 8, 10))
```

Excellent, it works as desired. I can now use `if` clauses inside for expressions with the `Sequence` class.

I'll implement more functionality in the next lesson, but it's worth pausing for a few moments here to learn more about the differences between implementing `withFilter` or `filter` in a class that you want to use in a for expression.

## filter vs withFilter

You can read more about how `for`/`yield` expressions are translated in a post on the official Scala website titled, “[How does yield work?](#),” but the short story is this:

- `for` comprehensions with `if` filters are translated to `withFilter` method calls
- If `withFilter` does not exist on the class being used in the `for` comprehension, the compiler will fall back and use the class’s `filter` method instead
- If neither method exists, the compilation attempt will fail

If I had implemented `filter` in this lesson (rather than `withFilter`), in the next lesson you’d start to see compiler warning messages like this:

```
Warning:(31, 14) `withFilter' method does not yet exist on
Sequence[A],
using `filter' method instead
  p <- peeps
    ^
```

To avoid those warning messages, I implemented `withFilter` here.

However — and that’s a big *however* — it’s important to know that my `withFilter` method is not exactly what the Scala compiler is expecting.

If you’re not familiar with the difference between `filter` and `withFilter` on the built-in Scala collection classes, I wrote about them in a blog post titled, “[An example that shows the differences between strict and lazy evaluation in Scala.](#)” What I wrote there can be summarized by what you find in the `withFilter` Scaladoc on Scala collection classes like [List](#):

```
withFilter creates a non-strict filter of this traversable
collection. Note: the difference between c filter p and
c withFilter p is that the former creates a new collection,
whereas the latter only restricts the domain of subsequent map,
```



`flatMap`, `foreach`, and `withFilter` operations.

There are probably ways that I could cheat to create a `withFilter` method that meets that definition, but I think that obscures the main purpose of this lesson:

- If you implement a `withFilter` or `filter` method in your custom class, you'll be able to use that class with an `if` clause in a `for` expression. (This assumes that you also implement other methods like `foreach` and `map`.)

# Summary

I can summarize what I accomplished in this lesson and the previous lessons with these lines of code:

```
// (1) a single generator works because `foreach` is defined
for (p <- peeps) println(p)
```

```
// (2) `yield` works because `map` is defined
val res: Sequence[Int] = for {
  i <- ints
} yield i * 2
res.foreach(println)
```

```
// (3) `if` works because `withFilter` is defined
val res = for {
  i <- ints
  if i > 2
} yield i*2
```

## **What's next**

Now that I have Sequence working in all of these ways, there's just one more thing to learn: how to modify it so we can use multiple generators in a for expression. We'll accomplish that in the next lesson.

# How to Enable the Use of Multiple Generators in a for Expression

One cool thing about for expressions is that you can use multiple generators inside of them. This lets you do some nice analytics when you have some interesting data relationships.

For instance, suppose you have some data like this:

```
case class Person(name: String)

val myFriends = Sequence(
  Person("Adam"),
  Person("David"),
  Person("Frank")
)

val adamsFriends = Sequence(
  Person("Nick"),
  Person("David"),
  Person("Frank")
)
```

If I want to find out which friends of mine are also friends of Adam, I can write a for expression like this:

```
val mutualFriends = for {
  myFriend    <- myFriends    // generator
  adamsFriend <- adamsFriends // generator
  if (myFriend.name == adamsFriend.name)
} yield myFriend
mutualFriends.foreach(println)
```

Notice how I use two Sequence instances as generators in that for expression.

Sadly, the compiler tells us that this code won't work, but happily it again tells us why:

```
<console>:17: error: value flatMap is not a member of Sequence[Person]
  myFriend <- myFriends
                ^
```

Since you're used to reading these error messages now, you know the compiler is telling us that we need to implement a flatMap method in the Sequence class for this code to work.

## flatMap, a curious creature

The `flatMap` method is an interesting creature, and experienced functional programmers seem to use it a lot.

As a bit of background, when you think about `map`'s signature for a moment, you'll remember that it looks like this:

```
def map[B](f: A => B): Sequence[B]
```

As shown, `map` takes a function that transforms a type `A` to a type `B`, and returns a `Sequence[B]` when it finishes, transforming all of the elements in the `Sequence`.

`flatMap`'s signature is similar to `map`:

```
def flatMap[B](f: A => Sequence[B]): Sequence[B]
```

As this shows, `flatMap` is similar to `map`, but it's also different. The function `flatMap` takes transforms a type `A` to a `Sequence` of type `B` — `Sequence[B]` — and then when it's finished it also returns a `Sequence[B]`. The type signatures tell us that the difference between `map` and `flatMap` is the type of functions they take as input parameters.

## flatMap background

If you come to Scala from a background like Java, after a while it becomes apparent that the map function is very cool – and you’ll use it all the time – but it can be hard to find a use for flatMap.

As I wrote in the [Scala Cookbook](#), I like to think of flatMap as “map flat,” because on collections classes it works similarly to a) calling map and then b) calling flatten. As an example of what I mean, these lines of code show the difference between calling map and flatMap on a Seq[String]:

```
scala> val fruits = Seq("apple", "banana", "orange")
fruits: Seq[java.lang.String] = List(apple, banana, orange)

scala> fruits.map(_.toUpperCase)
res0: Seq[java.lang.String] = List(APPLE, BANANA, ORANGE)

scala> fruits.flatMap(_.toUpperCase)
res1: Seq[Char] = List(A, P, P, L, E, B, A, N, A, N, A, O, R, A, N, G, E)
```

map applies the function to each element in the input Seq to create a transformed Seq, but flatMap takes the process a step further. In fact, you can show that calling flatMap is just like calling map and then calling flatten:

```
scala> val mapResult = fruits.map(_.toUpperCase)
mapResult: Seq[String] = List(APPLE, BANANA, ORANGE)

scala> val flattenResult = mapResult.flatten
flattenResult: Seq[Char] = List(A, P, P, L, E, B, A, N, A, N, A, O, R, A, N, G, E)
```

I won’t show any more examples of flatMap here, but if you want to see more examples of how it works, please see my article, “[A collection of Scala flatMap examples](#).” I also demonstrate more ways to use flatMap in lessons later in this book.

## Starting to write a flatMap method

Earlier I showed flatMap's signature to be:

```
def flatMap[B](f: A => Sequence[B]): Sequence[B]
```

Given that signature, and knowing that flatMap works like a map call followed by a flatten call, I can implement flatMap's function body by calling map and then flatten:

```
def flatMap[B](f: A => Sequence[B]): Sequence[B] = {  
  val mapRes: Sequence[Sequence[B]] = map(f) //map  
  flatten(mapRes) //flatten  
}
```

In the first line of the function body I call the map method we developed in the previous lessons, and I also explicitly show the type of mapRes:

```
val mapRes: Sequence[Sequence[B]] = map(f) //map
```

Because this result is a little complicated, I like to make the return type obvious. That's a great thing about Scala: You don't have to declare variable types, but you can show them when you want to.

In the second line of this function I quickly run into a problem: I haven't defined a flatten method yet! Let's fix that.

### *Aside: Why I wrote the code as shown*

It's important to note that I wrote the function body like this:

```
val mapRes: Sequence[Sequence[B]] = map(f) //map  
flatten(mapRes) //flatten
```

I did this because the function input parameter that flatMap takes looks like this:

```
f: A => Sequence[B]
```

Because that function transforms a type A into a Sequence[B], I can't just call map and flatten on elems. For example, this code won't work:

```
// this won't work  
def flatMap[B](f: A => Sequence[B]): Sequence[B] = {
```

```
    val mapRes = elems.map(f)
    mapRes.flatten
}
```

The reason I can't cheat like this is because `elems.map(f)` returns an `ArrayBuffer[Sequence[B]]`, and what I really need is a `Sequence[Sequence[B]]`. Because of this I need to take the approach I showed earlier:

```
def flatMap[B](f: A => Sequence[B]): Sequence[B] = {
    val mapRes: Sequence[Sequence[B]] = map(f) //map
    flatten(mapRes) //flatten
}
```



## How flatten works

Getting back to the problem at hand, I need to write a `flatten` method. If you read the [Scala Cookbook](#) you know how a `flatten` method should work — it converts a “list of lists” to a single list. A little example demonstrates this. In the REPL you can create a list of lists like this:

```
val a = List( List(1,2), List(3,4) )
```

Now when you call `flatten` on that data structure you get a combined (or flattened) result of `List(1, 2, 3, 4)`. Here’s what it looks like in the REPL:

```
scala> val a = List( List(1,2), List(3,4) )
a: List[List[Int]] = List(List(1, 2), List(3, 4))

scala> a.flatten
res0: List[Int] = List(1, 2, 3, 4)
```

Our `flatten` method should do the same thing.

## Writing a flatten function

Seeing how `flatten` works, I can write pseudocode for a `flatten` function like this:

```
create an empty list 'xs'
for each list 'a' in the original listOfLists
  for each element 'e' in the list 'a'
    add 'e' to 'xs'
return 'xs'
```

In Scala/OOP you can implement that pseudocode like this:

```
var xs = ArrayBuffer[B]()
for (listB: Sequence[B] <- listOfLists) {
  for (e <- listB) {
    xs += e
  }
}
xs
```

Because I'm working with my custom `Sequence` I need to modify that code slightly, but when I wrap it inside a function named `flatten`, it still looks similar:

```
def flatten[B](seqOfSeq: Sequence[Sequence[B]]): Sequence[B] = {
  var xs = ArrayBuffer[B]()
  for (listB: Sequence[B] <- seqOfSeq) {
    for (e <- listB) {
      xs += e
    }
  }
  Sequence(xs: _*)
}
```

The biggest difference here is that I convert the temporary `ArrayBuffer` to a `Sequence` in the last step, like this:

```
Sequence(xs: _*)
```

## From flatten to flattenLike

There's one problem with this function; the type signature for a `flatten` function on a Scala `List` looks like this:

```
def flatten[B]: List[B]
```

Because my type signature isn't the same as that, I'm not comfortable naming it `flatten`. Therefore I'm going to rename it and also make it private, so the new signature looks like this:

```
private def flattenLike[B](seqOfSeq: Sequence[Sequence[B]]): Sequence[B]
```

The short explanation for why the type signatures don't match up is that my cheating ways have finally caught up with me. Creating `Sequence` as a wrapper around an `ArrayBuffer` creates a series of problems if I try to define `flatten` like this:

```
def flatten[B]() : Sequence[B] = ...
```

Rather than go into those problems in detail, I'll leave that as an exercise for the reader. Focusing on the problem at hand — getting a `flatMap` function working — I'm going to move forward using my `flattenLike` function to get `flatMap` working.

## Making flatMap work

Now that I have flattenLike written, I can go back and update flatMap to call it:

```
def flatMap[B](f: A => Sequence[B]): Sequence[B] = {  
  val mapRes: Sequence[Sequence[B]] = map(f) //map  
  flattenLike(mapRes) //flatten  
}
```

# Testing flatMap

Now that I think I have a working flatMap function, I can add it to the Sequence class. Here's the complete source code for Sequence, including the functions I just wrote:

```
import scala.collection.mutable.ArrayBuffer

case class Sequence[A](private val initialElems: A*) {

  // this is a book, don't do this at home
  private val elems = ArrayBuffer[A]()

  // initialize
  elems ++= initialElems

  def flatMap[B](f: A => Sequence[B]): Sequence[B] = {
    val mapRes: Sequence[Sequence[B]] = map(f) //map
    flattenLike(mapRes) //flatten
  }

  private def flattenLike[B](seqOfSeq: Sequence[Sequence[B]]): Sequence[B] = {
    var xs = ArrayBuffer[B]()
    for (listB: Sequence[B] <- seqOfSeq) {
      for (e <- listB) {
        xs += e
      }
    }
    Sequence(xs: _*)
  }

  def withFilter(p: A => Boolean): Sequence[A] = {
    val tmpArrayBuffer = elems.filter(p)
    Sequence(tmpArrayBuffer: _*)
  }

  def map[B](f: A => B): Sequence[B] = {
    val abMap = elems.map(f)
    Sequence(abMap: _*)
  }

  def foreach(block: A => Unit): Unit = {
    elems.foreach(block)
  }
}
```

When I paste that code into the REPL, and then paste in the code I showed at the beginning of this lesson:

```
case class Person(name: String)

val myFriends = Sequence(
  Person("Adam"),
  Person("David"),
  Person("Frank"))
```

```
)  
val adamsFriends = Sequence(  
    Person("Nick"),  
    Person("David"),  
    Person("Frank")  
)
```

I can confirm that my for expression with multiple generators now works:

```
val mutualFriends = for {  
    myFriend <- myFriends           // generator  
    adamsFriend <- adamsFriends     // generator  
    if (myFriend.name == adamsFriend.name)  
} yield myFriend  
  
mutualFriends.foreach(println)
```

The output of that last line looks like this:

```
scala> mutualFriends.foreach(println)  
Person(David)  
Person(Frank)
```

Admittedly I did some serious cheating in this lesson to get a flatMap function working, but as you see, once flatMap is implemented, you can use multiple generators in a for expression.

# Summary

I can summarize what I showed in all of the for expression lessons with these lines of code:

```
// (1) works because `foreach` is defined
for (p <- peeps) println(p)

// (2) `yield` works because `map` is defined
val res: Sequence[Int] = for {
  i <- ints
} yield i * 2
res.foreach(println)

// (3) `if` works because `withFilter` is defined
val res = for {
  i <- ints
  if i > 2
} yield i*2

// (4) works because `flatMap` is defined
val mutualFriends = for {
  myFriend <- myFriends // generator
  adamsFriend <- adamsFriends // generator
  if (myFriend.name == adamsFriend.name)
} yield myFriend
```

# A Summary of the for Expression Lessons

As I mentioned at the beginning of these for expression lessons, the book, [Programming in Scala](#) describes the *translation rules* for how the Scala compiler converts the for comprehensions you write into a series of method calls that can include `map`, `flatMap`, `foreach`, and `withFilter`. As a reminder, those rules are:

1. If a custom data type defines a `foreach` method, it allows for *loops* (both with single and multiple generators). (Note the emphasis on the word “loops” in that definition. This refers to the simple Java-style use of a for loop, i.e., `for (i <- ints) println(i)`.)
2. If a data type defines only `map`, it can be used in for expressions consisting of a single generator. (Where “for expressions” means for/yield expressions.)
3. If it defines `flatMap` as well as `map`, it allows for expressions consisting of multiple generators.
4. If it defines `withFilter`, it allows for filter expressions starting with an `if` within the for expression.

For a trait named `CustomClass`, the signatures for these functions should look like this:

```
trait CustomClass[A] {  
  def map[B](f: A => B): CustomClass[B]  
  def flatMap[B](f: A => CustomClass[B]): CustomClass[B]  
  def withFilter(p: A => Boolean): CustomClass[A]  
  def foreach(b: A => Unit): Unit  
}
```

Through a series of lessons I showed how you can write your own `foreach`, `map`, `withFilter`, and `flatMap` functions so that your custom data type can be used inside a for expression.

As I've noted, I “cheated” a lot in these lessons because I'm not



concerned at this point with *how* these methods are implemented. In future lessons I'll show how to properly write these methods.

## What's next

As I mentioned in the first `for` expression lesson, the goal of all of this work is to help you understand how FP code like this can possibly work:

```
def stackManip: State[Stack, Int] = for {  
  _ <- push(3)  
  a <- pop  
  b <- pop  
} yield(b)
```

Now that you have the background on how to write a class that works in a `for` expression, you're much closer to being able to understand how this code works. The following lessons will build on what you just learned until the mysteries of this `for` expression will be completely revealed.

## See also

- [“Set comprehensions” defined on Wikipedia](#)
- [“Sequence comprehensions” on scala-lang.org](#)
- [How to use multiple generators in Scala ‘for’ expressions \(loops\)](#)
- [A collection of Scala ‘flatMap’ examples](#)
- [An example to show the differences between strict and lazy evaluation in Scala \(filter vs withFilter\)](#)
- [How does yield work?](#) (includes a discussion of withFilter versus filter)

# Pure Functions Tell No Lies

## Introduction

There's an important point about pure functions that I didn't emphasize enough earlier in this book:

Pure functions never throw exceptions!

This is an important point I need to stress, especially before getting into the following lessons.

Think of it this way: the signature of a pure function is a binding contract with the consumer of that function. If the function signature says it returns an `Int`:

```
def foo(a: String): Int = ...
```

then by golly it *must* return an `Int`.

Importantly, it can't return an `Int` *most* of the time and throw an exception *some* of the time. If a function was to behave like that, its signature would be a lie. This would be bad for your programming career, because other FP developers won't be happy with you.

Beyond that, it's also bad for your code because a key part of functional programming is something called *function composition*, and if your functions throw exceptions, they won't compose well.

## Function composition

As you'll see in the coming lessons, the ability to *compose* functions is a BIG feature of functional programming. Composing functions means that you can easily glue them together to form a solution, like links in a chain. For now you can think of composition as being like this:

```
val solution = myData.function1(arg1)
                    .function2(arg2, arg3)
                    .function3(arg4)
                    .function4(arg5)
```

If one of those functions can throw an exception, that function is a weak link in the chain. If it was a real, physical chain, it would mean that you could never rely on the chain because you'd never know when that link might break. In the code shown it would mean that `solution` might never get bound to a value because an exception could short-circuit the code.

## Example

To be clear, you should *never* write functions like these:

```
// bad: can throw an exception
@throws(classOf[NumberFormatException])
def makeFloat(s: String): Float = s.trim.toFloat

// worse: can throw an exception without telling you
def makeInt(s: String): Int = s.trim.toInt
```

Inside those functions both `toFloat` and `toInt` can throw exceptions, and whether or not you warn other developers with a `@throws` clause, from an FP standpoint they're both bad. If other people rely on these functions and they short-circuit, their code won't be reliable.

## The Scala/FP way

Rather than throwing exceptions, the Scala/FP idiom is to handle exceptions inside your functions and return an `Option`. This function signature tells the truth to consumers of the function:

```
def makeInt(s: String): Option[Int] = {  
  try {  
    Some(s.trim.toInt)  
  } catch {  
    case e: Exception => None  
  }  
}
```

The signature says, “If all goes well, you’re going to get a `Some[Int]` — an `Int` wrapped in a `Some` wrapper — but if something goes wrong you’re going to get a `None`.”

This is great because it means you can write code that uses `makeInt` like this:

```
makeInt(input) match {  
  case Some(i) => println(s"i = $i")  
  case None => println("toInt could not parse 'input'")  
}
```

In addition to `Option` you can also use `Try`, `Either`, or third-party approaches. I just say “`Option`” here to keep things simple. I show all of the approaches in the next lesson.

## Using Option with for

As a preview of what you're going to see in the upcoming lessons, this is also a valid (and important) way of using Option values in for expressions:

```
val result = for {
  x <- makeInt("1")
  y <- makeInt("2")
  z <- makeInt("3")
} yield x + y + z
```

The REPL shows what that code yields:

```
scala> val result = for {
  |   x <- makeInt("1")
  |   y <- makeInt("2")
  |   z <- makeInt("3")
  | } yield x + y + z
result: Option[Int] = Some(6)
```

A great way to think about this particular example is that it shows the “Happy Case” of this for expression. This means that makeInt is able to parse each string and you get the desired result in the end, in this case a Some(6).

But note that the world can also give us “Unhappy Cases”:

```
val result = for {
  x <- makeInt("1")
  y <- makeInt("hi mom")
  z <- makeInt("hi dad")
} yield x + y + z
```

In this example makeInt isn't going to be able to convert those last two strings to Int values, so the result isn't going to be as happy as the previous example.

But fear not: because (a) makeInt returns Option values, (b) the Option, Some, and None classes have map and flatMap methods, and (c) the for expression is built to work with map and flatMap, result simply ends up being bound to None:

```
scala> val result = for {
  |   x <- makeInt("1")
  |   y <- makeInt("hi mom")
  |   z <- makeInt("3")
  | } yield x + y + z
result: Option[Int] = None
```



Unlike an exception blowing up your code, this result is great! Your code didn't short-circuit and go flying off in some other direction with an exception; result just ended up being `None`. This isn't a problem at all, because the next part of your code also knows how to deal with an `Option`:

```
result match {  
  case Some(i) => println(s"result = $result")  
  case None => println("could not add the three strings as Int values")  
}
```

This is Scala/FP code as it was meant to be written:

- `makeInt` is a pure function
- `makeInt` returns an `Option`
- therefore:
  - `makeInt` can be used with `match/case`
  - multiple `makeInt` functions can be used in a `for` expression

As a thought exercise, look back at that Unhappy Case again, and consider what would have happened if `makeInt` would have thrown an exception when the `makeInt(hi mom)` call was reached. (That's what I call a "Really Unhappy Case.")

## Keys to remember

The key points of this lesson are:

- Pure functions *never* throw exceptions
- Pure function signatures are a contract with its consumers
- Scala/FP developers use `Option` rather than exceptions
- Scala/FP developers use `Option` rather than `null` values (I didn't demonstrate this point in these examples)
- Scala constructs like `match` and `for` work great with `Option`

Visually, the `Option` portion of the summary looks like Figure [fig:scalaFpDevsUseOption].

✓ `Option`



Scala/FP developers use `Option`, and don't use `null` values or exceptions.

## See also

- [Scala best practice: How to use the Option/Some/None pattern](#)
- Oracle's [Unchecked Exceptions: The Controversy](#)
- I think the first time I heard of the Happy and Unhappy Path terms was in an article titled, [First steps with monads in Scala](#)

# Functional Error Handling (Option, Try, Or, and Either)

[FunctionalErrorHandling]

## Goals

As you saw in the previous lesson, functional programmers *never* write functions that throw exceptions. As I show in that lesson, a main replacement for throwing exceptions is to return an `Option`.

As I mentioned, that was a bit of a simplification. While you'll use `Option` a lot, depending on your needs you may also want to use other Scala classes like `Try` and `Either`. In addition to those you can also use third-party approaches like the `or` construct in [the Scalactic library](#).

This lesson shows each of these approaches, along with the pros and cons of each approach.

## Option, Some, and None

I covered Option in the previous lesson, so all I'll do here is repeat the code I showed in that lesson:

```
def makeInt(s: String): Option[Int] = {
  try {
    Some(s.trim.toInt)
  } catch {
    case e: Exception => None
  }
}

makeInt(input) match {
  case Some(i) => println(s"i = $i")
  case None => println("toInt could not parse 'input'")
}

val result = makeInt(input).getOrElse(0)

val result = for {
  x <- makeInt("1")
  y <- makeInt("2")
  z <- makeInt("3")
} yield x + y + z
```

## A weakness of Option

While those are idiomatic examples of how to use `Option`, it's important to note that `Option` has a weakness: it doesn't tell you anything about *why* something failed. For example, a consumer of the `makeInt` function can't tell *why* a `String` wasn't converted to an `Int`, it only knows that it got a `None` in return.

For the times when this is a problem, Scala/FP developers use constructs that work like `Option` but also tell them *why* something failed. These constructs include `Try` and `Either` in the Scala API, and `Or` in the Scalactic library. The rest of this lesson shows those other approaches.

# Try, Success, and Failure

When you want to let consumers of your code know *why* something failed, use `Try` instead of `Option`. Just like `Option` has `Some` (the success case) and `None` (the failure case), `Try` has `Success` and `Failure` subclasses — and `Failure` contains the reason why something failed.

To demonstrate this, here's the `makeInt` function rewritten using `Try`:

```
import scala.util.{Try, Success, Failure}
def makeInt(s: String): Try[Int] = Try(s.trim.toInt)
```

As shown, all you have to do to use `Try` is to wrap the exception-throwing code in a `Try` constructor, and then declare that your function returns its success value wrapped in a `Try`, such as `makeInt` returning the type `Try[Int]` in this example. The REPL shows how this version of `makeInt` works:

```
scala> makeInt("1")
res0: scala.util.Try[Int] = Success(1)

scala> makeInt("foo")
res1: scala.util.Try[Int] = Failure(java.lang.NumberFormatException: For input string:
"foo")
```

The benefit of `Try` over `Option` is that when the enclosed code throws an exception, `Try` returns a `Failure` object that contains the exception information. That can be useful for logging, or to show a user why something failed.

Like `Option`, `Try` also works with match expressions:

```
makeInt("hello") match {
  case Success(i) => println(s"Success, value is: $i")
  case Failure(s) => println(s"Failed, message is: $s")
}
```

It can also be used in `for` expressions:

```
val answer = for {
  a <- makeInt("1")
  b <- makeInt("10")
} yield a + b
```

The REPL shows the output of the `for` expression:

```
scala> val answer = for {
  |   a <- makeInt("1")
```



```
|      b <- makeInt("10")  
|    } yield a + b  
answer: scala.util.Try[Int] = Success(11)
```

See the [Try class Scaladoc](#) for more information.

## Either, Left, and Right

An approach that's similar to `Try` is the Scala `Either`, `Left`, and `Right` classes. While `Try` has well-named subtypes in `Success` and `Failure`, `Either` relies on convention:

- `Left` holds the error
- `Right` holds the success value

Unfortunately, prior to Scala 2.12, that was just a convention. But, following that convention, this is what `makeInt` looks like when using `Either`:

```
def makeInt(s: String): Either[String,Int] = {
  try {
    Right(s.trim.toInt)
  } catch {
    case e: Exception => Left(e.toString)
  }
}
```

The REPL shows how this works:

```
scala> makeInt("1")
res0: Either[String,Int] = Right(1)

scala> makeInt("foo")
res1: Either[String,Int] = Left(java.lang.NumberFormatException: For input string: "foo")
```

`Either` can be used with `match`:

```
makeInt("11") match {
  case Left(s) => println("Error message: " + s)
  case Right(i) => println("Desired answer: " + i)
}
```

In Scala 2.12 `Either` was redesigned, so `right` is always the success case. This means that it implements `map` and `flatMap`, so it can now be used in `for` expressions. The REPL shows what this looks like:

```
// works with Scala 2.12 and newer
scala> val answer = for {
  |   a <- makeInt("1")
  |   b <- makeInt("10")
  | } yield a + b
answer: scala.util.Either[String,Int] = Right(11)
```

## Using Or from Scalactic

The Scalactic project — created by Bill Venners, co-author of [Programming in Scala](#), and creator of [ScalaTest](#) — includes an `Or` construct that works like `Option`, and also gives you access to the failure message.

Because Scalactic is a third-party library you'll have to include it in your `build.sbt` file. See the [Scalactic install page](#) for information on how to get it set up.

Once you have Scalactic set up with SBT, you can define `makeInt` like this:

```
def makeInt(s: String): Int Or ErrorMessage = {
  try {
    Good(s.trim.toInt)
  } catch {
    case e: Exception => Bad(e.toString)
  }
}
```

Notice that `makeInt`'s signature is a little different than the previous examples:

```
def makeInt(s: String): Int Or ErrorMessage
```

The `Int Or ErrorMessage` makes it clear that this function is either going to return an `Int` or it's going to return an `ErrorMessage`. While that's implied with `Option`, `Try`, and `Either`, a benefit of Scalactic is that it makes this very clear.

Once you have `makeInt` defined, you can use it in all of the following ways. This line:

```
println(makeInt("1"))
```

prints “Good(1).” This line:

```
println(makeInt("boo"))
```

prints:

```
Bad(java.lang.NumberFormatException: For input string: "boo")
```

This match expression:

```
makeInt("11") match {
```

```
    case Good(i) => println("Answer: " + i)
    case Bad(msg) => println("Error: " + msg)
}
```

prints:

Answer: 11

And this for expression code:

```
val result = for {
  a <- makeInt("1")
  b <- makeInt("10")
} yield a + b
println(result)
```

prints:

Good(11)

Scalactic has even more features, including the ability to accumulate error messages. See the [Scalactic “Or and Every” page](#) for more information.

## **Personal recommendation**

These days I generally use `Option` when I don't care about the failure reason, and I use `Try` or `Or` when I need the failure reason.

## Don't forget the Null Object Pattern

As a final note on functional error handling, don't forget that it can sometimes make sense to use the [Null Object Pattern](#). A simple example of this is that you may have a function that returns a `List[Int]`:

```
def doSomething(x: List[Int]): List[Int] = ...
```

With a function like this it can make sense to return an empty `List` rather than using `Option`, `Try`, `Either`, or `Or`:

```
def doSomething(list: List[Int]): List[Int] = {  
  if (someTestCondition(list)) {  
    // return some version of `list`  
  } else {  
    // return an empty List  
    Nil: List[Int]  
  }  
}
```

One example of where you can see this in real-world code is with the `filter` method of the Scala `List` class. It returns an empty `List` when you filter out all of the `List` elements:

```
scala> List(1,2,3).filter(_ > 10)  
res0: List[Int] = List()
```

## Handling null values

In all of these examples I showed the `makeInt` function, which handles an exception and returns an `Option`, `Try`, `Either`, or `Or` value. It's important to note that you should use the same technique when dealing with `null` values.

For example, when using [the Apache HttpClient Java library](#) as shown below, the entity variable can end up being `null`:

```
val httpGetRequest = new HttpGet(someUrl)
val httpClient = new DefaultHttpClient
val httpResponse = httpClient.execute(httpGetRequest)
val entity = httpResponse.getEntity() // null?
```

Rather than returning a `null` value, a Scala/FP function that works with code like this should handle the `null` value just like the previous examples handled the exception:

```
if (entity == null) {
  None
} else {
  val inputStream = entity.getContent
  content = io.Source.fromInputStream(inputStream).getLines.mkString
  inputStream.close
  Some(content)
}
```

## A technical term: “Biasing”

On the [Scalactic Or and Every page](#) you’ll find this text:

“or differs from Scala’s Either type in that Either treats both its Left and Right alternatives in an identical manner, whereas Or treats its two alternatives differently: it favors Good over Bad. Because of this, it is more convenient to work with Or when you prefer one alternative over the other; for example, if one alternative represents a valid result and another represents an error.”

The technical term for this is to say that Or is *biased* to the Good result. Similarly Option is biased to Some, and Try is biased to Success.

As an example of what this means, if makeInt returns a Some in a for expression, the expression continues, but if it returns a None, the for expression effectively short-circuits at that point.

Note: The Scalactic quote was true about Either prior to Scala 2.12, but Either is now biased, and Right is always the success case.)



## Key points

In summary, when you're working with code where (a) you want to use something like `Option`, but (b) you also want the "failure reason," you should use the Scala error-handling constructs `Try`, `Or` (from the Scalactic library), or `Either`.

Table [table:OptionTryOrEitherComparison] shows a comparison of these error-handling classes.

Error-handling classes you can use with  
Scala.

Base Type	Success Case	Failure Case
Option	Some	None
Try	Success	Failure
Or	Good	Bad
Either	Right	Left

Table [table:howRecommendUsingOptionalClasses] shows how I use each set of "optional" classes.

How I recommend using Scala's "optional" classes.

Construct	When to use
Option	When you don't need the error message
Try	Particularly good when you want to wrap exceptions
Or	An alternative to Try when you want the "failure reason"
Either	I don't use Either (because of its unbiased history and naming conventions)

Lastly, remember that the Null Object Pattern can make sense in certain situations.

## What's next

Now that you've seen how Scala's `for` expression works, and how to properly implement error-handling in your Scala/FP code, the next lesson takes a few moments to discuss "idiomatic" Scala/FP code.

## See also

- [Easing Into Functional Error Handling in Scala](#) by Long Cao was the inspiration for this lesson
- I originally wrote about this topic in a lesson titled, [Scala best practice: How to use the Option/Some/None pattern](#)
- [The Scalactic website](#)
- [The Scalactic “Or and Every” page](#)

# Embrace The Idioms!

Before you proceed any further in this book you need to be completely convinced that the ways I've shown to write Scala/FP code in this book are better than the ways that you've written imperative code in the past. First, you must buy into the Scala/FP "rules" I outlined early in the book:

1. Scala/FP code has no `null` values
2. Only *pure functions* will be used
3. Immutable variables will be used for all fields (`val` fields)
4. Whenever you use an `if`, you must always also use an `else`

Over the last few lessons I showed several more examples of idiomatic Scala/FP code, including:

1. Because pure functions don't throw exceptions, they instead return `Option`, `Try`, and `Or`
2. Because you never use `null`, you instead use `Option`, `Try`, and `Or`

It's important at this point to believe that all of these points represent better ways to write Scala code than the imperative code you've written up until this point in your career. Quite frankly, if you aren't sold that these approaches are better, there really isn't any reason to read any further, because the rest of this book builds on these points.

## Idiomatic Scala/FP

Although I haven't covered all of these topics yet, it's worth pointing out at this point what idiomatic Scala/FP code looks like:

- It uses only pure functions
- It uses `val`, not `var`
- Using only `val` requires using recursion and common collections methods like `map`, `filter`, `fold`, `reduce`
- It uses `Option`, `Try`, and `Or` rather than exceptions or `null` values
- It uses case classes with *immutable* fields rather than “OOP” classes with *mutable* fields

Those idioms naturally lead to:

- Scala/FP code uses a lot of `for` expressions, which work well with types like `Option`
- Scala/FP code uses a lot of `match` expressions (pattern matching), which work well with case classes

## Don't try to make your Scala code look like something else

To demonstrate the point of this lesson — to embrace the Scala/FP idioms — let me share a story from my own history, from somewhere around the year 2000. It goes like this ...

At the time I owned a software consulting firm, and we were trying to teach Java and OOP to developers at a Fortune 500 company. One of their programmers had previously used Visual Basic (VB), and when we started working with him he was trying to write Java code by using the VB standards he knew.

I never used VB so I don't know what those standards were, but I do know that his Java code looked like this:

```
public int Get_Some_Int_Value() {  
    int SomeValue = 1;  
    int AnotherValue = 2;  
    return SomeValue + AnotherValue;  
}
```

If you know Java, you know that even in this trivial example that code doesn't look right at all. Java standards look like this:

```
public int getSomeIntValue() {  
    int someValue = 1;  
    int anotherValue = 2;  
    return someValue + anotherValue;  
}
```

The important point for this lesson — and for your career — is that you shouldn't try to make your Scala code look like Java, VB, or any other programming language. And specifically in the case of this book: embrace the Scala/FP idioms! Only by embracing the idioms will you see that there's a different way to write your applications, and that different way may result in safer code that's generally easier to understand.

# What to Think When You See That Opening Curly Brace

During the process of writing this book I had to get away from Scala for a while, and when I came back to it one of the first things I saw was some code that looked like this:

```
val x = F00 {  
    // more code here  
}
```

More accurately, the code I saw looked like this:

```
val x = F00 { (s: State) =>  
    // more code here  
}
```

Right away I had to ask myself, “Okay, Al, what in the world is F00, and how does this code work?” It turns out that depending on exactly what the code looks like, F00 can be one of several things.

This style of code is used a lot by experienced Scala developers, so if you don’t know what F00 is, it’s another potential stumbling block to learning Scala/FP. Therefore, this lesson is about what F00 can possibly be when you see code that looks like that.

## The short answer

The short answer is that FOO in this example:

```
val x = FOO {  
    // more code here  
}
```

can be several things:

- An anonymous class
- A function that takes a by-name parameter

If the code is slightly different and looks like this:

```
val f = FOO { (a: String) =>  
    // more code here  
}
```

it can be:

- A class that takes a function parameter
- A function that takes a by-name parameter

I'll show examples of each of these in this lesson.



# 1) An anonymous class

In this code:

```
val mary = new Person {  
  val name = "mary"  
  val age = 22  
}
```

I create an instance of `Person` using Scala's "anonymous class" syntax. There's no way for you to know it by looking at this code, but I could have defined `Person` as either a trait or an abstract class (or less likely as a class), but for this example I created it as a trait:

```
trait Person {  
  def name: String  
  def age: Int  
  override def toString = s"name: $name, age: $age"  
}
```

When you paste that trait into the Scala REPL, and then also paste in this code:

```
val mary = new Person {  
  val name = "mary"  
  val age = 22  
}  
println(mary)
```

you'll see this output:

```
name: mary, age: 22
```

## ***Discussion***

One thing you know about `Person` is that *it's not* a case class. case classes don't allow the use of the `new` keyword, and they also must have at least one constructor parameter.

It's also unlikely, though possible, that `Person` is defined as a `class`. If `Person` is a class with `name` and `age` fields, those fields would require an `override` qualifier when `mary` is created. The only way `Person` can be a class in this example is if `name` and `age` are not defined in the class.

## 2) A function that takes a by-name parameter

A second thing that can look like this FOO example:

```
val x = FOO {  
    // more code here  
}
```

is a function that takes a by-name parameter.

In the [Scala Cookbook](#) I shared a timer function that can be used like this:

```
val (result, time) = timer {  
    // some long-running block of code here ...  
    Thread.sleep(1000)  
    42  
}
```

When I run that code I get a result like this:

```
result: 42, time: 1004.819575
```

As that example shows, the timer function does three things:

- Accepts a block of code
- Runs the block of code
- Returns the result of that code along with the length of time it took to run

In the Cookbook I showed that timer is a function that's defined to accept a *by-name* parameter named blockOfCode:

```
def timer[A](blockOfCode: => A) = {  
    val startTime = System.nanoTime  
    val result = blockOfCode  
    val stopTime = System.nanoTime  
    val delta = stopTime - startTime  
    (result, delta/1000000d)  
}
```

Therefore, for the purposes of this lesson, this timer code:

```
val (result, time) = timer {  
    Thread.sleep(1000)  
    42  
}
```

demonstrates that a function that takes a by-name parameter is a second way to let people write code that looks like this pattern:

```
val x = FOO {  
    // more code here  
}
```

### 3) A class that takes a function parameter

Another code pattern that you'll see that looks similar to the first two examples is this:

```
val f = F00 { (a: String) =>
  // more code here
}
```

In this code, F00 is either:

- A case class that takes a function input parameter (FIP)
- A function that takes a FIP

Furthermore, in this example that FIP must be defined to take one input parameter that is either a `String` or a generic type. As an example, you can create a case class that meets that criteria like this:

```
case class StringToInt(run: String => Int)
```

In this code, `run` is declared to be a FIP that transforms a `String` to an `Int`.

You can create an instance of that class by giving it an anonymous function, like this:

```
val stringToInt = StringToInt { s: String =>
  // algorithm can be as long as needed ...
  s.length
}
```

Now that you've created the `stringToInt` variable, you can call the `run` function on it at any later time:

```
// prints "7"
println(stringToInt.run("bananas"))
```

#### ***Note 1: Blurring out some code***

One key to understand what's happening with those curly braces is to recognize that the code shown in Figure [fig:blurredOutCurlyBrace] is a function literal that takes a single input parameter (a `String`), and returns an `Int` (because the

last line of the code block evaluates to an Int).

```
val stringToInt = StringToInt { s: String =>
    s.length
}
```

Blurring out code to understand what's happening in the curly braces.

I find that “blurring out” code like that in my mind is a helpful technique to see the function literal when I see curly braces used like this.

### ***Note 2: run is just a field in the class***

Another important point to understand is that because run is a constructor input parameter:

```
case class StringToInt(run: String => Int)
    ---
```

it also becomes a public field in the StringToInt class. It's a field in that class just like name is a field in this Person class:

```
case class Person(name: String)
```

Because name and run are both fields of their classes, this code:

```
val p = Person("mary")
println(p.name)
```

is similar to this code:

```
val stringToInt = StringToInt { s: String =>
    s.length
}
println(stringToInt.run("bananas"))
```

### ***Note 3: Passing in a real function***

If what's happening in the StringToInt code isn't clear, you may find that it's easier to pass in an instance of a *named* function as opposed to using an anonymous function. To demonstrate this, rather than giving StringToInt an anonymous function, define a “regular,” named function that matches run's signature, i.e., a function that transforms a String to an Int:

```
def len(s: String) = s.length
```

Now you can create a new instance of `StringToInt` by passing `len` into `StringToInt`'s constructor:

```
val stringToInt = StringToInt(len)
```

This is the same approach as before, except this time I declared `len` as a regular, named function.

### ***Note 4: A more complicated example***

Here's a slightly more complicated example of this technique. The following code shows a class that's defined to take a function (a FIP) that has two input parameters of generic type `A`, and transforms those parameters into a potentially different type `B`:

```
case class Transform2ParamsTo1Param[A, B](fun: (A, A) => B)
```

To be clear, here's the FIP signature by itself:

```
fun: (A, A) => B
```

Now I can write code like this to create an instance of `Transform2ParamsTo1Param`:

```
val x = Transform2ParamsTo1Param { (a: String, b: String) =>
  a.length + b.length
}
```

Then I can call `fun` on `x` like this:

```
// prints "6"
println(x.fun("foo", "bar"))
```

Because `Transform2ParamsTo1Param` defines its function input parameter `fun` to take generic types, I can also write code like this to take two `Int` values and return an `Int`:

```
val y = Transform2ParamsTo1Param { (a: Int, b: Int) =>
  a + b
}

// prints "3"
println(y.fun(1, 2))
```

While this might seem a little unusual if you come from an OOP background, this is just another example of a class that takes a function input parameter, i.e., an example of passing functions around.

If code like this isn't comfortable right now, fear not, it wasn't comfortable to me initially either. In my experience, I never got comfortable with it until I started using the technique in my own code. (Pro tip: Write a lot of code. As the saying goes, "One learns by doing the thing.")

## 4) A function that takes a function input parameter

Getting back to my F00 examples ... another code pattern that can look like this:

```
val f = F00 { (a: String) =>
  // more code here
}
```

is when a function takes a FIP. I'll show a variation of that in this section.

The following code looks like the F00 and Transform2ParamsTo1Param examples:

```
val res = s2i("hello") { s: String =>
  s.length
}
```

However, in this case `s2i` is either a case class, or a function that has two parameter groups. This code tells you that `s2i`'s first parameter group must take a `String` parameter (`hello` in this case), and the second parameter group takes a function that transforms a `String` to an `Int` (or it may use generic types).

While `s2i` can be implemented as either a function or as a case class, it's most likely a function. I show both approaches next.

### ***a) Implemented as a function***

The function approach will have two parameter groups that look like this:

```
def s2i (s: String)(f: String => Int) = f(s)
```

You can verify this by pasting the following code into the Scala REPL:

```
def s2i (s: String)(f: String => Int) = f(s)
val res = s2i("hello") { s: String =>
  s.length
}
println(res)
```

That last line will print the number 5. This is a straightforward implementation of `s2i`.



## ***b) Implemented as a case class***

While this solution is a little more convoluted, it's *possible* that `s2i` can be implemented as a case class, like this:

```
case class s2i (s: String)(_fun: String => Int) {
  def fun = _fun(s)
}

val res = s2i("hello") { s: String =>
  s.length
}

println(res.fun)
```

As the code shows, the primary difference to the consumer of `s2i` is that for the class you must call `println(res.fun)` to see the result, as opposed to calling `println(res)` with the function.

## ***Aside: A practical use of multiple parameter groups***

In the Scala Cookbook I shared a practical example of the multiple parameter group approach with this using code:

```
using(io.Source.fromFile("example.txt")) { source =>
  for (line <- source.getLines) {
    println(line)
  }
}
```

`using` is cool because it automatically calls the `close` method on the resource that's passed into it in the first parameter group. As you'll see in the code that follows, it calls `close` *after* the function that's passed into the second parameter group is run. This is a smart and useful application of this technique.

In this case, `using` is defined as a function, like this:

```
def using[A <: { def close(): Unit }, B](resource: A)(f: A => B): B = {
  try {
    f(resource)
  } finally {
    resource.close()
  }
}
```

I first learned about the `using` control structure in the book, [Beginning Scala](#). See the [Scala Cookbook](#) for a more thorough

discussion of this code. Somewhere in history, someone named this code a “[Loan Pattern](#),” and Joshua Suereth implemented the same technique in his [Scala ARM Library](#).

## 5) A non-FP possibility: Reassignable Properties

There's another technique that enables code like this, but a) the technique is rarely used, and b) it would never be used in functional programming. Therefore, I won't write about it here, but if you're interested in a technique that lets you write Scala/OOP code like this:

```
def top = new MainFrame {  
  title = "First Swing App"  
  contents = new Button {  
    text = "Click me"  
  }  
}
```

see my article, [Reassignable variables and properties](#).

## Key points

The following code examples provide a summary of the key points of this lesson.

### *Anonymous class*

This code shows the creation of a Person instance using the “anonymous class” technique:

```
val mary = new Person {  
    val name = "mary"  
    val age = 22  
}
```

In this specific example, Person may be defined as a trait or abstract class, or (much less likely) as a class.

### *A function that has a by-name parameter*

In this example, timer is implemented as a function that declares a by-name parameter, and therefore takes a block of code:

```
val (result, time) = timer {  
    // some long-running block of code here  
    // ...  
}
```

I implemented timer like this:

```
def timer[A](blockOfCode: => A) = {  
    val startTime = System.nanoTime  
    val result = blockOfCode  
    val stopTime = System.nanoTime  
    val delta = stopTime - startTime  
    (result, delta/100000000d)  
}
```

### *A case class that takes a function parameter*

In this code, StringToInt is implemented as a case class that has a function input parameter (FIP), and that FIP apparently transforms a String to an Int:

```
val stringToInt = StringToInt { s: String =>
```

```
    s.length
}
```

For that code I defined this case class:

```
case class StringToInt(run: String => Int)
```

(It's possible that the FIP also uses generic types.)

## ***A case class that takes a FIP that has multiple input parameters***

In this example:

```
val x = Transform2ParamsTo1Param { (a: String, b: String) =>
    a.length + b.length
}
```

Transform2ParamsTo1Param is defined as a case class that has a FIP, and that FIP must take two input parameters itself:

```
case class Transform2ParamsTo1Param[A, B](fun: (A, A) => B)
-----
```

## ***A function or class that has multiple parameter groups***

I also showed that when you see code like this:

```
val res = s2i("hello") { s: String =>
    s.length
}
```

s2i will be a function or case class that has two parameter groups. It's much more likely to be a function, which will be implemented like this:

```
def s2i (s: String)(f: String => Int) = f(s)
```

It's possible that it could also be a case class, which will be written like this:

```
case class s2i (s: String)(_fun: String => Int) {
    def fun = _fun(s)
}
```

## Pattern recognition

I wrote this lesson because over the last few years I've begun to look at computer programming as a form of pattern recognition. This was first made clear to me when I was reading a book about Lisp titled, [The Little Schemer](#), where the authors state:

“The goal of this book is to teach the reader to think recursively ... It is our belief that writing programs recursively in Scheme is essentially simple pattern recognition.”

Some patterns are easy for most programmers to understand, and they're adopted in many programming languages. Other patterns are easy for some programmers to recognize, but not for others. As I noted in this lesson, I stumbled on this pattern when I came back to Scala after a brief absence:

```
val x = FOO {  
    // more code here  
}
```

As a result, I tried to understand all of the things that FOO could possibly be, and I shared that information here.

A final reason I mention this specific pattern is because Scala/FP developers use it very often. Because you'll see it a lot in the code that follows, I wanted to be sure I covered it here.

# **A Quick Review of How flatMap Works**

## Overview

This lesson shows how `flatMap` is like using `map` followed by `flatten` on the Scala collections classes. As usual, if you're already comfortable with this topic, skip this lesson.



## Why would I ever need flatMap?

When I first started working with Scala, I assumed `flatMap` was some obscure method on the collections classes that I'd never use. I thought, "Why would I ever need to transform *one element* into a *list* of different elements?" That is, why would I ever want transform this:

```
"foo"
```

into this:

```
List("f", "o", "o")
```

So I ignored `flatMap` for a long time, but then when I started trying to learn Scala/FP, I found that functional programmers *really* love `flatMap`.

Therefore, before you get into the lessons that follow this one, it will help to take a few moments to quickly review how `flatMap` works. I'll start by showing how `map` works before getting into `flatMap`.

## A quick review of map's type signature

The type signature for the map method on the Scala List class looks like this:

```
map[B](f: A => B): List[B]
```

This part of the signature:

```
f: A => B
```

tells us that map takes a function input parameter (FIP), and that FIP must transform an element of type A into an element of type B. In this signature, A is the type held by the current List, so map on a List[Int] will take a FIP that has this signature:

```
f: Int => B
```

Next, this part of map's signature:

```
: List[B]
```

says that when map is finished running it will return a List whose elements are all of type B. This tells us that the function map is given will transform all of the individual List elements from type A to type B, and then map somehow accumulates all of those elements and returns a List[B] when it finishes.

While this type signature is cool because it tells us exactly what can *possibly* happen, it also helps to see a specific example. Here's an example that shows how to transform List[String] into a List[Int] by using a function that transforms a String to an Int:

```
scala> val x = List("hi", "world").map(s => s.length)
x: List[Int] = List(2, 5)
```

In this code map applies the anonymous function `s => s.length` to each element in the original List[String] to yield a new List[Int].

Note that I could have written that anonymous function using this more concise syntax:

```
List("hi", "world").map(_.length)
```

but I showed the verbose syntax because that's what I'll be using in many of the examples that follow.

At this point a key thing to note is that `map` uses the function it's given to transform one input list to one output list.

## flatMap's type signature

flatMap's type signature is different than map's:

```
flatMap[B](f: A => GenTraversableOnce[B]): List[B]
```

For the purposes of a `List` you can simplify this by changing `GenTraversableOnce` to `List`, like this:

```
flatMap[B](f: A => List[B]): List[B]
```

Where `map` takes a function that transforms an `A` to a `B` — such as a `String` to an `Int`:

```
f: A => B
```

`flatMap` takes a function that transforms an `A` to a `List[B]`:

```
f: A => List[B]
```

An example of this is a function that takes the string `foo` as input, and returns `List(f, o, o)` as a result. (More on this shortly.)

Notice that despite the fact that `map` and `flatMap` take different types of function input parameters, they both return a `List[B]` in the end:

```
: List[B]
```

This implies that even though `flatMap` takes a function that transforms one input element `foo` into a `List[f, o, o]` — and then transforms a second element `bar` into `List[b, a, r]`, etc. — in the end it somehow transforms `List[f, o, o]` and `List[b, a, r]` into a single list in the end, in this case returning, `List[f, o, o, b, a, r]`.

Conceptually the way this works is that `flatMap` first applies the given function to each of its elements. For instance, it applies a function to `foo` to get `List[f, o, o]`. As `flatMap` runs, this creates an intermediate “list of lists,” such as `List(List(f, o, o), List(“b”, “a”, “r”))`. Finally, the last thing it does is to *flatten* all of those lists into one final list.

You can see this by comparing the two approaches. First, this example shows

how `flatMap` works on a `List[String]`, given the anonymous function shown:

```
scala> List("foo", "bar").flatMap(s => s.split(""))
res0: List[String] = List(f, o, o, b, a, r)
```

You can make sense of this result by breaking `flatMap` into two steps. First, run `map` on the input list to get an intermediate result, i.e., the “list of lists” I mentioned. I’ll store this result in a variable named `tmpLol`:

```
scala> val tmpLol = List("foo", "bar").map(s => s.split(""))
tmpLol: List[Array[String]] = List(Array(f, o, o), Array(b, a, r))
```

As that output shows, `tmpLol` now contains `List(Array(f, o, o), Array(b, a, r))`. (Although the intermediate result shows a `List` of `Arrays`, that’s just an implementation detail; just think of it as a “list of lists.”)

Now, when you apply `flatten` to that intermediate result you get the exact same result that I got when applying `flatMap` to the original list:

```
scala> tmpLol.flatten
res1: List[String] = List(f, o, o, b, a, r)
```

This tells us:

- In the first step, `flatMap` transforms `foo` into `Array(f, o, o)`
- Next, it transforms `bar` into `Array(b, a, r)`
- At this point `flatMap` has applied the given function to all of its input `List` elements, and it has an intermediate result of `List(Array(f, o, o), Array(b, a, r))`
- In its last step, `flatMap` transforms that “list of lists” into one final list, i.e., `List(f, o, o, b, a, r)`

## What this means

As I mentioned, when I first started using Scala I thought `flatMap` was a bizarre construct that I would never use. But as you saw in the lessons about creating a custom sequence class to work with the `for` expression, `flatMap` plays a key role in getting your custom class to work with `for`.

In fact, because `flatMap` can be a little hard to understand, we're fortunate that Martin Odersky & Company created the `for` expression as some really sweet syntactic sugar for `flatMap` — as you're about to see.

## See also

If you want to see more examples of how `flatMap` works with collections classes, see my article, [A collection of Scala 'flatMap' examples](#).

# Option Naturally Leads to flatMap

In the last few lessons I demonstrated some things about `Option` and `flatMap` without explaining *why* they were important, other than to say, “You’ll see why this is important soon.”

Well, now you’re at that point: In this lesson you’ll begin to see why `Option` and `flatMap` are so important to the functional programming style.



## Options on top of Options

In the real world there's a "cause and effect" relationship that happens when you use `Option` as a wrapper for your function return types. If the *cause* is that you use `Option` because it's better than exceptions and `null` values, the *effect* is that all of those `Options` eventually coalesce at some point.

I'll demonstrate what I mean with our old friend, the `makeInt` function, and then I'll show a more real-world example.

## makeInt

To begin, here's the `makeInt` function I showed a few lessons ago:

```
def makeInt(s: String): Option[Int] = {  
  try {  
    Some(s.trim.toInt)  
  } catch {  
    case e: Exception => None  
  }  
}
```

This is an awesome function, right? By catching the exception inside the function and returning an `Int` wrapped in an `Option`, the function always returns *something* to its calling function. It doesn't try to throw an exception that will short-circuit the rest of your code. This is good. This is how pure functions work.

Although that's good, can you guess what happens when you have code like this:

```
val x = makeInt(string1)  
val y = makeInt(string2)
```

and then you want to add `x` and `y`? The REPL shows what you'd expect, that `x` and `y` have the type `Option[Int]`:

```
scala> val x = makeInt("1")  
x: Option[Int] = Some(1)  
  
scala> val y = makeInt("2")  
y: Option[Int] = Some(2)
```

This means that you can't just add `x` and `y`:

```
scala> x + y  
<console>:14: error: type mismatch;  
found   : Option[Int]  
required: String  
  x + y  
    ^
```

In fact, the REPL is confused and doesn't even know that you want to try to add two `Int`s, because those `Int`s are wrapped inside of `Options`.

So, what can you do?

Well, let's think, what are our main tools for working with `Option` values? So far

I've used:

- match expressions, or more rarely,
- `getOrElse`

Let's see what we can do with those.

### ***Adding x and y with match expressions***

If you try to add x and y using match expressions, you end up with code like this:

```
val sum = x match {
  case None => {
    y match {
      case None => {
        0
      }
      case Some(i) => {
        i
      }
    }
  }
  case Some(i) => {
    y match {
      case None => {
        i
      }
      case Some(j) => {
        i + j
      }
    }
  }
}
```

I have to be honest: that code is so ugly I didn't even bother to see if it would compile. I definitely don't want to use this approach.

### ***Adding x and y with `getOrElse`***

Here's how you might try to do the same thing with `getOrElse`:

```
val sum = x.getOrElse(0) + y.getOrElse(0)
```

That's a bit cleaner, but fortunately some smart people found that there's a better approach that's much more powerful.

## Adding x and y with flatMap and map

Somewhere in programming history, someone saw that if you try to add x and y using map:

```
x map { a =>
  y map { b =>
    a + b
  }
}
```

the result would look like this:

```
scala> x map { a => y map { b => a + b }}
res0: Option[Option[Int]] = Some(Some(3))
```

That's interesting, it almost works. Wrapped inside two Option values is the correct result, 3.

I suspect that seeing the Option[Option[Int]] made them think, "I can make this situation a little better by flattening at least one of those Options ... hmm, the word 'flatten' makes me think of flatMap ... what if ..."

That thought process led to them using flatMap in place of the first map:

```
scala> x flatMap { a => y map { b => a + b }}
res1: Option[Int] = Some(3)
```

"Whoa," they thought, "this gives me the solution wrapped inside only one Option. Now that's something I can work with!"

And then they remembered the relationship between map, flatMap, and the for expression, and a very cool thing happened ...

(See the next lesson.)

# flatMap Naturally Leads to for

“Since a type like `Option` that supports `map` and `flatMap` can be used in a `for` expression,” they thought, “What would happen if I do this?”:

```
val sum = for {  
  x <- makeInt("1")  
  y <- makeInt("2")  
} yield x + y
```

The REPL shows the answer:

```
scala> val sum = for {  
  |   x <- makeInt("1")  
  |   y <- makeInt("2")  
  | } yield x + y  
sum: Option[Int] = Some(3)
```

“Whoa,” they thought, “not only does this give me the solution wrapped in only one `Option`, it’s also much easier to read than using `map` and `flatMap`.”

And then they thought, “Because it supports `map` and `flatMap`, it should work with more than two `Option` values, right?” So they put this code in the REPL:

```
val sum = for {  
  a <- makeInt("1")  
  b <- makeInt("2")  
  c <- makeInt("3")  
  d <- makeInt("4")  
} yield a + b + c + d
```

and saw this result:

```
scala> val sum = for {  
  |   a <- makeInt("1")  
  |   b <- makeInt("2")  
  |   c <- makeInt("3")  
  |   d <- makeInt("4")  
  | } yield a + b + c + d  
sum: Option[Int] = Some(10)
```

Success!

This is much better than chaining together a whole bunch of `flatMap` and `map` functions, and it’s even easier to read than using a bunch of `getOrElse` calls.

And as you're about to see, it's also more flexible (and safer) than `getOrElse`.

# for Expressions are Better Than getOrElse

A great thing about using `for` expressions that might not be immediately obvious is that they're better than using a series of `getOrElse` calls. I'll demonstrate what I mean in this lesson.

## The for expression “Happy Path”

Imagine asking a user to input four Int values as strings. You could then sum those values using this for expression:

```
val sum = for {  
  a <- makeInt(input1)  
  b <- makeInt(input2)  
  c <- makeInt(input3)  
  d <- makeInt(input4)  
} yield a + b + c + d
```

Next, assume that they gave you exactly what you asked for, four strings that properly convert to integers, like this:

```
val sum = for {  
  a <- makeInt("1")  
  b <- makeInt("2")  
  c <- makeInt("3")  
  d <- makeInt("4")  
} yield a + b + c + d
```

This specific example shows the *Happy Path* for this for expression. When I say, “Happy Path,” it means that you got the input values you desired, and therefore the for expression completes properly, with sum ending up as `Option(10)`.



## The for expression “Unhappy Path”

But a great thing about the `for` expression is that it also handles the “Unhappy Path,” i.e., the path that is followed when one or more of the `String` values don’t convert to `Int` values:

```
val sum = for {
  a <- makeInt("ka-boom!")
  b <- makeInt("2")
  c <- makeInt("3")
  d <- makeInt("4")
} yield a + b + c + d
```

Can you guess what happens with this code?

Does it throw an exception? No, of course not, pure functions don’t throw exceptions!

Does `sum` end up with a value? Yes, it does. `sum` is bound to `None`, as the REPL shows:

```
scala> val sum = for {
  |   a <- makeInt("ka-boom!")
  |   b <- makeInt("2")
  |   c <- makeInt("3")
  |   d <- makeInt("4")
  | } yield a + b + c + d
sum: Option[Int] = None
```

What happens is that the `for` expression short-circuits when this line of code is reached:

```
a <- makeInt("ka-boom!")
```

When `makeInt` receives a `String` it can’t transform into an `Int`, these things happen:

- `makeInt` returns a `None`
- The `for` expression short-circuits at that point
- `sum` is bound to `None`

The `None` result tells you that `makeInt` was given something it couldn’t convert

to an Int.

It's important to note that even though this is an Unhappy Path, the good news is that the bad input doesn't completely blow up your for expression. The expression simply yields None, which is much better than doing something like throwing an exception.

## Compare that to getOrElse

Compare that code to the only thing you can do with `getOrElse`:

```
val sum = makeInt(`ka-boom!`).getOrElse(0) +  
          makeInt(`2`).getOrElse(0) +  
          makeInt(`3`).getOrElse(0) +  
          makeInt(`4`).getOrElse(0)
```

When you paste that code into the REPL, you'll see that `sum` is assigned to 9 — a completely different (and wrong) result!

If you think that's bad, this example just uses `Option[Int]` values; imagine what could happen when you use complex, real world classes like `Option[Person]`, `Option[Pizza]`, or `Option[List[List[Friend]]]`.

This is why experienced Scala/FP developers tell you not to use `getOrElse`. When you first start working with Scala it seems like `getOrElse` could be a good thing, but (a) it can also be an incorrect thing when used in the wrong places, and (b) in the long run it can keep you from seeing a much better solution in the `for` expression.

Remember: Embrace the idioms!

## Key points

In the last several lessons I showed a `for` expression like this:

```
val sum = for {  
  a <- makeInt(string1)  
  b <- makeInt(string2)  
  c <- makeInt(string3)  
  d <- makeInt(string4)  
} yield a + b + c + d
```

I mentioned that the “Happy Path” is when all of the `String` values can be converted to `Int` values and the expression yields a `Some[Int]`, and the “Unhappy Path” is what happens when a `String` value can’t be converted to an `Int` and the expression yields a `None`.

Also, even though that code can be said to have Happy and Unhappy paths, the great thing about the `for` expression is that it handles both cases. In the Happy case `sum` is bound to an `Option[Int]`, and in the Unhappy case `sum` is bound to `None`.

In this lesson I also demonstrated that this code is better than a `getOrElse` approach because `getOrElse` can give you a wrong (or inappropriate) answer. Beyond that, as you’ll see in the rest of this book, it can also keep you from embracing the Scala idioms that will lead you to a new style of coding.

## **What's next**

If what's happening in the for expressions I've shown so far isn't clear, I hope to clear up any confusion in the next lesson.

## Recap: `Option` -> `flatMap` -> `for`

I showed quite a few things in the previous lessons on `for` expressions, `Option`, and `flatMap`, so in this lesson I want to pause a little bit to review a few important points about what I just covered.

At the end of this lesson I'll share an important conclusion, so if you want to skip the "review" portions of this lesson, please be sure to read the conclusion sections (Parts 1 and 2) before moving on to the next lesson.

## Point 1: If something can go wrong, a pure function returns Option, Try, or Or

The first point to reiterate is this: Because pure functions don't throw exceptions, they have to do something else when bad things happen, and in Scala, the correct approach is to return an `Option`, `Try`, or `Or`. For example, in my code, `makeInt` returns an `Option[Int]`:

```
def makeInt(s: String): Option[Int] = {
  try {
    Some(s.trim.toInt)
  } catch {
    case e: Exception => None
  }
}
```

### *Option is a “wrapper”*

You can think of `Option` as a wrapper, kind of like receiving a wrapped gift on your birthday. In the case of `makeInt`, `Option` is a wrapper around an `Int`. An important feature of this particular wrapper is that it comes with `map` and `flatMap` methods. These enable `Option` to work in for expressions.

If you don't like to think of `Option` as a “wrapper,” it might be even better to think of it as a box. When dealing with an `Option[Int]`, Figure [fig:option2InABox] shows the Happy Case, where you get a box that contains what you want, an `Int`, which the `Option` delivers to you as a `Some[Int]`.

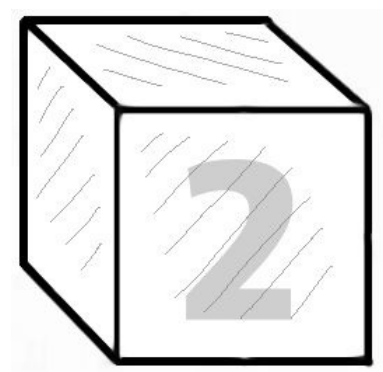

You can think of `Option` as a box. This box shows a Happy Case, where a

`Some[Int]` contains a 2.

Conversely, in the Unhappy Case you get an empty box, which `Option` delivers to you as a `None`, as shown in Figure [fig:optionNoneIsEmptyBox].

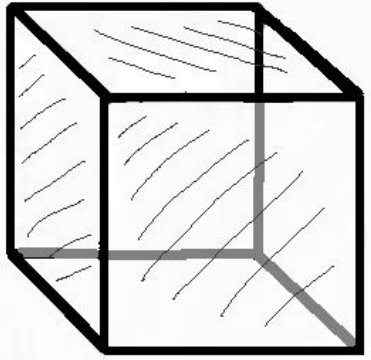

A `None` can be thought of as an empty box.



## Point 2: How Option's map method works

A second important point is to know how Option's map method works. The key points are:

- It yields a Some[A] for the Happy (success) cases
- It yields a None for all Unhappy (failure) cases

A few REPL examples show this. First, when makeInt can successfully transform a String, it yields a Some[Int]:

```
scala> makeInt("1")
res0: Option[Int] = Some(1)
-----
```

Second, when makeInt can't successfully transform a String, it yields a None:

```
scala> makeInt("foo")
res1: Option[Int] = None
-----
```

As expected, you get a Some(1) in the success case and a None in the failure case. So far, so good.

Taking this a step further, these examples show how map behaves with Option's two possible results:

```
scala> makeInt("1").map(_ * 2)
res2: Option[Int] = Some(2)

scala> makeInt("foo").map(_ * 2)
res3: Option[Int] = None
```

In the first case makeInt yields a Some(1) and then map is called on that result to yield a Some(2). In the second case makeInt can't convert foo into an Int so it yields a None without even invoking map.

The important behavior for your code is that map doesn't throw an exception, it just goes down either the Happy Path (yielding a Some[A]) or the Unhappy Path (yielding a None).

## Point 3: flatMap works well with multiple options

The next important point is that while map works well with *one* Option, flatMap shines when it comes to working with *multiple* Options.

As I showed in the previous lessons, given this code:

```
val x = Option(1)
val y = Option(2)
```

if you try to add the two Option[Int] values with map, you end up with an Option[Option[Int]]:

```
scala> x map { a => y map { b => a + b }}
res0: Option[Option[Int]] = Some(Some(3))
-----
```

But because of the way flatMap works, you can use it to replace the outer map call to yield an Option[Int], which is much easier to work with:

```
scala> x flatMap { a => y map { b => a + b }}
res1: Option[Int] = Some(3)
-----
```

## Point 4: Humans prefer for expressions

While that's nice, it can be hard for humans to understand. Fortunately, this is exactly what the much more readable for expression does for you; it's a replacement for a series of `flatMap` and `map` calls.

You can demonstrate this with the following code:

```
class Test {  
    val sum = for {  
        a <- makeInt("1")  
        b <- makeInt("2")  
        c <- makeInt("3")  
        d <- makeInt("4")  
    } yield a + b + c + d  
  
    def makeInt(s: String): Option[Int] = {  
        try {  
            Some(s.trim.toInt)  
        } catch {  
            case e: Exception => None  
        }  
    }  
}
```

When you compile that code with this command:

```
scalac -Xprint:parse Test.scala
```

you'll see this as part of the output:

```
val sum = makeInt("1").flatMap(  
  ((a) => makeInt("2").flatMap(  
    ((b) => makeInt("3").flatMap(  
      ((c) => makeInt("4").map(  
        ((d) => a.$plus(b).$plus(c).$plus(d))))))  
    )  
  )  
);
```

Note: You'll have to reformat `scalac`'s output to see it that clearly.

Notice that this is a series of `flatMap` calls followed by a single `map` call. This is how for expressions like this are converted by the Scala compiler. While

compilers like that code, most humans don't, so we use for expressions.

## Point 5: for isn't always a loop

As a final note, it's important to be clear that this is not a *loop*:

```
val sum = for {  
  a <- makeInt("1")  
  b <- makeInt("2")  
  c <- makeInt("3")  
  d <- makeInt("4")  
} yield a + b + c + d
```

That is, it doesn't "loop" repeatedly, it just runs once. If you're coming to Scala/FP from languages like C, Java, C#, etc., this behavior can be a surprise.

## Conclusion, Part 1

Here's a concise summary of the points I just covered:

- Because pure functions don't (a) return `null` or (b) throw exceptions, they return `Option`, `Try`, or `Or`
- Using `Option` naturally leads your code to look a certain way, a "pattern"
- In the real world that pattern eventually leads to the creation of values of the type `Option[Option[A]]`
- `flatMap` works well with `Option[Option[A]]`, but it's hard for humans to read
- The Scala `for` expression is a human-readable replacement for a series of `flatMap` and `map` calls

## A more-general observation

When you think about those statements more generally, you'll make this observation:

*Any class that implements `map` and `flatMap` can be used in a for expression in the same way that I used `Option` in these examples.*

For example, not only does `Option` work like this, but `Try`, `Or`, and `Either` also work the same way. And they're not the only ones.

### ***Scala collections classes have `map` and `flatMap`***

The Scala `Seq` class implements the `map` and `flatMap` methods, so it can be used in for expressions, such as this one:

```
val xs = Seq(1,2,3)
val ys = Seq(100,200,300)

for {
  x <- xs
  y <- ys
} yield x + y
```

When that for expression is pasted into the REPL, it yields this result:

```
res0: Seq[Int] = List(101, 201, 301, 102, 202, 302, 103, 203, 303)
```

All of the Scala collections classes have `map` and `flatMap` methods and work like this, including `List`, `ArrayBuffer`, `Vector`, etc., even the `Map` classes.

### ***The Scala Future has `map` and `flatMap`***

The Scala `Future` class implements `map` and `flatMap` methods, so it can also be used in for expressions, as shown in this example:

```
// (a) create the futures
val f1 = Future { sleep(10*1000); 1 }
val f2 = Future { sleep(2*1000); 2 }
val f3 = Future { sleep(4*1000); 3 }
```

```
// (b) run them simultaneously in a for-comprehension
val result = for {
  r1 <- f1
  r2 <- f2
  r3 <- f3
} yield (r1 + r2 + r3)

// (c) do whatever you need to do with the result
result.onComplete {
  case Success(x) => println(s"\nresult = $x")
  case Failure(e) => e.printStackTrace
}
```

This is a particularly interesting example because like `Option`, `Future` is not a *collection* class. However, because it implements `map` and `flatMap`, it can be used in a `for` expression.



## Conclusion, Part 2

Once again, here's the key observation: any class that implements `map` and `flatMap` can be used in a `for` expression.

Furthermore, while those of us with an OOP background are most comfortable using *collection classes* in `for` loops, the Scala/FP reality is that *non-collection classes* like `Option`, `Try`, `Future`, and many others can also be used in `for` expressions. These other classes tend to be “wrappers” of different types, which is why I've been using the term *wrapper*.

As it turns out, the Scala `for` expression is a sort of glue — a superglue — for getting pure functions to work together. The thing to remember is that for a class to be used with multiple generators in a `for` expression, that class must implement `map` and `flatMap`.

Similarly, for a function to work well in a `for` expression, it must return a type that implements `map` and `flatMap`. (I write more on this point in the lessons that follow.)

## The m-word

And this is where we get to the fun part.

When speaking casually, some people like to say that any Scala class that implements `map` and `flatMap` is a *monad*. While that isn't 100% true, it's in the ballpark of truth.

As Gabriele Petronella wrote in [a Stack Overflow post](#):

“The only thing monads are relevant for, from a Scala language perspective, is the ability of being used in a `for-comprehension`.”

By this he means that while monads are defined more formally in a language like Haskell, in Scala there is no base `Monad` trait to extend; all you have to do is implement `map` and `flatMap` so your class can be used as a generator in `for` expressions.

As you'll see as I dig into this more in the coming lessons, classes like `List` and `Option` truly are monads, so congratulations — if you thought monads were hard, they aren't; you've already been using them!

## See also

The “box” metaphor comes from [this adit.io tutorial](#).

# **A Note About Things That Can Be Mapped Over**

## **Goal**

The goal of this lesson is to explain a term known in functional programming as a “functor.”

## Discussion

As I mentioned earlier in this book, at some point in history someone declared that “things that can be mapped-over shall be called *functors*.” Therefore, classes like `List`, `Option`, `Future`, and many others are all functors.

As Miran Lipovaca states in his book, [Learn You a Haskell for Great Good!](#):

“Functors are things that can be mapped over.”

## Think of it as a trait

In his blog post, [First steps with monads](#), Darren Wilkinson makes the observation that in pseudocode, you can think of a functor as being a Scala trait:

```
trait Functor[A] {  
  def map(f: A => B): Functor[B]  
}
```

You can then think of classes like `List`, `Option`, `Future`, and many others as implementing that trait.

## **Key point**

The key point of this lesson: Don't be intimidated when you hear the term "functor"; just think of it like this:

Functor = map-able

or this:

Functor = a class that has a map method

## See also

- [The definition of “functor” on Wikipedia](#)
- Darren Wilkinson writes in his article, [First steps with monads](#), “Many collection and other container types have a map method ... any parameterized type that does have a map method like this is known as a Functor. Again, the name is due to category theory...”



# Starting to Glue Functions Together

As I mentioned at the beginning of this book, writing pure functions isn't hard. Just make sure that output depends only on input, and you're in good shape.

The hard part of functional programming involves how you glue together all of your pure functions to make a complete application. Because this process feels like you're writing "glue" code, I refer to this process as "gluing," and as I learned, a more technical term for this is called "binding." This process is what most of the remainder of this book is about.

As you might have guessed from the emphasis of the previous lessons, in Scala/FP this binding process involves the use of `for` expressions.

# Life is good when the output of one function matches the input of another

To set the groundwork for where we're going, let's start with a simplified version of a problem you'll run into in the real world.

Imagine that you have two functions named `f` and `g`, and they both a) take an `Int` as an input parameter, and b) return an `Int` as their result. Therefore, their function signatures look like this:

```
def f(a: Int): Int = ???  
def g(a: Int): Int = ???
```

A nice thing about these functions is that because the output of `f` is an `Int`, it perfectly matches the input of `g`, which takes an `Int` parameter. This is shown visually in Figure [fig:fOutputMatchesGInput].

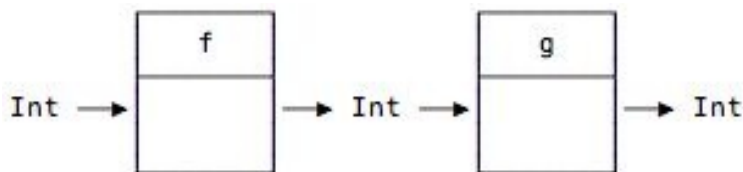

The output of `f` matches the input to `g`.

Because the output of `f` is a perfect match to the input of `g`, you can write this code:

```
val x = g(f(100))
```

Here's a complete example that demonstrates this:

```
def f(a: Int): Int = a * 2  
def g(a: Int): Int = a * 3  
val x = g(f(100))  
println(x)
```

Because `f(100)` is `200` and `g` of `200` is `600`, this code prints `600`. So far, so good.

## A new problem

Next, imagine a slightly more complicated set of requirements where `f` and `g` still take an `Int` as input, but now they return a `String` in addition to an `Int`. With this change their signatures look like this:

```
def f(a: Int): (Int, String) = ???  
def g(a: Int): (Int, String) = ???
```

One possible use case for this situation is to imagine that `f` and `g` are functions in an application that uses a rules engine or artificial intelligence (AI). In this situation, not only do you want to know their result (the `Int`), you also want to know *how* they came up with their answer, i.e., the logical explanation in the form of a `String`.

Think of writing an application to determine the shortest route from Point A to Point Z. A function might return a log message like, “I chose B as the next step because it was closer than C or D.”

While it’s nice to get a log message back from the functions, this also creates a problem: I can no longer use the output of `f` as the input to `g`. In this new world, `g` takes an `Int` input parameter, but `f` now returns `(Int, String)` (a `Tuple2[Int, String]`). This mismatch is shown visually in Figure [fig:fOutputDoesntMatchGInput].

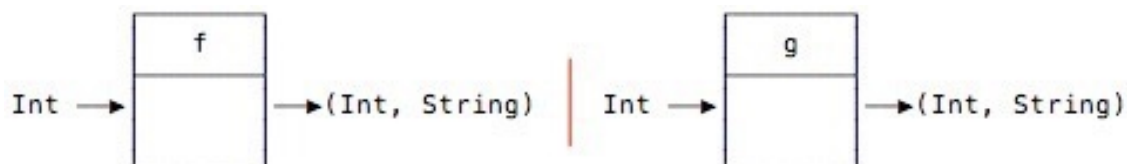

The output of `f` no longer matches the input to `g`.

When you *really* want to plug the output of `f` into the input of `g`, what can you do?

## Solving the problem manually

Let's look at how we'd solve this problem manually. First, I'd get the result from f:

```
val (fInt, fString) = f(100)
```

Next, I pass fInt into g to get its results:

```
val (gInt, gString) = g(fInt)
```

gInt is the final Int result, so now I glue the strings together to get the final String result:

```
val logMessage = fString + gString
```

Now I can print the final Int and String results:

```
println(s"result: $gInt, log: $logMessage")
```

This code shows a complete example of the manual solution to this problem:

```
object Step2Debug extends App {  
    def f(a: Int): (Int, String) = {  
        val result = a * 2  
        (result, s"\nf result: $result.")  
    }  
  
    def g(a: Int): (Int, String) = {  
        val result = a * 3  
        (result, s"\ng result: $result.")  
    }  
  
    // get the output of `f`  
    val (fInt, fString) = f(100)  
  
    // plug the Int from `f` as the input to `g`  
    val (gInt, gString) = g(fInt)  
  
    // create the total "debug string" by manually merging  
    // the strings from f and g  
    val debug = fString + " " + gString  
    println(s"result: $gInt, debug: $debug")  
}
```

That code prints this output:

```
result: 600, debug:
```

```
f result: 200.  
g result: 600.
```

While this approach works for this simple case, imagine what your code will look like when you need to string many more functions together. That would be an awful lot of manually written (and error-prone) code. We can do better.

# The “Bind” Concept

Because Scala supports higher-order functions (HOFs), you can improve this situation by writing a `bind` function to glue `f` and `g` together a little more easily. For instance, with a properly written `bind` function you can write code like this to glue together `f`, `g`, and `h` (a new function that has the same signature as `f` and `g`):

```
val fResult = f(100)
val gResult = bind(g, fResult)
val hResult = bind(h, gResult)
```

While this code might not be beautiful just yet, it’s certainly better and less error prone than the code I had at the end of the previous lesson.

In this lesson I’ll show how to write a `bind` function to make this work.

## The problem statement

Before beginning, let me clearly define the problem. Given three functions with these signatures:

```
def f(a: Int): (Int, String) = ???  
def g(a: Int): (Int, String) = ???  
def h(a: Int): (Int, String) = ???
```

I want to write a `bind` function that works like this:

```
val fResult = f(100)  
val gResult = bind(g, fResult)  
val hResult = bind(h, gResult)
```

If you think you know how to do this, step away from the book and start typing in your favorite IDE. Otherwise, read on.

## Writing bind's type signature

Let's solve this problem using the function-writing strategy I introduced early in the book: By writing bind's function signature before you do anything else.

### *bind's input parameters*

To understand what bind's signature needs to be, look at this line:

```
val gResult = bind(g, fResult)
```

This tells you that bind takes two parameters:

1. The first parameter is the function g. As I just showed, g has the type signature (a: Int): (Int, String) (or, (a: Int) => (Int, String), if you prefer).
2. The second parameter is fResult, which is the output of f. f's signature tells us that fResult's type is (Int, String) (i.e., a Tuple2[Int, String]).

This tells you that bind's input parameters look like this:

```
def bind(fun: (Int) => (Int, String),  
        tup: Tuple2[Int, String]) ...
```

Now all you need is bind's return type.

### *bind's return type*

By looking at these two lines of code:

```
val gResult = bind(g, fResult)  
val hResult = bind(h, gResult)
```

you can see that gResult will have the type of whatever bind returns. Because you know that a) fResult in the first line has the type (Int, String), and b) gResult must have the same type as fResult, you can deduce that c) bind must have this same return type: (Int, String).



Therefore, the complete type signature for `bind` must be this:

```
def bind(fun: (Int) => (Int, String),  
        tup: (Int, String) ): (Int, String) = ???
```

Now all you have to do is implement the body for `bind`.

Note: A `Tuple2` can also be written as `Tuple2[Int, String]`.

## Writing bind's body

As for writing `bind`'s body, all it does is automate the process I showed at the end of the previous lesson. There I showed this code:

```
val (fInt, fString) = f(100)
```

Imagine that this tuple result will be used as input to `bind`, so `bind` will receive:

- The function `g` as its first parameter
- The tuple `(fInt, fString)` as its second parameter

Now, where in the previous lesson I had these lines of code:

```
val (gInt, gString) = g(fInt)
val debug = fString + gString
```

you can imagine them being replaced by this `bind` call:

```
val (gInt, gString) = bind(g, (fInt, fString))
```

By looking at this you can say that `bind`'s algorithm should be:

1. Apply the function you're given (`g`) to the `Int` you're given (`fInt`). This creates an `(Int, String)` (`(gInt, gString)` in this example).
2. Append the new string (`gString`) to the string you were given (`fString`).
3. Return the new `Int` (`gInt`) and the merged `String` (`fString + gString`) as the result.

Following that algorithm, a first attempt at `bind` looks like this:

```
def bind(fun: (Int) => (Int, String),
        tup: Tuple2[Int, String]): (Int, String) =
{
  val givenInt = tup._1
  val givenString = tup._2

  // apply the given function to the given int
  val (intResult, stringResult) = fun(givenInt)

  // append `stringResult` to the given string
  val newString = givenString + stringResult
}
```

```
    // return the new int and string
    (intResult, newString)
}
```

Once you're comfortable with that code, you can reduce `bind` until it looks like this:

```
def bind(fun: (Int) => (Int, String),
        tup: Tuple2[Int, String]): (Int, String) =
{
    val (intResult, stringResult) = fun(tup._1)
    (intResult, tup._2 + stringResult)
}
```

(Or you can keep the original version, if you prefer.)

## A complete example

Here's the source code for a complete example that shows how `f`, `g`, `h`, and `bind` work together:

```
object Step3Bind extends App {  
  def f(a: Int): (Int, String) = {  
    val result = a * 2  
    (result, s"\nf result: $result.")  
  }  
  
  def g(a: Int): (Int, String) = {  
    val result = a * 3  
    (result, s"\ng result: $result.")  
  }  
  
  def h(a: Int): (Int, String) = {  
    val result = a * 4  
    (result, s"\nh result: $result.")  
  }  
  
  // bind, a HOF  
  def bind(fun: (Int) => (Int, String),  
          tup: Tuple2[Int, String]): (Int, String) =  
  {  
    val (intResult, stringResult) = fun(tup._1)  
    (intResult, tup._2 + stringResult)  
  }  
  
  val fResult = f(100)  
  val gResult = bind(g, fResult)  
  val hResult = bind(h, gResult)  
  
  println(s"result: ${hResult._1}, debug: ${hResult._2}")  
}
```

## Observations

What can we say about `bind` at this point? First, a few good things:

- It's a useful higher-order function (HOF)
- It gives us a way to bind/glue the functions `f`, `g`, and `h`
- It's simpler and less error-prone than the code at the end of the previous lesson

If there's anything bad to say about `bind`, it's that it looks like it's dying to be used in a `for` expression, but because `bind` doesn't have methods like `map` and `flatMap`, it won't work that way.

For example, wouldn't it be cool if you could write code that looked like this:

```
val finalResult = for {  
  fResult <- f(100)  
  gResult <- g(fResult)  
  hResult <- h(gResult)  
} yield hResult
```

# Getting Close to Using `bind` in `for` Expressions

Now we're at a point where we see that `bind` is better than what I started with, but not as good as it can be. That is, I want to use `f`, `g`, and `h` in a `for` expression, but I can't, because `bind` is a function, and therefore it has no way to implement `map` and `flatMap` so it can work in a `for` expression.

What to do?

Well, if we're going to succeed we need to figure out how to create a class that does two things:

1. Somehow works like `bind`
2. Implements `map` and `flatMap` methods so it can work inside `for` expressions

## **A different way to write map and flatMap methods**

I'll do that soon, but first I need to do something else: I need to demonstrate a different way to write map and flatMap methods.

In the previous examples I showed how to write map and flatMap methods for a sequence class that works like a collection class. Before we solve the bind problem I need to show how to write map and flatMap for classes that are more like a “wrapper” than a “collection.” I'll do that next.

# Using a “Wrapper” Class in a for Expression

To set the groundwork for solving the problem of using `bind` in a `for` expression, I’m going to create a simple “wrapper” class that you can use in a `for` expression. By the end of this lesson you’ll have a class that you can use like this:

```
val result: Wrapper[Int] = for {  
  a <- new Wrapper(1)  
  b <- new Wrapper(2)  
  c <- new Wrapper(3)  
} yield a + b + c
```

To keep things simple, the wrapper class won’t do much; by the end of this lesson that `for` expression will yield this result:

```
result: Wrapper[Int] = 6
```

But even though it will be simple, this class will demonstrate how to write `map` and `flatMap` methods for these kinds of classes, what I call “wrapper” classes.

It helps to think of these classes as being different than “collection” classes. As I’ve mentioned a few times, it’s better to think of them as being a wrapper around whatever it is that they wrap.

In this lesson I’ll create a wrapper around `Int`. I’ll do this because a) `Int` is a simple data type that’s easy to understand, and b) it lets us create `map` and `flatMap` methods in a manner that’s similar to what `bind` is going to need.



# Beginning

Following the concept of “beginning with the end in mind,” this is the solution that I’ll be able to write by the end of this lesson:

```
val result: Wrapper[Int] = for {  
  a <- new Wrapper(1)  
  b <- new Wrapper(2)  
  c <- new Wrapper(3)  
} yield a + b + c
```

This code tells me a couple of things:

1. wrapper will be a class that takes a single Int constructor parameter
2. Because it works with multiple generators in a for expression, Wrapper must implement map and flatMap methods
3. Because result has the type wrapper[Int], those map and flatMap functions must return that same type

Knowing these things, I can begin sketching the wrapper class like this:

```
class Wrapper[Int](value: Int) {  
  def map(f: Int => Int): Wrapper[Int] = ???  
  def flatMap(f: Int => Wrapper[Int]): Wrapper[Int] = ???  
}
```

That’s cool, I can sketch quite a bit of the wrapper class just by knowing how it’s used in a for expression. All that remains now is writing the body of the map and flatMap methods.

# Implementing map

When you look at map's signature:

```
def map(f: Int => Int): Wrapper[Int] = ???
```

you can say these things about map:

- It takes a function that transforms an Int to an Int
- After doing whatever it does, map returns a Wrapper[Int] (i.e., an Int inside a new Wrapper)

Writing those statements as comments inside map's body looks like this:

```
def map(f: Int => Int): Wrapper[Int] = {  
  // apply `f` to an `Int` to get a new `Int`  
  // wrap the new `Int` in a `Wrapper`  
}
```

If you're smarter than I was when I first learned about this, you might guess that those comments translate into code that looks like this:

```
def map(f: Int => Int): Wrapper[Int] = {  
  // apply `f` to an `Int` to get a new `Int`  
  val newInt = f(SOME_INT)  
  
  // wrap the new `Int` in a `Wrapper`  
  new Wrapper(newInt)  
}
```

As it turns out, map is a very literal interpretation of those two comments. The only question is, what is SOME\_INT? Where does it come from?

## *Where SOME\_INT comes from*

Remember that when you create a new wrapper, you create it like this:

```
val x = Wrapper(1)
```

That's where the Int comes from: wrapper's constructor:

```
class Wrapper[Int](value: Int) { ...
```

-----

This tells me that `SOME_INT` in `map`'s body should be changed to `value`, which leads to this code:

```
def map(f: Int => Int): Wrapper[Int] = {  
  // apply `f` to an `Int` to get a new `Int`  
  val newInt = f(value)  
  
  // wrap the new `Int` in a `Wrapper`  
  new Wrapper(newInt)  
}
```

Figure [fig:wrappersConstructorParameter] shows how `value` gets from wrapper's constructor into the `map` method.

```
class Wrapper[Int] (value: Int) {  
  
  def map(f: Int => Int): Wrapper[Int] = {  
    val newValue = f(value)  
    new Wrapper(newValue)  
  }  
}
```

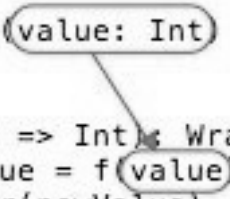

The `Int` that `map` operates on comes from `Wrapper`'s constructor parameter.

### ***If this feels unusual ...***

If this feels unusual at this point — congratulations! Your mind is now at a point where it feels like variables shouldn't just magically appear inside your functions. This is a good thing.

What's happening here is that you're using `value` just like you would in OOP code. It's a constructor parameter that you're using inside `map`. This is part of Scala's "functional objects" paradigm.

In another programming language you might write `map` in a separate `WrapperUtils` class, where `value` would be passed in *explicitly*:

```

class WrapperUtils {
    def map(value: Int, f: Int => Int): Wrapper[Int] = {
        val newInt = f(value)
        new Wrapper(newInt)
    }
}

```

But in Scala’s “functional objects” approach, you can access `value` implicitly. Technically this violates my rule that for pure functions, “Output depends only on input,” but when you use the functional objects coding style, this is the one case where you are allowed to implicitly access other fields in a function in your class.

If you’ve heard the term “closure” before, yes, this is essentially a closure.

Here’s the source code for the current wrapper class:

### ***The current wrapper class***

Getting back to the problem at hand, here’s the source code for the wrapper class with its new `map` method:

```

class Wrapper[Int](value: Int) {
    def map(f: Int => Int): Wrapper[Int] = {
        // apply `f` to an `Int` to get a new `Int`
        val newInt = f(value)

        // wrap the new `Int` in a `Wrapper`
        new Wrapper(newInt)
    }

    def flatMap(f: Int => Wrapper[Int]): Wrapper[Int] = ???
}

```

### ***If this is confusing ...***

If this is confusing, remember that it’s the same way that Scala’s `List` class works. It takes some parameters in its constructor:

```
val x = List(1,2,3)
```

and then its `map` method operates on those parameters:

```
x.map(_ * 2) // yields `List(2,4,6)`
```

Wrapper works the same way:

```
val x = new Wrapper(1)
x.map(_ * 2)
```

## ***Testing map***

If you paste the current wrapper class into the Scala REPL and then run those last two lines of code, you'll see this output:

```
scala> val x = new Wrapper(1)
x: Wrapper[Int] = 1

scala> x.map(_ * 2)
res0: Wrapper[Int] = 2
```

Very cool.

As a final note, remember that implementing a `map` method in a class like `Wrapper` lets you use one generator in a `for` expression, so this code also works right now:

```
scala> for { i <- x } yield i * 2
res1: Wrapper[Int] = 2
```

So far, so good. Now let's create a `flatMap` method in `Wrapper`.

## Implementing flatMap

Let's follow the same thought process to see if we can create flatMap's body. First, when you look at flatMap's signature:

```
def flatMap(f: Int => Wrapper[Int]): Wrapper[Int] = {
```

you can say these things about flatMap:

- It takes a function that transforms an Int to a Wrapper[Int]
- After doing whatever it does, flatMap returns a Wrapper[Int]

When I write those statements as comments inside flatMap's signature, I get this:

```
def flatMap(f: Int => Wrapper[Int]): Wrapper[Int] = {  
  // apply `f` to an `Int` to get a `Wrapper[Int]`  
  // return a new `Wrapper[Int]`  
}
```

flatMap always seems harder to grok than map, but if I'm reading those comments right, the flatMap solution is simpler than map. Here's what the solution looks like:

```
def flatMap(f: Int => Wrapper[Int]): Wrapper[Int] = {  
  // apply `f` to an `Int` to get a `Wrapper[Int]`  
  val newValue = f(value)  
  
  // return a new `Wrapper[Int]`  
  newValue  
}
```

It turns out that flatMap is so simple that you can reduce that code to this:

```
def flatMap(f: Int => Wrapper[Int]): Wrapper[Int] = {  
  f(value)  
}
```

and then this:

```
def flatMap(f: Int => Wrapper[Int]): Wrapper[Int] = f(value)
```

For a “wrapper” class like the wrapper, it turns out that flatMap is extremely

simple: It just applies the function it's given ( $f$ ) to the value it wraps (`value`).

# The complete source code

Here's the complete source code for the wrapper class:

```
class Wrapper[Int](value: Int) {  
  def map(f: Int => Int): Wrapper[Int] = {  
    val newValue = f(value)  
    new Wrapper(newValue)  
  }  
  
  def flatMap(f: Int => Wrapper[Int]): Wrapper[Int] = f(value)  
  
  override def toString = value.toString  
}
```

If you paste this wrapper class into the REPL and then run this for expression:

```
val result: Wrapper[Int] = for {  
  a <- new Wrapper(1)  
  b <- new Wrapper(2)  
  c <- new Wrapper(3)  
} yield a + b + c
```

you'll see the REPL show this result:

```
result: Wrapper[Int] = 6
```



## Kind of a big step

Congratulations, you just implemented `map` and `flatMap` methods for a non-collection class, i.e., a type of class that I call a “wrapper.”

If this seems like a minor achievement, well, it's actually kind of a big deal. You're about to see that this is an important step that will soon let you use the `bind` approach in a `for` expression. (And that's also going to be kind of a big deal.)

# Making wrapper More Generic

I wrote the previous lesson by creating a `Wrapper[Int]` so I wouldn't have to deal with generic types in that lesson, but now you can convert that class to a more generic class. All you have to do is:

1. Change all the `Int` references to the generic `A`
2. Change the `map` and `flatMap` signatures to return the generic type `B`

With those two changes you can convert this `Int`-specific code:

```
class Wrapper[Int](value: Int) {  
  def map(f: Int => Int): Wrapper[Int] = {  
    val newValue = f(value)  
    new Wrapper(newValue)  
  }  
  
  def flatMap(f: Int => Wrapper[Int]): Wrapper[Int] = f(value)  
  
  override def toString = value.toString  
}
```

into this more generic code:

```
class Wrapper[A](value: A) {  
  def map[B](f: A => B): Wrapper[B] = {  
    val newValue = f(value)  
    new Wrapper(newValue)  
  }  
  
  def flatMap[B](f: A => Wrapper[B]): Wrapper[B] = {  
    val newValue = f(value)  
    newValue  
  }  
  
  override def toString = value.toString  
}
```

This new generic class can still be used as a wrapper around `Int` in a `for` expression:

```
val intResult: Wrapper[Int] = for {  
  a <- new Wrapper(1)  
  b <- new Wrapper(2)  
  c <- new Wrapper(3)  
} yield a + b + c  
  
println(intResult)
```

And now it can also be used as a wrapper around `String` in a `for` expression:

```
val stringResult: Wrapper[String] = for {  
  a <- new Wrapper("a")  
  b <- new Wrapper("b")  
  c <- new Wrapper("c")  
} yield a + b + c  
  
println(stringResult)
```

There's still one more thing I'd like to do with this code: I'd like to change it so I don't have to use the `new` keyword when creating each wrapper instance. I'll do that in the next lesson.

# Changing “new Wrapper” to “Wrapper”

Now I want to make one last change to the wrapper class: I want to change it so I can just write `wrapper` to create a new instance, instead of having to write `new wrapper`. That is, I want to be able to write code like this:

```
val stringResult = for {  
  a <- Wrapper("a")  
  b <- Wrapper("b")  
  c <- Wrapper("c")  
} yield a + b + c
```

instead of this:

```
val stringResult = for {  
  a <- new Wrapper("a")  
  b <- new Wrapper("b")  
  c <- new Wrapper("c")  
} yield a + b + c
```

This is a small change, but:

- It makes the code more concise
- It will demonstrate a key point about what I’m doing in the larger scheme of things

There are two ways to do this. The first way is to change `wrapper` from a regular class to a case class. While that’s a good solution, for our purposes it will help to implement this as an `apply` method in a “companion object.” (I’ll explain why at the end of this lesson.)

## Creating an apply method in a companion object

Creating an apply method in a companion object for `Wrapper` takes just a couple of steps:

1. Modify the `Wrapper` class to make its constructor private
2. Create an object named `Wrapper` in the same file as the `Wrapper` class
3. Create an `apply` method in the object

## 1) Make the wrapper class constructor private

The first step is to make the wrapper class constructor private. All this requires is to change its class signature from this:

```
class Wrapper[A] (value: A) {
```

to this:

```
class Wrapper[A] private (value: A) {
```

I make it private so I can reference it from the companion object, but no outside code can reference it.

## 2) Create an object named wrapper in the same file as the wrapper class

The next step is to create an object named wrapper in the same file as the wrapper class:

```
class Wrapper[A] private (value: A) { ...  
}  
  
object Wrapper {  
}
```

When you do this, you create a *companion object* for the wrapper class.

### 3) Create an apply method in the companion object with the appropriate signature

The last step in the process is to create an apply method in the companion object. apply is essentially a [Factory method](#) that lets us create new Wrapper instances without needing the new keyword:

```
val a = Wrapper(1) // 'new' is not needed
```

#### *apply's syntactic sugar*

If you know your companion objects, you know that when you write this:

```
val a = Wrapper(1)
```

that code is translated by the Scala compiler into this:

```
val a = Wrapper.apply(1)
```

As shown, that code makes a call to the apply method in the companion object. It's an example of Scala's syntactic sugar at work, and I think you'll agree that this code:

```
val a = Wrapper(1)
```

is easier to read than this:

```
val a = Wrapper.apply(1)
```

or even this:

```
val a = new Wrapper(1)
```

#### *Defining apply's signature*

We know a few things about the apply method. First, from the previous examples we know that it takes an Int value, or more generically it takes an A. Therefore I can start to write its signature like this:

```
def apply[A](value: A)
```



From those examples I also know that `apply` returns a `Wrapper` instance, specifically a `Wrapper` around an `A`, so I can further write this:

```
def apply[A](value: A): Wrapper[A] = ???
```

Now the question is, how does `apply` create a new `Wrapper[A]`?

The answer is that it calls the `Wrapper` class constructor:

```
def apply[A](value: A): Wrapper[A] = new Wrapper(value)
```

The constructor is private to all other code, but because `apply` is created in `Wrapper`'s companion object, `apply` can still see that constructor.

That's the complete `apply` method. Here's what it looks like with the `Wrapper` class from the previous lesson, along with its new companion object:

```
class Wrapper[A] private (value: A) {
  def map[B](f: A => B): Wrapper[B] = {
    val newValue = f(value)
    new Wrapper(newValue)
  }
  def flatMap[B](f: A => Wrapper[B]): Wrapper[B] = {
    val newValue = f(value)
    newValue
  }
  override def toString = value.toString
}

object Wrapper {
  def apply[A](value: A): Wrapper[A] = new Wrapper(value)
}
```

## Testing apply

Now you can test the `apply` method with this little `App`:

```
object WrapperExample extends App {  
  val intResult = for {  
    a <- Wrapper(1)  
    b <- Wrapper(2)  
    c <- Wrapper(3)  
  } yield a + b + c  
  
  println(intResult)  
}
```

As shown in the previous lesson, this returns the result 6. The only difference between that lesson and this one is that you can now write `Wrapper(1)` instead of `new Wrapper(1)`. This is solely because of the companion object and its `apply` method.

## Why I used apply

The reason I wrote an `apply` method in a companion object in this lesson rather than using a case class is a technical one: FP developers like to say that a method like `apply` “lifts” an ordinary value into the wrapper. Put another way, an `Int` on its own looks like this:

```
100
```

But when you use `apply` to lift the `Int` into `wrapper`, the result is a wrapper around the `Int`:

```
wrapper(100)
```

## Key points

On the one hand, the last few lessons have been a series of small steps. You saw how to write a wrapper class that lets you write code like this:

```
val intResult = for {  
  a <- Wrapper(1)  
  b <- Wrapper(2)  
  c <- Wrapper(3)  
} yield a + b + c
```

On the other hand, if you're into technical terms, there has been a larger step behind all of this: You just wrote your first monad. Well, at least your first monad in this book.

As you'll see in the coming lessons, a monad in Scala is simply a class that has `map` and `flatMap` methods (so it can be used with multiple generators in a `for` expression), and it also has an `apply` method that is used to “lift” ordinary values like an `Int` into the monad.

That last sentence explains why I used `apply` in this example: I wanted to explain this “lifting” process. Now that you've seen this, in the future I'll use case classes for the same purpose.

## What's next

While creating our first monad is nice, I'm more interested in solving problems, and I still have a problem to solve: I want to be able to use something like a `bind` function inside a `for` expression so I can use the `f`, `g`, and `h` functions that I introduced a few lessons ago. To do this I'll use everything I just showed about `map`, `flatMap`, and `apply` in the last several wrapper lessons.

# A Quick Note About Case Classes and Companion Objects

Before you head into the following lessons, I want to note that I'm about to start using case classes quite a bit. In general, the reasons I'm about to use case classes are:

- I don't want to have to use the `new` keyword to create new instances of classes
- I don't want to have to write companion objects with `apply` methods to achieve this effect

If you know your case classes you know that they let you write code like this:

```
for {  
  a <- Wrapper(1)  
  b <- Wrapper(2)  
} yield c
```

rather than this:

```
for {  
  a <- new Wrapper(1)  
  b <- new Wrapper(2)  
} yield c
```

That may seem like a minor difference to some people, but I appreciate that getting rid of the `new` keyword makes the code cleaner and more concise.

As a final note, in real-world Scala/FP code you'll also want to use case classes so you can take advantage of the other features they offer, including pattern matching. But in the lessons that follow, I'm really just interested in those two bullet points.

If you're not familiar with writing an `apply` method, see the [Scala Cookbook](#), or the appendix, "Using `apply` with Scala Companion Objects," for more information.

# Using `bind` in a `for` Expression

A few lessons I asked that if you had three functions with these signatures:

```
def f(a: Int): (Int, String)
def g(a: Int): (Int, String)
def h(a: Int): (Int, String)
```

wouldn't it be cool if you could somehow use those functions in a `for` expression, like this:

```
val finalResult = for {
  fResult <- f(100)
  gResult <- g(fResult)
  hResult <- h(gResult)
} yield hResult
```

Now that I've covered the "wrapper" concept, in this lesson I'll show exactly how to do that.

## A big observation

At some point in the history of Scala, someone made a few observations that made this solution possible. The key insight may have been this:

For something to be used in a `for` expression, it doesn't have to be a *class* that implements the `map` and `flatMap` methods (like `Sequence`); it just needs to *return* a type that implements `map` and `flatMap` methods.

That's a big observation, or at least it was for me. So far in this book I've shown classes like `Sequence` and `Wrapper` that implement `map` and `flatMap` so they can be used in `for`, but the reality is that any function that *returns* such a type can be used in `for`.



## The next conceptual leap

With that observation in hand, it's a small conceptual leap to figure out how to get these functions to work in `for`:

```
def f(a: Int): (Int, String)
def g(a: Int): (Int, String)
def h(a: Int): (Int, String)
```

Can you see the solution?

Instead of these functions returning a tuple, they could return ... something else ... a type that implements `map` and `flatMap`.

The type these functions return should be something like a wrapper, but where wrapper contained a single value — such as a `Wrapper[Int]` — this type should be a wrapper around two values, an `Int` and a `String`. If such a type existed, `f`, `g`, and `h` could return their `Int` and `String` values wrapped in that type rather than a tuple.

You *could* call it a `TwoElementWrapper`:

```
def f(a: Int): TwoElementWrapper(Int, String)
def g(a: Int): TwoElementWrapper(Int, String)
def h(a: Int): TwoElementWrapper(Int, String)
```

But that's not very elegant. When you think about it, the purpose of `f`, `g`, and `h` is to show how functions can return “debug” information in addition to their primary return value, so a slightly more accurate name is `Debuggable`:

```
def f(a: Int): Debuggable(Int, String)
def g(a: Int): Debuggable(Int, String)
def h(a: Int): Debuggable(Int, String)
```

If `Debuggable` implements `map` and `flatMap`, this design will let `f`, `g`, and `h` be used in a `for` expression. Now all that's left to do is to create `Debuggable`.

Because `Debuggable` is going to work like `Wrapper`, I'm going to try to start with the `Wrapper` code from the previous lesson, and see if I can modify it to work as needed.

## Trimming wrapper down

The first thing I want to do is to convert wrapper into a case class to simplify it. When I do that, and then rename it to `Debuggable`, I get this:

```
case class Debuggable[A] (value: A) {
  def map[B](f: A => B): Debuggable[B] = {
    val newValue = f(value)
    new Debuggable(newValue)
  }
  def flatMap[B](f: A => Debuggable[B]): Debuggable[B] = {
    val newValue = f(value)
    newValue
  }
}
```

That's a start, but as this code shows:

```
def f(a: Int): Debuggable(Int, String)
```

`Debuggable` must take two input parameters. Ignoring generic types for a few moments, this tells me that `Debuggable`'s signature must look like this:

```
case class Debuggable (value: Int, message: String) {
```

When I further remove the generic types and bodies from the `map` and `flatMap` methods, `Debuggable` becomes this:

```
case class Debuggable (value: Int, message: String) {
  def map(f: Int => Int): Debuggable = ???
  def flatMap(f: Int => Debuggable): Debuggable = ???
}
```

Now I just need to think about the logic for the `map` and `flatMap` methods.

## A reminder of how for translates

An important thing to know at this point is that when you write a for expression like this:

```
val seq = Sequence(1,2,3)
for {
  i <- seq
  j <- seq
  k <- seq
  l <- seq
} yield (i+j+k+1)
```

it will be translated into three flatMap calls followed by one map call:

```
seq.flatMap { i =>
  seq.flatMap { j =>
    seq.flatMap { k =>
      seq.map { l =>
        i + j + k + 1
      }
    }
  }
}
```

For what we're about to do, the most important thing to observe is that map is (a) the last function called, and (b) the first one that returns.

You can think of the flatMap calls as being a series of recursive calls. flatMap keeps calling itself until the final expression is reached, at which point map is called. When map is called, it executes, returns its result, and then the flatMap calls unwind.

With that knowledge in hand, let's implement the map and flatMap methods for the Debuggable class.

## map

When I first created the `IntWrapper` class I showed its `map` signature:

```
def map(f: Int => Int): Wrapper[Int] = ???
```

and then wrote that you could say these things about `map`'s implementation:

- It takes a function that transforms an `Int` to an `Int`
- After doing whatever it does, `map` returns a `Wrapper[Int]`, i.e., an `Int` inside a new `Wrapper`

Similarly, when you look at `map`'s signature in `Debuggable`:

```
def map(f: Int => Int): Debuggable = ???
```

you can say these things about it:

- It takes a function that transforms an `Int` to an `Int`
- After doing whatever it does, `map` returns a `Debuggable` instance

As I did with `IntWrapper`, I write those sentences as comments inside `map` like this:

```
def map(f: Int => Int): Debuggable = {  
  // apply `f` to an `Int` to get a new `Int`  
  // wrap that result in a `Debuggable`  
}
```

I can implement the first sentence as I did in `Wrapper` — by applying the function `f` to the value in `Debuggable` — to get this:

```
def map(f: Int => Int): Debuggable = {  
  // apply `f` to an `Int` to get a new `Int`  
  val newValue = f(value)  
  
  // wrap that result in a `Debuggable`  
}
```

Now `map` just needs to return a new `Debuggable` instance.

The Debuggable constructor takes an Int and a String, which I named value and message. The *value* map should return is the new, transformed value I got by applying f to value, so that part is good.

While it may not be immediately clear *why* I should return the message from the Debuggable constructor, it's the only String message I have, so I'll use it to construct and return a new Debuggable instance:

```
def map(f: Int => Int): Debuggable = {  
  val newValue = f(value)  
  Debuggable(newValue, message)  
}
```

Figure [fig:howValueMessageComeIntoMap] shows how the value and message from the Debuggable class relate to how they are used in map.

```
case class Debuggable(value: Int, message: String) {  
  
  def map(f: Int => Int): Debuggable = {  
    val newValue = f(value)  
    Debuggable(newValue, message)  
  }  
  
  def flatMap(f: Int => Debuggable): Debuggable = {  
    val nextValue = f(value)  
    Debuggable(nextValue.value, message + nextValue.message)  
  }  
}
```

How value and message come into the map function.

When I write Scala/FP functions that use constructor parameters I often like to put a this reference in front of those values so I know where they came from. That change leads to this code:

```
def map(f: Int => Int): Debuggable = {  
  val newValue = f(this.value)  
  Debuggable(newValue, this.message)  
}
```

That's the complete map function.

***Why map returns message***

The short answer of “why” message is returned here is because map is the “last function called and the first to return.” As you’ll see in the details in the next lesson, map creates the first message in the stack of messages created in the for expression.

## flatMap

When I first created the wrapper class I wrote that you could say these things about its flatMap implementation:

- It takes a function that transforms an Int to a Wrapper[Int]
- After doing whatever it does, flatMap returns a Wrapper[Int]

That led to this code, which was a direct implementation of those statements:

```
def flatMap[B](f: A => Wrapper[B]): Wrapper[B] = {  
    val newValue = f(value)  
    newValue  
}
```

For the debuggable class you can say these things about its flatMap implementation:

- It takes a function that transforms an Int to a Debuggable instance
- After doing whatever it does, flatMap returns a Debuggable instance

Writing flatMap with those statements as comments looks like this:

```
def flatMap(f: Int => Debuggable): Debuggable = {  
    // (1) apply the function to an Int to get a new Debuggable  
    // (2) return a new Debuggable instance based on the new value  
}
```

As with the wrapper class, for the first comment the question is, “What Int should I apply the function to?” As before, the answer is, “Apply it to the value you hold.” This leads to this code:

```
def flatMap(f: Int => Debuggable): Debuggable = {  
    // (1) apply the function to an Int to get a new Debuggable  
    val newValue: Debuggable = f(value)  
    // (2) return a new Debuggable instance based on the new value  
}
```

So far this is the same as the wrapper class. Now let’s get the second line working.

The second comment states:

```
// return a new Debuggable instance based on the new value
```

This part was a little tricky for me, and the only way I could understand the solution was by really digging into the code (as shown in the next lesson). The short answer is that you need to create the new `Debuggable` instance from:

- The `Int` of the `newValue` created in the first line
- Appending `newValue.message` to the message that was passed into the current `Debuggable` instance

I'll explain this a little more shortly, but the short answer is that this is the solution:

```
Debuggable(nextValue.value, message + nextValue.message)
```

## ***How to think about that***

You can think about that solution as follows. Imagine that you have a `for` expression with a series of `Debuggable` instances, like this:

```
val finalResult = for {  
  fResult <- f(100)  
  gResult <- g(fResult)  
  hResult <- h(gResult)  
} yield hResult
```

Each of those lines — `f(100)`, `g(fResult)`, etc. — are going to add a new message to the overall string of messages. Therefore, at some point you need to string those messages together, and `flatMap` is the place where that happens. The most recent message is contained in `newValue.message`, and all of the previous messages are contained in the message that is passed into `Debuggable` (i.e., `this.message`).

I explain this in great detail in the next lesson, so if you want to completely understand how this works, go ahead and look at that lesson at this point.

## ***Finishing flatMap***



Finishing up with `flatMap`, I now know what the second expression looks like, so I add that to `flatMap`'s body:

```
def flatMap(f: Int => Debuggable): Debuggable = {  
    // (1) apply the function to an Int to get a new Debuggable  
    val newValue: Debuggable = f(value)  
  
    // (2) return a new Debuggable instance based on the new value  
    Debuggable(newValue.value, message + newValue.message)  
}
```

## The completed class

When I add `map` and `flatMap` to the `Debuggable` class definition, I now have this code:

```
case class Debuggable (value: Int, message: String) {
  def map(f: Int => Int): Debuggable = {
    val newValue = f(value)
    Debuggable(newValue, message)
  }
  def flatMap(f: Int => Debuggable): Debuggable = {
    val newValue: Debuggable = f(value)
    Debuggable(newValue.value, message + "\n" + newValue.message)
  }
}
```

Now I just need to figure out how to write the `f`, `g`, and `h` functions so I can write a `for` expression like this:

```
val finalResult = for {
  fResult <- f(100)
  gResult <- g(fResult)
  hResult <- h(gResult)
} yield hResult
```

## Writing f, g, and h

As I mentioned earlier, the solution to getting `f`, `g`, and `h` working in a `for` expression is that they should return a `Debuggable` instance. More specifically they should:

- Take an `Int` input parameter
- Return a `Debuggable` instance

This tells me that their signatures will look like this:

```
def f(a: Int): Debuggable = ???  
def g(a: Int): Debuggable = ???  
def h(a: Int): Debuggable = ???
```

In the previous lessons these functions worked like this:

- `f` multiplied its input value by 2
- `g` multiplied its input value by 3
- `h` multiplied its input value by 4

Thinking only about `f`, I can begin to write it like this:

```
def f(a: Int): Debuggable = {  
  val result = a * 2  
  val message = s"f: a ($a) * 2 = $result."  
  ???  
}
```

This gives me a `result` and `message` similar to what I had before, but now the function signature tells me that I need to return those values as a `Debuggable` instance rather than as a tuple. That's a simple step:

```
def f(a: Int): Debuggable = {  
  val result = a * 2  
  val message = s"f: a ($a) * 2 = $result."  
  Debuggable(result, message)  
}
```

`f` now takes an `Int` input parameter, and yields a `Debuggable`, as desired.

## A test App

g and h are simple variations of f, so when I create them and put all of the functions in a test App along with the original for expression, I get this:

```
object Test extends App {  
  val finalResult = for {  
    fResult <- f(100)  
    gResult <- g(fResult)  
    hResult <- h(gResult)  
  } yield hResult  
  
  // added a few "\n" to make the output easier  
  // to read  
  println(s"value:  ${finalResult.value}\n")  
  println(s"message: \n${finalResult.message}")  
  
  def f(a: Int): Debuggable = {  
    val result = a * 2  
    val message = s"f: a ($a) * 2 = $result."  
    Debuggable(result, message)  
  }  
  
  def g(a: Int): Debuggable = {  
    val result = a * 3  
    val message = s"g: a ($a) * 3 = $result."  
    Debuggable(result, message)  
  }  
  
  def h(a: Int): Debuggable = {  
    val result = a * 4  
    val message = s"h: a ($a) * 4 = $result."  
    Debuggable(result, message)  
  }  
}
```

Running that App yields this output:

```
value:  2400  
  
message:  
f: a (100) * 2 = 200.  
g: a (200) * 3 = 600.  
h: a (600) * 4 = 2400.
```

While that output may not be beautiful for many people, if this is the first time you've enabled something like this in a for expression it can be a really beautiful thing.

## More information

I went through some parts of this lesson a little quicker than usual. My thinking is that if you're comfortable with how `for`, `map`, and `flatMap` work, I didn't want to go too slow. But for people like me who struggle with this concept, I want to cover this topic more deeply. Therefore, the next lesson takes a deep dive into exactly how all of this code works.

# How Debuggable, f, g, and h Work

If you want to see the nitty-gritty details of how the `Debuggable` class works with the `f`, `g`, and `h` functions in the previous lesson, this lesson is for you. I won't introduce any new concepts in this lesson, but I'll add a *lot* of debugging statements to that code to show exactly how a `for` expression like this works.

## Source code

The best way to work with this lesson is to check the source code out from my Github project so you can easily refer to the code as you read the lesson. Here's a link to the code:

- [This version of the Debuggable code on Github](#)

## The flow of this lesson

The way this lesson works is:

- I'll show the same code as the previous lesson, but with many `println` statements added for debugging purposes
- After showing the new code, I'll show the output it produces
- After that, I'll explain that output

I hope all of this debug code (and its output) provides a good example of how a for expression works, especially with “wrapper” classes like `Debuggable`.



# The Debuggable class

First, here's the source code for the Debuggable class:

```
case class Debuggable(value: Int, msg: String) {

  def map(f: Int => Int): Debuggable = {
    println("\n>>>> entered map >>>>")
    println(s"map: value: ${value}")
    println(s"map: msg: (${msg})")
    val nextValue = f(value) //Int
    // there is no `nextValue.msg`
    println(s"map: nextValue: ${nextValue}")
    println("<<<< leaving map <<<<\n")
    Debuggable(nextValue, msg)
  }

  def flatMap(f: Int => Debuggable): Debuggable = {
    println("\n>>>> entered fmap >>>>")
    println(s"fmap: value: ${value}")
    println(s"fmap: msg: (${msg})")
    val nextValue = f(value)
    println(s"fmap: msg: (${msg})")
    println(s"fmap: next val: ${nextValue.value}")
    println(s"fmap: next msg: \n(${nextValue.msg})")
    println("<<<< leaving fmap <<<<\n")
    Debuggable(nextValue.value, msg + "\n" + nextValue.msg)
  }
}
```

The important notes about this code are:

- I added `println` statements to show the `value` and `msg` that `map` and `flatMap` have before they apply their functions
- I added `println` statements to show the `nextValue` that `map` and `flatMap` have *after* they apply their functions, and also show the new message that's created when `flatMap` applies its function

# The f, g, and h functions

Next, this is how I modified the f, g, and h functions:

```
object DebuggableTestDetails extends App {  
  def f(a: Int): Debuggable = {  
    println(s"\n[f: a = $a]")  
    val result = a * 2  
    Debuggable(result, s"f: input: $a, result: $result")  
  }  
  
  def g(a: Int): Debuggable = {  
    println(s"\n[g: a = $a]")  
    val result = a * 3  
    Debuggable(result, s"g: input: $a, result: $result")  
  }  
  
  def h(a: Int): Debuggable = {  
    println(s"\n[h: a = $a]")  
    val result = a * 4  
    Debuggable(result, s"h: input: $a, result: $result")  
  }  
  
  val finalResult = for {  
    fRes <- f(100)  
    gRes <- g(fRes)  
    hRes <- h(gRes)  
  } yield hRes  
  
  println("\n----- FINAL RESULT -----")  
  println(s"final value: ${finalResult.value}")  
  println(s"final msg:   \n${finalResult.msg}")  
}
```

As shown, in the f, g, and h functions I show the initial value that each function receives when it's called.

## How the for expression is translated

In the output that follows it also helps to understand how the for expression is translated by the Scala compiler. This is what my for expression looks like:

```
val finalResult = for {  
  fRes <- f(100)  
  gRes <- g(fRes)  
  hRes <- h(gRes)  
} yield hRes
```

And this is what the code looks like when I compile the for expression with the `scalac -Xprint:parse` command (and then clean up the output):

```
val finalResult = f(100).flatMap { fResult =>  
  g(fResult).flatMap { gResult =>  
    h(gResult).map { hResult =>  
      hResult  
    }  
  }  
}
```

Notice that there are two `flatMap` calls followed by one `map` call.

# The output

When I run the test App shown, this is the output I see:

```
[f: a = 100]
>>>> entered fmap >>>>
fmap: value: 200
fmap: msg: (f: input: 100, result: 200)

[g: a = 200]
>>>> entered fmap >>>>
fmap: value: 600
fmap: msg: (g: input: 200, result: 600)

[h: a = 600]
>>>> entered map >>>>
map: value: 2400
map: msg: (h: input: 600, result: 2400)
map: nextValue: 2400
<<<< leaving map <<<<

fmap: msg: (g: input: 200, result: 600)
fmap: next val: 2400
fmap: next msg:
(h: input: 600, result: 2400)
<<<< leaving fmap <<<<

fmap: msg: (f: input: 100, result: 200)
fmap: next val: 2400
fmap: next msg:
(g: input: 200, result: 600)
h: input: 600, result: 2400)
<<<< leaving fmap <<<<

----- FINAL RESULT -----
final value: 2400
final msg:
f: input: 100, result: 200
g: input: 200, result: 600
h: input: 600, result: 2400
```

Take a few moments to review that output to see if you understand how it works. One of the most important things to note is that the `map` method is called last, and it returns before the `flatMap` method calls return.

I'll provide an explanation of all of the output in the sections that follow.

## Explaining the output

The first thing that happens is that the `f` function is called with the value `100`:

```
[f: a = 100]
```

You can understand this when you look at the first part of my `for` expression:

```
val finalResult = for {  
  fRes <- f(100)  
  -----
```

The desugared `for` expression shows this even more clearly:

```
val finalResult = f(100).flatMap { fResult =>  
  -----
```

In both of those code snippets, `f(100)` is the first piece of code that is invoked.

### *What happens in `f`*

What happens inside of `f` is that this output is printed:

```
[f: a = 100]
```

After that, the value that's received is doubled, and a new `Debuggable` instance is created. You can see that in `f`'s body:

```
def f(a: Int): Debuggable = {  
  println(s"\n[f: a = $a]")  
  val result = a * 2  
  Debuggable(result, s"f: input: $a, result: $result")  
}
```

### *The first `flatMap` is called*

The next piece of output looks like this:

```
>>>> entered fmap >>>>  
fmap: value: 200  
fmap: msg: (f: input: 100, result: 200)
```

This shows that `flatMap` is invoked. This makes sense when you look at the first line of the desugared `for` expression:

```
val finalResult = f(100).flatMap { fResult =>
    -----
```

That code shows that `flatMap` is invoked after `f` is applied to the value `100`.

To understand the debug output, it helps to look at `flatMap`:

```
def flatMap(fip: Int => Debuggable): Debuggable = {
  println("\n>>>> entered fmap >>>>")
  println(s"fmap: value: ${this.value}")
  println(s"fmap: msg: (${this.msg}")")
  val nextValue = fip(value)
  println(s"fmap: msg: (${this.msg}")")
  println(s"fmap: next val: ${nextValue.value}")
  println(s"fmap: next msg: \n(${nextValue.msg}")")
  println("<<<< leaving fmap <<<<\n")
  Debuggable(nextValue.value, msg + "\n" + nextValue.msg)
}
```

The debug output shows that `this.value` in `flatMap` is `200`. This was passed into the new `Debuggable` by `f`. The `this.msg` value is also provided by `f` when it creates the new `Debuggable`.

At this point there's no more output from `flatMap`. What happens is that this line of code in `flatMap` is invoked:

```
val nextValue = fun(value)
```

That line causes this output to be printed:

```
[g: a = 200]
```

We're now at this point in the desugared for expression:

```
val finalResult = f(100).flatMap { fResult =>
  g(fResult)
  -----
```

## ***What happens in g***

The output `[g: a = 200]` shows that the `g` function is entered. Here's `g`'s source code:

```
def g(a: Int): Debuggable = {
  println(s"\n[g: a = $a]")
  val result = a * 3
  Debuggable(result, s"g: input: $a, result: $result")
}
```

As you saw with `f`, what happens here is:

- `g`'s `println` statement produces the output shown
- a new result is calculated
- `g` creates a new `Debuggable` instance as its last line

### ***The second flatMap call is reached***

When `g` returns the new `Debuggable` instance, the second `flatMap` call is invoked, which you can see in the desugared code:

```
val finalResult = f(100).flatMap { fResult =>
  g(fResult).flatMap { gResult => ...
  -----
```

`flatMap` is invoked with values given to it by `g`, as shown in its output:

```
>>>> entered fmap >>>>
fmap: value: 600
fmap: msg: (g: input: 200, result: 600)
```

`g` multiplied the value it was given (200) to produce a new value, 600, along with the message shown.

Those lines of debug output are produced by these first three lines of code in `flatMap`:

```
println("\n>>>> entered fmap >>>>")
println(s"fmap: value: ${this.value}")
println(s"fmap: msg: (${this.msg})")
```

After that, `flatMap`'s fourth line of code is reached:

```
val nextValue = fun(value)
```

That line of code causes the next line of output to be produced:

```
[h: a = 600]
```

This tells us that the `h` function was just entered.

***Note: The flatMap calls haven't returned yet***

I'll come back to the `h` function call in a moment, but first, it's important to note that the two `flatMap` function calls haven't returned yet. They both pause when that fourth line of code is reached.

You can understand that by a) looking at `flatMap`'s source code, and b) looking at the desugared for expression:

```
val finalResult = f(100).flatMap { fResult =>
  g(fResult).flatMap { gResult => // YOU ARE NOW HERE
    h(gResult).map { hResult =>
      hResult
    }
  }
}
```

The `flatMap` calls haven't returned yet because:

- The first `flatMap` function reaches its fourth line, which invokes `g`
- When `g` finishes, the second `flatMap` call is invoked
- When that instance of `flatMap` reaches its fourth line, `h` is invoked
- As you're about to see, when `h` finishes running, `map` is invoked

### ***h executes***

Getting back to where I was ... the last line of debug output was this:

```
[h: a = 600]
```

This tells you that the `h` function was just invoked. `h` prints that output, doubles the value it receives, then creates a new `Debuggable` instance with that new value and new message:

```
def h(a: Int): Debuggable = {
  println(s"\n[h: a = $a]")
  val result = a * 4
  Debuggable(result, s"h: input: $a, result: $result")
}
```

### ***map is entered***

As the desugared for expression shows, after `h` runs, `map` is invoked:



```
val finalResult = f(100).flatMap { fResult =>
  g(fResult).flatMap { gResult =>
    h(gResult).map { hResult => ...
```

The map call produces the next debug output you see:

```
>>>> entered map >>>>
map: value: 2400
map: msg: (h: input: 600, result: 2400)
map: nextValue: 2400
<<<< leaving map <<<<
```

This shows that map is called, it runs (producing this output), and then it exits. This confirms what I wrote in the previous lesson:

In a for expression, map is the last function called and the first to exit.

Here's a look at map's source code, followed by its output:

```
def map(f: Int => Int): Debuggable = {
  println("\n>>>> entered map >>>>")
  println(s"map: value: ${value}")
  println(s"map: msg: (${msg})")
  val nextValue = f(value) //Int
  // there is no `nextValue.msg`
  println(s"map: nextValue: ${nextValue}")
  println("<<<< leaving map <<<<\n")
  Debuggable(nextValue, msg)
}
```

```
>>>> entered map >>>>
map: value: 2400
map: msg: (h: input: 600, result: 2400)
map: nextValue: 2400
<<<< leaving map <<<<
```

## ***The flatMap calls unwind***

After the map method finishes, the next thing that happens is that the flatMap calls begin to unwind. A look at the de-sugared code reminds you why this unwinding happens now:

```
val finalResult = f(100).flatMap { fResult =>
  g(fResult).flatMap { gResult =>
    h(gResult).map { hResult => // map RETURNS
      hResult // CONTROL TO flatMap
    }
  }
}
```

What's happened so far is:

- f was called
- When f finished, the first flatMap function was called
- It called g
- When g finished, the second flatMap function was called
- It called h
- When h finished, map was called
- map just finished running

Now that map is finished, flow of control returns to the second flatMap invocation. This is the output from it:

```
fmap: msg: (g: input: 200, result: 600)
fmap: next val: 2400
fmap: next msg:
(h: input: 600, result: 2400)
<<<< leaving fmap <<<<
```

When that flatMap call finishes running, flow of control returns to the first flatMap invocation, which produces this output:

```
fmap: msg: (f: input: 100, result: 200)
fmap: next val: 2400
fmap: next msg:
(g: input: 200, result: 600
h: input: 600, result: 2400)
<<<< leaving fmap <<<<
```

When it finishes, the final output from the application is shown. This is what the println statements look like at the end of the App:

```
println("\n----- FINAL RESULT -----")
println(s"final value: ${finalResult.value}")
println(s"final msg:  \n${finalResult.msg}")
```

and this is what their output looks like:

```
----- FINAL RESULT -----
final value: 2400
final msg:
f: input: 100, result: 200
```

g: input: 200, result: 600  
h: input: 600, result: 2400

## Summary

If you had any confusion about how `for` expressions run — especially with wrapper classes like `Debuggable` — I hope this lesson is helpful. I encourage you to work with the source code and modify it until you're completely comfortable with how it works. The lessons that follow will continue to build on this knowledge.

# A Generic Version of Debuggable

## Source code

The source code for this lesson is at this URL:

- [github.com/alvinj/FPDebuggable](https://github.com/alvinj/FPDebuggable)

## Using generic types

In this lesson I'll share a version of the `Debuggable` class that uses generic types rather than `Ints` everywhere.

I'm going to assume that you're used to the process of converting a type-specific class to a class that uses generic types, so rather than explain the conversion process, I'll just show the code:

```
/**
 * The purpose of this class is to show a version of the `Debuggable`
 * class that takes a generic `value` (whereas the previous versions
 * required that `value` be an `Int`).
 */
case class Debuggable[A](value: A, message: String) {

  def map[B](f: A => B): Debuggable[B] = {
    val nextValue = f(value)
    Debuggable(nextValue, message)
  }

  def flatMap[B](f: A => Debuggable[B]): Debuggable[B] = {
    val nextValue = f(value)
    Debuggable(nextValue.value, message + nextValue.message)
  }
}
```

I used the following code to test this new version of `Debuggable`:

```
object DebuggableGenericExample extends App {

  def f(a: Int): Debuggable[Int] = {
    val result = a * 2
    Debuggable(result, s"f: multiply $a * 2 = $result\n")
  }

  def g(a: Int): Debuggable[Int] = {
    val result = a * 3
    Debuggable(result, s"g: multiply $a * 3 = $result\n")
  }

  def h(a: Int): Debuggable[Int] = {
    val result = a * 4
    Debuggable(result, s"h: multiply $a * 4 = $result\n")
  }

  val finalResult = for {
    fRes <- f(100)
    gRes <- g(fRes)
    hRes <- h(gRes)
  } yield s"result: $hRes"

  println(finalResult.message)
  println(s"Output is ${finalResult.value}")
}
```

```
}
```

Running that App results in this output:

```
f: multiply 100 * 2 = 200  
g: multiply 200 * 3 = 600  
h: multiply 600 * 4 = 2400
```

```
Output is result: 2400
```

This shows that after changing the `Debuggable` class to use generic types, it still works properly with `Int` values.

If you want to verify that the generics work as advertised, the [Github project](#) includes another App named `DebuggableGenericsWithFloats` that uses `Floats` rather than `Int` values.

# One Last Debuggable: Using List Instead of String

## Motivation for this lesson

In this lesson I'll (quickly) show a slight variation of the `Debuggable` class. The motivations for this are:

- It's important to get comfortable writing “wrapper” classes like this
- Many of the lessons that follow show more wrapper classes, and a simple variation now will help get you ready for those later



## Source code

The source code for this lesson is at this URL:

- [github.com/alvinj/FPDebuggable](https://github.com/alvinj/FPDebuggable)

## From String to List[String]

The change in this lesson is relatively simple: I'll show how to implement `Debuggable` with a `List` to store the log messages, rather than using a `String` as I did in the previous lessons.

Since I want to store the messages as a `List[String]`, the first change is to the `Debuggable` class signature, which now looks like this:

```
case class Debuggable[A](value: A, log: List[String]) {  
    -----  
}
```

Inside the `Debuggable` class, this change has no effect on `map`. The `log` parameter used to be a `String`, and now it's a `List[String]`, and the code requires no changes:

```
def map[B](f: A => B): Debuggable[B] = {  
    val nextValue = f(value)  
    Debuggable(nextValue, this.log)  
}
```

The change does affect `flatMap`, which now prepends the old `log` message before `nextValue.log` when creating a new `Debuggable` instance:

```
def flatMap[B](f: A => Debuggable[B]): Debuggable[B] = {  
    val nextValue: Debuggable[B] = f(value)  
    Debuggable(nextValue.value, this.log ::: nextValue.log)  
}
```

The change also affects `f` (and `g` and `h`), which now give `Debuggable` a `List` (rather than a `String`):

```
def f(a: Int): Debuggable[Int] = {  
    val result = a * 2  
    Debuggable(result, List(s"f: multiply $a * 2 = $result"))  
}
```

It also affects the final printing of the log messages:

```
// print a `List` (rather than a `String`)  
finalResult.log.foreach(l => println(s"LOG: $l"))
```

# The complete source code

With those changes, here's the complete source code for the new version of Debuggable:

```
// `log` is now a list
case class Debuggable[A](value: A, log: List[String]) {

  def map[B](f: A => B): Debuggable[B] = {
    val nextValue = f(value)
    Debuggable(nextValue, this.log)
  }

  // prepend `this.log` before `nextValue.log`
  def flatMap[B](f: A => Debuggable[B]): Debuggable[B] = {
    val nextValue: Debuggable[B] = f(value)
    Debuggable(nextValue.value, this.log ::: nextValue.log)
  }
}

object DebuggableList extends App {

  def f(a: Int): Debuggable[Int] = {
    val result = a * 2
    Debuggable(result, List(s"f: multiply $a * 2 = $result"))
  }

  def g(a: Int): Debuggable[Int] = {
    val result = a * 3
    Debuggable(result, List(s"g: multiply $a * 3 = $result"))
  }

  def h(a: Int): Debuggable[Int] = {
    val result = a * 4
    Debuggable(result, List(s"h: multiply $a * 4 = $result"))
  }

  val finalResult = for {
    fRes <- f(100)
    gRes <- g(fRes)
    hRes <- h(gRes)
  } yield s"result: $hRes"

  finalResult.log.foreach(l => println(s"LOG: $l"))
  println(s"Output is ${finalResult.value}")
}
```

The output of the App looks like this:

```
LOG: f: multiply 100 * 2 = 200
LOG: g: multiply 200 * 3 = 600
LOG: h: multiply 600 * 4 = 2400
Output is result: 2400
```

## Discussion

While this was a relatively minor change to the `Debuggable` class, it's helpful to see how that change has a ripple effect throughout the code. I showed this change so you could see that effect, but I also prefer this `List` approach, which is a more “real world” example than the previous `String`-based example.

## The Writer monad

If you're interested in where the `Debuggable` class comes from, it's actually an implementation of something known as the Writer monad in Haskell.

As [Learn You a Haskell for Great Good!](#) states, “the Writer monad is for values that have another value attached that acts as a sort of log value. Writer allows us to do computations while making sure that all the log values are combined into one log value that then gets attached to the result.”

## Key points

In the last few lessons I showed several different versions of the `Debuggable` class to help you get comfortable with it. Here are a few important points about it:

- A *monad* consists of a class with `map` and `flatMap` methods, along with some form of a “lift” function.
- In Scala, a class built like this is intended to be used in `for` expressions.
- I refer to these as “wrapper” classes. While they’re intended to be used in `for` expressions, they’re not “containers” like Scala collections classes, they’re more a type of “wrapper” or “box.” They wrap existing types so they can be used in `for` expressions.

## See also

When I was struggling to learn what a monad was, the following links were the best resources I found:

- An old Haskell tutorial, [You Could Have Invented Monads](#)
- Martin Snyder's YouTube presentation, [Monadic Logging and You](#)
- Darren Wilkinson's article, [First steps with monads in Scala](#)

You can read more about the Writer monad at these resources:

- The book, [Learn You a Haskell for Great Good!](#)
- [The Writer monad section](#) of the haskell.org wiki

# Key Points About Monads

At this time it's worth taking a moment to pause and make a few observations about monads in Scala:

- Their primary purpose is to let you compose code in `for` expressions (i.e., to glue code together)
- For a Scala class to be a monad, it needs three things:
  - A `map` method
  - A `flatMap` method
  - Some sort of lift function (to “lift” another type into the monad)

As you'll see in the rest of this book, there are different monads for different purposes.

If you ever get confused about monads — such as why in the world they are needed, or why people write about them so much — I encourage you to come back to this section to review those points.



# Signpost: Where We're Going Next

Now that you've seen what monads are, we're getting closer to being able to write a Scala/FP version of the Coin Flip game that would make an experienced functional programmer smile. That game will make extensive use of composition in a `for` expression.

However, before I can do that I'm going to have to develop a few new monads, including the `IO` and `State` monads. These are two of the most common monads that are used in functional programming.

In the next several lessons I'll demonstrate the `IO` monad, and then I'll show how to use a `State` monad. I'll also discuss *composition* a little more when the time is right.

# Introduction: The IO Monad

The IO monad is the grandfather of all monads. [Wikipedia states](#), “Haskell 1.3 introduced monads as a more flexible way to combine I/O with lazy evaluation.”

Before you jump into using the IO monad, let me share a personal warning: Some developers say that the IO monad somehow makes I/O pure. This isn’t true — and I wasted a lot of time trying to understand that claim.

As you’ll see in the following lessons, if you have a function named `getUserInput` that returns a type of `IO[String]`, and a user enters the string `fred`, `getUserInput` will return:

```
IO["fred"]
```

However, if the user enters the string `zombie`, `getUserInput` will return this:

```
IO["zombie"]
```

Clearly those values aren’t the same, just like `List[fred]` and `List[zombie]` aren’t the same. This tells you that there’s no guarantee that `getUserInput` will always return the same result when it’s called. Whether you want to say that `getUserInput` isn’t idempotent, deterministic, or referentially transparent, clearly it isn’t a pure function.

That being said, the IO monad does have at least two potential benefits in Scala:

- When you use it, your I/O function signatures will declare that they return an IO type, such as `getUserInput` returning `IO[String]`. This screams to other developers, “Watch out, this function interacts with the outside world!”
- It lets you use I/O functions in Scala for expressions.

While there’s no consensus that the IO monad is a huge benefit in Scala, I’ll use it in the remainder of this book. After that, you can decide whether those two benefits are useful in your own programming.

## See also

If you're interested in the history of monads, see [this Wikipedia "monad" article](#).

# How to Use an IO Monad

## Goal

The goal for this lesson is to show how to use an IO monad. I'm not going to show how to *write* an IO monad right now, I just want to show how to *use* one.

You can think of this lesson like this: If an IO monad was built into the Scala libraries, would you care how it was implemented? Sure, if you ever had a problem with it you'd care how it was written, but if you never had a problem with it, you'd probably just use it, just like you use a `String` or `List` without worrying about how they're implemented. So that's the approach I'm going to take in this lesson: I'll assume that an IO monad already exists, and I'll show how to use it.

## Background

An IO monad is a wrapper that you can use to wrap around I/O functions. It's not 100% necessary to use an IO monad to handle I/O, but in Scala the benefits of using one are:

- It serves as a “marker” data type. When developers see that a function returns an `IO[String]`, they immediately know that the function reaches out into the outside world to return that `String` (wrapped in an `IO`).
- Similarly, if a function signature shows that it returns `IO[Unit]`, developers know that the function writes data to the outside world. (The function presumably takes one or more input parameters that will be written to the outside world.)
- It lets you use I/O functions in `for` expressions.

I demonstrate these points in this lesson.

## Source code

The source code for the next three lessons is available at this URL:

- [github.com/alvinj/IOMonad](https://github.com/alvinj/IOMonad)

Three notes about the source code:

- The IO monad code is in the file named *IO.scala*.
- The code in *IO.scala* is a more complex version of a monad than what I've shown this far. I'll discuss it more in future versions of this book, but in these lessons I'm just going to use it without discussing it. As usual, feel free to study the code, and modify it as desired to make it your own. (I will spend a little time discussing a similar State monad in the upcoming lessons.)
- The `getLine` and `putStrLn` functions are in the *package.scala* file (i.e., the “package object” for that directory).

# Hello, IO World

If an IO monad existed in Scala, you could use it to wrap Scala's existing I/O functions, like this:

```
def getLine: IO[String] = IO(scala.io.StdIn.readLine())
def putStrLn(s: String): IO[Unit] = IO(println(s))
```

In that code, `getLine` returns a string that's retrieved by `scala.io.StdIn.readLine` and wraps it in an IO, so its return type is `IO[String]`. Similarly, `putStrLn` writes a string to STDOUT using Scala's `println` function, and because it has nothing meaningful to return, its return type is `IO[Unit]`. (More on this shortly.)

With those functions in hand you can write a `for` expression like this to get and then print a person's first and last name:

```
object IOTest1 extends App {
  for {
    _ <- putStrLn("First name?")
    firstName <- getLine
    _ <- putStrLn(s"Last name?")
    lastName <- getLine
    _ <- putStrLn(s"First: $firstName, Last: $lastName")
  } yield ()
}
```

A few points about that code:

- When you don't care what's returned by the right-hand side of a line in a `for` expression, you can use the `_` character on the left side of the `<-` assignment symbol to ignore that value. `putStrLn` returns `IO[Unit]`, which I don't care about, so I use this approach.
- In the end, this particular `for` expression doesn't return anything of interest, so I use `yield ()` at the end of it. (Remember that `()` is a way to return an instance of `Unit`. You can also write `yield Unit`, if you prefer.)

When I put that code in an `App` object, run it, and enter my first and last name, I see the following:

```
First name?
```



```
Alvin
Last name?
Alexander
First: Alvin, Last: Alexander
```

### ***Why this works in for***

This example shows that these new I/O functions — `getLine` and `putStrLn` — can be used inside `for` expressions. As you can imagine, they work because the `IO` class implements `map` and `flatMap` methods.

Conversely, if you replace `getLine` and `putStrLn` with Scala's built-in `readLine` and `println` methods, you'll see errors related to `println` that state, “`flatMap` is not a member of `Unit`,” and, “`map` is not a member of `Unit`.”

## **IO indicates interaction with the outside world**

As I mentioned, a great thing about the IO monad is that these signatures clearly tell you that these functions reach out into the outside world:

```
def getLine: IO[String] = ???  
def putStrLn(s: String): IO[Unit] = ???
```

When you see signatures like these you know that however `getLine` works internally, it clearly reaches into the outside world to retrieve a `String`. Similarly, `putStrLn` presumably takes the `String` that it receives and sends it into the outside world.

## Monads don't have to be scary

Where “monad” used to be a scary name, now you know that it just means that a data type implements `map` and `flatMap` methods so it can be used in `for` expressions.

I tend to call these things “wrappers,” and indeed, the `IO` monad is just another wrapper data type. For instance, you can imagine that `getLine` returns a `String` wrapped inside a box — an `IO` box — as shown in Figure [fig:stringInIoBox].

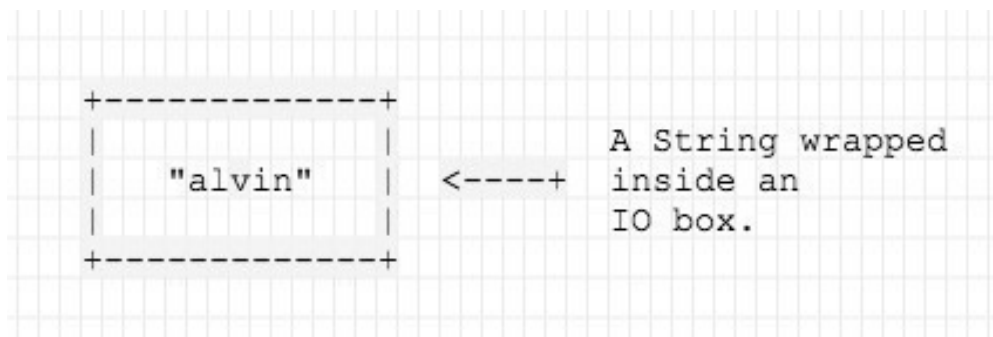

The `IO` monad is just a “wrapper” class. It has `map` and `flatMap` methods so it can be used in `for` expressions.

The great thing about that box is that the `for` expression knows how to open it, and pull the `String` out of it.

Just remember that monads in Scala implement `map` and `flatMap` so they can be used in `for` expressions. After that, they're not so scary.

# Assigning a for Expression to a Function

Once you have an IO monad, you can use it in a for expression, and then assign that expression to a function. Notice how `forExpression` in this code is assigned to the large for expression. Also notice how the for expression ends with `yield ()`, so its return type is `IO[Unit]`:

```
object IOTest2 extends App {  
  def forExpression: IO[Unit] = for {  
    _ <- putStrLn("First name?")  
    firstName <- getLine  
    _ <- putStrLn(s"Last name?")  
    lastName <- getLine  
    fNameUC = firstName.toUpperCase  
    lNameUC = lastName.toUpperCase  
    _ <- putStrLn(s"First: $fNameUC, Last: $lNameUC")  
  } yield ()  
  
  // run the block of code whenever you want to ...  
  forExpression.run  
}
```

One thing I didn't mention yet is that an IO monad gives you a way to execute the code at a later time. In this example I execute the for expression at a later time by calling the `run` method on the IO monad instance. In fact, no I/O happens until this line is executed:

```
forExpression.run
```

When I run this App and then type in my name, the result looks like this:

```
First name?  
alvin  
Last name?  
alexander  
First: ALVIN, Last: ALEXANDER
```

Cool. Now you've seen how to create a function using a for expression, where that expression uses a functional approach to I/O. The next lesson takes this one step further by returning to recursion.

## **A note**

On a personal note, I don't particularly like the function name `putStrLn`. However, a) it comes from Haskell, and b) you may see experienced Scala/FP developers use it, so I thought I'd show it here so you can get used to it.

# The IO Monad and a for Expression That Uses Recursion

In the next step of building up our knowledge, I'll add recursion to a `for` expression. This addition lets you write command-line applications that loop continuously, much like my Coin Flip game did earlier in this book.

Jumping right in, here's the source code for an application that continuously prompts you to input some text. The loop exits when you type in the string, "quit":

```
object FPrecursiveLoop extends App {  
  def loop: IO[Unit] = for {  
    _ <- putStrLn("Type something: ")  
    input <- getLine  
    _ <- putStrLn(s"You said '$input'.")  
    _ <- if (input == "quit") IO(Unit) else loop //RECURSE  
  } yield ()  
  
  loop.run  
}
```

This code is similar to the `for` expression in the previous lesson, except for this line:

```
_ <- if (input == "quit") IO(Unit) else loop
```

That line can be read as, "If the user types 'quit', return `IO(Unit)` — thereby ending the recursion — otherwise, recursively call the `loop` function."

When I run this application and type in a few strings, I see this result:

```
Type something:  
foo  
You said 'foo'.  
Type something:  
bar  
You said 'bar'.  
Type something:  
quit  
You said 'quit'.
```

## Discussion

If this technique seems simple — that’s great! This shows that you’re comfortable with the `IO` monad and recursion.

The cool thing about this loop is that it shows a pattern that you’ll soon be able to use to write all sorts of command-line applications. For instance, if you want to write a command-line “To Do List” application, you can write it using this same pattern when you have some `IO` functions that let you read and write files (or a database).

## **What's next**

Given these examples, this is a good time to take a deeper dive into the IO monad, including:

- Why it was originally created
- The IO monad philosophy



# Diving Deeper Into the IO Monad

While the IO monad works as I've described — it implements `map` and `flatMap` so it can be used in `for` expressions, and it's intended to wrap I/O functions — there's a little more to it than I've let on so far.

To peel back the IO curtain a little more, I'm going to use a “professional” version of an IO monad. This one comes from a project named [Cats](#), which is a play on the name, “category theory.” Cats is a leading library for functional programming in Scala.

## Source code

The source code for this project is available at this URL:

- [github.com/alvinj/IOMonadHelloWorld](https://github.com/alvinj/IOMonadHelloWorld)

## The problem with I/O and FP

If you want to take a deep dive into understanding the need for the IO monad in Haskell, [Learn You a Haskell for Great Good!](#) is probably the best resource. But to keep things simple in this book, in this lesson I'll reference the first paragraphs from an article titled, [An IO monad for Cats](#).

With a few simplifications, that story goes like this:

- In Haskell you only write pure functions.
- That's great, because it means you can compose your functions just like algebraic equations to create software applications.
- But when the Haskell creators got to I/O, they realized they had a problem. I/O functions aren't referentially transparent (RT), so you can't combine them like algebraic expressions. And if you can't compose I/O functions with your pure functions, you can't write an application that interacts with the outside world.

The short story of the solution to the problem is that monads were invented in 1991, and in 1998 the IO monad was added to Haskell as a way to deal with I/O. The IO monad contains a bit of a "trick" that lets you use I/O functions as though they are RT.

## The IO monad's trick

The trick of the IO monad is that it lets you write I/O functions as *effects*. Philosophically, what happens is that you use IO to *describe* how an I/O function works. Then, instead of dealing with the result of the I/O function at the time when the I/O function appears to be called, you defer the actual *action* until some time later when you really want it to be triggered.

As an example of this, if you run this little Scala app that *doesn't* use the IO monad:

```
object HelloVal extends App {  
  val result = println("Hello, world")  
}
```

you'll see that it prints `Hello, world` to STDOUT, as expected.

Conversely, the IO monad trick looks like this:

```
import cats.effect.IO  
  
object IOMonadAlmostHelloWorld extends App {  
  val hello = IO { println("Hello, world") }  
}
```

If you run this app, you'll see that no output is produced by this code; the App will run, but it won't produce any output.

What happens here is that instead of `hello` immediately printing to the outside world, it can be thought of as a *description* of how to print to the outside world. You can pass `hello` around, and it carries this description of *how* to print to the outside world along with it, but until it's explicitly told to execute, nothing happens.

Haskell developers refer to this sort of thing as an *effect*, and as a result, the Cats' creators put their IO monad in a package named *cats.effect*.

Continuing the story ... with Cats you trigger the action by calling a method named `unsafeRunSync` on the IO instance:

```
import cats.effect.IO

object IOMonadHelloWorld extends App {
  val helloEffect = IO { println("Hello, world") }
  // ...
  // some time later ...
  // ...
  helloEffect.unsafeRunSync()
}
```

This is a true “Hello, world” example using the Cats IO monad, because it uses `helloEffect.unsafeRunSync()` to trigger the action/effect when desired, and `Hello, world` is printed to `STDOUT`.

## ***Two notes***

I’ll make two notes about this code before moving on. First, `helloEffect`’s type is `IO[Unit]`, so I could have declared that type explicitly, like this:

```
val helloEffect: IO[Unit] = IO { println("Hello, world") }
```

Second, every IO monad may have some API differences, and where Cats names their method `unsafeRunSync`, the Scalaz project names their similar method, `unsafePerformIO`. Both of these names are intended to show that some “unsafe” I/O is about to happen.

## The IO monad philosophy

The IO monad philosophy is described well in the [“An IO monad for Cats” article](#), so I’ll quote directly from there (with a few minor changes):

“In Haskell, *effects* are treated as first-class values. The `putStrLn` function doesn’t print to standard out, it returns a value (of type `IO ()`) which *describes* how to print to standard out, but stops short of actually doing it. These sorts of values can be composed using the monadic operators (think Scala’s `for` expression), allowing programmers to build up expressions composed of sequences of dependent effects, all of which are merely *descriptions* of the side-effects which will eventually be performed by the runtime. Ultimately, the description which comprises your whole program is the return result from the main function.”

## A small demonstration of that philosophy

That article includes a demonstration of that philosophy that I've converted into a small but complete application:

```
import cats.effect.IO

object Program extends App {

  val program: IO[Unit] = for {
    _ <- IO { println("Welcome to Scala!  What's your name?") }
    name <- IO { scala.io.StdIn.readLine }
    nameUC = name.toUpperCase
    _ <- IO { println(s"Well hello, $nameUC!") }
  } yield ()

  // ...
  // ...
  // some time later ...
  // ...
  // ...
  program.unsafeRunSync()
}
```

As this example shows, the IO monad helps you *compose* function calls in a *for* expression, where those functions can be a combination of a) pure functions, and b) functions with I/O side effects. After composing those function calls and saving the result in a variable, you can then trigger it to be “run” at some point later in your application.

## **Key point**

To be clear, the key point here is that using `IO` lets you write code that contains side effects in a compositional style. In short, if you want to write for expressions using pure functions and I/O functions in a compositional style, the `IO` monad provides a solution.



## Terminology

Haskell developers use the words “effect” and “action” when talking about the IO monad. I noted the word “effect” above, and with the reminder that `putStrLn` is defined like this:

```
def putStrLn(s: String): IO[Unit] = IO { println(s) }
```

this is how [Learn You a Haskell for Great Good!](#) uses the term “action” when describing `putStrLn`:

“We can read the type of `putStrLn` like this: `putStrLn` takes a string and returns an I/O action that has a result type of `()` (i.e. the empty tuple, also known as unit). An *I/O action* is something that, when performed, will carry out an action with a side-effect (usually either reading from the input or printing stuff to the screen), and will also contain some kind of return value inside it. Printing a string to the terminal doesn’t really have any kind of meaningful return value, so a dummy value of `()` is used.”

Here’s another quote from [Learn You a Haskell for Great Good!](#) that expands on that point:

“You can think of an I/O action as a box with little feet that goes out into the real world and does something there (like write some graffiti on a wall) and maybe brings back some data. Once it’s fetched that data for you, the only way to open the box and get the data inside it is to use the `<-` construct ... This is how Haskell manages to neatly separate the pure and impure parts of our code.”

While that quote is about Haskell, you can see the similarity to Scala/FP when

talking about the <- symbol. In fact, this Haskell application is equivalent to the last Scala application I showed in this lesson:

```
import Data.Char

main = do
  _      <- putStrLn "What's your name?"
  name   <- getLine
  let nameUC = map toUpper name
      putStrLn ("Well hello, " ++ nameUC)
```

The Haskell do construct is similar to the Scala for expression, and as this code shows, there are some striking visual similarities between the two constructs.

## See also

- [Towards an Effect System in Scala: IO Monad](#)
- [An IO monad for cats](#)
- [Should there be an IO Monad?](#)
- [Monadic IO: Laziness Makes You Free](#)
- [Learn You a Haskell for Great Good!](#)

# I'll Come Back to the IO Monad

I'll come back to the IO monad in a little while when I get to a point where I'll want to write applications using it and the State monad at the same time.

Until then, I want to point out one last thing: So far I've only shown how to use the IO monad with *\*console\** I/O. Can you guess why that is?

If you've read other Scala IO monad tutorials on the internet, you've probably noticed the same thing: Everyone shows how to use "console I/O," but nobody discusses other types of I/O, such as file, network, and database I/O. At some point the curious reporter in you has to wonder, "Why is that?"

I believe the reason for this has to do with *exception-handling*. For example, imagine that you already have a Scala function like this to read a text file into a `List[String]`:

```
def readTextFileAsTry(filename: String): Try[List[String]] = {
  Try {
    val lines = using(io.Source.fromFile(filename)) { source =>
      (for (line <- source.getLines) yield line).toList
    }
    lines
  }
}
```

That function uses Scala's `Try`, `Success`, and `Failure` classes to let you write code like this to handle exceptions:

```
val passwdFile = readTextFileAsTry("/etc/passwd-foo")
passwdFile match {
  case Success(lines) => lines.foreach(println)
  case Failure(s) => println(s"Failed, message is: $s")
}
```

Good questions at this time are:

- Should I wrap `readTextFileAsTry` with `IO`, so the return type becomes `IO[Try[List[String]]]`?
- Am I supposed to do something else?

I'll dig into these questions later, but first I want to dig into the State monad.

## Exercises

If you like open-ended exercises, I recommend the following:

1. Try wrapping the `readTextFileAsTry` function with the `IO` type to see what benefits and drawbacks that approach offers.
2. Try using a function like the [Apache Commons IO](#) project's `org.apache.commons.io.FileUtils::readFileToString` function — which can throw an `IOException` — with the Cats `IO` monad. What benefits and drawbacks does that approach offer with real-world code?

# Functional Composition

This is a good time to say that it's impossible to overstate how important *function composition* is to “Pure FP” developers. The desire to compose *everything* — to make all code read like algebraic equations — is immense. The Pure FP mantra can be stated as, “If functions can't be composed like algebraic equations, they're wrong.”

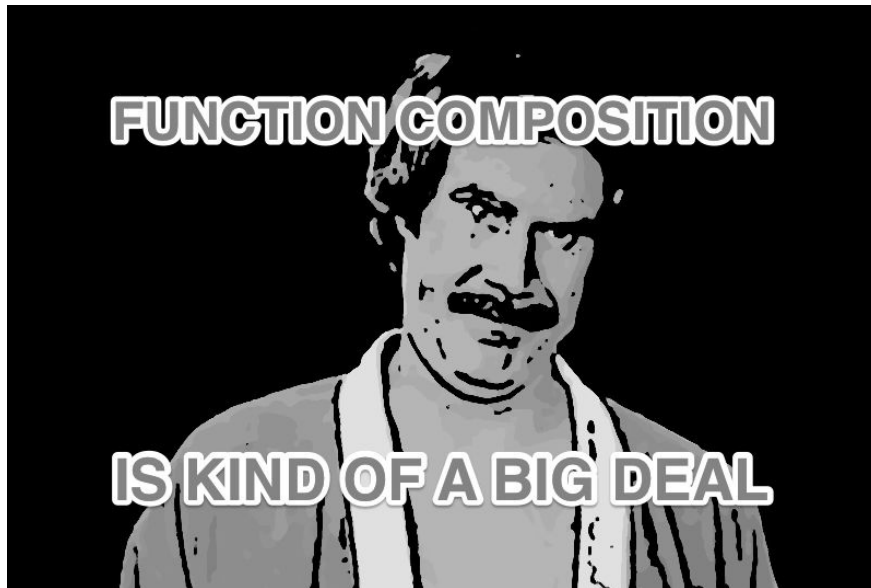

Function composition is kind of a big deal.

# Function composition in simple terms

[This page on utah.edu](#) offers a simple definition of function composition:

“*Composition* is a fancy term which means ‘combining’ ... Function composition is the process of combining two or more functions to produce a new function. Composing functions together is like snapping together a series of pipes for our data to flow through.”

Technically there are at least two types of function composition, but for now I’m only interested in the meaning of composition where you turn this code:

```
val y = g(x)
val z = f(y)
```

into this code:

```
val z = f(g(x))
```

Wikipedia refers to that last line as a “highly-composed form.”

The utah.edu page makes interesting points about these examples:

- You can refer to the first two lines as *non-composed* code.
- Non-composed code explicitly uses extra variables to hold the intermediate state (such as *y* in this example), while with the highly-composed form of code the compiler implicitly creates temporary, hidden variables behind the scenes.

My key points are:

- Function composition is like combining algebraic equations.
- You can only compose functions when your functions are pure.
- Beware: sometimes when you use *too much* function composition — i.e.,

the highly-composed form — your code can be hard to read. This isn't always true, but because we programmers spend the majority of our time reading code, this is something to keep an eye out for. (Make sure your code is easy to maintain.)



## An example of functional composition using IO

In theory, now that you have the [Cats](#) IO monad to make your I/O functions composable, you can compose the CoinFlip game inside a for expression:

```
def mainLoop(gameState: GameState, random: Random): IO[Unit] = for {
  _ <- IO { showPrompt() }
  userInput <- IO { getUserInput() }
  _ <- if (userInput == "H" || userInput == "T") for {
    // this first line is a hack; a for-expression must begin with a
generator
    _ <- IO { println("you said H or T") }
    coinTossResult = tossCoin(random)
    newNumFlips = gameState.numFlips + 1
    newGameState = createNewGameState(userInput, coinTossResult,
gameState, random, newNumFlips)
    _ <- IO {
printGameState(printableFlipResult(coinTossResult), newGameState)}
    _ <- mainLoop(newGameState, random)
  } yield Unit
else for {
  _ <- IO { println("did not enter H or T") }
  _ <- IO { printGameOver() }
  _ <- IO { printGameState(gameState) }
} yield Unit
} yield Unit

mainLoop(s, r).unsafeRunSync()
```

While I personally wouldn't want to maintain that particular block of code, I appreciate that it shows that with the addition of the IO monad, all of my code can theoretically be composed into one for expression, with one function call after another, with a few variable assignments mixed in as well.

When it makes sense, it can be good to write code like this. In this particular case I'm just showing this example to demonstrate that all of my function calls can be composed.

## Source code

You can download the source code shown at this URL:

- [github.com/alvinj/CoinFlipGameWithCatsIO](https://github.com/alvinj/CoinFlipGameWithCatsIO)

## See also

- The quotes in the utah.edu article are the same as in [this medium.com article](#).
- [The Wikipedia definition of function composition](#) states, “function composition is an act or mechanism to combine simple functions to build more complicated ones. Like the usual composition of functions in mathematics, the result of each function is passed as the argument of the next, and the result of the last one is the result of the whole.”

# An Introduction to Handling State

Keeping in mind that the end goal of these monad lessons is to be able to write my Coin Flip game (and other applications) entirely in a Scala/FP compositional style, the next thing I need to look at is how to handle “state” in an FP manner. (There’s no way for you to know that at this time, but I know that.)

## **Transitioning from IO to State**

While the IO monad is a wrapper that makes I/O functions easier to work with in `for` expressions, the State monad is a wrapper that makes the concept of “state” easier to work with in `for` expressions. The next few lessons will first demonstrate the problems of trying to work with state without a State monad, and then I’ll show how the State monad helps to alleviate those problems.

# Handling State Manually

If you don't happen to have a State monad laying around, you can still handle state in Scala/FP. The basic ideas are:

- First, create some sort of construct to model the state of your application at any moment in time. Typically this is a case class, but it doesn't have to be.
- Next, create a "helper" function that takes a) the previous state and b) some sort of increment or "delta" to that state. The function should return a new state based on those two values.

I'll demonstrate this process in this lesson.

## Source code

The source code for this lesson is available at:

- [github.com/alvinj/HandlingStateManually](https://github.com/alvinj/HandlingStateManually)

# Modeling my bad golf game, Part 1

My brother-in-law recently made me play golf, and as I don't play golf, the results were comical. But, the experience makes for a simple example of state, so here we go ...

Imagine that you're on the first hole of a golf course, and you swing at a ball three times, with these results:

- The first ball goes 20 yards
- The second ball goes 15 yards
- The third swing is a "swing and a miss," so technically the ball goes 0 yards

One way to model the state after each stroke is with a simple case class that stores the cumulative distance of all my swings:

```
case class GolfState(distance: Int)
```

Given that model, I can create a "helper" function named `nextStroke`. It takes the previous `GolfState` and the distance of the next stroke to return a new `GolfState`:

```
def nextStroke(
  previousState: GolfState,
  distanceOfNextHit: Int): GolfState = {
  GolfState(previousState.distance + distanceOfNextHit)
}
```

Now I can use those two pieces of code to create an application that models my three swings:

```
object Golfing1 extends App {
  def nextStroke(
    previousState: GolfState,
    distanceOfNextHit: Int): GolfState = {
    GolfState(previousState.distance + distanceOfNextHit)
  }

  val state1 = GolfState(20)
  val state2 = nextStroke(state1, 15)
  val state3 = nextStroke(state2, 0)

  println(state3) //prints "GolfState(35)"
}
```



```
}
```

In that application, these lines of code simulate my three swings at the ball:

```
val state1 = GolfState(20)
val state2 = nextStroke(state1, 15)
val state3 = nextStroke(state2, 0)
```

The last line of code prints the final golf state as `GolfState(35)`, meaning that the total distance of my swings is 35 yards.

This code won't win any awards — it's repetitive and error-prone — but it does show how you have to model changing state in a Scala/FP application with immutable state variables. (In the following lessons I show how to improve on this situation by handling state in a `for` expression.)

## Modeling my bad golf game, Part 2

While that example shows a basic solution to the problem at hand, a more real-world scenario is that you'll want to model the state by keeping a history of all golf strokes. Maintaining a history requires only a small change to the current code.

The following code shows one way to model a series of golf swings by using a state model that stores the series of golf strokes as a `List`:

```
object Golfing2 extends App {  
  case class GolfState(strokes: List[Int])  
  
  // take the old state, and an increment to that state  
  def nextStroke(gs: GolfState,  
                distanceOfNextHit: Int): GolfState = {  
    GolfState(distanceOfNextHit :: gs.strokes)  
  }  
  
  val state0 = GolfState(List())  
  val state1 = nextStroke(state0, 20)  
  val state2 = nextStroke(state1, 15)  
  val state3 = nextStroke(state2, 0)  
  
  println(state3) //prints "GolfState(List(0, 15, 20))"  
}
```

The important part of these examples is getting used to these patterns:

- Creating a case class to model the desired state
- Writing a function that takes a) an existing state, and b) an increment to that state, and returns a new state based on those values

## Aside: Thinking of state as pushing onto a list

As a brief aside, when you search the internet for State monad examples, you'll often see that people compare it to pushing items onto a list. That's a valid comparison, and in fact, I can rewrite the previous example like this:

```
object Golfing2bPushPop extends App {  
  def push[A](xs: List[A], a: A): List[A] = a :: xs  
  
  // model the three swings  
  val s0: List[Int] = Nil  
  val s1 = push(s0, 20)  
  val s2 = push(s1, 15)  
  val s3 = push(s2, 0)  
  
  // prints "List(0, 15, 20)"  
  println(s3)  
}
```

The concept of handling state in FP applications is often similar to pushing items onto a list, so examples like these are valid metaphors (though they're not complete on their own).

### *A pop function*

Note that a pop function isn't required for this example, but I can write one like this:

```
def pop[A](xs: List[A]): (A, List[A]) = (xs.head, xs.tail)
```

At the end of `Golfing2bPushPop` I can then use `pop` like this:

```
val (swing3, state2) = pop(s3)  
println(s"swing3 = $swing3") //swing3 = 0  
println(s"state2 = $state2") //state2 = List(15, 20)
```

## Recap

All of these examples show how to *manually* handle state in a Scala/FP application. You can significantly improve this situation by handling state in a `for` expression with a good State monad.

In the next lesson I'll show how to write a simple State monad that lets you *manually* handle state in a `for` expression. In the lesson after that I'll show how to completely automate state handling in a `for` expression with a significantly improved State monad.

# Getting State Working in a for Expression

Knowing that I wanted to get my code working in a for expression, I attempted to create my own State monad. I modeled my efforts after the wrapper and Debuggable classes I shared about 10-20 lessons earlier in this book. Starting with that code, and dealing with only Int values, I created the following first attempt at a State monad:

```
/**
 * this is a simple (naive) attempt at creating
 * a State monad
 */
case class State(value: Int) {

  def flatMap(f: Int => State): State = {
    val newState = f(value)
    State(newState.value)
  }

  def map(f: Int => Int) = State(f(value))
}
```

This code is very similar to the wrapper and Debuggable classes I created earlier in this book, so please see those lessons if you need a review of how this code works.

With this State monad in hand, I can write the following for expression to model my golf game:

```
object StateTester extends App {
  val res = for {
    a <- State(20)
    b <- State(a + 15) //manually carry over `a`
    c <- State(b + 0) //manually carry over `b`
  } yield c

  println(s"res: $res") //prints "State(35)"
}
```

The good news about this code is:

- It shows another example of a wrapper class that implements flatMap and map

- As long as I just need `Int` values, this code lets me use a concept of state in a `for` expression

Unfortunately, the bad news is that I have to manually carry over values like `a` and `b` (as shown in the comments), and this approach is still cumbersome and error-prone. Frankly, the only improvement I've made over the previous lesson is that I now have "something" working in a `for` expression.

What I need is a better `State` monad.

# Handling My Golfing State with a State Monad

Fortunately some other people worked on this problem long before me, and they created a better State monad that lets me handle the problem of my three golf strokes like this:

```
val stateWithNewDistance: State[GolfState, Int] = for {  
  _ <- swing(20)  
  _ <- swing(15)  
  totalDistance <- swing(0)  
} yield totalDistance
```

Unlike the code in the previous lesson, notice that there's no need to manually carry values over from one line in the for expression to the next line. A good State monad handles that bookkeeping for you.

In this lesson I'll show what you need to do to make this for expression work.

## Source code

The source code for this lesson is at:

- [github.com/alvinj/StateMonadExample](https://github.com/alvinj/StateMonadExample)



# Handling state with a State monad

With a properly-written State monad I can write an application to simulate my golf game like this:

```
object Golfing3 extends App {  
  case class GolfState(distance: Int)  
  
  def swing(distance: Int): State[GolfState, Int] = State { (s: GolfState) =>  
    val newAmount = s.distance + distance  
    (GolfState(newAmount), newAmount)  
  }  
  
  val stateWithNewDistance: State[GolfState, Int] = for {  
    _ <- swing(20)  
    _ <- swing(15)  
    totalDistance <- swing(0)  
  } yield totalDistance  
  
  // initialize a `GolfState`  
  val beginningState = GolfState(0)  
  
  // run/execute the effect.  
  // `run` is like `unsafeRunSync` in the Cats `IO` monad.  
  val result: (GolfState, Int) = stateWithNewDistance.run(beginningState)  
  
  println(s"GolfState:      ${result._1}") //GolfState(35)  
  println(s"Total Distance: ${result._2}") //35  
}
```

I'll explain this code in the remainder of this lesson.

## **GolfState**

First, as with the previous lesson, I use a case class to model the distance of each stroke:

```
case class GolfState(distance: Int)
```

There may be better names for this class, but I'm trying to emphasize the concept of state, so I use this name.

## The swing function

Next, assuming that you haven't worked with a State monad like this before, the swing function will require a little explanation:

```
def swing(distance: Int): State[GolfState, Int] = State { (s: GolfState) =>
    val newDistance = s.distance + distance
    (GolfState(newDistance), newDistance)
}
```

While swing is a little more gory than the nextStroke and push functions from the previous state lessons, it's similar in concept. The idea is that:

- It takes the distance of a golf swing as an input parameter
- It takes an old state as an input parameter (it takes this parameter as an input to the anonymous function)
- The result of the function is a new State instance that's created with the anonymous function
- The anonymous function adds a) the distance that's given as a function input parameter to b) the distance from the previous state, yielding a new distance
- The previous state is the State that's passed into the anonymous function (I name that variable s so the code will fit on one line in this book, but a better name is previousState)
- The new distance is used to yield a new tuple of (GolfState(newDistance), newDistance)
- The State monad yields that as a State[GolfState, Int]

### *swing uses an anonymous function*

Notice that the swing function uses many techniques that I demonstrated in the lessons leading up to this point. First, the highlighted section of code in Figure [fig:anonFunctionPassedIntoState] is an anonymous function.

```
def swing(distance: Int): State[GolfState, Int] = State { (s: GolfState) =>
    val newDistance = s.distance + distance
    (GolfState(newDistance), newDistance)
}
```

An anonymous function is passed into State to create the swing function.

The anonymous function can be read as, “Given an existing GolfState named s, calculate a new distance by adding the distance from s to the new distance that was passed in. Then use that new distance to create a new GolfState, and then return that new GolfState and the new distance as a Tuple2.” Because I’m using a State monad I have to yield what it wants, so I yield the Tuple2 as shown.

Next, notice in Figure [fig:newStateInstanceCreated] that a new State instance is created by passing that anonymous function into State’s constructor.

```
def swing(distance: Int): State[GolfState, Int] = State { (s: GolfState) =>
    val newDistance = s.distance + distance
    (GolfState(newDistance), newDistance)
}
```



A new State instance being constructed

A new State instance is created by giving it an anonymous function.

From the previous lessons you know this means that:

- State is either a case class, or a regular class with an apply method. (It could also be a function, but because State is capitalized, convention makes it most likely to be a class.)
- State’s constructor takes a function input parameter (FIP) or a by-name parameter (so it can accept an anonymous function as a parameter).

## The for expression

The next part of the code is this for expression:

```
val stateWithNewDistance: State[GolfState, Int] = for {  
  _ <- swing(20)  
  _ <- swing(15)  
  totalDistance <- swing(0)  
} yield totalDistance
```

All of the previous code was created to enable the for expression to be written like this. (This is a good time to note that earlier in the book I wrote, “Writing pure functions is easy, gluing them together is hard.”)

This expression assigns a block of code to the variable named `stateWithNewDistance`, where the “block of code” is the for expression that models my three swings. As usual, it isn’t necessary to show the variable’s type, but I do so to be clear that it’s an instance of `State`, specifically a `State[GolfState, Int]` instance.

An important point to notice in this code is that I don’t have to *manually* carry the state over from one line in the for expression to the next line. Because I’m working with a well-written `State` monad, its “magic” takes care of that bookkeeping for me.

## The action begins

In the final part of the code, the action begins. First I create an initial state:

```
val beginningState = GolfState(0)
```

Next, I kick off the action by invoking a run method on the state monad instance, giving it my beginningState to get it started:

```
val result: (GolfState, Int) = stateWithNewDistance.run(beginningState)
```

This run function has the same purpose as the unsafeRunSync method on the Cats IO monad, letting you defer the execution until a later time.

That line of code executes the for expression, and when it's finished running I print out the final result:

```
println(s"GolfState:      ${result._1}") //GolfState(35)
println(s"Total Distance: ${result._2}") //35
```

## The advantages of a State monad

As you can see from the code in this lesson, the advantages of a State monad are:

- It can be used in a for expression
- Inside the for expression it handles all of the bookkeeping involved in transitioning from one state to another, so you don't have to handle it manually

## **The disadvantages of a State monad**

Conversely, the primary disadvantage of a State monad is that some of your other code — such as the `swing` function — gets a little more complicated. In the long run this is offset somewhat by the fact that the state-handling pattern is pretty consistent; there's always a function like `swing` that helps automate the dirty work.



# The State Monad Source Code

Until this point I treated the State monad code as a black box: I asked you to use it as though it already existed in the Scala libraries, just like you use `String`, `List`, and hundreds of other classes without thinking about how they're implemented.

My reason for doing this is that the State code is a little complicated. You have to be a real master of `for` expressions to be able to write a State monad that works like this.

Note: A “master of `for` expressions” is a goal to shoot for!

In a way, the State monad just implements `map` and `flatMap` methods, so it's similar to the `Wrapper` and `Debuggable` classes I created previously. But it also takes those techniques to another level by using generic types, by-name parameters, and anonymous functions in several places.

## Source code

The source code for this lesson is at the same URL as the previous lesson:

- [github.com/alvinj/StateMonadExample](https://github.com/alvinj/StateMonadExample)

## The State source code

Here's the source code for the State monad I used in the previous lesson:

```
case class State[S, A](run: S => (S, A)) {  
  def flatMap[B](g: A => State[S, B]): State[S, B] = State { (s0: S) =>  
    val (s1, a) = run(s0)  
    g(a).run(s1)  
  }  
  def map[B](f: A => B): State[S, B] = flatMap(a => State.point(f(a)))  
}  
object State {  
  def point[S, A](v: A): State[S, A] = State(run = s => (s, v))  
}
```

In this code the generic type S stands for “state,” and then A and B are generic type labels, as usual.

In this first version of this book I'm not going to attempt to fully explain that code, but I encourage you to work with it and modify it until you understand how it works.

## A few points worth noting

One point I need to mention is that `State` takes a constructor parameter named `run`. The anonymous function I highlighted in the previous lesson is what's assigned to `run`, as shown in Figure [fig:constructorParamRunBoundToBlock].

```
def swing(distance: Int): State[GolfState, Int] = State { (s: GolfState) =>
  val newDistance = s.distance + distance
  (GolfState(newDistance), newDistance)
}
```



this code block is assigned  
to the `run` variable

The constructor parameter `run` is bound to the highlighted block of code.

In the previous lesson, this line of code passed `beginningState` into `run`:

```
val result: (GolfState, Int) = stateWithNewDistance.run(beginningState)
```

As a result, the parameter `s` in the anonymous function is bound to `beginningState` when that line of code is reached. Therefore, you can think of the first line of the anonymous function as using `beginningState` rather than `s`:

```
val newDistance = beginningState.distance + distance
-----
```

### ***Don't be intimidated!***

I'll also make two other points at this time. First, I doubt that anyone wrote a `State` monad like this on their first try. I'm sure it took several efforts before someone figured out how to get what they wanted in a `for` expression.

Second, while this code can be hard to understand in one sitting, I've looked at some of the source code inside the Scala collections classes, and there's code in there that's also hard to grok. (Take a look at the sorting algorithms and you'll see what I mean.) Personally, the only way I can understand complex code like this is to put it in a Scala IDE and then modify it until I make it my own.

## Where State comes from

I believe the original version of this State code came from this Github URL:

- [github.com/jdegoes/lambdaconf-2014-introgame](https://github.com/jdegoes/lambdaconf-2014-introgame)

As the text at that link states, “This repository contains the material for *Introduction to Functional Game Programming with Scala*, held at LambdaConf 2014 in Boulder, Colorado.” While I find a lot of that material to be hard to understand without someone to explain it (such as at a conference session), Mr. De Goes created his own State monad for that training session, and I believe that was the original source for the State monad I just showed.

Much of the inspiration for this book comes from attending that conference and thinking, “I have no idea what these people are talking about.”

## Make it your own!

As a final example of what I mean by “working with that code to make it your own,” this is what I did with another State monad that I found running wild on the internet:

```
case class State[A,S](run: S => (A,S)) {  
  
  // s1 = state1, s2 = state2, s3 = state3  
  def flatMap[B](f: A => State[B,S]): State[B,S] = State { s1: S =>  
    val (a, s2) = run(s1)  
    val stateChangeToB = f(a)  
    val (b, s3) = stateChangeToB.run(s2)  
    (b, s3)  
  }  
  
  def map[B](f: A => B): State[B,S] =  
    flatMap(a => State.lift(f(a)))  
}  
  
object State {  
  /**  
   * "lifts" a value and a state into a State[S,A]  
   */  
  def lift[A,S](value: A): State[A,S] = State(state => (value, state))  
}
```

Note: Most experienced FP developers seem to prefer the name `point` for the method in the object, but I prefer the name `lift`. I like to think that this method “lifts” a normal variable (such as an `Int`) into the monad. (If you think of a monad as a wrapper, another possible name for this method is `wrap`.)

I don’t remember for sure, but I believe that I found the original version of this state code in some work by James Earl Douglas, possibly on this slide:

- [Slide #3 from a presentation on the State Monad](#)

Again, if you want to understand how the State monad works, it’s important to work with the code to make it your own. Change the variable names as desired, add debug statements to the code, break the highly-composed lines into non-composed lines — do whatever you need to do to understand how it works.

# Signpost: Getting IO and State Working Together

The next section of this book contains twelve short lessons that show how to get the IO and State monads working together in a `for` expression.

## Source code

The source code for all of the following StateT “monad transformer” lessons is available at this Github URL:

- [StateT monad transformer source code](#)



# Trying to Write a for Expression with IO and State

At this point I'd *like* to be able to show you how to use the IO and State monads together in a for expression.

Unfortunately, that's not possible.

As John De Goes writes in his [LambdaConf 2014 project notes](#):

“It turns out that for theoretical reasons, we can't just take any two monads  $M_1$  and  $M_2$  and combine them into another monad  $M_3$ . It's not possible.”

If you've ever seen the image shown in Figure [fig:howWriteHelloWorldHaskell], it pretty much expresses the frustration I felt when I first read that sentence.

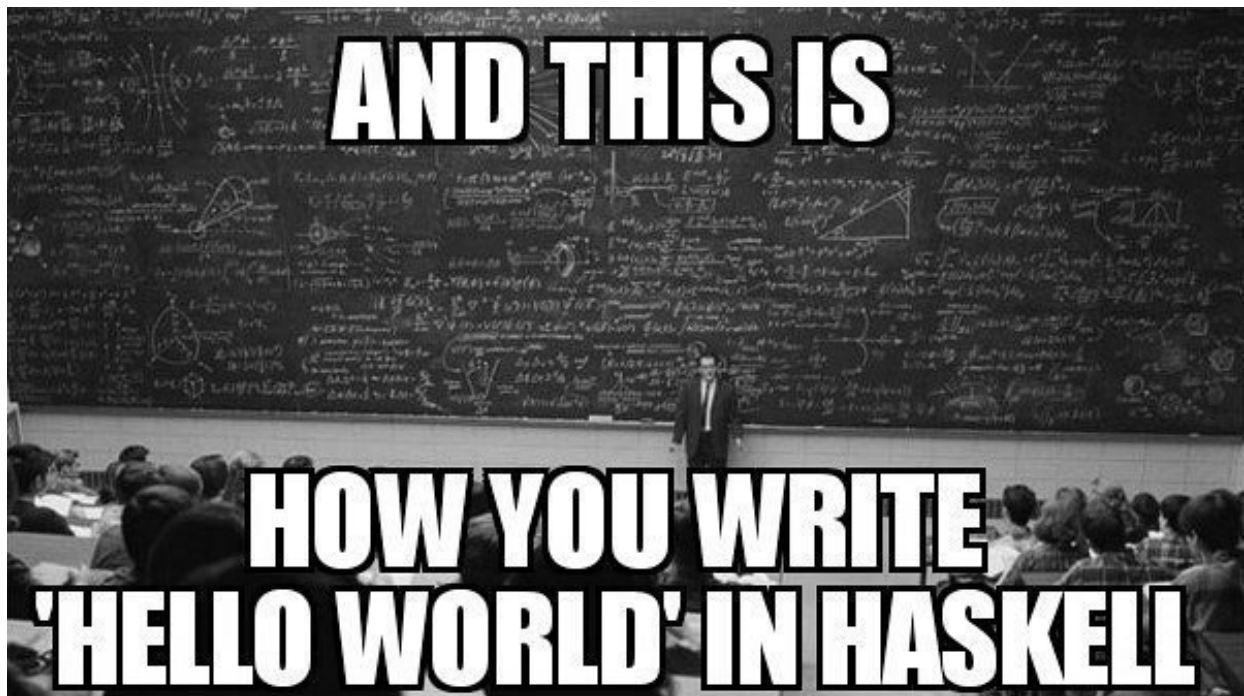

How you write “Hello, world” in Haskell. (I don't know the original creator of

this image.)

Fortunately, Mr. De Goes goes on to add these statements:

“However, there are a number of ways to combine monadic effects, ranging from Free monads to monad zippers and views to monad coproducts (and lots more). The particular approach we’re going to look at involves *monad transformers*.”

I’ll follow his approach in this section of the book, culminating with writing for expressions that use the concepts of I/O and State in a way that is pleasing to experienced Scala/FP developers.

# Seeing the Problem: Trying to Use State and IO Together

If you're interested in seeing the problem yourself, you can write a little test for expression that uses IO and State. Interestingly, when I put this code in an IDE, the IDE initially doesn't show any errors:

```
object TryStateAndIoTogether extends App {  
  /**  
   * State code  
   */  
  type Stack = List[String]  
  def push(x: String): State[Stack, Unit] = State[Stack, Unit] {  
    xs => (x :: xs, ())  
  }  
  
  /**  
   * IO functions  
   */  
  def getLine: IO[String] = IO(scala.io.StdIn.readLine())  
  def putStrLn(s: String): IO[Unit] = IO(println(s))  
  
  /**  
   * main loop: Prompt a user for some input, then push that input  
   * onto a stack  
   */  
  val res = for {  
    _ <- putStrLn("Type anything:") //IO  
    input <- getLine //IO  
    _ <- push(input) //State  
    _ <- putStrLn(s"Input: $input") //IO  
  } yield ()  
}
```

But when I attempt to run that App, I see the following error output:

```
Error:(31, 15) type mismatch;  
found   : IO[Unit]  
required: State[Stack,?]  
  (which expands to) State[List[String],?]  
    _ <- putStrLn(s"Input: $input")  
  
Error:(30, 15) polymorphic expression cannot be instantiated  
to expected type;  
found   : [B]State[Stack,B]  
  (which expands to) [B]State[List[String],B]  
required: IO[?]  
    _ <- push(input)  
  
Error:(30, 15) type mismatch;  
found   : State[Stack,B]
```

```
(which expands to) State[List[String],B]
required: IO[?]
  _    <- push(input)
Error:(28, 15) type mismatch;
found   : Unit => IO[Nothing]
required: Unit => IO[B]
  _    <- putStrLn("Type anything:")
```

The short version of those errors messages is that there are “type mismatches,” the worst of which is:

```
found   : IO[Unit]
required: State[Stack,?]
```

In this error message the compiler is saying, “I expected State here, but you gave me IO.”

If you attempt to translate that for expression into a series of flatMap and map calls, you’ll see the type mismatches. In short, because the return type of some method calls doesn’t match the expected input parameters of other methods, the code won’t compile. What we need is a series of flatMap calls that all return and expect the same wrapper type.

# Solving the Problem with Monad Transformers

As background for where we're about to go, I want to share one more quote from Mr. De Goes:

*“A monad transformer is a special version of a monad that can stack its own effects on those of another monad. If you stack a monad transformer on another monad, the result forms a monad, which combines the effects of both monads together.”*

*“Not all monads have monad transformers. For example, the IO monad doesn't have a transformer version. Fortunately, we're in luck: while IO doesn't come in a transformer flavor, the State monad does.”*

## The StateT monad transformer

The State monad transformer is named `StateT`. By convention monad transformers have a `T` at the end of their name, so in this case `StateT` is the monad transformer version of `State`. Similarly, an `Option` monad transformer is named `OptionT`.

In the following lessons I'll show everything that's needed to use the `StateT` monad transformer so you can use the concepts of I/O and `State` together in a `for` expression.

# **Beginning the Process of Understanding StateT**

## Source code

As a reminder, the source code for all of the `StateT` “monad transformer” lessons is available at this Github URL:

- [StateT monad transformer source code](#)



## Background

In the previous lessons I showed that you can't write a `for` expression that tries to use an `IO` monad and a `State` monad together. If you write out the equivalent `map/flatMap` calls, you'll see that the data type returned by one method won't match up with the type expected by another method.

As I mentioned, there are a few possible ways to solve this problem, and one common approach is to use something called a *monad transformer*.

## Goal for the StateT lessons

The main goal for these lessons is to show how to use a monad transformer named `StateT` that lets us use the concepts of I/O and State together in a `for` expression. By the end of these `StateT` lessons I'll show how to create and understand the following code:

```
def sumLoop: StateT[IO, SumState, Unit] = for {
  _ <- putStrAsStateT("\ngive me an int, or 'q' to quit: ")
  input <- getLineAsStateT
  _ <- if (input == "q") {
    liftIoIntoStateT(IO(Unit))
  } else for {
    i <- liftIoIntoStateT(IO(toInt(input)))
    _ <- doSumWithStateT(i)
    _ <- sumLoop
  } yield Unit
} yield Unit

val result = sumLoop.run(SumState(0)).run
println(s"Final SumState: ${result}")
```

In the process of building up to this `for` expression, I'll show several smaller examples of the individual functions.

## What that for expression does

Because that code is a series of functions you haven't seen before, it's hard to tell what that expression does, but the way it works is:

- `putStrAsStateT` prompts a user to enter an integer value, or `q` to quit
- `getLineAsStateT` reads the user input
- If the user enters `q`, the loop exits
- Otherwise, `toInt` is called to convert the input to an `Int`
- That `Int` is wrapped in an `IO` and then a `StateT`
- The game state is updated with the new `Int`
- The `sumLoop` function is called recursively

Here's an example of what this code looks like when it's run:

```
give me an int, or 'q' to quit: 1
updateIntState, old sum:  0
updateIntState, new input: 1
updateIntState, new sum:  1

give me an int, or 'q' to quit: 2
updateIntState, old sum:  1
updateIntState, new input: 2
updateIntState, new sum:  3

give me an int, or 'q' to quit: 3
updateIntState, old sum:  3
updateIntState, new input: 3
updateIntState, new sum:  6

give me an int, or 'q' to quit: q
Final SumState: (SumState(6),())
```

To see that output on your system, run the class named `LoopWithQuitLotsOfDebug` in the package `v3_loop_with_quit` in the source code for this lesson.

## Motivation

While this may not be the most exciting loop ever created, if you can understand how it works, you'll understand the `StateT` monad transformer, which is probably the most difficult concept in this book. Once you understand it, you'll also understand how monad transformers work in general, meaning that you'll be able to use other transformers, such as `OptionT` in the Cats library.

Furthermore, while this may sound like a bit of hyperbole, I hope you'll also be able to understand every good monad tutorial that has ever been written, and you'll also be able to understand books like [Functional Programming in Scala](#), [Functional and Reactive Domain Modeling](#), and the monad lessons in [Advanced Scala with Cats](#). More importantly, beyond being able to understand all of those resources, I hope you'll be able to use monads and monad transformers to solve real-world problems.

In case I didn't stress that enough, being able to understand monad transformers is a big deal. This topic is basically the "peak of the monad mountain" for FP and this book.

# Getting Started: We're Going to Need a Monad Trait

One thing that hasn't been important to our Scala/FP lives yet is that the standard Scala library doesn't define a Monad trait. Even though I've said that types like `Option`, `List`, and `Future` work like monads, you won't find code like this in the standard library:

```
// this code IS NOT in the Scala standard library
trait Monad
class Option extends Monad
class List extends Monad
class Future extends Monad
```

Until now it didn't matter to us that those types don't extend a base Monad trait because we could use all of those types *as if* they were monads because they implement `map` and `flatMap`.

However, because we're now at a point where we need to use the `StateT` monad transformer, and because a transformer can only be stacked on a type that is a known monad — i.e., a type that extends a Monad trait — we need to do a little work to let us use classes like `Option`, `List`, and `Future` with `StateT`.

Specifically:

- We need to define a Monad interface (a trait).
- We need to define the types we want to use as monads as instances that extend the Monad interface. This will let us use them with `StateT`.

Once we have a Monad trait and a `StateT` class, we'll be able to write the loop shown at the beginning of the previous lesson.

In the real world you won't have to go through this process; you can just use the `Monad` and transformer types from a Scala/FP library like [Cats](#). I'm only taking you through this process so you can understand some of the things that are happening behind the scenes.

## A Monad interface

I'm not going to take you all the way through the development of a Monad trait, but I will take you through the initial part of the thought process.

In Scala, you create a Monad interface by defining a trait that declares three methods: the usual `map` and `flatMap` methods, and also a `lift` method that “lifts” a normal value into the monad.

FP experts prefer to use names like `point` or `pure` instead of `lift`, but because the purpose of the method is to “lift” a normal value into a monad, I prefer the name `lift`. It's like when you write `Some(1)`; the `apply` method in `Some`'s companion object essentially “lifts” the regular integer value `1` into the `Some` wrapper.

Knowing that a Monad interface needs these three methods, I begin sketching the interface like this:

```
trait Monad {  
  def flatMap  
  def map  
  def lift  
}
```

Having seen `flatMap` before, you know that it takes a function that transforms a type `A` to a type like `Wrapper[B]`. In this case the wrapper is named `Monad`, so a first stab at `flatMap`'s signature looks like this:

```
def flatMap[A, B](f: A => Monad[B]): Monad[B]
```

Similarly, you've seen that `map` is a method that takes a function that transforms a type `A` to a type `B`, and then returns a result like `Wrapper[B]`. Therefore, a first stab at `map`'s signature looks like this:

```
def map[A, B](f: A => B): Monad[B]
```

Finally, knowing that the purpose of the `lift` method is to lift a normal type `A` into a wrapper, a first stab at its signature looks like this:

```
def lift[A](a: A): Monad[A]
```

Putting those together, a first sketch of a Monad interface looks like this:

```
trait Monad {  
  def lift[A](a: A): Monad[A]  
  def map[A, B](f: A => B): Monad[B]  
  def flatMap[A, B](f: A => Monad[B]): Monad[B]  
}
```

I'm going to stop at this point because I don't want to get into the gory details, I just want to give you an idea of what the interface looks like. (If you'd like to see the final implementation of the Monad trait, see the source code that comes with this project. But don't get bogged down in that code. Right now it's more important to learn how to *use* a Monad trait, not how to *write* one.)

## Creating two Monad instances

As an example of how a Monad trait can be used, if I was in a situation where I needed to use the Scala `Option` as a real Monad, I'd create an `OptionMonad` instance like this:

```
implicit val OptionMonad = new Monad[Option] {  
  def flatMap[A, B](ma: Option[A])(f: A => Option[B]): Option[B] = ma.flatMap(f)  
  def lift[A](a: => A): Option[A] = Some(a)  
}
```

For the purposes of creating my `for` expression I don't need an `OptionMonad`, but because I want to use the `IO` monad I've been using in this book with `StateT`, I *do* need an `IOMonad` instance:

```
implicit val IOMonad = new Monad[IO] {  
  def flatMap[A, B](ma: IO[A])(f: A => IO[B]): IO[B] = ma.flatMap(f)  
  def lift[A](a: => A): IO[A] = IO(a)  
}
```

Notice a few things:

- The `flatMap` signature is a little more complicated than what I showed in my trait, requiring two input parameter groups. (More on this shortly.)
- I don't define a `map` method because the `map` method I inherit from the `Monad` trait provides the right behavior for them.
- I mark `IOMonad` as `implicit`. I do this so it can be “pulled into” some of the code that follows. (More on this shortly.)



## **Key points**

In summary, I created a Monad trait so I could create an IO Monad instance. Because IO Monad extends Monad, I'll be able to use it with the StateT class that we'll develop next.

# Now We Can Create StateT

Now that I have a formally-defined `Monad` trait, I can use it with a `StateT` class. The guts of the `StateT` class are pretty gory, so I won't show all of the code here, but I will highlight the important things to know about it.

## StateT constructor's run parameter

The first thing to know is that similar to the State monad I showed in previous lessons, the StateT constructor takes a run parameter. run is defined as a function input parameter, so you need to supply it a function when creating a new StateT instance, and it has this type signature:

```
case class StateT(run: S => M[(S, A)]) {  
  -----
```

run's signature says that it's a function that transforms a state S to a tuple (S, A) that's wrapped by a monad M. In the previous state lessons, the run parameter in State had the type S => (S, A), so the change here is that the function that's passed in must further wrap (S, A) in a monad. Right away this shows why we needed to formally define a Monad type.

There's no way for you to know from looking at only this signature that M stands for Monad, S stands for state, and A stands for a base type (something like Int). The only way you could really know that — besides me telling you — is to look at StateT's Scaladoc or its source code.

## StateT's flatMap signature

A second thing to know about StateT is that its flatMap signature looks like this:

```
def flatMap[B](g: A => StateT[M, S, B])(implicit M: Monad[M]):  
  StateT[M, S, B] = StateT { (s0: S) =>
```

Notice that it has two parameter groups, and the second parameter group takes an implicit Monad input parameter:

```
def flatMap[B](g: A => StateT[M, S, B])(implicit M: Monad[M])  
  -----
```

This is why I defined the IO Monad to be an implicit variable in the previous lesson:

```
implicit val IO Monad = new Monad[IO] ...  
-----
```

In the code in the following lessons, what happens is that when an implicit instance of IO Monad is in scope when flatMap is invoked, the implicit instance is automatically pulled into flatMap's second parameter group.

Another point to notice about StateT's signature is that its return type is StateT[M, S, B]:

```
def flatMap[B](g: A ...)(...): StateT[M, S, B]  
-----
```

This means that flatMap returns a StateT instance, specifically of the type StateT[M, S, B], where M is a monad, S is a state, and B is the transformed version of the base type A.

I know that these details may not be too meaningful yet, but I want to point them out before we continue. If you come back to this lesson after you see the code that follows, I believe they'll be more meaningful then.

If you want to see all of StateT, see the source code for these lessons. (But again, don't get caught up in it. The current goal is to learn how to *use* StateT, not how to *write* it.)

# Using StateT in a for Expression

Given a Monad and a StateT with the attributes described in the previous lessons, we now have enough code to show a few examples of how StateT works. In this lesson I'll create the following for expression that uses the add and multiply functions I'm about to build:

```
val forExpression: StateT[IO, IntState, Int] = for {  
  _ <- add(2)  
  _ <- add(3)  
  x <- multiply(10)  
} yield x
```

## Source code

The source code for this lesson is in the package named `v1_hard_coded_for`, in [the same repository](#) as all of the other StateT lessons.

## A class to hold the state

The first thing I'll do is create a little case class to hold the state of this application, just like I did with the `GolfState` class in the “Handling State Manually” lesson:

```
case class IntState(i: Int)
```

Just as with those State lessons, this is a simple container for the “state” in my application.

## An “add” function

Next, I’ll create an add function that works with the StateT monad:

```
def add(i: Int) = StateT[IO, IntState, Int] { oldState: IntState =>
  val newValue = i + oldState.i
  val newState = oldState.copy(i = newValue)
  IO(newState, newValue)
}
```

Remember that StateT’s constructor takes the function input parameter named run, so everything between the curly braces is an anonymous function that I’m passing into run.

You can read add’s code like this:

- add takes an input parameter named i, which has the type Int
- add’s body creates a new StateT instance, specifically a StateT[IO, IntState, Int]
- The StateT instance is created by passing the anonymous function that’s defined in between the curly braces into StateT’s constructor
- The anonymous function adds the value i to oldState.i to create newValue
- A newState of type IntState (not shown) is created from oldState, using the usual copy process to update its field i
- In the last line, the newState and newValue are wrapped in an IO

In the end, the result of calling add is a new StateT instance that specifically has the type StateT[IO, IntState, Int].



## A “multiply” function

Next, I can do the same thing to create a multiply function:

```
def multiply(i: Int) = StateT[IO, IntState, Int] { oldState: IntState =>
  val newValue = i * oldState.i
  val newState = oldState.copy(i = newValue)
  IO(newState, newValue)
}
```

Because this function is identical to the previous function — with the exception that it multiplies `i` by `oldState.i` — I won’t describe it again.

## Testing add

Before using these functions in a `for` expression it can help to demonstrate how the `add` function works outside of a `for` expression. First, I can call `add` like this:

```
val a = add(1) //StateT[IO, IntState, Int]
```

As the comment shows, `a` has the type `StateT[IO, IntState, Int]`. Therefore, this code can be read as, “I have a `StateT` instance named `a` that’s primed to add 1 to something.”

The way you use the `StateT` instance `a` is that you give an *initial state* to `a`’s `run` method, like this:

```
val b = a.run(IntState(1)) //IO[(IntState, Int)]
```

Here I’ve given `a` the initial state `IntState(1)` to create the variable `b`. Intuitively you can guess that somewhere within the final result of this effort you’ll find a 2, but at this point that result is wrapped inside the `IO` type (shown in the comment).

As the comment in that code shows, `b` has the type `IO[(IntState, Int)]`, meaning that it’s an `IO` wrapped around a tuple. The `IO` part doesn’t make much sense in this little example — I’m not using any form of I/O yet — but I can extract the tuple out of the `IO` and print the `IntState` like this:

```
b.map(t => println(s"b state = ${t._1}"))
```

That code results in this output:

```
b state = IntState(2)
```

`IO` doesn’t have a `foreach` method, so I use `map` for the purpose of printing the `IntState` value.

As a review, here’s all of the code again:

```
val a = add(1) //StateT[IO, IntState, Int]
val b = a.run(IntState(1)) //IO[(IntState, Int)]
b.map(t => println(s"b state = ${t._1}"))
```

Given this overview of how add works, let's create a for expression that uses StateT.

## Using StateT in a for expression

Next, let's use the `add` and `multiply` functions in a more normal way — in a `for` expression. I won't use any I/O functions just yet, but this example shows how to use `add` and `multiply` in a `for` expression with a few hard-coded values:

```
val forExpression: StateT[I0, IntState, Int] = for {
  _ <- add(2)
  _ <- add(3)
  x <- multiply(10)
} yield x
```

This creates the variable `forExpression` as a `StateT` instance. As you saw in the previous example, you “run” a `StateT` instance by calling its `run` method while giving it an initial state:

```
val result: IO[(IntState, Int)] = forExpression.run(IntState(1))
-----
```

Supplied with that initial state, these comments show how the `for` expression works:

```
val forExpression: StateT[I0, IntState, Int] = for {
  _ <- add(2)           //2+1 = 3 (1 is run's seed value)
  _ <- add(3)           //3+3 = 6
  x <- multiply(10)     //6x10 = 60
} yield x
```

As the comments show, the final result is `60`, but we also know that `result`'s type is `IO`:

```
val result: IO[(IntState, Int)] = forExpression.run(IntState(1))
--
```

Because `result` is a tuple wrapped in an `IO`, I extract the `IntState` value from `result` like this:

```
result.map(tuple => println(s"IntState = ${tuple._1}"))
```

That code prints this output:

```
IntState = IntState(60)
```

## Key points

While this example uses hard-coded `Int` values, it shows how to use functions that yield a `StateT` inside a `for` expression.

Furthermore, it lays the foundation for what's next: I'll add some I/O functions into a `for` expression, and that will let us *really* use an IO monad with the `StateT` monad in a `for` expression.

# Trying to Combine IO and StateT in a for Expression

At this point I'm going to try to write my "sum up the integers a user gives me" for expression using IO and StateT. As I try to write it, I'll figure out what parts are missing, and add them in as I go along.

First, a reminder that the intent of this application is to:

- Prompt the user for input, which hopefully will be an Int value
- Sum up those Int values in the loop
- When the user types the letter q, the loop will exit

## Source code

The source code for this lesson is in the package named `v2_loop_without_quit`, in [the same repository](#) as all of the StateT lessons. Work with the `LoopWithoutQuitLotsOfDebug` class to see a lot of debug output, or the `LoopWithoutQuitNoDebug` class to run the application without debug output.

## I/O functions

One of the first things I'll need to solve this problem are some I/O functions to prompt the user and then read their input. I'll start with the IO functions I used in previous lessons:

```
def getLine(): IO[String] = IO(scala.io.StdIn.readLine())  
def putStr(s: String): IO[Unit] = IO(print(s))
```

For this lesson I changed the function `putStrLn` to `putStr` because I don't want it to print a newline character after printing the string, but otherwise it's the same as before.



## A toInt function

Next, I need a function to transform a `String` to an `Int`. This function will do the trick:

```
def toInt(s: String): Int = {
  try {
    s.toInt
  } catch {
    case e: NumberFormatException => 0
  }
}
```

In this case, `toInt` returns an `Int` rather than an `Option[Int]`. I did that to make my `for` expression simpler.

## A “state” class

Next, I need a little case class to hold the state of the application. In this case I need to track the sum of the integers the user gives me, so I create this class:

```
case class SumState(sum: Int)
```

## A state-updating function

Next up, I need a function to update the application’s state when a user gives me a new `Int`. Because this is a “sum” function, all I need to do is re-use the `add` function I showed in the previous lesson. I’ll just give it a new name that makes more sense in the context of this application:

```
def updateAppState(newValue: Int):
  StateT[IO, SumState, Int] = StateT { (oldState: SumState) =>

    // create a new sum from `i` and the previous sum from `s`
    val newSum = newValue + oldState.sum

    // create a new SumState
    val newState: SumState = oldState.copy(sum = newSum)

    // return the new state and the new sum, wrapped in an IO
    IO(newState, newSum)
  }
```

I didn’t mention it before, but notice that this function’s return type gives you a hint of how `StateT` and `IO` work together; `StateT` is a wrapper, and one of the things it wraps is an `IO`:

```
StateT[IO, SumState, Int]
--
```

Because `StateT` encapsulates both concepts — `State` and `IO` — in one type, it lets us use both types in a `for` expression.

## Trying to use all of this in a for expression

If I ignore the “type q to quit” part of the application I can write a for expression like this:

```
def sumLoop: StateT[IO, SumState, Unit] = for {
  _ <- putStr("\ngive me an int: ") /**
  input <- getLine /**
  i <- IO(toInt(input)) /**
  _ <- updateAppStateT(i)
  _ <- sumLoop
} yield Unit
```

Unfortunately this code won't work. The first three lines inside the for expression — the ones tagged with the \* comment — return an IO type, and updateAppStateT returns a StateT type.

This is a good time to mention an extremely important point:

- For this process to work, every function call inside the for expression must return a type of StateT[IO, SumState, A]

The type A can vary — it can be a String or Int as needed in this example — but each function must return a StateT[IO, SumState, A].

Therefore, knowing that the problem is (a) those functions return IO, and (b) they need to return StateT[IO, SumState, A], the solution is (c) I need to wrap those IO functions somehow so they'll return the correct type.

# Fixing the IO Functions With Monadic Lifting

We're at a point where the I/O functions in the previous lesson return an IO type, but they *need* to return a `StateT[IO, SumState, A]`. Let's fix this problem.

My I/O functions currently look like this:

```
def getLine(): IO[String] = IO(scala.io.StdIn.readLine())
def putStr(s: String): IO[Unit] = IO(print(s))
```

To work in the `for` expression they need to return the type `StateT[IO, SumState, A]`, so what can I do?

The solution is something called *monadic lifting*. Once again I need to “lift” something, and in this case I need to lift the type `IO[A]` into the type `StateT[IO, SumState, A]`.

## Source code

You can see the source code for the `liftIoIntoStateT` function in the package named `v2_loop_without_quit`, in [the same repository](#) as all of the `StateT` lessons.

## The “lift” function

Knowing that I need to write a function that lifts an `IO[A]` into the type `StateT[IO, SumState, A]`, I can sketch the initial function signature like this:

```
def lift(io: IO[A]): StateT[IO, SumState, A] = ???
```

At this point I’ll just show the complete function that does the lifting. The function is really just one line long, but I split it into several lines so I can add some comments to it:

```
def liftIoIntoStateT[A](io: IO[A]):  
  StateT[IO, SumState, A] = StateT { s: SumState =>  
  
    // transform `IO[A]` into `IO(SumState, A)`  
    val result: IO[(SumState, A)] = io.map(a => (s, a))  
  
    // use this as a way to see what's going on here.  
    // if you enter 1 and then 2 you'll see the output,  
    // `(SumState(1), 2)`.  
    //result.map(tup => println(s"lift: (${tup._1},  
    //${tup._2}"))  
  
    // yield the result of this anonymous function (which  
    // will be wrapped by StateT)  
    result  
  }
```

As the function signature shows, this function takes an `IO[A]` input parameter and yields a `StateT[IO, SumState, A]` type, which tells you that it “lifts” the given `IO` value into `StateT`. The `io.map` call inside the anonymous function merges the `io` input parameter and the `SumState` parameter `s` into a new type of `IO[(SumState, A)]`. Then that type is fed into `StateT`’s constructor to yield the final type, `StateT[IO, SumState, A]`.

As I mentioned, the anonymous function body is really only one line long; I just added the extra debug code so you can see the type inside the body. Here’s what the function looks like without the intermediate steps:

```
def liftIoIntoStateT[A](io: IO[A]):  
  StateT[IO, SumState, A] = StateT { s: SumState =>  
    io.map(a => (s, a)) //IO[(SumState, A)]  
  }
```

The end result is that you can use this function to lift variables of type `IO[A]` into `StateT`, specifically the type `StateT[IO, SumState, A]`.

## Creating new I/O functions

Now we can use this function to create new I/O functions that yield a `StateT` so they can be used in the “sum the integers” for expression. First, I use `liftIoIntoStateT` to transform `getLine` into a new function I name `getLineAsStateT`:

```
def getLineAsStateT(): StateT[IO, SumState, String] =  
  liftIoIntoStateT(getLine)
```

Then I do the same thing with the `putStr` function:

```
def putStrAsStateT(s: String): StateT[IO, SumState, Unit] =  
  liftIoIntoStateT(putStr(s))
```



## Welcome to the top of “Mount Monad”

Okay, admittedly that was a lot of setup work, but even if you don't know it yet, we're now at the top of the monad mountain. Because these functions yield a `StateT[IO, SumState, A]`, they can be used in the `for` expression I tried to create in the previous lesson. In the next lesson we'll finally get `IO` and `StateT` working together!

# A First IO/StateT for Expression

Now that we have a collection of functions that all return this type:

```
StateT[IO, SumState, A]
```

we can build a for expression to prompt a user to enter integer values, read those values, and then sum them.

To keep things simple, in this lesson I'm going to write a for expression that you have to kill manually, such as using CTRL-C at the command line, or pressing a "stop" button in an IDE:

```
def sumLoop: StateT[IO, SumState, Unit] = for {  
  _ <- putStrAsStateT("\ngive me an int: ")  
  input <- getLineAsStateT  
  i <- liftIOIntoStateT(IO(toInt(input)))  
  _ <- doSumWithStateT(i)  
  _ <- sumLoop  
} yield Unit
```

One thing to notice in this expression is this line:

```
liftIOIntoStateT(IO(toInt(input)))
```

I didn't bother to write a wrapper function around `toInt`, so in that line:

- `toInt` transforms `input` from a `String` to an `Int`
- That value is wrapped in an `IO` (an `IO[Int]`)
- That value is lifted into a `StateT` (a `StateT[IO, SumState, Int]`)

Just like I modified the I/O functions to return `StateT`, these steps are necessary to get `toInt` to work in the for expression.

## Running the for expression

Now you can run the for expression by giving the run function an initial state, like this:

```
val result: (SumState, Unit) = sumLoop.run(SumState(0)).run
```

Because you have to kill this loop manually you can't see the final `result`, but with some debug code included in the functions you can see some output. In the source code for this project, if you run the App named `v2_loop_without_quit.LoopWithoutQuitLotsOfDebug`, and enter the numbers 1, 2, and 3 before killing the loop, you'll see this combination of input/output:

```
give me an int: 1
updateIntState, old sum:  0
updateIntState, new input: 1
updateIntState, new sum:  1

give me an int: 2
updateIntState, old sum:  1
updateIntState, new input: 2
updateIntState, new sum:  3

give me an int: 3
updateIntState, old sum:  3
updateIntState, new input: 3
updateIntState, new sum:  6
```

The output comes from the `doSumWithStateT` function, which looks like this:

```
def doSumWithStateT(newValue: Int):
  StateT[IO, SumState, Int] = StateT { (oldState: SumState) =>

    // create a new sum from `i` and the previous sum from `s`
    val newSum = newValue + oldState.sum
    println(s"updateIntState, old sum:  " + oldState.sum)
    println(s"updateIntState, new input: " + newValue)
    println(s"updateIntState, new sum:  " + newSum)

    // create a new SumState
    val newState: SumState = oldState.copy(sum = newSum)

    // return the new state and the new sum, wrapped in an IO
    IO(newState, newSum)
  }
```

If you also uncomment the `map/println` statement in `liftIoIntoStateT`, you'll see this additional `SumState` output:

```
lift: (SumState(0), 1)
lift: (SumState(1), 2)
```

```
lift: (SumState(3), 3)  
(SumState(6), ())
```

All of that output shows the internal state of the `for` expression as you enter the values 1, 2, and 3.

At this point I encourage you to work with the source code in this portion of the project until you understand how it works. As usual, add more comments and debug statements to the code and modify it as desired to make it your own.

# The Final IO/StateT for Expression

## Source code

The source code for this lesson is in the package named `v3_loop_with_quit`, in [the same repository](#) as all of the StateT lessons. Work with the `LoopWithQuitLotsOfDebug` class to see a lot of debug output, or the `LoopWithQuitNoDebug` class to run the application without debug output.

## The final for expression

In the previous lesson I wanted to keep the for expression simple, so I left out the “type q to quit” part of the code, but now it’s time to show the complete code that lets the user type q to quit:

```
def sumLoop: StateT[IO, SumState, Unit] = for {
  _ <- putStrAsStateT("\ngive me an int, or 'q' to quit: ")
  input <- getLineAsStateT
  _ <- if (input == "q") {
    liftIoIntoStateT(IO(Unit))
  } else for {
    i <- liftIoIntoStateT(IO(toInt(input)))
    _ <- doSumWithStateT(i)
    _ <- sumLoop
  } yield Unit
} yield Unit

val result = sumLoop.run(SumState(0)).run
println(s"Final SumState: ${result}")
```

The big change to this code begins with this if statement inside the for expression:

```
if (input == "q")
```

As the comment after that line shows, if you type q, the expression returns Unit, which is first wrapped in an IO, and then wrapped in a StateT, and the loop/recursion ends. Otherwise, control is passed to the else clause where a second for expression does the work I showed previously, and a recursive call to sumLoop is made, prompting you to enter another integer, or q to quit.

A good thing about this loop is that when you type q you can see the final SumState. Here’s the input and output I get when running the LoopWithQuitLotsOfDebug application with the values 1, 2, and 3:

```
give me an int, or 'q' to quit: 1
updateIntState, old sum: 0
updateIntState, new input: 1
updateIntState, new sum: 1

give me an int, or 'q' to quit: 2
updateIntState, old sum: 1
updateIntState, new input: 2
updateIntState, new sum: 3

give me an int, or 'q' to quit: 3
updateIntState, old sum: 3
updateIntState, new input: 3
```

```
updateIntState, new sum: 6
```

```
give me an int, or 'q' to quit: q  
Final SumState: (SumState(6),())
```

As with the `for` expression in the previous lesson, I encourage you to work with the source code for this portion of the project and add debug statements and modify it until you understand it, making it your own.

## **You'll probably have to read it more than once**

Using and understanding `StateT` is probably the most difficult topic in this book. But if you can understand it, I believe you'll be able to deeply understand many uses of monads.

Because this topic is difficult, I suspect that you'll have to read these `StateT` lessons more than once, and I apologize for that. Throughout this book I've tried to make each topic as easy to understand as possible, but "monad transformers" is a deep topic that you may need to review several times to understand.



## Focus on how to *use* Monad and StateT

I'd like to add one more thing at this point: Unless you're interested in theory, don't get too caught up in how Monad and StateT are implemented. By that I mean that you should first focus on how to *use* StateT, and after that, if you want to know how to *write* Monad and StateT you can dig into that source code.

Think of it this way: When you first learned how to sort a list in Scala, did you check the Scala library source code out from Github to see how the sort algorithms were implemented, or did you just try to sort your collection?

# Summary of the StateT Lessons

As you saw in these StateT lessons, the key to being able to use both the IO and State monads in a for expression is to use a StateT transformer monad that encapsulates both State and IO within the same construct, specifically a StateT[IO, SumState, A] in this examples. StateT works just like State, and it's also a wrapper around IO.

There are other approaches to the problem of using multiple monads in a for expression, but using monad transformers like StateT is a common solution. For example, [the Cats project](#) includes monad transformers including StateT, OptionT, EitherT, and more.

## **How about those types!**

An interesting thing about everything you've been through in this book is that you're probably used to seeing types like `StateT[IO, SumState, A]` by now. If you're like me, when you first started this book you probably rarely used anything like that, but by now, seeing types like this is second nature.

## Conclusion: Always ask “Why?”

As you saw in this lesson — and even in the monad lessons leading up to this one — you have to go through a lot of setup work in FP to be able to use the concepts of State and I/O in the same for expression. Early in this book I encouraged you to always ask “Why?” as you work through the lessons, and this is a good time to do that again:

Why would anyone go through this much work when it’s so much easier to write imperative loops?

I encourage you to try to answer that question yourself, but I’ll provide my own thoughts as well.

The first part of my answer is that monads and Scala’s for expression give FP developers a way to write a sequence of computations using only immutable variables and pure functions. If you want to know how to write a series of computations using only “Pure FP,” this is the best way the brightest minds know how to do this today.

The second part of the answer is that you must have a strong — make that *intense* — desire to see *all* of your code as being like math, like algebra. In your mind you can’t just settle for writing pure functions, you must also have an intense dislike for mutable variables anywhere in your code. Only when you develop that passion will you be willing to go through this effort, and find the beauty in code like this.

In my own case I can say that going through this process has helped me learn to write better code. In my “Pure OOP” days I never thought much about mutable variables and method signatures, that was the only way I knew how to do things. But these days I use immutable variables and pure functions as much as possible, and I always follow the mantra of “write the function signature first” that I’ve shown in this book: I first sketch the function signature, and only when I’m confident that the input parameters and return type are correct do I write the function body.

## See also

These lessons are heavily based on the code from John De Goes' 2014 LambdaConf presentation, [Introduction to Functional Game Programming with Scala](#). The `Monad` and `StateT` source code comes directly from that project.

The `typelevel.org` book, "Advanced Scala with Cats," which is currently accessible [at this URL](#), is a good resource for learning more about monads.

# Signpost: Modeling the world with Scala/FP

As you can imagine, functional programming changes the way you model the world we live in. Where OOP tells us to encapsulate data and behavior in the same class, Scala/FP tells us that *data* should be modeled using case classes, and *behavior* — i.e., functions — should be modeled somewhere else. That concept of “somewhere else” is what the next several lessons are about.

Here’s an outline of the next nine lessons:

- First, I define the concept of *domain modeling*.
- Next, I provide a short review of domain modeling in OOP. I do this as a means of providing contrast to the FP approaches that follow.
- Then I show how to model FP behavior using a “utilities” class approach, and also do the same thing with companion objects.
- After that I’ll show how to put your behaviors in *modules*, an approach that encourages compositionality.
- Finally, I’ll show how to write the same application using a hybrid OOP/FP “functional objects” approach.

The next lesson begins with a short discussion of domain modeling.

# What is a Domain Model?

Before I get into the process of domain modeling in OOP and FP, it will help to be precise about what a “domain model” is.

# Domain

As shown in the introductory quote for this lesson, a *domain* is “a sphere of activity or knowledge.” When we build software applications, we work in the domains of the businesses we write applications for. For example, these are some of the businesses I’ve written software for in my career:

- a pizza company
- a magazine printing company
- a company that creates software for advertising agencies

As you can imagine, each of these businesses has their own “sphere of activity or knowledge”:

- a pizza company understands pizzas, toppings, customers, orders, stores, drivers, deliveries, etc.
- a printing company understands everything to do with magazines, covers, paper, ink, magazine pages, inserts, etc.
- advertising businesses know about advertisers, print ads, commercials on television and radio, billboards, and terms like “coverage” and “frequency”

As those examples show, each business domain is its own little world, with its own sphere of knowledge.



## Domain model

A *domain model* refers to the way we model the objects in a given domain as software engineers. It's a conceptual model where we organize and define the entities we encounter in the domain (pizzas, orders, etc.), the attributes of those entities (toppings, crust size, crust type), the relationships between the entities (a pizza has toppings, an order has one or more pizzas), and the behaviors and interactions of those entities (add topping to pizza, add pizza to order).

A domain model is also a vocabulary or dictionary that represents a shared understanding of the domain. Everyone involved in the project, including the product owner, stakeholders, development team, etc., should understand the vocabulary and be able to use it as a communication tool. When someone says, "A customer calls a store to order a pizza for delivery," all of those terms should be understood by everyone on the project.

The term "domain model" can refer to a visual model, the source code we write, or the written documentation we create, but in any format it is a conceptual model of the domain.

Finally, you can implement a domain model using OOP, FP, any other programming paradigms that may evolve in the future, and in terms of source code, a domain model can be implemented in any programming language.

## **What's next**

In the lessons that follow, I'll first show a Scala/OOP version of a domain model for a pizza store. After that I'll show different ways to implement the domain model using Scala/FP.

## See also

For *much* more information on the process of building domain models, see these books about *Domain-Driven Design*:

- [Domain Driven Design: Tackling Complexity in the Heart of Software](#)
- [Implementing Domain-Driven Design](#)

Both of those books are very detailed, and highly-regarded.

# A Review of OOP Data Modeling

Before I get into the Scala/FP domain modeling lessons, I want to share what a Scala/OOP data model might look like for a Pizza point of sales (POS) system. For the purposes of this lesson I'm going to assume that a pizza store can only sell pizzas; it doesn't sell other things like breadsticks, cheesesticks, salads, beverages, etc.

## The source code

The source code for this lesson is at this Github URL:

- [github.com/alvinj/PizzaPosOopStyle](https://github.com/alvinj/PizzaPosOopStyle)

## A note before we begin

If I was going to model a Pizza POS system using a “100% correct” OOP design, I would make the fields of each class private, and require get and set method calls on them, like this:

```
class Pizza {  
    type Money = BigDecimal  
  
    // private fields  
    private var _crustSize: CrustSize = MediumCrustSize  
    private var _crustType: CrustType = RegularCrustType  
    private val _toppings = ArrayBuffer[Topping]()  
  
    def getCrustSize = _crustSize  
    def setCrustSize(cs: CrustSize) {  
        _crustSize = cs  
    }  
  
    def getCrustType = _crustType  
    def setCrustType(ct: CrustType) {  
        _crustType = ct  
    }  
  
    def getToppings = _toppings  
    def addTopping(t: Topping) {  
        _toppings += t  
    }  
  
    // more code ...  
}
```

However, I’m not going to do that in this lesson because (a) I assume that you understand OOP, (b) this book isn’t about OOP, and (c) once I create several classes, that approach requires a lot of boilerplate code that obscures what I want to show. Therefore, in this lesson I’m going to write my OOP classes using public var fields without getter and setter methods.

## Modeling toppings, crust size, and crust type

To build a pizza you need to define what your toppings, crust size, and crust type look like. In both the OOP and FP worlds, these attributes are best defined as enumerations, as shown here:

```
sealed trait Topping
case object Cheese extends Topping
case object Pepperoni extends Topping
case object Sausage extends Topping
case object Mushrooms extends Topping
case object Onions extends Topping

sealed trait CrustSize
case object SmallCrustSize extends CrustSize
case object MediumCrustSize extends CrustSize
case object LargeCrustSize extends CrustSize

sealed trait CrustType
case object RegularCrustType extends CrustType
case object ThinCrustType extends CrustType
case object ThickCrustType extends CrustType
```

The benefits of enumerations are:

- You can use the types `Topping`, `CrustSize`, and `CrustType` in function signatures
- They work well in other places, such as match expressions
- Type safety in general

### ***Aside: Use enums, not strings***

Don't ever use strings where you should use enumerations. That is, don't ever do this:

```
val CHEESE = "cheese"
val PEPPERONI = "pepperoni"
```

That approach leads to code like this:

```
def addTopping(p: Pizza, t: String)
def getToppings(): Seq[String]
```

Enumerations also work much better with pattern matching.

## A Pizza class

Once you have those pizza attributes, you can define the OOP version of a Pizza class like this:

```
class Pizza {  
    var crustSize: CrustSize = MediumCrustSize  
    var crustType: CrustType = RegularCrustType  
  
    // no need for `toppings` to be a `var`; `ArrayBuffer` is mutable  
    val toppings = ArrayBuffer[Topping]()  
  
    def addTopping(t: Topping): Unit = { toppings += t }  
    def removeTopping(t: Topping): Unit = { toppings -= t }  
    def removeAllToppings(): Unit = { toppings.clear() }  
  
    def getPrice(  
        toppingsPrices: Map[Topping, Money],  
        crustSizePrices: Map[CrustSize, Money],  
        crustTypePrices: Map[CrustType, Money]  
    ): Money = ???  
}
```

Many developers use the `BigDecimal` class to handle currency, so I also create a type alias named `Money` to make those type signatures a little more meaningful:

```
type Money = BigDecimal
```

Here are a few important notes about this non-FP code:

- I use a regular Scala class to create `Pizza`, instead of case class
- `addTopping`, `removeTopping`, and `removeAllToppings` return `Unit`, and mutate toppings

Also, depending on your design beliefs, `getPrice` may or may not be included in this class. (When working on an OOP design, I used to use [CRC cards](#) and ask, “What class has the *responsibility* for this behavior?”) It’s important to note that the actual pizza price depends on the cost of the toppings, crust size, and crust type, so those prices — which are typically stored in a database — would have to be passed into this method.



## An OOP order class

Next, here's a Scala/OOP order class that models a customer's order, including how many pizzas they're buying, along with their customer information:

```
class Order {  
    // an order contains a list of pizzas  
    val pizzas = ArrayBuffer[Pizza]()  
  
    // could be a constructor parameter if you always create  
    // a customer before creating an order  
    var customer: Customer = null  
  
    def addPizzaToOrder(p: Pizza): Unit = {  
        pizzas += p  
    }  
  
    def removePizzaFromOrder(p: Pizza): Unit = {  
        pizzas -= p  
    }  
  
    // need to implement these  
    def getBasePrice(): Money = ???  
    def getTaxes(): Money = ???  
    def getTotalPrice(): Money = ???  
}
```

## Customer-related classes

Next, here are the customer-related classes:

```
class Customer (  
  var name: String,  
  var phone: String,  
  var address: Address  
)  
  
class Address (  
  var street1: String,  
  var street2: String,  
  var city: String,  
  var state: String,  
  var zipCode: String  
)
```

In a real-world OOP design those classes would have getter and setter methods, but notice that without them it's easier to see that `Customer` and `Address` don't have any behaviors, they're just data structures.

Finally, it's important to note that `street2` is actually an optional field; it's not required for all addresses. Depending on your OOP philosophy, you can leave the `Address` design as shown, and then have `street2` be `null` or an empty `String` when it isn't present, or you can define it as an optional field:

```
class Address (  
  var street1: String,  
  var street2: Option[String], //optional  
  var city: String,  
  var state: String,  
  var zipCode: String  
)
```

In OOP this choice is open to debate, but in FP it will *always* be specified as `Option[String]`.

# The important points of the OOP design

The important points to note about this design are that the `Pizza` class includes impure methods like these:

```
def addTopping(t: Topping): Unit
def removeTopping(t: Topping): Unit
def removeAllToppings(): Unit
```

The `Order` class also has these impure methods:

```
def addPizzaToOrder(p: Pizza): Unit
def removePizzaFromOrder(p: Pizza): Unit
```

Finally, because `Order` also encapsulates data and behavior, it may also have these built-in methods, which may also end up being impure:

```
def getBasePrice(): Money
def getTaxes(): Money
def getTotalPrice(): Money
```

## Recognizing impure method signatures

Remember that when you see a `Unit` return type you should immediately think, “This is not a pure function.” In these examples, all of the functions that have `Unit` return types are mutating some internal state.

In addition to those methods, the other methods that take no input parameters are technically not pure functions. These methods presumably make calculations based on the internal state of those classes and therefore might not be mutating any internal state, but you definitely can’t use the pure function mantra, “Output depends only on input.”

# Modeling the “Data” Portion of the Pizza POS System with Scala/FP

In FP, the *data* and the *operators on that data* are two separate things; you aren’t forced to encapsulate them together like you do with OOP.

The concept is like numerical algebra. When you think about whole numbers whose values are greater than or equal to zero, you have a *set* of possible values that looks like this:

0, 1, 2 ... Int.MaxValue

Ignoring the division of whole numbers, the possible *operators* on those values are:

+, -, \*

An FP design is implemented in a similar way:

- You have a set of values
- You have a collection of operators that work on those values

In this lesson I’ll show how to implement the “data” portion of the Scala/FP model for the Pizza POS system, and in the following lessons I’ll show different techniques for modeling the “behaviors” using Scala/FP.

# Modeling the data

Modeling the “data” portion of a domain model in Scala/FP is simple:

Model the data as case classes with immutable fields.

Given that one simple rule, the Scala/FP data model for the Pizza POS system is as follows. First, the toppings, crust size, and crust type are modeled as enumerations, just as they were in the OOP design:

```
sealed trait Topping
case object Cheese extends Topping
case object Pepperoni extends Topping
case object Sausage extends Topping
case object Mushrooms extends Topping
case object Onions extends Topping

sealed trait CrustSize
case object SmallCrustSize extends CrustSize
case object MediumCrustSize extends CrustSize
case object LargeCrustSize extends CrustSize

sealed trait CrustType
case object RegularCrustType extends CrustType
case object ThinCrustType extends CrustType
case object ThickCrustType extends CrustType
```

Next, all of the other classes are modeled as case classes with immutable fields:

```
case class Pizza (
  crustSize: CrustSize,
  crustType: CrustType,
  toppings: Seq[Topping]
)

case class Order (
  pizzas: Seq[Pizza],
  customer: Customer
)

case class Customer (
  name: String,
  phone: String,
  address: Address
)

case class Address (
  street1: String,
  street2: Option[String],
  city: String,
  state: String,
  zipCode: String
)
```

Notice that this code really is just a simple *data model*; there are no “behaviors” mixed in with the data. Personally, I like this. By separating (a) the data from (b) the operations on that data, the data attributes and relationships are clear. The data model is easy to read, like declaring the design for a relational database.

## **Skinny domain objects**

In his book, [Functional and Reactive Domain Modeling](#), Debasish Ghosh states that where OOP practitioners describe their classes as “rich domain models” that encapsulate data and behaviors, FP data models can be thought of as “skinny domain objects.” This is because, as this lesson shows, the data models are defined as case classes with attributes, but no behaviors.



## **What about the operations?**

This leads to a very interesting question:

Because FP separates the data from the operations on that data,  
how do you implement those operations in Scala/FP?

I'll show several possible approaches in the following lessons.

# First Attempts to Organize Pure Functions

There are several different ways to implement behaviors (functions) in Scala/FP. I'll begin by showing two possible approaches in this lesson, and then show better in the following lessons.

## Introduction

In this lesson I'll show how to put your functions in what I call a "Utils" object. After that, I'll show how to put the same functions in a companion object.

I generally don't recommend using these approaches, but they are what I tried when I first started working with Scala/FP. (I use a style similar to this when writing pure functions in Java for Android applications.)

## Source code

Because I don't recommend these approaches in Scala, I haven't created a Github project for this lesson.

## Option 1: Handling Scala/FP behavior with a “Utils” class

One option is to implement “behavior” in what I call a standalone “utilities” class. For instance, the `Pizza` case class from the previous lesson can have a corresponding `PizzaUtils` object that contains all of the pure functions that operate on a `Pizza`:

```
object PizzaUtils {  
    type Money = BigDecimal  
  
    def addTopping(p: Pizza, t: Topping): Pizza = ???  
    def removeTopping(p: Pizza, t: Topping): Pizza = ???  
    def removeAllToppings(p: Pizza): Pizza = ???  
  
    def updateCrustSize(p: Pizza, cs: CrustSize): Pizza = ???  
    def updateCrustType(p: Pizza, ct: CrustType): Pizza = ???  
  
    def calculatePrice (  
        p: Pizza,  
        toppingsPrices: Map[Topping, Money],  
        crustSizePrices: Map[CrustSize, Money],  
        crustTypePrices: Map[CrustType, Money]  
    ): Money = ???  
}
```

Notice that this is just a collection of pure functions that I put in a standalone object. You’d call these functions like this:

```
val pizza2 = PizzaUtils.addTopping(pizza1, Pepperoni)  
val pizza3 = PizzaUtils.updateCrustSize(LargeCrustSize)
```

With this approach I find that all of those `PizzaUtils` references clutter up the code, so it’s cleaner to import the functions and then use them like this:

```
import PizzaUtils._  
  
val pizza2 = addTopping(pizza1, Pepperoni)  
val pizza3 = updateCrustSize(LargeCrustSize)  
val price = calculatePrice(  
    pizza3,  
    toppingsPrices,  
    crustSizePrices,  
    crustTypePrices  
)
```

There are a few things to say about this code. First, all of the functions are pure functions. For instance, `addTopping` and `removeTopping` take a `Pizza` and a

Topping as inputs, and return a new `Pizza` as a result:

```
def addTopping(p: Pizza, t: Topping): Pizza = ???  
def removeTopping(p: Pizza, t: Topping): Pizza = ???
```

The crust size and type functions follow the same pattern:

```
def updateCrustSize(p: Pizza, cs: CrustSize): Pizza = ???  
def updateCrustType(p: Pizza, ct: CrustType): Pizza = ???
```

In the OOP design you can mutate the toppings, crust size, and crust type on an existing `Pizza` reference, but in FP you don't do that. Instead, you use functions like these to construct a new, updated pizza from the old pizza and the new toppings, crust size, and crust type. This is the way you update objects in FP, so the pure functions in the following two lessons will look just like these, they'll just be organized differently.

I wrote about this approach in the earlier, "" lesson, so I won't belabor this point here. See that lesson for more details.

Notice that a benefit of separating data from behavior is that it forces you to write pure functions. Because (a) the case classes contain immutable fields and (b) the behaviors are not encapsulated in the same class, each function must take an instance of the primary data type (such as `Pizza`) as an input parameter, and the function must also evaluate to a result. There's no way for you to "cheat" and mutate a data structure under the covers. The approach itself forces you to write pure functions.

## ***The remainder of the design***

If I were to implement more of this approach, I'd eventually create more "utilities" objects, such as an `OrderUtils` object, and possibly one or more objects related to price and tax calculations. But hopefully the `PizzaUtils` object gives you the central idea of this concept: Put all of your pure functions that operate on a domain object in a "Utils" object.

While I call this a "Utils" object, as you'll see in the next lesson, the preferred name for a collection of functions like this is a "service" class.

## Option 2: Handling behavior in FP with a companion object

As a variation of the first approach, rather than putting your functions in a separate Utils object, you can use Scala's concept of a "companion object" for the exact same purpose.

With the companion object approach you put the data model in a case class just as before, but then instead of putting your functions in a separate Utils object, you put them in an object in the same file as the case class, where the object has the same name as the case class. This type of object is known as a [companion object](#).

The result looks like this:

```
case class Pizza (
  crustSize: CrustSize,
  crustType: CrustType,
  val toppings: Seq[Topping]
)

object Pizza {
  def addTopping(p: Pizza, t: Topping): Pizza = ???
  def removeTopping(p: Pizza, t: Topping): Pizza = ???
  def removeAllToppings(p: Pizza): Pizza = ???

  def calculatePrice (
    p: Pizza,
    toppingsPrices: Map[Topping, Price],
    crustSizePrices: Map[CrustSize, Price],
    crustTypePrices: Map[CrustType, Price]
  ): Money = ???

  def updateCrustSize(p: Pizza, cs: CrustSize): Pizza = ???
  def updateCrustType(p: Pizza, ct: CrustType): Pizza = ???
}
```

With this approach the functions look just like the `PizzaUtils` code, but you call them on the `Pizza` object:

```
val pizza2 = Pizza.addTopping(pizza1, Pepperoni)
val pizza3 = Pizza.updateCrustSize(LargeCrustSize)
```

As before, all of those `Pizza` references tend to create unnecessary noise, so you can eliminate them by importing them like this:

```
import Pizza._
```

```
val pizza2 = addTopping(pizza1, Pepperoni)
val pizza3 = updateCrustSize(LargeCrustSize)
```

The end result of these two approaches is nearly identical. The only difference is where you put the functions that operate on `Pizza` instances.

One thing about companion objects is that a [companion object can access the private fields of the case class it's associated with](#). In OOP this is a helpful attribute, but in FP this feature might encourage you to write impure functions.



## **What's next**

As mentioned, I used these techniques as my first “naive” steps into Scala/FP. In the next lesson I'll show a more advanced technique that shows the concept of “modules” in Scala/FP.

# **Implementing FP Behavior with Modules**

## The source code

The source code for this lesson is at this Github URL:

- [github.com/alvinj/FPModulesIrishSetter](https://github.com/alvinj/FPModulesIrishSetter)

## What is a module?

This lesson is about implementing behaviors (functions) in modules, so it begs the question, what is a *module* in Scala?

The book, [Programming in Scala](#), describes a *module* like this:

“A module is a ‘smaller program piece’ with a well defined interface and a hidden implementation.”

The Scala Language Specification provides this hint as to what a module is:

“The object definition defines a single object (or: module) conforming to the template *t*.”

Those quotes provide a start, but they’re not too helpful on their own. The slide shown in Figure [fig:scalaTraitLikeOCamlModule] is from [a lambdafoo.com presentation](#), and provides the most clear definition of a module that I’ve seen.

### Rewrite Scala to be closer to OCaml

```
trait Ordering {  
  type T  
  def compare(x: T, y: T): Int  
}
```

### OCaml

```
module type ORDERING = sig  
  type t  
  val compare : t -> t -> int  
end
```

As you’ll see in this lesson, a Scala trait is similar to a module in the OCaml language.

As that slide begins to show, the idea of a module in Scala is to use a trait to

gather your pure functions into logical units of behavior. In this lesson I'll show how to use Scala traits to create modules, and then how to combine those traits to build larger objects and complete applications.

## The essence of the problem

The reasons for adopting a modular programming approach are described in [Programming in Scala](#):

“As a program grows in size, it becomes increasingly important to organize it in a modular way. First, being able to compile different modules that make up the system separately helps different teams work independently. In addition, being able to unplug one implementation of a module and plug in another is useful, because it allows different configurations of a system to be used in different contexts, such as unit testing on a developer’s desktop, integration testing, staging, and deployment.”

In regards to the first point, in FP it’s nice to be able to say, “Hey, Team A, how about if you work on the `Order` functions, and Team B will work on the `Pizza` functions?”

In regards to the second point, a good example is that you might use a mock database on your desktop and then use real databases in the Test and Production environments. In this case you’ll create traits like these:

```
trait Database { ... }
trait MockDatabase extends Database { ... }
trait TestDatabase extends Database { ... }
trait ProductionDatabase extends Database { ... }
```

One point I’ll add to that description is that modularization is a way to help you handle the complexity that comes with building large applications.

## The essence of the solution

The essence of the modular solution is also described well in [Programming in Scala](#):

“Any technique that aims to facilitate this kind of modularity needs to provide a few essentials. First, there should be a module construct that provides a good separation of interface and implementation. Second, there should be a way to replace one module with another that has the same interface without changing or recompiling the modules that depend on the replaced one. Lastly, there should be a way to wire modules together. This wiring task can be thought of as *configuring the system*.”

## The essence of the technique

Given that background, the essence of programming with modules in Scala/FP goes like this:

- You write pure functions, as I did in the previous lesson
- In this case, the pure functions are organized in relatively small, logically-organized traits
- You combine (compose) the traits together as needed to create objects, using the traits as mixins



## A simple example

Here's a simple example of this technique. Imagine that you want to define the behaviors for a dog, let's say an Irish Setter. One way to do this is to jump right in and create an `IrishSetter` class:

```
class IrishSetter { ... }
```

This is a bad idea. A better idea is to think about the interfaces for different types of dog behaviors, and then build a specific implementation of an Irish Setter when you're ready.

For example, an initial thought is that a dog is an animal:

```
trait Animal
```

More specifically, a dog is an animal with a tail, and that tail has a color:

```
abstract class AnimalWithTail(tailColor: Color) extends Animal
```

Next, you might think, "Since a dog has a tail, what kind of behaviors can a tail have?" With that thought, you might then sketch a trait like this:

```
trait DogTailServices {  
  def wagTail = ???  
  def lowerTail = ???  
  def raiseTail = ???  
  def curlTail = ???  
}
```

Next, because you know that you only want this trait to be mixed into classes that extend `AnimalWithTail`, you'll add a self-type to the trait:

```
trait DogTailServices {  
  // implementers must be a sub-type of AnimalWithTail  
  this: AnimalWithTail =>  
  
  def wagTail = ???  
  def lowerTail = ???  
  def raiseTail = ???  
  def curlTail = ???  
}
```

If you read the [Scala Cookbook](#), you know that this peculiar looking line declares a *self-type*, which means, "This trait can only be mixed into classes that

```
extend AnimalWithTail”:
```

```
this: AnimalWithTail =>
```

Because I want to keep this example simple, I’ll go ahead and implement the functions (“services”) in the `DogTailServices` class like this:

```
trait DogTailServices {  
  this: AnimalWithTail =>  
  def wagTail = println("wagging tail")  
  def lowerTail = println("lowering tail")  
  def raiseTail = println("raising tail")  
}
```

Next, as I think more about a dog, I know that it has a mouth, so I sketch another trait like this:

```
trait DogMouthServices {  
  this: AnimalWithTail =>  
  def bark = println("bark!")  
  def lick = println("licking")  
}
```

I could keep going on like this, but I hope you see the idea: You think about the *services* (or behaviors) that are associated with a domain object, and then you sketch those services as functions in logically organized traits. (Advice: Just start with your best ideas, then re-organize them as your thinking becomes more clear.)

Since I’m not going to go further and define more dog-related behaviors, I’ll stop at this point and create a module as an implementation of an Irish Setter with the services I’ve defined so far:

```
object IrishSetter  
  extends AnimalWithTail(Color.red)  
  with DogTailServices  
  with DogMouthServices
```

If you start the Scala REPL like this:

```
$ scala -Djava.awt.headless=true  
Welcome to Scala ...
```

and then import the necessary `Color` class:

```
scala> import java.awt.Color  
import java.awt.Color
```

and then import all of those traits into the REPL (not shown here), you'll see that you can call the functions/services on your `IrishSetter`:

```
scala> IrishSetter.bark
bark!
```

```
scala> IrishSetter.wagTail
wagging tail
```

While this is a simple example, it shows the general process of “programming with modules” in Scala.

### ***Aside: headless mode***

When I started the Scala REPL, I used this command:

```
scala -Djava.awt.headless=true
```

This starts the JVM in something known as “headless” mode. I did this because creating an instance of an AWT class in the REPL causes the JVM to think, “He’s using an AWT class, this must be a GUI application,” and the REPL loses input focus. Starting the JVM in headless mode disables that behavior.

If you’re using a Mac and want to see what I’m referring to, start the REPL without the `headless` argument:

```
$ scala
Welcome to Scala ...
```

and then run these two commands:

```
scala> import java.awt._
import java.awt._

scala> val c = Color.red
c: java.awt.Color = java.awt.Color[r=255,g=0,b=0]
```

You’ll see that the REPL and Terminal lose input focus, and the name `MainGenericRunner` appears in the Mac menu bar. (I assume that a similar thing happens on Windows and Linux systems.) If you use the `headless` argument, this won’t happen.

## About the name “service”

The name *service* comes from the fact that these functions provide a series of public “services” that are available to external clients. I find that this name makes sense when you imagine that these functions are implemented as a series of web service calls. For instance, when you use Twitter’s REST API to write a Twitter client, the functions they make available to you in that API are considered to be a series of web services.

# **Implementing the Pizza POS System Using a Modular Approach**

Now that you've seen how to go through the modular programming process once with some simple traits, I'll go ahead and implement the Pizza Store POS using modules.

## The source code

The source code for this lesson is at this Github URL:

- [github.com/alvinj/PizzaPosFpModularStyle](https://github.com/alvinj/PizzaPosFpModularStyle)

# The Pizza POS data models

First, although the Pizza POS data model hasn't changed, I'll show it again here as a reminder:

```
case class Pizza (
  crustSize: CrustSize,
  crustType: CrustType,
  toppings: Seq[Topping]
)

case class Order (
  pizzas: Seq[Pizza],
  customer: Customer
)

case class Customer (
  name: String,
  phone: String,
  address: Address
)

case class Address (
  street1: String,
  street2: Option[String],
  city: String,
  state: String,
  zipCode: String
)

sealed trait Topping
case object Cheese extends Topping
case object Pepperoni extends Topping
case object Sausage extends Topping
case object Mushrooms extends Topping
case object Onions extends Topping

sealed trait CrustSize
case object SmallCrustSize extends CrustSize
case object MediumCrustSize extends CrustSize
case object LargeCrustSize extends CrustSize

sealed trait CrustType
case object RegularCrustType extends CrustType
case object ThinCrustType extends CrustType
case object ThickCrustType extends CrustType
```

## The PizzaService interface

The next thing I tend to think about are the Pizza behaviors, so I initially sketch a `PizzaServiceInterface` trait like this:

```
trait PizzaServiceInterface {  
  
  def addTopping(p: Pizza, t: Topping): Pizza  
  def removeTopping(p: Pizza, t: Topping): Pizza  
  def removeAllToppings(p: Pizza): Pizza  
  
  def updateCrustSize(p: Pizza, cs: CrustSize): Pizza  
  def updateCrustType(p: Pizza, ct: CrustType): Pizza  
  
  def calculatePizzaPrice(  
    p: Pizza,  
    toppingsPrices: Map[Topping, Money],  
    crustSizePrices: Map[CrustSize, Money],  
    crustTypePrices: Map[CrustType, Money]  
  ): Money  
  
}
```

These are the exact same function signatures I used in the previous lesson; the only difference is that I’ve put them in a trait here, as opposed to a “Utils” class or companion object.

When you write a pure interface like this, you can think of it as a contract, a contract that states, “all non-abstract classes that extend this trait *must* provide an implementation of these services.”

In the real world, what I’d do at this point is imagine that I’m the consumer of this API. When I do that, I start sketching some code to make sure I like what this API looks like:

```
val p = Pizza(  
  MediumCrustSize,  
  RegularCrustType,  
  Seq(Cheese)  
)  
  
// the functions in PizzaServiceInterface  
val p1 = addTopping(p, Pepperoni)  
val p2 = addTopping(p1, Mushrooms)  
val p3 = updateCrustType(p2, ThickCrustType)  
val p4 = updateCrustSize(p3, LargeCrustSize)
```

That code “feels” okay — feels like what I want — so at this point I’d typically start sketching another interface. But since this is a book, I’m going to go ahead



and wrap up this module by going through the work of creating a concrete implementation of this interface.

Notice that this is usually a two-step process. In the first step, you sketch the contract of your API as an *interface*. In the second step you create a concrete *implementation* of that interface. In some cases you'll end up creating multiple concrete implementations of the base interface.

## Creating a concrete implementation

Now that I know what the `PizzaServiceInterface` looks like, I can create a concrete implementation of it by writing code for all of the functions I declared:

```
trait PizzaService extends PizzaServiceInterface {  
  def addTopping(p: Pizza, t: Topping): Pizza = {  
    val newToppings = p.toppings :+ t  
    p.copy(toppings = newToppings)  
  }  
  
  def removeTopping(p: Pizza, t: Topping): Pizza = {  
    val newToppings = ListUtils.dropFirstMatch(p.toppings, t)  
    p.copy(toppings = newToppings)  
  }  
  
  def removeAllToppings(p: Pizza): Pizza = {  
    val newToppings = Seq[Topping]()  
    p.copy(toppings = newToppings)  
  }  
  
  def updateCrustSize(p: Pizza, cs: CrustSize): Pizza = {  
    p.copy(crustSize = cs)  
  }  
  
  def updateCrustType(p: Pizza, ct: CrustType): Pizza = {  
    p.copy(crustType = ct)  
  }  
  
  def calculatePizzaPrice(  
    p: Pizza,  
    toppingsPrices: Map[Topping, Money],  
    crustSizePrices: Map[CrustSize, Money],  
    crustTypePrices: Map[CrustType, Money]  
  ): Money = {  
    // TODO implement a real algorithm based on those sequences  
    val base = BigDecimal(10)  
    val numToppings = p.toppings.size  
    val price = base + 1.00 * numToppings  
    price  
  }  
}
```

While this two-step process of creating an interface followed by an implementation isn't always necessary, if you want to be an API creator, it's a good discipline to learn.

# Database

In the real world, pizza-related prices will be stored in a database, and in this section I want to show the impact that has on a modular design.

Again I'll start with an interface that I'll name `PizzaDaoInterface`. It declares the methods that a "Pizza database access object (DAO)" should have:

```
trait PizzaDaoInterface {  
  
    def getToppingPrices(): Map[Topping, Money]  
    def getCrustSizePrices(): Map[CrustSize, Money]  
    def getCrustTypePrices(): Map[CrustType, Money]  
  
}
```

These methods return the pricing data maps that are passed into the `calculatePizzaPrice` function in the `PizzaService` trait.

One way to implement this interface is with a mock object, and that's what I'll do for this lesson. Here's a mock implementation of the `PizzaDaoInterface`:

```
object MockPizzaDao extends PizzaDaoInterface {  
  
    def getToppingPrices(): Map[Topping, Money] = {  
        Map(  
            Cheese    -> BigDecimal(1),  
            Pepperoni -> BigDecimal(1),  
            Sausage   -> BigDecimal(1),  
            Mushrooms -> BigDecimal(1)  
        )  
    }  
  
    def getCrustSizePrices(): Map[CrustSize, Money] = {  
        Map(  
            SmallCrustSize -> BigDecimal(0),  
            MediumCrustSize -> BigDecimal(1),  
            LargeCrustSize  -> BigDecimal(2)  
        )  
    }  
  
    def getCrustTypePrices(): Map[CrustType, Money] = {  
        Map(  
            RegularCrustType -> BigDecimal(0),  
            ThickCrustType   -> BigDecimal(1),  
            ThinCrustType    -> BigDecimal(1)  
        )  
    }  
  
}
```

In the real world you'd also have a `TestPizzaDao` and

ProductionPizzaDao, but this is enough for our purposes.

## The OrderService trait

The next thing I'd think about in the Pizza POS system are the behaviors/services related to an order. The main service this trait needs to provide is the ability to calculate the price of an order, so I begin by writing this:

```
trait OrderServiceInterface {  
    def calculateOrderPrice(o: Order): Money  
}
```

Given an `Order`, `calculateOrderPrice` returns the price of the order as a `Money` type.

To work the database into the application, let's assume that this is where I decide to access the database. I might not do this in the real world, but I don't want to make this example too complicated.

That assumption leads me to add this database reference to the interface:

```
trait OrderServiceInterface {  
    // implementing classes should provide their own database  
    // that is an instance of PizzaDaoInterface, such as  
    // MockPizzaDao, TestPizzaDao, or ProductionPizzaDao  
    protected def database: PizzaDaoInterface  
  
    def calculateOrderPrice(o: Order): Money  
}
```

# The implementation of OrderServiceInterface

Now I can put the work in to create an implementation of the OrderServiceInterface. I'll share the complete source code for the implementation, and then explain it:

```
trait AbstractOrderService extends OrderServiceInterface {  
  
  // create a concrete implementation of the trait so we  
  // can use its `calculatePizzaPrice` function  
  object PizzaService extends PizzaService  
  import PizzaService.calculatePizzaPrice  
  
  // all implementations of this trait will use these functions,  
  // so go ahead and define them here  
  private lazy val toppingPricesMap = database.getToppingPrices()  
  private lazy val crustSizePricesMap = database.getCrustSizePrices()  
  private lazy val crustTypePricesMap = database.getCrustTypePrices()  
  
  // the publicly-available service  
  def calculateOrderPrice(o: Order): Money =  
    calculateOrderPriceInternal(  
      o,  
      toppingPricesMap,  
      crustSizePricesMap,  
      crustTypePricesMap  
    )  
  
  private def calculateOrderPriceInternal(  
    o: Order,  
    toppingPrices: Map[Topping, Money],  
    crustSizePrices: Map[CrustSize, Money],  
    crustTypePrices: Map[CrustType, Money]  
  ): Money = {  
    val pizzaPrices: Seq[Money] = for {  
      pizza <- o.pizzas  
    } yield {  
      calculatePizzaPrice(  
        pizza,  
        toppingPrices,  
        crustSizePrices,  
        crustTypePrices  
      )  
    }  
    pizzaPrices.sum  
  }  
}
```

To understand this code, it helps to look at the calculateOrderPriceInternal function first. When you look at its code you'll see:

- It requires the three data maps from the database

- It also requires the `calculatePizzaPrice` function from the `PizzaService` trait

Knowing that, the other lines of code make sense. First, I create a concrete instance of the `PizzaService`:

```
object PizzaService extends PizzaService
```

You can't call functions on a trait, so you need to create a concrete instance of that trait before you do anything else. This technique is common with the modular programming approach, and it's known as "reifying" the trait. (The word *reify* is defined as, "Taking an abstract concept and making it concrete.")

Next, I import the function I need from `PizzaService`:

```
import PizzaService.calculatePizzaPrice
```

After that, I get the data maps I need from the database reference:

```
private lazy val toppingPrices = database.getToppingPrices()
private lazy val crustSizePrices = database.getCrustSizePrices()
private lazy val crustTypePrices = database.getCrustTypePrices()
```

I implement these as `private` because nobody else needs to access them.

I further define them as `lazy` for a totally different reason: This trait still isn't completely useful. Because it doesn't have a concrete database reference, it's not completely usable as it is (which is why I include the word "Abstract" in the trait name). To make use of this trait I'll have to extend it one more time.

## Using the MockPizzaDao

Because the `AbstractOrderService` class is nearly complete, it takes just one more step to create an implementation of it that works with the `MockPizzaDao`. All you have to do is declare an object that extends the trait and state that its database reference is the `MockPizzaDao`:

```
object MockDbOrderService extends AbstractOrderService {  
    val database = MockPizzaDao  
}
```

This is a nice technique, because if you want a `ProductionPizzaDao` you can easily create a similar object to use in Production:

```
object ProductionOrderService extends AbstractOrderService {  
    val database = ProductionPizzaDao  
}
```

Now that I have the `MockDbOrderService`, I can test all of my code in a “driver” class to show that it all works the way I want it to work.



## A driver class to test the design

Here's a driver class I created to test the API I created. I explain what I'm doing in the comments in the code, so please see those comments for the primary discussion of this code:

```
object MainDriver extends App {

    // create a concrete PizzaService instance so i can
    // call its functions
    object PizzaService extends PizzaService

    // import all of its functions
    import PizzaService._

    // create a sample Address
    val address = Address(
        "1 Main Street",
        None,
        "Talkeetna",
        "AK",
        "99676"
    )

    // create a sample Customer
    val customer = Customer(
        "Alvin Alexander",
        "907-555-1212",
        address
    )

    // start to create an Order for the Customer. notice that
    // this brings up a question, should i have used an Option
    // for the Seq[Pizza] parameter?
    val o1 = Order(
        Seq[Pizza](), //TODO use Option here instead?
        customer
    )

    // create a pizza
    val p1 = Pizza(
        MediumCrustSize,
        RegularCrustType,
        Seq(Cheese)
    )

    // with the current api, this is what you have to do to
    // add a new pizza to an existing order. this tells me
    // that OrderServiceInterface needs an `addPizzaToOrder`
    // function.
    val newPizzas = o1.pizzas :+ p1
    val o2 = o1.copy(pizzas = newPizzas)

    // build another pizza
    val p2 = Pizza(
        MediumCrustSize,
        RegularCrustType,
        Seq(Cheese)
    )
}
```

```

    )

    // test the PizzaService functions
    val p2a = addTopping(p2, Pepperoni)
    val p2b = addTopping(p2a, Mushrooms)
    val p2c = updateCrustType(p2b, ThickCrustType)
    val p2Last = updateCrustSize(p2c, LargeCrustSize)

    // update the order with the second pizza. again i see
    // that i should have create an `addPizzaToOrder` function.
    val pizzas3 = o2.pizzas :+ p2Last
    val o3 = o2.copy(pizzas = pizzas3)
    println(o3)

    // note that i could have created the second pizza like this
    val p2d = updateCrustSize(
        updateCrustType(
            addTopping(
                addTopping(p2, Pepperoni),
                Mushrooms
            ),
            ThickCrustType
        ),
        LargeCrustSize
    )

    // calculate the price of the current order (o3) using the
    // MockDbOrderService
    import com.alpizza.pos.services.MockDbOrderService.calculateOrderPrice
    val orderPrice = calculateOrderPrice(o3)
    println(s"Order Price = $orderPrice")

    // i forgot to test `removeTopping`, give it a spin
    val p5 = Pizza(
        MediumCrustSize,
        RegularCrustType,
        Seq(Cheese, Pepperoni, Pepperoni, Sausage)
    )
    val p5a = removeTopping(p5, Pepperoni)
    println("\nSHOULD BE Cheese/Pepperoni/Sausage:")
    println(p5a)
}

```

I made two discoveries by writing this driver class, one that you can see, and one that you don't see. The one you can see is that by going through this process I realized that the `OrderServiceInterface` should have had an `addPizzaToOrder` function.

The second thing you can't see is that by going through this process I realized that I didn't like the way I originally implemented the code in the `AbstractOrderService` trait. By working with this driver class I was able to improve my original approach to create the code you currently see in `AbstractOrderService`. (My previous mistakes were in leaving the price maps publicly available, and in requiring `MainDriver` to have those, and pass them into an earlier version of the `calculateOrderPrice` method.)

In summary, the main point of creating a driver App like this is that it lets me look at my service API from the perspective of a consumer of the API. Going through that process helps me find my mistakes.

## Discussion

There are a few important parts about what I showed that I should briefly note:

1. There are multiple ways to provide the “order services” implementation
2. Different designs of the DAO functions might return Try, DBIO, or another monad
3. I stressed the “interface” and “abstract” parts of this by using the names Interface and Abstract in the trait names
4. If i had taken this further you would see the advantages of combining/stacking/composing traits, like you saw with the Irish Setter example

I’ll briefly discuss these points in the sections that follow.

### ***1) There are multiple ways to provide the “order services” implementation***

There are different ways that I could have implemented the “order service” traits, but I chose the approach shown because the current code tells me that the `getToppingPrices`, `getCrustSizePrices`, and `getCrustTypePrices` functions can be implemented in `AbstractOrderService`. If and when that situation changes, my design would change to reflect that new knowledge.

In short, the solution I showed may not be perfect; it’s just an attempt to show a simple example of how to build a modular design that accesses a database for the current problem.

### ***2) The DAO functions might return Try, DBIO, or another monad***

The DAO functions I showed return a Map, but when you work with real databases, your functions may end up returning a monadic type. For instance, a function may return Try in case there’s a problem accessing the database. The Scala Slick database library methods return a type of [DBIO](#), which appears to be

similar to the IO approach I described in this book. (I haven't worked with it yet.)

If the functions work that way, the design would change to reflect that change.

### **3) I stressed the “interface” name**

The more I write code — actually, the more I *maintain* code — the more I prefer code that is obvious. For instance, many times I prefer a “verbose” style instead of a concise style, and that has to do with maintaining the code. I work on many different projects, and I don't like having to take extra time to try to understand code that has been reduced to an extremely condensed form.

The same is true for naming things like traits and classes. I prefer meaningful names, so while my style may go against the grain, I like to see the word “Interface” in a trait name when I truly mean that the trait is intended to be an interface, and I like to use the word “Abstract” when the trait is truly abstract (i.e., when it's not completely ready to be reified). I prefer that style, but if that's too literal for your taste, use whatever style you prefer.

### **4) If I had taken this further ...**

If I had built out a larger version of this example you would have seen many traits for different parts of the domain vocabulary:

- Possibly a separate “price calculator” trait
- Almost certainly there would be a series of traits for calculating taxes (which would be required for selling pizzas in different countries)
- Traits to model different employee roles
- A set of traits to model coupons and discounts

As just one example, if we decided to start selling other products besides pizzam there would be a series of traits that would look something like this:

```
sealed trait Product
```

```
trait Pizza extends Product
```

```
trait Breadsticks extends Product
```

```
trait Cheesesticks extends Product
trait Beverage extends Product
trait BottledBeverage extends Beverage
trait CannedBeverage extends Beverage
```

The exact implementation of those traits would depend on (a) what their behaviors (services) are, and (b) how you want to organize them, but almost certainly you'll want to be able to add a Product to an Order like this:

```
trait OrderServicesInterface {
  def addProductToOrder(o: Order, p: Product): Order
  ...
}
```

## Benefits of this approach

The benefits of a modular style of programming are described well in the original quote I shared from [Programming in Scala](#):

- As a program grows in size, it's important to organize it in a modular way as a means to handle complexity
- With separate modules, multiple teams can work on different modules independently
- Being able to unplug one implementation and plug in a different one lets you build different configurations, such as using a mock database in development and real databases in Test and Production

## Disadvantages of this approach

The main disadvantage of this approach is that you may need to learn a few new Scala programming techniques. (But if you want to be a top Scala developer, that's actually a good thing.)

For instance, if you haven't used traits as mixins, you'll be using that technique a lot, because it's the essence of the modular solution. Along with that you'll also want to use techniques like self-types, which I demonstrated in this lesson.

As another example of learning new techniques, when I first learned the "reify" technique, I had never seen a line of code like this before:

```
object OrderService extends OrderService
```

That line is a real head-scratcher if someone demonstrates it without explaining it.

Finally, it will take time and experience to learn how to properly organize your traits. For example, one thing I intentionally tried to show with the "order services" traits is that there are times that you'll want to avoid hard-coding one trait to another. In my example I intentionally had the `OrderServiceInterface` contain a reference to the `PizzaDaoInterface` so it wouldn't be hardwired to the `MockPizzaDao` (or any other specific DAO implementation):

```
trait OrderServiceInterface {  
    protected def database: PizzaDaoInterface  
}
```

If you come to Scala/FP from an OOP background, it can take a while to get used to modular programming with traits, but that example shows the pattern of how to avoid tying one trait to a concrete implementation of another trait.



## See also

The primary references for this style of programming are:

- The “Modular Programming Using Objects” chapter in the book, [Programming in Scala](#)
- The book, [Functional and Reactive Domain Modeling](#), by Debasish Ghosh, shows long, detailed examples of this technique

Other references that may be helpful:

- [Class composition with mixins](#) on scala-lang.org
- [Using Scala traits as modules](#)
- [How to use Scala traits as simple mixins](#)
- [Scala: How to limit which classes can use a trait by inheritance](#)
- [How to define a Scala trait so it can only be subclassed by a certain type](#)
- [A slide showing that Scala traits are like OCaml modules](#)

# The “Functional Objects” Approach

It seems like most Scala/FP developers prefer the modular programming approach shown in the previous lesson, but there’s still one more way you can implement behaviors in your code: Follow the same approach used in the Scala collections classes, such as the `List` class.

## Option 4: Handling behavior with functional objects

In Chapter 6 of the book [Programming in Scala](#), the authors define the term, “Functional Objects” as “objects that do not have any mutable state.” Like the `List` class, this means that the `List` methods don’t mutate the internal `List` state; instead, you get a copy of a new `List` as a result.

I sometimes refer to this approach as a “hybrid FP/OOP design” because you:

- Model the data as immutable fields in case classes.
- Put the behaviors (methods) in the same class as the data.
- Implement the behaviors as pure functions. They don’t mutate any internal state; rather, they return a new instance of the class.

This really is a hybrid approach:

- Like an OOP design, the methods are encapsulated in the class with the data, but
- The methods are implemented as pure functions that don’t mutate the data

## Example

Using this approach, the `Pizza` class I used in the previous lesson is built like this:

```
case class Pizza (
  crustSize: CrustSize,
  crustType: CrustType,
  val toppings: Seq[Topping]
) {
  def addTopping(t: Topping): Pizza = ???
  def removeTopping(t: Topping): Pizza = ???
  def removeAllToppings(): Pizza = ???

  def updateCrustSize(cs: CrustSize): Pizza = ???
  def updateCrustType(ct: CrustType): Pizza = ???

  def getPrice(
    toppingPrices: Map[Topping, Money],
    crustSizePrices: Map[CrustSize, Money],
    crustTypePrices: Map[CrustType, Money]
  ): Money = ???
}
```

Notice that unlike the previous approaches, these methods no longer take a `Pizza` reference as an input parameter. They assume that the `Pizza` to be operated on is the current `Pizza` reference, i.e., `this`.

Code that uses this design looks like this:

```
val pizza1 = Pizza(
  LargeCrustSize,
  ThinCrustType,
  Seq(Cheese)
)
val pizza2 = pizza1.addTopping(Pepperoni)
val pizza3 = pizza2.updateCrustType(ThickCrustType)

val price = pizza3.getPrice(
  toppingPrices,
  crustSizePrices,
  crustTypePrices
)
```

Notice that in this line:

```
val pizza2 = pizza1.addTopping(Pepperoni)
```

the `Pepperoni` topping is added to whatever toppings are in the `pizza1` reference to create a new `Pizza` instance named `pizza2`. Following the FP model, `pizza1` isn't mutated, it's just used to create a new instance with the updated data.

## Are the functions pure?

In this example, because `getPrice` doesn't take any input parameters, by my own definition it's not a strictly pure function. You can't say, "Output depends only on input," because there appears to be no input.

That being said, what's really going on with these method calls is that they receive an implicit `this` reference, so under the covers they really look like this:

```
val pizza2 = pizza1.addTopping(this, Pepperoni)
val pizza3 = pizza2.updateCrustType(this, ThickCrustType)

val price = pizza3.getPrice(
    this,
    toppingPrices,
    crustSizePrices,
    crustTypePrices
)
```

In that regard, these methods on the `Pizza` class are as pure as methods like `map` and `filter` on the `List` class.

## The same design as the Scala collections classes

As I mentioned, this approach is exactly how the Scala collections classes are designed:

```
val list = List(1,2,3,4,5)
val littleNumbers = list.filter(_ < 3)
```

Just like the `Pizza` class, you can say these things about the `List` class:

- It has an immutable internal data model (in this case the list of numbers 1 to 5)
- `filter` is defined as a method in `List`
- `filter` doesn't mutate the `List`'s internal state; it returns a new `List` based on (a) its internal model, and (b) the function you supply to `filter`

I provide a complete example of this approach in the next lesson.

# Demonstrating the “Functional Objects” Approach

To demonstrate the “functional objects” approach I created an example project, which I share in this lesson. To follow along with this discussion, the source code for this lesson is at this Github URL:

- [github.com/alvinj/PizzaPosFpFunctionalObjectsStyle](https://github.com/alvinj/PizzaPosFpFunctionalObjectsStyle)

# The enumerations

The enumerations are the same as in all previous lessons:

```
sealed trait Topping
case object Cheese extends Topping
case object Pepperoni extends Topping
case object Sausage extends Topping
case object Mushrooms extends Topping
case object Olives extends Topping

sealed trait CrustType
case object RegularCrustType extends CrustType
case object ThinCrustType extends CrustType
case object ThickCrustType extends CrustType

sealed trait CrustSize
case object SmallCrustSize extends CrustSize
case object MediumCrustSize extends CrustSize
case object LargeCrustSize extends CrustSize
```



# Database access object (DAO)

The DAO for this project is the same as the `MockPizzaDao` from the previous lesson, without bothering to extend an interface:

```
object MockPizzaDao {  
    def getToppingPrices(): Map[Topping, Money] = {  
        Map(  
            Cheese    -> BigDecimal(1),  
            Pepperoni -> BigDecimal(1),  
            Sausage   -> BigDecimal(1),  
            Mushrooms -> BigDecimal(1)  
        )  
    }  
  
    def getCrustSizePrices(): Map[CrustSize, Money] = {  
        Map(  
            SmallCrustSize -> BigDecimal(0),  
            MediumCrustSize -> BigDecimal(1),  
            LargeCrustSize  -> BigDecimal(2)  
        )  
    }  
  
    def getCrustTypePrices(): Map[CrustType, Money] = {  
        Map(  
            RegularCrustType -> BigDecimal(0),  
            ThickCrustType   -> BigDecimal(1),  
            ThinCrustType    -> BigDecimal(1)  
        )  
    }  
}
```

# The Pizza model

Finally — getting to the purpose of this lesson — I create the `Pizza` model using the same pizza behaviors I used in the previous lesson, with slight modifications so they can be used inside a `Pizza` class:

```
// the data model
case class Pizza (
  crustSize: CrustSize,
  crustType: CrustType,
  val toppings: Seq[Topping]
) {

  // the operations on the data model

  def addTopping(t: Topping): Pizza = {
    this.copy(toppings = this.toppings :+ t)
  }

  def removeTopping(t: Topping): Pizza = {
    val newToppings = Utils.dropFirstMatch(this.toppings, t)
    this.copy(toppings = newToppings)
  }

  def removeAllToppings(p: Pizza): Pizza = {
    val newToppings = Seq[Topping]()
    this.copy(toppings = newToppings)
  }

  def updateCrustSize(cs: CrustSize): Pizza = {
    this.copy(crustSize = cs)
  }

  def updateCrustType(ct: CrustType): Pizza = {
    this.copy(crustType = ct)
  }

  def getPrice(
    toppingPrices: Map[Topping, Money],
    crustSizePrices: Map[CrustSize, Money],
    crustTypePrices: Map[CrustType, Money]
  ): Money = {
    // TODO implement a real algorithm based on those sequences
    val base = BigDecimal(10)
    val numToppings = this.toppings.size
    val price = base + 1.00 * numToppings
    price
  }
}
```

As those functions show, rather than taking an explicit `Pizza` reference as an input parameter, the functions refer to the current `Pizza` instance with the `this` reference. Other than that change, these functions are identical to the pizza-related functions in the previous lesson.

## A “driver” application

When I’m writing classes like this I usually create a little test application I can use to test the API that I’m creating. This is the code I wrote to test the “model” code I just showed:

```
object Driver extends App {  
  
    // initialize the data from database  
    val toppingPrices = MockPizzaDao.getToppingPrices()  
    val crustSizePrices = MockPizzaDao.getCrustSizePrices()  
    val crustTypePrices = MockPizzaDao.getCrustTypePrices()  
  
    // create a pizza  
    val pizza1 = Pizza(  
        MediumCrustSize,  
        ThinCrustType,  
        Seq(Cheese, Pepperoni)  
    )  
  
    // make sure you can create modified versions of  
    // the initial pizza  
    val pizza2 = pizza1.addTopping(Olives)  
    val pizza3 = pizza2.updateCrustSize(LargeCrustSize)  
    println(s"pizza3: $pizza3")  
  
    // getPrice looks like this  
    val pizzaPrice = pizza3.getPrice(  
        toppingPrices,  
        crustSizePrices,  
        crustTypePrices  
    )  
    println(s"price of pizza3: $pizzaPrice")  
  
    // can also do this  
    val pizza4 = pizza1.addTopping(Olives)  
        .updateCrustSize(LargeCrustSize)  
        .updateCrustType(ThickCrustType)  
    println(s"pizza4: $pizza4")  
  
}
```

## Discussion

Visually, I prefer this “functional object” coding style:

```
val pizza2 = pizza1.addTopping(Pepperoni)
```

to this style:

```
val pizza2 = addTopping(pizza1, Pepperoni)
```

Something about seeing a method name attached to a variable name as `variable.method(parameters)` is easier for my brain to read, though that may just be the result of programming in an OOP style for a few decades.

That being said, I’m currently developing applications using the modular programming style, and I’ve come to enjoy the process of using traits to build modules, and then combining those modules to build applications. At the time of this writing I can’t recommend one style 100% over the other style for all situations.

# Summary of the Domain Modeling Approaches

In the last several lessons I showed a variety of ways to model data and behaviors (functions) in Scala/FP.

Defining a data model in Scala/FP is simple: Just model the data as case classes with immutable fields. This approach is similar to creating a relational database design, and it becomes a blueprint of the classes, their fields, and their relationships.

When it comes to modeling behaviors I showed several different possible approaches:

- Put your functions in “Utils” classes
- Put your functions in companion objects
- Use a modular programming style
- Use a “functional objects” approach

While I like the readability of the “functional objects” approach, the modular programming style may offer advantages related to using modules, such as letting multiple teams work on different modules simultaneously, and the ability to “wire together” modules to create different configurations.

While I’m sure FP experts will say “just use modules,” I encourage you to use both the modular approach and the functional objects approach to see which style you prefer. While the modular approach may be preferred by FP experts, it’s worth noting that the Scala language designers could have implemented the collections classes in that manner, but they chose to use the functional objects approach, which I find very readable.

Historically, the modular programming style has its roots in [ML](#)-based languages such as [OCaml](#), and this style is also used

in other FP languages, such as Haskell and F# (which is based on OCaml).

# ScalaCheck 1: Introduction

Once all of your functions work like algebraic equations and you look at an individual function, it's a simple step to wonder:

- Are there some general properties I can state about my function?
- If there are general properties, is there a way I can test those *properties* without having to write a bunch of little unit tests?

The answer to the first question is typically “Yes,” and [ScalaCheck](#) is a tool that lets you answer “yes” to the second question. In this lesson I’ll demonstrate how ScalaCheck works (and explain everything I just wrote).

## Overview

Here's the elevator pitch on ScalaCheck, from the book, [ScalaCheck: The Definitive Guide](#):

ScalaCheck is a tool for testing Scala and Java programs, based on property specifications and automatic test data generation. The basic idea is that you define a *property* that specifies the behaviour of a method or some unit of code, and ScalaCheck checks that the property holds. All test data are generated automatically in a random fashion, so you don't have to worry about any missed cases.

The rest of this lesson will show how ScalaCheck works, and how it compares to other testing tools, like JUnit and ScalaTest.



# Introduction

Let's say that you've just written this function:

```
def increaseRandomly(i: Int) = {  
    val randomNum = getRandomIntFrom1To100()  
    i + randomNum  
}
```

Because it increments the value it's given by a random amount, it isn't a pure function, but it is a relatively simple function. It adds a random number that varies from 1 to 100 to the number it's given.

Two notes about this code:

- I show the source code for `getRandomIntFrom1To100` later
- I use an impure function with a random number generator because it makes the tests that follow more interesting

Having written this function, you now want to test it. If you were writing unit tests you'd start to write a number of test cases to prove (or disprove) that the function works, but with ScalaCheck you start differently. The first thing you do is ask the question, "What are some general properties or observations I can make about how `increaseRandomly` works?"

When I think about the *general* behavior of this function, I know that the number given to it will always be increased by at least 1. Therefore, I can make this observation:

- Regardless of how many times it's called, the result of `increaseRandomly` should always be greater than the number given to it as an input parameter

It may be greater by 1, or it may be greater by any number up to 100, but in general, the result should always be greater; it should never be equal to or lower than the input value. ScalaCheck refers to this general observation as a "property" of the function.

## Writing a test

The way you write this “general property test” with ScalaCheck looks like this:

```
property("increaseRandomly") = forAll { input: Int =>
  val result = MathUtils.increaseRandomly(input)
  result > input
}
```

I’ll explain that code in a moment, but once you get used to the syntax, you’ll find that you can read it as, “The property named `increaseRandomly` says that for *all* `Int` values, call the function `increaseRandomly`. Then for every `Int` value `increaseRandomly` is given, its `result` should be greater than its `input`.”

As you get more familiar with ScalaCheck you’ll read that more concisely as, “For any `Int` value, the result of `increaseRandomly` should always be greater than its input value.”

### *Explaining the property test*

Here’s a breakdown of how that code works. First, the test begins with this line, where you give the property test a name:

```
property("increaseRandomly") = ...
```

This is similar to JUnit, but ScalaCheck refers to this as a “property” rather than a “test.”

Next, that line continues:

```
property("increaseRandomly") = forAll { input: Int =>
```

As you know from reading this book, this piece of code indicates the beginning of an anonymous function:

```
{ input: Int =>
```

This tells you that `forAll` is a case class or function that takes a block of code as an input value.

What you have no way of knowing at this time is that `forAll` is an important

ingredient in the ScalaCheck recipe: most property tests begin with `forAll`. When you see `forAll`, you can read it as, “For all possible elements of the type shown, run the block of code that follows.”

`forAll` has some options that I’ll show in a little while, but with this specific example, just know that `forAll` sees the `Int` parameter input, and responds by generating random `Int` values that it will feed into your anonymous function, one at a time. By default, `forAll` generates 100 random `Int` values to test your function, with a special emphasis on edge conditions like `0`, `Int.MinValue`, and `Int.MaxValue`.

The rest of the code in the anonymous function is standard Scala. The `increaseRandomly` function is called, and then `forAll` requires a `Boolean` value to be returned at the end of the block:

```
property("increaseRandomly") = forAll { input: Int =>
  val result = MathUtils.increaseRandomly(input)
  result > input
}
```

As I showed earlier in the book, you can infer from this code that `forAll`’s type signature looks something like this:

```
def forAll(codeBlock: => Boolean)
```

## Source code

The easiest way to run the test is to check my project out of Github, and then run it from your IDE or from the SBT command line. The source code is available at this Github URL:

- [github.com/alvinj/FPScalaCheck](https://github.com/alvinj/FPScalaCheck)

The code for this lesson is in these two files in that project:

- `MathUtils` under `src/main/scala/Utils`
- `IncreaseRandomlySpec` under `src/test/scala/Utils`

One note about the project code: As usual, [SBT](#) project dependencies are declared in the `build.sbt` file. I import both `ScalaCheck` and `ScalaTest` dependencies with these lines of code so I can show the differences between the two approaches in these lessons:

```
// all of these imports will only work under 'src/test/scala'
libraryDependencies += Seq(
  "org.scalacheck" %% "scalacheck" % "1.13.4" % "test", //scalacheck
  "org.scalactic" %% "scalactic" % "3.0.1" % "test", //scalatest
  "org.scalatest" %% "scalatest" % "3.0.1" % "test" //scalatest
)
```

## Running the test

Given that SBT configuration, when you run the test (such as with `sbt test`) you'll see output that looks like this:

```
! AddOneSpec.increaseRandomly: Falsified after 13 passed tests.  
> ARG_0: 2147483647  
Found 1 failing properties.
```

Wait, what? *Falsified*? There's an error in my function? That can't be right ...

If you know your `Int` values well, you know that indeed there is a problem with my function. When you take the number 2147483647 — also known as `Int.MaxValue` — and add 1 to it, you see this result in the REPL:

```
scala> 2147483647 + 1  
res0: Int = -2147483648
```

As shown, adding 1 to `Int.MaxValue` causes the result to roll over to `Int.MinValue`. This causes my property test to fail.

Note that there's nothing wrong with this property specification:

```
property("increaseRandomly") = forAll { input: Int =>  
  val result = MathUtils.increaseRandomly(input)  
  result > input  
}
```

This is the correct way to use `ScalaCheck` to state, “When `increaseRandomly` is given any `Int`, the value it returns should be greater than the value it's given.” The problem is with the `increaseRandomly` function, specifically what happens when it adds any positive number to `Int.MaxValue`.

## Looking at how a ScalaCheck property test works

I'll fix `increaseRandomly` shortly, but before I do that, it will help to see what ScalaCheck just did to “falsify” my property test. You can learn more about ScalaCheck by adding a print statement to the property:

```
property("increaseRandomly") = forAll { input: Int =>
  println(s"input = $input")
  val result = MathUtils.increaseRandomly(input)
  result > input
}
```

When you add that print statement and run the test again, you'll see lines of output that look like this:

```
input = -2147483648
input = 2147483647
input = 1073741823
input = -1073741823
input = 536870911
input = -536870911
input = 268435455
input = -268435455
...
...
...
! AddOneSpec.increaseRandomly: Falsified after 1 passed tests.
> ARG_0: 2147483647
Found 1 failing properties.
```

The input values are generated randomly, so you'll see different values each time you run a test, but the general process is that ScalaCheck will run up to 100 tests against your function, trying to “falsify” the property you stated. It will do this whether you're testing against `Ints`, `Strings`, or any other data type you specify, including your own custom data types.

## What “falsify” means (and does)

“Falsifying” a property is similar to a unit test: If a ScalaCheck property test returns `false`, the test is considered to be failed. More accurately, it means that the property you stated about your function has been proven false, or wrong.

[ScalaCheck: The Definitive Guide](#), describes how property tests work like this:

“When ScalaCheck tests a property created with the `forAll` method, it tries to falsify it by assigning different values to the parameters of the provided function, and evaluating the boolean result. If it can’t locate a set of arguments that makes the property `false`, then ScalaCheck will regard the property as passed.”

### ***Test case simplification***

ScalaCheck takes this even further with a feature known as *test case simplification*. [ScalaCheck: The Definitive Guide](#) describes this feature as follows:

“Test case simplification is a powerful feature of ScalaCheck. It is enabled by the fact that properties are abstract, and ScalaCheck therefore has control over the test data that is used. As soon as ScalaCheck finds a set of arguments that makes a property false, it tries to simplify those arguments. For example, if a property takes a list of integers as its parameter, then ScalaCheck will first generate many different integer lists and feed them to the property. If it stumbles across a list that makes the property false, ScalaCheck will test the property with smaller and smaller variants of that list, as long as the property still fails. Then ScalaCheck prints both the smallest list that still

causes property failure, and the original list it stumbled across.  
By default, the first generated parameter is called ARG\_0.”

The book continues:

“In the end, the smallest possible test case that makes the property false will be presented along with the original arguments that caused the initial failure.”

This process doesn't work in all cases, but when it works it's a nice way to cut to the root of the problem.



## Fixing increaseRandomly

The problem with `increaseRandomly` is that when it's given `Int.MaxValue` as an input parameter, the number it returns flips over to being a negative value:

```
scala> Int.MaxValue + 1
res0: Int = -2147483648
```

One way to fix the problem is to force the calculation to take place as a `Long` rather than an `Int`. I show how to do this in the REPL:

```
scala> Int.MaxValue + 1.toLong
res1: Long = 2147483648
```

To implement the solution, add that change to the body of `increaseRandomly`, and then declare that it returns a `Long` value:

```
def increaseRandomly(i: Int): Long = {
  val randomNum = getRandomIntFrom1To100()
  i + randomNum.toLong
}
```

When I make that change, remove the `println` statement from my property test, and then run the test, I see this output:

```
+ AddOneSpec.increaseRandomly: OK, passed 100 tests.
```

This tells me that `increaseRandomly` passed 100 tests that were thrown at it by the `ScalaCheck` framework. I can now feel comfortable that the general property I stated — `increaseRandomly`'s result must always be greater than its input value — is correct.

## ScalaCheck also works with OOP

As you saw with this example, ScalaCheck not only works with pure functions, but with impure methods as well. It also works with OOP code. In fact, there isn't anything specific to ScalaCheck and FP, with one exception:

- It's a lot easier to test FP functions than it is to test OOP methods, because FP functions don't deal with hidden state

As I wrote in the lesson about the benefits of pure functions, this attribute alone makes pure functions easier to test in general, and easier to test in ScalaCheck specifically. With OOP, you often need to set up state before testing a method, but with FP functions there is significantly less setup work: output depends only on input.

## ScalaCheck concepts

Although this was a simple example, it demonstrated many of the most important things to know about ScalaCheck:

- You use it to test general *properties* of your functions
- Therefore, you don't write low-level unit tests
- By default, each function is tested 100 times (100 times if all tests succeed; less than that if a test is falsified)
- The tests are run with randomly-generated data
- What I haven't discussed yet is that the test data is created with *generators*
- You can use built-in generators, as I did in this example, letting ScalaCheck generate random integers; you can also write your own generators, which you'll need to do for your custom data types

(I'll discuss generators more in the next lesson.)

Other concepts are similar to JUnit. For instance, you can create many property tests in one file, and you can also put tests in many different files.

## Benefits of property-based testing (from the ScalaCheck book)

[ScalaCheck: The Definitive Guide](#), lists the following benefits of using ScalaCheck as compared to other testing frameworks:

- Test coverage can increase: Because test cases are generated randomly, many more tests are thrown at your functions than you'll get with static unit tests
- Specification completeness: Because you define exactly how your function should work under all conditions, it's similar to writing a test specification
- Maintenance: Because a single property often compares to many individual unit tests, code size and repetition decreases, and refactoring is easier
- Test readability: Again, it can take many unit tests to compare to a single property test, which at the very least reduces the amount of code you need to read
- Test case simplification: I discussed this in the "What 'falsify' means (and does)" lesson, but in short, ScalaCheck will try to find the smallest possible test case that makes a property test false

## Disadvantages of property-based testing

The major disadvantages of ScalaCheck compared to traditional unit tests are:

- Because it runs 100 tests for each property, and generates random data for each test, it's arguably 100 times slower than a unit test
- While sometimes it can be easy to state a property of a function in words, it can occasionally be difficult to implement that property in Scala code
- When you know that one or more specific fringe conditions can cause a problem with a function, you may want the comfort of ensuring those tests are run with static ScalaTest (or JUnit) unit tests

In regards to the first point, it's important to add this caveat: a single property test is often the equivalent of many individual unit tests.

## Where ScalaCheck works well

When I first learned about ScalaCheck, I wondered if it could replace unit tests completely. The reality I've found is that ScalaCheck works well for some cases, and unit tests works well for others.

The example I showed demonstrates a case where ScalaCheck works well:

- You can clearly state one or more general properties about how a function works in English (or whatever your preferred spoken language is).
- You can *easily* express those same properties in Scala code. That is, it doesn't feel like a great deal of work (or a hack) to create the necessary generators and property tests.

## Where ScalaCheck doesn't work as well

I haven't yet found a simple, "OMG, *don't even try* to use ScalaCheck for these tests!" rule of thumb, but I can state where ScalaCheck doesn't work as well by writing the opposite of the previous rules. Specifically, don't use ScalaCheck where:

- You *can't* clearly state in English the general properties about how a function works. (Hopefully this will be very rare now that you write pure functions.)
- You *can't* easily write property tests in Scala to express those properties, i.e., it feels like a tremendous workaround or hack to create the necessary generators and tests.

# ScalaCheck 2: A More-Complicated Example

In this lesson I'll share a non-trivial example of how I used [ScalaCheck](#) to test a function I wrote recently.

While working on a Scala/FP application, I needed to create a function that reduced duplicate occurrences of a value in a list down to a single value. More accurately, given (a) a list, and (b) a value to look for, the purpose of the function is to retain the first occurrence of that element, and remove all subsequent occurrences of that element. I named this function, `dropAllButFirst`.

As an example of how this works, imagine that you have this list:

```
val xs = List(1, 2, 3, 2, 4, 2, 5)
```

With this list, I can use `dropAllButFirst` to create a new list that keeps the first occurrence of the number 2 and removes all subsequent occurrences like this:

```
val xss = dropAllButFirst(xs, 2)
```

When I apply `dropAllButFirst` as shown, `xss` should have this data:

```
List(1, 2, 3, 4, 5)
```



## Testing with ScalaTest or JUnit

If I was going to test `dropAllButFirst` with ScalaTest or JUnit — and assuming that I want to keep looking for the number 2 — the first thing I'd do is think about what sample lists I should test with. When I do that, I come up with a series of test lists like these:

```
List()  
List(1)  
List(1,2)  
List(1,2,2)  
List(1,2,2,3)  
List(1,2,2,3,2)  
List(2)  
List(2,1)  
List(2,1,2)  
List(2,1,2,3)  
List(2,1,2,3,2)
```

Can you think of any other lists I should test against? That's a little bit of a problem with the traditional ScalaTest/JUnit approach: Have you really thought of *every* possible set of data to test your function with?

# Testing with ScalaCheck

While that's probably your first thought when working with unit tests, you'll find that your first thought when using ScalaCheck is quite different. With ScalaCheck, the first thing you think is, "What general statements or observations can I make about this function that are always true?" I find that this thought process feels more like writing a test specification (or requirements specification) than writing a unit test.

## *A first observation about dropAllButFirst*

When I thought about `dropAllButFirst`, the first general observation that came to mind is:

1. If the element you want to drop is not in the input list, the resulting list should be exactly the same as the input list

Using my `ScalaTest/JUnit` test data as an example, this means that if `dropAllButFirst` gets this list as an input:

```
List(1)
```

it should return the exact same list as an output. Using just this one list as an example, I can express this general property in Scala code like this:

```
val xs = List(1)
val result = dropAllButFirst(xs, 2)
result == xs
```

If that last line doesn't return `true`, there's something wrong with my function.

(I'll demonstrate how to write this property more generally with ScalaCheck in a few moments.)

## *A second observation about dropAllButFirst*

The second general observation I can make about `dropAllButFirst` is similar to the first one:

1. If only one occurrence of the element you want to drop is in the input list, the resulting list should be the same as the input list

I can test this statement just like the first observation, so I won't say anything else about it.

### ***A third observation about `dropAllButFirst`***

Next, I begin thinking about lists that contain more than one instance of the value I'm searching for, and I come up with this observation:

1. If more than one occurrence of the element you want to drop is in the input list, then: (A) the first element should remain in its original position; (B) all other occurrences of that element should be dropped; (C) all other elements in the list should be as they were.

Parts A and B of that statement are easy to test — and I'll show how to do that shortly — but I initially found Part C to be hard to implement without using `dropAllButFirst` to prove itself(!). This is a potential problem with using random data. For instance, with static test data you know that this list:

```
List(1,2,2,3)
```

should be reduced to this:

```
List(1,2,3)
```

But when you get 100 random lists like this:

```
List(1,2,3,2,4,5,2,6)  
List(1000,-2347896,9876543,1133456)
```

you have no idea what you're going to get as input, so you have to find different ways to prove that the output list is correct.

### ***Implementing the third observation***

The way I implemented the third observation was to think about tests that I could actually write in Scala. After a little trial and error, I came up with a set of sub-tests to implement each phrase of that observation. Specifically, given any input list that has more than one occurrence of the element I want to search for, after

running `dropAllButFirst`:

- *A. The first element should remain in its original position.* I can implement this by finding the first occurrence in both the “before” and “after” lists using the `List` class `indexOf` method.
- *B. All other occurrences should be dropped.* Because the first test confirms that the first occurrence is in the proper location, this test only needs to confirm that the “after” list contains only one occurrence of the value I want to remove. I can do this with the `List` class `count` method.
- *C. All other elements in the list should be as they were.* This is a more complicated algorithm that I’ll describe next.

There are other ways to write an algorithm for this third test, but the method I came up with is to split the `input` and `result` lists at the point of the first occurrence, and work with those sub-lists. For instance, given this input list:

```
val input = List(1, 2, 3, 2, 4, 2, 5)
```

the correct result should be:

```
val result = List(1, 2, 3, 4, 5)
```

If I split the input list at the location of the first 2, I get these two lists:

```
val inputBefore = List(1)
val inputAfter  = List(3, 2, 4, 2, 5)
```

Next, my algorithm is supposed to remove all remaining 2 values in `inputAfter`, so I can use `filter` to achieve that effect:

```
val inputAfterFilter = inputAfter.filter(_ != 2)
```

That gives me:

```
val inputAfterFilter = List(3, 4, 5)
```

Therefore, splitting my “input” list into two sub-lists, and removing the matches from the second sub-list results in these two lists:

```
val inputBefore = List(1)
val inputAfterFilter = List(3, 4, 5)
```

Now I can do the same thing with the `result` list. Starting with this `result`, which I know to be correct:

```
val result = List(1, 2, 3, 4, 5)
```

I split it at the location of the 2, and get these two sub-lists:

```
val resultBefore = List(1)
val resultAfter  = List(3, 4, 5)
```

If everything works properly, I can then compare those two lists to these two lists:

```
val inputBefore      = List(1)
val inputAfterFilter = List(3, 4, 5)
```

If, for all possible `List[Int]`, `inputBefore` equals `resultBefore`, and `inputAfterFilter` equals `resultAfter`, I can be sure that `dropAllButFirst` works.

## ***Discussion***

Item C shows a problem with `ScalaCheck`: I basically had to create a second version of my algorithm to prove that the first version of my algorithm works properly. (I haven't shown its source code yet, but `dropAllButFirst` uses a recursive algorithm.)

There may be other ways that you can write tests to feel comfortable about Item C, but this is the best "proof" I came up with. There are other less-extensive ways that are easier to implement that will give you a pretty high level of confidence that `dropAllButFirst` works as intended, but they didn't give me as much confidence as this approach.

## The ScalaCheck thought process

While property tests can occasionally be hard to implement, I really like the ScalaCheck thought process. In several cases, such as with `dropAllButFirst`, it made me think harder.

In fact, as I was working on these property tests I thought, “Hmm, `dropAllButFirst` is really a special implementation of a more general algorithm. For instance, what if I ever want to keep the first *two* elements, and then drop all of the rest? Or the first three elements, etc.” The process of thinking more generally about the properties of `dropAllButFirst` made me think of that, and I don’t know if I would have had that same thought while writing unit tests.

## Source code

The source code for this project is at the same URL as the previous lesson:

- [github.com/alvinj/FPScalaCheck](https://github.com/alvinj/FPScalaCheck)

# The ScalaCheck code

At this point the best thing I can do is show the code I used to implement those property tests using the ScalaCheck syntax. Excluding the import statements, boilerplate class code, and the `List[Int]` generators I created for these tests, here's the property test that implements the three observations I made about `dropAllButFirst`:

```
object DropAllButFirstSpec extends Properties("DropAllButFirstSpec") {

  val NUM_TO_DROP = 2

  property("dropAllButFirstIntLists") =
    forAll(GenSeq.g1to5) { input: List[Int] =>

      // run `dropAllButFirst`
      val result = ListUtils.dropAllButFirst(input, 2)

      // start the tests
      val numMatches = input.count(_ == NUM_TO_DROP)
      if (numMatches == 0) {
        /**
         * OBSERVATION 1: If the element you want to drop is not
         * in the input list, the resulting list should be the
         * same as the input list
         */
        input == result
      } else if (numMatches == 1) {
        /**
         * OBSERVATION 2: If only one occurrence of the element
         * you want to drop is in the input list, the resulting
         * list should be the same as the input list
         */
        input == result
      } else {
        /**
         * OBSERVATION 3: If more than one occurrence of the
         * element you want to drop is in the input list, then:
         * (a) the first element should remain in its original
         * position; (b) all other occurrences should be dropped;
         * (c) all other elements in the list should be as they were.
         */

        // (a) "the first element should remain in its original position."
        val element1PositionOriginal = input.indexOf(NUM_TO_DROP)
        val element1PositionFinal = result.indexOf(NUM_TO_DROP)

        // (b) "all other occurrences should be dropped." it's enough
        // to test that there is only one occurrence in `result`
        val numOccurrencesInResult = result.count(_ == NUM_TO_DROP)

        // (c) "all other elements in the list should be as they were."
        val locationOfFirstOccurrenceInInput = input.indexOf(NUM_TO_DROP)
        val (inputBefore, inputAfter) =
          input.splitAt(locationOfFirstOccurrenceInInput)
        // splitAt retains the 'split' element as the first element
      }
    }
}
```



```

// of the "after" list. therefore, only look at the tail of
// the "after" list.
val inputAfterTail = inputAfter.tail
val inputAfterFiltered = inputAfterTail.filter(_ != NUM_TO_DROP)

val locationOfFirstOccurrenceInResult = result.indexOf(NUM_TO_DROP)
val (resultBefore, resultAfter) =
  result.splitAt(locationOfFirstOccurrenceInResult)
val resultAfterTail = resultAfter.tail

// run all of the "Observation 3" property tests
(
  element1PositionOriginal == element1PositionFinal && //property 3.a
  numOccurrencesInResult == 1 && //property 3.b
  inputBefore == resultBefore && //property 3.c
  inputAfterFiltered == resultAfterTail //property 3.c
)
}
}
}

```

Hopefully most of that code is readable. If you're new to ScalaCheck, this line probably needs the most explanation:

```

property("dropAllButFirstIntLists") =
  forAll(GenSeq.g1to5) { input: List[Int] =>

```

In this case I created a ScalaCheck *generator* named `GenSeq.g1to5` that generates lists of integers in a manner that I thought was best to stress-test `dropAllButFirst`. I'll discuss that shortly.

Another point worth mentioning is that the `splitAt` method retains the element you're splitting on — 2 in this case — in the second list, so you need to drop that element from the second list. It's always the head element of that list, so you can easily drop it by just taking the tail of that list:

```

val inputAfterTail = inputAfter.tail

```

Finally, a property test wants a single, final `Boolean` value as a result, and I achieve that by running all of the "Observation 3" tests at the end:

```

(
  element1PositionOriginal == element1PositionFinal && //property 3.a
  numOccurrencesInResult == 1 && //property 3.b
  inputBefore == resultBefore && //property 3.c
  inputAfterFiltered == resultAfterTail //property 3.c
)

```

## Creating a List[Int] generator

There are two critical skills involved in working with ScalaCheck:

- Writing properties (what I call “property tests”)
- Writing generators

Generators are the functions that generate the random data that is used to test your code. There are many default generators, such as the generator that created random Int values for the test in the previous lesson. However, you’ll often need to create your own, such as when you need to test against your own custom case classes.

If you want to learn a lot about writing generators, I encourage you to read [ScalaCheck: The Definitive Guide](#), but in this section I’ll show how I wrote a few List[Int] generators to test dropAllButFirst.

I could easily write 20-50 pages on this topic, so as a bit of a warning, I only cover generators here at a high level.

### *The default List[Int] generator*

First, I tried to use the default List[Int] generator like this:

```
property("dropAllButFirstIntLists") = forAll { input: List[Int] =>
```

The problem with it is that I need to make sure my tests usually have at least one 2 in them, but because this generator creates Int values from Int.MinValue to Int.MaxValue, that rarely happens.

### *Generate values in a range*

One of the better generators I created looks like this:

```
val g1to5: Gen[List[Int]] = Gen.containerOf[List,Int](Gen.choose(1, 5))
```

This creates lists of random lengths by evenly distributing the numbers 1 to 5.

Here are some sample values from this generator:

```
input: List()
input: List(3)
input: List(2, 1)
input: List(4, 3, 5)
input: List(1, 3, 3, 5)
input: List(3, 2, 2, 2, 2, 3, 4)
input: List(1, 1, 1, 2, 5, 4, 2, 4, 5, 2)
input: List(5, 1, 2, 1, 5, 5, 2, 4, 3, 3, 5, 2, 5, 5)
```

Some of the lists it generates are much longer than what I've shown here, which is good or bad, depending on your needs.

### ***Generate values using a frequency distribution***

I also created a generator that let me control how many 2's were generated in comparison to other values. This is a two-step process. In the first step, you set up your frequency distribution. Here I declare that I want four times as many 2's as I want other integers:

```
val favorTwos: Gen[Int] = Gen.frequency(
  (1, 1),
  (4, 2), //4x the number of 2s
  (1, 3),
  (1, 4),
  (1, 5)
)
```

In the second step, I create a generator that generates `List[Int]` values:

```
genMostlyTwos: Gen[List[Int]] = Gen.containerOf[List,Int](favorTwos)
```

Here is some sample data from this generator:

```
input: List()
input: List(2)
input: List(2, 2, 1)
input: List(2, 2, 2, 2)
input: List(3, 1, 5, 2, 5, 2)
input: List(3, 2, 1, 2, 3, 2, 2)
input: List(2, 4, 3, 2, 5, 2, 1, 4, 1)
```

As with the previous generator, the lists it generates are much longer than what I've shown, which is good or bad, depending on your needs.

### ***Another way to control the distribution***

This third example shows another way I came up with to control the distribution of Int values. First, I created a List[Int] like this:

```
import scala.util.Random
val littleList: List[Int] = Random.shuffle(List(1,2,3,4,5,6,2,7,8,9))
```

Then I use the Gen.someOf helper function to create this List[Int] generator:

```
val littleListGen: Gen[List[Int]] = Gen.someOf(littleList).map(_.toList)
```

One of the best features of this approach is that it creates lists that contain ten elements or less:

```
input: List(8)
input: List(5, 8, 6)
input: List(4, 8, 9, 6)
input: List(4, 7, 5, 3, 2, 8)
input: List(2, 5, 9, 3, 2, 6, 8, 4)
input: List(8, 7, 9, 3, 2, 6, 1, 4, 5)
input: List(2, 7, 9, 3, 2, 6, 1, 4, 5, 8)
```

## ***More on generators***

As I mentioned, I could easily write dozens of pages about ScalaCheck generators. Rather than doing that, I encourage you to clone my project from Github, then (a) un-comment the println statement inside the DropAllButFirstSpec\_IntLists property test, and then (b) experiment and change the first line of code in the property test to use the different generators, like this:

```
property("dropAllButFirstIntLists") = forAll(GenIntSeq.g1to5) ...
property("dropAllButFirstIntLists") = forAll(GenIntSeq.genMostlyTwos) ...
property("dropAllButFirstIntLists") = forAll(GenIntSeq.littleListGen) ...
```

After that, experiment with the process to see the pros and cons of each approach, and see if you can create better generators.

## Running the property test

When you run the “dropAllButFirstIntLists” property test with (a) your IDE or (b) from the SBT command line (with `sbt test`), you should see this result:

```
+ DropFirstSpec.dropAllButFirst_SeqOfInts: OK, passed 100 tests.
```

That tells you that this property test was tested with 100 random lists, and ScalaCheck didn't find any problems.

## One problem not found

Unless you create a generator to generate very large lists, one problem that ScalaCheck won't find is that because my `dropAllButFirst` function isn't tail-recursive, it will run into `StackOverflow` errors on large lists. I didn't concern myself with this problem because I knew that I only wanted to use the function on small lists, but this is a potential problem with both ScalaCheck (and unit test frameworks).

Please clone my Github project to see the `dropAllButFirst` implementation.

## One more note: Tests as specification

[ScalaCheck: The Definitive Guide](#), makes a good observation that also describes this process well:

“While the idea of ‘tests as specification’ is to make your specification more test-centered, property-based testing goes in the opposite direction by making your tests more specification-like. It does so by generalizing tests to properties.”

The book further adds, “A specification is a definition of a program’s behavior in the general case.” In my view, that’s exactly what property tests are.

## Summary

I hope these two chapters have given you a taste of how ScalaCheck works, including a glimpse of its pros and cons.

I find it easiest to learn something like this by experimenting with it, so I encourage you to clone my Github project and work with it as desired to become comfortable with it. In the project I also include additional property tests, so you can see even more examples. One of the tests works with pizza toppings and a `List[Topping]` generator so you can see something besides `Int` tests.



## See also

- [The ScalaCheck user guide](#)
- [A presentation titled, “Practical ScalaCheck”](#)
- [Code Examples for ScalaCheck: The Definitive Guide](#)
- [The SBT “Testing” page](#)
- [How to use ScalaCheck in the SBT REPL](#)
- [Adventures in Abstract Algebra Part III: Using ScalaCheck to Verify Infinite Algebraic Structures](#)
- ScalaCheck was originally based on QuickCheck, which is a Haskell testing library. If you’re interested in reading about it (and know Haskell) this [An introduction to QuickCheck testing](#) article is good

# The Problem with the IO Monad

When I first learned about the `IO` monad I thought it was extremely cool. The idea that all of my I/O functions could return an `IO` type sounded terrific. Any developer on a project could look at a function signature in the source code or Scaladoc, see that it returned `IO`, and they would immediately know that it interacted with the outside world.

But as I went from theory to reality, I noticed that *every* example of the `IO` monad only showed how to use *console* I/O. I couldn't find an example of anyone using the `IO` monad with *network* or *file* I/O.

## The reality

As I dug into it, I learned about the reality of the situation. The short version of the story goes like this:

- Your `I/O` functions are probably already returning `Try` (or maybe `Option`)
- `Try` and `Option` are both monads, so it doesn't make sense to further wrap those results in `IO`

I'll show an example of this situation in the rest of this lesson, and also show two ways to declare the return type of `I/O` functions.

## **Note: Prefer Try over Option for I/O functions**

I prefer to use `Try` for file and network I/O functions because I usually want to know what the exception was when a function fails. `Try` gives me the exception when there is a problem, but `Option` just returns `None`, which doesn't tell me what the actual problem was.

## Source code

The source code for this lesson is available at the following URL:

- [github.com/alvinj/FPIOMonadNotReallyUsed](https://github.com/alvinj/FPIOMonadNotReallyUsed)

## Discussion

To demonstrate this situation, let's look at a short example. First, imagine that you already have this `readTextFileAsString` function, which returns `Try[String]`:

```
def readTextFileAsString(filename: String): Try[String] =
  Try {
    val lines = using(io.Source.fromFile(filename)) { source =>
      (for (line <- source.getLines) yield line).toList
    }
    lines.mkString("\n")
  }
```

As I showed in the “,” one way to use functions that return `Try` is like this:

```
val passwdFile = readTextFileAsString("/etc/passwdFoo")
passwdFile match {
  case Success(s) => println(s)
  case Failure(e) => println(e)
}
```

### *Attempt to wrap that in IO*

Next, imagine that you want to wrap all of your functions in the `IO` monad, so you write this code:

```
def readTextFileAsStringIO(filename: String): IO[Try[String]] = {
  IO(readTextFileAsString(filename))
}
```

All that function does is wrap the result of the previous function with the `IO` monad. As shown, the function now returns the type `IO[Try[String]]`, which you can loosely read as, “A monad wrapped around a monad wrapped around a `String`.”

Now imagine trying to use this result. You might attempt to write code like this:

```
val pfile2 = readTextFileAsStringIO("/etc/passwdFoo")
val z = for {
  a <- pfile2 //get Try[String] out of IO
  b <- a      //get String out of Try
} yield b
println(z)
```

But as you can guess from what you saw in the `StateT` lessons, that will give

you a type mismatch error:

```
Error:(16, 11) type mismatch;  
found   : scala.util.Try[String]  
required: io_examples.v1.IO[?]  
    b <- a      //get String out of Try
```

Just as bad as that error, all this approach does is make your code more complicated for no good reason. Because the first function (`readTextFileAsString`) already returns its result as a `Try`, you can already use it in `for` and `match` expressions; `IO` doesn't add a benefit here.

Once I dug into this code and saw these problems, I understood why `IO` doesn't seem to be used in the real world, at least not for file and network I/O in Scala: It makes the code more complicated, and adds no value, other than trying to have all of your I/O functions return an `IO` type.

## If you really like the IO idea ...

If you really like the idea of using an `IO` type as a way to signal to other developers, “This function interacts with the outside world via I/O,” one thing you can do is create a type alias that lets you use `IO` rather than `Try` in your function signatures:

```
import scala.util.Try
type IO[A] = Try[A]
```

With this type alias you can declare that your functions return `IO` rather than `Try`:

```
def readTextFileAsString(filename: String): IO[String] =
  Try {
    val lines = using(io.Source.fromFile(filename)) { source =>
      (for (line <- source.getLines) yield line).toList
    }
    lines.mkString("\n")
  }
```

### ***Benefits***

Assuming that you’re not already using an `IO` monad in your project, I don’t think this approach will be confusing, and it will give you the intended benefits of the `IO` monad:

- It tells all other developers that this function uses I/O
- It lets developers use the function in the usual monadic ways, i.e., such as combining instances in `for` expressions

Before you run off and use this approach, I should make a few more points:

- I don’t know if anyone uses this technique in the real world
- You arguably get the same two benefits by returning `Try`

### ***Or take it even further***

Finally, if you decide that you do like this type alias technique, you can take it a step further and create a type alias named `FileIO` for file I/O functions, and



NetworkIO for network I/O functions.

As an example of this, [the Slick database library](#) from Lightbend has functions that return the type alias DBIO for non-streaming database functions, and StreamingDBIO for streaming functions. Both of those are aliases for the DBIOAction type.

## Key points

In summary, the benefits of returning an `IO` type from your I/O functions are:

- It tells all other developers, “this function uses I/O”
- Because it implements `map` and `flatMap`, it lets developers use the function in the usual monadic ways, i.e., in `for` expressions

However, because functions that work with file and network resources already return `Try`, it doesn't make sense to stack `IO` onto `Try`, and in fact, it only makes your code more complicated, at best.

Therefore, the two main options are:

- Define your I/O functions to return `Try`.
- As an experiment, create a type alias `IO` and use it as the function return type instead of `Try`. You can also take that a step further and declare multiple aliases, such as `FileIO`, `NetworkIO`, and `DatabaseIO`.

# Signpost: Type Classes

In this section of the book I'll cover Scala *type classes*, a programming technique that lets you add new behavior to closed data types. The use of type classes isn't strictly limited to the functional programming style, but because they're used so much in the [Cats library](#) — an FP library for Scala — it's important to know how they work.

# **Type Classes 101: Introduction**

## Source code

The source code for all of the type class lessons is available at the following URL:

- [github.com/alvinj/FPTypeClasses](https://github.com/alvinj/FPTypeClasses)

The code for this lesson is in the *typeclasses.v1\_humanlike* package. One note about the source code: It contains an extra `eatHumanFood` function that isn't shown in the examples that follow. I include that function in the source code so you can see how to define multiple functions in a type class.

## Introduction

The book [Advanced Scala with Cats](#) defines a *type class* as a programming technique that lets you add new behavior to closed data types without using inheritance, and without having access to the original source code of those types. Strictly speaking, this isn't a technique that's limited to functional programming, but because it's used so much in the [Cats library](#), I want to show some examples of the approach here, as well as the motivation for the technique.

Cats is a popular FP library for Scala.

## Motivation

The authors of *Advanced Scala with Cats* make an interesting observation about inheritance, and I'll offer a slight variation of that point.

Given an OOP `Pizza` class like this:

```
class Pizza(var crustSize: CrustSize, var crustType: CrustType) {  
  val toppings = ArrayBuffer[Topping]()  
  
  def addTopping(t: Topping): Unit = { toppings += t }  
  def removeTopping(t: Topping): Unit = { toppings -= t }  
  def removeAllToppings(): Unit = { toppings.clear() }  
}
```

If you want to change the *data* or *methods* in this OOP approach, what would you normally do? The answer in both cases is that you'd modify that class.

Next, given a modular FP design of that same code:

```
case class Pizza (  
  crustSize: CrustSize,  
  crustType: CrustType,  
  toppings: Seq[Topping]  
)  
  
trait PizzaService {  
  def addTopping(p: Pizza, t: Topping): Pizza = ???  
  def removeTopping(p: Pizza, t: Topping): Pizza = ???  
  def removeAllToppings(p: Pizza): Pizza = ???  
}
```

If you want to change the data or methods in this code, what would you normally do? The answer here is a little different. If you want to change the *data*, you update the case class, and if you want to change the methods, you update the code in *PizzaService*.

These two examples show that there's a difference in the code you have to modify when you want to add new data or behavior to OOP and FP designs.

Type classes give you a completely different approach. Rather than updating *any* existing source code, you create type classes to implement the new behavior.

In these lessons I'll show type class examples so you can learn about the

technique in general, and more specifically learn about it so you can understand how [the Cats library](#) works, since much of it is implemented using type classes.



# Type classes have three components

Let's jump into some examples of how to create and use type classes so you can see how they work.

Type classes consist of three components:

- The type class, which is defined as a trait that takes at least one generic parameter (a generic “type”)
- Instances of the type class for types you want to extend
- Interface methods you expose to users of your new API

## *Data for the first example*

For the first example, assume that I have these existing data types:

```
sealed trait Animal
final case class Dog(name: String) extends Animal
final case class Cat(name: String) extends Animal
final case class Bird(name: String) extends Animal
```

Now assume that you want to add new behavior to the `Dog` class. Because dogs are well known for [their ability to speak like humans](#), you want to add a new `speak` behavior to `Dog` instances, but you don't want to add the same behavior to cats or birds.

If you have the source code for those behaviors, you could just add the new function there. But in this example I'm going to show how to add the behavior using a type class.

## Step 1: The type class

The first step is to create a trait that uses at least one generic parameter. In this case, because I want to add a “speak” function, which is a “human like” behavior, I define my trait like this:

```
trait BehavesLikeHuman[A] {  
  def speak(a: A): Unit  
}
```

Using the generic type A lets us apply this new functionality to whatever type we want. For instance, if you want to apply it to a Dog and a Cat, you can do that because I’ve left the type generic.

## Step 2: Type class instances

The second step of the process is to create instances of the type class for the data types you want to enhance. In my case, because I only want to add this new behavior to the Dog type, I create only one instance, which I define like this:

```
object BehavesLikeHumanInstances {  
  // only for `Dog`  
  implicit val dogBehavesLikeHuman = new BehavesLikeHuman[Dog] {  
    def speak(dog: Dog): Unit = {  
      println(s"I'm a Dog, my name is ${dog.name}")  
    }  
  }  
}
```

The key points about this step are:

- I only create an instance of BehavesLikeHuman for the Dog type.
- I didn't create instances for Cat or Bird because I don't want them to have this behavior.
- I implement the speak method as desired for the Dog type.
- I tag the instance as `implicit` so it can be easily pulled into the code that I'll write in the next steps.
- I wrap the code in an object, primarily as a way to help me organize it. This isn't too important in a small example, but it's helpful in larger, real-world applications.

## Step 3: The API (interface)

In the third step of the process you create the functions that you want consumers of your API to see. There are two possible approaches in this step:

- Define a function in an object, just like the “Utils” approach I described in the domain modeling lessons
- Define an `implicit` function that can be invoked on a `Dog` instance

I refer to these approaches as options 3a and 3b, and for consumers of these approaches, their code will look like this:

```
BehavesLikeHuman.speak(aDog) //3a
aDog.speak                    //3b
```

I’ll show how to implement these approaches next, but to be clear, you don’t have to implement *both* approaches. They are two different options — competitive approaches.

### *Option 3a: The Interface Objects approach*

In the [Advanced Scala with Cats book](#), the authors refer to approach 3a as the “Interface Objects” approach. I refer to this as the “explicit” approach because it uses functions in objects, just like the “Utils” approach I described in the Domain Modeling lessons.

For my dog example, I just define a `speak` function in an object, like this:

```
object BehavesLikeHumanInstances {
  // only for `Dog`
  implicit val dogBehavesLikeHuman = new BehavesLikeHuman[Dog] {
    def speak(dog: Dog): Unit = {
      println(s"I'm a Dog, my name is ${dog.name}")
    }
  }
}
```

Because `speak` can be applied to any type, I still need to use a generic type to define the function. The function also expects an instance of `BehavesLikeHuman` to be in scope when the function is executed, and that instance is pulled into the

function through the implicit parameter in the second parameter group.

As a consumer, you use this 3a approach as follows. First, import the `dogBehavesLikeHuman` instance:

```
import BehavesLikeHumanInstances.dogBehavesLikeHuman
```

Remember that it contains a `speak` method that's implemented for a `Dog`. Next, create a `Dog` instance:

```
val rover = Dog("Rover")
```

Finally, you can apply the `BehavesLikeHuman.speak` function to the `rover` instance:

```
BehavesLikeHuman.speak(rover)
```

That results in this output:

```
I'm a Dog, my name is Rover
```

That's the summary of the complete approach using Option 3a. As a final point, notice that you can also manually pass the `dogBehavesLikeHuman` instance into the second parameter group:

```
BehavesLikeHuman.speak(rover)(dogBehavesLikeHuman)
```

That's not necessary, because the parameter in the second parameter group is defined as an `implicit` variable, but I wanted to show that you can also pass the type in manually, if you prefer.

Notice that the final result of this approach is that you have a new function named `speak` that works for the `Dog` type. This is nice, but it also seems like a lot of work to create a “Utils” function you can apply to a `Dog`. In my opinion, Option 3b is where all of this work really pays off.

### ***Option 3b: The Interface Syntax approach***

As an alternative to Option 3a, you can use a second approach that the [Advanced Scala with Cats book](#) refers to as the “Interface Syntax” approach. The keys of this approach are:

- In the end, it lets you call your new function as `dog.speak`
- The Cats book refers to the methods you create as “extension methods,” because they *extend* existing data types with the new methods
- The Cats project refers to this as “syntax” for the type class

As a quick review, in Step 1 of the process I created a trait that uses a generic type:

```
trait BehavesLikeHuman[A] {
  def speak(a: A): Unit
}
```

Then in Step 2 I created an instance of the type class for the Dog data type:

```
object BehavesLikeHumanInstances {
  // only for `Dog`
  implicit val dogBehavesLikeHuman = new BehavesLikeHuman[Dog] {
    def speak(dog: Dog): Unit = {
      println(s"I'm a Dog, my name is ${dog.name}")
    }
  }
}
```

Now in Step 3b, I create the new “interface syntax” like this:

```
object BehavesLikeHumanSyntax {
  implicit class BehavesLikeHumanOps[A](value: A) {
    def speak(implicit behavesLikeHumanInstance: BehavesLikeHuman[A]): Unit = {
      behavesLikeHumanInstance.speak(value)
    }
  }
}
```

Consumers of this approach will write their code as follows. First, they import the `dogBehavesLikeHuman` instance as before:

```
import BehavesLikeHumanInstances.dogBehavesLikeHuman
```

Then they import the `implicit` class from inside the `BehavesLikeHumanSyntax` object:

```
import BehavesLikeHumanSyntax.BehavesLikeHumanOps
```

Next, they create a `Dog` instance as usual:

```
val rover = Dog("Rover")
```

Finally, the big difference between options 3a and 3b is that with Option 3b, they can invoke your methods directly on the rover instance, like this:

```
rover.speak
```

This shows the benefit of all of the work leading up to this point: The Dog instance has a new speak method. If you didn't have access to the original Dog source code, this would be a huge win. More generally, it shows a three-step process you can use to add new functionality to any "closed" class.

Note: As I mentioned earlier, the source code for this lesson has an additional eatHumanFood function that shows how to define multiple functions in a type class.

## Key points

As demonstrated, a type class consists of three components:

- The type class itself, which is defined as a trait that takes at least one generic parameter
- Instances of the type class for the data types you want to extend
- Interface methods you expose to users of your new API

The benefits of using a type class are:

- It provides an approach that lets you add new behavior to existing classes without using traditional inheritance, especially in the case where you can't (or don't want to) modify the existing source code of existing data types



## **What's next**

In the next lesson I'll provide a more practical example of using a type class, using the source code from the pizza classes from the Domain Modeling lessons.

# Type Classes 102: The Pizza Class

If you looked at the source code for the Domain Modeling lessons you probably noticed that I said one thing, but did another. I *said* that I liked the approach of not including any methods in my case classes, but then I *wrote* this code:

```
case class Pizza (  
  crustSize: CrustSize,  
  crustType: CrustType,  
  toppings: Seq[Topping]  
) {  
  override def toString =  
    s"  
      | Pizza ($crustSize, $crustType), toppings = $toppings"  
}
```

I overrode the `toString` method in both the `Pizza` and `Order` classes because I wanted to control how they looked when they were printed out. This shows a conflict of that situation:

- I want to declare my data types with plain case classes (with no behaviors)
- I also want to control what those data types look like when they are printed

There are several ways to resolve this conflict, and in this lesson I'll show how to use type classes so (a) I can declare my data types without any methods, and (b) still get the output I want.

## Source code

The source code for this lesson is in the same repository as the previous lesson:

- [github.com/alvinj/FPTypeClasses](https://github.com/alvinj/FPTypeClasses)

The code for this lesson is in the *typeclasses.v2\_pizza2string* package of that project.

## The solution

To implement the solution, I first define the `Pizza` class the way I really want it, as a simple declaration of its data types without any methods:

```
case class Pizza (  
  crustSize: CrustSize,  
  crustType: CrustType,  
  toppings: Seq[Topping]  
)
```

Next, I'll implement a type class that lets me get the printed output I want. I'll follow the same three-step approach I showed in the previous lesson:

- Define the type class as a trait that takes at least one generic parameter
- Define an instance of the type class for the `Pizza` class
- Create interface methods that I'll expose to consumers of this code

## Step 1: Define the type class

First, I create a type class named `ToString`. It takes a generic parameter, and defines an abstract method:

```
trait ToString[A] {  
  def toString(a: A): String  
}
```

## Step 2: Define an instance of the type class for the Pizza class

Next, I define an instance of the type class named `pizzaAsString` that overrides the `toString` method to declare the way I want a `Pizza` to be printed:

```
implicit val pizzaAsString = new ToString[Pizza] {  
  def toString(p: Pizza): String = {  
    s"""|Pizza(${p.crustSize}, ${p.crustType}),  
        |      toppings = ${p.toppings}""".stripMargin  
  }  
}
```

## Step 3: Create interface methods to make available to consumers of this code

Finally, I create the code that I want consumers of my API to use. In the source code for this lesson I show code for both Option 3a and Option 3b, but in this text I'll only use the code for Option 3b, which looks like this:

```
object ToStringSyntax {  
  implicit class ToStringOps[A](value: A) {  
    def asString(implicit toStringInstance: ToString[A]): String = {  
      toStringInstance.toString(value)  
    }  
  }  
}
```

## Step 4: Using the API

With that code in place, I can write some test code as follows. First, I import what I need:

```
import ToStringInstances.pizzaAsString
import ToStringSyntax._
```

Next, I create a `Pizza` instance:

```
val p = Pizza(
  LargeCrustSize,
  ThinCrustType,
  Seq(Cheese, Pepperoni, Sausage)
)
```

Finally, I print the `Pizza` instance using the `asString` method I defined in my type class:

```
println(p.asString)
```

This results in the following output:

```
Pizza(LargeCrustSize, ThinCrustType),
  toppings = List(Cheese, Pepperoni, Sausage)
```



## Discussion

In this example I followed the steps from the previous lesson, so I won't go over them in detail. One thing I will mention is that I intentionally named the method in the `ToString` trait `toString`:

```
trait ToString[A] {  
  def toString(a: A): String  
  -----
```

And then in Step 3b I intentionally named my API method `asString`:

```
object ToStringSyntax {  
  implicit class ToStringOps[A](value: A) {  
    def asString(implicit toStringInstance: ToString[A]): String = {  
      -----
```

I did this to show you that the method name in your public API — the `asString` method in `ToStringOps` — doesn't have to match the method name in the type class trait. You are more than welcome to keep those method names consistent, but as this example shows, they don't have to be the same.

The second thing to notice with this approach is that to get the “to string” effect, you need to call `asString` when printing a pizza:

```
println(p.asString)  
-----
```

This isn't quite as convenient as overriding the `toString` method in the `Pizza` class, but because I like to keep my case class definitions clean of any methods, I prefer this approach in this situation.

## Work with the source code

I encourage you to work with the source code for this project to understand this technique. In the code you'll find two packages under the root *typeclasses* package:

- *v2\_pizza2string* contains the source code I just showed, and includes code for both options 3a and 3b
- *v3\_order2string* shows the same approach applied to both the `Pizza` and `Order` case classes

The code in *v3\_order2string* shows a minor adjustment I had to make to the process because an order contains one or more pizzas, and I want to avoid duplicating code. See the `pizzaAsAStringHelper` method in the `ToStringInstances` object for those details.

## Other approaches

It's important to note that if I want to keep my case classes clean, I can also put these functions in a “Utils” class:

```
object PizzaUtils {  
  def pizzaToString(p: Pizza): String = ???  
  def orderToString(o: Order): String = ???  
}
```

and then print like this:

```
println(PizzaUtils.pizzaToString(pizza))  
println(PizzaUtils.orderToString(order))
```

But in the larger scheme of things, I'm also trying to help you get ready to use the type classes in [the Cats project](#).

## Key points

The key point of this lesson is that this approach lets me cleanly define my case classes using only the data types:

```
case class Pizza (  
  crustSize: CrustSize,  
  crustType: CrustType,  
  toppings: Seq[Topping]  
)  
  
case class Order (  
  pizzas: Seq[Pizza],  
  customer: Customer  
)
```

*and* it also gives me a way to print them in a readable format using the `asString` method that appears to be defined directly on the `Pizza` and `Order` classes:

```
println(pizza.asString)  
println(order.asString)
```

# Type Classes 103: The Cats Library

As a final example of how to use type classes, I'll show how to repeat the example from the previous lesson using the open source [“Cats” FP library for Scala](#). With the examples you've seen already, this will be a quick process.

## Source code

Step 1 is to clone my source code for this lesson, which is available at this URL:

- [github.com/alvinj/FPTypeClassesWithCats](https://github.com/alvinj/FPTypeClassesWithCats)

The first important thing to notice in this code is that I include [the Cats library](#) in the project with this line in the *build.sbt* file:

```
libraryDependencies += Seq(  
  "org.typelevel" %% "cats-core" % "1.0.0-MF"  
)
```

## The Pizza class

In the source code, the `Pizza` case class is defined as usual:

```
case class Pizza (  
  crustSize: CrustSize,  
  crustType: CrustType,  
  toppings: Seq[Topping]  
)
```

## Using Cats

In this lesson I'm going to use the Cats Show type class. Show is similar to the ToString type class I used in the previous lesson in that it provides a way to add a "to string" method to an existing class.

The first thing I do in my driver class is import everything I need from the Cats library:

```
import cats.Show           //the type class
import cats.syntax.show._ //the interface syntax
```

As the comments show, this imports the Cats Show type class and its interface syntax.

Next, this is how you create an implicit instance of the Show type class, which I name `pizzaShow`:

```
implicit val pizzaShow = Show.show[Pizza] { p =>
  s"""|Pizza(${p.crustSize}, ${p.crustType}),
    |         toppings = ${p.toppings}""|.stripMargin
}
```

While that code is slightly different from what I showed in the previous lessons, I hope you can see the similarity between my approach and the Cats approach.

To use this implicit instance, all I have to do is create a `Pizza`:

```
val pizza = Pizza(
  LargeCrustSize,
  ThinCrustType,
  Seq(Cheese, Pepperoni, Sausage)
)
```

and then print it using the `show` method that's now available to it, thanks to the `pizzaShow` instance:

```
println(pizza.show)
```

This results in the same output as in the previous lessons:

```
Pizza(LargeCrustSize, ThinCrustType),
      toppings = List(Cheese, Pepperoni, Sausage)
```



## More about Cats and Show

If you're serious about working with Scala/FP, I encourage you to get a copy of [Advanced Scala with Cats](#). You can download the PDF for free, or donate any amount you want for the book. (The current suggested donation is \$10, and it's well worth that price if you want to use the Cats project.)

To see more about how Show works, start an SBT session from the root directory of the project for this lesson:

```
$ sbt
```

Then, inside of SBT, start a REPL session like this:

```
> console
```

After a few moments you'll be in a Scala REPL session, with the additional benefit that the Cats library is available to you (thanks to this nice feature of SBT).

Now you can import the Show type class and its syntax, as before:

```
import cats.Show
import cats.syntax.show._
```

Then you can import a few pre-built instances Cats provides for you, including these for the Int and List types:

```
import cats.instances.int._
import cats.instances.list._
```

Once you've done that, you can call the show method on those built-in Scala types:

```
scala> 123.show //Int
res0: String = 123

scala> List(1,2,3).show //List
res1: String = List(1, 2, 3)
```

The Show library has instances for many more built-in Scala types. While this only shows the tip of the iceberg, I hope you can see the power of the approach.

## Key points

The key points of this lesson are:

- The Cats library has type classes like `Show` available, so you don't always have to write your own
- Even though the people who wrote Cats have never seen the `Pizza` class, it was easy to use `Pizza` and `Show` together because of the power of the type class approach
- I also wanted to give you an idea of how to get started using Cats

## See also

In this lesson I showed how to start a REPL session inside of SBT using the `console` command. You can also use the `consoleQuick` command to start a REPL session faster. I describe the two approaches here:

- [How to start a Scala REPL session inside SBT](#)

The two best Cats resources I know are here:

- The Cats library is available at [github.com/typelevel/cats](https://github.com/typelevel/cats)
- The book, *Advanced Scala with Cats*, is available at [underscore.io/books/advanced-scala/](https://underscore.io/books/advanced-scala/)

# **Lenses, to Simplify “Update as You Copy”**

## Goal

In the “” lesson I showed that when you use the “update as you copy” approach on nested data structures, your code can quickly get ugly and complicated. As this lesson’s introductory quote states, a *Lens* is a way of simplifying this problem. Therefore, the goal of this lesson is to show how lenses work.

## Source code

If you want to follow along with the code in this lesson, get a copy of the source code from this Github repository:

- [github.com/alvinj/FPLenses](https://github.com/alvinj/FPLenses)

## Lens libraries

There are no “lens” libraries built into Scala, but there are several third-party libraries. In the following example I’ll show an example of how to use a library named [Quicklens](#).

# A Scala Quicklens example

To get started, here's the data model I'll use in this lesson:

```
case class User(  
  id: Int,  
  name: Name,  
  billingInfo: BillingInfo,  
  phone: String,  
  email: String  
)  
  
case class Name(  
  firstName: String,  
  lastName: String  
)  
  
case class Address(  
  street1: String,  
  street2: String,  
  city: String,  
  state: String,  
  zip: String  
)  
  
case class CreditCard(  
  name: Name,  
  number: String,  
  month: Int,  
  year: Int,  
  cvv: String  
)  
  
case class BillingInfo(  
  creditCards: Seq[CreditCard]  
)
```

Given that model, I create this instance of a User:

```
val user = User(  
  id = 1,  
  name = Name(  
    firstName = "Al",  
    lastName = "Alexander"  
  ),  
  billingInfo = BillingInfo(  
    creditCards = Seq(  
      CreditCard(  
        name = Name("Al", "Alexander"),  
        number = "1111111111111111",  
        month = 3,  
        year = 2020,  
        cvv = ""  
      )  
    )  
  ),  
  phone = "907-555-1212",
```



```
    email = "al@al.com"  
  )
```

To show how a lens works, assume that you need to change both the `User.phone` and `User.email` fields. One way to do this using Quicklens is with a step-by-step process, like this:

```
val user1 = user.modify(_.phone).setTo("720-555-1212")  
val user2 = user1.modify(_.email).setTo("al@example.com")
```

That's a good start, but with Quicklens I can do even better. This example shows how to modify those fields as well as the `firstName` field in the `Name` object, all with one expression:

```
val newUser = user.modify(_.phone).setTo("720-555-1212")  
                  .modify(_.email).setTo("al@example.com")  
                  .modify(_.name.firstName).setTo("Alvin")
```

That's pretty cool, and it's much easier than what I showed at the end of the "Update as You Copy" lesson.

## Discussion

As mentioned, lenses let you create updated versions of immutable objects. While the “update as you copy” approach is useful for non-nested objects, a good lens library is extremely helpful when you need to update values that are buried deep inside nested objects.

Lenses basically hide the nasty object-copying operations you would have to handle manually, and they make your code look clean in the process.

## Lens projects

I showed the Quicklens library in this lesson because it's relatively simple and easy to use:

- [github.com/adamw/quicklens](https://github.com/adamw/quicklens)

Here's a list of a few other Scala Lens libraries that are available:

- [Monocle](#) is under active development
- You can find an example of the Shapeless lens library [on this Github page](#)
- [Goggles](#) aims to simplify Monocle

## See also

- My example in this lesson is a simplification of the examples on [this koff.io page](#)

# Signpost: Concurrency

This section of the book covers tools for writing parallel and concurrent applications in Scala. Here's an outline of the next several lessons:

- First, I'll demonstrate the problem of using mutable data structures with multiple threads
- Then I'll show how to use Akka actors to create long-running parallel processes
- Finally, I'll show how to use Scala futures for “one-shot” tasks that run in parallel and return a result when they complete

# **Concurrency and Mutability Don't Mix**

## Source code

The source code for this lesson is available at the following URL:

- [github.com/alvinj/FPConcurrencyAndMutability](https://github.com/alvinj/FPConcurrencyAndMutability)

## Goals

The goal of this lesson is to show that concurrency and mutability don't work well together. While history has shown us that it is *possible* to write parallel and concurrent applications with mutable data structures, the reality is that it's much easier to write them using immutable data.

The extremely short version of this lesson goes like this:

`mutable data structures + multiple threads = very complex`



## **My background**

Historically, I've enjoyed the complexity of writing multi-threaded applications; I took them on as a challenge. Back in the early 2000s I used Java threads a fair amount, and even wrote a “database connection pool” library that was featured in a book. I mention this only to point out that I'm familiar with the problems of writing parallel/concurrent applications using only the Java Thread primitive. Knowing those perils — and being more interested in solving problems than challenging the limits of my brain — when I first learned about Scala futures and Akka actors, I quickly switched to using them.

# The problem of mutable data structures and multiple threads

If you try to use mutable data structures with multiple threads, you'll find that it's easy to create race and deadlock conditions. In the case of my database connection pool library, I ran tests on it for *days* at a time with different simulated conditions until I had confidence that it worked properly.

You can easily create corrupt, inconsistent data with threads and mutable data structures. Indeed, I can show the problem with just a few lines of Scala code. Given this class with mutable fields:

```
class Person (  
  var name: String,  
  var town: String,  
  var state: String  
) {  
  override def toString = s"name: $name, town: $town, state: $state"  
}
```

The following code with just one thread running in parallel demonstrates the problem:

```
object SimpleBadConcurrency extends App {  
  val me = new Person("Alvin", "Talkeetna", "Alaska")  
  
  val t1 = new Thread {  
    override def run {  
      Thread.sleep(1000)  
      me.town = "Boulder"  
      Thread.sleep(3000)  
      me.state = "Colorado"  
    }  
  }  
  
  // start the thread  
  t1.start  
  
  println(s"1) $me")  
  
  Thread.sleep(2000)  
  println(s"2) $me")  
  
  Thread.sleep(2000)  
  println(s"3) $me")  
}
```

That code prints the following output:

- 1) name: Alvin, town: Talkeetna, state: Alaska
- 2) name: Alvin, town: Boulder, state: Alaska
- 3) name: Alvin, town: Boulder, state: Colorado

In case it's not clear, the data in this line is corrupt:

- 2) name: Alvin, town: Boulder, state: Alaska

Boulder is in Colorado, not Alaska.

Of course this is a relatively simple [“race condition”](#) example that I created with exaggerated delay times, but it illustrates the real problem: If mutable data can be modified by more than one thread, there's *always* a chance for data corruption. Then, once you start trying to fix that problem with synchronization, you enter the world of [multi-thread locks](#).

# That can't happen with immutable data structures

Conversely, the same problem *can't happen* with immutable data structures, even when using the Thread primitive. The following code shows why. First, I start with the usual Scala/FP case class with immutable fields:

```
case class Person (  
  name: String,  
  town: String,  
  state: String  
) {  
  override def toString = s"name: $name, town: $town, state: $state"  
}
```

Next, here's an attempt to write the same code as before:

```
object GoodConcurrency extends App {  
  val me = Person("Alvin", "Talkeetna", "Alaska")  
  val t1 = new Thread {  
    override def run {  
      Thread.sleep(1000)  
  
      // this code won't compile - Person is immutable  
      //me.town = "Boulder"  
  
      Thread.sleep(3000)  
  
      // this code won't compile - Person is immutable  
      //me.state = "Colorado"  
    }  
  }  
  t1.start  
  
  // more code here ...  
}
```

As I show in the comments, you can't even write code the same way as the first example because you can't mutate the fields inside the Person object. If you use immutable data structures — such as case classes with immutable fields in Scala/FP — you can't possibly run into the same problem.

## Quotes from the masters

Rather than writing more about using threads with mutable data structures, I'll conclude this lesson with a few "quotes from the masters." I found this quote by John Carmack in the book, [Learning Concurrent Programming in Scala](#):

"Programming in a functional style makes the state presented to your code explicit, which makes it much easier to reason about, and, in a completely pure system, makes thread race conditions impossible."

Related to that quote, it's important to note that everything I write in this book about Scala/FP shows how to create a "completely pure system."

In relation to parallel/concurrent programming, Joe Armstrong, creator of the Erlang language, writes:

*"State is the root of all evil."*

In that comment he's referring to "mutable state."

From [this fpcomplete.com article](#) by [Bartosz Milewski](#):

"Did you notice that in the definition of 'data race' there's always talk of mutation?"

Martin Odersky, creator of the Scala language, once shared this simple equation:

non-determinism = parallel processing + mutable state

(In programming, "non-determinism" is bad.)

### ***One more quote***

In the terrific book, [Java Concurrency in Practice](#), Brian Goetz writes about mutable objects. He states, "The publication requirements for an object depend

on its mutability.” By “publication” he means, “how an object can be shared publicly.” He follows that statement with these bullet points:

- *Immutable objects* can be published through any mechanism
- *Effectively immutable objects* must be safely published
- *Mutable objects* must be safely published, and must be either thread-safe or guarded by a lock

For this discussion it doesn’t matter what the definition of “effectively immutable objects” is; the key point is that when you use anything but immutable objects, things quickly get more complicated.

As he further writes, “Whenever you acquire a reference to an object, you should know what you are allowed to do with it. Do you need to acquire a lock before using it? Are you allowed to modify its state, or only read it? Many concurrency errors stem from failing to understand these ‘rules of engagement’ for a shared object. When you publish an object, you should document how the object can be accessed.”

A great thing about using only immutable objects in Scala/FP is that there’s no need to “document how the object can be accessed.” Every object is immutable, and can therefore “be published through any mechanism.” I’ll end this section with one last quote from his book:

“Immutable objects are always thread-safe.”

## **What's next**

While I won't write any more about the Thread primitive, the following lessons cover Scala's main tools for writing parallel and concurrent applications: Scala futures, and Akka actors.

## See also

If you're interested in writing parallel/concurrent applications, I can confirm that these books are excellent:

- [Java Concurrency in Practice](#), Brian Goetz
- [Learning Concurrent Programming in Scala](#), is written by Aleksandar Prokopec, creator of the Scala Parallel Collections framework

Two main solutions for dealing with concurrency in Scala are to use (a) futures and (b) the Akka actors library. While this book is now a little dated, it covers both of the topics very well:

- [Akka Concurrency](#)



# Scala Concurrency Tools

Now that you've seen an example of the problem with mutable data structures and concurrency, we'll look at some of the tools Scala provides to support parallel and concurrent programming. The two main tools are:

- Akka actors
- Scala futures (which came from Akka)

Scala also comes with a third tool:

- Parallel collections classes

The Scala and Java industries also provide [reactive extensions](#), which are libraries for “composing asynchronous and event-based programs using observable sequences”:

- [RxScala](#)
- [RxJava](#)

In addition to these tools, you can also use the Java Thread primitive in the (rare) situations where it makes sense.

In the next lessons I'll focus on Akka actors and Scala futures, which have been the two primary tools in my experience.

## The differences between Actors and Futures

The book [Akka Concurrency](#) provides a good description of the differences between actors and futures:

“An *actor* is a live object that can interact between itself and any number of other objects, functioning as long-lived message processors with potentially changing state. The *future*, on the other hand, is intended as a one-shot, single-purpose entity that is only addressable by the chunk of code waiting for the future’s promise, and the other chunk of code that fulfills that promise.”

Actors and futures are deep topics that entire books have been written about. I won’t be able to go into the detail those books cover, but I’ll provide an overview of them in the next several lessons, focusing on how they relate to the functional programming concepts presented in this book.

## Scala's parallel collections classes

A third tool that can help in certain situations are Scala's parallel collections classes. I won't be covering those classes in this book, but they were written by Aleksandar Prokopec, who wrote a terrific book named [Learning Concurrent Programming in Scala](#) that covers those classes, and Scala concurrency in general. Please see that book, or these other resources for learning about Scala's parallel collections classes:

- The [scala-lang.org Parallel Collections Overview](#)
- My [Examples of how to use parallel collections in Scala](#)

## The best tool for each job

No tool is right for every job. A nice benefit of Scala is that it offers different tools for different parallel programming needs:

- *Actors* are long running entities that can run on distributed systems, and respond to messages to perform their tasks. They're useful in building event-driven systems, where each actor can serialize concurrent access to its resource(s).
- *Futures* are intended for "one-shot," concurrent tasks. When it returns, a future is expected to produce a single value as a result, such as accessing a REST web service.
- The *parallel collections classes* may be useful for running algorithms (think `map`, `filter`, etc.) on large data sets.
- *Reactive extensions* are useful when building asynchronous, event-driven applications; streaming data from external sources; and incrementally propagating changes in the data model throughout the application. (Most of this text is from the book, *Learning Concurrent Programming in Scala*.)
- The Java `Thread` is a relatively primitive tool for building low-level tasks, such as building other parallel/concurrent libraries.

In the lessons that follow I'll demonstrate Akka actors and Scala futures.

## See also

- I briefly wrote about the [Scala parallel collection classes](#)

# **Akka Actors**

# Introduction

This lesson is about the [Akka actors library](#). In the lesson you'll learn about:

- Actors and the actor model
- Akka's benefits

I also share several Akka examples you can work with.

Technically, Akka isn't *directly* related to functional programming, other than a few concepts:

- Actors are long-running threads that respond to immutable messages sent to them
- The messages sent to actors are typically instances of case classes and case objects
- Actors respond to messages with pattern-matching statements
- Actors don't share any state with other actors, so by definition there is no mutable, shared state

## ***Background: Erlang***

The original Scala actor library — which was replaced by Akka — was patterned after a language named [Erlang](#). In the book [Programming Erlang](#), Erlang co-creator Joe Armstrong writes:

“Erlang belongs to the family of *functional programming languages*. Functional programming forbids code with side effects. Side effects and concurrency don't mix. In Erlang it's OK to mutate state within an individual process but not for one process to tinker with the state of another process.”

An Erlang *process* is equivalent to an Akka *actor*, so you can say, “In Akka it's

OK to mutate state within an individual actor but not for one process to tinker with the state of another actor.”

Notice that unlike “Pure FP,” Mr. Armstrong states that it’s okay to mutate state within an individual process. This is similar to saying, “It’s okay to mutate state within a pure function — such as using a var field and for loop rather than recursion — as long as you don’t mutate state outside of the pure function.”



## Akka benefits

While (in my opinion) Akka isn't *directly* related to functional programming, it's a great way to build massively parallel systems using Scala. All of these industry buzzwords are used to describe Akka:

- asynchronous
- event-driven
- message-driven
- reactive
- scalable (“scale up” and “scale out”)
- concurrent and parallel
- non-blocking
- location transparency
- resilient and redundant (no single point of failure with multiple, distributed servers)
- fault-tolerant

All of those benefits are great, but the first great benefit is that Akka and the actor model *greatly* simplify the process of working with multiple, long-running threads. In fact, when working with Akka, you never really think about threads, you just write actors to respond to messages in a non-blocking manner, and the threads take of themselves.

# Actors and the Actor Model

The first thing to know about Akka actors is the *actor model*, which is a mental model of how to think about a system built with actors. In that model the first concept to understand is an *actor*:

- An actor is a long-running process that runs in parallel to the main application thread, and responds to messages that are sent to it.
- An actor is the smallest unit when building an actor-based system, just like a class is the smallest unit in an OOP system.
- Like a class, an actor encapsulates state and behavior.
- You can't peek inside an actor to get its state. You can send an actor a message requesting state information (like texting a person to ask how they're feeling), but you can't reach in and execute one of its methods or access its fields (just like you can't peek inside someone else's brain).
- An actor has a mailbox (an inbox), and the actor's purpose in life is to process the messages in its mailbox.
- You communicate with an actor by sending it an immutable message. These messages go directly into the actor's mailbox.
- When an actor receives a message, it's like taking a letter out of its mailbox. It opens the letter, processes the message using one of its algorithms, then moves on to the next message in the mailbox. If there are no more messages, the actor waits until it receives one.

Akka experts recommend thinking of an actor as being like a person, such as a person in a business organization:

- You can't know what's going on inside another person. All you can do is send them a message and wait for their response.
- An actor has one parent, known as a *supervisor*. In Akka, that supervisor is the actor that created it.

- An actor may have children. For instance, a President in a business may have a number of Vice Presidents. Those VPs are like children of the President, and they may also have many subordinates. (And those subordinates may have many subordinates, etc.)
- An actor may have siblings — i.e., other actors at the same level. For instance, there may be 10 VPs in an organization, and they are all at the same level in the organization chart.

### ***Actors should delegate their work***

There's one more important point to know about actors: As soon as an actor receives a message, it should delegate its work. Actors need to be able to respond to messages in their mailbox as fast as possible, so the actor mantra is, "Delegate, delegate, delegate."

If you think of an actor as being a person, imagine that one message includes a task that's going to take a month to complete. If the actor worked on that task for a month, it wouldn't be able to respond to its mailbox for a month. That's bad. But if the actor delegates that task to one of its children, it can respond to the next message in its mailbox immediately (and delegate that as well).

## Akka benefits

Here are some benefits of using Akka actors, mostly coming from Lightbend's [Akka Quickstart Guide](#) and [the Akka.io website](#):

- Event-driven model: Actors perform work in response to messages.
- Communication between actors is asynchronous, allowing actors to send messages and continue their own work without blocking to wait for a reply.
- Actors and streams let you build systems that *scale up*, using the resources of a server more efficiently, and *scale out*, using multiple servers.
- Performance: Actors have been shown to process up to 50 million messages/second on a single machine.
- Lightweight: Each instance consumes only a few hundred bytes, which allows millions of concurrent actors to exist in a single application (allowing ~2.5 million actors per GB of heap).
- Distributed systems without single points of failure. Load balancing and adaptive routing across nodes.
- Asynchronous, non-blocking stream processing with backpressure.
- Strong isolation principles: Unlike regular objects in Scala, an actor does not have a public API in terms of methods that you can invoke. Instead, its public API is defined through messages that the actor handles.
- Location transparency: The system constructs actors from a factory and returns references to the instances. Because the location of actors doesn't matter — they can be running on the current server or some other server — actor instances can start, stop, move, and restart to scale up and down, as well as recover from unexpected failures.

## A video example

Way back in 2011 I started developing a “personal assistant” named SARAH, which was based on the computer assistant of the same name on the television show [Eureka](#). The entire application was based on Akka actors. SARAH is like the [Amazon Echo](#) running on your computer. You speak to it to access and manage information:

- Get news headlines from different sources
- Get weather reports and stock prices
- Manage a “to-do list”
- Control iTunes with voice commands
- Check your email
- Perform Google searches

Beyond just *responding* to voice commands with spoken and displayed output, SARAH also has long-running background tasks — small pieces of software I call “agents” — so it can do other things:

- Tell me when I receive new email from people I’m interested in
- Report the time at the top of every hour (“The time is 11 a.m.”)

For more information on SARAH, see the “Sarah - Version 2” video at [alvinalexander.com/sarah](http://alvinalexander.com/sarah). I haven’t worked on SARAH in a while, but it gives you an idea of what can be done with Akka actors.

## How Akka relates to FP

In my opinion, the main ways Akka relates to functional programming are:

- The best way to send messages to actors is with immutable case classes and case objects
- When actors receive those messages, they can't even attempt to mutate them
- Actors respond to messages with pattern-matching statements in their receive method
- Because actors don't share state, it's often easier to implement actor behaviors with pure functions
- Because actors run on different threads, they give you a relatively simple way to implement concurrency in an application with immutable data

## **What's next**

Given this background, the next lesson shows several examples of how to use Akka actors.

# Akka Actor Examples

In this lesson I'll show two examples of applications that use Akka actors, and I'll show where you can find a third Akka application that's more complicated, but hopefully not too complicated for a next step.



## Source code

The source code for this lesson is available at the following URL:

- [github.com/alvinj/FPAkkaHelloWorld](https://github.com/alvinj/FPAkkaHelloWorld)

# An Akka Hello, world example

Let's look at an example of how to write a "Hello, world" application using Akka.

## *Writing a Hello actor*

An actor is an instance of the `akka.actor.Actor` class, and once it's created, all it does is respond to messages that are sent to it. For this "Hello, world" example I want an actor that responds to "hello" messages, so I start with code like this:

```
case class Hello(msg: String)

class HelloActor extends Actor {
  def receive = {
    case Hello(s) => {
      println(s"you said '$s'")
      println(s"$s back at you!\n")
    }
    case _ => println("huh?")
  }
}
```

In the first line of code I define a case class named `Hello`. The preferred way to send messages with Akka is to use instances of case classes and case objects, which support immutability and pattern-matching. Therefore, I define `Hello` as a simple wrapper around a string.

After that, I define `HelloActor` as an instance of `Actor`. The body of `HelloActor` is just the `receive` method, which you implement to define the actor's initial behavior, i.e., how the actor responds to the messages it receives.

The way this code works is that when `HelloActor` receives a new message in its inbox, `receive` is triggered as a response to that event, and the incoming message is tested against `receive`'s case statements. In this example, if the message is of the type `Hello`, the first case statement handles the message; if the message is *anything else*, the second case statement is triggered. (The second case statement is a "catch-all" statement that handles all unknown messages.)

Of course actors get more complicated than this, but that's the essence of the actor programming pattern. You create case classes and case objects to define the types of messages you want your actor to receive. Because the only way the

rest of your code can interact with the actor is by sending messages to it, those classes and objects become your actor's API. Then inside the receive method you define how you want to respond to each message type. At a high level, that's how you write actor code.

## ***A test program***

Now all you need is a little driver program to test the actor. This one will do:

```
object AkkaHelloWorld extends App {  
    // an actor needs an ActorSystem  
    val system = ActorSystem("HelloSystem")  
  
    // create and start the actor  
    val helloActor = system.actorOf(  
        Props[HelloActor],  
        name = "helloActor"  
    )  
  
    // send the actor two known messages  
    helloActor ! Hello("hello")  
    helloActor ! Hello("buenos dias")  
  
    // send it an unknown message  
    helloActor ! "hi!"  
  
    // shut down the system  
    system.terminate()  
}
```

Here's how that code works. First, actors need an [ActorSystem](#) that they can run in, so you create one like this:

```
val system = ActorSystem("HelloSystem")
```

Just give the ActorSystem a unique name, and you're ready to go.

The ActorSystem is the main construct that takes care of the gory thread details behind the scenes. Per the Akka website, "An ActorSystem is a heavyweight structure that will allocate 1...N Threads, so create one per logical application ... It is also the entry point for creating or looking up actors."

Next, as that quote states, you create new actors with the ActorSystem, so this is how you create an instance of a HelloActor:

```
val helloActor = system.actorOf(  
  Props[HelloActor],  
  name = "helloActor"  
)
```

There are a few variations of that syntax, but the important part is that you create an instance of `HelloActor` by calling `actorOf` on the `ActorSystem` as shown.

Besides the required `import` statements, that's the entire setup process. At this point the `helloActor` instance is up and running (in parallel with the main application thread), and you can send it messages. This is how you send it a message:

```
helloActor ! Hello("hello")
```

This line of code can be read as, “Send the message `Hello(hello)` to the actor named `helloActor`, and don't wait for a reply.”

The `!` character is how you send a message to an actor. More precisely, it's how you send a message to an actor *without waiting for a reply back from the actor*. This is by far the most common way to send a message to an actor; you don't want to wait for a reply back from the actor, because that would cause your application's thread to block at that point, and *blocking* is bad.

This case statement inside the `HelloActor` will handle this message when it's received:

```
// in HelloActor  
case Hello(s) => {  
  println(s"you said '$s'")  
  println(s"$s back at you!\n")  
}
```

Inside that case statement I print two lines of output, but this is normally where you call other functions to respond to the message. You'll often delegate work to child actors at this point.

Looking back at the code, after I send the two `Hello` messages to the `HelloActor`, I send it this message:

```
helloActor ! "hi!"
```

Because `HelloActor` doesn't know how to handle a `String` message, it will respond to this message with its “catch-all” case statement:

```
// in HelloActor  
case _ => println("huh?")
```

At this point the AkkaHelloWorld application reaches this line of code, which shuts down the ActorSystem:

```
system.terminate()
```

That's the entire Akka "Hello, world" application.

I encourage you to work with the source code from the repository for this lesson. In the *HelloWorld.scala* file, add new messages (as case classes and objects), and then add new case statements to the receive method in HelloActor to respond to those messages. Keep fooling around with it until you're sure you know how it all works.

## A second example

As a slightly more complicated example, *Echo.scala* in this lesson's source code contains an Akka application that responds to whatever you type at the command line. First, the application has a case class and a case object that are used to send and receive messages:

```
case class Message(msg: String)
case object Bye
```

Next, this is how the `EchoActor` responds to the messages it receives:

```
class EchoActor extends Actor {
  def receive = {
    case Message(s) => println("\nyou said " + s)
    case Bye => println("see ya!")
    case _ => println("huh?")
  }
}
```

That follows the same pattern I showed in the first example.

Finally, here's a driver program you can use to test the `EchoActor`:

```
object EchoMain extends App {
  // an actor needs an ActorSystem
  val system = ActorSystem("EchoSystem")

  // create and start the actor
  val echoActor = system.actorOf(Props[EchoActor], name = "echoActor")

  // prompt the user for input
  var input = ""
  while (input != "q") {
    print("type something (q to quit): ")
    input = StdIn.readLine()
    echoActor ! Message(input)
  }

  echoActor ! Bye

  // shut down the system
  system.terminate()
}
```

Notice that after the `ActorSystem` and `echoActor` are created, the application sits in a loop prompting you for input, until you enter the character `q`. Once you type `q` and the loop terminates, the `echoActor` is sent one last message:

```
echoActor ! Bye
```

After that, the system shuts down.

This is what the output of the application looks like when you run it and type a few things at the command line:

```
type something (q to quit): hello  
you said hello
```

```
type something (q to quit): hola  
you said hola
```

```
type something (q to quit): q  
you said q
```

```
bye!
```

## More examples

I could keep showing more examples, but the pattern is the same:

- Create case classes and case objects for the messages you want your actor to handle. These messages become the API for the actor.
- Program your actor(s) to respond to those messages as desired.
- Send messages to your actors using !.

If you'd like to work with a more-complicated example that isn't *too* complicated, I created an Akka application that works a little like SARAH and the [Amazon Echo](#), albeit at your computer's command line. See this page on my website for more details:

- [alvinalexander.com/amazon-echo-akka](http://alvinalexander.com/amazon-echo-akka)

That web page describes how the application works, but here's a quick example of some command-line input and output with the application:

```
ekko: weather
stand by ...
The current temperature is 78 degrees, and the sky is partly cloudy.

ekko: forecast
stand by ...
Here's the forecast.
For Sunday, a low of 59, a high of 85, and Partly Cloudy skies.
For Monday, a low of 53, a high of 72, and Scattered Thunderstorms skies.

ekko: todo add Wake Up
1. Wake Up
```

Again, please see that web page for more details and the source code. Additionally, see the “See Also” section at the end of this lesson for more Akka examples.



## Where Akka fits in

As these examples show, an actor is an instance of `Actor`. Once created, an actor resides in memory, waiting for messages to appear in its inbox. When it receives a new message, it responds to the message with the case statements defined in its `receive` method.

An actor runs on its own thread, so when you send it a message from the main thread in your application, it does whatever it does on that other thread. Depending on your needs, this can be a great approach for reactive programming, because it can help to keep the UI for your application responsive. In something like a Swing (or JavaFX) GUI application, the process can look like this:

- The user provides input through the GUI.
- Your application's event-handling code responds to that input event by sending a message to the appropriate actor.
- The Swing "Event Dispatch Thread" (EDT) remains responsive because the work is not being handled on the EDT.
- When the actor receives the message, it immediately delegates that work to a child actor. (I didn't show that process in this book, but you can find examples on my website and in the [Scala Cookbook](#).)
- When the actor (and its children) finish processing the message, it sends a message back, and that message results in the UI being updated (eventually being handled by `SwingUtilities.invokeLater()`, in the case of Swing).

This is exactly the way SARAH works.

While the actor model isn't the only way to handle this situation, actors work well when you want to create parallel processes that will live in memory for a long time, and have messages that they know how to respond to.

In the case of SARAH — which works like Amazon Echo or a long-running instance of Siri — it has many actors that know how to do different kinds of

work, including:

- Actors to get news headlines, check my email, get stock quotes, search Google, and get Twitter trends, etc.
- Actors to represent a mouth, ears, and brain, where the “ear actor” listens to your computer’s microphone, the “mouth actor” speaks through the computer’s speakers, and the “brain actor” knows how to process inputs and outputs, and delegate work to all of the other actors.

## Key points

While the Akka actor system isn't *directly* tied to functional programming, it's primary mechanisms are:

- Messages are typically sent with case classes and case objects
- Actors respond to messages with pattern-matching statements in their `receive` method
- Actors don't share any state with other actors, so there is no mutable, shared state
- Because actors don't share state, it's often easier to implement actor behaviors with pure functions

Akka is intended for building reactive, responsive, event-driven (message-driven), scalable systems, and the actor model *greatly* simplifies the process of working with many long-running threads.

Actors work well when you want objects that live in RAM for a long time, and respond to one or more messages during their lifetime. (*Futures*, which you'll see in the next lesson, are better for "one shot," short-lived concurrency needs.)

Finally, all of these buzzwords truly apply to Akka actors: scalable (scale up and scale out), reactive, event-driven, message-driven, concurrent, parallel, asynchronous, non-blocking, location transparency, resilient, redundant, fault-tolerant (and more).

## See also

- [The Akka website](#)
- [The Akka documentation](#)
- Akka is based on the “[Actor Model](#)”
- I wrote about [Akka](#) Actors in depth in the [Scala Cookbook](#)
- SARAH, at [alvinalexander.com/sarah](http://alvinalexander.com/sarah)
- My “Akkazon Ekko” application, which is a simple version of SARAH: [alvinalexander.com/amazon-echo-akka](http://alvinalexander.com/amazon-echo-akka)
- Akka was inspired by the [Erlang language](#), which is used to “build massively scalable soft real-time systems with requirements on high availability”
- [Akka Actors: An example video game](#)
- [A ‘Ping Pong’ Scala Akka actors example](#)
- [An Akka actors ‘remote’ example](#)
- [Understanding the methods in the Scala/Akka Actor lifecycle](#)
- [How to create a Scala/Akka Actor whose constructor requires arguments](#)

# Scala Futures

## Source code

The source code for this lesson is at this URL:

- [github.com/alvinj/FPFutures](https://github.com/alvinj/FPFutures)

## Introduction

While an Akka actor runs for a long time and is intended to handle *many* messages over its lifetime, a Scala *future* is intended as a one-shot, “handle this relatively slow and potentially long-running computation, and call me back with a result when you’re done” construct.

While I see Akka as only being related to functional programming in the ways I described in the previous lessons, a `Future` is directly related to the FP concepts described in this book. Indeed, the book [Advanced Scala with Cats](#) says this about Scala futures:

“Future is a monad that allows us to sequence computations without worrying that they are asynchronous.”

As usual, this means that `Future` is a class that implements `map` and `flatMap`, so it can be used in `for` expressions.

And as this quote from the [scala-lang.org](http://scala-lang.org) [“Futures and Promises”](#) page shows, futures support FP buzzwords like ‘combinators’ and ‘compose’:

“By default, futures and promises are non-blocking, making use of callbacks instead of typical blocking operations. To simplify the use of callbacks both syntactically and conceptually, Scala provides combinators such as `flatMap`, `foreach`, and `filter` used to compose futures in a non-blocking way.”

In this lesson I’ll show how to run several futures in parallel, and then combine their results in a `for` expression, and a few other useful `Future` methods.

## Goals

Futures are a large topic that I could write a small book about. Since there are already good books about Akka and futures I'm not going to do that, but I do want to cover enough about futures so you can see:

- Their basic use
- How they're used in a monadic programming style
- How some of the Future callback methods work
- A real-world example



## An example in the REPL

Let's start with an example of a Future in the Scala REPL. First, paste in these import statements:

```
import scala.concurrent.Future
import scala.concurrent.ExecutionContext.Implicits.global
import scala.util.{Failure, Success}
```

Now, you can create a future that will sleep for one second, and then return the value 42:

```
scala> val a = Future { Thread.sleep(1000); 42 }
a: scala.concurrent.Future[Int] = Future(<not completed>)
```

Because Future has a map function, you use it as usual:

```
scala> val b = a.map(_ * 2)
b: scala.concurrent.Future[Int] = Future(<not completed>)
```

This shows Future(<not completed>) right away, but if you check b's value again, you'll see that it contains the expected result of 84:

```
scala> b
res1: scala.concurrent.Future[Int] = Future(Success(84))
```

Notice that the 84 you expected is wrapped in a Success, which is further wrapped in a Future. This is a key point to know: The value in a Future is always an instance of one of the Try types: Success or Failure. Therefore, when working with the result of a future, use the usual Try-handling techniques, or one of the other Future callback methods. One commonly used callback method is onComplete, which takes a partial function, in which you should handle the Success and Failure cases, like this:

```
a.onComplete {
  case Success(value) => println(s"Got the callback, value = $value")
  case Failure(e) => e.printStackTrace
}
```

When you paste that code in the REPL you'll see the result:

```
Got the callback, value = 42
```

There are other ways to process the results from futures, and I'll list the most

common methods later in this lesson.

# An example application

I like to use the following application to introduce futures because it's simple, and it shows several key points about how to work with futures:

- How to create futures
- How to combine multiple futures in a for expression to obtain a single result
- How to work with that result once you have it, in this case using `onComplete` to handle the result as a side effect

Here's the example:

```
package futures.v1

import scala.concurrent.Future
import scala.concurrent.ExecutionContext.Implicits.global
import scala.util.{Failure, Success}

object MultipleFutures1 extends App {

  // (a) create three futures
  val f1 = Future { sleep(800); 1 }
  val f2 = Future { sleep(200); 2 }
  val f3 = Future { sleep(400); 3 }

  // (b) get a combined result in a for-comprehension
  val result = for {
    r1 <- f1
    r2 <- f2
    r3 <- f3
  } yield (r1 + r2 + r3)

  // (c) do whatever you need to do with the result
  result.onComplete {
    case Success(x) => println(s"\nresult = $x")
    case Failure(e) => e.printStackTrace
  }

  // important for a little parallel demo: need to keep
  // the jvm's main thread alive
  sleep(3000)

  def sleep(time: Long): Unit = Thread.sleep(time)
}
```

## *Creating the futures*

Let's walk through that code to see how it works. First, I create three futures with these lines of code:

```
val f1 = Future { sleep(800); 1 }
val f2 = Future { sleep(200); 2 }
val f3 = Future { sleep(400); 3 }
```

Those lines of code are equivalent to calling the `apply` method in `Future`'s companion object:

```
val f1 = Future.apply { sleep(800); 1 }
-----
```

An important thing to know about `Future` is that it *immediately* begins running the block of code inside the curly braces. (It isn't like the Java `Thread`, where you create an instance and later call its `start` method.) For example, the `sleep` function call in `f1` begins running immediately after this line of code:

```
val f1 = Future { sleep(800); 1 }
```

The three futures in the example admittedly don't do much. They sleep for their allotted times, and then return `Int` values. For example, after 800 ms, `f1` will eventually contain the value `1`. People often use the word *eventually* with futures because the return time is usually indeterminate: you don't know when you'll get a result back, you just hope to get a successful result back "eventually."

Another important point to know is that a `Future` always returns a type of `Future[A]`. In these examples, that type is `Future[Int]`:

```
val f1: Future[Int] = Future { sleep(800); 1 }
-----
```

You declare the return type like that, but remember that a `Future` always contains an instance of `Try`, so the actual result of `f1` will be `Future(Success(1))`.

## ***The for expression***

The `for` expression in the application looks like this:

```
val result = for {
  r1 <- f1
  r2 <- f2
```

```
    r3 <- f3
  } yield (r1 + r2 + r3)
```

You can read this as, “Whenever `f1`, `f2`, and `f3` return with their values, sum them up with `yield`, and assign that value to the variable `result`.” I didn’t show it in the code, but `result` also has the type `Future[Int]`:

```
val result: Future[Int] = for { ...
    -----
```

It’s important to know that the main thread in the application doesn’t stop at this point. In fact, if you print the result from `System.currentTimeMillis()` before and after the `for` expression, you probably won’t see a difference of more than a few milliseconds. I demonstrate this in the example in the next lesson.

## onComplete

The final part of the application looks like this:

```
result.onComplete {  
    case Success(x) => println(s"\nresult = $x")  
    case Failure(e) => e.printStackTrace  
}
```

As I showed before, `onComplete` is a method that's available on a `Future`, and you use it to process the future's result as a side effect. In the same way that the `foreach` method on collections classes returns `Unit` and is only used for side effects, `onComplete` returns `Unit` and you only use it for side effects like printing the results, updating a GUI, updating a database, etc.

You can read that code as, “Whenever `result` has a final value — i.e., after all of the futures return and are summed in the `for` expression — come here. If everything returned successfully, run the `println` statement shown in the `Success` case. Otherwise, if an exception was thrown, go to the `Failure` case and print the exception's stack trace.”

As that code implies, it's completely possible that a `Future` may fail. For example, imagine that you call a web service in a future, but the web service is down. That `Future` instance will contain an exception, so when you call `result.onComplete` like this, control will flow to the `Failure` case.

### *That sleep call*

A final point to note about small examples like this is that you need to have a sleep call at the end of your `App`:

```
sleep(3000)
```

That call keeps the main thread of the JVM alive for three seconds. If you don't include a call like this, the JVM's main thread will exit before you get a result from the three futures, which are running on other threads. This isn't usually a problem in the real world, but it's a problem for little demos like this.

## Similar to the real world

While that example doesn't do much and you know up front long it takes for each `Future` to complete, it's remarkably similar to code that you'll use in the real world. For example, if you call a function named `Cloud.executeLongRunningTask()` to get an `Int` result that will take an indeterminate amount of time, you'll still construct the future in the same way:

```
val task: Future[Int] = Future {  
    Cloud.executeLongRunningTask(a, b, c)  
}
```

Then, whenever the future is finished, you'll also use a method like `onComplete` to process the result:

```
task.onComplete {  
    case Success(value) => outputTheResult(value)  
    case Failure(e) => outputTheError(e)  
}
```

So although the code in the curly braces of the `f1/f2/f3` example doesn't do much, the use of futures in that example follows the same pattern that you'll use in the real world:

- Construct one or more futures to run tasks off of the main thread
- If you're using multiple futures to yield a single result, combine the futures in a `for` expression
- Use a callback method like `onComplete` to process the final result

# A Second Futures Example

## Source code

The source code for this lesson is at the same URL as the previous lesson:

- [github.com/alvinj/FPFutures](https://github.com/alvinj/FPFutures)



## A Futures example with debug output

To create the example in this lesson, I modified the delay times of the first example, added calls to get the Thread IDs, and added time checks at various points in the application to show the details of how futures work, especially with for expressions and callback methods. Here's the source code for this example:

```
package futures.v1

import scala.concurrent.Future
import scala.concurrent.ExecutionContext.Implicits.global
import scala.util.{Failure, Success}

object MultipleFuturesWithThreadIds extends App {

  val mainThreadId = Thread.currentThread.getId
  val f1ThreadId = 0L
  val f2ThreadId = 0L
  val f3ThreadId = 0L

  val startTime = currentTime

  /**
   * (a) create the futures. as you'll see in the
   * time-related output, they start running immediately.
   */
  val f1: Future[Int] = Future {
    println(s"f1 start:      ${deltaTime(startTime)}")
    f1ThreadId = Thread.currentThread.getId
    sleep(1200)
    1
  }
  val f2: Future[Int] = Future {
    println(s"f2 start:      ${deltaTime(startTime)}")
    f2ThreadId = Thread.currentThread.getId
    sleep(400)
    2
  }
  val f3: Future[Int] = Future {
    println(s"f3 start:      ${deltaTime(startTime)}")
    f3ThreadId = Thread.currentThread.getId
    sleep(800)
    3
  }

  // (b) merge the results when they become available
  println(s"before for:      ${deltaTime(startTime)}")
  val result: Future[(Long, Int)] = for {
    r1 <- f1
    r2 <- f2
    r3 <- f3
  } yield (deltaTime(startTime), r1 + r2 + r3)
  println(s"after for:      ${deltaTime(startTime)}")

  /**
   * the f1/f2/f3 println statements show that those code
   * blocks are started immediately. but because they're
   */
}
```

```

* on different threads, the time-related println statements
* in this (main) thread show that the main thread goes
* flying right through the for-expression.
*/

// (c) handle the result as a side effect
println(s"before onComplete: ${deltaTime(startTime)}")
result.onComplete {
  case Success(x) => {

    // sleep to show that for's `yield` expression
    // happens just before this point
    sleep(10)

    // the "in success" time should be almost exactly the
    // same as the longest sleep time, plus the 10ms delay
    // above; approximately 1210ms for my sample times.
    val tInSuccessCase = deltaTime(startTime)
    println(s"in Success case:  ${tInSuccessCase}")
    println(s"\nresult = $x")
    println(s"onComplete tid: ${Thread.currentThread.getId}")

  }
  case Failure(e) => e.printStackTrace()
}
println(s"after onComplete:  ${deltaTime(startTime)}")

// important for a small parallel demo: keep the main jvm
// thread alive
println(s"start sleep(2000): ${deltaTime(startTime)}")
sleep(2000)

println("")
println("Thread IDs")
println("-----")
println(s"Main Thread ID: ${mainThreadId}")
println(s"F1 Thread ID:  ${f1ThreadId}")
println(s"F2 Thread ID:  ${f2ThreadId}")
println(s"F3 Thread ID:  ${f3ThreadId}")

def sleep(time: Long) = Thread.sleep(time)
def currentTime = System.currentTimeMillis()
def deltaTime(t0: Long) = System.currentTimeMillis() - t0
}

```

I encourage you to view that code in your IDE as I discuss it in the following paragraphs.

When I run that code at the command line with SBT, I see output that looks like this:

```

f1 start:      1
f2 start:      1
f3 start:      2
before for:    1
after for:     2
before onComplete: 2
after onComplete: 2

```

```
start sleep(2000): 2
result = (1204,6)
in Success case: 1215

Thread IDs
-----
Main Thread ID: 85
F1 Thread ID: 74
F2 Thread ID: 72
F3 Thread ID: 73
onComplete tid: 74
```

I rearranged that output slightly to highlight the key points:

- The main thread flies through `f1`, `f2`, `f3`, the `for` expression, and the `onComplete` expression almost instantly
- The `sleep(2000)` statement begins after only 2 ms
- The `(1204, 6)` output shows that the `yield` statement in the `for` expression returns its value at 1204 ms
- Because of the 10 ms sleep time I added, the “in Success case” statement prints 11 ms later, at 1215 ms
- I’ll discuss the thread IDs shortly, but the important point to notice is that `F1`, `F2`, and `F3` are all different than the Main Thread ID

A key here is the time the `yield` statement returns (1204 ms): This value is just a few milliseconds more than `f1`’s sleep time. This confirms that `f1`, `f2` and `f3` ran in parallel. If they had run serially — one after the other — the `yield` statement would not have returned until 2400 ms had passed (i.e., the combined run times of `f1`, `f2`, and `f3`).

Also note that I added a 10 ms sleep time in the `Success case`. I did this to show that the `yield` statement returns before `onComplete` is called. (On my computer, if I don’t add that delay, the `yield` and `Success` times are identical.)

### ***Key points of this example***

I added all of the print statements to the code to show how this process works:

- The futures are started immediately

- The main JVM thread flies right through the `for` and `onComplete` expressions
- `yield` in the `for` expression is executed when all of the futures complete
- `onComplete` is executed immediately after that

## ***The thread IDs***

Once you're comfortable with how the code works time-wise, another thing to look at is the printout of the Thread IDs at the end of the App:

```
Thread IDs
-----
Main Thread ID: 85
F1 Thread ID:   74
F2 Thread ID:   72
F3 Thread ID:   73
onComplete tid: 74
```

The actual numeric values don't matter, they'll be different if you run them in your IDE or in SBT — and they keep getting larger the more times you run the App in SBT — but the important point is that `f1`, `f2`, and `f3` all have different values than the main thread. I show this output as another way to demonstrate that all of the futures ran on different threads than the main thread — they were all running in parallel.

I also show the Thread ID from inside `onComplete`. In this case, it's 74, which is `f1`'s Thread ID:

```
F1 Thread ID:   74
onComplete tid: 74
```

Futures will re-use threads where they can, and while there's no guarantee that this will *always* be the case, I've found that in small examples with these sleep times, the `onComplete` Thread ID is the same as `f1`'s. (This Thread ID will vary if you make `f2` or `f3` sleep longer than `f1`.)

## ***The final result***

The actual result of this application isn't too important — I really just want to show how futures work — but the final answer is 6, which I returned in the tuple from `yield`:

```
result = (1204,6)
```

## Details to know about Futures

Here are a few more details to know about futures. First, the [scala-lang.org](http://scala-lang.org) [“Futures and Promises” page](#) provides this summary:

“The idea is simple: a `Future` is a sort of a placeholder object that you can create for a result that does not yet exist. Generally, the result of the `Future` is computed concurrently and can be later collected. Composing concurrent tasks in this way tends to result in faster, asynchronous, non-blocking parallel code. A `Future` is an object holding a value which may become available at some point.”

Here are some key points about futures:

- A future represents the result of an asynchronous computation, and has a return type, such as `Future[Int]`.
- The value in a future is always an instance of `Try`, so you always deal with `Success` and `Failure` when handling a future’s result.
- You typically work with the results of a future using its callback methods, such as `onComplete`.
- A future is a monad, and can be composed. It has combinator methods like `map`, `flatMap`, `filter`, etc.
- There’s no guarantee that your future’s callback method will be called on the same thread the future was run on.

In regards to that last point, here’s another quote from the “Futures and Promises” page:

“We should now comment on when exactly the callback gets called. Since it requires the value in the future to be available, it

can only be called after the future is completed. However, there is no guarantee it will be called by the thread that completed the future or the thread which created the callback. Instead, the callback is executed by *some* thread, at some time after the future object is completed. We say that the callback is executed eventually.”

# Future's callback methods

The [scala.concurrent.Future class Scaladoc](#) separates Future methods into three categories:

## 1. Callbacks:

- onComplete
- andThen
- foreach

## 1. Polling:

- isCompleted
- value

## 1. Transformations:

- transform
- transformWith
- failed
- fallbackTo
- mapTo
- recover
- recoverWith
- transform
- familiar methods: collect, filter, flatten, flatMap, map, withFilter, zip, and zipWith



## ***An example of transform***

As an example of the transform combinator, if you put these import statements into a Scala REPL session:

```
import scala.concurrent.Future
import scala.concurrent.ExecutionContext.Implicits.global
import scala.util.{Failure, Success}
```

and then paste in these lines of code:

```
val f1 = Future { Thread.sleep(500); 1 }
val rez = f1.transform (
  i => i * 42,
  e => new Exception("something bad happened: " + e)
)
rez.value
Thread.sleep(600)
rez.value
```

you'll see these results:

```
scala> val f1 = Future { Thread.sleep(500); 1 }
f1: scala.concurrent.Future[Int] = Future(<not completed>)

scala> val rez = f1.transform (
  |   i => i * 42,
  |   e => new Exception("something bad happened: " + e)
  | )
rez: scala.concurrent.Future[Int] = Future(<not completed>)

scala> rez.value
res0: Option[scala.util.Try[Int]] = None

scala> Thread.sleep(600)

scala> rez.value
res1: Option[scala.util.Try[Int]] = Some(Success(42))
```

Notice how rez is initially listed as Future(<not completed>). After that, rez.value yields a None initially, but after you wait long enough for the future to complete, it eventually yields a Some(Success(42)).

In code outside the REPL you should use callback methods like onComplete and transform, and not value. (value is a method that shows the current value of a Future.)

## ***Key points about callback methods***

Here are a few key points about Future's callback methods:

- Callback methods are called asynchronously when a future completes.
- A callback method is executed by some thread, some time after the future is completed.
- `onComplete` takes a callback function of type `Try[T] => Unit`. As usual, the `Unit` return type is a great hint that it only lets you handle the result as a side effect.
- The order in which callbacks are executed is not guaranteed.
- From the “Futures and Promises” page, “`onComplete`, `onSuccess`, and `onFailure` have the result type `Unit`, so they can't be chained. This design was intentional, to avoid any suggestion that callbacks may be executed in a particular order.”

## If you struggle with the name ...

One more point about Scala futures: If you're struggling with the concept, it might be because of the name "future." In my case that name slowed me down for a while (and I was *used* to writing multi-threaded code). I kept having to ask myself, "Why are they using the name 'future'? What is that name trying to convey?"

One night I was reading the book [Akka Concurrency](#) and I got so frustrated that I wrote 35 alternate names for Future in the margins of the book. I knew the name "thread" wasn't right, because that would be confusing with Java threads. I eventually decided that for me, the name "ConcurrentTask" made more sense than "Future."

Fortunately in Scala you can rename types when you import them, so in the following example I rename Future to ConcurrentTask so you can see what I'm talking about:

```
import scala.concurrent.{Future => ConcurrentTask} //rename

// start a long-running task
val task = ConcurrentTask {
  Cloud.executeLongRunningTask(a, b, c)
}

// whenever the task completes, execute this code
task.onComplete {
  case Success(value) => println(s"Success, value = $value")
  case Failure(e) => println(s"Failure: ${e.getMessage}")
}
```

Even as I look at this code four years after I wrote in the margin of that book, the name ConcurrentTask is still easier for my brain to understand than Future. So, if you're struggling with the concept, it may just be the name.

### ***About the name ConcurrentTask***

If you're wondering how I came up with the name ConcurrentTask, I found it in the scala-lang.org ["Futures and Promises" documentation](#):

"Composing *concurrent tasks* in this way tends to result in faster, asynchronous, non-blocking parallel code."

As that quote implies, other meaningful, alternate names for a future can be `AsynchronousTask` or `NonBlockingParallelTask`.

## A larger example

If you're interested in a larger, real-world example, the source code for this lesson includes a Swing/GUI application that uses futures and `onComplete`.

The main class of the application is named *FutureBoard*. The intent of the application is to work a little like a text-only version of [Flipboard](#) or an RSS reader. When you go to the File menu and click the Update menu item, the application uses three futures as part of the process of reaching out onto the internet to get content from the Chicago Tribune, the Denver Post, and Scala-related tweets from Twitter. Those three news sources are contacted in parallel using futures, and the windows in the GUI are updated “whenever.”

Until all of those websites change their URLs and/or CSS, the application looks like Figure [fig:futureBoardAfterData].



What the FutureBoard application looks like after it gets data from its three internet resources.

As usual, I encourage you to work with that code and make it your own to learn more about futures.

# Key Points About Futures

As a summary of the last two lessons, here are some key points about working with Scala futures.

First, a few points about futures as they relate to functional programming:

- Future implements `map` and `flatMap`, so it works as a monad.
- As Debashish Ghosh wrote in [Functional and Reactive Domain Modeling](#), “Just as Try manages *exceptions* using effects, another abstraction in the Scala library called Future helps you manage *latency* as an effect.”
- When you need to start several futures and combine their results into one value, merge the results in a `for` expression.
- Future has a nice collection of callback methods, and I demonstrated the `map`, `onComplete`, and `transform` methods.
- The value in a future is always an instance of `Try`, so you always work with `Success` and `Failure` when handling a future’s result.

Other Future keys:

- I think of a future as a one-shot, “handle this relatively slow and potentially long-running computation, and call me back with a result when you’re done” construct.
- Personally, I find the name `ConcurrentTask` more meaningful than `Future`.
- A future represents the result of an asynchronous computation, and has a return type of `Future[A]`, which was `Future[Int]` in my examples.
- Futures are started immediately. (Unlike the Java `Thread` class, there is no `run` method to call.)
- The examples show that the main JVM thread flies right through the `for` and `onComplete` expressions. They aren’t executed until the future(s) return.

- In the examples I showed, `yield` in the `for` expression is executed when all of the futures complete, and `onComplete` is executed immediately after that.
- You typically work with the results of a future using its callback methods, such as `onComplete` and `transform`.
- Callback methods are called asynchronously when a future completes.
- There's no guarantee that your future's callback method will be called on the same thread the future was run on.
- There's no guarantee about the order in which callback methods are executed.

## ***Promises***

Lastly, I didn't write about the Scala `Promise` class because it's rarely used directly. The book [Learning Concurrent Programming in Scala](#) states:

*“A promise and a future represent two aspects of a single-assignment variable: the promise allows you to assign a value to the future object, whereas the future allows you to read that value.”*

and then later:

*“We would like to somehow create a bridge between legacy callback-based APIs and futures ... this is where promises come in handy ... Use promises to bridge the gap between callback-based APIs and futures.”*



## See also

- [Programming in Scala](#) has an excellent chapter about Scala Futures
- [Akka Concurrency](#) is a little out of date now, but it's still an excellent resource about Akka actors and futures
- [Learning Concurrent Programming in Scala](#) is an excellent resource about concurrent programming
- My post, [A look at how exceptions work with Scala Futures and the onComplete 'Failure' case](#)
- [The Future scaladoc](#)
- ["Futures and Promises"](#) on scala-lang.org

# To Be Continued

I'll add the final lessons to this book as soon as I can. At this point there are only a few more things to add, including a "Summary/Conclusion" chapter, more source code examples, and possibly a few other things.

Once I finish those lessons, I'll work on improving the formatting of the book.

# Appendices

I created the following lessons as appendices because I thought they would be helpful in supporting your process of learning functional programming in Scala.

# Explaining Scala's `val` Function Syntax

## Background

I wrote in the “Functions are Values” lesson that most developers prefer to use the `def` syntax to define *methods* — as opposed to writing *functions* using `val` — because they find the method syntax easier to read than the function syntax. When you write methods, you let the compiler convert them into functions with its built-in “Eta Expansion” capability. There’s nothing wrong with this. Speaking as someone who used Java for 15+ years, the `def` syntax was easier for me to read at first, and I still use it a lot.

But if you come from something like a Haskell background, you may find that the `val` function syntax is easier to read; it’s more familiar. Or, once you dig into the `val` function syntax — as shown in this lesson — you may say, “Hey, I prefer the `val` syntax.”

Beyond your background and preferences, there’s another important point about `val` functions: You’ll use the exact same syntax to define functions as input parameters. For example, this `calculate` function declares an input parameter named `f`:

```
calculate(f: (Int, Int) => Int)
```

`f` is a function that transforms two `Int` values into a resulting `Int` value, and the syntax you use to define `f`’s type is the same syntax that I explore in this lesson.

## Goals

Given that background, the primary goal of this lesson is to explain and demonstrate Scala's `val` syntax for writing functions. I'll show both forms of the function syntax, (a) the "explicit return type" syntax, and (b) the "implicit return type" syntax.

I also show that when you define a function as a `val`, what you're really doing is giving a value name to an anonymous function. Finally, I also show that behind the scenes, when Scala compiles a function, what it really does is create an instance of the `Function0` through `Function22` traits.

## Scala's function syntax

In Scala, there are at least two syntax forms for defining functions using `val`. The biggest distinction is whether you want to (a) let the return type be “implicit” — meaning that you don't show it, and the compiler infers it — or (b) define the function's return type explicitly.

In this lesson I'm going to use the terms “explicit return type” (ERT), and “implicit return type” (IRT). These aren't industry-standard acronyms, but because I will be using these phrases often in this lesson, I have come up with these acronyms.

The following lines show the *implicit* and *explicit* syntax for a function named `add1`, which returns an `Int` value that is 1 larger than the `Int` value it is given as an input parameter:

```
val add1 = (i: Int) => i + 1      // implicit return type (IRT)
val add1: Int => Int = (i) => i + 1  // explicit return type (ERT)
```

One variation of this is that you can put curly braces around the function body:

```
val add1 = (i: Int) => { i + 1 }
val add1: Int => Int = (i) => { i + 1 }
```

You generally need to use curly braces around multi-line functions, but you can also use them in one-line functions if you prefer.

With the ERT syntax, when you have only one input parameter, you can leave the parentheses off of the parameter name:

```
val add1: Int => Int = (i) => { i + 1 }
val add1: Int => Int = i => { i + 1 }  // parentheses not required
```

All of those examples show a function that takes one input parameter. The next examples show the syntax for a sum function that takes two input parameters:

```
val sum = (a: Int, b: Int) => a + b      // implicit
val sum: (Int, Int) => Int = (a, b) => a + b  // explicit
```

When I first came to Scala from Java, I didn't like this syntax — *at all* — but

now that I understand it, I have no problems with it, and even like it.

## Explaining the ERT syntax

Figure [fig:fieldsInErtSumFunction] explains the fields in the ERT version of the sum function.

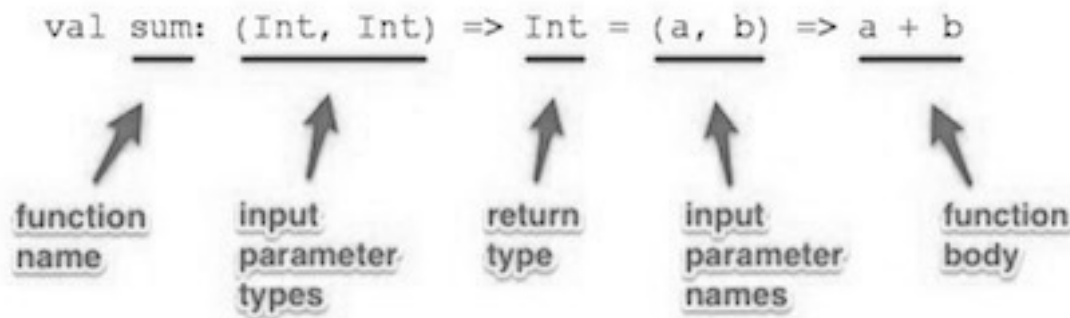

The fields in the ERT version of the sum function.

As that shows, the signature consists of:

- Assigning a function name, sum.
- The function's input parameter type(s).
- The function's return type.
- Giving names to the function's input parameters.
- Writing the function body.

In any programming language that declares its input and output types, you need to declare all of these things; it's just a matter of *how* you declare them that makes each approach different. For instance, when you look at Scala's method syntax, you see that it requires the exact same fields, they're just ordered differently, with different field-separator symbols:

```
def sum(a: Int, b: Int): Int = a + b
```

### *Viewing the function signature as two blocks*



A method that helped me understand Scala’s function syntax was to break it up into different “blocks.” Figure [fig:funSigIsTwoBlocks] shows that you can look at the signature as two blocks.

```
val sum: (Int, Int) => Int = (a, b) => a + b
```

You can look at Scala’s function signature as containing two blocks.

When you do that, you can see that the first block declares the function’s input and return *types*, as shown in Figure [fig:funSigFirstBlock].

```
val sum: (Int, Int) => Int = (a, b) => a + b
```

input and return types

The first block declares a function’s input and return types.

If you’ve worked with a language like C, where you declare a function’s types in a header file, this becomes clear.

In a similar manner, the second block declares the function’s input parameter *names* and the function’s algorithm, as shown in Figure [fig:secondBlockDeclaresInputParams].

```
val sum: (Int, Int) => Int = (a, b) => a + b
```

input parameters and  
return value

A function’s second block declares the input parameter names and its algorithm.

A key point of this block is that it shows how the input parameter names are used within the algorithm; it makes sense that the parameter names are close to the

function body.

I find that when I highlight the code like this, the `val` function signature makes a lot of sense.

### **`=>`, the “Universal Transformer”**

Furthermore, because I like to think of the `=>` symbol as Scala’s “Universal Transformer” – like Star Trek’s “Universal Translator” — I can also look *inside* each block to see the intended transformation.

For instance, Figure [fig:theErtTransformerSymbol] shows that the `=>` symbol in the first block of the `sum` function shows that it transforms two input `Int` values into an `Int` return value.

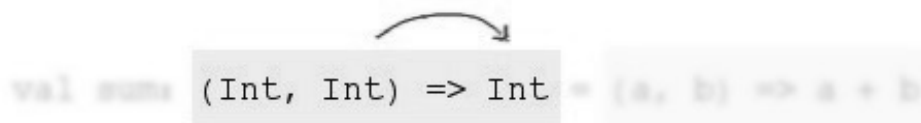

The diagram shows the code `val sum (Int, Int) => Int = (a, b) => a + b`. A grey highlight box covers the first block `(Int, Int) => Int`. A curved arrow points from this box to the second block `(a, b) => a + b`, indicating the transformation of the function signature into its implementation.

The transformer symbol in the function’s first block.

As shown in Figure [fig:transformerSymbolIn2ndBlock], the `=>` in the second block similarly shows how the function transforms its input parameter names with its algorithm.



The diagram shows the code `val sum (Int, Int) => Int = (a, b) => a + b`. A grey highlight box covers the second block `(a, b) => a + b`. A curved arrow points from this box to the first block `(Int, Int) => Int`, indicating the transformation of the function implementation into its signature.

The transformer symbol in the function’s second block.

## Reading IRT function signatures

Those examples show how you can read the function signature when you explicitly show the function's return type, i.e., the ERT approach. You can use a similar approach to understand the implicit return type syntax.

To demonstrate this, the following `isEven` function determines whether the input `Int` parameter is an even or odd number. It returns a `Boolean` value, but because you and the Scala compiler can both infer the return type by looking at the function body, I don't explicitly declare it:

```
val isEven = (i: Int) => i % 2 == 0
```

You can view the fields in `isEven` as shown in Figure [fig:fieldsInIsEven].

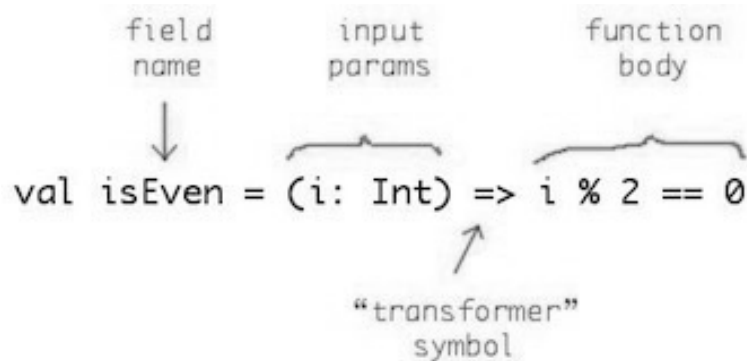

A breakdown of the fields in the `isEven` function.

As with the previous examples, you can see in the signature that the “Universal Transformer” symbol transforms an input value to an output value, as shown in Figure [fig:universalTransformerTransformsI2O].

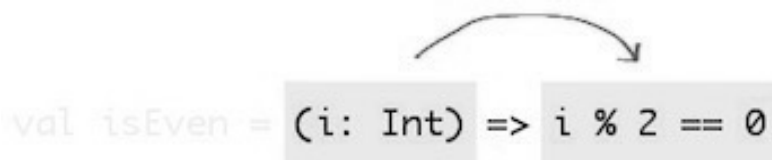

The “Universal Transformer” symbol transforms an input value to an output value.

This IRT syntax is more concise than the ERT syntax, and it's similar to the def method signature.

With both the ERT and IRT signatures, I find that it helps to read function signatures as sentences. For example, I read this function:

```
val isEven = (i: Int) => i % 2 == 0
```

like this:

“The function `isEven` transforms the input `Int` into a `Boolean` value based on its algorithm, which in this case is `i % 2 == 0`.”

### ***Exercise***

- Take a moment to sketch the syntax for an `isEven` function that declares an explicit return type:

## Key: Using return doesn't feel right

Another eye-opener for me is that once I understood the `val` function syntax, I realized that using Scala's `return` keyword doesn't feel right. To me, this code looks and feels right:

```
val isEven = (i: Int) => i % 2 == 0
```

But this attempt to use `return` *does not* look right:

```
val isEven = (i: Int) => return i % 2 == 0
```

With the function syntax you're not really "returning" anything, you're just assigning a block of code to a value, so `return` feels out of place here. (In fact, `return` is so out of place here that the second example won't even compile.)

There are times I still want to "return" something from a `def` method, but I find that I never want to use `return` when I use the `val` function syntax. As I wrote in the early "Functional Code Feels Like Algebra" lesson, in FP you really are writing a series of equations.

## Examples of function syntax using isEven

If the body of `isEven (i % 2 == 0)` is hard to read, that's okay, for at least one reason: It gives me a chance to write a little more about the function syntax.

First off, it may help to know that the `isEven` function I showed originally:

```
val isEven = (i: Int) => i % 2 == 0
```

is a shorthand way of writing this:

```
val isEven = (i: Int) => if (i % 2 == 0) true else false
```

This longer form makes it more clear about how `isEven` works. If you really prefer longer forms, you can write this same function like this:

```
val isEven = (i: Int) => {  
  if (i % 2 == 0) {  
    true  
  } else {  
    false  
  }  
}
```

I show these examples because I want to list the many ways you can write `isEven` using an *implicit* return type:

```
val isEven = (i: Int) => { if (i % 2 == 0) true else false }  
val isEven = (i: Int) => if (i % 2 == 0) true else false  
  
val isEven = (i: Int) => { i % 2 == 0 }  
val isEven = (i: Int) => i % 2 == 0  
val isEven = i: Int => i % 2 == 0
```

The next examples show different ways you can write `isEven` when declaring an *explicit* return type:

```
val isEven: (Int) => Int = (i) => { if (i % 2 == 0) true else false }  
val isEven: (Int) => Int = i => { if (i % 2 == 0) true else false }  
  
val isEven: (Int) => Int = (i) => { i % 2 == 0 }  
val isEven: (Int) => Int = i => { i % 2 == 0 }  
  
val isEven: (Int) => Int = (i) => i % 2 == 0  
val isEven: (Int) => Int = i => i % 2 == 0  
  
val isEven: (Int) => Int = (i) => {  
  if (i % 2 == 0) {  
    true
```

```
    } else {  
        false  
    }  
}
```

There are even more ways that you can write `isEven`. Later in this lesson I'll show how you can write it by explicitly extend `Function1` with the *anonymous class* syntax.

## The REPL shows the explicit function syntax

It's interesting to note that the REPL shows the same function signature whether I use the ERT or IRT syntax:

```
// ERT
scala> val sum: (Int, Int) => Int = (a, b) => a + b
sum: (Int, Int) => Int = <function2>
```

```
// IRT
scala> val sum = (a: Int, b: Int) => a + b
sum: (Int, Int) => Int = <function2>
```

But what I really like about the REPL output is that it shows the ERT function syntax. Note the similarity between the ERT syntax I wrote, and what the REPL responds with:

```
val sum: (Int, Int) => Int = (a, b) => a + b    // my code
    sum: (Int, Int) => Int = <function2>      // repl output
```

The type signature the REPL shows is identical to the ERT's type signature.



## We're giving an anonymous function a name

Assuming that you've already written *anonymous functions* in Scala, you may have noticed that what I'm doing in all of these examples is that I'm assigning the anonymous function `i % 2 == 0` to a `val` named `isEven`:

```
val isEven = (i: Int) => i % 2 == 0
```

What I mean by that is that this code is an anonymous function:

```
(i: Int) => i % 2 == 0
```

and the only thing the previous code is doing is assigning the value named `isEven` to this anonymous function. You can see that more clearly in the following images. First, Figure [fig:anonFunctionPart] shows the anonymous function part.

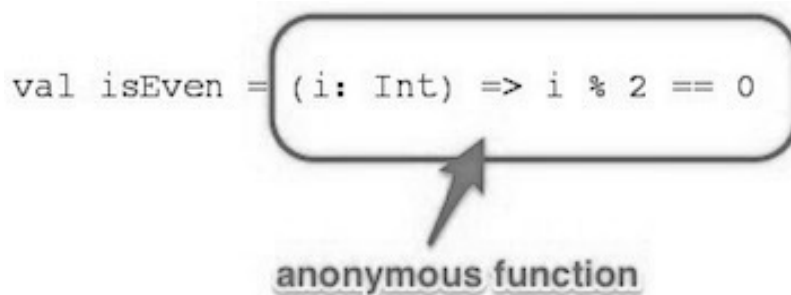

The diagram shows the code `val isEven = (i: Int) => i % 2 == 0`. A rounded rectangular box highlights the expression `(i: Int) => i % 2 == 0`. An arrow points from the text `anonymous function` below to the highlighted expression.

The anonymous function part of the expression.

Then Figure [fig:variableAssignedToAnonFunction] shows the variable name that is assigned to the anonymous function.

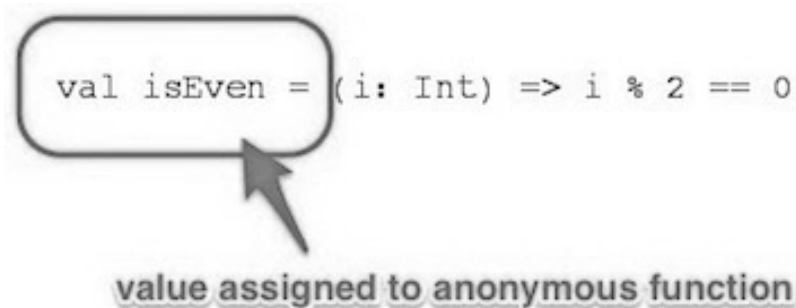

The diagram shows the code `val isEven = (i: Int) => i % 2 == 0`. A rounded rectangular box highlights the variable name `isEven`. An arrow points from the text `value assigned to anonymous function` below to the highlighted variable name.

The variable name that is assigned to the anonymous function.

As another way of showing this, you can paste the anonymous function into the REPL:

```
scala> (i: Int) => i % 2 == 0  
res0: Int => Boolean = <function1>
```

and then assign `isEven` to `res0`:

```
scala> val isEven = res0  
isEven: Int => Boolean = <function1>
```

After that, you can use `isEven` as before:

```
scala> isEven(42)  
res1: Boolean = true
```

As shown, the function syntax just assigns a value name to an anonymous function.

## isEven is an instance of Function1

I discuss this next point in the “Functions are Values” lesson, so I won’t go into it too much here, but it’s worth mentioning that in all of these examples, `isEven` is an instance of [the Function1 trait](#).

This is what the output is trying to tell you when you paste `isEven` into the REPL:

```
scala> val isEven = (i: Int) => i % 2 == 0
isEven: Int => Boolean = <function1>
```

The REPL output shows that `isEven`’s result is an instance of `Function1`, which it shows as `<function1>`.

If you haven’t seen this before, the reason that `isEven` is an instance of `Function1` is because it takes one input parameter. As shown in Figure [fig:function1ScaladocValFunSyn], the `Function1` Scaladoc shows that this is exactly what it’s intended for.

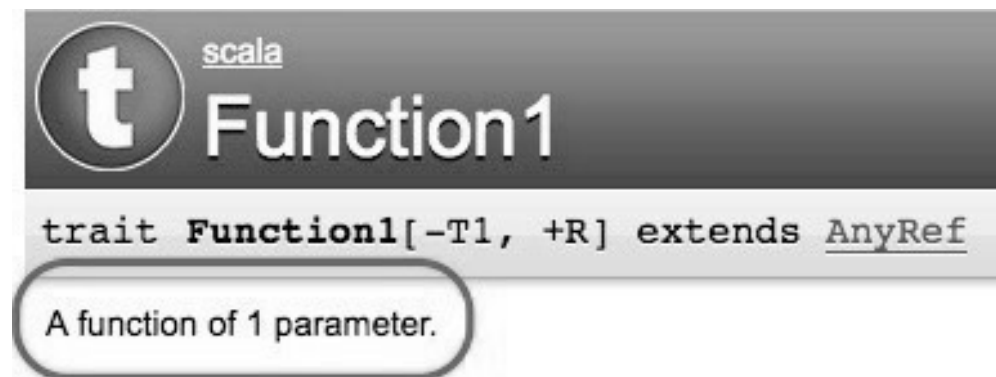

The Scaladoc clearly shows that `Function1` is a “function of ‘ parameter”.

By comparison, a sum function that takes *two* input parameters is an instance of the `Function2` trait:

```
scala> val sum: (Int, Int) => Int = (a, b) => a + b
sum: (Int, Int) => Int = <function2>
```

In fact, I note in “The differences between `def` and `val` when defining functions” appendix that, if you want to, you can define `sum` like this:

```
val sum = new Function2[Int, Int, Int] {  
  def apply(a: Int, b: Int): Int = a + b  
}
```

As I show in that appendix, that's what the Scala compiler *really* does for you when you define sum.

Finally, while I'm in the neighborhood, this is how you define isEven using this approach:

```
val isEven = new Function1[Int, Boolean] {  
  def apply(i: Int): Boolean = i % 2 == 0  
}
```

Most developers don't use this approach; I'm just trying to show how things work under the hood.

# Conspiracy Theory: The function syntax has its root in Haskell

I can neither confirm nor deny what I'm about to write, but in the spirit of a good *The X-Files* conspiracy, I suspect that this syntax:

```
val sum: (Int, Int) => Int = (a, b) => a + b
```

has its roots in Haskell, or perhaps another language like ML (which I only know from looking at [its Wikipedia page](#)).

The reason I suspect this is because of how you define Haskell functions. For example, here's the Haskell syntax to define a function named `addPizzaToOrder`, which takes `Order` and `Pizza` instances as input parameters, and returns a new `Order` as a result:

```
addPizzaToOrder :: Order -> Pizza -> Order
addPizzaToOrder anOrder aPizza = (function body here ...)
```

The first line shows the function's signature, which includes only (a) the function name, (b) its input types, and (c) its output type. This is a little like declaring a function signature in a C header file.

In Haskell, it's a slight simplification to say that the output type is the last type listed after the string of `->` symbols. So in this example, the `addPizzaToOrder` function returns an `Order`.

The second line shows the input parameter names (`anOrder`, `aPizza`), which correspond to the types declared on the first line (`Order`, `Pizza`). The same function is written like this using Scala's ERT syntax:

```
val addPizzaToOrder: (Order, Pizza) => Order = (anOrder, aPizza) => ???
```

I don't know about you, but when I look at Figure [fig:funSyntaxHaskellBlocks], to me it looks like the Scala syntax merges the two Haskell lines into one line.

```
addPizzaToOrder :: Order -> Pizza -> Order // haskell line 1
val addPizzaToOrder: (Order, Pizza) => Order = (anOrder, aPizza) => ...
addPizzaToOrder anOrder aPizza = ... // haskell line 2
```

The Scala function syntax seems to merge two Haskell lines into one.

But again, this is just X-Files speculation. I've never spoken to Martin Odersky or anyone else about this. ;)

(As supporting conspiracy theory material, Haskell 1.0 was defined in 1990, and the "Haskell 98" standard was published in February, 1999. The [history of Scala on Wikipedia](#) states, "The design of Scala started in 2001 ... following from work on [Funnel](#), a programming language combining ideas from functional programming and Petri nets. After an internal release in late 2003, Scala 1.0 was released publicly in early 2004 on the Java platform." So, the timeline fits the conspiracy theory. ;)

For more information on Scala's history, see [Scala's Prehistory on scala-lang.org](#).

## Summary

The intent of this lesson was to explain and explore Scala's function syntax. Here's a summary of what was covered:

- I showed two forms of the Scala function syntax, showing the *implicit* return type (IRT) syntax, and the *explicit* return type (ERT) syntax.
- I showed how you can break the ERT syntax down into blocks to understand it more easily.
- I showed that the REPL output for functions looks just like the ERT type signature syntax.
- I showed where the => (Universal Transformer) symbol fits in both the ERT and IRT approaches.
- I noted that since the function approach really just assigns a block of code to a `val` field, it doesn't feel right to use the `return` keyword when defining functions.
- I noted that all we're really doing when we define a function is giving a name to an anonymous function.
- I showed that "under the hood," you'll find that functions are instances of traits like `Function1` and `Function2`.
- Then I took a detour and shared a little conspiracy theory. ;)

## See also

- Scala's [Function1 trait](#)
- [The ML programming language](#)
- [The Funnel programming language](#)
- [history of Scala on Wikipedia](#)
- [Scala's Prehistory on scala-lang.org](#)



# The Differences Between `val` and `def` When Creating Functions

## Goals

The main goals for this lesson are:

- Discuss the differences between `val` and `def` “functions”
- Demonstrate the differences between `val` and `def` “functions”

## Background

For the most part — maybe 98% of the time — the differences between defining a “function” using `def` or `val` aren’t important. As I can personally attest, you can write Scala code for several years without knowing the differences. As long as you’re able to define a `val` function or `def` method like this:

```
val isEvenVal = (i: Int) => i % 2 == 0
def isEvenDef(i: Int) = i % 2 == 0
```

and then pass them into the `filter` method of a `List`, like this:

```
scala> val xs = List(1,2,3,4)
xs: List[Int] = List(1, 2, 3, 4)

scala> xs.filter(isEvenVal)    //val
res0: List[Int] = List(2, 4)

scala> xs.filter(isEvenDef)    //def
res1: List[Int] = List(2, 4)
```

the differences between them rarely seem to matter.

But as you become a more advanced Scala developer — and as you see the code that some Scala/FP developers like to write — knowing the differences between `val` functions and `def` methods can be helpful, and in some cases it may be essential to understand how code works.

### *case expressions in functions*

One example of where this is essential is when Scala/FP developers use case expressions to define functions, like this:

```
val f: (Any) => String = {
  case i: Int => "Int"
  case d: Double => "Double"
  case _ => "Other"
}
```

When I saw code like this for the first time I thought, “How can that possibly work? There’s no match before the case statements, and the definition also don’t show any input parameters defined ... how can this work?”

The answer is that this function does compile and it does work, yielding the

results that you'd expect from the case expressions:

```
f(1)      // Int
f(1d)     // Double
f(1f)     // Other
f("a")    // Other
```

But *why* this works can be a mystery — a mystery I'll resolve in this lesson.

## **Terminology in this lesson**

While `def` is technically used to define a method, in this section I'll often refer to it as a function. Furthermore, I'll use the terms “function created with `val`” and “function created with `def`” — or more concisely, “`val` function” and “`def` function” — when I want to be clear about what I'm referring to.

# A quick summary of the differences between `val` and `def` functions

To get started, here's a quick summary of the differences between `val` and `def` functions.

## *`val` functions*

There are a few different ways you can write a `val` function, but a common way to write them looks like this:

```
val add = (a: Int, b: Int) => a + b
```

A `val` function has these attributes:

- It is 100% correct to use the term “function” when referring to it.
- `add` is created as a variable, in this case as a `val` field.
- Under the hood, the Scala compiler implements this specific example as an instance of the `Function2` trait.
- `val` functions are concrete instances of `Function0` through `Function22`.
- Because `val` functions are instances of `Function0` through `Function22`, there are several methods available on these instances, including `andThen`, `compose`, and `toString`.
- As shown earlier, `val` functions can use case expressions without a beginning `match`.

Note that you can manually define functions using syntax like this:

```
val sum = new Function2[Int, Int, Int] { ...
```

That's rarely done, but I'll fully demonstrate that syntax later in this lesson so you can learn more about how things work under the covers.

Because `add` is a true variable (a `val` field), you can examine it in the REPL, like

this:

```
scala> add  
res0: (Int, Int) => Int = <function2>
```

Note that the `add` function isn't invoked; the REPL just shows its value.

## ***def functions***

What I call a “def function” looks like this:

```
def add(a: Int, b: Int) = a + b
```

It has these attributes:

- It is *not* 100% correct to use the term “function” when referring to it. Technically, it is *not* a function.
- It is a *method* that needs to be defined within a class or object.
- As a method in a class:
  - It has access to the other members in the same class.
  - It's passed an implicit reference to the class's instance. (For example, when the `map` method is called on a `List`, `map` has an implicit reference to the `this` object, so it can access the elements in the instance's `List`.)
- When you write a `def`, you can specify parameterized (generic) types, like this:

```
def fooA: String = ???
```

Finally, note that when you define `add` like this in the REPL:

```
def add(a: Int, b: Int) = a + b
```

you can't examine its value in the REPL in the same way you could with a `val` function:

```
scala> add  
<console>:12: error: missing arguments for method add;  
follow this method with `_' if you want to treat it as a  
partially applied function
```

```
add  
^
```

## ***Converting methods to functions***

As a final note in this initial summary, you can convert a `def` method into a real `val` function. You can do this manually yourself, and the Scala compiler also does it automatically when needed. This feature is called, “Eta Expansion,” and I show how it works in another appendix in this book.

### ***More details***

I’ll show many more details in this lesson — for instance, I’ll show decompiled examples of `val` and `def` functions — but I wanted to start with these key points.

# Why a val function can use a case expression without a beginning match

I noted at the beginning of this lesson that you can write a `val` function using case expressions without a beginning `match` keyword, like this:

```
val f: (Any) => String = {  
  case i: Int => "Int"  
  case d: Double => "Double"  
  case _ => "Other"  
}
```

The reasons this syntax works are:

1. A block of code with one or more case expressions is a legal way to define an anonymous function.
2. As I mention in the “Functions are Values” lesson, when you create a `val` function, all you’re really doing with code like this is assigning a variable name to an anonymous function.

To support that first statement, Section 15.7 of [Programming in Scala](#) states:

“A sequence of cases in curly braces can be used anywhere a function literal can be used.”

Here are two examples that show how you can use a case expression as an anonymous function. First, a modulus example:

```
scala> List(1,2,3,4).filter({ case i: Int => i % 2 == 0 })  
res0: List[Int] = List(2, 4)
```

Next, a “string length” example:

```
scala> val misc = List("adam", "alvin", "scott")  
misc: List[String] = List(adam, alvin, scott)  
  
scala> misc.map({ case s: String => s.length > 4 })  
res1: List[Boolean] = List(false, true, true)
```

If you read the [Scala Cookbook](#), you may also remember this example from Section 9.8 on Partial Functions:



```
scala> List(0,1,2) collect { case i: Int if i != 0 => 42 / i }  
res2: List[Int] = List(42, 21)
```

This example works because (a) the case expression creates an anonymous function, and (b) the collect method works with Partial Functions. Contrast that with map, which explodes with a MatchError when it's used with that same case expression:

```
scala> List(0,1,2) map { case i: Int if i != 0 => 42 / i }  
scala.MatchError: 0 (of class java.lang.Integer)
```

## The val function syntax

As I noted earlier, a `val` function is simply a variable name that's assigned to a function literal. To demonstrate this, Figure [fig:AnonymousFunction-1-literal] shows the function literal.

```
val isEven = (i: Int) => i % 2 == 0
```

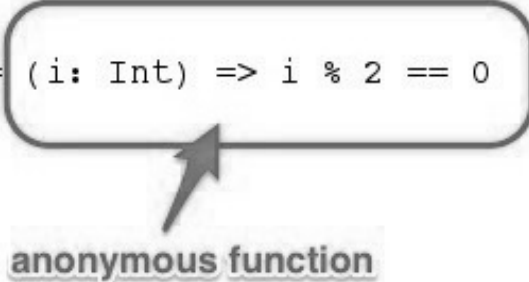

anonymous function

The function literal (anonymous function) is highlighted.

And Figure [fig:AnonymousFunction-2-name] shows the variable name being assigned to the function literal.

```
val isEven = (i: Int) => i % 2 == 0
```

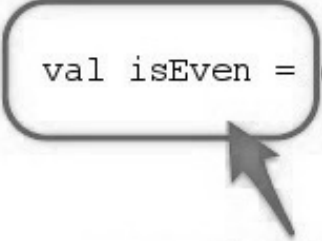

name assigned to anonymous function

A variable name is assigned to the function literal.

By contrast, if you want to write the same code using `def`, it would be defined like this:

```
def isEven(i: Int): Boolean = i % 2 == 0
```

## Decompiling a def method

As you might suspect, a `def` method in a Scala class is compiled into a similar method on a Java class. To demonstrate this, if you start with this Scala class:

```
class DefTest {  
  def add1(a: Int) = a + 1  
}
```

you can then compile it with `scalac`. When you compile it with the following command and look at its output, you'll find that there's still a method in a class:

```
$ scalac -Xprint:all DefTest.scala  
  
package <empty> {  
  class DefTest extends Object {  
    def add1(a: Int): Int = a.+(1); //<-- the method  
    def <init>(): DefTest = {  
      DefTest.super.<init>();  
      ()  
    }  
  }  
}
```

If you further disassemble the resulting `.class` file with `javap`, you'll see this output:

```
$ javap DefTest  
  
Compiled from "DefTest.scala"  
public class DefTest {  
  public int add1(int); //<-- the method  
  public DefTest();  
}
```

Clearly, `add1` is a method in the bytecode for the `DefTest` class.

Finally, if you completely decompile the `.class` file back into Java source code using `Jad`, you'll again see that `add1` is a method in the Java version of the `DefTest` class:

```
public class DefTest {  
  public int add1(int a) {  
    return a + 1;  
  }  
  
  public DefTest() {}  
}
```

By all accounts, creating a Scala `def` method creates a standard method in a Java class.

## Decompiling a val function

A Scala *function* that's created with `val` is very different than a *method* created with `def`. While `def` creates a method in a class, a function is an *instance of a class* that implements one of the `Function0` through `Function22` traits.

To see this, create a class named `ValTest.scala` with these contents:

```
class ValTest {
  val add1 = (a: Int) => a + 1
}
```

When you compile that class with `scalac`, you'll see that it creates two `.class` files:

```
ValTest.class
ValTest$$anonfun$1.class
```

When you decompile `ValTest.class` with `javap` you see this output:

```
$ javap ValTest

Compiled from "ValTest.scala"
public class ValTest {
    public scala.Function1<java.lang.Object, java.lang.Object> add1();
    public ValTest();
}
```

That output shows that `add1` is defined as a method in the `ValTest` class that returns an instance of the `Function1` trait.

Back in the good old days (around Scala 2.8) it was much easier to look at this code to see what's going on, but these days I find it hard to see what's going on in these class files using `javap`, so I revert to decompiling them with `Jad`.

Decompiling `ValTest.class` converts the class file to Java source code:

```
import scala.Function1;
import scala.Serializable;
import scala.runtime.BoxesRunTime;

public class ValTest {

    public Function1 add1() {
        return add1;
    }

    public ValTest() {}
}
```

```

private final Function1 add1 = new Serializable() {
    public final int apply(int a) {
        return apply$mcII$sp(a);
    }

    public int apply$mcII$sp(int a) {
        return a + 1;
    }

    public final volatile Object apply(Object v1) {
        return
            BoxesRunTime.boxToInteger(apply(BoxesRunTime.unboxToInt(v1)));
    }

    public static final long serialVersionUID = 0L;
}
;
}

```

While this code is still hard to interpret, a couple of things are clear:

- `add1()` is a method in the `ValTest` class.
- The `add1()` method returns the `add1` instance.
- The `add1` instance is created by making an anonymous class instance of `scala.Serializable`.
- The `add1` instance has an `apply` method that calls another method named `apply$mcII$sp`, and that second method contains the body of the original function, `a + 1`.

What isn't clear from this code unless you dig pretty deep into it is that the original Scala function:

```
val add1 = (a: Int) => a + 1
```

creates `add1` as an instance of `Function1`. It's easier to see this in the REPL.

## ***Looking at val functions in the REPL***

When you put this function in the Scala REPL, you see this result:

```
scala> val add1 = (a: Int) => a + 1
add1: Int => Int = <function1>
```

This shows that `add1` is an instance of `Function1`. If you're not comfortable with

the REPL output, one way you can prove this is to show that `add1` is an object with an `apply` method:

```
scala> add1.apply(2)
res0: Int = 3
```

To be clear, when you call `add1(2)`, this is exactly what happens under the hood. Scala has some nice syntactic sugar that hides this from you — and makes your code easy to read — but this is what *really* happens under the hood.

You can further demonstrate this by looking at the [Function1 Scaladoc](#). There you'll see that any class that implements `Function1` must have these three methods:

- `andThen`
- `compose`
- `toString`

This code demonstrates that `add1` has the `andThen` method:

```
scala> (add1 andThen add1)(5)
res1: Int = 7
```

This shows that `compose` is available on `add1`:

```
scala> (add1 compose add1)(10)
res2: Int = 12
```

`toString` also works:

```
scala> add1.toString
res3: String = <function1>
```

Finally, because `add1` takes an `Int` input parameter and returns an `Int`, it is implemented as an instance of `Function1[Int, Int]`. You can also demonstrate this in the REPL:

```
scala> add1.isInstanceOf[Function1[Int, Int]]
res4: Boolean = true
```

Clearly, `add1` is an object of type `Function1`.

## ***Trying that on a def method***

By comparison, if you try to call `toString` on a method created with `def`, all you get is an error:

```
scala> def double(a: Int) = a * 2
double: (a: Int)Int

scala> double.toString
<console>:12: error: missing arguments for method double;
follow this method with `_' if you want to treat it as a
partially applied function
    double.toString
      ^
```

As mentioned, a `def` is not really a `val`, it just works *like* a `val` when you pass it to other functions because of the Eta Expansion feature that I mentioned earlier.



## Creating Function instances manually

As a final way of showing that a function created with `val` creates a complete object, it may help to know that you can create your own `Function1`, `Function2` ... `Function22` instances manually. This gives you another idea of how things work under the hood.

Previously I defined an `add1` function like this:

```
val add1 = (a: Int) => a + 1
```

Then I showed that it looks like this in the REPL:

```
scala> val add1 = (a: Int) => a + 1
add1: Int => Int = <function1>
```

The following code shows the manual way to create a similar function:

```
class Add2 extends Function1[Int, Int] {
  def apply(a: Int) = a + 2
}
val add2 = new Add2
```

Once you've taken those steps, you can invoke `add2` just like `add1`:

```
add2(1)
```

Because `add2` takes an `Int` and returns an `Int`, it's implemented as an instance of `Function1[Int, Int]`. Had it been a function that took a `Double` and returned a `String`, it would be defined as a `Function1[Double, String]`.

If a function takes two input parameters, you define it as an instance of `Function2`, a function with three input parameters is an instance of `Function3`, etc.

If you copy and paste those `add2` lines of code into the REPL, you'll see this output, which confirms that it works as described:

```
defined class Add2
add2: Add2 = <function1>
res0: Int = 3
```

## *Using the anonymous class syntax*

You can also manually create a function using the *anonymous class* syntax. Here's a `Function2` instance named `sumLengths` that adds the lengths of two strings you provide:

```
val sumLengths = new Function2[String, String, Int] {  
  def apply(a: String, b: String): Int = a.length + b.length  
}
```

The REPL shows that it works as expected:

```
scala> sumLengths("talkeetna", "alaska")  
res0: Int = 15
```

In practice I don't create functions like this, but it can be helpful to know some of the things that the Scala compiler does for you.

## Using parameterized (generic) types

One thing you can do with `def` methods that you can't do with `val` functions is use generic types. That is, with `def` you can write a function that takes a generic type `A`, like this:

```
def firstChar[A](a: A) = a.toString.charAt(0)
```

and then use it as shown in these examples:

```
firstChar("foo")
firstChar(42)
```

You can't do the same thing with the simple `val` function syntax:

```
// error: this won't compile
val firstChar[A] = (a: A) => a.toString.charAt(0)
```

### *Coerce a parameterized method into a function*

You can *coerce* a parameterized method into a function. For example, start with a method that uses a generic type:

```
def lengthOfThing[A] = (a: A) => a.toString.length
```

Then coerce that method into a function as you declare a specific type:

```
val f = lengthOfThing[Int]
```

Once you do that, you can call the function `f` you just created:

```
f(694)
```

This works, as shown in the REPL:

```
scala> def lengthOfThing[A] = (a: A) => a.toString.length
lengthOfThing: [A]=> A => Int

scala> val f = lengthOfThing[Int]
f: Int => Int = <function1>

scala> f(694)
res0: Int = 3
```

### *Kinda-sorta use generic types with `FunctionX` traits*

Digging deeper into the magic toolbox ... you can more or less do the same thing by using parameterized types with the `FunctionX` traits, like this `Function2` example:

```
class SumLengths[A, B] extends Function2[A, B, Int] {  
  def apply(a: A, b: B): Int =  
    a.toString.length + b.toString.length  
}
```

Once you've defined that class, you can create a `sumLengths` instance like this:

```
val sumLengths = new SumLengths[Any, Any]  
sumLengths("homer", "alaska")
```

If you paste the class and those last two lines into the REPL, you'll see this output:

```
defined class SumLengths  
sumLengths: SumLengths[Any,Any] = <function2>  
res0: Int = 11
```

Some of these examples aren't very practical; I just want to show some things that can be done.

## Summary

In summary, this lesson showed the differences between `val` functions and `def` methods. Some of the topics that were covered are:

- Using case expressions with `val` functions and anonymous classes without requiring the leading `match`
- A `def` method is a method in a class (just like a Java method is a method in its class)
- `val` functions are a concrete instances of `Function0` through `Function22`
- `val` functions are objects that have methods like `andThen` and `compose`
- How to manually define `val` functions

## See also

- Much of this discussion was inspired by Jim McBeath's article, [Scala functions vs methods](#)
- [Function composition \(andThen, compose\)](#)
- Stack Overflow has a discussion titled, [Difference between method and function in Scala](#), which builds on Mr. McBeath's blog post
- [How much one ought to know about Eta Expansion](#)
- [Revealing the Scala magician's code: method vs function](#)
- An old scala-lang.org post, [Passing methods around](#)

# **Recursion is Great, But ...**

## Source code

The source code for this lesson is available at the following URL:

- [github.com/alvinj/FPRecursionIsGreatBut](https://github.com/alvinj/FPRecursionIsGreatBut)



## Goal

The primary goal of this lesson is to show that while recursion is cool, fun, and interesting, with Scala methods like `filter`, `map`, `fold`, and `reduce`, you won't need to use recursion as often as you think. As just one example of this, if you find yourself writing a recursive function to walk over all of the elements in a list to return some final, single value, this is a sign that you may want to use `fold` or `reduce` instead.

## Introduction

As you saw in the lessons on recursive programming, you can use recursion to solve “looping” programming problems in a functional way. Hopefully you also saw that recursion isn’t too hard, and might even be fun.

So, while recursion is great, as a functional programmer you also need to know that you won’t need to use it as often as you might think. When you’re working with Scala collections it’s often easier to use built-in collection methods that take care of the recursion for you. Some of the most common methods you’ll use are:

- `filter`
- `map`
- `reduce`
- `fold`

This lesson shows how to use built-in collections methods like *reduce*, *fold*, and *scan*, so you can use them instead of writing custom recursion functions.

## Calculating a sum with recursion

As a quick review, in the recursion lessons you saw that if you have a `List` like this:

```
val list = List(1, 2, 3, 4)
```

you can write a recursive function to calculate the sum of the list elements like this:

```
def sum(list: List[Int]): Int = list match {  
  case Nil => 0  
  case x :: xs => x + sum(xs)  
}
```

This function isn't tail-recursive, but it's simpler than the tail-recursive sum function, so I'll use it in this lesson.

As a quick review, you can read this function — the second case statement in particular — as, “The sum of a `List` is (a) the value of the first element plus (b) the sum of the remaining elements.” Also, because the last element in a Scala `List` is the `Nil` value, you write the first case condition to end the recursion (and return from it) when that last element is reached.

## That's nice, but ...

That recursive sum function is awesome, but if you look closely at a product algorithm, you'll begin to see a pattern:

```
def product(list: List[Int]): Int = list match {  
  case Nil => 1  
  case x :: xs => x * product(xs)  
}
```

Do you see the pattern?

If not, see if you can find the pattern by filling in the blanks in the following code:

```
def ALGORITHM(list: List[Int]): Int = list match {  
  // this case always handles what?  
  case _____  
  // this case always seems to have a head, tail, and <something else>  
  case ____ :: ____ => ____ _____ ALGORITHM(____)  
}
```

I probably didn't give you enough hints of what I'm looking for, so I'll give you my solution. When you look at sum and product in a general sense, the pattern I see looks like this:

```
def ALGORITHM(xs: List[Int]): Int = xs match {  
  case [TERMINATING CONDITION]  
  case HEAD :: TAIL => HEAD [OPERATOR] ALGORITHM(TAIL)  
}
```

Because there's a set of commonly-needed recursive algorithms — and because programmers don't like writing the same code over and over — these algorithms have been encapsulated as methods in the Scala collections classes. The great thing about this is that you can use these existing methods instead of having to write custom recursive functions manually each time.

In the case of the sum and product algorithms I just showed, this general pattern is encapsulated as a series of “reduce” functions in the collections classes. I'll demonstrate those next.

## Using reduce

While the `reduce` method on the Scala `List` class isn't implemented exactly as I showed in the `sum` and `product` functions, it does encapsulate the same basic algorithm: walk through a sequence of elements, apply a function to each element, and then return a final, single value. As a result, you can use `reduce` instead of custom recursive algorithms, like the `sum` and `product` functions.

At the time of this writing, the `List` class `reduce` method is implemented in the [TraversableOnce trait](#). If you look at the source code for that class, you'll see that `reduce` calls `reduceLeft`, so you'll want to pay attention to the `reduceLeft` source code.

When you first use `reduce` it may look a little unusual, but you'll quickly get used to it, and eventually appreciate it.

### *How to calculate a sum with reduce*

To use `reduce` on a Scala sequence, all you have to do is provide the algorithm you want `reduce` to use. For example, a “sum” algorithm using `reduce` looks like this:

```
def sum(list: List[Int]): Int = list.reduce(_ + _)
```

If you've never used `reduce` before, that `_ + _` code may look a little unusual at first, but it's just an anonymous function. It may also be easier to read if I show the long form for the anonymous function:

```
def sum(list: List[Int]): Int = list.reduce((x,y) =>
  x + y
)
```

A key here is knowing that `reduce` passes two variables to the anonymous function. I'll explain these variables more in the next section.

Until then, a quick example in the Scala REPL demonstrates that this approach works as a “sum the elements in a list” algorithm:

```
scala> def sum(list: List[Int]): Int = list.reduce((x,y)
=> x + y)
sum: (list: List[Int])Int

scala> val a = List(1,2,3,4)
a: List[Int] = List(1, 2, 3, 4)

scala> sum(a)
res1: Int = 10
```

Cool, right?

Let's take a look at how reduce works.

## How reduce works

The `reduce` method in Scala is implemented as a little wrapper method that calls the `reduceLeft` method, so I'll describe how `reduceLeft` works first. After that I'll show how `reduceRight` works.

Have no fear about those names. `reduceLeft` simply walks a collection from the first element to the last element (from the left to the right), and `reduceRight` does the opposite thing, walking the collection from the last element backwards to the first element.

### *How reduceLeft works*

When you use `reduceLeft` to walk through a sequence, it walks the sequence in order from its first element (the head element) to the last element. For instance, if a sequence named `friends` has four elements, `reduceLeft` first works with `friends[0]`, then `friends[1]`, then `friends[2]`, and finally `friends[3]`.

More accurately, what `reduceLeft` does is:

- It applies your algorithm to the first two elements in the sequence. In the first step it applies the algorithm to `friends[0]` and `friends[1]`.
- Applying your algorithm to those two elements yields a result.
- Next, `reduceLeft` applies your algorithm to (a) that result, and (b) the next element in the sequence (`friends[2]`, in this case). That yields a new result.
- `reduceLeft` continues in this manner for all elements in the list.
- When `reduceLeft` finishes running over all of the elements in the sequence, it returns the final result as its value. For example, a `sum` algorithm returns the sum of all of the elements in a list as a single value, and a `product` algorithm returns the product of all list elements as a single value.

As you can imagine, this is where the name “reduce” comes from — it’s used to reduce an entire list down to some meaningful, single value.

One subtle but important note about `reduceLeft`: the function you supply must return the same data type that’s stored in the collection. This is necessary so `reduceLeft` can combine (a) the temporary result from each step with (b) the next element in the collection.

### ***Demonstrating how `reduceLeft` works***

Next, I’ll demonstrate how `reduceLeft` works in two ways. First, I’ll add some “debug/trace” code to an algorithm so you can see output from `reduceLeft` as it runs. Second, I’ll show a handy diagram I use when I apply `reduceLeft` to new algorithms.



# 1) Showing how reduceLeft works with debug/trace code

A good way to show how reduceLeft works is to put some debugging println statements inside an algorithm. I'll use a modified version of the sum function I showed earlier to demonstrate this.

First, I'll define an add function that produces debug output:

```
def add(x: Int, y: Int): Int = {  
  val theSum = x + y  
  println(s"received $x and $y, their sum is $theSum")  
  theSum  
}
```

All this function does is add two integers, but before it returns its result it prints out information that will help demonstrate how reduceLeft works.

Now all I have to do is use this add function with some sample data. This is what it looks like when I use add with reduceLeft on a simple List[Int]:

```
scala> val a = List(1,2,3,4)  
a: List[Int] = List(1, 2, 3, 4)  
  
scala> a.reduceLeft(add)  
received 1 and 2, their sum is 3  
received 3 and 3, their sum is 6  
received 6 and 4, their sum is 10  
res0: Int = 10
```

This output shows:

- The first time add is called by reduceLeft it receives the values 1 and 2. It yields the result 3.
- The second time add is called it receives the value 3 — the result of the previous application — and 3, the next value in the list. It yields the result 6.
- The third time add is called it receives the value 6 — the result of the previous application — and 4, the next value in the list. It yields the result 10.

- At this point `reduceLeft` has finished walking over the elements in the list and it returns the final result, 10.

## ***Exercise***

Write down what the `reduceLeft` output looks like if you change the `add` algorithm to a product algorithm:

```
scala> a.reduceLeft(product)
received __ and __, their product is ____
received __ and __, their product is ____
received __ and __, their product is ____
res0: Int = ____
```

## ***Exercise***

`reduceLeft` is flexible, and can be used for any purpose where you need to walk through a sequence in the manner described to yield a final, single result. For instance, this function yields the largest of the two values it's given:

```
def max(a: Int, b: Int) = {
  val max = if (a > b) a else b
  println(s"received $a and $b, their max is $max")
  max
}
```

Exercise: Given this new list:

```
val xs = List(11, 7, 14, 9)
```

write down what the output looks like when you use `max` with `reduceLeft` on that list:

```
scala> xs.reduceLeft(max)
received __ and __, their max is ____
received __ and __, their max is ____
received __ and __, their max is ____
res0: Int = ____
```

## 2) Showing how reduceLeft works with diagrams

Whenever I forget how Scala's "reduce" functions work, I come back to a simple diagram that helps remind me of how the process works.

To demonstrate it, I'll start with this list of values:

```
val a = List(1, 2, 5, 10)
```

Then I'll imagine that I'm using the add function with reduceLeft on that list:

```
a.reduceLeft(add)
```

The first thing I do is write out the first several values of the list in a row, as shown in Figure [fig:fold-1].

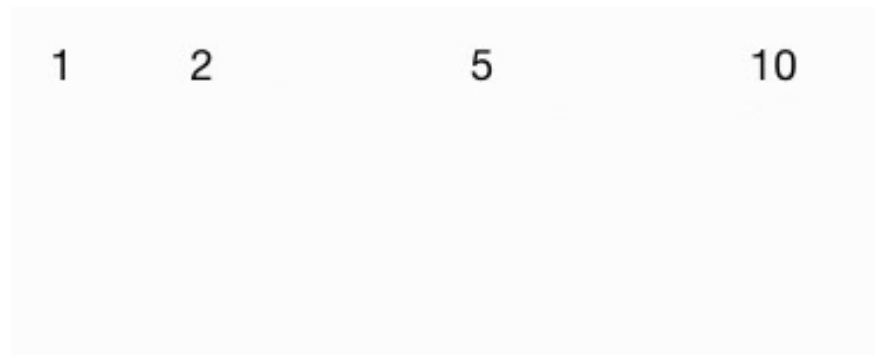

I leave spaces between the values because my next step involves hand-calculating the result of applying my algorithm to the first two elements of the list, as shown in Figure [fig:fold-2].



This shows that I'm using a + algorithm, and in its first step, reduceLeft applies

that algorithm to the first two values in the list, 1 and 2. This yields the first intermediate result, 3, as shown in Figure [fig:fold-3].

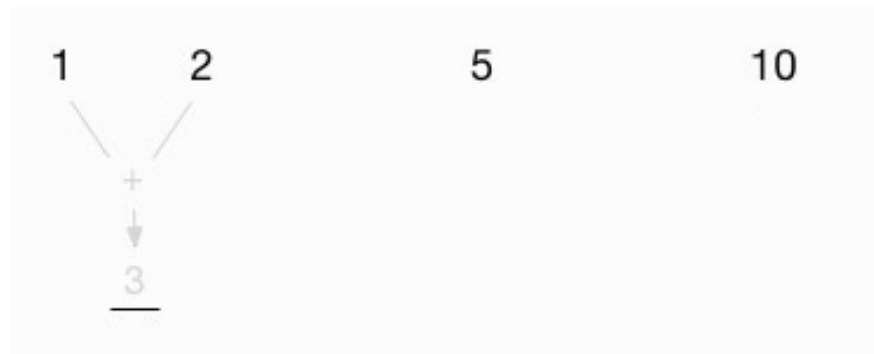

The next thing I do is carry this intermediate value up to the space between the original 2 and 5 in the list. This is shown in Figure [fig:fold-4].



As shown in Figure [fig:fold-5], I then add this intermediate value (3) to the next value, 5.

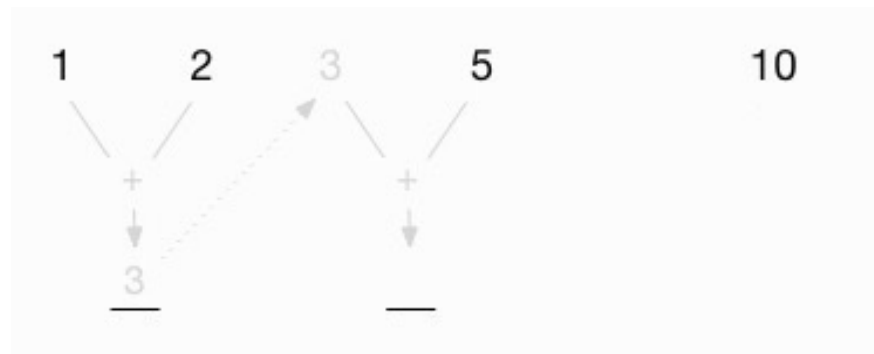

This gives me a new intermediate value of 8, as shown in Figure [fig:fold-6].

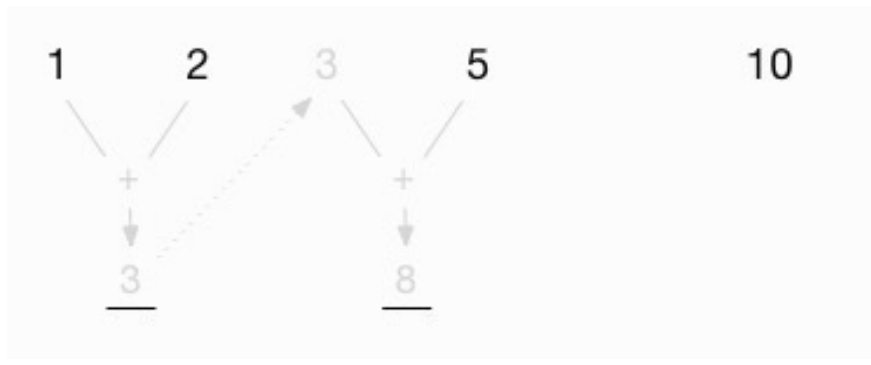

Now I proceed as before, carrying that value back to the top, between the original 5 and 10. This is shown in Figure [fig:fold-7].

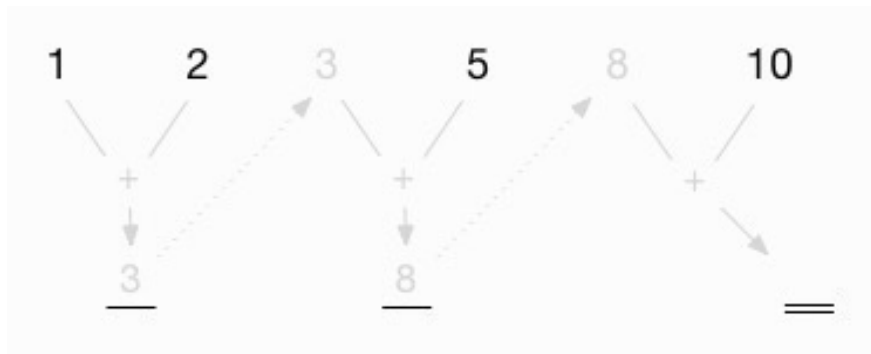

Finally, as shown in Figure [fig:fold-8], I add this intermediate value (8) to the last value in the list (10) to get the final result, 18.

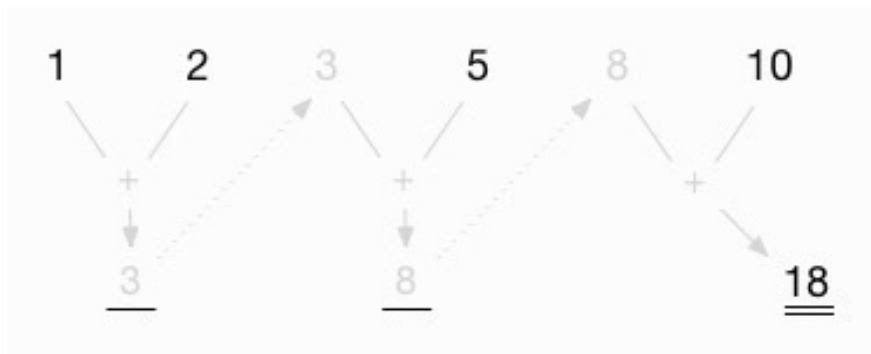

For me, this is a nice way of visualizing how the `reduceLeft` function works. When I haven't used it for a while, I find that it helps to see a diagram like this.

### ***Exercises***

1. Using the same list values, draw the “product” algorithm. (See

Figure [fig:fold-11].)

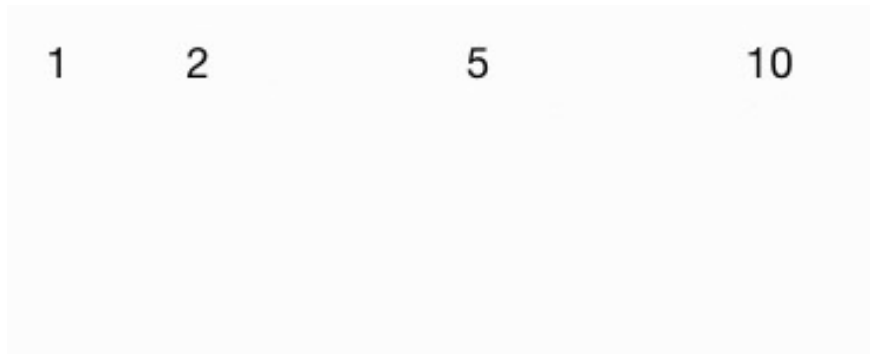

1. Using the same list values, draw the “max” algorithm. (See Figure [fig:fold-12].)

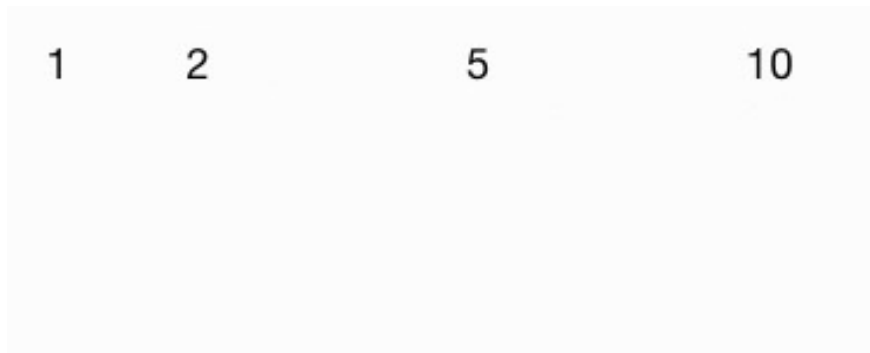

### ***Summary of the visual diagram***

In summary, this diagram is a visual way to show how `reduceLeft` works. The generic version of the diagram is shown in Figure [fig:fold-Generic-Fold].

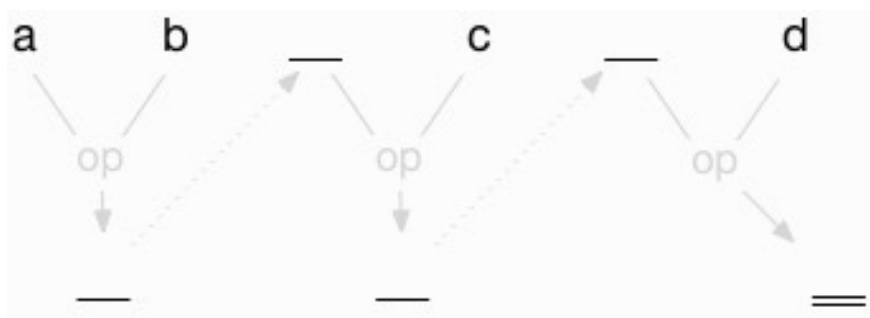

## A look at a different data type

The data type contained in the sequence you're working on can be anything you need. For instance, if you want to determine the longest or shortest string in a list of strings, you can use `reduceLeft` with the `length` method of the `String` class.

To demonstrate this, start with a sequence of strings:

```
val peeps = Vector(
  "al", "hannah", "emily", "christina", "aleka"
)
```

Then you can determine the longest string like this:

```
scala> peeps.reduceLeft((x,y) => if
  (x.length > y.length) x else y)
res0: String = christina
```

and the shortest string like this:

```
scala> peeps.reduceLeft((x,y) => if
  (x.length < y.length) x else y)
res1: String = al
```

You can also create functions like `longest` and `shortest`:

```
def longest(x: String, y: String) =
  if (x.length > y.length) x else y

def shortest(x: String, y: String) =
  if (x.length < y.length) x else y
```

and use them to get the same results:

```
scala> peeps.reduceLeft(longest)
res0: String = christina

scala> peeps.reduceLeft(shortest)
res1: String = al
```

If this had been a collection of `Person` instances, you could run a similar algorithm on each person's name to get the longest and shortest names.

As another example, you can concatenate a list of strings using the same approach I used to sum the elements in a list:

```
scala> val x = List("foo", "bar", "baz")
```

```
x: List[String] = List(foo, bar, baz)
```

```
scala> x.reduceLeft(_ + _)
res0: String = foobarbaz
```



## reduceRight

The `reduceRight` method works like `reduceLeft`, but it marches through the elements in order from the last element to the first element. For summing the elements in a `List[Int]` the order doesn't matter:

```
scala> val a = List(1,2,3,4)
a: List[Int] = List(1, 2, 3, 4)
```

```
scala> a.reduceLeft(_ + _)
res1: Int = 10
```

```
scala> a.reduceRight(_ + _)
res2: Int = 10
```

But if for some reason you want to apply a subtraction algorithm to the same list, it can make a big difference:

```
scala> val a = List(1,2,3,4)
a: List[Int] = List(1, 2, 3, 4)
```

```
scala> a.reduceLeft(_ - _)
res0: Int = -8
```

```
scala> a.reduceRight(_ - _)
res1: Int = -2
```

### *How reduceRight receives its elements*

To be clear about how `reduceRight` works, this example shows how it works with the earlier “debug add” function:

```
scala> val a = List(1,2,3,4)
a: List[Int] = List(1, 2, 3, 4)

scala> a.reduceRight(add(_,_))
received 3 and 4, their sum is 7
received 2 and 7, their sum is 9
received 1 and 9, their sum is 10
res0: Int = 10
```

Note that in the first step, `reduceRight` receives the elements as 3 and 4. When I first learned about it, I assumed that it would receive those elements as 4 and 3 (starting with the last element, then the next-to-last element, etc.). This is an important detail to know.

### *Note 1: reduce vs reduceLeft*

Being one for brevity, I'd prefer to use `reduce` in my code rather than `reduceLeft`, assuming that they work the same way. However, that doesn't appear to be a safe assumption.

Ever since I began looking into it (starting somewhere around 2011), the `reduce` method in the Scala sequence classes has always just called `reduceLeft`. This is how the `reduce` method is defined in the `TraversableOnce` class in Scala 2.12.2:

```
def reduce[A1 >: A](op: (A1, A1) => A1): A1 =  
  reduceLeft(op)
```

That being said, there appears to be no guarantee that this will always be the case. The documentation for the `reduce` method in the `List` class Scaladoc states, “The order in which operations are performed on elements is unspecified and may be nondeterministic.” As a result, I always use `reduceLeft` when I want to walk a collection from its first element to its last.

In the [Scala Cookbook](#) I showed that `reduce` is definitely not deterministic when using the parallel collections classes.

## ***Note 2: Performance***

In *theory*, if your algorithm is [commutative](#) — changing the order of the operands does not change the result, such as `+` and `*` — you can use `reduceLeft` or `reduceRight` to get the same result.

In *practice*, my tests are different than theory. In one example, using Scala 2.12 with the default JVM parameters, when I create a `Vector` that contains ten million random `Int` values, `xs.reduceLeft(max)` is consistently *at least* three times faster than `xs.reduceRight(max)`.

Microbenchmarks like this are notoriously criticized, but a difference of 3-4X is significant. You can test this on your own system with the `ReducePerformanceTest1` application in this lesson's source code.

Furthermore, if (a) you're specifically working with a Scala `List` and (b) your algorithm is commutative, you should always use `reduceLeft`. This is because

List is a *linear* sequential collection — not an *indexed* sequential collection — so it will naturally be faster for an algorithm to work from the head of a List towards the tail. (A Scala List is a singly linked-list, so moving from the head towards the tail of the list is fast and efficient.)

The source code for this lesson shows that the List problem is worse than the previous paragraph suggests. I've found that if you're specifically working with a Scala List you can easily generate a StackOverflowError with a call to reduceRight(max). As you can see in the ReducePerformanceTest1 application source code for this lesson, with the default JVM settings and a List with 30,000 Int values, calling xs.reduceRight(max) throws a StackOverflowError.

In a related note, the reduceRight method attempts to do what it can to be efficient. In the [TraversableOnce](#) class in Scala 2.12.2, reduceRight first reverses the list and then calls reduceLeft:

```
def reduceRight[B >: A](op: (A, B) => B): B = {
  if (isEmpty)
    throw new
      UnsupportedOperationException("empty.reduceRight")
  reversed.reduceLeft[B]((x, y) => op(y, x))
}
```

In that same class, reversed is defined like this:

```
protected[this] def reversed = {
  var elems: List[A] = Nil
  self foreach (elems ::= _)
  elems
}
```

See the source code of that class for more information. (And wow, did you notice the use of a var field and a foreach call in reversed, and how it takes no input parameters? There's no FP in this method.)

In summary, my rules for List are:

- If the function is commutative, use reduceLeft or reduce
- If the function is not commutative, use what you need for your algorithm (reduceLeft or reduceRight)

Finally, if your algorithm requires you to use reduceRight and you find that

there is a performance problem, consider using an *indexed* sequential collection such as `Vector`.

If you're not familiar with the terms *linear* and *indexed* in this discussion, I write about them in the Collections lessons in the [Scala Cookbook](#).

## How foldLeft works

The `foldLeft` method works just like `reduceLeft`, but it lets you set a seed value for the first element. The following examples demonstrate a “sum” algorithm, first with `reduceLeft` and then with `foldLeft`, to demonstrate the difference:

```
scala> val a = Seq(1, 2, 3)
a: Seq[Int] = List(1, 2, 3)

scala> a.reduceLeft(_ + _)
res0: Int = 6

scala> a.foldLeft(20)(_ + _)
res1: Int = 26

scala> a.foldLeft(100)(_ + _)
res2: Int = 106
```

In the last two examples, `foldLeft` uses 20 and then 100 for its first element, which affects the final sum, as shown.

To further demonstrate how `foldLeft` works, I’ll go back to the debug `add` function I used earlier:

```
def add (x: Int, y: Int): Int = {
  val theSum = x + y
  println(s"received $x and $y, their sum is $theSum")
  theSum
}
```

Here’s the result of applying `add` to the last `foldLeft` example:

```
scala> val a = Seq(1, 2, 3)
a: Seq[Int] = List(1, 2, 3)

scala> a.foldLeft(100)(add)
received 100 and 1, their sum is 101
received 101 and 2, their sum is 103
received 103 and 3, their sum is 106
res0: Int = 106
```

### ***Aside: foldLeft uses two parameter lists***

Remember that when you see something like `foldLeft(20)(_ + _)`, it means that `foldLeft` is defined to take two parameter lists. Figure [fig:fold-foldLeft-signature] shows what `foldLeft`’s signature looks like on Scala’s sequential

collection classes.

```
def foldLeft[B](z: B)(f: (B,A) => B): B
```

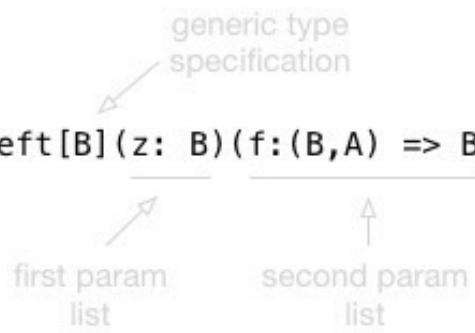

The diagram illustrates the components of the `foldLeft` function signature. The text `def foldLeft[B](z: B)(f: (B,A) => B): B` is shown with three annotations:   
1. `generic type specification` with an arrow pointing to the type parameter `[B]`.   
2. `first param list` with an arrow pointing to the parameter `z: B`.   
3. `second param list` with an arrow pointing to the parameter list `(f: (B,A) => B)`.

`foldLeft` in the `Seq` class is defined to take two parameter lists

## How foldRight works

The `foldRight` method works just like `reduceRight` — working through the sequence in order from the last element back to the first element — and also lets you set a seed value. Here's an example of how `foldRight` works with the `add` function I just showed:

```
scala> a.foldRight(100)(add)
received 3 and 100, their sum is 103
received 2 and 103, their sum is 105
received 1 and 105, their sum is 106
res0: Int = 106
```

Again, for algorithms that aren't commutative, it can be important to notice the order in which the first two elements are supplied to your function.

## scanLeft and scanRight

Two methods named `scanLeft` and `scanRight` walk through a sequence in a manner similar to `foldLeft` and `foldRight`, but the key difference is that they return a *sequence* rather than a single value.

The `scanLeft` Scaladoc states, “Produces a collection containing cumulative results of applying the operator going left to right.” To understand how it works, I’ll use the trusty `add` function again:

```
def add (x: Int, y: Int): Int = {
  val theSum = x + y
  println(s"received $x and $y, their sum is $theSum")
  theSum
}
```

Here’s what `scanLeft` looks like when it’s used with `add` and a seed value:

```
scala> val a = Seq(1, 2, 3)
a: Seq[Int] = List(1, 2, 3)

scala> a.scanLeft(10)(add)
received 10 and 1, their sum is 11
received 11 and 2, their sum is 13
received 13 and 3, their sum is 16
res0: Seq[Int] = List(10, 11, 13, 16)
```

A few notes about this:

- `scanLeft` returns a new *sequence*, as opposed to the single value that `reduceLeft` and `foldLeft` return.
- `scanLeft` is a little like `map`, but where `map` applies a function to each element in a collection, `scanLeft` applies a function to (a) the previous result and (b) the current element in the sequence.

As a final note, the `scanRight` method works the same way, but marches through the collection from the last element backwards to the first element:

```
scala> a.scanRight(10)(add)
received 3 and 10, their sum is 13
received 2 and 13, their sum is 15
received 1 and 15, their sum is 16
res1: Seq[Int] = List(16, 15, 13, 10)
```



## How foldLeft is like recursion

I mentioned at the beginning of this lesson that you won't have to use recursion as often as you think because the FP developers who came before us recognized that there are certain common patterns involved in writing recursive functions.

For instance, imagine a world in which all lists contain only three elements, and you want to write a `foldLeft` function. If you further assume that you're writing a `foldLeft` function for only `Int` values, you can write `foldLeft` like this:

```
def foldLeft(a: Int)(xs: List[Int])(f: (Int, Int) => Int):
  Int = {
    // 1st application
    val result1 = f(a, xs(0))

    // 2nd application
    val result2 = f(result1, xs(1))

    // 3rd application
    val result3 = f(result2, xs(2))

    result3
  }
```

When you look at that code, it sure looks like there's a pattern there: a recursive pattern at that! In fact, if you rename the input parameter `a` to `result0`, the pattern becomes even more obvious:

```
// 1st iteration
val result1 = f(result0, xs(0))

// 2nd iteration
val result2 = f(result1, xs(1))

// 3rd iteration
val result3 = f(result2, xs(2))

result3
```

The pattern is:

- Create a result by applying the function `f` to (a) the previous result and (b) the current element in the list.
- Do the same thing with the new result and the next list item.
- Do the same thing with the new result and the next list item ...

## ***Implementing foldLeft with recursion***

I showed how to write recursive code earlier in this book, so at this point I'll just jump right into a complete example of how to write a `foldLeft` function for a `List[Int]` using recursion:

```
package folding

object FoldLeftInt extends App {

  val a = List(1,2,3,4)

  def add(a: Int, b: Int) = a + b

  println(foldLeft(0)(a)(add))

  def foldLeft(lastResult: Int)(list: List[Int])(f: (Int, Int) => Int):
    Int = list match {

    case Nil => lastResult
    case x :: xs => {
      val result = f(lastResult, x)
      println(s"last: $lastResult, x: $x, result = $result")
      foldLeft(result)(xs)(f)
    }
  }
}
```

I left the debugging `println` statement in there so you can see this output when you run this program:

```
last: 0, x: 1, result = 1
last: 1, x: 2, result = 3
last: 3, x: 3, result = 6
last: 6, x: 4, result = 10
10
```

As this shows, `foldLeft` and other functions like it are just convenience functions that exist so you don't have to write the same recursive code over and over again.

## ***Convert foldLeft to use generic types***

As I've shown throughout this book, I often write functions using a specific type, then convert them to a generic type when I see that the algorithm doesn't depend on the specific type. The `foldLeft` algorithm doesn't depend on the type being an `Int`, so I can replace all of the `Int` references in the function signature to `A`, and then add the required `[A]` before the function parameter lists:

```
def foldLeft[A](lastResult: A)(list: List[A])(f: (A, A) => A): A
  = list match { ...
```

## Even more methods

There are more methods in the Scala collections classes that work in a similar manner. See the [List class Scaladoc](#) for a complete list of the methods that are available for the `List` class.

## Key points

In summary, the goal of this lesson is to demonstrate why you won't need to write recursive functions as often as you might expect. Built-in Scala collection methods like `filter`, `map`, `reduce`, and `fold` greatly reduce the number of custom "iterate over this list" functions you'll need to write.

In fact, if you find yourself writing a recursive function to walk over all of the elements in a list to return some final, single value, this is a sign that you may want to use `fold` or `reduce` instead.

## See also

- [“Fold” on the Haskell Wiki](#)
- [“Fold” on Wikipedia](#)
- [How to use variable names with foldLeft](#)
- [How to walk through a Scala collection with reduce and fold](#)
- [The Scala Cookbook](#) intentionally includes over 130 pages of recipes and examples of how to use the Scala collections methods

## for expression translation examples

This appendix consists of examples of how different `for` expressions translate to `map` and `flatMap` function calls. A few examples also show `foreach` and `withFilter`. (I don't include a thorough discussion of each translation, I just show my initial code and how it's translated by the Scala compiler.)

## Sample lists

The examples that follow assume that three `List` variables named `xs`, `ys`, and `zs` exist, such as these:

```
val xs = List(1,2,3)
val ys = List(4,5,6)
val zs = List(7,8,9)
```



The Scala compiler translates this for expression:

```
for {  
  x <- xs  
} println(x)
```

into this code:

```
xs.foreach(x => println(x))
```

## ***Notes***

- for/println translates to foreach

This for expression:

```
val a = for {  
  x <- xs  
} yield x
```

translates to this code:

```
val a = xs.map(x => x)
```

## ***Notes***

- a single generator in for/yield translates to map

This for expression:

```
val a = for {  
  x <- xs  
  y <- ys  
} yield x + y
```

translates to this code:

```
val a = xs.flatMap { x =>  
  ys.map(y => x + y)  
}
```

## ***Notes***

- two generators in for/yield becomes flatMap/map

This for expression:

```
val x = for {  
  i <- Option(1)  
  j <- Option(2)  
} yield i * j
```

translates to this code:

```
val x = Option(1).flatMap { i =>  
  Option(2).map { j =>  
    i * j  
  }  
}
```

## ***Notes***

- as in the previous example, two generators in for/yield becomes flatMap/map. It doesn't matter if they class in the for expression is a List or an Option.

This for expression:

```
val a = for {  
  x <- xs  
  y <- ys  
  z <- zs  
} yield x + y + z
```

translates to this code:

```
val a = xs.flatMap { x =>  
  ys.flatMap { y =>  
    zs.map { z =>  
      x + y + z  
    }  
  }  
}
```

Notice that what I show in the translated code as `x + y + z` is a simplification of what really happens. When `scalac` compiles the code, it really looks like this:

```
zs.map((z) => x.$plus(y).$plus(z))
```

I mention this now because you'll see it in some of the examples that follow.

## **Notes**

- three generators in `for/yield` becomes `flatMap/flatMap/map`

This for expression:

```
val a = for {  
  x <- xs  
  if x < 2 //filter  
} yield x
```

translates to this code:

```
val a = xs.withFilter(x => x < 2)  
         .map(x => x)
```

## ***Notes***

- 'if' translates to `withFilter`
- notice that `withFilter` is called before `map`

This for expression:

```
val a = for {
  x <- xs
  if x > 2 //filter
  y <- ys
  z <- zs
} yield x + y + z
```

translates to this code:

```
val a = xs.withFilter { x =>
  x.$greater(2).flatMap { x =>
    ys.flatMap { y =>
      zs.map { z =>
        x.$plus(y).$plus(z)
      }
    }
  }
}
```

## **Notes**

- if translates to withFilter (at the appropriate place)

This for expression:

```
val a = for {
  x <- xs
  if x > 2 //filter
  y <- ys
  z <- zs
} yield {
  val b = x + y
  val c = b * z
  c
}
```

translates to this code:

```
val a = xs.withFilter { x =>
  x.$greater(2).flatMap { x =>
    ys.flatMap { y =>
      zs.map { z =>
        val b = x.$plus(y)
        val c = b.$times(z)
        c
      }
    }
  }
}
```

## ***Notes***

I created this example to show that (a) you can use a block of code after `yield`, and (b) how that code is translated by the compiler into an anonymous function inside `map`.



# A Review of Case Classes

## Introduction

This appendix chapter is an excerpt from the [Scala Cookbook](#). This is Recipe 4.14 of the Cookbook, “How to generate boilerplate code with Scala case classes.”

I’m including this chapter in this book because case classes are so important to functional programming, and I want to make sure you have background information about how they work. Please note that some of the information that follows may refer to var fields in case classes; as Scala/FP developers, we don’t use those features, but for the times when you’re writing OOP code it can be helpful to know about them.

## Problem

You're working with [Scala](#) match expressions, actors, or other situations where you want to use the case class syntax to automatically generate boilerplate code, including accessor and mutator methods, along with `apply`, `unapply`, `toString`, `equals`, and `hashCode` methods, and more.

## Solution

Define your class as a case class, defining any parameters it needs in its constructor:

```
// name and relation are 'val' by default
case class Person(name: String, relation: String)
```

Defining a class as a case class results in a lot of boilerplate code being generated for you, with the following benefits:

- An apply method is generated, so you don't need to use the new keyword to create a new instance of the class.
- Accessor methods are generated for the constructor parameters, because case class constructor parameters are val by default. Mutator methods are further generated for parameters declared as var.
- A good, default toString method is generated.
- An unapply method is generated, making it easy to use case classes in match expressions.
- equals and hashCode methods are generated.
- A copy method is generated.

Here's a look at those features. First, when you define a class as a case class, you don't have to use the new keyword to create a new instance:

```
scala> case class Person(name: String, relation: String)
defined class Person

// "new" not needed before Person
scala> val emily = Person("Emily", "niece")
emily: Person = Person(Emily,niece)
```

Case class constructor parameters are val by default, so accessor methods are generated for the parameters, but mutator methods are not generated:

```
scala> emily.name
res0: String = Emily
```

```
scala> emily.name = "Fred"
<console>:10: error: reassignment to val
    emily.name = "Fred"
           ^
```

By defining a case class constructor parameter as a var, both accessor and mutator methods are generated:

```
scala> case class Company (var name: String)
defined class Company

scala> val c = Company("Mat-Su Valley Programming")
c: Company = Company(Mat-Su Valley Programming)

scala> c.name
res0: String = Mat-Su Valley Programming

// because it's a var, you can change the name
scala> c.name = "Valley Programming"
c.name: String = Valley Programming
```

Case classes also have a good default toString method implementation:

```
scala> emily
res0: Person = Person(Emily,niece)
```

Because an unapply method is automatically created for a case class, it works well when you need to extract information in match expressions, as shown here:

```
scala> emily match { case Person(n, r) => println(n, r) }
(Emily,niece)
```

Case classes also have generated equals and hashCode methods, so instances can be compared:

```
scala> val hannah = Person("Hannah", "niece")
hannah: Person = Person(Hannah,niece)

scala> emily == hannah
res1: Boolean = false
```

A case class even creates a copy method that is helpful when you need to (a) clone an object and (b) change some of the fields during the cloning process:

```
scala> case class Employee(name: String, loc: String, role: String)
defined class Employee

scala> val fred = Employee("Fred", "Anchorage", "Salesman")
fred: Employee = Employee(Fred,Anchorage,Salesman)

scala> val joe = fred.copy(name="Joe", role="Mechanic")
joe: Employee = Employee(Joe,Anchorage,Mechanic)
```

## Discussion

Case classes are primarily intended to create “immutable records” that you can easily use in pattern-matching expressions. Indeed, pure FP developers look at case classes as being similar to immutable records found in ML, Haskell, and other languages.

As a result of this, case class constructor parameters are `val` by default. As a reviewer of this book with an FP background wrote, “Case classes allow `var` fields, but then you are subverting their very purpose.”

### *Generated code*

As shown in the Solution, when you create a case class, Scala generates a wealth of code for your class. To see the code that’s generated for you, first compile a simple case class, then disassemble it with `javap`.

For example, put this small amount of code in a file named *Person.scala*:

```
case class Person(  
  var name: String,  
  var age: Int  
)
```

Then compile the file:

```
$ scalac Person.scala
```

This creates two class files, *Person.class* and *Person\$.class*. Disassemble *Person.class* with this command:

```
$ javap Person
```

This results in the following output, which is the public signature of the class:

```
Compiled from "Person.scala"  
public class Person extends java.lang.Object  
implements scala.ScalaObject, scala.Product, scala.Serializable{  
  public static final scala.Function1 tupled();  
  public static final scala.Function1 curry();  
  public static final scala.Function1 curried();  
  public scala.collection.Iterator productIterator();  
  public scala.collection.Iterator productElements();  
  public java.lang.String name();
```

```

public void name_$eq(java.lang.String);
public int age();
public void age_$eq(int);
public Person copy(java.lang.String, int);
public int copy$default$2();
public java.lang.String copy$default$1();
public int hashCode();
public java.lang.String toString();
public boolean equals(java.lang.Object);
public java.lang.String productPrefix();
public int productArity();
public java.lang.Object productElement(int);
public boolean canEqual(java.lang.Object);
public Person(java.lang.String, int);
}

```

Then disassemble *Person\$.class*:

```

$ javap Person$

Compiled from "Person.scala"
public final class Person$
extends scala.runtime.AbstractFunction2
implements scala.ScalaObject,scala.Serializable {
    public static final Person$ MODULE$;
    public static {};
    public final java.lang.String toString();
    public scala.Option unapply(Person);
    public Person apply(java.lang.String, int);
    public java.lang.Object readResolve();
    public java.lang.Object apply(java.lang.Object, java.lang.Object);
}

```

As you can see, Scala generates a *lot* of source code when you declare a class as a case class.

As a point of comparison, if you remove the keyword `case` from that code — making it a “regular” class — compile it, and then disassemble it, Scala only generates the following code:

```

public class Person extends java.lang.Object{
    public java.lang.String name();
    public void name_$eq(java.lang.String);
    public int age();
    public void age_$eq(int);
    public Person(java.lang.String, int);
}

```

That’s a big difference. The case class results in 22 more methods than the “regular” class. If you need that functionality, this is a good thing. However, if you don’t need all this additional functionality, consider using a “regular” class declaration instead. For instance, if the only thing you want is to be able to create new instances of a class without the `new` keyword:

```
val p = Person("Alex")
```

create an `apply` method in the companion object of a “regular” class, as described in Recipe 6.8, “Creating Object Instances Without Using the `new` Keyword”. Remember, there isn’t anything in a case class you can’t code for yourself.

## See Also

- Recipe 4.3 of the [Scala Cookbook](#), “How to Define Auxiliary Constructors in Scala Classes” shows how to write additional apply methods so a case class can appear to have multiple constructors
- [A discussion of extractor objects on scala-lang.org](#)



# **Algebraic Data Types**

## Introduction

I debated for a long time about how to introduce Algebraic Data Types (ADTs) in this book. I finally decided that ADTs aren't a way of proactively *designing* FP code; instead, they're a way of *categorizing* the FP code you've already written, specifically your FP data models. That is, you don't sit down and say, "I want to write my Customer class as a 'sum of the products' ADT." Instead, if you do anything, you might look at some code and say, "Hey, Mary, did you notice that the Customer class is a 'sum of the products' ADT?"

Because I look at ADTs as a way of categorizing or classifying code rather than designing code, I decided it was best to include this topic as an appendix in this book, rather than as a lesson in the front of the book.

The "TL;DR" version of this lesson goes like this: If you create your data models using (a) case classes with immutable fields and (b) case objects, and (c) those data types have no methods, you're already writing ADTs.

Surprise: Almost every case class and case object in this book is some form of ADT. I just didn't think it was important to categorize them when I wrote them.

## Goals, motivation

The goals of this lesson are:

- To define basic ADT terminology
- To show examples of the different ADT types
- To help demonstrate another way to see your Scala/FP code as algebra

In regards to that last point, a main benefit of being aware of ADTs is that you begin to see your code as being even more like algebra. You specifically begin to see your case classes and case objects as *sets of objects*, and the functions that operate on them as *operators* on those data sets. To understand what that means, it will help to formally define *algebra*.

# What is “Algebra”?

To understand ADTs, you first have to understand what is meant by the word “algebra.” Informally, an *algebra* can be thought of as consisting of two things:

- A set of objects
- The operations that can be applied to those objects to create new objects

Technically an algebra also consists of a third item, the *laws* that govern the algebra, but I’m not going to cover laws in this lesson.

If you’re like me, you never thought of algebra as anything other than high school algebra, but it turns out that any concept that can be thought of as (a) a set of objects, and (b) operators on those objects is a form of algebra. Here are a few examples.

## ***Numeric algebra***

“High school algebra” is the algebra we learned back in high school (or possibly earlier). It’s more formally known as “numeric algebra,” the algebra of numbers. You can think of it like this:

- A set of objects, such as whole numbers
- The operations that can be used on those objects: +, -, \* (and /)

One thing I never thought about is that the *operators* are used on existing numbers (objects) to create new numbers (objects):

$$\begin{array}{l} 1 + 1 = 2 \\ 3 * 3 = 9 \end{array}$$

Notice that even in basic math, the numbers 2 and 9 are “created” from the numbers 1 and 3 by using the + and \* operators.

## ***Relational algebra***

Another type of algebra is known as “relational algebra.” This is the algebra of relational databases, and in this algebra the database tables are the “set of objects,” and query tools like SELECT, UPDATE, and JOIN are the “operators” that let you create new objects from the existing objects.

## ***Algebra in programming***

Throughout this book you’ve been using algebra, possibly without knowing it. (I certainly didn’t know it when I started working with FP.) For example, take a look at this case class:

```
case class Pair (  
  a: Int,  
  b: Int  
)
```

This code creates a new type `Pair` from two instances of the existing type `Int`. The *class constructor* itself is an “operator” that lets you create new types from existing Scala types, just like `+` and `*` let you create new numbers from existing numbers.

Here’s another example of how you can use Scala operators to create new data types from existing ones:

```
sealed trait Direction  
case object North extends Direction  
case object South extends Direction  
case object East extends Direction  
case object West extends Direction
```

To learn about the “algebra” of these two examples, read on ...

# Three types of Algebraic Data Types

ADTs fall into three main categories:

- *Sum* type
- *Product* type
- Hybrid types

You actually just saw the first two types, and I'll explain all three of them in the following sections.

## The Sum type

The `Direction` example I just showed is called a “Sum type,” or Sum ADT. The Sum type is also referred to as an “enumerated type” because you simply enumerate all of the possible instances of the type. A few important points about this are:

- Sum types are typically created with a `sealed trait` as the base type, with instances created as `case objects`. You use a `sealed trait` because you don’t want them to be extended.
- The number of enumerated types you list are the only possible instances of the base type. In this example, `Direction` has four possible values: `North`, `South`, `East`, or `West`.
- We use the phrases “is a” and “or” when talking about Sum types. For example, `North is a type of Direction`, and `Direction is a North or a South or an East or a West`.

People use different names for the concrete instances in a Sum type, including value constructors, alternates, and cases.

### *Another example*

As another example, imagine that you need to write your own “boolean” type for Scala. You can write them as a Sum type like this:

```
sealed trait Bool
case object True extends Bool
case object False extends Bool
```

Just like the `Direction` example, the base type is defined as a `sealed trait` and the two possible values are defined as `case object`. Also notice that this approach uses the `sealed trait` and `case object` syntax as *operators* to create new data types.

### *Why use sealed trait?*

A great feature of using `sealed trait` is that it lets the compiler perform “exhaustiveness checking.” What happens is that a sealed trait can only be extended in the file in which it was defined; because it can’t be extended *anywhere* else, the compiler knows all of the subtypes of the trait that can possibly exist. Because of this, the compiler can exhaustively check the possible cases in match expressions, and it will emit a warning if the match expression isn’t exhaustive. This makes your programming life easier, and your code safer.

### ***Why use case object?***

The reason Sum types use the `case object` declaration is that they only require *singleton* instances, and the Scala `object` provides that functionality. For instance, with the `Bool` example it makes sense to have only one `True` instance in *all* of your code. There’s no need to create new `True` and `False` instances every time you work with boolean values. Scala’s `object` gives you this singleton functionality.

As Scala/FP developers, we further use `case object` — as opposed to `object` — because it provides important additional functionality, with the most important feature being support for pattern matching; its automatically-generated `unapply` method lets case objects work easily in match expressions. (`case object` also provides default `equals` and `hashCode` methods, extends `Serializable`, has a good default `toString` method, etc.)



## The Product type

The second type of ADT is known as a “Product type.” It’s name comes from the fact that you use the Scala case class constructor to create a data type whose number of possible concrete instances can be determined by multiplying the number of possibilities of all of its constructor fields.

Take this class for example:

```
case class DoubleBoo (  
    b1: Bool,  
    b2: Bool  
)
```

How many possible instances of this class can you have? Well, each field can either be True or False, so the possibilities are:

```
DoubleBoo(True, True)  
DoubleBoo(True, False)  
DoubleBoo(False, True)  
DoubleBoo(False, False)
```

Therefore, the correct answer is that there are four possible instances. You can also derive this answer mathematically:

- b1 has two possibilities
- b2 has two possibilities
- The total number of possible instances is determined by multiplying the number of possibilities of each constructor field, and 2 multiplied by 2 is 4

Because the number of possible instances of Product ADTs can be calculated by multiplying the number of possible values of every constructor parameter, what do you think the number of possibilities of this Pair type are:

```
case class Pair (  
    a: Int,  
    b: Int  
)
```

If you answered, “A lot,” that’s close enough. An Int has  $2^{32}$  possible values, so if you multiply the number of possible Int values by itself, you get a very

large number.

Next, what do you think the number of possibilities are for this class:

```
case class Person (  
  firstName: String,  
  lastName: String,  
  mother: Person,  
  father: Person  
)
```

If you answered, “Infinite,” that’s a good answer. Because a `String` has an infinite number of possibilities, `Person` can have an infinite number of concrete instances.

While I don’t concern myself with ADTs too much, this particular point had a significant impact on me. When I first saw this, I realized that any time a function accepted a `String`, that `String` had an infinite number of possibilities. That’s a lot to account for. Similarly, a boolean value has two possibilities, a `Byte` has 256 possible values, and the `Direction Sum` type has four possibilities. The lesson for me is that the fewer possibilities you have to deal with, the simpler your code will be. (At the very least, this was the last time I ever used a series of string constants instead of enumerations.)

Before we move on, here are a few important points about the `Product` type:

- Writing `case class` and defining the constructor parameters is essentially the “product” operator.
- The number of possible values of a `Product` type is the product of all possible combinations of the constructor parameters (i.e., a Cartesian product).
- We use the phrases “has a” and “and” when talking about `Product` types. `Pair` has a `a` and a `b`; `Person` has a `firstName`, `lastName`, `mother`, and `father`.

- As shown in the Person example, Product types can be recursive; mother and father are declared as Person types inside the Person definition.

## Hybrid types

The Sum and Product types are the two base ADTs; all other ADTs are hybrids created from those base types. As the book [Essential Scala](#) states, “An algebraic data type is any data that uses the above two patterns” (Sum and Product).

One formally-defined hybrid type is known as the “Sum of Products” type. With a few minor changes to reflect modern Scala practices, Mario Gleichmann created [a good example of this in 2011](#):

```
sealed trait Shape
final case class Circle(radius: Double) extends Shape
final case class Rectangle(width: Double, height: Double) extends Shape
```

These types represent a Sum type because Shape *is a Circle or a Rectangle*; Circle is a Product type because it *has a radius*; and Rectangle is also Product type because it *has a width and a height*.

There are other variations of these possibilities, which is why I refer to all other combinations as “hybrid” types. For instance, the Pizza class in the domain modeling lessons is a Product type that contains three Sum types:

```
case class Pizza (
  crustSize: CrustSize,
  crustType: CrustType,
  toppings: Seq[Topping]
)
```

Sum and Product types can be combined in any ways that are needed to solve the problem at hand. Hopefully this demonstrates the point I made at the beginning of this lesson: ADTs are just a way of formally categorizing the data types in your data model.

# Pattern matching

A great benefit of ADTs is that they simplify and encourage the use of pattern matching in your code. For instance, given these Shape types:

```
sealed trait Shape
final case class Circle(radius: Double) extends Shape
final case class Rectangle(width: Double, height: Double) extends Shape
```

you can easily write an `isRound` function using pattern matching:

```
def isRound(s: Shape): Boolean = s match {
  case Circle(_) => true
  case _ => false
}
```

Similarly, using the `Bool` type I created earlier:

```
sealed trait Bool
case object True extends Bool
case object False extends Bool
```

you can define `and` and `or` functions with pattern matching:

```
def and(a: Bool, b: Bool): Bool = (a,b) match {
  case (True, True)    => True
  case (False, False) => True
  case (True, False)   => False
  case (False, True)   => False
}

def or(a: Bool, b: Bool): Bool = (a,b) match {
  case (True, _) => True
  case (_, True) => True
  case (_, _)   => False
}
```

This is what those last two functions look like in the Scala REPL:

```
scala> or(True,False)
res0: Bool = True

scala> and(True,False)
res1: Bool = False
```

As demonstrated in these examples, using pattern matching with ADTs is a common programming pattern ... a Scala/FP idiom.

## Key points

The key points of this lesson are:

- If you create your data models using (a) case classes with immutable fields and (b) case objects, and (c) those data types have no methods, you're already writing ADTs (whether you knew it or not).
- I view ADTs as a way of categorizing or observing code, not designing code.
- An “algebra” is a set of objects, the operators that can be used on those objects, and laws governing their behavior.
- The two main types of ADTs are the Sum type and Product type. Other hybrid ADTs are derived from these base types.
- ADTs encourage a pattern-matching style of programming.

## See also

- If you don't mind a little Haskell, Chris Taylor's [The Algebra of ADTs](#) is an excellent resource, and discusses ADT "laws"
- Mario Gleichmann wrote a series of articles on ADTs in Scala, [starting with this one](#)
- Daniel Eklund wrote a good article, [What the heck are Algebraic Data Types?](#)
- [Susan Potter has a nice example of ADTs in Scala](#)
- Tim Perrett uses ADTs well [in this "traffic signal" example](#)
- ADTs are described [here on Wikipedia](#)
- ADTs are described [here on Haskell.org](#)
- Wikipedia has this definition of [Universal Algebra](#)
- Martin Odersky mentions ADTs in [this acm.org article](#)
- In underscore.io's [article on sealed traits](#) they have a nice discussion of ADTs

# A Review of Anonymous Functions

This lesson provides a review of *anonymous functions*, including:

- The basics
- When and how you can reduce anonymous functions
- A simple way to recognize them in complex code
- How to pass multiple parameters to anonymous functions



## An example

In Scala you can use anonymous functions — also known as *function literals* — to solve problems in a concise yet still readable way.

For example, given this List:

```
val x = List.range(1, 10)
```

you can pass an anonymous function to x's filter method to create a new List that contains only even numbers:

```
val evens = x.filter((i: Int) => i % 2 == 0)
```

The REPL demonstrates this:

```
scala> val evens = x.filter((i: Int) => i % 2 == 0)
evens: List[Int] = List(2, 4, 6, 8)
```

In that example, this portion of the code is known as an anonymous function:

```
(i: Int) => i % 2 == 0
```

This is the most explicit form for defining a function literal in Scala. Thanks to several shortcuts that I'll describe soon, the original solution can be made this concise, if you prefer:

```
val evens = x.filter(_ % 2 == 0)
```

The REPL shows that this yields the same result as the previous code:

```
scala> val evens = x.filter(_ % 2 == 0)
evens: List[Int] = List(2, 4, 6, 8)
```

## Reducing anonymous functions

In the example shown, this code is the original function literal:

```
(i: Int) => i % 2 == 0
```

When reading this code it helps to think of the `=>` symbol as a *transformer*, because the expression transforms the parameter list on the left side of the symbol (an `Int` named `i`):

```
(i: Int) => i % 2 == 0  
-----
```

into a new result using the algorithm on the right side of the symbol (in this case, an expression that results in a `Boolean`):

```
(i: Int) => i % 2 == 0  
-----
```

As mentioned, this example shows the long form for defining an anonymous function, which can be simplified in several different ways. Once again, here's the most explicit form:

```
val evens = x.filter((i: Int) => i % 2 == 0)
```

Because the Scala compiler knows that `x` is a `List[Int]` it can infer `i`'s type, and the `Int` declaration can be dropped off:

```
val evens = x.filter(i => i % 2 == 0)
```

Because Scala lets you use the `_` wildcard character instead of a variable name when the parameter appears only once in the function, this code can be simplified even more:

```
val evens = x.filter(_ % 2 == 0)
```

In other situations you can simplify your anonymous functions further. For instance, here's the explicit form for an anonymous function that prints each element in a `List`:

```
x.foreach((i: Int) => println(i))
```

As before, the `Int` declaration isn't required:

```
x.foreach((i) => println(i))
```

Because there's only one argument, the parentheses around the `i` parameter aren't needed:

```
x.foreach(i => println(i))
```

Because `i` is used only once in the function body, the expression can be further simplified with the `_` wildcard:

```
x.foreach(println(_))
```

Finally, if a function literal consists of one statement that takes a single argument, you don't need to explicitly name and specify the argument, so the statement can be reduced to just this:

```
x.foreach(println)
```

## Recognizing anonymous functions in complex code

I find that reading small anonymous functions isn't too hard, but when they span multiple lines and are used with code I haven't seen before, sometimes they can take a few moments to recognize.

Eventually I discovered the technique shown in Figure [fig:idComplexAnonFunctions] to identify complex anonymous functions.

```
scala> import gigahorse._
scala> import scala.concurrent._, duration._
scala> Gigahorse.withHttp(Gigahorse.config) { http =>
  val r = Gigahorse.url("http://api.duckduckgo.com").get.
    addQueryString(
      "q" -> "1 + 1",
      "format" -> "json"
    )
  val f = http.run(r, Gigahorse.asString andThen {_.take(60)})
  Await.result(f, 120.seconds)
}
```

1) Whenever you see this pattern, think "an anonymous function follows."

2) see that "http" is referenced here

How to recognize an anonymous function in complex code.

As that image shows, when you see an opening curly brace followed by a new variable name and the transformer symbol:

```
{ http =>
```

you should recognize that this is the beginning of an anonymous function.

In this code the anonymous function takes one parameter which is named `http`. When you see this pattern you can assume that the parameter will be used in the block of code that follows it. In this example, the `http` parameter is eventually used in the sixth line of the anonymous function.

### *The pattern is the same in simple examples*

While that code is complicated, it follows the same pattern as the examples I showed before. For instance, this example:

```
x.foreach((i) => println(i))
```

can be rewritten in a multi-line form, like this:

```
x.foreach { i =>
  println(i)
}
```

Again, as soon as you see this pattern:

```
{ i =>
```

you know:

- “Something” is being passed from `x.foreach` into the block of code that follows
- That something is represented by the new variable named `i`
- Because (a) `x` is a `List[Int]`, and (b) `foreach` iterates over each element in the list — passing one element at a time to the function inside the curly braces — you know that `i` is an `Int`

If the code you’re reading is confusing, you can also learn that by inspecting `i` in your IDE. Or, if it’s your code, you can also declare `i`’s type like this, if you prefer:

```
x.foreach { i: Int =>
  println(i)
}
```

In any case, you know that `i` represents an element that’s being passed by `foreach` into the anonymous function that follows.

In the same way, you can know that in the code shown in Figure [fig:httpIsAParam], `http` is a parameter that’s being passed by the `withHttp` function of the `Gigahorse` object.

```
scala> import gigahorse._
scala> import scala.concurrent._, duration._
scala> Gigahorse.withHttp(Gigahorse.config) { http =>
  val r = Gigahorse.url("http://api.duckduckgo.com").get.
    addQueryString(
      "q" -> "1 + 1",
      "format" -> "json"
    )
  val f = http.run(r, Gigahorse.asString andThen {_.take(60)})
  Await.result(f, 120.seconds)
}
```

1) Whenever you see this pattern, think "an anonymous function follows."

2) see that "http" is referenced here

http is a parameter that's passed into an anonymous function.

### ***The general pattern***

More generally, this anonymous function "pattern recognition" process looks like Figure [fig:anonFunctionPatternRecognition].

```
1) this function
└─┬─
   │
   ▼
foo.bar(yada) { baz =>
    // some code here
    // more code here
    val fooz = someFunction(baz)
    // more code here
}
```

```
2) passes this parameter
   └─┬─
      │
      ▼
foo.bar(yada) { baz =>
    // some code here
    // more code here
    val fooz = someFunction(baz)
    // more code here
}
```

```
foo.bar(yada) { baz =>
    // some code here
    // more code here
    val fooz = someFunction(baz)
    // more code here
}
3) into this code block
┌───┐
```

The general process of how to recognize anonymous functions in complex code.

## Passing multiple parameters to an anonymous function

Scala code can also pass multiple parameters to anonymous functions. You can demonstrate this with a Map:

```
// create a Map
val map = Map(
  1 -> 10,
  2 -> 20,
  3 -> 30
)

// an anonymous function that takes two parameters
val newMap = map.transform((k,v) => k + v)
```

In that last line of code, each Map key/value pair is passed to the anonymous function  $k + v$ . As before, you can rewrite that code in a multi-line format to look like the `http` example:

```
val newMap = map.transform { (k,v) =>
  k + v
}
```

No matter how you write it, the Scala REPL shows the result of using  $k + v$  with `transform`:

```
scala> val newMap = map.transform((k,v) => k + v)
newMap: scala.collection.immutable.Map[Int,Int] = Map(1 -> 11, 2 -> 22, 3 -> 33)
```

In this example, the `transform` function creates a new value for each key by adding the key and value for each element in the Map.



## See also

- [How to filter a Scala Map \(filterKeys, retain, transform\)](#)
- [How to traverse a Map in Scala \(for loop, foreach\)](#)

# On Using `def` vs `val` To Define Abstract Members in Traits

When I update the [Scala Cookbook](#), I need to update Recipe 8.2, “How to use abstract and concrete fields in Scala traits.” That recipe is written particularly with an OOP developer in mind, and I didn’t write about handling the same situation from an FP perspective.

## Short story: Use def to define fields in your traits

The short story is that if you want to declare an abstract member in a trait, and that member may later be fulfilled by a `def` or `val` field in an implementing class, the most flexible approach is to define the member as a `def` field. The primary benefit of this approach is depicted in Figure [fig:defVsValInTraits], which is a slide from an “Effective Scala” talk given by [Mirco Dotta](#).

*Abstract members*

```
trait Shape {  
  val edges: Int  
}
```

*Why?*

**NO**

```
class Triangle extends Shape {  
  override def edges: Int = 3  
}
```

*Because this doesn't compile!*

Why you shouldn't use `val` to define fields in traits.

I'll expand on this point in this lesson.

# “A `val` can override a `def`, but a `def` cannot override a `val`”

A good way to think about this situation is with a quote from [this Stack Overflow page](#):

“A `val` can override a `def`, but a `def` cannot override a `val`”

## *`val` can override a `def`*

The “`val` can override a `def`” part of that statement is demonstrated with this code:

```
// val can override def
trait SentientBeing {
  def id: Int
}

class Person extends SentientBeing {
  val id = 2
}
```

That code compiles and works as expected.

## *`def` cannot override a `val`*

The “`def` cannot override a `val`” statement can be shown by attempting to write code like this:

```
trait SentientBeing {
  val id: Int
}

class Person extends SentientBeing {
  // won't compile.
  // error: "method `id` needs to be a stable,
  // immutable value"
  def id = 2
}
```

As the comments show, attempting to create code like this results in a compiler error. As the error message implies, using `val` implies a guarantee that the variable is *stable* and *immutable*, and a `def` does not imply that same guarantee. If you make `id` a `var` field in `SentientBeing`, that error message will go away.

(But Scala/FP developers don't use var fields.)

## More motivation to use def in traits

A comment on this [Stack Overflow page](#) makes a few more good points about why you should use a `def` field in a trait:

“A `def` can be implemented by either of a `def`, a `val`, a lazy `val`, or an object. So it’s the most abstract form of defining a member. Since traits are usually abstract interfaces, saying you want a `val` is saying how the implementation should do.”

From the standpoint of writing really meaningful code, the last two sentences in that paragraph are good. They get to the essence of creating a field like this in a trait:

- What is my intent?
- What am I really trying to express about the `id` field in the trait?

I used to program very casually in Java — such as not worrying about marking fields `private` or `final`, etc. — but as I get older (and hopefully wiser), I’ve learned that with Scala you can be very clear about what you’re trying to communicate to yourself and other developers by taking a few moments to think about issues like this. You should be able to say to other developers, “I did that intentionally, and here’s why ...”

## More information

If you want to dig into this topic more, I encourage you to read the links below, and also use the usual tools to examine how the compiler translates your Scala code into bytecode:

- Use `scalac -Xprint:all` when compiling your code
- Disassemble your bytecode with `javac -p`
- Use JAD or a similar tool to decompile your class files to see how the code is implemented in Java

As just a hint of what you'll see, when you compile the `SentientBeing` class when it declares `id` as a `def` field, you'll see this output:

```
abstract trait SentientBeing extends Object {  
    def id(): Int  
}
```

And when you declare it as a `val` field, you'll see this output:

```
abstract trait SentientBeing extends Object {  
    <stable> <accessor> def id(): Int  
}
```

## See also

- Mirco Dotta's [Effective Scala slides](#)
- A Stack Overflow Q&A on [When to use a val or def in traits](#)
- [Choices with def and val in Scala](#)





# FUNCTIONAL PROGRAMMING



A SIMPLE STEP-BY-STEP  
APPROACH TO LEARNING  
FUNCTIONAL PROGRAMMING

# SIMPLIFIED

ALVIN  
ALEXANDER